

MARKS PUBLISHED FOR OPPOSITION

The following marks are published in compliance with section 12(a) of the Trademark Act of 1946. Applications for the registration of marks in more than one class have been filed as provided in section 30 of said act as amended by Public Law 772, 87th Congress, approved Oct. 9, 1962, 76 Stat. 769. Opposition under section 13 may be filed within thirty days of the date of this publication. See rules 2.101 to 2.105.

A separate fee of two hundred dollars for opposing each mark in each class must accompany the opposition.

SECTION 1.— INTERNATIONAL CLASSIFICATION

The short titles associated below with the international class numbers are terms designed merely for quick identification and are not an official part of the international classification. The full names of international classes are given in section 6.1 of the trademark rules of practice.

The designation "U.S. Cl." appearing in this section refers to the U.S. class in effect prior to Sep. 1, 1973 rather than the international class which applies to applications filed on or after that date. For adoption of international classification see notice in the OFFICIAL GAZETTE of Jun. 26, 1973 (911 O.G. TM 210).

Application in more than one class

SN 75-817,749. STAGE ENTERTAINMENT, INC., ALOHA, OR. FILED 10-7-1999.



OWNER OF FED REP GERMANY REG. NO. 39859689, DATED 6-14-1999, EXPIRES 10-31-2008.

NO CLAIM IS MADE TO THE EXCLUSIVE RIGHT TO USE "STARS" AND "CONCERT", APART FROM THE MARK AS SHOWN.

THE STIPPLING SHOWN IN THE DRAWING OF THE MARK IS A FEATURE OF THE MARK AND IS NOT INTENDED TO INDICATE COLOR.

CLASS 9—ELECTRICAL AND SCIENTIFIC APPARATUS

FOR PRERECORDED PHONOGRAPH DISCS FEATURING CELEBRITY IMPERSONATIONS, MUSICAL ENTERTAINMENT, BANDS, VOCAL ENTERTAINMENT, CHORAL ENTERTAINMENT, GROUP VOCAL ENTERTAINMENT, SOLO VOCAL ENTERTAINMENT, COMEDY ENTERTAINMENT, POLITICAL COMMENTARY, AND CHOREOGRAPHY; PRERECORDED PHONOGRAPHIC MECHANICALLY GROOVED DISCS FEATURING CELEBRITY IMPERSONATIONS, MUSICAL ENTERTAINMENT, BANDS, VOCAL ENTERTAINMENT, CHORAL ENTERTAINMENT, GROUP VOCAL ENTERTAINMENT, SOLO VOCAL ENTERTAINMENT, COMEDY ENTERTAINMENT, POLITICAL COMMENTARY, AND CHOREOGRAPHY; RECORDING DISCS FEATURING CELEBRITY IMPERSONATIONS, MUSICAL ENTERTAINMENT, BANDS, VOCAL ENTERTAINMENT, CHORAL ENTERTAINMENT, GROUP VOCAL ENTERTAINMENT, SOLO VOCAL ENTERTAINMENT, COMEDY ENTERTAINMENT, POLITICAL COMMENTARY, DANCE, AND CHOREOGRAPHY; TAPE CASSETTES FEATURING CELEBRITY IMPERSONATIONS, MUSICAL ENTERTAINMENT, BANDS, VOCAL ENTERTAINMENT, CHORAL ENTERTAINMENT, GROUP VOCAL ENTERTAINMENT, SOLO VOCAL ENTERTAINMENT, COMEDY ENTERTAINMENT, POLITICAL COMMENTARY, DANCE, AND CHOREOGRAPHY; PHOTOGRAPHIC AND VIDEOGRAPHIC APPARATUS, NAMELY, MACHINES FOR THE TRANSFER OF PHOTOGRAPHIC AND CINEMATOGRAPHIC IMAGES AND IMPERSONATION SERVICES; PRERECORDED SOUND AND IMAGE CARRIERS, NAMELY, VIDEO DISCS, SOUND AND VIDEO CASSETTES AND TAPES, AND PHONOGRAPH

ENTERTAINMENT, BANDS, VOCAL ENTERTAINMENT, CHORAL ENTERTAINMENT, GROUP VOCAL ENTERTAINMENT, SOLO VOCAL ENTERTAINMENT, COMEDY ENTERTAINMENT, POLITICAL COMMENTARY, DANCE, AND CHOREOGRAPHY; PHONOGRAPH RECORDS FEATURING CELEBRITY IMPERSONATIONS, MUSICAL ENTERTAINMENT, BANDS, VOCAL ENTERTAINMENT, CHORAL ENTERTAINMENT, GROUP VOCAL ENTERTAINMENT, SOLO VOCAL ENTERTAINMENT, COMEDY ENTERTAINMENT, POLITICAL COMMENTARY, AND CHOREOGRAPHY; BLANK AUDIO TAPES; VIDEO TAPES FEATURING CELEBRITY IMPERSONATIONS, MUSICAL ENTERTAINMENT, BANDS, VOCAL ENTERTAINMENT, CHORAL ENTERTAINMENT, GROUP VOCAL ENTERTAINMENT, SOLO VOCAL ENTERTAINMENT, COMEDY ENTERTAINMENT, POLITICAL COMMENTARY, DANCE, AND CHOREOGRAPHY; BLANK AUDIO CASSETTES; BLANK VIDEO CASSETTES; PRE-RECORDED VIDEO TAPES FEATURING CELEBRITY IMPERSONATIONS, MUSICAL ENTERTAINMENT, BANDS, VOCAL ENTERTAINMENT, CHORAL ENTERTAINMENT, GROUP VOCAL ENTERTAINMENT, SOLO VOCAL ENTERTAINMENT, COMEDY ENTERTAINMENT, POLITICAL COMMENTARY, DANCE, AND CHOREOGRAPHY; VIDEO DISCS, LASER DISCS, AND SOUND AND VIDEO RECORDINGS, ALL IN THE FORM OF DAT TAPES, DAT CASSETTES, RECORDS, DISCS, OR TAPES, ALL IN THE FIELD OF MUSICAL, VOCAL AND THEATRICAL ENTERTAINMENT; COMPACT DISCS, NAMELY, COMPACT DISCS WITH READ-ONLY MEMORIES (CD-ROMS), ALL IN THE FIELD OF MUSICAL, VOCAL, AND THEATRICAL ENTERTAINMENT; CINEMATOGRAPHIC FILMS; MOTION PICTURE AND SOUND FILMS AND SILENT FILMS ABOUT CELEBRITY IMPERSONATIONS, MUSICAL ENTERTAINMENT, BANDS, VOCAL ENTERTAINMENT, CHORAL ENTERTAINMENT, GROUP VOCAL ENTERTAINMENT, SOLO VOCAL ENTERTAINMENT, COMEDY ENTERTAINMENT, POLITICAL COMMENTARY, DANCE, AND CHOREOGRAPHY; PHOTOGRAPHIC AND VIDEOGRAPHIC APPARATUS, NAMELY, MACHINES FOR THE TRANSFER OF PHOTOGRAPHIC AND CINEMATOGRAPHIC IMAGES AND IMPERSONATION SERVICES; PRERECORDED SOUND AND IMAGE CARRIERS, NAMELY, VIDEO DISCS, SOUND AND VIDEO CASSETTES AND TAPES, AND PHONOGRAPH

RECORDS IN THE AREA OF CELEBRITY IMPERSONATIONS; PHOTOGRAPHIC SLIDE TRANSPARENCIES (U.S. CLS. 21, 23, 26, 36 AND 38).

CLASS 16—PAPER GOODS AND PRINTED MATTER

FOR PHOTOGRAPHIC MATTER, NAMELY, PHOTOGRAPHIC ALBUMS OR MOUNTS, RELATING TO CELEBRITY IMPERSONATIONS, MUSICAL ENTERTAINMENT, BANDS, VOCAL ENTERTAINMENT, CHORAL ENTERTAINMENT, GROUP VOCAL ENTERTAINMENT, SOLO VOCAL ENTERTAINMENT, COMEDY ENTERTAINMENT, POLITICAL COMMENTARY, DANCE, AND CHOREOGRAPHY; PRINTED MATTER, NAMELY, POSTERS AND BROCHURES RELATING TO CELEBRITY IMPERSONATION; PRINTED PUBLICATIONS, NAMELY, CATALOGUES, JOURNALS, ADVERTISING PUBLICATIONS; PRINTED MATTER RELATING TO CELEBRITY IMPERSONATION, MUSICAL ENTERTAINMENT, BANDS, VOCAL ENTERTAINMENT, CHORAL ENTERTAINMENT, GROUP VOCAL ENTERTAINMENT, SOLO VOCAL ENTERTAINMENT, COMEDY ENTERTAINMENT, POLITICAL COMMENTARY, DANCE AND CHOREOGRAPHY IN THE FORM OF BROCHURES, PAMPHLETS, PROGRAMS, PLAYBILLS, MAGAZINES, MONTHLY MAGAZINES, PERIODICALS, PERIODICAL PUBLICATIONS, PRINTED PERIODICAL PUBLICATIONS, NEWSPAPERS, AND BOOKS AND MAGAZINES IN THE FIELD OF ENTERTAINMENT SERVICES, NAMELY, IN THE FIELD OF CELEBRITY IMPERSONATION; MONTHLY MAGAZINES IN THE FIELD OF ENTERTAINMENT SERVICES, NAMELY, IN THE FIELD OF CELEBRITY IMPERSONATION; PERIODICALS IN THE FIELD OF ENTERTAINMENT SERVICES, NAMELY, IN THE FIELD OF CELEBRITY IMPERSONATION; PERIODICAL PUBLICATIONS IN THE FIELD OF ENTERTAINMENT SERVICES, NAMELY, IN THE FIELD OF CELEBRITY IMPERSONATION; PERIODICAL PUBLICATIONS IN THE FIELD OF ENTERTAINMENT SERVICES, NAMELY, IN THE FIELD OF CELEBRITY IMPERSONATION; PRINTED PERIODICAL PUBLICATIONS IN THE FIELD OF ENTERTAINMENT SERVICES, NAMELY, IN THE FIELD OF CELEBRITY IMPERSONATION; NEWSPAPERS AND BOOKS IN THE FIELD OF IMPERSONATIONS; PHOTOGRAPHS, NAMELY, MOUNTED AND UNMOUNTED PHOTOGRAPHS; CARTOONS; PRINTED TEACHING MATERIALS, NAMELY, BROCHURES AND PAMPHLETS IN THE AREA OF ENTERTAINMENT SERVICES, NAMELY, IN THE FIELD OF CELEBRITY IMPERSONATION; MANUALS IN THE FIELD OF IMPERSONATIONS, ALL OF THE AFOREMENTIONED GOODS BOUND IN BULK SHEET OR HARDCOPY VERSIONS; TRADING CARDS; PICTURE POSTCARDS; GREETING CARDS; BEER COASTERS MADE OF PAPER; MAPS; CALENDARS; RUBBER ADDRESS STAMPS; DOCUMENT FILES; FILE COVERS (U.S. CLS. 2, 5, 22, 23, 29, 37, 38 AND 50).

CLASS 41—EDUCATION AND ENTERTAINMENT

FOR ENTERTAINMENT SERVICES, NAMELY, PRODUCTION OF STAGE SHOWS; ENTERTAINMENT SERVICES, NAMELY, PRODUCTION OF STAGE SHOWS RELATING TO CELEBRITY IMPERSONATION; PRODUCTION AND ORGANIZATION OF SHOWS, NAMELY, THEATRICAL AND VARIETY SHOWS, FILMS, TELEVISION, SONG AND DANCE; ENTERTAINMENT, NAMELY, LIVE PERFORMANCES BY A MUSICAL BAND; LIVE MUSICAL AND CHORAL ENTERTAINMENT AND SHOWS FOR OTHERS; LIVE ENTERTAINMENT SERVICES WITH MUSICAL AND VOCAL PRESENTATIONS AND SHOWS; TELEVISION SHOW PRODUCTION; ENTERTAINMENT IN THE NATURE OF THEATER PRODUCTIONS; MOTION PICTURE FILM PRODUCTION; RADIO ENTERTAINMENT PRODUCTION; PRODUCTION OF VIDEO CASSETTES AND VIDEO DISCS FOR OTHERS; ENTERTAINMENT SERVICES, NAMELY, MUSICAL AND CHORAL ENTERTAINMENT FEATURING CELEBRITY IMPERSONATIONS, MUSICAL ENTERTAINMENT, BANDS, VOCAL ENTERTAINMENT, CHORAL ENTERTAINMENT, GROUP VOCAL ENTERTAINMENT, SOLO VOCAL ENTERTAINMENT, COMEDY ENTERTAINMENT, POLITICAL COMMENTARY, DANCE, AND CHOREOGRAPHY; PROVIDING EDUCATIONAL SERVICES, NAMELY, PROVIDING CLASSES, SEMINARS,

WORKSHOPS IN THE FIELD OF CELEBRITY IMPERSONATIONS, THEATRICAL AND VARIETY SHOWS, SONG AND DANCE, AND LIVE MUSICAL ENTERTAINMENT; ENTERTAINMENT SERVICES IN THE FIELD OF IMPERSONATIONS; PRODUCTION OF FILMS, CINEMA AND TELEVISION; PRODUCTION OF RADIO, TELEVISION PROGRAMS, AND VIDEO PROGRAMS; CABARET AND NIGHTCLUB SERVICES RENDERED BY VOCAL GROUPS AND/OR INSTRUMENTAL GROUPS; CABARET AND NIGHTCLUB SERVICES RENDERED BY VOCAL GROUPS AND/OR INSTRUMENTAL GROUPS, NAMELY, CELEBRITY IMPERSONATORS (U.S. CLS. 100, 101 AND 107).

INGA ERVIN, EXAMINING ATTORNEY

SN 75-857,048. COGENESYS, INC., ROCKVILLE, MD. FILED 11-24-1999.

COGENESYS

THE MARK CONSISTS OF STANDARD CHARACTERS WITHOUT CLAIM TO ANY PARTICULAR FONT, STYLE, SIZE, OR COLOR.

CLASS 16—PAPER GOODS AND PRINTED MATTER

FOR PRINTED MATTER, NAMELY, BROCHURES, MANUALS AND WORKBOOKS IN THE FIELDS OF BIOINFORMATICS AND PHARMACEUTICAL RESEARCH AND DEVELOPMENT (U.S. CLS. 2, 5, 22, 23, 29, 37, 38 AND 50).

CLASS 42—SCIENTIFIC AND COMPUTER SERVICES

FOR INFORMATION SERVICES, NAMELY, PROVIDING SCIENTIFIC INFORMATION IN THE AREA OF BIOINFORMATICS AND PHARMACEUTICAL RESEARCH AND DEVELOPMENT; INSTALLATION, MAINTENANCE AND UPGRADE SERVICES FOR COMPUTER SOFTWARE IN THE FIELD OF BIOINFORMATICS AND PHARMACEUTICAL RESEARCH AND DEVELOPMENT; SCIENTIFIC RESEARCH INFORMATION SERVICES (U.S. CLS. 100 AND 101).

DAVID MURRAY, EXAMINING ATTORNEY

SN 76-072,215. BRIAN LAVIOLETTE SCHOLARSHIP FOUNDATION, INC., THE, ONEIDA, WI. FILED 6-19-2000.

THE JOURNEY IS THE REWARD

CLASS 16—PAPER GOODS AND PRINTED MATTER

FOR PRINTED INSTRUCTIONAL, EDUCATIONAL, AND TEACHING MATERIALS FOR MOTIVATIONAL AND PERSONAL DEVELOPMENT PURPOSES; STATIONERY; DESK ACCESSORIES, NAMELY, DESK PADS, DESK CALENDARS, PEN/PENCIL HOLDERS, PAPER HOLDERS, AND PAPER DISPENSERS (U.S. CLS. 2, 5, 22, 23, 29, 37, 38 AND 50).

CLASS 18—LEATHER GOODS

FOR LEATHER GOODS, NAMELY, KEY CHAINS, ATTACHE' CASES, AND CARRYON BAGS (U.S. CLS. 1, 2, 3, 22 AND 41).

CLASS 20—FURNITURE AND ARTICLES NOT OTHERWISE CLASSIFIED

FOR PICTURE FRAMES; NON-METAL KEY CHAINS (U.S. CLS. 2, 13, 22, 25, 32 AND 50).

CLASS 41—EDUCATION AND ENTERTAINMENT

FOR TRAINING AND EDUCATIONAL SERVICES, NAMELY, CONDUCTING SEMINARS AND TRAINING COURSES IN THE FIELD OF PERSONAL MOTIVATION AND DEVELOPMENT, SUCH TRAINING AND EDUCATIONAL SERVICES TO BE PROVIDED EITHER LIVE, BY TAPE, COMPACT DISC, OR VIDEO (U.S. CLS. 100, 101 AND 107).

PAM WILLIS, EXAMINING ATTORNEY

SN 76-184,490. MEDIACORP NEWS PTE LTD, ANDREW ROAD, SINGAPORE, FILED 12-20-2000.



OWNER OF SINGAPORE REG. NO. T00/06346E, DATED 4-15-2000, EXPIRES 4-15-2010.

OWNER OF SINGAPORE REG. NO. T00/06345G, DATED 4-15-2005, EXPIRES 4-15-2010.

OWNER OF SINGAPORE REG. NO. T00/06344I, DATED 4-15-2000, EXPIRES 4-15-2010.

OWNER OF SINGAPORE REG. NO. T00/06343J, DATED 4-15-2000, EXPIRES 4-15-2010.

OWNER OF SINGAPORE REG. NO. T00/06342B, DATED 4-15-2000, EXPIRES 4-15-2010.

NO CLAIM IS MADE TO THE EXCLUSIVE RIGHT TO USE "CHANNEL", APART FROM THE MARK AS SHOWN. COLOR IS NOT CLAIMED AS A FEATURE OF THE MARK.

SEC. 2(F) AS TO "NEWSASIA".

CLASS 35—ADVERTISING AND BUSINESS

FOR (BASED ON USE IN COMMERCE) AND (BASED ON 44(E)) UPDATING OF ADVERTISING MATERIAL; DISSEMINATION OF ADVERTISING MATTER; RENTAL OF ADVERTISING SPACE; BUSINESS INFORMATION, NAMELY, ECONOMIC, INDUSTRY, PROPERTY, POLITICO-SOCIO, MARKETING AND DEMOGRAPHIC DATA, NEWS AND REPORTS; COMMERCIAL INFORMATION AGENCIES; PUBLICATION OF PUBLICITY TEXTS; PROVIDING TELEVISION ADVERTISING FOR OTHERS; AND PRODUCTION OF TELEVISION COMMERCIALS; (BASED ON 44(E)) BUSINESS MANAGEMENT OF PERFORMING ARTISTS (U.S. CLS. 100, 101 AND 102).

FIRST USE 3-1-1999; IN COMMERCE 0-0-1999.

CLASS 36—INSURANCE AND FINANCIAL

FOR (BASED ON USE IN COMMERCE) AND (BASED ON 44(E)) PROVISION OF FINANCIAL INFORMATION, NAMELY, INFORMATION RELATED TO STOCK EXCHANGE PRICES AND FINANCIAL PRODUCTS, SERVICES AND INDUSTRY, AND INVESTMENT ADVICE; (BASED ON 44(E)) REAL PROPERTY VALUATION AND APPRAISAL (U.S. CLS. 100, 101 AND 102).

FIRST USE 3-1-1999; IN COMMERCE 0-0-1999.

CLASS 38—COMMUNICATION

FOR (BASED ON USE IN COMMERCE) AND (BASED ON 44(E)) COMMUNICATIONS BY COMPUTER TERMINALS; COMPUTER AIDED TRANSMISSION OF MESSAGES AND IMAGES; ELECTRONIC MAIL SERVICES; PROVIDING INFORMATION IN THE FIELDS OF BROADCASTING AND TELECOMMUNICATIONS; NEWS AGENCIES, NAMELY, THE TRANSMISSION OF NEWS ITEMS TO NEWS REPORTING ORGANIZATIONS; RENTAL OF TELECOMMUNICATIONS EQUIPMENT AND MESSAGE SENDING EQUIPMENT; SATELLITE TRANSMISSION; AND TELEVISION BROADCASTING (U.S. CLS. 100, 101 AND 104).

FIRST USE 3-1-1999; IN COMMERCE 0-0-1999.

CLASS 41—EDUCATION AND ENTERTAINMENT

FOR (BASED ON USE IN COMMERCE) AND (BASED ON 44(E)) DUBBING; FILM EDITING AND/OR VIDEO EDITING; RECORDING STUDIO SERVICES; PRODUCTION OF TELEVISION PROGRAMS; ENTERTAINMENT SERVICES, NAMELY, VARIETY, NEWS, CURRENT AFFAIRS, LIFESTYLE, RECREATIONAL, INFO-ENTERTAINMENT AND DOCUMENTARY PROGRAMS, SHOWS AND PRODUCTIONS PERFORMED, PRESENTED, DISTRIBUTED AND DISSEMINATED OVER TELEVISION, SATELLITE, AUDIO AND AUDIO-VISUAL MEDIA; ENTERTAINMENT SERVICES, NAMELY, TELEVISION NEWS SHOWS; AND PRODUCTION OF DOCUMENTARY PROGRAMS, SHOWS AND PRODUCTIONS PERFORMED, PRESENTED, DISTRIBUTED AND DISSEMINATED OVER TELEVISION, SATELLITE, AUDIO AND AUDIO-VISUAL MEDIA; FILM REPORTING, NAMELY, PROVIDING ONLINE REVIEWS OF MOVIES; (BASED ON 44(E)) FILM PRODUCTION; MOVIE STUDIOS; PRODUCTION OF RADIO PROGRAMS; LIVE PERFORMANCES BY A MUSICAL BAND (U.S. CLS. 100, 101 AND 107).

FIRST USE 3-1-1999; IN COMMERCE 0-0-1999.

CLASS 42—SCIENTIFIC AND COMPUTER SERVICES

FOR (BASED ON USE IN COMMERCE) AND (BASED ON 44(E)) NEWS AGENCIES, NAMELY, GATHERING AND DISSEMINATION OF NEWS; NEWS REPORTING SERVICES (U.S. CLS. 100 AND 101).

FIRST USE 3-1-1999; IN COMMERCE 0-0-1999.

JENNIFER MARTIN, EXAMINING ATTORNEY

SN 76-185,576. INFECTIO RECHERCHE INC., QUEBEC, CANADA, FILED 12-21-2000.

GEALTH PREVENTION

THE MARK CONSISTS OF STANDARD CHARACTERS WITHOUT CLAIM TO ANY PARTICULAR FONT, STYLE, SIZE, OR COLOR.

PRIORITY CLAIMED UNDER SEC. 44(D) ON CANADA APPLICATION NO. 1077628, FILED 10-5-2000, REG. NO. TMA704,000, DATED 1-7-2008, EXPIRES 1-7-2023.

NO CLAIM IS MADE TO THE EXCLUSIVE RIGHT TO USE "PREVENTION", APART FROM THE MARK AS SHOWN.

CLASS 5—PHARMACEUTICALS

FOR PREPARATIONS FOR MEDICAL USE, NAMELY, TOPICAL GELS FOR PROTECTION AGAINST SEXUALLY TRANSMITTED DISEASES (U.S. CLS. 6, 18, 44, 46, 51 AND 52).

CLASS 35—ADVERTISING AND BUSINESS

FOR WHOLESALE DISTRIBUTORSHIPS FEATURING PREPARATIONS, NAMELY, GELS, USED FOR PROTECTION AGAINST SEXUALLY TRANSMITTED DISEASES (U.S. CLS. 100, 101 AND 102).

CLASS 42—SCIENTIFIC AND COMPUTER SERVICES

FOR PRODUCT RESEARCH AND DEVELOPMENT OF PREPARATIONS, NAMELY GELS, USED FOR PROTECTION AGAINST SEXUALLY TRANSMITTED DISEASES (U.S. CLS. 100 AND 101).

FRED MANDIR, EXAMINING ATTORNEY

SN 76-189,010. INFECTIO RECHERCHE INC., QUEBEC, CANADA, FILED 1-3-2001.



PRIORITY CLAIMED UNDER SEC. 44(D) ON CANADA APPLICATION NO. 1077629, FILED 10-5-2000, REG. NO. TMA703,999, DATED 1-7-2008, EXPIRES 1-7-2023.

NO CLAIM IS MADE TO THE EXCLUSIVE RIGHT TO USE "PREVENTION", APART FROM THE MARK AS SHOWN.

COLOR IS NOT CLAIMED AS A FEATURE OF THE MARK.

CLASS 5—PHARMACEUTICALS

FOR PREPARATIONS FOR MEDICAL USE, NAMELY, TOPICAL GELS FOR PROTECTION AGAINST SEXUALLY TRANSMITTED DISEASES (U.S. CLS. 6, 18, 44, 46, 51 AND 52).

CLASS 35—ADVERTISING AND BUSINESS

FOR WHOLESALE DISTRIBUTORSHIPS FEATURING PREPARATIONS, NAMELY, GELS, USED FOR PROTECTION AGAINST SEXUALLY TRANSMITTED DISEASES (U.S. CLS. 100, 101 AND 102).

CLASS 42—SCIENTIFIC AND COMPUTER SERVICES

FOR PRODUCT RESEARCH AND DEVELOPMENT OF PREPARATIONS, NAMELY GELS, USED FOR PROTECTION AGAINST SEXUALLY TRANSMITTED DISEASES (U.S. CLS. 100 AND 101).

FRED MANDIR, EXAMINING ATTORNEY

SN 76-292,573. STRIDE TOOL, INC., ELLICOTTVILLE, NY, FILED 7-31-2001.

IMPERIAL

OWNER OF U.S. REG. NO. 336,012.

CLASS 6—METAL GOODS

FOR METAL COUPLINGS FOR USE WITH HIGH PRESSURE HOSES; AND METAL FITTINGS FOR CONNECTING REFRIGERATION SERVICES HOSES TO ACCESS VALVES; MANIFOLD REPAIR KITS FOR REFRIGERATION AND AIR CONDITIONING SYSTEMS COMPRISED OF METAL VALVE HANDLES, METAL SPRINGS, METAL VALVE STEMS, AND METAL WASHERS SOLD TOGETHER AS KITS (U.S. CLS. 2, 12, 13, 14, 23, 25 AND 50).

FIRST USE 2-20-1905; IN COMMERCE 2-20-1905.

CLASS 7—MACHINERY

FOR PRE-ASSEMBLED SERVICE MANIFOLDS FOR SERVICING REFRIGERATION AND AIR CONDITIONING UNITS, NAMELY, CHARGING MANIFOLDS FOR REFRIGERATION UNITS; COOLANT CHARGING UNITS, NAMELY, REFRIGERANT MANIFOLDS FOR REFRIGERATORS AND AIR CONDITIONERS (U.S. CLS. 13, 19, 21, 23, 31, 34 AND 35).

FIRST USE 2-20-1905; IN COMMERCE 2-20-1905.

CLASS 8—HAND TOOLS

FOR MANUALLY OPERATED PIPE AND TUBE WORKING TOOLS, NAMELY, TUBE BENDERS, FLARING TOOLS, SWAGING TOOLS, SHEARS, REAMERS, DEBURRERS, AND PIPE AND TUBE CUTTERS; MANUALLY-OPERATED RATCHET WRENCHES FOR TUBE FITTINGS AND FASTENERS; MANUALLY-OPERATED PINCH OFF TOOLS FOR USE IN CLOSING OR PINCHING-OFF TUBING; AND HAND OPERATED WIRE CUTTERS, CRIMPERS AND STRIPPERS (U.S. CLS. 23, 28 AND 44).

FIRST USE 2-20-1905; IN COMMERCE 2-20-1905.

CLASS 9—ELECTRICAL AND SCIENTIFIC APPARATUS

FOR PRESSURE GAUGES; AND PRESSURE TESTING UNITS FOR AIR CONDITIONERS AND REFRIGERATORS; TUBING TEST PLUGS (U.S. CLS. 21, 23, 26, 36 AND 38).

FIRST USE 2-20-1905; IN COMMERCE 2-20-1905.

CLASS 11—ENVIRONMENTAL CONTROL APPARATUS

FOR AIR CONDITIONER PIERCING AND SHUT OFF VALVES (U.S. CLS. 13, 21, 23, 31 AND 34).

FIRST USE 2-20-1905; IN COMMERCE 2-20-1905.

CLASS 17—RUBBER GOODS

FOR NON-METAL HOSES FOR USE IN THE AIR CONDITIONING AND REFRIGERATION SERVICE INDUSTRIES (U.S. CLS. 1, 5, 12, 13, 35 AND 50).

FIRST USE 2-20-1905; IN COMMERCE 2-20-1905.

COLLEEN DOMBROW, EXAMINING ATTORNEY

SN 76-392,257. KABUSHIKI KAISHA SONY COMPUTER ENTERTAINMENT, TA SONY COMPUTER ENTERTAINMENT INC., MINATO-KU, TOKYO 107-0052, JAPAN, FILED 4-8-2002.

OWNER OF JAPAN REG. NO. 4781295, DATED 6-25-2004, EXPIRES 6-25-2014.

CLASS 9—ELECTRICAL AND SCIENTIFIC APPARATUS

FOR MOUSE PADS FOR COMPUTERS; MOUSE FOR COMPUTERS; ELECTRONIC CIRCUITS, BLANK MAGNETIC DISCS AND BLANK MAGNETIC TAPES FOR ENCODING COMPUTER PROGRAMS FOR ENCRYPTING OR DECRYPTING INFORMATION DATA; ENCRYPTING AND MICRO PROGRAMMING DEVICES FOR INFORMATION PROCESSING MACHINES, NAMELY, ELECTRONIC CIRCUITS; STRAPS FOR CELLULAR PHONES; INSTANT CAMERAS WITH FILMS; VIDEO OUTPUT GAME MACHINES FOR USE WITH TELEVISIONS; SLOT MACHINES; DOWNLOADABLE COMPUTER PROGRAMS FOR PLAYING COMPUTER GAMES; DOWNLOADABLE ELECTRONIC PUBLICATIONS IN THE NATURE OF BOOKS, MAGAZINES AND MANUALS FEATURING COMPUTER GAMES AND VIDEO GAMES; DOWNLOADABLE VIDEO GAME SOFTWARE; ELECTRONIC CIRCUITS AND BLANK MAGNETIC DISCS, MAGNETIC TAPES, OPTICAL DISCS, CD-ROM, MAGNETIC CARDS AND OTHER MEMORY MEDIA ENCODING ASSEMBLERS AND COMPUTER PROGRAMS; COMPILERS, AND COMPUTER PROGRAMS FOR SOFTWARE DEVELOPMENT AND COMPUTER PROGRAMMING, ENCRYPTION DEVICES, NAMELY, MODEM USED FOR SCRAMBLING IN TELECOMMUNICATION; ELECTRONIC CIRCUITS AND BLANK MAGNETIC DISCS, OPTICAL DISCS, MAGNETIC OPTICAL DISCS, CD-ROM, MAGNETIC TAPES AND DIGITAL VERSATILE DISC ROMS FOR ENCODING VIDEO GAME PROGRAMS FOR PERSONAL USE; ELECTRONIC CIRCUITS AND BLANK MAGNETIC DISCS, OPTICAL DISCS, MAGNETIC OPTICAL DISCS, CD-ROMS, MAGNETIC TAPES AND DIGITAL VERSATILE DISC ROMS FOR ENCODING VIDEO GAME PROGRAMS FOR BUSINESS USE, CONTROLLERS, JOYSTICKS, MEMORY CARDS, VOLUME CONTROLLERS, MOUSE AND OTHER PARTS AND ACCESSORIES, NAMELY, CABLES AND MULTITAPS FOR VIDEO GAMES WITH TELEVISION FOR PERSONAL USE; BLANK MAGNETIC DISCS, OPTICAL DISCS, MAGNETIC OPTICAL DISCS, CD-ROMS, MAGNETIC TAPES AND DIGITAL VERSATILE DISC ROMS FOR ENCODING MAGAZINES, BOOKS, NEWSPAPERS, MAPS, PICTURES, IMAGES AND LITERAL INFORMATION, APPARATUS AND INSTRUMENTS FOR SCIENTIFIC RESEARCH IN LABORATORIES; ROTARY CONVERTERS, PHASE MODIFIERS; DRY CELLS; WET CELLS; ACCUMULATORS AND BATTERIES; PHOTO VOLTAIC CELLS; ELECTRIC MAGNETIC METERS AND TESTERS, ELECTRIC WIRES; ELECTRIC CABLES, PHOTOGRAPHIC APPARATUS AND INSTRUMENTS, NAMELY, TILTING HEADS FOR CAMERAS, CAMERAS; RANGE FINDERS FOR CAMERAS; TRIPODS FOR CAMERAS, SHUTTERS FOR CAMERAS, BELLOWES FOR CAMERAS, SPOOLS FOR CAMERAS, SLIDE PROJECTORS, SELF-TIMERS FOR CAMERAS, PHOTOGRAPHIC FLASH UNITS FOR CAMERAS, FLASH LAMPS FOR CAMERAS, VIEWFINDERS FOR CAMERAS, LENS FILTERS FOR CAMERAS, LENS HOODS

FOR CAMERAS, FLASH GUNS FOR CAMERAS, FILM MAGAZINES FOR CAMERAS, SHUTTER RELEASES FOR CAMERAS, LENSES FOR PHOTOGRAPHIC APPARATUS, EXPOSURE METERS; CINEMATOGRAPHIC APPARATUS AND INSTRUMENTS, NAMELY, MOVIE, MOVIE FILM PROJECTORS; LIFE NETS; LIFE BELTS; LIFE JACKETS; LIFE-BUOYS; TELEPHONE APPARATUS, NAMELY, INTERCOMS, TELEPHONE APPARATUS, NAMELY, INTERCOMS, FAX MACHINES, AND TELEPHONE ANSWERING MACHINES; MANUAL SWITCH BOXES, MODULAR PHONE CONNECTORS; WIRE COMMUNICATION APPARATUS, NAMELY, TELETYPEWRITERS, AUTOMATIC TELEGRAPH APPARATUS; NAMELY, VIDEO FREQUENCY APPARATUS, NAMELY, VIDEO CAMERAS, NAMELY, VIDEO CAMCORDERS; VIDEODISC PLAYERS, VIDEOTAPE RECORDERS; PARTS AND ACCESSORIES FOR ELECTRIC COMMUNICATION APPARATUS AND INSTRUMENTS, NAMELY, MODEMS; RECORDS CONTAINING MUSIC; LP RECORDS CONTAINING MUSIC, METRONOMES, RECORDED COMPACT DISCS CONTAINING MUSIC; COMPUTERS; ELECTRON MICROSCOPES; ELECTRONIC DESK CALCULATORS; WORD PROCESSORS; X-RAY TUBES, NOT FOR MEDICAL USE; PHOTO-SENSITIVE TUBES; VACUUM TUBES; RECTIFIER TUBES; CATHODE RAY TUBES; DISCHARGE TUBES; THERMISTORS, DIODES; TRANSISTORS; ELECTRON TUBES; SEMICONDUCTOR ELEMENTS; INTEGRATED CIRCUITS; LARGE SCALE INTEGRATED CIRCUITS; ELECTRIC FLATIRONS FOR HOUSEHOLD USE; ELECTRIC HAIR-CURLERS FOR HOUSEHOLD USE; ELECTRIC BUZZERS FOR HOUSEHOLD USE; EXPOSED CINEMATOGRAPHIC FILMS, EXPOSED SLIDE FILMS, PHOTOGRAPHIC SLIDE TRANSPARENCIES; SLIDE FILM MOUNTS; ENCODED VIDEO DISCS AND TAPES CONTAINING PICTURES; VENDING MACHINES; VIDEO GAMES FOR USE WITH TELEVISION FOR PERSONAL USE (U.S. CLS. 21, 23, 26, 36 AND 38).

CLASS 35—ADVERTISING AND BUSINESS

FOR DATA PROCESSING AND INPUT SERVICES; COMPUTERIZED TRACKING AND TRACING OF PACKAGES IN TRANSIT; DATA PROCESSING FOR OTHERS; INPUT OF COMPUTER-AIDED DESIGNING DATA FOR DESIGNING AND DRAWING MACHINES, APPARATUS, AND FACILITIES BY A COMPUTER; DATA INPUT INTO A COMPUTER FILE, DATA INPUT BY A COMPUTER, INPUT INTO MAGNETIC CARDS BY COMPUTER; DATA PROCESSING SERVICES VIA COMPUTER IN THE FIELD OF COMPUTER GAME AND VIDEO GAME SOFTWARE (U.S. CLS. 100, 101 AND 102).

CLASS 41—EDUCATION AND ENTERTAINMENT

FOR PROVIDING ONLINE INFORMATION ABOUT COMPUTER GAMES AND COMPUTER GAME PROGRAMS DESCRIBED IN MAGAZINES, MANUALS, AND PUBLICATIONS; PROVIDING A COMPUTER DATABASE IN THE FIELD OF COMPUTER GAME SOFTWARE AND VIDEO GAME SOFTWARE (U.S. CLS. 100, 101 AND 107).

CLASS 42—SCIENTIFIC AND COMPUTER SERVICES

FOR MAINTENANCE OF SOFTWARE FOR ELECTRONIC MAIL SERVERS FOR OTHERS; DESIGN AND MAINTENANCE OF COMPUTER SOFTWARE FOR INFORMATION PROCESSING SYSTEMS FOR OTHERS; ENCRYPTION OF INFORMATION AVAILABLE ON A COMPUTER; PLANNING, PRODUCING, AND MAINTAINING COMPUTER SYSTEM PROGRAMS FOR OTHERS FOR DATA SECURITY AVAILABLE ON A COMPUTER; DATA ENCRYPTION SERVICES; PROVIDING ELECTRONIC VERIFICATION OF ON-LINE ORDERS OF DIGITAL CONTENT AND GENERATING ELECTRONIC PERMISSION CODES WHICH THEN ALLOW USERS TO ACCESS SAID DIGITAL CONTENT ONLINE; CONDUCTING COMPUTER SEARCHES FOR OTHERS ABOUT NEWS ARTICLES; COMPUTER AIDED GRAPHICS DESIGN; DESIGNING AND PRODUCING COMPUTER GRAPHICS PROGRAMS FOR OTHERS; ESTABLISHING AND MANAGING INTERNET WEB

SITES FOR OTHERS; ESTABLISHING AND MAINTAINING A WEB PAGE FOR OTHERS IN INTERNET COMMUNICATION; PROFESSIONAL CONSULTANCY REGARDING DESIGNING COMPUTER SYSTEMS; DEVELOPING COMPUTER SYSTEMS FOR OTHERS; DEVELOPING VIDEO GAME SOFTWARE FOR OTHERS; PROVIDING ELECTRONIC VERIFICATION OF ELECTRONIC MAIL AND WEB PAGE USERS; DESIGNING PROGRAMS FOR OTHERS FOR VIDEO GAMES WITH TELEVISION FOR PERSONAL USE; WRITING MANUALS FOR OTHERS FOR PROGRAMS FOR VIDEO GAMES WITH TELEVISION FOR PERSONAL USE; PROVIDING INFORMATION ABOUT COMPUTER PROGRAMS AND COMPUTERS; WRITING MANUALS FOR OTHERS FOR COMPUTER PROGRAMS AND COMPUTERS; PROFESSIONAL CONSULTANCY REGARDING COMPUTER PROCESSING; COMPUTER GRAPHIC IMAGE INFORMATION PROCESSING BY COMPUTER; MAKING, PROCESSING, AND EDITING COMPUTER PROGRAMS FOR OTHERS; DESIGNING COMPUTER NETWORKS; PROFESSIONAL CONSULTANCY REGARDING DESIGNING AND STUDYING COMPUTER NETWORKS; RENTAL AND LEASING OF MAGNETIC TAPES FOR ENCODING COMPUTER PROGRAMS FOR COMPUTER SYSTEM SECURITY; RENTAL AND LEASING OF MAGNETIC TAPES FOR ENCODING PROGRAMS FOR VIDEO GAMES FOR USE WITH TELEVISION FOR PERSONAL USE FOR COMPUTER SYSTEM SECURITY; LEASING SERVERS FOR WEB PAGES; RENTAL AND LEASING OF COMPUTERS AND COMPUTER PROGRAMS; HOURLY RENTAL AND LEASING OF COMPUTERS VIA ON-LINE NETWORKS (U.S. CLS. 100 AND 101).

CAROLYN CATALDO, EXAMINING ATTORNEY

SN 76-514,970. JOSEPH DEFUSCO, III, HADDAM, CT. FILED 5-16-2003.

TEAM SOFA KING

NO CLAIM IS MADE TO THE EXCLUSIVE RIGHT TO USE "TEAM" FOR CLASS 41, APART FROM THE MARK AS SHOWN.

CLASS 16—PAPER GOODS AND PRINTED MATTER

FOR STICKERS (U.S. CLS. 2, 5, 22, 23, 29, 37, 38 AND 50).
FIRST USE 5-26-1999; IN COMMERCE 5-26-1999.

CLASS 21—HOUSEWARES AND GLASS

FOR INSULATED SLEEVE HOLDERS FOR BEVERAGE CANS (U.S. CLS. 2, 13, 23, 29, 30, 33, 40 AND 50).
FIRST USE 5-0-2002; IN COMMERCE 5-0-2002.

CLASS 25—CLOTHING

FOR CLOTHING, NAMELY, SHIRTS AND HATS (U.S. CLS. 22 AND 39).
FIRST USE 5-0-2002; IN COMMERCE 5-0-2002.

CLASS 35—ADVERTISING AND BUSINESS

FOR PLACEMENT, ON THE INTERNET, OF ADVERTISING ON BEHALF OF OTHERS FOR PUBLICIZING THEIR LAND, AIR OR WATER VEHICLES (U.S. CLS. 100, 101 AND 102).
FIRST USE 7-0-2002; IN COMMERCE 7-0-2002.

CLASS 41—EDUCATION AND ENTERTAINMENT

FOR ENTERTAINMENT IN THE NATURE OF AUTOMOBILE RACES (U.S. CLS. 100, 101 AND 107).
FIRST USE 6-2-2002; IN COMMERCE 6-2-2002.
JEFFERY COWARD, EXAMINING ATTORNEY

SN 76-537,316. ANDERSON, KENT G, BISMARCK, ND. FILED 8-14-2003.

FUTURE

OWNER OF U.S. REG. NOS. 2,540,936, 2,767,131 AND OTHERS.

CLASS 35—ADVERTISING AND BUSINESS

FOR ADVERTISING SERVICES, NAMELY, THE DISSEMINATION OF ADVERTISING MATERIALS FOR OTHERS VIA THE INTERNET AND ADVERTISING MATERIAL, NAMELY, BROCHURES; PROVIDING TELEVISION AND RADIO ADVERTISING FOR OTHERS; PRODUCTION OF TELEVISION COMMERCIALS; PROMOTING PRODUCTS AND SERVICES OF THIRD PARTIES THROUGH PRODUCT ENDORSEMENTS, NAMELY, PROVIDING CONSUMER PRODUCT INFORMATION VIA THE INTERNET; AUCTIONEERING SERVICES; WHOLESALE AND RETAIL STORE SERVICES, FEATURING, FOOD, BEVERAGES, TOYS, APPLIANCE, FURNITURE, GAMES, PLANTS, SPORTING GOODS, EYE WEAR, KITCHEN WARE, CARDS AND GIFTS, NOVELTIES, CRAFTS, OFFICE AND HOME SUPPLIES, CLOTHING APPAREL, MOVIES, MUSIC AND CONSUMER ELECTRONICS; BUSINESS MANAGEMENT SERVICES; DISTRIBUTORSHIPS IN THE FIELD OF GAMES, TOYS, COMPUTERS, CELL PHONES, FOOD, BEVERAGES, WATER, POP, FRUIT JUICES, NON ALCOHOLIC BEVERAGES, GENERAL MERCHANDISE, CLOTHING, TOOLS, HARDWARE, HEALTH AND BEAUTY PRODUCTS, LUGGAGE, HAND BAGS, AND EYE WEAR (U.S. CLS. 100, 101 AND 102).

CLASS 42—SCIENTIFIC AND COMPUTER SERVICES

FOR ENGINEERING CONSULTATION SERVICES, NAMELY, RENDERING OF DESIGNS, SCHEMATICS, IDEAS, DRAWINGS FOR COMMERCIAL STRUCTURES; COMPUTER SERVICES, NAMELY, PROVIDING SEARCH ENGINES FOR OBTAINING DATA ON A GLOBAL COMPUTER NETWORK; COMPUTER SOFTWARE DESIGN SERVICES FOR OTHERS; CONSUMER PRODUCT SAFETY TESTING; CONSULTATION SERVICES IN THE FIELD OF AUTOMOTIVE DESIGN AND ENGINEERING FOR OTHERS; DESIGN AND TESTING FOR NEW PRODUCT DEVELOPMENT; DESIGN AND TESTING OF NEW PRODUCTS FOR OTHERS; TESTING OR RESEARCH ON ELECTRICITY; ENGINEERING CONSULTATION; SCIENTIFIC RESEARCH; LICENSING OF INTELLECTUAL PROPERTY; COPYRIGHT MANAGEMENT CONSULTATION, COPYRIGHT MANagements; PATENT AGENCY AND INDUSTRIAL PROPERTY CONSULTATION; PATENT LICENSING; DESIGN, CREATION, HOSTING AND MAINTENANCE OF INTERNET SITES FOR THIRD PARTIES; DESIGN CREATION, HOSTING, MAINTENANCE OF WEB SITES FOR OTHERS; HOSTING OF DIGITAL CONTENT ON THE INTERNET; HOSTING THE WEB SITES OF OTHERS ON A COMPUTER SERVER FOR A GLOBAL COMPUTER NETWORK; INDUSTRIAL DESIGN; INTELLECTUAL PROPERTY CONSULTATION; MECHANICAL ENGINEERING; MEDICAL AND SCIENTIFIC RESEARCH, NAMELY, FOR THE PURPOSE OF DEVELOPING NEW PRODUCTS AND DISCOVERING NEW WAYS OF SAVING LIVES; REGISTRATION OF DOMAIN NAMES FOR IDENTIFICATION OF USERS A GLOBAL COMPUTER NETWORK; CONSULTATION SERVICE OF OTHERS IN THE FIELD OF AEROSPACE ENGINEERING; RESEARCH AND DESIGN OF AUTOMOBILES, AIRCRAFT, WATER CRAFT (U.S. CLS. 100 AND 101).

CLASS 43—HOTEL AND RESTAURANT SERVICES

FOR RESTAURANT SERVICES; SELF SERVICE RESTAURANTS, DELICATESSEN SERVICES; CAFES, CARRY-OUT RESTAURANTS, SNACK BARS (U.S. CLS. 100 AND 101).
HOWARD SMIGA, EXAMINING ATTORNEY

SN 76-556,804. THE INSTITUTE FOR THE DEVELOPMENT OF EARTH AWARENESS, NEW YORK, NY. FILED 10-20-2003.

IDEA

CLASS 35—ADVERTISING AND BUSINESS

FOR PROMOTING PUBLIC AWARENESS RELATING TO ANIMAL WELFARE, THE TREATMENT OF ANIMALS, ENCOURAGING THE HUMANE TREATMENT OF ANIMALS; HUMAN ISSUES CONCERNING VIOLENCE, NON-VIOLENCE, DOMESTIC VIOLENCE, PREJUDICES, SLAVERY, EQUALITY, HUNGER, POVERTY, TOLERANCE, NUTRITION AND TOXINS IN FOOD; ENVIRONMENTAL ISSUES, POLLUTION, AGRICULTURAL ISSUES AND POLICIES, GLOBAL WARMING, ENERGY, ALTERNATIVE ENERGY AND TECHNOLOGIES, BUILDING PRACTICES AND METHODOLOGIES, LAND PRESERVATION, DEFORESTATION, FORESTS, SOIL QUALITY, SOIL EROSION, WATER QUALITY, WATER USAGE, AIR QUALITY AND TOXINS (U.S. CLS. 100, 101 AND 102).

FIRST USE 7-0-1989; IN COMMERCE 7-0-1989.

CLASS 41—EDUCATION AND ENTERTAINMENT

FOR CHARITABLE SERVICES, NAMELY, PROVIDING EDUCATIONAL MATERIALS, ENTERTAINMENT AND CULTURAL EVENTS IN THE FIELD OF HUMAN, ANIMAL AND ENVIRONMENTAL ISSUES, AND LAND PRESERVATION; DONATING BOOKS TO LIBRARIES; DEVELOPING CURRICULUM FOR GRADE-SCHOOL AND HIGH-SCHOOL CLASSROOMS; PUBLICATION OF BOOKS, BROCHURES, JOURNALS, LEAFLETS, MAGAZINES, MANUALS, BOOKS FOR THE GENERAL PUBLIC AND TEXTBOOKS; ARRANGING PUBLIC AND PRIVATE EXHIBITIONS; PRODUCTION OF PUBLIC SERVICE ANNOUNCEMENTS RECORDED ON VIDEO CASSETTES, FILMS, CDS AND DVDS; ALL CONCERNING ANIMAL WELFARE, THE TREATMENT OF ANIMALS, ENCOURAGING THE HUMANE TREATMENT OF ANIMALS; HUMAN ISSUES CONCERNING VIOLENCE, NON-VIOLENCE, DOMESTIC VIOLENCE, PREJUDICES, SLAVERY, EQUALITY, HUNGER, POVERTY, TOLERANCE, NUTRITION AND TOXINS IN FOOD; ENVIRONMENTAL ISSUES, POLLUTION, AGRICULTURAL ISSUES AND POLICIES, FOOD AND FOOD ISSUES, GLOBAL WARMING, ENERGY, ALTERNATIVE ENERGY AND TECHNOLOGIES, BUILDING PRACTICES AND METHODOLOGIES, LAND PRESERVATION, DEFORESTATION, FORESTS, SOIL QUALITY, SOIL EROSION, WATER QUALITY, WATER USAGE, AIR QUALITY AND TOXINS (U.S. CLS. 100, 101 AND 107).

FIRST USE 7-0-1989; IN COMMERCE 7-0-1989.

WILLIAM BRECKENFELD, EXAMINING ATTORNEY

SN 76-627,518. MICROBIOLOGICAL AIR SAFETY LABORATORIES, INC., NORRISTOWN, PA. FILED 1-10-2005.



THE MARK CONSISTS OF AN ATOM SYMBOL DESIGN TO THE LEFT OF THE WORD "MASLABS".

CLASS 40—MATERIAL TREATMENT

FOR MOLD REMEDIATION SERVICES; MOLD PREVENTION TREATMENT OF TEXTILES, CLOTHING RUGS AND DRYWALL, NONE OF THE ABOVE SERVICES UTILIZING MASS SPECTROMETRY OR MASS SPECTROSCOPY ANALYSIS (U.S. CLS. 100, 103 AND 106).

FIRST USE 12-1-2003; IN COMMERCE 12-1-2003.

CLASS 42—SCIENTIFIC AND COMPUTER SERVICES

FOR ENVIRONMENTAL TESTING, NAMELY, INDOOR AIR QUALITY TESTING, INSPECTING BUILDINGS FOR THE EXISTENCE OF MOLD, SAMPLING FOR MOLDS BY MEANS OF AIR SAMPLING MACHINES, NONE OF THE ABOVE SERVICES UTILIZING MASS SPECTROMETRY OR MASS SPECTROSCOPY ANALYSIS (U.S. CLS. 100 AND 101).

FIRST USE 12-1-2003; IN COMMERCE 12-1-2003.

DAVID COLLIER, EXAMINING ATTORNEY

SN 76-627,647. GENUINE HEALTH INC., TORONTO, ONTARIO, CANADA, FILED 1-12-2005.

GENUINE BEAUTY

THE MARK CONSISTS OF STANDARD CHARACTERS WITHOUT CLAIM TO ANY PARTICULAR FONT, STYLE, SIZE, OR COLOR.

PRIORITY CLAIMED UNDER SEC. 44(D) ON CANADA APPLICATION NO. 1,235,415, FILED 10-28-2004, REG. NO. 695047, DATED 8-29-2007, EXPIRES 8-29-2022.

CLASS 5—PHARMACEUTICALS

FOR HERBS, VITAMINS, MINERALS AND NUTRITIONAL SUPPLEMENTS, NAMELY, FOOD SUPPLEMENTS PROVIDING A SOURCE OF VITAMINS, MINERALS, ESSENTIAL FATTY ACIDS AND PROBIOTIC CULTURES IN POWDER, LIQUID OR CAPSULE FORM; MEDICINAL HERBS IN POWDER, LIQUID OR CAPSULE FORM FOR THE RELIEF OF THE SYMPTOMS ASSOCIATED WITH MENOPAUSE, PMS, INSOMNIA, ADRENAL FATIGUE, WEAKENED IMMUNE SYSTEMS, AND LIVER STRESS; NUTRITIONAL FOODS, NAMELY, HEALTHY SNACK ENERGY BARS FOR USE AS A MEAL SUBSTITUTE; VITAMINS, MINERAL AND HOMEOPATHIC MEDICINAL SUPPLEMENTS FOR TREATMENT OF THE RELIEF OF THE SYMPTOMS ASSOCIATED WITH MENOPAUSE, PMS, INSOMNIA, ADRENAL FATIGUE, WEAKENED IMMUNE SYSTEMS, AND LIVER STRESS (U.S. CLS. 6, 18, 44, 46, 51 AND 52).

CLASS 35—ADVERTISING AND BUSINESS

FOR DISTRIBUTORSHIP FEATURING NUTRITIONAL SUPPLEMENTS AND HEALTH CARE PRODUCTS (U.S. CLS. 100, 101 AND 102).

DAVID HOFFMAN, EXAMINING ATTORNEY

SN 76-646,730. KURARAY CO., LTD., OKAYAMA PREFECTURE, JAPAN, FILED 9-13-2005.

KURARISTER

THE MARK CONSISTS OF STANDARD CHARACTERS WITHOUT CLAIM TO ANY PARTICULAR FONT, STYLE, SIZE, OR COLOR.

PRIORITY CLAIMED UNDER SEC. 44(D) ON JAPAN APPLICATION NO. 2005-074640, FILED 8-10-2005, REG. NO. 4935865, DATED 3-10-2006, EXPIRES 3-10-2016.

PRIORITY CLAIMED UNDER SEC. 44(D) ON JAPAN APPLICATION NO. 2005-074639, FILED 8-10-2005, REG. NO. 4935864, DATED 3-10-2006, EXPIRES 3-10-2016.

CLASS 16—PAPER GOODS AND PRINTED MATTER

FOR PLASTIC MATERIALS FOR PACKAGING AND WRAPPING, NAMELY, FOOD WRAPPING PLASTIC FILM AND FOOD WRAPPING PLASTIC WRAP FOR HOUSEHOLD USE; PLASTIC GARBAGE BAGS FOR HOUSEHOLD USE; AND INDUSTRIAL PACKAGING PLASTIC FILM IN THE NATURE OF PLASTIC BUBBLE PACKS (U.S. CLS. 2, 5, 22, 23, 29, 37, 38 AND 50).

CLASS 17—RUBBER GOODS

FOR PLASTICS SEMI-WORKED PRODUCTS, NAMELY, EXTRUDED PLASTICS AND CASTED PLASTICS IN THE FORM OF FIBERS, THREADS, YARNS, STRIPS, BARS, BLOCKS, PELLETS, RODS, FILMS, SHEETS, TUBES AND ADHESIVE COATED PLASTIC SHEETS, FOR USE IN MANUFACTURING; PLASTIC SHEETING FOR AGRICULTURAL PURPOSES, NAMELY, PLASTIC FILM USED AS PACKAGING FOR AGRICULTURAL PRODUCTS; PLASTIC FILMS FOR INDUSTRIAL AND COMMERCIAL PACKING USE; CHEMICAL FIBER NOT FOR TEXTILE USE; CHEMICAL FIBER YARN AND THREAD NOT FOR TEXTILE USE (U.S. CLS. 1, 5, 12, 13, 35 AND 50).

KATHERINE M. DUBRAY, EXAMINING ATTORNEY

SN 76-648,349. LUMETRA, SAN FRANCISCO, CA. FILED 10-12-2005.

BRIGHTER INSIGHTS. BETTER HEALTHCARE.

THE MARK CONSISTS OF STANDARD CHARACTERS WITHOUT CLAIM TO ANY PARTICULAR FONT, STYLE, SIZE, OR COLOR.

CLASS 35—ADVERTISING AND BUSINESS

FOR ASSOCIATION SERVICES, NAMELY, PROMOTING INTERESTS OF HEALTHCARE CONSUMERS AS IT RELATES TO THE QUALITY OF THEIR HEALTHCARE; ACCOUNT AUDITING IN THE MEDICAL FIELD; ANALYZING AND COMPILING DATA FOR MEASURING THE PERFORMANCE OF HEALTHCARE ORGANIZATIONS, HEALTHCARE PROVIDERS, PURCHASERS AND GROUPS INVOLVED IN HEALTHCARE DELIVERY AND MEASUREMENT OF HEALTHCARE DELIVERY; TRACKING AND MONITORING MEDICAL AND MEDICARE INSURANCE COMPLIANCE; AND INSURANCE CLAIMS AUDITING SERVICES, NAMELY, ENSURING THAT PAYMENTS ARE CORRECT AND CONSISTENT WITH APPLICABLE POLICY; AND CONSULTATION IN THE FIELD OF MEDICAL OFFICE BUSINESS PROCESS REENGINEERING; PROVIDING MEDICAL RECORD DATA ABSTRACTION SERVICES FOR USE BY HEALTHCARE PROFESSIONALS IN THE ASSESSMENT AND MEASUREMENT OF QUALITY IN HEALTHCARE (U.S. CLS. 100, 101 AND 102).

CLASS 36—INSURANCE AND FINANCIAL

FOR PROVIDING INFORMATION VIA A GLOBAL COMPUTER NETWORK RELATING TO HEALTHCARE AND MEDICARE INSURANCE BENEFITS; MEDICAL INSURANCE CASE AND UTILIZATION REVIEW AND INSURANCE CLAIMS ADJUSTMENT SERVICES FOR HEALTHCARE PURCHASERS AND PAYORS AND PROVIDERS AND MEDICARE BENEFICIARIES; AND FINANCIAL ANALYSIS AND CONSULTATION FOR CARRIERS, CONTRACTORS, HOSPITALS, PHYSICIANS, PROVIDERS AND VARIOUS AGENCIES OF GOVERNMENTAL ENTITIES, ALL RELATING TO HEALTHCARE (U.S. CLS. 100, 101 AND 102).

CLASS 41—EDUCATION AND ENTERTAINMENT

FOR EDUCATIONAL SERVICES, NAMELY, CONDUCTING TRAINING SESSIONS AND PROFESSIONAL CONFERENCES IN THE FIELD OF HEALTHCARE AND MEDICARE (U.S. CLS. 100, 101 AND 107).

CLASS 42—SCIENTIFIC AND COMPUTER SERVICES

FOR MEDICAL RESEARCH, INCLUDING DATA ANALYSES OF PERSONAL MEDICAL HISTORY RECORDS AND FILES; AND QUALITY CONTROL FOR HEALTHCARE PROVIDERS AND PAYORS; CONSULTATION SERVICES IN THE FIELD OF IMPLEMENTING COMPUTER HARDWARE AND COMPUTER SOFTWARE SYSTEMS FOR MANAGING HEALTH RECORDS AND FOR MEDICAL PRACTICE MANAGEMENT; AND CONSULTATION IN THE FIELD OF CONVERSION OF DATA OR DOCUMENTS FROM PHYSICAL TO ELECTRONIC MEDIA IN THE HEALTHCARE FIELD; DESIGN FOR OTHERS OF COMPUTER DATABASES IN THE FIELD OF HEALTHCARE (U.S. CLS. 100 AND 101).

CLASS 44—MEDICAL, BEAUTY AND AGRICULTURAL SERVICES

FOR PROVIDING INFORMATION VIA A GLOBAL COMPUTER NETWORK IN THE FIELD OF HEALTHCARE; AND CONSULTING TO AND ADVISING HEALTHCARE PROVIDERS AND PAYORS ON THE SUBJECT OF PROVIDING EFFECTIVE AND QUALITY HEALTHCARE; CONSULTATION IN THE FIELD OF HEALTHCARE; CONSULTING IN THE FIELD OF HEALTHCARE SERVICES; PROVIDING COMPUTER DATABASES CONTAINING INFORMATION IN THE FIELD OF HEALTHCARE (U.S. CLS. 100 AND 101).

COLLEEN DOMBROW, EXAMINING ATTORNEY

SN 76-651,022. TALISKER MOUNTAIN INCORPORATED,
PARK CITY, UT. FILED 11-28-2005.

BONANZA

THE MARK CONSISTS OF STANDARD CHARACTERS WITHOUT CLAIM TO ANY PARTICULAR FONT, STYLE, SIZE, OR COLOR.

CLASS 36—INSURANCE AND FINANCIAL

FOR INVESTMENT AND REAL ESTATE SERVICES, NAMELY, THE ACQUISITION, DIVESTITURE IN THE NATURE OF BROKERAGE, MANAGEMENT, AND LEASING OF COMMERCIAL AND RESIDENTIAL PROPERTIES (U.S. CLS. 100, 101 AND 102).

CLASS 37—CONSTRUCTION AND REPAIR

FOR LAND DEVELOPMENT AND REAL ESTATE SERVICES, NAMELY THE PLANNING AND LAYING OUT OF RESIDENTIAL GOLF COURSE COMMUNITIES AND COMMERCIAL PROPERTIES. (U.S. CLS. 100, 103 AND 106).

CLASS 44—MEDICAL, BEAUTY AND AGRICULTURAL SERVICES

FOR HEALTH SPA SERVICES, NAMELY COSMETIC BODY CARE SERVICES IN THE NATURE OF SKIN CARE SERVICES AND TREATMENTS, MASSAGE THERAPIES, BODY WRAPS, AROMATHERAPY, NAIL MANICURING SERVICES AND BODY, HAND AND FOOT TREATMENTS (U.S. CLS. 100 AND 101).
TARAH HARDY, EXAMINING ATTORNEY

SN 76-653,286. SCHLEIFRING UND APPARATEBAU GMBH,
D-82256 FÜRSTENFELDBRUCK, FED REP GERMANY,
FILED 1-12-2006.

GIGACAP

THE MARK CONSISTS OF STANDARD CHARACTERS WITHOUT CLAIM TO ANY PARTICULAR FONT, STYLE, SIZE, OR COLOR.

CLASS 9—ELECTRICAL AND SCIENTIFIC APPARATUS

FOR APPARATUS AND INSTRUMENTS FOR CONDUCTING, SWITCHING, TRANSFORMING, ACCUMULATING, REGULATING OR CONTROLLING ELECTRICITY, NAMELY, ROTARY JOINTS, SLIP RINGS AND ELECTRICAL CURRENT COLLECTORS AND PARTS THEREOF; DATA PROCESSING EQUIPMENT, NAMELY, ROTARY JOINTS, SLIP RINGS, ELECTRICAL CURRENT COLLECTORS AND PARTS THEREOF AND COMPUTERS; ELECTRONIC, OPTICAL AND ELECTRO OPTICAL APPARATUS, DEVICES AND COMPONENTS FOR PROCESSING AND TRANSFER OF DATA BETWEEN DEVICES MOVABLE AND PIVOTED AGAINST EACH OTHER, NAMELY, ROTARY JOINTS, SLIP RINGS AND ELECTRICAL CURRENT COLLECTORS AND PARTS THEREOF (U.S. CLS. 21, 23, 26, 36 AND 38).

CLASS 42—SCIENTIFIC AND COMPUTER SERVICES

FOR SCIENTIFIC AND TECHNOLOGICAL SERVICES, NAMELY, PRODUCT RESEARCH AND DEVELOPMENT OF ROTARY JOINTS, SLIP RINGS AND COLLECTORS AND THEIR PARTS; SCIENTIFIC RESEARCH AND DESIGN IN THE FIELD OF ROTARY JOINTS, SLIP RINGS AND ELECTRICAL CURRENT COLLECTORS AND PARTS THEREOF; INDUSTRIAL RESEARCH IN THE FIELD OF ROTARY JOINTS, SLIP RINGS AND COLLECTORS AND PARTS THEREOF; DESIGN AND DEVELOPMENT OF COMPUTER HARDWARE AND SOFTWARE, NAMELY, ELECTRONIC, OPTICAL AND ELECTRO OPTICAL APPARATUS, DEVICES AND COMPONENTS FOR PROCESSING AND TRANSFER OF DATA BETWEEN DEVICES MOVABLE AND PIVOTED AGAINST EACH OTHER, NAMELY, ROTARY JOINTS, SLIP RINGS, ELECTRICAL CURRENT COLLECTORS AND PARTS THEREOF (U.S. CLS. 100 AND 101).
REBECCA EISINGER, EXAMINING ATTORNEY

SN 76-654,211. SHAH, UDAY LALJI, MULUND (EAST),
MUMBAI, INDIA, FILED 1-30-2006.



NO CLAIM IS MADE TO THE EXCLUSIVE RIGHT TO USE THE HANDICAPPED SYMBOL IN THE NATURE OF A PERSON IN A WHEELCHAIR, APART FROM THE MARK AS SHOWN.

CLASS 36—INSURANCE AND FINANCIAL

FOR CHARITABLE FUND RAISING FOR HANDICAPPED AND PHYSICALLY CHALLENGED CHILDREN AND CHILDREN WITH LIFE-THREATENING MEDICAL CONDITIONS; PHILANTHROPIC SERVICES CONCERNING MONETARY DONATIONS; PHILANTHROPIC SERVICES CONCERNING MONETARY DONATIONS COLLECTED IN CONNECTION WITH FUND RAISING EVENTS (U.S. CLS. 100, 101 AND 102).

CLASS 41—EDUCATION AND ENTERTAINMENT

FOR PUBLICATION OF BOOKS, JOURNALS, BROCHURES, LEAFLETS, MAGAZINES AND MANUALS; PHYSICAL EDUCATION SERVICES, PHYSICAL FITNESS CONSULTATION; SPECIAL EVENT PLANNING OF FUND RAISING EVENTS (U.S. CLS. 100, 101 AND 107).
GINA FINK, EXAMINING ATTORNEY

SN 76-654,447. OAKWOOD ASSET MANAGEMENT, INC.,
GREAT NECK, NY. FILED 2-2-2006.

NOVELGUIDE

THE MARK CONSISTS OF STANDARD CHARACTERS WITHOUT CLAIM TO ANY PARTICULAR FONT, STYLE, SIZE, OR COLOR.
SEC. 2(F).

CLASS 9—ELECTRICAL AND SCIENTIFIC APPARATUS

FOR DOWNLOADABLE ELECTRONIC PUBLICATIONS IN THE NATURE OF PRINTED HANDBOOKS IN THE FIELD OF LITERATURE THAT SUMMARIZE CHAPTERS OF POPULAR BOOKS (U.S. CLS. 21, 23, 26, 36 AND 38).

FIRST USE 6-8-1998; IN COMMERCE 6-8-1998.

CLASS 16—PAPER GOODS AND PRINTED MATTER

FOR PRINTED PUBLICATIONS, NAMELY, HANDBOOKS IN THE FIELD OF LITERATURE THAT SUMMARIZE CHAPTERS OF POPULAR BOOKS (U.S. CLS. 2, 5, 22, 23, 29, 37, 38 AND 50).

FIRST USE 6-8-1998; IN COMMERCE 6-8-1998.

CLASS 41—EDUCATION AND ENTERTAINMENT

FOR PROVIDING ON-LINE, NON-DOWNLOADABLE PRINTED HANDBOOKS IN THE FIELD OF LITERATURE THAT SUMMARIZE CHAPTERS OF POPULAR BOOKS (U.S. CLS. 100, 101 AND 107).

FIRST USE 6-8-1998; IN COMMERCE 6-8-1998.

KEVIN CORWIN, EXAMINING ATTORNEY

CLASS 16—PAPER GOODS AND PRINTED MATTER

FOR WET TOWELS OF PAPER, HANKERCHIEFS OF PAPER, TOWELS OF PAPER, FACE TOWELS OF PAPER, TOILET PAPER, TISSUES OF PAPER FOR REMOVING MAKE-UP, MEMO PAPER, BUSINESS CARD PAPER, PAPER FILE JACKETS, POCKET NOTEBOOKS, SCRAPBOOKS, PHOTOGRAPHIC ALBUMS, WRITING PADS, FOUNTAIN PENS, BALL POINT PENS, SHARP PENCILS, SLATE PENCILS, PENCILS, STEEL PENS, PENS, PENHOLDERS, PEN NIBS, INDOOR DECORATIONS OF PAPER, PAPER MATS FOR BEER GLASSES, PLACE-MATS OF PAPER, TABLEMATS OF PAPER, TABLE LINEN OF PAPER, PRINTED MATTER EXCEPT MAGNETIC TYPES, NAMELY, BOOKS, BOOKLETS, PAMPHLETS, PERIODICALS, CATALOGUES, AND NEWSLETTERS, ALL IN THE FIELD OF AIR TRANSPORT, PICTURE POSTCARDS, CALENDARS, COMIC BOOKS, MUSICAL GREETING CARDS, CREDIT CARDS WITHOUT MAGNETIC CODING, GREETING CARDS, POSTCARDS, PRINTED TIMETABLES, DIARIES, IN-FLIGHT MAGAZINES, PASSENGER TICKETS, POSTERS, PHOTOGRAPHS, THREE-DIMENSIONAL MODELS FOR EDUCATIONAL PURPOSES AND MODELING MATERIALS AND COMPOUNDS FOR USE BY CHILDREN, ARCHITECTURE AND STRUCTURES MODELS (U.S. CLS. 2, 5, 22, 23, 29, 37, 38 AND 50).

CLASS 28—TOYS AND SPORTING GOODS

FOR SCALE MODEL AIRPLANES (U.S. CLS. 22, 23, 38 AND 50).

SUNG IN, EXAMINING ATTORNEY

SN 76-655,021. ASIANA AIRLINES, INC., SEOUL, REPUBLIC OF KOREA, AND KUMHO INDUSTRIAL CO., LTD., NAJU-SI, JEOLLANAM-DO, REPUBLIC OF KOREA, AND KOREA KUMHO PETROCHEMICAL CO., LTD., SEOUL, REPUBLIC OF KOREA, FILED 2-13-2006.

SN 76-658,405. EHLER ENTERPRISES, INC., ALPHARETTA, GA. FILED 4-13-2006.

NEXTIRE



ASIANA AIRLINES

THE MARK CONSISTS OF STANDARD CHARACTERS WITHOUT CLAIM TO ANY PARTICULAR FONT, STYLE, SIZE, OR COLOR.

CLASS 12—VEHICLES

FOR ADHESIVE RUBBER PATCHES FOR REPAIRING TUBES OR TIRES; INNER TUBES FOR VEHICLE TIRES; PNEUMATIC TYRES AND INNER TUBES FOR MOTORCYCLES; TIRE LINERS; TIRE PATCHES; TIRE VALVES FOR VEHICLE TIRES; TIRES; TIRES FOR AUTOMOBILES; TUBULAR TIRES; TUBULAR TYRES; VALVE STEMS FOR VEHICLE TIRES; VALVES FOR VEHICLE TIRES; VEHICLE TIRE VALVE STEM CAPS; AUTOMOBILE ENGINES; INNER TUBES FOR AUTOMOBILES; SUSPENSION SYSTEMS FOR AUTOMOBILES; TIRES FOR AUTOMOBILES; WHEEL RIMS FOR AUTOMOBILES; WHEELS OF AUTOMOBILES; WINDSCREEN WIPERS FOR AUTOMOBILES; CUSTOM WHEELS FOR AUTOMOBILES; EXHAUST SYSTEMS; VEHICLE PARTS, NAMELY, SHOCK ABSORBERS AND SUSPENSION STRUTS; AND WINDSHIELD WIPER BLADES (U.S. CLS. 19, 21, 23, 31, 35 AND 44).

OWNER OF U.S. REG. NOS. 1,579,472, 2,894,465 AND OTHERS.

THE COLOR(S) RED AND BLACK IS/ARE CLAIMED AS A FEATURE OF THE MARK.

THE MARK INCLUDES THE DESIGN OF A RED ARROW POSITIONED AT THE END OF THE WORD FEATURE OF THE MARK AND POINTING UP AND TO THE RIGHT OF THE MARK. THE COLOR RED APPEARS IN THE ARROW POSITIONED AT THE END OF THE WORD FEATURE OF THE MARK AND THE COLOR BLACK APPEARS IN THE WORDING "ASIANA AIRLINES".

CLASS 37—CONSTRUCTION AND REPAIR

FOR MAINTENANCE AND REPAIR OF AIR CONDITIONING SERVICES; AUTOMOBILE REPAIR SERVICES IN THE NATURE OF ALIGNMENTS; ALTERNATOR SERVICING; BATTERY SERVICING; BELTS AND HOSES REPLACEMENT; BRAKE REPAIRS; CV AXLE REPAIR SERVICE; COOLING SYSTEM SERVICE; ELECTRICAL REPAIRS; EMISSION REPAIR; ENGINE REPAIR; EXHAUST SYSTEM SERVICE; FUEL, AIR AND EMISSION FILTER SERVICE; LUBRICATION; OIL AND FILTER CHANGE; POWER STEERING FLUSH AND REPAIR; RACK AND PINION REPAIRS, STARTER REPAIRS; SUSPENSION AND STEERING REPAIR SERVICES; TIMING BELT REPLACEMENT; TIRE REPAIR, TRANSMISSION SERVICE; WHEEL BALANCING; AUTOMOBILE CLEANING; AUTOMOBILE GREASING; AUTOMOBILE LUBRICATION; GARAGE SERVICES, NAMELY, REPAIR OF AUTOMOBILES; AND MAINTENANCE AND/OR REPAIR OF AUTOMOBILES (U.S. CLS. 100, 103 AND 106).

ARETHA SOMERVILLE, EXAMINING ATTORNEY

SN 76-662,602. THE UNITED METHODIST PUBLISHING HOUSE, NASHVILLE, TN. FILED 7-5-2006.

THE AMAZING BIBLE RACE

THE MARK CONSISTS OF STANDARD CHARACTERS WITHOUT CLAIM TO ANY PARTICULAR FONT, STYLE, SIZE, OR COLOR.

NO CLAIM IS MADE TO THE EXCLUSIVE RIGHT TO USE BIBLE, APART FROM THE MARK AS SHOWN.

CLASS 9—ELECTRICAL AND SCIENTIFIC APPARATUS

FOR PRE-RECORDED VIDEO AND AUDIO CASSETTES AND DVDS IN THE FIELDS OF RELIGION, CHRISTIANITY, AND FAMILY VALUES (U.S. CLS. 21, 23, 26, 36 AND 38).

CLASS 16—PAPER GOODS AND PRINTED MATTER

FOR PRINTED INSTRUCTIONAL, EDUCATIONAL AND TEACHING MATERIALS IN THE NATURE OF BOOKS IN THE FIELDS OF BIBLICAL KNOWLEDGE AND CHRISTIANITY (U.S. CLS. 2, 5, 22, 23, 29, 37, 38 AND 50).

CLASS 45—PERSONAL AND LEGAL SERVICES

FOR PROVIDING INFORMATION ABOUT MINISTERIAL SERVICES RELATED TO RELIGION, CHRISTIANITY, AND FAMILY VALUES (U.S. CLS. 100 AND 101).

BRIDGETT SMITH, EXAMINING ATTORNEY

SN 76-670,193. ENVTECH, INC., SACRAMENTO, CA. FILED 12-11-2006.

ENVTECH

THE MARK CONSISTS OF STANDARD CHARACTERS WITHOUT CLAIM TO ANY PARTICULAR FONT, STYLE, SIZE, OR COLOR.

CLASS 1—CHEMICALS

FOR GAS-FREEING, NON-TOXIC ENVIRONMENTALLY-FRIENDLY CHEMICALS, NAMELY, SOLVENTS, SCALE REMOVERS, ACID INHIBITORS, BUFFERS AND FLUORIDE PRECIPITANTS FOR INDUSTRIAL USE FOR REFINERY AND CHEMICAL PLANT PROCESS EQUIPMENT DECONTAMINATION (U.S. CLS. 1, 5, 6, 10, 26 AND 46).

CLASS 37—CONSTRUCTION AND REPAIR

FOR CONSULTING SERVICES IN THE FIELD OF CLEANING REFINERY AND CHEMICAL PLANT PROCESS EQUIPMENT THROUGH THE USE OF INDUSTRIAL CHEMICALS (U.S. CLS. 100, 103 AND 106).

FIRST USE 1-0-1991; IN COMMERCE 0-0-1992.
SIMON TENG, EXAMINING ATTORNEY

SN 76-671,459. BOSS HOSS CYCLES, INC., DYERSBURG, TN. FILED 1-17-2007.



OWNER OF U.S. REG. NOS. 1,784,829, 2,503,927 AND 2,544,462.

NO CLAIM IS MADE TO THE EXCLUSIVE RIGHT TO USE "CYCLES V8" AS TO CLASS 12, APART FROM THE MARK AS SHOWN.

"BOSS HOSS" DOES NOT IDENTIFY A LIVING INDIVIDUAL.

THE MARK CONSISTS OF THE WORDING "BOSS HOSS CYCLES" APPEARING ABOVE A DESIGN ELEMENT COMPRISED OF WINGS AND A CIRCLE; INSIDE THE CIRCLE INTERSECT THE LETTER "V" AND THE NUMBER "8".

CLASS 12—VEHICLES

FOR MOTORCYCLES AND STRUCTURAL PARTS THEREFOR; MOTORCYCLE ENGINES; MOTORCYCLE PARTS AND ACCESSORIES, NAMELY, BRAKE CABLES, CLUTCH CABLES, FORK BEARINGS AND RACES, FORK DUST BOOTS, FORK SEALS, HANDLE BARS, HANDLE BAR CONTROL LEVERS, HANDLE BAR DAMPERS, HANDLE BAR GRIPS, BRAKE CALIPEERS, BRAKE PEDALS, BRAKE ROTORS, FRONT SPACERS, FRONT DASH PANELS, SHIFT LEVERS, HEADLIGHT MOUNTS, HANDLE BAR THROTTLES, PNEUMATIC TIRES AND INNER TUBES, SIDECARS, KICKSTANDS, WHEEL HUBS, SADDLEBAGS, VISOR STORAGE ORGANIZERS AND SEAT BACK STORAGE ORGANIZERS; DERBY COVERS, TIMER COVERS, AIR CLEANER COVERS, GAS CAP MEDALLIONS, PARTS OF MOTORCYCLES IN THE NATURE OF FENDER SKIRTS, MOTORCYCLE ACCESSORIES IN THE NATURE OF GAS TANK SHROUDS, VEHICLE TIRE VALVE STEM CAPS, LICENSE PLATE FASTENERS, PARTS OF MOTORCYCLES IN THE NATURE OF INSERTS FOR FOOT BOARD, MOTORCYCLE PARTS IN THE NATURE OF BRAKE PEDAL PADS, MOTORCYCLE PARTS IN THE NATURE OF FOOT PEGS, MOTORCYCLE PARTS IN THE NATURE OF SHIFTER PEGS, MOTORCYCLE PARTS IN THE NATURE OF HEEL RESTS, MOTORCYCLE PARTS IN THE NATURE OF PANELS FOR GAS TANK SHROUDS, PARTS OF MOTORCYCLES IN THE NATURE OF HANDLE BAR GRIPS (U.S. CLS. 19, 21, 23, 31, 35 AND 44).

FIRST USE 11-0-1991; IN COMMERCE 11-0-1991.

CLASS 25—CLOTHING

FOR CLOTHING, NAMELY, RIDING APPAREL AND WEARING APPAREL AND DECORATIVE APPAREL FOR MEN, WOMEN, TEENS, CHILDREN AND INFANTS, SPECIFICALLY, MOTORCYCLIST GLOVES, MOTORCYCLIST BOOTS; MOTORCYCLIST JACKETS AND COATS; MOTORCYCLIST PANTS; MONEY BELTS; MEN'S, WOMEN'S, TEENS', CHILDREN'S, AND INFANTS'S JACKETS, COATS, SWEATERS, TROUSERS, VESTS, JEANS, PANTS, COVERALLS, TANK TOPS, LEATHER JACKETS, LEATHER HEADWEAR, LEATHER PANTS, LEATHER SHOES, LEATHER VESTS, LEATHER SHIRTS, LEATHER CHAPS; DENIM JACKETS; DOWN JACKETS, LIGHT-REFLECTING JACKETS, RAIN JACKETS, RAIN SUITS, RAIN PANTS, RAIN SHOES, RAINPROOF JACKETS, SUITS, SHOES; WIND JACKETS AND WIND RESISTANT JACKETS; MITTENS; GLOVES; LEG WARMERS, FLEECE PULLOVERS, FLEECE SHORTS, FLEECE PANTS, CHAPS, LONG-SLEEVE AND SHORT-SLEEVE T-SHIRTS; NECKTIES; NECKERCHIEFS; NECKWEAR; WRISTBANDS, SUSPENDERS, APRONS, SWIMSUITS, SKIRTS, NIGHTWEAR, NIGHTGOWNS, NIGHT SHIRTS, PAJAMAS; HOSIERY, HALTER TOPS, HEADGEAR, NAMELY, HATS, CAPS, BEANIE CAPS, KNIT HATS, RAIN HATS, HEADSCARVES, SCARVES, HEADBANDS; BANDANAS; KERCHIEFS; BELTS, NAMELY, LEATHER BELTS, TEXTILE BELTS, FABRIC BELTS; BATHROBES, BOXER SHORTS, CAMP SHIRTS, SHIRTS, SHORTS, SPEED SOCKS, UNDERWEAR; CHILDREN'S AND INFANTS' HEADWEAR AND INFANTS' CLOTH EATING BIBS AND BIBS NOT OF PAPER; INFANT AND TODDLER WEAR, NAMELY, INFANT SLEEPERS, INFANTS' TROUSERS AND ONE PIECE GARMENT FOR INFANTS AND TODDLERS; FOOTWEAR, NAMELY, BOOTS AND PARTS OF FOOTWEAR, NAMELY, BOOT TIPS, SOLE PLATES, AND HEEL GUARDS (U.S. CLS. 22 AND 39).

FIRST USE 11-0-1991; IN COMMERCE 11-0-1991.

KAELIE KUNG, EXAMINING ATTORNEY

SN 76-671,517. ENERMAX TECHNOLOGY CORPORATION, TAOYUAN, TAIWAN, FILED 1-19-2007.

ENERMADE

SN 76-671,478. W.C. HERAEUS GMBH, D-63450 HANAU, FED REP GERMANY, FILED 1-18-2007.

HeraSample

THE MARK CONSISTS OF STANDARD CHARACTERS WITHOUT CLAIM TO ANY PARTICULAR FONT, STYLE, SIZE, OR COLOR.

PRIORITY CLAIMED UNDER SEC. 44(D) ON FED REP GERMANY APPLICATION NO. 30653000.7, FILED 8-28-2006, REG. NO. 30653000, DATED 11-23-2006, EXPIRES 8-28-2016.

CLASS 40—MATERIAL TREATMENT

FOR FULL AND PARTIAL RECYCLING OF NOBLE METALS; TREATMENT OF NOBLE METAL SAMPLES FOR ANALYSIS; MANUFACTURING SERVICES, NAMELY, HOMOGENIZATION OF NOBLE METAL CONTAINING MATERIAL TO THE ORDER AND SPECIFICATION OF OTHERS (U.S. CLS. 100, 103 AND 106).

CLASS 42—SCIENTIFIC AND COMPUTER SERVICES

FOR EXECUTING OF CHEMICAL ANALYSES, PARTICULARLY FROM NOBLE METAL SAMPLES (U.S. CLS. 100 AND 101).

SHAUNIA CARLYLE, EXAMINING ATTORNEY

THE MARK CONSISTS OF STANDARD CHARACTERS WITHOUT CLAIM TO ANY PARTICULAR FONT, STYLE, SIZE, OR COLOR.

CLASS 9—ELECTRICAL AND SCIENTIFIC APPARATUS

FOR PERSONAL COMPUTERS AND PARTS THEREOF, NAMELY, HARD DISK DRIVES; PORTABLE COMPUTERS; INDUSTRIAL COMPUTERS; SERVER COMPUTERS; COMPUTER KEYBOARDS; COMPUTER MOUSE; COMPUTER PERIPHERALS; HARD DISK MOBILE RACKS; USB HUBS; DATA CARD READERS; CD-ROM DRIVES; MODEMS; ELECTRIC CABLES; ELECTRIC CONNECTORS; ADAPTERS FOR COMPUTER HARDWARE; ELECTRICAL POWER SUPPLIES FOR COMPUTERS, NAMELY, SWITCHING, REDUNDANT AND UNINTERRUPTED POWER SUPPLIES; COMPUTER SOFTWARE FOR COLLECTING, EDITING, ORGANIZING, MODIFYING, BOOK MARKING, TRANSMISSION, STORAGE AND SHARING OF DATA AND INFORMATION AND COMPUTER OPERATING SOFTWARE RECORDED ON COMPUTER MEDIA AND DOWNLOADABLE; ELECTRONIC HEAT DISSIPATION APPARATUS, NAMELY, COMPUTER HEAT DISSIPATION FANS, CPU HEAT DISSIPATION FANS, POWER SUPPLIES DISSIPATION FANS (U.S. CLS. 21, 23, 26, 36 AND 38).

FIRST USE 9-28-2006; IN COMMERCE 9-28-2006.

CLASS 28—TOYS AND SPORTING GOODS

FOR VOLLEYBALLS, BASKETBALLS; GOLF BALLS, GOLF BAGS; SQUASH RACKETS; HOCKEY PUCKS; ROLLER SKATES; CHEST EXPANDERS; STATIONARY EXERCISE BIKES; BODY-BUILDING APPARATUS, NAMELY, ROWING MACHINES, STEP MACHINES, TREADMILLS, WEIGHT LIFTING BENCHES, BAR BELLS AND DUMBBELLS (U.S. CLS. 22, 23, 38 AND 50).

FIRST USE 9-28-2006; IN COMMERCE 9-28-2006.

MICHELE SWAIN, EXAMINING ATTORNEY

SN 76-671,617. BOSS HOSS CYCLES, INC., DYERSBURG, TN.
FILED 1-22-2007.



OWNER OF U.S. REG. NOS. 1,784,829, 2,503,927 AND 2,544,462.

NO CLAIM IS MADE TO THE EXCLUSIVE RIGHT TO USE "V8 CYCLES" AS TO CLASS 12, APART FROM THE MARK AS SHOWN.

"BOSS HOSS" DOES NOT IDENTIFY A LIVING INDIVIDUAL.

THE MARK CONSISTS OF THE WORDING "BOSS HOSS" APPEARING ABOVE A DESIGN ELEMENT COMPRISED OF WINGS AND A CIRCLE; INSIDE THE CIRCLE INTERSECT THE LETTER "V" AND THE NUMBER "8"; BELOW THE DESIGN ELEMENT APPEARS THE WORDING "CYCLES".

CLASS 12—VEHICLES

FOR MOTORCYCLES AND STRUCTURAL PARTS THEREFOR; MOTORCYCLE ENGINES; MOTORCYCLE PARTS AND ACCESSORIES, NAMELY, BRAKE CABLES, CLUTCH CABLES, FORK BEARINGS AND RACES, FORK DUST BOOTS, FORK SEALS, HANDLE BARS, HANDLE BAR CONTROL LEVERS, HANDLE BAR DAMPERS, HANDLE BAR GRIPS, BRAKE CALIPERS, BRAKE PEDALS, BRAKE ROTORS, FRONT SPACERS, FRONT DASH PANELS, SHIFT LEVERS, HEADLIGHT MOUNTS, HANDLE BAR THROTTLES, PNEUMATIC TIRES AND INNER TUBES, SIDECARS, KICKSTANDS, WHEEL HUBS, SADDLEBAGS, VISOR STORAGE ORGANIZERS AND SEAT BACK STORAGE ORGANIZERS; DERBY COVERS, TIMER COVERS, AIR CLEANER COVERS, GAS CAP MEDALLIONS, PARTS OF MOTORCYCLES IN THE NATURE OF FENDER SKIRTS, MOTORCYCLE ACCESSORIES IN THE NATURE OF GAS TANK SHROUDS, VEHICLE TIRE VALVE STEM CAPS, LICENSE PLATE FASTENERS, PARTS OF MOTORCYCLES IN THE NATURE OF INSERTS FOR FOOT BOARD, MOTORCYCLE PARTS IN THE NATURE OF BRAKE PEDAL PADS, MOTORCYCLE PARTS IN THE NATURE OF FOOT PEGS, MOTORCYCLE PARTS IN THE NATURE OF SHIFTER PEGS, MOTORCYCLE PARTS IN THE NATURE OF HEEL RESTS, MOTORCYCLE PARTS IN THE NATURE OF PANELS FOR GAS TANK SHROUDS, PARTS OF MOTORCYCLES IN THE NATURE OF HANDLE BAR GRIPS (U.S. CLS. 19, 21, 23, 31, 35 AND 44).

FIRST USE 11-0-1991; IN COMMERCE 11-0-1991.

CLASS 25—CLOTHING

FOR CLOTHING, NAMELY, RIDING APPAREL AND WEARING APPAREL AND DECORATIVE APPAREL FOR MEN, WOMEN, TEENS, CHILDREN AND INFANTS, SPECIFICALLY, MOTORCYCLIST GLOVES, MOTORCYCLIST BOOTS; MOTORCYCLIST JACKETS AND COATS; MOTORCYCLIST PANTS; MONEY BELTS; MEN'S, WOMEN'S, TEENS', CHILDREN'S, AND INFANTS' JACKETS, COATS, SWEATERS, TROUSERS, VESTS, JEANS, PANTS, COVERALLS, TANK TOPS, LEATHER JACKETS, LEATHER HEADWEAR, LEATHER PANTS, LEATHER SHOES, LEATHER VESTS, LEATHER SHIRTS, LEATHER CHAPS; DENIM JACKETS; DOWN JACKETS, LIGHT-REFLECTING JACKETS, RAIN JACKETS, RAIN SUITS, RAIN PANTS, RAIN SHOES, RAINPROOF JACKETS, SUITS, SHOES; WIND JACKETS AND WIND RESISTANT JACKETS; MITTENS; GLOVES; LEG WARMERS, FLEECE PULLOVERS, FLEECE SHORTS, FLEECE PANTS, CHAPS, LONG-SLEEVE AND SHORT-SLEEVE T-SHIRTS; NECKTIES; NECKERCHIEFS; NECKWEAR; WRISTBANDS, SUSPENDERS, APRONS, SWIMSUITS, SKIRTS, NIGHTWEAR, NIGHTGOWNS, NIGHT SHIRTS, PAJAMAS; HOSIERY, HALTER TOPS, HEADGEAR, NAMELY, HATS, CAPS, BEANIE CAPS, KNIT HATS, RAIN HATS, HEADSCARVES, SCARVES, HEADBANDS; BANDANAS; KERCHIEFS; BELTS, NAMELY, LEATHER BELTS, TEXTILE BELTS, FABRIC BELTS; BATHROBES, BOXER SHORTS, CAMP SHIRTS, SHIRTS, SHORTS, SPEED SOCKS, UNDERWEAR; CHILDREN'S AND INFANTS' HEADWEAR AND INFANTS' CLOTH EATING BIBS AND BIBS NOT OF PAPER; INFANT AND TODDLER WEAR, NAMELY, INFANT SLEEPERS, INFANTS' TROUSERS AND ONE PIECE GARMENT FOR INFANTS AND TODDLERS; FOOTWEAR, NAMELY, BOOTS AND PARTS OF FOOTWEAR, NAMELY, BOOT TIP, SOLE PLATES, AND HEEL GUARDS (U.S. CLS. 22 AND 39).

FIRST USE 11-0-1991; IN COMMERCE 11-0-1991.

KAELIE KUNG, EXAMINING ATTORNEY

SN 76-671,675. BARROW, SCOTT, LOS ANGELES, CA.
FILED 1-22-2007.

MEDIA HOG

THE MARK CONSISTS OF STANDARD CHARACTERS WITHOUT CLAIM TO ANY PARTICULAR FONT, STYLE, SIZE, OR COLOR.

CLASS 9—ELECTRICAL AND SCIENTIFIC APPARATUS

FOR HARDWARE AND SOFTWARE THAT ENABLES USERS TO BACKUP, STORE, PLAY, AND UNIQUELY SHARE THEIR OWN MULTIMEDIA CONTENT, AS WELL AS BROWSE AND ACQUIRE CONTENT FROM OTHER USERS (U.S. CLS. 21, 23, 26, 36 AND 38).

CLASS 38—COMMUNICATION

FOR EMAIL SERVICES (U.S. CLS. 100, 101 AND 104).
YAT SYE, LEE, EXAMINING ATTORNEY

SN 76-672,371. BODY DOCTRINE, LORTON, VA. FILED 2-7-2007.

SN 76-673,209. STAPLES THE OFFICE SUPERSTORE, LLC, FRAMINGHAM, MA. FILED 2-26-2007.

BODY DOCTRINE

THE MARK CONSISTS OF STANDARD CHARACTERS WITHOUT CLAIM TO ANY PARTICULAR FONT, STYLE, SIZE, OR COLOR.

NO CLAIM IS MADE TO THE EXCLUSIVE RIGHT TO USE "BODY", APART FROM THE MARK AS SHOWN.

CLASS 9—ELECTRICAL AND SCIENTIFIC APPARATUS

FOR PRERECORDED VIDEO AND AUDIO COMPACT DISCS AND DVDS FEATURING FITNESS AND WELLNESS INFORMATION (U.S. CLS. 21, 23, 26, 36 AND 38).

CLASS 41—EDUCATION AND ENTERTAINMENT

FOR EDUCATIONAL SERVICES, NAMELY, CONDUCTING TRAINING PROGRAMS, CLASSES, AND WORKSHOPS IN THE FIELD OF FITNESS AND WELLNESS AND DISTRIBUTING COURSE MATERIALS THEREWITH; ORGANIZING COMMUNITY EVENTS IN THE FIELD OF FITNESS AND WELLNESS (U.S. CLS. 100, 101 AND 107).

MICHELE SWAIN, EXAMINING ATTORNEY

SN 76-672,827. ORC INDUSTRIES, INC., LA CROSSE, WI. FILED 2-16-2007.



NO CLAIM IS MADE TO THE EXCLUSIVE RIGHT TO USE "CANOE WORKS", APART FROM THE MARK AS SHOWN.

CLASS 12—VEHICLES

FOR CANOES, KAYAKS AND CANOE AND KAYAK PADDLES (U.S. CLS. 19, 21, 23, 31, 35 AND 44).
FIRST USE 1-0-1995; IN COMMERCE 1-0-1995.

CLASS 25—CLOTHING

FOR CLOTHING, NAMELY, HATS AND SHIRTS (U.S. CLS. 22 AND 39).
FIRST USE 1-0-1995; IN COMMERCE 1-0-1995.
ELIZABETH BEYER, EXAMINING ATTORNEY



OWNER OF U.S. REG. NOS. 1,438,390, 1,487,171 AND OTHERS.

CLASS 9—ELECTRICAL AND SCIENTIFIC APPARATUS

FOR COMPUTER PARTS AND PERIPHERALS USED IN THE INSTALLATION, REPAIR AND MAINTENANCE OF COMPUTER HARDWARE, SOFTWARE AND WIRELESS NETWORKS, NAMELY, KEYBOARDS, MEMORY CARDS, HARD DRIVES, MONITORS, WIRELESS CARDS, COMPUTER CABLES, MODEM, DISC DRIVES, BUFFERS, CENTRAL PROCESSING UNITS, MICE, COMPUTER HUBS, SWITCHES AND ROUTERS (U.S. CLS. 21, 23, 26, 36 AND 38).

CLASS 37—CONSTRUCTION AND REPAIR

FOR INSTALLATION, REPAIR AND MAINTENANCE OF COMPUTER HARDWARE AND WIRELESS NETWORKS (U.S. CLS. 100, 103 AND 106).

CLASS 42—SCIENTIFIC AND COMPUTER SERVICES

FOR INSTALLATION, REPAIR AND MAINTENANCE OF COMPUTER SOFTWARE (U.S. CLS. 100 AND 101).
JENNY PARK, EXAMINING ATTORNEY

SN 76-673,469. BODY DOCTRINE, LORTON, VA. FILED 3-2-2007.

MY MATWORK

THE MARK CONSISTS OF STANDARD CHARACTERS WITHOUT CLAIM TO ANY PARTICULAR FONT, STYLE, SIZE, OR COLOR.

NO CLAIM IS MADE TO THE EXCLUSIVE RIGHT TO USE "MATWORK", APART FROM THE MARK AS SHOWN.

CLASS 9—ELECTRICAL AND SCIENTIFIC APPARATUS

FOR PRERECORDED VIDEO AND AUDIO COMPACT DISCS AND DVDS FEATURING FITNESS AND WELLNESS INFORMATION (U.S. CLS. 21, 23, 26, 36 AND 38).

CLASS 41—EDUCATION AND ENTERTAINMENT

FOR EDUCATIONAL SERVICES, NAMELY, CONDUCTING TRAINING PROGRAMS, CLASSES, AND WORKSHOPS IN THE FIELD OF FITNESS AND WELLNESS AND DISTRIBUTING COURSE MATERIALS THEREWITH; ORGANIZING COMMUNITY EVENTS IN THE FIELD OF FITNESS AND WELLNESS (U.S. CLS. 100, 101 AND 107).
MICHELE SWAIN, EXAMINING ATTORNEY

SN 76-673,637. BASS FISHING HALL OF FAME, INC., HOT SPRINGS NATIONAL PARK, AR. FILED 3-6-2007.



OWNER OF U.S. REG. NOS. 2,885,416 AND 2,969,283.
NO CLAIM IS MADE TO THE EXCLUSIVE RIGHT TO USE "BASS FISHING HALL OF FAME" AS TO CLASS 41, APART FROM THE MARK AS SHOWN.

CLASS 25—CLOTHING

FOR CAPS AND T-SHIRTS (U.S. CLS. 22 AND 39).

CLASS 26—FANCY GOODS

FOR ORNAMENTAL CLOTH PATCHES (U.S. CLS. 37, 39, 40, 42 AND 50).

CLASS 41—EDUCATION AND ENTERTAINMENT

FOR PROVIDING RECOGNITION AND INCENTIVES BY THE WAY OF AWARDS TO RECOGNIZE AND HONOR INDIVIDUAL CONTRIBUTIONS IN THE FIELD OF BASS FISHING; AWARDS PROGRAMS TO RECOGNIZE AND HONOR INDIVIDUAL CONTRIBUTIONS IN THE FIELD OF BASS FISHING (U.S. CLS. 100, 101 AND 107).

WOODROW HARTZOG, EXAMINING ATTORNEY

SN 76-673,685. THE KENTUCKY BOURBON FESTIVAL, INCORPORATED, BARDSTOWN, KY. FILED 3-7-2007.

BOURBON CAPITAL OF THE WORLD

THE MARK CONSISTS OF STANDARD CHARACTERS WITHOUT CLAIM TO ANY PARTICULAR FONT, STYLE, SIZE, OR COLOR.

NO CLAIM IS MADE TO THE EXCLUSIVE RIGHT TO USE "BOURBON", APART FROM THE MARK AS SHOWN.

CLASS 35—ADVERTISING AND BUSINESS

FOR PROMOTION OF TRADE, TRAVEL, TOURISM, AND CONVENTION BUSINESS IN AND AROUND THE AREA OF BARDSTOWN, KENTUCKY; ADVERTISING AND PROMOTING THE SERVICES OF OTHERS IN CONNECTION WITH TRADE, TRAVEL, TOURISM, AND CONVENTIONS THROUGH PRINT, RADIO, TELEVISION, AND THE INTERNET; ASSISTING OTHERS WITH PLANNING, PROMOTING, AND CONDUCTING BUSINESS MEETINGS AND BUSINESS TRADE SHOWS; PROVIDING INFORMATION ON LOCATIONS FOR SHOPPING (U.S. CLS. 100, 101 AND 102).

FIRST USE 10-1-2002; IN COMMERCE 10-1-2002.

CLASS 41—EDUCATION AND ENTERTAINMENT

FOR PROVIDING INFORMATION ON LOCAL ATTRACTIONS AND RECREATIONAL, CULTURAL, AND SPORTING EVENTS AND FACILITIES, NAMELY, FESTIVALS, FOLK SONGS, FOOD FAIR, ARTS AND CRAFTS FAIR, CAR SHOW, COUNTRY MUSIC CONCERTS, GOLF TOURNAMENT, RAILWAY MUSEUM HISTORICAL TRAIN RIDES, BARREL MAKING, HISTORY SEMINARS, GUIDED HISTORICAL TOURS OF TOWN AND BUSINESSES, FAIRS, CONCERTS, ART EXHIBITS, RELAY RACES, COMPANY TOURS, LINE DANCING AND WESTERN RELATED ACTIVITIES, FOOD AND DRINK TASTE TESTS, MUSEUM TOURS, JAZZ CONCERTS, BALLROOM DANCING, AND BALLOON RACES (U.S. CLS. 100, 101 AND 107).

FIRST USE 10-1-2002; IN COMMERCE 10-1-2002.

CLASS 43—HOTEL AND RESTAURANT SERVICES

FOR (BASED ON INTENT TO USE) PROVIDING INFORMATION ON RESTAURANTS, HOTELS, MOTELS, RESORTS, AND CONVENTION FACILITIES (U.S. CLS. 100 AND 101).

CHRISTINE COOPER, EXAMINING ATTORNEY

SN 76-673,686. B & K ENTERPRISES COSTUME CO., INC., CHARLESTOWN, IN. FILED 3-7-2007.



CLASS 14—JEWELRY

FOR JEWELRY, NAMELY, RINGS, PINS, BRACELETS, CUFF LINKS, TIE PINS, CHAINS, EARRINGS, AND TIE CLASP (U.S. CLS. 2, 27, 28 AND 50).

FIRST USE 9-1-2006; IN COMMERCE 9-1-2006.

CLASS 25—CLOTHING

FOR CLOTHING, NAMELY, TV AND ON-STAGE ENTERTAINER AND ACTORS COSTUMES, TV AND ON-STAGE ENTERTAINER AND ACTORS EMBROIDERED COSTUMES, JUMP SUIT, SHIRTS, VESTS, ROBES, SUITS, CLOTH BELTS, LEATHER BELTS, CAPES, FORMAL WEAR IN THE NATURE OF TUXEDOS AND DINNER JACKETS, POLO SHIRTS, SWEATERS, TIES, HATS, CAPS, BOOTS, PANTS, SLACKS, JOGGING SUITS, SWEAT SUITS, SWEAT PANTS AND BODY SUITS, SKI JACKETS, JEANS, SHORTS, TOPS, JACKETS, COATS, SPORT COATS, SPORT SHIRTS, KNIT SHIRTS, PULLOVERS, BLAZERS, LEATHER JACKETS, FOOTWEAR, SHOES, SANDALS, HEAD WEAR, HOODS, HEADBANDS, SWEAT BANDS, NECKWEAR, NECKTIES, NECKERCHIEFS, SCARVES, BANDANNAS, SLEEPWEAR, PAJAMAS, NIGHTSHIRTS, RAINWEAR, UNIFORMS, SUSPENDERS (U.S. CLS. 22 AND 39).

FIRST USE 9-1-2006; IN COMMERCE 9-1-2006.

CLASS 26—FANCY GOODS

FOR FANCIFUL BELT BUCKLES, JEWEL BELT BUCKLES AND FANCIFUL BUTTONS (U.S. CLS. 37, 39, 40, 42 AND 50).

FIRST USE 9-1-2006; IN COMMERCE 9-1-2006.

CHRISTINE COOPER, EXAMINING ATTORNEY

SN 76-673,779. STAPLES THE OFFICE SUPERSTORE, LLC, FRAMINGHAM, MA. FILED 3-5-2007.



OWNER OF U.S. REG. NOS. 1,438,390, 1,487,171 AND OTHERS.

CLASS 9—ELECTRICAL AND SCIENTIFIC APPARATUS

FOR COMPUTER PARTS AND PERIPHERALS USED IN THE INSTALLATION, REPAIR AND MAINTENANCE OF COMPUTER HARDWARE, SOFTWARE AND WIRELESS NETWORKS, NAMELY, KEYBOARDS, MEMORY CARDS, HARD DRIVES, MONITORS, WIRELESS CARDS, COMPUTER CABLES, MODEM, DISC DRIVES, BUFFERS, CENTRAL PROCESSING UNITS, MICE, COMPUTER HUBS, SWITCHES AND ROUTERS (U.S. CLS. 21, 23, 26, 36 AND 38).

CLASS 37—CONSTRUCTION AND REPAIR

FOR INSTALLATION, REPAIR AND MAINTENANCE OF COMPUTER HARDWARE AND WIRELESS NETWORKS (U.S. CLS. 100, 103 AND 106).

CLASS 42—SCIENTIFIC AND COMPUTER SERVICES

FOR INSTALLATION, REPAIR AND MAINTENANCE OF COMPUTER SOFTWARE (U.S. CLS. 100 AND 101).
JENNY PARK, EXAMINING ATTORNEY

SN 76-674,372. THE MEDTRONIC FOUNDATION, MINNEAPOLIS, MN. FILED 3-21-2007.

I WILL

THE MARK CONSISTS OF STANDARD CHARACTERS WITHOUT CLAIM TO ANY PARTICULAR FONT, STYLE, SIZE, OR COLOR.

CLASS 16—PAPER GOODS AND PRINTED MATTER

FOR PUBLICATIONS, NAMELY, EDUCATIONAL MATERIALS, NEWSLETTERS AND PUBLIC SERVICE ANNOUNCEMENTS IN THE FORM OF POSTCARDS IN THE FIELD OF PERSONAL HEALTH AWARENESS AND THE PROMOTION AND FULFILLMENT OF PERSONAL HEALTH PLEDGE COMMITMENTS (U.S. CLS. 2, 5, 22, 23, 29, 37, 38 AND 50).

FIRST USE 5-4-2006; IN COMMERCE 5-4-2006.

CLASS 35—ADVERTISING AND BUSINESS

FOR PUBLIC SERVICE CAMPAIGN, NAMELY PROVIDING PUBLIC SERVICE ANNOUNCEMENTS PROMOTING PUBLIC AWARENESS IN THE FIELD OF PERSONAL HEALTH AWARENESS AND THE PROMOTION AND FULFILLMENT OF PERSONAL HEALTH PLEDGE COMMITMENTS (U.S. CLS. 100, 101 AND 102).
FIRST USE 5-4-2006; IN COMMERCE 5-4-2006.

CLASS 41—EDUCATION AND ENTERTAINMENT

FOR EDUCATIONAL SERVICES, NAMELY, PROVIDING LIVE AND ON-LINE WORKSHOPS AND PROGRAMS IN THE FIELD OF PERSONAL HEALTH AWARENESS AND THE PROMOTION AND FULFILLMENT OF PERSONAL HEALTH PLEDGE COMMITMENTS (U.S. CLS. 100, 101 AND 107).

FIRST USE 5-4-2006; IN COMMERCE 5-4-2006.

CLASS 44—MEDICAL, BEAUTY AND AGRICULTURAL SERVICES

FOR PROVIDING A WEBSITE FEATURING INFORMATION ON PERSONAL HEALTH AND WELLNESS AND HEALTHY LIFESTYLE CHOICES THROUGH WHICH INDIVIDUALS MAKE AND FULFILL PERSONAL HEALTH COMMITMENTS (U.S. CLS. 100 AND 101).

FIRST USE 5-4-2006; IN COMMERCE 5-4-2006.

ARETHA SOMERVILLE, EXAMINING ATTORNEY

SN 76-674,373. THE MEDTRONIC FOUNDATION, MINNEAPOLIS, MN. FILED 3-21-2007.

MAKE YOUR BODY A GREAT PLACE TO LIVE

THE MARK CONSISTS OF STANDARD CHARACTERS WITHOUT CLAIM TO ANY PARTICULAR FONT, STYLE, SIZE, OR COLOR.

CLASS 16—PAPER GOODS AND PRINTED MATTER

FOR PUBLICATIONS, NAMELY, EDUCATIONAL MATERIALS, NEWSLETTERS AND PUBLIC SERVICE ANNOUNCEMENTS IN THE FORM OF POSTCARDS IN THE FIELD OF PERSONAL HEALTH AWARENESS AND THE PROMOTION AND FULFILLMENT OF PERSONAL HEALTH PLEDGE COMMITMENTS (U.S. CLS. 2, 5, 22, 23, 29, 37, 38 AND 50).

FIRST USE 5-4-2006; IN COMMERCE 5-4-2006.

CLASS 35—ADVERTISING AND BUSINESS

FOR PUBLIC SERVICE CAMPAIGN, NAMELY PROVIDING PUBLIC SERVICE ANNOUNCEMENTS PROMOTING PUBLIC AWARENESS IN THE FIELD OF PERSONAL HEALTH AWARENESS AND THE PROMOTION AND FULFILLMENT OF PERSONAL HEALTH PLEDGE COMMITMENTS (U.S. CLS. 100, 101 AND 102).

FIRST USE 5-4-2006; IN COMMERCE 5-4-2006.

CLASS 41—EDUCATION AND ENTERTAINMENT

FOR EDUCATIONAL SERVICES, NAMELY, PROVIDING LIVE AND ON-LINE WORKSHOPS AND PROGRAMS IN THE FIELD OF PERSONAL HEALTH AWARENESS AND THE PROMOTION AND FULFILLMENT OF PERSONAL HEALTH PLEDGE COMMITMENTS (U.S. CLS. 100, 101 AND 107).

FIRST USE 5-4-2006; IN COMMERCE 5-4-2006.

CLASS 44—MEDICAL, BEAUTY AND AGRICULTURAL SERVICES

FOR PROVIDING A WEBSITE FEATURING INFORMATION ON PERSONAL HEALTH AND WELLNESS AND HEALTHY LIFESTYLE CHOICES THROUGH WHICH INDIVIDUALS MAKE AND FULFILL PERSONAL HEALTH COMMITMENTS (U.S. CLS. 100 AND 101).
FIRST USE 5-4-2006; IN COMMERCE 5-4-2006.
ARETHA SOMERVILLE, EXAMINING ATTORNEY

SN 76-674,799. AJAX TOOL WORKS, INC., FRANKLIN PARK, IL. FILED 3-29-2007.



OWNER OF U.S. REG. NO. 3,210,486.

SN 76-674,636. MARY LEE LABAY, INC., BELLEVUE, WA. FILED 3-27-2007.

AWARENESS ENGINEERING

THE MARK CONSISTS OF STANDARD CHARACTERS WITHOUT CLAIM TO ANY PARTICULAR FONT, STYLE, SIZE, OR COLOR.

CLASS 16—PAPER GOODS AND PRINTED MATTER

FOR (BASED ON INTENT TO USE) A SERIES OF BOOKS AND WORKBOOKS IN THE FIELD OF HOLISTIC HEALING AND METAPHYSICS (U.S. CLS. 2, 5, 22, 23, 29, 37, 38 AND 50).

CLASS 41—EDUCATION AND ENTERTAINMENT

FOR (BASED ON USE IN COMMERCE) EDUCATIONAL SERVICES, NAMELY, CONDUCTING CLASSES, SEMINARS, CONFERENCES, WORKSHOPS, TELE-SEMINARS, AND PRACTICE SESSIONS IN THE FIELD OF HOLISTIC HEALING AND METAPHYSICS AND DISTRIBUTION OF COURSE MATERIAL IN CONNECTION THEREWITH (U.S. CLS. 100, 101 AND 107).
FIRST USE 3-10-2007; IN COMMERCE 3-15-2007.
CAROLINE WOOD, EXAMINING ATTORNEY

CLASS 7—MACHINERY

FOR TOOLS FOR MACHINES, NAMELY, BUSHING TOOLS, MACHINE OPERATED CHISELS, COUPLERS, POINT OF WORK PNEUMATIC CONTROL, NEEDLE SCALER ATTACHMENTS, NEEDLE SCALER PARTS, CHIPPING HAMMER RETAINERS, ZIP GUN AND RIVET HAMMER RETAINERS, RIVETING HAMMERS AND RIVET BUSTER SLEEVES, SWIVEL HOSE CONNECTORS, ELECTRIC HAMMER CHISELS, PAVING BREAKER CHISELS AND HYDRAULIC HAMMER BITS, AND RESCUE TOOLS AND KITS COMPRISING AIR HAMMERS AND MACHINE OPERATED CHISELS (U.S. CLS. 13, 19, 21, 23, 31, 34 AND 35).
FIRST USE 0-0-1981; IN COMMERCE 0-0-1981.

CLASS 8—HAND TOOLS

FOR HAND TOOLS, NAMELY, CROWBARS, PINCH BARS, DIGGING BARS, PRY BARS, CHISEL BARS, LINING BARS, FIT UP BARS, CONNECTING BARS, CHISELS, FLANGE SCRAPERS, WELDING PINS, DRIFT PINS, COTTER PIN PULLERS, COTTER PIN PULLERS AND SPREADERS, PUNCHES, TONGS, AND WEDGES, AND RESCUE TOOLS AND KITS COMPRISING CHISELS (U.S. CLS. 23, 28 AND 44).
FIRST USE 0-0-1981; IN COMMERCE 0-0-1981.
KYLE PEETE, EXAMINING ATTORNEY

SN 76-675,028. UNI-CLEANER AMERIKA APS, DK-6990 ULFBORG, DENMARK, FILED 4-3-2007.



THE MARK CONSISTS OF THE WORDING "MIL-TEK" PRINTED BELOW A SILHOUETTE OF A HUMAN FIGURE SQUEEZING A BUNDLE OF TIED MATERIAL WHICH IS LOCATED WITHIN AN ARC IN THE FORM OF A CURVED ARROW.

SN 76-674,670. BON MARKETING, INC., CUDAHY, CA. FILED 3-27-2007.

Luv-a-Lily**CLASS 18—LEATHER GOODS**

FOR DIAPER HOLDERS NAMELY, DIAPER BAGS (U.S. CLS. 1, 2, 3, 22 AND 41).
FIRST USE 3-14-2007; IN COMMERCE 3-14-2007.

CLASS 24—FABRICS

FOR BEDDING NAMELY, BLANKETS (U.S. CLS. 42 AND 50).
FIRST USE 3-14-2007; IN COMMERCE 3-14-2007.
BRIAN NEVILLE, EXAMINING ATTORNEY

CLASS 3—COSMETICS AND CLEANING PREPARATIONS

FOR GENERAL HOUSEHOLD BIOLOGICAL DETERGENTS, NAMELY, DETERGENT SOAPS AND LAUNDRY DETERGENTS (U.S. CLS. 1, 4, 6, 50, 51 AND 52).

CLASS 7—MACHINERY

FOR BLAST GUNS FOR USE IN CLEANING AND COMPACTING MACHINES FOR COMPACTING, SQUEEZING AND COMPRESSING WASTE, MATERIALS, PAPER, PLASTIC, AND GARBAGE BAGS; COMPRESSED AIR BLAST GUNS FOR GENERAL CLEANING AND DUSTING PURPOSES FOR CLEANING ARTICLES OF DUST, DIRT, AND OILY OR STICKY SUBSTANCE (U.S. CLS. 13, 19, 21, 23, 31, 34 AND 35).

CLASS 22—CORDAGE AND FIBERS

FOR CORDAGE (U.S. CLS. 1, 2, 7, 19, 22, 42 AND 50).
MARLENE BELL, EXAMINING ATTORNEY

SN 76-675,300. ANIBOOM LTD, TEL AVIV 61297, ISRAEL,
FILED 4-10-2007.

ANIMACHINES

THE MARK CONSISTS OF STANDARD CHARACTERS WITHOUT CLAIM TO ANY PARTICULAR FONT, STYLE, SIZE, OR COLOR.

CLASS 9—ELECTRICAL AND SCIENTIFIC APPARATUS

FOR COMPUTER GAME SOFTWARE; COMPUTER SOFTWARE FOR USE IN RELATION TO DIGITAL ANIMATION AND SPECIAL EFFECTS OF IMAGES; COMPUTER GAME PROGRAMS; COMPUTER GAME TOOLS AND EQUIPMENT, NAMELY, JOYSTICKS; COMPUTER GAME APPARATUS, NAMELY, VIDEO GAME MACHINES FOR USE WITH EXTERNAL DISPLAY SCREEN OR MONITOR; COMPUTER GAME DISCS AND VIDEO GAME CARTRIDGES; COMPUTER GAMES CARTRIDGES FOR USE WITH VIDEO MACHINES FOR USE WITH TELEVISION OR SCREEN; VIDEOTAPES AND VIDEO DISKS RECORDED WITH ANIMATION (U.S. CLS. 21, 23, 26, 36 AND 38).

CLASS 41—EDUCATION AND ENTERTAINMENT

FOR ANIMATED MOTION PICTURE PRODUCTION; PRODUCTION OF ON-LINE ANIMATED MOTION PICTURES; INTERNET SITES, NAMELY, PROVIDING ON-LINE REVIEWS OF MOTION PICTURES (U.S. CLS. 100, 101 AND 107).

ERNEST SHOSHO, EXAMINING ATTORNEY

SN 76-675,675. THE SOCCER WARRIORS COMPANY, LLC,
NEW YORK, NY. FILED 4-18-2007.

RUMBAL SOCCA

THE MARK CONSISTS OF STANDARD CHARACTERS WITHOUT CLAIM TO ANY PARTICULAR FONT, STYLE, SIZE, OR COLOR.

NO CLAIM IS MADE TO THE EXCLUSIVE RIGHT TO USE "SOCCER", APART FROM THE MARK AS SHOWN.

CLASS 9—ELECTRICAL AND SCIENTIFIC APPARATUS

FOR PRE-RECORDED AUDIO AND VIDEO CASSETTES, COMPACT DISCS, VIDEO DISCS, CD-ROMS, ALL FEATURING ANIMATION AND LIVE-ACTION AND MUSICAL PERFORMANCES; VIDEO GAME MACHINE THAT IS ADAPTED OR INTENDED FOR USE WITH A TELEVISION, MONITOR, OR OTHER EXTERNAL DISPLAY SCREEN; COMPUTER GAME EQUIPMENT CONTAINING MEMORY DEVICES, NAMELY, DISCS AND INTERACTIVE VIDEO GAME PROGRAMS; AND INTERACTIVE COMPUTER GAME SOFTWARE DOWNLOADABLE FROM A GLOBAL COMPUTER NETWORK; VIDEO GAME CARTRIDGES AND COMPUTER GAME PROGRAMS (U.S. CLS. 21, 23, 26, 36 AND 38).

CLASS 16—PAPER GOODS AND PRINTED MATTER

FOR ADDRESS BOOKS, ADDRESS LABELS, APPOINTMENT BOOKS, ARTS AND CRAFT PAINT KITS, AUTOGRAPH BOOKS, BALL-POINT PENS, BINDERS, BOOK BINDINGS, BOOK COVERS, BOOKMARKS, CALENDARS, WALL CALENDARS, DESK CALENDARS, CHILDREN'S ACTIVITY BOOKS, CHILDREN'S BOOKS, COLORING BOOKS, COMIC BOOKS, COMPOSITION BOOKS, CRAYONS, DAILY PLANNERS, DECALS, ENGAGEMENT BOOKS, FINGERPRINT KITS, FOUNTAIN PENS, GIFT WRAPPING PAPER, GIFT CARDS, GREETING CARDS, LOOSE LEAF BINDERS, MODELING CLAY, MODELING CLAY FOR CHILDREN, MODELING COMPOUNDS, MODELING MATERIALS AND COMPOUNDS FOR USE BY CHILDREN, PAPER NAME BADGES, NOTE CARDS, NOTE BOOKS, PAINTING SETS FOR CHILDREN, PAPER PARTY DECORATIONS, PAPER PARTY HATS, PAPER PARTY BAGS, PAPER CAKE DECORATIONS, PAPER BANNERS, PEN CASES, PEN OR PENCIL HOLDERS, PENCIL BOXES, PENCIL CASES, PENS, PERSONAL ORGANIZERS, PHOTOGRAPH ALBUMS, RUBBER STAMPS, SCRAPBOOK ALBUMS, SERIES OF FICTION BOOKS, SERIES OF NON-FICTION BOOKS IN THE FIELD OF SOCCER AND SOCCER RELATED TELEVISION PROGRAMMING AND MOTION PICTURES, STATIONERY, STATIONERY BOXES, STATIONERY FOLDERS, STENCILS, STICKERS, PRINTED TEACHING MATERIALS COMPRISING GAMES FEATURING SOCCER THEMES, TELEPHONE NUMBER BOOKS, WIRE-BOUND NOTEBOOKS, WRAPPING PAPER, EDUCATIONAL BOOKS IN THE FIELD OF SOCCER, TRADING CARDS, AND COMPUTER GAME INSTRUCTION MANUALS (U.S. CLS. 2, 5, 22, 23, 29, 37, 38 AND 50).

CLASS 25—CLOTHING

FOR CLOTHING, NAMELY, RAINWEAR, T-SHIRTS, SWEAT SHIRTS, JERSEYS, SHORTS, SWEAT PANTS, JACKETS, JEANS, HATS, CAPS, SCARVES, GLOVES, HOSIERY, NECKTIES, PAJAMAS, ROBES, NIGHT SHIRTS, NIGHT GOWNS, UNDERWEAR, HEAD BANDS, WRIST BANDS, SWIM SUITS, SKIRTS, SHIRTS, TANK TOPS, PANTS, COATS, SWEATERS, LEOTARDS, LEG WARMERS, STOCKINGS, SOCKS, PANTYHOSE, TIGHTS, BELTS, FOOTWEAR, NAMELY, SHOES, ATHLETIC SHOES, SLIPPERS, BOOTS AND SANDALS (U.S. CLS. 22 AND 39).

CLASS 28—TOYS AND SPORTING GOODS

FOR ACTION FIGURES, AND ACCESSORIES THEREFOR, ACTION SKILL GAMES, STUFFED TOY ANIMALS, BALLOONS, TOY BANKS, BATH TOYS, BATHTUB TOYS, BOARD GAMES, CARD GAMES, CASES FOR PLAY ACCESSORIES, ACTION FIGURE OR PLAY FIGURE CLOTHING, DOLL CLOTHING, COSTUME MASKS, DOLL COSTUMES, DOLLS AND DOLL ACCESSORIES, DOLL CASES, STUFFED TOYS, DOLL COSTUMES, BEAN BAG DOLLS, RAG DOLLS, SOFT SCULPTURE DOLLS, DOLLS AND PLAYSETS THEREFOR, PARTY FAVORS IN THE NATURE OF NOISEMAKERS AND SMALL TOYS, PLAY FIGURES, ROLE PLAYING GAMES, DOLL HOUSE FURNISHINGS, JIGSAW PUZZLES, KITES, MUSIC BOX TOYS, MUSICAL TOYS, PLUSH TOYS, SOFT SCULPTURE PLUSH TOYS, PROMOTIONAL GAME MATERIALS, PUPPETS, THREE DIMENSIONAL CUBE-TYPE PUZZLES, PUZZLES, CHILDREN'S MULTIPLE ACTIVITY TOYS, SQUEEZABLE SQUEAKING TOYS, WIND-UP WALKING TOYS, WIND-UP TOYS, AND ELECTRONIC HAND-HELD GAMES (U.S. CLS. 22, 23, 38 AND 50).

CLASS 41—EDUCATION AND ENTERTAINMENT

FOR ENTERTAINMENT AND EDUCATION SERVICES, NAMELY, A SERIES OF ANIMATED AND LIVE-ACTION TELEVISION PROGRAMS AND MOTION PICTURES, ON-LINE COMPUTER GAMES, AND FOR PROVIDING A WEBSITE FEATURING ELECTRONIC GAME CONTENT AND INFORMATION RELATED TO ALL OF THE FOREGOING (U.S. CLS. 100, 101 AND 107).
H. M. FISHER, EXAMINING ATTORNEY

SN 76-675,982. AMERICAN PSYCHOLOGICAL ASSOCIATION, WASHINGTON, DC. FILED 4-25-2007.

CPSE

THE MARK CONSISTS OF STANDARD CHARACTERS WITHOUT CLAIM TO ANY PARTICULAR FONT, STYLE, SIZE, OR COLOR.

CLASS 9—ELECTRICAL AND SCIENTIFIC APPARATUS

FOR DOWNLOADABLE ELECTRONIC PUBLICATIONS IN THE FIELD OF PSYCHOLOGY AND THE APPLICATION OF PSYCHOLOGY TO EDUCATION (U.S. CLS. 21, 23, 26, 36 AND 38).

FIRST USE 3-14-1996; IN COMMERCE 3-14-1996.

CLASS 35—ADVERTISING AND BUSINESS

FOR PROMOTING THE PUBLIC AWARENESS FOR THE IMPORTANCE OF HIGH QUALITY APPLICATION OF PSYCHOLOGY TO PROGRAMS AND POLICIES FOR SCHOOLS AND EDUCATION (U.S. CLS. 100, 101 AND 102).

FIRST USE 12-0-1995; IN COMMERCE 12-0-1995.

CLASS 41—EDUCATION AND ENTERTAINMENT

FOR EDUCATIONAL TRAINING AND WORKSHOPS IN THE FIELD OF PSYCHOLOGY AND THE APPLICATION OF PSYCHOLOGY TO EDUCATION; EDUCATIONAL RESEARCH IN THE FIELD OF PSYCHOLOGY, AND DEVELOPMENT AND DISSEMINATION OF EDUCATIONAL MATERIALS OF OTHERS IN THE FIELD OF PSYCHOLOGY (U.S. CLS. 100, 101 AND 107).

FIRST USE 12-0-1995; IN COMMERCE 12-0-1995.
JOHN DWYER, EXAMINING ATTORNEY

SN 76-676,051. FLEMING, JOSEPH, NEW YORK, NY. FILED 4-26-2007.

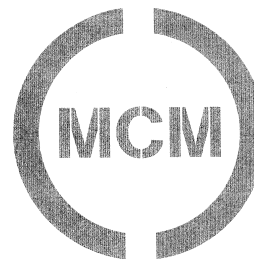

We Make Music With a Conscious Message

CLASS 9—ELECTRICAL AND SCIENTIFIC APPARATUS

FOR CD AND ALBUM COVERS, NAMELY, CD CASES; MUSICAL SOUND RECORDINGS, MUSICAL VIDEO RECORDINGS VIDEO RECORDINGS FEATURING MUSIC (U.S. CLS. 21, 23, 26, 36 AND 38).

CLASS 16—PAPER GOODS AND PRINTED MATTER

FOR POSTERS (U.S. CLS. 2, 5, 22, 23, 29, 37, 38 AND 50).

SARA THOMAS, EXAMINING ATTORNEY

SN 76-676,212. AMERICAN PSYCHOLOGICAL ASSOCIATION, WASHINGTON, DC. FILED 4-30-2007.

CGEP

THE MARK CONSISTS OF STANDARD CHARACTERS WITHOUT CLAIM TO ANY PARTICULAR FONT, STYLE, SIZE, OR COLOR.

CLASS 9—ELECTRICAL AND SCIENTIFIC APPARATUS

FOR DOWNLOADABLE ELECTRONIC PUBLICATIONS IN THE FIELDS OF PSYCHOLOGY AND EDUCATION (U.S. CLS. 21, 23, 26, 36 AND 38).

FIRST USE 0-0-2000; IN COMMERCE 0-0-2000.

CLASS 35—ADVERTISING AND BUSINESS

FOR PROMOTING PUBLIC AWARENESS OF THE NEED FOR THE ENHANCEMENT IN ACHIEVEMENT AND PERFORMANCE OF CHILDREN AND ADOLESCENTS WITH SPECIAL GIFTS AND TALENTS (U.S. CLS. 100, 101 AND 102).

FIRST USE 0-0-2003; IN COMMERCE 0-0-2003.

CLASS 41—EDUCATION AND ENTERTAINMENT

FOR EDUCATIONAL RESEARCH IN THE AREA OF CHILDREN AND ADOLESCENTS WITH SPECIAL GIFTS AND TALENTS, NAMELY, THE ACADEMIC DISCIPLINES, ARTS, SPORTS AND THE PROFESSIONS, AND DISSEMINATION OF EDUCATIONAL MATERIALS THEREWITH; PROVIDING AN ONLINE COMPUTER DATABASE IN THE FIELD OF EDUCATIONAL POLICY; EDUCATIONAL SERVICES, NAMELY, CONDUCTING PROGRAMS IN THE FIELD OF CHILDREN AND ADOLESCENTS WITH SPECIAL GIFTS AND TALENTS, NAMELY, THE ACADEMIC DISCIPLINES, ARTS, SPORTS AND THE PROFESSIONS (U.S. CLS. 100, 101 AND 107).

FIRST USE 0-0-2001; IN COMMERCE 0-0-2003.
KEVON CHISOLM, EXAMINING ATTORNEY

SN 76-677,205. A-TRAIN MARKETING COMMUNICATIONS, INC., FORT COLLINS, CO. FILED 5-21-2007.

a-train
marketing communications inc.

NO CLAIM IS MADE TO THE EXCLUSIVE RIGHT TO USE "MARKETING COMMUNICATIONS INC.", APART FROM THE MARK AS SHOWN.

CLASS 35—ADVERTISING AND BUSINESS

FOR PROVIDING ADVERTISING, MARKETING, PROMOTION SERVICES, MARKET RESEARCH SERVICES, AND PUBLIC RELATIONS SERVICES; DEVELOPMENT OF MARKETING STRATEGIES AND CONCEPTS (U.S. CLS. 100, 101 AND 102).

FIRST USE 9-1-2005; IN COMMERCE 1-1-2006.

CLASS 42—SCIENTIFIC AND COMPUTER SERVICES

FOR DESIGN OF HOMEPAGES AND WEB-SITES (U.S. CLS. 100 AND 101).

FIRST USE 9-1-2005; IN COMMERCE 1-1-2006.
LAURIE MAYES, EXAMINING ATTORNEY

SN 76-677,006. AMERICAN PSYCHOLOGICAL ASSOCIATION, WASHINGTON, DC. FILED 5-17-2007.

PTN

THE MARK CONSISTS OF STANDARD CHARACTERS WITHOUT CLAIM TO ANY PARTICULAR FONT, STYLE, SIZE, OR COLOR.

CLASS 9—ELECTRICAL AND SCIENTIFIC APPARATUS

FOR DOWNLOADABLE NEWSLETTERS AND ARTICLES DIRECTED TO TEACHERS OF PSYCHOLOGY IN THE AREA OF PSYCHOLOGY AND THE SOCIAL SCIENCE (U.S. CLS. 21, 23, 26, 36 AND 38).

FIRST USE 10-0-1991; IN COMMERCE 10-0-1991.

CLASS 16—PAPER GOODS AND PRINTED MATTER

FOR PRINTED PUBLICATIONS, NAMELY, NEWSLETTERS AND ARTICLES DIRECTED TO TEACHERS OF PSYCHOLOGY IN THE AREA OF PSYCHOLOGY AND THE SOCIAL SCIENCES (U.S. CLS. 2, 5, 22, 23, 29, 37, 38 AND 50).

FIRST USE 10-0-1991; IN COMMERCE 10-0-1991.
KEVON CHISOLM, EXAMINING ATTORNEY

SN 76-678,261. KBC AMERICA, INC., DBA SONIC RACING SPORTS, BURBANK, CA. FILED 6-14-2007.

RIDE AS FAST AS YOUR GUARDIAN ANGEL CAN FLY

THE MARK CONSISTS OF STANDARD CHARACTERS WITHOUT CLAIM TO ANY PARTICULAR FONT, STYLE, SIZE, OR COLOR.

CLASS 9—ELECTRICAL AND SCIENTIFIC APPARATUS

FOR MOTORCYCLE HELMETS; LEATHER AND TEXTILE BODY PROTECTORS FOR MOTORCYCLE RIDERS (U.S. CLS. 21, 23, 26, 36 AND 38).

CLASS 12—VEHICLES

FOR PANNIER BAGS, SISSYBAR BAGS, TOURING BAGS, TANK BAGS, SEAT TOP BAGS, SADDLEBAG TOP BAGS, SADDLEBAGS, ROLL BAGS AND TOOL BAGS, ALL SPECIALLY DESIGNED FOR USE WITH MOTORCYCLES (U.S. CLS. 19, 21, 23, 31, 35 AND 44).

CLASS 25—CLOTHING

FOR CLOTHING, NAMELY, BOOTS, SHOES, GLOVES, WET SUITS, LEATHER PANTS, JACKETS AND VESTS, AND TEXTILE PANTS, JACKETS AND VESTS (U.S. CLS. 22 AND 39).

CLASS 35—ADVERTISING AND BUSINESS

FOR ON-LINE RETAIL AND WHOLESALE STORE SERVICES AND RETAIL AND WHOLESALE STORE SERVICES FEATURING HELMETS, BAGS, LEATHER AND TEXTILE BODY PROTECTORS FOR MOTORCYCLE RIDERS, AND CLOTHING, NAMELY, BOOTS, SHOES, GLOVES, WET SUITS, LEATHER PANTS, JACKETS, AND VESTS, AND TEXTILE PANTS, JACKETS, AND VESTS (U.S. CLS. 100, 101 AND 102).

APRIL ROACH, EXAMINING ATTORNEY

SN 76-679,486. RUSSELL MARKETING INC., BRAMPTON, ONTARIO, CANADA, FILED 7-13-2007.

SN 76-679,645. AS FOUR INC., NEW YORK, NY. FILED 7-19-2007.

MR. RICE

THE MARK CONSISTS OF STANDARD CHARACTERS WITHOUT CLAIM TO ANY PARTICULAR FONT, STYLE, SIZE, OR COLOR.

CLASS 29—MEATS AND PROCESSED FOODS

FOR SOUP (U.S. CL. 46).

CLASS 30—STAPLE FOODS

FOR RICE, SEASONED RICE, DEHYDRATED RICE MEALS, RICE-BASED SNACK FOODS, AND DEHYDRATED SEASONED RICE FOR MAKING SOUP (U.S. CL. 46).

ANNE E. GUSTASON, EXAMINING ATTORNEY

SN 76-679,517. PRINGLE & ZIMRING DESIGN GROUP, INC., NEW YORK, NY. FILED 7-16-2007.

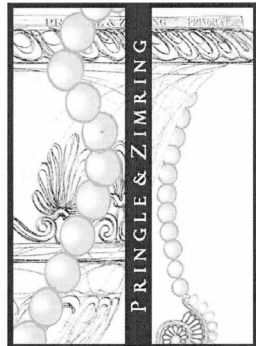

THE NAME "PRINGLE & ZIMRING" IDENTIFIES A LIVING INDIVIDUAL WHOSE CONSENT IS OF RECORD. THE MARK CONSISTS OF THE WORDING "PRINGLE & ZIMRING" ON A VERTICAL STRIPE IN FRONT OF A VASE WITH A PEARL NECKLACE DRAPED OVER THE TOP OF THE VASE.

CLASS 14—JEWELRY

FOR WORKS OF ART OF PRECIOUS METAL (U.S. CLS. 2, 27, 28 AND 50).
FIRST USE 7-1-2005; IN COMMERCE 7-1-2005.

CLASS 35—ADVERTISING AND BUSINESS

FOR RETAIL STORE SERVICES FEATURING FINE JEWELRY AND ACCESSORIES; ONLINE RETAIL STORE SERVICES FEATURING FINE JEWELRY AND ACCESSORIES, GIFT REGISTRY SERVICES (U.S. CLS. 100, 101 AND 102).
FIRST USE 7-1-2005; IN COMMERCE 7-1-2005.
ANGELA GAW, EXAMINING ATTORNEY

AS FOUR

THE MARK CONSISTS OF STANDARD CHARACTERS WITHOUT CLAIM TO ANY PARTICULAR FONT, STYLE, SIZE, OR COLOR.

CLASS 25—CLOTHING

FOR FASHION APPAREL, NAMELY, SHIRTS, PANTS, DRESSES, TOPS, SKIRTS, SWEATERS, SHOES (U.S. CLS. 22 AND 39).

CLASS 35—ADVERTISING AND BUSINESS

FOR RETAIL STORE SERVICES FEATURING CLOTHING, CLOTHING ACCESSORIES (U.S. CLS. 100, 101 AND 102).
BERNICE MIDDLETON, EXAMINING ATTORNEY

SN 76-680,382. THIRSTY EAR, INC., BOZEMAN, MT. FILED 8-6-2007.

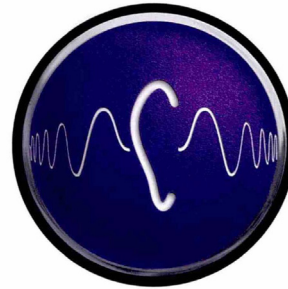

THIRSTY EAR HI-FI

NO CLAIM IS MADE TO THE EXCLUSIVE RIGHT TO USE "HI-FI", APART FROM THE MARK AS SHOWN.

THE COLOR(S) VIOLET, BLACK, WHITE AND GRAY IS/ARE CLAIMED AS A FEATURE OF THE MARK.

THE MARK CONSISTS A BLACK CIRCLE, WITH A GRAY INSIDE BORDER, ENCIRCLING A VIOLET FILLED CIRCLE WITH A WHITE "EAR" CENTERED WITHIN THE VIOLET FILLED CIRCLE AND WITH A WHITE SOUND WAVE MOVING PERPENDICULARLY THROUGH THE CENTER OF THE WHITE "EAR" AND MOVING HORIZONTALLY THROUGH THE MIDDLE OF THE VIOLET FILLED CIRCLE, WITH THE WORDS "THIRSTY EAR HI-FI" IN BLACK LETTERING BENEATH IT.

CLASS 35—ADVERTISING AND BUSINESS

FOR RETAIL STORE SERVICES FEATURING CONSUMER ELECTRONICS, HOME ENTERTAINMENT DEVICES AND HOME THEATER LIGHTING, FURNITURE AND FURNISHINGS (U.S. CLS. 100, 101 AND 102).
FIRST USE 3-31-1978; IN COMMERCE 3-31-1978.

CLASS 37—CONSTRUCTION AND REPAIR

FOR INSTALLATION OF HOME THEATERS, HOME THEATER ELECTRONIC DEVICES AND HOME THEATER LIGHTING, FURNITURE AND FURNISHINGS (U.S. CLS. 100, 103 AND 106).
FIRST USE 3-31-1978; IN COMMERCE 3-31-1978.
SUSAN LESLIE DUBOIS, EXAMINING ATTORNEY

SN 76-682,358. JORDNY, REI, LTD., VENTURA, CA. FILED 9-27-2007.

JORDNY

THE MARK CONSISTS OF STANDARD CHARACTERS WITHOUT CLAIM TO ANY PARTICULAR FONT, STYLE, SIZE, OR COLOR.

CLASS 25—CLOTHING

FOR MEN'S AND BOY'S WEARING APPAREL, NAMELY, T-SHIRTS, SWEATSHIRTS, TANK TOPS, WOVEN SHIRTS, SWEATERS, CARDIGANS, VESTS, JACKETS, PANTS, SWEAT PANTS, JEANS, SHORTS, HATS, CAPS, COATS, SCARVES, NECKERCHIEFS, NECK BANDS, WRIST BANDS, HEAD BANDS, GLOVES, BELTS, PAJAMAS, SHOES, SOCKS, UNDERWEAR, SWIM WEAR, AND TRUNKS; AND WOMEN'S AND GIRL'S WEARING APPAREL, NAMELY, T-SHIRTS, SWEATSHIRTS, TANK TOPS, WOVEN SHIRTS, SWEATERS, CARDIGANS, VESTS, JACKETS, PANTS, SWEAT PANTS, JEANS, SHORTS, HATS, CAPS, COATS, BELTS, SCARVES, NECKERCHIEFS, NECK BANDS, WRIST BANDS, HEAD BANDS, GLOVES, PAJAMAS, SHOES, SOCKS, UNDERWEAR, FOUNDATION GARMENTS, PANTYHOSE, TEDDIES, BRAS, SKIRTS, DRESSES, BLOUSES, SWIM WEAR, AND BIKINIS (U.S. CLS. 22 AND 39).

CLASS 35—ADVERTISING AND BUSINESS

FOR INDEPENDENT SALES REPRESENTATIVE SERVICES IN THE FIELD OF REAL ESTATE (U.S. CLS. 100, 101 AND 102).

CLASS 36—INSURANCE AND FINANCIAL

FOR MORTGAGE BROKERAGE AND FINANCING SERVICES AND MORTGAGE LENDING SERVICES (U.S. CLS. 100, 101 AND 102).
LEE-ANNE BERNS, EXAMINING ATTORNEY

SN 76-682,516. NOROOZ PRODUCTIONS, LLC, NEW YORK, NY. FILED 10-2-2007.

MIXED NUTZ

THE MARK CONSISTS OF STANDARD CHARACTERS WITHOUT CLAIM TO ANY PARTICULAR FONT, STYLE, SIZE, OR COLOR.

CLASS 9—ELECTRICAL AND SCIENTIFIC APPARATUS

FOR DVD'S, VIDEOTAPES, CD'S AND AUDIOTAPES FEATURING ANIMATED CHARACTERS FOR CHILDREN'S VIEWING; HAND-HELD UNITS FOR PLAYING ELECTRONIC GAMES FOR USE WITH EXTERNAL DISPLAY SCREEN OR MONITOR; VIDEO GAME MACHINES FOR USE WITH TELEVISION (U.S. CLS. 21, 26, 36 AND 38).

CLASS 16—PAPER GOODS AND PRINTED MATTER

FOR CHILDREN'S BOOKS, COMIC BOOKS AND EDUCATIONAL BOOKS FEATURING ANIMATED CHARACTERS FOR CHILDREN'S READING (U.S. CLS. 2, 5, 22, 23, 29, 37, 38 AND 50).

CLASS 25—CLOTHING

FOR CHILDREN'S CLOTHING, NAMELY, SHIRTS, T-SHIRTS, SOCKS, UNDERWEAR, PANTS, JACKETS, SWEATSHIRTS, SWEATPANTS, SHORTS, HATS, BELTS (U.S. CLS. 22 AND 39).

CLASS 28—TOYS AND SPORTING GOODS

FOR TOYS, NAMELY, PLUSH TOYS, MOLDED AND ACTION FIGURES, BOARD GAMES, ELECTRONIC GAMES OTHER THAN THOSE ADAPTED FOR USE WITH TELEVISION RECEIVERS ONLY, AND ARCADE-TYPE ELECTRONIC VIDEO GAMES (U.S. CLS. 22, 23, 38 AND 50).

CLASS 41—EDUCATION AND ENTERTAINMENT

FOR ENTERTAINMENT SERVICES IN THE NATURE OF ON-GOING TELEVISION PROGRAMS IN THE FIELD OF CHILDREN'S ENTERTAINMENT; PRODUCTION OF DVD'S, VIDEOTAPES AND TELEVISION PROGRAMS FEATURING CARTOON AND COMIC BOOK CHARACTERS (U.S. CLS. 100, 101 AND 107).

GINA HAYES, EXAMINING ATTORNEY

SN 76-682,517. ERA DESIGN, LTD., BROOKLYN, NY. FILED 10-2-2007.

DON'T BE SHY, SHINE!

THE MARK CONSISTS OF STANDARD CHARACTERS WITHOUT CLAIM TO ANY PARTICULAR FONT, STYLE, SIZE, OR COLOR.

CLASS 9—ELECTRICAL AND SCIENTIFIC APPARATUS

FOR SUNGLASSES AND EYEGLASSES (U.S. CLS. 21, 23, 26, 36 AND 38).

CLASS 14—JEWELRY

FOR WATCHES (U.S. CLS. 2, 27, 28 AND 50).

CLASS 16—PAPER GOODS AND PRINTED MATTER

FOR BALLPOINT PENS (U.S. CLS. 2, 5, 22, 23, 29, 37, 38 AND 50).

GINA HAYES, EXAMINING ATTORNEY

SN 76-683,396. PLAYHUT, INC., CITY OF INDUSTRY, CA.
FILED 10-29-2007.

SN 76-684,886. CELLULAR TECHNOLOGIES LIMITED,
SHAKER HEIGHTS, OH. FILED 12-13-2007.

GOLIVE2 STIX

THE MARK CONSISTS OF STANDARD CHARACTERS WITHOUT CLAIM TO ANY PARTICULAR FONT, STYLE, SIZE, OR COLOR.

NO CLAIM IS MADE TO THE EXCLUSIVE RIGHT TO USE "STICKS", APART FROM THE MARK AS SHOWN.

CLASS 9—ELECTRICAL AND SCIENTIFIC APPARATUS

FOR COMPUTER STYLUS; CHILDREN'S EDUCATIONAL SOFTWARE; DVD PLAYERS; ELECTRONIC PERSONAL ORGANIZER; MOBILE TELEPHONES; PERSONAL DIGITAL ASSISTANTS; TELEVISION MONITORS; TELEVISION SETS; TOUCH PADS; TOUCH PANELS; COMPUTER TOUCH SCREENS; TRACK-BALLS; COMPUTER MOUSE; CAMERAS; VIDEO GAME CARTRIDGES; COMPUTER GAME CARTRIDGES; COMPUTER GAME CASSETTES; COMPUTER GAME DISCS; COMPUTER GAME SOFTWARE; ELECTRONIC AND VIDEO GAME CONTROLLERS INCORPORATED INTO EXERCISE MACHINES; ELECTRONIC GAME PROGRAMS; ELECTRONIC GAME SOFTWARE FOR CELLULAR TELEPHONES; ELECTRONIC GAME SOFTWARE FOR HANDHELD ELECTRONIC DEVICES; PLAYER-OPERATED ELECTRONIC CONTROLLERS FOR ELECTRONIC VIDEO GAME MACHINES; VIDEO GAME INTERACTIVE HAND HELD REMOTE CONTROLS FOR PLAYING ELECTRONIC GAMES (U.S. CLS. 21, 23, 26, 36 AND 38).

CLASS 28—TOYS AND SPORTING GOODS

FOR ACTION SKILL GAMES; ACTION TARGET GAMES; ARCADE-TYPE ELECTRONIC EDUCATION VIDEO GAMES; BABY AND CHILDREN'S MULTIPLE ACTIVITY TOYS; BALLS FOR GAMES; BATTERY OPERATED ACTION TOYS; BOARD GAMES; CARD GAMES; CONSTRUCTION TOYS; DICE GAMES; DOLLS AND ACCESSORIES THEREFOR; DOLL CASES; DOLL CLOTHING; DOLL COSTUMES; DOLL FURNITURE; DOLL HOUSE FURNISHINGS; DOLL HOUSES; DOLLS AND PLAYSETS THEREFOR; ELECTRIC ACTION TOYS; ELECTRONIC EDUCATIONAL GAME MACHINES FOR CHILDREN; ELECTRONIC LEARNING TOYS; EQUIPMENT SOLD AS A UNIT FOR PLAYING BOARD GAMES; EQUIPMENT SOLD AS A UNIT FOR PLAYING CARD GAMES; EQUIPMENT SOLD AS A UNIT FOR PLAYING A MEMORY GAME; EQUIPMENT SOLD AS A UNIT FOR PLAYING ACTION TYPE TARGET GAMES; FANTASY CHARACTER TOYS; HAND HELD UNIT FOR PLAYING ELECTRONIC GAMES; HAND HELD UNIT FOR PLAYING VIDEO GAMES; HEADGEAR FOR DOLLS; INFANT DEVELOPMENT TOYS; INFANT TOYS; JIGSAW PUZZLES; MANIPULATIVE GAMES; MECHANICAL TOYS; MODEL CARS; MODELED PLASTIC TOY FIGURINES; MOLDED TOY FIGURES; PLAY HOUSES; PLAY TENTS; PLAY TUNNELS; PLAYSETS FOR DOLLS; PLUSH TOYS; PORCELAIN DOLLS; POSITIONABLE TOY FIGURES FOR USE IN GAMES AND PUZZLES; POSITIONABLE TWO DIMENSIONAL TOYS FOR USE IN GAMES; ROLE PLAYING GAMES; SPORT BALLS; STAND ALONE VIDEO GAME MACHINES; STATIONARY EXERCISE BICYCLES; STUFFED DOLLS, TOYS AND TOY ANIMALS; TABLETOP UNITS FOR PLAYING ELECTRONIC GAMES OTHER THAN IN CONJUNCTION WITH A TELEVISION OR COMPUTER; TALKING TOYS; TARGET GAMES; TOY ACTION FIGURES AND ACCESSORIES THEREFOR; TOY HOUSES; TOY MODEL CARS; TOY VEHICLES; TRADING CARD GAMES (U.S. CLS. 22, 23, 38 AND 50).

ALYSSA PALADINO, EXAMINING ATTORNEY

IMMUNOSPOT

THE MARK CONSISTS OF STANDARD CHARACTERS WITHOUT CLAIM TO ANY PARTICULAR FONT, STYLE, SIZE, OR COLOR.

CLASS 5—PHARMACEUTICALS

FOR MEDICAL DIAGNOSTIC KITS COMPRISED OF REAGENTS AND ASSAY PLATES FOR CLINICAL OR MEDICAL LABORATORY USE (U.S. CLS. 6, 18, 44, 46, 51 AND 52).

FIRST USE 2-1-1998; IN COMMERCE 2-1-1998.

CLASS 9—ELECTRICAL AND SCIENTIFIC APPARATUS

FOR LABORATORY EQUIPMENT, NAMELY, AUTOMATED IMMUNOASSAY ANALYZERS AND PARTS THEREFOR FOR SCIENTIFIC RESEARCH (U.S. CLS. 21, 23, 26, 36 AND 38).

FIRST USE 2-1-1998; IN COMMERCE 2-1-1998.

CLASS 10—MEDICAL APPARATUS

FOR MEDICAL EQUIPMENT, NAMELY, AUTOMATED IMMUNOASSAY ANALYZERS AND PARTS THEREFOR FOR MEDICAL DIAGNOSIS (U.S. CLS. 26, 39 AND 44).

FIRST USE 2-1-1998; IN COMMERCE 2-1-1998.

TASNEEM HUSSAIN, EXAMINING ATTORNEY

SN 77-000,492. GRO-GROUP INTERNATIONAL LIMITED,
ASHBURTON, DEVON, TQ13 7UP, ENGLAND, FILED 9-15-2006.

TIME OUT TRAINER

THE MARK CONSISTS OF STANDARD CHARACTERS WITHOUT CLAIM TO ANY PARTICULAR FONT, STYLE, SIZE, OR COLOR.

NO CLAIM IS MADE TO THE EXCLUSIVE RIGHT TO USE "TIME OUT", APART FROM THE MARK AS SHOWN.

CLASS 20—FURNITURE AND ARTICLES NOT OTHERWISE CLASSIFIED

FOR MATTRESSES; CUSHIONS; MATTRESSES INCORPORATING ELECTRONICS; CUSHIONS INCORPORATING ELECTRONICS (U.S. CLS. 2, 13, 22, 25, 32 AND 50).

CLASS 27—FLOOR COVERINGS

FOR NON-SLIP PERSONAL SITTING MATS; NON-SLIP PERSONAL SITTING MATS INCORPORATING ELECTRONICS (U.S. CLS. 19, 20, 37, 42 AND 50).

BRENDAN REGAN, EXAMINING ATTORNEY

SN 77-000,604. THE SENERA COMPANY INC., NORTH WOODMERE, UNITED STATES, FILED 9-15-2006.

THE SENERA COMPANY

THE MARK CONSISTS OF STANDARD CHARACTERS WITHOUT CLAIM TO ANY PARTICULAR FONT, STYLE, SIZE, OR COLOR.

NO CLAIM IS MADE TO THE EXCLUSIVE RIGHT TO USE "COMPANY", APART FROM THE MARK AS SHOWN.

CLASS 25—CLOTHING

FOR WOMEN'S AND GIRLS' WEARING APPAREL, NAMELY, TOPS, TROUSERS, SKIRTS, SHORTS, DRESSES, SCARVES, JACKETS, SWEATERS, COATS AND SCARVES (U.S. CLS. 22 AND 39).

FIRST USE 9-1-2006; IN COMMERCE 9-1-2006.

CLASS 35—ADVERTISING AND BUSINESS

FOR ADVERTISING SERVICES, NAMELY, PROMOTING GOODS OF OTHERS (U.S. CLS. 100, 101 AND 102).

FIRST USE 6-1-2005; IN COMMERCE 6-1-2005.
JOHN WILKE, EXAMINING ATTORNEY

SN 77-001,475. REAL GIRLS MEDIA NETWORK, INC., SAN FRANCISCO, CA. FILED 9-18-2006.

DIVINE CAROLINE

THE MARK CONSISTS OF STANDARD CHARACTERS WITHOUT CLAIM TO ANY PARTICULAR FONT, STYLE, SIZE, OR COLOR.

THE NAME "DIVINE CAROLINE" DOES NOT IDENTIFY A LIVING INDIVIDUAL.

CLASS 35—ADVERTISING AND BUSINESS

FOR PROVIDING ONLINE INFORMATION SERVICES ON TOPICS OF INTEREST TO WOMEN, NAMELY, CAREER INFORMATION (U.S. CLS. 100, 101 AND 102).

FIRST USE 1-30-2007; IN COMMERCE 1-30-2007.

CLASS 36—INSURANCE AND FINANCIAL

FOR PROVIDING ONLINE INFORMATION SERVICES ON TOPICS OF INTEREST TO WOMEN, NAMELY, FINANCIAL INFORMATION, AND FINANCIAL INFORMATION IN THE FIELD OF INVESTING AND SAVING (U.S. CLS. 100, 101 AND 102).

FIRST USE 1-30-2007; IN COMMERCE 1-30-2007.

CLASS 41—EDUCATION AND ENTERTAINMENT

FOR PROVIDING ONLINE INFORMATION SERVICES ON TOPICS OF INTEREST TO WOMEN, NAMELY, INFORMATION IN THE FIELD OF PARENTING CONCERNING EDUCATION AND ENTERTAINMENT OF CHILDREN, AND ENTERTAINMENT INFORMATION CONCERNING MUSIC, MOVIES, BOOK REVIEWS, TELEVISION AND FINE ARTS (U.S. CLS. 100, 101 AND 107).

FIRST USE 1-30-2007; IN COMMERCE 1-30-2007.

CLASS 44—MEDICAL, BEAUTY AND AGRICULTURAL SERVICES

FOR PROVIDING ONLINE INFORMATION SERVICES ON TOPICS OF INTEREST TO WOMEN, NAMELY, HEALTH, AND INFORMATION IN THE FIELD OF PARENTING CONCERNING THE HEALTH OF CHILDREN (U.S. CLS. 100 AND 101).

FIRST USE 1-30-2007; IN COMMERCE 1-30-2007.

CLASS 45—PERSONAL AND LEGAL SERVICES

FOR PROVIDING ONLINE INFORMATION SERVICES ON TOPICS OF INTEREST TO WOMEN, NAMELY, INFORMATION IN THE FIELDS OF PERSONAL RELATIONSHIPS, INTRAFAMILY RELATIONSHIPS, PERSONAL RELATIONSHIPS WITH FAMILY AND FRIENDS, AND FASHION (U.S. CLS. 100 AND 101).

FIRST USE 1-30-2007; IN COMMERCE 1-30-2007.

MARY MUNSON, EXAMINING ATTORNEY

SN 77-007,853. OPENHYDRO GROUP LIMITED, DUBLIN, IRELAND, FILED 9-26-2006.

OpenHydro

THE MARK CONSISTS OF STANDARD CHARACTERS WITHOUT CLAIM TO ANY PARTICULAR FONT, STYLE, SIZE, OR COLOR.

PRIORITY CLAIMED UNDER SEC. 44(D) ON ERPNTY TM OFC APPLICATION NO. 4980827, FILED 3-27-2006, REG. NO. 004980827, DATED 5-31-2007, EXPIRES 3-27-2016.

CLASS 7—MACHINERY

FOR GENERATORS OF ELECTRICITY; TURBINE ELECTRICITY GENERATING MACHINES; TIDAL TURBINE ELECTRICITY GENERATING MACHINES; HYDROELECTRIC APPARATUS, NAMELY, HYDROPOWERED ELECTRICITY GENERATORS AND TURBINES USED IN TIDAL, RIVER, RUN OF RIVER AND DAM INSTALLATIONS (U.S. CLS. 13, 19, 21, 23, 31, 34 AND 35).

CLASS 37—CONSTRUCTION AND REPAIR

FOR INSTALLATION AND MAINTENANCE OF ELECTRICITY GENERATORS; INSTALLATION AND MAINTENANCE OF HYDROELECTRIC APPARATUS; INSTALLATION AND MAINTENANCE OF TURBINE ELECTRICITY GENERATING APPARATUS (U.S. CLS. 100, 103 AND 106).

CLASS 40—MATERIAL TREATMENT

FOR GENERATION OF ELECTRICITY; HYDROELECTRIC GENERATION OF ELECTRICITY (U.S. CLS. 100, 103 AND 106).

CLASS 42—SCIENTIFIC AND COMPUTER SERVICES

FOR LICENSING SERVICES, NAMELY, INTELLECTUAL PROPERTY LICENSING; LICENSING OF MARINE TURBINE TECHNOLOGY, TECHNOLOGY RELATED TO MANUFACTURE OF TURBINES, LICENSING OF ELECTRICAL GENERATION TECHNOLOGY AND LICENSING OF INSTALLATION AND MAINTENANCE SERVICES RELATING TO TIDAL SYSTEMS (U.S. CLS. 100 AND 101).

NATALIE POLZER, EXAMINING ATTORNEY

SN 77-008,594, HUNTER DEMOLITION & WRECKING CORPORATION, JOURDANTON, TX. FILED 9-27-2006.

HUNTER DEMOLITION & WRECKING CORPORATION

THE MARK CONSISTS OF STANDARD CHARACTERS WITHOUT CLAIM TO ANY PARTICULAR FONT, STYLE, SIZE, OR COLOR.

NO CLAIM IS MADE TO THE EXCLUSIVE RIGHT TO USE DEMOLITION AND WRECKING CORPORATION, APART FROM THE MARK AS SHOWN.

CLASS 37—CONSTRUCTION AND REPAIR

FOR ASBESTOS REMOVAL; BUILDING DEMOLITION; HOUSE AND BUILDING DEMOLITION (U.S. CLS. 100, 103 AND 106).

FIRST USE 0-0-1988; IN COMMERCE 0-0-1988.

CLASS 40—MATERIAL TREATMENT

FOR DEMOLITION SERVICES (U.S. CLS. 100, 103 AND 106).

FIRST USE 0-0-1988; IN COMMERCE 0-0-1988.

ALYSSA PALADINO, EXAMINING ATTORNEY

SN 77-009,817, KOZINN, LISA, NEW YORK, NY. FILED 9-28-2006.

RHINESTONE RUBY

THE MARK CONSISTS OF STANDARD CHARACTERS WITHOUT CLAIM TO ANY PARTICULAR FONT, STYLE, SIZE, OR COLOR.

CLASS 18—LEATHER GOODS

FOR UMBRELLAS; BAGS, NAMELY, ALL PURPOSE ATHLETIC AND CARRYING BAGS, BABY CARRYING BAGS, BEACH, BELT, BOOK, CHARM, CLUTCH, COSMETIC, DIAPER, DUFFEL AND TOTE BAGS; STRAPS, NAMELY, HARNESS, LEATHER, SHOULDER STRAPS, CARRYALL AND CARRYING CASES, HANDBAGS, HOLD ALLS, LUGGAGE AND THONG STRAPS (U.S. CLS. 1, 2, 3, 22 AND 41).

CLASS 25—CLOTHING

FOR APPAREL, NAMELY, FLIP FLOPS, HATS, VISORS, WEDGES, FOOTWEAR AND HEADWEAR, COATS, JACKETS, SWEATERS, SHIRTS, EVENING GOWNS, DRESSES, SKIRTS, PANTS, SHORTS, JEANS, BRASSIERES, BUSTIERS, PANTIES, GIRDLES, BODY SHAPERS, GARTER BELTS, TAP PANTS, TEDDIES, SLIPS, CAMISOLES, BRIEFS, BOXER SHORTS, UNDERSHIRTS, PAJAMAS, ROBES, NIGHTGOWNS, NIGHTSHIRTS, BIKINIS, SWIMWEAR SEPARATES, BATHING SUITS, BATHING TRUNKS, SARONGS, BEACH COVER-UPS, BATHING CAPS, TANK TOPS, T-SHIRTS, SWEAT SHIRTS, SWEAT PANTS, SURF SHORTS, RASH GUARDS, WETSUITS, HOSIERY, SOCKS, SLIPPERS, SANDALS, SHOES, CAPS, COLLARS, GLOVES, BELTS (U.S. CLS. 22 AND 39).

CLASS 35—ADVERTISING AND BUSINESS

FOR RETAIL STORE SERVICES, WHOLESALE DISTRIBUTORSHIP, ORDERING AND STORE SERVICES, MAIL ORDER CATALOG SERVICES, MAIL ORDER SERVICES, RETAIL SERVICES BY DIRECT SOLICITATION BY SALES AGENTS, COMPUTERIZED ON-LINE ORDERING SERVICES, RETAIL STORE SERVICES VIA THE TELEPHONE, AND RETAIL SHOP AT HOME PARTY SERVICES ALL FEATURING JEWELRY, JEWELRY ACCESSORIES, APPAREL, APPAREL ACCESSORIES, COSMETICS AND COSMETICS ACCESSORIES (U.S. CLS. 100, 101 AND 102).

JANICE L. MCMORROW, EXAMINING ATTORNEY

SN 77-010,100, AUTRY NATIONAL CENTER OF THE AMERICAN WEST, LOS ANGELES, CA. FILED 9-28-2006.

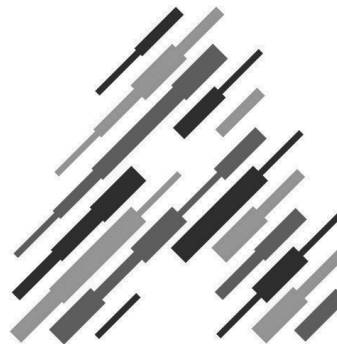
**CLASS 35—ADVERTISING AND BUSINESS**

FOR RETAIL STORE SERVICES FEATURING MERCHANDISE RELATED TO THE AUTRY NATIONAL CENTER'S COLLECTIONS AND EXHIBITS (U.S. CLS. 100, 101 AND 102).

FIRST USE 10-13-2003; IN COMMERCE 10-13-2003.

CLASS 41—EDUCATION AND ENTERTAINMENT

FOR MUSEUMS; REFERENCE LIBRARIES OF LITERATURE, ART, HISTORICAL AND DOCUMENTARY RECORDS; EDUCATIONAL SERVICES NAMELY, PROVIDING SEMINARS, LECTURES, CLASSES IN THE FIELD OF THE AMERICAN WEST, WESTERN HISTORY, ART AND ARTIFACTS RELATING TO HISTORY AND THE STUDY OF THE AMERICAN WEST; LIVE DRAMATIC AND MUSICAL PERFORMANCES BY AN INDIVIDUAL OR GROUP; SPECIAL EVENT PLANNING; CONDUCTING EDUCATIONAL EXHIBITS IN THE FIELD OF WESTERN HISTORY, ART AND ARTIFACTS RELATING TO THE HISTORY OF THE AMERICAN WEST (U.S. CLS. 100, 101 AND 107).

FIRST USE 1-1-2003; IN COMMERCE 1-1-2003.

CLASS 43—HOTEL AND RESTAURANT SERVICES

FOR RENTAL OF MEETING ROOMS AND VENUES FOR PARTIES AND SPECIAL EVENTS (U.S. CLS. 100 AND 101).

FIRST USE 10-13-2003; IN COMMERCE 10-13-2003.
ALYSSA PALADINO, EXAMINING ATTORNEY

SN 77-011,734. HLB INTERNATIONAL LIMITED, LONDON SW1W 0LD, UNITED KINGDOM, FILED 10-2-2006.

SN 77-011,300. DECATHLON, VILLENEUVE D'ASCQ, FRANCE, FILED 10-1-2006.

HLB

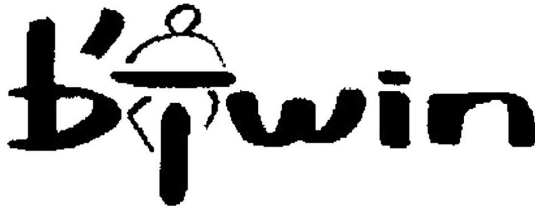

OWNER OF U.S. REG. NO. 2,790,077.

THE MARK CONSISTS OF THE LETTER "B" FOLLOWED BY AN APOSTROPHE FOLLOWED BY THE WORD "TWIN" WITH A HUMAN LIKE FIGURE SUPERIMPOSED ON THE LETTER "T".

THE MARK CONSISTS OF STANDARD CHARACTERS WITHOUT CLAIM TO ANY PARTICULAR FONT, STYLE, SIZE, OR COLOR.

OWNER OF ERPN CMNTY TM OFC REG. NO. 488296, DATED 12-23-1998, EXPIRES 2-28-2017.

CLASS 12—VEHICLES

FOR TIRES, BICYCLE SADDLES, TRAILERS FOR CHILDREN, TRAILERS FOR LUGGAGE, MUD-GUARDS, BICYCLE BAGS (U.S. CLS. 19, 21, 23, 31, 35 AND 44).

CLASS 18—LEATHER GOODS

FOR LUGGAGE; BACKPACKS; SPORT BAGS (U.S. CLS. 1, 2, 3, 22 AND 41).

CLASS 28—TOYS AND SPORTING GOODS

FOR GYMNASTIC AND SPORTING ARTICLES, NAMELY, STATIONARY CYCLES, STATIONARY BICYCLES, EXERCISE MACHINES, EXERCISE PLATFORMS, EXERCISE BENCHES, BAGS ESPECIALLY ADAPTED FOR SPORTS EQUIPMENT, ATHLETIC WRIST AND JOINT SUPPORTS, MOUTH GUARDS, KNEE GUARDS, SHIN GUARDS, ELBOW GUARDS, CASES FOR PLAY ACCESSORIES (U.S. CLS. 22, 23, 38 AND 50).

CLASS 39—TRANSPORTATION AND STORAGE

FOR RENTAL OF VEHICLES; RENTAL OF BICYCLES (U.S. CLS. 100 AND 105).

CLASS 41—EDUCATION AND ENTERTAINMENT

FOR SPORT AND CULTURAL ACTIVITIES IN THE NATURE OF CYCLING TRAINING CAMPS, INTRODUCTORY FORUMS TO CYCLING, ORGANIZATION OF CULTURAL OR EDUCATIONAL EXHIBITIONS IN THE FIELD OF CYCLING SPORTS; ORGANIZATION OF IMPROVEMENT COURSES IN THE FIELD OF CYCLING; ORGANIZATION OF SPORTING EVENTS, NAMELY, CYCLING RACES, CYCLING COMPETITIONS (U.S. CLS. 100, 101 AND 107).

JORDAN BAKER, EXAMINING ATTORNEY

CLASS 35—ADVERTISING AND BUSINESS

FOR ACCOUNTING SERVICES; DRAWING UP STATEMENTS OF ACCOUNT; COST PRICE ANALYSIS, BUSINESS APPRAISALS; BUSINESS MANAGEMENT ASSISTANCE; BUSINESS INVESTIGATIONS SERVICES; BUSINESS AUDITING SERVICES; BOOK-KEEPING SERVICES; BUSINESS CONSULTANCY SERVICES; BUSINESS MANAGEMENT AND ORGANIZATION CONSULTANCY SERVICES; BUSINESS MANAGEMENT ASSISTANCE SERVICES; BUSINESS RESEARCH SERVICES; BUSINESS INFORMATION SERVICES; BUSINESS INQUIRY SERVICES; BUSINESS MANAGEMENT ADVISORY SERVICES; BUSINESS MANAGEMENT CONSULTANCY SERVICES; BUSINESS ORGANIZATION CONSULTANCY SERVICES; RELOCATION SERVICES FOR BUSINESS; COMMERCIAL INFORMATION AGENCY SERVICES; COMMERCIAL AND INDUSTRIAL MANAGEMENT ASSISTANCE SERVICES; ECONOMIC FORECASTING SERVICES; EFFICIENCY EXPERT SERVICES; PAYROLL PREPARATION SERVICES; TAX ADVICE SERVICES AND PREPARATION OF TAX ACCOUNTS; PREPARATION OF STATEMENTS OF ACCOUNT; STATISTICAL INFORMATION SERVICES (U.S. CLS. 100, 101 AND 102).

CLASS 36—INSURANCE AND FINANCIAL

FOR FINANCIAL ANALYSIS SERVICES; CAPITAL INVESTMENT SERVICES; FINANCIAL CONSULTANCY SERVICES; DEBT COLLECTION SERVICES; FINANCIAL EVALUATION OF BUSINESSES, EQUITIES, TAX, INVESTMENTS AND OFF SHORE FINANCIAL INVESTMENTS; FINANCIAL INFORMATION SERVICES IN THE FIELD OF TAX, TAX PLANNING, FUNDRAISING, DUE DILIGENCE, MERGERS, ACQUISITIONS, JOINT VENTURES ACTIVITIES, AUDITING AND ACCOUNTING, FRAUD PREVENTION, FORENSIC ACCOUNTING AND LIQUIDATION; FINANCIAL MANAGEMENT SERVICES; FINANCIAL CONSULTANCY SERVICES; STOCK EXCHANGE PRICE QUOTATION SERVICES; INVESTMENT ADVISORY SERVICES, NAMELY, THE SERVICES OF ACTING AS ADVISORS TO COMPANIES SEEKING A STOCK EXCHANGE LISTING; FISCAL VALUATION SERVICES; FINANCING SERVICES; FISCAL ASSESSMENT SERVICES; FUND INVESTMENT SERVICES; TRUSTEESHIP REPRESENTATIVE SERVICES (U.S. CLS. 100, 101 AND 102).

JAMES STEIN, EXAMINING ATTORNEY

SN 77-014,800. SHIRON DEVELOPMENT, LLC, LAS VEGAS, NV. FILED 10-5-2006.



THE MARK CONSISTS OF THE WORDS "PAXTON WALK" WITHIN A BORDER DEPICTING AN ANTIQUE STREET SIGN.

CLASS 36—INSURANCE AND FINANCIAL

FOR REAL ESTATE SERVICES, NAMELY, LISTING, AGENCIES, LEASING, FINANCING, AND MANAGING COMMERCIAL AND RESIDENTIAL PROPERTY (U.S. CLS. 100, 101 AND 102).
FIRST USE 7-31-2006; IN COMMERCE 7-31-2006.

CLASS 37—CONSTRUCTION AND REPAIR

FOR REAL ESTATE DEVELOPMENT AND CONSTRUCTION OF COMMERCIAL AND RESIDENTIAL PROPERTY (U.S. CLS. 100, 103 AND 106).
FIRST USE 7-31-2006; IN COMMERCE 7-31-2006.
ANTHONY RINKER, EXAMINING ATTORNEY

SN 77-019,433. TECH ELECTRONICS, INC., NORCROSS, GA. FILED 10-12-2006.



CLASS 9—ELECTRICAL AND SCIENTIFIC APPARATUS

FOR COMPUTER SOFTWARE FOR CONTENT SERVERS, MEDIA PLAYERS, MOBILE DEVICES, DESKTOPS AND ROOM SIGNS IN THE FIELD OF DYNAMIC VISUAL MESSAGING APPLICATIONS ENABLING USERS TO CREATE, IMPORT, MANAGE AND SCHEDULE THE DELIVERY OF DYNAMIC CONTENT TO MEDIA PLAYERS, MOBILE DEVICES, DESKTOPS AND ROOM SIGNS (U.S. CLS. 21, 23, 26, 36 AND 38).

CLASS 42—SCIENTIFIC AND COMPUTER SERVICES

FOR TECHNICAL SUPPORT SERVICES, NAMELY, TROUBLESHOOTING OF COMPUTER SOFTWARE PROBLEMS; DESIGN, DEVELOPMENT AND IMPLEMENTATION OF SOFTWARE; COMPUTER SERVICE, NAMELY, ACTING AS AN APPLICATION SERVICE PROVIDER IN THE FIELD OF DYNAMIC VISUAL MESSAGING APPLICATIONS ENABLING USERS TO CREATE, IMPORT, MANAGE AND SCHEDULE THE DELIVERY OF DYNAMIC CONTENT TO MEDIA PLAYERS, MOBILE DEVICES, DESKTOPS AND ROOM SIGNS; REMOTE MONITORING OF COMMUNICATION NETWORK SYSTEMS (U.S. CLS. 100 AND 101).
DAVID TAYLOR, EXAMINING ATTORNEY

SN 77-022,067. PHILLIPS, TRACY K., LOS ANGELES, CA. AND CARBONE, DOMINIC P., LOS ANGELES, CA. FILED 10-16-2006.



THE LIKENESS (OR, "PORTRAIT") IN THE MARK DOES NOT IDENTIFY A LIVING INDIVIDUAL.

THE COLOR(S) BLACK AND WHITE IS/ARE CLAIMED AS A FEATURE OF THE MARK.

THE MARK CONSISTS OF AN ORIGINAL BLACK AND WHITE DRAWING OF A GIRL MANIPULATED INTO A NEGATIVE IMAGE.

CLASS 16—PAPER GOODS AND PRINTED MATTER

FOR COFFEE TABLE BOOKS FEATURING PHOTOGRAPHY; POSTERS (U.S. CLS. 2, 5, 22, 23, 29, 37, 38 AND 50).

CLASS 40—MATERIAL TREATMENT

FOR CUSTOM IMPRINTING OF LINGERIE, T-SHIRTS, SWEATSHIRTS, TANK TOPS WITH DECORATIVE DESIGNS (U.S. CLS. 100, 103 AND 106).

CLASS 41—EDUCATION AND ENTERTAINMENT

FOR CABARETS; ENTERTAINMENT IN THE NATURE OF DANCE PERFORMANCES; ENTERTAINMENT IN THE NATURE OF LIVE PERFORMANCES BY DANCERS (U.S. CLS. 100, 101 AND 107).

TOBY BULLOFF, EXAMINING ATTORNEY

SN 77-023,080. BIALETTI INDUSTRIE S.P.A., COCCAGLIO (BS), ITALY, FILED 10-17-2006.

THERMO-PLY

THE MARK CONSISTS OF STANDARD CHARACTERS WITHOUT CLAIM TO ANY PARTICULAR FONT, STYLE, SIZE, OR COLOR.

PRIORITY CLAIMED UNDER SEC. 44(D) ON ERPN CMNTY TM OFC APPLICATION NO. 5399811, FILED 10-10-2006, REG. NO. 5399811, DATED 1-10-2007, EXPIRES 10-10-2016.

CLASS 11—ENVIRONMENTAL CONTROL APPARATUS

FOR APPARATUS FOR LIGHTING, HEATING, STEAM GENERATING, COOKING, REFRIGERATING, DRYING, VENTILATING, WATER SUPPLY AND SANITARY PURPOSES, NAMELY, ELECTRIC LIGHT BULBS, PORTABLE ELECTRIC HEATERS, STEAM GENERATORS, REFRIGERATORS, CLOTHES DRYERS, VENTILATING FANS FOR COMMERCIAL USE, AIR FILTERS FOR DOMESTIC USE, AIR CONDITIONING UNITS, BATHTUBS AND TOILETS, WATER FILTERING UNITS FOR DOMESTIC AND COMMERCIAL USE, COOKING APPARATUS, NAMELY, ELECTRIC KETTLES, BARBECUE GRILLS, ELECTRIC COFFEE PERCOLATORS, ELECTRIC DEEP FRYERS, ELECTRIC GRILLS, ELECTRIC TOASTERS, ICE-CREAM MAKERS, ELECTRIC HOUSEHOLD MACHINES FOR MAKING COFFEE AND HOT BEVERAGES, COFFEE MACHINES, AUTOMATIC COFFEE MACHINES, COFFEE FILTERS, ELECTRIC LIGHTS FOR CHRISTMAS TREES, SUN LAMPS (U.S. CLS. 13, 21, 23, 31 AND 34).

CLASS 21—HOUSEWARES AND GLASS

FOR HOUSEHOLD AND KITCHEN UTENSILS AND CONTAINERS, NAMELY, LADLES AND DIPPERS, PANS, COOKING PANS, KETTLES, NON-ELECTRIC KETTLES, POTS, SAUCEPANS, PRESSURE COOKERS, NON-ELECTRIC PRESSURE COOKERS, BAKING PANS, FRYING PANS, NON ELECTRIC COFFEE MAKERS AND COMPONENT PARTS THEREOF, NAMELY, LIDS, HANDLES, COLANDERS, STRAINERS, NOT MADE FROM PRECIOUS METAL; HAIR COMBS; SPONGES, NAMELY, SCOURING AND CLEANING SPONGES; BRUSHES, NAMELY, NAIL AND MUSHROOM BRUSHES; MATERIAL FOR BRUSH MAKING; ARTICLES FOR CLEANING PURPOSES, NAMELY, FIRE PLACE BRUSHES; STEEL WOOL FOR CLEANING; BEVERAGE GLASSWARE; ARTICLES MADE OF PORCELAIN, NAMELY, MUGS AND KNOBS; EARTHENWARE, NAMELY, MUGS AND BASINS (U.S. CLS. 2, 13, 23, 29, 30, 33, 40 AND 50).

SHARON MEIER, EXAMINING ATTORNEY

SN 77-025,206. DSM IP ASSETS B.V., HEERLEN, NETHERLANDS, FILED 10-19-2006.

DYNEEMA THE WORLD'S STRONGEST FIBER

THE MARK CONSISTS OF STANDARD CHARACTERS WITHOUT CLAIM TO ANY PARTICULAR FONT, STYLE, SIZE, OR COLOR.

OWNER OF U.S. REG. NOS. 2,078,586 AND 3,123,827.

NO CLAIM IS MADE TO THE EXCLUSIVE RIGHT TO USE "THE WORLD'S STRONGEST FIBER", APART FROM THE MARK AS SHOWN.

CLASS 9—ELECTRICAL AND SCIENTIFIC APPARATUS

FOR PROTECTION DEVICES FOR PERSONAL USE AGAINST ACCIDENTS, NAMELY, GLOVES, CLOTHING AND GARMENTS, COMMERCIAL SAFETY NETS, SAFETY NETS FOR USE IN CONSTRUCTION, TRAWL SAFETY NETS, AQUACULTURE SAFETY NETS USED IN COMMERCIAL FISHING AND CARGO SAFETY NETS USED IN TRANSPORT, PROTECTIVE HELMETS; BARRIER SAFETY NETS; PROTECTIVE CLOTHING; BULLET RESISTANT AND BLAST RESISTANT CLOTHING (U.S. CLS. 21, 23, 26, 36 AND 38).

CLASS 12—VEHICLES

FOR CAR PARTS FOR THE PROTECTION AGAINST ACCIDENTS, NAMELY, VEHICLE ARMOR PANELS; FITTED LINERS FOR THE CARGO AREA OF VEHICLES AND ARMOR PANELS FOR MILITARY VEHICLES, POLICE VEHICLES, VIP VEHICLES (U.S. CLS. 19, 21, 23, 31, 35 AND 44).

CLASS 17—RUBBER GOODS

FOR PLASTICS AS SEMI-PROCESSED MATERIALS IN THE FORMS OF STRIPS, SHEETS, PLATES, SLABS OR PANELS, CONTAINER PANELS (U.S. CLS. 1, 5, 12, 13, 35 AND 50).

CLASS 18—LEATHER GOODS

FOR LEATHER UNWORKED, SEMI-WORKED AND IMITATIONS OF LEATHER; ANIMAL SKINS AND HIDES; TRUNKS AND TRAVELING BAGS; UMBRELLAS, PARASOLS AND WALKING STICKS; WHIPS, HARNESS AND SADDLERY; LEATHER LEADS FOR HORSES; LEATHER STRAPS; LEATHER THREAD (U.S. CLS. 1, 2, 3, 22 AND 41).

CLASS 22—CORDAGE AND FIBERS

FOR NETS FOR FISHING/AQUACULTURE, YACHTING SAILS AND LINES (U.S. CLS. 1, 2, 7, 19, 22, 42 AND 50).

CLASS 24—FABRICS

FOR NON-WOVEN TEXTILE FABRICS, NAMELY, YACHTING SAIL CLOTH, TEXTILE SUBSTITUTE MATERIALS MADE FROM SYNTHETIC MATERIALS, KNITTED FABRIC, NON-WOVEN FABRICS FOR USE IN THE MANUFACTURE OF CONTAINER DOOR CURTAINS, REINFORCEMENT FABRICS FOR SPORTS EQUIPMENT AND SPORTS CLOTHING, SURF AND SKATE BOARD REINFORCEMENT FABRIC, HOCKEY STICKS REINFORCEMENT FABRIC, HELMET REINFORCEMENT FABRIC, SKI REINFORCEMENT FABRIC, DIVING SUITS REINFORCEMENT FABRIC (U.S. CLS. 42 AND 50).

CLASS 25—CLOTHING

FOR HEADWEAR, FOOTWEAR; FISHING VESTS, SWIMSUITS, APRON; GLOVES; HOSIERY; WATER-PROOF CLOTHING, NAMELY, JACKETS AND PANTS; SCARVES; BELTS, FENCING SUITS (U.S. CLS. 22 AND 39).

CLASS 28—TOYS AND SPORTING GOODS

FOR SPORTING GOODS, NAMELY, ARCHERY BOW STRINGS AND KITE LINES; LINES FOR FISHING, LANDING NET FOR ANGLERS; NETS FOR SPORTS, NAMELY, TENNIS, VOLLEYBALL, BASKETBALL; STRINGS FOR RACKETS; GUT FOR FISHING, WATER-SKI AND WAKEBOARD ROPES, ROCK CLIMBING FASTENERS AND HARNESSSES (U.S. CLS. 22, 23, 38 AND 50).

SHAUNIA CARLYLE, EXAMINING ATTORNEY

SN 77-025,392. SPX COOLING TECHNOLOGIES BELGIUM S.A./N.V., BRUSSELS, BELGIUM, FILED 10-19-2006.

SN 77-025,851. REDMERE TECHNOLOGY LIMITED, DROGHEDA, CO. LOUTH, IRELAND, FILED 10-20-2006.

HEXACOOOL

THE MARK CONSISTS OF STANDARD CHARACTERS WITHOUT CLAIM TO ANY PARTICULAR FONT, STYLE, SIZE, OR COLOR.

OWNER OF BELGIUM REG. NO. 004493813, DATED 8-29-2006, EXPIRES 6-16-2015.

OWNER OF ERPN CMNTY TM OFC REG. NO. 004493813, DATED 8-29-2006, EXPIRES 6-16-2015.

CLASS 7—MACHINERY

FOR AIR COOLED CONDENSERS (U.S. CLS. 13, 19, 21, 23, 31, 34 AND 35).

CLASS 11—ENVIRONMENTAL CONTROL APPARATUS

FOR PLANTS FOR HEATING, STEAM GENERATING, REFRIGERATING, COOLING, DRYING, VENTILATING, WATER SUPPLY AND SANITARY PURPOSES; WATER COOLING TOWERS; HEAT EXCHANGERS NOT PART OF MACHINES; ENVIRONMENTAL CONTROL APPARATUS, NAMELY, WATER COOLED SURFACE CONDENSERS; FEEDWATER HEATERS, HEAT REGENERATORS; PARTS AND FITTINGS FOR THE AFORESAID GOODS (U.S. CLS. 13, 21, 23, 31 AND 34).

CLASS 37—CONSTRUCTION AND REPAIR

FOR BUILDING CONSTRUCTION; BUILDING REPAIR; INSTALLATION OF PLANTS FOR HEATING, STEAM GENERATING, REFRIGERATING, COOLING, DRYING, VENTILATING, WATER SUPPLY AND SANITARY PURPOSES; INSTALLATION OF APPARATUS FOR HEATING, STEAM GENERATING, REFRIGERATING, COOLING, DRYING, VENTILATING, WATER SUPPLY AND SANITARY PURPOSES, NAMELY, AIR COOLED CONDENSERS; INSTALLATION OF WATER COOLING TOWERS, HEAT EXCHANGERS NOT PART OF MACHINES AND ENVIRONMENTAL CONTROL APPARATUS IN THE NATURE OF WATER COOLED SURFACE CONDENSERS; INSTALLATION OF FEEDWATER HEATERS AND HEAT REGENERATORS; CONSTRUCTION, REPAIR, INSTALLATION AND MAINTENANCE OF COOLING TOWERS (U.S. CLS. 100, 103 AND 106).

CLASS 42—SCIENTIFIC AND COMPUTER SERVICES

FOR SCIENTIFIC AND INDUSTRIAL RESEARCH; TECHNOLOGICAL CONSULTANCY; DESIGN SERVICES IN THE FIELD OF WATER COOLING TOWERS (U.S. CLS. 100 AND 101).

ESTHER A. BORSUK, EXAMINING ATTORNEY

HDPure

THE MARK CONSISTS OF STANDARD CHARACTERS WITHOUT CLAIM TO ANY PARTICULAR FONT, STYLE, SIZE, OR COLOR.

PRIORITY CLAIMED UNDER SEC. 44(D) ON IRELAND APPLICATION NO. 2006/01039, FILED 5-3-2006, REG. NO. 235299, DATED 5-3-2006, EXPIRES 5-2-2016.

"HD" HAS NO MEANING IN A FOREIGN LANGUAGE.

CLASS 9—ELECTRICAL AND SCIENTIFIC APPARATUS

FOR SEMICONDUCTORS; SOFTWARE FOR USE IN THE MANUFACTURE, PRODUCTION, DESIGN AND IMPLEMENTATION OF SEMICONDUCTORS; INTEGRATED COMPUTER HARDWARE AND SOFTWARE PROGRAMS FOR THE PROCESSING, NETWORKING AND DELIVERY OF MULTIMEDIA CONTENT (U.S. CLS. 21, 23, 26, 36 AND 38).

CLASS 42—SCIENTIFIC AND COMPUTER SERVICES

FOR TECHNICAL AND TECHNOLOGICAL CONSULTANCY RELATING TO THE DESIGN OF SEMICONDUCTORS; TECHNICAL AND TECHNOLOGICAL CONSULTANCY RELATING TO THE DESIGN AND IMPLEMENTATION OF SOFTWARE RELATING TO THE FOREGOING SEMICONDUCTORS; RESEARCH AND DESIGN FOR OTHERS IN THE FIELD OF SEMICONDUCTORS AND SOFTWARE RELATED THERETO; INDUSTRIAL ANALYSIS AND RESEARCH SERVICES IN THE FIELD OF SEMICONDUCTORS; DESIGN AND DEVELOPMENT OF COMPUTER HARDWARE AND SOFTWARE (U.S. CLS. 100 AND 101).

TINA KUAN, EXAMINING ATTORNEY

SN 77-028,432. DILLARD'S INC., LITTLE ROCK, AR. FILED 10-24-2006.

KATE LANDRY

THE MARK CONSISTS OF STANDARD CHARACTERS WITHOUT CLAIM TO ANY PARTICULAR FONT, STYLE, SIZE, OR COLOR.

OWNER OF U.S. REG. NOS. 2,086,397 AND 2,977,007.

THE NAME(S), PORTRAIT(S), AND/OR SIGNATURE(S) SHOWN IN THE MARK DOES NOT IDENTIFY A PARTICULAR LIVING INDIVIDUAL.

CLASS 18—LEATHER GOODS

FOR SMALL LEATHER GOODS, NAMELY, WALLETS, CHANGE PURSES, BILLFOLDS, KEYCASES, TRAVEL KITS SOLD EMPTY, COSMETIC CASES SOLD EMPTY, TRAVEL DOCUMENT CASES, AND HANDBAGS (U.S. CLS. 1, 2, 3, 22 AND 41).

CLASS 25—CLOTHING

FOR BELTS, HATS, NECKWEAR, GLOVES (U.S. CLS. 22 AND 39),
CAROL SPILS, EXAMINING ATTORNEY

SN 77-030,744. TRUMP, DONALD J., NEW YORK, NY.
FILED 10-27-2006.



OWNER OF U.S. REG. NOS. 1,688,083, 3,046,990 AND OTHERS.

THE COLOR(S) GOLD IS/ARE CLAIMED AS A FEATURE OF THE MARK.

THE MARK CONSISTS OF A HERALDIC COAT OF ARMS CONSISTING OF A SHIELD AND CREST DESIGN, ALL IN GOLD, WITH A GOLD OUTLINED BANNER UNDERNEATH IT CONTAINING THE WORDING TRUMP IN GOLD.

CLASS 16—PAPER GOODS AND PRINTED MATTER

FOR ART PRINTS, GRAPHIC ART REPRODUCTIONS, PRINTED ART REPRODUCTIONS; BOOKLETS IN THE FIELDS OF ART, PHOTOGRAPHY, DISPLAY BOOKLETS FEATURING ART AND PHOTOGRAPHY; ORNAMENTAL AND COFFEE-TABLE BOOKLETS FEATURING ART AND PHOTOGRAPHY, ADDRESS BOOKLETS, ANNIVERSARY BOOKLETS, APPOINTMENT BOOKLETS, AUTOGRAPH BOOKLETS, BABY BOOKLETS, CHECK BOOKLETS, CHILDREN'S BOOKLETS, COMPOSITION BOOKLETS, ENGAGEMENT BOOKLETS, GUEST BOOKLETS, NOTE BOOKLETS, PICTURE BOOKLETS, SKETCH BOOKLETS, TELEPHONE NUMBER BOOKLETS, TRAVEL BOOKLETS, WEDDING BOOKLETS, WIRE BOUND BOOKLETS FEATURING ART AND PHOTOGRAPHY, INFORMATIONAL BOOKLETS FEATURING INFORMATION ON ART AND PHOTOGRAPHY; REFERENCE BOOKLETS FEATURING INFORMATION ON ART AND PHOTOGRAPHY; BOOKLETS IN THE FIELD OF SCULPTURE; BOOKS IN THE FIELDS OF ART, PHOTOGRAPHY, DISPLAY BOOKS FEATURING ART AND PHOTOGRAPHY; ORNAMENTAL AND COFFEE-TABLE BOOKS FEATURING ART AND PHOTOGRAPHY, ADDRESS BOOKS, ANNIVERSARY BOOKS, APPOINTMENT BOOKS, AUTOGRAPH BOOKS, BABY BOOKS, CHECK BOOKS, CHILDREN'S BOOKS, COMPOSITION BOOKS, ENGAGEMENT BOOKS, GUEST BOOKS, NOTE BOOKS, PICTURE BOOKS, SKETCH BOOKS, TELEPHONE NUMBER BOOKS, TRAVEL BOOKS, WEDDING BOOKS, WIRE BOUND BOOKS FEATURING ART AND PHOTOGRAPHY; INFORMATIONAL BOOKS FEATURING INFORMATION ON ART AND PHOTOGRAPHY; REFERENCE BOOKS FEATURING INFORMATION ON ART AND PHOTOGRAPHY; BOOKS IN THE FIELD OF SCULPTURE; CATALOGS IN THE FIELDS OF ART, PHOTOGRAPHY, DISPLAY BOOKLETS AND BOOKS, ORNAMENTAL AND COFFEE-TABLE BOOKLETS AND BOOKS, ADDRESS BOOKLETS AND BOOKS, ANNIVERSARY BOOKLETS AND BOOKS, APPOINTMENT BOOKLETS AND BOOKS, AUTOGRAPH BOOKLETS AND BOOKS, BABY BOOKLETS AND BOOKS, CHECK BOOK-

LETS AND BOOKS, CHILDREN'S BOOKLETS AND BOOKS, COMPOSITION BOOKLETS AND BOOKS, ENGAGEMENT BOOKLETS AND BOOKS, GUEST BOOKLETS AND BOOKS, NOTE BOOKLETS AND BOOKS, PICTURE BOOKLETS AND BOOKS, SKETCH BOOKLETS AND BOOKS, TELEPHONE NUMBER BOOKLETS AND BOOKS, TRAVEL BOOKLETS AND BOOKS, WEDDING BOOKLETS AND BOOKS, WIRE BOUND BOOKLETS AND BOOKS, INFORMATIONAL BOOKLETS AND BOOKS, REFERENCE BOOKLETS AND BOOKS, BOOKLETS AND BOOKS IN THE FIELD OF SCULPTURE; PAINTINGS, PHOTOGRAPHIC AND ART MOUNTS, PHOTOGRAPHIC PRINTS, PICTURE BOOKS, PICTURES, POSTCARDS, PICTURE POSTCARDS, POSTERS, PRINTS, NAMELY ART, CARTOON, COLOR, LITHOGRAPHIC, PHOTOGRAPHIC, AND PICTORIAL; PUZZLES, NAMELY, CROSSWORD AND SUDOKU, AND PRINTED PUZZLES CONTAINED WITHIN COLORING BOOKS; SKETCH BOOKS, SKETCHES, STATIONERY (U.S. CLS. 2, 5, 22, 23, 29, 37, 38 AND 50).

CLASS 28—TOYS AND SPORTING GOODS

FOR PUZZLES, JIGSAW PUZZLES, MANIPULATIVE PUZZLES (U.S. CLS. 22, 23, 38 AND 50).

CLASS 35—ADVERTISING AND BUSINESS

FOR RETAIL STORE SERVICES FEATURING ART (U.S. CLS. 100, 101 AND 102).

CLASS 36—INSURANCE AND FINANCIAL

FOR ART BROKERAGE, ELECTRONIC PAYMENT FOR ART, NAMELY, ELECTRONIC PROCESSING AND TRANSMISSION OF BILL PAYMENT DATA FOR ART PURCHASES (U.S. CLS. 100, 101 AND 102).

CLASS 40—MATERIAL TREATMENT

FOR PHOTO ENLARGING, PHOTOFINISHING, FRAMING OF WORKS OF ART (U.S. CLS. 100, 103 AND 106).

LYDIA BELZER, EXAMINING ATTORNEY

SN 77-039,892. BODY IMAGE SOLUTIONS, LLC, BATON ROUGE, LA. FILED 11-8-2006.



NO CLAIM IS MADE TO THE EXCLUSIVE RIGHT TO USE "SOLUTIONS", APART FROM THE MARK AS SHOWN.

THE MARK CONSISTS OF A MALE FIGURE OVER THE CREST OF A WAVE ON THE LEFT SIDE OF THE PHRASE "BODY IMAGE SOLUTIONS" AND A FEMALE FIGURE OVER THE CREST OF THE A WAVE ON THE RIGHT SIDE OF THE PHRASE.

CLASS 5—PHARMACEUTICALS

FOR DIETARY AND NUTRITIONAL SUPPLEMENTS; DIETARY SUPPLEMENTS; NUTRITIONAL SUPPLEMENTS; STIMULATORY MEDICATIONS FOR USE IN WEIGHT REDUCTION PROGRAMS (U.S. CLS. 6, 18, 44, 46, 51 AND 52).

FIRST USE 6-1-2005; IN COMMERCE 6-1-2005.

CLASS 41—EDUCATION AND ENTERTAINMENT

FOR PERSONAL TRAINER SERVICES (U.S. CLS. 100, 101 AND 107).
FIRST USE 6-1-2005; IN COMMERCE 6-1-2005.

CLASS 44—MEDICAL, BEAUTY AND AGRICULTURAL SERVICES

FOR COSMETIC AND PLASTIC SURGERY; DIETARY AND NUTRITIONAL GUIDANCE; PROVIDING INFORMATION ABOUT DIETARY SUPPLEMENTS AND NUTRITION; WEIGHT REDUCTION DIET PLANNING AND SUPERVISION (U.S. CLS. 100 AND 101).
FIRST USE 6-1-2005; IN COMMERCE 6-1-2005.
CHRISTINA SOBRAL, EXAMINING ATTORNEY

SN 77-041,795. DECENTRALTV CORPORATION, SAN FRANCISCO, CA. FILED 11-10-2006.

KYTE

THE MARK CONSISTS OF STANDARD CHARACTERS WITHOUT CLAIM TO ANY PARTICULAR FONT, STYLE, SIZE, OR COLOR.

CLASS 9—ELECTRICAL AND SCIENTIFIC APPARATUS

FOR SOFTWARE TO ENABLE UPLOADING, POSTING, SHOWING, DISPLAYING, TAGGING, BLOGGING, AND SHARING OF ELECTRONIC MEDIA OR INFORMATION OVER ELECTRONIC COMMUNICATION NETWORKS; SOFTWARE FOR USE ON COMPUTERS AND HANDHELD AND MULTIMEDIA DEVICES PROVIDING A VIDEO-ON-DEMAND FEATURE TO ENABLE THE CREATION AND TRANSFER OF USER-DEFINED CONTENT OVER ELECTRONIC COMMUNICATIONS NETWORKS; DOWNLOADABLE AUDIO FILES, ONLINE DISCUSSION BOARDS, WEB CASTS, AND POD CASTS FEATURING MUSIC, AUDIO BOOKS, AND NEWS BROADCASTS PROVIDED VIA AN ELECTRONIC COMMUNICATION NETWORK; DOWNLOADABLE RING TONES, GRAPHICS AND MUSIC VIA AN ELECTRONIC COMMUNICATION NETWORK (U.S. CLS. 21, 23, 26, 36 AND 38).

CLASS 38—COMMUNICATION

FOR INFORMATION TRANSMISSION VIA ELECTRONIC COMMUNICATION NETWORKS; PROVIDING ONLINE CHAT ROOMS AND ELECTRONIC BULLETIN BOARDS FOR TRANSMISSION OF MESSAGES AMONG USERS IN THE FIELD OF GENERAL INTEREST; PROVIDING EMAIL AND INSTANT MESSAGING SERVICES; PROVIDING ON-LINE COMMUNICATIONS LINKS WHICH TRANSFER THE WEBSITE USER TO OTHER LOCAL AND GLOBAL WEB PAGES; WEB MESSAGING; MOBILE MEDIA AND ENTERTAINMENT SERVICES IN THE NATURE OF ELECTRONIC TRANSMISSION OF ENTERTAINMENT MEDIA CONTENT (U.S. CLS. 100, 101 AND 104).

CLASS 41—EDUCATION AND ENTERTAINMENT

FOR EDUCATIONAL AND ENTERTAINMENT SERVICES, NAMELY, PROVIDING NON-DOWNLOADABLE AUDIO FILES IN THE NATURE OF MUSIC AND AUDIO BOOKS VIA ELECTRONIC COMMUNICATIONS NETWORKS; PROVIDING NON-DOWNLOADABLE FILMS AND TV PROGRAMS VIA A VIDEO-ON-DEMAND SERVICE (U.S. CLS. 100, 101 AND 107).

CLASS 42—SCIENTIFIC AND COMPUTER SERVICES

FOR COMPUTER SERVICES, NAMELY, HOSTING ONLINE WEB FACILITIES FOR OTHERS FOR ORGANIZING AND CONDUCTING ONLINE MEETINGS, GATHERINGS, AND INTERACTIVE DISCUSSIONS; COMPUTER SERVICES IN THE NATURE OF CUSTOMIZED WEB PAGES FEATURING USER-DEFINED INFORMATION, PERSONAL PROFILES AND INFORMATION; PROVIDING TEMPORARY USE OF ON-LINE NON-DOWNLOADABLE COMPUTER SOFTWARE THAT ALLOWS USERS TO BROADCAST IMAGES AND VIDEO, AND WHICH CAN BE ACCESSED THROUGH ELECTRONIC COMMUNICATION NETWORKS; COMPUTER SERVICES, NAMELY, CREATING AN ONLINE COMMUNITY FOR REGISTERED USERS TO PARTICIPATE IN COMPETITIONS, SHOWCASE THEIR SKILLS, GET FEEDBACK FROM THEIR PEERS, FORM VIRTUAL COMMUNITIES, ENGAGE IN SOCIAL NETWORKING AND IMPROVE THEIR TALENT (U.S. CLS. 100 AND 101).

CLASS 45—PERSONAL AND LEGAL SERVICES

FOR ONLINE SOCIAL NETWORKING SERVICES (U.S. CLS. 100 AND 101).
LEE-ANNE BERNIS, EXAMINING ATTORNEY

SN 77-042,822. AROLAX INTERNSTIONAL INC., AVEN- TURA, FL. FILED 11-13-2006.

TOOTSING

THE MARK CONSISTS OF STANDARD CHARACTERS WITHOUT CLAIM TO ANY PARTICULAR FONT, STYLE, SIZE, OR COLOR.

CLASS 3—COSMETICS AND CLEANING PREPARATIONS

FOR ARTIFICIAL FINGERNAILS; LOTIONS FOR STRENGTHENING THE NAILS; NAIL CARE PREPARATIONS; NAIL CREAM; NAIL ENAMELS; NAIL GROOMING PRODUCTS, NAMELY, TIPS, GLUE, LACQUER AND GLITTER; NAIL HARDENERS; NAIL POLISH AND COLOR; NAIL POLISH BASE COAT; NAIL POLISH TOP COATS; NAIL POLISH REMOVER; NAIL STRENGTHENERS; NAIL TIPS; NAIL VARNISH FOR COSMETIC PURPOSES; ADHESIVES FOR ATTACHING ARTIFICIAL FINGERNAILS; ABRASIVE PAPERS; NAIL AND CUTICLE CONDITIONING PREPARATIONS AND TREATMENTS; ANTI-FUNGAL NAIL GLUE; NAIL REPAIR KITS CONSISTING OF NAIL ADHESIVES; ARTIFICIAL NAIL FORMS; NAIL ART KITS CONSISTING OF ADHESIVES, GLITTER AND DECORATIVE ADHESIVE DECALS; PREPARATIONS FOR FORMING ARTIFICIAL NAILS, NAMELY, ACRYLIC NAIL MAKER AND SCULPTURE GEL; FINGERNAIL ART AND DESIGN PRODUCTS FOR USE ONLY ON FINGERNAILS, NAMELY, FOILS, GLITTERS, STRIPPING TAPE, WATER DECALS, STICKERS, CHARMS, AIR BRUSH NAIL STENCILS AND PAINTS (U.S. CLS. 1, 4, 6, 50, 51 AND 52).

FIRST USE 1-3-2006; IN COMMERCE 1-3-2006.

CLASS 8—HAND TOOLS

FOR NAIL BUFFERS (U.S. CLS. 23, 28 AND 44).
FIRST USE 1-3-2006; IN COMMERCE 1-3-2006.

CLASS 21—HOUSEWARES AND GLASS

FOR NAIL BRUSHES (U.S. CLS. 2, 13, 23, 29, 30, 33, 40 AND 50).
JENNY PARK, EXAMINING ATTORNEY

SN 77-045,821. ISOMERS LABORATORIES INC., TORONTO, CANADA, FILED 11-16-2006.

Nutritone

THE MARK CONSISTS OF STANDARD CHARACTERS WITHOUT CLAIM TO ANY PARTICULAR FONT, STYLE, SIZE, OR COLOR.
PRIORITY CLAIMED UNDER SEC. 44(D) ON CANADA APPLICATION NO. 1323760, FILED 11-10-2006.

CLASS 3—COSMETICS AND CLEANING PREPARATIONS

FOR NON-MEDICATED SKIN PREPARATIONS, NAMELY GELS, CREAMS AND LOTIONS FOR USE WITH EQUIPMENT FOR ELECTRONIC STIMULUS TO MUSCLES (U.S. CLS. 1, 4, 6, 50, 51 AND 52).

CLASS 10—MEDICAL APPARATUS

FOR MEDICAL DEVICES, NAMELY EQUIPMENT FOR ELECTRONIC STIMULUS TO MUSCLES (U.S. CLS. 26, 39 AND 44).
KIMBERLY PERRY, EXAMINING ATTORNEY

SN 77-047,145. LIVE WATER PROPERTIES, LLC, JACKSON, WY. FILED 11-17-2006.

LIVE WATER

THE MARK CONSISTS OF STANDARD CHARACTERS WITHOUT CLAIM TO ANY PARTICULAR FONT, STYLE, SIZE, OR COLOR.

NO CLAIM IS MADE TO THE EXCLUSIVE RIGHT TO USE "WATER", APART FROM THE MARK AS SHOWN.

CLASS 35—ADVERTISING AND BUSINESS

FOR RETAIL STORE SERVICES IN THE FIELD OF FISHING EQUIPMENT, TACKLE AND FISHING ACCESSORIES (U.S. CLS. 100, 101 AND 102).

CLASS 36—INSURANCE AND FINANCIAL

FOR REAL ESTATE BROKERAGE SERVICES; FINANCIAL SERVICES IN THE NATURE OF REAL ESTATE INVESTMENT AND INVESTMENT FUNDS VESTED IN REAL ESTATE; HEDGE FUND INVESTMENT SERVICES; RANCH REAL ESTATE MANAGEMENT (U.S. CLS. 100, 101 AND 102).

CLASS 41—EDUCATION AND ENTERTAINMENT

FOR FISHING GUIDE SERVICES (U.S. CLS. 100, 101 AND 107).

CLASS 42—SCIENTIFIC AND COMPUTER SERVICES

FOR ENVIRONMENTAL PRESERVATION AND HABITAT ENHANCEMENT SERVICES, NAMELY, WILDLIFE AND FISHERY INSPECTIONS, RESEARCH IN THE FIELD OF ENVIRONMENTAL PROTECTION AND ECOLOGICAL CONSTRAINTS, WETLAND MAPPING, DESIGN FOR OTHERS IN THE FIELD OF WETLAND AND AQUATIC HABITATS, WATER QUALITY ANALYSIS AND CONSULTING; SEPTIC FIELD ANALYSIS AND CONSULTING FOR QUALITY PURPOSES, AND CONSULTING SERVICES IN THE FIELD OF ENVIRONMENTAL ASSESSMENT, COMPLIANCE AND PLANNING (U.S. CLS. 100 AND 101).

CLASS 43—HOTEL AND RESTAURANT SERVICES

FOR RESORT LODGING SERVICES FEATURING FISHING (U.S. CLS. 100 AND 101).
DAWN HAN, EXAMINING ATTORNEY

SN 77-048,132. THE ORGANIZATION ZONE, LLC, WEST HILLS, CA. FILED 11-20-2006.

WANT-OLGY

THE MARK CONSISTS OF STANDARD CHARACTERS WITHOUT CLAIM TO ANY PARTICULAR FONT, STYLE, SIZE, OR COLOR.

CLASS 35—ADVERTISING AND BUSINESS

FOR ORGANIZATIONAL CONSULTATION SERVICES, NAMELY, ADVISING BUSINESS ENTITIES AND INDIVIDUALS IN THE FIELD OF CAREER ENHANCEMENT DECISION MAKING TECHNIQUES (U.S. CLS. 100, 101 AND 102).

FIRST USE 6-1-2006; IN COMMERCE 6-1-2006.

SN 77-049,985. S.C. WRIGHT CONSTRUCTION, INC., LA MESA, CA. FILED 11-22-2006.

CLASS 41—EDUCATION AND ENTERTAINMENT

FOR TRAINING IN THE FIELDS OF PERSONAL AND ORGANIZATIONAL DEVELOPMENT, NAMELY, PERSONAL AND EMPLOYEE CAREER ENHANCEMENT AND DEVELOPMENT DECISION-MAKING TRAINING (U.S. CLS. 100, 101 AND 107).

FIRST USE 6-1-2006; IN COMMERCE 6-1-2006.
GEORGIA CARTY, EXAMINING ATTORNEY



S.C. WRIGHT CONSTRUCTION, INC.

SN 77-048,447. SHELKO CONSULTING, LLC, RIDGEWOOD, NJ. FILED 11-21-2006.

SAVE ON SUPPORT

THE MARK CONSISTS OF STANDARD CHARACTERS WITHOUT CLAIM TO ANY PARTICULAR FONT, STYLE, SIZE, OR COLOR.

CLASS 41—EDUCATION AND ENTERTAINMENT

FOR PROVIDING TRAINING SERVICES IN THE USE OF COMPUTER HARDWARE AND SOFTWARE FOR OTHERS (U.S. CLS. 100, 101 AND 107).

FIRST USE 1-1-2005; IN COMMERCE 1-1-2005.

CLASS 42—SCIENTIFIC AND COMPUTER SERVICES

FOR CONSULTATION SERVICES IN THE FIELD OF SELECTION, IMPLEMENTATION, AND USE OF COMPUTER HARDWARE AND SOFTWARE FOR OTHERS (U.S. CLS. 100 AND 101).

FIRST USE 1-1-2005; IN COMMERCE 1-1-2005.
DAVID I, EXAMINING ATTORNEY

NO CLAIM IS MADE TO THE EXCLUSIVE RIGHT TO USE "CONSTRUCTION, INC.", APART FROM THE MARK AS SHOWN.

THE NAME(S), PORTRAIT(S), AND/OR SIGNATURE(S) SHOWN IN THE MARK IDENTIFIES S.C. WRIGHT, WHOSE CONSENT(S) TO REGISTER IS SUBMITTED.

THE COLOR(S) RED AND BLACK IS/ARE CLAIMED AS A FEATURE OF THE MARK.

THE MARK CONSISTS, IN PART, OF "S C WRIGHT" IN SIGNATURE FORM IN THE COLOR RED APPEARING ACROSS, AND ONLY PARTIALLY WITHIN, A SINGLE LINE DIAMOND IN THE COLOR BLACK. "S.C. WRIGHT CONSTRUCTION, INC." APPEARS IN THE COLOR BLACK BELOW THE SIGNATURE AND DIAMOND DESIGN.

CLASS 35—ADVERTISING AND BUSINESS

FOR PRE-CONSTRUCTION COST ANALYSES IN THE FIELD OF RESIDENTIAL AND COMMERCIAL CONSTRUCTION; SCHEDULING OF CONSTRUCTION PROJECTS FOR OTHERS (U.S. CLS. 100, 101 AND 102).

FIRST USE 11-13-1986; IN COMMERCE 11-13-1986.

CLASS 37—CONSTRUCTION AND REPAIR

FOR GENERAL CONSTRUCTION SERVICES, NAMELY, PLANNING, LAYING OUT, AND CONSTRUCTION OF RESIDENTIAL AND COMMERCIAL BUILDINGS; RESIDENTIAL AND BUILDING CONSTRUCTION CONSULTING, CONSTRUCTION SUPERVISION, REAL ESTATE SITE SELECTION EVALUATION, AND CONSTRUCTION CONSULTATION SERVICES (U.S. CLS. 100, 103 AND 106).

FIRST USE 11-13-1986; IN COMMERCE 11-13-1986.

CLASS 42—SCIENTIFIC AND COMPUTER SERVICES

FOR EXPERT WITNESS SERVICES IN THE FIELD OF CONSTRUCTION; TESTING ON RESIDENTIAL AND COMMERCIAL BUILDINGS FOR CAPABILITY FROM DESTRUCTION DURING SEVERE WEATHER; PROVIDING QUALITY ASSURANCE SERVICES IN THE FIELD OF CONSTRUCTION DURING CONSTRUCTION PROJECTS (U.S. CLS. 100 AND 101).

FIRST USE 11-13-1986; IN COMMERCE 11-13-1986.

CLASS 45—PERSONAL AND LEGAL SERVICES

FOR LITIGATION CONSULTANCY IN THE FIELD OF CONSTRUCTION (U.S. CLS. 100 AND 101).

FIRST USE 11-13-1986; IN COMMERCE 11-13-1986.
ZHALEH DELANEY, EXAMINING ATTORNEY

SN 77-050,011. HIGH ABOVE ENTERPRISES, LLC, LAKE WORTH, FL. FILED 11-22-2006.



NO CLAIM IS MADE TO THE EXCLUSIVE RIGHT TO USE "ENTERPRISES, LLC", APART FROM THE MARK AS SHOWN.

CLASS 9—ELECTRICAL AND SCIENTIFIC APPARATUS

FOR DVDS FEATURING THE SUBJECT OF PREPARING THE ROOF OF A DWELLING OR OTHER STRUCTURE FOR A HURRICANE OR OTHER STORM AND OTHER SUCH STORMS, FOR MAKING REPAIRS OF FILING INSURANCE CLAIMS (U.S. CLS. 21, 23, 26, 36 AND 38).

CLASS 41—EDUCATION AND ENTERTAINMENT

FOR PRODUCTION OF MOTION PICTURES ON THE SUBJECT OF PREPARING THE ROOF OF A DWELLING OR OTHER STRUCTURE FOR A HURRICANE OR OTHER STORM AND AFTER SUCH STORMS, FOR MAKING REPAIRS OR FILING INSURANCE CLAIMS (U.S. CLS. 100, 101 AND 107).

CAROLYN CATALDO, EXAMINING ATTORNEY

SN 77-050,071. INTUIT INC., MOUNTAIN VIEW, CA. FILED 11-22-2006.

PAYCHECK MAXIMIZER

THE MARK CONSISTS OF STANDARD CHARACTERS WITHOUT CLAIM TO ANY PARTICULAR FONT, STYLE, SIZE, OR COLOR.

CLASS 35—ADVERTISING AND BUSINESS

FOR PROVISION OF INFORMATION, ADVICE AND ANALYSIS ON PAYROLL TAXES, TAX WITHHOLDINGS, TAX PLANNING, TAX CALCULATION, AND TAX RETURN PREPARATION AND FILING; PROVISION OF TAX AND TAX MANAGEMENT INFORMATION VIA COMPUTER AND COMMUNICATIONS NETWORKS; ELECTRONIC TRANSMISSION OF TAX INFORMATION; PROVIDING TAX CALCULATION, PLANNING, PREPARATION, AND FILING SERVICES; ELECTRONIC TAX FILING SERVICES; PROVIDING WEB SITES IN THE FIELDS OF PAYROLL PREPARATION, PAYROLL TAXES, AND TAX WITHHOLDINGS (U.S. CLS. 100, 101 AND 102).

CLASS 36—INSURANCE AND FINANCIAL

FOR ELECTRONIC TRANSMISSION OF TAX REFUNDS (U.S. CLS. 100, 101 AND 102).

CLASS 42—SCIENTIFIC AND COMPUTER SERVICES

FOR PROVIDING TEMPORARY USE OF ON-LINE NON-DOWNLOADABLE SOFTWARE FOR TAX PLANNING, TAX CALCULATION, AND TAX RETURN PREPARATION AND FILING; PROVIDING A WEBSITE FEATURING TEMPORARY USE OF NON-DOWNLOADABLE SOFTWARE ALLOWING THE USER TO PREPARE AND FILE TAX RETURNS; PROVIDING TEMPORARY USE OF ON-LINE NON-DOWNLOADABLE SOFTWARE FOR PROCESSING TAX PAYMENTS; PROVIDING TEMPORARY USE OF NON-DOWNLOADABLE SOFTWARE IN THE FIELDS OF PAYROLL PREPARATION, PAYROLL TAXES, AND TAX WITHHOLDINGS (U.S. CLS. 100 AND 101).

DORITT L. CARROLL, EXAMINING ATTORNEY

SN 77-051,695. MALCARNEY, TIM, AUDUBON, NJ. AND MCINTYRE, EVAN, PHILADELPHIA, PA. FILED 11-28-2006.

THE SILENCE

THE MARK CONSISTS OF STANDARD CHARACTERS WITHOUT CLAIM TO ANY PARTICULAR FONT, STYLE, SIZE, OR COLOR.

CLASS 9—ELECTRICAL AND SCIENTIFIC APPARATUS

FOR SOUND RECORDINGS FEATURING MUSIC (U.S. CLS. 21, 23, 26, 36 AND 38).
FIRST USE 12-0-1989; IN COMMERCE 12-0-1989.

CLASS 41—EDUCATION AND ENTERTAINMENT

FOR ENTERTAINMENT, NAMELY, LIVE PERFORMANCES BY A MUSICAL BAND (U.S. CLS. 100, 101 AND 107).
FIRST USE 12-0-1989; IN COMMERCE 12-0-1989.
YONG KIM, EXAMINING ATTORNEY

SN 77-053,014. WALTER, RICHARD, CARSON CITY, NV. FILED 11-29-2006.

RtownCard

THE MARK CONSISTS OF STANDARD CHARACTERS WITHOUT CLAIM TO ANY PARTICULAR FONT, STYLE, SIZE, OR COLOR.

CLASS 9—ELECTRICAL AND SCIENTIFIC APPARATUS

FOR MAGNETICALLY CODED CREDIT AND DEBIT CARDS (U.S. CLS. 21, 23, 26, 36 AND 38).

CLASS 16—PAPER GOODS AND PRINTED MATTER

FOR PRINTED MATTER, NAMELY, NON-MAGNETICALLY CODED CREDIT AND DEBIT CARDS; PRINTED TRAVELER'S CHECKS; PRINTED COUPONS PLACED IN PUBLICATIONS; AND RELATED ADVERTISING IN SUCH PUBLICATIONS (U.S. CLS. 2, 5, 22, 23, 29, 37, 38 AND 50).

CLASS 36—INSURANCE AND FINANCIAL

FOR FINANCIAL SERVICES, NAMELY, CREDIT CARD SERVICES, DEBIT CARD SERVICES, TRAVELERS CHECK SERVICES, ELECTRONIC FUNDS AND CURRENCY TRANSFER SERVICES, TRAVEL FINANCIAL ASSISTANCE SERVICES, DISBURSEMENT AND TRANSACTION AUTHORIZATION AND SETTLEMENT SERVICES (U.S. CLS. 100, 101 AND 102).

RICHARD A. STRASER, EXAMINING ATTORNEY

CLASS 9—ELECTRICAL AND SCIENTIFIC APPARATUS

FOR TELEVISION RECEIVING SETS; VIDEO SCREENS; VIDEO TELEPHONES; TELEPHONES; COMPUTERS; COMPUTER SOFTWARE FOR USE IN HOME NETWORKING; MONITORS FOR COMPUTERS; PERSONAL DIGITAL ASSISTANTS; CELLULAR PHONES; VIDEO TAPE RECORDERS; DIGITAL VERSATILE DISC PLAYERS; LOUD SPEAKERS; HEAD PHONES; TELEVISION SET-TOP BOXES; DIGITAL CAMERAS; CAMCORDERS; NETWORK ACCESS SERVERS; COMPUTER GATEWAY SYSTEM FOR HOME NETWORKING, CONSISTING OF COMPUTER NETWORK HUBS, SWITCHES AND ROUTERS; ELECTRIC CONVERTERS; ELECTRIC CURRENT SWITCHES; INTERFACES FOR DETECTORS; ELECTRONIC DATA TRANSFER HARDWARE, NAMELY, PERIPHERAL COMPONENT INTERFACE CARDS; ELECTRIC LIGHT SWITCHES; LIGHTING CONTROL PANELS; PLUG-IN CONNECTORS; ELECTRIC AND ELECTRONIC VIDEO SURVEILLANCE CAMERAS; HANDHELD PERSONAL COMPUTERS; WIRELESS CONTROLLER TO MONITOR AND CONTROL THE FUNCTIONING OF OTHER ELECTRONIC DEVICES; COMPUTER NETWORK ADAPTERS; AND MOBILE ROBOTS FOR HOME USE, NAMELY, CLEANING ROBOTS AND ROBOTS FOR PERSONAL OR HOBBY USE (U.S. CLS. 21, 23, 26, 36 AND 38).

CLASS 11—ENVIRONMENTAL CONTROL APPARATUS

FOR HOUSEHOLD WATER PURIFIERS; TABLEWARE STERILIZERS; ELECTRIC KITCHEN OVEN RANGES; SINKS; HOT WATER HEATERS; HOT WATER TANKS; AIR CONDITIONERS; MICROWAVE OVENS; ELECTRIC FANS; REFRIGERATORS; ELECTRIC KETTLES; ELECTRIC REFRIGERATORS FOR KIMCHI; HUMIDIFIERS; AND ELECTRIC STOVES (U.S. CLS. 13, 21, 23, 31 AND 34).

CHRISTINA SOBRAL, EXAMINING ATTORNEY

SN 77-053,605. SAMSUNG ELECTRONICS CO., LTD., SUWON-SI, GYEONGGI-DO, REPUBLIC OF KOREA, FILED 11-29-2006.

SN 77-055,162. GAMBOA, ALEX, RENO, NV. FILED 12-1-2006.

homevita 

Envirolution

PRIORITY CLAIMED UNDER SEC. 44(D) ON REPUBLIC OF KOREA APPLICATION NO. 40-2006-0059, FILED 11-23-2006, REG. NO. 0726232, DATED 10-18-2007, EXPIRES 10-18-2017.

OWNER OF U.S. REG. NO. 3,019,607.

THE MARK CONSISTS OF THE WORD "HOMEVITA" FOLLOWED BY A STYLIZED "V" IN A SQUARE BACKGROUND.

THE MARK CONSISTS OF STANDARD CHARACTERS WITHOUT CLAIM TO ANY PARTICULAR FONT, STYLE, SIZE, OR COLOR.

CLASS 7—MACHINERY

FOR ELECTRIC MIXERS FOR HOUSEHOLD USE; AUTOMATIC DISHWASHERS; ELECTRIC CLOTHES WASHING MACHINES; ELECTRIC VACUUM CLEANERS; MOBILE ROBOTS FOR BUSINESS USE, NAMELY, INDUSTRIAL ROBOTS; AND ELECTRICALLY OPERATED BRUSHES, BEING PARTS OF MACHINES (U.S. CLS. 13, 19, 21, 23, 31, 34 AND 35).

CLASS 16—PAPER GOODS AND PRINTED MATTER

FOR PRINT MATERIAL, NAMELY, BOOKS, MAGAZINES, BROCHURES, AND BOOKLETS IN THE FIELD OF ENVIRONMENTAL REMEDIATION, FINANCIAL AND SOCIAL BEHAVIOR NECESSARY TO IMPROVE THE ENVIRONMENT (U.S. CLS. 2, 5, 22, 23, 29, 37, 38 AND 50).

CLASS 25—CLOTHING

FOR CLOTHING, FORMAL WEAR, CASUAL WEAR, AND SPORTSWEAR FOR MEN, WOMEN, CHILDREN AND INFANTS, NAMELY, SHIRTS, T-SHIRTS, JACKETS, SWEATSHIRTS, JERSEYS, HATS, CAPS, SCARVES, BANDANAS, SHORTS, JEANS, SKIRTS, SLACKS, BLOUSES, DRESSES, VESTS, COATS, SWEATERS, SWIMSUITS, UNDERWEAR, UNDERPANTS, SLIPS, CAMISOLES, BRAS, NIGHTGOWNS, ROBES, SOCKS, HOSIERY, LONG SLEEVED SHIRTS, PANTS, JUMPERS, JUMPSUITS, OVERALLS, ONE-PIECE PLAYSUITS, PJAMAS, FOOTWEAR, HEADWEAR, BELTS, UNDER SHIRTS, NIGHT SHIRTS, RUGBY SHIRTS, POLO SHIRTS, TOPS, CROP TOPS, TANK TOPS, HALTER TOPS, SWEAT SHIRTS, SWEAT SHORTS, SWEAT PANTS, WARM-UP SUITS, JOGGING SUITS, FLEECE VESTS, PULLOVERS, FLEECE PULLOVERS, PARKAS, ANORAKS, PONCHOS, DINNER JACKETS, SPORTS JACKETS, WRAPS, TOPS, TIES, GOLF AND SKI JACKETS, REVERSIBLE JACKETS, COATS, BLAZERS, TURTLENECKS, SWIMWEAR, BEACHWEAR, HEADBANDS, WRIST BANDS, BRIEFS, TRUNKS, LOUNGEWEAR, RAINWEAR, UNIFORMS, ATHLETIC UNIFORMS, TROUSERS, DENIM JEANS, COVERALLS, JUMP SUITS, AND BOXER SHORTS (U.S. CLS. 22 AND 39).

CLASS 35—ADVERTISING AND BUSINESS

FOR BUSINESS NETWORKING; EMPLOYMENT HIRING, RECRUITING, PLACEMENT STAFFING, AND CAREER NETWORKING SERVICES; GENERAL BUSINESS NETWORKING REFERRAL SERVICES, NAMELY, PROMOTING THE GOODS AND SERVICES OF OTHERS BY PASSING BUSINESS LEADS AND REFERRALS AMONG GROUP MEMBERS; ONLINE BUSINESS NETWORKING SERVICES; PROMOTION, ADVERTISING AND MARKETING OF ON-LINE WEBSITES OF OTHERS; COOPERATIVE ADVERTISING AND MARKETING; CONDUCTING BUSINESS CONFERENCES; COOPERATIVE ADVERTISING AND MARKETING SERVICES BY WAY OF SOLICITATION, CUSTOMER SERVICE AND PROVIDING MARKETING INFORMATION VIA WEBSITES ON A GLOBAL COMPUTER NETWORK; PROVIDING AND RENTAL OF ADVERTISING SPACE ON THE INTERNET; JOB PLACEMENT; JOB AND PERSONAL PLACEMENT; PROVIDING ON-LINE INFORMATION IN THE FIELDS OF EMPLOYMENT AND RECRUITMENT COUNSELING AND OPPORTUNITIES, CAREER PLACEMENT SERVICES, JOB PLACEMENT RESOURCES, AND JOB LISTINGS AND RESUMES; PROVIDING ON-LINE INTERACTIVE EMPLOYMENT COUNSELING AND RECRUITMENT SERVICES; PROVIDING ON-LINE EMPLOYMENT PLACEMENT SERVICES, NAMELY, RESUME MATCHING SERVICES VIA A GLOBAL COMPUTER NETWORK; ONLINE COMPUTER SERVICES, NAMELY, PROVIDING A WEBSITE IN THE FIELD OF EMPLOYMENT OPPORTUNITIES AND CAREER PLACEMENT WHICH OFFERS THE EXCHANGE OF INFORMATION (U.S. CLS. 100, 101 AND 102).

CLASS 38—COMMUNICATION

FOR STREAMING OF VIDEO MATERIAL ON THE INTERNET; STREAMING OF AUDIO MATERIAL ON THE INTERNET (U.S. CLS. 100, 101 AND 104).

CLASS 41—EDUCATION AND ENTERTAINMENT

FOR CONDUCTING SEMINARS AND EDUCATIONAL CONFERENCES IN THE FIELD OF ENVIRONMENTAL REMEDIATION, FINANCIAL AND SOCIAL BEHAVIOR NECESSARY TO IMPROVE THE ENVIRONMENT (U.S. CLS. 100, 101 AND 107).

CLASS 42—SCIENTIFIC AND COMPUTER SERVICES

FOR COMPUTER SERVICES, NAMELY, CREATING AN ONLINE COMMUNITY FOR REGISTERED USERS TO PARTICIPATE IN DISCUSSIONS, DEBATES, SHOWCASING SKILLS, COMPETITIONS, FEEDBACK FROM PEERS, FORM VIRTUAL COMMUNITIES, ENGAGE IN SOCIAL NETWORKING, IMPROVING TALENT, EDUCATION, SKILLS, KNOWLEDGE AND AWARENESS; HOSTING OF DIGITAL CONTENT ON THE INTERNET; HOSTING THE DIGITAL AUDIO AND VIDEO CONTENT OF OTHERS (U.S. CLS. 100 AND 101).

CLASS 45—PERSONAL AND LEGAL SERVICES

FOR ONLINE SOCIAL NETWORKING SERVICES; INTERNET BASED SOCIAL NETWORKING, INTRODUCTIONS, AND DATING NETWORKING; PROVIDING INFORMATION IN THE FIELD OF FINANCIAL, ENVIRONMENTAL, SOCIAL AND SOCIAL SELF-AWARENESS (U.S. CLS. 100 AND 101).
HANNO RITTNER, EXAMINING ATTORNEY

SN 77-055,362. ACE LIMITED, HAMILTON, BERMUDA, FILED 12-1-2006.

ACE ONLINE

THE MARK CONSISTS OF STANDARD CHARACTERS WITHOUT CLAIM TO ANY PARTICULAR FONT, STYLE, SIZE, OR COLOR.

OWNER OF U.S. REG. NOS. 2,947,303, 3,177,329 AND OTHERS.

NO CLAIM IS MADE TO THE EXCLUSIVE RIGHT TO USE "ONLINE", APART FROM THE MARK AS SHOWN.

CLASS 35—ADVERTISING AND BUSINESS

FOR PROVIDING BUSINESS RISK MANAGEMENT AND REGULATORY COMPLIANCE RECORD-KEEPING SERVICES VIA A WEB-BASED PORTAL USED BY LICENSED AND APPOINTED INSURANCE PRODUCERS AND RISK MANAGERS (U.S. CLS. 100, 101 AND 102).

FIRST USE 3-1-2005; IN COMMERCE 10-31-2005.

CLASS 36—INSURANCE AND FINANCIAL

FOR PROVIDING REAL-TIME INSURANCE QUOTES, BINDING INSURANCE POLICY TRANSACTIONS, REINSURANCE UNDERWRITING, AND FINANCIAL RISK MANAGEMENT SERVICES IN THE FIELDS OF PROPERTY, CASUALTY, LIABILITY, ACCIDENT, WORKER'S COMPENSATION AND RECREATIONAL MARINE INSURANCE, ALL PROVIDED VIA A WEB-BASED PORTAL USED BY LICENSED AND APPOINTED INSURANCE PRODUCERS (U.S. CLS. 100, 101 AND 102).

FIRST USE 3-1-2005; IN COMMERCE 10-31-2005.
SUE LAWRENCE, EXAMINING ATTORNEY

SN 77-056,551. BOSTON FOUNDATION, INC., BOSTON, MA.
FILED 12-4-2006.

SKILLWORKS PARTNERS FOR A
PRODUCTIVE WORKFORCE

THE MARK CONSISTS OF STANDARD CHARACTERS
WITHOUT CLAIM TO ANY PARTICULAR FONT, STYLE,
SIZE, OR COLOR.

NO CLAIM IS MADE TO THE EXCLUSIVE RIGHT TO
USE "PARTNERS", APART FROM THE MARK AS SHOWN.

CLASS 35—ADVERTISING AND BUSINESS

FOR LOBBYING SERVICES, NAMELY, PROMOTING
THE INTERESTS OF LOW SKILLED WORKERS TO
LOCAL, STATE AND FEDERAL LEGISLATORS TO
INFLUENCE AND EFFECT LEGISLATIVE CHANGE IN
POLICIES, REGULATIONS, AND LEGISLATION RE-
LATING TO WORKFORCE TRAINING; PROMOTING
PUBLIC AWARENESS OF THE NEED TO PROVIDE
TRAINING AND ENHANCEMENT OF JOB SKILLS IN
THE WORKFORCE; PROMOTING AWARENESS IN THE
BUSINESS COMMUNITY OF THE NEED TO PROVIDE
TRAINING AND ENHANCEMENT OF JOB SKILLS IN
THE WORKFORCE (U.S. CLS. 100, 101 AND 102).

CLASS 36—INSURANCE AND FINANCIAL

FOR CHARITABLE FUNDRAISING SERVICES; PRO-
VIDING INFORMATION ON CHARITABLE FUNDRAIS-
ING VIA A GLOBAL COMPUTER INFORMATION
NETWORK (U.S. CLS. 100, 101 AND 102).
SCOTT SISUN, EXAMINING ATTORNEY

SN 77-057,776. WATERFORD WEDGWOOD PLC, WATER-
FORD, IRELAND, FILED 12-6-2006.

WATERFORD

THE MARK CONSISTS OF STANDARD CHARACTERS
WITHOUT CLAIM TO ANY PARTICULAR FONT, STYLE,
SIZE, OR COLOR.

PRIORITY CLAIMED UNDER SEC. 44(D) ON ERPN
CMNTY TM OFC APPLICATION NO. 005516117, FILED 12-
1-2006, REG. NO. 005516117, DATED 11-8-2007, EXPIRES 12-1-
2016.

OWNER OF U.S. REG. NOS. 2,402,350, 3,056,140 AND
OTHERS.

CLASS 29—MEATS AND PROCESSED FOODS

FOR MEAT, FISH, POULTRY AND GAME; MEAT
EXTRACTS; PRESERVED, DRIED AND COOKED
FRUITS AND VEGETABLES; JELLIES, JAMS, COM-
POTES; MILK AND MILK PRODUCTS EXCLUDING
ICE CREAM, ICE MILK, AND FROZEN YOGURT;
EDIBLE OILS AND FATS (U.S. CL. 46).

CLASS 30—STAPLE FOODS

FOR COFFEE; TEA; COCOA; SUGAR; RICE; TAPIO-
CA; SAGO; ARTIFICIAL COFFEE; FLOUR; PREPARA-
TIONS MADE FROM CEREALS, NAMELY, CEREAL
BASED SNACK FOOD; BREAD; PASTRY; CONFEC-
TIONERY, NAMELY, PASTILLES; ICES; HONEY, TREA-
CLE; YEAST, BAKING-POWDER; SALT, MUSTARD;
VINEGAR, CONDIMENT SAUCES, NAMELY, PEPPER
SAUCE; SPICES; ICE (U.S. CL. 46).

DANNEAN HETZEL, EXAMINING ATTORNEY

SN 77-060,217. ASSOCIATION OF LATE-DEAFENED
ADULTS, ROCKFORD, IL. FILED 12-8-2006.

ALDA

THE MARK CONSISTS OF STANDARD CHARACTERS
WITHOUT CLAIM TO ANY PARTICULAR FONT, STYLE,
SIZE, OR COLOR.

CLASS 41—EDUCATION AND ENTERTAIN- MENT

FOR SPONSORSHIP AND HOSTING OF MEETINGS
AND CONFERENCES RELATING TO INDIVIDUALS
WITH HEARING LOSS, NAMELY, MEETING AND
CONFERENCE ARRANGING; SUPPORT SERVICES DI-
RECTED TOWARD INDIVIDUALS WITH HEARING
LOSS, NAMELY, PROVISION OF PERSONAL NET-
WORKING OPPORTUNITIES, NAMELY, ARRANGING
AND CONDUCTING CONFERENCES AND SEMINARS
IN THE AREA OF HEARING LOSS AND PERSONAL
NETWORKING FOR PERSONS WITH HEARING LOSS
(U.S. CLS. 100, 101 AND 107).

FIRST USE 8-31-1988; IN COMMERCE 8-31-1988.

CLASS 42—SCIENTIFIC AND COMPUTER SERVICES

FOR HOSTING OF AN ONLINE WEBSITE TO FACIL-
ITATE THE PROVISION OF INFORMATION ABOUT
AND FOR LATE-DEAFENED INDIVIDUALS AND
HEARING LOSS (U.S. CLS. 100 AND 101).

FIRST USE 12-31-1998; IN COMMERCE 12-31-1998.

CLASS 44—MEDICAL, BEAUTY AND AGRI- CULTURAL SERVICES

FOR PROVIDING SUPPORT SERVICES FOR LATE-
DEAFENED INDIVIDUALS, THEIR FAMILIES AND
FRIENDS, NAMELY, PROVISION OF INFORMATION
RELATING TO HEARING LOSS (U.S. CLS. 100 AND 101).

FIRST USE 8-31-1988; IN COMMERCE 8-31-1988.

JAMES STEIN, EXAMINING ATTORNEY

SN 77-060,555. GMCC FINANCES SAS, 81000 ALBI, FRANCE,
FILED 12-8-2006.

Easy Oeillet

OWNER OF FRANCE REG. NO. 053390005, DATED 10-27-2005, EXPIRES 10-27-2015.

NO CLAIM IS MADE TO THE EXCLUSIVE RIGHT TO USE "OEILLET", APART FROM THE MARK AS SHOWN.

THE FOREIGN WORDING IN THE MARK TRANSLATES INTO ENGLISH AS EYELET.

CLASS 20—FURNITURE AND ARTICLES NOT OTHERWISE CLASSIFIED

FOR SECTION 1(B) AND SECTION 44(E): DRAPERY HARDWARE, NAMELY, HOOKS AND BUTTONS FOR DRAPERIES AND CURTAINS (U.S. CLS. 2, 13, 22, 25, 32 AND 50).

CLASS 26—FANCY GOODS

FOR (BASED ON INTENT TO USE) LACE TRIMMINGS, PASSEMENTERIE, AND EYELETS SECTION (BASED ON 44(E)) PASSEMENTERIE, AND EYELETS (U.S. CLS. 37, 39, 40, 42 AND 50).

CLASS 42—SCIENTIFIC AND COMPUTER SERVICES

FOR (BASED ON INTENT TO USE) INTERIOR DECORATING, NAMELY, DESIGN AND INTERIOR DECOR (BASED ON 44(E)) INTERIOR DECORATING, NAMELY, INTERIOR DECOR (U.S. CLS. 100 AND 101).
LINDSEY RUBIN, EXAMINING ATTORNEY

SN 77-061,630. CRANIUM, INC., SEATTLE, WA. FILED 12-11-2006.

CRANIUM BLOOM

THE MARK CONSISTS OF STANDARD CHARACTERS WITHOUT CLAIM TO ANY PARTICULAR FONT, STYLE, SIZE, OR COLOR.

CLASS 3—COSMETICS AND CLEANING PREPARATIONS

FOR PERSONAL CARE PRODUCTS FOR CHILDREN, NAMELY, SOAP, SHAMPOO, BUBBLE BATH, BODY LOTIONS, AND SUNSCREEN CREAMS (U.S. CLS. 1, 4, 6, 50, 51 AND 52).

CLASS 8—HAND TOOLS

FOR CUTLERY FOR CHILDREN (U.S. CLS. 23, 28 AND 44).

CLASS 18—LEATHER GOODS

FOR LUGGAGE, BACKPACKS, UMBRELLAS, AND DIAPER BAGS (U.S. CLS. 1, 2, 3, 22 AND 41).

CLASS 24—FABRICS

FOR TOWELS, BED BLANKETS, BED SHEETS, PILLOW CASES, AND DUVET COVERS (U.S. CLS. 42 AND 50).

CLASS 27—FLOOR COVERINGS

FOR FLOOR COVERINGS, CARPETS, AND RUGS (U.S. CLS. 19, 20, 37, 42 AND 50).

MAUREEN DALL, EXAMINING ATTORNEY

SN 77-063,732. BARCLAYS BANK PLC, LONDON, UNITED KINGDOM, FILED 12-13-2006.

THE BARCLAYS

THE MARK CONSISTS OF STANDARD CHARACTERS WITHOUT CLAIM TO ANY PARTICULAR FONT, STYLE, SIZE, OR COLOR.

OWNER OF U.S. REG. NOS. 1,527,325, 1,530,036 AND OTHERS.
SEC. 2(F).

CLASS 16—PAPER GOODS AND PRINTED MATTER

FOR EVENT PROGRAMS; SPECTATOR HANDBOOKS; POSTERS; PENS; PENCILS; POSTCARDS; PHOTOGRAPHS; CALENDARS; AND SCORING SHEETS; ALL THE AFORESAID SOLD OR DISTRIBUTED IN CONNECTION WITH GOLF TOURNAMENTS (U.S. CLS. 2, 5, 22, 23, 29, 37, 38 AND 50).

CLASS 18—LEATHER GOODS

FOR BAGS, NAMELY, ALL PURPOSE SPORT BAGS AND TOTE BAGS; UMBRELLAS; ALL THE AFORESAID SOLD OR DISTRIBUTED IN CONNECTION WITH GOLF TOURNAMENTS (U.S. CLS. 1, 2, 3, 22 AND 41).

CLASS 20—FURNITURE AND ARTICLES NOT OTHERWISE CLASSIFIED

FOR CHAIRS; FOLDING CHAIRS; CHAIR CUSHIONS; ALL THE AFORESAID SOLD OR DISTRIBUTED IN CONNECTION WITH GOLF TOURNAMENTS (U.S. CLS. 2, 13, 22, 25, 32 AND 50).

CLASS 21—HOUSEWARES AND GLASS

FOR CUPS; PLASTIC CUPS; DRINKING CUPS; PLASTIC WATER BOTTLES SOLD EMPTY; ALL THE AFORESAID SOLD OR DISTRIBUTED IN CONNECTION WITH GOLF TOURNAMENTS (U.S. CLS. 2, 13, 23, 29, 30, 33, 40 AND 50).

CLASS 24—FABRICS

FOR TOWELS; BATH TOWELS; FACE TOWELS; HAND TOWELS; GOLF TOWELS; BEACH TOWELS; ALL THE AFORESAID SOLD OR DISTRIBUTED IN CONNECTION WITH GOLF TOURNAMENTS (U.S. CLS. 42 AND 50).

CLASS 25—CLOTHING

FOR CLOTHING, NAMELY, T-SHIRTS, CAPS, VISORS, HATS, SWEATSHIRTS, SWEATPANTS, GOLF SHIRTS, POLO SHIRTS, JACKETS, SLACKS, SHORTS, SWEATERS, RAIN COATS, SOCKS, PONCHOS, BABY BIBS NOT OF PAPER, CHILDREN'S AND INFANTS' CLOTH BIBS, CLOTH BIBS, GLOVES; ALL THE AFORESAID SOLD OR DISTRIBUTED IN CONNECTION WITH GOLF TOURNAMENTS (U.S. CLS. 22 AND 39).

SN 77-065,414. BONWRX, INC., PHOENIX, AZ. FILED 12-15-2006.

CLASS 28—TOYS AND SPORTING GOODS

FOR SPORTING GOODS, NAMELY, GOLF BALLS, GOLF TEES, GOLF BALL MARKERS, GOLF BAGS, GOLF BALL WASHERS, DIVOT REPAIR TOOLS, GOLF TOWEL CLIPS FOR ATTACHMENT TO GOLF BAGS, AND GOLF GLOVES FOR GOLFERS; ALL THE AFORESAID SOLD OR DISTRIBUTED IN CONNECTION WITH GOLF TOURNAMENTS (U.S. CLS. 22, 23, 38 AND 50).

**CLASS 41—EDUCATION AND ENTERTAINMENT**

FOR ENTERTAINMENT SERVICES, NAMELY, ARRANGING, ORGANIZING AND CONDUCTING GOLF TOURNAMENT ACTIVITIES (U.S. CLS. 100, 101 AND 107).

CORY BOONE, EXAMINING ATTORNEY

THE COLOR(S) BLACK AND BLUE IS/ARE CLAIMED AS A FEATURE OF THE MARK.

THE MARK CONSISTS OF "BONWRX" WITH THE LETTERS B, O, AND N IN BLACK. LETTERS W, R, AND X IN BLUE. MARK UNDERLINED IN BLUE. LETTER O UNDER BLUE LINE. LETTERS N, W, R AND W UNDER BLACK LINE.

THE WORDING "BONWRX" OR "WRX" HAS NO MEANING IN A FOREIGN LANGUAGE.

SN 77-064,846. NICHOLSON, CHARLES A., AURORA, CO. FILED 12-14-2006.

ROCKY MOUNTAIN GARAGE DOOR

THE MARK CONSISTS OF STANDARD CHARACTERS WITHOUT CLAIM TO ANY PARTICULAR FONT, STYLE, SIZE, OR COLOR.

NO CLAIM IS MADE TO THE EXCLUSIVE RIGHT TO USE "GARAGE DOOR", APART FROM THE MARK AS SHOWN.

SEC. 2(F).

CLASS 6—METAL GOODS

FOR METAL GARAGE DOORS (U.S. CLS. 2, 12, 13, 14, 23, 25 AND 50).

FIRST USE 4-1-1984; IN COMMERCE 4-1-1984.

CLASS 19—NON-METALLIC BUILDING MATERIALS

FOR NON-METAL GARAGE DOORS (U.S. CLS. 1, 12, 33 AND 50).

FIRST USE 4-1-1984; IN COMMERCE 4-1-1984.

CLASS 37—CONSTRUCTION AND REPAIR

FOR INSTALLATION OF GARAGE DOORS, OVERHEAD DOORS, DOOR OPERATORS, ROLLING DOORS, SLIDING DOORS, UPWARD ACTING TRUCK TRAILER DOORS, SWINGING GATES, STORE FRONT SWINGING DOORS, SLIDING GATES, STRIP DOORS, TRAFFIC DOORS, DOCK LEVELERS, LIFT TABLES, AND ASSOCIATED HARDWARE, MACHINERY, AND CONTROLS; MECHANIC SERVICES (U.S. CLS. 100, 103 AND 106).

FIRST USE 4-1-1984; IN COMMERCE 4-1-1984.

JAMES LOVELACE, EXAMINING ATTORNEY

CLASS 5—PHARMACEUTICALS

FOR BIOCOMPATIBLE POLYMERS FOR MEDICAL PURPOSES IN THE FIELD OF PERCUTANEOUS VERTEBROPLASTY AND PERCUTANEOUS KYPHOPLASTY; BIOCOMPATIBLE POLYMERS, NAMELY, FOR FILLING OF CAVITIES, VOIDS AND DEFECTS IN BONE, IN VIVO BONE REPAIR, SECURING OF PROSTHETIC DEVICES, BONE SUBSTITUTES FOR SURGICAL USE, SYNTHETIC FILLER TO SERVE AS REPLACEMENT FOR BONE; BIOCOMPATIBLE POLYMERS, NAMELY, POLYMERS TO PROMOTE THE REGENERATION OF DAMAGED OR SEVERED NERVES AND THE REGENERATION OF TISSUE, MUSCLE, CARTILAGE, LIGAMENTS, TENDONS, SKIN; BIOCOMPATIBLE POLYMERS FOR SYNTHETIC NERVE TUBES FOR MEDICAL USE (U.S. CLS. 6, 18, 44, 46, 51 AND 52).

CLASS 10—MEDICAL APPARATUS

FOR DEVICES, NAMELY, MEDICAL DEVICES IN THE NATURE OF INJECTION DELIVERY DEVICES FOR PERCUTANEOUS VERTEBROPLASTY AND PERCUTANEOUS KYPHOPLASTY; MEDICAL DEVICES, NAMELY, DEVICES FOR PERCUTANEOUS VERTEBROPLASTY AND PERCUTANEOUS KYPHOPLASTY; MEDICAL DEVICES AND COMPONENTS OF MEDICAL DEVICES FOR FILLING BONE VOIDS AND THE REPAIR OF BONE DEFECTS AND BONE FRACTURES, NAMELY, INJECTION SYSTEMS, NAMELY, INJECTORS, FOR DISPENSING MATERIAL FOR FILLING OR REPAIRING OF BONE AND BONE VOIDS, MIXING AND DISPENSING SYSTEMS, NAMELY, MIXERS, CARTRIDGES AND SYRINGES, FOR MIXING AND DISPENSING BONE FILLER MATERIAL, MIXING AND DISPENSING CARTRIDGES FOR BONE FILLER MATERIALS, MIXING AND DISPENSING SYRINGES FOR BONE FILLER MATERIALS; PREFILLED BONE FILLER MATERIAL DISPENSING CARTRIDGES AND SYRINGES, HYPODERMIC NEEDLES, MATERIAL DELIVERY TUBING FOR MEDICAL PURPOSES AND OTHER ASSOCIATED COMPONENTS, NAMELY, TROCARS; MEDICAL DEVICES, NAMELY, DEVICES IN THE NATURE OF SYNTHETIC NERVE TUBES THAT PROMOTE THE REGENERATION OF DAMAGED OR SEVERED NERVES AND THE REGENERATION OF TISSUE, MUSCLE, CARTILAGE, LIGAMENTS, TENDONS, SKIN (U.S. CLS. 26, 39 AND 44).

MATTHEW PAPPAS, EXAMINING ATTORNEY

SN 77-065,513. MUTHALAMPET MAHADEVAN, CHENNAI, 600 0086, INDIA, FILED 12-15-2006.

SN 77-070,292. ADAMSON, DANIEL JOHN, ST. PAUL, MN. FILED 12-22-2006.

HOT BREADS

THE MARK CONSISTS OF STANDARD CHARACTERS WITHOUT CLAIM TO ANY PARTICULAR FONT, STYLE, SIZE, OR COLOR.

NO CLAIM IS MADE TO THE EXCLUSIVE RIGHT TO USE "BREADS", APART FROM THE MARK AS SHOWN. SEC. 2(F).

CLASS 35—ADVERTISING AND BUSINESS

FOR RETAIL BAKERY SHOPS AND ONLINE COMPUTER ORDERING SERVICES FEATURING BAKERY AND CONFECTIONERY ITEMS (U.S. CLS. 100, 101 AND 102).

FIRST USE 0-0-1988; IN COMMERCE 0-0-1998.

CLASS 43—HOTEL AND RESTAURANT SERVICES

FOR FRENCH CAFE' AND DELICATESSEN SERVICES FEATURING SALADS, BURGERS, PIZZA, ICE CREAM, BAKERY AND CONFECTIONERY ITEMS, DESSERTS, COFFEE DRINKS AND SOFT DRINKS (U.S. CLS. 100 AND 101).

FIRST USE 0-0-1988; IN COMMERCE 0-0-1998.

STEVEN PEREZ, EXAMINING ATTORNEY

SN 77-066,481. PACIFIC PEBBLES CORPORATION, SAN DIEGO, CA. FILED 12-18-2006.

WESTCOAT SPECIALTY COATING SYSTEMS

THE MARK CONSISTS OF STANDARD CHARACTERS WITHOUT CLAIM TO ANY PARTICULAR FONT, STYLE, SIZE, OR COLOR.

NO CLAIM IS MADE TO THE EXCLUSIVE RIGHT TO USE "COATING SYSTEMS", APART FROM THE MARK AS SHOWN.

CLASS 2—PAINTS

FOR COATINGS IN THE NATURE OF INDUSTRIAL SEALANTS FOR WATERPROOFING AND SURFACE HARDENING, NAMELY, ACRYLIC COATINGS, URETHANE COATINGS, ACRYLIC POLYMER SEALER AND EPOXY COATINGS (U.S. CLS. 6, 11 AND 16).

CLASS 17—RUBBER GOODS

FOR WATERPROOF SEALANTS FOR DECK FLOORING, NAMELY, ACRYLIC COATINGS, URETHANE COATINGS, ACRYLIC POLYMER SEALER AND EPOXY COATINGS (U.S. CLS. 1, 5, 12, 13, 35 AND 50).

JULIE GUTTADAURO, EXAMINING ATTORNEY



THE COLOR(S) RED AND TAN IS/ARE CLAIMED AS A FEATURE OF THE MARK.

THE MARK CONSISTS OF THE COLOR TAN FORMING AN OUTLINE OF THE BARN DOOR AND AN "X" AGAINST THE RED BACKGROUND.

CLASS 25—CLOTHING

FOR WOMEN'S, MEN'S, AND CHILDREN'S CLOTHING, NAMELY, SHIRTS, T-SHIRTS, SWEATSHIRTS, PANTS/TROUSERS, JEANS, OVERALLS, COVERALLS, JUMPERS, ATHLETIC PANTS, SKIRTS, SHORTS, JUMPSUITS, BEACHWEAR, UNDERWEAR, LOUNGEWEAR, PAJAMAS, SLEEPWEAR, OUTERWEAR, NAMELY, COATS, JACKETS; HEADWEAR, BELTS, INFANT WEAR (U.S. CLS. 22 AND 39).

CLASS 26—FANCY GOODS

FOR BUCKLES, NAMELY, CLOTHING BUCKLES, BELT BUCKLES NOT OF PRECIOUS METAL (U.S. CLS. 37, 39, 40, 42 AND 50).

MIDGE BUTLER, EXAMINING ATTORNEY

SN 77-072,557. CONSTRUCTION RESEARCH & TECHNOLOGY, GMBH, TROSTBERG, FED REP GERMANY, FILED 12-28-2006.

SELBY

THE MARK CONSISTS OF STANDARD CHARACTERS WITHOUT CLAIM TO ANY PARTICULAR FONT, STYLE, SIZE, OR COLOR.

SEC. 2(F).

CLASS 1—CHEMICALS

FOR CHEMICAL ADDITIVES FOR FLOOR AND WALL COATINGS (U.S. CLS. 1, 5, 6, 10, 26 AND 46).

FIRST USE 4-6-1928; IN COMMERCE 4-6-1928.

CLASS 2—PAINTS

FOR POLYMERIC FLOOR COATINGS AND MEMBRANES, AGGREGATE-FILLED POLYMERIC FLOOR COATINGS AND TOPPING, WALL COATINGS, PRIMERS FOR FLOOR COATINGS (U.S. CLS. 6, 11 AND 16).

FIRST USE 4-6-1928; IN COMMERCE 4-6-1928.

LAURA KOVALSKY, EXAMINING ATTORNEY

SN 77-073,661. TOSHISHIRO OBATA, SAN GABRIEL, CA.
FILED 12-29-2006.

SN 77-074,991. AQUAFAIRY CORPORATION, OSAKA, JAPAN,
FILED 1-3-2007.

真剣道



THE COLOR(S) BLUE IS/ARE CLAIMED AS A FEATURE OF THE MARK.
THE MARK CONSISTS OF THE COLOR BLUE IN THE WHOLE MARK.

OWNER OF U.S. REG. NOS. 1,967,826 AND 2,627,236.
THE FOREIGN WORDING IN THE MARK TRANSLATES INTO ENGLISH AS 'THE WAY OF THE REAL SWORD'.

THE NON-LATIN CHARACTER(S) IN THE MARK TRANSLITERATES INTO 'SHIN-KEN-DO', AND THIS MEANS 'THE WAY OF THE REAL SWORD' IN ENGLISH.

CLASS 25—CLOTHING

FOR CLOTHING, NAMELY, MARTIAL ARTS UNIFORMS, PRACTICE UNIFORMS (DOGI), PLEATED SKIRTS FOR FORMAL KIMONOS (HAKAMA), SASH BANDS FOR KIMONOS (OBI), JACKETS, VESTS (MACHI-GI), T-SHIRTS, SHIRTS, SWEATSHIRTS, JEANS, KIMONOS, JAPANESE STYLE SANDALS (ZORI), JAPANESE STYLE SOCKS (TABI), BASEBALL CAPS, VISORS, HEADSCARVES/BANDANA (HACHIMAKI), BANDANA (TENUGUI) (U.S. CLS. 22 AND 39).

FIRST USE 1-1-1990; IN COMMERCE 1-1-1990.

CLASS 28—TOYS AND SPORTING GOODS

FOR SPORTING GOODS AND TRAINING EQUIPMENT FOR MARTIAL ARTS, NAMELY, WAXWOOD BOKUTO (WAXWOOD SWORD), WAXWOOD BO (WAXWOOD LONG STICK), BOKEN (WOODEN SWORD), PADDED DOUBLE SWORDS, CUTTING STAND FOR SWORD CUTTING TRAINING, LAITO (UNSHARPENED SWORD FOR TRAINING), SPARRING GEAR, SWORD HAND GUARD (TSUBA), SHINAI TRAINING EQUIPMENT (EQUIPMENT FOR SWORD TRAINING), SWORD BELT (U.S. CLS. 22, 23, 38 AND 50).

FIRST USE 1-1-1990; IN COMMERCE 1-1-1990.

CLASS 41—EDUCATION AND ENTERTAINMENT

FOR EDUCATION SERVICES, NAMELY, INSTRUCTION IN THE JAPANESE MARTIAL ARTS (U.S. CLS. 100, 101 AND 107).

FIRST USE 1-1-1990; IN COMMERCE 1-1-1990.
YAT SYE, LEE, EXAMINING ATTORNEY

CLASS 9—ELECTRICAL AND SCIENTIFIC APPARATUS

FOR FUEL BATTERIES; FUEL BATTERY CHARGERS; BATTERY CHARGERS FOR CELLULAR PHONE; BATTERY CHARGERS FOR PERSONAL DIGITAL ASSISTANT (PDA); BATTERY CHARGERS FOR LCD (LIQUID CRYSTAL DISPLAY) HAND-HELD GAME MACHINE; BATTERY CHARGERS; BATTERIES AND ELECTRICAL CELLS; ACCUMULATORS; CELLULAR PHONES AND PERSONAL DIGITAL ASSISTANT (PDA); DIGITAL AUDIO RECORDERS AND PLAYERS; SOUND REPRODUCING AND RECORDING APPARATUS OF MP3 TYPE (U.S. CLS. 21, 23, 26, 36 AND 38).

CLASS 28—TOYS AND SPORTING GOODS

FOR STAND ALONE VIDEO GAME MACHINES AND THEIR PARTS (U.S. CLS. 22, 23, 38 AND 50).
TIMOTHY FINNEGAN, EXAMINING ATTORNEY

SN 77-075,292. COGNOS INCORPORATED, OTTAWA, ONTARIO, CANADA, FILED 1-3-2007.

COGNOS ACADEMY

OWNER OF CANADA REG. NO. TMA698560, DATED 10-29-2007, EXPIRES 10-29-2022.

OWNER OF U.S. REG. NOS. 1,721,880, 1,725,260 AND 3,019,838.

NO CLAIM IS MADE TO THE EXCLUSIVE RIGHT TO USE "ACADEMY", APART FROM THE MARK AS SHOWN.

CLASS 9—ELECTRICAL AND SCIENTIFIC APPARATUS

FOR COMPUTER SOFTWARE FOR TEACHING COMPUTER USE, AND FOR ADMINISTERING EXAMINATIONS IN THE FIELD OF COMPUTER USE, AND PRINTED MANUALS REGARDING THE FOREGOING SOFTWARE SOLD AS A UNIT THEREWITH (U.S. CLS. 21, 23, 26, 36 AND 38).

CLASS 41—EDUCATION AND ENTERTAINMENT

FOR EDUCATIONAL SERVICES, NAMELY, WORKSHOPS TO TRAIN PARTICIPANTS ABOUT HOW TO USE COMPUTER SOFTWARE, AND EDUCATIONAL EXAMINATION SERVICES IN THE FIELD OF COMPUTER SOFTWARE USE (U.S. CLS. 100, 101 AND 107).

ANDREA BUTLER, EXAMINING ATTORNEY

CLASS 20—FURNITURE AND ARTICLES NOT OTHERWISE CLASSIFIED

FOR PLASTIC CONTAINERS FOR COMMERCIAL OR INDUSTRIAL USE IN POD FORM, STORAGE CONTAINERS MADE OF PLASTICS FOR COMMERCIAL OR INDUSTRIAL USE, PORTABLE STORAGE CONTAINERS OF PLASTIC FOR COMMERCIAL OR INDUSTRIAL USE, CONTAINERS NOT OF METAL FOR COMMERCIAL STORAGE AND/OR TRANSPORT PURPOSES OTHER THAN FOR HOUSEHOLD OR KITCHEN USE (U.S. CLS. 2, 13, 22, 25, 32 AND 50).

SN 77-076,024. PHASE FORWARD INCORPORATED, WALTHAM, MA. FILED 1-4-2007.

EMPIRICA

THE MARK CONSISTS OF STANDARD CHARACTERS WITHOUT CLAIM TO ANY PARTICULAR FONT, STYLE, SIZE, OR COLOR.

CLASS 9—ELECTRICAL AND SCIENTIFIC APPARATUS

FOR COMPUTER SOFTWARE FOR USE IN CONNECTION WITH COMPILING ADMINISTRATIVE AND ANALYTICAL SAFETY DATA FOR DRUGS, MEDICAL DEVICES, VACCINES AND BIOLOGICS (U.S. CLS. 21, 23, 26, 36 AND 38).

CLASS 45—PERSONAL AND LEGAL SERVICES

FOR PROVIDING CONSUMER PRODUCT INFORMATION, NAMELY, CONSULTING SERVICES IN CONNECTION WITH PRODUCT SAFETY DATA FOR DRUGS, MEDICAL DEVICES, VACCINES AND BIOLOGICS (U.S. CLS. 100 AND 101).

CURTIS FRENCH, EXAMINING ATTORNEY

CLASS 21—HOUSEWARES AND GLASS

FOR HOUSEHOLD OR KITCHEN CONTAINERS, PLASTIC STORAGE CONTAINERS FOR DOMESTIC USE, VACUUM FLASKS, COOL BAGS, NAMELY, THERMAL INSULATED BAGS FOR FOOD OR BEVERAGES, PORTABLE COOLERS, THERMAL INSULATED BOTTLES FOR FOOD OR BEVERAGES, THERMAL INSULATED BOTTLE WRAPS USED TO KEEP THE CONTENTS COLD OR HOT; ICE PACKS USED TO KEEP FOOD AND DRINK COLD, THERMAL INSULATED STORAGE CONTAINERS TO KEEP FOOD AND/OR LIQUID HOT OR COLD, PICNIC BASKETS, PICNIC WARE, NAMELY, PLASTIC STORAGE CONTAINERS FOR PICNICS; LUNCH BOXES, CONTAINERS FOR DOMESTIC OR HOUSEHOLD OR KITCHEN USE MADE OF PLASTICS, INCLUDING THOSE FOR STORAGE AND/OR TRANSPORT PURPOSES; PLASTIC STORAGE CONTAINERS FOR DOMESTIC USE, NAMELY FOR THE STORAGE OF SPORTING ARTICLES AND TOYS, GAMES AND PLAYTHINGS (U.S. CLS. 2, 13, 23, 29, 30, 33, 40 AND 50).

CLASS 28—TOYS AND SPORTING GOODS

FOR TOYS, GAMES AND PLAYTHINGS, NAMELY SPHERICAL OBJECTS IN THE NATURE OF BALLS USED AS PUZZLES, BALLS AND MAGIC TRICKS; SPORTING ARTICLES, NAMELY SPHERICAL OBJECTS IN THE NATURE OF BALLS AND BALLS; TOYS RELATING TO MAGIC, NAMELY SPHERICAL OBJECTS IN THE NATURE OF BALLS FOR USE IN MAGIC TRICKS; MAGIC TRICKS AND APPARATUS FOR PRESENTING MAGIC TRICKS AND EFFECTS, NAMELY SPHERICAL OBJECTS IN THE NATURE OF BALLS AND CONTAINERS FOR CREATING THE EFFECTS REQUIRED FOR MAGIC, MAGIC TRICKS AND EFFECTS (U.S. CLS. 22, 23, 38 AND 50).

MARIAM MAHMOUDI, EXAMINING ATTORNEY

SN 77-076,863. FILLABALL HOLDINGS LIMITED, TENTERDEN, KENT, UNITED KINGDOM, FILED 1-5-2007.

FILLABALL

THE MARK CONSISTS OF STANDARD CHARACTERS WITHOUT CLAIM TO ANY PARTICULAR FONT, STYLE, SIZE, OR COLOR.

PRIORITY CLAIMED UNDER SEC. 44(D) ON UNITED KINGDOM APPLICATION NO. 2426564, FILED 7-7-2006, REG. NO. 2426564, DATED 7-7-2006, EXPIRES 7-7-2016.

CLASS 11—ENVIRONMENTAL CONTROL APPARATUS

FOR APPARATUS FOR LIGHTING, NAMELY, LAMPS; LANTERNS, NAMELY, CANDLE LANTERNS AND ELECTRIC LANTERNS; AND PARTS AND FITTINGS FOR SUCH GOODS (U.S. CLS. 13, 21, 23, 31 AND 34).

SN 77-079,387. THE JACK AND JILL LATE STAGE CANCER FOUNDATION, INC., ATLANTA, GA. FILED 1-9-2007.

JACK & JILL

THE MARK CONSISTS OF STANDARD CHARACTERS WITHOUT CLAIM TO ANY PARTICULAR FONT, STYLE, SIZE, OR COLOR.

CLASS 36—INSURANCE AND FINANCIAL

FOR CHARITABLE FUND RAISING WITH FUNDS BEING PRIMARILY USED TO CREATE MEMORY OPPORTUNITIES FOR FAMILIES WITH A FAMILY MEMBER WITH LATE STAGE CANCER (U.S. CLS. 100, 101 AND 102).

FIRST USE 11-1-2005; IN COMMERCE 5-11-2006.

CLASS 39—TRANSPORTATION AND STORAGE

FOR CHARITABLE SERVICES IN THE NATURE OF ORGANIZATION OF TRIPS AND EXCURSIONS THAT HELP CREATE EXPERIENCES, FOR, BETWEEN, AND AMONG PERSONS (U.S. CLS. 100 AND 105).
FIRST USE 11-1-2005; IN COMMERCE 5-11-2006.
SEAN CROWLEY, EXAMINING ATTORNEY

SN 77-079,429. THE JACK AND JILL LATE STAGE CANCER FOUNDATION, INC., ATLANTA, GA. FILED 1-9-2007.



SN 77-079,411. THE JACK AND JILL LATE STAGE CANCER FOUNDATION, INC., ATLANTA, GA. FILED 1-9-2007.

THE COLOR(S) GREEN AND LIGHT GREEN IS/ARE CLAIMED AS A FEATURE OF THE MARK.
THE MARK CONSISTS OF A SMALLER CURSIVE BACKWARDS LOWERCASE FIRST LETTER "J", SAID FIRST LETTER "J" IN GREEN COLOR, BESIDE A LARGER CURSIVE FORWARDS LOWERCASE SECOND LETTER "J", SAID SECOND LETTER "J" IN A LIGHT GREEN COLOR.

**JACK & JILL LATE STAGE
CANCER FOUNDATION**

CLASS 36—INSURANCE AND FINANCIAL

FOR CHARITABLE FUND RAISING WITH FUNDS BEING PRIMARILY USED TO CREATE MEMORY OPPORTUNITIES FOR FAMILIES WITH A FAMILY MEMBER WITH LATE STAGE CANCER (U.S. CLS. 100, 101 AND 102).
FIRST USE 3-9-2006; IN COMMERCE 3-13-2006.

CLASS 39—TRANSPORTATION AND STORAGE

FOR CHARITABLE SERVICES IN THE NATURE OF ORGANIZATION OF TRIPS AND EXCURSIONS THAT HELP CREATE EXPERIENCES FOR, BETWEEN, AND AMONG PERSONS (U.S. CLS. 100 AND 105).
FIRST USE 3-9-2006; IN COMMERCE 3-13-2006.
SEAN CROWLEY, EXAMINING ATTORNEY

THE MARK CONSISTS OF STANDARD CHARACTERS WITHOUT CLAIM TO ANY PARTICULAR FONT, STYLE, SIZE, OR COLOR.

NO CLAIM IS MADE TO THE EXCLUSIVE RIGHT TO USE "LATE STAGE CANCER FOUNDATION", APART FROM THE MARK AS SHOWN.

SN 77-080,203. BUTTERY, INC., BOSTON, MA. FILED 1-10-2007.

CLASS 36—INSURANCE AND FINANCIAL

FOR CHARITABLE FUND RAISING WITH FUNDS BEING PRIMARILY USED TO CREATE MEMORY OPPORTUNITIES FOR FAMILIES WITH A FAMILY MEMBER WITH LATE STAGE CANCER (U.S. CLS. 100, 101 AND 102).
FIRST USE 11-5-2005; IN COMMERCE 5-11-2006.

SOUTH END BUTTERY

THE MARK CONSISTS OF STANDARD CHARACTERS WITHOUT CLAIM TO ANY PARTICULAR FONT, STYLE, SIZE, OR COLOR.

CLASS 39—TRANSPORTATION AND STORAGE

FOR CHARITABLE SERVICES IN THE NATURE OF ORGANIZATION OF TRIPS AND EXCURSIONS THAT HELP CREATE EXPERIENCES, FOR, BETWEEN, AND AMONG PERSONS (U.S. CLS. 100 AND 105).
FIRST USE 11-1-2005; IN COMMERCE 5-11-2006.
SEAN CROWLEY, EXAMINING ATTORNEY

CLASS 35—ADVERTISING AND BUSINESS

FOR RETAIL SHOPS FEATURING BAKED GOODS, PASTRIES, SANDWICHES, SOUPS, SALADS, AND COFFEE DRINKS (U.S. CLS. 100, 101 AND 102).
FIRST USE 12-1-2005; IN COMMERCE 12-1-2005.

CLASS 43—HOTEL AND RESTAURANT SERVICES

FOR RESTAURANT/CAFE (U.S. CLS. 100 AND 101).
FIRST USE 12-1-2005; IN COMMERCE 12-1-2005.
DORITT L. CARROLL, EXAMINING ATTORNEY

SN 77-080,560. VMARK INC., HILLSIDE, IL. FILED 1-11-2007.

VMARK

THE MARK CONSISTS OF STANDARD CHARACTERS WITHOUT CLAIM TO ANY PARTICULAR FONT, STYLE, SIZE, OR COLOR.

CLASS 35—ADVERTISING AND BUSINESS

FOR PACKAGING ARTICLES TO THE ORDER AND SPECIFICATION OF OTHERS; LETTERSHOP SERVICES, NAMELY, FOLDING, LABELING, CUTTING, SEALING AND STACKING PACKAGES TO SPECIFICATION; COMPUTERIZED DATABASE MANAGEMENT OF MAILING DATABASES, NAMELY, ADDRESS DELIVERY IMPROVEMENT, LIST PROCESSING, DATA PROCESSING, DATABASE MANAGEMENT AND DATA MART DEVELOPMENT; OFFICE FUNCTIONS FOR OTHERS, NAMELY, FOLDING, CUTTING, INSERTING, STITCHING, LABELING AND GLUING; COMPUTERIZED TRACKING AND TRACING OF PACKAGES IN TRANSIT; MAIL SORTING AND BAR CODING (U.S. CLS. 100, 101 AND 102).

CLASS 39—TRANSPORTATION AND STORAGE

FOR POSTAL SERVICES, NAMELY, DAILY, FIRST-CLASS, STANDARD AND INTERNATIONAL MAIL SERVICES, EXPEDITED FIRST CLASS POSTAL DELIVERY OF MAIL AND PACKAGES, PARCEL DELIVERY, PACKAGING ARTICLES FOR TRANSPORTATION, PRESORTING, STUFFING, SEALING, POSTAGE METERING, BUNDLING, AND DELIVERING MAIL TO POST OFFICE (U.S. CLS. 100 AND 105).

CLASS 40—MATERIAL TREATMENT

FOR PRINTING SERVICES, NAMELY, PERSONALIZATION AND FINISHING OF STANDARD AND CUSTOM DIRECT MAIL DOCUMENTS, BLACK AND WHITE AND COLOR PRINTING OF FORMS, LASER PRINTING, INK JET PRINTING, IMPACT PRINTING; CUSTOM MANUFACTURE OF THERMOPLASTIC CARDS, NAMELY, SECURE AND NON-SECURE BANKING CARDS, SMART CARDS, SMART BLANK CONTACTLESS CARDS, GIFT CARDS, ATM CARDS, DEBIT CARDS, RETAIL STORE ISSUED CARDS, PHONE CARDS, ID CARDS, PROMOTIONAL CARDS, KEY CARDS, PLASTIC COATED, SCRATCH OFF AND LAMINATED CARDS; THERMOPLASTIC CARD PERSONALIZATION, NAMELY EMBOSsing, ENCODING, THERMAL IMAGING, INKJET IMAGING, CUSTOMIZED PRINTING OF BAR CODES ON CARDS AND AFFIXING CARDS TO MAILING FORMS FOR OTHERS, PRINTING, PHOTOGRAPHIC PRINTING, HOT STAMPING, LABEL AFFIXING AND LABEL REMOVAL ALL WITH RESPECT TO THERMOPLASTIC CARDS, NAMELY, SECURE AND NON-SECURE BANKING CARDS, SMART CARDS, SMART BLANK CONTACTLESS CARDS, GIFT CARDS, ATM CARDS, DEBIT CARDS, RETAIL STORE ISSUED CARDS, PHONE CARDS, ID CARDS, PROMOTIONAL CARDS, KEY CARDS, PLASTIC COATED, SCRATCH OFF AND LAMINATED CARDS (U.S. CLS. 100, 103 AND 106).

CLASS 42—SCIENTIFIC AND COMPUTER SERVICES

FOR CUSTOM DESIGN OF THERMOPLASTIC CARDS, NAMELY, SECURE AND NON-SECURE BANKING CARDS, SMART CARDS, SMART BLANK CONTACTLESS CARDS, GIFT CARDS, ATM CARDS, DEBIT CARDS, RETAIL STORE ISSUED CARDS, PHONE CARDS, ID CARDS, PROMOTIONAL CARDS, KEY CARDS, PLASTIC COATED, SCRATCH OFF AND LAMINATED CARDS (U.S. CLS. 100 AND 101).
LEE-ANNE BERNS, EXAMINING ATTORNEY

SN 77-081,761. MERCY CORPS, PORTLAND, OR. FILED 1-12-2007.

FILM CONNECTION

THE MARK CONSISTS OF STANDARD CHARACTERS WITHOUT CLAIM TO ANY PARTICULAR FONT, STYLE, SIZE, OR COLOR.

NO CLAIM IS MADE TO THE EXCLUSIVE RIGHT TO USE "FILM", APART FROM THE MARK AS SHOWN.

CLASS 36—INSURANCE AND FINANCIAL

FOR CHARITABLE FUND RAISING, NAMELY, FOR FILM LIBRARY BORROWING SERVICES (U.S. CLS. 100, 101 AND 102).
FIRST USE 3-1-2002; IN COMMERCE 10-17-2003.

CLASS 41—EDUCATION AND ENTERTAINMENT

FOR REFERENCE LIBRARIES CONSISTING OF VIDEO RECORDINGS, PRE-RECORDED VIDEOTAPES, DIGITAL VIDEO DISKS, MULTIMEDIA RECORDINGS; LENDING OF VIDEO RECORDINGS, PRE-RECORDED VIDEOTAPES, DIGITAL VIDEO DISKS, MULTIMEDIA RECORDINGS; LENDING OF VIDEO RECORDINGS, PRE-RECORDED VIDEOTAPES, DIGITAL VIDEO DISKS, MULTIMEDIA RECORDINGS, NAMELY, OF DOCUMENTARY AND FOREIGN FILMS; PROVIDING INFORMATION, REVIEWS AND PERSONALIZED RECOMMENDATIONS IN THE FIELD OF ENTERTAINMENT; ON-LINE SERVICES, NAMELY, PROVIDING ELECTRONIC REFERENCE LIBRARY SERVICES WHICH FEATURE FILMS (U.S. CLS. 100, 101 AND 107).
FIRST USE 3-1-2002; IN COMMERCE 10-17-2003.

CLASS 42—SCIENTIFIC AND COMPUTER SERVICES

FOR COMPUTER SERVICES, NAMELY, HOSTING ON-LINE WEB FACILITIES FOR OTHERS FOR ORGANIZING AND CONDUCTING ON-LINE MEETINGS, GATHERINGS, AND INTERACTIVE DISCUSSIONS INVOLVING FILMS (U.S. CLS. 100 AND 101).
FIRST USE 3-1-2002; IN COMMERCE 10-17-2003.
MARIAM MAHMOUDI, EXAMINING ATTORNEY

SN 77-083,157. PARK AVENUE TRAVEL, INC., SWARTHMORE, PA. FILED 1-15-2007.



NO CLAIM IS MADE TO THE EXCLUSIVE RIGHT TO USE "TRAVEL" OR "AMERIQUE NORD" OR "AMERIQUE SUD" OR "AFRIQUE" OR "EUROPE" OR "ASIE" OR "AUSTRALIE" OR "PARIS" OR "POLE SUD", APART FROM THE MARK AS SHOWN.

THE FOREIGN WORDING IN THE MARK TRANSLATES INTO ENGLISH AS "OCEAN ATLANTIQUE" MEANS "ATLANTIC OCEAN"; "AMERIQUE NORD" MEANS "NORTH AMERICA"; "AMERIQUE SUD" MEANS "SOUTH AMERICA"; "AFRIQUE" MEANS "AFRICA"; "EUROPE" MEANS "EUROPE"; "ASIE" MEANS "ASIA"; "AUSTRALIE" MEANS "AUSTRALIA"; "PARIS" MEANS "PARIS"; "MAPPE MONDE" MEANS "WORLD MAP"; "EQUATEUR" MEANS "EQUATOR"; "PAR" MEANS "BY"; "POLE SUD" MEANS "SOUTH POLE"; AND "L'ADRENT ET DEBERNY" ARE THE NAMES OF THE MAP MAKERS; "ET" MEANS "AND."

CLASS 39—TRANSPORTATION AND STORAGE

FOR ARRANGING FOR TRAVEL VISAS, PASSPORTS AND TRAVEL DOCUMENTS FOR PERSONS TRAVELING ABROAD; ARRANGING TRAVEL TOURS; ARRANGING TRAVEL TOURS AS A BONUS PROGRAM FOR CREDIT CARDS CUSTOMERS; COORDINATING TRAVEL ARRANGEMENTS FOR INDIVIDUALS AND FOR GROUPS; ORGANISATION OF TRAVEL; ORGANIZATION OF EXCURSIONS, SIGHTSEEING TOURS, HOLIDAYS, TOURS AND TRAVEL; ORGANIZATION OF TRAVEL AND BOAT TRIPS; TRAVEL AGENCY SERVICES, NAMELY, MAKING RESERVATIONS AND BOOKINGS FOR TRANSPORTATION; TRAVEL AND TOUR INFORMATION SERVICE; TRAVEL AND TOUR TICKET RESERVATION SERVICE; TRAVEL BOOKING AGENCIES; TRAVEL INFORMATION SERVICES; TRAVEL, EXCURSION AND CRUISE ARRANGEMENT (U.S. CLS. 100 AND 105).

FIRST USE 0-0-1990; IN COMMERCE 0-0-1990.

CLASS 43—HOTEL AND RESTAURANT SERVICES

FOR PROVIDING TRAVEL LODGING INFORMATION SERVICES AND TRAVEL LODGING BOOKING AGENCY SERVICES FOR TRAVELERS; RESERVATION OF HOTEL ROOMS FOR TRAVELERS; RESERVATION OF HOTEL ROOMS FOR TRAVELLERS; RESERVATION OF ROOMS FOR TRAVELLERS; TRAVEL AGENCY SERVICES, NAMELY, MAKING RESERVATIONS AND BOOKING FOR TEMPORARY LODGING; TRAVEL AGENCY SERVICES, NAMELY, MAKING RESERVATIONS AND BOOKINGS FOR RESTAURANTS AND MEALS (U.S. CLS. 100 AND 101).

FIRST USE 0-0-1990; IN COMMERCE 0-0-1990. JENNIFER HETU, EXAMINING ATTORNEY

SN 77-083,494. NORTH AMERICAN NUTRITION COMPANIES, INC., LEWISBURG, OH. FILED 1-16-2007.



NO CLAIM IS MADE TO THE EXCLUSIVE RIGHT TO USE "NUTRITION", APART FROM THE MARK AS SHOWN.

THE MARK CONSISTS OF THE WORDS "NUTRITION HORIZONS" WITH DESIGN.

CLASS 5—PHARMACEUTICALS

FOR ANIMAL FEED SUPPLEMENTS (U.S. CLS. 6, 18, 44, 46, 51 AND 52).

CLASS 31—NATURAL AGRICULTURAL PRODUCTS

FOR NON-MEDICATED ADDITIVES FOR ANIMAL FEED AND ANIMAL FEED, NAMELY, LIVESTOCK FEED, HORSE FEED AND PET FOOD (U.S. CLS. 1 AND 46).

CLASS 35—ADVERTISING AND BUSINESS

FOR WHOLESALE AND RETAIL DISTRIBUTORSHIPS FEATURING FEED ADDITIVES; ANIMAL FEED SUPPLEMENTS AND ANIMAL FEED, NAMELY, LIVESTOCK FEED, HORSE FEED AND PET FOOD (U.S. CLS. 100, 101 AND 102).

H. M. FISHER, EXAMINING ATTORNEY

SN 77-083,706. KPMG LLP, NEW YORK, NY. FILED 1-16-2007.

A GREAT PLACE TO BUILD YOUR CAREER

THE MARK CONSISTS OF STANDARD CHARACTERS WITHOUT CLAIM TO ANY PARTICULAR FONT, STYLE, SIZE, OR COLOR.

CLASS 9—ELECTRICAL AND SCIENTIFIC APPARATUS

FOR PRE-RECORDED MEDIA, NAMELY, CD'S AND DVD'S, DOWNLOADABLE WEBCASTS AND DOWNLOADABLE PODCASTS FEATURING EMPLOYMENT HIRING, RECRUITING, PLACEMENT, STAFFING AND CAREER NETWORKING INFORMATION (U.S. CLS. 21, 23, 26, 36 AND 38).

FIRST USE 3-0-2006; IN COMMERCE 6-0-2006.

CLASS 16—PAPER GOODS AND PRINTED MATTER

FOR PRINTED MATERIALS NAMELY, BROCHURES, PAMPHLETS AND NEWSLETTERS FEATURING EMPLOYMENT HIRING, RECRUITING, PLACEMENT, STAFFING AND CAREER NETWORKING INFORMATION (U.S. CLS. 2, 5, 22, 23, 29, 37, 38 AND 50).

FIRST USE 3-0-2006; IN COMMERCE 6-0-2006.

CLASS 35—ADVERTISING AND BUSINESS

FOR ACCOUNTING; AUDITING, NAMELY, ACCOUNT AUDITING, BUSINESS AUDITING, AUDITING OF FINANCIAL REPORTING; TAX AND BUSINESS MANAGEMENT CONSULTING SERVICES (U.S. CLS. 100, 101 AND 102).

FIRST USE 3-0-2006; IN COMMERCE 6-0-2006.
RICHARD WHITE, EXAMINING ATTORNEY

SN 77-084,145. INTERNATIONAL PROFIT ASSOCIATES, INC., BUFFALO GROVE, IL. FILED 1-16-2007.

BUSINESSTODAY

THE MARK CONSISTS OF STANDARD CHARACTERS WITHOUT CLAIM TO ANY PARTICULAR FONT, STYLE, SIZE, OR COLOR.

OWNER OF U.S. REG. NO. 3,222,497.

CLASS 16—PAPER GOODS AND PRINTED MATTER

FOR MAGAZINES IN THE FIELDS OF BUSINESS AND FINANCE, NOT DIRECTED TO COLLEGE STUDENTS (U.S. CLS. 2, 5, 22, 23, 29, 37, 38 AND 50).

CLASS 41—EDUCATION AND ENTERTAINMENT

FOR PROVIDING AN ON-LINE PUBLICATION IN THE NATURE OF A MAGAZINE IN THE FIELDS OF BUSINESS AND FINANCE, NOT DIRECTED TO COLLEGE STUDENTS; CONDUCTING WORKSHOPS AND SEMINARS IN THE FIELDS OF BUSINESS AND FINANCE, NOT DIRECTED TO COLLEGE STUDENTS (U.S. CLS. 100, 101 AND 107).

BRIAN PINO, EXAMINING ATTORNEY

SN 77-085,774. SOLID QUALITY LEARNING, LLC, BELLEVUE, WA. FILED 1-18-2007.

SOLID QUALITY LEARNING

THE MARK CONSISTS OF STANDARD CHARACTERS WITHOUT CLAIM TO ANY PARTICULAR FONT, STYLE, SIZE, OR COLOR.

NO CLAIM IS MADE TO THE EXCLUSIVE RIGHT TO USE "LEARNING", APART FROM THE MARK AS SHOWN.

CLASS 41—EDUCATION AND ENTERTAINMENT

FOR COMPUTER EDUCATION TRAINING; EDUCATION SERVICES, NAMELY, MENTORING IN THE FIELD OF APPLICATION DEVELOPMENT, DATABASE SOFTWARE, SQL DATABASE PROGRAMMING, AND COMPUTER DATABASES; EDUCATION SERVICES, NAMELY, PROVIDING WORKSHOPS, CONFERENCES, SEMINARS, AND COURSES TO BUSINESS, ORGANIZATIONS, AND INDIVIDUALS IN THE FIELDS OF APPLICATION DEVELOPMENT, DATABASE SOFTWARE, SQL DATABASE PROGRAMMING, AND COMPUTER DATABASES; EDUCATIONAL SERVICES, NAMELY, CONDUCTING PROGRAMS IN THE FIELD OF APPLICATION DEVELOPMENT, DATABASE SOFTWARE, SQL DATABASE PROGRAMMING, AND COMPUTER DATABASES; EDUCATIONAL SERVICES, NAMELY, CONDUCTING WORKSHOPS, CONFERENCES, SEMINARS, AND COURSES TO BUSINESS, ORGANIZATIONS, AND INDIVIDUALS IN THE FIELD OF APPLICATION DEVELOPMENT, DATABASE SOFTWARE, SQL DATABASE PROGRAMMING, AND COMPUTER DATABASES AND DISTRIBUTION OF COURSE MATERIAL IN CONNECTION THEREWITH; EDUCATIONAL SERVICES, NAMELY, DEVELOPING, ARRANGING, AND CONDUCTING EDUCATIONAL CONFERENCES AND PROGRAMS AND PROVIDING COURSES OF INSTRUCTION IN THE FIELD OF APPLICATION DEVELOPMENT, DATABASE SOFTWARE, SQL DATABASE PROGRAMMING, AND COMPUTER DATABASES (U.S. CLS. 100, 101 AND 107).

FIRST USE 12-15-2002; IN COMMERCE 12-15-2002.

CLASS 42—SCIENTIFIC AND COMPUTER SERVICES

FOR COMPUTER SOFTWARE CONSULTATION; COMPUTER SOFTWARE DESIGN FOR OTHERS; COMPUTER SOFTWARE DESIGN, COMPUTER PROGRAMMING, OR MAINTENANCE OF COMPUTER SOFTWARE; COMPUTER SOFTWARE DEVELOPMENT; CONSULTANCY IN THE FIELD OF SOFTWARE DESIGN (U.S. CLS. 100 AND 101).

FIRST USE 12-15-2002; IN COMMERCE 12-15-2002.
ERNEST SHOSHO, EXAMINING ATTORNEY

SN 77-086,550. FREY HOMES, LLC, ALTAMONTE SPRINGS, FL. FILED 1-19-2007.

REMODELING SOLUTIONS BY FREY

THE MARK CONSISTS OF STANDARD CHARACTERS WITHOUT CLAIM TO ANY PARTICULAR FONT, STYLE, SIZE, OR COLOR.

NO CLAIM IS MADE TO THE EXCLUSIVE RIGHT TO USE "REMODELING SOLUTIONS", APART FROM THE MARK AS SHOWN.

CLASS 37—CONSTRUCTION AND REPAIR

FOR GENERAL CONSTRUCTION SERVICES (U.S. CLS. 100, 103 AND 106).

FIRST USE 1-8-2007; IN COMMERCE 1-8-2007.

CLASS 42—SCIENTIFIC AND COMPUTER SERVICES

FOR BUILDING DESIGN AND BUILDING DESIGN CONSULTATION SERVICES IN THE FIELD OF RESIDENTIAL AND COMMERCIAL PROPERTY (U.S. CLS. 100 AND 101).

FIRST USE 1-8-2007; IN COMMERCE 1-8-2007.
GRETTA YAO, EXAMINING ATTORNEY

SN 77-086,704. INTERSECTIONS INC., CHANTILLY, VA.
FILED 1-19-2007.

GOOD START

THE MARK CONSISTS OF STANDARD CHARACTERS WITHOUT CLAIM TO ANY PARTICULAR FONT, STYLE, SIZE, OR COLOR.

CLASS 35—ADVERTISING AND BUSINESS

FOR CREDIT CARD REGISTRATION SERVICES; MONITORING CONSUMER CREDIT REPORTS AND PROVIDING INFORMATION REGARDING CHANGES THEREIN (U.S. CLS. 100, 101 AND 102).

CLASS 36—INSURANCE AND FINANCIAL

FOR CREDIT CARD CANCELLATION AND NOTIFICATION SERVICES FOR LOST OR STOLEN CREDIT CARDS; PROVIDING CREDIT REPORTING DATA MAINTAINED BY OTHERS; PROVIDING IDENTITY THEFT INSURANCE UNDERWRITTEN BY OTHERS; OBTAINING CREDIT INFORMATION AND OTHER PUBLIC AND PERSONAL FINANCIAL INFORMATION FOR USE IN PROVIDING REPORTS ON CREDIT RISKS DUE TO IDENTITY THEFT; CREDIT MANAGEMENT SERVICES, NAMELY, ASSISTANCE WITH RESTORING CREDIT DAMAGED BY IDENTITY THEFT; CREDIT MANAGEMENT SERVICES, NAMELY, ASSISTANCE WITH RESTORING CREDIT DAMAGED BY IDENTITY THEFT; AND PROVIDING INFORMATION ONLINE AND VIA TELEPHONE IN THE FIELD OF CONSUMER CREDIT EDUCATION (U.S. CLS. 100, 101 AND 102).

CLASS 45—PERSONAL AND LEGAL SERVICES

FOR IDENTITY THEFT PROTECTION SERVICES, NAMELY, FRAUD PREVENTION IN THE FORM OF PERSONAL INFORMATION AND FINANCIAL IDENTITY MONITORING; FRAUD RESOLUTION ASSISTANCE, NAMELY, PROVIDING ADVICE AND CONSULTATION IN THE FIELD OF IDENTITY THEFT (U.S. CLS. 100 AND 101).

ALLISON SCHRODY, EXAMINING ATTORNEY

SN 77-086,721. INTERSECTIONS INC., CHANTILLY, VA.
FILED 1-19-2007.

WATCHFUL EYE

THE MARK CONSISTS OF STANDARD CHARACTERS WITHOUT CLAIM TO ANY PARTICULAR FONT, STYLE, SIZE, OR COLOR.

CLASS 35—ADVERTISING AND BUSINESS

FOR CREDIT CARD REGISTRATION SERVICES; MONITORING CONSUMER CREDIT REPORTS AND PROVIDING INFORMATION REGARDING CHANGES THEREIN (U.S. CLS. 100, 101 AND 102).

CLASS 36—INSURANCE AND FINANCIAL

FOR CREDIT CARD CANCELLATION AND NOTIFICATION SERVICES FOR LOST OR STOLEN CREDIT CARDS; PROVIDING CREDIT REPORTING DATA MAINTAINED BY OTHERS; PROVIDING IDENTITY THEFT INSURANCE UNDERWRITTEN BY OTHERS; OBTAINING CREDIT INFORMATION AND OTHER PUBLIC AND PERSONAL FINANCIAL INFORMATION FOR USE IN PROVIDING REPORTS ON CREDIT RISKS DUE TO IDENTITY THEFT; CREDIT MANAGEMENT SERVICES, NAMELY, ASSISTANCE WITH RESTORING CREDIT DAMAGED BY IDENTITY THEFT; AND PROVIDING INFORMATION ONLINE AND VIA TELEPHONE IN THE FIELD OF CONSUMER CREDIT EDUCATION (U.S. CLS. 100, 101 AND 102).

CLASS 45—PERSONAL AND LEGAL SERVICES

FOR IDENTITY THEFT PROTECTION SERVICES, NAMELY, FRAUD PREVENTION IN THE FORM OF PERSONAL INFORMATION AND FINANCIAL IDENTITY MONITORING; FRAUD RESOLUTION ASSISTANCE, NAMELY, PROVIDING ADVICE AND CONSULTATION IN THE FIELD OF IDENTITY THEFT (U.S. CLS. 100 AND 101).

ALLISON SCHRODY, EXAMINING ATTORNEY

SN 77-087,154. CELLUFUN INC., NEW YORK, NY. FILED 1-19-2007.



CLASS 9—ELECTRICAL AND SCIENTIFIC APPARATUS

FOR DOWNLOADABLE GAME SOFTWARE FOR USE ON MOBILE PHONES, DOWNLOADED VIA THE INTERNET AND WIRELESS DEVICES (U.S. CLS. 21, 23, 26, 36 AND 38).

FIRST USE 9-13-2005; IN COMMERCE 9-13-2005.

CLASS 41—EDUCATION AND ENTERTAINMENT

FOR ENTERTAINMENT SERVICES, NAMELY, NON-DOWNLOADABLE ON-LINE COMPUTER GAMES PRESENTED TO MOBILE PHONES VIA A GLOBAL COMPUTER NETWORK (U.S. CLS. 100, 101 AND 107).

FIRST USE 9-13-2005; IN COMMERCE 9-13-2005.

CHRISIE B. KING, EXAMINING ATTORNEY

SN 77-087,350. SEAYU ENTERPRISES, INC., SAN FRANCISCO, CA. FILED 1-20-2007.

CLEAN + GREEN

THE MARK CONSISTS OF STANDARD CHARACTERS WITHOUT CLAIM TO ANY PARTICULAR FONT, STYLE, SIZE, OR COLOR.

CLASS 3—COSMETICS AND CLEANING PREPARATIONS

FOR PET ODOR REMOVERS, BUT NOT ALGAECIDE, FUNGICIDE, OR BACTERICIDE, FOR OFFICE AND HOUSEHOLD USE (U.S. CLS. 1, 4, 6, 50, 51 AND 52).
FIRST USE 1-29-2007; IN COMMERCE 2-2-2007.

CLASS 5—PHARMACEUTICALS

FOR CARPET FRESHENERS AND ODOR ELIMINATORS, BUT NOT ALGAECIDE, FUNGICIDE, OR BACTERICIDE, FOR OFFICE AND HOUSEHOLD USE (U.S. CLS. 6, 18, 44, 46, 51 AND 52).
FIRST USE 1-29-2007; IN COMMERCE 2-2-2007.
KAPIL BHANOT, EXAMINING ATTORNEY

SN 77-087,507. BOYD, MICHAEL T., DBA FEDERALIME AMFC, BROOKLYN, NY. FILED 1-21-2007.

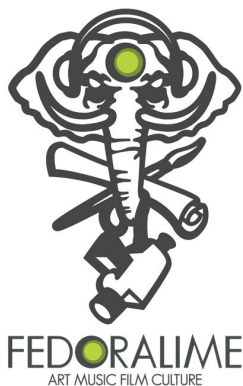

NO CLAIM IS MADE TO THE EXCLUSIVE RIGHT TO USE "ART MUSIC FILM CULTURE", APART FROM THE MARK AS SHOWN.

THE COLOR(S) GREY, WHITE, AND LIME GREEN IS/ ARE CLAIMED AS A FEATURE OF THE MARK.

THE MARK CONSISTS OF THE HEAD OF AN ELEPHANT WEARING HEADPHONES WITH A CIRCLE ON ITS FOREHEAD HOLDING A SCROLL, PAINT BRUSH AND VIDEO CAMERA WITH THE WORD "FEDORALIME" BELOW THE ELEPHANT AND THE WORDS "ART MUSIC FILM CULTURE" BELOW THE WORD "FEDORALIME." THE COLOR LIME GREEN APPEARS IN THE CIRCLE ON THE ELEPHANT'S FOREHEAD AND IN THE LETTER "O" IN THE WORD "FEDORALIME." THE COLOR WHITE APPEARS AS THE INTERIOR OF THE ELEPHANT AND THE INTERIOR COLOR OF THE PAINTBRUSH, SCROLL, HEADPHONES, AND VIDEO CAMERA. THE WORDING IN THE MARK AND THE OUTLINE OF THE ELEPHANT, PAINTBRUSH, SCROLL, HEADPHONES, AND VIDEO CAMERA, ARE IN THE COLOR GREY.

CLASS 25—CLOTHING

FOR TOPS (U.S. CLS. 22 AND 39).

CLASS 41—EDUCATION AND ENTERTAINMENT

FOR ENTERTAINMENT IN THE NATURE OF VISUAL AND AUDIO PERFORMANCES, NAMELY, MUSICAL BAND, ROCK GROUP, GYMNASIAC, DANCE, AND BALLET PERFORMANCES; ENTERTAINMENT IN THE NATURE OF LIVE PERFORMANCES BY MUSICAL GROUPS; ENTERTAINMENT, NAMELY, LIVE PERFORMANCES BY A MUSICAL BAND; ENTERTAINMENT SERVICES, NAMELY, AN ONLINE ACTIVITY WHERE YOU CREATE YOUR OWN MUSIC VIDEOS; ENTERTAINMENT SERVICES, NAMELY, PROVIDING A WEB SITE FEATURING MUSICAL PERFORMANCES, MUSICAL VIDEOS, RELATED FILM CLIPS, PHOTOGRAPHS, AND OTHER MULTIMEDIA MATERIALS; ENTERTAINMENT SERVICES, NAMELY, PROVIDING ON-LINE REVIEWS OF MUSIC, MOVIES, PLAYS AND SHOWS; ENTERTAINMENT SERVICES, NAMELY, PROVIDING PRERECORDED MUSIC, INFORMATION IN THE FIELD OF MUSIC, AND COMMENTARY AND ARTICLES ABOUT MUSIC, ALL ON-LINE VIA A GLOBAL COMPUTER NETWORK; ENTERTAINMENT, NAMELY, LIVE MUSIC CONCERTS; ENTERTAINMENT, NAMELY, LIVE PERFORMANCES BY MUSICAL BANDS; MAGAZINE PUBLISHING; MUSIC COMPOSITION AND TRANSCRIPTION FOR OTHERS; MUSIC COMPOSITION FOR OTHERS; MUSIC PRODUCTION SERVICES; MUSIC PUBLISHING SERVICES; MUSIC TRANSCRIPTION FOR OTHERS; PLANNING ARRANGEMENT OF SHOWING MOVIES, SHOWS, PLAYS OR MUSICAL PERFORMANCES; PRESENTATION OF MUSICAL PERFORMANCE; PRODUCTION OF SOUND AND MUSIC VIDEO RECORDINGS (U.S. CLS. 100, 101 AND 107).

CHARLOTTE CORWIN, EXAMINING ATTORNEY

SN 77-088,581. HOSKING HARDWOOD FLOORING, INC., WALPOLE, MA. FILED 1-23-2007.

HOSKING HARDWOOD

THE MARK CONSISTS OF STANDARD CHARACTERS WITHOUT CLAIM TO ANY PARTICULAR FONT, STYLE, SIZE, OR COLOR.

NO CLAIM IS MADE TO THE EXCLUSIVE RIGHT TO USE "HARDWOOD", APART FROM THE MARK AS SHOWN.

SEC. 2(F).

CLASS 19—NON-METALLIC BUILDING MATERIALS

FOR LAMINATE FLOORING, WOODEN FLOORING AND PARQUET FLOORING OF WOOD (U.S. CLS. 1, 12, 33 AND 50).

FIRST USE 1-1-1939; IN COMMERCE 1-1-1939.

CLASS 35—ADVERTISING AND BUSINESS

FOR RETAIL AND ONLINE STORE SERVICES FEATURING HARDWOOD AND LAMINATE FLOORING (U.S. CLS. 100, 101 AND 102).

FIRST USE 1-1-1939; IN COMMERCE 1-1-1939.

CLASS 37—CONSTRUCTION AND REPAIR

FOR INSTALLING WOOD FLOORING AND FLOOR TILE (U.S. CLS. 100, 103 AND 106).

FIRST USE 1-1-1939; IN COMMERCE 1-1-1939.
KIMBERLY FRYE, EXAMINING ATTORNEY

SN 77-088,656. COGI SYSTEMS, L.L.C., MINNETONKA, MN.
FILED 1-23-2007.

SN 77-089,809. PREMIER MANUFACTURING SUPPORT
SERVICES, INC., CINCINNATI, OH. FILED 1-24-2007.

EMINDER

THE MARK CONSISTS OF STANDARD CHARACTERS
WITHOUT CLAIM TO ANY PARTICULAR FONT, STYLE,
SIZE, OR COLOR.



CLASS 38—COMMUNICATION

FOR ELECTRONIC TRANSMISSION OF REMINDER
MESSAGES REGARDING APPOINTMENTS, MEDICA-
TIONS AND OTHER MEDICAL TREATMENT VIA E-
MAIL, INSTANT MESSAGES, WIRELESS DEVICES,
CELL PHONES, AND HOME PHONES (U.S. CLS. 100,
101 AND 104).

FIRST USE 9-20-2006; IN COMMERCE 9-20-2006.

CLASS 44—MEDICAL, BEAUTY AND AGRICULTURAL SERVICES

FOR MEDICAL REMINDER SERVICE FOR REMIND-
ING CLIENTS OF MEDICAL INFORMATION, NAMELY,
MEDICAL APPOINTMENTS, MEDICATIONS, AND
MEDICAL TREATMENT VIA E-MAIL, INSTANT MES-
SAGES, WIRELESS DEVICES, CELL PHONES, AND
HOME PHONES (U.S. CLS. 100 AND 101).

AISHA CLARKE, EXAMINING ATTORNEY

OWNER OF U.S. REG. NO. 2,427,166.

CLASS 35—ADVERTISING AND BUSINESS

FOR TECHNICAL STAFFING SERVICES (U.S. CLS.
100, 101 AND 102).

FIRST USE 0-0-1984; IN COMMERCE 0-0-1984.

CLASS 37—CONSTRUCTION AND REPAIR

FOR MANUFACTURING MACHINERY MAINTENANCE AND REPAIR SERVICES; MANUFACTURING PRODUCTION SUPPORT SERVICES, NAMELY, PROVIDING MACHINERY MAINTENANCE, MANUFACTURING MACHINERY INSTALLATION AND REPAIR FOR OTHERS; REPAIR AND MAINTENANCE OF CONVEYORS; SNOW REMOVAL SERVICES; PEST CONTROL SERVICES; AND MAINTENANCE OF SIGNS AND ELECTRIC LIGHTING APPARATUSES; CONSULTING SERVICES IN THE FIELD OF PREVENTIVE AND PREDICTIVE MAINTENANCE OF COMPUTER NETWORK; CONSULTING IN THE FIELD OF PREVENTIVE AND PREDICTIVE MAINTENANCE OF MACHINERY (U.S. CLS. 100, 103 AND 106).

FIRST USE 0-0-1992; IN COMMERCE 0-0-1992.

CLASS 40—MATERIAL TREATMENT

FOR MANUFACTURING PROCESS CONSULTING;
AND RECYCLING SERVICES (U.S. CLS. 100, 103 AND 106).

FIRST USE 0-0-1986; IN COMMERCE 0-0-1986.

CLASS 42—SCIENTIFIC AND COMPUTER SERVICES

FOR TECHNICAL CONSULTING IN THE FIELD OF FACILITY MACHINERY AND EQUIPMENT OPERATIONS; CONSULTATION, TESTING AND DIAGNOSTIC SERVICES IN THE FIELDS OF MANUFACTURING EQUIPMENT AND VIBRATION ANALYSIS; CONSULTATION, TESTING AND DIAGNOSTIC SERVICES IN THE FIELD OF INFRARED SCANNING OF MANUFACTURING EQUIPMENT FOR PURPOSES OF DETECTING EQUIPMENT TROUBLE AND FAILURE; DEVELOPING, UPDATING AND MAINTENANCE OF COMPUTERIZED MAINTENANCE MANAGEMENT SOFTWARE (CMMS); TECHNICAL SUPPORT SERVICES, NAMELY, TROUBLESHOOTING OF COMPUTER SOFTWARE PROBLEMS; TECHNICAL SUPPORT SERVICES, NAMELY, TROUBLESHOOTING OF INDUSTRIAL PROCESS CONTROL COMPUTER SOFTWARE PROBLEMS (U.S. CLS. 100 AND 101).

FIRST USE 0-0-1998; IN COMMERCE 0-0-1998.

SHARON MEIER, EXAMINING ATTORNEY

SN 77-088,726. JUNGLE PEAK STUDIOS AB, 411 09 GÖTEBORG, SWEDEN, FILED 1-23-2007.

AZATAR

THE MARK CONSISTS OF STANDARD CHARACTERS
WITHOUT CLAIM TO ANY PARTICULAR FONT, STYLE,
SIZE, OR COLOR.

PRIORITY CLAIMED UNDER SEC. 44(D) ON SWEDEN
APPLICATION NO. 2006/05677, FILED 7-24-2006, REG. NO.
386170, DATED 1-12-2007, EXPIRES 1-12-2017.

CLASS 9—ELECTRICAL AND SCIENTIFIC APPARATUS

FOR COMPUTER GAME SOFTWARE; COMPUTER
GAME PROGRAMS; DVDS FEATURING MOVIES AND
TELEVISION MOVIES; DOWNLOADABLE COMPUTER
GAME SOFTWARE (U.S. CLS. 21, 23, 26, 36 AND 38).

CLASS 28—TOYS AND SPORTING GOODS

FOR GAMES AND PLAYTHINGS, NAMELY, TRADING
CARD GAMES, MODELED PLASTIC TOY FIGURES
AND ACCESSORIES THEREFOR (U.S. CLS. 22, 23,
38 AND 50).

WENDY GOODMAN, EXAMINING ATTORNEY

SN 77-090,731. CAMURUS AB, S-213 75 MALMO, SWEDEN,
FILED 1-25-2007.

FLUIDCRYSTAL

THE MARK CONSISTS OF STANDARD CHARACTERS WITHOUT CLAIM TO ANY PARTICULAR FONT, STYLE, SIZE, OR COLOR.

PRIORITY CLAIMED UNDER SEC. 44(D) ON ERPN CMNTY TM OFC APPLICATION NO. 005483425, FILED 11-20-2006, REG. NO. 005483425112, DATED 10-19-2007, EXPIRES 11-20-2016.

CLASS 5—PHARMACEUTICALS

FOR PHARMACEUTICAL PREPARATIONS FOR THE TREATMENT OF CANCER, INFECTION, CENTRAL NERVOUS SYSTEM DISORDERS, PAIN, INFLAMMATION, IMMUNOLOGICAL DISEASE, HORMONAL DISORDERS, GROWTH DISORDERS, DIABETIC AND METABOLIC CONDITIONS; VETERINARY PREPARATIONS FOR THE TREATMENT OF CANCER, INFECTIONS, CENTRAL NERVOUS SYSTEM DISORDERS, PAIN, INFLAMMATION, IMMUNOLOGICAL DISEASE, HORMONAL DISORDERS, GROWTH DISORDERS, DIABETIC AND METABOLIC CONDITIONS; SANITARY PREPARATIONS FOR MEDICAL USE; MATERIAL FOR STOPPING TEETH (U.S. CLS. 6, 18, 44, 46, 51 AND 52).

CLASS 42—SCIENTIFIC AND COMPUTER SERVICES

FOR CHEMICAL LABORATORIES, CHEMICAL RESEARCH, CHEMICAL ANALYSIS; RESEARCH WITHIN THE PHARMACEUTICAL, COSMETIC AND BIOTECHNICAL FIELDS (U.S. CLS. 100 AND 101).

CLASS 44—MEDICAL, BEAUTY AND AGRICULTURAL SERVICES

FOR MEDICAL SERVICES AND ASSISTANCE, NAMELY PROVIDING COUNSELING AND INFORMATION CONCERNING DRUG DELIVERY SYSTEMS AND THE TREATMENT OF ILLNESSES BY MEANS OF CARRYING AGENTS FOR DRUGS (U.S. CLS. 100 AND 101).

CLASS 45—PERSONAL AND LEGAL SERVICES

FOR LICENSING OF INTELLECTUAL PROPERTY (U.S. CLS. 100 AND 101).

G. MAYERSCHOFF, EXAMINING ATTORNEY

SN 77-091,892. ACCREDO HEALTH INCORPORATED,
MEMPHIS, TN. FILED 1-26-2007.

ACCREDO
Clinical Business Solutions

NO CLAIM IS MADE TO THE EXCLUSIVE RIGHT TO USE "CLINICAL BUSINESS SOLUTIONS", APART FROM THE MARK AS SHOWN.

CLASS 41—EDUCATION AND ENTERTAINMENT

FOR PROVIDING PATIENT EDUCATIONAL SERVICES, NAMELY, CONDUCTING PROGRAMS IN THE FIELD OF CHRONIC DISEASE, PROPER PRODUCT-RECONSTITUTION AND ADMINISTRATION, AND RESOURCES APPROPRIATE FOR SUPPORT OF DISEASE MANAGEMENT; EDUCATIONAL SERVICES FOR PRODUCT MANUFACTURERS, PHARMACEUTICAL CLINICIANS AND BIOTECH COMPANIES, CLINICIANS, CONTRACT RESEARCH ORGANIZATIONS AND INSURANCE PROVIDERS, NAMELY, CONDUCTING CLASSES, ONE-ON-ONE SESSIONS AND TELEPHONIC WORKSHOPS IN THE FIELD OF CLINICAL MEDICAL RESEARCH AND DISTRIBUTING COURSE MATERIALS IN CONNECTION THEREWITH; EDUCATIONAL SERVICES, NAMELY, CLASSES, ONE ON ONE SESSIONS AND TELEPHONIC WORKSHOPS WHICH PROVIDE PHYSICIANS, INSURANCE COMPANIES AND PATIENTS WITH SPECIFIC CHARACTERISTICS ASSOCIATED WITH DISEASE MANAGEMENT PRODUCTS (U.S. CLS. 100, 101 AND 107).

FIRST USE 8-0-2006; IN COMMERCE 8-0-2006.

CLASS 42—SCIENTIFIC AND COMPUTER SERVICES

FOR PROVIDING CLINICAL RESEARCH IN THE FIELD OF MEDICINE FOR PRODUCT MANUFACTURERS, PHARMACEUTICAL AND BIOTECH COMPANIES, CONTRACT RESEARCH ORGANIZATIONS AND INSURANCE PROVIDERS, AND PRODUCT DEVELOPMENT CONSULTATION IN SUPPORT OF NEW DRUG PRODUCT LAUNCHES (U.S. CLS. 100 AND 101).

FIRST USE 8-0-2006; IN COMMERCE 8-0-2006.

STEVEN R. FINE, EXAMINING ATTORNEY

SN 77-092,250. DALLAS PROJECT HOLDINGS LIMITED,
BRIDGETOWN, BARBADOS, FILED 1-26-2007.



OWNER OF U.S. REG. NOS. 2,869,154, 2,914,426 AND OTHERS.

THE MARK CONSISTS OF TWO ARCS OVER THE WORD "BEARINGPOINT" ENCLOSED IN A RECTANGLE.

CLASS 9—ELECTRICAL AND SCIENTIFIC APPARATUS

FOR COMPUTER SOFTWARE FOR DESIGNING, INSTALLING AND EXECUTING MAINFRAME AND CLIENT/SERVER APPLICATION PROGRAMS; COMPUTER SOFTWARE FOR INTEGRATING THE FINANCIAL FUNCTIONS AND FUNCTIONS FOR PRODUCTION AND SALES FUNCTIONS OF A BUSINESS; COMPUTER SOFTWARE FOR THE MANAGEMENT OF SERVICES SUPPORTING A BUSINESS; COMPUTER SOFTWARE FOR CUSTOMER SERVICE; COMPUTER HARDWARE AND SOFTWARE FOR TESTING, MONITORING AND PROTECTING COMPUTER NETWORKS AND COMPUTER NETWORK EQUIPMENT (U.S. CLS. 21, 23, 26, 36 AND 38).

CLASS 35—ADVERTISING AND BUSINESS

FOR BUSINESS MANAGEMENT, CONSULTATION AND PLANNING, AND PROVIDING INFORMATION RELATED TO BUSINESS MANAGEMENT, CONSULTATION AND PLANNING; BUSINESS MARKETING ADVICE; COMMERCIAL AND BUSINESS CONSULTING AND PROVIDING INFORMATION RELATED TO COMMERCIAL AND BUSINESS CONSULTING; BUSINESS CONSULTING REGARDING MERGERS AND ACQUISITIONS; BUSINESS ANALYSIS; MARKET ANALYSIS; BUSINESS EVALUATIONS; ASSISTANCE TO MANAGEMENT OF COMMERCIAL ACTIVITIES AND MARKET RESEARCH SURVEYS; RESEARCH IN THE FIELD OF COMMERCIAL ACTIVITIES; ECONOMIC RESEARCH AND ANALYSIS; DRAFTING BUSINESS EXPERT REPORTS; ARRANGING AND CONDUCTING TRADE SHOWS AND CONFERENCES FOR COMMERCIAL OR ADVERTISING PURPOSES IN THE COMMERCIAL AND MANAGEMENT SECTOR; ADMINISTRATIVE MANAGEMENT OF PROJECTS IN THE FIELD OF DEVELOPING, SPECIFYING, INSTALLING AND IMPLEMENTING INFORMATION SYSTEMS; BUSINESS CONSULTING IN THE AREA OF TRADE IN TECHNOLOGICAL PRODUCTS; PROVIDING INFORMATION RELATED TO CONSULTING IN THE AREA OF ENTERPRISE ORGANIZATION; THE AFOREMENTIONED SERVICES RENDERED THROUGH A WORLDWIDE OFFICE NETWORK; MEDIATION OF TRADE BUSINESS FOR THIRD PARTIES IN THE NATURE OF BUSINESS MEDIATION FOR THE PROCUREMENT OF COMPUTER HARDWARE AND SOFTWARE FOR THIRD PARTIES (U.S. CLS. 100, 101 AND 102).

CLASS 36—INSURANCE AND FINANCIAL

FOR FINANCIAL SERVICES, NAMELY, FINANCIAL ANALYSIS, ADVICE AND CONSULTATION, FINANCIAL CLEARING HOUSES, FINANCIAL EXCHANGE, FINANCIAL FORECASTING, FINANCIAL INFORMATION IN THE NATURE OF RATES OF EXCHANGE, FINANCIAL INFORMATION PROVIDED BY ELECTRONIC MEANS, FINANCIAL INFORMATION PROCESSING, FINANCIAL MANAGEMENT, FINANCIAL PLANNING, FINANCIAL PORTFOLIO MANAGEMENT, FINANCIAL RESEARCH, FINANCIAL SERVICES IN THE NATURE OF AN INVESTMENT SECURITY, PROVIDING ON-LINE STORED VALUE ACCOUNTS IN AN ELECTRONIC ENVIRONMENT, INVESTMENT FUND TRANSFER AND TRANSACTION SERVICES AND FINANCIAL VALUATION OF PERSONAL PROPERTY AND REAL ESTATE; VENTURE CAPITAL FINANCING, NAMELY, PROVIDING FINANCING TO EMERGING AND START-UP COMPANIES (U.S. CLS. 100, 101 AND 102).

CLASS 37—CONSTRUCTION AND REPAIR

FOR INSTALLATION, IMPLEMENTATION, REPAIR AND MAINTENANCE OF COMPUTERS, COMPUTER SYSTEMS, COMPUTER NETWORKS, AND COMPUTER HARDWARE (U.S. CLS. 100, 103 AND 106).

CLASS 42—SCIENTIFIC AND COMPUTER SERVICES

FOR COMPUTER CONSULTATION SERVICES, NAMELY, PROVIDING INFORMATION IN THE AREAS OF INFORMATION TECHNOLOGY AND USE AND APPLICATION OF COMPUTERS AND COMPUTER SYSTEMS, COMPUTER HARDWARE DEVELOPMENT, COMPUTER NETWORK DESIGN FOR OTHERS, COMPUTER SERVICES, NAMELY, CREATING AND MAINTAINING WEB SITES FOR OTHERS, COMPUTER SOFTWARE DEVELOPMENT, COMPUTER CONSULTING SERVICES IN THE FIELD OF DESIGN, SELECTION, IMPLEMENTATION AND USE OF COMPUTER HARDWARE AND SOFTWARE SYSTEMS FOR OTHERS; INSTALLATION, MAINTENANCE AND UPDATING OF SOFTWARE; IMPLEMENTATION OF COMPUTER SYSTEMS AND COMPUTER NETWORKS; MANAGEMENT OF BACK-END SOFTWARE FUNCTIONS IN THE NATURE OF MAINTENANCE, UPDATING, UPGRADING, IMPLEMENTATION AND REPAIR OF COMPUTER SOFTWARE; RENDERING INFORMATION REGARDING INFORMATION TECHNOLOGY, NAMELY, PROVIDING A WEB SITE THAT FEATURES INFORMATION ON COMPUTER TECHNOLOGY AND USE AND APPLICATION OF COMPUTERS AND COMPUTER SYSTEMS; INFORMATION TECHNOLOGY CONSULTATION IN THE NATURE OF PROVIDING INFORMATION REGARDING CONSULTING WITH RESPECT TO INFORMATION TECHNOLOGY AND USE AND APPLICATION OF COMPUTERS AND COMPUTER SYSTEMS; ADVICE REGARDING USE AND APPLICATION OF COMPUTERS, COMPUTER SYSTEMS AND DEVELOPMENT OF COMPUTER SYSTEMS; DEVELOPMENT OF ON-LINE COMPUTER SOFTWARE SYSTEMS; ADVISING WITH RESPECT TO INFORMATION TECHNOLOGY IN THE NATURE OF INFORMATION TECHNOLOGY CONSULTATION; DEVELOPMENT OF COMPUTER SOFTWARE AND INTERNET WEB SITES; INSTALLATION, MAINTENANCE AND UPDATING OF COMPUTER SOFTWARE; TECHNICAL SUPPORT, NAMELY, COMPUTER NETWORK TESTING TO ENSURE NETWORK INTEGRITY AND MONITORING OF NETWORK SYSTEMS (U.S. CLS. 100 AND 101).

ANDREA K. NADELMAN, EXAMINING ATTORNEY

SN 77-092,384. KRIEN, DAVID, HAYS, KS. FILED 1-26-2007.

TA

THE MARK CONSISTS OF STANDARD CHARACTERS WITHOUT CLAIM TO ANY PARTICULAR FONT, STYLE, SIZE, OR COLOR.

CLASS 21—HOUSEWARES AND GLASS

FOR NOVELTY ITEMS, NAMELY, GAME ANIMALS AND FISH FIGURINES OF CHINA, CRYSTAL, EARTHENWARE, GLASS, PORCELAIN, TERRA COTTA (U.S. CLS. 2, 13, 23, 29, 30, 33, 40 AND 50).

CLASS 42—SCIENTIFIC AND COMPUTER SERVICES

FOR COMPUTER SERVICES, NAMELY, THREE-DIMENSIONAL SCANNING AND MEASURING OF GAME ANIMALS AND FISH (U.S. CLS. 100 AND 101).

NAKWAMA ANKRAH, EXAMINING ATTORNEY

SN 77-092,395. GEIER, MITCHELL, NEW EGYPT, NJ. FILED 1-26-2007.

SN 77-092,603. LIGHT SCIENCES ONCOLOGY, INC., SNO-QUALMIE, WA. FILED 1-26-2007.

I GET HIGH

THE MARK CONSISTS OF STANDARD CHARACTERS WITHOUT CLAIM TO ANY PARTICULAR FONT, STYLE, SIZE, OR COLOR.

CLASS 9—ELECTRICAL AND SCIENTIFIC APPARATUS

FOR SUNGLASSES; MOUSE PADS; ELECTRONIC GOODS RELATED TO AVIATION, NAMELY, AVIATION COMMUNICATION HEADSETS FOR USE WITH COMMUNICATION RADIOS, NAVIGATION APPARATUS FOR AIRCRAFT, COMMUNICATION EQUIPMENT, NAMELY TRANSPONDERS AND RADIOS (U.S. CLS. 21, 23, 26, 36 AND 38).

CLASS 16—PAPER GOODS AND PRINTED MATTER

FOR STICKERS, BUMPER STICKERS, POSTERS, BOOKMARKS, CALENDARS, NEWSLETTERS IN THE FIELD OF AVIATION, AVIATION-RELATED LOG BOOKS, WINDOW CLINGS, AVIATION KNEE BOARDS IN THE NATURE OF CLIPBOARDS FOR PLACEMENT ON A USER'S KNEE (U.S. CLS. 2, 5, 22, 23, 29, 37, 38 AND 50).

CLASS 18—LEATHER GOODS

FOR AVIATION-RELATED GEAR, NAMELY, FLIGHT CARRY-ALL BAGS, LUGGAGE, TOTE BAGS (U.S. CLS. 1, 2, 3, 22 AND 41).

CLASS 25—CLOTHING

FOR CLOTHING, NAMELY, HATS, CAPS, SHIRTS, PANTS, JACKETS, FLIGHT JACKETS, JUMPSUITS, FLIGHT SUITS, COATS, BLAZERS, SWEAT SHIRTS, SWEAT PANTS, SOCKS, TOPS, JEANS, BELTS, SHORTS, TIES, PAJAMAS, NIGHTWEAR, SLEEPWEAR, UNDERWEAR, ROBES, SWEATERS, SCARVES, GLOVES, BOOTS AND SHOES (U.S. CLS. 22 AND 39).

CLASS 35—ADVERTISING AND BUSINESS

FOR ON-LINE RETAIL STORE SERVICES FEATURING CLOTHING, SUNGLASSES, STICKERS, BUMPER STICKERS, WINDOW CLINGS, BOOK MARKS, CALENDARS, PHOTOGRAPHS, MUGS, JEWELRY, MOUSE PADS, AVIATION-RELATED GEAR, AND AVIATION-RELATED ELECTRONIC GOODS; PROVIDING A WEB SITE THAT ENABLES USERS TO POST AND RESPOND TO BULLETIN BOARD POSTINGS AND CLASSIFIED ADVERTISEMENTS (U.S. CLS. 100, 101 AND 102).
MICHAEL LITZAU, EXAMINING ATTORNEY

LIGHT INFUSION

THE MARK CONSISTS OF STANDARD CHARACTERS WITHOUT CLAIM TO ANY PARTICULAR FONT, STYLE, SIZE, OR COLOR.

CLASS 5—PHARMACEUTICALS

FOR PHARMACEUTICALS, NAMELY, ENERGY-ACTIVATED COMPOUNDS USED IN CONJUNCTION WITH PHOTOTHERAPEUTIC DEVICES FOR TREATMENT IN THE AREAS OF ONCOLOGY, OPHTHALMOLOGY, CARDIOVASCULAR SYSTEMS, INFECTIOUS DISEASES, UROLOGICAL DISEASES, AND ADIPOSE TISSUE REDUCTION (U.S. CLS. 6, 18, 44, 46, 51 AND 52).

CLASS 10—MEDICAL APPARATUS

FOR PHOTOTHERAPEUTIC DEVICES FOR MEDICAL PURPOSES (U.S. CLS. 26, 39 AND 44).
TRACY CROSS, EXAMINING ATTORNEY

SN 77-092,629. SEJUNG USA HARRY VARDON GOLF CORPORATION, WINONA, MN. FILED 1-26-2007.

Harry Vardon

THE MARK CONSISTS OF STANDARD CHARACTERS WITHOUT CLAIM TO ANY PARTICULAR FONT, STYLE, SIZE, OR COLOR.

THE NAME "HARRY VARDON" DOES NOT IDENTIFY A LIVING INDIVIDUAL.

CLASS 3—COSMETICS AND CLEANING PREPARATIONS

FOR PERSONAL CARE PRODUCTS, NAMELY BODY LOTIONS, BODY CREAMS, SOAPS, HAIR SHAMPOOS AND CONDITIONERS, DEODORANTS FOR PERSONAL USE, SKIN CONDITIONERS, SHAVING PRODUCTS, NAMELY SHAVING CREAM AND SHAVING PREPARATIONS, COLOGNES AND PERFUMES (U.S. CLS. 1, 4, 6, 50, 51 AND 52).

CLASS 9—ELECTRICAL AND SCIENTIFIC APPARATUS

FOR SUNGLASSES (U.S. CLS. 21, 23, 26, 36 AND 38).

CLASS 14—JEWELRY

FOR WATCHES, BRACELETS (U.S. CLS. 2, 27, 28 AND 50).

CLASS 18—LEATHER GOODS

FOR LUGGAGE, DUFFLE BAGS, BRIEFCASES, LUGGAGE TAGS, SMALL STORAGE DRAWSTRING POUCHES (U.S. CLS. 1, 2, 3, 22 AND 41).

CLASS 28—TOYS AND SPORTING GOODS

FOR GOLF BAGS, GOLF BAG TRAVEL COVERS, FITTED HEAD COVERS FOR GOLF CLUBS, GOLF VALUABLES STORAGE BAGS AND POUCHES (U.S. CLS. 22, 23, 38 AND 50).

CLASS 32—LIGHT BEVERAGES

FOR BEER, ALE, SPARKLING WATER, SODA WATER, FRUIT AND VEGETABLE JUICES (U.S. CLS. 45, 46 AND 48).

CLASS 33—WINES AND SPIRITS

FOR WINE (U.S. CLS. 47 AND 49).
WON TEAK OH, EXAMINING ATTORNEY

CLASS 33—WINES AND SPIRITS

FOR WINE (U.S. CLS. 47 AND 49).
WON TEAK OH, EXAMINING ATTORNEY

SN 77-093,747. THE NEW YORK TIMES COMPANY, NEW YORK, NY. FILED 1-29-2007.

Patient Money

SN 77-092,639. SEJUNG USA HARRY VARDON GOLF CORPORATION, WINONA, MN. FILED 1-26-2007.

Vardon & Ray

THE MARK CONSISTS OF STANDARD CHARACTERS WITHOUT CLAIM TO ANY PARTICULAR FONT, STYLE, SIZE, OR COLOR.

CLASS 3—COSMETICS AND CLEANING PREPARATIONS

FOR PERSONAL CARE PRODUCTS, NAMELY BODY LOTIONS, BODY CREAMS, SOAPS, HAIR SHAMPOOS AND CONDITIONERS, DEODORANTS FOR PERSONAL USE, SKIN CONDITIONERS, SHAVING PRODUCTS, NAMELY SHAVING CREAM AND SHAVING PREPARATIONS, COLOGNES AND PERFUMES (U.S. CLS. 1, 4, 6, 50, 51 AND 52).

CLASS 9—ELECTRICAL AND SCIENTIFIC APPARATUS

FOR SUNGLASSES (U.S. CLS. 21, 23, 26, 36 AND 38).

CLASS 14—JEWELRY

FOR WATCHES, BRACELETS (U.S. CLS. 2, 27, 28 AND 50).

CLASS 18—LEATHER GOODS

FOR LUGGAGE, DUFFEL BAGS, BRIEFCASES, LUGGAGE TAGS, SMALL STORAGE DRAWSTRING POUCHES (U.S. CLS. 1, 2, 3, 22 AND 41).

CLASS 28—TOYS AND SPORTING GOODS

FOR GOLF BAGS, GOLF BAG TRAVEL COVERS, FITTED HEAD COVERS FOR GOLF CLUBS, GOLF VALUABLES STORAGE BAGS AND POUCHES (U.S. CLS. 22, 23, 38 AND 50).

CLASS 32—LIGHT BEVERAGES

FOR BEER, ALE, SPARKLING WATER, SODA WATER, FRUIT AND VEGETABLE JUICES (U.S. CLS. 45, 46 AND 48).

CLASS 16—PAPER GOODS AND PRINTED MATTER

FOR COLUMNS ON THE SUBJECT OF HEALTH, MEDICAL, AND FINANCIAL ISSUES ENCOUNTERED BY MEDICAL PATIENTS (U.S. CLS. 2, 5, 22, 23, 29, 37, 38 AND 50).

CLASS 41—EDUCATION AND ENTERTAINMENT

FOR PROVIDING ON-LINE PUBLICATIONS IN THE NATURE OF COLUMNS, BLOGS, AND NEWSPAPER SECTIONS IN THE FIELD OF HEALTH, MEDICAL, AND FINANCIAL ISSUES ENCOUNTERED BY MEDICAL PATIENTS (U.S. CLS. 100, 101 AND 107).
ROSELLE HERRERA, EXAMINING ATTORNEY

SN 77-094,550. MCDAVID KNEE-GUARD, INC., WOODRIDGE, IL. FILED 1-30-2007.

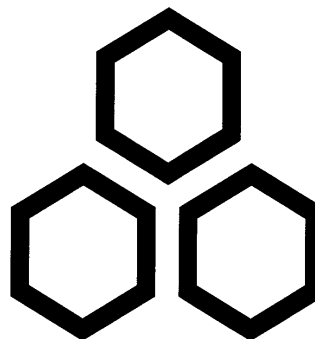
**CLASS 10—MEDICAL APPARATUS**

FOR SUPPORT PADS AND BRACES FOR ANATOMICAL JOINTS AND MUSCLES (U.S. CLS. 26, 39 AND 44).

CLASS 25—CLOTHING

FOR CLOTHING, NAMELY, T-SHIRTS, SHIRTS, SHORTS, GYM SHORTS, SPORTS SHORTS, SWEAT SHORTS, TIGHTS, ATHLETIC SUPPORT TOPS, ATHLETIC CROP TOPS, TOPS, BRIEFS, SOCKS, HOODS, GIRDLES, COMPRESSION SHIRTS, COMPRESSION TOPS, COMPRESSION SHORTS, COMPRESSION PANTS, HEEL INSERTS, WRIST BANDS (U.S. CLS. 22 AND 39).
BARBARA A. GOLD, EXAMINING ATTORNEY

SN 77-094,881. AMERICAN GIRL, LLC, EL SEGUNDO, CA.
FILED 1-30-2007.

NICKI

THE MARK CONSISTS OF STANDARD CHARACTERS WITHOUT CLAIM TO ANY PARTICULAR FONT, STYLE, SIZE, OR COLOR.
OWNER OF U.S. REG. NO. 2,261,294.

CLASS 16—PAPER GOODS AND PRINTED MATTER

FOR PUBLICATIONS, NAMELY, CHILDREN'S BOOKS (U.S. CLS. 2, 5, 22, 23, 29, 37, 38 AND 50).
FIRST USE 1-1-2007; IN COMMERCE 1-1-2007.

CLASS 28—TOYS AND SPORTING GOODS

FOR TOYS, GAMES AND PLAYTHINGS, NAMELY, DOLLS, DOLL CLOTHING AND DOLL ACCESSORIES (U.S. CLS. 22, 23, 38 AND 50).
FIRST USE 1-1-2007; IN COMMERCE 1-1-2007.
LAURIE KAUFMAN, EXAMINING ATTORNEY

SN 77-094,959. CZT/ACN TRADEMARKS, L.L.C., SCHAUMBURG, IL. FILED 1-30-2007.

nielsen
● ● ● ● ● ● ● ●

OWNER OF U.S. REG. NOS. 540,915, 3,230,380 AND OTHERS.

THE COLOR(S) BLUE AND GRAY IS/ARE CLAIMED AS A FEATURE OF THE MARK.

THE MARK CONSISTS OF THE STYLIZED WORD "NIELSEN", IN WHICH THE COLOR BLUE APPEARS IN THE LETTER "N" WHILE THE COLOR GRAY APPEARS IN THE REMAINDER OF THE WORD, "IELSEN", AND IN THE NINE DOTS BENEATH THE STYLIZED WORD.

SEC. 2(F) AS TO "NIELSEN".

CLASS 9—ELECTRICAL AND SCIENTIFIC APPARATUS

FOR ELECTRONIC DATABASES IN THE FIELDS OF ADVERTISING AND MARKETING RESEARCH, MARKET RESEARCH, AND CORPORATE AND BUSINESS INFORMATION, AND CONTAINING INFORMATION REGARDING PRODUCT MANUFACTURERS AND DISTRIBUTORS, RETAIL STORES, MASS MERCHANDISERS, WHOLESALE CLUBS, SUPERCENTERS, DOLLAR STORES, CHAIN DRUG STORES, DEPARTMENT STORES, SPECIALTY RETAILERS, MILITARY BUYING CENTERS, AND OTHER ALTERNATE CHANNEL RETAILERS, FILMS AND TELEVISION PROGRAMMING, MEDIA RATING INFORMATION, RADIO AIRPLAY, BOOK SALES, MUSIC SALES, VIDEO SALES, NEW MOVIE LISTINGS AND MEDIA RESEARCH, SALES AND PROFIT INFORMATION, RETAIL AND ON-PREMISES BUSINESS LOCATIONS, DEMOGRAPHIC INFORMATION, AND ADVERTISING, PROMOTION, TRADE AND MARKETING PLANNING, ALL IN DOWNLOADABLE FORM OR RECORDED ON COMPUTER MEDIA; COMPUTER PROGRAMS USED TO MANAGE AND ANALYZE AND PREPARE REPORTS CONTAINING THE AFORESAID INFORMATION, ALL IN DOWNLOADABLE FORM OR RECORDED ON COMPUTER MEDIA; COMPUTER SOFTWARE PROGRAMS, DATABASE MANAGEMENT PROGRAMS AND MANUALS SOLD THEREWITH AS A UNIT USED TO CREATE, ACCESS, VIEW, REVIEW, MANIPULATE, CATEGORIZE, ANALYZE, FORMAT, AND PREPARE AND PRINT REPORTS FROM DATA AND INFORMATION IN ALL THE AFORESAID DATABASES, ALL IN DOWNLOADABLE FORM OR RECORDED ON COMPUTER MEDIA; COMPUTER SOFTWARE FOR USE IN COLLECTING, ANALYZING, AND PRODUCING REPORTS REGARDING INFORMATION ABOUT THE TRANSMISSION AND RECEPTION OF SIGNALS DELIVERED VIA OVER-THE-AIR BROADCAST, CABLE, SATELLITE, AND A GLOBAL COMPUTER NETWORK AND THEIR CONTENT, AND THE LISTENING, VIEWING, AND USAGE HABITS OF SIGNAL RECEIVING AUDIENCES AND USER MANUALS SOLD AS A UNIT THEREWITH; DATABASES ON COMPUTER MEDIA CONTAINING INFORMATION REGARDING AND RELATING TO CABLE HEADEND AND CABLE SYSTEM INFORMATION FOR CABLE TELEVISION AND MEDIA, DIGITAL AUDIO, DIGITAL MEDIA, AND BROADBAND TRANSMISSION, PERSONAL GLOBAL POSITIONING SATELLITE RECEIVING AND TRANSMISSION DEVICE FOR USE IN TRACKING TRAVELS BY SUBJECT; COMPUTER SOFTWARE AND HARDWARE FOR USE IN ENCODING, READING, AND ANALYZING BROADCAST, TELEVISION, VIDEO AND AUDIO SIGNALS, AUDIO AND VIDEO CODING AND DECODING OF SAME, NAMELY, COMPUTER SOFTWARE PROGRAM AND COMPUTER HARDWARE AND FIRMWARE, NAMELY, ELECTRONIC AND INTEGRATED CIRCUITS; AUDIO AND VIDEO ENCODERS; AND ELECTRONIC AUDIO AND VIDEO READERS, NAMELY, AUDIO AND VIDEO ENCODERS AND DECODERS; COMPUTER SOFTWARE FOR PLANNING AND SCHEDULING ADVERTISING AND MARKETING IN THE FIELDS OF ADVERTISING AND MARKETING RESEARCH, MARKET RESEARCH, MEDIA RESEARCH AND RATING, AND CORPORATE AND BUSINESS INFORMATION; COMPUTER SOFTWARE FOR PLANNING ADVERTISING AND DETERMINING AND ESTIMATING MEDIA AND MARKETING PLAN EFFECTIVENESS AND FOR MEASURING CONSUMER RESPONSIVENESS TO ADVERTISING; COMPUTER SOFTWARE PROGRAMS THAT MATCH PRODUCT ADVERTISEMENTS, THE BUDGET ALLOCATED FOR ADVERTISING THE INDIVIDUAL PRODUCTS, AND PROBABLE BUYING HABITS OF AN EXPECTED VIEWING AUDIENCE OF TELEVISION PROGRAMMING; AND ELECTRONIC PUBLICATIONS, NAMELY, BUSINESS-TO-BUSINESS MAGAZINES, NEWSPAPERS, PERIODICALS, PRESENTATIONS AND REPORTS IN THE FIELDS OF ADVERTISING AND MARKETING RESEARCH, MARKET RESEARCH, MEDIA RESEARCH AND RATING, AND CORPORATE AND BUSINESS INFORMATION, AND DIRECTORIES FEATURING RETAIL BUSINESS AND BUSINESS LOCATIONS, CINEMA THEATRES, ADVERTISING, MARKETING RESEARCH, AND BUSINESS ENTITIES IN DOWNLOADABLE FORM OR RECORDED ON COMPUTER MEDIA (U.S. CLS. 21, 23, 26, 36 AND 38).

CLASS 16—PAPER GOODS AND PRINTED MATTER

FOR PRINTED REPORTS, CALENDARS, DIRECTORIES, MAGAZINES, AND PUBLICATIONS, NAMELY, NEWSLETTERS, IN THE FIELDS OF MARKETING, MEDIA RESEARCH, MEDIA RATINGS, PROGRAMMING, ADVERTISING, MEDIA RATING SERVICES, MARKET RESEARCH, CONSUMER PURCHASES, CONSUMER MEDIA USAGE, ADVERTISING RESEARCH, BUSINESS RESEARCH AND ANALYSIS, DEMOGRAPHIC RESEARCH, AND MEDIA AND MARKETING MEASUREMENT INFORMATION, ANALYSES, AND DIRECTORIES; PERIODICAL JOURNALS CONTAINING MEDIA VIEWING AND ADVERTISING REPORTS, AND CONSUMER PROMOTION REPORTS; REPORTS, CALENDARS, NEWSPAPER COLUMNS, MAGAZINE COLUMNS, PERIODICAL COLUMNS, AND BOOKLETS CONTAINING STATISTICAL AND OTHER INFORMATION CONCERNING FILMS, NEW MOVIE LISTINGS, FILM DISTRIBUTION, FILM VIEWING, AND THEATRICAL EXHIBITION OF MOTION PICTURES, BOOKS, MUSIC AND VIDEO SALES AND PROMOTIONS, SPORTS EVENTS AND PROMOTIONS; MAPS AND MAPS OF AREAS SHOWING LOCATIONS OF THEATRES OR THEATERS AND FEATURING INFORMATION REGARDING THOSE THEATRES OR THEATERS; PRINTED MARKET RESEARCH REPORTS, NEWSPAPER COLUMNS, MAGAZINE COLUMNS AND PERIODICAL COLUMNS DEALING WITH BOX OFFICE PERFORMANCE OF MOTION PICTURES; DIARIES FOR ENTRY OF INFORMATION RELATING TO THE LISTENING, VIEWING AND USAGE HABITS OF SIGNAL RECEIVING AUDIENCES, INTERNET AND/OR COMPUTER USERS; PRINTED PUBLICATIONS, NAMELY, BUSINESS-TO-BUSINESS MAGAZINES, NEWSPAPERS, PERIODICALS, PRINTED REPORTS, PRESENTATIONS AND RETAIL STORE DIRECTORIES IN THE FIELDS OF ADVERTISING AND MARKETING RESEARCH, MARKET RESEARCH, MEDIA RESEARCH, AND CORPORATE AND BUSINESS INFORMATION, AND DIRECTORIES IN THE FIELDS OF ADVERTISING AND MARKETING RESEARCH, MARKET RESEARCH, MEDIA RESEARCH, AND CORPORATE AND BUSINESS INFORMATION, AND FEATURING RETAIL BUSINESS AND BUSINESS LOCATIONS, CINEMA THEATRES, ADVERTISING, MARKETING RESEARCH, AND BUSINESS ENTITIES; NEWSLETTERS AND PRINTED PERIODICALS FEATURING INFORMATION RELATED TO BUSINESS, MARKETING, DEVELOPMENTS, TRENDS AND LEGAL ISSUES RELATED TO RETAIL MARKETING AND SALES, COMPANIES, RETAILERS, MASS MERCHANDISERS, WHOLESALE CLUBS, SUPERCENTERS, DOLLAR STORES, CHAIN DRUG STORES, DEPARTMENT STORES, SPECIALTY RETAILERS, MILITARY BUYING CENTERS, AND OTHER ALTERNATE CHANNEL RETAILERS; DIRECTORIES LISTING RETAIL STORES IN SHOPPING MALLS; AND PRINTED CHARTS AND REPORTS FEATURING SOUND RECORDING SALES, RATINGS, AND POPULARITY CHARTS (U.S. CLS. 2, 5, 22, 23, 29, 37, 38 AND 50).

CLASS 35—ADVERTISING AND BUSINESS

FOR MARKET RESEARCH SERVICES; ADVERTISING RESEARCH SERVICES; BUSINESS RESEARCH SERVICES; RETAIL MARKETING AND SALES INFORMATION SERVICES; CONSUMER PURCHASE AND BEHAVIOR RESEARCH SERVICES; CONDUCTING MARKET, ADVERTISING AND MEDIA USAGE AND RATING RESEARCH, AND ANALYZING, AND PREPARING REPORTS BASED THEREON REGARDING CONSUMER, ADVERTISING, MEDIA VIEWING, MARKET RESEARCH AND BUSINESS RESEARCH SURVEYS, POLLS, OPINION STUDIES, STUDIES, ANALYSES AND EVALUATIONS, AND ON-LINE SURVEY PANELS; BUSINESS AND BRAND CONSULTING SERVICES; MARKET RESEARCH SERVICES RELATED TO NEW RETAIL SALES, PRODUCT PLACEMENT AND POINT-OF-PURCHASE DISPLAYS, AND RETAIL FACILITY INFORMATION, PRODUCT IDEAS, INTRODUCTIONS AND RE-INTRODUCTIONS; PROVIDING MARKETING, ADVERTISING AND BUSINESS CONSULTING SERVICES RELATED TO PRODUCT AND PACKAGE BREAKTHROUGH AND VISIBILITY RELATING TO PRODUCT PACKAGE PERFORMANCE; OUTDOOR ADVERTISING RESEARCH SERVICES AND MEDIA AUDIENCE MEASUREMENT SERVICES; MED-

IA RESEARCH SERVICES; MEDIA RATING RESEARCH SERVICES; MEDIA RESEARCH SERVICES REGARDING COMPUTERS AND COMPUTER NETWORKS AND THEIR USE; DEMOGRAPHIC AND CONSUMER RESEARCH SERVICES; COLLECTING DATA, CONDUCTING MARKET, ADVERTISING, MEDIA, AND BUSINESS RESEARCH, ANALYZING AND PROVIDING REPORTS BASED THEREON RELATING TO POPULATION AND PRODUCT TREND STUDIES AND INFORMATION; COLLECTING DATA AND PROVIDING REPORTS BASED THEREON CONCERNING THE MARKETING, SALES, AND USAGE OF CONSUMER PRODUCTS, PHARMACEUTICALS AND NUTRACEUTICALS, DURABLE GOODS, BOOKS, MUSIC AND VIDEO MARKETING AND SALES AND CONSUMER BEHAVIOR; MARKET RESEARCH AND BUSINESS RESEARCH SERVICES RELATING TO; CODING AND CONFORMING CLIENT PRODUCT, RETAIL STORE AND MARKETING DATA AND RECORDS; MEDIA RESEARCH AND RATING SERVICES, NAMELY, MARKET RESEARCH SERVICES RELATING TO THE BROADCASTING, NARROW CASTING, CABLE, AND NETWORK TRANSMISSION, SIGNAL RECEIVING AUDIENCE DEMOGRAPHICS AND BEHAVIOR, AND THE LISTENING, VIEWING, AND USAGE HABITS OF SIGNAL RECEIVING AUDIENCES, COMPUTER USERS, AND USERS OF A GLOBAL COMPUTER NETWORK; SALES VOLUME TRACKING FOR OTHERS; SALES VOLUME TRACKING FOR OTHERS THROUGH THE COLLECTION OF SALES DATA AND MARKET RESEARCH AND THE DISTRIBUTION OF THE RESULTS THEREOF FOR OTHERS OF MUSIC, MUSIC VIDEOS, PRERECORDED DVDS, PRERECORDED CD-ROMS, AND AUDIO SELL-THROUGH DATA, BLANK AUDIO TAPES, BLANK VIDEO TAPES AND RELATED AUDIO AND VISUAL PRODUCTS, PRERECORDED VIDEOS ON VHS, VIDEO DVDS, AND VIDEO SELL-THROUGH DATA, BOOKS, INCLUDING AUDIO AND ELECTRONIC BOOKS, SOLD ON-LINE AND BY RETAIL AND WHOLESALE STORES, CONSUMER GOODS, DURABLE GOODS, PHARMACEUTICALS, SPORTS EVENTS, SPORTING GOODS, MUSIC, MUSIC VIDEOS, BLANK AUDIO TAPES, BLANK VIDEO TAPES, DVDS, BOOKS, NAMELY, PRINTED, AUDIO AND ELECTRONIC BOOKS SOLD ON-LINE AND BY RETAIL AND WHOLESALE STORES, TELEPHONE AND CELL PHONE RING TONES, RING BACKS, MUSIC-RELATED PRODUCTS AND SERVICES FOR MOBILE TELEPHONE CONSUMERS, ONLINE MUSIC DOWNLOADS, ONLINE VIDEO AND MOVIE DOWNLOADS; COLLECTING AND CORRELATING MARKETING, ADVERTISING, AND BUSINESS INFORMATION REGARDING SPORTS VENUE ADVERTISING AND SIGNAGE, ADVERTISEMENTS, AND SPONSORSHIP MARKETING DERIVED FROM AND INCLUDING IMAGES OF TELEVISION, CABLE, AND RADIO PROGRAMMING AND INTERNET AND PRINT PUBLICATIONS, AS WELL AS REVENUE, FOR STATISTICAL ANALYSIS AND MARKET RESEARCH PURPOSES VIA THE INTERNET AND PREPARATION AND DISSEMINATION OF PRINTED REPORTS BASED THEREON TO THIRD PARTIES; COMPILING INFORMATION ABOUT COMMERCIAL ADVERTISEMENTS TELEVISED DURING NATIONAL AND REGIONAL TELECASTS; BROADCAST RECOGNITION INFORMATION SERVICES FOR OTHERS, NAMELY, ELECTRONIC RECOGNITION AND IDENTIFICATION OF PRE-RECORDED MUSIC, COMMERCIALS AND PROGRAMMING ON RADIO, TELEVISION, CABLE STATIONS, AND ONLINE BY USE OF PASSIVE PATTERN RECOGNITION TECHNOLOGY; AND REVIEWING, CODING, AND CONFORMING RETAIL, RETAIL STORE, PRODUCT, AND MARKETING DATA AND RECORDS; PLANNING AND CONDUCTING BUSINESS MEETINGS, AND TRADESHOWS IN THE FIELDS OF ADVERTISING AND MARKETING RESEARCH, MARKET RESEARCH, MEDIA RESEARCH, AND CORPORATE AND BUSINESS INFORMATION; PREPARING MARKET RESEARCH AND BUSINESS RESEARCH REPORTS FROM COMPUTER DATABASES, IN THE FIELDS OF MARKET RESEARCH AND PRODUCT RETAILER AND MANUFACTURER INFORMATION RELATING TO RETAIL SALES, CONSUMER DEMOGRAPHICS, PRODUCT PLACEMENT AND POINT-OF-PURCHASE DISPLAYS, AND RETAIL FACILITY INFORMATION, PRODUCT INFORMATION, PRODUCT CATALOGS, PRODUCT SALES, COMPETITOR INFORMATION, RETAIL CONSUMER INFORMATION, SEGMENTATION AND TARGETING INFORMATION, MANUFACTURING INFORMATION, AND MARKETING; BUSINESS INFORMATION AND

MARKET RESEARCH SERVICES, NAMELY, CONDUCTING MARKET, ADVERTISING AND MARKETING RESEARCH, ANALYZING STATISTICAL DATA, PREPARING REPORTS, AND CONSULTING REGARDING BUSINESS AND MARKET RESEARCH INFORMATION; AND PROVIDING ON-LINE INTERACTIVE COMPUTER DATABASES IN THE FIELDS OF BUSINESS AND MARKET RESEARCH, DEMOGRAPHIC INFORMATION AND DATA RELATING TO THE SALE AND PROMOTION OF CONSUMER AND DURABLE GOODS, CONDUCTING MARKET AND BUSINESS SURVEYS, STUDIES, ANALYSES AND EVALUATIONS; PROVIDING TEMPORARY USE OF ON-LINE NON-DOWNLOADABLE ELECTRONIC DATABASES AND WEBSITES IN THE FIELDS OF ADVERTISING, MARKETING, BUSINESS, MEDIA AND MARKET RESEARCH, CONSUMER SURVEYS, PRODUCT RETAILER, RETAIL STORE AND PRODUCT SALES, TRADING AREAS, AND DEMOGRAPHIC INFORMATION; PROVIDING TEMPORARY USE OF ONLINE NON-DOWNLOADABLE DATABASES FOR CREATING, ACCESSING, UPDATING, DOWNLOADING, VIEWING AND MANIPULATING INFORMATION IN THE FIELDS OF MARKET RESEARCH AND PRODUCT RETAILER AND MANUFACTURER INFORMATION RELATING TO RETAIL SALES, CONSUMER DEMOGRAPHICS, PRODUCT PLACEMENT AND POINT-OF-PURCHASE DISPLAYS, AND RETAIL FACILITY INFORMATION, PRODUCT INFORMATION, PRODUCT CATALOGS, PRODUCT SALES, COMPETITOR INFORMATION, RETAIL CONSUMER INFORMATION, SEGMENTATION AND TARGETING INFORMATION, MANUFACTURING INFORMATION, AND MARKETING; PROVIDING TEMPORARY USE OF ONLINE NON-DOWNLOADABLE ELECTRONIC DATABASES FOR USE IN ANALYZING ADVERTISING, MARKETING, SALES, AND PRODUCT INFORMATION IN CONNECTION WITH RETAIL STORE MARKETING SALES, PROMOTION, AND OTHER MARKETING ACTIVITIES (U.S. CLS. 100, 101 AND 102).

CLASS 38—COMMUNICATION

FOR ELECTRONIC MESSAGE BOARDS FOR POSTING AND TRANSMISSION OF MESSAGES AMONG COMPUTER USERS CONCERNING MARKET RESEARCH, MARKETING AND MARKET RESEARCH, ADVERTISING RESEARCH, MEDIA RATINGS, AND CORPORATE AND BUSINESS INFORMATION (U.S. CLS. 100, 101 AND 104).

CLASS 41—EDUCATION AND ENTERTAINMENT

FOR PLANNING AND CONDUCTING, BUSINESS AND EDUCATIONAL SEMINARS; AND CONDUCTING WORKSHOPS AND SEMINARS IN MARKET RESEARCH, MARKETING AND ADVERTISING RESEARCH, AND CONSUMER RESEARCH AND CONSULTING (U.S. CLS. 100, 101 AND 107).

CLASS 42—SCIENTIFIC AND COMPUTER SERVICES

FOR PROVIDING ONLINE NON-DOWNLOADABLE DATABASE MANAGEMENT SOFTWARE FOR CREATING, ACCESSING, UPDATING, DOWNLOADING, VIEWING AND MANIPULATING INFORMATION IN THE FIELDS OF MARKET RESEARCH AND PRODUCT RETAILER AND MANUFACTURER INFORMATION RELATING TO RETAIL SALES, CONSUMER DEMOGRAPHICS, PRODUCT PLACEMENT AND POINT-OF-PURCHASE DISPLAYS, AND RETAIL FACILITY INFORMATION, PRODUCT INFORMATION, PRODUCT CATALOGS, PRODUCT SALES, COMPETITOR INFORMATION, RETAIL CONSUMER INFORMATION, SEGMENTATION AND TARGETING INFORMATION, MANUFACTURING INFORMATION, AND MARKETING; PROVIDING ONLINE NON-DOWNLOADABLE COMPUTER SOFTWARE FOR USE IN ANALYZING ADVERTISING, MARKETING, SALES, AND PRODUCT INFORMATION IN CONNECTION WITH RETAIL STORE MARKETING SALES, PROMOTION, AND OTHER MARKETING ACTIVITIES (U.S. CLS. 100 AND 101).

JUDITH HELFMAN, EXAMINING ATTORNEY

SN 77-094,963. CZT/ACN TRADEMARKS, L.L.C., SCHAUMBURG, IL. FILED 1-30-2007.

nielsen
● ● ● ● ● ● ● ● ● ●

OWNER OF U.S. REG. NOS. 540,915, 3,230,380 AND OTHERS.

THE MARK CONSISTS OF THE STYLIZED WORD "NIELSEN" AND NINE DOTS BENEATH THE STYLIZED WORD.

SEC. 2(F) AS TO "NIELSEN".

CLASS 9—ELECTRICAL AND SCIENTIFIC APPARATUS

FOR ELECTRONIC DATABASES IN THE FIELDS OF ADVERTISING AND MARKETING RESEARCH, MARKET RESEARCH, AND CORPORATE AND BUSINESS INFORMATION, AND CONTAINING INFORMATION REGARDING PRODUCT MANUFACTURERS AND DISTRIBUTORS, RETAIL STORES, MASS MERCHANDISERS, WHOLESALE CLUBS, SUPERCENTERS, DOLLAR STORES, CHAIN DRUG STORES, DEPARTMENT STORES, SPECIALTY RETAILERS, MILITARY BUYING CENTERS, AND OTHER ALTERNATE CHANNEL RETAILERS, FILMS AND TELEVISION PROGRAMMING, MEDIA RATING INFORMATION, RADIO AIRPLAY, BOOK SALES, MUSIC SALES, VIDEO SALES, NEW MOVIE LISTINGS AND MEDIA RESEARCH, SALES AND PROFIT INFORMATION, RETAIL AND ON-PREMISES BUSINESS LOCATIONS, DEMOGRAPHIC INFORMATION, AND ADVERTISING, PROMOTION, TRADE AND MARKETING PLANNING, ALL IN DOWNLOADABLE FORM OR RECORDED ON COMPUTER MEDIA; COMPUTER PROGRAMS USED TO MANAGE AND ANALYZE AND PREPARE REPORTS CONTAINING THE AFORESAID INFORMATION, ALL IN DOWNLOADABLE FORM OR RECORDED ON COMPUTER MEDIA; COMPUTER SOFTWARE PROGRAMS, DATABASE MANAGEMENT PROGRAMS AND MANUALS SOLD THEREWITH AS A UNIT USED TO CREATE, ACCESS, VIEW, REVIEW, MANIPULATE, CATEGORIZE, ANALYZE, FORMAT, AND PREPARE AND PRINT REPORTS FROM DATA AND INFORMATION IN ALL THE AFORESAID DATABASES, ALL IN DOWNLOADABLE FORM OR RECORDED ON COMPUTER MEDIA; COMPUTER SOFTWARE FOR USE IN COLLECTING, ANALYZING, AND PRODUCING REPORTS REGARDING INFORMATION ABOUT THE TRANSMISSION AND RECEPTION OF SIGNALS DELIVERED VIA OVER-THE-AIR BROADCAST, CABLE, SATELLITE, AND A GLOBAL COMPUTER NETWORK AND THEIR CONTENT, AND THE LISTENING, VIEWING, AND USAGE HABITS OF SIGNAL RECEIVING AUDIENCES AND USER MANUALS SOLD AS A UNIT THEREWITH; DATABASES ON COMPUTER MEDIA CONTAINING INFORMATION REGARDING AND RELATING TO CABLE HEADEND AND CABLE SYSTEM INFORMATION FOR CABLE TELEVISION AND MEDIA, DIGITAL AUDIO, DIGITAL MEDIA, AND BROADBAND TRANSMISSION, PERSONAL GLOBAL POSITIONING SATELLITE RECEIVING AND TRANSMISSION DEVICE FOR USE IN TRACKING TRAVELS BY SUBJECT; COMPUTER SOFTWARE AND HARDWARE FOR USE IN ENCODING, READING, AND ANALYZING BROADCAST, TELEVISION, VIDEO AND AUDIO SIGNALS, AUDIO AND VIDEO CODING AND DECODING OF SAME, NAMELY, COMPUTER SOFTWARE PROGRAM AND COMPUTER HARDWARE AND FIRMWARE, NAMELY, ELECTRONIC AND INTEGRATED CIRCUITS; AUDIO AND VIDEO ENCODERS; AND ELECTRONIC AUDIO AND VIDEO READERS, NAMELY, AUDIO AND VIDEO ENCODERS AND DECODERS; COMPUTER SOFTWARE FOR PLANNING AND SCHEDULING ADVERTISING AND MARKETING IN THE FIELDS OF ADVERTISING AND MARKETING RESEARCH, MARKET RESEARCH, MEDIA RESEARCH

AND RATING, AND CORPORATE AND BUSINESS INFORMATION; COMPUTER SOFTWARE FOR PLANNING ADVERTISING AND DETERMINING AND ESTIMATING MEDIA AND MARKETING PLAN EFFECTIVENESS AND FOR MEASURING CONSUMER RESPONSIVENESS TO ADVERTISING; COMPUTER SOFTWARE PROGRAMS THAT MATCH PRODUCT ADVERTISEMENTS, THE BUDGET ALLOCATED FOR ADVERTISING THE INDIVIDUAL PRODUCTS, AND PROBABLE BUYING HABITS OF AN EXPECTED VIEWING AUDIENCE OF TELEVISION PROGRAMMING; AND ELECTRONIC PUBLICATIONS, NAMELY, BUSINESS-TO-BUSINESS MAGAZINES, NEWSPAPERS, PERIODICALS, PRESENTATIONS AND REPORTS IN THE FIELDS OF ADVERTISING AND MARKETING RESEARCH, MARKET RESEARCH, MEDIA RESEARCH AND RATING, AND CORPORATE AND BUSINESS INFORMATION, AND DIRECTORIES FEATURING RETAIL BUSINESS AND BUSINESS LOCATIONS, CINEMA THEATRES, ADVERTISING, MARKETING RESEARCH, AND BUSINESS ENTITIES IN DOWNLOADABLE FORM OR RECORDED ON COMPUTER MEDIA (U.S. CLS. 21, 23, 26, 36 AND 38).

CLASS 16—PAPER GOODS AND PRINTED MATTER

FOR PRINTED REPORTS, CALENDARS, DIRECTORIES, MAGAZINES, AND PUBLICATIONS, NAMELY, NEWSLETTERS, IN THE FIELDS OF MARKETING, MEDIA RESEARCH, MEDIA RATINGS, PROGRAMMING, ADVERTISING, MEDIA RATING SERVICES, MARKET RESEARCH, CONSUMER PURCHASES, CONSUMER MEDIA USAGE, ADVERTISING RESEARCH, BUSINESS RESEARCH AND ANALYSIS, DEMOGRAPHIC RESEARCH, AND MEDIA AND MARKETING MEASUREMENT INFORMATION, ANALYSES, AND DIRECTORIES; PERIODICAL JOURNALS CONTAINING MEDIA VIEWING AND ADVERTISING REPORTS, AND CONSUMER PROMOTION REPORTS; REPORTS, CALENDARS, NEWSPAPER COLUMNS, MAGAZINE COLUMNS, PERIODICAL COLUMNS, AND BOOKLETS CONTAINING STATISTICAL AND OTHER INFORMATION CONCERNING FILMS, NEW MOVIE LISTINGS, FILM DISTRIBUTION, FILM VIEWING, AND THEATRICAL EXHIBITION OF MOTION PICTURES, BOOKS, MUSIC AND VIDEO SALES AND PROMOTIONS, SPORTS EVENTS AND PROMOTIONS; MAPS AND MAPS OF AREAS SHOWING LOCATIONS OF THEATRES OR THEATERS AND FEATURING INFORMATION REGARDING THOSE THEATRES OR THEATERS; PRINTED MARKET RESEARCH REPORTS, NEWSPAPER COLUMNS, MAGAZINE COLUMNS AND PERIODICAL COLUMNS DEALING WITH BOX OFFICE PERFORMANCE OF MOTION PICTURES; DIARIES FOR ENTRY OF INFORMATION RELATING TO THE LISTENING, VIEWING AND USAGE HABITS OF SIGNAL RECEIVING AUDIENCES, INTERNET AND/OR COMPUTER USERS; PRINTED PUBLICATIONS, NAMELY, BUSINESS-TO-BUSINESS MAGAZINES, NEWSPAPERS, PERIODICALS, PRINTED REPORTS, PRESENTATIONS AND RETAIL STORE DIRECTORIES IN THE FIELDS OF ADVERTISING AND MARKETING RESEARCH, MARKET RESEARCH, MEDIA RESEARCH, AND CORPORATE AND BUSINESS INFORMATION, AND DIRECTORIES IN THE FIELDS OF ADVERTISING AND MARKETING RESEARCH, MARKET RESEARCH, MEDIA RESEARCH, AND CORPORATE AND BUSINESS INFORMATION, AND FEATURING RETAIL BUSINESS AND BUSINESS LOCATIONS, CINEMA THEATRES, ADVERTISING, MARKETING RESEARCH, AND BUSINESS ENTITIES; NEWSLETTERS AND PRINTED PERIODICALS FEATURING INFORMATION RELATED TO BUSINESS, MARKETING, DEVELOPMENTS, TRENDS AND LEGAL ISSUES RELATED TO RETAIL MARKETING AND SALES, COMPANIES, RETAILERS, MASS MERCHANDISERS, WHOLESALE CLUBS, SUPERCENTERS, DOLLAR STORES, CHAIN DRUG STORES, DEPARTMENT STORES, SPECIALTY RETAILERS, MILITARY BUYING CENTERS, AND OTHER ALTERNATE CHANNEL RETAILERS; DIRECTORIES LISTING RETAIL STORES IN SHOPPING MALLS; AND PRINTED CHARTS AND REPORTS FEATURING SOUND RECORDING SALES, RATINGS, AND POPULARITY CHARTS (U.S. CLS. 2, 5, 22, 23, 29, 37, 38 AND 50).

CLASS 35—ADVERTISING AND BUSINESS

FOR MARKET RESEARCH SERVICES; ADVERTISING RESEARCH SERVICES; BUSINESS RESEARCH SERVICES; RETAIL MARKETING AND SALES INFORMATION SERVICES; CONSUMER PURCHASE AND BEHAVIOR RESEARCH SERVICES; CONDUCTING MARKET, ADVERTISING AND MEDIA USAGE AND RATING RESEARCH, AND ANALYZING, AND PREPARING REPORTS BASED THEREON REGARDING CONSUMER, ADVERTISING, MEDIA VIEWING, MARKET RESEARCH AND BUSINESS RESEARCH SURVEYS, POLLS, OPINION STUDIES, STUDIES, ANALYSES AND EVALUATIONS, AND ON-LINE SURVEY PANELS; BUSINESS AND BRAND CONSULTING SERVICES; MARKET RESEARCH SERVICES RELATED TO NEW RETAIL SALES, PRODUCT PLACEMENT AND POINT-OF-PURCHASE DISPLAYS, AND RETAIL FACILITY INFORMATION, PRODUCT IDEAS, INTRODUCTIONS AND RE-INTRODUCTIONS; PROVIDING MARKETING, ADVERTISING AND BUSINESS CONSULTING SERVICES RELATED TO PRODUCT AND PACKAGE BREAKTHROUGH AND VISIBILITY RELATING TO PRODUCT PACKAGE PERFORMANCE; OUTDOOR ADVERTISING RESEARCH SERVICES AND MEDIA AUDIENCE MEASUREMENT SERVICES; MEDIA RESEARCH SERVICES; MEDIA RATING RESEARCH SERVICES; MEDIA RESEARCH SERVICES REGARDING COMPUTERS AND COMPUTER NETWORKS AND THEIR USE; DEMOGRAPHIC AND CONSUMER RESEARCH SERVICES; COLLECTING DATA, CONDUCTING MARKET, ADVERTISING, MEDIA, AND BUSINESS RESEARCH, ANALYZING AND PROVIDING REPORTS BASED THEREON RELATING TO POPULATION AND PRODUCT TREND STUDIES AND INFORMATION; COLLECTING DATA AND PROVIDING REPORTS BASED THEREON CONCERNING THE MARKETING, SALES, AND USAGE OF CONSUMER PRODUCTS, PHARMACEUTICALS AND NUTRACEUTICALS, DURABLE GOODS, BOOKS, MUSIC AND VIDEO MARKETING AND SALES AND CONSUMER BEHAVIOR; MARKET RESEARCH AND BUSINESS RESEARCH SERVICES RELATING TO: CODING AND CONFORMING CLIENT PRODUCT, RETAIL STORE AND MARKETING DATA AND RECORDS; MEDIA RESEARCH AND RATING SERVICES, NAMELY, MARKET RESEARCH SERVICES RELATING TO THE BROADCASTING, NARROW CASTING, CABLE, AND NETWORK TRANSMISSION, SIGNAL RECEIVING AUDIENCE DEMOGRAPHICS AND BEHAVIOR, AND THE LISTENING, VIEWING, AND USAGE HABITS OF SIGNAL RECEIVING AUDIENCES, COMPUTER USERS, AND USERS OF A GLOBAL COMPUTER NETWORK; SALES VOLUME TRACKING FOR OTHERS; SALES VOLUME TRACKING FOR OTHERS THROUGH THE COLLECTION OF SALES DATA AND MARKET RESEARCH AND THE DISTRIBUTION OF THE RESULTS THEREOF FOR OTHERS OF MUSIC, MUSIC VIDEOS, PRERECORDED DVDS, PRERECORDED CD-ROMS, AND AUDIO SELL-THROUGH DATA, BLANK AUDIO TAPES, BLANK VIDEO TAPES AND RELATED AUDIO AND VISUAL PRODUCTS, PRERECORDED VIDEOS ON VHS, VIDEO DVDS, AND VIDEO SELL-THROUGH DATA, BOOKS, INCLUDING AUDIO AND ELECTRONIC BOOKS, SOLD ON-LINE AND BY RETAIL AND WHOLESALE STORES, CONSUMER GOODS, DURABLE GOODS, PHARMACEUTICALS, SPORTS EVENTS, SPORTING GOODS, MUSIC, MUSIC VIDEOS, BLANK AUDIO TAPES, BLANK VIDEO TAPES, DVDS, BOOKS, NAMELY, PRINTED, AUDIO AND ELECTRONIC BOOKS SOLD ON-LINE AND BY RETAIL AND WHOLESALE STORES, TELEPHONE AND CELL PHONE RING TONES, RING BACKS, MUSIC-RELATED PRODUCTS AND SERVICES FOR MOBILE TELEPHONE CONSUMERS, ONLINE MUSIC DOWNLOADS, ONLINE VIDEO AND MOVIE DOWNLOADS; COLLECTING AND CORRELATING MARKETING, ADVERTISING, AND BUSINESS INFORMATION REGARDING SPORTS VENUE ADVERTISING AND SIGNAGE, ADVERTISEMENTS, AND SPONSORSHIP MARKETING DERIVED FROM AND INCLUDING IMAGES OF TELEVISION, CABLE, AND RADIO PROGRAMMING AND INTERNET AND PRINT PUBLICATIONS, AS WELL AS REVENUE, FOR STATISTICAL ANALYSIS AND MARKET RESEARCH PURPOSES VIA THE INTERNET AND PREPARATION AND DISSEMINATION OF PRINTED REPORTS BASED THEREON TO THIRD PARTIES; COMPILING INFORMATION ABOUT COMMERCIAL ADVERTISEMENTS TELEVIEWED DURING NATIONAL AND REGIONAL TELECASTS; BROADCAST RECOGNITION

TION INFORMATION SERVICES FOR OTHERS, NAMELY, ELECTRONIC RECOGNITION AND IDENTIFICATION OF PRE-RECORDED MUSIC, COMMERCIALS AND PROGRAMMING ON RADIO, TELEVISION, CABLE STATIONS, AND ONLINE BY USE OF PASSIVE PATTERN RECOGNITION TECHNOLOGY; AND REVIEWING, CODING, AND CONFORMING RETAIL, RETAIL STORE, PRODUCT, AND MARKET-ING DATA AND RECORDS; PLANNING AND CONDUCTING BUSINESS MEETINGS, AND TRADESHOWS IN THE FIELDS OF ADVERTISING AND MARKETING RESEARCH, MARKET RESEARCH, MEDIA RESEARCH, AND CORPORATE AND BUSINESS INFORMATION; PREPARING MARKET RESEARCH AND BUSINESS RESEARCH REPORTS FROM COMPUTER DATABASES, IN THE FIELDS OF MARKET RESEARCH AND PRODUCT RETAILER AND MANUFACTURER INFORMATION RELATING TO RETAIL SALES, CONSUMER DEMOGRAPHICS, PRODUCT PLACEMENT AND POINT-OF-PURCHASE DISPLAYS, AND RETAIL FACILITY INFORMATION, PRODUCT INFORMATION, PRODUCT CATALOGS, PRODUCT SALES, COMPETITOR INFORMATION, RETAIL CONSUMER INFORMATION, SEGMENTATION AND TARGETING INFORMATION, MANUFACTURING INFORMATION, AND MARKETING; BUSINESS INFORMATION AND MARKET RESEARCH SERVICES, NAMELY, CONDUCTING MARKET, ADVERTISING AND MARKETING RESEARCH, ANALYZING STATISTICAL DATA, PREPARING REPORTS, AND CONSULTING REGARDING BUSINESS AND MARKET RESEARCH INFORMATION; AND PROVIDING ON-LINE INTERACTIVE COMPUTER DATABASES IN THE FIELDS OF BUSINESS AND MARKET RESEARCH, DEMOGRAPHIC INFORMATION AND DATA RELATING TO THE SALE AND PROMOTION OF CONSUMER AND DURABLE GOODS, CONDUCTING MARKET AND BUSINESS SURVEYS, STUDIES, ANALYSES AND EVALUATIONS; PROVIDING TEMPORARY USE OF ON-LINE NON-DOWNLOADABLE ELECTRONIC DATABASES AND WEBSITES IN THE FIELDS OF ADVERTISING, MARKETING, BUSINESS, MEDIA AND MARKET RESEARCH, CONSUMER SURVEYS, PRODUCT RETAILER, RETAIL STORE AND PRODUCT SALES, TRADING AREAS, AND DEMOGRAPHIC INFORMATION; PROVIDING TEMPORARY USE OF ONLINE NON-DOWNLOADABLE DATABASES FOR CREATING, ACCESSING, UPDATING, DOWNLOADING, VIEWING AND MANIPULATING INFORMATION IN THE FIELDS OF MARKET RESEARCH AND PRODUCT RETAILER AND MANUFACTURER INFORMATION RELATING TO RETAIL SALES, CONSUMER DEMOGRAPHICS, PRODUCT PLACEMENT AND POINT-OF-PURCHASE DISPLAYS, AND RETAIL FACILITY INFORMATION, PRODUCT INFORMATION, PRODUCT CATALOGS, PRODUCT SALES, COMPETITOR INFORMATION, RETAIL CONSUMER INFORMATION, SEGMENTATION AND TARGETING INFORMATION, MANUFACTURING INFORMATION, AND MARKETING; PROVIDING TEMPORARY USE OF ONLINE NON-DOWNLOADABLE ELECTRONIC DATABASES FOR USE IN ANALYZING ADVERTISING, MARKETING, SALES, AND PRODUCT INFORMATION IN CONNECTION WITH RETAIL STORE MARKETING SALES, PROMOTION, AND OTHER MARKETING ACTIVITIES (U.S. CLS. 100, 101 AND 102).

CLASS 38—COMMUNICATION

FOR ELECTRONIC MESSAGE BOARDS FOR POSTING AND TRANSMISSION OF MESSAGES AMONG COMPUTER USERS CONCERNING MARKET RESEARCH, MARKETING AND MARKET RESEARCH, ADVERTISING RESEARCH, MEDIA RATINGS, AND CORPORATE AND BUSINESS INFORMATION (U.S. CLS. 100, 101 AND 104).

CLASS 41—EDUCATION AND ENTERTAINMENT

FOR PLANNING AND CONDUCTING, BUSINESS AND EDUCATIONAL SEMINARS; AND CONDUCTING WORKSHOPS AND SEMINARS IN MARKET RESEARCH, MARKETING AND ADVERTISING RESEARCH, AND CONSUMER RESEARCH AND CONSULTING (U.S. CLS. 100, 101 AND 107).

CLASS 42—SCIENTIFIC AND COMPUTER SERVICES

FOR PROVIDING ONLINE NON-DOWNLOADABLE DATABASE MANAGEMENT SOFTWARE FOR CREATING, ACCESSING, UPDATING, DOWNLOADING, VIEWING AND MANIPULATING INFORMATION IN THE FIELDS OF MARKET RESEARCH AND PRODUCT RETAILER AND MANUFACTURER INFORMATION RELATING TO RETAIL SALES, CONSUMER DEMOGRAPHICS, PRODUCT PLACEMENT AND POINT-OF-PURCHASE DISPLAYS, AND RETAIL FACILITY INFORMATION, PRODUCT INFORMATION, PRODUCT CATALOGS, PRODUCT SALES, COMPETITOR INFORMATION, RETAIL CONSUMER INFORMATION, SEGMENTATION AND TARGETING INFORMATION, MANUFACTURING INFORMATION, AND MARKETING; PROVIDING ONLINE NON-DOWNLOADABLE COMPUTER SOFTWARE FOR USE IN ANALYZING ADVERTISING, MARKETING, SALES, AND PRODUCT INFORMATION IN CONNECTION WITH RETAIL STORE MARKETING SALES, PROMOTION, AND OTHER MARKETING ACTIVITIES (U.S. CLS. 100 AND 101).

JUDITH HELFMAN, EXAMINING ATTORNEY

SN 77-094,981. CZT/ACN TRADEMARKS, L.L.C., SCHAMBURG, IL. FILED 1-30-2007.

NIELSEN

THE MARK CONSISTS OF STANDARD CHARACTERS WITHOUT CLAIM TO ANY PARTICULAR FONT, STYLE, SIZE, OR COLOR.

OWNER OF U.S. REG. NOS. 540,915, 3,230,380 AND OTHERS.

SEC. 2(F).

CLASS 9—ELECTRICAL AND SCIENTIFIC APPARATUS

FOR ELECTRONIC DATABASES IN THE FIELDS OF ADVERTISING AND MARKETING RESEARCH, MARKET RESEARCH, AND CORPORATE AND BUSINESS INFORMATION, AND CONTAINING INFORMATION REGARDING PRODUCT MANUFACTURERS AND DISTRIBUTORS, RETAIL STORES, MASS MERCHANTS, WHOLESALE CLUBS, SUPERCENTERS, DOLLAR STORES, CHAIN DRUG STORES, DEPARTMENT STORES, SPECIALTY RETAILERS, MILITARY BUYING CENTERS, AND OTHER ALTERNATE CHANNEL RETAILERS, FILMS AND TELEVISION PROGRAMMING, MEDIA RATING INFORMATION, RADIO AIRPLAY, BOOK SALES, MUSIC SALES, VIDEO SALES, NEW MOVIE LISTINGS AND MEDIA RESEARCH, SALES AND PROFIT INFORMATION, RETAIL AND ON-PREMISES BUSINESS LOCATIONS, DEMOGRAPHIC INFORMATION, AND ADVERTISING, PROMOTION, TRADE AND MARKETING PLANNING, ALL IN DOWNLOADABLE FORM OR RECORDED ON COMPUTER MEDIA; COMPUTER PROGRAMS USED TO MANAGE AND ANALYZE AND PREPARE REPORTS CONTAINING THE AFORESAID INFORMATION, ALL IN DOWNLOADABLE FORM OR RECORDED ON COMPUTER MEDIA; COMPUTER SOFTWARE PROGRAMS, DATABASE MANAGEMENT PROGRAMS AND MANUALS SOLD THEREWITH AS A UNIT USED TO CREATE, ACCESS, VIEW, REVIEW, MANIPULATE, CATEGORIZE, ANALYZE, FORMAT, AND PREPARE AND PRINT REPORTS FROM DATA AND INFORMATION IN ALL THE AFORESAID DATABASES, ALL IN DOWNLOADABLE FORM OR RECORDED ON COMPUTER MEDIA; COMPUTER SOFTWARE FOR USE IN COLLECTING, ANALYZING, AND PRODUCING REPORTS REGARDING INFORMATION ABOUT THE TRANSMISSION AND RECEPTION OF SIGNALS DELIVERED VIA OVER-THE-AIR BROAD-

CAST, CABLE, SATELLITE, AND A GLOBAL COMPUTER NETWORK AND THEIR CONTENT, AND THE LISTENING, VIEWING, AND USAGE HABITS OF SIGNAL RECEIVING AUDIENCES AND USER MANUALS SOLD AS A UNIT THEREWITH; DATABASES ON COMPUTER MEDIA CONTAINING INFORMATION REGARDING AND RELATING TO CABLE HEADEND AND CABLE SYSTEM INFORMATION FOR CABLE TELEVISION AND MEDIA, DIGITAL AUDIO, DIGITAL MEDIA, AND BROADBAND TRANSMISSION, PERSONAL GLOBAL POSITIONING SATELLITE RECEIVING AND TRANSMISSION DEVICE FOR USE IN TRACKING TRAVELS BY SUBJECT; COMPUTER SOFTWARE AND HARDWARE FOR USE IN ENCODING, READING, AND ANALYZING BROADCAST, TELEVISION, VIDEO AND AUDIO SIGNALS, AUDIO AND VIDEO CODING AND DECODING OF SAME, NAMELY, COMPUTER SOFTWARE PROGRAM AND COMPUTER HARDWARE AND FIRMWARE, NAMELY, ELECTRONIC AND INTEGRATED CIRCUITS; AUDIO AND VIDEO ENCODERS; AND ELECTRONIC AUDIO AND VIDEO READERS, NAMELY, AUDIO AND VIDEO ENCODERS AND DECODERS; COMPUTER SOFTWARE FOR PLANNING AND SCHEDULING ADVERTISING AND MARKETING IN THE FIELDS OF ADVERTISING AND MARKETING RESEARCH, MARKET RESEARCH, MEDIA RESEARCH AND RATING, AND CORPORATE AND BUSINESS INFORMATION; COMPUTER SOFTWARE FOR PLANNING ADVERTISING AND DETERMINING AND ESTIMATING MEDIA AND MARKETING PLAN EFFECTIVENESS AND FOR MEASURING CONSUMER RESPONSIVENESS TO ADVERTISING; COMPUTER SOFTWARE PROGRAMS THAT MATCH PRODUCT ADVERTISEMENTS, THE BUDGET ALLOCATED FOR ADVERTISING THE INDIVIDUAL PRODUCTS, AND PROBABLE BUYING HABITS OF AN EXPECTED VIEWING AUDIENCE OF TELEVISION PROGRAMMING; AND ELECTRONIC PUBLICATIONS, NAMELY, BUSINESS-TO-BUSINESS MAGAZINES, NEWSPAPERS, PERIODICALS, PRESENTATIONS AND REPORTS IN THE FIELDS OF ADVERTISING AND MARKETING RESEARCH, MARKET RESEARCH, MEDIA RESEARCH AND RATING, AND CORPORATE AND BUSINESS INFORMATION, AND DIRECTORIES FEATURING RETAIL BUSINESS AND BUSINESS LOCATIONS, CINEMA THEATRES, ADVERTISING, MARKETING RESEARCH, AND BUSINESS ENTITIES IN DOWNLOADABLE FORM OR RECORDED ON COMPUTER MEDIA (U.S. CLS. 21, 23, 26, 36 AND 38).

CLASS 16—PAPER GOODS AND PRINTED MATTER

FOR PRINTED REPORTS, CALENDARS, DIRECTORIES, MAGAZINES, AND PUBLICATIONS, NAMELY, NEWSLETTERS, IN THE FIELDS OF MARKETING, MEDIA RESEARCH, MEDIA RATINGS, PROGRAMMING, ADVERTISING, MEDIA RATING SERVICES, MARKET RESEARCH, CONSUMER PURCHASES, CONSUMER MEDIA USAGE, ADVERTISING RESEARCH, BUSINESS RESEARCH AND ANALYSIS, DEMOGRAPHIC RESEARCH, AND MEDIA AND MARKETING MEASUREMENT INFORMATION, ANALYSES, AND DIRECTORIES; PERIODICAL JOURNALS CONTAINING MEDIA VIEWING AND ADVERTISING REPORTS, AND CONSUMER PROMOTION REPORTS; REPORTS, CALENDARS, NEWSPAPER COLUMNS, MAGAZINE COLUMNS, PERIODICAL COLUMNS, AND BOOKLETS CONTAINING STATISTICAL AND OTHER INFORMATION CONCERNING FILMS, NEW MOVIE LISTINGS, FILM DISTRIBUTION, FILM VIEWING, AND THEATRICAL EXHIBITION OF MOTION PICTURES, BOOKS, MUSIC AND VIDEO SALES AND PROMOTIONS, SPORTS EVENTS AND PROMOTIONS; MAPS AND MAPS OF AREAS SHOWING LOCATIONS OF THEATRES OR THEATERS AND FEATURING INFORMATION REGARDING THOSE THEATRES OR THEATERS; PRINTED MARKET RESEARCH REPORTS, NEWSPAPER COLUMNS, MAGAZINE COLUMNS AND PERIODICAL COLUMNS DEALING WITH BOX OFFICE PERFORMANCE OF MOTION PICTURES; DIARIES FOR ENTRY OF INFORMATION RELATING TO THE LISTENING, VIEWING AND USAGE HABITS OF SIGNAL RECEIVING AUDIENCES, INTERNET AND/OR COMPUTER USERS; PRINTED PUBLICATIONS, NAMELY, BUSINESS-TO-BUSINESS MAGAZINES, NEWSPAPERS, PERIODICALS, PRINTED REPORTS, PRESENTATIONS AND RETAIL STORE DIRECTORIES

IN THE FIELDS OF ADVERTISING AND MARKETING RESEARCH, MARKET RESEARCH, MEDIA RESEARCH, AND CORPORATE AND BUSINESS INFORMATION, AND DIRECTORIES IN THE FIELDS OF ADVERTISING AND MARKETING RESEARCH, MARKET RESEARCH, MEDIA RESEARCH, AND CORPORATE AND BUSINESS INFORMATION, AND FEATURING RETAIL BUSINESS AND BUSINESS LOCATIONS, CINEMA THEATRES, ADVERTISING, MARKETING RESEARCH, AND BUSINESS ENTITIES; NEWSLETTERS AND PRINTED PERIODICALS FEATURING INFORMATION RELATED TO BUSINESS, MARKETING, DEVELOPMENTS, TRENDS AND LEGAL ISSUES RELATED TO RETAIL MARKETING AND SALES, COMPANIES, RETAILERS, MASS MERCHANDISERS, WHOLESALE CLUBS, SUPERCENTERS, DOLLAR STORES, CHAIN DRUG STORES, DEPARTMENT STORES, SPECIALTY RETAILERS, MILITARY BUYING CENTERS, AND OTHER ALTERNATE CHANNEL RETAILERS; DIRECTORIES LISTING RETAIL STORES IN SHOPPING MALLS; AND PRINTED CHARTS AND REPORTS FEATURING SOUND RECORDING SALES, RATINGS, AND POPULARITY CHARTS (U.S. CLS. 2, 5, 22, 23, 29, 37, 38 AND 50).

CLASS 35—ADVERTISING AND BUSINESS

FOR MARKET RESEARCH SERVICES; ADVERTISING RESEARCH SERVICES; BUSINESS RESEARCH SERVICES; RETAIL MARKETING AND SALES INFORMATION SERVICES; CONSUMER PURCHASE AND BEHAVIOR RESEARCH SERVICES; CONDUCTING MARKET, ADVERTISING AND MEDIA USAGE AND RATING RESEARCH, AND ANALYZING, AND PREPARING REPORTS BASED THEREON REGARDING CONSUMER, ADVERTISING, MEDIA VIEWING, MARKET RESEARCH AND BUSINESS RESEARCH SURVEYS, POLLS, OPINION STUDIES, STUDIES, ANALYSES AND EVALUATIONS, AND ON-LINE SURVEY PANELS; BUSINESS AND BRAND CONSULTING SERVICES; MARKET RESEARCH SERVICES RELATED TO NEW RETAIL SALES, PRODUCT PLACEMENT AND POINT-OF-PURCHASE DISPLAYS, AND RETAIL FACILITY INFORMATION, PRODUCT IDEAS, INTRODUCTIONS AND RE-INTRODUCTIONS; PROVIDING MARKETING, ADVERTISING AND BUSINESS CONSULTING SERVICES RELATED TO PRODUCT AND PACKAGE BREAKTHROUGH AND VISIBILITY RELATING TO PRODUCT PACKAGE PERFORMANCE; OUTDOOR ADVERTISING RESEARCH SERVICES AND MEDIA AUDIENCE MEASUREMENT SERVICES; MEDIA RESEARCH SERVICES; MEDIA RATING RESEARCH SERVICES; MEDIA RESEARCH SERVICES REGARDING COMPUTERS AND COMPUTER NETWORKS AND THEIR USE; DEMOGRAPHIC AND CONSUMER RESEARCH SERVICES; COLLECTING DATA, CONDUCTING MARKET, ADVERTISING, MEDIA, AND BUSINESS RESEARCH, ANALYZING AND PROVIDING REPORTS BASED THEREON RELATING TO POPULATION AND PRODUCT TREND STUDIES AND INFORMATION; COLLECTING DATA AND PROVIDING REPORTS BASED THEREON CONCERNING THE MARKETING, SALES, AND USAGE OF CONSUMER PRODUCTS, PHARMACEUTICALS AND NUTRACEUTICALS, DURABLE GOODS, BOOKS, MUSIC AND VIDEO MARKETING AND SALES AND CONSUMER BEHAVIOR; MARKET RESEARCH AND BUSINESS RESEARCH SERVICES RELATING TO; CODING AND CONFORMING CLIENT PRODUCT, RETAIL STORE AND MARKETING DATA AND RECORDS; MEDIA RESEARCH AND RATING SERVICES, NAMELY, MARKET RESEARCH SERVICES RELATING TO THE BROADCASTING, NARROW CASTING, CABLE, AND NETWORK TRANSMISSION, SIGNAL RECEIVING AUDIENCE DEMOGRAPHICS AND BEHAVIOR, AND THE LISTENING, VIEWING, AND USAGE HABITS OF SIGNAL RECEIVING AUDIENCES, COMPUTER USERS, AND USERS OF A GLOBAL COMPUTER NETWORK; SALES VOLUME TRACKING FOR OTHERS; SALES VOLUME TRACKING FOR OTHERS THROUGH THE COLLECTION OF SALES DATA AND MARKET RESEARCH AND THE DISTRIBUTION OF THE RESULTS THEREOF FOR OTHERS OF MUSIC, MUSIC VIDEOS, PRERECORDED DVDS, PRERECORDED CD-ROMS, AND AUDIO SELL-THROUGH DATA, BLANK AUDIO TAPES, BLANK VIDEO TAPES AND RELATED AUDIO AND VISUAL PRODUCTS, PRERECORDED VIDEOS ON VHS, VIDEO DVDS, AND VIDEO SELL-THROUGH DATA, BOOKS, INCLUDING AUDIO AND ELECTRONIC BOOKS, SOLD ON-LINE

AND BY RETAIL AND WHOLESALE STORES, CONSUMER GOODS, DURABLE GOODS, PHARMACEUTICALS, SPORTS EVENTS, SPORTING GOODS, MUSIC, MUSIC VIDEOS, BLANK AUDIO TAPES, BLANK VIDEO TAPES, DVDS, BOOKS, NAMELY, PRINTED, AUDIO AND ELECTRONIC BOOKS SOLD ON-LINE AND BY RETAIL AND WHOLESALE STORES, TELEPHONE AND CELL PHONE RING TONES, RING BACKS, MUSIC-RELATED PRODUCTS AND SERVICES FOR MOBILE TELEPHONE CONSUMERS, ONLINE MUSIC DOWNLOADS, ONLINE VIDEO AND MOVIE DOWNLOADS; COLLECTING AND CORRELATING MARKETING, ADVERTISING, AND BUSINESS INFORMATION REGARDING SPORTS VENUE ADVERTISING AND SIGNAGE, ADVERTISEMENTS, AND SPONSORSHIP MARKETING DERIVED FROM AND INCLUDING IMAGES OF TELEVISION, CABLE, AND RADIO PROGRAMMING AND INTERNET AND PRINT PUBLICATIONS, AS WELL AS REVENUE, FOR STATISTICAL ANALYSIS AND MARKET RESEARCH PURPOSES VIA THE INTERNET AND PREPARATION AND DISSEMINATION OF PRINTED REPORTS BASED THEREON TO THIRD PARTIES; COMPILING INFORMATION ABOUT COMMERCIAL ADVERTISEMENTS TELEVISED DURING NATIONAL AND REGIONAL TELECASTS; BROADCAST RECOGNITION INFORMATION SERVICES FOR OTHERS, NAMELY, ELECTRONIC RECOGNITION AND IDENTIFICATION OF PRE-RECORDED MUSIC, COMMERCIALS AND PROGRAMMING ON RADIO, TELEVISION, CABLE STATIONS, AND ONLINE BY USE OF PASSIVE PATTERN RECOGNITION TECHNOLOGY; AND REVIEWING, CODING, AND CONFORMING RETAIL, RETAIL STORE, PRODUCT, AND MARKETING DATA AND RECORDS; PLANNING AND CONDUCTING BUSINESS MEETINGS, AND TRADESHOWS IN THE FIELDS OF ADVERTISING AND MARKETING RESEARCH, MARKET RESEARCH, MEDIA RESEARCH, AND CORPORATE AND BUSINESS INFORMATION; PREPARING MARKET RESEARCH AND BUSINESS RESEARCH REPORTS FROM COMPUTER DATABASES, IN THE FIELDS OF MARKET RESEARCH AND PRODUCT RETAILER AND MANUFACTURER INFORMATION RELATING TO RETAIL SALES, CONSUMER DEMOGRAPHICS, PRODUCT PLACEMENT AND POINT-OF-PURCHASE DISPLAYS, AND RETAIL FACILITY INFORMATION, PRODUCT INFORMATION, PRODUCT CATALOGS, PRODUCT SALES, COMPETITOR INFORMATION, RETAIL CONSUMER INFORMATION, SEGMENTATION AND TARGETING INFORMATION, MANUFACTURING INFORMATION, AND MARKETING; BUSINESS INFORMATION AND MARKET RESEARCH SERVICES, NAMELY, CONDUCTING MARKET, ADVERTISING AND MARKETING RESEARCH, ANALYZING STATISTICAL DATA, PREPARING REPORTS, AND CONSULTING REGARDING BUSINESS AND MARKET RESEARCH INFORMATION; AND PROVIDING ON-LINE INTERACTIVE COMPUTER DATABASES IN THE FIELDS OF BUSINESS AND MARKET RESEARCH, DEMOGRAPHIC INFORMATION AND DATA RELATING TO THE SALE AND PROMOTION OF CONSUMER AND DURABLE GOODS, CONDUCTING MARKET AND BUSINESS SURVEYS, STUDIES, ANALYSES AND EVALUATIONS; PROVIDING TEMPORARY USE OF ON-LINE NON-DOWNLOADABLE ELECTRONIC DATABASES AND WEBSITES IN THE FIELDS OF ADVERTISING, MARKETING, BUSINESS, MEDIA AND MARKET RESEARCH, CONSUMER SURVEYS, PRODUCT RETAILER, RETAIL STORE AND PRODUCT SALES, TRADING AREAS, AND DEMOGRAPHIC INFORMATION; PROVIDING TEMPORARY USE OF ONLINE NON-DOWNLOADABLE DATABASES FOR CREATING, ACCESSING, UPDATING, DOWNLOADING, VIEWING AND MANIPULATING INFORMATION IN THE FIELDS OF MARKET RESEARCH AND PRODUCT RETAILER AND MANUFACTURER INFORMATION RELATING TO RETAIL SALES, CONSUMER DEMOGRAPHICS, PRODUCT PLACEMENT AND POINT-OF-PURCHASE DISPLAYS, AND RETAIL FACILITY INFORMATION, PRODUCT INFORMATION, PRODUCT CATALOGS, PRODUCT SALES, COMPETITOR INFORMATION, RETAIL CONSUMER INFORMATION, SEGMENTATION AND TARGETING INFORMATION, MANUFACTURING INFORMATION, AND MARKETING; PROVIDING TEMPORARY USE OF ONLINE NON-DOWNLOADABLE ELECTRONIC DATABASES FOR USE IN ANALYZING ADVERTISING, MARKETING, SALES, AND PRODUCT INFORMATION IN CONNECTION WITH RETAIL

STORE MARKETING SALES, PROMOTION, AND OTHER MARKETING ACTIVITIES (U.S. CLS. 100, 101 AND 102).

CLASS 38—COMMUNICATION

FOR ELECTRONIC MESSAGE BOARDS FOR POSTING AND TRANSMISSION OF MESSAGES AMONG COMPUTER USERS CONCERNING MARKET RESEARCH, MARKETING AND MARKET RESEARCH, ADVERTISING RESEARCH, MEDIA RATINGS, AND CORPORATE AND BUSINESS INFORMATION (U.S. CLS. 100, 101 AND 104).

CLASS 41—EDUCATION AND ENTERTAINMENT

FOR PLANNING AND CONDUCTING, BUSINESS AND EDUCATIONAL SEMINARS; AND CONDUCTING WORKSHOPS AND SEMINARS IN MARKET RESEARCH, MARKETING AND ADVERTISING RESEARCH, AND CONSUMER RESEARCH AND CONSULTING (U.S. CLS. 100, 101 AND 107).

CLASS 42—SCIENTIFIC AND COMPUTER SERVICES

FOR PROVIDING ONLINE NON-DOWNLOADABLE DATABASE MANAGEMENT SOFTWARE FOR CREATING, ACCESSING, UPDATING, DOWNLOADING, VIEWING AND MANIPULATING INFORMATION IN THE FIELDS OF MARKET RESEARCH AND PRODUCT RETAILER AND MANUFACTURER INFORMATION RELATING TO RETAIL SALES, CONSUMER DEMOGRAPHICS, PRODUCT PLACEMENT AND POINT-OF-PURCHASE DISPLAYS, AND RETAIL FACILITY INFORMATION, PRODUCT INFORMATION, PRODUCT CATALOGS, PRODUCT SALES, COMPETITOR INFORMATION, RETAIL CONSUMER INFORMATION, SEGMENTATION AND TARGETING INFORMATION, MANUFACTURING INFORMATION, AND MARKETING; PROVIDING ONLINE NON-DOWNLOADABLE COMPUTER SOFTWARE FOR USE IN ANALYZING ADVERTISING, MARKETING, SALES, AND PRODUCT INFORMATION IN CONNECTION WITH RETAIL STORE MARKETING SALES, PROMOTION, AND OTHER MARKETING ACTIVITIES (U.S. CLS. 100 AND 101).

JUDITH HELFMAN, EXAMINING ATTORNEY

SN 77-096,216. WONDERTABLITZ CORPORATION, WALPOLE, MA. FILED 1-31-2007.

WONDER TABLITZ

THE MARK CONSISTS OF STANDARD CHARACTERS WITHOUT CLAIM TO ANY PARTICULAR FONT, STYLE, SIZE, OR COLOR.

NO CLAIM IS MADE TO THE EXCLUSIVE RIGHT TO USE "TABLETS", APART FROM THE MARK AS SHOWN.

CLASS 3—COSMETICS AND CLEANING PREPARATIONS

FOR ALL PURPOSE CLEANING CHEMICAL PREPARATIONS; ALL PURPOSE CLEANING CHEMICAL PREPARATIONS SOLD IN TABLETIZED FORM; ALL PURPOSE CLEANING CHEMICALS SOLD AS A UNIT WITH SPRAY DISPENSERS (U.S. CLS. 1, 4, 6, 50, 51 AND 52).

CLASS 21—HOUSEWARES AND GLASS

FOR SPRAY DISPENSERS FOR CLEANING AND DISINFECTING SOLUTIONS (U.S. CLS. 2, 13, 23, 29, 30, 33, 40 AND 50).
ANNE MADDEN, EXAMINING ATTORNEY

CLASS 20—FURNITURE AND ARTICLES NOT OTHERWISE CLASSIFIED

FOR PICTURE FRAMES; SLEEPING BAGS; MIRRORS; PLASTIC NAME BADGES; PILLOWS; FURNITURE; WIND CHIMES (U.S. CLS. 2, 13, 22, 25, 32 AND 50).

SN 77-098,280. AUTOCENTRO CALIFORNIA, INC., CANOGA PARK, CA. FILED 2-2-2007.

Precio Justo y Fijo

THE MARK CONSISTS OF STANDARD CHARACTERS WITHOUT CLAIM TO ANY PARTICULAR FONT, STYLE, SIZE, OR COLOR.
THE FOREIGN WORDING IN THE MARK TRANSLATES INTO ENGLISH AS "FIXED AND FAIR PRICE".

CLASS 35—ADVERTISING AND BUSINESS

FOR RETAIL OUTLETS FEATURING AUTOMOBILES AND TRUCKS; ADVERTISING SERVICES, NAMELY, PROVIDING INFORMATION ON THE AVAILABILITY OF AUTOMOBILES AND TRUCKS FOR RENT OR PURCHASE, BY MEANS OF A GLOBAL COMMUNICATIONS NETWORK (U.S. CLS. 100, 101 AND 102).

CLASS 21—HOUSEWARES AND GLASS

FOR HOUSEWARES, NAMELY, BOWLS, BROOMS, CAKE PANS, CAKE MOLDS, CAKE SERVERS, CANDLE HOLDERS NOT OF PRECIOUS METAL, CANDLE SNUFFERS, COOKIE CUTTERS, CORK SCREWS, CUPS, DECORATING BAGS FOR CONFECTIONERS, DECORATIVE CRYSTAL PRISMS, DECORATIVE GLASS NOT FOR BUILDING, DECORATIVE PLATES, DISHES, FIGURINES MADE OF CHINA, CRYSTAL, EARTHENWARE, GLASS, CERAMICS, AND PORCELAIN, HEAT-INSULATED VESSELS, INSULATING SLEEVE HOLDERS FOR BEVERAGE CONTAINERS, LUNCH BOXES, MUGS, NAPKIN HOLDERS, NAPKIN RINGS NOT OF PRECIOUS METALS, PIE PANS, PIE SERVERS, PLATES, SPORTS BOTTLES SOLD EMPTY, SOAP DISHES, TEA KETTLES, TEA SETS, THERMAL INSULATED CONTAINERS FOR FOOD AND BEVERAGE, TRAYS NOT OF PRECIOUS METAL, TRIVETS, VACUUM BOTTLES, WASTE BASKETS, CONTAINERS FOR HOUSEHOLD USE; DINNERWARE; BEVERAGE GLASSWARE; BEVERAGEWARE; COASTERS NOT OF PAPER AND NOT BEING TABLE LINEN; REMOVABLE INSULATORS FOR DRINK CANS AND BOTTLES; LUNCH KITS CONSISTING OF LUNCH BOXES AND INSULATED CONTAINERS; HAIR BRUSHES AND HAIR COMBS; TOOTHBRUSHES; PLASTIC CUPS; COOKIE JARS; PAPER CUPS; PAPER PLATES (U.S. CLS. 2, 13, 23, 29, 30, 33, 40 AND 50).

JASON BLAIR, EXAMINING ATTORNEY

CLASS 36—INSURANCE AND FINANCIAL

FOR FINANCIAL SERVICES, NAMELY, FINANCING SERVICES AND LEASE PURCHASE FINANCING FOR NEW AND USED CARS; GAP FINANCING FOR NEW AND USED CARS; PROVIDING INFORMATION ABOUT VEHICLE FINANCING BY MEANS OF A GLOBAL COMMUNICATIONS NETWORK (U.S. CLS. 100, 101 AND 102).

SN 77-099,167. EVANS, LESLIE M., CAPE ELIZABETH, ME. FILED 2-5-2007.

CLASS 39—TRANSPORTATION AND STORAGE

FOR AUTOMOBILE AND TRUCK LEASING SERVICES; PROVIDING INFORMATION ON LEASING VEHICLES BY MEANS OF A GLOBAL COMMUNICATIONS NETWORK (U.S. CLS. 100 AND 105).
CURTIS FRENCH, EXAMINING ATTORNEY

rinkl

SN 77-098,450. DISNEY ENTERPRISES, INC., BURBANK, CA. FILED 2-2-2007.

PINOCCHIO

THE MARK CONSISTS OF STANDARD CHARACTERS WITHOUT CLAIM TO ANY PARTICULAR FONT, STYLE, SIZE, OR COLOR.
OWNER OF U.S. REG. NOS. 272,070 AND 2,920,964.

THE MARK CONSISTS OF STANDARD CHARACTERS WITHOUT CLAIM TO ANY PARTICULAR FONT, STYLE, SIZE, OR COLOR.

CLASS 18—LEATHER GOODS

FOR TOTE BAGS (U.S. CLS. 1, 2, 3, 22 AND 41).

CLASS 25—CLOTHING

FOR CLOTHING, NAMELY, FOOTWEAR (U.S. CLS. 22 AND 39).
CHRISTINE COOPER, EXAMINING ATTORNEY

SN 77-099,540. N. DEAN MEYER & ASSOCIATES INC.,
RIDGEFIELD, CT. FILED 2-5-2007.

FullCost

THE MARK CONSISTS OF STANDARD CHARACTERS WITHOUT CLAIM TO ANY PARTICULAR FONT, STYLE, SIZE, OR COLOR.

CLASS 9—ELECTRICAL AND SCIENTIFIC APPARATUS

FOR COMPUTER SOFTWARE FOR BUDGET PLANNING AND RATE-SETTING IN THE FIELD OF CORPORATE, GOVERNMENT AND NOT-FOR-PROFIT INTERNAL SERVICE PROVIDER, AND PRINTED INSTRUCTIONAL MATERIALS DISTRIBUTED AS A UNIT (U.S. CLS. 21, 23, 26, 36 AND 38).

FIRST USE 3-6-2007; IN COMMERCE 3-6-2007.

CLASS 41—EDUCATION AND ENTERTAINMENT

FOR PROVIDING TRAINING FOR BUDGET PLANNING AND RATE-SETTING SOFTWARE IN THE FIELD OF CORPORATE, GOVERNMENT AND NOT-FOR-PROFIT INTERNAL SERVICE PROVIDERS (U.S. CLS. 100, 101 AND 107).

FIRST USE 3-6-2007; IN COMMERCE 3-6-2007.
REBECCA EISINGER, EXAMINING ATTORNEY

CLASS 9—ELECTRICAL AND SCIENTIFIC APPARATUS

FOR UTILITY METERS AND METERS FOR MEASURING THE QUANTITY OF FLUIDS PASSING THROUGH AND COMPONENTS THEREFORE, NAMELY, REGISTERS FOR USE WITH METERS, AND METER READING REGISTERS, NAMELY, ELECTRICAL OUTPUT REGISTERS; UTILITY METER READING SYSTEMS COMPRISED OF A UTILITY METER, A TRANSMITTER FOR TRANSMITTING INFORMATION FROM THE METER AND AN ACCUMULATOR FOR RECEIVING THE TRANSMITTED INFORMATION; REMOTE UTILITY READER SYSTEMS COMPRISING A TRANSPONDER THAT TRANSMITS INFORMATION VIA A TRANSMITTER BEING RECEIVED BY A RECEIVER; REMOTE METER READING SYSTEMS; NAMELY, METER EQUIPPED WITH REGISTER CONFIGURED TO INCREMENT ELECTRONIC USAGE MEMORY HOUSED IN A SEPARATE ELECTRONIC UNIT WHICH ACCUMULATES USAGE AND STORES METER AND ACCOUNT IDENTIFIERS AND COMMUNICATES OVER A TWO WIRE CONNECTION TO EITHER A REMOTE LOCATION WHERE DATA CAN BE COLLECTED, OR THE ELECTRONIC UNIT CAN BE PROGRAMMED, BY RF COMMUNICATION THROUGH AN ANTENNA COIL WITH AN ELECTRONIC HAND HELD DEVICE EQUIPPED WITH COMPATIBLE SOFTWARE, OR TO AN INTERMEDIATE MODULE WHICH CONVERTS THE INFORMATION TO THREE WIRE OUTPUT AND RELAYS THE INFORMATION TO A METER INTERFACE UNIT FOR DIRECT CONNECTION TO A LOCAL TELEPHONE LINE FOR READING AT A REMOTE SITE THROUGH A PERSONAL COMPUTER ON WHICH METER READING AND REPORT GENERATING SOFTWARE IS INSTALLED; UTILITY METER REGISTERS; WATER, GAS AND ELECTRIC METER REGISTERS; AND ELECTRONIC PUBLICATIONS, NAMELY, MANUALS AND BROCHURES FEATURING METERS AND REGISTERS AND PARTS AND ACCESSORIES THEREFOR RECORDED ON COMPUTER MEDIA (U.S. CLS. 21, 23, 26, 36 AND 38).

CLASS 16—PAPER GOODS AND PRINTED MATTER

FOR PUBLICATIONS, NAMELY, MANUALS AND BROCHURES PERTAINING TO METERS AND REGISTERS AND PARTS AND ACCESSORIES THEREFOR (U.S. CLS. 2, 5, 22, 23, 29, 37, 38 AND 50).

ELIZABETH KAJUBI, EXAMINING ATTORNEY

SN 77-099,933. MASTER METER, INC., MANSFIELD, TX.
FILED 2-6-2007.

SN 77-100,760. CRG WEST, L.L.C., LOS ANGELES, CA.
FILED 2-6-2007.

CONNECTIONFREE

THE MARK CONSISTS OF STANDARD CHARACTERS WITHOUT CLAIM TO ANY PARTICULAR FONT, STYLE, SIZE, OR COLOR.

CRG WEST

THE MARK CONSISTS OF STANDARD CHARACTERS WITHOUT CLAIM TO ANY PARTICULAR FONT, STYLE, SIZE, OR COLOR.

CLASS 36—INSURANCE AND FINANCIAL

FOR REAL ESTATE MANAGEMENT AND CONSULTATION (U.S. CLS. 100, 101 AND 102).

CLASS 38—COMMUNICATION

FOR PROVIDING CONNECTIVITY SERVICES FOR DATA TRANSFER OR STORAGE; DATA TRANSFER OR RECEPTION SERVICES VIA TELECOMMUNICATIONS MEANS; PROVIDING CO-LOCATION SERVICES FOR VOICE, VIDEO OR DATA COMMUNICATIONS APPLICATIONS; TELECOMMUNICATIONS CONSULTATION (U.S. CLS. 100, 101 AND 104).
LINDA M. KING, EXAMINING ATTORNEY

SN 77-100,777. CRG WEST, L.L.C., LOS ANGELES, CA. FILED 2-6-2007.

WILSHIRE ANNEX

SN 77-100,768. CRG WEST, L.L.C., LOS ANGELES, CA. FILED 2-6-2007.

MARKET POST TOWER

THE MARK CONSISTS OF STANDARD CHARACTERS WITHOUT CLAIM TO ANY PARTICULAR FONT, STYLE, SIZE, OR COLOR.

THE MARK CONSISTS OF STANDARD CHARACTERS WITHOUT CLAIM TO ANY PARTICULAR FONT, STYLE, SIZE, OR COLOR.

CLASS 36—INSURANCE AND FINANCIAL

FOR REAL ESTATE MANAGEMENT AND CONSULTATION (U.S. CLS. 100, 101 AND 102).

CLASS 36—INSURANCE AND FINANCIAL

FOR REAL ESTATE MANAGEMENT AND CONSULTATION (U.S. CLS. 100, 101 AND 102).

CLASS 38—COMMUNICATION

FOR PROVIDING CONNECTIVITY SERVICES FOR DATA TRANSFER OR STORAGE; DATA TRANSFER OR RECEPTION SERVICES VIA TELECOMMUNICATIONS MEANS; PROVIDING CO-LOCATION SERVICES FOR VOICE, VIDEO OR DATA COMMUNICATIONS APPLICATIONS; TELECOMMUNICATIONS CONSULTATION (U.S. CLS. 100, 101 AND 104).
LINDA M. KING, EXAMINING ATTORNEY

CLASS 38—COMMUNICATION

FOR PROVIDING CONNECTIVITY SERVICES FOR DATA TRANSFER OR STORAGE; DATA TRANSFER OR RECEPTION SERVICES VIA TELECOMMUNICATIONS MEANS; PROVIDING CO-LOCATION SERVICES FOR VOICE, VIDEO OR DATA COMMUNICATIONS APPLICATIONS; TELECOMMUNICATIONS CONSULTATION (U.S. CLS. 100, 101 AND 104).
LINDA M. KING, EXAMINING ATTORNEY

SN 77-100,779. CRG WEST, L.L.C., LOS ANGELES, CA. FILED 2-6-2007.

SN 77-100,772. CRG WEST, L.L.C., LOS ANGELES, CA. FILED 2-6-2007.

MIAMI EXCHANGE

VALLEY EXCHANGE

THE MARK CONSISTS OF STANDARD CHARACTERS WITHOUT CLAIM TO ANY PARTICULAR FONT, STYLE, SIZE, OR COLOR.

THE MARK CONSISTS OF STANDARD CHARACTERS WITHOUT CLAIM TO ANY PARTICULAR FONT, STYLE, SIZE, OR COLOR.

CLASS 36—INSURANCE AND FINANCIAL

FOR REAL ESTATE MANAGEMENT AND CONSULTATION (U.S. CLS. 100, 101 AND 102).

CLASS 36—INSURANCE AND FINANCIAL

FOR REAL ESTATE MANAGEMENT AND CONSULTATION (U.S. CLS. 100, 101 AND 102).

CLASS 38—COMMUNICATION

FOR PROVIDING CONNECTIVITY SERVICES FOR DATA TRANSFER OR STORAGE; DATA TRANSFER OR RECEPTION SERVICES VIA TELECOMMUNICATIONS MEANS; PROVIDING CO-LOCATION SERVICES FOR VOICE, VIDEO OR DATA COMMUNICATIONS APPLICATIONS; TELECOMMUNICATIONS CONSULTATION (U.S. CLS. 100, 101 AND 104).
LINDA M. KING, EXAMINING ATTORNEY

CLASS 38—COMMUNICATION

FOR PROVIDING CONNECTIVITY SERVICES FOR DATA TRANSFER OR STORAGE; DATA TRANSFER OR RECEPTION SERVICES VIA TELECOMMUNICATIONS MEANS; PROVIDING CO-LOCATION SERVICES FOR VOICE, VIDEO OR DATA COMMUNICATIONS APPLICATIONS; TELECOMMUNICATIONS CONSULTATION (U.S. CLS. 100, 101 AND 104).
LINDA M. KING, EXAMINING ATTORNEY

SN 77-101,077. RCG HOLDINGS LIMITED, HONG KONG, HONG KONG, FILED 2-7-2007.

RCG
Biometrics • RFID • Security

OWNER OF HONG KONG REG. NO. 300686205, DATED 7-24-2006, EXPIRES 7-24-2016.

NO CLAIM IS MADE TO THE EXCLUSIVE RIGHT TO USE "BIOMETRICS," "RFID" AND "SECURITY", APART FROM THE MARK AS SHOWN.

THE COLOR(S) PURPLE AND BLACK IS/ARE CLAIMED AS A FEATURE OF THE MARK.

THE MARK CONSISTS OF THE COLOR PURPLE APPEARS IN THE WORDING "RCG" AND THE COLOR BLACK APPEARS IN THE WORDING "BIOMETRICS" "RFID" "SECURITY" AND IN TWO BLACK DOTS SEPARATING THESE WORDS.

CLASS 9—ELECTRICAL AND SCIENTIFIC APPARATUS

FOR VERIFICATION AND IDENTIFICATION SYSTEMS USING BIOMETRICS AND RADIO FREQUENCIES AND SECURITY DEVICES, NAMELY, ACCESS CONTROL AND ALARM MONITORING SYSTEMS AND AUTOMATED PROCESS CONTROL SYSTEM IN THE NATURE OF MICRO-PROCESSOR BASED HARDWARE AND SOFTWARE USED TO MONITOR THE STATUS OF INDUSTRIAL MACHINERY, NAMELY TURBINES, GENERATORS AND COMPRESSORS; BIOMETRIC FINGERPRINT DOOR LOCK; COMPUTER APPLICATION SOFTWARE FOR MOBILE PHONES; COMPUTER INTERFACES AND SOFTWARE USED FOR THE CONTROL OF VOICE CONTROLLED INFORMATION AND COMMUNICATION DEVICES; COMPUTER HARDWARE FOR TELECOMMUNICATIONS, NAMELY, MODEMS; COMPUTER PROCESSING SOFTWARE TO PROCESS THE IMAGE COLORS WITH THE COLOR AND INTENSITY AND INTERPRET THE RESULTS AS TENDENCIES OF THE ORGANS, GLANDS AND TISSUES ACCORDING TO THE IRIDODOLOGY CHARTS; COMPUTER PROGRAMS FOR THE ENABLING OF ACCESS OR ENTRANCE CONTROL; COMPUTER STORAGE DEVICES, NAMELY, FLASH DRIVES; FACILITIES MANAGEMENT SOFTWARE, NAMELY, SOFTWARE TO CONTROL BUILDING ENVIRONMENTAL, ACCESS AND SECURITY SYSTEMS; NETWORK ACCESS SERVER OPERATING SOFTWARE; RADIO FREQUENCY IDENTIFICATION (RFID) TAGS; RFID READERS (U.S. CLS. 21, 23, 26, 36 AND 38).

CLASS 38—COMMUNICATION

FOR INFORMATION TRANSMISSION VIA ELECTRONIC COMMUNICATIONS NETWORKS; SIGNAL TRANSMISSION FOR ELECTRONIC COMMERCE VIA TELECOMMUNICATION SYSTEMS AND DATA COMMUNICATION SYSTEMS; TRANSMISSION OF INFORMATION BY ELECTRONIC COMMUNICATIONS NETWORKS (U.S. CLS. 100, 101 AND 104).

CLASS 42—SCIENTIFIC AND COMPUTER SERVICES

FOR COMPUTER SERVICES, NAMELY, REMOTE AND ON-SITE MANAGEMENT OF ELECTRONIC MESSAGING SYSTEMS AND APPLICATIONS FOR OTHERS (U.S. CLS. 100 AND 101).

CLASS 45—PERSONAL AND LEGAL SERVICES

FOR CONTROL OF BUILDING ENVIRONMENTAL ACCESS AND SECURITY SYSTEMS; SECURITY PRINTING, NAMELY, ENCODING IDENTIFICATION INFORMATION ON VALUABLE DOCUMENTS AND PRODUCTS (U.S. CLS. 100 AND 101).

HEATHER BIDDULPH, EXAMINING ATTORNEY

SN 77-101,560. STRUCTURE HOUSE ACQUISITION, LLC, CUPERTINO, CA. FILED 2-7-2007.

STRUCTURE HOUSECALLS

THE MARK CONSISTS OF STANDARD CHARACTERS WITHOUT CLAIM TO ANY PARTICULAR FONT, STYLE, SIZE, OR COLOR.

CLASS 9—ELECTRICAL AND SCIENTIFIC APPARATUS

FOR ELECTRONIC COMMUNICATIONS EQUIPMENT, NAMELY, ELECTRONIC WEIGHT SCALES AND CELLULAR TELEPHONES FOR USE IN TRANSMITTING DATA FROM ELECTRONIC WEIGHT SCALES (U.S. CLS. 21, 23, 26, 36 AND 38).

CLASS 38—COMMUNICATION

FOR TELECOMMUNICATIONS SERVICES, NAMELY, TRANSMISSION OF DATA FROM ELECTRONIC WEIGHT SCALES VIA CELLULAR TELEPHONES (U.S. CLS. 100, 101 AND 104).

CLASS 41—EDUCATION AND ENTERTAINMENT

FOR INDIVIDUALIZED CONSULTATION AND INFORMATION RELATED TO PHYSICAL FITNESS (U.S. CLS. 100, 101 AND 107).

CLASS 44—MEDICAL, BEAUTY AND AGRICULTURAL SERVICES

FOR PSYCHOTHERAPY AS IT RELATES TO NUTRITION AND WEIGHT LOSS; NUTRITION COUNSELING; CONSULTING TO INDIVIDUALS AND COMMUNITIES ENGAGED IN GROUP WEIGHT LOSS PROGRAMS; WEIGHT REDUCTION DIET PLANNING AND SUPERVISION (U.S. CLS. 100 AND 101).

MARCIE MILONE, EXAMINING ATTORNEY

SN 77-101,747. UGOBE, INC., EMERYVILLE, CA. FILED 2-7-2007.

PLEO

THE MARK CONSISTS OF STANDARD CHARACTERS WITHOUT CLAIM TO ANY PARTICULAR FONT, STYLE, SIZE, OR COLOR.

CLASS 9—ELECTRICAL AND SCIENTIFIC APPARATUS

FOR COMPUTER SOFTWARE FOR USE IN CONNECTION WITH ROBOTIC TOYS, NAMELY, COMPUTER SOFTWARE THAT RUNS, PROGRAMS OR ENHANCES THE FEATURES AND CHARACTERISTICS OF ROBOTIC TOYS; ELECTRONIC GAME SOFTWARE; PRE-RECORDED CDS AND DVDS FEATURING EDUCATIONAL MATERIALS IN THE FIELD OF ROBOTIC TOYS; PRE-RECORDED CDS AND DVDS FEATURING ENTERTAINMENT MATERIALS ABOUT ROBOTIC TOYS AND DINOSAURS; SWIM GOGGLES; DECORATIVE MAGNETS (U.S. CLS. 21, 23, 26, 36 AND 38).

CLASS 25—CLOTHING

FOR CLOTHING, NAMELY, TANK TOPS, KNIT SHIRTS, T-SHIRTS, POLO SHIRTS, SWEATSHIRTS, JACKETS, FLEECE PULLOVERS, RAIN SLICKERS, RAIN PONCHOS, SCARVES, GLOVES, SLEEPWEAR, BATHROBES, UNDERWEAR, SOCKS, PANTS, JEANS, SHORTS; HEADGEAR, NAMELY, HATS, CAPS, VISORS; FOOTWEAR; CLOTHING, NAMELY, HALLOWEEN COSTUMES (U.S. CLS. 22 AND 39).

CLASS 28—TOYS AND SPORTING GOODS

FOR ROBOTIC TOYS; ACCESSORIES FOR ROBOTIC TOYS, NAMELY TOY PET LEASHES, TOY PET COLLARS, CHARMS FOR TOY PET COLLARS, TOY PET IDENTIFICATION TAGS, TOY PET CARRIERS, TOY PET BEDS; CLOTHING FOR ROBOTIC TOYS; TOY FIGURES; DOLLS; STUFFED AND PLUSH TOYS; PUZZLES; BALLS FOR PLAYING GAMES WITH ROBOTIC TOYS; COSTUME MASKS (U.S. CLS. 22, 23, 38 AND 50).

CLASS 38—COMMUNICATION

FOR COMPUTER ON-LINE SERVICES, NAMELY, PROVIDING ON-LINE CHAT ROOMS, ELECTRONIC BULLETIN BOARDS AND ON-LINE FORUMS FOR TRANSMISSION OF MESSAGES AMONG USERS IN THE FIELDS OF TOYS AND ROBOTICS (U.S. CLS. 100, 101 AND 104).

CLASS 42—SCIENTIFIC AND COMPUTER SERVICES

FOR APPLICATION SERVICE PROVIDER (ASP) FEATURING TOOLS FOR PROGRAMMING OF ROBOTIC TOYS (U.S. CLS. 100 AND 101).

MARGARET POWER, EXAMINING ATTORNEY

SN 77-102.505. UNIFIED BARCODE & RFID, INC., PALATINE, IL. FILED 2-8-2007.

Enterprise Companion

THE MARK CONSISTS OF STANDARD CHARACTERS WITHOUT CLAIM TO ANY PARTICULAR FONT, STYLE, SIZE, OR COLOR.

NO CLAIM IS MADE TO THE EXCLUSIVE RIGHT TO USE "ENTERPRISE", APART FROM THE MARK AS SHOWN.

CLASS 9—ELECTRICAL AND SCIENTIFIC APPARATUS

FOR COMPUTER HARDWARE AND COMPUTER SOFTWARE PROGRAMS FOR THE INTEGRATION OF TEXT, AUDIO, GRAPHICS, STILL IMAGE AND MOVING PICTURES INTO AN INTERACTIVE DELIVERY FOR MULTIMEDIA APPLICATIONS; COMPUTER SEARCH ENGINE SOFTWARE; COMPUTER SOFTWARE DEVELOPMENT TOOLS; COMPUTER SOFTWARE FOR ACCESSING INFORMATION DIRECTORIES THAT MAY BE DOWNLOADED FROM THE GLOBAL COMPUTER NETWORK; COMPUTER SOFTWARE FOR APPLICATION AND DATABASE INTEGRATION; COMPUTER SOFTWARE FOR COMMUNICATING WITH USERS OF HAND-HELD COMPUTERS; COMPUTER SOFTWARE FOR COMPUTER SYSTEM AND APPLICATION DEVELOPMENT, DEPLOYMENT AND MANAGEMENT; COMPUTER SOFTWARE FOR CONTROLLING AND MANAGING ACCESS SERVER APPLICATIONS; COMPUTER SOFTWARE FOR CONTROLLING SELF-SERVICE TERMINALS; COMPUTER SOFTWARE FOR CREATING SEARCHABLE DATABASES OF INFORMATION AND DATA; COMPUTER SOFTWARE FOR PROVIDING AN ON-LINE DATABASE IN THE FIELD OF TRANSACTION PROCESSING TO UPLOAD TRANSACTIONAL DATA, PROVIDE STATISTICAL ANALYSIS, AND PRODUCE NOTIFICATIONS AND REPORTS; COMPUTER SOFTWARE FOR THE FIELD OF WAREHOUSING AND DISTRIBUTION, TO MANAGE TRANSACTIONAL DATA, PROVIDE STATISTICAL ANALYSIS, AND PRODUCE NOTIFICATIONS AND REPORTS; COMPUTER SOFTWARE FOR USE IN CUSTOMER RELATIONSHIP MANAGEMENT (CRM); COMPUTER SOFTWARE FOR WIRELESS CONTENT DELIVERY; COMPUTER SOFTWARE THAT PROVIDES REAL-TIME, INTEGRATED BUSINESS MANAGEMENT INTELLIGENCE BY COMBINING INFORMATION FROM VARIOUS DATABASES AND PRESENTING IT IN AN EASY-TO-UNDERSTAND USER INTERFACE; COMPUTER SOFTWARE TO AUTOMATE DATA WAREHOUSING; COMPUTER SOFTWARE, NAMELY, AN APPLICATION ALLOWING SALES AND FIELD SERVICE EMPLOYEES TO UPDATE AND RECEIVE DATA STORED IN AN ENTERPRISE'S COMPUTER DATABASES IN REAL TIME, USING A MOBILE DEVICE, WITH FULL TELEPHONY INTEGRATION WITH THE TELEPHONE AND/OR SOFTWARE FEATURES OF THE MOBILE DEVICE; COMPUTER SOFTWARE, NAMELY, SOFTWARE DEVELOPMENT TOOLS FOR THE CREATION OF MOBILE INTERNET APPLICATIONS AND CLIENT INTERFACES; SOFTWARE FOR PROCESSING IMAGES, GRAPHICS AND TEXT (U.S. CLS. 21, 23, 26, 36 AND 38).

CLASS 42—SCIENTIFIC AND COMPUTER SERVICES

FOR DATA AUTOMATION AND COLLECTION SERVICE USING PROPRIETARY SOFTWARE TO EVALUATE, ANALYZE AND COLLECT SERVICE DATA (U.S. CLS. 100 AND 101).

MARK SPARACINO, EXAMINING ATTORNEY

SN 77-104.271. BETTER PLANET INVESTMENTS, LLC, PALO ALTO, CA. FILED 2-9-2007.

BETTER PLANET

THE MARK CONSISTS OF STANDARD CHARACTERS WITHOUT CLAIM TO ANY PARTICULAR FONT, STYLE, SIZE, OR COLOR.

CLASS 35—ADVERTISING AND BUSINESS

FOR INCUBATION SERVICES IN THE NATURE OF BUSINESS DEVELOPMENT SERVICES, NAMELY, PROVIDING START-UP SUPPORT FOR THE BUSINESS OF OTHERS; PROVIDING ASSISTANCE IN THE DEVELOPMENT OF START-UP COMPANIES, NAMELY, PROVIDING BUSINESS CONSULTING, MENTORING AND MANAGEMENT SERVICES; OFFERING TECHNICAL ASSISTANCE IN THE ESTABLISHMENT AND/OR OPERATION OF START-UP COMPANIES; RENTAL AND LEASING OF OFFICE EQUIPMENT; PROVIDING ADMINISTRATIVE SUPPORT AND SERVICES, NAMELY, SECRETARIAL AND CLERICAL SERVICES (U.S. CLS. 100, 101 AND 102).

CLASS 36—INSURANCE AND FINANCIAL

FOR INCUBATION SERVICES, NAMELY, PROVIDING VENTURE CAPITAL FUNDING TO EMERGING AND START-UP COMPANIES AND VENTURE CAPITAL SERVICES, NAMELY, PROVIDING FINANCING TO EMERGING AND START-UP COMPANIES; LEASING OF OFFICE SPACE (U.S. CLS. 100, 101 AND 102).

CLASS 43—HOTEL AND RESTAURANT SERVICES

FOR RENTAL AND LEASING OF FURNITURE (U.S. CLS. 100 AND 101).
SUE LAWRENCE, EXAMINING ATTORNEY

SN 77-104,425. ALPHA PHI ALPHA FRATERNITY, INC., BALTIMORE, MD. FILED 2-10-2007.



THE NON-LATIN CHARACTERS IN THE MARK TRANSLITERATE TO "ALPHA PHI ALPHA" AND THIS MEANS NOTHING IN ENGLISH.

CLASS 8—HAND TOOLS

FOR NUT CRACKERS MADE OF PRECIOUS METAL (U.S. CLS. 23, 28 AND 44).
FIRST USE 12-4-1906; IN COMMERCE 12-4-1906.

CLASS 14—JEWELRY

FOR JEWELRY, NAMELY, WRIST BRACELETS, ANKLE BRACELETS, BRACELETS MADE OF PRECIOUS METAL, IDENTIFICATION BRACELETS, JEWELRY BOXES MADE OF PRECIOUS METAL, JEWELRY CASES MADE OF PRECIOUS METAL, BROOCHES, BUSTS MADE OF PRECIOUS METAL, JEWELRY CHAINS, JEWELRY LAPEL PINS, WATCH CHAINS, CHARMS, TIE CLIPS, CLOCKS, WALL CLOCKS, ALARM CLOCKS, CLOCKS INCORPORATING A RADIO, COSTUME JEWELRY, CUFF LINKS, NECKTIE FASTENERS, FIGURINES MADE OF PRECIOUS METAL, EAR CLIPS, EARRINGS, NECKLACES, NUT CRACKERS MADE OF PRECIOUS METAL, ORNAMENTAL LAPEL PINS, ORNAMENTAL PINS, PENDANTS, POCKET WATCHES, RINGS, STATUTES MADE OF PRECIOUS METAL, WATCH STRAPS, WRISTWATCHES, WATCH CASES, WATCH CHAINS, STOP WATCHES, CHRONOGRAPHS FOR USE AS WATCHES, CHRONOMETERS, WATCHES (U.S. CLS. 2, 27, 28 AND 50).
FIRST USE 12-4-1906; IN COMMERCE 12-4-1906.

CLASS 16—PAPER GOODS AND PRINTED MATTER

FOR PHOTOGRAPH ALBUMS, COIN ALBUMS, STAMP ALBUMS, ANNIVERSARY BOOKS, ANNOUNCEMENT CARDS, APPOINTMENT BOOKS, ART PICTURES, ART PRINTS, GRAPHIC ART REPRODUCTIONS, PRINT ART REPRODUCTIONS, GENERAL PURPOSE PLASTIC BAGS, BALL-POINT PENS, TELEPHONE NUMBER BOOKS, BUMPER STICKERS, BUSINESS FORMS, CALENDAR STANDS, CALENDARS, FOUNTAIN PENS, PEN CASES, PENCIL CASES, CHRISTMAS CARDS, TELEPHONE DIRECTORIES, GIFT WRAPPING PAPER, INK PENS, POSTERS, POSTCARDS, PAPER TABLE LINEN, LOOSE LEAF BINDERS, PAPER BANNERS, TRIVIA CARDS, MONEY CLIPS MADE OF PRECIOUS METAL (U.S. CLS. 2, 5, 22, 23, 29, 37, 38 AND 50).
FIRST USE 12-4-1906; IN COMMERCE 12-4-1906.

CLASS 21—HOUSEWARES AND GLASS

FOR CANDLE HOLDERS MADE OF PRECIOUS METAL, CANDLE RINGS MADE OF PRECIOUS METAL, CANDLE SNUFFERS MADE OF PRECIOUS METAL (U.S. CLS. 2, 13, 23, 29, 30, 33, 40 AND 50).
FIRST USE 12-4-1906; IN COMMERCE 12-4-1906.

CLASS 25—CLOTHING

FOR CLOTHING, NAMELY, T-SHIRTS, SWEATSHIRTS, TANK TOPS, JACKETS, HATS, SHORTS, PANTS, SHOES, SOCKS, JOGGING SUITS, SWEAT SUITS, POLO SHIRTS, SWEAT PANTS, UNDERWEAR, SWIM WEAR, COATS, LEATHER COATS, BANDANNAS, SWEAT BANDS, BOOTS, GYM SHOES, TENNIS SHOES, AEROBIC SHOES, AND WALKING SHOES (U.S. CLS. 22 AND 39).
FIRST USE 12-4-1906; IN COMMERCE 12-4-1906.

CLASS 26—FANCY GOODS

FOR BELT BUCKLES MADE OF PRECIOUS METAL, HAT ORNAMENTS MADE OF PRECIOUS METAL (U.S. CLS. 37, 39, 40, 42 AND 50).
FIRST USE 12-4-1906; IN COMMERCE 12-4-1906.

CLASS 28—TOYS AND SPORTING GOODS

FOR PLAYING CARDS (U.S. CLS. 22, 23, 38 AND 50).
FIRST USE 12-4-1906; IN COMMERCE 12-4-1906.

CLASS 34—SMOKERS' ARTICLES

FOR CIGARETTE HOLDERS MADE OF PRECIOUS METAL, CIGARETTE LIGHTERS MADE OF PRECIOUS METAL, CIGARETTE CASES MADE OF PRECIOUS METAL, AND ASHTRAYS MADE OF PRECIOUS METAL (U.S. CLS. 2, 8, 9 AND 17).
FIRST USE 12-4-1906; IN COMMERCE 12-4-1906.
FRED CARL, EXAMINING ATTORNEY

SN 77-105,242. THE RESEARCH FOUNDATION OF STATE UNIVERSITY OF NEW YORK, ALBANY, NY. FILED 2-12-2007.



THE MARK CONSISTS OF STANDARD CHARACTERS WITHOUT CLAIM TO ANY PARTICULAR FONT, STYLE, SIZE, OR COLOR.

CLASS 38—COMMUNICATION

FOR WEBCASTING SERVICES IN THE FIELD OF NANOTECHNOLOGY AND THE EFFECT OF NANOTECHNOLOGY ON SOCIETY; STREAMING OF VIDEO MATERIAL ON THE INTERNET IN THE FIELD OF NANOTECHNOLOGY AND THE EFFECT OF NANOTECHNOLOGY ON SOCIETY; PODCASTING SERVICES, NAMELY, AUDIO AND VIDEO PODCASTS PROVIDING NEWS, COMMENTARY AND PROGRAMMING IN THE FIELD OF NANOTECHNOLOGY AND THE EFFECT OF NANOTECHNOLOGY ON SOCIETY (U.S. CLS. 100, 101 AND 104).

FIRST USE 9-17-2006; IN COMMERCE 9-17-2006.

CLASS 41—EDUCATION AND ENTERTAINMENT

FOR ENTERTAINMENT AND EDUCATIONAL SERVICES NAMELY PRODUCING AND DISTRIBUTING TELEVISION PROGRAMS, CABLE TELEVISION PROGRAMS IN THE FIELD OF NANOTECHNOLOGY AND THE EFFECT OF NANOTECHNOLOGY ON SOCIETY; PUBLISHING SERVICES, NAMELY, PUBLISHING OF MAGAZINES, NEWSLETTERS, ELECTRONIC MAGAZINES, AND ELECTRONIC NEWSLETTERS PROVIDING EDUCATIONAL INFORMATION, NEWS AND COMMENTARY IN THE FIELD OF NANOTECHNOLOGY AND THE EFFECT OF NANOTECHNOLOGY ON SOCIETY; ENTERTAINMENT SERVICES, NAMELY, PROVISION OF NON-DOWNLOADABLE FILMS AND TV PROGRAMMES VIA A VIDEO-ON-DEMAND SERVICE IN THE FIELD OF NANOTECHNOLOGY AND THE EFFECT OF NANOTECHNOLOGY ON SOCIETY; PUBLISHING SERVICES, NAMELY, PUBLISHING OF WEB MAGAZINES FEATURING EDUCATIONAL INFORMATION, NEWS, COMMENTARY, AND INFORMATION REGARDING ENTERTAINMENT AND EDUCATIONAL SERVICES IN THE FIELD OF NANOTECHNOLOGY AND THE EFFECT OF NANOTECHNOLOGY ON SOCIETY (U.S. CLS. 100, 101 AND 107).

FIRST USE 9-17-2006; IN COMMERCE 9-17-2006.
MARK SPARACINO, EXAMINING ATTORNEY

SN 77-105,963. COMMON GROUND RESTORATION, INC., AURORA, CO. AND COMMON GROUND RESTORATION, LLC, AURORA, CO. AND MONALISA S. PHILLIPS, AURORA, NOT PROVIDED, FILED 2-13-2007.

Common Ground Restoration
Empowering Restored Lives
to Restore History

THE MARK CONSISTS OF STANDARD CHARACTERS WITHOUT CLAIM TO ANY PARTICULAR FONT, STYLE, SIZE, OR COLOR.

NO CLAIM IS MADE TO THE EXCLUSIVE RIGHT TO USE "RESTORATION", APART FROM THE MARK AS SHOWN.

SEC. 2(F).

CLASS 37—CONSTRUCTION AND REPAIR

FOR BUILDING RESTORATION; REAL ESTATE DEVELOPMENT (U.S. CLS. 100, 103 AND 106).

CLASS 41—EDUCATION AND ENTERTAINMENT

FOR CHARITABLE SERVICES, NAMELY, PROVIDING TRAINING IN THE FIELD OF HISTORIC RESTORATION (U.S. CLS. 100, 101 AND 107).

HENRY S. ZAK, EXAMINING ATTORNEY

SN 77-106,101. HEIDELBERGER DRUCKMASCHINEN AG, HEIDELBERG, FED REP GERMANY, FILED 2-13-2007.

Prinect Press Center

THE MARK CONSISTS OF STANDARD CHARACTERS WITHOUT CLAIM TO ANY PARTICULAR FONT, STYLE, SIZE, OR COLOR.

OWNER OF ERPN CMNTY TM OFC REG. NO. 005346242, DATED 9-29-2006, EXPIRES 9-29-2016.

NO CLAIM IS MADE TO THE EXCLUSIVE RIGHT TO USE "PRESS CENTER", APART FROM THE MARK AS SHOWN.

CLASS 7—MACHINERY

FOR PRINTING MACHINES AND PARTS THEREFOR (U.S. CLS. 13, 19, 21, 23, 31, 34 AND 35).

CLASS 9—ELECTRICAL AND SCIENTIFIC APPARATUS

FOR COMPUTERS; ELECTRONIC CONTROL SYSTEMS FOR PRINT SHOP MACHINES, ELECTRONIC CONTROLLERS FOR PRINT SHOP MACHINES; CONTROL SOFTWARE FOR OPERATING PRINTING MACHINES; DATA INPUT DEVICES, NAMELY, KEY BOARDS, CONTROL PANELS, SCANNERS, COMPUTER MICE, TOUCHSCREEN MONITORS, LIGHT PENS, BARCODE READERS AND MICROPHONES FOR RECEIVING VOICE DATA; DATA OUTPUT DEVICES, NAMELY, MONITORS, PRINTERS, DISPLAYS, VOICE OUTPUT SYSTEMS, AND DATA STORAGE MEDIA, NAMELY, HARD DISKS AND MEMORY CARDS; DEVICES AND APPARATUS FOR CONTROLLING, NETWORKING AND REGULATING PRINTING MACHINES, NAMELY, PRINTING PRESS CONTROL STATIONS AND PRINTING PRESS CONSOLES (U.S. CLS. 21, 23, 26, 36 AND 38).

JILL C. ALT, EXAMINING ATTORNEY

SN 77-107,516. WAL-MART STORES, INC., BENTONVILLE, AR. FILED 2-14-2007.

5TH ENERGY

THE MARK CONSISTS OF STANDARD CHARACTERS WITHOUT CLAIM TO ANY PARTICULAR FONT, STYLE, SIZE, OR COLOR.

NO CLAIM IS MADE TO THE EXCLUSIVE RIGHT TO USE "ENERGY", APART FROM THE MARK AS SHOWN.

CLASS 9—ELECTRICAL AND SCIENTIFIC APPARATUS

FOR COMPUTERIZED COMMERCIAL OR INDUSTRIAL APPLIANCES, NAMELY, ELECTRICAL CONTROL DEVICES FOR HVAC (HEATING, VENTILATING AND AIR CONDITIONING), REFRIGERATION, AND LIGHTING SYSTEMS FOR COMMERCIAL BUILDINGS, AND BUILDING OR FACILITIES MANAGEMENT SYSTEMS, COMPRISED OF COMPUTER SOFTWARE, ELECTRICAL AND ELECTRONIC MEASURING AND CONTROL MONITORING DEVICES, MOTION SENSORS, MAGNETIC AND ELECTROMAGNETIC SCANNING AND MONITORING DEVICES; ELECTRONIC CIRCUITS AND CIRCUIT BOARDS; MICROPROCESSORS; COMPUTERS, SOLD INDIVIDUALLY AND/OR AS A COMPONENT OF CUSTOMIZED PRODUCTS AND/OR SYSTEMS FOR MONITORING AND ENHANCING ENERGY EFFICIENCY (U.S. CLS. 21, 23, 26, 36 AND 38).

CLASS 36—INSURANCE AND FINANCIAL

FOR BROKERAGE OF COMPUTERIZED ENERGY EFFICIENT DEVICES, NAMELY, ELECTRICAL CONTROL DEVICES FOR HVAC (HEATING, VENTILATING AND AIR CONDITIONING), REFRIGERATION, AND LIGHTING SYSTEMS FOR COMMERCIAL BUILDINGS, AND OF COMPUTERIZED ENERGY EFFICIENT BUILDING OR FACILITIES MANAGEMENT SYSTEMS (U.S. CLS. 100, 101 AND 102).

CLASS 37—CONSTRUCTION AND REPAIR

FOR INSTALLATION OF COMPUTERIZED ENERGY EFFICIENT DEVICES, NAMELY, ELECTRICAL CONTROL DEVICES FOR HVAC (HEATING, VENTILATING AND AIR CONDITIONING), REFRIGERATION, AND LIGHTING SYSTEMS FOR COMMERCIAL BUILDINGS, AND OF COMPUTERIZED ENERGY EFFICIENT BUILDING OR FACILITIES MANAGEMENT SYSTEMS (U.S. CLS. 100, 103 AND 106).

CLASS 42—SCIENTIFIC AND COMPUTER SERVICES

FOR TECHNICAL CONSULTATION, DESIGN AND DEVELOPMENT IN THE FIELD OF COMPUTERIZED ENERGY EFFICIENT DEVICES, NAMELY, ELECTRICAL CONTROL DEVICES FOR HVAC (HEATING, VENTILATING AND AIR CONDITIONING), REFRIGERATION, AND LIGHTING SYSTEMS FOR COMMERCIAL BUILDINGS; AND IN THE FIELD OF COMPUTERIZED ENERGY EFFICIENT BUILDING OR FACILITIES MANAGEMENT SYSTEMS (U.S. CLS. 100 AND 101).
STEVEN R. FINE, EXAMINING ATTORNEY

SN 77-107,827. LOUISIANA WORKERS' COMPENSATION CORPORATION, BATON ROUGE, LA. FILED 2-14-2007.

LWCC INTERACTIVE

THE MARK CONSISTS OF STANDARD CHARACTERS WITHOUT CLAIM TO ANY PARTICULAR FONT, STYLE, SIZE, OR COLOR.
OWNER OF U.S. REG. NO. 1,816,133.
NO CLAIM IS MADE TO THE EXCLUSIVE RIGHT TO USE "INTERACTIVE", APART FROM THE MARK AS SHOWN.

CLASS 35—ADVERTISING AND BUSINESS

FOR WORKERS' COMPENSATION CLAIMS AUDITING, CLAIMS MANAGEMENT, AND MEDICAL COST CONTAINMENT; HEALTH CARE REFERRAL SERVICES PROVIDED TO EMPLOYERS AS PART OF UNDERWRITING SERVICES FOR WORKERS' COMPENSATION INSURANCE; PROVIDING QUOTES ON WORKERS' COMPENSATION INSURANCE TO INSURANCE AGENTS FOR THE PURPOSE OF SAID INSURANCE AGENTS SERVICING THEIR CUSTOMERS (U.S. CLS. 100, 101 AND 102).

CLASS 36—INSURANCE AND FINANCIAL

FOR WORKERS' COMPENSATION INSURANCE UNDERWRITING SERVICES AND SERVICES RELATED THERETO, SUCH RELATED SERVICES BEING INDUSTRY CLASSIFICATION IDENTIFICATION AND LOSS CONTROL MANAGEMENT FOR OTHERS; PROVIDING INFORMATION IN THE FIELD OF WORKERS' COMPENSATION INSURANCE; INSURANCE SERVICES, NAMELY, UNDERWRITING A HEALTH AND LIFE INSURANCE PRODUCT, NAMELY, OFF-THE-JOB ACCIDENT INSURANCE; PROVIDING INFORMATION ON INSURANCE MATTERS TO INSURANCE AGENTS TO ASSIST SAID INSURANCE AGENTS IN SERVICING THEIR CUSTOMERS (U.S. CLS. 100, 101 AND 102).

CLASS 44—MEDICAL, BEAUTY AND AGRICULTURAL SERVICES

FOR PROVIDING INFORMATION IN THE FIELD OF OCCUPATIONAL MEDICINE; INSURANCE SERVICES, NAMELY, OCCUPATIONAL REHABILITATION SERVICES (U.S. CLS. 100 AND 101).

CLASS 45—PERSONAL AND LEGAL SERVICES

FOR RETURN-TO-WORK SERVICES, IN THE NATURE OF COORDINATION OF NECESSARY MEDICAL SERVICES, VOCATIONAL ISSUES, EDUCATIONAL SERVICES AND MODIFIED-DUTY PROGRAMS FOR PERSONS INJURED AT WORK (U.S. CLS. 100 AND 101).
HEATHER THOMPSON, EXAMINING ATTORNEY

SN 77-107,838. LOUISIANA WORKERS' COMPENSATION CORPORATION, BATON ROUGE, LA. FILED 2-14-2007.

LWCC

THE MARK CONSISTS OF STANDARD CHARACTERS WITHOUT CLAIM TO ANY PARTICULAR FONT, STYLE, SIZE, OR COLOR.
OWNER OF U.S. REG. NO. 1,816,133.

CLASS 35—ADVERTISING AND BUSINESS

FOR PATIENT REFERRAL SERVICES PROVIDED TO HEALTH CARE PROVIDERS; CUSTOMER REFERRAL SERVICES PROVIDED TO PHARMACIES; HEALTH CARE AND PHARMACY REFERRAL SERVICES PROVIDED TO INJURED WORKERS; HEALTH CARE REFERRAL SERVICES PROVIDED TO EMPLOYERS AS PART OF UNDERWRITING SERVICES FOR WORKERS' COMPENSATION INSURANCE; PROVIDING QUOTES ON WORKERS' COMPENSATION INSURANCE TO INSURANCE AGENTS FOR THE PURPOSE OF SAID INSURANCE AGENTS SERVICING THEIR CUSTOMERS (U.S. CLS. 100, 101 AND 102).

CLASS 36—INSURANCE AND FINANCIAL

FOR PROVIDING INFORMATION IN THE FIELD OF WORKERS' COMPENSATION INSURANCE; INSURANCE SERVICES, NAMELY, UNDERWRITING A HEALTH AND LIFE INSURANCE PRODUCT, NAMELY, OFF-THE-JOB ACCIDENT INSURANCE; PROVIDING INFORMATION ON INSURANCE MATTERS TO INSURANCE AGENTS TO ASSIST SAID INSURANCE AGENTS IN SERVICING THEIR CUSTOMERS (U.S. CLS. 100, 101 AND 102).

CLASS 44—MEDICAL, BEAUTY AND AGRICULTURAL SERVICES

FOR PROVIDING INFORMATION IN THE FIELD OF OCCUPATIONAL MEDICINE; INSURANCE SERVICES, NAMELY, OCCUPATIONAL REHABILITATION SERVICES (U.S. CLS. 100 AND 101).

CLASS 45—PERSONAL AND LEGAL SERVICES

FOR RETURN-TO-WORK SERVICES IN THE NATURE OF COORDINATION OF NECESSARY MEDICAL SERVICES, VOCATIONAL ISSUES, EDUCATIONAL SERVICES, AND MODIFIED-DUTY PROGRAMS FOR PERSONS INJURED AT WORK (U.S. CLS. 100 AND 101).
HEATHER THOMPSON, EXAMINING ATTORNEY

SN 77-107,847. LOUISIANA WORKERS' COMPENSATION CORPORATION, BATON ROUGE, LA. FILED 2-14-2007.

HOW WORKERS' COMP IS SUPPOSED TO WORK

THE MARK CONSISTS OF STANDARD CHARACTERS WITHOUT CLAIM TO ANY PARTICULAR FONT, STYLE, SIZE, OR COLOR.

OWNER OF U.S. REG. NO. 2,264,120.

CLASS 35—ADVERTISING AND BUSINESS

FOR PATIENT REFERRAL SERVICES PROVIDED TO HEALTH CARE PROVIDERS; CUSTOMER REFERRAL SERVICES PROVIDED TO PHARMACIES; HEALTH CARE AND PHARMACY REFERRAL SERVICES PROVIDED TO INJURED WORKERS; HEALTH CARE REFERRAL SERVICES PROVIDED TO EMPLOYERS AS PART OF UNDERWRITING SERVICES FOR WORKERS' COMPENSATION INSURANCE; PROVIDING QUOTES ON WORKERS' COMPENSATION INSURANCE TO INSURANCE AGENTS FOR THE PURPOSE OF SAID INSURANCE AGENTS SERVICING THEIR CUSTOMERS (U.S. CLS. 100, 101 AND 102).

CLASS 36—INSURANCE AND FINANCIAL

FOR PROVIDING INFORMATION IN THE FIELD OF WORKERS' COMPENSATION INSURANCE; INSURANCE SERVICES, NAMELY, UNDERWRITING A HEALTH AND LIFE INSURANCE PRODUCT, NAMELY, OFF-THE-JOB ACCIDENT INSURANCE; PROVIDING INFORMATION ON INSURANCE MATTERS TO INSURANCE AGENTS TO ASSIST SAID INSURANCE AGENTS IN SERVICING THEIR CUSTOMERS (U.S. CLS. 100, 101 AND 102).

CLASS 44—MEDICAL, BEAUTY AND AGRICULTURAL SERVICES

FOR PROVIDING INFORMATION IN THE FIELD OF OCCUPATIONAL MEDICINE; INSURANCE SERVICES, NAMELY, OCCUPATIONAL REHABILITATION SERVICES (U.S. CLS. 100 AND 101).

CLASS 45—PERSONAL AND LEGAL SERVICES

FOR RETURN-TO-WORK SERVICES IN THE NATURE OF COORDINATION OF NECESSARY MEDICAL SERVICES, VOCATIONAL ISSUES, EDUCATIONAL SERVICES, AND MODIFIED-DUTY PROGRAMS FOR PERSONS INJURED AT WORK (U.S. CLS. 100 AND 101).
HEATHER THOMPSON, EXAMINING ATTORNEY

SN 77-107,880. INTERNATIONAL GROWER'S SUPPLY INCORPORATED, CULVER CITY, CA. FILED 2-14-2007.

**CLASS 9—ELECTRICAL AND SCIENTIFIC APPARATUS**

FOR ELECTRIC CORDS FOR LIGHTS; LIGHTING BALLASTS (U.S. CLS. 21, 23, 26, 36 AND 38).

CLASS 11—ENVIRONMENTAL CONTROL APPARATUS

FOR LIGHT BULBS; LIGHT REFLECTORS; LIGHT FIXTURES IN THE NATURE OF LIGHT HOODS; LAMP SOCKETS IN THE NATURE OF SOCKETS FOR ELECTRIC LIGHTS; LIGHTING EQUIPMENT, NAMELY, LIGHTING FIXTURES (U.S. CLS. 13, 21, 23, 31 AND 34).
CHARLOTTE CORWIN, EXAMINING ATTORNEY

SN 77-108,213. MOXIE JAVA INTERNATIONAL, LLC, BOISE, ID. FILED 2-15-2007.

MOXIE MATÉ

THE MARK CONSISTS OF STANDARD CHARACTERS WITHOUT CLAIM TO ANY PARTICULAR FONT, STYLE, SIZE, OR COLOR.

OWNER OF U.S. REG. NOS. 1,705,588 AND 2,062,542.
NO CLAIM IS MADE TO THE EXCLUSIVE RIGHT TO USE "MATE", APART FROM THE MARK AS SHOWN.

CLASS 29—MEATS AND PROCESSED FOODS

FOR BLENDED ICED DRINKS INCLUDING CHOCOLATE AND CANDY BARS, NAMELY, DAIRY BASED BEVERAGES AND FRUIT-BASED FOOD BEVERAGES (U.S. CL. 46).

CLASS 30—STAPLE FOODS

FOR BLENDED ICED COFFEE DRINKS; BLENDED ICED DRINKS INCLUDING CHOCOLATE AND CANDY BARS, NAMELY, COCOA BEVERAGES WITH MILK, BEVERAGES MADE OF COFFEE, AND BEVERAGES MADE OF TEA; COFFEE AND ESPRESSO BEVERAGES; AND COFFEE AND ESPRESSO BASED BEVERAGES (U.S. CL. 46).

CLASS 32—LIGHT BEVERAGES

FOR BLENDED ICED DRINKS, NAMELY, ICED FRUIT BEVERAGES, FROZEN FRUIT-BASED BEVERAGES, AND SMOOTHIES (U.S. CLS. 45, 46 AND 48).
HOWARD B. LEVINE, EXAMINING ATTORNEY

SN 77-108,277. BALDOR ELECTRIC COMPANY, FORT SMITH, AR. FILED 2-15-2007.



OWNER OF U.S. REG. NOS. 990,504, 1,917,623 AND OTHERS.
THE MARK CONSISTS OF TWO BARS ABOVE AND BELOW THE WORD "BALDOR", AND BULLETS IN TAG LINE BETWEEN THE WORDS "BALDOR" AND "DODGE, DODGE" AND "RELIANCE", THAT ARE BELOW THE INITIAL WORDING "BALDOR", WITH A DIAMOND SHAPE BEHIND "DODGE" AND A STYLIZED "R" FOLLOWING THE WORD "RELIANCE".

CLASS 7—MACHINERY

FOR ALTERNATING CURRENT MOTORS NOT FOR LAND VEHICLES, AND ALTERNATING CURRENT GENERATORS; DIRECT CURRENT MOTORS NOT FOR LAND VEHICLES, AND GENERATORS; MACHINE PARTS NAMELY, BEARINGS, BRUSHINGS, BEARING HOUSINGS, BEARING INSERTS SHEAVES; SPROCKETS, GEARS AND ENCLOSED DRIVES FOR INDUSTRIAL MACHINERY; TRANSMISSION GEARS FOR MACHINES; CLUTCHES FOR MACHINES; DISC BRAKES FOR INDUSTRIAL MACHINES AND ELECTRIC MOTORS AND NOT FOR LAND VEHICLES; TORQUE CONVERTERS NOT FOR LAND VEHICLES; PULLEYS AND PULLEY ASSEMBLIES BEING PARTS OF MACHINES; TRANSMISSIONS OTHER THAN FOR LAND VEHICLES; BELTS FOR MACHINES; POWER TRANSMISSION BELTS FOR MACHINES AND ELECTRIC MOTORS USED IN INDUSTRIAL APPLICATIONS; TRANSMISSION BELTS OTHER THAN FOR LAND VEHICLES; COUPLINGS FOR MACHINES; SHAFT COUPLINGS FOR MACHINES; GEAR REDUCERS; MOTOR DRIVE CONTROLLERS FOR CONTROL AND REGULATION OF ALTERNATING AND DIRECT CURRENT MOTORS NOT FOR LAND VEHICLES; ELECTRIC MOTORS FOR COMMERCIAL AND AGRICULTURAL USES AND NOT FOR LAND VEHICLES; POWER OPERATED INDUSTRIAL GRINDERS; POWER OPERATED INDUSTRIAL BUFFERS; POWER OPERATED POLISHING LATHES; AND LIFTING MAGNET ELECTRIC GENERATORS (U.S. CLS. 13, 19, 21, 23, 31, 34 AND 35).

CLASS 9—ELECTRICAL AND SCIENTIFIC APPARATUS

FOR ELECTRICAL DRIVE AND DRIVE-CONTROL APPARATUS OTHER THAN AUTOMOTIVE, NAMELY, APPARATUS FOR CONTROLLING SPEED, ROTATION, OR TORQUE APPLIED TO A SHAFT OR OTHER DRIVEN MACHINE ELEMENT, AND RELATED INSTRUMENTATION INCORPORATED THEREIN FOR CONTROLLING THE FUNCTIONING THEREOF, AND PARTS THEREOF; ELECTRIC MOTOR CONTROLS AND CONTROLLERS NAMELY ELECTRONIC CONTROLLERS FOR STARTING AND BRAKING ELECTRIC MOTORS; AND TACHOMETERS FOR ELECTRIC MOTORS (U.S. CLS. 21, 23, 26, 36 AND 38).

CLASS 37—CONSTRUCTION AND REPAIR

FOR ELECTRICAL REPAIRS AND INSTALLATION OF ELECTRIC MOTORS AND GENERATORS; REPAIR, REFURBISHMENT OR MAINTENANCE OF ELECTRIC MOTORS AND GENERATORS; REPAIR, REFURBISHMENT, OR MAINTENANCE OF INDUSTRIAL MACHINES NAMELY, ENCLOSED GEARING, BRAKES NOT FOR LAND VEHICLES, BEARINGS, VACUUM PUMPS, COMPRESSORS, FANS, BLOWERS, HEAT EXCHANGERS, AND CONTROLLED START TRANSMISSIONS (U.S. CLS. 100, 103 AND 106).
LINDA POWELL, EXAMINING ATTORNEY

SN 77-108,587. LOUISIANA WORKERS' COMPENSATION CORPORATION, BATON ROUGE, LA. FILED 2-15-2007.



OWNER OF U.S. REG. NO. 1,816,133.
NO CLAIM IS MADE TO THE EXCLUSIVE RIGHT TO USE "INTERACTIVE", APART FROM THE MARK AS SHOWN.

CLASS 35—ADVERTISING AND BUSINESS

FOR WORKERS' COMPENSATION CLAIMS AUDITING, CLAIMS MANAGEMENT, AND MEDICAL COST CONTAINMENT; HEALTH CARE REFERRAL SERVICES PROVIDED TO EMPLOYERS AS PART OF UNDERWRITING SERVICES FOR WORKERS' COMPENSATION INSURANCE; PROVIDING QUOTES ON WORKERS' COMPENSATION INSURANCE TO INSURANCE AGENTS FOR THE PURPOSE OF SAID INSURANCE AGENTS SERVICING THEIR CUSTOMERS (U.S. CLS. 100, 101 AND 102).

CLASS 36—INSURANCE AND FINANCIAL

FOR WORKERS' COMPENSATION INSURANCE UNDERWRITING SERVICES AND SERVICES RELATED THERETO, SUCH RELATED SERVICES BEING INDUSTRY CLASSIFICATION IDENTIFICATION AND LOSS CONTROL MANAGEMENT FOR OTHERS; PROVIDING INFORMATION IN THE FIELD OF WORKERS' COMPENSATION INSURANCE; INSURANCE SERVICES, NAMELY, UNDERWRITING A HEALTH AND LIFE INSURANCE PRODUCT, NAMELY, OFF-THE-JOB ACCIDENT INSURANCE; PROVIDING INFORMATION ON INSURANCE MATTERS TO INSURANCE AGENTS TO ASSIST SAID INSURANCE AGENTS IN SERVICING THEIR CUSTOMERS (U.S. CLS. 100, 101 AND 102).

CLASS 44—MEDICAL, BEAUTY AND AGRICULTURAL SERVICES

FOR PROVIDING INFORMATION IN THE FIELD OF OCCUPATIONAL MEDICINE; INSURANCE SERVICES, NAMELY, OCCUPATIONAL REHABILITATION SERVICES (U.S. CLS. 100 AND 101).

CLASS 45—PERSONAL AND LEGAL SERVICES

FOR RETURN-TO-WORK SERVICES, IN THE NATURE OF COORDINATION OF NECESSARY MEDICAL SERVICES, VOCATIONAL ISSUES, EDUCATIONAL SERVICES AND MODIFIED-DUTY PROGRAMS FOR PERSONS INJURED AT WORK (U.S. CLS. 100 AND 101).
HEATHER THOMPSON, EXAMINING ATTORNEY

SN 77-108,882. PREMARK RWP HOLDINGS, INC., WILMINGTON, DE. FILED 2-15-2007.

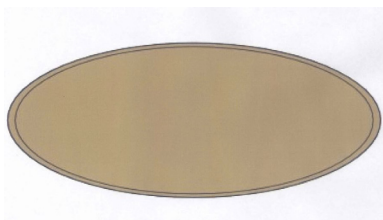

THE COLOR(S) BLACK AND GOLD IS/ARE CLAIMED AS A FEATURE OF THE MARK.

THE MARK CONSISTS OF TWO CONCENTRIC, SINGLE LINE BLACK OVALS WITH GOLD BETWEEN THE OVALS AND INSIDE OF THE INNERMOST OVAL.

CLASS 19—NON-METALLIC BUILDING MATERIALS

FOR LAMINATE FLOORING; LAMINATE MOLDINGS; ARTIFICIAL STONE FOR USE IN FLOORING; NON-METAL DECORATIVE MOLDINGS AND DECORATIVE TRIM FOR USE IN BUILDING CONSTRUCTION AND ON WALLS; NON-METAL WALL PANELS AND TILES (U.S. CLS. 1, 12, 33 AND 50).

CLASS 20—FURNITURE AND ARTICLES NOT OTHERWISE CLASSIFIED

FOR FURNITURE; FURNITURE PARTS, NAMELY, COUNTERTOPS, TABLE TOPS, DESK TOPS AND VANITY TOPS, WORK SURFACES, CABINETS, SHELVING, FREE STANDING OFFICE PARTITIONS, FURNITURE PARTITIONS, BACKSPASHES FOR USE WITH FURNITURE AND CABINETS (U.S. CLS. 2, 13, 22, 25, 32 AND 50).

SARA THOMAS, EXAMINING ATTORNEY

SN 77-109,074. KABUSHIKI KAISHA NIBARIKI, TOKYO, JAPAN, FILED 2-16-2007.

PONYO ON THE CLIFF BY THE SEA

THE MARK CONSISTS OF STANDARD CHARACTERS WITHOUT CLAIM TO ANY PARTICULAR FONT, STYLE, SIZE, OR COLOR.

CLASS 9—ELECTRICAL AND SCIENTIFIC APPARATUS

FOR CARTRIDGES, CASSETTES, CARDS AND DISCS WHICH CONTAIN PRE-RECORDED COMPUTER VIDEO GAME PROGRAMS; VIDEO GAME MACHINES FOR USE WITH TELEVISIONS; AUDIO AND VIDEO COMPACT DISKS CONTAINING RECORDED MUSIC, ANIMATED CARTOONS, AND ACTION ADVENTURE MOTION PICTURE FILMS; BLANK MAGNETIC TAPES FOR COMPUTERS; MOBILE PHONES, NAMELY, TELEPHONES AND MODEMS; EXPOSED CAMERA FILMS; PHOTOGRAPHIC SLIDE TRANSPARENCIES; SOUND RECORDED MAGNETIC TAPES; VIDEO TAPES FEATURING ANIMATED CARTOONS (U.S. CLS. 21, 23, 26, 36 AND 38).

CLASS 14—JEWELRY

FOR ALARM CLOCKS; BADGES, BROOCHES, INGOTS, NECKLACES, AND PINS OF PRECIOUS METAL; JEWELRY; ORNAMENTS OF PRECIOUS METAL; TIE CLIPS; TIE PINS; WATCHES; WATCH BANDS; JEWELRY CASES OF WOOD OR PLASTIC (U.S. CLS. 2, 27, 28 AND 50).

CLASS 15—MUSICAL INSTRUMENTS

FOR MUSICAL INSTRUMENTS IN GENERAL (U.S. CLS. 2, 21 AND 36).

CLASS 16—PAPER GOODS AND PRINTED MATTER

FOR STATIONERY OF ALL KINDS; PAPERS, NAMELY, TRACING PAPER, TISSUE PAPER; ALBUMS, NAMELY, COIN, EVENT, PHOTOGRAPH, SCRAPBOOK, STAMP, AND WEDDING ALBUMS; PRINTED PUBLICATIONS, NAMELY, COMIC BOOKS, COMIC MAGAZINES; CALENDARS, PAMPHLETS IN THE FIELD OF ANIMATION FILMS AND GOODS REFERRED TO IN THE ANIMATION; MOUNTED AND UNMOUNTED PHOTOGRAPHS; PASTELS; WRITING PADS; PENS; PHOTOGRAPH STANDS; ERASERS; RUBBER STAMPS; STAMP PAD INKS; BINDERS; GRAPHIC ART REPRODUCTIONS (U.S. CLS. 2, 5, 22, 23, 29, 37, 38 AND 50).

CLASS 18—LEATHER GOODS

FOR BAGS, NAMELY, SHOPPING BAGS MADE OF LEATHER OR TEXTILE, SPORTS BAGS, BOOK BAGS, GARMENT BAGS FOR TRAVEL, AND SCHOOL BAGS; BRIEFCASES; KEY CASES; LEATHER STRAPS; WALLETS; PURSES; SADDLERY; SUITCASES; UMBRELLAS, UMBRELLA COVERS; TOILETRY CASES SOLD EMPTY (U.S. CLS. 1, 2, 3, 22 AND 41).

CLASS 20—FURNITURE AND ARTICLES NOT OTHERWISE CLASSIFIED

FOR FURNITURE OF ALL KINDS; CUSHIONS; MATTRESSES; PILLOWS; CHAIRS; BEDS; CASES, NAMELY, NON-METAL STORAGE CONTAINERS FOR CLOTHES, NAMELY, DRESSERS; BOXES AND BINS OF WOOD OR PLASTIC; CLOTHES HANGERS; DESKS; MAGAZINE RACKS; MIRRORS; NON-METAL NAMEPLATES; PICTURE FRAMES; SLEEPING BAGS (U.S. CLS. 2, 13, 22, 25, 32 AND 50).

CLASS 21—HOUSEWARES AND GLASS

FOR BABY BATH TUBS; DUST BINS; COOKING POTS; WASHING AND CLEANING INSTRUMENTS, NAMELY, CLOTHS FOR CLEANING, MOPS, BROOMS, SPONGES FOR WASHING, WASHING BOARDS; HAIR COMBS; COMB CASES; BRUSHES, NAMELY, BRUSHES FOR CLOTHES, DISHWASHING BRUSHES, FOOTWEAR BRUSHES, HAIR BRUSHES, NAIL BRUSHES; DISHES FOR SOAP; DUSTING CLOTHS; BUCKETS; COSMETIC UTENSILS, NAMELY, COSMETIC BRUSHES, NON-ELECTRONIC APPLIANCES FOR REMOVING MAKE-UP, NAMELY, POWDER PUFFS; POTS, DRINKING FLASKS; KITCHEN CONTAINERS; NAPKIN HOLDERS; SHOE HORNS; SOAP BOXES; TOILET UTENSILS, NAMELY, TOILET BRUSHES, TOILET PAPER HOLDERS; BOTTLES SOLD EMPTY; HOUSEHOLD UTENSILS, NAMELY, BASKETS FOR DOMESTIC USE NOT OF PRECIOUS METAL, TRAYS NOT OF PRECIOUS METAL, COFFEE SERVICES NOT OF PRECIOUS METAL, ROLLING PINS, TURNERS, WHISKS; TABLEWARE OTHER THAN KNIVES, FORKS AND SPOONS, NOT OF PRECIOUS METAL, NAMELY, COFFEE CUPS, MILK CUPS, TEA CUPS, SERVING BOWLS; CLOTHES PINS; PLASTIC STORAGE CONTAINERS FOR CLOTHING, FOR DOMESTIC USE (U.S. CLS. 2, 13, 23, 29, 30, 33, 40 AND 50).

CLASS 24—FABRICS

FOR CLOTH FLAGS; CLOTHS, NAMELY, TABLE CLOTHS NOT OF PAPER; BED COVERS, NAMELY, BED BLANKETS, BED LINENS, BED SHEETS; FABRIC, NAMELY, NYLON, POLYESTER, RAYON, AND COTTON; MATTRESS COVERS; MITTS, NAMELY, WASHING MITTS, TOILET MITTS, OVEN MITTS; PILLOW CASES; QUILTS; SHAMS; AND CURTAINS (U.S. CLS. 42 AND 50).

CLASS 25—CLOTHING

FOR CLOTHING, NAMELY, SUSPENDERS, BELTS, PANTS, APRONS, SWIMSUITS, CAPS, COATS, JACKETS, JERSEYS, JUMPERS, GLOVES, UNDERWEAR, CUFFS, EARMUFFS, NECKTIES, PARKAS, PAJAMAS, SCARVES, SHIRTS, SOCKS, SUITS, TROUSERS, VESTS, SHOES OF ALL KINDS, SANDALS; AND SLIPPERS (U.S. CLS. 22 AND 39).

CLASS 26—FANCY GOODS

FOR SEWING INSTRUMENTS, NAMELY, SEWING BOXES, SEWING NEEDLES, SEWING THIMBLES, TASSELS; ACCESSORIES, NOT OF PRECIOUS METAL AND NOT IMITATION JEWELRY, NAMELY, LAPEL AND ORNAMENTAL BADGES, BROOCHES, BUCKLES; BUTTONS FOR CLOTHING; ARTIFICIAL FLOWERS; HAIR BANDS; HAIR NETS; HAIR ORNAMENTS; AND RIBBONS (U.S. CLS. 37, 39, 40, 42 AND 50).

CLASS 27—FLOOR COVERINGS

FOR CARPETS, FLOOR COVERING, RUGS, DOOR MATS, WALLPAPER, NON-TEXTILE WALL HANGINGS (U.S. CLS. 19, 20, 37, 42 AND 50).

CLASS 28—TOYS AND SPORTING GOODS

FOR TOYS, NAMELY, DOLLS; GAMES, NAMELY, BOARD GAMES, CARD GAMES, STAND-ALONE VIDEO OUTPUT GAME MACHINES FOR TELEVISION; DOLL CLOTHES; SPORTING GOOD BALLS FOR GAMES, NAMELY, BASEBALLS, BASKETBALLS, FOOTBALLS, SOCCER BALLS, VOLLEYBALLS, AND TENNIS BALLS; SPORTING GOOD BATS FOR GAMES, NAMELY, BASEBALL BATS, CRICKET BATS, AND SOFTBALL BATS; TENNIS RACKETS, SKATEBOARDS, SURFBOARDS; TABLE TENNIS EQUIPMENT, NAMELY, BALLS, NETS, PADDLES, RACKETS, AND TABLES; FISHING TACKLE; AND CHRISTMAS TREE ORNAMENTS (U.S. CLS. 22, 23, 38 AND 50).

CLASS 29—MEATS AND PROCESSED FOODS

FOR DAIRY PRODUCTS EXCLUDING ICE CREAM, ICE MILK AND FROZEN YOGURT; MILK BEVERAGES, NAMELY, MILK AND HALF AND HALF, RICE MILK AND SOY-BASED FOOD BEVERAGES USED AS A MILK SUBSTITUTE; MEAT-BASED FOOD PRODUCTS, NAMELY, CHOW MEIN, MEAT-BASED SPREADS; FISH-BASED FOOD PRODUCTS, NAMELY, PROCESSED ANCHOVIES, CAVIAR; PRESERVED FOODS, NAMELY, DRIED BEANS, DRIED FRUITS, FISH, AND VEGETABLES (U.S. CL. 46).

CLASS 30—STAPLE FOODS

FOR ALMOND CONFECTIONERY, NAMELY, ALMOND PASTE AND FLAVORINGS MADE OF ALMOND; PEANUT CONFECTIONERY, NAMELY, PEANUT BRITTLE; COFFEE OR CHOCOLATE BASED BEVERAGES, NAMELY, COFFEE, ESPRESSO, AND HOT CHOCOLATE; STARCH FOODS, NAMELY, POTATO FLOUR, WHEAT AND RICE STARCH FLOUR (U.S. CL. 46).

CLASS 32—LIGHT BEVERAGES

FOR AERATED WATER; NONALCOHOLIC MALT BEVERAGES; FRUIT JUICE CONCENTRATES; MALT WORT; WATERS, NAMELY, DRINKING, MINERAL, QUININE, SELTZER, SODA, SPRING AND TABLE WATER, AND BEER (U.S. CLS. 45, 46 AND 48).

CLASS 33—WINES AND SPIRITS

FOR PREPARED ALCOHOLIC COCKTAILS (U.S. CLS. 47 AND 49).

CLASS 38—COMMUNICATION

FOR RADIO AND TELEVISION BROADCASTING; TELECOMMUNICATIONS SERVICES, NAMELY, COMMUNICATIONS BY COMPUTER TERMINALS, COMMUNICATIONS BY TELEPHONE, PERSONAL COMMUNICATIONS SERVICES; ELECTRONIC MAIL; ELECTRONIC VOICE MESSAGING, NAMELY, THE RECORDING, STORAGE AND SUBSEQUENT TRANSMISSION OF VOICE MESSAGES BY TELEPHONE; TRANSMISSION OF MESSAGES AND IMAGES BY COMPUTER TERMINALS; TRANSMISSION OF MESSAGES AND IMAGES BY FACSIMILE; ELECTRONIC TRANSMISSION OF MESSAGES AND DATA; TELEGRAM TRANSMISSION AND COMMUNICATION; PROVIDING INFORMATION ABOUT TELECOMMUNICATION VIA GLOBAL COMPUTER NETWORKS (U.S. CLS. 100, 101 AND 104).

CLASS 41—EDUCATION AND ENTERTAINMENT

FOR RENTAL OF CINEMA FILMS; EDUCATION IN THE FIELD OF ART AND COMPUTER GRAPHICS RENDERED THROUGH CORRESPONDENCE COURSES; PROVIDING INFORMATION IN THE FIELD OF EDUCATION VIA GLOBAL COMPUTER NETWORKS; ENTERTAINMENT IN THE NATURE OF AMUSEMENT PARK RIDES, LIVE PERFORMANCES BY A MUSICAL GROUP; PARTY PLANNING; PRODUCTION OF ENTERTAINMENT SHOWS, NAMELY, TELEVISION SHOWS AND LIVE THEATER PRODUCTIONS; MOTION PICTURE FILM PRODUCTION; PROVIDING CASINO FACILITIES; MOVIE STUDIO; ORGANIZATION OF MOTION PICTURE, ANIMATION, AND LIVE MUSIC EXHIBITIONS; THEATER PRODUCTIONS; PUBLICATION OF BOOKS; PRODUCTION OF RADIO AND TELEVISION PROGRAMS; RENTAL OF VIDEO TAPES; CONDUCTING OF ENTERTAINMENT EXHIBITIONS IN THE NATURE OF LIVE MUSICAL PERFORMANCES, MOTION PICTURE FESTIVALS; ENTERTAINMENT IN THE NATURE OF LIVE MUSICAL PERFORMANCES (U.S. CLS. 100, 101 AND 107).

CLASS 42—SCIENTIFIC AND COMPUTER SERVICES

FOR COMPUTER PROGRAMMING FOR OTHERS; COMPUTER SOFTWARE DESIGN FOR OTHERS; GRAPHIC ART DESIGN; RENTAL OF COMPUTER SOFTWARE (U.S. CLS. 100 AND 101).

JOHN GARTNER, EXAMINING ATTORNEY

SN 77-109,547. WEEMS INDUSTRIES, INC., DBA LEGACY MANUFACTURING COMPANY, MARION, IA. FILED 2-16-2007.

LEGACY

THE MARK CONSISTS OF STANDARD CHARACTERS WITHOUT CLAIM TO ANY PARTICULAR FONT, STYLE, SIZE, OR COLOR.

CLASS 6—METAL GOODS

FOR METAL HOSE REELS, NAMELY, MANUALLY OPERATED HOSE REELS AND SELF-RETRACTING HOSE REELS; METAL HOSE CLAMPS AND METAL HOSE FITTINGS; METAL COUPLERS AND PLUGS FOR AIR HOSES (U.S. CLS. 2, 12, 13, 14, 23, 25 AND 50).

FIRST USE 11-1-2004; IN COMMERCE 11-1-2004.

CLASS 7—MACHINERY

FOR AIR-OPERATED POWER TOOLS, NAMELY, IMPACT WRENCHES, RATCHETS, SANDERS, AIR HAMMERS, CHISELS, DRILLS, NAILERS, GRINDERS, CUT-OFF DISCS; ABRASIVE DISKS FOR AIR-OPERATED POWER SANDERS; GRINDING DISKS FOR AIR-OPERATED POWER GRINDERS, BLOW GUNS; COMPRESSED AIR PUMPS, MACHINE PARTS, NAMELY, METAL AIR NOZZLES, AIR HOSE ADAPTERS, AIR HOSE CHUCKS, NEEDLES AND CONNECTERS WHICH ARE PARTS OF AIR-OPERATED POWER TOOLS; NEEDLES FOR PUMPS FOR INFLATING TIRES; TIRE INFLATION NOZZLES; AIR OPERATED GREASE SYSTEMS, NAMELY, GREASE PUMPS, GREASE GUNS, GREASE RESERVOIRS, HOSES, HOSE REELS, COUPLERS, PLUGS, DOLLIES, FITTINGS FOR CONNECTION OF HOSES, CLAMPS, GREASE FITTING REPAIR TOOLS, GREASE STORAGE CONTAINERS, GREASE DISPENSERS, GREASE, RECHARGEABLE BATTERIES, GREASE INJECTORS, GREASE INJECTOR NEEDLES, GREASE GUN NIPPLES, AIR BLEEDER VALVES, GREASE GUN HOLDERS, WARMING BAGS FOR GREASE GUNS AND GREASE ALL FOR USE WITH DISPENSING GREASE; AIR OPERATED OIL SYSTEMS, NAMELY, OIL PUMPS, OIL CONTROL GUNS, OIL GUN EXTENSIONS, OIL NOZZLES, OIL SWIVELS, HOSES, SUCTION TUBES FOR OIL PUMPS, OIL DISPENSING TAPPERS FOR OIL PUMPS, COUPLERS, PLUGS, METERS FOR MEASURING VOLUME, DOLLIES, OIL STORAGE CONTAINERS, AND WASTE OIL RECOVERY CONTAINERS ALL FOR USE WITH PUMPING OIL (U.S. CLS. 13, 19, 21, 23, 31, 34 AND 35).

FIRST USE 12-1-2000; IN COMMERCE 12-1-2000.

CLASS 8—HAND TOOLS

FOR MANUALLY OPERATED GREASE GUNS, MANUALLY OPERATED PUMPS FOR LUBRICANTS AND FUELS, MANUALLY OPERATED LUBRICATORS FOR AIR POWERED TOOLS (U.S. CLS. 23, 28 AND 44).

FIRST USE 2-1-1994; IN COMMERCE 2-1-1994.

CLASS 9—ELECTRICAL AND SCIENTIFIC APPARATUS

FOR TIRE PRESSURE GAUGES, TIRE TREAD DEPTH GAUGES, AND ELECTRICAL CIRCUIT TESTERS (U.S. CLS. 21, 23, 26, 36 AND 38).

FIRST USE 1-1-1991; IN COMMERCE 1-1-1991.

CLASS 17—RUBBER GOODS

FOR HOSES FOR COMPRESSED AIR POWERED TOOLS, HOSE KITS FOR COMPRESSED AIR POWERED TOOLS CONSISTING OF HOSES, HOSE FITTINGS AND CONNECTORS, NOZZLES AND NEEDLES; AIR HOSES, WATER HOSES, OIL HOSES (U.S. CLS. 1, 5, 12, 13, 35 AND 50).

FIRST USE 8-1-1987; IN COMMERCE 8-1-1987.

CLASS 20—FURNITURE AND ARTICLES NOT OTHERWISE CLASSIFIED

FOR NON-METAL HOSE REELS, NAMELY, MANUALLY OPERATED HOSE REELS AND SELF-RETRACTING HOSE REELS (U.S. CLS. 2, 13, 22, 25, 32 AND 50).

FIRST USE 1-1-1993; IN COMMERCE 1-1-1993.

CLASS 21—HOUSEWARES AND GLASS

FOR PLASTIC COMPRESSED AIR HOSE NOZZLES, HOSE NOZZLES, POURING SPOUTS AND FUNNELS; PLASTIC POUR SPOUTS WITH VALVE FOR MOUNTING ON MOTOR OIL BOTTLE; PLASTIC SPRAY NOZZLES (U.S. CLS. 2, 13, 23, 29, 30, 33, 40 AND 50).

FIRST USE 1-1-1989; IN COMMERCE 1-1-1989.

BARBARA GAYNOR, EXAMINING ATTORNEY

SN 77-110,475. FALCON COMMUNICATIONS, INC., MALDEN, MO. FILED 2-19-2007.



NO CLAIM IS MADE TO THE EXCLUSIVE RIGHT TO USE "COMMUNICATIONS, INC.", APART FROM THE MARK AS SHOWN.

CLASS 37—CONSTRUCTION AND REPAIR

FOR INSTALLATION, REPAIR AND EMERGENCY DISASTER REPAIR SERVICES OF TELECOMMUNICATIONS NETWORKS, APPARATUS AND INSTRUMENTS, PROVIDED TO TELEPHONE COMPANIES (U.S. CLS. 100, 103 AND 106).

FIRST USE 0-0-1967; IN COMMERCE 0-0-1967.

CLASS 38—COMMUNICATION

FOR TELECOMMUNICATION SERVICES, NAMELY, LEASING OF TELECOMMUNICATION EQUIPMENT TO TELEPHONE COMPANIES; RENTAL OF EQUIPMENT FOR TELECOMMUNICATIONS TO TELEPHONE COMPANIES (U.S. CLS. 100, 101 AND 104).

FIRST USE 0-0-1967; IN COMMERCE 0-0-1967.

CLASS 42—SCIENTIFIC AND COMPUTER SERVICES

FOR ENGINEERING SERVICES, NAMELY, ENGINEERING IN THE FIELD OF TELECOMMUNICATIONS, FOR TELEPHONE COMPANIES (U.S. CLS. 100 AND 101).

FIRST USE 0-0-1967; IN COMMERCE 0-0-1967.
NATALIE POLZER, EXAMINING ATTORNEY

SN 77-110,732. KROEKER FARMS LIMITED, WINKLER, MANITOBA, CANADA, FILED 2-19-2007.



PRIORITY CLAIMED UNDER SEC. 44(D) ON CANADA APPLICATION NO. 1332138, FILED 1-22-2007, REG. NO. TMA705755, DATED 1-25-2008, EXPIRES 1-25-2023.

NO CLAIM IS MADE TO THE EXCLUSIVE RIGHT TO USE "SINCE 1928", APART FROM THE MARK AS SHOWN.

THE MARK CONSISTS OF A VERTICAL ARRANGEMENT OF THE WORDS "SINCE 1928", "POPLAR", "GROVE" AND "SIMPLE GOODNESS" WITH A LEAF DESIGN POSITIONED WITHIN AND FORMING A PORTION OF THE LETTER "O" IN "GROVE".

CLASS 29—MEATS AND PROCESSED FOODS

FOR BLUEBERRY, RASPBERRY, SASKATOON BERRY AND STRAWBERRY SPREADS, AND ORGANIC SPREADS OF THE FOREGOING BERRIES (U.S. CL. 46).

CLASS 31—NATURAL AGRICULTURAL PRODUCTS

FOR FRESH RASPBERRIES; UNPROCESSED ORGANIC ONIONS AND POTATOES (U.S. CLS. 1 AND 46).
IRA J. GOODSAD, EXAMINING ATTORNEY

SN 77-111,148. SACHIKO IWASAKI, EUGENE, OR. FILED 2-20-2007.

ECOTOPIA

THE MARK CONSISTS OF STANDARD CHARACTERS WITHOUT CLAIM TO ANY PARTICULAR FONT, STYLE, SIZE, OR COLOR.

CLASS 3—COSMETICS AND CLEANING PREPARATIONS

FOR COSMETICS, BODY LOTIONS, BODY CREAMS, HAIR CARE PREPARATIONS, PERFUMES, BATH OILS, FRAGRANCES FOR PERSONAL USE (U.S. CLS. 1, 4, 6, 50, 51 AND 52).

CLASS 16—PAPER GOODS AND PRINTED MATTER

FOR ART PAPER, WRITING PAPER, AND PAPER FOR WRAPPING AND PACKAGING, PAPER DIAPERS (U.S. CLS. 2, 5, 22, 23, 29, 37, 38 AND 50).

CLASS 24—FABRICS

FOR TOWELS AND HANDKERCHIEFS (U.S. CLS. 42 AND 50).

CLASS 27—FLOOR COVERINGS

FOR BATH MATS AND WALL PAPER (U.S. CLS. 19, 20, 37, 42 AND 50).

CLASS 35—ADVERTISING AND BUSINESS

FOR ONLINE RETAIL STORE SERVICES FEATURING COSMETICS, BODY LOTIONS, BODY CREAMS, HAIR CARE PREPARATIONS, PERFUMES, BATH OILS, FRAGRANCES FOR PERSONAL USE, PAPER DIAPERS, ART PAPER, WRITING PAPER AND PAPER FOR WRAPPING AND PACKAGING, TOWELS, HANDKERCHIEFS, BATH MATS AND WALL PAPER (U.S. CLS. 100, 101 AND 102).
GISELLE AGOSTO, EXAMINING ATTORNEY

SN 77-111,818. HYPERION INNOVATIONS INC., BELLEVUE, WA. FILED 2-20-2007.

DUOTEMP

THE MARK CONSISTS OF STANDARD CHARACTERS WITHOUT CLAIM TO ANY PARTICULAR FONT, STYLE, SIZE, OR COLOR.

CLASS 11—ENVIRONMENTAL CONTROL APPARATUS

FOR ANIMAL AND PET SUPPLIES AND ACCESSORIES, NAMELY, HEATED AND COOLED PET FOOD BOWLS AND WATER DISHES (U.S. CLS. 13, 21, 23, 31 AND 34).

CLASS 19—NON-METALLIC BUILDING MATERIALS

FOR ANIMAL AND PET SUPPLIES AND ACCESSORIES, NAMELY, PRE-FABRICATED HEATED AND COOLED PET HOUSES FOR DOGS, CATS, AND OTHER MAMMALS (U.S. CLS. 1, 12, 33 AND 50).

CLASS 20—FURNITURE AND ARTICLES NOT OTHERWISE CLASSIFIED

FOR ANIMAL AND PET SUPPLIES AND ACCESSORIES, NAMELY, HEATED AND COOLED PET CUSHIONS, HEATED AND COOLED PET BEDS, HEATED AND COOLED PET CARRIERS AND CRATES, HEATED AND/OR COOLED FITTED FABRIC SOFA AND CHAIR PET PROTECTIVE COVERS TO PREVENT DAMAGE AND SOILING (U.S. CLS. 2, 13, 22, 25, 32 AND 50).

CLASS 24—FABRICS

FOR UNFITTED HEATED AND/OR COOLED FABRIC HUMAN BED PROTECTIVE COVERS TO PREVENT DAMAGE AND SOILING (U.S. CLS. 42 AND 50).
JAMES STEIN, EXAMINING ATTORNEY

SN 77-112,173. EASYTEL.NET, LAS VEGAS, NV. FILED 2-21-2007.

CellPlusPlus

THE MARK CONSISTS OF STANDARD CHARACTERS WITHOUT CLAIM TO ANY PARTICULAR FONT, STYLE, SIZE, OR COLOR.

CLASS 35—ADVERTISING AND BUSINESS

FOR AUTOMATIC TELEPHONE ANSWERING AND SCREENING SERVICES (U.S. CLS. 100, 101 AND 102).

CLASS 36—INSURANCE AND FINANCIAL

FOR PREPAID TELEPHONE CALLING CARD SERVICES; BANKING AND RELATED FINANCIAL SERVICES; NAMELY, PROVIDING BANK ACCOUNT INFORMATION BY TELEPHONE, MONEY TRANSFER BY TELEPHONE AND GLOBAL COMPUTER NETWORK, CREDIT AND DEBIT CARD SERVICES (U.S. CLS. 100, 101 AND 102).

CLASS 38—COMMUNICATION

FOR AUTOMATIC TELEPHONE FORWARDING SERVICES; TELECOMMUNICATIONS SERVICES, NAMELY, ELECTRONIC FAX, DATA, AND VOICE MESSAGING SERVICE, NAMELY, THE RECORDING AND SUBSEQUENT TRANSMISSION OF FAX, DATA, AND VOICE MESSAGE BY FAX, COMPUTER, AND/OR TELEPHONE (U.S. CLS. 100, 101 AND 104).

CLASS 39—TRANSPORTATION AND STORAGE

FOR TELECOMMUNICATIONS SERVICES, NAMELY, ELECTRONIC FAX, DATA, AND VOICE MESSAGING SERVICES, NAMELY, THE STORAGE AND RETRIEVAL OF FAX, DATA, AND VOICE MESSAGES (U.S. CLS. 100 AND 105).
JAMES MACFARLANE, EXAMINING ATTORNEY

SN 77-112,277. REALITYWORKS, INC., EAU CLAIRE, WI. FILED 2-21-2007.

Y START

THE MARK CONSISTS OF STANDARD CHARACTERS WITHOUT CLAIM TO ANY PARTICULAR FONT, STYLE, SIZE, OR COLOR.

CLASS 9—ELECTRICAL AND SCIENTIFIC APPARATUS

FOR DVDS FEATURING ABUSIVE AND ADDICTIVE BEHAVIOR DETERRENCE EDUCATIONAL MATERIALS (U.S. CLS. 21, 23, 26, 36 AND 38).

CLASS 16—PAPER GOODS AND PRINTED MATTER

FOR PRINTED INSTRUCTIONAL, EDUCATIONAL, AND TEACHING MATERIALS IN THE FIELD OF ABUSIVE AND ADDICTIVE BEHAVIOR DETERRENCE; PRINTED INSTRUCTIONAL, EDUCATIONAL, AND TEACHING MATERIALS IN THE FIELD OF TOBACCO USAGE DETERRENCE (U.S. CLS. 2, 5, 22, 23, 29, 37, 38 AND 50).

CLASS 41—EDUCATION AND ENTERTAINMENT

FOR PROVIDING EDUCATIONAL PROGRAMS IN THE FIELD OF ADDICTIVE AND ABUSIVE BEHAVIOR DETERRENCE (U.S. CLS. 100, 101 AND 107).
ADA HAN, EXAMINING ATTORNEY

SN 77-112,677. BEYOND WEIGHT LLC, NEWTOWN SQUARE, PA. FILED 2-21-2007.

BEYOND WEIGHT METABOLIC REHAB

THE MARK CONSISTS OF STANDARD CHARACTERS WITHOUT CLAIM TO ANY PARTICULAR FONT, STYLE, SIZE, OR COLOR.

NO CLAIM IS MADE TO THE EXCLUSIVE RIGHT TO USE "WEIGHT" AND "METABOLIC REHAB", APART FROM THE MARK AS SHOWN.

CLASS 9—ELECTRICAL AND SCIENTIFIC APPARATUS

FOR MEDICAL SOFTWARE FOR MONITORING AND COACHING INDIVIDUAL WEIGHT LOSS AND HEALTH IMPROVEMENT EFFORTS (U.S. CLS. 21, 23, 26, 36 AND 38).

CLASS 16—PAPER GOODS AND PRINTED MATTER

FOR PRINTED INSTRUCTIONAL, EDUCATIONAL, AND TEACHING MATERIALS IN THE FIELD OF HEALTH AND WEIGHT LOSS (U.S. CLS. 2, 5, 22, 23, 29, 37, 38 AND 50).

CLASS 41—EDUCATION AND ENTERTAINMENT

FOR EDUCATIONAL SERVICES, NAMELY, PROVIDING CLASSES, SEMINARS, WORKSHOPS AND INDIVIDUALIZED INSTRUCTION IN THE FIELDS OF HEALTH, WEIGHT LOSS, NUTRITION AND EXERCISE (U.S. CLS. 100, 101 AND 107).

CLASS 44—MEDICAL, BEAUTY AND AGRICULTURAL SERVICES

FOR MEDICAL SERVICES, NAMELY, HEALTH SCREENINGS, HEALTH ASSESSMENTS, MEDICAL TESTING, NUTRITION COUNSELING, WEIGHT REDUCTION DIET PLANNING AND SUPERVISION, STRESS REDUCTION AND BEHAVIOR MODIFICATION (U.S. CLS. 100 AND 101).

GEORGE LORENZO, EXAMINING ATTORNEY

SN 77-112,686. STAPLES THE OFFICE SUPERSTORE, LLC, FRAMINGHAM, MA. FILED 2-21-2007.

FINALLY, A BETTER WAY

THE MARK CONSISTS OF STANDARD CHARACTERS WITHOUT CLAIM TO ANY PARTICULAR FONT, STYLE, SIZE, OR COLOR.

CLASS 9—ELECTRICAL AND SCIENTIFIC APPARATUS

FOR COMPUTER PARTS AND PERIPHERALS USED IN THE INSTALLATION, REPAIR AND MAINTENANCE OF COMPUTER HARDWARE, SOFTWARE AND WIRELESS NETWORKS, NAMELY, KEYBOARDS, MEMORY CARDS, HARD DRIVES, MONITORS, WIRELESS CARDS, COMPUTER CABLES, MODEM, DISC DRIVES, BUFFERS, CENTRAL PROCESSING UNITS, MICE, COMPUTER HUBS, SWITCHES AND ROUTERS (U.S. CLS. 21, 23, 26, 36 AND 38).

CLASS 37—CONSTRUCTION AND REPAIR

FOR INSTALLATION, REPAIR AND MAINTENANCE OF COMPUTER HARDWARE AND WIRELESS NETWORKS (U.S. CLS. 100, 103 AND 106).

CLASS 42—SCIENTIFIC AND COMPUTER SERVICES

FOR INSTALLATION, REPAIR AND MAINTENANCE OF COMPUTER SOFTWARE (U.S. CLS. 100 AND 101).

JENNY PARK, EXAMINING ATTORNEY

SN 77-113,115. PARK NICOLLET HEALTH SERVICES, SAINT LOUIS PARK, MN. FILED 2-22-2007.

PARK NICOLLET HEALTHSOURCE

THE MARK CONSISTS OF STANDARD CHARACTERS WITHOUT CLAIM TO ANY PARTICULAR FONT, STYLE, SIZE, OR COLOR.

OWNER OF U.S. REG. NOS. 2,001,823, 2,847,987 AND OTHERS.

CLASS 16—PAPER GOODS AND PRINTED MATTER

FOR PRINTED MATERIALS, NAMELY, BROCHURES, PAMPHLETS AND QUESTIONNAIRES IN THE FIELD OF HEALTH, FITNESS AND WELLNESS EVALUATIONS; CATALOGS REGARDING CLASSES, SEMINARS AND WORKSHOPS AVAILABLE TO EMPLOYERS FOR PROVIDING HEALTH, FITNESS AND WELLNESS PROGRAMS TO EMPLOYEES (U.S. CLS. 2, 5, 22, 23, 29, 37, 38 AND 50).

FIRST USE 0-0-1995; IN COMMERCE 0-0-1995.

CLASS 35—ADVERTISING AND BUSINESS

FOR BUSINESS CONSULTING SERVICES IN THE FIELD OF CUSTOMIZING AND ADMINISTERING OF HEALTH, FITNESS AND WELLNESS PROGRAMS FOR EMPLOYERS FOR THE PURPOSE OF PROMOTING BETTER HEALTH FOR EMPLOYEES THROUGH THESE PROGRAMS (U.S. CLS. 100, 101 AND 102).

FIRST USE 0-0-1995; IN COMMERCE 0-0-1995.

CLASS 36—INSURANCE AND FINANCIAL

FOR ORGANIZING AND ADMINISTERING HEALTH, FITNESS AND WELLNESS PROGRAMS FOR EMPLOYEES PRE-PAID FOR BY EMPLOYERS (U.S. CLS. 100, 101 AND 102).

FIRST USE 0-0-1995; IN COMMERCE 0-0-1995.

JENNY PARK, EXAMINING ATTORNEY

SN 77-113,290. FOOT LEVELERS, INC., ROANOKE, VA. FILED 2-22-2007.



OWNER OF U.S. REG. NOS. 805,279 AND 2,807,647.

NO CLAIM IS MADE TO THE EXCLUSIVE RIGHT TO USE "FOOT", APART FROM THE MARK AS SHOWN.

THE COLOR(S) WHITE, LIGHT BLUE, MEDIUM BLUE, ROYAL BLUE IS/ARE CLAIMED AS A FEATURE OF THE MARK.

THE MARK CONSISTS OF A WHITE SIDE VIEW OF A HUMAN FOOT OUTLINED IN ROYAL BLUE SHOWN STANDING ON A SURFACE COLORED ROYAL BLUE WITH A LIGHT BLUE SURFACE UNDERNEATH; WHITE RAYS EXTEND OUTWARDLY FROM THE FOOT AND ARE SHADOWED IN A RAINBOW SHAPE IN MEDIUM AND LIGHT BLUE. THE BORDER IS RAINBOW-SHAPED COLORED ROYAL BLUE AND IS FLAT AT THE BOTTOM; A RECTANGULAR-SHAPED STRIP IS SHOWN UNDERNEATH IN ROYAL BLUE ENCLOSING THE WORDS "FOOT LEVELERS" IN WHITE.

CLASS 16—PAPER GOODS AND PRINTED MATTER

FOR PRINTED MATERIALS, NAMELY, BROCHURES, PAMPHLETS, EDUCATIONAL MAGAZINES, STATIONERY, BUSINESS CARDS; PENS AND PENCILS (U.S. CLS. 2, 5, 22, 23, 29, 37, 38 AND 50).

CLASS 35—ADVERTISING AND BUSINESS

FOR ON-LINE RETAIL AND WHOLESALE STORE SERVICES FEATURING ORTHOTICS AND OTHER HEALTHCARE PRODUCTS; HEALTH CARE REFERRAL SERVICES (U.S. CLS. 100, 101 AND 102).

CLASS 41—EDUCATION AND ENTERTAINMENT

FOR EDUCATIONAL SERVICES, NAMELY, CONDUCTING LECTURES IN SEMINARS IN THE FIELD OF HEALTHCARE ON SETTING AND MEETING GOALS, OFFICE MANAGEMENT, RELATIONSHIPS WITH PATIENTS AND FINANCIAL MANAGEMENT (U.S. CLS. 100, 101 AND 107).

SN 77-114,488. ALLCARE OF ARKANSAS, JONESBORO, AR. FILED 2-23-2007.



Helping Seniors Stay Independent

CLASS 44—MEDICAL, BEAUTY AND AGRICULTURAL SERVICES

FOR MEDICAL SERVICES, NAMELY, PHYSICAL EXAMINATIONS PROVIDED BY A PRIMARY CARE DOCTOR; HEALTHCARE INFORMATION SERVICES TO HEALTH CARE PROFESSIONALS AND TO THE GENERAL PUBLIC, HEALTH CARE INFORMATION SERVICES TO PROFESSIONALS AND THE GENERAL PUBLIC (U.S. CLS. 100 AND 101).

JOHN DALIER, EXAMINING ATTORNEY

NO CLAIM IS MADE TO THE EXCLUSIVE RIGHT TO USE "HEALTHCARE", APART FROM THE MARK AS SHOWN.

THE MARK CONSISTS OF , IN PART, LINES FORMING A GENERALLY CIRCULAR SHAPE AROUND THE WORDS "TOTAL LIFE HEALTHCARE".

CLASS 36—INSURANCE AND FINANCIAL

FOR ALL-INCLUSIVE HEALTH CARE SERVICES FOR THE FRAIL AND ELDERLY, NAMELY, ADMINISTRATION OF HEALTH PLANS; COORDINATING THE PROVIDING OF HEALTH CARE SERVICES AND PROGRAMS TO THE FRAIL AND ELDERLY, NAMELY, COORDINATING AND PROVIDING HEALTH CARE PLANS TO THE FRAIL AND ELDERLY FOR ACUTE AND LONG-TERM CARE AND SERVICES (U.S. CLS. 100, 101 AND 102).

SN 77-114,043. JUNXION, INC., SEATTLE, WA. FILED 2-22-2007.

FIELD COMMANDER

THE MARK CONSISTS OF STANDARD CHARACTERS WITHOUT CLAIM TO ANY PARTICULAR FONT, STYLE, SIZE, OR COLOR.

CLASS 44—MEDICAL, BEAUTY AND AGRICULTURAL SERVICES

FOR ALL-INCLUSIVE HEALTH CARE SERVICES FOR THE FRAIL AND ELDERLY, NAMELY, HEALTH CARE PROVIDING TO THE FRAIL AND ELDERLY HEALTH CARE AND MEDICAL SERVICES USING PRIMARILY COMMUNITY-BASED SERVICES (U.S. CLS. 100 AND 101).

HANNO RITTNER, EXAMINING ATTORNEY

SN 77-114,706. INTERSECTIONS INC., CHANTILLY, VA. FILED 2-23-2007.

PREPARED, PROTECTED, PORTABLE.

CLASS 9—ELECTRICAL AND SCIENTIFIC APPARATUS

FOR COMPUTER SOFTWARE FOR ACCESS TO AND MANAGEMENT OF ONE OR MORE REMOTE COMMUNICATIONS AND NETWORK DEVICES (U.S. CLS. 21, 23, 26, 36 AND 38).

THE MARK CONSISTS OF STANDARD CHARACTERS WITHOUT CLAIM TO ANY PARTICULAR FONT, STYLE, SIZE, OR COLOR.

CLASS 38—COMMUNICATION

FOR TELECOMMUNICATION SERVICES, NAMELY, PROVISION OF ACCESS TO AND MANAGEMENT OF ONE OR MORE REMOTE COMMUNICATIONS AND NETWORK DEVICES (U.S. CLS. 100, 101 AND 104).

CLASS 9—ELECTRICAL AND SCIENTIFIC APPARATUS

FOR ENCODED SMART CARDS CONTAINING PROGRAMMING USED TO STORE PERSONAL INFORMATION (U.S. CLS. 21, 23, 26, 36 AND 38).

CLASS 42—SCIENTIFIC AND COMPUTER SERVICES

FOR PROVIDING USERS OF TELECOMMUNICATION NETWORKING EQUIPMENT WITH TEMPORARY USE OF NON-DOWNLOADABLE SOFTWARE WITH WHICH A USER CAN MONITOR, CONFIGURE AND UPDATE ONE OR MORE REMOTE COMMUNICATIONS AND NETWORK DEVICES (U.S. CLS. 100 AND 101).

BARNEY CHARLON, EXAMINING ATTORNEY

CLASS 35—ADVERTISING AND BUSINESS

FOR CREDIT CARD REGISTRATION SERVICES (U.S. CLS. 100, 101 AND 102).

CLASS 36—INSURANCE AND FINANCIAL

FOR CREDIT CARD CANCELLATION AND NOTIFICATION SERVICES FOR LOST OR STOLEN CREDIT CARDS; PROVIDING IDENTITY THEFT INSURANCE UNDERWRITTEN BY OTHERS (U.S. CLS. 100, 101 AND 102).

SN 77-114,985. KEEP IT CLEAN, LLC, MOUNT PLEASANT, SC. FILED 2-23-2007.

CLASS 39—TRANSPORTATION AND STORAGE

FOR PROVIDING ONLINE SECURE ELECTRONIC STORAGE AND RETRIEVAL OF DIGITAL CONTENT, MEDIA AND IMAGES, NAMELY, PASSWORDS, PINS, ACCOUNT NUMBERS, MEDICAL RECORDS AND PRESCRIPTIONS, IMPORTANT DOCUMENTS, EMERGENCY CONTACT, DIGITAL PHOTOGRAPHS AND DIARIES FOR OTHERS (U.S. CLS. 100 AND 105).

KEEP IT CLEAN

THE MARK CONSISTS OF STANDARD CHARACTERS WITHOUT CLAIM TO ANY PARTICULAR FONT, STYLE, SIZE, OR COLOR.

CLASS 45—PERSONAL AND LEGAL SERVICES

FOR IDENTITY THEFT AND FRAUD PROTECTION SERVICES, NAMELY, PERSONAL INFORMATION AND FINANCIAL IDENTITY MONITORING; FRAUD RESOLUTION ASSISTANCE, NAMELY, PROVIDING ADVICE AND CONSULTATION IN THE FIELD OF IDENTITY THEFT; INTERNET SURVEILLANCE OF FINANCIAL AND PERSONAL INFORMATION (U.S. CLS. 100 AND 101).

CLASS 16—PAPER GOODS AND PRINTED MATTER

FOR SAFETY WINDOW STICKERS TO ALERT EMERGENCY PERSONNEL OF PETS INSIDE (U.S. CLS. 2, 5, 22, 23, 29, 37, 38 AND 50).

ALLISON SCHRODY, EXAMINING ATTORNEY

CLASS 21—HOUSEWARES AND GLASS

FOR DENTAL CARE KITS FOR PETS, NAMELY, A KIT CONTAINING TOOTHBRUSHES AND TOOTH-PASTES (U.S. CLS. 2, 13, 23, 29, 30, 33, 40 AND 50).
ARETHA SOMERVILLE, EXAMINING ATTORNEY

SN 77-114,847. PRICEWATERHOUSECOOPERS LLP, NEW YORK, NY. FILED 2-23-2007.

SN 77-115,430. UNIVERSAL COIN & BULLION, LTD., BEAUMONT, TX. FILED 2-24-2007.

CFODIRECT

1ST CAPITAL RESERVE

THE MARK CONSISTS OF STANDARD CHARACTERS WITHOUT CLAIM TO ANY PARTICULAR FONT, STYLE, SIZE, OR COLOR.

OWNER OF U.S. REG. NO. 2,458,050.

THE MARK CONSISTS OF STANDARD CHARACTERS WITHOUT CLAIM TO ANY PARTICULAR FONT, STYLE, SIZE, OR COLOR.

NO CLAIM IS MADE TO THE EXCLUSIVE RIGHT TO USE "CAPITAL", APART FROM THE MARK AS SHOWN.

CLASS 35—ADVERTISING AND BUSINESS

FOR PROVIDING INFORMATION IN THE FIELD OF BUSINESS DIRECTED AT CHIEF FINANCIAL OFFICERS OF ORGANIZATIONS VIA A GLOBAL COMPUTER NETWORK (U.S. CLS. 100, 101 AND 102).
FIRST USE 1-15-1999; IN COMMERCE 1-1-2000.

CLASS 35—ADVERTISING AND BUSINESS

FOR RETAIL STORES FEATURING COLLECTIBLE COINS (U.S. CLS. 100, 101 AND 102).
FIRST USE 6-1-2003; IN COMMERCE 6-1-2003.

CLASS 36—INSURANCE AND FINANCIAL

FOR PROVIDING INFORMATION IN THE FIELD OF FINANCE DIRECTED AT CHIEF FINANCIAL OFFICERS OF ORGANIZATIONS VIA A GLOBAL COMPUTER NETWORK (U.S. CLS. 100, 101 AND 102).
FIRST USE 1-15-1999; IN COMMERCE 1-1-2000.
PAUL E. FAHRENKOPF, EXAMINING ATTORNEY

CLASS 36—INSURANCE AND FINANCIAL

FOR COIN APPRAISAL, BROKERAGE IN THE FIELD OF COLLECTIBLE COINS, CONSULTATION RELATING TO APPRAISAL OF COINS, AND PROVIDING A WEBSITE THAT FEATURES INFORMATION ON INVESTING IN COINS (U.S. CLS. 100, 101 AND 102).
FIRST USE 6-1-2003; IN COMMERCE 6-1-2003.
STEPHEN AQUILA, EXAMINING ATTORNEY

SN 77-115,432. UNIVERSAL COIN & BULLION, LTD.,
BEAUMONT, TX. FILED 2-24-2007.

UNIVERSAL COIN & BULLION

THE MARK CONSISTS OF STANDARD CHARACTERS WITHOUT CLAIM TO ANY PARTICULAR FONT, STYLE, SIZE, OR COLOR.

NO CLAIM IS MADE TO THE EXCLUSIVE RIGHT TO USE "COIN & BULLION", APART FROM THE MARK AS SHOWN.

CLASS 35—ADVERTISING AND BUSINESS

FOR RETAIL STORES FEATURING COLLECTIBLE COINS (U.S. CLS. 100, 101 AND 102).

FIRST USE 12-31-1994; IN COMMERCE 12-31-1994.

CLASS 36—INSURANCE AND FINANCIAL

FOR COIN APPRAISAL, BROKERAGE IN THE FIELD OF COLLECTIBLE COINS, CONSULTATION RELATING TO APPRAISAL OF COINS, AND PROVIDING A WEBSITE THAT FEATURES INFORMATION ON INVESTING IN COINS (U.S. CLS. 100, 101 AND 102).

FIRST USE 12-31-1994; IN COMMERCE 12-31-1994.

STEPHEN AQUILA, EXAMINING ATTORNEY

SN 77-115,935. PROFESSIONAL DIAGNOSTICS & SAFETY,
INC., NAPPANEE, IN. FILED 2-26-2007.

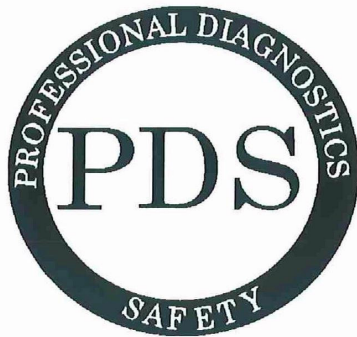

NO CLAIM IS MADE TO THE EXCLUSIVE RIGHT TO USE "PROFESSIONAL DIAGNOSTICS" OR "SAFETY", APART FROM THE MARK AS SHOWN.

CLASS 41—EDUCATION AND ENTERTAINMENT

FOR PROMOTING A SAFE, SECURE, AND DRUG FREE WORK PLACE, NAMELY, PROVIDING TRAINING ON SAFETY IN THE WORKPLACE (U.S. CLS. 100, 101 AND 107).

FIRST USE 8-1-2006; IN COMMERCE 8-14-2006.

CLASS 44—MEDICAL, BEAUTY AND AGRICULTURAL SERVICES

FOR MEDICAL SERVICES THAT PROMOTE A SAFE, SECURE AND DRUG FREE WORK PLACE, NAMELY, PRE AND POST EMPLOYMENT DRUG SCREENING (U.S. CLS. 100 AND 101).

FIRST USE 8-1-2006; IN COMMERCE 8-14-2006.

CLASS 45—PERSONAL AND LEGAL SERVICES

FOR PROMOTING A SAFE, SECURE AND DRUG FREE WORK PLACE, NAMELY, PRE-EMPLOYMENT BACKGROUND SCREENING (U.S. CLS. 100 AND 101).

FIRST USE 8-1-2006; IN COMMERCE 8-14-2006.

BRIAN PINO, EXAMINING ATTORNEY

SN 77-116,188. SAP AG, WALLDORF, FED REP GERMANY,
FILED 2-26-2007.

CLICK-TO-ADAPT

THE MARK CONSISTS OF STANDARD CHARACTERS WITHOUT CLAIM TO ANY PARTICULAR FONT, STYLE, SIZE, OR COLOR.

CLASS 9—ELECTRICAL AND SCIENTIFIC APPARATUS

FOR COMPUTER SOFTWARE, DOWNLOADABLE COMPUTER SOFTWARE, AND ONLINE NON-DOWNLOADABLE SOFTWARE, USED TO PERFORM BUSINESS OPERATIONS AND GENERAL OFFICE FUNCTIONS, NAMELY, DOCUMENT AUTHORING, STORAGE, RETRIEVAL, VERSION HISTORY TRACKING, PROFILING, ACCESS CONTROL, AND SECURITY, MANAGING ELECTRONIC MAIL, CALENDAR AND SCHEDULING, DESKTOP PUBLISHING, IMAGE EDITING, GRAPHICS CREATION AND EDITING, DRAWING, COMPUTER AIDED DESIGN AND DRAFTING, CREATION OF MULTIMEDIA PRESENTATIONS, PROJECT MANAGEMENT, CUSTOMER MANAGEMENT, BUSINESS PLANNING, BUSINESS CONSOLIDATION, RISK MANAGEMENT, QUALITY MANAGEMENT, PROJECT MANAGEMENT, STAKE HOLDER AND SHAREHOLDER RELATIONSHIP MANAGEMENT, SIMULATION AND ENTERPRISE BUSINESS MANAGEMENT, BUSINESS FINANCIAL MANAGEMENT AND DIRECT MAIL MANAGEMENT, PRODUCTION AND MATERIALS MANAGEMENT, ACCOUNTING AND FINANCE, QUALITY MANAGEMENT AND PLANT MAINTENANCE, MARKETING AND SALES, AND PERSONNEL AND PROJECT MANAGEMENT, PLATFORM FOR SOFTWARE INTEGRATION IN THE FIELD OF BUSINESS MANAGEMENT, GRAPHICAL USER INTERFACE, COMPUTER GRAPHICS, DATABASE MANAGEMENT, APPLICATION AND DATABASE INTEGRATION, EDITING, ORGANIZING, MODIFYING, BOOK MARKING, TRANSMISSION, STORAGE, AND SHARING OF DATA AND INFORMATION, CUSTOMER RELATIONSHIP MANAGEMENT, DATABASE MANAGEMENT, FACILITIES MANAGEMENT, BUSINESS PROCESS INTEGRATION, RESOURCE MANAGEMENT, ADAPTIVE MANUFACTURING, OBJECT MODELING, APPLICATION DEVELOPMENT, PREDICTIVE MAINTENANCE, PERSONNEL AND RESOURCE MANAGEMENT, DEVICE INTEGRATION, SUPPLY CHAIN MANAGEMENT, RESEARCH AND DEVELOPMENT; COMMUNICATIONS SOFTWARE FOR CONNECTING GLOBAL COMPUTER NETWORKS; COMPUTER SOFTWARE FOR CREATING SEARCHABLE DATABASES OF INFORMATION AND DATA; COMPUTER SOFTWARE FOR THE COLLECTION, EDITING, ORGANIZING, MODIFYING, BOOK MARKING, TRANSMISSION, STORAGE AND SHARING OF DATA AND INFORMATION; COMPUTER SOFTWARE FOR ADMINISTRATION OF COMPUTER LOCAL AREA NETWORKS; COMPUTER SOFTWARE FOR CONTROLLING AND MANAGING ACCESS SERVER APPLICATIONS; COMPUTER SOFTWARE FOR ENCRYPTION; COMPUTER SOFTWARE THAT PROVIDES REAL-TIME, INTEGRATED BUSINESS MANAGEMENT INTELLIGENCE BY COMBINING INFORMATION FROM VARIOUS DATABASES AND PRESENTING IT IN AN EASY-TO-UNDERSTAND USER INTERFACE; COMPUTER

SOFTWARE TO ENHANCE THE AUDIO-VISUAL CAPABILITIES OF MULTIMEDIA APPLICATIONS, NAMELY, FOR THE INTEGRATION OF TEXT, AUDIO, GRAPHICS, STILL IMAGES AND MOVING PICTURES; COMPUTER SOFTWARE, NAMELY, SOFTWARE DEVELOPMENT TOOLS FOR THE CREATION OF MOBILE INTERNET APPLICATIONS AND CLIENT INTERFACES; ENTERPRISE SOFTWARE IN THE NATURE OF A DATABASE FOR NON-TRANSACTIONAL DATA AND A SEARCH ENGINE FOR DATABASE CONTENT; FACILITIES MANAGEMENT SOFTWARE, NAMELY, SOFTWARE TO CONTROL BUILDING ENVIRONMENTAL, ACCESS AND SECURITY SYSTEMS (U.S. CLS. 21, 23, 26, 36 AND 38).

CLASS 16—PAPER GOODS AND PRINTED MATTER

FOR PRINTED MATERIALS, NAMELY, CATALOGS, MANUALS, AND OPERATING INSTRUCTIONS, FEATURING INFORMATION ON THE OPERATION OF COMPUTER SOFTWARE (U.S. CLS. 2, 5, 22, 23, 29, 38 AND 50).

CLASS 38—COMMUNICATION

FOR COMMUNICATION SERVICES, NAMELY, ELECTRONIC TRANSMISSION OF DATA AND DOCUMENTS AMONG USERS OF COMPUTERS; PROVIDING PRIVATE AND SECURE REAL TIME ELECTRONIC COMMUNICATION OVER A COMPUTER NETWORK (U.S. CLS. 100, 101 AND 104).

CLASS 41—EDUCATION AND ENTERTAINMENT

FOR EDUCATIONAL SERVICES, NAMELY, TRAINING IN THE CREATION, DEVELOPMENT, USE, AND APPLICATION OF COMPUTER SOFTWARE AND ELECTRONIC DATA PROCESSING (U.S. CLS. 100, 101 AND 107).

CLASS 42—SCIENTIFIC AND COMPUTER SERVICES

FOR CONSULTING SERVICES IN THE FIELDS OF DESIGN, SELECTION, CREATION, DEVELOPMENT, IMPLEMENTATION, AND USE OF COMPUTER HARDWARE AND SOFTWARE SYSTEMS FOR OTHERS; RESEARCH IN THE AREA OF COMPUTER PROGRAMS AND SOFTWARE; MAINTENANCE OF COMPUTER SOFTWARE; UPDATING OF COMPUTER SOFTWARE FOR OTHERS; RENTAL OF COMPUTER SOFTWARE; COMPUTER SERVICES, NAMELY, HOSTING ON-LINE WEB FACILITIES FOR OTHERS FOR ORGANIZING AND CONDUCTING ONLINE MEETINGS, GATHERINGS, AND INTERACTIVE DISCUSSIONS; COMPUTER SOFTWARE CONSULTATION (U.S. CLS. 100 AND 101).
DAVID COLLIER, EXAMINING ATTORNEY

SN 77-116,557. YAMAHA MOTOR CORPORATION, U.S.A., CYPRESS, CA. FILED 2-26-2007.

ARE YOU TRUE BLUE?

THE MARK CONSISTS OF STANDARD CHARACTERS WITHOUT CLAIM TO ANY PARTICULAR FONT, STYLE, SIZE, OR COLOR.

CLASS 7—MACHINERY

FOR OUTBOARD MOTORS FOR BOATS (U.S. CLS. 13, 19, 21, 23, 31, 34 AND 35).

CLASS 12—VEHICLES

FOR PERSONAL RECREATIONAL VEHICLES, NAMELY, MOTORIZED GOLF CARTS, MOTORCYCLES, MOTOR SCOOTERS, SNOWMOBILES, AND ALL-TERRAIN VEHICLES INCLUDING OFF ROAD LIGHT UTILITY VEHICLES AND OFF ROAD SIDE BY SIDE VEHICLES, AND STRUCTURAL PARTS FOR ALL OF THE ABOVE (U.S. CLS. 19, 21, 23, 31, 35 AND 44).
CHRISTINE COOPER, EXAMINING ATTORNEY

SN 77-116,745. RKD PREMIUM PRODUCTS, INC., CLACKAMAS, OR. FILED 2-26-2007.

Healthwise

THE MARK CONSISTS OF THE WORD "HEALTHWISE" SET ON A RECTANGULAR BACKGROUND FIELD.

CLASS 20—FURNITURE AND ARTICLES NOT OTHERWISE CLASSIFIED

FOR MATTRESSES, MATTRESS TOPPERS, BED FRAMES (U.S. CLS. 2, 13, 22, 25, 32 AND 50).

CLASS 24—FABRICS

FOR MATTRESS COVERS, MATTRESS PADS, AND BEDDING, NAMELY, BED LINENS AND BED COVERS (U.S. CLS. 42 AND 50).
JOHN E. MICHOS, EXAMINING ATTORNEY

SN 77-117,206. CHOPPER INSTITUTE OF AMERICA, LLC, CLARKSTON, MI. FILED 2-27-2007.



THE MARK CONSISTS OF A CHOPPER DESIGN FORMED BY THE WORDING "CIA."

CLASS 16—PAPER GOODS AND PRINTED MATTER

FOR PAPER GOODS, NAMELY, PRINTED INSTRUCTIONAL MATERIALS FEATURING CHOPPERS AND CHOPPER CONSTRUCTION (U.S. CLS. 2, 5, 22, 23, 29, 37, 38 AND 50).

FIRST USE 1-31-2007; IN COMMERCE 1-31-2007.

CLASS 21—HOUSEWARES AND GLASS

FOR HOUSEWARES AND GLASS, NAMELY, SHOT GLASSES, DRINKING GLASSES, AND MUGS (U.S. CLS. 2, 13, 23, 29, 30, 33, 40 AND 50).

FIRST USE 1-31-2007; IN COMMERCE 1-31-2007.

CLASS 25—CLOTHING

FOR CLOTHING, NAMELY, T-SHIRTS, SWEAT-SHIRTS, HATS, CAPS, BANDANAS AND LEATHER CLOTHING, NAMELY, LEATHER JACKETS, LEATHER PANTS, LEATHER HEADWEAR, LEATHER VESTS, LEATHER BELTS AND LEATHER CHAPS (U.S. CLS. 22 AND 39).

FIRST USE 1-31-2007; IN COMMERCE 1-31-2007.

CLASS 41—EDUCATION AND ENTERTAINMENT

FOR EDUCATIONAL SERVICES, NAMELY, CONDUCTING CLASSES, SEMINARS, CONFERENCES, AND WORKSHOPS IN THE FIELD OF CHOPPER BUILDING AND CONSTRUCTION, AND DISTRIBUTION OF COURSE MATERIALS IN CONNECTION THEREWITH; TRAINING IN THE USE AND OPERATION OF CHOPPERS (U.S. CLS. 100, 101 AND 107).

FIRST USE 1-31-2007; IN COMMERCE 1-31-2007.

MARCIE MILONE, EXAMINING ATTORNEY

SN 77-117,494. GUITAR CENTER, INC., WEST LAKE VILLAGE, CA. FILED 2-27-2007.

RAVEN

THE MARK CONSISTS OF STANDARD CHARACTERS WITHOUT CLAIM TO ANY PARTICULAR FONT, STYLE, SIZE, OR COLOR.

CLASS 9—ELECTRICAL AND SCIENTIFIC APPARATUS

FOR CARRYING BAGS, CARRYING CASES AND COVERS FOR DEEJAY AUDIO-VISUAL AND SPECIAL EFFECTS EQUIPMENT; SOUND REINFORCEMENT AND RECORDING EQUIPMENT, NAMELY, AUDIO TAPE RECORDERS, AMPLIFIERS, PUBLIC ADDRESS SYSTEMS, DIGITAL SOUND BOARDS FOR AMPLIFIERS; RACK EQUIPMENT, NAMELY, RACKS FOR LOUDSPEAKERS AND AMPLIFIERS, AUDIO EXTENSION CORDS FOR USE WITH SOUND AMPLIFIERS, ELECTRONIC EFFECTS PEDALS FOR USE WITH SOUNDS AMPLIFIERS, SIGNAL PROCESSORS, STANDS FOR MICROPHONES, MICROPHONES; PORTABLE DIGITAL MEDIA PLAYERS; DRUM HARDWARE AND ACCESSORIES, NAMELY, DRUM AMPLIFIERS (U.S. CLS. 21, 23, 26, 36 AND 38).

CLASS 15—MUSICAL INSTRUMENTS

FOR PERCUSSION INSTRUMENTS AND PARTS AND ACCESSORIES THEREFOR, NAMELY, ELECTRONIC DRUMS, ACOUSTIC DRUMS AND STRUCTURAL PARTS THEREFOR, CYMBALS, CYMBAL STANDS, DRUM STANDS, SNARE WIRES FOR USE WITH SNARE DRUMS, DRUM STICKS AND SOUND EFFECT PEDALS FOR DRUMS; CARRYING BAGS, CARRYING CASES AND COVERS FOR RACKS AND STANDS FOR MUSICAL INSTRUMENTS; MUSICAL INSTRUMENTS NAMELY, ACOUSTIC AND ELECTRIC GUITARS, BRASS AND WOODWIND INSTRUMENTS AND ALL PERCUSSION INSTRUMENTS, NAMELY, DRUM KITS CONSISTING OF DRUMS AND DRUMSTICKS, AND HAND AND ETHNIC PERCUSSION INSTRUMENTS; BACKPACKS SPECIALLY DESIGNED FOR MUSICAL INSTRUMENTS (U.S. CLS. 2, 21 AND 36).

DAWN HAN, EXAMINING ATTORNEY

SN 77-117,683. DAVID BROWN ENGINEERING LIMITED, HUDDERSFIELD, ENGLAND, FILED 2-27-2007.

SWIFT

THE MARK CONSISTS OF STANDARD CHARACTERS WITHOUT CLAIM TO ANY PARTICULAR FONT, STYLE, SIZE, OR COLOR.

CLASS 7—MACHINERY

FOR POWER TRANSMISSIONS AND GEARING FOR MACHINES; GEARS AND ENCLOSED DRIVERS FOR INDUSTRIAL MACHINES; MECHANICAL AND FLUID COUPLINGS, NAMELY, COUPLINGS FOR MACHINES; MECHANICAL ACTUATORS; ELECTRIC MOTORS; STRUCTURAL PARTS THEREFOR (U.S. CLS. 13, 19, 21, 23, 31, 34 AND 35).

CLASS 9—ELECTRICAL AND SCIENTIFIC APPARATUS

FOR ELECTRONIC AND ELECTRICAL EQUIPMENT FOR THE CONTROL OF MACHINERY, NAMELY, ELECTRONIC CONTROLS FOR MOTORS, ELECTRONIC CONTROL SYSTEMS FOR MACHINES; STRUCTURAL PARTS THEREFOR (U.S. CLS. 21, 23, 26, 36 AND 38).

CLASS 37—CONSTRUCTION AND REPAIR

FOR MAINTENANCE, INSTALLATION, RECONDITIONING AND REPAIR OF MACHINERY AND POWER TRANSMISSION SYSTEMS, NAMELY, GEARS, GEAR BOXES, MECHANICAL AND FLUID COUPLINGS, ELECTRIC MOTORS AND PARTS THEREOF (U.S. CLS. 100, 103 AND 106).

CLASS 40—MATERIAL TREATMENT

FOR CUSTOM MANUFACTURING OF POWER TRANSMISSION SYSTEMS, HYDRAULIC EQUIPMENT, GEARS, TRANSMISSIONS, POWER TRANSMISSIONS AND PARTS THEREOF (U.S. CLS. 100, 103 AND 106).

DORITT L. CARROLL, EXAMINING ATTORNEY

SN 77-117,696. ADAMPLUSEVE, INC., NEW YORK, NY. FILED 2-27-2007.

ADAM ADAM LIPPES

THE MARK CONSISTS OF STANDARD CHARACTERS WITHOUT CLAIM TO ANY PARTICULAR FONT, STYLE, SIZE, OR COLOR.

THE NAME IN THE MARK IDENTIFIES A LIVING INDIVIDUAL, WHOSE CONSENT TO REGISTER HIS NAME AS A TRADEMARK IS OF RECORD.

CLASS 3—COSMETICS AND CLEANING PREPARATIONS

FOR PERFUME, COLOGNE, EAU DE TOILETTE, BODY LOTION, BODY OIL, BODY SPRAYS, BODY POWDERS (U.S. CLS. 1, 4, 6, 50, 51 AND 52).

CLASS 9—ELECTRICAL AND SCIENTIFIC APPARATUS

FOR SUNGLASSES (U.S. CLS. 21, 23, 26, 36 AND 38).

CLASS 18—LEATHER GOODS

FOR WALLETS, HANDBAGS, COIN PURSES, KEY CASES, LEATHER KEY CHAINS (U.S. CLS. 1, 2, 3, 22 AND 41).

CLASS 24—FABRICS

FOR BED BLANKETS, BED SHEETS, PILLOW CASES, COMFORTERS, DUVET COVERS, TOWELS, SHOWER CURTAINS, TABLE CLOTHS NOT OF PAPER, CLOTH NAPKINS AND PLACEMATS (U.S. CLS. 42 AND 50).

CLASS 25—CLOTHING

FOR SHIRTS, SWEATERS, SWEATSHIRTS, DRESSES, COATS, PANTS, SKIRTS, VESTS, JACKETS, TOPS, SWIMWEAR, FUR COATS, FUR JACKETS, FUR VESTS, FUR HATS, FUR SCARVES, SHORTS, UNDERWEAR, SHOES, SCARVES, BATHROBES, BELTS (U.S. CLS. 22 AND 39).

EDWARD NELSON, EXAMINING ATTORNEY

SN 77-117,745. THE GENERATIONS NETWORK, INC., PROVO, UT. FILED 2-27-2007.



NO CLAIM IS MADE TO THE EXCLUSIVE RIGHT TO USE NETWORK, APART FROM THE MARK AS SHOWN.

THE MARK CONSISTS OF A STYLIZED LOWERCASE LETTER "G", WITH THE UPPER CIRCULAR SECTION OF THE "G" IN A SHAPE SIMILAR TO ONE-HALF OF A PAIR OF READING GLASSES, AND THE LOWER CIRCULAR PART OF THE "G" IN THE SHAPE OF A LEAF, ADJACENT TO THE WORDS "THE GENERATIONS NETWORK" IN STYLIZED FONTS.

CLASS 9—ELECTRICAL AND SCIENTIFIC APPARATUS

FOR COMPUTER SOFTWARE FOR TRACING THE DESCENT OF INDIVIDUALS OR FAMILIES AND INSTRUCTIONAL MANUALS SUPPLIED AND SOLD THEREWITH AS A UNIT AND SOFTWARE FEATURES CONNECTED THERETO; COMPUTER SOFTWARE FOR MANAGING, RECORDING AND GRAPHICALLY DEPICTING GENEALOGICAL HISTORICAL DATA AND INSTRUCTIONAL MANUALS SUPPLIED AND SOLD THEREWITH AS A UNIT AND SOFTWARE FEATURES CONNECTED THERETO; COMPUTER SOFTWARE FOR CREATING GENEALOGY DATABASES AND INSTRUCTIONAL MANUALS SUPPLIED AND SOLD THEREWITH AS A UNIT AND SOFTWARE FEATURES CONNECTED THERETO; COMPUTER SOFTWARE FOR USE IN CREATING, DISPLAYING, SHARING AND STORING MULTIMEDIA PRESENTATIONS THAT INCLUDE PHOTOGRAPHS AND SOUND; COMPUTER SOFTWARE FOR APPLICATION AND DATABASE INTEGRATION FOR USE IN SEARCHABLE DATABASES AND INFORMATION STORAGE, MANIPULATION AND RETRIEVAL OF AUDIO FAMILY HISTORIES, AUDIO NOTES ATTACHED TO FAMILY TREES AND OTHER DATABASE ELEMENTS AND AUDIO NARRATIONS OF PHOTO STORIES, TIMELINES AND PERSONAL MEMORIALS (U.S. CLS. 21, 23, 26, 36 AND 38).

CLASS 35—ADVERTISING AND BUSINESS

FOR DISTRIBUTORSHIP, ONLINE RETAIL STORE, AND MAIL ORDER SERVICES IN THE FIELD OF GENEALOGY PUBLICATIONS AND COMPUTER HARDWARE AND SOFTWARE (U.S. CLS. 100, 101 AND 102).

FIRST USE 1-7-2007; IN COMMERCE 1-7-2007.

CLASS 38—COMMUNICATION

FOR INTERNET-BASED COMMUNICATION SERVICES, NAMELY, ELECTRONIC TRANSMISSION OF DATA AND DOCUMENTS AMONG USERS OF COMPUTERS, TRANSMITTING STREAMED SOUND AND AUDIO-VISUAL RECORDINGS VIA THE INTERNET, ON-LINE CHAT ROOMS FOR TRANSMISSION OF MESSAGES AMONG COMPUTER USERS CONCERNING GENEALOGY; PROVIDING MULTIPLE-USER ACCESS TO THE GLOBAL COMPUTER INFORMATION NETWORK TO ENABLE USERS TO CREATE AND MAINTAIN THEIR OWN WEBSITES (U.S. CLS. 100, 101 AND 104).

FIRST USE 11-28-2006; IN COMMERCE 11-28-2006.

CLASS 39—TRANSPORTATION AND STORAGE

FOR TRAVEL AGENCY SERVICES, NAMELY, MAKING RESERVATIONS AND BOOKINGS FOR TRANSPORTATION (U.S. CLS. 100 AND 105).

CLASS 42—SCIENTIFIC AND COMPUTER SERVICES

FOR APPLICATION SERVICE PROVIDER (ASP) FEATURING SOFTWARE FOR USE IN CREATING, DISPLAYING, SHARING AND STORING MULTIMEDIA PRESENTATIONS THAT INCLUDE PHOTOGRAPHS AND SOUND; PROVIDING TEMPORARY USE OF NON-DOWNLOADABLE COMPUTER SOFTWARE FOR USE IN CREATING, DISPLAYING, SHARING AND STORING MULTIMEDIA PRESENTATIONS THAT INCLUDE PHOTOGRAPHS AND SOUND; GENEALOGICAL RESEARCH SERVICES, COMPUTER SERVICES, NAMELY, HOSTING AND MAINTAINING AN ONLINE WEBSITE FOR OTHERS TO ENABLE FAMILY GROUPS TO CREATE AND MAINTAIN PERSONALIZED WEBSITES FOR THE PURPOSE OF SHARING INFORMATION REGARDING FAMILY MEMBERS; COMPUTER SERVICES, NAMELY, HOSTING AND MAINTAINING AN ONLINE WEBSITE FOR OTHERS TO ACCESS FAMILY PHOTO ALBUMS AND CALENDARS; PROVIDING FAMILY HISTORY INFORMATION SERVICES, NAMELY, RETRIEVING, RECORDING AND REVIEWING ANCESTRAL DATA VIA THE GLOBAL COMPUTER NETWORK (U.S. CLS. 100 AND 101).

FIRST USE 11-28-2006; IN COMMERCE 11-28-2006.

CLASS 43—HOTEL AND RESTAURANT SERVICES

FOR TRAVEL AGENCY SERVICES, NAMELY, MAKING RESERVATIONS AND BOOKING FOR TEMPORARY LODGING (U.S. CLS. 100 AND 101).

BARBARA RUTLAND, EXAMINING ATTORNEY

SN 77-118,731. ICBA SERVICES NETWORK, INC., WASHINGTON, DC. FILED 2-28-2007.

RIGHT SIZE SOLUTIONS FOR ANY SIZE BANK

THE MARK CONSISTS OF STANDARD CHARACTERS WITHOUT CLAIM TO ANY PARTICULAR FONT, STYLE, SIZE, OR COLOR.

CLASS 35—ADVERTISING AND BUSINESS

FOR MARKET ANALYSIS; BUSINESS MARKETING CONSULTING SERVICES; CONSULTATION IN THE FIELD OF BUSINESS MANAGEMENT OF BANKS FOR OTHERS (U.S. CLS. 100, 101 AND 102).
FIRST USE 1-1-2007; IN COMMERCE 1-1-2007.

CLASS 36—INSURANCE AND FINANCIAL

FOR BANKING SERVICES; DEPOSIT ACQUISITION AND SERVICING, NAMELY, REMOTE DEPOSIT SERVICES FOR CHECKING AND OTHER DEPOSIT ACCOUNTS; LOAN FINANCING AND COMMERCIAL, CONSUMER, AND MORTGAGE LENDING SERVICES; COMMERCIAL LENDING SERVICES FOR RESIDENTIAL AND COMMERCIAL CONSTRUCTION; ISSUING CREDIT CARDS; INVESTMENT BROKERAGE SERVICES; INSURANCE UNDERWRITING SERVICES IN THE FIELDS OF LIFE AND CASUALTY INSURANCE, NAMELY, WHOLE LIFE, TERM LIFE, CREDIT LIFE, DISABILITY AND MORTGAGE REINSURANCE; FINANCIAL MANAGEMENT, NAMELY, MUTUAL FUND MANAGEMENT SERVICES; INVESTMENT BANKING SERVICES; MORTGAGE LENDING; BROKERAGE OF MORTGAGE LOANS (U.S. CLS. 100, 101 AND 102).
FIRST USE 1-1-2007; IN COMMERCE 1-1-2007.
BILL DAWE, EXAMINING ATTORNEY

SN 77-118,992. RITA'S WATER ICE FRANCHISE COMPANY, LLC, BENSALEM, PA. FILED 2-28-2007.



OWNER OF U.S. REG. NOS. 2,614,810, 3,109,750 AND OTHERS.

NO CLAIM IS MADE TO THE EXCLUSIVE RIGHT TO USE "CUSTARD" AND "ICE", APART FROM THE MARK AS SHOWN.

THE COLOR(S) RED, GREEN, WHITE AND BLUE IS/ARE CLAIMED AS A FEATURE OF THE MARK.

THE MARK CONSISTS OF THE WORD "RITA'S" APPEARING IN WHITE ON A GREEN BANNER, WITH THE WORDING "ICE CUSTARD HAPPINESS," IN WHITE, APPEARING BENEATH; ALL OVER A CIRCLE OUTLINE IN BLUE WITH WHITE AND RED VERTICAL STRIPES.

CLASS 30—STAPLE FOODS

FOR FROZEN CONFECTIONS; FLAVORED WATER ICES; FROZEN CUSTARDS (U.S. CL. 46).

CLASS 35—ADVERTISING AND BUSINESS

FOR RETAIL STORE SERVICES FEATURING ITALIAN ICE, FROZEN CUSTARD AND OTHER FROZEN CONFECTIONS, FOR CONSUMPTION ON AND OFF THE PREMISES; RESTAURANT FRANCHISING (U.S. CLS. 100, 101 AND 102).
GRETTA YAO, EXAMINING ATTORNEY

SN 77-119,055. SOUTHWEST PUBLICATIONS, INC., AUSTIN, TX. FILED 2-28-2007.

MARKETMETRIC

THE MARK CONSISTS OF STANDARD CHARACTERS WITHOUT CLAIM TO ANY PARTICULAR FONT, STYLE, SIZE, OR COLOR.

CLASS 35—ADVERTISING AND BUSINESS

FOR ADVERTISING SERVICES, NAMELY, CREATING INTERACTIVE STREAMING MEDIA FOR DISTRIBUTION ON THE INTERNET AND THROUGH BROADCASTING AND DIRECT CHANNELS FOR ADVERTISING PURPOSES AND CREATING FLASH PLAYER MEDIA FOR ADVERTISING PURPOSES (U.S. CLS. 100, 101 AND 102).
FIRST USE 2-1-2000; IN COMMERCE 2-1-2000.

CLASS 42—SCIENTIFIC AND COMPUTER SERVICES

FOR DESIGN AND DEVELOPMENT OF FLASH SOFTWARE PRESENTATIONS (U.S. CLS. 100 AND 101).
FIRST USE 2-1-2000; IN COMMERCE 2-1-2000.
GRETTA YAO, EXAMINING ATTORNEY

SN 77-119,314. NPPL LLC, SANTA BARBARA, CA. FILED 3-1-2007.

NATIONAL PROFESSIONAL PAINTBALL LEAGUE

THE MARK CONSISTS OF STANDARD CHARACTERS WITHOUT CLAIM TO ANY PARTICULAR FONT, STYLE, SIZE, OR COLOR.

OWNER OF U.S. REG. NO. 2,889,717.
NO CLAIM IS MADE TO THE EXCLUSIVE RIGHT TO USE "PAINTBALL", APART FROM THE MARK AS SHOWN.
SEC. 2(F).

CLASS 9—ELECTRICAL AND SCIENTIFIC APPARATUS

FOR DVDS FEATURING PAINTBALL COMPETITION TOURNAMENTS (U.S. CLS. 21, 23, 26, 36 AND 38).
FIRST USE 3-31-2003; IN COMMERCE 3-31-2003.

CLASS 25—CLOTHING

FOR BASEBALL CAPS; HATS; JACKETS; SHIRTS; SHOES; SWEAT PANTS; SWEAT SHIRTS (U.S. CLS. 22 AND 39).

FIRST USE 10-31-2001; IN COMMERCE 10-31-2001.

CLASS 41—EDUCATION AND ENTERTAINMENT

FOR ORGANIZING SPORTING EVENTS, NAMELY, PAINTBALL COMPETITION TOURNAMENTS (U.S. CLS. 100, 101 AND 107).

FIRST USE 3-1-2001; IN COMMERCE 3-1-2001.
CYNTHIA SLOAN, EXAMINING ATTORNEY

SN 77-119,557. IMSAFER, INC., THE WOODLANDS, TX.
FILED 3-1-2007.



OWNER OF U.S. REG. NO. 2,833,125.
THE MARK CONSISTS OF SIX OVERLAPPING SILHOUETTE FIGURES WITH THE WORD "IMSAFER" UNDERNEATH THE FIGURES.

CLASS 9—ELECTRICAL AND SCIENTIFIC APPARATUS

FOR CHILDREN'S EDUCATIONAL SOFTWARE; COMPUTER SOFTWARE FOR THE COLLECTION, EDITING, ORGANIZING, MODIFYING, BOOK MARKING, TRANSMISSION, STORAGE AND SHARING OF DATA AND INFORMATION; COMPUTER SOFTWARE FOR INSTANT MESSAGING AND ELECTRONIC MAIL; SOFTWARE FOR ENSURING THE SECURITY OF ELECTRONIC MAIL (U.S. CLS. 21, 23, 26, 36 AND 38).

FIRST USE 6-29-2006; IN COMMERCE 6-29-2006.

CLASS 41—EDUCATION AND ENTERTAINMENT

FOR EDUCATIONAL SERVICES, NAMELY, CONDUCTING INFORMAL PROGRAMS IN THE FIELDS OF INSTANT MESSAGING AND ELECTRONIC MAIL, USING ON-LINE ACTIVITIES AND INTERACTIVE EXHIBITS, AND PRINTABLE MATERIALS DISTRIBUTED THEREWITH (U.S. CLS. 100, 101 AND 107).

FIRST USE 6-29-2006; IN COMMERCE 6-29-2006.

CLASS 42—SCIENTIFIC AND COMPUTER SERVICES

FOR COMPUTER CONSULTATION IN THE FIELD OF COMPUTER SECURITY; COMPUTER SECURITY SERVICE, NAMELY, RESTRICTING ACCESS TO AND BY COMPUTER NETWORKS TO AND OF UNDESIRED WEB SITES, MEDIA AND INDIVIDUALS AND FACILITIES (U.S. CLS. 100 AND 101).

FIRST USE 6-29-2006; IN COMMERCE 6-29-2006.

CLASS 45—PERSONAL AND LEGAL SERVICES

FOR MONITORING OF COMPUTER SYSTEMS FOR SECURITY PURPOSES; PERSONAL SECURITY CONSULTATION (U.S. CLS. 100 AND 101).

FIRST USE 6-29-2006; IN COMMERCE 6-29-2006.
ALICE BENMAMAN, EXAMINING ATTORNEY

SN 77-119,558. CORTEC CORPORATION, ST. PAUL, MN.
FILED 3-1-2007.

BIOCORR

THE MARK CONSISTS OF STANDARD CHARACTERS WITHOUT CLAIM TO ANY PARTICULAR FONT, STYLE, SIZE, OR COLOR.

CLASS 3—COSMETICS AND CLEANING PREPARATIONS

FOR DISPOSABLE WIPES IMPREGNATED WITH CLEANSING COMPOUNDS FOR USE ON ITEMS SUBJECT TO CORROSION FOR SIMULTANEOUS REMOVAL OF GREASE, RUST, OIL, AND DUST AND APPLICATION OF A CORROSION INHIBITOR (U.S. CLS. 1, 4, 6, 50, 51 AND 52).

CLASS 17—RUBBER GOODS

FOR PACKAGING FOAMS IN SHEET, ROLL, AND BLOCK FORM CONTAINING CORROSION INHIBITORS (U.S. CLS. 1, 5, 12, 13, 35 AND 50).

ELLEN PERKINS, EXAMINING ATTORNEY

SN 77-119,762. PROTRANS INTERNATIONAL, INC., INDIANAPOLIS, IN. FILED 3-1-2007.

PROTRANS

OWNER OF U.S. REG. NOS. 2,207,108, 2,544,779 AND OTHERS.

CLASS 35—ADVERTISING AND BUSINESS

FOR BUSINESS CONSULTATION SERVICES IN THE FIELD OF INVENTORY OPTIMIZATION, NAMELY, PREPARING BUSINESS REPORTS FROM CUSTOMER DATA GATHERED CONCERNING INVENTORY AND SALES PROFILES, AND PROVIDING RECOMMENDATIONS BASED THEREON FOR IMPROVING AND OPTIMIZING INVENTORY QUANTITIES AND DISTRIBUTION, AND PROVIDING RECOMMENDATIONS REGARDING ADDING ADVANTAGEOUS MISSING PRODUCTS TO INVENTORY, REMOVING UNDER PERFORMING PRODUCTS FROM INVENTORY, AND/OR OPTIMIZING INVENTORY LEVELS OF ONE OR MORE PRODUCTS; BUSINESS CONSULTING SERVICES FOR SELLERS OF AUTOMOBILE PARTS IN THE FIELD OF INVENTORY CONTROL, NAMELY, PREPARING BUSINESS REPORTS AND PROVIDING RECOMMENDATIONS BASED THEREON CONCERNING INVENTORY OPTIMIZATION (U.S. CLS. 100, 101 AND 102).

FIRST USE 8-10-2006; IN COMMERCE 8-10-2006.

CLASS 39—TRANSPORTATION AND STORAGE

FOR SUPPLY CHAIN, LOGISTICS AND REVERSE LOGISTICS SERVICES CONCERNING DOMESTIC AND INTERNATIONAL FREIGHT TRANSPORTATION BY TRUCK, RAIL, SHIP OR AIR, NAMELY, STORAGE OF DOCUMENTS, PACKAGES, RAW MATERIALS AND OTHER FREIGHT FOR OTHERS, TRANSPORTATION AND DELIVERY OF DOCUMENTS, PACKAGES, RAW MATERIALS, AND OTHER FREIGHT FOR OTHERS BY TRUCK, ASSISTING CLIENTS WITH MANAGEMENT OF INBOUND AND OUTBOUND FREIGHT TRAFFIC IN THE NATURE OF MANAGEMENT OF VEHICULAR TRAFFIC FLOW THROUGH ADVANCED COMMUNICATIONS NETWORK AND TECHNOLOGY, FREIGHT TRANSPORTATION BY TRUCK, WAREHOUSING OF FREIGHT FOR OTHERS, NAMELY, STORAGE OF DOCUMENTS, PACKAGES, RAW MATERIALS, AND OTHER FREIGHT FOR OTHERS, RENTAL OF FREIGHT CONTAINERS SUITABLE FOR SHIPMENT BY TRUCK TO OTHERS (U.S. CLS. 100 AND 105).

FIRST USE 8-10-2006; IN COMMERCE 8-10-2006.

LAURIE MAYES, EXAMINING ATTORNEY

SN 77-120,704. SCHMIDT, PETER, ROSRATH, FED REP GERMANY, FILED 3-2-2007.

SmartscaNNdy

OWNER OF FED REP GERMANY REG. NO. 30666126, DATED 10-27-2006, EXPIRES 10-31-2016.

CLASS 9—ELECTRICAL AND SCIENTIFIC APPARATUS

FOR ELECTRIC AND ELECTRONIC APPARATUS AND INSTRUMENTS, NAMELY, READING DEVICES FOR BARCODES AND RFID DEVICES; WRITING DEVICES FOR RFID; DISPLAYS, DIGITAL TRANSMITTERS, CIRCUIT BOARDS AND DIGITAL DATA ENTRY DEVICES; APPARATUS FOR LOGGING, RECORDING, TRANSMISSION, PROCESSING AND REPRODUCTION OF DATA; COMPUTERS AND PERIPHERAL DEVICES THEREFOR; COMPUTER SOFTWARE FOR EVALUATION, PROCESSING AND TRANSMISSION OF BARCODE DATA AND RFID DATA; DATA CARRIERS CONTAINING RECORDED COMPUTER PROGRAMS IN THE FIELD OF EVALUATION, PROCESSING AND TRANSMISSION OF BAR CEDE DATA AND RFID DATA; COMMUNICATIONS APPARATUS FOR THE TRANSMISSION OF MESSAGES AND DATA; SOFTWARE FOR THE TRANSMISSION OF MESSAGES AND DATA OR COMMUNICATIONS NETWORK (U.S. CLS. 21, 23, 26, 36 AND 38).

CLASS 37—CONSTRUCTION AND REPAIR

FOR MAINTENANCE AND REPAIR OF ELECTRIC AND ELECTRONIC APPARATUS, NAMELY, COMPUTERS AND PERIPHERAL DEVICES THEREFOR, READING DEVICES FOR BARCODES AND RFID AND WRITING DEVICES FOR RFID (U.S. CLS. 100, 103 AND 106).

CLASS 42—SCIENTIFIC AND COMPUTER SERVICES

FOR COMPUTER SOFTWARE DEVELOPMENT SERVICES FOR OTHERS, NAMELY, CREATING COMPUTER PROGRAMS FOR DATA PROCESSING (U.S. CLS. 100 AND 101).

ELLEN BURNS, EXAMINING ATTORNEY

SN 77-120,798. VIRGINIE NEUMANN, PARIS, FRANCE, FILED 3-2-2007.

virginie castaway

THE MARK CONSISTS OF STANDARD CHARACTERS WITHOUT CLAIM TO ANY PARTICULAR FONT, STYLE, SIZE, OR COLOR.

"THE NAME(S), PORTRAIT(S), AND/OR SIGNATURE(S) SHOWN IN THE MARK DOES NOT IDENTIFY A PARTICULAR LIVING INDIVIDUAL."

CLASS 14—JEWELRY

FOR JEWEL CHAINS; JEWEL PENDANTS; LEATHER JEWELRY AND ACCESSORY BOXES; WATCH STRAPS MADE OF METAL OR LEATHER OR PLASTIC; WATCH-STRAPS MADE OF LEATHER (U.S. CLS. 2, 27, 28 AND 50).

CLASS 18—LEATHER GOODS

FOR EVENING HANDBAGS; HANDBAG FRAMES; HANDBAGS; HANDBAGS FOR MEN; LEATHER HANDBAGS; STRAPS FOR HANDBAGS (U.S. CLS. 1, 2, 3, 22 AND 41).

CLASS 25—CLOTHING

FOR INFANT CLOTH DIAPERS; JERSEYS; LEATHER BELTS; MANTLES; MUFFLERS; NON-DISPOSABLE CLOTH TRAINING PANTS; PAPER HATS FOR USE AS CLOTHING ITEMS; PARTS OF CLOTHING, NAMELY, GUSSETS FOR TIGHTS, GUSSETS FOR STOCKINGS, GUSSETS FOR BATHING SUITS, GUSSETS FOR UNDERWEAR, GUSSETS FOR LEOTARDS AND GUSSETS FOR FOOTLETS; PERSPIRATION ABSORBENT UNDERWEAR CLOTHING; SHIFTS; SHORT SETS; SHOULDER PADS FOR CLOTHING; SHOULDER WRAPS; SWADDLING CLOTHES; TIES; TOPS; UNDERARM CLOTHING SHIELDS; WRAPS (U.S. CLS. 22 AND 39).

CLASS 26—FANCY GOODS

FOR BELT BUCKLES; BELT BUCKLES NOT OF PRECIOUS METAL; BELT BUCKLES OF PRECIOUS METAL; BODY AND CLOTHING TAPE TO HOLD UP STRAPLESS GOWNS; BROOCHES; BUCKLES FOR CLOTHING; BUNDLE WRAPPING CLOTHS; BUTTONS FOR CLOTHING; CHILD RESTRAINING DEVICES IN THE NATURE OF CLOTH CHILD HARNESS FOR HOUSEHOLD CHAIR; CLASPS FOR CLOTHING; CLOTH PATCHES FOR CLOTHING; CLOTHING BUCKLES; CLOTHING HOOKS; EMBROIDERED PATCHES FOR CLOTHING; EYELETS FOR CLOTHING; LOOPS FOR CLOTHING; ORNAMENTAL CLOTH PATCHES; PATCHES FOR CLOTHING MADE OF RUBBER, PLASTIC AND VINYL; SWEATER GUARDS (U.S. CLS. 37, 39, 40, 42 AND 50).

DANIEL BRODY, EXAMINING ATTORNEY

SN 77-120,831. BOEHRINGER INGELHEIM VETMEDICA, INC., ST. JOSEPH, MO. FILED 3-2-2007.

NAVIGATOR

THE MARK CONSISTS OF STANDARD CHARACTERS WITHOUT CLAIM TO ANY PARTICULAR FONT, STYLE, SIZE, OR COLOR.

CLASS 35—ADVERTISING AND BUSINESS

FOR HEALTH CARE COST CONTAINMENT SERVICES FOR OTHERS FOR THE TREATMENT OF SWINE (U.S. CLS. 100, 101 AND 102).

CLASS 44—MEDICAL, BEAUTY AND AGRICULTURAL SERVICES

FOR PROVIDING VACCINATION SERVICES FOR SWINE (U.S. CLS. 100 AND 101).

CAROLYN CATALDO, EXAMINING ATTORNEY

SN 77-121,000. MENTOR CORPORATION, SANTA BARBARA, CA. FILED 3-2-2007.

BODYLOGIC

THE MARK CONSISTS OF STANDARD CHARACTERS WITHOUT CLAIM TO ANY PARTICULAR FONT, STYLE, SIZE, OR COLOR.

CLASS 16—PAPER GOODS AND PRINTED MATTER

FOR MANUALS, WORKBOOKS, BOOKLETS, AND PRINTED INSTRUCTIONAL MATERIALS IN THE FIELDS OF BREAST IMPLANTS, BREAST RECONSTRUCTION AND COSMETIC SURGERY (U.S. CLS. 2, 5, 22, 23, 29, 37, 38 AND 50).

FIRST USE 12-31-2006; IN COMMERCE 12-31-2006.

CLASS 44—MEDICAL, BEAUTY AND AGRICULTURAL SERVICES

FOR PROVIDING INFORMATION TO PHYSICIANS AND PATIENTS REGARDING BREAST IMPLANT SIZING, BREAST IMPLANTS, BREAST RECONSTRUCTION, AND COSMETIC SURGERY; CONSULTATION SERVICES IN THE FIELD OF BREAST IMPLANTS, BREAST RECONSTRUCTION AND COSMETIC SURGERY (U.S. CLS. 100 AND 101).

FIRST USE 12-31-2006; IN COMMERCE 12-31-2006.

JENNIFER VASQUEZ, EXAMINING ATTORNEY

SN 77-121,317. CODEXIS, INC., REDWOOD CITY, CA. FILED 3-2-2007.

CODEX

THE MARK CONSISTS OF STANDARD CHARACTERS WITHOUT CLAIM TO ANY PARTICULAR FONT, STYLE, SIZE, OR COLOR.

OWNER OF U.S. REG. NO. 3,177,355.

CLASS 40—MATERIAL TREATMENT

FOR DIRECTED EVOLUTION SERVICES, NAMELY, THE RECOMBINATION OF GENES FOR THE BENEFIT OF OTHERS TO PRODUCE NOVEL GENE SEQUENCES FOR USE IN SCIENCE, RESEARCH, CHEMISTRY, BIO-FUELS TECHNOLOGY, RENEWABLE FUEL TECHNOLOGY, AND MEDICINE; MANUFACTURE OF CHEMICALS, BIO-FUELS AND RENEWABLE FUELS FOR OTHERS (U.S. CLS. 100, 103 AND 106).

CLASS 42—SCIENTIFIC AND COMPUTER SERVICES

FOR CHEMICAL RESEARCH SERVICES; SCIENTIFIC RESEARCH SERVICES; RESEARCH, PRODUCT DEVELOPMENT, AND PROCESS DEVELOPMENT SERVICES FOR OTHERS IN THE FIELDS OF CHEMISTRY, PHARMACEUTICALS, BIO-FUELS, RENEWABLE FUELS AND BIOCATALYSIS (U.S. CLS. 100 AND 101).

CHARLOTTE CORWIN, EXAMINING ATTORNEY

SN 77-121,335. CODEXIS, INC., REDWOOD CITY, CA. FILED 3-2-2007.

CODEX PANEL

THE MARK CONSISTS OF STANDARD CHARACTERS WITHOUT CLAIM TO ANY PARTICULAR FONT, STYLE, SIZE, OR COLOR.

OWNER OF U.S. REG. NO. 3,177,355.

NO CLAIM IS MADE TO THE EXCLUSIVE RIGHT TO USE "PANEL", APART FROM THE MARK AS SHOWN.

CLASS 40—MATERIAL TREATMENT

FOR DIRECTED EVOLUTION SERVICES, NAMELY, THE RECOMBINATION OF GENES FOR THE BENEFIT OF OTHERS TO PRODUCE NOVEL GENE SEQUENCES FOR USE IN SCIENCE, RESEARCH, CHEMISTRY, BIO-FUELS TECHNOLOGY, RENEWABLE FUEL TECHNOLOGY, AND MEDICINE; MANUFACTURE OF CHEMICALS, BIO-FUELS AND RENEWABLE FUELS FOR OTHERS (U.S. CLS. 100, 103 AND 106).

SN 77-121,350. CODEXIS, INC., REDWOOD CITY, CA. FILED 3-2-2007.

CODEX BIOCATALYST PANEL

CLASS 42—SCIENTIFIC AND COMPUTER SERVICES

FOR CHEMICAL RESEARCH SERVICES; SCIENTIFIC RESEARCH SERVICES; RESEARCH, PRODUCT DEVELOPMENT, AND PROCESS DEVELOPMENT SERVICES FOR OTHERS IN THE FIELDS OF CHEMISTRY, PHARMACEUTICALS, BIO-FUELS, RENEWABLE FUELS AND BIOCATALYSIS (U.S. CLS. 100 AND 101).
CHARLOTTE CORWIN, EXAMINING ATTORNEY

THE MARK CONSISTS OF STANDARD CHARACTERS WITHOUT CLAIM TO ANY PARTICULAR FONT, STYLE, SIZE, OR COLOR.
OWNER OF U.S. REG. NO. 3,177,355.
NO CLAIM IS MADE TO THE EXCLUSIVE RIGHT TO USE "BIOCATALYST PANEL", APART FROM THE MARK AS SHOWN.

CLASS 40—MATERIAL TREATMENT

FOR DIRECTED EVOLUTION SERVICES, NAMELY, THE RECOMBINATION OF GENES FOR THE BENEFIT OF OTHERS TO PRODUCE NOVEL GENE SEQUENCES FOR USE IN SCIENCE, RESEARCH, CHEMISTRY, BIO-FUELS TECHNOLOGY, RENEWABLE FUEL TECHNOLOGY, AND MEDICINE; MANUFACTURE OF CHEMICALS, BIO-FUELS AND RENEWABLE FUELS FOR OTHERS (U.S. CLS. 100, 103 AND 106).

SN 77-121,339. CODEXIS, INC., REDWOOD CITY, CA. FILED 3-2-2007.

CLASS 42—SCIENTIFIC AND COMPUTER SERVICES

FOR CHEMICAL RESEARCH SERVICES; SCIENTIFIC RESEARCH SERVICES; RESEARCH, PRODUCT DEVELOPMENT, AND PROCESS DEVELOPMENT SERVICES FOR OTHERS IN THE FIELDS OF CHEMISTRY, PHARMACEUTICALS, BIO-FUELS, RENEWABLE FUELS AND BIOCATALYSIS (U.S. CLS. 100 AND 101).
CHARLOTTE CORWIN, EXAMINING ATTORNEY

CODEX KRED PANEL

CODEX DIAGNOSTIC PANEL

THE MARK CONSISTS OF STANDARD CHARACTERS WITHOUT CLAIM TO ANY PARTICULAR FONT, STYLE, SIZE, OR COLOR.
OWNER OF U.S. REG. NO. 3,177,355.
NO CLAIM IS MADE TO THE EXCLUSIVE RIGHT TO USE "KRED PANEL", APART FROM THE MARK AS SHOWN.

SN 77-121,366. CODEXIS, INC., REDWOOD CITY, CA. FILED 3-2-2007.

CLASS 40—MATERIAL TREATMENT

FOR DIRECTED EVOLUTION SERVICES, NAMELY, THE RECOMBINATION OF GENES FOR THE BENEFIT OF OTHERS TO PRODUCE NOVEL GENE SEQUENCES FOR USE IN SCIENCE, RESEARCH, CHEMISTRY, BIO-FUELS TECHNOLOGY, RENEWABLE FUEL TECHNOLOGY, AND MEDICINE; MANUFACTURE OF CHEMICALS, BIO-FUELS AND RENEWABLE FUELS FOR OTHERS (U.S. CLS. 100, 103 AND 106).

THE MARK CONSISTS OF STANDARD CHARACTERS WITHOUT CLAIM TO ANY PARTICULAR FONT, STYLE, SIZE, OR COLOR.
OWNER OF U.S. REG. NO. 3,177,355.
NO CLAIM IS MADE TO THE EXCLUSIVE RIGHT TO USE "DIAGNOSTIC PANEL", APART FROM THE MARK AS SHOWN.

CLASS 42—SCIENTIFIC AND COMPUTER SERVICES

FOR CHEMICAL RESEARCH SERVICES; SCIENTIFIC RESEARCH SERVICES; RESEARCH, PRODUCT DEVELOPMENT, AND PROCESS DEVELOPMENT SERVICES FOR OTHERS IN THE FIELDS OF CHEMISTRY, PHARMACEUTICALS, BIO-FUELS, RENEWABLE FUELS AND BIOCATALYSIS (U.S. CLS. 100 AND 101).
CHARLOTTE CORWIN, EXAMINING ATTORNEY

CLASS 40—MATERIAL TREATMENT

FOR DIRECTED EVOLUTION SERVICES, NAMELY, THE RECOMBINATION OF GENES FOR THE BENEFIT OF OTHERS TO PRODUCE NOVEL GENE SEQUENCES FOR USE IN SCIENCE, RESEARCH, CHEMISTRY, BIO-FUELS TECHNOLOGY, RENEWABLE FUEL TECHNOLOGY, AND MEDICINE; MANUFACTURE OF CHEMICALS, BIO-FUELS AND RENEWABLE FUELS FOR OTHERS (U.S. CLS. 100, 103 AND 106).

CLASS 42—SCIENTIFIC AND COMPUTER SERVICES

FOR CHEMICAL RESEARCH SERVICES; SCIENTIFIC RESEARCH SERVICES; RESEARCH, PRODUCT DEVELOPMENT, AND PROCESS DEVELOPMENT SERVICES FOR OTHERS IN THE FIELDS OF CHEMISTRY, PHARMACEUTICALS, BIO-FUELS, RENEWABLE FUELS AND BIOCATALYSIS (U.S. CLS. 100 AND 101).
CHARLOTTE CORWIN, EXAMINING ATTORNEY

SN 77-122,293. BYRN, ANNE, NASHVILLE, TN. FILED 3-5-2007.

THE CAKE MIX DOCTOR

THE MARK CONSISTS OF STANDARD CHARACTERS WITHOUT CLAIM TO ANY PARTICULAR FONT, STYLE, SIZE, OR COLOR.

OWNER OF U.S. REG. NO. 2,790,131.

NO CLAIM IS MADE TO THE EXCLUSIVE RIGHT TO USE "CAKE MIX", APART FROM THE MARK AS SHOWN.

SN 77-121,561. VISIONMAKER WORLDWIDE, LLC, ORANGE, CA. FILED 3-2-2007.

VISIONMAKER

THE MARK CONSISTS OF STANDARD CHARACTERS WITHOUT CLAIM TO ANY PARTICULAR FONT, STYLE, SIZE, OR COLOR.

CLASS 36—INSURANCE AND FINANCIAL

FOR REAL ESTATE OPERATIONS MANAGEMENT SERVICES, NAMELY, MANAGEMENT OF RESIDENTIAL AND COMMERCIAL COMMUNITIES (U.S. CLS. 100, 101 AND 102).
FIRST USE 9-1-2003; IN COMMERCE 9-1-2003.

CLASS 21—HOUSEWARES AND GLASS

FOR BAKING ACCESSORIES AND COOKWARE, NAMELY, BAKING MOULDS, MIXING BOWLS, COOKIE SHEETS, AND PANS (U.S. CLS. 2, 13, 23, 29, 30, 33, 40 AND 50).

CLASS 30—STAPLE FOODS

FOR CAKE MIX; PACKAGED MIXES, NAMELY, CAKE MIX, COOKIE MIX AND BAKING MIXES; CAKE KITS, NAMELY, KITS COMPRISED OF CAKE MIX, ICING, CAKE TOPPINGS, AND EDIBLE CAKE DECORATIONS (U.S. CL. 46).

KELLY BOULTON, EXAMINING ATTORNEY

CLASS 37—CONSTRUCTION AND REPAIR

FOR REAL ESTATE DEVELOPMENT SERVICES (U.S. CLS. 100, 103 AND 106).
FIRST USE 9-1-2003; IN COMMERCE 9-1-2003.
WILLIAM ROSSMAN, EXAMINING ATTORNEY

SN 77-122,720. STARZ MEDIA, LLC, BURBANK, CA. FILED 3-5-2007.

REBIRTH OF A NATION

THE MARK CONSISTS OF STANDARD CHARACTERS WITHOUT CLAIM TO ANY PARTICULAR FONT, STYLE, SIZE, OR COLOR.

SN 77-122,177. MTD PRODUCTS INC, VALLEY CITY, OH. FILED 3-5-2007.

SUREFIT

THE MARK CONSISTS OF STANDARD CHARACTERS WITHOUT CLAIM TO ANY PARTICULAR FONT, STYLE, SIZE, OR COLOR.

CLASS 6—METAL GOODS

FOR NON-ELECTRIC CABLES USED IN THE MAINTENANCE OR REPAIR OF LAWN AND GARDEN EQUIPMENT (U.S. CLS. 2, 12, 13, 14, 23, 25 AND 50).

CLASS 9—ELECTRICAL AND SCIENTIFIC APPARATUS

FOR PRERECORDED VIDEO RECORDINGS, DVDS, CDS, AND CD ROMS FEATURING ENTERTAINMENT IN THE NATURE OF FEATURE LENGTH LIVE ACTION FILMS AND BOOKS OR BOOKLETS SOLD AS A UNIT THEREWITH; AUDIO RECORDINGS FEATURING MUSIC (U.S. CLS. 21, 23, 26, 36 AND 38).

CLASS 7—MACHINERY

FOR AIR FILTERS, SPARK PLUGS, AND FUEL FILTERS USED IN THE MAINTENANCE OR REPAIR OF LAWN AND GARDEN EQUIPMENT; CHAINSAW REPLACEMENT PARTS, NAMELY, CHAINS FOR CHAINSAWS (U.S. CLS. 13, 19, 21, 23, 31, 34 AND 35).
NATALIE POLZER, EXAMINING ATTORNEY

CLASS 18—LEATHER GOODS

FOR CARRY-ON BAGS, DUFFLE BAGS, GARMENT BAGS FOR TRAVEL, BOOK BAGS (U.S. CLS. 1, 2, 3, 22 AND 41).

CLASS 25—CLOTHING

FOR CLOTHING, NAMELY, T-SHIRTS, SWEAT-SHIRTS, HATS, PANTS, SHORTS, SOCKS, SWEATERS (U.S. CLS. 22 AND 39).

CLASS 41—EDUCATION AND ENTERTAINMENT

FOR MOTION PICTURE FILM AND VIDEO DISCS PRODUCTION; ENTERTAINMENT IN THE NATURE OF ONGOING PRERECORDED AND LIVE ACTION MOTION PICTURE FILMS, VIDEO RECORDINGS, TELEVISION PROGRAMS, AND MUSIC VIDEOS (U.S. CLS. 100, 101 AND 107).

AMOS T. MATTHEWS, JR., EXAMINING ATTORNEY



SN 77-122,828. WORDLOCK LLC, LOS ALTOS, CA. FILED 3-5-2007.

EASY TO SET • NEVER FORGET

CLASS 6—METAL GOODS

FOR METAL COMBINATION LOCKS; METAL PADLOCKS; METAL BICYCLE LOCKS; METAL LUGGAGE LOCKS; METAL COMPUTER AND LAPTOP LOCKS; METAL LOCKS FOR LOCKERS; METAL BACKPACK LOCKS; METAL SKI AND SNOWBOARD LOCKS; METAL CASH BOXES; METAL LOCK BOXES (U.S. CLS. 2, 12, 13, 14, 23, 25 AND 50).

CLASS 12—VEHICLES

FOR LOCKS FOR AUTOMOTIVE USE, NAMELY, ANTI-THEFT LOCKS FOR USE ON AUTOMOBILE STEERING WHEELS (U.S. CLS. 19, 21, 23, 31, 35 AND 44).

CLASS 18—LEATHER GOODS

FOR SUITCASES; LUGGAGE; BRIEFCASES (U.S. CLS. 1, 2, 3, 22 AND 41).

CLASS 20—FURNITURE AND ARTICLES NOT OTHERWISE CLASSIFIED

FOR NON-METAL CASH BOXES; NON-METAL LOCK BOXES (U.S. CLS. 2, 13, 22, 25, 32 AND 50).
SHANNON TWOHIG, EXAMINING ATTORNEY



SN 77-122,943. DANIEL, LESSARD, STE-JULIE, CANADA, FILED 3-6-2007.

UNIVERSAL HOCKEY
ASSOCIATION

THE MARK CONSISTS OF STANDARD CHARACTERS WITHOUT CLAIM TO ANY PARTICULAR FONT, STYLE, SIZE, OR COLOR.

NO CLAIM IS MADE TO THE EXCLUSIVE RIGHT TO USE "HOCKEY ASSOCIATION", APART FROM THE MARK AS SHOWN.

CLASS 25—CLOTHING

FOR CLOTHING AND ACCESSORIES, NAMELY, BLOUSES, COATS, DRESSES, JACKETS, JEANS, JUMPSUITS, LINGERIE, OVERALLS, PANTS, POLO SHIRTS, RAINCOATS, SHIRTS, SHORTS, SKIRTS, SWEATERS, SWEATPANTS, SWEATSHIRTS, SWIMSUITS, PONCHOS, RAINWEAR, COVERALLS, T-SHIRTS, TOPS, JERSEYS, HOCKEY JERSEYS, PULLOVERS, TROUSERS, VESTS, TANK TOPS, JOGGING SUITS, WARM-UP SUITS, SHORT SETS, DRESS AND PANT SETS, INFANT SLEEPERS, SNOWSUITS, LOUNGEWEAR, UNDERWEAR, HOUSECOATS, BATH ROBES, BATH WRAPS, UNDERSHIRTS, CLOTH BIBS, SLEEPWEAR, PAJAMAS, NIGHTGOWNS, NIGHTSHIRTS, BOXER SHORTS, SOCKS, HOSIERY, WRISTBANDS, MITTENS, GLOVES, SCARVES, BELTS, SUSPENDERS, TIES, MASQUERADE COSTUMES COMPRISED OF BODY SUITS AND FACE MASKS SOLD AS A UNIT; FOOTWEAR, NAMELY, ATHLETIC SHOES, SNOW BOOTS, BOOTS, SHOES; HEADGEAR, NAMELY, HATS, CAPS, VISORS, HEADBANDS (U.S. CLS. 22 AND 39).

CLASS 41—EDUCATION AND ENTERTAINMENT

FOR ENTERTAINMENT IN THE NATURE OF ARRANGING AND CONDUCTING ICE HOCKEY CONTESTS BETWEEN HOCKEY CLUBS OF DIFFERENT CITIES, REGIONS, NATIONS OR ETHNIC ORIGINS, WITH THE GOAL OF HOLDING HOCKEY CHAMPIONSHIPS; DEVELOPMENT AND DISSEMINATION OF INFORMATIONAL AND EDUCATIONAL MATERIAL, NAMELY, PROVIDING EDUCATIONAL INFORMATION IN THE FIELD OF ICE HOCKEY; PROVIDING ON-LINE MAGAZINES AND NEWSLETTERS IN THE FIELD OF ICE HOCKEY (U.S. CLS. 100, 101 AND 107).
SHAUNIA CARLYLE, EXAMINING ATTORNEY



SN 77-123,021. SCIENTIFIC ASSOCIATES, GREENSBORO, NC. FILED 3-6-2007.

PURESHRIMP

THE MARK CONSISTS OF STANDARD CHARACTERS WITHOUT CLAIM TO ANY PARTICULAR FONT, STYLE, SIZE, OR COLOR.

CLASS 21—HOUSEWARES AND GLASS

FOR WATER TANK SYSTEMS FOR AQUACULTURE APPLICATIONS COMPRISING A GROW OUT TANK, SWIRL SEPARATOR, SUMP, DRUM FILTER, CIRCULATING PUMP, BIOLOGICAL FILTER, PROTEIN SKIMMER, FOAM FRACTIONATOR, DENITRIFICATION UNIT, OXYGEN CONTACT VESSEL, OZONE CONTACT VESSEL, SHRIMP CONDO, AND ALGAE SCRUBBER (U.S. CLS. 2, 13, 23, 29, 30, 33, 40 AND 50).

CLASS 29—MEATS AND PROCESSED FOODS

FOR SHELLFISH (U.S. CL. 46).

CLASS 35—ADVERTISING AND BUSINESS

FOR BUSINESS MANAGEMENT SERVICES RELATING TO THE MANAGEMENT OF AQUACULTURE SYSTEMS FOR OTHERS (U.S. CLS. 100, 101 AND 102).

CLASS 44—MEDICAL, BEAUTY AND AGRICULTURAL SERVICES

FOR AQUACULTURE SERVICES, NAMELY, THE CULTIVATION AND BREEDING OF MARINE LIFE (U.S. CLS. 100 AND 101).

HOWARD SMIGA, EXAMINING ATTORNEY

CLASS 26—FANCY GOODS

FOR COASTAL WREATHS, NAMELY, ARTIFICIAL WREATHS (U.S. CLS. 37, 39, 40, 42 AND 50).

CLASS 28—TOYS AND SPORTING GOODS

FOR TROPICAL THEMED CHESS SETS (U.S. CLS. 22, 23, 38 AND 50).

GEOFFREY FOSDICK, EXAMINING ATTORNEY

SN 77-123,251. BDSRSCO, INC., WILMINGTON, DE. FILED 3-6-2007.

SN 77-123,491. WORK+LIFE FIT, INC., MADISON, NJ. FILED 3-6-2007.

BRIGHTEN THE SEASON

THE MARK CONSISTS OF STANDARD CHARACTERS WITHOUT CLAIM TO ANY PARTICULAR FONT, STYLE, SIZE, OR COLOR.

CLASS 4—LUBRICANTS AND FUELS

FOR CANDLES (U.S. CLS. 1, 6 AND 15).

CLASS 6—METAL GOODS

FOR METAL SIGNS/WALL ART, NAMELY, NON-LUMINOUS AND NON-MECHANICAL METAL SIGNS (U.S. CLS. 2, 12, 13, 14, 23, 25 AND 50).

CLASS 11—ENVIRONMENTAL CONTROL APPARATUS

FOR ANIMATED LAWN SCULPTURES, NAMELY, LIGHTED OUTDOOR HOLIDAY SCULPTURES AND WIRE FRAME STATUES; NEON LAMPS IN THE SHAPE OF PALM TREES; NEON LIGHTED ITEMS, NAMELY, LIGHTED PARTY-THEMED DECORATIONS; AND COASTAL PARTY LIGHTS, NAMELY, ELECTRIC LIGHT DECORATIVE STRINGS (U.S. CLS. 13, 21, 23, 31 AND 34).

CLASS 16—PAPER GOODS AND PRINTED MATTER

FOR PHOTO ALBUMS (U.S. CLS. 2, 5, 22, 23, 29, 37, 38 AND 50).

CLASS 19—NON-METALLIC BUILDING MATERIALS

FOR BAMBOO CURTAINS, NAMELY, NON-METAL CURTAIN WALLS; WOOD SIGNS/WALL ART, NAMELY, NON-LUMINOUS, NON-MECHANICAL SIGNS NOT OF METAL (U.S. CLS. 1, 12, 33 AND 50).

CLASS 20—FURNITURE AND ARTICLES NOT OTHERWISE CLASSIFIED

FOR RESIN PLAQUES; RESIN AND WOOD FIGURINES, NAMELY, NOVELTY LIFE PRESERVERS, WOOD BOATS AND LIGHTHOUSES; PICTURE FRAMES NOT OF PRECIOUS METAL; COASTAL WIND CHIMES (U.S. CLS. 2, 13, 22, 25, 32 AND 50).

CLASS 21—HOUSEWARES AND GLASS

FOR CANDLE HOLDERS NOT OF PRECIOUS METAL (U.S. CLS. 2, 13, 23, 29, 30, 33, 40 AND 50).

THE SLOWER LANE

THE MARK CONSISTS OF STANDARD CHARACTERS WITHOUT CLAIM TO ANY PARTICULAR FONT, STYLE, SIZE, OR COLOR.

CLASS 16—PAPER GOODS AND PRINTED MATTER

FOR BOOKS AND PRINTED INSTRUCTIONAL, EDUCATIONAL AND TEACHING MATERIALS, IN THE FIELD OF CAREER AND LIFE IMPROVEMENT AND FLEXIBILITY (U.S. CLS. 2, 5, 22, 23, 29, 37, 38 AND 50).

CLASS 35—ADVERTISING AND BUSINESS

FOR PROVIDING ONLINE CAREER INFORMATION (U.S. CLS. 100, 101 AND 102).

CLASS 41—EDUCATION AND ENTERTAINMENT

FOR EDUCATION AND TRAINING SERVICES, NAMELY, PROVIDING CLASSES, SEMINARS AND WORKSHOPS IN THE FIELDS OF CAREER AND LIFE IMPROVEMENT AND PROVIDING A FLEXIBLE WORK ENVIRONMENT SO THAT EMPLOYEES CAN BALANCE WORK AND OTHER PERSONAL OBLIGATIONS (U.S. CLS. 100, 101 AND 107).

CLASS 45—PERSONAL AND LEGAL SERVICES

FOR PROVIDING ONLINE INFORMATION IN THE FIELD OF SELF-IMPROVEMENT AND TIME MANAGEMENT, PARTICULARLY CONCERNING THE BALANCE OF WORK AND LIFE OBLIGATIONS (U.S. CLS. 100 AND 101).

GEOFFREY FOSDICK, EXAMINING ATTORNEY

SN 77-123,967. INTUIT INC., MOUNTAIN VIEW, CA. FILED 3-6-2007.

SN 77-124,477. ISI BRANDS, INC., GRAND RAPIDS, MI. FILED 3-7-2007.

FINANCEWORKS

THE MARK CONSISTS OF STANDARD CHARACTERS WITHOUT CLAIM TO ANY PARTICULAR FONT, STYLE, SIZE, OR COLOR.

CLASS 9—ELECTRICAL AND SCIENTIFIC APPARATUS

FOR COMPUTER SOFTWARE FOR PROVIDING ON-LINE ACCESS FOR CONSUMERS AND BUSINESSES IN THE BANKING, INVESTMENT, CREDIT, AND BILL PAYMENT FIELDS; COMPUTER SOFTWARE FOR MANAGING AND PERFORMING DATA ANALYSIS ON CHECKING, SAVINGS, AND OTHER BANK ACCOUNTS, AND BROKERAGE ACCOUNTS; COMPUTER SOFTWARE FOR PRESENTING, VIEWING, AND MANAGING TRANSACTIONAL RECORDS, INCLUDING ACCOUNT STATEMENTS AND CHECK IMAGES; COMPUTER SOFTWARE FOR PRESENTING BILLS AND INVOICES FOR PAYMENT, AND ACCEPTING AND PROCESSING BILL PAYMENTS; COMPUTER SOFTWARE FOR CONDUCTING, PROCESSING, MANAGING AND TRACKING FINANCIAL TRANSACTIONS, INCLUDING CHECK ORDERS, ELECTRONIC FUNDS TRANSFERS, AND STOP PAYMENT ORDERS; COMPUTER SOFTWARE FOR DATA AGGREGATION; USER MANUALS SUPPLIED AS A UNIT WITH THE FOREGOING COMPUTER SOFTWARE; NONE OF THE FOREGOING DESIGNED FOR FINANCIAL PLANNING (U.S. CLS. 21, 23, 26, 36 AND 38).

CLASS 42—SCIENTIFIC AND COMPUTER SERVICES

FOR PROVIDING TEMPORARY USE OF ONLINE NON-DOWNLOADABLE COMPUTER SOFTWARE FOR ON-LINE ACCESS FOR CONSUMERS AND BUSINESSES IN THE BANKING, INVESTMENT, CREDIT, AND BILL PAYMENT FIELDS; PROVIDING TEMPORARY USE OF ONLINE NON-DOWNLOADABLE COMPUTER SOFTWARE FOR MANAGING AND PERFORMING DATA ANALYSIS ON CHECKING, SAVINGS, AND OTHER BANK ACCOUNTS, AND BROKERAGE ACCOUNTS; PROVIDING TEMPORARY USE OF ONLINE NON-DOWNLOADABLE COMPUTER SOFTWARE FOR PRESENTING, VIEWING, AND MANAGING TRANSACTIONAL RECORDS, INCLUDING ACCOUNT STATEMENTS AND CHECK IMAGES; PROVIDING TEMPORARY USE OF ONLINE NON-DOWNLOADABLE COMPUTER SOFTWARE FOR PRESENTING BILLS AND INVOICES FOR PAYMENT, AND ACCEPTING AND PROCESSING BILL PAYMENTS; PROVIDING TEMPORARY USE OF ONLINE NON-DOWNLOADABLE COMPUTER SOFTWARE FOR CONDUCTING, PROCESSING, MANAGING AND TRACKING FINANCIAL TRANSACTIONS, INCLUDING CHECK ORDERS, ELECTRONIC FUNDS TRANSFERS, AND STOP PAYMENT ORDERS; PROVIDING TEMPORARY USE OF ONLINE NON-DOWNLOADABLE COMPUTER SOFTWARE FOR DATA AGGREGATION; APPLICATION SERVICE PROVIDER (ASP), NAMELY, HOSTING COMPUTER SOFTWARE APPLICATIONS AND ASSOCIATED DATA FOR OTHERS; TECHNICAL CONSULTATION IN THE FIELD OF APPLICATION SERVICE PROVIDER (ASP) SERVICES AND HOSTED COMPUTER SOFTWARE; DESIGNING, CUSTOMIZING, IMPLEMENTING, INTEGRATING AND MAINTAINING NETWORK-BASED COMPUTER SOFTWARE APPLICATIONS FOR OTHERS; TECHNICAL SUPPORT SERVICES, NAMELY, TROUBLESHOOTING OF COMPUTER HARDWARE, SOFTWARE, AND NETWORK PROBLEMS (U.S. CLS. 100 AND 101).

DANIEL BRODY, EXAMINING ATTORNEY

NATIONAL CALCIUM INITIATIVE

THE MARK CONSISTS OF STANDARD CHARACTERS WITHOUT CLAIM TO ANY PARTICULAR FONT, STYLE, SIZE, OR COLOR.

NO CLAIM IS MADE TO THE EXCLUSIVE RIGHT TO USE "NATIONAL CALCIUM", APART FROM THE MARK AS SHOWN.

CLASS 5—PHARMACEUTICALS

FOR CALCIUM SUPPLEMENTS (U.S. CLS. 6, 18, 44, 46, 51 AND 52).

CLASS 29—MEATS AND PROCESSED FOODS

FOR WHIPPED DAIRY TOPPING, DAIRY-BASED FOOD BEVERAGES, DAIRY-BASED DIPS, AND DAIRY-BASED BEVERAGES, BUTTER, BUTTER SUBSTITUTES, CHEESE, MILK (U.S. CL. 46).

CLASS 30—STAPLE FOODS

FOR BREAKFAST CEREALS; CEREAL-BASED SNACK FOOD; PROCESSED CEREALS; GRANOLA-BASED SNACK BARS; READY-TO-EAT, CEREAL-DERIVED FOOD BARS; BAKERY DESSERTS; BAKERY GOODS; BAKERY PRODUCTS; ICE CREAM (U.S. CL. 46).

CLASS 32—LIGHT BEVERAGES

FOR FRUIT JUICE; BEVERAGE VEGETABLE JUICES; BEVERAGE TOMATO JUICE; MINERAL WATER; SPRING WATER; SOFT DRINK COLAS; DRINKING WATER; FLAVORED WATERS; FRUIT FLAVORED DRINKS; SELTZER WATER; SOFT DRINKS; SPORTS DRINKS; TABLE WATER (U.S. CLS. 45, 46 AND 48).

CLASS 41—EDUCATION AND ENTERTAINMENT

FOR EDUCATIONAL SERVICES IN THE NATURE OF CLASSES, WORKSHOPS, AND SEMINARS IN THE FIELD OF NUTRITION (U.S. CLS. 100, 101 AND 107).

DAVID C. REIHNER, EXAMINING ATTORNEY

SN 77-124,623. INTERSECTIONS INC., CHANTILLY, VA. FILED 3-7-2007.

PIL

THE MARK CONSISTS OF STANDARD CHARACTERS WITHOUT CLAIM TO ANY PARTICULAR FONT, STYLE, SIZE, OR COLOR.

CLASS 9—ELECTRICAL AND SCIENTIFIC APPARATUS

FOR ENCODED SMART CARDS CONTAINING PROGRAMMING USED TO STORE PERSONAL INFORMATION (U.S. CLS. 21, 23, 26, 36 AND 38).

CLASS 35—ADVERTISING AND BUSINESS

FOR CREDIT CARD REGISTRATION SERVICES (U.S. CLS. 100, 101 AND 102).

CLASS 36—INSURANCE AND FINANCIAL

FOR CREDIT CARD CANCELLATION AND NOTIFICATION SERVICES FOR LOST OR STOLEN CREDIT CARDS; PROVIDING IDENTITY THEFT INSURANCE UNDERWRITTEN BY OTHERS (U.S. CLS. 100, 101 AND 102).

CLASS 39—TRANSPORTATION AND STORAGE

FOR PROVIDING ONLINE SECURE ELECTRONIC STORAGE AND RETRIEVAL OF DIGITAL CONTENT, MEDIA AND IMAGES, NAMELY, PASSWORDS, PINS, ACCOUNT NUMBERS, MEDICAL RECORDS AND PRESCRIPTIONS, IMPORTANT DOCUMENTS, EMERGENCY CONTACT, DIGITAL PHOTOGRAPHS AND DIARIES FOR OTHERS (U.S. CLS. 100 AND 105).

CLASS 45—PERSONAL AND LEGAL SERVICES

FOR IDENTITY THEFT PROTECTION SERVICES, NAMELY, PERSONAL INFORMATION AND FINANCIAL IDENTITY MONITORING; FRAUD RESOLUTION ASSISTANCE, NAMELY, PROVIDING ADVICE AND CONSULTATION IN THE FIELD OF IDENTITY THEFT; INTERNET SURVEILLANCE OF FINANCIAL AND PERSONAL INFORMATION (U.S. CLS. 100 AND 101).
ALLISON SCHRODY, EXAMINING ATTORNEY

SN 77-124,626. FILM MOVEMENT, LLC, NEW YORK, NY. FILED 3-7-2007.

BRING THE FESTIVAL HOME!

THE MARK CONSISTS OF STANDARD CHARACTERS WITHOUT CLAIM TO ANY PARTICULAR FONT, STYLE, SIZE, OR COLOR.

CLASS 9—ELECTRICAL AND SCIENTIFIC APPARATUS

FOR MOTION PICTURE FILMS AND CINEMATOGRAPHIC FILMS ON A WIDE VARIETY OF THEMES FOR DISTRIBUTION TO OTHERS ON DVDS AND VIDEO TAPES, DOWNLOADABLE FILMS PROVIDED VIA A VIDEO-ON-DEMAND SERVICE (U.S. CLS. 21, 23, 26, 36 AND 38).

FIRST USE 1-15-2004; IN COMMERCE 1-15-2004.

CLASS 25—CLOTHING

FOR CLOTHING, NAMELY, SHIRTS, POLO SHIRTS, KNIT SHIRTS, SWEATSHIRTS, PULLOVERS, HATS, BASEBALL CAPS AND JACKETS (U.S. CLS. 22 AND 39).

CLASS 35—ADVERTISING AND BUSINESS

FOR ONLINE SUBSCRIPTION SERVICES FEATURING PRE-RECORDED DVDS, MAIL ORDER SERVICES FEATURING CINEMATOGRAPHIC AND MOTION PICTURE FILMS ON VARIOUS MEDIA FORMATS (U.S. CLS. 100, 101 AND 102).

FIRST USE 1-15-2004; IN COMMERCE 1-15-2004.

CLASS 41—EDUCATION AND ENTERTAINMENT

FOR PRODUCTION AND DISTRIBUTION OF MOTION PICTURE FILMS ON A WIDE VARIETY OF THEMES (U.S. CLS. 100, 101 AND 107).

FIRST USE 1-15-2004; IN COMMERCE 1-15-2004.
TASHIA BUNCH, EXAMINING ATTORNEY

SN 77-125,148. VIBRANT MEDIA INC., NEW YORK, NY. FILED 3-8-2007.

VIBRANT MEDIA

THE MARK CONSISTS OF STANDARD CHARACTERS WITHOUT CLAIM TO ANY PARTICULAR FONT, STYLE, SIZE, OR COLOR.

NO CLAIM IS MADE TO THE EXCLUSIVE RIGHT TO USE "MEDIA", APART FROM THE MARK AS SHOWN.

CLASS 35—ADVERTISING AND BUSINESS

FOR ADVERTISING THE PRODUCTS AND SERVICES OF OTHERS VIA ONLINE INFORMATION AND ADVERTISEMENTS THAT ARE KEYED OR LINKED TO PRE-SPECIFIED TERMS, PHRASES, OR OTHER DIGITAL CONTENT; ADVERTISING THE PRODUCTS AND SERVICES OF OTHERS ALONGSIDE CONTEXTUALLY RELEVANT ARTICLES (U.S. CLS. 100, 101 AND 102).

FIRST USE 10-15-2001; IN COMMERCE 10-15-2001.

CLASS 42—SCIENTIFIC AND COMPUTER SERVICES

FOR PROVIDING ONLINE, NON-DOWNLOADABLE SOFTWARE FOR USE IN DISPLAYING INFORMATION AND ADVERTISEMENTS OF OTHERS ABOUT THE PRODUCTS AND SERVICES OF OTHERS WHERE SUCH INFORMATION OR ADVERTISEMENTS APPEAR ONLY IN RESPONSE TO KEYWORDS, PHRASES, OR OTHER PRE-SPECIFIED DIGITAL CONTENT; PROVIDING ONLINE, NON-DOWNLOADABLE SOFTWARE FOR USE IN ADVERTISING THE PRODUCTS AND SERVICES OF OTHERS ALONGSIDE CONTEXTUALLY RELEVANT ARTICLES (U.S. CLS. 100 AND 101).

FIRST USE 10-15-2001; IN COMMERCE 10-15-2001.

MICHAEL GAFFAR, EXAMINING ATTORNEY

SN 77-125,354. BOART LONGYEAR INTERNATIONAL HOLDINGS, INC., SALT LAKE CITY, UT. FILED 3-8-2007.



THE COLOR(S) ORANGE AND BROWN IS/ARE CLAIMED AS A FEATURE OF THE MARK.

THE MARK IS COMPOSED OF TWO ADJACENT PARALLELOGRAMS. THE COLOR ORANGE APPEARS IN PARALLELOGRAM ON THE LEFT AND THE COLOR BROWN APPEARS IN THE PARALLELOGRAM ON THE RIGHT.

SEC. 2(F).

CLASS 7—MACHINERY

FOR DRILL BITS FOR EARTH DRILLING EQUIPMENT; POWER OPERATED DIAMOND DRILLING RIGS, RODS AND TOOLS AND PARTS THEREFOR, NAMELY, CORES, BARRELS, DIAMOND DRILLING BITS AND REAMING SHELLS; POWER OPERATED DIAMOND SAWING AND CUTTING MACHINES AND POWER OPERATED DIAMOND SAWING AND CUTTING TOOLS, NAMELY, CIRCULAR AND DIAMOND WIRE SAWS; PARTS FOR POWER OPERATED VIBRATORY ROTARY AND ROTARY PERCUSSION DRILLING RIGS, MACHINES AND TOOLS, NAMELY, CEMENTED TUNGSTEN CARBIDE TIPPED DRILLING BITS, TAPERED AND THREADED DRILLING RODS, COUPLINGS AND SHANKS; HIGH PRECISION ABRADING AND GRINDING MACHINES AND POWER OPERATED TOOLS, NAMELY, DIAMOND, CUBIC BORON NITRIDE AND SUPERHARD ABRASIVE CONTAINING GRINDING WHEELS; CEMENTED TUNGSTEN CARBIDE COMPONENT PARTS FOR MINING AND INDUSTRIAL APPLICATIONS, NAMELY, EARTH AND ROCK DRILLING INSERTS FOR USE ON ROTARY/PERCUSSIVE ROCK DRILLING EQUIPMENT; DIAMOND SYNTHESIS, GRINDING BURRS FOR USE ON METAL DEBURRING MACHINES; END MILL RODS FOR USE ON MILLING MACHINES FOR METAL REMOVAL IN ENGINEERING AND MANUFACTURING WORK SHOPS; EARTH DRILLING EQUIPMENT, NAMELY, DRILL RODS FOR ROCK AND EARTH; WIRE LINE CORE BARRELS FOR EARTH DRILLING; OVERSHOT ASSEMBLIES FOR DRILL RODS FOR ROCK AND EARTH (U.S. CLS. 13, 19, 21, 23, 31, 34 AND 35).

FIRST USE 0-0-1994; IN COMMERCE 0-0-1994.

CLASS 37—CONSTRUCTION AND REPAIR

FOR EARTH DRILLING SERVICES; TECHNICAL DRILLING CONSULTATION FOR THE OIL, GAS, AND MINING INDUSTRIES (U.S. CLS. 100, 103 AND 106).

FIRST USE 0-0-1994; IN COMMERCE 0-0-1994.

CLASS 42—SCIENTIFIC AND COMPUTER SERVICES

FOR TECHNICAL RESEARCH FOR THE OIL, GAS AND MINING INDUSTRIES; GEOLOGICAL, GEOPHYSICAL AND GEOCHEMICAL EXPLORATION; MINING AND MINERAL EXPLORATION SERVICES; OIL AND GEOLOGICAL PROSPECTING AND MAPPING; CUSTOM DESIGN OF MINES AND MINE LAYOUTS; SCIENTIFIC RESEARCH SERVICES; ENGINEERING SERVICES; OIL FIELD ANALYSIS SERVICES IN THE OIL, GAS AND MINING FIELDS (U.S. CLS. 100 AND 101).

FIRST USE 0-0-1994; IN COMMERCE 0-0-1994.
MARY CRAWFORD, EXAMINING ATTORNEY

SN 77-125,443. APTUS ENDOSYSTEMS, INC., SUNNYVALE, CA. FILED 3-8-2007.

APTUS

THE MARK CONSISTS OF STANDARD CHARACTERS WITHOUT CLAIM TO ANY PARTICULAR FONT, STYLE, SIZE, OR COLOR.

CLASS 10—MEDICAL APPARATUS

FOR MEDICAL DEVICES AND INSTRUMENTS, NAMELY, ENDOVASCULAR FASTENERS AND ENDOVASCULAR FASTENER APPLIERS, ENDOVASCULAR GUIDES, AND KITS COMPRISING ENDOVASCULAR FASTENERS AND ENDOVASCULAR FASTENER APPLIERS, ENDOVASCULAR GUIDES, EACH FOR USE IN THE FIELD OF DEPLOYING, STABILIZING, AND SECURING OF AN ENDOVASCULAR PROSTHESIS IN A BLOOD VESSEL FOR THE TREATMENT OF AN ENDOVASCULAR ANEURYSM (U.S. CLS. 26, 39 AND 44).

CLASS 41—EDUCATION AND ENTERTAINMENT

FOR EDUCATIONAL SERVICES, NAMELY, ORGANIZING AND CONDUCTING TRAINING, WORKSHOPS AND CONFERENCES IN THE FIELD OF DEVICES, INSTRUMENTS, AND TECHNIQUES FOR DEPLOYING, STABILIZING, AND SECURING OF AN ENDOVASCULAR PROSTHESIS IN A BLOOD VESSEL FOR THE TREATMENT OF AN ENDOVASCULAR ANEURYSM (U.S. CLS. 100, 101 AND 107).

CLASS 44—MEDICAL, BEAUTY AND AGRICULTURAL SERVICES

FOR MEDICAL SERVICES, NAMELY, TECHNICAL AND PROFESSIONAL CONSULTATION AND ONLINE PHYSICIAN AND PATIENT INFORMATION ON THE SUBJECT OF DEVICES, INSTRUMENTS, AND TECHNIQUES FOR DEPLOYING, STABILIZING, AND SECURING OF AN ENDOVASCULAR PROSTHESIS IN A BLOOD VESSEL FOR THE TREATMENT OF AN ENDOVASCULAR ANEURYSM (U.S. CLS. 100 AND 101).

DAVID TAYLOR, EXAMINING ATTORNEY

SN 77-125,884. THOMSON PROFESSIONAL & REGULATORY INC., CARROLLTON, TX. FILED 3-8-2007.

SN 77-126,109. PREFERRED HOTEL GROUP, INC., CHICAGO, IL. FILED 3-8-2007.

**ACCOUNTING & COMPLIANCE
ALERT**

THE MARK CONSISTS OF STANDARD CHARACTERS WITHOUT CLAIM TO ANY PARTICULAR FONT, STYLE, SIZE, OR COLOR.

NO CLAIM IS MADE TO THE EXCLUSIVE RIGHT TO USE "ACCOUNTING AND COMPLIANCE", APART FROM THE MARK AS SHOWN.

CLASS 35—ADVERTISING AND BUSINESS

FOR PROVIDING BUSINESS NEWS AND INFORMATION ON ACCOUNTING AND TO FINANCE AND ACCOUNTING PROFESSIONALS, DELIVERED VIA A PROPRIETARY ONLINE PLATFORM (U.S. CLS. 100, 101 AND 102).

CLASS 36—INSURANCE AND FINANCIAL

FOR PROVIDING FINANCIAL REPORTING INFORMATION TO FINANCE AND ACCOUNTING PROFESSIONALS, DELIVERED VIA A PROPRIETARY ONLINE PLATFORM (U.S. CLS. 100, 101 AND 102).

PAULA MAHONEY, EXAMINING ATTORNEY

SN 77-126,018. WHITE, LEWIS, BIRMINGHAM, AL. FILED 3-8-2007.

**TREASURE CUP COFFEE
ROASTERS**

THE MARK CONSISTS OF STANDARD CHARACTERS WITHOUT CLAIM TO ANY PARTICULAR FONT, STYLE, SIZE, OR COLOR.

NO CLAIM IS MADE TO THE EXCLUSIVE RIGHT TO USE "COFFEE ROASTERS", APART FROM THE MARK AS SHOWN.

CLASS 30—STAPLE FOODS

FOR COFFEE AND TEA (U.S. CL. 46).

CLASS 35—ADVERTISING AND BUSINESS

FOR ON-LINE RETAIL STORE SERVICES FEATURING COFFEE AND TEA (U.S. CLS. 100, 101 AND 102).

JENNIFER VASQUEZ, EXAMINING ATTORNEY

PREFERRED COLLECTIONS

THE MARK CONSISTS OF STANDARD CHARACTERS WITHOUT CLAIM TO ANY PARTICULAR FONT, STYLE, SIZE, OR COLOR.

OWNER OF U.S. REG. NOS. 1,227,080, 1,419,160 AND OTHERS.

NO CLAIM IS MADE TO THE EXCLUSIVE RIGHT TO USE "COLLECTIONS", APART FROM THE MARK AS SHOWN.

SEC. 2(F) AS TO "PREFERRED".

CLASS 36—INSURANCE AND FINANCIAL

FOR VACATION RESORT TIME SHARE SERVICES (U.S. CLS. 100, 101 AND 102).

CLASS 43—HOTEL AND RESTAURANT SERVICES

FOR HOTEL SERVICES (U.S. CLS. 100 AND 101).
LINDA LAVACHE, EXAMINING ATTORNEY

SN 77-126,112. PREFERRED HOTEL GROUP, INC., CHICAGO, IL. FILED 3-8-2007.

PREFERRED RESIDENCES

THE MARK CONSISTS OF STANDARD CHARACTERS WITHOUT CLAIM TO ANY PARTICULAR FONT, STYLE, SIZE, OR COLOR.

OWNER OF U.S. REG. NOS. 1,227,080, 1,419,160 AND OTHERS.

NO CLAIM IS MADE TO THE EXCLUSIVE RIGHT TO USE "RESIDENCES", APART FROM THE MARK AS SHOWN.

SEC. 2(F) AS TO "PREFERRED".

CLASS 36—INSURANCE AND FINANCIAL

FOR VACATION RESORT TIME SHARE SERVICES (U.S. CLS. 100, 101 AND 102).

CLASS 43—HOTEL AND RESTAURANT SERVICES

FOR HOTEL SERVICES (U.S. CLS. 100 AND 101).
LINDA LAVACHE, EXAMINING ATTORNEY

SN 77-126,282. MOBIDIA, INC., RICHMOND, BC, CANADA, FILED 3-8-2007.

CUBUDDY

THE MARK CONSISTS OF STANDARD CHARACTERS WITHOUT CLAIM TO ANY PARTICULAR FONT, STYLE, SIZE, OR COLOR.

CLASS 9—ELECTRICAL AND SCIENTIFIC APPARATUS

FOR COMPUTER SOFTWARE, NAMELY, APPLICATION SOFTWARE FOR USE IN THE REAL-TIME CAPTURING, RECEIVING FROM OTHER PARTIES, PROCESSING, TRANSMITTING, SHARING WITH ONE OR MORE OTHER PARTIES, SAVING, COMMUNICATING, VIEWING, SEARCHING, EDITING AND INTEGRATION OF AUDIO, VIDEO AND TEXT DATA INPUT FOR MOBILE PHONES (U.S. CLS. 21, 23, 26, 36 AND 38).

CLASS 38—COMMUNICATION

FOR PROVIDING PRIVATE AND SECURE REAL TIME ELECTRONIC COMMUNICATION OVER A COMPUTER NETWORK FOR THE CAPTURING, RECEIVING, PROCESSING, SHARING, SAVING DATA, VIEWING, SEARCHING, EDITING AND TRANSMISSION OF DATA, SOUND AND IMAGES (U.S. CLS. 100, 101 AND 104).

CLASS 42—SCIENTIFIC AND COMPUTER SERVICES

FOR COMPUTER SERVICES, NAMELY, CREATING INDEXES OF INFORMATION AND OTHER RESOURCES AVAILABLE ON COMPUTER NETWORKS; APPLICATION SERVICE PROVIDER SERVICES, NAMELY, PROVIDING, HOSTING, MANAGING, DEVELOPING, AND MAINTAINING APPLICATIONS, SOFTWARE, WEBSITES AND DATABASES IN THE FIELDS OF WIRELESS COMMUNICATIONS, MOBILE INFORMATION ACCESS, AND REMOTE DATA MANAGEMENT FOR WIRELESS DELIVERY OF CONTENT TO MOBILE DEVICES (U.S. CLS. 100 AND 101).

BERNICE MIDDLETON, EXAMINING ATTORNEY

SN 77-126,283. KIDS VILLAGE WORKSHOP, INC., OREM, UT. FILED 3-8-2007.

WHERE LEARNING, LOVE, AND
MAGIC MEET

THE MARK CONSISTS OF STANDARD CHARACTERS WITHOUT CLAIM TO ANY PARTICULAR FONT, STYLE, SIZE, OR COLOR.

CLASS 25—CLOTHING

FOR APPAREL, NAMELY, APRONS, T-SHIRTS, SWEATSHIRTS, AND SWEATPANTS (U.S. CLS. 22 AND 39).

CLASS 41—EDUCATION AND ENTERTAINMENT

FOR EDUCATIONAL SERVICES, NAMELY, PROVIDING COURSES OF INSTRUCTION IN THE FIELDS OF COOKING, SEWING, PHOTOGRAPHY, WOOD-WORKING, CRAFTS, DRAWING, PERSONAL FINANCE, ETIQUETTE, ENGINEERING, COMPUTERS, BUSINESS, ENTREPRENEURSHIP, SALES, MUSIC, ART, DANCE, DRAMA, HEALTH, PHYSICAL EDUCATION, MATHEMATICS, SCIENCE, SOCIAL STUDIES, HISTORY, GEOGRAPHY, CIVICS, LANGUAGES, LANGUAGE ARTS, READING, WRITING, SPELLING, GRAMMAR, HAND WRITING, SPEAKING, LISTENING, AND COMPREHENSION; EDUCATIONAL SERVICES, NAMELY, PROVIDING WORKSHOPS IN THE FIELDS COOKING, SEWING, PHOTOGRAPHY, WOOD-WORKING, ART, DRAWING, PERSONAL FINANCE, ETIQUETTE, SCIENCE, ENGINEERING, COMPUTERS, BUSINESS, ENTREPRENEURSHIP AND SALES (U.S. CLS. 100, 101 AND 107).

BENJAMIN ALLEN, EXAMINING ATTORNEY

SN 77-126,336. VISA INTERNATIONAL SERVICE ASSOCIATION, FOSTER CITY, CA. FILED 3-9-2007.

VISA PAYWAVE

THE MARK CONSISTS OF STANDARD CHARACTERS WITHOUT CLAIM TO ANY PARTICULAR FONT, STYLE, SIZE, OR COLOR.

CLASS 9—ELECTRICAL AND SCIENTIFIC APPARATUS

FOR MAGNETIC CODED BANK CARDS, CREDIT CARDS, DEBIT CARDS, PREPAID CARDS, AND CHIP CARDS; MAGNETIC CODED CARDS AND CARDS IMPREGNATED WITH INTEGRATED CIRCUIT CHIPS FOR USE IN FINANCIAL APPLICATIONS; MAGNETIC CODED AND ELECTRONIC DATA CARRIER CARD READERS CONTAINING RADIO FREQUENCY IDENTIFICATION DEVICES FOR TRANSMITTING, DISPLAYING, AND STORING PAYMENT INFORMATION FOR USE IN CONNECTION WITH PAYMENT SERVICES PROVIDING PAYMENT DATA AND REPORTS (U.S. CLS. 21, 23, 26, 36 AND 38).

CLASS 36—INSURANCE AND FINANCIAL

FOR FINANCIAL SERVICES, NAMELY, BANKING SERVICES, CREDIT CARD SERVICES, DEBIT CARD SERVICES, AND PREPAID CARD SERVICES, NAMELY, PROCESSING ELECTRONIC PAYMENTS MADE THROUGH PREPAID CARDS; PAYMENT CARD SERVICES OFFERED BY MEANS OF RADIO FREQUENCY IDENTIFICATION DEVICES, NAMELY, PROCESSING ELECTRONIC PAYMENTS MADE THROUGH CREDIT CARDS, DEBIT CARDS, AND PREPAID CARDS; ELECTRONIC FUNDS TRANSFER AND CURRENCY EXCHANGE SERVICES; ELECTRONIC PAYMENT PROCESSING SERVICES; PREPAID PHONE CARD SERVICES; CREDIT CARD, DEBIT CARD, AND PREPAID CARD TRANSACTION AUTHORIZATION AND SETTLEMENT SERVICES; DEPOSIT ACCESS AND AUTOMATED TELLER MACHINE SERVICES; CREDIT, DEBIT, AND PREPAID CARD PAYMENT VERIFICATION SERVICES; PERSON-TO-PERSON PAYMENT SERVICES THROUGH ELECTRONIC MEANS; TRAVEL INSURANCE BROKERAGE SERVICES; PAYMENT IDENTIFICATION SERVICES, NAMELY, PAYMENT TRANSACTION, AUTHENTICATION, AND VERIFICATION SERVICES; ADVISORY SERVICES RELATING TO ALL OF THE AFORESAID SERVICES (U.S. CLS. 100, 101 AND 102).

EMILY CARLSEN, EXAMINING ATTORNEY

SN 77-126,377. KEEP IT CLEAN, LLC, MOUNT PLEASANT, SC. FILED 3-9-2007.



KEEP IT CLEAN

THE MARK CONSISTS OF A CONCENTRIC CIRCLE ENDING IN A STAR APPEARING OVER THE WORDS "KEEP IT CLEAN".

CLASS 16—PAPER GOODS AND PRINTED MATTER

FOR SAFETY WINDOW STICKERS TO ALERT EMERGENCY PERSONNEL OF PETS INSIDE (U.S. CLS. 2, 5, 22, 23, 29, 37, 38 AND 50).

CLASS 21—HOUSEWARES AND GLASS

FOR DENTAL CARE KITS FOR PETS, NAMELY, A KIT CONTAINING TOOTHBRUSHES AND TOOTH-PASTES (U.S. CLS. 2, 13, 23, 29, 30, 33, 40 AND 50).

ARETHA SOMERVILLE, EXAMINING ATTORNEY

SN 77-126,424. CYMI, LTD., DAYTON, OH. FILED 3-9-2007.

CYMI, LTD.

THE MARK CONSISTS OF STANDARD CHARACTERS WITHOUT CLAIM TO ANY PARTICULAR FONT, STYLE, SIZE, OR COLOR.

NO CLAIM IS MADE TO THE EXCLUSIVE RIGHT TO USE LTD., APART FROM THE MARK AS SHOWN.

CLASS 35—ADVERTISING AND BUSINESS

FOR HUMAN RESOURCES CONSULTING; BUSINESS ADMINISTRATION CONSULTING SERVICES (U.S. CLS. 100, 101 AND 102).

FIRST USE 1-0-1998; IN COMMERCE 1-0-1998.

CLASS 36—INSURANCE AND FINANCIAL

FOR FINANCIAL CONSULTING SERVICES IN THE FIELDS OF FINANCIAL PLANNING, FINANCIAL MANAGEMENT, BILL PAYMENT SERVICES, AND INVESTMENTS FOR INDIVIDUALS AND BUSINESSES (U.S. CLS. 100, 101 AND 102).

FIRST USE 1-0-1998; IN COMMERCE 1-0-1998.

CLASS 45—PERSONAL AND LEGAL SERVICES

FOR CONCIERGE SERVICES FOR OTHERS, NAMELY, MAKING REQUESTED PERSONAL ARRANGEMENTS AND RESERVATIONS AND PROVIDING CUSTOMER-SPECIFIC INFORMATION TO MEET INDIVIDUAL NEEDS RENDERED TOGETHER IN BUSINESS ESTABLISHMENTS, OFFICE BUILDINGS, AND HOMES (U.S. CLS. 100 AND 101).

FIRST USE 1-0-1998; IN COMMERCE 1-0-1998.

MARILYN IZZI, EXAMINING ATTORNEY

SN 77-126,426. CYMI, LTD., DAYTON, OH. FILED 3-9-2007.



THE MARK CONSISTS OF A DESIGN OF THREE TRIANGLES, WITH ONE LARGER TRIANGLE IN THE BACKGROUND AND TWO SMALLER, TOUCHING TRIANGLES IN THE FOREGROUND.

CLASS 35—ADVERTISING AND BUSINESS

FOR HUMAN RESOURCES CONSULTING; BUSINESS ADMINISTRATION CONSULTING SERVICES (U.S. CLS. 100, 101 AND 102).

FIRST USE 1-0-1998; IN COMMERCE 1-0-1998.

CLASS 36—INSURANCE AND FINANCIAL

FOR FINANCIAL CONSULTING SERVICES IN THE FIELDS OF FINANCIAL PLANNING, FINANCIAL MANAGEMENT, BILL PAYMENT SERVICES, AND INVESTMENTS FOR INDIVIDUALS AND BUSINESSES (U.S. CLS. 100, 101 AND 102).

FIRST USE 1-0-1998; IN COMMERCE 1-0-1998.

CLASS 45—PERSONAL AND LEGAL SERVICES

FOR CONCIERGE SERVICES FOR OTHERS, NAMELY, MAKING REQUESTED PERSONAL ARRANGEMENTS AND RESERVATIONS AND PROVIDING CUSTOMER-SPECIFIC INFORMATION TO MEET INDIVIDUAL NEEDS RENDERED TOGETHER IN BUSINESS ESTABLISHMENTS, OFFICE BUILDINGS, AND HOMES (U.S. CLS. 100 AND 101).

FIRST USE 1-0-1998; IN COMMERCE 1-0-1998.
MARILYN IZZI, EXAMINING ATTORNEY

SN 77-126,741. SANDAHL, GREG, ROCKFORD, IL. FILED 3-9-2007.

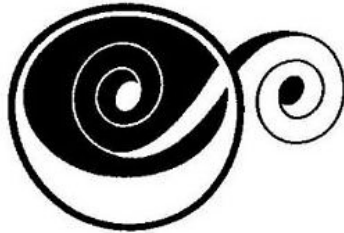

THE MARK CONSISTS OF A CIRCLE ENCOMPASSING A SWIRL DESIGN ALONG WITH AN ATTACHED SWIRL DESIGN AFFIXED TO THE LARGER CIRCLE SHAPE DESIGN ALL TO FORM A STYLIZED COFFEE CUP.

CLASS 30—STAPLE FOODS

FOR COFFEE BEANS, COFFEE-BASED BEVERAGES, PASTRIES, BISCUITS, BREADS, COOKIES, CAKES, PIES, CONFECTIONS AND GELATO (U.S. CL. 46).
FIRST USE 4-30-2006; IN COMMERCE 11-18-2006.

CLASS 43—HOTEL AND RESTAURANT SERVICES

FOR COFFEE-HOUSE AND SNACK-BAR SERVICES (U.S. CLS. 100 AND 101).
FIRST USE 4-30-2006; IN COMMERCE 11-18-2006.
ANDREA HACK, EXAMINING ATTORNEY

SN 77-126,831. CHOCOGELATIER, LLC, AUSTIN, TX. FILED 3-9-2007.

Viva Chcolato!

THE MARK CONSISTS OF STANDARD CHARACTERS WITHOUT CLAIM TO ANY PARTICULAR FONT, STYLE, SIZE, OR COLOR.

THE FOREIGN WORDING IN THE MARK TRANSLATES INTO ENGLISH AS LONG LIVE CHOCOLATE!

CLASS 30—STAPLE FOODS

FOR CHOCOLATE, COFFEE, TEA, COCOA, PREPARED COFFEE AND COFFEE-BASED BEVERAGES; PREPARED COCOA AND COCOA-BASED BEVERAGES; PREPARED ICE CREAM AND ICE CREAM-BASED BEVERAGES; BEVERAGES MADE OF TEA; POWDERED CHOCOLATE AND VANILLA; CHOCOLATE AND CANDY, NAMELY, CHOCOLATES, CHOCOLATE BARS, CHOCOLATE-COVERED FRUITS, CHOCOLATE-COVERED NUTS, CHOCOLATE-COVERED DRIED FRUITS, CHOCOLATE-COVERED CRACKERS, CHOCOLATE TRUFFLES, AND CHOCOLATE TOPPING; CHOCOLATE FONDUE; CHOCOLATE FOOD BEVERAGES NOT BEING DAIRY-BASED OR VEGETABLE BASED WITH COFFEE FLAVORS; POWDERED FLAVORING ADDITIVES FOR NON-NUTRITIONAL PURPOSES; COCOA PRODUCTS, NAMELY, COCOA MIXES AND COCOA POWDERS; CHOCOLATE POWDER; HOT CHOCOLATE; COCOA BEVERAGES WITH MILK; ICE CREAM, ICE CREAM DRINKS, ICE CREAM MIXES, ICE CREAM POWDER, ICE CREAM SUBSTITUTES; GELATO; ICE CREAM AND CHOCOLATE-BASED DESSERTS, NAMELY, CHOCOLATE MOUSSE, CHOCOLATE FONDUE, CHOCOLATE CREPES AND WAFFLES, CHOCOLATE CAKES, AND CHOCOLATE SUNDAES; GIFT BASKETS CONTAINING CANDY (U.S. CL. 46).

FIRST USE 1-1-2007; IN COMMERCE 1-1-2007.

CLASS 35—ADVERTISING AND BUSINESS

FOR ON-LINE ORDERING SERVICES FEATURING FOOD, INCLUDING CHOCOLATES, CANDIES AND CANDY-BASED GIFT BASKETS; RESTAURANT FRANCHISING, NAMELY, FRANCHISING CHOCOLATE AND GELATO STORES AND CAFES; FRANCHISING SERVICES, NAMELY, OFFERING TECHNICAL ASSISTANCE IN THE ESTABLISHMENT AND/OR OPERATION OF CHOCOLATE AND GELATO STORES AND CAFES; SERVICES FOR PROVIDING FOOD AND DRINK, NAMELY, FOOD KIOSK SERVICES (U.S. CLS. 100, 101 AND 102).

FIRST USE 1-1-2007; IN COMMERCE 1-1-2007.

CLASS 43—HOTEL AND RESTAURANT SERVICES

FOR SERVICES FOR PROVIDING FOOD AND DRINK, NAMELY, RESTAURANTS, CAFES, AND COFFEE SHOPS; CAFÉ-RESTAURANTS FEATURING CHOCOLATES, COFFEE, CANDY GIFTS, ICE CREAM PRODUCTS, DESSERTS, PREPARED DRINKS AND BEVERAGES; CATERING FOR THE PROVISION OF FOOD AND BEVERAGES (U.S. CLS. 100 AND 101).

FIRST USE 1-1-2007; IN COMMERCE 1-1-2007.

ROSELLE HERRERA, EXAMINING ATTORNEY

SN 77-126,969. TLV CO., LTD, HYOGO-KEN 675-8511, JAPAN, FILED 3-9-2007.

EEP

THE MARK CONSISTS OF STANDARD CHARACTERS WITHOUT CLAIM TO ANY PARTICULAR FONT, STYLE, SIZE, OR COLOR.

CLASS 37—CONSTRUCTION AND REPAIR

FOR MAINTENANCE AND REPAIR OF ELECTRICAL SYSTEMS, STEAM SYSTEMS, HEATING EQUIPMENT, AND AIR CONDITIONING SYSTEMS; MAINTENANCE AND REPAIR OF ELECTRICAL SYSTEMS, STEAM SYSTEMS, HEATING EQUIPMENT, AND AIR CONDITIONING SYSTEMS, NAMELY, ROTATING EQUIPMENT, STEAM TRAPS, VALVES, PIPING, AND CONTAINERS (U.S. CLS. 100, 103 AND 106).

CLASS 42—SCIENTIFIC AND COMPUTER SERVICES

FOR THERMOGRAPHY SURVEY AND DIAGNOSTIC SERVICES FOR ELECTRICAL SYSTEMS, STEAM SYSTEMS, HEATING EQUIPMENT, AND AIR CONDITIONING SYSTEMS; MONITORING, CHECKING AND DIAGNOSTIC SERVICES FOR ROTATING EQUIPMENT; AND SURVEY AND DIAGNOSTIC SERVICES FOR STEAM TRAPS, VALVES, PIPING, AND CONTAINERS (U.S. CLS. 100 AND 101).

MARK SPARACINO, EXAMINING ATTORNEY

SN 77-126,971. WINTER, DAVID, MOUNTAIN VIEW, CA.
FILED 3-9-2007.

ARCH & PANEL

THE MARK CONSISTS OF STANDARD CHARACTERS WITHOUT CLAIM TO ANY PARTICULAR FONT, STYLE, SIZE, OR COLOR.

CLASS 6—METAL GOODS

FOR DOOR HARDWARE, NAMELY, METAL DOOR-KNOBS, METAL DOOR HANDLES, AND METAL DOOR LATCHES (U.S. CLS. 2, 12, 13, 14, 23, 25 AND 50).

CLASS 37—CONSTRUCTION AND REPAIR

FOR INSTALLATION OF INTERIOR DOORS (U.S. CLS. 100, 103 AND 106).

MARK SPARACINO, EXAMINING ATTORNEY

SN 77-127,211. YZERMAN, STEPHEN G., SOUTHFIELD, MI.
FILED 3-9-2007.



THE MARK CONSISTS OF THE STYLIZED WORDING "STEVE YZERMAN 19".

CLASS 9—ELECTRICAL AND SCIENTIFIC APPARATUS

FOR HOCKEY HELMETS; PROTECTIVE HOCKEY VISORS DESIGNED FOR USE WITH HOCKEY HELMETS (U.S. CLS. 21, 23, 26, 36 AND 38).

CLASS 16—PAPER GOODS AND PRINTED MATTER

FOR ART PRINTS, POSTERS, PAPER PENNANTS, CALENDARS, MOUNTED AND UNMOUNTED PHOTOGRAPHS AND ART PRINTS, TRADING CARDS, DECALS, TEMPORARY TATTOOS, BOOKS IN THE FIELD OF SPORTS AND BOOKLETS IN THE FIELD OF SPORTS, NOTEPADS, COMMEMORATIVE PROGRAMS CONCERNING HOCKEY AND SPORTING EVENTS (U.S. CLS. 2, 5, 22, 23, 29, 37, 38 AND 50).

CLASS 25—CLOTHING

FOR CLOTHING, NAMELY, SHIRTS, JERSEYS, HATS, SWEATSHIRTS, PANTS, JACKETS, SHORTS, SUN VISORS, SCARVES, BABY SLEEPERS, GLOVES, WRISTBANDS, FOOTWEAR, HOCKEY PANTS (U.S. CLS. 22 AND 39).

CLASS 28—TOYS AND SPORTING GOODS

FOR HOCKEY EQUIPMENT, NAMELY, HOCKEY STICKS, HOCKEY STICK BLADES, HOCKEY STICK SHAFTS; PROTECTIVE GEAR FOR PLAYING HOCKEY, NAMELY, HOCKEY PADS, SHIN GUARDS, AND GLOVES; HOCKEY PUCKS AND BALLS; ICE SKATES; MINIATURE TOY HOCKEY STICKS, MINIATURE TOY HELMETS; BATTERY OPERATED, ELECTRICAL OR MECHANICAL ACTION TOYS AND ACTION FIGURES, BOBBLE HEADS; PUZZLES; STUFFED ANIMALS; SNOW GLOBES, CHRISTMAS TREE ORNAMENTS (U.S. CLS. 22, 23, 38 AND 50).

FRANK LATTUCA, EXAMINING ATTORNEY

SN 77-127,242. YZERMAN, STEPHEN G., SOUTHFIELD, MI.
FILED 3-9-2007.

STEVE YZERMAN

THE MARK CONSISTS OF STANDARD CHARACTERS WITHOUT CLAIM TO ANY PARTICULAR FONT, STYLE, SIZE, OR COLOR.

CLASS 9—ELECTRICAL AND SCIENTIFIC APPARATUS

FOR HOCKEY HELMETS; PROTECTIVE HOCKEY VISORS DESIGNED FOR USE WITH HOCKEY HELMETS (U.S. CLS. 21, 23, 26, 36 AND 38).

CLASS 16—PAPER GOODS AND PRINTED MATTER

FOR ART PRINTS, POSTERS, PAPER PENNANTS, CALENDARS, MOUNTED AND UNMOUNTED PHOTOGRAPHS AND ART PRINTS, TRADING CARDS, DECALS, TEMPORARY TATTOOS, BOOKS IN THE FIELD OF SPORTS AND BOOKLETS IN THE FIELD OF SPORTS, NOTEPADS, COMMEMORATIVE PROGRAMS CONCERNING HOCKEY AND SPORTING EVENTS (U.S. CLS. 2, 5, 22, 23, 29, 37, 38 AND 50).

CLASS 25—CLOTHING

FOR CLOTHING, NAMELY, SHIRTS, JERSEYS, HATS, SWEATSHIRTS, PANTS, JACKETS, SHORTS, SUN VISORS, SCARVES, BABY SLEEPERS, GLOVES, WRISTBANDS, FOOTWEAR, HOCKEY PANTS (U.S. CLS. 22 AND 39).

CLASS 28—TOYS AND SPORTING GOODS

FOR HOCKEY EQUIPMENT, NAMELY, HOCKEY STICKS, HOCKEY STICK BLADES, HOCKEY STICK SHAFTS; PROTECTIVE GEAR FOR PLAYING HOCKEY, NAMELY, HOCKEY PADS, SHIN GUARDS, AND GLOVES; HOCKEY PUCKS AND BALLS; ICE SKATES; MINIATURE TOY HOCKEY STICKS, MINIATURE TOY HOCKEY HELMETS; BATTERY OPERATED, ELECTRICAL, OR MECHANICAL ACTION TOYS AND ACTION FIGURES, BOBBLE HEADS; PUZZLES; STUFFED ANIMALS; SNOW GLOBES, CHRISTMAS TREE ORNAMENTS (U.S. CLS. 22, 23, 38 AND 50).

FRANK LATTUCA, EXAMINING ATTORNEY

SN 77-127,637. RXF LLC, KIRKLAND, WA. FILED 3-9-2007.

RX FOR ROMANCE

THE MARK CONSISTS OF STANDARD CHARACTERS WITHOUT CLAIM TO ANY PARTICULAR FONT, STYLE, SIZE, OR COLOR.

CLASS 4—LUBRICANTS AND FUELS

FOR CANDLES (U.S. CLS. 1, 6 AND 15).

CLASS 35—ADVERTISING AND BUSINESS

FOR INTERNET RETAIL STORE SERVICES AND RETAIL SHOP-AT-HOME PARTY SERVICES IN THE FIELD OF SEX EDUCATION, ADULT NOVELTY ITEMS, GAMES, CANDIES, MASSAGE LUBRICANTS, CANDLES, MARITAL AIDS, ADULT NOVELTY APPAREL, LINGERIE, BOOKS, VIDEOS, ACCESSORIES, COSMETICS, TOYS, GIFT ITEMS, AND KITS CONTAINING A COMBINATION OF AT LEAST TWO OF THE GOODS DESCRIBED HEREIN (U.S. CLS. 100, 101 AND 102).

FIRST USE 2-20-2007; IN COMMERCE 2-20-2007.
ALICE BENMAMAN, EXAMINING ATTORNEY

SN 77-128,014. BIRMINGHAM, ANDREW W., DENVER, CO. FILED 3-12-2007.

Snake River Ranch

THE MARK CONSISTS OF STANDARD CHARACTERS WITHOUT CLAIM TO ANY PARTICULAR FONT, STYLE, SIZE, OR COLOR.

CLASS 41—EDUCATION AND ENTERTAINMENT

FOR EDUCATIONAL SERVICES IN THE NATURE OF SEMINARS AND WORKSHOPS RELATING TO THE ENVIRONMENT AND ECONOMICS; ARRANGING, ORGANIZING AND CONDUCTING EDUCATIONAL CONFERENCES, SYMPOSIUMS, SEMINARS, FORUMS, CLASSES, AND WORKSHOPS ABOUT THE ENVIRONMENT AND ECONOMICS (U.S. CLS. 100, 101 AND 107).

CLASS 43—HOTEL AND RESTAURANT SERVICES

FOR RESTAURANT AND BAR SERVICES AND DUDE RANCH SERVICES (U.S. CLS. 100 AND 101).

CHARLOTTE CORWIN, EXAMINING ATTORNEY

SN 77-128,135. T2 BIOSYSTEMS, INC., CAMBRIDGE, MA. FILED 3-12-2007.

T2 BIOSYSTEMS

THE MARK CONSISTS OF STANDARD CHARACTERS WITHOUT CLAIM TO ANY PARTICULAR FONT, STYLE, SIZE, OR COLOR.

NO CLAIM IS MADE TO THE EXCLUSIVE RIGHT TO USE "BIOSYSTEMS", APART FROM THE MARK AS SHOWN.

CLASS 1—CHEMICALS

FOR ASSAYS FOR USE IN BIOLOGICAL AND CHEMICAL RESEARCH (U.S. CLS. 1, 5, 6, 10, 26 AND 46).

CLASS 5—PHARMACEUTICALS

FOR DIAGNOSTIC REAGENTS FOR MEDICAL USE; MEDICAL DIAGNOSTIC ASSAYS FOR TESTING BIOLOGICAL FLUIDS; ASSAYS FOR USE IN MEDICAL AND CLINICAL DIAGNOSTICS (U.S. CLS. 6, 18, 44, 46, 51 AND 52).

CLASS 10—MEDICAL APPARATUS

FOR MEDICAL DIAGNOSTIC EQUIPMENT, NAMELY, PORTABLE NUCLEAR MAGNETIC RESONANCE INSTRUMENTS FOR IN VITRO DIAGNOSTICS (U.S. CLS. 26, 39 AND 44).

CLASS 44—MEDICAL, BEAUTY AND AGRICULTURAL SERVICES

FOR MEDICAL DIAGNOSTIC SERVICES (U.S. CLS. 100 AND 101).

DAVID COLLIER, EXAMINING ATTORNEY

SN 77-128,415. KABUSHIKI KAISHA NIBARIKI, TOKYO, JAPAN, FILED 3-12-2007.

千と千尋の神隠し

THE MARK CONSISTS OF THE ENGLISH TRANSLATION OF THE JAPANESE CHARACTERS IS SPIRITED AWAY.

THE NON-LATIN CHARACTER(S) IN THE MARK TRANSLITERATE INTO KAMIKAKUSHI, AND THIS MEANS SPIRITED AWAY IN ENGLISH.

CLASS 9—ELECTRICAL AND SCIENTIFIC APPARATUS

FOR CARTRIDGES, CASSETTES, CARDS AND DISCS THAT CONTAIN PRE RECORDED COMPUTER VIDEO GAME PROGRAMS; VIDEO GAME MACHINES FOR USE WITH TELEVISIONS; PRERECORDED MAGNETIC TAPES FOR COMPUTERS FEATURING COMPUTER GAMES; MOBILE PHONES, NAMELY, TELEPHONES AND MODEMS; EXPOSED CAMERA FILMS; PHOTOGRAPHIC SLIDE TRANSPARENCIES; SOUND RECODING TAPES; VIDEO TAPES FEATURING ANIMATED CARTOONS (U.S. CLS. 21, 23, 26, 36 AND 38).

CLASS 14—JEWELRY

FOR ALARM CLOCKS; BADGES, BROOCHES, INGOTS, NECKLACES, AND PINS OF PRECIOUS METAL; JEWELRY; JEWELRY ORNAMENTS; TIE CLIPS; TIE PINS; WATCHES; WATCH BANDS; JEWELRY CASES OF WOOD OR PLASTIC (U.S. CLS. 2, 27, 28 AND 50).

CLASS 15—MUSICAL INSTRUMENTS

FOR MUSICAL INSTRUMENTS (U.S. CLS. 2, 21 AND 36).

CLASS 16—PAPER GOODS AND PRINTED MATTER

FOR STATIONERY OF ALL KINDS; PAPERS, NAMELY, TRACING PAPER, TISSUE PAPER; ALBUMS; PRINTED PUBLICATIONS, NAMELY, CALENDARS, PAMPHLETS FEATURING AND INTRODUCING ANIMATED CARTOONS; MOUNTED AND UN MOUNTED PHOTOGRAPHS; PASTELS; WRITING PADS; PENS; PHOTOGRAPH STANDS; ERASERS; RUBBER STAMPS; STAMP PAD INKS; PLAYING CARDS; BINDERS; GRAPHIC ART REPRODUCTIONS (U.S. CLS. 2, 5, 22, 23, 29, 37, 38 AND 50).

CLASS 18—LEATHER GOODS

FOR BAGS, NAMELY, LEATHER AND TEXTILE SHOPPING BAGS, BOOK BAGS, GARMENT BAGS FOR TRAVEL, AND SCHOOL BAGS; BRIEFCASES; KEY CASES; LEATHER STRAPS FOR LUGGAGE; WALLETS; PURSES; SADDLERY; SUITCASES; UMBRELLAS, UMBRELLA COVERS (U.S. CLS. 1, 2, 3, 22 AND 41).

CLASS 20—FURNITURE AND ARTICLES NOT OTHERWISE CLASSIFIED

FOR FURNITURE OF ALL KINDS; CUSHIONS; MATTRESSES; PILLOWS; CHAIRS; BEDS; CLOTHES DRESSERS OF WOOD OR PLASTIC; BOXES AND BINS OF WOOD OR PLASTIC; CLOTHES HANGERS; DESKS; MAGAZINE RACKS; MIRRORS; NON-METAL NAMEPLATES; PICTURE FRAMES; SLEEPING BAGS (U.S. CLS. 2, 13, 22, 25, 32 AND 50).

CLASS 21—HOUSEWARES AND GLASS

FOR BABY BATH TUBS; DUST BINS; COOKING POTS; WASHING AND CLEANING INSTRUMENTS, NAMELY, CLOTHS FOR CLEANING, MOPS, BROOMS, SPONGES FOR WASHING, WASHING BOARDS; HAIR COMBS; COMB CASES; BRUSHES, NAMELY, BRUSHES FOR CLOTHES, DISHWASHING BRUSHES, FOOTWEAR BRUSHES, HAIR BRUSHES, NAIL BRUSHES; DISHES FOR SOAP; DUSTING CLOTHS; BUCKETS; COSMETIC UTENSILS, NAMELY, COSMETIC BRUSHES, POWDER PUFFS; POTS, DRINKING FLASKS; KITCHEN CONTAINERS; NAPKIN HOLDERS; SHOE HORNS; SOAP BOXES; TOILET UTENSILS NAMELY, TOILET BRUSHES, TOILET PAPER HOLDERS; BOTTLES SOLD EMPTY; HOUSEHOLD UTENSILS, NAMELY BASKETS OF STRAW, BASKETS OF WOOD, BASKETS OF CLOTH FOR DOMESTIC USE; TRAYS NOT OF PRECIOUS METAL, COFFEE SERVICES NOT OF PRECIOUS METAL, ROLLING PINS, TURNERS, WHISKS; TABLE PLATES NOT OF PRECIOUS METAL; CLOTHES PINS (U.S. CLS. 2, 13, 23, 29, 30, 33, 40 AND 50).

CLASS 24—FABRICS

FOR CLOTH FLAGS; CLOTHS, NAMELY TABLE CLOTHS NOT OF PAPER; BED COVERS, NAMELY BED BLANKETS, BED LINENS, BED SHEETS; FABRIC, NAMELY, NYLON, POLYESTER, RAYON, AND COTTON; MATTRESS COVERS; MITTS, NAMELY WASHING MITTS, TOILET MITTS, OVEN MITTS; PILLOW CASES; QUILTS; SHAMS; AND CURTAINS (U.S. CLS. 42 AND 50).

CLASS 25—CLOTHING

FOR CLOTHING, NAMELY, SUSPENDERS, BELTS, PANTS, APRONS, SWIMSUITS, CAPS, COATS, JACKETS, JERSEYS, JUMPERS, GLOVES, UNDERWEAR, CUFFS, EARMUFFS, NECKTIES, PARKAS, PAJAMAS, SCARVES, SHIRTS, SOCKS, SUITS, TROUSERS, VESTS, SHOES OF ALL KINDS, SANDALS; AND SLIPPERS (U.S. CLS. 22 AND 39).

CLASS 26—FANCY GOODS

FOR SEWING INSTRUMENTS, NAMELY, SEWING BOXES, SEWING NEEDLES, SEWING THIMBLES, TASELS; ACCESSORIES, NOT OF PRECIOUS METAL AND NOT IMITATION JEWELRY, NAMELY, CLOTH PATCHES FOR CLOTHING, BROOCHES, BUCKLES; BUTTONS FOR CLOTHING; ARTIFICIAL FLOWERS; HAIR BANDS; HAIR NETS; HAIR ORNAMENTS; AND RIBBONS (U.S. CLS. 37, 39, 40, 42 AND 50).

CLASS 27—FLOOR COVERINGS

FOR CARPETS, VINYL FLOOR COVERING, RUGS, DOOR MATS, WALLPAPER, WALL HANGINGS NOT OF TEXTILE (U.S. CLS. 19, 20, 37, 42 AND 50).

CLASS 28—TOYS AND SPORTING GOODS

FOR TOYS, NAMELY, DOLLS; GAMES, NAMELY, BOARD GAMES, PLAYING CARDS, CARD GAMES; STAND-ALONE VIDEO OUTPUT GAME MACHINES; DOLL CLOTHES; SPORTING GOOD BALLS FOR GAMES, NAMELY, BASEBALLS, BASKETBALLS, FOOTBALLS, SOCCER BALLS, VOLLEYBALLS, AND TENNIS BALLS; SPORTING GOOD BATS FOR GAMES, NAMELY BASEBALL BATS, CRICKET BATS, AND SOFTBALL BATS; TENNIS RACKETS; SKATEBOARDS; SURFBOARDS; TABLE TENNIS EQUIPMENT, NAMELY, BALLS, NETS, PADDLES, RACKETS, AND TABLES; FISHING TACKLE; AND CHRISTMAS TREE ORNAMENTS (U.S. CLS. 22, 23, 38 AND 50).

CLASS 29—MEATS AND PROCESSED FOODS

FOR DAIRY PRODUCTS EXCLUDING ICE CREAM, ICE MILK AND FROZEN YOGURT; MILK BEVERAGES, NAMELY, MILK, HALF AND HALF, MILK-BASED BEVERAGE CONTAINING COFFEE; MEAT-BASED CROQUETTES, FISH-BASED CROQUETTES; MEAT-BASED SAUSAGES, FISH-BASED SAUSAGES; PRESERVED FOODS, NAMELY, BEANS, DRIED FRUITS, FISH, VEGETABLES; AND WHEY BASED FOOD BEVERAGES (U.S. CL. 46).

CLASS 30—STAPLE FOODS

FOR CONFECTIONERY, NAMELY, PEANUT BUTTER CONFECTIONERY CHIPS, ALMOND CANDY, CANDY FOR DECORATING CHRISTMAS TREES, PEANUT CANDY, CHOCOLATE COVERED PEANUTS; COFFEE BASED BEVERAGES; CHOCOLATE-BASED BEVERAGES NOT BEING DAIRY-BASED OR VEGETABLE BASED; BREAD OF ALL KINDS; PASTA; CORN FLAKES; FOOD FLAVORINGS; ICE CREAM AND SHERBET SUBSTITUTES, NAMELY, POWDER FOR ICE CREAM OR SHERBET; POPPED POPCORN; PIES (U.S. CL. 46).

CLASS 32—LIGHT BEVERAGES

FOR AERATED WATER; NONALCOHOLIC MALT BEVERAGES; FRUIT JUICE CONCENTRATES; MALT WORT; WATERS, NAMELY, DRINKING, MINERAL, QUININE, SELTZER, SODA, SPRING, AND TABLE WATER, AND BEER (U.S. CLS. 45, 46 AND 48).

CLASS 33—WINES AND SPIRITS

FOR PREPARED ALCOHOLIC COCKTAILS (U.S. CLS. 47 AND 49).

CLASS 38—COMMUNICATION

FOR RADIO AND TELEVISION BROADCASTING; TELECOMMUNICATIONS SERVICES, NAMELY E-MAIL COMMUNICATION SERVICES BY COMPUTER TERMINALS, COMMUNICATIONS BY TELEPHONE, PERSONAL COMMUNICATIONS SERVICES; ELECTRONIC MAIL; ELECTRONIC VOICE MESSAGING, NAMELY, THE RECORDING, STORAGE AND SUBSEQUENT TRANSMISSION OF VOICE MESSAGES BY TELEPHONE; TRANSMISSION OF MESSAGES AND IMAGES BY COMPUTER TERMINALS; TRANSMISSION OF MESSAGES AND IMAGES BY FACSIMILE; ELECTRONIC TRANSMISSION OF MESSAGES AND DATA; TELEGRAM TRANSMISSION AND COMMUNICATION; PROVIDING TELECOMMUNICATIONS INFORMATION REGARDING THE USE OF E-MAIL AND VOICE MESSAGING (U.S. CLS. 100, 101 AND 104).

CLASS 41—EDUCATION AND ENTERTAINMENT

FOR RENTAL OF CINEMA FILMS; EDUCATION IN THE FIELD OF ART AND COMPUTER GRAPHICS RENDERED THROUGH CORRESPONDENCE COURSES; PROVIDING INFORMATION REGARDING EDUCATIONAL CLASSES OFFERED AT VARIOUS COLLEGES VIA GLOBAL COMPUTER NETWORKS; ENTERTAINMENT IN THE NATURE OF AMUSEMENT PARK RIDES, LIVE PERFORMANCES BY A MUSICAL GROUP; PARTY PLANNING; PRODUCTION OF TELEVISIONS SHOWS; PRODUCTION OF PLAYS; MOTION PICTURE FILM PRODUCTION; PROVIDING CASINO FACILITIES; MOVIE STUDIOS; ORGANIZATION OF EXHIBITIONS IN THE NATURE OF MOVIES, CARTOONS, AND MUSIC; THEATER PRODUCTIONS; PUBLICATION OF BOOKS; PRODUCTION OF RADIO AND TELEVISION PROGRAMS; RENTAL OF VIDEO TAPES; ARRANGING AND CONDUCTING OF SHOWS AND ENTERTAINMENT IN THE NATURE OF LIVE MUSICAL PERFORMANCES (U.S. CLS. 100, 101 AND 107).

CLASS 42—SCIENTIFIC AND COMPUTER SERVICES

FOR COMPUTER PROGRAMMING FOR OTHERS; COMPUTER SOFTWARE DESIGN FOR OTHERS; GRAPHIC ART DESIGN; RENTAL OF COMPUTER SOFTWARE (U.S. CLS. 100 AND 101).
JOHN GARTNER, EXAMINING ATTORNEY

SN 77-128,964. MOMENTIVE PERFORMANCE MATERIALS INC., WILTON, CT. FILED 3-12-2007.

SILFORCE

THE MARK CONSISTS OF STANDARD CHARACTERS WITHOUT CLAIM TO ANY PARTICULAR FONT, STYLE, SIZE, OR COLOR.

CLASS 1—CHEMICALS

FOR SILICONE RELEASE PRODUCTS, NAMELY, SILICONE FLUIDS AND RESINS (U.S. CLS. 1, 5, 6, 10, 26 AND 46).

CLASS 17—RUBBER GOODS

FOR SILICONE RELEASE PRODUCTS, NAMELY, SILICONE BASED SEALANTS AND ADHESIVES (U.S. CLS. 1, 5, 12, 13, 35 AND 50).

ROBERT LAVACHE, EXAMINING ATTORNEY

SN 77-129,155. QUATTRO WIRELESS, INC., WALTHAM, MA. FILED 3-13-2007.

GET MOBILE

THE MARK CONSISTS OF STANDARD CHARACTERS WITHOUT CLAIM TO ANY PARTICULAR FONT, STYLE, SIZE, OR COLOR.

CLASS 35—ADVERTISING AND BUSINESS

FOR ADVERTISING SERVICES; DISSEMINATION OF ADVERTISING FOR OTHERS VIA THE INTERNET AND MOBILE COMMUNICATIONS NETWORKS; ONLINE ADVERTISING AND MARKETING SERVICES (U.S. CLS. 100, 101 AND 102).

CLASS 42—SCIENTIFIC AND COMPUTER SERVICES

FOR DESIGN AND DEVELOPMENT OF WEBSITES FOR OTHERS; COMPUTER SERVICES, NAMELY CONVERSION OF WEBSITE DATA AND IMAGES INTO SMALLER FORM AND OPTIMIZATION OF WEB SITE LAYOUTS FOR VIEWING ON MOBILE DEVICES FOR OTHERS (U.S. CLS. 100 AND 101).

LAURA KOVALSKY, EXAMINING ATTORNEY

SN 77-129,179. ICP ELECTRONICS, INC., TAIPEI COUNTY, TAIWAN, FILED 3-13-2007.



THE MARK CONSISTS OF THE STYLIZED LETTERS "IOVU" TO THE LEFT OF A SMILEY FACE DESIGN. THE FEATURES OF THE SMILEY FACE ARE DEPICTED WITH STYLIZED LETTERS, I.E., AN "I" AND "O" FOR THE EYES, A "V" FOR THE NOSE, AND A "U" FOR THE MOUTH. A STYLIZED FINGER IS TOUCHING THE RIGHT EYE OF THE SMILEY FACE DESIGN.

CLASS 9—ELECTRICAL AND SCIENTIFIC APPARATUS

FOR INDUSTRIAL COMPUTERS; TFT DISPLAYS, NAMELY, THIN FILM TRANSISTOR LIQUID CRYSTAL DISPLAYS; COMPUTER WORKSTATIONS COMPRISED OF MONITORS AND CPUS; MICRO-COMPUTERS; MICRO PROCESSORS; RECORDED COMPUTER SOFTWARE FOR DRIVING THE HUMAN MACHINE INTERFACES RECORDED ON CD-ROMS; ELECTRONIC DATA PROCESSORS; COMPUTER INTERFACE DEVICES, NAMELY, COMPUTER INTERFACE CARDS; COMPUTER TERMINALS; ELECTRIC CONTROL PANELS; COMPUTER NETWORK CONTROLLERS, NAMELY, PROGRAMMING MACHINES (U.S. CLS. 21, 23, 26, 36 AND 38).

CLASS 42—SCIENTIFIC AND COMPUTER SERVICES

FOR COMPUTER SOFTWARE DEVELOPMENT; INDUSTRIAL DESIGN; INTEGRATION OF COMPUTER SYSTEMS, COMPUTER HARDWARE, AND COMPUTER SOFTWARE (U.S. CLS. 100 AND 101).

JORDAN BAKER, EXAMINING ATTORNEY

SN 77-129,675. SALLIE MAE, INC., RESTON, VA. FILED 3-13-2007.

WhizKid

THE MARK CONSISTS OF STANDARD CHARACTERS WITHOUT CLAIM TO ANY PARTICULAR FONT, STYLE, SIZE, OR COLOR.

OWNER OF U.S. REG. NO. 1,422,583.

CLASS 9—ELECTRICAL AND SCIENTIFIC APPARATUS

FOR COMPUTER SOFTWARE FOR LOAN ORIGINATION PROCESSING (U.S. CLS. 21, 23, 26, 36 AND 38).

FIRST USE 7-15-1985; IN COMMERCE 7-15-1985.

CLASS 36—INSURANCE AND FINANCIAL

FOR FINANCIAL INFORMATION PROCESSING; FINANCIAL INFORMATION PROVIDED BY ELECTRONIC MEANS; STUDENT LOAN SERVICES (U.S. CLS. 100, 101 AND 102).

FIRST USE 7-15-1985; IN COMMERCE 7-15-1985.

TAMARA FRAZIER, EXAMINING ATTORNEY

SN 77-129,931. BNI ENTERPRISES, INC., UPLAND, CA. FILED 3-13-2007.

BNI

THE MARK CONSISTS OF STANDARD CHARACTERS WITHOUT CLAIM TO ANY PARTICULAR FONT, STYLE, SIZE, OR COLOR.

OWNER OF U.S. REG. NOS. 1,805,510 AND 2,233,431.

CLASS 35—ADVERTISING AND BUSINESS

FOR ORGANIZING WEEKLY BUSINESS MEETINGS FOR THE PURPOSE OF DEVELOPING BUSINESS NETWORKING RELATIONSHIPS AND PROMOTING BUSINESS CONNECTIONS; PROVIDING BUSINESS NETWORKING OPPORTUNITIES IN THE NATURE OF GATHERINGS TO EDUCATE ITS MEMBERS ON HOW TO PROMOTE THEIR BUSINESS; PROVIDING FACILITIES AND A LIVE FORUM FOR BUSINESS PEOPLE TO EXCHANGE BUSINESS IDEAS, REFERRALS, CONTACTS, SERVICES, AND BUSINESS; AND PROVIDING INFORMATION AND ADVICE FOR THE PROMOTION OF BUSINESS NETWORKING (U.S. CLS. 100, 101 AND 102).

FIRST USE 2-16-1993; IN COMMERCE 2-16-1993.

CLASS 41—EDUCATION AND ENTERTAINMENT

FOR EDUCATIONAL SERVICES, NAMELY, CONDUCTING CONFERENCES AND SEMINARS IN THE FIELD OF BUSINESS PROMOTION (U.S. CLS. 100, 101 AND 107).

FIRST USE 2-16-1993; IN COMMERCE 2-16-1993.

DAVID MURRAY, EXAMINING ATTORNEY

SN 77-129,949. INDEPENDENT CYCLE, INC., RAPID CITY, SD. FILED 3-13-2007.



THE MARK CONSISTS OF A STAR.

CLASS 12—VEHICLES

FOR MOTORCYCLES, FRAMES, SUSPENSIONS, AND STRUCTURAL COMPONENTS FOR MOTORCYCLES (U.S. CLS. 19, 21, 23, 31, 35 AND 44).

FIRST USE 0-0-2000; IN COMMERCE 0-0-2000.

CLASS 25—CLOTHING

FOR CLOTHING, NAMELY, T-SHIRTS, SHIRTS, SWEATSHIRTS, HATS, SHORTS, PANTS, GLOVES, AND JACKETS (U.S. CLS. 22 AND 39).

FIRST USE 0-0-2000; IN COMMERCE 0-0-2000.

CHARLES L. JENKINS, EXAMINING ATTORNEY

SN 77-130,270. NEWCOMER SUPPLY, INC., MIDDLETON, WI. FILED 3-13-2007.

NEWCOMER SUPPLY

THE MARK CONSISTS OF STANDARD CHARACTERS WITHOUT CLAIM TO ANY PARTICULAR FONT, STYLE, SIZE, OR COLOR.

NO CLAIM IS MADE TO THE EXCLUSIVE RIGHT TO USE "SUPPLY", APART FROM THE MARK AS SHOWN.

CLASS 1—CHEMICALS

FOR HISTOLOGICAL FIXATIVES, STAINS, AND REAGENTS FOR SCIENTIFIC OR RESEARCH USE (U.S. CLS. 1, 5, 6, 10, 26 AND 46).

FIRST USE 9-0-1986; IN COMMERCE 9-0-1986.

CLASS 5—PHARMACEUTICALS

FOR HISTOLOGICAL FIXATIVES, STAINS, AND REAGENTS FOR CLINICAL OR MEDICAL USE (U.S. CLS. 6, 18, 44, 46, 51 AND 52).

FIRST USE 9-0-1986; IN COMMERCE 9-0-1986.

CLASS 9—ELECTRICAL AND SCIENTIFIC APPARATUS

FOR HISTOLOGICAL CONTROL SLIDES AND ADHESIVE SLIDES FOR SCIENTIFIC OR RESEARCH USE (U.S. CLS. 21, 23, 26, 36 AND 38).

FIRST USE 9-0-1987; IN COMMERCE 9-0-1987.

CLASS 10—MEDICAL APPARATUS

FOR HISTOLOGICAL CONTROL SLIDES AND ADHESIVE SLIDES FOR MEDICAL, CLINICAL OR VETERINARY USE (U.S. CLS. 26, 39 AND 44).

FIRST USE 9-0-1987; IN COMMERCE 9-0-1987.

JULIE GUTTADAURO, EXAMINING ATTORNEY

SN 77-130,414. SODEXHO ALLIANCE, MONTIGNY-LE-BRETONNEUX, FRANCE, FILED 3-14-2007.

zenngo

PRIORITY CLAIMED UNDER SEC. 44(D) ON FRANCE APPLICATION NO. 073475217, FILED 1-17-2007, REG. NO. 073475217, DATED 1-17-2007, EXPIRES 1-17-2017.

THE COLOR(S) PINK AND PURPLE IS/ARE CLAIMED AS A FEATURE OF THE MARK.

THE MARK CONSISTS OF THE WORD "ZENGO" SHOWN IN LOWER-CASE LETTERS, WITH THE LETTERS "ZEN" SHOWN IN PINK, AND THE LETTERS "GO" SHOWN IN PURPLE, WITH THE LETTER "N" SHOWN IN A STYLIZED MANNER SUGGESTING A BUILDING WITH A SLOPED ROOF AND A CHIMNEY. AS USED IN THE FOREGOING DESCRIPTION, PINK REFERS TO PANTONE 233C AND PURPLE REFERS TO PANTONE 261C.

CLASS 37—CONSTRUCTION AND REPAIR

FOR JANITORIAL SERVICES, NAMELY, CLEANING OF BUILDING INTERIORS; WINDOW CLEANING; LAUNDRING; LINEN IRONING; MENDING CLOTHING; VEHICLE CLEANING; INSTALLATION AND REPAIR OF COMPUTERS AND COMPUTER HARDWARE, TELEPHONE INSTALLATION AND REPAIR; BOILER INSTALLATION AND REPAIR, BUILDING SPACE HEATING EQUIPMENT INSTALLATION AND REPAIR, KITCHEN APPLIANCE INSTALLATION AND REPAIR, FREEZER INSTALLATION AND REPAIR, INSTALLATION AND REPAIR OF SECURITY LOCKS, FIRE ALARM INSTALLATION AND REPAIR, BURGLAR ALARM INSTALLATION AND REPAIR, PAINTING, PLASTERING, PLUMBING, ROOFING SERVICES, PAPER HANGING (U.S. CLS. 100, 103 AND 106).

CLASS 41—EDUCATION AND ENTERTAINMENT

FOR COMPUTER EDUCATION TRAINING (U.S. CLS. 100, 101 AND 107).

CLASS 44—MEDICAL, BEAUTY AND AGRICULTURAL SERVICES

FOR HOME HEALTH CARE SERVICES; LANDSCAPE GARDENING (U.S. CLS. 100 AND 101).

CLASS 45—PERSONAL AND LEGAL SERVICES

FOR BABY SITTING (U.S. CLS. 100 AND 101).
TIMOTHY FINNEGAN, EXAMINING ATTORNEY

SN 77-130,416. INGRAM ENTITIES, INC., MACON, GA. FILED 3-14-2007.



NO CLAIM IS MADE TO THE EXCLUSIVE RIGHT TO USE "DIVERSIFIED CAPITAL MANAGEMENT", APART FROM THE MARK AS SHOWN.

THE STIPPLING IS FOR SHADING PURPOSES ONLY.

THE MARK CONSISTS OF THE TOP OF A BUILDING WHICH RESEMBLES THE CAPITAL BUILDING IN WASHINGTON DC AND THE WORDS "DIVERSIFIED CAPITAL MANAGEMENT" APPEAR BELOW THE BUILDING.

CLASS 35—ADVERTISING AND BUSINESS

FOR REAL ESTATE ADVERTISING SERVICES; EVALUATION OF STANDING TIMBER (U.S. CLS. 100, 101 AND 102).

FIRST USE 2-4-2007; IN COMMERCE 2-4-2007.

CLASS 36—INSURANCE AND FINANCIAL

FOR ASSESSMENT AND MANAGEMENT OF REAL ESTATE; EVALUATION OF REAL PROPERTY; FINANCIAL VALUATION OF PERSONAL PROPERTY AND REAL ESTATE; LEASING OF REAL ESTATE; REAL ESTATE ACQUISITION SERVICES; REAL ESTATE CONSULTATION; REAL ESTATE INVESTMENT; REAL ESTATE MANAGEMENT; REAL ESTATE MANAGEMENT CONSULTATION; REAL ESTATE PROCUREMENT FOR OTHERS; REAL ESTATE VALUATION SERVICES; REAL ESTATE VALUATIONS (U.S. CLS. 100, 101 AND 102).

FIRST USE 2-4-2007; IN COMMERCE 2-4-2007.

CLASS 37—CONSTRUCTION AND REPAIR

FOR REAL ESTATE DEVELOPMENT; REAL ESTATE SITE SELECTION (U.S. CLS. 100, 103 AND 106).

FIRST USE 2-4-2007; IN COMMERCE 2-4-2007.
TIMOTHY FINNEGAN, EXAMINING ATTORNEY

SN 77-130,446. PLACEMENTS YOUNG INC., MIRABEL, CANADA, FILED 3-14-2007.



NO CLAIM IS MADE TO THE EXCLUSIVE RIGHT TO USE "SPA INTERNATIONAL", APART FROM THE MARK AS SHOWN.

THE MARK CONSISTS OF A STYLIZED DESIGN OF THE LETTERS "E", "S" AND "I"; LETTER "S" APPEARS AS A VERTICAL WAVY LINE BETWEEN "E" AND "I". LETTERS "E" AND "I" HAVE A MARBLED TEXTURE, WHEREIN "S" IS SOLID. THE WORDS "ESTHÉTIQUE SPA INTERNATIONAL" APPEAR IN A COLUMN UNDER THE LETTER "I".

THE ENGLISH TRANSLATION OF THE FRENCH WORD "ESTHÉTIQUE" IN THE MARK IS "AESTHETIC".

SN 77-130,436. PLACEMENTS YOUNG INC., MIRABEL, CANADA, FILED 3-14-2007.

E.S.I.

THE MARK CONSISTS OF STANDARD CHARACTERS WITHOUT CLAIM TO ANY PARTICULAR FONT, STYLE, SIZE, OR COLOR.

CLASS 16—PAPER GOODS AND PRINTED MATTER

FOR PRINTED PUBLICATIONS FOR PROFESSIONALS IN THE DOMAIN OF AESTHETICS AND SPAS, NAMELY, BOOKS, MAGAZINES, NEWSPAPERS, BROCHURES, PAMPHLETS, AND CATALOGUES IN THE FIELD OF BODY CARE, COSMETICS, SKIN CARE AND SPA SERVICES; STICKERS; NOTEPADS; CALENDARS; NOTEBOOKS; POSTCARDS (U.S. CLS. 2, 5, 22, 23, 29, 37, 38 AND 50).

CLASS 35—ADVERTISING AND BUSINESS

FOR ORGANIZING SALONS AND EXPOSITIONS IN THE DOMAIN OF AESTHETICS AND SPAS, NAMELY, ARRANGING AND CONDUCTING TRADE SHOW EXHIBITIONS IN THE FIELD OF COSMETIC BODY CARE, COSMETICS, SKIN CARE, AND SPA SERVICES AND EQUIPMENT (U.S. CLS. 100, 101 AND 102).

MICHAEL TANNER, EXAMINING ATTORNEY

CLASS 16—PAPER GOODS AND PRINTED MATTER

FOR PRINTED PUBLICATIONS FOR PROFESSIONALS IN THE DOMAIN OF AESTHETICS AND SPAS, NAMELY, BOOKS, MAGAZINES, NEWSPAPERS, BROCHURES, PAMPHLETS, AND CATALOGUES IN THE FIELD OF BODY CARE, COSMETICS, SKIN CARE AND SPA SERVICES; STICKERS; NOTEPADS; CALENDARS; NOTEBOOKS; POSTCARDS (U.S. CLS. 2, 5, 22, 23, 29, 37, 38 AND 50).

CLASS 35—ADVERTISING AND BUSINESS

FOR ORGANIZING SALONS AND EXPOSITIONS IN THE DOMAIN OF AESTHETICS AND SPAS, NAMELY, ARRANGING AND CONDUCTING TRADE SHOW EXHIBITIONS IN THE FIELD OF COSMETIC BODY CARE, COSMETICS, SKIN CARE, AND SPA SERVICES AND EQUIPMENT (U.S. CLS. 100, 101 AND 102).

MICHAEL TANNER, EXAMINING ATTORNEY

SN 77-130,488. AMERICAN PSYCHOLOGICAL ASSOCIATION, WASHINGTON, DC. FILED 3-14-2007.

APAJOURNAL

THE MARK CONSISTS OF STANDARD CHARACTERS WITHOUT CLAIM TO ANY PARTICULAR FONT, STYLE, SIZE, OR COLOR.

CLASS 9—ELECTRICAL AND SCIENTIFIC APPARATUS

FOR ELECTRONIC JOURNALS PERTAINING TO BEHAVIORAL, PSYCHOLOGICAL AND SOCIAL SCIENCE TOPICS RECORDED ON COMPUTER MEDIA (U.S. CLS. 21, 23, 26, 36 AND 38).

CLASS 16—PAPER GOODS AND PRINTED MATTER

FOR SERIES OF PRINTED BOOKS PERTAINING TO THE BEHAVIORAL, PSYCHOLOGICAL AND SOCIAL SCIENCES (U.S. CLS. 2, 5, 22, 23, 29, 37, 38 AND 50).

CLASS 44—MEDICAL, BEAUTY AND AGRICULTURAL SERVICES

FOR PROVIDING COMPUTERIZED DATABASES IN THE FIELDS OF BEHAVIORAL, PSYCHOLOGICAL AND SOCIAL SCIENCES (U.S. CLS. 100 AND 101).
KEVON CHISOLM, EXAMINING ATTORNEY

SN 77-131,012. GUIFX, LLC, WEST PALM BEACH, FL. FILED 3-14-2007.



NO CLAIM IS MADE TO THE EXCLUSIVE RIGHT TO USE "SCORE", APART FROM THE MARK AS SHOWN. THE COLOR(S) BLUE, WHITE AND GREEN IS/ARE CLAIMED AS A FEATURE OF THE MARK.

THE MARK CONSISTS OF A SOCCER BALL-LIKE FIGURE OUTLINED IN BLUE WITH GREEN AND WHITE INTERIOR, THE WORD "CAP" IN BLUE LETTERS AND "SCORE" IN GREEN LETTERS.

CLASS 9—ELECTRICAL AND SCIENTIFIC APPARATUS

FOR COMPUTER SOFTWARE FOR TESTING AND EVALUATION OF ATHLETIC APTITUDE; DOWNLOADABLE SOFTWARE FOR TESTING AND EVALUATION OF ATHLETIC APTITUDE; EDUCATIONAL SOFTWARE FEATURING INSTRUCTION IN TESTING AND EVALUATION OF ATHLETIC APTITUDE (U.S. CLS. 21, 23, 26, 36 AND 38).

CLASS 16—PAPER GOODS AND PRINTED MATTER

FOR EDUCATIONAL PUBLICATIONS, NAMELY, EDUCATIONAL LEARNING CARDS, FLASH CARDS, ACTIVITY CARDS, WORKBOOKS, TEXTBOOKS, ACTIVITY BOOKS, STORY BOOKS, PUZZLE BOOKS, PUZZLES, TEACHER GUIDES, MANUALS, POSTERS, EDUCATIONAL CARD GAMES AND EDUCATIONAL BOOKLETS IN THE FIELD OF SCORING AND EVALUATING ATHLETIC APTITUDE; PRINTED INSTRUCTIONAL, EDUCATIONAL, AND TEACHING MATERIALS IN THE FIELD OF SCORING AND EVALUATING ATHLETIC APTITUDE (U.S. CLS. 2, 5, 22, 23, 29, 37, 38 AND 50).

CLASS 41—EDUCATION AND ENTERTAINMENT

FOR EDUCATIONAL EXAMINATION SERVICES; EDUCATIONAL TESTING; PREPARING, ADMINISTERING, AND SCORING STANDARDIZED TESTS; EDUCATION SERVICES, NAMELY, PROVIDING TESTING AND EVALUATION IN THE FIELD OF ATHLETIC APTITUDE (U.S. CLS. 100, 101 AND 107).
SANI KHOURI, EXAMINING ATTORNEY

SN 77-131,324. MOBIDIA TECHNOLOGY, INC., RICHMOND, BC, CANADA, FILED 3-14-2007.

MOBIDIA

THE MARK CONSISTS OF STANDARD CHARACTERS WITHOUT CLAIM TO ANY PARTICULAR FONT, STYLE, SIZE, OR COLOR.

CLASS 9—ELECTRICAL AND SCIENTIFIC APPARATUS

FOR COMPUTER SOFTWARE FOR USE IN COMMUNICATIONS NETWORKS, NAMELY, SOFTWARE FOR ENABLING MOBILE DEVICES TO PARTICIPATE IN WIRELESS NETWORKS AND PROVIDING MIX DATA TRAFFIC MANAGEMENT OVER SINGLE OR MIX DATA NETWORK TYPES (U.S. CLS. 21, 23, 26, 36 AND 38).

CLASS 38—COMMUNICATION

FOR TELECOMMUNICATIONS CONSULTING SERVICES IN THE FIELD OF SOFTWARE FOR USING MOBILE DEVICES IN WIRELESS NETWORKS (U.S. CLS. 100, 101 AND 104).

CLASS 42—SCIENTIFIC AND COMPUTER SERVICES

FOR IMPLEMENTATION OF COMPUTER SOFTWARE FOR OTHERS FOR ENABLING MOBILE DEVICES TO PARTICIPATE IN WIRELESS NETWORKS AND FOR PROVIDING MIX DATA TRAFFIC MANAGEMENT OVER SINGLE OR MIX DATA NETWORK TYPES; COMPUTER SOFTWARE DEVELOPMENT AND DESIGN (U.S. CLS. 100 AND 101).
BERNICE MIDDLETON, EXAMINING ATTORNEY

SN 77-131,385. LINCOLN BROADCASTING COMPANY, BRISBANE, CA. FILED 3-14-2007.

**COOKING WITH PASSION
POWERED BY CHEFS**

THE MARK CONSISTS OF STANDARD CHARACTERS WITHOUT CLAIM TO ANY PARTICULAR FONT, STYLE, SIZE, OR COLOR.

NO CLAIM IS MADE TO THE EXCLUSIVE RIGHT TO USE "COOKING" AND "CHEFS", APART FROM THE MARK AS SHOWN.

CLASS 16—PAPER GOODS AND PRINTED MATTER

FOR RECIPE BOOKLETS AND COOKBOOKS (U.S. CLS. 2, 5, 22, 23, 29, 37, 38 AND 50).

CLASS 41—EDUCATION AND ENTERTAINMENT

FOR ENTERTAINMENT SERVICES IN THE NATURE OF A TELEVISION PROGRAM IN THE FIELD OF COOKING AND CULINARY ART; ENTERTAINMENT SERVICES, NAMELY, ORGANIZING AND CONDUCTING COOKING COMPETITIONS (U.S. CLS. 100, 101 AND 107).

BENJAMIN ALLEN, EXAMINING ATTORNEY

CLASS 9—ELECTRICAL AND SCIENTIFIC APPARATUS

FOR DOWNLOADABLE PUBLICATIONS IN THE NATURE OF TEXTS OTHER THAN ADVERTISING TEXTS AND DATA FEATURING STATISTICS AND INDEXES IN CONNECTION WITH SECURITIES EXCHANGE TRANSACTIONS SUCH AS PURCHASE PRICES, INTEREST RATES, EXCHANGE RATES, COMPANIES, MARKETS AND ECONOMIC REALITIES (U.S. CLS. 21, 23, 26, 36 AND 38).

SN 77-131,449. MKP DEVELOPMENT LLC, LOS ANGELES, CA. FILED 3-14-2007.

NEW AGE OF APPAREL ENGINEERING

THE MARK CONSISTS OF STANDARD CHARACTERS WITHOUT CLAIM TO ANY PARTICULAR FONT, STYLE, SIZE, OR COLOR.

NO CLAIM IS MADE TO THE EXCLUSIVE RIGHT TO USE "APPAREL ENGINEERING", APART FROM THE MARK AS SHOWN.

CLASS 35—ADVERTISING AND BUSINESS

FOR BUSINESS CONSULTATION AND MANAGEMENT FOR THE CLOTHING AND APPAREL INDUSTRY, NAMELY, PRE-PRODUCTION MANAGEMENT; COST ASSESSMENT SERVICES (U.S. CLS. 100, 101 AND 102).

FIRST USE 10-13-2006; IN COMMERCE 10-13-2006.

CLASS 42—SCIENTIFIC AND COMPUTER SERVICES

FOR COMPUTERIZED TECHNICAL DESIGN FOR OTHERS IN THE CLOTHING AND APPAREL INDUSTRY, NAMELY, THE DESIGN OF PATTERNS AND LINE SHEETS AND MARKING AND GRADING; DESIGNING TECHNICAL PACKAGES FOR OTHERS IN THE CLOTHING AND APPAREL INDUSTRY IN THE NATURE OF STYLE DESIGN, GARMENT SKETCHES, AND SEWING INSTRUCTIONS; QUALITY CONTROL FOR OTHERS IN THE CLOTHING AND APPAREL INDUSTRY (U.S. CLS. 100 AND 101).

FIRST USE 10-13-2006; IN COMMERCE 10-13-2006.

NATALIE POLZER, EXAMINING ATTORNEY

CLASS 35—ADVERTISING AND BUSINESS

FOR CALCULATION, RECORDING, CREATION, COMPOSITION AND SYSTEMATIZATION OF STATISTICS AND INDEXES CONCERNING STOCK EXCHANGE TRANSACTIONS AND TRADING WITH FINANCIAL SECURITIES, NAMELY, STOCKS, OPTIONS, FUTURES AND OTHER DERIVATIVE INSTRUMENTS, INTEREST RATES, PRICES, EXCHANGE RATES AND OTHER ECONOMIC DATA; MANAGEMENT AND COMPILATION OF COMPUTERIZED DATABASES, NAMELY, SYSTEMATIZATION, COMPOSITION, INPUT AND RECORDING OF INFORMATION AND DATA AND SERVICES OF PROCESSING OF COMPUTER DATA CONCERNING SECURITIES INFORMATION VIA COMPUTER; RESEARCH AND INFORMATION CONCERNING COMMERCIAL AND BUSINESS MATTERS; COLLECTION, SYSTEMATIZATION AND PROVISION OF INFORMATION AND DATA IN CONNECTION WITH COMPANIES AND THE ECONOMY, COLLECTION AND SYSTEMATIZATION OF SECURITY TRADING INFORMATION AND DATA; COMPILATION AND SYSTEMATIZATION OF INFORMATION IN DATABASES AND DATABASE MANAGEMENT SERVICES, NAMELY, COLLECTION, COMPILATION AND UPDATING OF DATA (U.S. CLS. 100, 101 AND 102).

CLASS 36—INSURANCE AND FINANCIAL

FOR LIFE INSURANCE UNDERWRITING SERVICES; SECURITIES MARKET QUOTATIONS; FINANCIAL SERVICES, NAMELY, CREATION, DEVELOPMENT AND ISSUE OF FINANCIAL INSTRUMENTS IN THE NATURE OF SECURITIES, FUNDS, NOTES, CERTIFICATES, EXCHANGE TRADED FUNDS, WARRANTS, PORTFOLIOS, OPTIONS, FUTURES, TERM CONTRACTS; BANKING AND FINANCING SERVICES; DETERMINATION OF AND CALCULATIONS CONCERNING INDEXES FOR SECURITIES AND FORWARD CONTRACTS; FINANCIAL CONSULTING IN CONNECTION WITH THESE SERVICES; PROVISION OF INFORMATION CONCERNING SECURITIES MARKETS, NAMELY, REGARDING STOCKS AND OPTIONS; FINANCIAL SERVICES OF RESEARCH, DEVELOPMENT, CONSULTATION AND MONITORING IN CONNECTION WITH SECURITIES EXCHANGE INDEXES; DEFINITION, MAINTENANCE AND CALCULATION OF SECURITIES EXCHANGE INDEXES; FINANCIAL ANALYSIS OF SECURITIES EXCHANGE INFORMATION BY MEANS OF COMPUTER; SUPPLY OF SECURITIES EXCHANGE INFORMATION AND DATA (U.S. CLS. 100, 101 AND 102).

SN 77-131,503. STOXX AG, ZURICH, SWITZERLAND, FILED 3-15-2007.

VSTOXX

THE MARK CONSISTS OF STANDARD CHARACTERS WITHOUT CLAIM TO ANY PARTICULAR FONT, STYLE, SIZE, OR COLOR.

OWNER OF SWITZERLAND REG. NO. 534170, DATED 4-20-2005, EXPIRES 4-20-2015.

OWNER OF U.S. REG. NOS. 3,041,831 AND 3,076,939.

CLASS 41—EDUCATION AND ENTERTAINMENT

FOR PUBLICATION OF BOOKS, MAGAZINES, JOURNALS, NEWSPAPERS, PERIODICALS, CATALOGS AND BROCHURES FEATURING INFORMATION ON QUOTED SECURITIES, FORWARD CONTRACTS; PUBLICATION OF BROCHURES AND DATASHEETS FEATURING INDEX FIGURES; PUBLICATION OF TEXTS OTHER THAN ADVERTISING TEXTS FEATURING STATISTICS AND INDEXES IN CONNECTION WITH SECURITIES EXCHANGE TRANSACTIONS SUCH AS PURCHASE PRICES, INTEREST RATES, EXCHANGE RATES, COMPANIES, MARKETS AND ECONOMIC REALITIES; PROVIDING ON-LINE PUBLICATIONS OF TEXTS OTHER THAN ADVERTISING TEXTS AND DATA FEATURING STATISTICS AND INDEXES IN CONNECTION WITH SECURITIES EXCHANGE TRANSACTIONS SUCH AS PURCHASE PRICES, INTEREST RATES, EXCHANGE RATES, COMPANIES, MARKETS AND ECONOMIC REALITIES (U.S. CLS. 100, 101 AND 107).

CAROLYN CATALDO, EXAMINING ATTORNEY

SN 77-131,686. A VISION IN DESIGN, LLC, MATTHEWS, NC. FILED 3-15-2007.



THE MARK CONSISTS OF AN IMAGE OF A STYLIZED BLUEPRINT WITH THE WORDS "AVID A VISION IN DESIGN".

CLASS 16—PAPER GOODS AND PRINTED MATTER

FOR ARCHITECTURAL PLANS AND SPECIFICATIONS, NAMELY, STOCK AND CUSTOM RESIDENTIAL HOME PLANS (U.S. CLS. 2, 5, 22, 23, 29, 37, 38 AND 50). FIRST USE 1-1-2006; IN COMMERCE 1-1-2006.

CLASS 42—SCIENTIFIC AND COMPUTER SERVICES

FOR ARCHITECTURAL DESIGN, NAMELY, PROVIDING INTERNET-BASED STOCK AND CUSTOM RESIDENTIAL HOME PLAN SERVICES (U.S. CLS. 100 AND 101).

FIRST USE 1-1-2006; IN COMMERCE 1-1-2006.
JENNIFER VASQUEZ, EXAMINING ATTORNEY

SN 77-131,636. THE ASSOCIATION OF PET DOG TRAINERS, GREENVILLE, SC. FILED 3-15-2007.



THE COLOR(S) BROWN, WHITE AND GREEN IS/ARE CLAIMED AS A FEATURE OF THE MARK.

THE COLOR BROWN APPEARS IN THE DESIGN OF THE DOG AND THE HORIZONTAL LINES, THE COLOR WHITE APPEARS IN THE DESIGN OF THE DOG AND THE WORDING "APDT", THE COLOR GREEN APPEARS IN THE RECTANGULAR BACKGROUND AND THE WORDING "ASSOCIATION OF PET DOG TRAINERS".

SEC. 2(F) AS TO "ASSOCIATION OF PET DOG TRAINERS".

CLASS 35—ADVERTISING AND BUSINESS

FOR ASSOCIATION SERVICES, NAMELY, PROMOTING THE INTEREST OF PET DOG TRAINERS COMMITTED TO BECOMING BETTER TRAINERS THROUGH EDUCATION (U.S. CLS. 100, 101 AND 102).

FIRST USE 8-0-1993; IN COMMERCE 8-0-1993.

CLASS 41—EDUCATION AND ENTERTAINMENT

FOR DOG TRAINING SERVICES; ARRANGING AND CONDUCTING EDUCATIONAL CONFERENCES IN THE FIELD OF DOG TRAINING (U.S. CLS. 100, 101 AND 107).

FIRST USE 8-0-1993; IN COMMERCE 8-0-1993.
SHANNON TWOHIG, EXAMINING ATTORNEY

SN 77-131,747. WICZLING, JON, ST. LOUIS PARK, MN. FILED 3-15-2007.

Bloody Gorgeous

THE MARK CONSISTS OF STANDARD CHARACTERS WITHOUT CLAIM TO ANY PARTICULAR FONT, STYLE, SIZE, OR COLOR.

CLASS 30—STAPLE FOODS

FOR STAPLE FOODS, NAMELY, BEVERAGES MADE OF COFFEE, BEVERAGES MADE OF TEA AND PARFAITS (U.S. CL. 46).

CLASS 32—LIGHT BEVERAGES

FOR LIGHT BEVERAGES, NAMELY, AERATED FRUIT JUICES, AERATED WATER, BOTTLED ARTESIAN WATER, BOTTLED WATER, FLAVORED BOTTLED WATER, FLAVORED WATERS, ISOTONIC BEVERAGES, NON-ALCOHOLIC BEVERAGES, NAMELY, CARBONATED BEVERAGES, NON-ALCOHOLIC COCKTAILS, SMOOTHIES, SPARKLING WATER, TOMATO JUICE BEVERAGES, VEGETABLE JUICES (U.S. CLS. 45, 46 AND 48).

CLASS 33—WINES AND SPIRITS

FOR WINE AND DISTILLED SPIRITS (U.S. CLS. 47 AND 49).

TANYA AMOS, EXAMINING ATTORNEY

SN 77-131,938. SMITH, LUNDY, PLAYA DEL REY, UNITED STATES, FILED 3-15-2007.

SIGNSHARE

THE MARK CONSISTS OF STANDARD CHARACTERS WITHOUT CLAIM TO ANY PARTICULAR FONT, STYLE, SIZE, OR COLOR.

CLASS 9—ELECTRICAL AND SCIENTIFIC APPARATUS

FOR COMPUTER PROGRAM FOR MAKING AND DISTRIBUTING SIGNS (U.S. CLS. 21, 23, 26, 36 AND 38).

CLASS 39—TRANSPORTATION AND STORAGE

FOR DISTRIBUTION SERVICES, NAMELY, DELIVERY OF SIGNS (U.S. CLS. 100 AND 105).

CLASS 40—MATERIAL TREATMENT

FOR COMPUTERIZED SIGN MAKING SERVICES, NAMELY, SIGN PRINTING (U.S. CLS. 100, 103 AND 106).

TASNEEM HUSSAIN, EXAMINING ATTORNEY

SN 77-132,036. BLUE PRINT PROPERTIES, LLC, HUNT VALLEY, MD. FILED 3-15-2007.

THE NAKED CRAB

THE MARK CONSISTS OF STANDARD CHARACTERS WITHOUT CLAIM TO ANY PARTICULAR FONT, STYLE, SIZE, OR COLOR.

NO CLAIM IS MADE TO THE EXCLUSIVE RIGHT TO USE "CRAB", APART FROM THE MARK AS SHOWN.

CLASS 29—MEATS AND PROCESSED FOODS

FOR SEAFOOD, FISH, SHELLFISH, CRUSTACEANS, LOBSTER, CRAB, FISH FILLETS, CRAB MEAT; PACKAGE COMBINATIONS CONSISTING PRIMARILY OF CRABMEAT, PACKAGED ENTREES CONSISTING PRIMARILY OF CRABMEAT; PREPARED APPETIZERS CONSISTING PRIMARILY OF CRABMEAT; PREPARED SEAFOOD SUITABLE FOR USE AS APPETIZERS OR ENTREES; PACKAGED COMBINATIONS CONSISTING PRIMARILY OF FISH, SEAFOOD, OR CRAB MEAT; PACKAGED ENTREES CONSISTING PRIMARILY OF FISH, SEAFOOD, OR CRAB MEAT; PREPARED APPETIZERS CONSISTING PRIMARILY OF FISH, SEAFOOD, OR CRAB MEAT; FROZEN ENTREES CONSISTING PRIMARILY OF FISH, SEAFOOD, OR CRAB MEAT; FROZEN APPETIZERS CONSISTING PRIMARILY OF FISH, SEAFOOD, OR CRAB MEAT; PREPARED OR FROZEN SOUPS; ALL THE FOREGOING EXCLUDING SHRIMP (U.S. CL. 46).

CLASS 30—STAPLE FOODS

FOR SPICES AND SEASONINGS FOR SEAFOOD, FISH, SHELLFISH, CRUSTACEANS, LOBSTER, CRAB, BUT EXCLUDING SHRIMP (U.S. CL. 46).

CLASS 43—HOTEL AND RESTAURANT SERVICES

FOR RESTAURANTS, CARRY-OUT RESTAURANTS, BARS, COCKTAIL LOUNGES, RESTAURANT SERVICES, CARRY-OUT RESTAURANT SERVICES, BAR SERVICES, BAR SERVICES AND COCKTAIL LOUNGE SERVICES, AND CATERING SERVICES (U.S. CLS. 100 AND 101).

ALICIA COLLINS, EXAMINING ATTORNEY

SN 77-132,222. CINCINNATI BENGALS, INC., CINCINNATI, OH. FILED 3-15-2007.

BENGALS

THE MARK CONSISTS OF STANDARD CHARACTERS WITHOUT CLAIM TO ANY PARTICULAR FONT, STYLE, SIZE, OR COLOR.

OWNER OF U.S. REG. NOS. 940,763, 1,861,765 AND OTHERS.

CLASS 9—ELECTRICAL AND SCIENTIFIC APPARATUS

FOR FOOTBALL HELMETS, MAGNETICALLY ENCODED CREDIT CARDS, DECORATIVE MAGNETS, PRERECORDED COMPACT DISCS CONTAINING MUSIC AND AUDIO TRACKS FEATURING THE SPORT OF FOOTBALL, COMPUTER GAME SOFTWARE AND DISCS, AND VIDEO GAME CARTRIDGES (U.S. CLS. 21, 23, 26, 36 AND 38).

FIRST USE 9-0-1987; IN COMMERCE 9-0-1987.

CLASS 14—JEWELRY

FOR JEWELRY, WATCHES, CLOCKS, ORNAMENTAL PINS, EARRINGS, NECKLACES, CHARMS, COLLECTIBLE AND COMMEMORATIVE COINS MADE OF PRECIOUS METAL, PENDANTS AND KEY CHAINS MADE OF PRECIOUS METAL (U.S. CLS. 2, 27, 28 AND 50).

FIRST USE 9-0-1987; IN COMMERCE 9-0-1987.

CLASS 25—CLOTHING

FOR MEN'S, WOMEN'S AND CHILDREN'S CLOTHING, NAMELY, FLEECE TOPS AND BOTTOMS, HEADWEAR, CAPS, KNIT HATS, T-SHIRTS, SWEATSHIRTS, SHORTS, TANK TOPS, PANTS, JACKETS, GOLF SHIRTS, KNIT SHIRTS, JERSEYS, GLOVES AND APRONS (U.S. CLS. 22 AND 39).

FIRST USE 9-0-1987; IN COMMERCE 9-0-1987.

STEVEN PEREZ, EXAMINING ATTORNEY

SN 77-132,243. CINCINNATI BENGALS, INC., CINCINNATI, OH. FILED 3-15-2007.

SN 77-132,703. WORKING THE HOME, LLC, GREENCASTLE, PA. FILED 3-16-2007.

CINCINNATI BENGALS

THE MARK CONSISTS OF STANDARD CHARACTERS WITHOUT CLAIM TO ANY PARTICULAR FONT, STYLE, SIZE, OR COLOR.

OWNER OF U.S. REG. NOS. 940,763, 1,071,979 AND 1,861,765.

SEC. 2(F) "CINCINNATI".

CLASS 9—ELECTRICAL AND SCIENTIFIC APPARATUS

FOR FOOTBALL HELMETS, MAGNETICALLY ENCODED CREDIT CARDS, PRERECORDED COMPACT DISCS CONTAINING MUSIC AND AUDIO TRACKS FEATURING THE SPORT OF FOOTBALL, DECORATIVE MAGNETS, COMPUTER GAME SOFTWARE AND DISCS AND VIDEO GAME CARTRIDGES (U.S. CLS. 21, 23, 26, 36 AND 38).

FIRST USE 9-0-1987; IN COMMERCE 9-0-1987.

CLASS 28—TOYS AND SPORTING GOODS

FOR TOYS AND SPORTING GOODS, NAMELY, PLUSH TOYS, STUFFED TOY ANIMALS, PLAY FIGURES, GOLF BALLS, GOLF BAGS, FOOTBALLS, CHRISTMAS TREE ORNAMENTS, TOY TRUCKS, PLAYING CARDS, AND MINIATURE TOY HELMETS (U.S. CLS. 22, 23, 38 AND 50).

FIRST USE 9-0-1987; IN COMMERCE 9-0-1987.

STEVEN PEREZ, EXAMINING ATTORNEY

SN 77-132,570. CALIFORNIA CUSTOM FRUITS AND FLAVORS, INC., IRWINDALE, CA. FILED 3-15-2007.

CALIFORNIA CUSTOM FRUITS AND FLAVORS, INC.

THE MARK CONSISTS OF STANDARD CHARACTERS WITHOUT CLAIM TO ANY PARTICULAR FONT, STYLE, SIZE, OR COLOR.

NO CLAIM IS MADE TO THE EXCLUSIVE RIGHT TO USE "FRUITS AND FLAVORS, INC.", APART FROM THE MARK AS SHOWN.

SEC. 2(F).

CLASS 29—MEATS AND PROCESSED FOODS

FOR PRESERVED, COOKED, AND PROCESSED FRUITS, JELLIES, JAMS, AND FRUIT SAUCES, NAMELY, CRANBERRY SAUCE AND APPLE SAUCE; FROZEN FRUITS; FRUIT CHIPS; FRUIT CONSERVES; FRUIT PASTE; FRUIT PECTIN; FRUIT PRESERVES; FRUIT PULPS; FRUIT RINDS; AND FRUIT TOPPING (U.S. CL. 46).

FIRST USE 6-15-1986; IN COMMERCE 6-15-1986.

CLASS 30—STAPLE FOODS

FOR FRUIT SAUCES EXCLUDING CRANBERRY SAUCE AND APPLESAUCE; FRUIT PASTE FOR FLAVORING OF FOOD (U.S. CL. 46).

FIRST USE 6-15-1986; IN COMMERCE 6-15-1986.

LEE-ANNE BERNS, EXAMINING ATTORNEY

WORKING THE HOME

THE MARK CONSISTS OF STANDARD CHARACTERS WITHOUT CLAIM TO ANY PARTICULAR FONT, STYLE, SIZE, OR COLOR.

CLASS 16—PAPER GOODS AND PRINTED MATTER

FOR PERSONAL, HOUSEHOLD AND FAMILY MANAGEMENT SYSTEMS, NAMELY, PAPER DAY PLANNERS, ORGANIZERS, CALENDARS, AND ADDRESS BOOKS (U.S. CLS. 2, 5, 22, 23, 29, 37, 38 AND 50).

CLASS 41—EDUCATION AND ENTERTAINMENT

FOR EDUCATIONAL SERVICES, NAMELY, CONDUCTING CLASSES AND SEMINARS ON PERSONAL, HOUSEHOLD AND FAMILY MANAGEMENT (U.S. CLS. 100, 101 AND 107).

MATTHEW PAPPAS, EXAMINING ATTORNEY

SN 77-132,718. WORKING THE HOME, LLC, GREENCASTLE, PA. FILED 3-16-2007.

SIX POINTS OF PEACE

THE MARK CONSISTS OF STANDARD CHARACTERS WITHOUT CLAIM TO ANY PARTICULAR FONT, STYLE, SIZE, OR COLOR.

CLASS 16—PAPER GOODS AND PRINTED MATTER

FOR PERSONAL, HOUSEHOLD AND FAMILY MANAGEMENT SYSTEMS, NAMELY, PAPER DAY PLANNERS, ORGANIZERS, CALENDARS, AND ADDRESS BOOKS (U.S. CLS. 2, 5, 22, 23, 29, 37, 38 AND 50).

CLASS 41—EDUCATION AND ENTERTAINMENT

FOR EDUCATIONAL SERVICES, NAMELY, CONDUCTING CLASSES AND SEMINARS ON PERSONAL, HOUSEHOLD AND FAMILY MANAGEMENT (U.S. CLS. 100, 101 AND 107).

MATTHEW PAPPAS, EXAMINING ATTORNEY

SN 77-132,743. WORKING THE HOME, LLC, GREENCASTLE, PA. FILED 3-16-2007.

SN 77-133,178. IHD POWDERCOAT SERVICES, INC., NORTH KANSAS CITY, MO. FILED 3-16-2007.

BRANGI



THE MARK CONSISTS OF STANDARD CHARACTERS WITHOUT CLAIM TO ANY PARTICULAR FONT, STYLE, SIZE, OR COLOR.

NO CLAIM IS MADE TO THE EXCLUSIVE RIGHT TO USE "POWDERCOAT SERVICES, INC.", APART FROM THE MARK AS SHOWN.

CLASS 16—PAPER GOODS AND PRINTED MATTER

FOR PERSONAL, HOUSEHOLD AND FAMILY MANAGEMENT SYSTEMS, NAMELY, PAPER DAY PLANNERS, ORGANIZERS, CALENDARS, AND ADDRESS BOOKS (U.S. CLS. 2, 5, 22, 23, 29, 37, 38 AND 50).

THE MARK CONSISTS OF THE WORDING "IHD" ABOVE THE WORDING "POWDERCOAT SERVICES, INC". A DESIGN OF A CABLE IS PARTIALLY SITUATED BELOW THE WORDING "POWDERCOAT SERVICES, INC"., WRAPS AROUND THE LEFT SIDE OF THE WORDING, RUNS THROUGH THE MIDDLE OF "IHD" AND ENDS IN A DESIGN APPROXIMATING SPRAYING PARTICLES.

CLASS 41—EDUCATION AND ENTERTAINMENT

FOR EDUCATIONAL SERVICES, NAMELY, CONDUCTING CLASSES AND SEMINARS ON PERSONAL, HOUSEHOLD AND FAMILY MANAGEMENT (U.S. CLS. 100, 101 AND 107).

MATTHEW PAPPAS, EXAMINING ATTORNEY

CLASS 37—CONSTRUCTION AND REPAIR

FOR APPLYING DECORATIVE COATINGS TO METAL, WOOD AND PLASTICS (U.S. CLS. 100, 103 AND 106).

CLASS 40—MATERIAL TREATMENT

FOR APPLICATION OF PROTECTIVE COATINGS (U.S. CLS. 100, 103 AND 106).

RICHARD A. STRASER, EXAMINING ATTORNEY

SN 77-132,841. ADVANTAGE EQUITY SERVICES, INC., PITTSBURGH, PA. FILED 3-16-2007.

SN 77-133,313. MISTER HOLLYWOOD CO., LTD., OSAKA-SHI, OSAKA, JAPAN, FILED 3-16-2007.



N . HOOLYWOOD
 1/2 MISTER HÖLLYWOOD

OWNER OF U.S. REG. NOS. 2,627,126 AND 2,661,130.

CLASS 14—JEWELRY

FOR JEWELRY, NAMELY, EMBLEMS OF PRECIOUS METAL FOR PLACEMENT ON CLOTHING, NECKLACES, BRACELETS, PENDANTS AND RINGS (U.S. CLS. 2, 27, 28 AND 50).

CLASS 36—INSURANCE AND FINANCIAL

FOR REAL ESTATE TITLE INSURANCE SERVICES (U.S. CLS. 100, 101 AND 102).
 FIRST USE 1-1-2007; IN COMMERCE 1-1-2007.

CLASS 25—CLOTHING

FOR BLOUSONS, BLAZERS, PARKAS, JACKETS, JUMPERS, SUITS, PANTS, COATS, SWEATERS, VESTS, SHIRTS, SWEAT SHIRTS, SWEAT PANTS, POLO SHIRTS, TEE-SHIRTS, UNDERWEAR, SOCKS, STOLERS, SHAWLS, SCARFS, NECKTIES, NECKERCHIEFS, BANDANAS, MUFFLERS, HATS, STOCKING SUSPENDERS, BRACES IN THE NATURE OF SUSPENDERS, WAISTBANDS, BELTS, FOOTWEAR, AND SPECIAL SPORTING/GYMNASTIC FOOTWEAR (U.S. CLS. 22 AND 39).
 TRACY WHITTAKER-BROWN, EXAMINING ATTORNEY

CLASS 45—PERSONAL AND LEGAL SERVICES

FOR REAL ESTATE CLOSING SERVICES (U.S. CLS. 100 AND 101).
 FIRST USE 1-1-2007; IN COMMERCE 1-1-2007.
 AMEETA JORDAN, EXAMINING ATTORNEY

SN 77-133,350. ROBERTONI S.A. DE C.V., SAN SALVADOR, EL SALVADOR, FILED 3-16-2007.

SN 77-133,787. HERO SOLUTION, INC., LAS VEGAS, NV, FILED 3-17-2007.

Robertoni

THE MARK CONSISTS OF STANDARD CHARACTERS WITHOUT CLAIM TO ANY PARTICULAR FONT, STYLE, SIZE, OR COLOR.

THE WORDING "ROBERTONI" IN THE MARK HAS NO MEANING IN A FOREIGN LANGUAGE.

CLASS 29—MEATS AND PROCESSED FOODS

FOR MEAT; FISH; MEAT EXTRACT; SOUPS; PRESERVED FRUITS; PRESERVED VEGETABLES; DRIED FRUITS; DRIED VEGETABLES; JELLIES; JAMS; COM-POTES; EGGS; MILK; MILK PRODUCTS, EXCLUDING ICE CREAM, ICE MILK AND FROZEN YOGURT; OILS FOR FOOD; EDIBLE FATS (U.S. CL. 46).

CLASS 30—STAPLE FOODS

FOR COFFEE; SPICES; TEA; COCOA; SUGAR; ICE; SALT; RICE; VINEGAR; TAPIOCA; SAGO; COFFEE SUBSTITUTES; FLOUR; PREPARATIONS OF CEREAL, NAMELY, CEREAL BASED SNACK FOODS; BREAD; PASTRY; CONFECTIONERY, NAMELY, PASTILLES; PASTA; SAUCES; ICE CREAM; HONEY; MOLASSES; YEAST; MUSTARD (U.S. CL. 46).

KATHERINE M. DUBRAY, EXAMINING ATTORNEY

SN 77-133,505. TELEVISA, S.A. DE C.V., COLONIA ZEDEC SANTA FE, MEXICO, FILED 3-16-2007.

SUPER MAMA

THE MARK CONSISTS OF STANDARD CHARACTERS WITHOUT CLAIM TO ANY PARTICULAR FONT, STYLE, SIZE, OR COLOR.

CLASS 9—ELECTRICAL AND SCIENTIFIC APPARATUS

FOR PRERECORDED DIGITAL VIDEO DISCS (DVDS) CONTAINING VARIETY TELEVISION PROGRAMS (U.S. CLS. 21, 23, 26, 36 AND 38).

CLASS 41—EDUCATION AND ENTERTAINMENT

FOR ENTERTAINMENT SERVICES, NAMELY, AN ONGOING VARIETY TELEVISION PROGRAM (U.S. CLS. 100, 101 AND 107).

LYDIA BELZER, EXAMINING ATTORNEY

STOP SITTING ON YOUR ASSETS

THE MARK CONSISTS OF STANDARD CHARACTERS WITHOUT CLAIM TO ANY PARTICULAR FONT, STYLE, SIZE, OR COLOR.

CLASS 36—INSURANCE AND FINANCIAL

FOR FINANCIAL CONSULTATION; FINANCIAL CONSULTATION IN THE FIELD OF REAL ESTATE EQUITY MANAGEMENT; FINANCIAL LOAN CONSULTATION; FINANCIAL PLANNING; FINANCIAL PLANNING CONSULTATION; FINANCIAL PLANNING FOR RETIREMENT; FINANCIAL PLANNING, NAMELY, THE CREATION OF PERSONALIZED STRATEGIES TO ACHIEVE FINANCIAL INDEPENDENCE; FINANCIAL RESEARCH; FINANCIAL SERVICES IN THE FIELD OF MONEY LENDING; FINANCIAL SERVICES, NAMELY, MONEY LENDING; FINANCIAL SERVICES, NAMELY, MORTGAGE PLANNING; HOUSING SERVICES, NAMELY, REAL PROPERTY ACQUISITION AND CONSUMER FINANCING TO FACILITATE HOME OWNERSHIP; INSURANCE CONSULTATION; INVESTMENT SERVICES, NAMELY, ASSET ACQUISITION, CONSULTATION, DEVELOPMENT AND MANAGEMENT SERVICES; MORTGAGE BANKING SERVICES, NAMELY, ORIGINATION, ACQUISITION, SERVICING, SECURITIZATION AND BROKERAGE OF MORTGAGE LOANS; MORTGAGE SERVICES, NAMELY, BUYER PRE-QUALIFICATION OF MORTGAGES FOR MORTGAGE BROKERS AND BANKS; REAL ESTATE CONSULTANCY; REAL ESTATE CONSULTATION; REAL ESTATE LENDING SERVICES (U.S. CLS. 100, 101 AND 102).

CLASS 41—EDUCATION AND ENTERTAINMENT

FOR BUSINESS TRAINING; MAGAZINE PUBLISHING; MULTIMEDIA PUBLISHING OF BOOKS, MAGAZINES, JOURNALS, SOFTWARE, GAMES, MUSIC, AND ELECTRONIC PUBLICATIONS; ON-LINE PUBLICATION OF NEWSLETTERS AND TEXTBOOKS FOR TRAINING CLASSES; PROVIDING NEWSLETTERS IN THE FIELD OF ASSET MANAGEMENT VIA E-MAIL; PROVIDING ON-LINE PUBLICATIONS IN THE NATURE OF TEXTBOOKS FOR TRAINING AND EDUCATION PROGRAMS IN THE FIELD OF ASSET MANAGEMENT; PROVIDING ON-LINE TRAINING SESSIONS AND CLASSES IN THE FIELD OF ASSET MANAGEMENT, MORTGAGE PLANNING, REAL ESTATE INVESTMENT, REAL ESTATE EQUITY MANAGEMENT AND RETIREMENT PLANNING; PUBLICATION OF BOOKS; PUBLICATION OF BOOKS, OF MAGAZINES, OF JOURNALS, OF NEWSPAPERS, OF PERIODICALS, OF CATALOGS, OF BROCHURES; PUBLICATION OF ELECTRONIC MAGAZINES; PUBLICATION OF PRINTED MATTER; PUBLISHING OF BOOKS, MAGAZINES; PUBLISHING OF ELECTRONIC PUBLICATIONS; PUBLISHING OF WEB MAGAZINES; CONDUCTING WORKSHOPS AND SEMINARS IN FINANCE, INSURANCE, MORTGAGE BANKING, REAL ESTATE INVESTMENT, MORTGAGE PLANNING AND REAL ESTATE EQUITY MANAGEMENT; EDUCATION SERVICES, NAMELY, PROVIDING LIVE AND ON-LINE TRAINING AND CLASSES IN THE FIELD OF FINANCE, MORTGAGE PLANNING, RETIREMENT PLANNING, FINANCIAL PLANNING AND REAL ESTATE EQUITY MANAGEMENT; WORKSHOPS AND SEMINARS IN THE FIELD OF FINANCE, INSURANCE, MORTGAGE PLANNING, REAL ESTATE INVESTMENT, FINANCIAL PLANNING IN THE NATURE OF REAL ESTATE EQUITY MANAGEMENT (U.S. CLS. 100, 101 AND 107).

BILL DAWE, EXAMINING ATTORNEY

SN 77-134,915. VISA INTERNATIONAL SERVICE ASSOCIATION, FOSTER CITY, CA. FILED 3-19-2007.

VISA INTELLILINK

THE MARK CONSISTS OF STANDARD CHARACTERS WITHOUT CLAIM TO ANY PARTICULAR FONT, STYLE, SIZE, OR COLOR.

CLASS 35—ADVERTISING AND BUSINESS

FOR PROVIDING BROAD BASED FINANCIAL INFORMATION SERVICES, NAMELY, FINANCIAL RECORDS MANAGEMENT (U.S. CLS. 100, 101 AND 102).

CLASS 36—INSURANCE AND FINANCIAL

FOR CREDIT CARD SERVICES, DEBIT CARD SERVICES; PROVIDING CREDIT AND DEBIT PAYMENT DATA AND REPORTS; FINANCIAL ASSESSMENT AND RISK MANAGEMENT SERVICES; CREDIT MANAGEMENT SERVICES IN THE FIELD OF FINANCIAL ASSESSMENT AND RISK MANAGEMENT; DISSEMINATION OF FINANCIAL INFORMATION VIA A GLOBAL COMPUTER NETWORK. FINANCIAL INFORMATION RENDERED BY COMPUTER BY MEANS OF A SECURE INFORMATION COMPUTER NETWORK; ADVISORY SERVICES RELATING TO CREDIT AND DEBIT PAYMENT SERVICES (U.S. CLS. 100, 101 AND 102).
EMILY CARLSEN, EXAMINING ATTORNEY

SN 77-135,089. CHIANTI CASHMERE COMPANY SRL, POGGIBONSI (SIENA), ITALY, FILED 3-20-2007.

**CHIANTI
CASHMERE**



COMPANY

PRIORITY CLAIMED UNDER SEC. 44(D) ON ERPN CMNTY TM OFC APPLICATION NO. 5484886, FILED 11-20-2006, REG. NO. 5484886, DATED 11-29-2007, EXPIRES 11-20-2016.

NO CLAIM IS MADE TO THE EXCLUSIVE RIGHT TO USE "CHIANTI CASHMERE COMPANY", APART FROM THE MARK AS SHOWN.

CLASS 3—COSMETICS AND CLEANING PREPARATIONS

FOR COSMETICS, NAMELY, BODY SOAPS, SHAMPOOS, HYDRATING FLUID, PERFUMES AND ESSENTIAL OILS FOR PERSONAL USE; LIQUID SOAP FOR WASHING CASHMERE AND OTHER FINE FIBERS (U.S. CLS. 1, 4, 6, 50, 51 AND 52).

CLASS 24—FABRICS

FOR BLANKETS, NAMELY, BED BLANKETS, BLANKET THROWS MADE IN WHOLE OR SUBSTANTIAL PART OF CASHMERE; THROWS MADE IN WHOLE OR SUBSTANTIAL PART OF CASHMERE (U.S. CLS. 42 AND 50).

CLASS 25—CLOTHING

FOR CLOTHING, NAMELY, SWEATERS MADE IN WHOLE OR SUBSTANTIAL PART OF CASHMERE; SCARVES AND SHAWLS MADE IN WHOLE OR SUBSTANTIAL PART OF CASHMERE (U.S. CLS. 22 AND 39).
PETER B. BROMAGHIM, EXAMINING ATTORNEY

SN 77-135,387. KABUSHIKI KAISHA HITACHI SEISAKUSHO (D/B/A HITACHI, LTD.), TOKYO, JAPAN, FILED 3-20-2007.

VeinID

THE MARK CONSISTS OF STANDARD CHARACTERS WITHOUT CLAIM TO ANY PARTICULAR FONT, STYLE, SIZE, OR COLOR.

CLASS 9—ELECTRICAL AND SCIENTIFIC APPARATUS

FOR COMPUTER HARDWARE AND SOFTWARE PROVIDED ON CD-ROMS FOR USE IN CONNECTION WITH SECURE PERSONAL COMPUTER LOGIN SYSTEMS, DOOR ACCESS CONTROL SYSTEMS, AUTOMATED TELLER MACHINES, AND OTHER APPLICATIONS WHERE SECURE ACCESS WOULD BE NEEDED (U.S. CLS. 21, 23, 26, 36 AND 38).

CLASS 42—SCIENTIFIC AND COMPUTER SERVICES

FOR DESIGN, INTEGRATION, AND REMOTE SUPERVISION OF SECURE ACCESS CONTROL SYSTEMS CONSISTING OF CONTROLLERS, SCANNERS, AND DOORS; MAINTENANCE OF SOFTWARE USED IN CONNECTION WITH SECURE ACCESS CONTROL SYSTEMS; CONSULTING SERVICES IN THE FIELD OF SECURE ACCESS CONTROL SYSTEMS (U.S. CLS. 100 AND 101).

JACQUELINE A. LAVINE, EXAMINING ATTORNEY

SN 77-135,407. THE VERSAILLES FOUNDATION, INC.,
NEW YORK, NY. FILED 3-20-2007.

SN 77-135,454. PHARMACEUTICAL RESEARCH AND MAN-
UFACTURERS OF AMERICA, WASHINGTON, DC.
FILED 3-20-2007.

RX RESPONSE

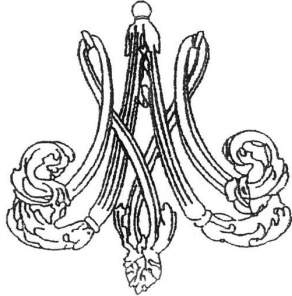

THE MARK CONSISTS OF THE LETTERS "M" AND "A"
INTERTWINED.

CLASS 20—FURNITURE AND ARTICLES NOT OTHERWISE CLASSIFIED

FOR CURTAIN RODS AND DRAPERY HARDWARE, NAMELY, TRAVERSE RODS, POLES, CURTAIN HOOKS, RINGS, CLIPS, AND FINIALS; NON-METAL WALL HOOKS, NON-METAL CLOTHES HOOKS; FURNITURE MIRRORS; HAND-HELD MIRRORS; DECORATIVE FIXTURES, NAMELY, NON-METAL TOWEL HOLDERS; STORAGE SHELVING AND CLOSET ACCESSORIES, NAMELY, CLOSET DRAWERS; UPHOLSTERED HEADBOARDS AND WINDOW SHADES; PLASTIC TISSUE BOX HOLDERS (U.S. CLS. 2, 13, 22, 25, 32 AND 50).

CLASS 21—HOUSEWARES AND GLASS

FOR BATH ACCESSORIES, NAMELY, TOOTHBRUSH HOLDERS, BEAKERS, SOAP DISHES, VANITY DISHES, VANITY BOXES FOR SORTING TOILETRIES, COSMETICS AND JEWELRY, FITTED VANITY BOXES; CERAMIC TISSUE BOX HOLDERS; DECORATIVE FIXTURES, NAMELY, SHOWER CADDIES, STORAGE CONTAINERS, NAMELY, LAUNDRY BASKETS AND BOXES MADE OF WICKER TO STORE LINENS; WASTEPAPER BASKETS (U.S. CLS. 2, 13, 23, 29, 30, 33, 40 AND 50).

CLASS 24—FABRICS

FOR CURTAIN TIE-BACK HARDWARE; COMFORTERS, QUILTS, BEDSPREADS, DUVETS AND DUVET BED COVERS, BED SHEETS, PILLOW CASES, SHAMS, MATTRESS PADS, FEATHER BEDS, BED SKIRTS, BED BLANKETS, COORDINATED TOP-OF-BED THROWS; BATH LINEN, NAMELY, TOWELS, WASHCLOTHS, BATH SHEETS; BEACH TOWELS; SHOWER CURTAINS; WINDOW TREATMENTS, NAMELY, CURTAINS, DRAPERIES, SHEERS AND VALANCES (U.S. CLS. 42 AND 50).
EMILY CARLSEN, EXAMINING ATTORNEY

THE MARK CONSISTS OF STANDARD CHARACTERS WITHOUT CLAIM TO ANY PARTICULAR FONT, STYLE, SIZE, OR COLOR.

CLASS 16—PAPER GOODS AND PRINTED MATTER

FOR PUBLICATIONS, NAMELY, PAMPHLETS AND NEWSLETTERS REGARDING PHARMACEUTICALS AND EMERGENCY PLANNING AND PREPAREDNESS (U.S. CLS. 2, 5, 22, 23, 29, 37, 38 AND 50).

CLASS 44—MEDICAL, BEAUTY AND AGRICULTURAL SERVICES

FOR PROVIDING ON-LINE INFORMATION IN THE FIELD OF PHARMACEUTICALS AND MEDICAL EMERGENCY PLANNING AND PREPAREDNESS (U.S. CLS. 100 AND 101).

CLASS 45—PERSONAL AND LEGAL SERVICES

FOR PROVIDING INFORMATION SERVICES IN THE FIELD OF EMERGENCY PLANNING AND PREPAREDNESS (U.S. CLS. 100 AND 101).

JILL PRATER, EXAMINING ATTORNEY

SN 77-135,732. ACXIOM CORPORATION, LITTLE ROCK,
AR. FILED 3-20-2007.

CDI-X

THE MARK CONSISTS OF STANDARD CHARACTERS WITHOUT CLAIM TO ANY PARTICULAR FONT, STYLE, SIZE, OR COLOR.

CLASS 9—ELECTRICAL AND SCIENTIFIC APPARATUS

FOR COMPUTER SOFTWARE FOR CREATING SEARCHABLE DATABASES OF INFORMATION AND DATA (U.S. CLS. 21, 23, 26, 36 AND 38).

CLASS 35—ADVERTISING AND BUSINESS

FOR INFORMATION AND DATA COMPILING AND ANALYZING RELATED TO BUSINESS MANAGEMENT (U.S. CLS. 100, 101 AND 102).
MORGAN WYNNE, EXAMINING ATTORNEY

SN 77-135,740. ACXIOM CORPORATION, LITTLE ROCK, AR. FILED 3-20-2007.

SN 77-136,205. DERMWORX, INC., HOLLYWOOD, FL. FILED 3-21-2007.

ACXIOM CDI-X

OPTIMIZING DERMATOLOGICAL EFFICACY WITH SMALL MOLECULE TECHNOLOGY

THE MARK CONSISTS OF STANDARD CHARACTERS WITHOUT CLAIM TO ANY PARTICULAR FONT, STYLE, SIZE, OR COLOR.
OWNER OF U.S. REG. NOS. 1,907,571, 3,232,323 AND OTHERS.

THE MARK CONSISTS OF STANDARD CHARACTERS WITHOUT CLAIM TO ANY PARTICULAR FONT, STYLE, SIZE, OR COLOR.

CLASS 9—ELECTRICAL AND SCIENTIFIC APPARATUS

FOR COMPUTER SOFTWARE FOR CREATING SEARCHABLE DATABASES OF INFORMATION AND DATA IN THE FIELD OF CONSUMER INFORMATION FOR BUSINESSES (U.S. CLS. 21, 23, 26, 36 AND 38).

CLASS 5—PHARMACEUTICALS

FOR TOPICAL COMPOUNDS AND DERMATOLOGICAL PREPARATIONS FOR MEDICAL USE, NAMELY, MEDICATED LOTIONS, CREAMS, AND OINTMENTS FOR SKIN AND FACE FOR TREATMENT OF DERMATOLOGICAL CONDITIONS (U.S. CLS. 6, 18, 44, 46, 51 AND 52).

CLASS 35—ADVERTISING AND BUSINESS

FOR INFORMATION AND DATA COMPILING AND ANALYZING RELATED TO BUSINESS MANAGEMENT IN THE FIELD OF CONSUMER INFORMATION FOR BUSINESSES (U.S. CLS. 100, 101 AND 102).
MORGAN WYNNE, EXAMINING ATTORNEY

CLASS 42—SCIENTIFIC AND COMPUTER SERVICES

FOR PHARMACEUTICAL RESEARCH SERVICES, NAMELY, DEVELOPMENT OF DERMATOLOGICAL COMPOUNDS AND PREPARATION FOR MEDICAL USE, AND COSMETICS; PHARMACEUTICAL DRUG DEVELOPMENT SERVICES (U.S. CLS. 100 AND 101).
AMY MCMENAMIN, EXAMINING ATTORNEY

SN 77-136,163. DERMWORX, INC., HOLLYWOOD, FL. FILED 3-21-2007.

SN 77-136,213. DERMWORX, INC., HOLLYWOOD, FL. FILED 3-21-2007.

DERMWORX

OPTIMIZING EFFICACY

THE MARK CONSISTS OF STANDARD CHARACTERS WITHOUT CLAIM TO ANY PARTICULAR FONT, STYLE, SIZE, OR COLOR.

THE MARK CONSISTS OF STANDARD CHARACTERS WITHOUT CLAIM TO ANY PARTICULAR FONT, STYLE, SIZE, OR COLOR.

CLASS 5—PHARMACEUTICALS

FOR TOPICAL COMPOUNDS AND DERMATOLOGICAL PREPARATIONS FOR MEDICAL USE, NAMELY, MEDICATED LOTIONS, CREAMS, AND OINTMENTS FOR SKIN AND FACE FOR TREATMENT OF DERMATOLOGICAL CONDITIONS (U.S. CLS. 6, 18, 44, 46, 51 AND 52).

CLASS 5—PHARMACEUTICALS

FOR TOPICAL COMPOUNDS AND DERMATOLOGICAL PREPARATIONS FOR MEDICAL USE, NAMELY, MEDICATED LOTIONS, CREAMS, AND OINTMENTS FOR SKIN AND FACE FOR TREATMENT OF DERMATOLOGICAL CONDITIONS (U.S. CLS. 6, 18, 44, 46, 51 AND 52).

CLASS 42—SCIENTIFIC AND COMPUTER SERVICES

FOR PHARMACEUTICAL RESEARCH SERVICES, NAMELY, DEVELOPMENT OF DERMATOLOGICAL COMPOUNDS AND PREPARATION FOR MEDICAL USE, AND COSMETICS; PHARMACEUTICAL DRUG DEVELOPMENT SERVICES (U.S. CLS. 100 AND 101).
AMY MCMENAMIN, EXAMINING ATTORNEY

CLASS 42—SCIENTIFIC AND COMPUTER SERVICES

FOR PHARMACEUTICAL RESEARCH SERVICES, NAMELY, DEVELOPMENT OF DERMATOLOGICAL COMPOUNDS AND PREPARATION FOR MEDICAL USE, AND COSMETICS; PHARMACEUTICAL DRUG DEVELOPMENT SERVICES (U.S. CLS. 100 AND 101).
AMY MCMENAMIN, EXAMINING ATTORNEY

SN 77-136,231. ADINA WASSERMAN, DAVIE, FL. FILED 3-21-2007.

SN 77-136,293. EVOORGANIC, LLC, VERSAILLES, KY. FILED 3-21-2007.

TODDLERWARE

THE MARK CONSISTS OF STANDARD CHARACTERS WITHOUT CLAIM TO ANY PARTICULAR FONT, STYLE, SIZE, OR COLOR.

THE WORDLING "TODDLERWARE" HAS NO MEANING IN A FOREIGN LANGUAGE.

CLASS 8—HAND TOOLS

FOR CUTLERY, NAMELY, FORKS, KNIVES, SPORKS, NAMELY, SPOONS FEATURING FORK PRONGS, SPOONS (U.S. CLS. 23, 28 AND 44).

CLASS 21—HOUSEWARES AND GLASS

FOR DISHES AND PLATES (U.S. CLS. 2, 13, 23, 29, 30, 33, 40 AND 50).
MICHAEL GAAFAR, EXAMINING ATTORNEY

SN 77-136,244. QUADSO SOFTWARE SOLUTIONS, LLC, GRAND LEDGE, MI. FILED 3-21-2007.

QuadSo Software Solutions

THE MARK CONSISTS OF STANDARD CHARACTERS WITHOUT CLAIM TO ANY PARTICULAR FONT, STYLE, SIZE, OR COLOR.

NO CLAIM IS MADE TO THE EXCLUSIVE RIGHT TO USE "SOFTWARE SOLUTIONS", APART FROM THE MARK AS SHOWN.

CLASS 9—ELECTRICAL AND SCIENTIFIC APPARATUS

FOR INVENTORY SEARCH SOFTWARE FOR USE IN CREATING RETAIL CUSTOMER SHOPPING LISTS HAVING THE LOCATION AND AVAILABILITY OF ITEMS; INTERACTIVE COMPUTER KIOSKS COMPRISING COMPUTER HARDWARE, COMPUTER PERIPHERALS AND COMPUTER OPERATING SOFTWARE FOR USE IN RETAIL ESTABLISHMENTS, NAMELY, TO CREATE RETAIL SHOPPING LISTS, TO LOCATE ITEMS AND TO SHOW THE AVAILABILITY OF ITEMS; AND WIRELESS HANDHELD DEVICES COMPRISING COMPUTER HARDWARE, COMPUTER OPERATING SOFTWARE AND COMPUTER APPLICATION SOFTWARE FOR USE IN RETAIL ESTABLISHMENTS, NAMELY, TO CREATE RETAIL SHOPPING LISTS, TO LOCATE ITEMS, AND TO SHOW THE AVAILABILITY OF ITEMS (U.S. CLS. 21, 23, 26, 36 AND 38).

CLASS 42—SCIENTIFIC AND COMPUTER SERVICES

FOR CUSTOMIZATION OF COMPUTER SOFTWARE (U.S. CLS. 100 AND 101).
MARILYN IZZI, EXAMINING ATTORNEY

EVOORGANIC

THE MARK CONSISTS OF STANDARD CHARACTERS WITHOUT CLAIM TO ANY PARTICULAR FONT, STYLE, SIZE, OR COLOR.

CLASS 1—CHEMICALS

FOR PREPARATIONS FOR FORTIFYING PLANTS; PLANT FOOD; FERTILIZERS (U.S. CLS. 1, 5, 6, 10, 26 AND 46).

CLASS 35—ADVERTISING AND BUSINESS

FOR ON-LINE RETAIL STORE SERVICES FEATURING GARDENING SUPPLIES (U.S. CLS. 100, 101 AND 102).
KAREN K. BUSH, EXAMINING ATTORNEY

SN 77-136,368. REX G. MAUGHAN, DBA LAKE AMISTAD RESORT & MARINA, SCOTTSDALE, AZ. FILED 3-21-2007.

LAKE AMISTAD RESORT & MARINA

THE MARK CONSISTS OF STANDARD CHARACTERS WITHOUT CLAIM TO ANY PARTICULAR FONT, STYLE, SIZE, OR COLOR.

NO CLAIM IS MADE TO THE EXCLUSIVE RIGHT TO USE "RESORT & MARINA", APART FROM THE MARK AS SHOWN.

SEC. 2(F).

CLASS 35—ADVERTISING AND BUSINESS

FOR BUSINESS MANAGEMENT OF MARINAS, PARKS, RESORTS, CONCESSIONS AND RESTAURANTS; RETAIL SOUVENIR, GIFT, CONCESSION AND CONVENIENCE STORES; CONCESSION STANDS FEATURING FOOD, BEVERAGES AND SOUVENIRS (U.S. CLS. 100, 101 AND 102).
FIRST USE 7-0-1989; IN COMMERCE 7-0-1989.

CLASS 39—TRANSPORTATION AND STORAGE

FOR RENTAL OF HOUSEBOATS, BOATS, AND OTHER WATERCRAFT; MARINA SERVICES; BOAT DOCKAGE AND DRY STORAGE SERVICES; LONG-TERM AND SHORT-TERM BOAT STORAGE AND WET SLIP RENTALS; BOAT LAUNCHING SERVICES (U.S. CLS. 100 AND 105).
FIRST USE 7-0-1989; IN COMMERCE 7-0-1989.

CLASS 41—EDUCATION AND ENTERTAINMENT

FOR RECREATIONAL PARK SERVICES, RECREATIONAL SERVICES IN THE NATURE OF FISHING GUIDE SERVICES AND PROVIDING A LAKEFRONT FACILITY FOR SWIMMING, WATERSKIING AND SCUBA DIVING; PROVIDING FACILITIES FOR RECREATION ACTIVITIES (U.S. CLS. 100, 101 AND 107).
FIRST USE 7-0-1989; IN COMMERCE 7-0-1989.

CLASS 43—HOTEL AND RESTAURANT SERVICES

FOR PROVIDING TEMPORARY HOUSEBOAT LODGING (U.S. CLS. 100 AND 101).
FIRST USE 7-0-1989; IN COMMERCE 7-0-1989.
ELISSA GARBER KON, EXAMINING ATTORNEY

SN 77-136,475. ZOO TOO LLC, SECAUCUS, NJ. FILED 3-21-2007.



THE MARK CONSISTS OF SILHOUETTES OF A BIRD, HORSE, DOG, CAT, FISH AND REPTILE POSITIONED TO THE LEFT OF STYLIZED LOWERCASE LETTERS "ZOO TOO".

CLASS 38—COMMUNICATION

FOR VIDEO BROADCASTING SERVICES OVER THE INTERNET OR ELECTRONIC COMMUNICATIONS NETWORKS, NAMELY, UPLOADING, POSTING, SHOWING, DISPLAYING, TAGGING AND ELECTRONICALLY TRANSMITTING VIDEO CLIPS; PROVIDING ON-LINE FORUMS, CHAT ROOMS, AND ELECTRONIC BULLETIN BOARDS FOR TRANSMISSION OF MESSAGES AMONG COMPUTER USERS IN THE FIELD OF PET OWNERSHIP, CARE AND MAINTENANCE (U.S. CLS. 100, 101 AND 104).

SN 77-136,434. LIMELIGHT NETWORKS, INC., TEMPE, AZ. FILED 3-21-2007.

LLNW

CLASS 41—EDUCATION AND ENTERTAINMENT

FOR ENTERTAINMENT SERVICES IN THE NATURE OF AN ON-GOING TELEVISION SHOW ABOUT ANIMALS AND PETS; ENTERTAINMENT SERVICES IN THE NATURE OF AN ON-GOING TELEVISION SERIES DOCUMENTING MAKEOVERS OF ANIMAL SHELTERS (U.S. CLS. 100, 101 AND 107).
SKYE YOUNG, EXAMINING ATTORNEY

SN 77-136,588. DOC2DOC INC., LAFAYETTE, CA. FILED 3-21-2007.

DOC2DOC

THE MARK CONSISTS OF STANDARD CHARACTERS WITHOUT CLAIM TO ANY PARTICULAR FONT, STYLE, SIZE, OR COLOR.

CLASS 38—COMMUNICATION

FOR ELECTRONIC TRANSMISSION OF DATA, PICTURES, SOFTWARE, MUSIC, AND VIDEO, AND STREAMING OF DATA, PICTURES, SOFTWARE, MUSIC, AND VIDEO FOR OTHERS VIA GLOBAL AND LOCAL COMPUTER NETWORKS (U.S. CLS. 100, 101 AND 104).

THE MARK CONSISTS OF STANDARD CHARACTERS WITHOUT CLAIM TO ANY PARTICULAR FONT, STYLE, SIZE, OR COLOR.

THE WORDING "DOC2DOC" HAS NO MEANING IN A FOREIGN LANGUAGE.

CLASS 42—SCIENTIFIC AND COMPUTER SERVICES

FOR HOSTING THIRD PARTY WEB CONTENT, AND, APPLICATION SERVICE PROVIDER (ASP), NAMELY, HOSTING SOFTWARE APPLICATIONS OF OTHERS; COMPUTER NETWORK MANAGEMENT, NAMELY, GLOBAL TRAFFIC MANAGEMENT, NAMELY, MANAGEMENT OF CONTENT DELIVERY FOR OTHERS; WEB SITE TRAFFIC MONITORING, ANALYSIS AND REPORTING FOR OTHERS; DIGITAL RIGHTS MANAGEMENT SERVICES TO PROTECT DATA, PICTURES, SOFTWARE, MUSIC, AND VIDEO DELIVERED FOR OTHERS; DESIGNING COMPUTER NETWORKS AND SOFTWARE FOR OTHERS (U.S. CLS. 100 AND 101).
HANNO RITTNER, EXAMINING ATTORNEY

CLASS 38—COMMUNICATION

FOR PROVIDING PRIVATE AND SECURE REAL TIME ELECTRONIC COMMUNICATION OVER A COMPUTER NETWORK (U.S. CLS. 100, 101 AND 104).

CLASS 42—SCIENTIFIC AND COMPUTER SERVICES

FOR CUSTOM DEVELOPMENT OF SECURE COMPUTER NETWORK COMMUNICATION SYSTEMS FOR OTHERS (U.S. CLS. 100 AND 101).
LINDA ESTRADA, EXAMINING ATTORNEY

SN 77-136,775. CARNIVAL CORPORATION, MIAMI, FL.
FILED 3-21-2007.

SN 77-136,884. LIVE EARTH, LLC, BEVERLY HILLS, CA.
FILED 3-21-2007.

CARNIVAL SPLENDOR

THE MARK CONSISTS OF STANDARD CHARACTERS WITHOUT CLAIM TO ANY PARTICULAR FONT, STYLE, SIZE, OR COLOR.

OWNER OF U.S. REG. NOS. 1,489,408, 1,591,384 AND OTHERS.

CLASS 39—TRANSPORTATION AND STORAGE

FOR CRUISE SHIP SERVICES (U.S. CLS. 100 AND 105).

CLASS 41—EDUCATION AND ENTERTAINMENT

FOR ENTERTAINMENT SERVICES, NAMELY, CASINO SERVICES, ORGANIZING AND CONDUCTING STAGE SHOWS, NIGHTCLUB SHOWS, CONTESTS, DANCES AND PARTIES (U.S. CLS. 100, 101 AND 107).

CLASS 43—HOTEL AND RESTAURANT SERVICES

FOR HOTEL SERVICES AND RESTAURANT SERVICES (U.S. CLS. 100 AND 101).
MARCIE MILONE, EXAMINING ATTORNEY

SN 77-136,879. HEALTH PAYMENT SYSTEMS, INC., MILWAUKEE, WI. FILED 3-21-2007.

SUPEREOB

THE MARK CONSISTS OF STANDARD CHARACTERS WITHOUT CLAIM TO ANY PARTICULAR FONT, STYLE, SIZE, OR COLOR.

CLASS 36—INSURANCE AND FINANCIAL

FOR PROVIDING INSURANCE INFORMATION, NAMELY, PROVIDING HEALTH CARE CLAIM AND INSURANCE BENEFITS PAYMENT INFORMATION TO PATIENTS IN HEALTH CARE INSURANCE FIELDS INCLUDING HEALTHCARE PLANS, DENTAL CARE, DENTAL PLANS, VISION CARE, PRESCRIPTION DRUG CARE AND VISION PLANS (U.S. CLS. 100, 101 AND 102).

CLASS 44—MEDICAL, BEAUTY AND AGRICULTURAL SERVICES

FOR PROVIDING MEDICAL INFORMATION, NAMELY, PROVIDING COMPREHENSIVE EXPLANATIONS OF MEDICAL SERVICES TO PATIENTS; PROVIDING HEALTH, NUTRITION AND MEDICAL WELLNESS INFORMATION (U.S. CLS. 100 AND 101).
STEVEN PEREZ, EXAMINING ATTORNEY

LIVE EARTH

THE MARK CONSISTS OF STANDARD CHARACTERS WITHOUT CLAIM TO ANY PARTICULAR FONT, STYLE, SIZE, OR COLOR.

NO CLAIM IS MADE TO THE EXCLUSIVE RIGHT TO USE "LIVE", APART FROM THE MARK AS SHOWN.

CLASS 9—ELECTRICAL AND SCIENTIFIC APPARATUS

FOR PRERECORDED CDS AND DVDS, AUDIO AND VIDEO CASSETTES FEATURING MUSIC AND PERFORMANCES BY ARTISTS IN THE MUSIC INDUSTRY; DOWNLOADABLE MUSICAL PERFORMANCES VIA THE INTERNET AND WIRELESS DEVICES (U.S. CLS. 21, 23, 26, 36 AND 38).

CLASS 16—PAPER GOODS AND PRINTED MATTER

FOR PAPER PRODUCTS, NAMELY, BLANK PAPER NOTEBOOKS AND NOTE CARDS; PRINTED MATERIALS, NAMELY, NON-FICTION BOOKS RELATING TO THE ENVIRONMENT OR ENVIRONMENTAL ISSUES, PROGRAMS, BROCHURES AND BANNERS RELATING TO THE ENVIRONMENT, ENVIRONMENTAL ISSUES OR MUSICAL PERFORMANCES; CALENDARS, POSTERS, GREETING CARDS, NOTE CUBES, NAMELY, NOTE PAPER, NOTEPADS, AND FOLDERS (U.S. CLS. 2, 5, 22, 23, 29, 37, 38 AND 50).

CLASS 18—LEATHER GOODS

FOR BACKPACKS AND WALLETS; LEATHER KEY CHAINS (U.S. CLS. 1, 2, 3, 22 AND 41).

CLASS 20—FURNITURE AND ARTICLES NOT OTHERWISE CLASSIFIED

FOR NON-METAL KEY CHAINS; KEY FOBS, NOT OF METAL (U.S. CLS. 2, 13, 22, 25, 32 AND 50).

CLASS 21—HOUSEWARES AND GLASS

FOR HOUSE WARES, NAMELY, DRINKING GLASSES, VASES AND GLASS BOWLS, CERAMIC BOWLS, FLOWER POTS, PLANTERS FOR FLOWERS AND PLANTS; SHOT GLASSES AND MUGS (U.S. CLS. 2, 13, 23, 29, 30, 33, 40 AND 50).

CLASS 25—CLOTHING

FOR CLOTHING AND APPAREL, NAMELY, SHIRTS, T-SHIRTS, PANTS, SHORTS, DRESSES, JACKETS, SWEATSHIRTS, SWEAT PANTS, CLOTHING BELTS AND LEATHER BELTS, HATS, CAPS, VISORS AND BANDANAS (U.S. CLS. 22 AND 39).

CLASS 38—COMMUNICATION

FOR BROADCAST OF LIVE AND PRERECORDED PERFORMANCES BY MUSICAL ARTISTS OVER TELEVISION, RADIO, CABLE, SATELLITE, INTERNET (U.S. CLS. 100, 101 AND 104).

CLASS 41—EDUCATION AND ENTERTAINMENT

FOR ENTERTAINMENT SERVICES, NAMELY, LIVE PERFORMANCES BY MUSICAL PERFORMERS (U.S. CLS. 100, 101 AND 107).

DOMINIC FATHY, EXAMINING ATTORNEY

SN 77-137,273. CARPENTER., JOSEPH L., LAS VEGAS, NV.
FILED 3-22-2007.

MYSCHOOL

THE MARK CONSISTS OF STANDARD CHARACTERS WITHOUT CLAIM TO ANY PARTICULAR FONT, STYLE, SIZE, OR COLOR.

CLASS 35—ADVERTISING AND BUSINESS

FOR ADVERTISING SERVICES, NAMELY, ADVERTISING, PROMOTING AND OFFERING INFORMATION ABOUT THE GOODS AND SERVICES OF OTHERS VIA A GLOBAL COMMUNICATION NETWORK; PROVIDING A WEB SITE THAT ENABLES USERS TO POST ITEMS FOR SALE THROUGH ON-LINE CLASSIFIED ADVERTISEMENTS AND MESSAGES (U.S. CLS. 100, 101 AND 102).

CLASS 38—COMMUNICATION

FOR COMMUNICATIONS SERVICES, NAMELY, PROVIDING ON-LINE CHAT ROOMS AND FORUMS FOR TRANSMISSION OF MESSAGES, PHOTOGRAPHS, INFORMATION AND DATA AMONG COMPUTER USERS IN THE FIELD OF GENERAL INTEREST, INCLUDING AMONG ALUMNI OF VARIOUS EDUCATIONAL INSTITUTIONS; ELECTRONIC TRANSMISSION OF INFORMATION, MESSAGES, DATA, SOUND, IMAGES AND DOCUMENTS AMONG USERS OF COMPUTERS; PROVIDING ON-LINE COMMUNICATIONS LINKS WHICH TRANSFER THE WEBSITE USER TO OTHER LOCAL AND GLOBAL WEB PAGES ELECTRONIC TRANSMISSION OF DATA AND DOCUMENTS AMONG USERS OF COMPUTERS; PROVIDING ACCESS TO DATABASES VIA A GLOBAL COMMUNICATION NETWORK (U.S. CLS. 100, 101 AND 104).

JOHN DALIER, EXAMINING ATTORNEY

SN 77-137,208. DIVX, INC., SAN DIEGO, CA. FILED 3-21-2007.

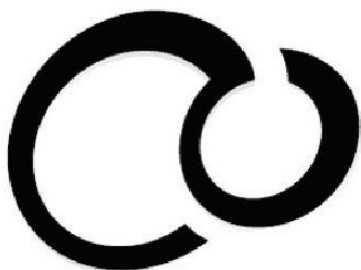

THE MARK CONSISTS OF A STYLIZED DESIGN OF TWO INCOMPLETE CONNECTED CIRCLES.

CLASS 9—ELECTRICAL AND SCIENTIFIC APPARATUS

FOR COMPUTER OPERATING SYSTEMS; COMPUTER HARDWARE AND SOFTWARE FOR DOWNLOADING, TRANSFERRING AND SHARING, AUDIO, VIDEO, DATA, AND OTHER MULTIMEDIA TRANSMISSIONS (U.S. CLS. 21, 23, 26, 36 AND 38).

CLASS 35—ADVERTISING AND BUSINESS

FOR ADVERTISING AND INFORMATION DISTRIBUTION SERVICES, NAMELY, PROVIDING CLASSIFIED ADVERTISING SPACE VIA THE GLOBAL COMPUTER NETWORK; PROMOTING THE GOODS AND SERVICES OF OTHERS OVER THE INTERNET; PROVIDING ON-LINE COMPUTER DATABASES AND ON-LINE SEARCHABLE DATABASES FEATURING CLASSIFIED LISTINGS AND WANT ADS (U.S. CLS. 100, 101 AND 102).

CLASS 38—COMMUNICATION

FOR PROVIDING ON-LINE CHAT ROOMS AND ELECTRONIC BULLETIN BOARDS FOR TRANSMISSION OF MESSAGES AMONG USERS IN THE FIELD OF GENERAL INTEREST; AND PROVIDING EMAIL AND INSTANT MESSAGING SERVICES (U.S. CLS. 100, 101 AND 104).

CLASS 42—SCIENTIFIC AND COMPUTER SERVICES

FOR COMPUTER SERVICES, NAMELY, WEBSITE HOSTING SERVICES; COMPUTER SERVICES IN THE NATURE OF PROVIDING CUSTOMIZED WEB PAGES FEATURING USER-DEFINED INFORMATION, PERSONAL PROFILES AND INFORMATION; TESTING AND EVALUATING GOODS OF OTHERS FOR THE PURPOSE OF CERTIFICATION (U.S. CLS. 100 AND 101).

BERNICE MIDDLETON, EXAMINING ATTORNEY

SN 77-137,274. CARPENTER., JOSEPH L., LAS VEGAS, NV.
FILED 3-22-2007.

MYSCHOOL411

THE MARK CONSISTS OF STANDARD CHARACTERS WITHOUT CLAIM TO ANY PARTICULAR FONT, STYLE, SIZE, OR COLOR.

CLASS 35—ADVERTISING AND BUSINESS

FOR ADVERTISING SERVICES, NAMELY, ADVERTISING, PROMOTING AND OFFERING INFORMATION ABOUT THE GOODS AND SERVICES OF OTHERS VIA A GLOBAL COMMUNICATION NETWORK; PROVIDING A WEB SITE THAT ENABLES USERS TO POST ITEMS FOR SALE THROUGH ON-LINE CLASSIFIED ADVERTISEMENTS AND MESSAGES (U.S. CLS. 100, 101 AND 102).

CLASS 38—COMMUNICATION

FOR COMMUNICATIONS SERVICES, NAMELY, PROVIDING ON-LINE CHAT ROOMS AND FORUMS FOR TRANSMISSION OF MESSAGES, PHOTOGRAPHS, INFORMATION AND DATA AMONG COMPUTER USERS IN THE FIELD OF GENERAL INTEREST, INCLUDING AMONG ALUMNI OF VARIOUS EDUCATIONAL INSTITUTIONS; ELECTRONIC TRANSMISSION OF INFORMATION, MESSAGES, DATA, SOUND, IMAGES AND DOCUMENTS AMONG USERS OF COMPUTERS; PROVIDING ON-LINE COMMUNICATIONS LINKS WHICH TRANSFER THE WEBSITE USER TO OTHER LOCAL AND GLOBAL WEB PAGES ELECTRONIC TRANSMISSION OF DATA AND DOCUMENTS AMONG USERS OF COMPUTERS; PROVIDING ACCESS TO DATABASES VIA A GLOBAL COMMUNICATION NETWORK (U.S. CLS. 100, 101 AND 104).

JOHN DALIER, EXAMINING ATTORNEY

SN 77-137,448. CAROLINA LAND REALTY, LLC, GREENVILLE, SC. FILED 3-22-2007.



NO CLAIM IS MADE TO THE EXCLUSIVE RIGHT TO USE CAROLINA LAND REALTY, APART FROM THE MARK AS SHOWN.

THE MARK CONSISTS OF GRAPHIC REPRESENTATION OF A TREE WITH THE LITERAL ELEMENT CAROLINA LAND REALTY.

SN 77-137,429. BRUNO MASCOLO, CARROLLTON, TX. FILED 3-22-2007.



NO CLAIM IS MADE TO THE EXCLUSIVE RIGHT TO USE "EST." AND "1963", APART FROM THE MARK AS SHOWN.

THE MARK CONSISTS OF A CREST CONSISTING OF A SHIELD WITH A STYLIZED "M" AND A CROSS, FLANKED BY 2 LIONS, AND A BANNER WITH "EST." ON THE LEFT SIDE OF THE BANNER, "MASCOLO" IN THE MIDDLE OF THE BANNER, AND "1963" ON THE RIGHT SIDE OF THE BANNER.

CLASS 16—PAPER GOODS AND PRINTED MATTER

FOR PAINTINGS; PRINTS, NAMELY, SKETCHES, DRAWINGS AND LITHOGRAPHS; POSTERS; ART BOOKS; CALENDARS; NOTE CARDS; FILE FOLDERS; POSTAGE STAMPS; EXHIBITION AND PROMOTIONAL CATALOGS IN THE FIELD OF ART AND ARTISTIC WORKS; AND MURALS (U.S. CLS. 2, 5, 22, 23, 29, 37, 38 AND 50).

CLASS 35—ADVERTISING AND BUSINESS

FOR ADVERTISING, MARKETING AND PUBLICITY AND PROMOTION SERVICES IN RESPECT OF ARTISTIC WORKS, VIA THE INTERNET AND THROUGH TRADITIONAL MEANS (U.S. CLS. 100, 101 AND 102).

CLASS 41—EDUCATION AND ENTERTAINMENT

FOR ORGANIZING OF ART EXHIBITIONS (U.S. CLS. 100, 101 AND 107).

DARRYL SPRUILL, EXAMINING ATTORNEY

CLASS 36—INSURANCE AND FINANCIAL

FOR REAL ESTATE SERVICES, NAMELY, REAL ESTATE BROKERAGE (U.S. CLS. 100, 101 AND 102).

FIRST USE 1-15-2007; IN COMMERCE 1-15-2007.

CLASS 37—CONSTRUCTION AND REPAIR

FOR REAL ESTATE DEVELOPMENT (U.S. CLS. 100, 103 AND 106).

FIRST USE 1-15-2007; IN COMMERCE 1-15-2007.

DARRYL SPRUILL, EXAMINING ATTORNEY

SN 77-137,552. REIN, ROSEMARY, MIAMI, FL. FILED 3-22-2007.

GO WILD GO GREAT

THE MARK CONSISTS OF STANDARD CHARACTERS WITHOUT CLAIM TO ANY PARTICULAR FONT, STYLE, SIZE, OR COLOR.

CLASS 9—ELECTRICAL AND SCIENTIFIC APPARATUS

FOR DIGITAL MATERIALS, NAMELY, DVDS AND ELECTRONIC EDUCATIONAL AND TRAINING BOOKS IN THE FIELD OF SELF IMPROVEMENT AND BUSINESS CONSULTING RECORDED ON COMPUTER MEDIA; DIGITAL MATERIALS, NAMELY, DOWNLOADABLE AUDIO FILES AND AUDIO RECORDINGS, DOWNLOADABLE WEB CASTS AND DOWNLOADABLE POD CASTS, AND DOWNLOADABLE AUDIO BOOKS ALL IN THE FIELD OF SELF IMPROVEMENT AND BUSINESS CONSULTING (U.S. CLS. 21, 23, 26, 36 AND 38).

CLASS 16—PAPER GOODS AND PRINTED MATTER

FOR A SERIES OF BOOKS, WRITTEN ARTICLES, HANDOUTS AND WORKSHEETS IN THE FIELD OF SELF IMPROVEMENT AND BUSINESS CONSULTING (U.S. CLS. 2, 5, 22, 23, 29, 37, 38 AND 50).

CLASS 41—EDUCATION AND ENTERTAINMENT

FOR PRODUCTION OF RADIO AND TELEVISION PROGRAMS; EDUCATIONAL SERVICES, NAMELY, CONDUCTING CLASSES, SEMINARS, WORKSHOPS AND RETREATS IN THE FIELD OF SELF IMPROVEMENT AND BUSINESS CONSULTING, AND THE DISTRIBUTION OF RELATED COURSE MATERIALS IN CONNECTION THEREWITH (U.S. CLS. 100, 101 AND 107).

KELLY MCCOY, EXAMINING ATTORNEY

SN 77-137,588. SOUTHWESTERN INVESTMENT GROUP, INC., ENGLEWOOD, CO. FILED 3-22-2007.



SOUTHWESTERN
INVESTMENT GROUP, INC.

NO CLAIM IS MADE TO THE EXCLUSIVE RIGHT TO USE "INVESTMENT GROUP, INC.", APART FROM THE MARK AS SHOWN.

THE MARK CONSISTS OF A SQUARE WITH A WAVY LINE CUTTING THROUGH IT FROM TOP TO BOTTOM AND THE WORDS "SOUTHWESTERN" AND "INVESTMENT GROUP, INC." BELOW IT.

SEC. 2(F) AS TO "SOUTHWESTERN".

CLASS 36—INSURANCE AND FINANCIAL

FOR REAL ESTATE INVESTMENT AND REAL ESTATE MANAGEMENT (U.S. CLS. 100, 101 AND 102).
FIRST USE 2-26-1998; IN COMMERCE 6-24-1999.

CLASS 37—CONSTRUCTION AND REPAIR

FOR REAL ESTATE DEVELOPMENT (U.S. CLS. 100, 103 AND 106).

FIRST USE 2-26-1998; IN COMMERCE 6-24-1999.

JENNIFER VASQUEZ, EXAMINING ATTORNEY

SN 77-137,617. STEWARD SOFTWARE COMPANY, LLC, CENTENNIAL, CO. FILED 3-22-2007.



THE MARK CONSISTS OF TWO SIDE-BY-SIDE STRIPES TILTING UPWARD FROM LEFT TO RIGHT WITH THE WORDS "PASSIT" AND THE PHRASE "ROADMAP TO LOAN PORTFOLIO CERTAINTY" TO THE RIGHT.

CLASS 9—ELECTRICAL AND SCIENTIFIC APPARATUS

FOR COMPUTER SOFTWARE WHICH ALLOWS FINANCIAL INSTITUTIONS TO ANALYZE AND MANAGE RISK WITH RESPECT TO CONSUMER AND COMMERCIAL LOAN PORTFOLIOS, MANAGE CONSUMER AND COMMERCIAL LOAN PORTFOLIOS, CONTROL PROCESSES FOR LOAN OPERATIONS AND LOAN MANAGEMENT, AND SATISFY REGULATORY REQUIREMENTS (U.S. CLS. 21, 23, 26, 36 AND 38).

CLASS 42—SCIENTIFIC AND COMPUTER SERVICES

FOR COMPUTER SERVICES, NAMELY, PROVIDING TEMPORARY USE OF NON-DOWNLOADABLE SOFTWARE FOR FINANCIAL INSTITUTIONS TO ANALYZE AND MANAGE RISK WITH RESPECT TO CONSUMER AND COMMERCIAL LOAN PORTFOLIOS, MANAGE CONSUMER AND COMMERCIAL LOAN PORTFOLIOS, CONTROL PROCESSES FOR LOAN OPERATIONS AND LOAN MANAGEMENT, AND SATISFY REGULATORY REQUIREMENTS; COMPUTER SERVICES, NAMELY, ACTING AS AN APPLICATION SERVICE PROVIDER IN THE FIELD OF FINANCIAL INSTITUTIONS TO HOST COMPUTER APPLICATION SOFTWARE FOR THE MANAGEMENT AND ANALYSIS OF RISK WITH RESPECT TO CONSUMER AND COMMERCIAL LOAN PORTFOLIOS, MANAGEMENT OF CONSUMER AND COMMERCIAL LOAN PORTFOLIOS, PROCESS CONTROL FOR LOAN OPERATIONS AND LOAN MANAGEMENT, AND REGULATORY COMPLIANCE; TECHNICAL SUPPORT SERVICES, NAMELY, TROUBLESHOOTING OF COMPUTER HARDWARE AND SOFTWARE PROBLEMS; CONSULTING SERVICES IN THE FIELD OF DESIGN, SELECTION, IMPLEMENTATION AND USE OF COMPUTER HARDWARE AND SOFTWARE SYSTEMS FOR OTHERS (U.S. CLS. 100 AND 101).

DOMINICK J. SALEMI, EXAMINING ATTORNEY

SN 77-137,625. STEWARD SOFTWARE COMPANY, LLC, CENTENNIAL, CO. FILED 3-22-2007.



NO CLAIM IS MADE TO THE EXCLUSIVE RIGHT TO USE "SOFTWARE", APART FROM THE MARK AS SHOWN.

THE MARK CONSISTS OF A SQUARE WITH A STRIPE RUNNING THROUGH IT FROM THE LEFT OF THE BOTTOM CORNER TO THE TOP OF THE RIGHT CORNER WITH THE WORDS "STEWARD" TO THE RIGHT AND "SOFTWARE" UNDERNEATH.

CLASS 9—ELECTRICAL AND SCIENTIFIC APPARATUS

FOR COMPUTER SOFTWARE WHICH ALLOWS FINANCIAL INSTITUTIONS TO ANALYZE AND MANAGE RISK WITH RESPECT TO CONSUMER AND COMMERCIAL LOAN PORTFOLIOS, MANAGE CONSUMER AND COMMERCIAL LOAN PORTFOLIOS, CONTROL PROCESSES FOR LOAN OPERATIONS AND LOAN MANAGEMENT, AND SATISFY REGULATORY REQUIREMENTS (U.S. CLS. 21, 23, 26, 36 AND 38).

CLASS 42—SCIENTIFIC AND COMPUTER SERVICES

FOR COMPUTER SERVICES, NAMELY, PROVIDING TEMPORARY USE OF NON-DOWNLOADABLE SOFTWARE FOR FINANCIAL INSTITUTIONS TO ANALYZE AND MANAGE RISK WITH RESPECT TO CONSUMER AND COMMERCIAL LOAN PORTFOLIOS, MANAGE CONSUMER AND COMMERCIAL LOAN PORTFOLIOS, CONTROL PROCESSES FOR LOAN OPERATIONS AND LOAN MANAGEMENT, AND SATISFY REGULATORY REQUIREMENTS; COMPUTER SERVICES, NAMELY, ACTING AS AN APPLICATION SERVICE PROVIDER IN THE FIELD OF FINANCIAL INSTITUTIONS TO HOST COMPUTER APPLICATION SOFTWARE FOR THE MANAGEMENT AND ANALYSIS OF RISK WITH RESPECT TO CONSUMER AND COMMERCIAL LOAN PORTFOLIOS, MANAGEMENT OF CONSUMER AND COMMERCIAL LOAN PORTFOLIOS, PROCESS CONTROL FOR LOAN OPERATIONS AND LOAN MANAGEMENT, AND REGULATORY COMPLIANCE; TECHNICAL SUPPORT SERVICES, NAMELY, TROUBLESHOOTING OF COMPUTER HARDWARE AND SOFTWARE PROBLEMS; CONSULTING SERVICES IN THE FIELD OF DESIGN, SELECTION, IMPLEMENTATION AND USE OF COMPUTER HARDWARE AND SOFTWARE SYSTEMS FOR OTHERS (U.S. CLS. 100 AND 101).

DOMINICK J. SALEMI, EXAMINING ATTORNEY

SN 77-137,919. MIGUELINA, INC., NEW YORK, NY. FILED 3-22-2007.

HOLY WOOD

THE MARK CONSISTS OF STANDARD CHARACTERS WITHOUT CLAIM TO ANY PARTICULAR FONT, STYLE, SIZE, OR COLOR.

CLASS 3—COSMETICS AND CLEANING PREPARATIONS

FOR PERFUME, FRAGRANCE FOR PERSONAL USE, DEODORANT FOR PERSONAL USE, FACIAL MAKE UP, LIPSTICK, EYE SHADOWS, MASCARA, BLUSH, BODY AND FACIAL SOAPS, COLOGNES, BODY POWDERS, POTPOURRI AND INCENSE (U.S. CLS. 1, 4, 6, 50, 51 AND 52).

CLASS 4—LUBRICANTS AND FUELS

FOR SCENTED CANDLES (U.S. CLS. 1, 6 AND 15).
KELLEY WELLS, EXAMINING ATTORNEY

SN 77-137,780. MEDWISE CLINICAL MANAGEMENT LLC, HOUSTON, TX. FILED 3-22-2007.

VPC . Valued Patient Care

educate • encourage • empower

NO CLAIM IS MADE TO THE EXCLUSIVE RIGHT TO USE "VALUED PATIENT CARE", APART FROM THE MARK AS SHOWN.

THE MARK CONSISTS OF THE TERMS "VPC VALUED PATIENT CARE" OVER A RECTANGULAR BAR WITH THE TERMS "EDUCATE ENCOURAGE EMPOWER" LOCATED BENEATH THE BAR.

CLASS 41—EDUCATION AND ENTERTAINMENT

FOR EDUCATIONAL SERVICES, NAMELY OFFERING CLASSES, SEMINARS, AND COURSES OF INSTRUCTION TO PATIENTS, PHYSICIANS, NURSES, AND PHYSICIANS' OFFICE STAFF IN THE FIELDS OF CHRONIC DISEASE CARE, NUTRITION, PAIN MANAGEMENT, DISEASE MANAGEMENT, PATIENT SUPPORT AND INTERVENTIONS, THERAPY, AND HEALTHY ACTIVE LIFESTYLES IN ORDER TO IMPROVE OUTCOMES (U.S. CLS. 100, 101 AND 107).

FIRST USE 2-28-2007; IN COMMERCE 2-28-2007.

CLASS 44—MEDICAL, BEAUTY AND AGRICULTURAL SERVICES

FOR CONSULTING TO PATIENTS, PHYSICIANS, NURSES, AND PHYSICIANS' OFFICE STAFF IN THE FIELDS OF CHRONIC DISEASE CARE, NUTRITION, PAIN MANAGEMENT, DISEASE MANAGEMENT, PATIENT SUPPORT AND INTERVENTIONS, THERAPY, AND HEALTHY ACTIVE LIFESTYLES IN ORDER TO IMPROVE OUTCOMES (U.S. CLS. 100 AND 101).

FIRST USE 2-28-2007; IN COMMERCE 2-28-2007.
LA TONIA FISHER, EXAMINING ATTORNEY

SN 77-137,964. FKA DISTRIBUTING CO., DBA HOMEDICS, INC., COMMERCE TOWNSHIP, MI. FILED 3-22-2007.

PURE DECADENCE

THE MARK CONSISTS OF STANDARD CHARACTERS WITHOUT CLAIM TO ANY PARTICULAR FONT, STYLE, SIZE, OR COLOR.

CLASS 17—RUBBER GOODS

FOR FOAM RUBBER MATERIALS AND POLYMERIC BEADS FOR USE IN STUFFING PILLOWS AND CUSHIONS (U.S. CLS. 1, 5, 12, 13, 35 AND 50).

CLASS 20—FURNITURE AND ARTICLES NOT OTHERWISE CLASSIFIED

FOR PILLOWS AND CUSHIONS; MATTRESSES; MATTRESS TOPPERS; MATTRESS CUSHIONS (U.S. CLS. 2, 13, 22, 25, 32 AND 50).

CLASS 22—CORDAGE AND FIBERS

FOR POLYMERS, NAMELY, WOVEN POLYMERIC FIBERS AND NON-WOVEN POLYMERIC FIBERS FOR USE IN STUFFING PILLOWS AND CUSHIONS (U.S. CLS. 1, 2, 7, 19, 22, 42 AND 50).

CLASS 24—FABRICS

FOR PILLOW ACCESSORIES, NAMELY, CASES, COVERS, SLIPS; MATTRESS PADS; MATTRESS COVERS (U.S. CLS. 42 AND 50).
MARLENE BELL, EXAMINING ATTORNEY

SN 77-137,982. WARRIOR SPORTS, INC., WARREN, MI.
FILED 3-22-2007.

SN 77-138,539. STEVEN USDAN, NEW YORK, NY. FILED 3-23-2007.



OWNER OF U.S. REG. NO. 2,274,667.
THE MARK CONSISTS OF A STYLIZED VERSION OF
THE WORD "WARRIOR".

CLASS 18—LEATHER GOODS

FOR ALL-PURPOSE SPORTING EQUIPMENT BAGS
(U.S. CLS. 1, 2, 3, 22 AND 41).
FIRST USE 6-0-2006; IN COMMERCE 6-0-2006.

CLASS 28—TOYS AND SPORTING GOODS

FOR HOCKEY EQUIPMENT, NAMELY, STICKS,
HANDLES, AND BLADES, PROTECTIVE EQUIPMENT
FOR USE IN THE SPORT OF HOCKEY, NAMELY,
GLOVES, SHOULDER PADS, ELBOW PADS, ARM PADS,
CHEST PROTECTORS, HIP PADS, AND SHIN PADS;
BAGS SPECIFICALLY ADAPTED FOR CARRYING
SPORTING EQUIPMENT (U.S. CLS. 22, 23, 38 AND 50).
FIRST USE 11-0-2005; IN COMMERCE 11-0-2005.
KIMBERLY FRYE, EXAMINING ATTORNEY

SN 77-138,240. RED ROBIN INTERNATIONAL, INC.,
GREENWOOD VILLAGE, CO. FILED 3-22-2007.

U-ACT

THE MARK CONSISTS OF STANDARD CHARACTERS
WITHOUT CLAIM TO ANY PARTICULAR FONT, STYLE,
SIZE, OR COLOR.

CLASS 35—ADVERTISING AND BUSINESS

FOR CHARITABLE COMMUNITY SUPPORT AND
RELATIONS SERVICES, NAMELY, ORGANIZING AND
CONDUCTING VOLUNTEER PROGRAMS AND COM-
MUNITY SERVICE PROJECTS (U.S. CLS. 100, 101 AND
102).

CLASS 43—HOTEL AND RESTAURANT SER- VICES

FOR RESTAURANT AND BAR SERVICES (U.S. CLS.
100 AND 101).
PAUL F. GAST, EXAMINING ATTORNEY

CEIBAFIL

THE MARK CONSISTS OF STANDARD CHARACTERS
WITHOUT CLAIM TO ANY PARTICULAR FONT, STYLE,
SIZE, OR COLOR.

CLASS 23—YARNS AND THREADS

FOR YARNS AND THREADS (U.S. CL. 43).

CLASS 24—FABRICS

FOR BED COVERS, NAMELY, BLANKETS, PILLOW-
CASES AND SHEETS; AND TEXTILE FABRIC FOR USE
IN THE MANUFACTURE OF CLOTHING (U.S. CLS. 42
AND 50).

CLASS 25—CLOTHING

FOR CLOTHING AND HEADGEAR, NAMELY,
SOCKS, SWEATERS, SHIRTS, JACKETS AND HATS
(U.S. CLS. 22 AND 39).
WILLIAM VERHOSEK, EXAMINING ATTORNEY

SN 77-138,548. MIRET, ROGELIO, SCOTTSDALE, AZ. FILED
3-23-2007.



THE COLOR(S) BLACK, WHITE, RED, BLUE AND GRAY
IS/ARE CLAIMED AS A FEATURE OF THE MARK.

THE MARK CONSISTS OF STYLIZED LETTERS "R U M B
L E R S" IN WHITE; DEVIL'S HEAD IN RED, WITH SINGLE
WHITE TOOTH, BLACK MOUTH AND WHITE EYES, AND
BLACK OUTLINING; GOGGLES ON THE DEVIL'S FORE-
HEAD IN BLUE AND WHITE AND GRAY STRAPS; A
STUDED COLLAR AROUND THE DEVIL'S NECK WITH
COLLAR IN GRAY AND SPIKES IN WHITE; AND THE
WHOLE DESIGN OUTLINED IN WHITE; AND ON A
BLACK BACKGROUND. THE BLACK BACKGROUND IS
NOT A PART OF THE MARK.

CLASS 25—CLOTHING

FOR T-SHIRTS, SWEATSHIRTS AND HATS (U.S. CLS.
22 AND 39).
FIRST USE 3-1-2002; IN COMMERCE 3-1-2002.

CLASS 41—EDUCATION AND ENTERTAINMENT

SN 77-138,771. BTS GROUP, INC., MIAMI, FL. FILED 3-23-2007.

FOR ENTERTAINMENT SERVICES, NAMELY, ORGANIZING AND CONDUCTING VINTAGE CAR SHOWS (U.S. CLS. 100, 101 AND 107).
FIRST USE 3-1-2002; IN COMMERCE 3-1-2002.
WILLIAM VERHOSEK, EXAMINING ATTORNEY

HAITEL

SN 77-138,754. BTS GROUP, INC., MIAMI, FL. FILED 3-23-2007.

HONDUTEL

THE MARK CONSISTS OF STANDARD CHARACTERS WITHOUT CLAIM TO ANY PARTICULAR FONT, STYLE, SIZE, OR COLOR.

CLASS 35—ADVERTISING AND BUSINESS

FOR PROCUREMENT, NAMELY, PURCHASING TELECOMMUNICATIONS SERVICES FOR OTHERS (U.S. CLS. 100, 101 AND 102).

THE MARK CONSISTS OF STANDARD CHARACTERS WITHOUT CLAIM TO ANY PARTICULAR FONT, STYLE, SIZE, OR COLOR.

CLASS 38—COMMUNICATION

FOR PROVIDING TELECOMMUNICATIONS SERVICES, NAMELY, PROVIDING ACCESS TO TELECOMMUNICATION NETWORKS (U.S. CLS. 100, 101 AND 104).
LYDIA BELZER, EXAMINING ATTORNEY

CLASS 35—ADVERTISING AND BUSINESS

FOR PROCUREMENT, NAMELY, PURCHASING TELECOMMUNICATIONS SERVICES FOR OTHERS (U.S. CLS. 100, 101 AND 102).

CLASS 38—COMMUNICATION

FOR PROVIDING TELECOMMUNICATIONS SERVICES, NAMELY, PROVIDING ACCESS TO TELECOMMUNICATION NETWORKS (U.S. CLS. 100, 101 AND 104).
LYDIA BELZER, EXAMINING ATTORNEY

SN 77-138,808. DECKERT, ELEANOR, KAMLOOPS, CANADA, FILED 3-23-2007.

SN 77-138,760. BTS GROUP, INC., MIAMI, FL. FILED 3-23-2007.

SEVEN PREDICTABLE PATTERNS

ETAPA

THE MARK CONSISTS OF STANDARD CHARACTERS WITHOUT CLAIM TO ANY PARTICULAR FONT, STYLE, SIZE, OR COLOR.

THE MARK CONSISTS OF STANDARD CHARACTERS WITHOUT CLAIM TO ANY PARTICULAR FONT, STYLE, SIZE, OR COLOR.

CLASS 16—PAPER GOODS AND PRINTED MATTER

FOR PRINTED INSTRUCTIONAL, EDUCATIONAL, AND TEACHING MATERIALS IN THE FIELD OF PARENTING, CHILD DEVELOPMENT AND FAMILY RELATIONS (U.S. CLS. 2, 5, 22, 23, 29, 37, 38 AND 50).
FIRST USE 10-31-2003; IN COMMERCE 10-31-2003.

CLASS 35—ADVERTISING AND BUSINESS

FOR PROCUREMENT, NAMELY, PURCHASING TELECOMMUNICATIONS SERVICES FOR OTHERS (U.S. CLS. 100, 101 AND 102).

CLASS 41—EDUCATION AND ENTERTAINMENT

CLASS 38—COMMUNICATION

FOR PROVIDING TELECOMMUNICATIONS SERVICES, NAMELY, PROVIDING ACCESS TO TELECOMMUNICATIONS NETWORKS (U.S. CLS. 100, 101 AND 104).
LYDIA BELZER, EXAMINING ATTORNEY

FOR TEACHING IN THE FIELD OF PARENTING, CHILD DEVELOPMENT AND FAMILY RELATIONS (U.S. CLS. 100, 101 AND 107).
FIRST USE 10-31-2003; IN COMMERCE 10-31-2003.
MICHAEL KEATING, EXAMINING ATTORNEY

SN 77-138,870. SER SOLUTIONS, INC., DULLES, VA. FILED 3-23-2007.

SER

THE MARK CONSISTS OF STANDARD CHARACTERS WITHOUT CLAIM TO ANY PARTICULAR FONT, STYLE, SIZE, OR COLOR.

CLASS 9—ELECTRICAL AND SCIENTIFIC APPARATUS

FOR COMPUTER SOFTWARE AND HARDWARE FOR USE IN CALL CENTER AUTOMATION AND MANAGEMENT; COMPUTER SOFTWARE, HARDWARE AND MANUALS SOLD TOGETHER AS A UNIT FOR AUTOMATIC PROCESSING, MANAGEMENT AND ROUTING OF INBOUND AND OUTBOUND TELEPHONE CALLS; COMPUTER HARDWARE AND SOFTWARE FOR TRANSMISSION AND ROUTING OF VOICE AND DATA FOR USE WITH COMPUTER SYSTEMS, COMPUTER TELEPHONY, CALL CONTACT CENTER OPERATIONS; COMPUTER HARDWARE AND SOFTWARE FOR MANAGING BOTH INBOUND AND OUTBOUND CALLS IN A BLENDED ENVIRONMENT IN CALL CONTACT CENTER OPERATIONS; COMPUTER HARDWARE AND SOFTWARE FOR MANAGING AND CONTROLLING CALL CONTACT CENTER OPERATIONS; COMPUTER HARDWARE AND SOFTWARE FOR CUSTOMER RELATIONSHIP MANAGEMENT AT CALL CONTACT CENTERS OPERATIONS, NAMELY, MANAGING, MONITORING AND TRACKING COMMUNICATIONS AND TRANSACTIONS, ASSESSING THE SKILLS OF EMPLOYEES AND MANAGEMENT OF THE ALLOCATION OF THOSE EMPLOYEES WITHIN THE BUSINESS, STATISTICS REPORTING, PROVIDING MARKETING RESEARCH, PLACING TELEPHONE CALLS FOR DIRECT MARKETING AND FOR SALES CAMPAIGN MANAGEMENT, PROVIDING LISTS OF PURCHASERS INTERESTED IN PURCHASING GOODS AND SERVICES AND MANAGING THOSE LISTS, CONTACT MANAGEMENT, LIABILITY MANAGEMENT, RISK MANAGEMENT, TRACKING THE AMOUNT OF BUSINESS TRANSACTED DURING A GIVEN PERIOD OF TIME (U.S. CLS. 21, 23, 26, 36 AND 38).

FIRST USE 1-31-2001; IN COMMERCE 1-31-2001.

CLASS 35—ADVERTISING AND BUSINESS

FOR BUSINESS MANAGEMENT AND CONSULTATION SERVICES IN THE FIELD OF CALL CONTACT CENTER OPERATIONS AND CALL CONTACT CENTER APPLICATIONS; PROVIDING CUSTOMER SERVICES IN THE FIELD OF TELEPHONE CALL CENTERS FOR OTHERS; MANAGEMENT OF CALL CONTACT CENTERS FOR OTHERS; PROVIDING CONSULTING SERVICES TO OTHERS IN THE FIELD OF CALL CENTER OPERATIONS (U.S. CLS. 100, 101 AND 102).

FIRST USE 1-31-2001; IN COMMERCE 1-31-2001.

CLASS 37—CONSTRUCTION AND REPAIR

FOR INSTALLATION OF COMPUTER HARDWARE; MAINTENANCE OF COMPUTER HARDWARE; INSTALLATION OF COMPUTER AND TELEPHONY NETWORKS, NAMELY, CALL CONTACT CENTERS; MAINTENANCE AND REPAIR OF COMPUTER NETWORKS AND TELEPHONY NETWORKS, NAMELY, CALL CONTACT CENTERS (U.S. CLS. 100, 103 AND 106).

FIRST USE 1-31-2001; IN COMMERCE 1-31-2001.

CLASS 38—COMMUNICATION

FOR TELECOMMUNICATIONS SERVICES, NAMELY, CONSULTING SERVICES IN THE FIELD OF CUSTOMIZED AUTOMATED DIALING AND CALL CONTACT CENTER SYSTEMS; TELECOMMUNICATIONS SERVICES, NAMELY, PROVIDING TELEPHONIC CALL ROUTING SERVICES FOR CALL CENTER OPERATIONS ALLOWING AUTOMATIC DISTRIBUTION OF INBOUND AND OUTBOUND CALLS; CALL CENTER TELECOMMUNICATIONS SERVICES IN THE NATURE OF PROVIDING INBOUND AND OUTBOUND TELESERVICES TO OTHERS, NAMELY, TELEPHONE COMMUNICATIONS SERVICES (U.S. CLS. 100, 101 AND 104).

FIRST USE 1-31-2001; IN COMMERCE 1-31-2001.

CLASS 42—SCIENTIFIC AND COMPUTER SERVICES

FOR INSTALLATION AND MAINTENANCE OF COMPUTER SOFTWARE ; DESIGN OF COMPUTER SOFTWARE AND COMPUTER SYSTEMS FOR OTHERS; INTEGRATION OF COMPUTER SYSTEMS AND NETWORKS; COMPUTER CONSULTATION; DEVELOPMENT OF COMPUTER TELEPHONE SYSTEMS INTEGRATING COMPUTER HARDWARE AND SOFTWARE FOR AUTOMATIC PROCESSING OF INBOUND AND OUTBOUND TELEPHONE CALLS FOR OTHERS; COMPUTER CONSULTING CONCERNING SOFTWARE AND HARDWARE FOR TELECOMMUNICATIONS AND CALL CENTER OPERATIONS; DEVELOPMENT AND DESIGN FOR OTHERS OF COMPUTER HARDWARE AND SOFTWARE SOLUTIONS FOR CALL CENTER OPERATIONS; COMPUTER ENGINEERING; INSTALLATION OF COMPUTER SOFTWARE; MAINTENANCE OF COMPUTER SOFTWARE; DESIGN OF COMPUTER SOFTWARE AND COMPUTER SYSTEMS FOR OTHERS; INTEGRATION OF COMPUTER SYSTEMS AND NETWORKS; COMPUTER CONSULTATION (U.S. CLS. 100 AND 101).

FIRST USE 1-31-2001; IN COMMERCE 1-31-2001.

CAROLYN GRAY, EXAMINING ATTORNEY

SN 77-139,301. BEAVER HOUSE, LLC, NEW YORK, NY. FILED 3-23-2007.

WILLIAM BEAVER HOUSE

THE MARK CONSISTS OF STANDARD CHARACTERS WITHOUT CLAIM TO ANY PARTICULAR FONT, STYLE, SIZE, OR COLOR.

THE NAME "WILLIAM BEAVER HOUSE" DOES NOT IDENTIFY A LIVING INDIVIDUAL.

CLASS 35—ADVERTISING AND BUSINESS

FOR REAL ESTATE MARKETING SERVICES IN THE FIELD OF CONDOMINIUM RESIDENCES (U.S. CLS. 100, 101 AND 102).

CLASS 36—INSURANCE AND FINANCIAL

FOR REAL ESTATE MANAGEMENT SERVICES; REAL ESTATE BROKERAGE SERVICES (U.S. CLS. 100, 101 AND 102).

CLASS 37—CONSTRUCTION AND REPAIR

FOR MAID AND CLEANING SERVICES; LAUNDRY SERVICES; CAR CLEANING SERVICES (U.S. CLS. 100, 103 AND 106).

CLASS 39—TRANSPORTATION AND STORAGE

FOR VALET PARKING SERVICES (U.S. CLS. 100 AND 105).

CLASS 41—EDUCATION AND ENTERTAINMENT

FOR HEALTH CLUB SERVICES, NAMELY, PROVIDING INSTRUCTION AND EQUIPMENT IN THE FIELD OF PHYSICAL EXERCISE (U.S. CLS. 100, 101 AND 107).

CLASS 43—HOTEL AND RESTAURANT SERVICES

FOR BAR AND RESAURANT SERVICES; CATERING OF FOOD AND DRINKS (U.S. CLS. 100 AND 101).

CLASS 44—MEDICAL, BEAUTY AND AGRICULTURAL SERVICES

FOR HEALTH SPA SERVICES FOR HEALTH AND WELLNESS OF THE MIND, BODY AND SPIRIT OFFERED IN OR FROM A REMOTE, MOBILE OR TEMPORARY ON-SITE LOCATION (U.S. CLS. 100 AND 101).

CLASS 45—PERSONAL AND LEGAL SERVICES

FOR PERSONAL CONCIERGE SERVICES FOR OTHERS COMPRISING MAKING REQUESTED PERSONAL ARRANGEMENTS AND RESERVATIONS, RUNNING ERRANDS AND PROVIDING CUSTOMER SPECIFIC INFORMATION TO MEET INDIVIDUAL NEEDS, ALL RENDERED IN BUSINESS ESTABLISHMENTS, OFFICE BUILDINGS, HOTELS, RESIDENTIAL COMPLEXES AND HOMES (U.S. CLS. 100 AND 101).
CURTIS FRENCH, EXAMINING ATTORNEY

CLASS 37—CONSTRUCTION AND REPAIR

FOR MAID AND CLEANING SERVICES; LAUNDRY SERVICES; CAR CLEANING SERVICES (U.S. CLS. 100, 103 AND 106).

CLASS 39—TRANSPORTATION AND STORAGE

FOR VALET PARKING SERVICES (U.S. CLS. 100 AND 105).

CLASS 41—EDUCATION AND ENTERTAINMENT

FOR HEALTH CLUB SERVICES, NAMELY, PROVIDING INSTRUCTION AND EQUIPMENT IN THE FIELD OF PHYSICAL EXERCISE (U.S. CLS. 100, 101 AND 107).

CLASS 43—HOTEL AND RESTAURANT SERVICES

FOR BAR AND RESTAURANT SERVICES; CATERING OF FOOD AND DRINKS (U.S. CLS. 100 AND 101).

CLASS 44—MEDICAL, BEAUTY AND AGRICULTURAL SERVICES

FOR HEALTH SPA SERVICES FOR HEALTH AND WELLNESS OF THE MIND, BODY AND SPIRIT OFFERED IN OR FROM A REMOTE, MOBILE OR TEMPORARY ON-SITE LOCATION (U.S. CLS. 100 AND 101).

CLASS 45—PERSONAL AND LEGAL SERVICES

FOR PERSONAL CONCIERGE SERVICES FOR OTHERS COMPRISING MAKING REQUESTED PERSONAL ARRANGEMENTS AND RESERVATIONS, RUNNING ERRANDS AND PROVIDING CUSTOMER SPECIFIC INFORMATION TO MEET INDIVIDUAL NEEDS, ALL RENDERED IN BUSINESS ESTABLISHMENTS, OFFICE BUILDINGS, HOTELS, RESIDENTIAL COMPLEXES AND HOMES (U.S. CLS. 100 AND 101).
CURTIS FRENCH, EXAMINING ATTORNEY

SN 77-139,320. BEAVER HOUSE, LLC, NEW YORK, NY. FILED 3-23-2007.



THE MARK CONSISTS OF A STYLIZED RENDITION OF A BEAVER HOLDING A CHAMPAGNE GLASS IN ONE HAND (PAW).

CLASS 35—ADVERTISING AND BUSINESS

FOR REAL ESTATE MARKETING SERVICES IN THE FIELD OF CONDOMINIUM RESIDENCES (U.S. CLS. 100, 101 AND 102).

CLASS 36—INSURANCE AND FINANCIAL

FOR REAL ESTATE MANAGEMENT SERVICES; REAL ESTATE BROKERAGE SERVICES (U.S. CLS. 100, 101 AND 102).

SN 77-139,952. SHAKLEE CORPORATION, PLEASANTON, CA. FILED 3-26-2007.

HEALTHY YOU, HEALTHY HOME,
HEALTHY PLANET

THE MARK CONSISTS OF STANDARD CHARACTERS WITHOUT CLAIM TO ANY PARTICULAR FONT, STYLE, SIZE, OR COLOR.

CLASS 9—ELECTRICAL AND SCIENTIFIC APPARATUS

FOR PRE-RECORDED CD-ROMS AND DVDS, ALL FEATURING INFORMATION IN THE FIELDS OF SKIN CARE, BEAUTY CARE, COSMETICS AND PERSONAL CARE PREPARATIONS; PRE-RECORDED CD-ROMS AND DVDS, ALL FEATURING INFORMATION IN THE FIELDS OF NUTRITION AND HEALTH; PRE-RECORDED CD-ROMS AND DVDS, ALL FEATURING INFORMATION IN THE FIELD OF THE ENVIRONMENT IN RELATION TO HEALTH AND NUTRITION; AND PRE-RECORDED CD-ROMS AND DVDS, ALL FEATURING MOTIVATIONAL OR INSTRUCTIONAL INFORMATION CONCERNING MULTI-LEVEL MARKETING OF GOODS AND SERVICES (U.S. CLS. 21, 23, 26, 36 AND 38).

CLASS 16—PAPER GOODS AND PRINTED MATTER

FOR PRINTED MATTER, NAMELY, DIRECT SELLING AIDS AND SALES LITERATURE IN THE NATURE OF PRINTED FORMS, INFORMATIONAL BOOKLETS, BROCHURES AND PAMPHLETS, BOOKS, MAGAZINES, BUSINESS KITS COMPRISED OF PRINTED LITERATURE, BROCHURES, FLYERS, INFORMATION SHEETS, PRODUCT BRIEFS, TECHNICAL BULLETINS, AND FACTS SHEETS, ALL RELATED TO HEALTH CARE MANAGEMENT AND HEALTH CARE PRODUCTS, HEALTH AND THE ENVIRONMENT, PRE-PRINTED BUSINESS MATTER, NAMELY, CARDS, SHIPPING LABELS, ORDER FORMS AND DECALS, PRINTED PRODUCT GUIDES CONTAINING INFORMATION ON SKIN CARE, BEAUTY CARE, COSMETICS AND PERSONAL CARE PREPARATIONS, DIETARY AND NUTRITIONAL SUPPLEMENTS, HOUSEHOLD AND INDUSTRIAL CLEANING PREPARATIONS, LAUNDRY CARE PRODUCTS, DISHWASHING PRODUCTS, DISINFECTANTS, NON-MEDICATED SKIN CARE PRODUCTS, BATH PRODUCTS, SHOWER PRODUCTS, COSMETICS, PERFUMES, HAIR PREPARATIONS, DENTIFRICES, SUNSCREEN PREPARATIONS, WATER AND AIR PURIFICATION DEVICES, AND MAGAZINES IN THE FIELD OF HEALTH AND THE ENVIRONMENT AND MULTI-LEVEL MARKETING (U.S. CLS. 2, 5, 22, 23, 29, 37, 38 AND 50).

JILL C. ALT, EXAMINING ATTORNEY

SN 77-140,368. GOODMAN MEDIA GROUP, INC., NEW YORK, NY. FILED 3-26-2007.

LA YOGA

THE MARK CONSISTS OF STANDARD CHARACTERS WITHOUT CLAIM TO ANY PARTICULAR FONT, STYLE, SIZE, OR COLOR.

NO CLAIM IS MADE TO THE EXCLUSIVE RIGHT TO USE "YOGA", APART FROM THE MARK AS SHOWN. SEC. 2(F).

CLASS 9—ELECTRICAL AND SCIENTIFIC APPARATUS

FOR DOWNLOADABLE ELECTRONIC PUBLICATIONS IN THE NATURE OF MAGAZINES IN THE FIELD OF YOGA, HEALTH, EXERCISE, FITNESS, NUTRITION, DIET, INTERPERSONAL RELATIONSHIPS, WEIGHTLOSS, ASTROLOGY, BOOK REVIEWS, RESTAURANT REVIEWS, MUSIC REVIEWS, MOVIE REVIEWS, FOOD PREPARATION RECIPES, HEALTHY EATING, YOGA AND FITNESS WORKSHOP SCHEDULES, SCIENTIFIC AND MEDICAL RESEARCH (U.S. CLS. 21, 23, 26, 36 AND 38).

FIRST USE 9-0-2002; IN COMMERCE 9-0-2002.

CLASS 16—PAPER GOODS AND PRINTED MATTER

FOR MAGAZINES FEATURING YOGA, HEALTH, EXERCISE, FITNESS, NUTRITION, DIET, INTERPERSONAL RELATIONSHIPS, WEIGHTLOSS, ASTROLOGY, BOOK REVIEWS, RESTAURANT REVIEWS, MUSIC REVIEWS, MOVIE REVIEWS, FOOD PREPARATION RECIPES, HEALTHY EATING, YOGA AND FITNESS WORKSHOP SCHEDULES, SCIENTIFIC AND MEDICAL RESEARCH (U.S. CLS. 2, 5, 22, 23, 29, 37, 38 AND 50).

FIRST USE 8-0-2002; IN COMMERCE 8-0-2002.

AHSEN KHAN, EXAMINING ATTORNEY

SN 77-140,956. NISSAN JIDOSHA KABUSHIKI KAISHA, TA NISSAN MOTOR CO., LTD., YOKOHAMA-SHI, JAPAN, FILED 3-27-2007.

NISSAN

THE MARK CONSISTS OF STANDARD CHARACTERS WITHOUT CLAIM TO ANY PARTICULAR FONT, STYLE, SIZE, OR COLOR.

OWNER OF JAPAN REG. NO. 2333738, DATED 9-30-1991, EXPIRES 9-30-2011.

OWNER OF JAPAN REG. NO. 2183655, DATED 10-31-1989, EXPIRES 10-31-2009.

OWNER OF JAPAN REG. NO. 2376522, DATED 2-28-1992, EXPIRES 2-29-2012.

OWNER OF U.S. REG. NOS. 686,587, 2,444,813 AND OTHERS.

CLASS 8—HAND TOOLS

FOR (BASED ON USE IN COMMERCE) HAND TOOLS, NAMELY, SCREWDRIVERS AND MULTI-FUNCTIONAL TOOLS, NAMELY, COMBINATION NIPPERS AND WIRE CUTTERS; (BASED ON INTENT TO USE) HAND TOOLS, NAMELY, DRILLS, HAMMERS, SPANNERS, WRENCHES, VICES AND PLIERS (U.S. CLS. 23, 28 AND 44).

FIRST USE 6-30-2006; IN COMMERCE 6-30-2006.

CLASS 9—ELECTRICAL AND SCIENTIFIC APPARATUS

FOR (BASED ON USE IN COMMERCE) COMPUTER SOFTWARE GAMES; COMPUTER STORAGE DEVICES, NAMELY, FLASH DRIVES; (BASED ON INTENT TO USE) COMPUTER PERIPHERALS, NAMELY, MOUSE PADS (U.S. CLS. 21, 23, 26, 36 AND 38).

FIRST USE 9-30-2006; IN COMMERCE 9-30-2006.

CLASS 18—LEATHER GOODS

FOR (BASED ON USE IN COMMERCE) LUGGAGE, BACKPACKS AND UMBRELLAS; (BASED ON INTENT TO USE) LUGGAGE TAGS, AND WALLETS (U.S. CLS. 1, 2, 3, 22 AND 41).

CLASS 20—FURNITURE AND ARTICLES NOT OTHERWISE CLASSIFIED

FOR (BASED ON USE IN COMMERCE) BAR STOOLS; (BASED ON INTENT TO USE) PICTURE FRAMES; FURNITURE, NAMELY, CHAIRS; NON-METALLIC BOTTLE STOPPERS (U.S. CLS. 2, 13, 22, 25, 32 AND 50).

FIRST USE 6-1-2006; IN COMMERCE 6-1-2006.

CLASS 21—HOUSEWARES AND GLASS

FOR (BASED ON USE IN COMMERCE) HOUSEWARES AND BEVERAGEWARE, NAMELY, MUGS, CUPS; THERMAL INSULATED BEVERAGE CONTAINERS; (BASED ON INTENT TO USE) PLASTIC WATER BOTTLES SOLD EMPTY AND FOAM DRINK HOLDERS IN THE NATURE OF INSULATING SLEEVE HOLDERS FOR BEVERAGE CANS; PORTABLE COOLERS; CORK SCREWS; FITTED PICNIC BASKETS; CAMPING GRILLS (U.S. CLS. 2, 13, 23, 29, 30, 33, 40 AND 50).

FIRST USE 6-30-2006; IN COMMERCE 6-30-2006.

CLASS 24—FABRICS

FOR (BASED ON USE IN COMMERCE) TOWELS; (BASED ON INTENT TO USE) CLOTH COASTERS (U.S. CLS. 42 AND 50).

FIRST USE 6-30-2006; IN COMMERCE 6-30-2006.

CLASS 26—FANCY GOODS

FOR (BASED ON 44(E)) ORNAMENTAL CLOTH PATCHES AND EMBROIDERED EMBLEMS (U.S. CLS. 37, 39, 40, 42 AND 50).

CLASS 28—TOYS AND SPORTING GOODS

FOR (BASED ON INTENT TO USE) STAND-ALONE VIDEO OUTPUT GAME MACHINES AND ARCADE GAMES; ARCADE-TYPE ELECTRONIC VIDEO GAMES AND COIN-OPERATED VIDEO GAMES (U.S. CLS. 22, 23, 38 AND 50).

CLASS 34—SMOKERS' ARTICLES

FOR (BASED ON 44(E)) CIGARETTE LIGHTERS NOT FOR LAND VEHICLES; ASH TRAYS (U.S. CLS. 2, 8, 9 AND 17).

ANDREA K. NADELMAN, EXAMINING ATTORNEY

SN 77-140,957. TOWER CLEANING SYSTEMS, INC., NORRISTOWN, PA. FILED 3-27-2007.



NO CLAIM IS MADE TO THE EXCLUSIVE RIGHT TO USE "HVAC SERVICES", APART FROM THE MARK AS SHOWN.

CLASS 37—CONSTRUCTION AND REPAIR

FOR HVAC SERVICES, NAMELY, MAINTENANCE, REPAIR AND INSTALLATION OF HVAC UNITS AND PARTS THEREOF; AND HVAC CONTRACTOR SERVICES (U.S. CLS. 100, 103 AND 106).

CLASS 42—SCIENTIFIC AND COMPUTER SERVICES

FOR HVAC SERVICES, NAMELY, INSPECTION OF INSTALLATIONS, AND INSPECTION OF HVAC UNITS AND SYSTEMS AND PARTS THEREOF (U.S. CLS. 100 AND 101).

REBECCA EISINGER, EXAMINING ATTORNEY

SN 77-141,205. BERHAD, KIBBUTZ EVRON, ISRAEL, FILED 3-27-2007.

BERHAD

THE MARK CONSISTS OF STANDARD CHARACTERS WITHOUT CLAIM TO ANY PARTICULAR FONT, STYLE, SIZE, OR COLOR.

OWNER OF U.S. REG. NO. 2,043,248.

CLASS 6—METAL GOODS

FOR MANUALLY-OPERATED VALVES OF METAL OTHER THAN PARTS OF MACHINES (U.S. CLS. 2, 12, 13, 14, 23, 25 AND 50).

CLASS 9—ELECTRICAL AND SCIENTIFIC APPARATUS

FOR LEVEL CONTROL VALVES FOR REGULATING THE FLOW OF GAS AND LIQUIDS IN TANKS, AUTOMATIC CLOSING VALVES, PRESSURE REDUCER VALVES FOR REGULATING THE FLOW OF WATER FOR IRRIGATION SYSTEMS, WATERWORKS AND FIRE PROTECTION; AUTOMATIC CLOSING VALVES MADE OF METAL, OTHER THAN PARTS OF MACHINES; AUTOMATIC CLOSING VALVES MADE OF PLASTIC FOR REGULATING WATER SUPPLY AND FOR IRRIGATION SYSTEMS (U.S. CLS. 21, 23, 26, 36 AND 38).

CLASS 11—ENVIRONMENTAL CONTROL APPARATUS

FOR WATER CONTROL VALVES MADE OF PLASTIC AND METAL FOR REGULATING WATER SUPPLY AND FOR IRRIGATION SYSTEMS (U.S. CLS. 13, 21, 23, 31 AND 34).

WILLIAM VERHOSEK, EXAMINING ATTORNEY

SN 77-141,478. SEEGARS FENCE COMPANY, INC., GOLDSBORO, NC. FILED 3-27-2007.

SEEGARS

THE MARK CONSISTS OF STANDARD CHARACTERS WITHOUT CLAIM TO ANY PARTICULAR FONT, STYLE, SIZE, OR COLOR.

SEC. 2(F).

CLASS 6—METAL GOODS

FOR FENCING PRODUCTS, NAMELY, METAL CHAIN LINK FENCING, METAL FENCING PANELS, METAL FENCE POSTS, METAL FENCE RAILS, METAL GATES AND METAL GUARDRAILS (U.S. CLS. 2, 12, 13, 14, 23, 25 AND 50).

FIRST USE 0-0-1960; IN COMMERCE 0-0-1960.

CLASS 19—NON-METALLIC BUILDING MATERIALS

FOR FENCING PRODUCTS, NAMELY, NON-METAL CHAIN LINK FENCING, FENCING PANELS, FENCE POSTS, FENCE RAILS, GATES, FENCE SLATS, FENCE SCREENS, AND GUARDRAILS, MADE OF WOOD, VINYL AND PLASTIC (U.S. CLS. 1, 12, 33 AND 50).
FIRST USE 0-0-1960; IN COMMERCE 0-0-1960.

CLASS 35—ADVERTISING AND BUSINESS

FOR ON-LINE RETAIL STORE SERVICES FEATURING FENCING PRODUCTS (U.S. CLS. 100, 101 AND 102).
FIRST USE 8-0-2006; IN COMMERCE 8-0-2006.

CLASS 37—CONSTRUCTION AND REPAIR

FOR DESIGNING, INSTALLING AND SERVICING FENCING (U.S. CLS. 100, 103 AND 106).
FIRST USE 0-0-1960; IN COMMERCE 0-0-1960.
ERIN FALK, EXAMINING ATTORNEY

SN 77-141,799. TOTAL LOCK & KEY, STAFFORD, VA. FILED 3-27-2007.

TOTAL LOCK & KEY

THE MARK CONSISTS OF STANDARD CHARACTERS WITHOUT CLAIM TO ANY PARTICULAR FONT, STYLE, SIZE, OR COLOR.

NO CLAIM IS MADE TO THE EXCLUSIVE RIGHT TO USE "LOCK AND KEY", APART FROM THE MARK AS SHOWN.

CLASS 37—CONSTRUCTION AND REPAIR

FOR LOCKSMITH SERVICES, NAMELY, INSTALLATION AND REPAIR OF LOCKS (U.S. CLS. 100, 103 AND 106).
FIRST USE 11-20-2006; IN COMMERCE 11-20-2006.

CLASS 40—MATERIAL TREATMENT

FOR LOCKSMITH SERVICES, NAMELY, CUSTOM FABRICATION OF KEYS AND LOCKS (U.S. CLS. 100, 103 AND 106).
FIRST USE 11-20-2006; IN COMMERCE 11-20-2006.
CHRISTINE COOPER, EXAMINING ATTORNEY

SN 77-141,722. QUALCOMM INCORPORATED, SAN DIEGO, CA. FILED 3-27-2007.

UNLEASH THE POWER OF TV

THE MARK CONSISTS OF STANDARD CHARACTERS WITHOUT CLAIM TO ANY PARTICULAR FONT, STYLE, SIZE, OR COLOR.

NO CLAIM IS MADE TO THE EXCLUSIVE RIGHT TO USE "TV", APART FROM THE MARK AS SHOWN.

CLASS 35—ADVERTISING AND BUSINESS

FOR DATA PROCESSING SERVICES; PREPARING AND PROCESSING DATA AND AUDIO-VISUAL DISPLAYS IN THE FIELD OF TELECOMMUNICATIONS, TRANSMITTED BY SATELLITE AND TERRESTRIAL COMMUNICATION SYSTEMS, NETWORK SYSTEMS, AND WIRELESS COMMUNICATIONS SYSTEMS (U.S. CLS. 100, 101 AND 102).

CLASS 38—COMMUNICATION

FOR TELECOMMUNICATIONS SERVICES, NAMELY, ELECTRONIC TRANSMISSION AND RECEIVER SERVICES FOR DATA AND AUDIO-VISUAL DISPLAYS VIA COMPUTER TERMINALS AND WIRELESS COMMUNICATION DEVICES; SATELLITE AND TERRESTRIAL COMMUNICATION SERVICES; TEXT AND NUMERIC WIRELESS DIGITAL MESSAGING SERVICES; ONLINE DOCUMENT DELIVERY VIA A GLOBAL COMPUTER NETWORK (U.S. CLS. 100, 101 AND 104).

CLASS 41—EDUCATION AND ENTERTAINMENT

FOR AUDIO-VISUAL PRODUCTION SERVICES (U.S. CLS. 100, 101 AND 107).
MICHELE SWAIN, EXAMINING ATTORNEY

SN 77-142,039. TURTLEBACK MOUNTAIN PARTNERS, LLC, BRECKENRIDGE, CO. FILED 3-27-2007.

SIERRA DEL RIO

THE MARK CONSISTS OF STANDARD CHARACTERS WITHOUT CLAIM TO ANY PARTICULAR FONT, STYLE, SIZE, OR COLOR.

THE ENGLISH TRANSLATION OF "DEL RIO" IS THE RIVER.

CLASS 35—ADVERTISING AND BUSINESS

FOR RETAIL STORE SERVICES FEATURING CLOTHING, GOLF RELATED GOODS AND GIFTS (U.S. CLS. 100, 101 AND 102).

CLASS 41—EDUCATION AND ENTERTAINMENT

FOR GOLF CLUB AND COUNTRY CLUB SERVICES, NAMELY, PROVIDING GOLF COURSE FACILITIES, GOLF PRACTICE RANGES, ARRANGING AND CONDUCTING GOLF TOURNAMENTS, AND PROVIDING GOLF INSTRUCTION (U.S. CLS. 100, 101 AND 107).

CLASS 43—HOTEL AND RESTAURANT SERVICES

FOR RESTAURANT AND COCKTAIL LOUNGE SERVICES (U.S. CLS. 100 AND 101).
RONALD MCMORROW, EXAMINING ATTORNEY

SN 77-142,049. ADVENTIST HEALTH SYSTEM/SUNBELT, INC., WINTER PARK, FL. FILED 3-27-2007.

SN 77-142,166. IRA S. KRIEGER, MIAMI BEACH, FL. FILED 3-28-2007.

hospatel

THE MARK CONSISTS OF STANDARD CHARACTERS WITHOUT CLAIM TO ANY PARTICULAR FONT, STYLE, SIZE, OR COLOR.

CLASS 41—EDUCATION AND ENTERTAINMENT

FOR EDUCATIONAL SERVICES, NAMELY, CONDUCTING CLASSES, SEMINARS, TRAINING PROGRAMS, WORKSHOPS, CONFERENCES, LECTURES, MEETINGS, ROUNDTABLES AND SYMPOSIUMS IN THE FIELDS OF MEDICINE AND MEDICAL RESEARCH AND DISTRIBUTING COURSE MATERIALS IN CONNECTION THEREWITH; DEVELOPMENT AND DISSEMINATION OF EDUCATIONAL MATERIALS OF OTHERS IN THE FIELDS OF MEDICINE AND MEDICAL RESEARCH; ORGANIZATION OF SEMINARS, WORKING GROUPS, RESEARCH GROUPS AND CONVENTIONS, IN THE FIELD OF MEDICINE (U.S. CLS. 100, 101 AND 107).

CLASS 42—SCIENTIFIC AND COMPUTER SERVICES

FOR MEDICAL AND SCIENTIFIC RESEARCH SERVICES, NAMELY, CONDUCTING MEDICAL RESEARCH, CLINICAL TRIALS, PHARMACEUTICAL TRIALS AND MEDICAL DEVICE TRIALS (U.S. CLS. 100 AND 101).

CLASS 43—HOTEL AND RESTAURANT SERVICES

FOR HOTEL SERVICES, NAMELY, PROVIDING TEMPORARY LODGING FOR PATIENTS AND FAMILIES OF PATIENTS; PROVIDING CONVENTION FACILITIES; HEALTH RESORT SERVICES, NAMELY, PROVIDING FOOD AND LODGING THAT SPECIALIZE IN PROMOTING PATRONS' GENERAL HEALTH AND WELL-BEING; FOOD AND BEVERAGE PREPARATION AND SERVICE (U.S. CLS. 100 AND 101).

CLASS 44—MEDICAL, BEAUTY AND AGRICULTURAL SERVICES

FOR MEDICAL SERVICES AND HOSPITAL SERVICES INCLUDING INPATIENT AND OUTPATIENT MEDICAL AND HOSPITAL SERVICES, CLINICS, MEDICAL EVALUATION AND EMOTIONAL SUPPORT SERVICES FOR PATIENTS AND FAMILIES OF PATIENT; PROVIDING MEDICAL INFORMATION; NURSING CARE; PHYSICAL REHABILITATION; MASSAGE; HYDROTHERAPY; GENERAL HEALTH CARE AND EMERGENCY MEDICAL SERVICES (U.S. CLS. 100 AND 101).
RONALD MCMORROW, EXAMINING ATTORNEY

SEA STALLION

THE MARK CONSISTS OF STANDARD CHARACTERS WITHOUT CLAIM TO ANY PARTICULAR FONT, STYLE, SIZE, OR COLOR.

CLASS 9—ELECTRICAL AND SCIENTIFIC APPARATUS

FOR SUNGLASSES (U.S. CLS. 21, 23, 26, 36 AND 38).

CLASS 14—JEWELRY

FOR WATCHES; CLOCKS; JEWELRY (U.S. CLS. 2, 27, 28 AND 50).

CLASS 25—CLOTHING

FOR APPAREL, NAMELY, HATS, SHIRTS, BLOUSES, JACKETS (U.S. CLS. 22 AND 39).
LAURA KOVALSKY, EXAMINING ATTORNEY

SN 77-142,279. OROSCIENCE, INC., PALO ALTO, CA. FILED 3-28-2007.

OROSCIENCE

THE MARK CONSISTS OF STANDARD CHARACTERS WITHOUT CLAIM TO ANY PARTICULAR FONT, STYLE, SIZE, OR COLOR.

CLASS 3—COSMETICS AND CLEANING PREPARATIONS

FOR TOOTH WHITENING GELS AND PREPARATIONS (U.S. CLS. 1, 4, 6, 50, 51 AND 52).

CLASS 5—PHARMACEUTICALS

FOR GELS, EMULSIONS AND FLUORIDE FOR SOFT TISSUE TREATMENT OF THE MOUTH, TEETH AND GUMS (U.S. CLS. 6, 18, 44, 46, 51 AND 52).

CLASS 9—ELECTRICAL AND SCIENTIFIC APPARATUS

FOR LASERS NOT FOR MEDICAL USE (U.S. CLS. 21, 23, 26, 36 AND 38).

CLASS 41—EDUCATION AND ENTERTAINMENT

FOR EDUCATIONAL SERVICES, NAMELY, CONDUCTING CLASSES IN THE FIELD OF DENTISTRY (U.S. CLS. 100, 101 AND 107).

CLASS 44—MEDICAL, BEAUTY AND AGRICULTURAL SERVICES

FOR TEETH WHITENING SERVICES; DENTISTRY (U.S. CLS. 100 AND 101).
ESTHER A. BORSUK, EXAMINING ATTORNEY

SN 77-142,638. KUM'O TEX CO., LTD, SEOUL, REPUBLIC OF KOREA, FILED 3-28-2007.



THE COLOR(S) BLACK, WHITE AND RED IS/ARE CLAIMED AS A FEATURE OF THE MARK.

THE MARK CONSISTS OF A WHITE LETTER "A" INSIDE A BLACK AND RED CIRCLE FOLLOWED BY BLACK LETTERS "CTONE".

CLASS 22—CORDAGE AND FIBERS

FOR WASTE COTTON, RAW COTTON, COTTON, NAMELY, COTTON FIBERS, COTTON NETTING, COTTON WADDINGS FOR CLOTHES, SILK FLOCK, HEMP, RAMIE, NAMELY, RAW RAMIE FIBER, RAFFIA FIBERS, RAMIE FIBER, RAW LINEN FLAX, SISAL FIBER, COCONUT FIBER, ESPARTO GRASS, JUTE, SEMI-SYNTHETIC FIBERS FOR TEXTILE USE, ARAMID FIBERS FOR TEXTILE USE, PLASTIC FIBERS FOR TEXTILE USE, SYNTHETIC FIBERS FOR TEXTILE USE, WOOL, GLASS FIBER FOR TEXTILE USE (U.S. CLS. 1, 2, 7, 19, 22, 42 AND 50).

CLASS 23—YARNS AND THREADS

FOR SPUN SILK, SILK YARN, GOLD COLORED YARN, METALLIC FIBER YARN, METAL YARN, WASTE COTTON YARN, HEMP YARN, RAMIE YARN, RAYON YARN, SPUN COTTON, COTTON YARN, WOOL YARN, SPUN THREAD AND YARN, COLORED YARN, CHENILLE YARN, WORSTED YARN, HAND KNIT YARN, NAMELY, KNITTING YARN; LINEN YARN, COIR YARN, WILD SILK YARN, SPUN WOOL, DOUPION YARN, EMBROIDERY YARN, FANCY YARN, SEWING YARN, RUBBER THREAD FOR TEXTILE USE, SEMI-SYNTHETIC FIBER YARN FOR TEXTILE USE, REGENERATED FIBER YARN FOR TEXTILE USE; ELASTIC FIBER YARN FOR TEXTILE USE, THREADS OF PLASTIC MATERIALS FOR TEXTILE USE, SYNTHETIC FIBER YARN FOR TEXTILE USE, BLENDED SILK YARN, BLENDED BAST YARN, BLENDED COTTON YARN, BLENDED WOOL YARN, BLENDED INORGANIC YARN, BLENDED CHEMICAL-FIBER YARN, JUTE YARN, REGENERATED FIBERS FOR TEXTILE USE (U.S. CL. 43).

CLASS 24—FABRICS

FOR SILK AND COTTON MIXED FABRIC, SILK-COTTON UNION FABRIC, SILK AND WOOL MIXED FABRIC, SILK-WOOL UNION FABRIC, BOURETTE FABRIC, SPUN SILK FABRIC, SILK FABRIC, COVERED RUBBER-YARN FABRICS FOR TEXTILE USE, METALLIC FABRIC CONSISTING OF YARN THAT CONTAINS METAL FOR TEXTILE USE, RAISED FABRIC, WASTED COTTON FABRIC, HEMP FABRIC, LAMINATED FABRIC FOR TEXTILE USE; RAMIE FABRIC, RAYON FABRIC, COTTON FABRICS, WOOL CLOTH, INORGANIC FIBER MIXED FABRIC, INORGANIC FIBER UNION CLOTH, WOOLEN FABRIC, WATER-PROOF FABRIC, CHENILLE FABRIC, WORSTED FABRIC, FLAX FABRIC, ESPARTO FABRIC, ARTIFICIAL SUEDE FABRIC, REGENERATED FIBER YARN FABRIC, JERSEY FABRIC, COATED FABRIC, NAMELY, POLYURETHANE-COATED FABRIC FOR UPHOLSTERY, VINYL COATED FABRIC FOR USE IN UPHOLSTERY PURPOSES, ELASTIC WOVEN MATERIAL FOR USE IN THE MANUFACTURE OF CLOTHING, ELASTIC FABRIC FOR CLOTHING, PILE FABRIC, NAMELY, KNITTED PILE FABRIC; COVERED RUBBER YARN FABRIC, SYNTHETIC FIBER FABRIC, BLENDED SILK FABRIC, BLENDED BAST FABRIC, BLENDED COTTON FABRIC, BLENDED WOOL FABRIC, BLENDED CHEMICAL FIBER FABRIC, CHEMICAL FIBER MIXED FABRIC, CHEMICAL FIBER UNION CLOTH, JUTE FABRIC, KNITTED FABRIC, SILK KNITTED GREY FABRIC, COTTON KNITTED GREY FABRIC, WOOL KNITTED GREY FABRIC, CHEMICAL FIBER KNITTED GREY FABRIC (U.S. CLS. 42 AND 50).

CARYN GLASSER, EXAMINING ATTORNEY

SN 77-142,764. UFOOD RESTAURANT GROUP, INC., NEWTON, MA. FILED 3-28-2007.

UFOOD GRILL

THE MARK CONSISTS OF STANDARD CHARACTERS WITHOUT CLAIM TO ANY PARTICULAR FONT, STYLE, SIZE, OR COLOR.

NO CLAIM IS MADE TO THE EXCLUSIVE RIGHT TO USE GRILL, APART FROM THE MARK AS SHOWN.

CLASS 29—MEATS AND PROCESSED FOODS

FOR PREPARED FOODS, NAMELY, MEALS CONSISTING PRIMARILY OF MEAT, FISH, POULTRY OR VEGETABLES (U.S. CL. 46).

CLASS 35—ADVERTISING AND BUSINESS

FOR RETAIL STORE SERVICES FEATURING FOOD AND NUTRITIONAL PRODUCTS (U.S. CLS. 100, 101 AND 102).

CLASS 43—HOTEL AND RESTAURANT SERVICES

FOR RESTAURANT AND TAKE-OUT RESTAURANT SERVICES (U.S. CLS. 100 AND 101).
GISELLE AGOSTO, EXAMINING ATTORNEY

SN 77-142,775. UFOOD RESTAURANT GROUP, INC., NEWTON, MA. FILED 3-28-2007.

SN 77-142,796. BEAM GLOBAL UK LIMITED, HORSHAM, UNITED KINGDOM, FILED 3-28-2007.



CLASS 29—MEATS AND PROCESSED FOODS

FOR PREPARED FOODS, NAMELY, MEALS CONSISTING PRIMARILY OF MEAT, FISH, POULTRY OR VEGETABLES (U.S. CL. 46).

CLASS 35—ADVERTISING AND BUSINESS

FOR RETAIL STORE SERVICES FEATURING FOOD AND NUTRITIONAL PRODUCTS (U.S. CLS. 100, 101 AND 102).

CLASS 43—HOTEL AND RESTAURANT SERVICES

FOR RESTAURANT AND TAKE-OUT RESTAURANT SERVICES (U.S. CLS. 100 AND 101).
GISELLE AGOSTO, EXAMINING ATTORNEY

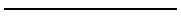

SN 77-142,777. BEAM GLOBAL UK LIMITED, HORSHAM, UNITED KINGDOM, FILED 3-28-2007.

PROOF BEAM DESIGN STUDIO

THE MARK CONSISTS OF STANDARD CHARACTERS WITHOUT CLAIM TO ANY PARTICULAR FONT, STYLE, SIZE, OR COLOR.
NO CLAIM IS MADE TO THE EXCLUSIVE RIGHT TO USE "DESIGN STUDIO", APART FROM THE MARK AS SHOWN.

CLASS 33—WINES AND SPIRITS

FOR ALCOHOLIC BEVERAGES, NAMELY, DISTILLED SPIRITS (U.S. CLS. 47 AND 49).

CLASS 35—ADVERTISING AND BUSINESS

FOR CREATIVE MARKETING DESIGN SERVICES (U.S. CLS. 100, 101 AND 102).
RICHARD A. STRASER, EXAMINING ATTORNEY



NO CLAIM IS MADE TO THE EXCLUSIVE RIGHT TO USE "DESIGN STUDIO", APART FROM THE MARK AS SHOWN.

THE MARK CONSISTS OF THE WORDS "PROOF BEAM DESIGN STUDIO" IN A RECTANGLE DESIGN; THE WORD "PROOF" IS SITUATED ABOVE THE WORDS "BEAM DESIGN STUDIO".

CLASS 33—WINES AND SPIRITS

FOR ALCOHOLIC BEVERAGES, NAMELY, DISTILLED SPIRITS (U.S. CLS. 47 AND 49).

CLASS 35—ADVERTISING AND BUSINESS

FOR CREATIVE MARKETING DESIGN SERVICES (U.S. CLS. 100, 101 AND 102).
RICHARD A. STRASER, EXAMINING ATTORNEY



SN 77-142,809. GRANITE TELECOMMUNICATIONS, LLC, QUINCY, MA. FILED 3-28-2007.

Granite Infrastructure Solutions

THE MARK CONSISTS OF STANDARD CHARACTERS WITHOUT CLAIM TO ANY PARTICULAR FONT, STYLE, SIZE, OR COLOR.

OWNER OF U.S. REG. NO. 2,486,667.
NO CLAIM IS MADE TO THE EXCLUSIVE RIGHT TO USE "INFRASTRUCTURE SOLUTIONS", APART FROM THE MARK AS SHOWN.

CLASS 37—CONSTRUCTION AND REPAIR

FOR INSTALLATION OF TELECOMMUNICATIONS SYSTEMS (U.S. CLS. 100, 103 AND 106).

CLASS 42—SCIENTIFIC AND COMPUTER SERVICES

FOR DESIGN OF TELECOMMUNICATIONS SYSTEMS (U.S. CLS. 100 AND 101).
MICHAEL KEATING, EXAMINING ATTORNEY

SN 77-142,815. FIRST ACT INC., BOSTON, MA. FILED 3-28-2007.

Delgada

THE MARK CONSISTS OF STANDARD CHARACTERS WITHOUT CLAIM TO ANY PARTICULAR FONT, STYLE, SIZE, OR COLOR.

THE ENGLISH TRANSLATION OF THE WORD "DELGADA" IN THE MARK IS "SLENDER".

CLASS 8—HAND TOOLS

FOR GUITAR TOOL KITS COMPRISING A SCREW DRIVER, HEX KEYS AND WIRE CUTTER FOR USE IN GUITAR MAINTENANCE AND REPAIR (U.S. CLS. 23, 28 AND 44).

CLASS 9—ELECTRICAL AND SCIENTIFIC APPARATUS

FOR COMPUTER SOFTWARE FOR INSTRUCTION IN MUSIC AND THE PLAYING OF MUSICAL INSTRUMENTS; PRERECORDED CDS, AUDIO TAPES AND DVDS FEATURING INSTRUCTION IN MUSIC AND THE PLAYING OF MUSICAL INSTRUMENTS; ELECTRONIC ACCESSORIES FOR MUSICAL INSTRUMENTS, NAMELY, METRONOMES; SOUND AMPLIFIERS; AND MICROPHONES (U.S. CLS. 21, 23, 26, 36 AND 38).

CLASS 15—MUSICAL INSTRUMENTS

FOR MUSICAL INSTRUMENTS, NAMELY, GUITARS, AND PARTS AND ACCESSORIES FOR GUITARS, NAMELY, GUITAR STRAPS, STRING WINDERS, GUITAR STRINGS, GUITAR PICKS, TUNERS FOR GUITARS, GUITAR STANDS, GUITAR CASES, SHEET MUSIC STANDS, CAPOS, GUITAR NECK STANDS, AND GUITAR PLAYING ASSISTANCE DEVICES, NAMELY, A SLIDING STRUCTURE HAVING AN ARCED SURFACE THAT THE MUSICIAN MOVEABLY POSITIONS ON GUITAR STRINGS TO MODIFY THE GUITAR SOUND (U.S. CLS. 2, 21 AND 36).

MICHAEL WEBSTER, EXAMINING ATTORNEY

SN 77-143,007. OLANDER, JOHN N., SAN CLEMENTE, CA. FILED 3-28-2007.

ROCK REBELLION

THE MARK CONSISTS OF STANDARD CHARACTERS WITHOUT CLAIM TO ANY PARTICULAR FONT, STYLE, SIZE, OR COLOR.

CLASS 14—JEWELRY

FOR NECKLACES, RINGS, PENDANTS, EAR RINGS AND BRACELETS (U.S. CLS. 2, 27, 28 AND 50).

CLASS 18—LEATHER GOODS

FOR CLUTCH BAGS, PURSES, HANDBAGS AND WALLETS (U.S. CLS. 1, 2, 3, 22 AND 41).

CLASS 25—CLOTHING

FOR CLOTHING, NAMELY, JACKETS, HATS, SHIRTS, T-SHIRTS, SWEATSHIRTS, BELTS (U.S. CLS. 22 AND 39).

CLASS 26—FANCY GOODS

FOR BELT BUCKLES NOT OF PRECIOUS METAL, HAIR BARRETTES AND HAIR CLIPS (U.S. CLS. 37, 39, 40, 42 AND 50).

CLASS 35—ADVERTISING AND BUSINESS

FOR ON-LINE RETAIL AND WHOLESALE STORE SERVICES FEATURING APPAREL, BAGS, HANDBAGS, PURSES, WALLETS, NECKLACES, PENDANTS, BRACELETS, EAR RINGS, BELTS AND BELT BUCKLES, HAIR BARRETTES AND CLIPS (U.S. CLS. 100, 101 AND 102).
MATTHEW PAPPAS, EXAMINING ATTORNEY

SN 77-143,156. KNUCKLEHEADS INC., AGOURA HILLS, CA. FILED 3-28-2007.



THE COLOR(S) RED, WHITE AND BLACK IS/ARE CLAIMED AS A FEATURE OF THE MARK.

THE MARK CONSISTS OF THE STYLIZED WORD "KNUCKLEHEADS" APPEARING IN THE COLOR WHITE, OUTLINED IN BLACK AND BORDERED IN RED. NO BACKGROUND COLOR IS CLAIMED.

CLASS 35—ADVERTISING AND BUSINESS

FOR FRANCHISE SERVICES, NAMELY, OFFERING TECHNICAL AND BUSINESS MANAGEMENT ASSISTANCE IN THE ESTABLISHMENT AND OPERATION OF FITNESS CENTERS (U.S. CLS. 100, 101 AND 102).

CLASS 41—EDUCATION AND ENTERTAINMENT

FOR PROVIDING FACILITIES FOR EXERCISE AND PHYSICAL FITNESS TRAINING; EDUCATION SERVICES, NAMELY, PROVIDING HEALTH AND FITNESS PROGRAMS; FITNESS CENTERS PROVIDING FITNESS AND EXERCISE FACILITIES (U.S. CLS. 100, 101 AND 107).

CLASS 44—MEDICAL, BEAUTY AND AGRICULTURAL SERVICES

FOR WEIGHT REDUCTION DIET PLANNING COUNSELING AND SUPERVISION (U.S. CLS. 100 AND 101).
JUDITH HELFMAN, EXAMINING ATTORNEY

SN 77-143,959. ROHR, INC., CHULA VISTA, CA. FILED 3-29-2007.

SN 77-144,136. TOYOTA MAPMASTER INC., NAGOYA-SHI, AICHI, JAPAN, FILED 3-29-2007.

PRIME SOLUTIONS

THE MARK CONSISTS OF STANDARD CHARACTERS WITHOUT CLAIM TO ANY PARTICULAR FONT, STYLE, SIZE, OR COLOR.

CLASS 36—INSURANCE AND FINANCIAL

FOR EQUIPMENT FINANCING SERVICES, NAMELY, FINANCING AND LEASING SERVICES FOR AEROSPACE NACELLE SYSTEMS AND NACELLE COMPONENTS (U.S. CLS. 100, 101 AND 102).

CLASS 39—TRANSPORTATION AND STORAGE

FOR LEASING OF AEROSPACE NACELLE SYSTEMS AND NACELLE COMPONENTS (U.S. CLS. 100 AND 105).
DAVID HOFFMAN, EXAMINING ATTORNEY

SN 77-144,006. TAKE-TWO INTERACTIVE SOFTWARE, INC., NEW YORK, NY. FILED 3-29-2007.

GTA

THE MARK CONSISTS OF STANDARD CHARACTERS WITHOUT CLAIM TO ANY PARTICULAR FONT, STYLE, SIZE, OR COLOR.

CLASS 9—ELECTRICAL AND SCIENTIFIC APPARATUS

FOR ENTERTAINMENT SOFTWARE, NAMELY, GAME DISCS AND DOWNLOADABLE GAME SOFTWARE FOR USE WITH PERSONAL COMPUTERS, VIDEO GAME CONSOLES, HAND HELD GAMING DEVICES; PROVIDING DOWNLOADABLE COMPUTER GAMES AND MOTION PICTURES FEATURING ACTION AND ADVENTURE BY MEANS OF A GLOBAL COMPUTER NETWORK (U.S. CLS. 21, 23, 26, 36 AND 38).

FIRST USE 9-30-1999; IN COMMERCE 9-30-1999.

CLASS 41—EDUCATION AND ENTERTAINMENT

FOR ENTERTAINMENT SERVICES, NAMELY, PRODUCTION OF ENTERTAINMENT SOFTWARE AND MOTION PICTURES (U.S. CLS. 100, 101 AND 107).

FIRST USE 9-30-1999; IN COMMERCE 9-30-1999.
TARAH HARDY, EXAMINING ATTORNEY

MAPMASTER

THE MARK CONSISTS OF STANDARD CHARACTERS WITHOUT CLAIM TO ANY PARTICULAR FONT, STYLE, SIZE, OR COLOR.

PRIORITY CLAIMED UNDER SEC. 44(D) ON JAPAN APPLICATION NO. 2006-097243, FILED 10-19-2006, REG. NO. 5062105, DATED 10-19-2006, EXPIRES 10-19-2016.

CLASS 9—ELECTRICAL AND SCIENTIFIC APPARATUS

FOR COMPUTER NAVIGATIONAL PROGRAMS USED FOR IN-CAR NAVIGATION, CELL PHONES AND OTHER RELATED IT EQUIPMENT; DIGITAL MATERIALS, NAMELY, CDS AND DVDS FEATURING CARTOGRAPHIC INFORMATION ABOUT ROADS AND BUILDINGS, ADDRESSES, TELEPHONE NUMBERS AND OTHER USEFUL RESOURCES, WHICH ARE USED FOR IN-CAR NAVIGATION, CELL PHONES AND OTHER RELATED IT EQUIPMENT; ELECTRIC NAVIGATIONAL INSTRUMENTS FOR LAND VEHICLES; GLOBAL POSITIONING SYSTEM (GPS) RECEIVERS (U.S. CLS. 21, 23, 26, 36 AND 38).

CLASS 42—SCIENTIFIC AND COMPUTER SERVICES

FOR PROVIDING A COMPUTER DATABASE IN THE FIELD OF MAPPING AND CARTOGRAPHY; COMPUTER SOFTWARE DESIGN, COMPUTER PROGRAMMING, AND MAINTENANCE OF COMPUTER SOFTWARE THAT FEATURES DIGITALIZED CARTOGRAPHIC INFORMATION USED FOR IN-CAR NAVIGATION, CELL PHONES AND OTHER RELATED IT EQUIPMENT (U.S. CLS. 100 AND 101).
JENNIFER HETU, EXAMINING ATTORNEY

SN 77-144,187. MIKEL MESH, LAHAINA, HI. FILED 3-29-2007.

CRAZY INU

THE MARK CONSISTS OF STANDARD CHARACTERS WITHOUT CLAIM TO ANY PARTICULAR FONT, STYLE, SIZE, OR COLOR.

CLASS 18—LEATHER GOODS

FOR TRAVEL BAGS; ALL-PURPOSE CARRYING BAGS; HANDBAGS; PURSES; TOTES BAGS; BACKPACKS; BOOK BAGS; SPORTS BAGS (U.S. CLS. 1, 2, 3, 22 AND 41).

CLASS 25—CLOTHING

FOR FOOTWEAR, NAMELY, SLIPPERS, BOOTS, SHOES, BEACH SHOES, THONGED AND STRAPPED SANDALS; CLOTHING, NAMELY, SWIM WEAR, SINGLET, T-SHIRTS, SHIRTS AND CASUAL TOPS WITH LONG AND SHORT SLEEVES, SLEEVELESS SHIRTS, SLEEVELESS TOPS, SWEAT TOPS, JACKETS, COATS, JUMPERS, SHORTS, LONG PANTS, JEANS, DRESSES, SKIRTS, SARONGS, LEISURE WEAR IN THE NATURE OF LOUNGEWEAR, NIGHT CLOTHES IN THE NATURE OF NIGHT GOWNS, UNDERWEAR; HEADWEAR, NAMELY, HATS, CAPS (U.S. CLS. 22 AND 39).

DAVID MURRAY, EXAMINING ATTORNEY

SN 77-144,331. EARLS, ALLEN L., LITHONIA, GA. FILED 3-29-2007.

The Spiritual Advantage

THE MARK CONSISTS OF STANDARD CHARACTERS WITHOUT CLAIM TO ANY PARTICULAR FONT, STYLE, SIZE, OR COLOR.

NO CLAIM IS MADE TO THE EXCLUSIVE RIGHT TO USE "SPIRITUAL", APART FROM THE MARK AS SHOWN.

CLASS 16—PAPER GOODS AND PRINTED MATTER

FOR BOOKS FEATURING SPIRITUAL AND RELIGIOUS TOPICS (U.S. CLS. 2, 5, 22, 23, 29, 37, 38 AND 50).

CLASS 25—CLOTHING

FOR SPORTSWEAR, NAMELY, TEE SHIRTS, JEANS, GOLF SHIRTS, UNDERSHIRTS, UNDERWEAR, PANTIES, JOGGING SUITS, SWEAT SUITS, SWEAT SHIRTS, SWEAT PANTS, MEN'S SUITS, LADIES SUITS, DRESSES, FOOTWEAR, SPORT COATS, VESTS, SWEATERS, BELTS, SHIRTS, PANTS, SHORTS, SOCKS, AND BASKETBALL, FOOTBALL, BASEBALL, HOCKEY, AND AUTO RACING SPORTSWEAR, NAMELY, SPORTS JERSEYS, ATHLETIC SHOES, ATHLETIC UNIFORMS, BASEBALL CAPS, SPORTS JACKETS, SWEAT BANDS AND WRIST BANDS (U.S. CLS. 22 AND 39).

BRENDAN MCCAULEY, EXAMINING ATTORNEY

SN 77-144,479. CONTESTS2WIN.COM INDIA PVT. LTD., MUMBAI, INDIA, FILED 3-30-2007.

2WIN

THE MARK CONSISTS OF STANDARD CHARACTERS WITHOUT CLAIM TO ANY PARTICULAR FONT, STYLE, SIZE, OR COLOR.

CLASS 38—COMMUNICATION

FOR TELECOMMUNICATION SERVICES, NAMELY, PROVIDING TELECOMMUNICATIONS CONNECTIONS TO A GLOBAL COMPUTER NETWORK AND TRANSMISSION OF INFORMATION WITH THE HELP OF TELECOMMUNICATION MEDIA; RADIO BROADCASTING, CELLULAR TELEPHONE COMMUNICATION, COMMUNICATION BY COMPUTER TERMINALS, COMMUNICATION BY OPTICAL FIBER, COMMUNICATION BY TELEGRAMS, COMMUNICATION BY TELEPHONE, COMPUTER AIDED TRANSMISSION OF MESSAGES AND IMAGES, ELECTRONIC MAIL, ELECTRONIC MESSAGE SENDING, BROADCASTING OF RADIO AND TELEVISION PROGRAMS, BROADCASTING OF PROGRAMS VIA GLOBAL COMMUNICATION NETWORK, ELECTRONIC TRANSMISSION OF VOICE, DATA AND IMAGES BY TELEVISION AND VIDEO BROADCASTING (U.S. CLS. 100, 101 AND 104).

CLASS 41—EDUCATION AND ENTERTAINMENT

FOR ENTERTAINMENT SERVICES, NAMELY, GAME SHOW EVENTS, GAME SHOWS, CULTURAL ACTIVITIES, SPORT ACTIVITIES, ENTERTAINMENT IN THE NATURE OF GAME SHOWS (U.S. CLS. 100, 101 AND 107).

CLASS 42—SCIENTIFIC AND COMPUTER SERVICES

FOR HOSTING OF WEBSITES, DESIGN OF COMPUTER DATA BASE (U.S. CLS. 100 AND 101).

GRETNA YAO, EXAMINING ATTORNEY

SN 77-145,251. PRUDENTIAL UTAH REAL ESTATE, MIDVALE, UT. FILED 3-30-2007.

CONCIERGE RELOCATION

THE MARK CONSISTS OF STANDARD CHARACTERS WITHOUT CLAIM TO ANY PARTICULAR FONT, STYLE, SIZE, OR COLOR.

NO CLAIM IS MADE TO THE EXCLUSIVE RIGHT TO USE "RELOCATION", APART FROM THE MARK AS SHOWN.

CLASS 35—ADVERTISING AND BUSINESS

FOR BUSINESS RELOCATION; BUSINESS RELOCATION CONSULTING; EMPLOYEE RELOCATION AND INFORMATION; MOVING AND RELOCATION SERVICES, NAMELY, PLANNING AND IMPLEMENTING MOVES OF HOMES AND OFFICES; PERSONNEL RELOCATION; MATCHING CONSUMERS WITH REAL ESTATE PROFESSIONALS IN THE FIELD OF REAL ESTATE SERVICES VIA COMPUTER NETWORK; PROVIDING REAL ESTATE LEADS FOR PROSPECTIVE PURCHASERS; REAL ESTATE ADVERTISING SERVICES; REAL ESTATE AUCTIONS; REAL ESTATE MARKETING SERVICES IN THE FIELD OF RELOCATION SERVICES; REAL ESTATE MARKETING SERVICES, NAMELY, ON-LINE SERVICES FEATURING TOURS OF RESIDENTIAL AND COMMERCIAL REAL ESTATE; REAL ESTATE SALES MANAGEMENT (U.S. CLS. 100, 101 AND 102).

FIRST USE 12-1-2006; IN COMMERCE 1-1-2007.

CLASS 36—INSURANCE AND FINANCIAL

FOR APPRAISAL OF REAL ESTATE; ASSESSMENT AND MANAGEMENT OF REAL ESTATE; EVALUATION OF REAL PROPERTY; FINANCIAL VALUATION OF PERSONAL PROPERTY AND REAL ESTATE; HOUSING SERVICES, NAMELY, REAL PROPERTY ACQUISITION AND CONSUMER FINANCING TO FACILITATE HOME OWNERSHIP; LAND ACQUISITION, NAMELY, REAL ESTATE BROKERAGE; LEASING OF REAL ESTATE; LEASING OF REAL PROPERTY; PROVIDING INFORMATION IN THE FIELD OF REAL ESTATE BY MEANS OF LINKING THE WEB SITE TO OTHER WEB SITES FEATURING REAL ESTATE INFORMATION; PROVIDING INFORMATION IN THE FIELD OF REAL ESTATE VIA THE INTERNET; PROVIDING REAL ESTATE LISTINGS AND REAL ESTATE INFORMATION VIA THE INTERNET; REAL ESTATE ACQUISITION SERVICES; REAL ESTATE AGENCIES; REAL ESTATE APPRAISAL; REAL ESTATE BROKERAGE; REAL ESTATE CONSULTANCY; REAL ESTATE CONSULTATION; REAL ESTATE ESCROW SERVICES; REAL ESTATE LISTING; REAL ESTATE MANAGEMENT; REAL ESTATE MANAGEMENT CONSULTATION; REAL ESTATE MULTIPLE LISTING SERVICES; REAL ESTATE PROCUREMENT FOR OTHERS; REAL ESTATE VALUATION SERVICES; REAL ESTATE VALUATIONS (U.S. CLS. 100, 101 AND 102).

FIRST USE 12-1-2006; IN COMMERCE 1-1-2007.
JENNIFER VASQUEZ, EXAMINING ATTORNEY

SN 77-145,444. DESIGN BY ME HANDBAG STUDIO, LLC, SAN FRANCISCO, CA. FILED 3-31-2007.

DBM Handbag Studio

THE MARK CONSISTS OF STANDARD CHARACTERS WITHOUT CLAIM TO ANY PARTICULAR FONT, STYLE, SIZE, OR COLOR.

NO CLAIM IS MADE TO THE EXCLUSIVE RIGHT TO USE "HANDBAG STUDIO", APART FROM THE MARK AS SHOWN.

CLASS 18—LEATHER GOODS

FOR CHANGE PURSES; CLUTCH PURSES; CLUTCHES; COIN PURSES; COIN PURSES NOT MADE OF PRECIOUS METAL; COIN PURSES, NOT OF PRECIOUS METALS; MULTI-PURPOSE PURSES; PURSES; PURSES; SMALL CLUTCH PURSES; SMALL PURSES; WRIST MOUNTED PURSES; EVENING HANDBAGS; HANDBAGS; STRAPS FOR HANDBAGS; BAGS FOR CARRYING BABIES' ACCESSORIES; DIAPER BAGS; ALL PURPOSE SPORT BAGS; ALL-PURPOSE ATHLETIC BAGS; ALL-PURPOSE CARRYING BAGS; ATHLETIC BAGS; BAGS AND HOLDALLS FOR SPORTS CLOTHING; BEACH BAGS; BOOK BAGS; CARRY-ALL BAGS; CLUTCH BAGS; COSMETIC BAGS SOLD EMPTY; DUFFEL BAGS; DUFFLE BAGS; MAKE-UP BAGS SOLD EMPTY; MESSENGER BAGS; SHOULDER BAGS; SLING BAGS; TOTE BAGS; WRISTLET BAGS (U.S. CLS. 1, 2, 3, 22 AND 41).

FIRST USE 12-5-2006; IN COMMERCE 12-5-2006.

CLASS 24—FABRICS

FOR BURP CLOTHS; DIAPER CHANGING MATS; DIAPER CHANGING PADS NOT OF PAPER; CHILDREN'S BLANKETS; RECEIVING BLANKETS; SILK BLANKETS (U.S. CLS. 42 AND 50).

FIRST USE 12-5-2006; IN COMMERCE 1-13-2007.

CLASS 25—CLOTHING

FOR NURSING APPAREL, NAMELY, NURSING COVERS (U.S. CLS. 22 AND 39).

FIRST USE 12-5-2006; IN COMMERCE 1-13-2007.
CHARLOTTE CORWIN, EXAMINING ATTORNEY

SN 77-145,519. OTTO, DAVID D/B/A STRESSED OUT SOLUTIONS, GRAPEVINE, TX. FILED 3-31-2007.

MASTER STRESS 101

THE MARK CONSISTS OF STANDARD CHARACTERS WITHOUT CLAIM TO ANY PARTICULAR FONT, STYLE, SIZE, OR COLOR.

NO CLAIM IS MADE TO THE EXCLUSIVE RIGHT TO USE "STRESS", APART FROM THE MARK AS SHOWN.

CLASS 9—ELECTRICAL AND SCIENTIFIC APPARATUS

FOR ELECTRONIC MEDIA, NAMELY, PRE-RECORDED AUDIO AND VIDEO CASSETTES, DISCS AND TAPES AND DIGITAL RECORDING DISCS AND TAPES ALL FEATURING INFORMATION IN THE FIELD OF PERSONAL DEVELOPMENT, STRESS MANAGEMENT AND WELLNESS (U.S. CLS. 21, 23, 26, 36 AND 38).

CLASS 16—PAPER GOODS AND PRINTED MATTER

FOR PAPER AND PRINTED MATTER, NAMELY, BOOKLETS, BROCHURES, NEWSLETTERS AND PAMPHLETS FEATURING INFORMATION IN THE FIELD OF PERSONAL DEVELOPMENT, STRESS MANAGEMENT AND WELLNESS; PRINTED EDUCATIONAL, INSTRUCTIONAL AND TEACHING MATERIALS FEATURING INFORMATION IN THE FIELD OF PERSONAL DEVELOPMENT, STRESS MANAGEMENT AND WELLNESS; AGENDAS; PHOTOGRAPH AND SCRAPBOOK ALBUMS; BOOKMARKS; CALENDARS; DESK DIARIES; PHOTOGRAPHS MOUNTED AND UNMOUNTED; PROMOTIONAL POSTCARDS AND POSTERS; SERIES OF NON-FICTION BOOKS, MANUALS AND WORKBOOKS FEATURING INFORMATION IN THE FIELD OF PERSONAL DEVELOPMENT, STRESS MANAGEMENT AND WELLNESS; STATIONERY, NAMELY, LETTERHEAD AND ENVELOPES, PADS, FOLDERS AND STICKERS; STATIONERY COVERS; PENS AND PENCILS (U.S. CLS. 2, 5, 22, 23, 29, 37, 38 AND 50).

CLASS 35—ADVERTISING AND BUSINESS

FOR RETAIL, WHOLESALE, MAIL-ORDER CATALOG AND ONLINE STORE SERVICES FEATURING PRODUCTS AND SERVICES RELATING TO PERSONAL DEVELOPMENT, STRESS MANAGEMENT AND WELLNESS (U.S. CLS. 100, 101 AND 102).

CLASS 38—COMMUNICATION

FOR TELECOMMUNICATIONS SERVICES, NAMELY, BROADCASTING RADIO AND TELEVISION PROGRAMS AND FILMS VIA A GLOBAL COMPUTER NETWORK AND STREAMING OF AUDIO MATERIAL ON THE INTERNET; ELECTRONIC, ELECTRIC, AND DIGITAL TRANSMISSION OF VOICE, DATA, IMAGES, SOUND, SIGNAL AND MESSAGES; ELECTRONIC TRANSMISSION OF E-BOOKS, E-ZINES AND NEWSLETTERS VIA A GLOBAL COMPUTER NETWORK; ELECTRONIC TRANSMISSION OF GREETING CARDS AND MAILERS VIA A GLOBAL COMPUTER NETWORK; TRANSMISSION OF DATA, DOCUMENTS AND INFORMATION BY ELECTRONIC MEDIA; TELECOMMUNICATION SERVICES, NAMELY, TRANSMISSION OF WEBCASTS; AND VIDEO ON-DEMAND TRANSMISSION SERVICES (U.S. CLS. 100, 101 AND 104).

CLASS 41—EDUCATION AND ENTERTAINMENT

FOR EDUCATIONAL AND INSTRUCTIONAL SERVICES, NAMELY, ARRANGING AND CONDUCTING CONFERENCES, RETREATS, SEMINARS, AND WORKSHOPS IN THE FIELD OF PERSONAL DEVELOPMENT, STRESS MANAGEMENT AND WELLNESS; ENTERTAINMENT SERVICES, NAMELY, LIVE SPEAKING PERFORMANCES AND SPEAKING ENGAGEMENTS IN THE FIELD OF PERSONAL DEVELOPMENT, STRESS MANAGEMENT AND WELLNESS; PRODUCTION OF RADIO AND TELEVISION AND FILM PROGRAMS FOR TRANSMISSION VIA BROADCAST, CABLE, DIGITAL AND GLOBAL COMPUTER NETWORK AND PUBLICATION OF ACCOMPANYING MATERIALS IN THE FORM OF BOOKS, MAGAZINES AND NEWSLETTERS; INTERNET RADIO SERVICES, NAMELY, PROVIDING PODCASTS FEATURING INFORMATION IN THE FIELD OF PERSONAL DEVELOPMENT, STRESS MANAGEMENT AND WELLNESS (U.S. CLS. 100, 101 AND 107).

CLASS 44—MEDICAL, BEAUTY AND AGRICULTURAL SERVICES

FOR PROVIDING INFORMATION IN THE FIELDS OF MENTAL AND PHYSICAL HEALTH, NAMELY, STRESS MANAGEMENT AND WELLNESS (U.S. CLS. 100 AND 101).

NAAKWAMA ANKRAH, EXAMINING ATTORNEY

SN 77-146,199. JIFFY LUBE INTERNATIONAL, INC., HOUSTON, TX. FILED 4-2-2007.



OWNER OF U.S. REG. NOS. 1,289,366, 1,556,732 AND OTHERS.

THE MARK CONSISTS OF STYLIZED "J" IN A CIRCLE.

CLASS 7—MACHINERY

FOR VEHICLE AIR AND OIL FILTERS FOR AUTOMOTIVE ENGINES (U.S. CLS. 13, 19, 21, 23, 31, 34 AND 35).

CLASS 16—PAPER GOODS AND PRINTED MATTER

FOR PRINTED MATERIALS IN THE FIELD OF VEHICLE MAINTENANCE, NAMELY, VEHICLE MAINTENANCE, SCHEDULES, BROCHURES AND INSTRUCTIONAL MATERIALS (U.S. CLS. 2, 5, 22, 23, 29, 37, 38 AND 50).

CLASS 25—CLOTHING

FOR CLOTHING, NAMELY SHIRTS, HATS AND JACKETS (U.S. CLS. 22 AND 39).

CLASS 37—CONSTRUCTION AND REPAIR

FOR VEHICLE PREVENTATIVE MAINTENANCE SERVICES, NAMELY, LUBRICATING CHASSIS; CHANGING MOTOR OIL; CHANGING OIL AND AIR FILTERS; REFILLING TRANSMISSION, DIFFERENTIAL, BRAKE, POWER STEERING, RADIATOR, WINDSHIELD WASHER AND BATTERY RESERVOIRS TO PROPER FLUID LEVELS; CHANGING WINDSHIELD WIPER BLADES; INFLATING TIRES TO PROPER PRESSURE; VACUUMING INTERIORS; AND WASHING WINDOWS (U.S. CLS. 100, 103 AND 106).

HEATHER BIDDULPH, EXAMINING ATTORNEY

SN 77-146,407. WARNER-ELEKTRA-ATLANTIC CORPORATION, NEW YORK, NY. FILED 4-2-2007.



NO CLAIM IS MADE TO THE EXCLUSIVE RIGHT TO USE "MUSIC VIDEO INTERACTIVE", APART FROM THE MARK AS SHOWN.

THE MARK CONSISTS OF THE WORDS "MUSIC VIDEO INTERACTIVE" OVER THE LETTERS "MVI". COLOR IS NOT CLAIMED AS A FEATURE OF THE MARK.

CLASS 9—ELECTRICAL AND SCIENTIFIC APPARATUS

FOR AUDIO AND AUDIOVISUAL RECORDINGS FEATURING MUSIC AND MUSICAL ENTERTAINMENT; HYBRID, TWO-SIDED OPTICAL DISCS FEATURING COMBINATIONS OF AUDIO AND AUDIOVISUAL RECORDINGS, MULTIMEDIA CONTENT, GRAPHICS, TEXT, VIDEO GAMES, INTERNET WEB LINKS, TELEPHONE RING TONES, AND MUSIC AND MUSICAL ENTERTAINMENT-ORIENTED INFORMATION (U.S. CLS. 21, 23, 26, 36 AND 38).

CLASS 35—ADVERTISING AND BUSINESS

FOR ON-LINE RETAIL STORE SERVICES FEATURING AUDIO AND AUDIOVISUAL RECORDINGS, RING TONES AND MERCHANDISE (U.S. CLS. 100, 101 AND 102).

CLASS 41—EDUCATION AND ENTERTAINMENT

FOR ENTERTAINMENT SERVICES, NAMELY, PROVIDING PRERECORDED MUSIC, INFORMATION IN THE FIELD OF MUSIC, AND COMMENTARY AND ARTICLES ABOUT MUSIC, ALL ON-LINE VIA A GLOBAL COMPUTER NETWORK; PROVIDING ENTERTAINMENT INFORMATION, NAMELY, PROVIDING VISUAL, SOUND, AND INTERACTIVE INFORMATION ON RECORDING ARTISTS, RECORDINGS, LYRICS, CONCERT TOURS AND BIOGRAPHICAL INFORMATION ON ARTISTS VIA A GLOBAL COMPUTER NETWORK; ON-LINE JOURNALS, NAMELY, WEB BLOGS FEATURING INFORMATION IN THE FIELD OF MUSIC AND MUSICAL ENTERTAINMENT; PROVIDING MOBILE MEDIA AND ENTERTAINMENT SERVICES IN THE NATURE OF CONTENT PREPARATION; ENTERTAINMENT SERVICES, NAMELY, PROVIDING RING TONES, PRE-RECORDED MUSIC, VIDEO AND GRAPHICS FOR MOBILE COMMUNICATIONS DEVICES VIA A GLOBAL COMPUTER NETWORK AND WIRELESS NETWORKS (U.S. CLS. 100, 101 AND 107).

BRIAN CALLAGHAN, EXAMINING ATTORNEY

SN 77-146,703. THOMPSON HOLDINGS, L.P., NEW YORK, NY. FILED 4-2-2007.

ZOO TOO

THE MARK CONSISTS OF STANDARD CHARACTERS WITHOUT CLAIM TO ANY PARTICULAR FONT, STYLE, SIZE, OR COLOR.

CLASS 35—ADVERTISING AND BUSINESS

FOR PROVIDING ON-LINE COMPUTER DATABASES AND ON-LINE SEARCHABLE DATABASES FEATURING CLASSIFIED ADVERTISEMENT LISTINGS AND COMMERCIAL ANNOUNCEMENTS ABOUT VOLUNTEER PROGRAMS AND COMMUNITY SERVICE PROJECTS OFFERED BY CHARITABLE ORGANIZATIONS AND BUSINESSES; PROVIDING AN ON-LINE COMPUTER DATABASE FEATURING A REGISTRY OF BREEDS IN THE FIELD OF DOGS, CATS, BIRDS, FISH, HORSES, AND REPTILES; CHARITABLE SERVICES, NAMELY, ORGANIZING AND CONDUCTING VOLUNTEER PROGRAMS AND COMMUNITY SERVICE PROJECTS FOR VOLUNTEERS TO ASSIST WITH ANIMAL SHELTERS, ANIMAL PROTECTION AND WELFARE CAUSES, AND PETS; CHARITABLE SERVICES, NAMELY, ORGANIZING AND CONDUCTING VOLUNTEER PROGRAMS AND COMMUNITY SERVICE PROJECTS FOR ANIMAL PROTECTION AND WELFARE CAUSES, PETS, AND ANIMAL SHELTERS; DEVELOPING AND COORDINATING VOLUNTEER PROJECTS FOR CHARITABLE ORGANIZATIONS, NAMELY, PROVIDING COMMUNITY OUTREACH PROGRAMS TO ENCOURAGE VOLUNTEERISM WITH ANIMAL SHELTERS, ANIMAL PROTECTION AND WELFARE CAUSES, AND PETS; PROVIDING A WEB SITE FEATURING PRODUCT REVIEWS OF PET PRODUCTS FOR PURCHASE, NAMELY, FOOD, TOYS AND PET ACCESSORIES; PROVIDING A WEB SITE WHERE USERS CAN POST RATINGS, REVIEWS AND RECOMMENDATIONS ON SHELTERS, VETS, AND GROOMING SERVICES (U.S. CLS. 100, 101 AND 102).

CLASS 39—TRANSPORTATION AND STORAGE

FOR PROVIDING AN ON-LINE COMPUTER DATABASE IN THE FIELD OF ANIMAL RESCUE SERVICES (U.S. CLS. 100 AND 105).

CLASS 41—EDUCATION AND ENTERTAINMENT

FOR PROVIDING AN ON-LINE COMPUTER DATABASE IN THE FIELD OF ANIMAL TRAINING (U.S. CLS. 100, 101 AND 107).

CLASS 42—SCIENTIFIC AND COMPUTER SERVICES

FOR COMPUTER SERVICES, NAMELY, PROVIDING SEARCH ENGINES FOR OBTAINING INFORMATION ON ANIMALS AND PETS ON A GLOBAL COMPUTER NETWORK; DESIGN OF SPECIALTY INTERIOR AND EXTERIOR ENVIRONMENT SETTINGS IN ANIMAL SHELTERS (U.S. CLS. 100 AND 101).

CLASS 43—HOTEL AND RESTAURANT SERVICES

FOR PROVIDING AN ON-LINE COMPUTER DATABASE IN THE FIELD OF BOARDING FOR ANIMALS (U.S. CLS. 100 AND 101).

CLASS 44—MEDICAL, BEAUTY AND AGRICULTURAL SERVICES

FOR CHARITABLE SERVICES, NAMELY, PROVIDING FIRST AID SUPPLIES TO ANIMAL SHELTERS; PROVIDING AN ON-LINE COMPUTER DATABASE IN THE FIELD OF ANIMAL BREEDING AND ANIMAL GROOMING (U.S. CLS. 100 AND 101).

SKYE YOUNG, EXAMINING ATTORNEY

SN 77-146,950. PIK CENTR CO., LTD, MOSCOW, RUSSIAN FED., FILED 4-3-2007.



PRIORITY CLAIMED UNDER SEC. 44(D) ON RUSSIAN FED. APPLICATION NO. 2006732756, FILED 11-13-2006.

OWNER OF RUSSIAN FED. REG. NO. 325537, DATED 5-3-2007, EXPIRES 11-13-2016.

THE NAME(S), PORTRAIT(S), AND/OR SIGNATURE(S) SHOWN IN THE MARK IDENTIFIES KIRA PLASTININA, WHOSE CONSENT(S) TO REGISTER IS SUBMITTED.

THE MARK CONSISTS OF STYLIZED LETTERS SPELLING THE WORDS KIRA PLASTININA.

CLASS 3—COSMETICS AND CLEANING PREPARATIONS

FOR ADHESIVES FOR COSMETIC USE, AFTER SUN CREAMS, AFTER-SHAVE, AFTER-SHAVE BALMS, AFTER-SHAVE CREAMS, AFTER-SHAVE EMULSIONS, AFTER-SHAVE GEL, AFTER-SHAVE LOTIONS, AFTER-SUN LOTIONS, AGE RETARDANT GEL, AGE RETARDANT LOTION, AGE SPOT REDUCING CREAMS, ALCOHOL FOR CLEANING PURPOSES, ALL PURPOSE CLEANING PREPARATIONS, ALL PURPOSE COTTON SWABS FOR PERSONAL USE, ALL-PURPOSE CLEANERS, AMBERGRIS, ALMOND SOAPS, ANTIBACTERIAL SOAP, ANTIPERSPIRANTS FOR PERSONAL USE, ANTI-AGING CREAM, ANTI-WRINKLE CREAM, AROMATHERAPY CREAMS, AROMATHERAPY LOTIONS, AROMATHERAPY OILS, ARTIFICIAL EYELASHES, ARTIFICIAL FINGERNAILS, ASTRINGENTS FOR COSMETIC PURPOSES, BABY OILS, BABY POWDERS, BABY SHAMPOO, BAR SOAP, BATH FOAM, BATH GEL, BATH LOTION, BATH OILS FOR COSMETIC

PURPOSES, BATH SALTS, BEAUTY CREAMS, BEAUTY CREAMS FOR BODY CARE, BEAUTY GELS, BEAUTY LOTIONS, BEAUTY MASKS, BEAUTY MILKS, BERGAMOT OIL, BLEACHING PREPARATIONS FOR COSMETIC PURPOSES, BLUSH, BODY AND BEAUTY CARE COSMETICS, BODY ART PENS, BODY CREAM, BODY CREAM SOAP, BODY DEODORANT IN PILL FORM, BODY EMULSIONS, BODY LOTION, BODY MASK CREAM, BODY MILK, BODY OIL, BODY SCRUB, BODY SPRAYS, BODY WASHES, CHALK FOR COSMETIC USE, CLEANSING CREAMS, COCOA BUTTER FOR COSMETIC PURPOSES, COLD CREAM, COLOGNE, COLORING PREPARATIONS FOR COSMETIC PURPOSES, COMPACTS CONTAINING MAKE-UP, COSMETIC BALLS, COSMETIC CREAMS, COSMETIC FACIAL BLOTTERING PAPERS, COSMETIC MILKS, COSMETIC OILS, COSMETIC PADS, COSMETIC PENCILS, COSMETIC PREPARATIONS FOR SKIN RENEWAL, COSMETIC PREPARATIONS AGAINST SUNBURN, COSMETIC PREPARATIONS FOR BODY CARE, COSMETIC PREPARATIONS FOR EYE LASHES, COSMETIC PREPARATIONS FOR THE CARE OF MOUTH AND TEETH, COSMETIC ROUGES, COSMETIC SOAPS, COSMETIC SUN-PROTECTING PREPARATIONS, COSMETIC SUN-TANNING PREPARATIONS, COSMETICS, COSMETICS, NAMELY, COMPACTS, LIP PRIMER, LIP REPAIRERS; COTTON FOR COSMETIC PURPOSES; COTTON STICKS FOR COSMETIC PURPOSES; CREAM SOAPS; CREAMS FOR CELLULITE REDUCTION; CREAMY FACE POWDER; CREAMY FOUNDATION; CUTICLE CONDITIONERS; CUTICLE CREAM; CUTICLE REMOVING PREPARATIONS; DECORATIVE TRANSFERS AND SKIN JEWELS FOR COSMETIC PURPOSES; DEODORANT FOR PERSONAL USE; DEODORANT SOAP; DEPLATORIES; EAU DE PARFUM; EAU DE TOILETTE; EPILATORY STRIPS; ESSENTIAL OILS; EXFOLIANT CREAMS; EYE COMPRESSES FOR COSMETIC PURPOSES; EYE CREAM; EYE MAKE-UP; EYE MAKE-UP REMOVER; EYE PENCILS; EYE SHADOW; EYEBROW COLORS; EYEBROW PENCILS; EYELINER; EYELINER PENCILS; FACE AND BODY CREAMS; FACE MILK AND LOTIONS; FACE POWDER; FACIAL MAKE-UP; FALSE EYELASHES; FALSE NAILS; FOAMS CONTAINING COSMETICS AND SUNSCREENS; FOUNDATION MAKE-UP; GAUZE FOR COSMETIC PURPOSES; GEL EYE MASKS; HAIR BALSAM; HAIR BLEACH; HAIR BLEACHES; HAIR CARE CREAMS; HAIR CARE PREPARATIONS; HAIR CLEANING PREPARATIONS; HAIR COLOR; HAIR COLOR REMOVERS; HAIR CONDITIONER; HAIR DRESSINGS FOR MEN; HAIR DRESSINGS FOR WOMEN; HAIR FIXERS; HAIR GEL; HAIR LOTIONS; HAIR MOUSSES; HAIR OILS; HAIR RELAXING PREPARATIONS; HAIR REMOVING CREAM; HAIR SPRAY; HAIR STRAIGHTENING PREPARATIONS; HAIR STYLING PREPARATIONS; HAIR TONICS; HAND CLEANING PREPARATIONS; HAND CREAMS; HAND LOTIONS; HAND SOAPS; HENNA FOR COSMETIC PURPOSES; LIP BALM; LIP CREAM; LIP GLOSS; LIP LINER; LIPSTICK; LIPSTICK HOLDERS; LIQUID SOAPS FOR HANDS, FACE AND BODY; LIQUID PERFUMES; LOTIONS FOR FACE AND BODY CARE; MAKE UP FOUNDATIONS; MAKE UP REMOVING PREPARATIONS; MAKE-UP; MAKE-UP PENCILS; MAKE-UP POWDER; MAKE-UP PRODUCTS FOR THE FACE AND BODY; MASCARAS; MASSAGE OILS; MINERAL SALT IN THE NATURE OF BATH SALTS NOT FOR MEDICAL PURPOSES; MOISTURIZING MILKS; NAIL CARE PREPARATIONS; NAIL CREAM; NAIL ENAMELS; NAIL HARDENERS; NAIL POLISH; NAIL STRENGTHENERS; NAIL TIPS; NAIL VARNISH FOR COSMETIC PURPOSES; NAIL-POLISH REMOVERS; NATURAL ESSENTIAL OILS; NATURAL MINERAL MAKE-UP; NON-MEDICATED ACNE TREATMENT PREPARATIONS; NON-MEDICATED BATH PREPARATIONS; NON-MEDICATED BODY SOAKS; NON-MEDICATED FOOT CREAM; NON-MEDICATED LIP CARE PREPARATIONS; NON-MEDICATED LIP PROTECTOR; NON-MEDICATED OINTMENTS FOR THE PREVENTION AND TREATMENT OF SUNBURN; NON-MEDICATED SCALP TREATMENT CREAM; NON-MEDICATED SKIN CARE PREPARATIONS; NON-MEDICATED SKIN CREAMS; NON-MEDICATED SUN CARE PREPARATIONS; NON-MEDICATED TOILETRIES; NUTRITIONAL OILS FOR COSMETIC PURPOSES; OIL BATHS FOR HAIR CARE; OILS FOR HAIR CONDITIONING; PARAFFIN WAX FOR COSMETIC PURPOSES; PENCILS FOR COSMETIC PURPOSES; PERFUME OILS; PERFUME OILS FOR THE MANUFACTURE OF COSMETIC PREPARATIONS; PERFUMED CREAMS; PERFUMED

EXTRACTS FOR TISSUES AND PERFUMES; PERFUMED PASTE; PERFUMED POWDERS; PERFUMED SOAPS; PERFUMERY; PERFUMING SACHETS; PRE-SHAVE CREAMS; ROSE OIL FOR COSMETIC PURPOSES; ROUGES; SHAMPOOS; SHAMPOO-CONDITIONERS; SHAVING BALM; SHAVING CREAMS; SHAVING FOAM; SHAVING GELS; SHAVING LOTIONS; SHAVING PREPARATIONS; SHAVING SOAP; SHOWER AND BATH GEL; SHOWER CREAMS; SKIN AND BODY TOPICAL LOTIONS, CREAMS AND OILS FOR COSMETIC USE; SKIN ABRASIVE PREPARATIONS; SKIN BRONZING CREAMS; SKIN CLEANSING CREAM; SKIN CLEANSING LOTION; SKIN CONDITIONERS; SKIN CREAMS; SKIN LOTIONS; SKIN SOAP; SUN CARE LOTIONS; SUN CREAMS; SUN SCREEN PREPARATIONS; SUNTANNING PREPARATIONS; SYNTHETIC PERFUMERY; TALCUM POWDERS; TOILET SOAPS; TOILET WATER; TOOTHPASTES (U.S. CLS. 1, 4, 6, 50, 51 AND 52).

CLASS 9—ELECTRICAL AND SCIENTIFIC APPARATUS

FOR FRAMES FOR SPECTACLES AND SUNGLASSES; ANTI-DAZZLE SPECTACLES; SPECTACLES; CHILDREN'S EYE GLASSES; PROTECTIVE GLASSES; READING GLASSES; SPORTS GLASSES; SUNGLASSES (U.S. CLS. 21, 23, 26, 36 AND 38).

CLASS 14—JEWELRY

FOR JEWELRY, NAMELY, AMULETS; ANKLE BRACELETS; BADGES OF PRECIOUS METAL; BODY-PIERCING RINGS; BODY-PIERCING STUDS; BRACELETS; BRACELETS OF PRECIOUS METAL; BRONZE JEWELRY; BROOCHES; CHARMS; BOXES FOR TIMEPIECES; CHRONOGRAPHS FOR USE AS WATCHES; CLIP EARRINGS; CLOCK AND WATCH HANDS; CLOCKS; CLOISONNE PINS; COLLECTIBLE COINS; COMMEMORATIVE COINS; COMMEMORATIVE STATUARY CUPS MADE OF PRECIOUS METAL; COSTUME JEWELRY; CUFF-LINKS; DESKTOP STATUARY MADE OF PRECIOUS METAL; DIALS FOR CLOCK-AND-WATCH-MAKING; DIAMOND BELTS; DIVING WATCHES; DRAWER PULLS OF PRECIOUS METAL; EAR CLIPS; EAR STUDS; EARRINGS; FANCY KEYRINGS OF PRECIOUS METALS; FIGURES OF PRECIOUS METAL; IDENTIFICATION BRACELETS; JEWEL CHAINS; JEWEL PENDANTS; JEWELRY; JEWELRY BOXES; JEWELRY CASES; JEWELRY CASKETS; JEWELRY FOR THE HEAD; JEWELRY PINS FOR USE ON HATS; JEWELRY WATCHES; JEWELRY, NAMELY, CROSSES; JEWELRY, NAMELY, PRECIOUS METAL PLATED REAL LEAVES AND FLOWERS; KEY CHAINS OF PRECIOUS METAL; KEY HOLDERS OF PRECIOUS METALS; KEY RINGS OF PRECIOUS METAL; LAPEL PINS; LEATHER JEWELRY AND ACCESSORY BOXES; MEDALLIONS; MEDALS; NECK CHAINS; NECKLACES; NECKTIE FASTENERS; NON-MONETARY COINS; ORNAMENTAL LAPEL PINS; ORNAMENTAL PINS; ORNAMENTS OF PRECIOUS METAL; PENDANTS; PENDULUM CLOCKS; PINS BEING JEWELRY; POCKET WATCHES; RINGS BEING JEWELRY; SCULPTURES MADE OF PRECIOUS METAL; SHIRT STUDS; STATUETTES OF PRECIOUS METAL; TIARAS; WATCH CHAINS; WATCH CASES; WATCH BRACELETS; WATCH BANDS AND STRAPS; WATCH PARTS; WATCH STRAPS; WATCHES; WOODEN JEWELLERY BOXES; WORKS OF ART OF PRECIOUS METAL; WRIST WATCHES (U.S. CLS. 2, 27, 28 AND 50).

CLASS 16—PAPER GOODS AND PRINTED MATTER

FOR PRINTED FORMS; NOTE BOOKS; PATTERNS FOR MAKING CLOTHES; PLASTIC OR PAPER BAGS FOR MERCHANDISE PACKAGING; ADVERTISING SIGNS OF PAPER OR CARDBOARD; CARDBOARD BACKING FOR BINDING BOOKS; CARDBOARD BOXES; CARDBOARD CARRIERS FOR FOOD AND BEVERAGES; CARDBOARD CARTONS; CARDBOARD CONTAINERS; CARDBOARD FLOOR DISPLAY UNITS FOR MERCHANDISING PRODUCTS; CARDBOARD HANG TAGS; CARDBOARD MAILING TUBES; CARDBOARD PACKAGING; COLLAPSIBLE CARDBOARD BOXES; CONTAINERS FOR ICE MADE OF PAPER OR CARDBOARD; CORRUGATED CARDBOARD BOXES; HAT BOXES OF CARDBOARD; PICTURE MOUNTS OF CARDBOARD; PLACARDS OF PAPER OR CARDBOARD; TRADING CARD DISCS OF PAPER OR CARDBOARD; CALENDARS; BOXES OF PAPER OR CARDBOARD; PAPER RIBBONS; MUSICAL GREETING CARDS; GREETING CARDS; POSTCARDS; PAPER BAGS; PAPER TOWELS; FACIAL TISSUE (U.S. CLS. 2, 5, 22, 23, 29, 37, 38 AND 50).

CLASS 18—LEATHER GOODS

FOR RAINPROOF PARASOLS; PARASOLS (U.S. CLS. 1, 2, 3, 22 AND 41).

CLASS 21—HOUSEWARES AND GLASS

FOR PERFUME SPRAYERS; COMBS; FLASKS (U.S. CLS. 2, 13, 23, 29, 30, 33, 40 AND 50).

CLASS 25—CLOTHING

FOR BANDANAS; NECKERCHIEFS; UNDERWEAR; OVERALLS; BOAS; ANKLE BOOTS; BREECHES; TROUSERS; BRASSIERES; VEILS; ASCOTS; LEGGINGS; GAITERS; VESTS; SPORTS JERSEYS; HOSIERY; HOODS; COLLAR PROTECTORS; CAP VISORS; TIGHTS; COMBINATIONS; WET SUITS FOR WATER-SKIING AND SUBAQUA; SUITS; BATHING SUITS; MASQUERADE COSTUMES; BEACHWEAR; JACKETS; CAMISOLES; T-SHIRTS; SPORTS SHIRTS WITH SHORT SLEEVES; SHIRT FRONTS; FUR STOLETS; SOCKS; BATH SLIPPERS; BEACH SHOES; AFTER SKI BOOTS; CLIMBING BOOTS; FOOTBALL BOOTS AND STUDS THEREFORE; HIKING BOOTS; HORSE-RIDING BOOTS; MOTORCYCLIST BOOTS; SKI AND SNOWBOARD SHOES AND PARTS THEREOF; SOCCER BOOTS; ANGLERS' SHOES; ATHLETIC SHOES; BALLET SHOES; BASEBALL SHOES; BOWLING SHOES; BOXING SHOES; CYCLING SHOES; GOLF SHOES; HANDBALL SHOES; HOCKEY SHOES; RUGBY SHOES; TENNIS SHOES; VOLLEYBALL SHOES; PUMPS; FOOTWEAR; JERSEYS; LEATHER BELTS; LEATHER COATS; LEATHER HEADWEAR; LEATHER JACKETS; LEATHER PANTS; SUITS OF LEATHER; TROUSERS OF LEATHER; TOPCOATS; RAINCOATS; TRENCH COATS; PARKAS; PELERINES; GLOVES; PAJAMAS; SCARVES; FROCKS; WATERPROOF JACKETS AND PANTS; HEADBANDS; GARTERS; SUSPENDER BELTS FOR WOMEN; LACE BOOTS; BELTS; MONEY BELTS; PULLOVERS; SHIRTS; FOOTWEAR MADE OF WOOD; SANDALS; BOOTS; SARIS; SWEATERS; UNDERPANTS; GYMNASTIC SHOES; SLIPPERS; SHOES; TURBANS; HEAD WEAR; APRONS; DRESSING GOWNS; SHOWER CAPS; STOCKINGS; SHAWLS; SKULL CAPS; BATHING CAPS; SASHES; PELISSES; CANVAS SHOES; SKIRTS; PETTICOATS (U.S. CLS. 22 AND 39).

CLASS 26—FANCY GOODS

FOR BROOCHES; BONNET PINS; BONNET PINS NOT OF PRECIOUS METAL; BONNET PINS OF PRECIOUS METAL; CURLING PINS; HAIR PINS AND GRIPS; HAT PINS; HAT PINS OF PRECIOUS METAL; MARKING PINS; ORIENTAL HAIR PINS; ORNAMENTAL NOVELTY PINS; PINS WITH GLASS HEADS; SAFETY PINS; SEWING PINS; CLOTHING HOOKS; METAL FASTENERS FOR SHOES AND BOOTS; BELT CLASPS; HOOK AND PILE FASTENING TAPES; SLIDE FASTENERS; HAIR ORNAMENTS; ARTIFICIAL FLOWERS OF TEXTILE; ORNAMENTAL BOWS OF TEXTILE FOR DECORATION; ORNAMENTAL RIBBONS MADE OF TEXTILES; PATCHES FOR REPAIRING TEXTILE ARTICLES; BRAIDS; SNAP FASTENERS; LACE TRIMMING; BUCKLES FOR CLOTHING; SHOE BUCKLES; BUTTONS FOR CLOTHING; ORNAMENTAL NOVELTY BUTTONS; SHOE ORNAMENTS; CAMPAIGN BUTTONS; EMBROIDERY FOR GARMENTS; FABRIC APPLIQUES; FEATHERS FOR ORNAMENTATION; GOLD EMBROIDERY FOR GARMENTS; SILVER EMBROIDERY FOR GARMENTS; HAT ORNAMENTS NOT OF PRECIOUS METAL; HAT ORNAMENTS OF PRECIOUS METAL; PASSEMENTERIE; SEQUINS; SPANGLES (U.S. CLS. 37, 39, 40, 42 AND 50).

CLASS 35—ADVERTISING AND BUSINESS

FOR DEMONSTRATION OF PRODUCTS; ARRANGING AND CONDUCTING OF FAIRS AND EXHIBITIONS FOR BUSINESS AND ADVERTISING PURPOSES (U.S. CLS. 100, 101 AND 102).

CLASS 44—MEDICAL, BEAUTY AND AGRICULTURAL SERVICES

FOR HAIRDRESSING SALONS; MANICURING; MASSAGE; BEAUTY SALONS; TATTOOING; PHARMACEUTICAL ADVICE (U.S. CLS. 100 AND 101).
JOHN DWYER, EXAMINING ATTORNEY

SN 77-147,235. CORMELL, RICHARD L., LEWISBURG, PA. AND HASELOFF, IRIS C., LEWISBURG, PA. FILED 4-3-2007.

GIVE THE GIFT OF LOVE FROM
THE HARDWOOD FORESTS OF
PENNSYLVANIA

THE MARK CONSISTS OF STANDARD CHARACTERS WITHOUT CLAIM TO ANY PARTICULAR FONT, STYLE, SIZE, OR COLOR.

CLASS 20—FURNITURE AND ARTICLES NOT OTHERWISE CLASSIFIED

FOR WOODEN FURNITURE (U.S. CLS. 2, 13, 22, 25, 32 AND 50).

CLASS 21—HOUSEWARES AND GLASS

FOR CUTTING BOARDS (U.S. CLS. 2, 13, 23, 29, 30, 33, 40 AND 50).
STEPHEN AQUILA, EXAMINING ATTORNEY

SN 77-147,471. SHIMANO INC., SAKAI CITY, JAPAN, FILED 4-3-2007.

CYCLINK

THE MARK CONSISTS OF STANDARD CHARACTERS WITHOUT CLAIM TO ANY PARTICULAR FONT, STYLE, SIZE, OR COLOR.

CLASS 9—ELECTRICAL AND SCIENTIFIC APPARATUS

FOR ELECTRIC ACCUMULATORS FOR BICYCLES; ELECTRIC CABLES FOR BICYCLES; BICYCLE COMPUTERS; COMPUTER SOFTWARE FOR USE IN CONNECTION WITH BICYCLE COMPUTERS; BICYCLE ODOMETERS; BICYCLE CLINOMETERS; AUTOMATIC INDICATORS FOR PRESSURE IN BICYCLE TIRES; PROTECTIVE HELMETS FOR SPORTS; PROTECTIVE HELMETS FOR BICYCLISTS; EYEGLASSES; SUNGLASSES; BICYCLE GOGGLES AND CASES THEREFORE; SIGNAL BELLS FOR BICYCLES; PROTECTIVE CLOTHING FOR BICYCLISTS; EYEGLASSES FRAMES (U.S. CLS. 21, 23, 26, 36 AND 38).

CLASS 12—VEHICLES

FOR ELECTRIC BICYCLES; BICYCLES; BICYCLE PARTS AND FITTINGS, NAMELY, WHEEL HUBS, INTERNAL GEAR HUBS, DYNAMO HUBS FOR BICYCLE WHEELS, HUB QUICK RELEASE LEVERS, GEAR RELEASE LEVERS, GEAR SHIFT LEVERS, FRONT DERAILLEURS, REAR DERAILLEURS, CHAIN GUIDES, FREEWHEELS, SPROCKETS, PULLEYS, CHAINS, CHAIN DEFLECTORS, SHIFT CABLES, CRANKS, CRANK SETS, CHAIN WHEELS, PEDALS, TOE CLIPS, BRAKE LEVERS, FRONT BRAKES, REAR BRAKES, BRAKE CABLES, BRAKE SHOES, WHEEL RIMS, WHEELS, SPOKES, SPOKE CLIPS, BOTTOM BRACKETS, SEAT PILLARS, SEAT PILLAR QUICK RELEASE, HEAD PARTS FOR FRAME-FORK ASSEMBLY, FRONT WHEEL SUSPENSIONS, REAR WHEEL SUSPENSIONS, HANDLEBARS, HANDLEBAR STEMS, GRIPS FOR HANDLEBARS, SADDLES, DERAILLEURS CONTROLLED BY COMPUTER, WHEEL BAGS FOR BICYCLES, GEAR POSITION INDICATORS FOR BICYCLES AND DIRECTIONAL SIGNALS FOR BICYCLES, NAMELY, STOP SIGNALS (U.S. CLS. 19, 21, 23, 31, 35 AND 44).

BILL DAWE, EXAMINING ATTORNEY

SN 77-147,721. HINT CREATIVE, LLC, SALT LAKE CITY, UT. FILED 4-3-2007.

HINT

THE MARK CONSISTS OF STANDARD CHARACTERS WITHOUT CLAIM TO ANY PARTICULAR FONT, STYLE, SIZE, OR COLOR.

CLASS 35—ADVERTISING AND BUSINESS

FOR ADVERTISING, MARKETING AND BRANDING SERVICES, NAMELY, CREATING AND EXTENDING CORPORATE AND BRAND IDENTITY FOR OTHERS (U.S. CLS. 100, 101 AND 102).

FIRST USE 12-27-2006; IN COMMERCE 12-27-2006.

CLASS 42—SCIENTIFIC AND COMPUTER SERVICES

FOR GRAPHIC DESIGN SERVICES (U.S. CLS. 100 AND 101).

FIRST USE 12-27-2006; IN COMMERCE 12-27-2006.

KATHRYN COWARD, EXAMINING ATTORNEY

SN 77-147,793. VIEJAS BAND OF KUMEYAAY INDIANS CAPITAN GRANDE BAND OF DIEGUENO MISSION INDIANS OF CALIFORNIA; VIEJAS (BARON LONG) GROUP OF CAPITAN GRANDE BAND OF MISSION INDIANS OF THE VIEJAS RESERVATION, ALSO KNOWN AS VIEJAS BAND OF KUMEYAAY INDIANS, THE MEMBERS OF WHICH ARE UNITED STATES CITIZENS, ALPINE, CA. FILED 4-3-2007.

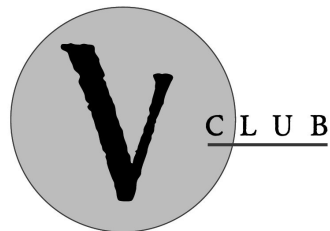

NO CLAIM IS MADE TO THE EXCLUSIVE RIGHT TO USE "CLUB", APART FROM THE MARK AS SHOWN.

THE MARK CONSISTS OF A STYLIZED LETTER "V" POSITIONED WITHIN A SOLID CIRCLE SURROUNDED BY A NARROW RING WITH AN UNDERLINED TEXTUAL ELEMENT.

CLASS 9—ELECTRICAL AND SCIENTIFIC APPARATUS

FOR MAGNETICALLY ENCODED MEMBERSHIP CARDS (U.S. CLS. 21, 23, 26, 36 AND 38).

CLASS 16—PAPER GOODS AND PRINTED MATTER

FOR PRINTED MATTER, NAMELY, CALENDARS, POSTCARDS, GREETING CARDS, NOTE CARDS, NOTE PADS, STATIONERY, STICKERS, DECALS, POSTERS, FOOD AND BEVERAGE SERVICE ITEMS, NAMELY, PAPER NAPKINS, PAPER COASTERS, PAPER PLACE-MATS, PAPER TABLECLOTHS, PAPER TAKE-OUT CARTONS FOR FOOD, AND CATALOGS IN THE FIELD OF ENTERTAINMENT AND CLUB-RELATED DISCOUNTS ON GOODS AND SERVICES (U.S. CLS. 2, 5, 22, 23, 29, 37, 38 AND 50).

CLASS 21—HOUSEWARES AND GLASS

FOR CUPS, FOOD AND BEVERAGE SERVICE ITEMS, NAMELY, PAPER PLATES AND BOWLS, AND BEVERAGE STIRRERS (U.S. CLS. 2, 13, 23, 29, 30, 33, 40 AND 50).

CLASS 35—ADVERTISING AND BUSINESS

FOR ADMINISTRATION OF A PROGRAM FOR ENABLING PARTICIPANTS TO OBTAIN DISCOUNTS ON GOODS AND RECEIVE IMPROVED SERVICES AT CASINO AND GAMING FACILITIES (U.S. CLS. 100, 101 AND 102).

KATHY DE JONGE, EXAMINING ATTORNEY

SN 77-147,947. ERICSON, RYAN, ELGIN, IL. FILED 4-3-2007.

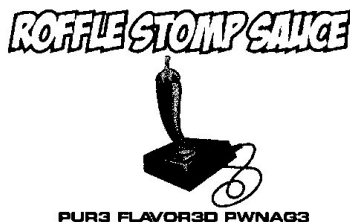

NO CLAIM IS MADE TO THE EXCLUSIVE RIGHT TO USE "SAUCE" AND "PURE FLAVORED", APART FROM THE MARK AS SHOWN.

THE MARK CONSISTS OF THE WORDS "ROFFLE STOMP SAUCE", THE WORDS "PUR3 FLAVOR3D" "PWNAG3". THERE IS A LOGO THAT LOOKS LIKE A HAND HELD OLD STYLE VIDEO GAME CONTROLLER WITH A JALAPENO FOR THE JOYSTICK. THE JALAPENO HAS A LEAFY TOP.

CLASS 25—CLOTHING

FOR HEADGEAR, NAMELY, HATS, CAPS; SHORT-SLEEVED OR LONG-SLEEVED T-SHIRTS; T-SHIRTS (U.S. CLS. 22 AND 39).

CLASS 30—STAPLE FOODS

FOR HOT SAUCE; SAUCES (U.S. CL. 46).
REBECCA GILBERT, EXAMINING ATTORNEY

CLASS 41—EDUCATION AND ENTERTAINMENT

FOR ELECTRONIC PUBLISHING SERVICES, NAMELY, PUBLICATION OF TEXT, GRAPHIC, VIDEO, PHOTOGRAPHIC AND AUDIO WORKS OF OTHERS ONLINE FEATURING NEWS, INFORMATION AND COMMENTARY ON CAREERS, RELATIONSHIPS, LIFESTYLES, PERSONAL FINANCES, PERSONAL WELL-BEING, FOOD, PHYSICAL AND MENTAL HEALTH, AND OTHER TOPICS OF INTEREST (U.S. CLS. 100, 101 AND 107).

CLASS 42—SCIENTIFIC AND COMPUTER SERVICES

FOR COMPUTER SERVICES, NAMELY, CREATING AND HOSTING AN ONLINE COMMUNITY FOR OTHERS TO PUBLISH AND SHARE CONTENT AND IMAGES ONLINE AND FOR ORGANIZING AND CONDUCTING ONLINE MEETINGS, GATHERINGS, AND INTERACTIVE DISCUSSIONS; COMPUTER SERVICES IN THE NATURE OF CUSTOMIZED WEB PAGES FEATURING USER-DEFINED INFORMATION, PERSONAL PROFILES AND INFORMATION (U.S. CLS. 100 AND 101).

CLASS 45—PERSONAL AND LEGAL SERVICES

FOR INTERNET BASED SOCIAL NETWORKING, INTRODUCTION, AND DATING SERVICES (U.S. CLS. 100 AND 101).

CYNTHIA SLOAN, EXAMINING ATTORNEY

SN 77-147,958. MYTIME, INC., LOS ANGELES, CA. FILED 4-3-2007.

MYTIME

THE MARK CONSISTS OF STANDARD CHARACTERS WITHOUT CLAIM TO ANY PARTICULAR FONT, STYLE, SIZE, OR COLOR.

CLASS 35—ADVERTISING AND BUSINESS

FOR ADVERTISING AND COMMERCIAL INFORMATION DISSEMINATION SERVICES, NAMELY, PROVIDING ADVERTISING VIA THE GLOBAL COMPUTER NETWORK; PROMOTING THE GOODS AND SERVICES OF OTHERS OVER THE INTERNET; PROMOTING THE GOODS AND SERVICES OF OTHERS BY MEANS OF OPERATING AN ON-LINE SITE WITH LINKS TO THE RETAIL WEB SITES OF OTHERS; ONLINE RETAIL STORE SERVICES; PROVIDING ON-LINE COMPUTER DATABASES AND ON-LINE SEARCHABLE DATABASES FEATURING CLASSIFIED LISTINGS AND WANT ADS (U.S. CLS. 100, 101 AND 102).

SN 77-148,013. MUSEAMI, INC., PRINCETON, NJ. FILED 4-4-2007.

MUSEAMI

THE MARK CONSISTS OF STANDARD CHARACTERS WITHOUT CLAIM TO ANY PARTICULAR FONT, STYLE, SIZE, OR COLOR.

CLASS 9—ELECTRICAL AND SCIENTIFIC APPARATUS

FOR SOFTWARE USED TO TRANSCRIBE, SCAN, TRANSLATE, AND SYNTHESIZE MUSIC; COMPUTER SEARCH ENGINE SOFTWARE; ELECTRONIC AUDIO TRANSCRIPTION AND PLAYBACK MACHINES; INTERACTIVE VIDEO GAMES COMPRISED OF HARDWARE AND SOFTWARE FEATURING MUSIC (U.S. CLS. 21, 23, 26, 36 AND 38).

CLASS 28—TOYS AND SPORTING GOODS

FOR ELECTRONIC MUSIC TOYS; GAMES, NAMELY, STAND ALONE VIDEO GAME MACHINES (U.S. CLS. 22, 23, 38 AND 50).

CLASS 41—EDUCATION AND ENTERTAINMENT

FOR OPERATING A WEB PORTAL FOR COMPOSING AND SHARING MUSIC (U.S. CLS. 100, 101 AND 107).

CLASS 42—SCIENTIFIC AND COMPUTER SERVICES

FOR PROVIDING A SEARCH ENGINE FOR OBTAINING DATA ON A GLOBAL COMPUTER NETWORK (U.S. CLS. 100 AND 101).

CYNTHIA SLOAN, EXAMINING ATTORNEY

SN 77-148,468. LAMIFLEX AB, 611 35 NYKOPING, SWEDEN, FILED 4-4-2007.

LAMIFLEX

THE MARK CONSISTS OF STANDARD CHARACTERS WITHOUT CLAIM TO ANY PARTICULAR FONT, STYLE, SIZE, OR COLOR.

OWNER OF SWEDEN REG. NO. 195143, DATED 3-8-1985, EXPIRES 3-8-2015.

CLASS 16—PAPER GOODS AND PRINTED MATTER

FOR PACKING PAPER AND CARDBOARD; PACKING CONSISTING PRIMARILY OF PAPER IN COMBINATION WITH BOARD, NAMELY, PACKAGING CARDBOARD CONTAINERS, FIBERBOARD BOXES, AND CORRUGATED BOXES (U.S. CLS. 2, 5, 22, 23, 29, 37, 38 AND 50).

CLASS 20—FURNITURE AND ARTICLES NOT OTHERWISE CLASSIFIED

FOR PACKING MATERIALS, NAMELY, PACKING CONTAINERS OF PLASTIC MATERIAL; PACKING MATERIALS CONSISTING PRIMARILY OF WOODEN BOARD IN COMBINATION WITH PAPER, NAMELY, WOOD BOXES AND COMPOSITE, PARTICLE BOARD, AND FIBERBOARD FOR USE IN MANUFACTURING PACKING CONTAINERS (U.S. CLS. 2, 13, 22, 25, 32 AND 50).

ELI HELLMAN, EXAMINING ATTORNEY

SN 77-148,766. GEORGE & COMPANY, LLC, NAPLES, FL. FILED 4-4-2007.



OWNER OF U.S. REG. NOS. 2,802,321 AND 2,989,658. THE MARK CONSISTS OF THE LETTERS "L", "C" AND "R" SHOWN IN A ROLLING DICE CONFIGURATION.

CLASS 9—ELECTRICAL AND SCIENTIFIC APPARATUS

FOR ELECTRONIC GAME PROGRAMS; DOWNLOADABLE ELECTRONIC GAMES VIA THE INTERNET AND WIRELESS DEVICES; ELECTRONIC GAME CARTRIDGES; ELECTRONIC GAME SOFTWARE FOR HANDHELD ELECTRONIC DEVICES; ELECTRONIC GAME SOFTWARE FOR CELLULAR TELEPHONES; ELECTRONIC GAME SOFTWARE FOR WIRELESS DEVICES; COMPUTER GAME PROGRAMS; COMPUTER GAME DISCS; COMPUTER GAME TAPES; COMPUTER PROGRAMS FOR PRE-RECORDED GAMES; COMPUTER GAME SOFTWARE; VIDEO GAMES; VIDEO GAME SOFTWARE; GAME SOFTWARE; AND VIDEO GAME DISCS (U.S. CLS. 21, 23, 26, 36 AND 38).

CLASS 41—EDUCATION AND ENTERTAINMENT

FOR ENTERTAINMENT SERVICES, NAMELY, PROVIDING ON-LINE COMPUTER GAMES; PROVIDING INFORMATION ON-LINE RELATING TO COMPUTER GAMES AND COMPUTER ENHANCEMENTS FOR GAMES; PROVIDING A COMPUTER GAME THAT MAY BE ACCESSED NETWORK-WIDE BY NETWORK USERS; ORGANIZING COMPUTER AND VIDEO GAME COMPETITIONS; MOBILE MEDIA AND ENTERTAINMENT SERVICES IN THE NATURE OF CONTENT PREPARATION; PROVIDING ON-LINE COMPUTER AND VIDEO GAMES; ENTERTAINMENT INFORMATION SERVICES, NAMELY, PROVIDING ON-LINE INFORMATION WITH REGARD TO ENTERTAINMENT TIME FOR MOVIES, GAMES, SHOWS, LIVE PERFORMANCES, EXHIBITIONS, SPORTS AND MUSICAL EVENTS THROUGH WORLD WIDE WEB AND MOBILE PHONES; ON-LINE PUBLICATION OF COMPUTER AND VIDEO GAMES, MOTION PICTURES, ANIMATION AND TELEVISION FILMS; MOTION PICTURE AND ANIMATION FILM PRODUCTION AND DISTRIBUTION SERVICES; TELEVISION PROGRAM PRODUCTION AND DISTRIBUTION SERVICES; PROVIDING INFORMATION IN THE FIELDS OF ENTERTAINMENT, MOTION PICTURES AND MUSIC OVER COMPUTER NETWORKS AND GLOBAL COMMUNICATION NETWORKS; PROVIDING ONLINE COMPUTER GAMES; ENTERTAINMENT SERVICES, NAMELY, PROVIDING VIDEO GAMES FOR PLAY ONLINE, ON WIRELESS DEVICES, ON COMPUTERS, OR ON GAME CONSOLES; ENTERTAINMENT SERVICES IN THE FORM OF PRODUCTION AND DISTRIBUTION OF ANIMATION, VISUAL EFFECTS, AND COMPUTER GRAPHICS FOR MOTION PICTURES AND TELEVISION (U.S. CLS. 100, 101 AND 107).

TEJBIR SINGH, EXAMINING ATTORNEY

SN 77-149,545. UNITED PARCEL SERVICE OF AMERICA, INC., ATLANTA, GA. FILED 4-5-2007.



NO CLAIM IS MADE TO THE EXCLUSIVE RIGHT TO USE "THE SEARCH FOR AMERICA'S FAVORITE UPS DRIVERS", APART FROM THE MARK AS SHOWN.

CLASS 39—TRANSPORTATION AND STORAGE

FOR FREIGHT FORWARDING; TRANSPORTATION OF PASSENGERS AND/OR GOODS BY AIR, RAIL, BOAT AND MOTOR VEHICLE; SHIPPING AND DELIVERY SERVICES, NAMELY, PICKUP, TRANSPORTATION, AND DELIVERY OF PACKAGES AND LETTERS BY VARIOUS MODES OF TRANSPORTATION; WAREHOUSING SERVICES, NAMELY, STORAGE, DISTRIBUTION, PICK-UP, PACKING, AND SHIPPING OF PERSONAL PROPERTY (U.S. CLS. 100 AND 105).

SN 77-149,735. JOHNSON & JOHNSON, NEW BRUNSWICK, NJ. FILED 4-5-2007.

AGENT COOL BLUE**CLASS 41—EDUCATION AND ENTERTAINMENT**

FOR ENTERTAINMENT SERVICES, NAMELY, CONDUCTING CONTESTS (U.S. CLS. 100, 101 AND 107).
LINDA E. BLOHM, EXAMINING ATTORNEY

THE MARK CONSISTS OF STANDARD CHARACTERS WITHOUT CLAIM TO ANY PARTICULAR FONT, STYLE, SIZE, OR COLOR.

OWNER OF U.S. REG. NO. 3,230,643.

NO CLAIM IS MADE TO THE EXCLUSIVE RIGHT TO USE "BLUE", APART FROM THE MARK AS SHOWN.

CLASS 3—COSMETICS AND CLEANING PREPARATIONS

FOR TOOTHPASTE (U.S. CLS. 1, 4, 6, 50, 51 AND 52).

SN 77-149,699. WOOMI CONSTRUCTION CO., LTD., JANG-SEONG-GUN, REPUBLIC OF KOREA, FILED 4-5-2007.

CLASS 21—HOUSEWARES AND GLASS

FOR TOOTHBRUSHES AND DENTAL FLOSS (U.S. CLS. 2, 13, 23, 29, 30, 33, 40 AND 50).

STEVEN JACKSON, EXAMINING ATTORNEY



NO CLAIM IS MADE TO THE EXCLUSIVE RIGHT TO USE "CONSTRUCTION", APART FROM THE MARK AS SHOWN.

THE MARK CONSISTS OF A DESIGN COMPOSED OF A TRIANGLE AND AN ARC INSIDE A CIRCLE AND THE WORDING "WOOMI CONSTRUCTION".

THE FOREIGN WORDING IN THE MARK TRANSLATES INTO ENGLISH AS GRACEFUL.

SN 77-149,748. JOHNSON & JOHNSON, NEW BRUNSWICK, NJ. FILED 4-5-2007.

SPIRIT**CLASS 36—INSURANCE AND FINANCIAL**

FOR REAL ESTATE AGENCY SERVICES FEATURING APARTMENTS, STORES AND OFFICE BUILDINGS; REAL ESTATE BROKERAGE; REAL ESTATE MANAGEMENT IN THE NATURE OF DEPARTMENT STORE MANAGEMENT FOR OTHERS; REAL ESTATE MANAGEMENT; LEASING OF REAL ESTATE, APARTMENT HOUSE MANAGEMENT, RENTAL OF APARTMENTS (U.S. CLS. 100, 101 AND 102).

THE MARK CONSISTS OF STANDARD CHARACTERS WITHOUT CLAIM TO ANY PARTICULAR FONT, STYLE, SIZE, OR COLOR.

CLASS 16—PAPER GOODS AND PRINTED MATTER

FOR PRINTED INSTRUCTIONAL AND EDUCATIONAL MATERIALS RELATED TO CLINICAL TRIALS (U.S. CLS. 2, 5, 22, 23, 29, 37, 38 AND 50).

CLASS 37—CONSTRUCTION AND REPAIR

FOR CONSTRUCTION OF HIGHWAYS, OFFICE BUILDINGS, RETAIL STORE BUILDINGS, APARTMENT BUILDINGS, TENEMENT HOUSES, HOUSES, HOTELS AND EXTENDED-STAY HOTELS, AND CONDOMINIUMS; CONSTRUCTION SERVICES, NAMELY, RESIDENTIAL LAND PREPARATION FOR BUILDING; LAND DEVELOPMENT SERVICES, NAMELY, PLANNING AND LAYING OUT OF RESIDENTIAL AND/OR COMMERCIAL COMMUNITIES (U.S. CLS. 100, 103 AND 106).

KATHERINE CONNOLLY, EXAMINING ATTORNEY

CLASS 42—SCIENTIFIC AND COMPUTER SERVICES

FOR PROVIDING MEDICAL AND SCIENTIFIC RESEARCH INFORMATION IN THE FIELD OF PHARMACEUTICALS AND CLINICAL TRIALS VIA THE INTERNET; AND PROVIDING A WEBSITE FEATURING INFORMATION ON CLINICAL TRIALS FOR PHARMACEUTICAL PRODUCTS (U.S. CLS. 100 AND 101).

STEVEN JACKSON, EXAMINING ATTORNEY

SN 77-149,757. JOHNSON & JOHNSON, NEW BRUNSWICK, NJ. FILED 4-5-2007.

SN 77-149,797. JOHNSON & JOHNSON, NEW BRUNSWICK, NJ. FILED 4-5-2007.

GO-AFTER

THE MARK CONSISTS OF STANDARD CHARACTERS WITHOUT CLAIM TO ANY PARTICULAR FONT, STYLE, SIZE, OR COLOR.

CLASS 16—PAPER GOODS AND PRINTED MATTER

FOR PRINTED INSTRUCTIONAL AND EDUCATIONAL MATERIALS IN THE FIELD OF CLINICAL TRIAL RESEARCH AND INFORMATION (U.S. CLS. 2, 5, 22, 23, 29, 37, 38 AND 50).

CLASS 42—SCIENTIFIC AND COMPUTER SERVICES

FOR PROVIDING MEDICAL AND SCIENTIFIC RESEARCH INFORMATION IN THE FIELD OF PHARMACEUTICALS AND CLINICAL TRIALS VIA THE INTERNET; AND PROVIDING A WEBSITE FEATURING INFORMATION ON CLINICAL TRIALS FOR PHARMACEUTICAL PRODUCTS (U.S. CLS. 100 AND 101).
STEVEN JACKSON, EXAMINING ATTORNEY

SN 77-149,792. ORIENTAL MOTOR CO., LTD., TAITO-KU, TOKYO, JAPAN, FILED 4-5-2007.

Orientalmotor

OWNER OF JAPAN REG. NO. 5015110, DATED 1-5-2007, EXPIRES 1-5-2017.
OWNER OF U.S. REG. NOS. 1,035,962 AND 1,607,167.
SEC. 2(F).

CLASS 7—MACHINERY

FOR AC MOTORS AND DC MOTORS NOT INCLUDING THOSE FOR LAND VEHICLES, NAMELY, STEPPING MOTORS, SERVO MOTORS, LINEAR MOTORS, INDUCTION MOTORS, SYNCHRONOUS MOTORS, BRUSHLESS DC MOTORS, AND STRUCTURAL PARTS THEREFORE; CONTROL AND INSTRUMENTS FOR MOTORS FOR MACHINES, NAMELY, MOTOR DRIVERS, POWER TRANSMISSIONS AND GEARING FOR MACHINES, NOT FOR LAND VEHICLES; AC GENERATORS; DC GENERATORS; LINEAR ACTUATORS; LINEAR MOTORS; MOTOR FANS AND BLOWERS (U.S. CLS. 13, 19, 21, 23, 31, 34 AND 35).

CLASS 9—ELECTRICAL AND SCIENTIFIC APPARATUS

FOR ELECTRICAL AND ELECTROMECHANICAL CONTROLLERS FOR MOTORS; INVERTERS; OSCILLATORS; SPEED INDICATORS; BATTERIES; DATA EDITING SOFTWARE; ELECTRIC WIRES AND CABLES; INTEGRATED CIRCUIT; SEMICONDUCTOR DEVICES; ELECTRICAL CONNECTION BOXES (U.S. CLS. 21, 23, 26, 36 AND 38).
KAREN K. BUSH, EXAMINING ATTORNEY

MY WAY WITH MIGRAINES

THE MARK CONSISTS OF STANDARD CHARACTERS WITHOUT CLAIM TO ANY PARTICULAR FONT, STYLE, SIZE, OR COLOR.

NO CLAIM IS MADE TO THE EXCLUSIVE RIGHT TO USE "MIGRAINES", APART FROM THE MARK AS SHOWN.

CLASS 16—PAPER GOODS AND PRINTED MATTER

FOR PRINTED EDUCATIONAL MATERIALS IN THE FIELD OF TREATMENT AND PREVENTION OF MIGRAINES (U.S. CLS. 2, 5, 22, 23, 29, 37, 38 AND 50).

CLASS 44—MEDICAL, BEAUTY AND AGRICULTURAL SERVICES

FOR PROVIDING A WEBSITE FEATURING INFORMATION ON THE TREATMENT AND PREVENTION OF MIGRAINES (U.S. CLS. 100 AND 101).
STEVEN JACKSON, EXAMINING ATTORNEY

SN 77-150,490. TRUSTCORE FINANCIAL, INC., BRENTWOOD, TN. FILED 4-6-2007.

TRUSTCORE

THE MARK CONSISTS OF STANDARD CHARACTERS WITHOUT CLAIM TO ANY PARTICULAR FONT, STYLE, SIZE, OR COLOR.

OWNER OF U.S. REG. NOS. 2,484,202, 2,882,645 AND OTHERS.

CLASS 35—ADVERTISING AND BUSINESS

FOR BUSINESS MANAGEMENT SERVICES DIRECTED TO ATHLETES, PERFORMERS, CREATIVE ARTISTS, CELEBRITIES, PROFESSIONALS, PUBLIC FIGURES AND EXECUTIVES (U.S. CLS. 100, 101 AND 102).
FIRST USE 4-7-1995; IN COMMERCE 1-1-1996.

CLASS 36—INSURANCE AND FINANCIAL

FOR FINANCIAL ANALYSIS, PLANNING AND CONSULTING SERVICES IN THE FIELDS OF INSURANCE, TAX STRATEGIES, ESTATES, TRUSTS, EXECUTIVE STOCK OPTION STRATEGIES, INVESTMENT PORTFOLIO MANAGEMENT; INSURANCE BROKERAGE SERVICES, NAMELY, LIFE INSURANCE AND ANNUITY SERVICES; GENERAL SECURITY BROKER SERVICES, NAMELY, MUTUAL FUND, STOCK, AND BOND BROKERAGE SERVICES; RENDERING FINANCIAL ADVICE TO INDIVIDUALS, FOUNDATIONS AND ENDOWMENTS; FINANCIAL MANAGEMENT SERVICES DIRECTED TO ATHLETES, PERFORMERS, CREATIVE ARTISTS, CELEBRITIES, PROFESSIONALS, PUBLIC FIGURES AND EXECUTIVES (U.S. CLS. 100, 101 AND 102).
FIRST USE 4-7-1995; IN COMMERCE 1-1-1996.
KATHY DE JONGE, EXAMINING ATTORNEY

SN 77-150,746. HIGHLIGHTS FOR CHILDREN, INC., COLUMBUS, OH. FILED 4-6-2007.

HighlightsParents.com

THE MARK CONSISTS OF STANDARD CHARACTERS WITHOUT CLAIM TO ANY PARTICULAR FONT, STYLE, SIZE, OR COLOR.

OWNER OF U.S. REG. NOS. 441,032, 2,746,436 AND OTHERS.

CLASS 41—EDUCATION AND ENTERTAINMENT

FOR PROVIDING A COMPUTER WEBSITE FOR PARENTS FEATURING INFORMATION IN THE FIELDS OF SPORTS AND RECREATION FOR CHILDREN, INFORMATION REGARDING CHILDREN'S LEARNING AND EDUCATION, ACTIVITY GUIDES CONTAINING EDUCATIONAL, RECREATIONAL AND ENTERTAINMENT ACTIVITIES FOR PARENTS AND CHILDREN, READING LISTS, AND NEWS REGARDING CURRENT EVENTS OF INTEREST TO PARENTS (U.S. CLS. 100, 101 AND 107).

CLASS 45—PERSONAL AND LEGAL SERVICES

FOR PROVIDING A COMPUTER WEBSITE FOR PARENTS FEATURING INFORMATION ABOUT INFAMILY RELATIONSHIPS (U.S. CLS. 100 AND 101).
KIMBERLY FRYE, EXAMINING ATTORNEY

SN 77-150,920. GRIPTION HOLDINGS, LLC, DRAPER, UT. FILED 4-6-2007.

TRIKE

THE MARK CONSISTS OF STANDARD CHARACTERS WITHOUT CLAIM TO ANY PARTICULAR FONT, STYLE, SIZE, OR COLOR.

CLASS 16—PAPER GOODS AND PRINTED MATTER

FOR OFFICE PRODUCTS AND ACCESSORIES, NAMELY, DRY ERASE WRITING BOARDS AND WRITING SURFACES; WRITING IMPLEMENTS INCLUDING DRY ERASE MARKERS; DOCUMENT RACKS OR STANDS INCLUDING DESKTOP OR SHELF-BASED BOOK HOLDERS AND BOOK ENDS; HOLDERS FOR PENS, PENCILS, AND INK; DESKTOP ORGANIZERS; CALENDARS INCLUDING CALENDAR DESK PADS OR STANDS, AND WALL CALENDARS; BOOKCASE ACCESSORIES, NAMELY, BOOKENDS (U.S. CLS. 2, 5, 22, 23, 29, 37, 38 AND 50).

CLASS 20—FURNITURE AND ARTICLES NOT OTHERWISE CLASSIFIED

FOR FURNITURE PRODUCTS AND ACCESSORIES, NAMELY, BOOKCASES, OFFICE CHAIRS, CHILDREN'S CHAIRS, AND HANGING ORGANIZERS FOR AFORESAID CHAIRS; KITCHEN FURNITURE (U.S. CLS. 2, 13, 22, 25, 32 AND 50).

MICHELE SWAIN, EXAMINING ATTORNEY

SN 77-151,104. DESIGN ENGINE, INC., SANDY, UT. FILED 4-6-2007.

Ambient Field

THE MARK CONSISTS OF STANDARD CHARACTERS WITHOUT CLAIM TO ANY PARTICULAR FONT, STYLE, SIZE, OR COLOR.

CLASS 9—ELECTRICAL AND SCIENTIFIC APPARATUS

FOR ELECTRIC CURRENT SWITCHES; ELECTRIC LIGHT DIMMERS; ELECTRIC LIGHT SWITCHES; ELECTRONIC MOTION SENSITIVE SWITCHES; HOME AND OFFICE AUTOMATION SYSTEMS COMPRISING WIRELESS AND WIRED CONTROLLERS, CONTROLLED DEVICES, AND SOFTWARE FOR LIGHTING, HVAC, SECURITY, SAFETY AND OTHER HOME AND OFFICE MONITORING AND CONTROL APPLICATIONS; COMPUTER NETWORK HUBS, SWITCHES AND ROUTERS; COMPUTER SOFTWARE FOR ACCESSING INFORMATION DIRECTORIES THAT MAY BE DOWNLOADED FROM THE GLOBAL COMPUTER NETWORK (U.S. CLS. 21, 23, 26, 36 AND 38).

CLASS 10—MEDICAL APPARATUS

FOR MEDICAL DIAGNOSTIC APPARATUS, ANALYTICAL APPARATUS FOR MEDICAL PURPOSES AND BLOOD PRESSURE MEASURING APPARATUS; MEDICAL PRODUCTS, NAMELY, BIOFEEDBACK SENSORS; THERMOMETERS FOR MEDICAL PURPOSES (U.S. CLS. 26, 39 AND 44).

ANDREA BUTLER, EXAMINING ATTORNEY

SN 77-151,819. RADIOLOGICAL SOCIETY OF NORTH AMERICA, INC., OAK BROOK, IL. FILED 4-9-2007.

MIRC

THE MARK CONSISTS OF STANDARD CHARACTERS WITHOUT CLAIM TO ANY PARTICULAR FONT, STYLE, SIZE, OR COLOR.

SEC. 2(F).

CLASS 9—ELECTRICAL AND SCIENTIFIC APPARATUS

FOR COMPUTER SOFTWARE FOR USE IN ENABLING SET UP OF TEACHING FILE SYSTEMS, MANAGEMENT AND EXCHANGE OF MEDICAL IMAGES AND RELATED INFORMATION, ALL IN THE FIELD OF RADIOLOGY (U.S. CLS. 21, 23, 26, 36 AND 38).

FIRST USE 5-0-2002; IN COMMERCE 5-0-2002.

CLASS 39—TRANSPORTATION AND STORAGE

FOR STORAGE OF ELECTRONIC MEDIA, NAMELY, MEDICAL IMAGES WITH RELATED TEXT (U.S. CLS. 100 AND 105).

FIRST USE 12-0-2001; IN COMMERCE 12-0-2001.
GEOFFREY FOSDICK, EXAMINING ATTORNEY

SN 77-153,074. EXERCISE RHYMES, LLC, SCOTTSDALE, AZ. FILED 4-10-2007.



NO CLAIM IS MADE TO THE EXCLUSIVE RIGHT TO USE "EXERCISE RHYMES", APART FROM THE MARK AS SHOWN.

THE MARK CONSISTS OF AN ADULT AND CHILD FIGURE HOLDING HANDS.

CLASS 16—PAPER GOODS AND PRINTED MATTER

FOR EDUCATIONAL PUBLICATIONS, NAMELY, EDUCATIONAL LEARNING CARDS, EDUCATIONAL CARD GAMES AND INSTRUCTION SHEETS THAT FEATURE RHYMING EXERCISES TO PROMOTE PHYSICAL FITNESS AND FAMILY FUN (U.S. CLS. 2, 5, 22, 23, 29, 37, 38 AND 50).

CLASS 28—TOYS AND SPORTING GOODS

FOR CARD GAMES AND BOARD GAMES THAT FEATURE RHYMING EXERCISES TO PROMOTE PHYSICAL FITNESS AND FAMILY FUN (U.S. CLS. 22, 23, 38 AND 50).

RUSS HERMAN, EXAMINING ATTORNEY

SN 77-153,260. ABOUTGOLF LIMITED, MAUMEE, OH. FILED 4-10-2007.

ABOUTGOLF

THE MARK CONSISTS OF STANDARD CHARACTERS WITHOUT CLAIM TO ANY PARTICULAR FONT, STYLE, SIZE, OR COLOR.

OWNER OF U.S. REG. NOS. 2,523,596 AND 3,145,097.
SEC. 2(F).

CLASS 28—TOYS AND SPORTING GOODS

FOR GOLF EQUIPMENT, NAMELY, ELECTRONIC, INTERACTIVE GOLF SIMULATORS, AND SWING ANALYSIS VIDEO SYSTEMS COMPRISED OF MATS USED TO MONITOR THE WEIGHT TRANSFER OF A GOLFER, ARTIFICIAL SURFACES UPON WHICH TO REST AND HIT A GOLF BALL, DISPLAY SCREENS, COMPUTER HARDWARE, COMPUTER SOFTWARE, COMPUTER VIDEO PROJECTORS OR COMPUTER MONITORS, AND DIGITAL CAMERAS, ALL SOLD AS COMPONENTS OF OR TOGETHER AS A UNIT WITH SAID SIMULATORS (U.S. CLS. 22, 23, 38 AND 50).

FIRST USE 12-31-1999; IN COMMERCE 12-31-1999.

CLASS 41—EDUCATION AND ENTERTAINMENT

FOR PHOTOGRAPHIC AND VIDEO SERVICES, NAMELY, THREE-DIMENSIONAL VIDEO AND MOTION CAPTURE OF SPORTS VENUES AND ACTIVITIES FOR USE IN VIRTUAL SPORT SIMULATORS FEATURING VIRTUAL PLAYERS, GOLF COURSES, SPORTS FIELDS, ARENAS AND SPORTING ENVIRONMENTS, AND FOR USE IN PRODUCING PROMOTIONAL VIDEOS, TELEVISION PROGRAMS, WEBSITES AND OTHER AUDIO VISUAL RECORDINGS THAT WOULD ALLOW USERS TO VIEW THREE DIMENSIONAL IMAGES OF THE CAPTURED VENUES (U.S. CLS. 100, 101 AND 107).

FIRST USE 12-31-1999; IN COMMERCE 12-31-1999.
ELISSA GARBER KON, EXAMINING ATTORNEY

SN 77-154,998. ACTONEME, INC., MOUNTAIN VIEW, CA. FILED 4-12-2007.

ACTONME

THE MARK CONSISTS OF STANDARD CHARACTERS WITHOUT CLAIM TO ANY PARTICULAR FONT, STYLE, SIZE, OR COLOR.

CLASS 9—ELECTRICAL AND SCIENTIFIC APPARATUS

FOR COMPUTER SOFTWARE FOR USE IN UPLOADING, DOWNLOADING, PUBLISHING, DISPLAYING, MANIPULATING, SHARING, AND DISTRIBUTING TEXT, IMAGES, GRAPHICS, PHOTOGRAPHS, AND VIDEOS VIA GLOBAL COMPUTER NETWORKS, MOBILE TELEPHONES, AND OTHER DIGITAL COMMUNICATIONS NETWORKS AND DEVICES; DOWNLOADABLE COMPUTER SOFTWARE FOR USE IN UPLOADING, DOWNLOADING, PUBLISHING, DISPLAYING, MANIPULATING, SHARING, AND DISTRIBUTING TEXT, IMAGES, GRAPHICS, PHOTOGRAPHS, AND VIDEOS VIA GLOBAL COMPUTER NETWORKS, MOBILE TELEPHONES, AND OTHER DIGITAL COMMUNICATIONS NETWORKS AND DEVICES (U.S. CLS. 21, 23, 26, 36 AND 38).

CLASS 38—COMMUNICATION

FOR COMPUTER SERVICES, NAMELY, CREATING AND PROVIDING ACCESS TO A SEARCH ENGINE AND SEARCHABLE DATABASES OF TEXT, IMAGES, GRAPHICS, PHOTOGRAPHS, AND VIDEOS; COMPUTER SERVICES, NAMELY, CREATING AN ONLINE COMMUNITY OF REGISTERED USERS TO SHARE TEXT, IMAGES, GRAPHICS, PHOTOGRAPHS, AND VIDEOS, AND ENGAGE IN SOCIAL NETWORKING; HOSTING OF DIGITAL CONTENT, IMAGES, PHOTOGRAPHS AND VIDEOS ONLINE (U.S. CLS. 100, 101 AND 104).

FRANK LATTUCA, EXAMINING ATTORNEY

SN 77-155,366. TOTAL SYSTEM SERVICES, INC., COLUMBUS, GA. FILED 4-12-2007.

THE ACTION BEHIND THE TRANSACTION

THE MARK CONSISTS OF STANDARD CHARACTERS WITHOUT CLAIM TO ANY PARTICULAR FONT, STYLE, SIZE, OR COLOR.

CLASS 35—ADVERTISING AND BUSINESS

FOR BUSINESS MANAGEMENT SERVICES, NAMELY, PROVIDING CUSTOMER SERVICES FOR CUSTOMERS OF OTHER COMPANIES IN THE FIELD OF DEBT COLLECTION; BUSINESS MANAGEMENT SERVICES, NAMELY PROVIDING CUSTOMER SERVICES FOR CUSTOMERS OF OTHER COMPANIES THAT ISSUE CREDIT CARDS, DEBIT CARDS, BANKCARDS, STORED VALUE CARDS, AND SMART CARDS; BUSINESS MANAGEMENT SERVICES, NAMELY, DATA CAPTURE AND ANALYSIS OF INFORMATION FROM CREDIT CARD, DEBIT CARD, BANKCARD, STORED VALUE CARD AND SMART CARD TRANSACTIONS; BUSINESS MANAGEMENT SERVICES, NAMELY, DATA AGGREGATION, REPORTING, STORAGE AND PROCESSING FOR LOYALTY AND REWARDS PROGRAMS; FINANCIAL STATEMENT PREPARATION SERVICES (U.S. CLS. 100, 101 AND 102).

FIRST USE 12-0-2001; IN COMMERCE 12-0-2001.

CLASS 36—INSURANCE AND FINANCIAL

FOR FINANCIAL DATA, CREDIT CARD, DEBIT CARD, BANKCARD, STORED VALUE AND SMART CARD TRANSACTION PROCESSING SERVICES; FINANCIAL ACCOUNT ACQUISITION SERVICES; FINANCIAL RISK MANAGEMENT SERVICES; FINANCIAL RISK MANAGEMENT SERVICES, NAMELY, BANKRUPTCY MANAGEMENT SERVICES; CREDIT REPORTING SERVICES; CREDIT RATING SERVICES; CREDIT CARD SERVICES; COLLECTION AGENCY SERVICES; COLLECTION OF DEBTS; FINANCIAL SERVICES, NAMELY, ELECTRONIC SWITCHING AND PROCESSING OF ELECTRONIC FUND TRANSFERS FOR OTHERS, INITIATED AT ANY POINT-OF-SALE TERMINAL; AUTHORIZING ELECTRONIC PAYMENTS AT THE POINT OF SALE; FINANCIAL RISK REPORTING AND MANAGEMENT SERVICES; FINANCIAL ANALYSIS AND CONSULTATION SERVICES, NAMELY, PROVIDING PROFITABILITY SCORING SERVICES (U.S. CLS. 100, 101 AND 102).

FIRST USE 12-0-2001; IN COMMERCE 12-0-2001.

CLASS 42—SCIENTIFIC AND COMPUTER SERVICES

FOR WEB SITE HOSTING SERVICES (U.S. CLS. 100 AND 101).

FIRST USE 12-0-2001; IN COMMERCE 12-0-2001.

CLASS 45—PERSONAL AND LEGAL SERVICES

FOR FRAUD MONITORING (U.S. CLS. 100 AND 101).

FIRST USE 12-0-2001; IN COMMERCE 12-0-2001.

ANDREA HACK, EXAMINING ATTORNEY

SN 77-155,480. HUB GROUP, INC., DOWNERS GROVE, IL. FILED 4-12-2007.

COMTRAK LOGISTICS

THE MARK CONSISTS OF STANDARD CHARACTERS WITHOUT CLAIM TO ANY PARTICULAR FONT, STYLE, SIZE, OR COLOR.

NO CLAIM IS MADE TO THE EXCLUSIVE RIGHT TO USE "LOGISTICS", APART FROM THE MARK AS SHOWN.

CLASS 35—ADVERTISING AND BUSINESS

FOR ARRANGING FREIGHT TRANSPORTATION BY TRUCK (U.S. CLS. 100, 101 AND 102).

FIRST USE 0-0-1990; IN COMMERCE 0-0-1990.

CLASS 39—TRANSPORTATION AND STORAGE

FOR DRAYAGE SERVICES, NAMELY, COMMON CARRIER AND CONTRACT CARRIER SERVICES; TRANSPORTATION BROKERING (U.S. CLS. 100 AND 105).

FIRST USE 7-1-1983; IN COMMERCE 7-1-1983.

SIMON TENG, EXAMINING ATTORNEY

SN 77-155,563. BETTER TOGETHER, INC., MILWAUKEE, WI. FILED 4-12-2007.

BETTER TOGETHER

THE MARK CONSISTS OF STANDARD CHARACTERS WITHOUT CLAIM TO ANY PARTICULAR FONT, STYLE, SIZE, OR COLOR.

CLASS 25—CLOTHING

FOR APPAREL AND ACCESSORIES, NAMELY, T-SHIRTS, SWEATSHIRTS, HATS, CAPS, SHIRTS, APRONS, BELTS, WARM-UP SUITS, JACKETS, SLEEPWEAR, PANTS AND TOPS (U.S. CLS. 22 AND 39).

CLASS 35—ADVERTISING AND BUSINESS

FOR ONLINE RETAIL STORE SERVICES FEATURING APPAREL AND ACCESSORIES (U.S. CLS. 100, 101 AND 102).

G. MAYERSCHOFF, EXAMINING ATTORNEY

SN 77-155,719. SCOTTISH AMERICAN MEDIA, LLC, VALLEY VILLAGE, CA. FILED 4-12-2007.

LEN'LL FIX IT

THE MARK CONSISTS OF STANDARD CHARACTERS WITHOUT CLAIM TO ANY PARTICULAR FONT, STYLE, SIZE, OR COLOR.

CLASS 9—ELECTRICAL AND SCIENTIFIC APPARATUS

FOR APPARATUS FOR RECORDING, TRANSMISSION OR REPRODUCTION OF SOUND AND IMAGES, NAMELY, MP3 PLAYERS, COMPACT DISC PLAYERS, PORTABLE COMPACT DISC PLAYERS, VIDEO RECORDERS, TELEVISION SETS AND CAMCORDERS; BLANK MAGNETIC DATA CARRIERS, RECORDING DISCS, NAMELY, BLANK RECORDABLE COMPACT DISCS; BLANK VIDEO TAPES; PRE-RECORDED VIDEO TAPES, PRE-RECORDED LASER DISCS PRE-RECORDED COMPACT DISCS, AND PRE-RECORDED DVD'S FEATURING MUSIC, CHARACTERS, SCENES AND SITUATIONS RELATING TO A TELEVISION SERIES AS WELL AS MUSIC, SCENES, CHARACTERS AND SITUATIONS FROM AN INTERNET SITE RELATED TO A TELEVISION SERIES; ELECTRONIC GAME PROGRAMS; ELECTRONIC GAME PROGRAMS RECORDED ON COMPACT DISCS AND DVDS (U.S. CLS. 21, 23, 26, 36 AND 38).

CLASS 41—EDUCATION AND ENTERTAINMENT

FOR ENTERTAINMENT SERVICES IN THE NATURE OF AN ON-GOING REALITY-BASED TELEVISION PROGRAM BROADCAST OVER TELEVISION, SATELLITE, AUDIO AND VIDEO MEDIA; PROVIDING INFORMATION IN THE FIELD OF ENTERTAINMENT FEATURING INFORMATION ON REALITY-BASED TELEVISION BY MEANS OF A GLOBAL COMPUTER NETWORK (U.S. CLS. 100, 101 AND 107).

REBECCA SMITH, EXAMINING ATTORNEY

SN 77-156,094. BAYER SCHERING PHARMA AG, BERLIN, FED REP GERMANY, FILED 4-13-2007.

SKINSIDER

THE MARK CONSISTS OF STANDARD CHARACTERS WITHOUT CLAIM TO ANY PARTICULAR FONT, STYLE, SIZE, OR COLOR.

CLASS 16—PAPER GOODS AND PRINTED MATTER

FOR PRINTED MATTER AND PUBLICATIONS, NAMELY, MAGAZINES AND NEWSLETTERS IN THE FIELD OF MEDICAL ADVICE AND PHARMACEUTICALS (U.S. CLS. 2, 5, 22, 23, 29, 37, 38 AND 50).

CLASS 41—EDUCATION AND ENTERTAINMENT

FOR EDUCATIONAL SERVICES, NAMELY, CONDUCTING WORKSHOPS, CONFERENCES, CLASSES, AND SEMINARS IN THE FIELD OF PHARMACEUTICALS (U.S. CLS. 100, 101 AND 107).

CLASS 44—MEDICAL, BEAUTY AND AGRICULTURAL SERVICES

FOR MEDICAL ANALYSIS SERVICES, NAMELY, COUNSELING, RELATING TO THE TREATMENT OF PERSONS; PHARMACEUTICAL ADVICE (U.S. CLS. 100 AND 101).

MARY BOAGNI, EXAMINING ATTORNEY

SN 77-156,157. HAMAMATSU PHOTONICS K.K., HAMAMATSU-SHI SHIZUOKA, JAPAN, FILED 4-13-2007.

FDSS / RayCatcher

PRIORITY CLAIMED UNDER SEC. 44(D) ON JAPAN APPLICATION NO. 2007-024278, FILED 3-20-2007.

OWNER OF JAPAN REG. NO. 5095430, DATED 11-30-2007, EXPIRES 11-30-2017.

OWNER OF JAPAN REG. NO. 509430, DATED 11-30-2007, EXPIRES 11-30-2017.

OWNER OF U.S. REG. NO. 2,550,153.

CLASS 9—ELECTRICAL AND SCIENTIFIC APPARATUS

FOR DRUG SCREENING SYSTEM FOR LABORATORY USE PRINCIPALLY COMPRISED OF A LIGHT SOURCE, SENSOR, IMAGE PROCESSOR AND COMPUTER DISPLAY (U.S. CLS. 21, 23, 26, 36 AND 38).

CLASS 10—MEDICAL APPARATUS

FOR MEDICAL APPARATUS, NAMELY, A SYSTEM PRINCIPALLY COMPRISED OF A LIGHT SOURCE, SENSOR, IMAGE PROCESSOR AND COMPUTER DISPLAY FOR DRUG SCREENING AND MEDICAL USE, NAMELY FOR EXAMINING SAMPLES SUCH AS HUMAN CELLS, BLOOD AND URINE (U.S. CLS. 26, 39 AND 44).

JEFF DEFORD, EXAMINING ATTORNEY

CLASS 21—HOUSEWARES AND GLASS

FOR BARBECUE GRILLING EQUIPMENT AND ACCESSORIES, NAMELY, PLASTIC STORAGE CONTAINERS FOR DOMESTIC USE, ALL PURPOSE PORTABLE HOUSEHOLD CONTAINERS, PORTABLE COOLERS, FORKS, TONGS, TURNERS, DISHES, PLATES, AND SERVING SPOONS (U.S. CLS. 2, 13, 23, 29, 30, 33, AND 50).

LESLIE RICHARDS, EXAMINING ATTORNEY

SN 77-156,298. FAZZINO, CHARLES, NEW ROCHELLE, NY. FILED 4-13-2007.

SN 77-157,040. ALEXANDRIA REAL ESTATE EQUITIES, INC., PASADENA, CA. FILED 4-15-2007.

OWNER OF U.S. REG. NOS. 2,461,052, 2,548,000 AND 2,667,566.

CLASS 14—JEWELRY

FOR JEWELRY; ORNAMENTAL PINS (U.S. CLS. 2, 27, 28 AND 50).

FIRST USE 0-0-1996; IN COMMERCE 0-0-1996.

CLASS 15—MUSICAL INSTRUMENTS

FOR MUSIC BOXES (U.S. CLS. 2, 21 AND 36).
FIRST USE 0-0-2005; IN COMMERCE 0-0-2005.

CLASS 18—LEATHER GOODS

FOR HANDPAGS; PURSES (U.S. CLS. 1, 2, 3, 22 AND 41).

FIRST USE 0-0-2005; IN COMMERCE 0-0-2005.
LINDA POWELL, EXAMINING ATTORNEY

ALEXANDRIA TECHNOLOGY
SQUARE

THE MARK CONSISTS OF STANDARD CHARACTERS WITHOUT CLAIM TO ANY PARTICULAR FONT, STYLE, SIZE, OR COLOR.

OWNER OF U.S. REG. NOS. 2,300,322 AND 2,300,323.

CLASS 35—ADVERTISING AND BUSINESS

FOR BUSINESS MANAGEMENT AND CONSULTATION SERVICES; RENTAL AND LEASING OF OFFICE MACHINERY AND EQUIPMENT (U.S. CLS. 100, 101 AND 102).

CLASS 36—INSURANCE AND FINANCIAL

FOR REAL ESTATE SERVICES NAMELY REAL ESTATE ACQUISITION, RENTAL, LEASING AND MANAGEMENT (U.S. CLS. 100, 101 AND 102).

IRA J. GOODSaid, EXAMINING ATTORNEY

SN 77-157,350. ANSON VANCE LLC, ST. DAVIDS, PA. FILED 4-16-2007.

SN 77-156,592. GEOGLOBAL PARTNERS, LLC, SOUTH PLAINFIELD, NJ. FILED 4-13-2007.

CHARPRO

THE MARK CONSISTS OF STANDARD CHARACTERS WITHOUT CLAIM TO ANY PARTICULAR FONT, STYLE, SIZE, OR COLOR.

CLASS 11—ENVIRONMENTAL CONTROL APPARATUS

FOR BARBECUE GRILLS AND BARBECUE GRILLING EQUIPMENT AND ACCESSORIES, NAMELY, BARBECUE GRILL COVERS (U.S. CLS. 13, 21, 23, 31 AND 34).

LIVE MUSIC. HAND MADE.

THE MARK CONSISTS OF STANDARD CHARACTERS WITHOUT CLAIM TO ANY PARTICULAR FONT, STYLE, SIZE, OR COLOR.

NO CLAIM IS MADE TO THE EXCLUSIVE RIGHT TO USE "LIVE MUSIC", APART FROM THE MARK AS SHOWN.

CLASS 35—ADVERTISING AND BUSINESS

FOR PROMOTING THE CONCERTS OF OTHERS (U.S. CLS. 100, 101 AND 102).

CLASS 41—EDUCATION AND ENTERTAINMENT

FOR ENTERTAINMENT, NAMELY, LIVE MUSIC CONCERTS (U.S. CLS. 100, 101 AND 107).

TRICIA SONNEBORN, EXAMINING ATTORNEY

SN 77-157,866. THREE RIVERS HOLDINGS, INC., WILMINGTON, DE. FILED 4-16-2007.



OWNER OF U.S. REG. NOS. 3,089,857, 3,182,743 AND 3,202,785.

CLASS 35—ADVERTISING AND BUSINESS

FOR PROVIDING A RECOGNITION AND REWARDS PROGRAM TO RECOGNIZE THE EXCELLENCE OF PARTICIPATING PHYSICIANS WITH RESPECT TO THEIR COMMITMENT TO THE HEALTH PLAN, THEIR ACCESSIBILITY TO HEALTH PLAN MEMBERS, THEIR PROVISION OF EFFECTIVE AND ECONOMIC MEDICAL SERVICES, THEIR QUALITY OF CARE AND SERVICE, AND THEIR ADMINISTRATIVE EFFICIENCY, AND TO REWARD THEM WITH RECOGNITION, PUBLICITY, RELIEF FROM SPECIFIED HEALTH PLAN ADMINISTRATIVE REQUIREMENTS SUCH AS ASPECTS OF PRIOR AUTHORIZATION FOR DOCUMENTATION OF MEDICAL NECESSITY OF COVERED SERVICES, AND FINANCIAL BONUSES, FOR THE PURPOSE OF IMPROVING THE QUALITY OF HEALTH CARE SERVICES DELIVERED TO MEMBERS OF THE HEALTH PLANS AND TO REDUCE ADMINISTRATIVE BURDENS FOR THE PROVIDERS AND THE HEALTH PLAN ADMINISTRATORS (U.S. CLS. 100, 101 AND 102). FIRST USE 2-1-2007; IN COMMERCE 2-1-2007.

CLASS 36—INSURANCE AND FINANCIAL

FOR ADMINISTRATION OF HEALTH CARE BENEFIT PLANS FOR MEDICARE AND MEDICAID ELIGIBLE INDIVIDUALS, MANAGED CARE INSURANCE SERVICE (HMO) (U.S. CLS. 100, 101 AND 102). FIRST USE 2-1-2007; IN COMMERCE 2-1-2007. JILL C. ALT, EXAMINING ATTORNEY

SN 77-158,671. INC INTERNATIONAL COMPANY, BERYN, PA. FILED 4-17-2007.

Intelligent Grip

THE MARK CONSISTS OF STANDARD CHARACTERS WITHOUT CLAIM TO ANY PARTICULAR FONT, STYLE, SIZE, OR COLOR.

NO CLAIM IS MADE TO THE EXCLUSIVE RIGHT TO USE "GRIP", APART FROM THE MARK AS SHOWN.

CLASS 8—HAND TOOLS

FOR MANUALLY OPERATED HAND TOOLS, NAMELY, SHOVELS, RAKES, AXES, PICKS; YARD TOOLS, NAMELY, SHOVELS, RAKES, AXES (U.S. CLS. 23, 28 AND 44).

CLASS 12—VEHICLES

FOR BICYCLE GRIP TAPE; MOTORCYCLE GRIP TAPE (U.S. CLS. 19, 21, 23, 31, 35 AND 44).

CLASS 13—FIREARMS

FOR GRIPS FOR SMALL ARMS; PISTOL GRIPS (U.S. CLS. 2 AND 9).

CLASS 28—TOYS AND SPORTING GOODS

FOR GOLF CLUB GRIPS; HAND GRIPS FOR GOLF CLUBS; HANDLE GRIPS FOR SPORTING EQUIPMENT (U.S. CLS. 22, 23, 38 AND 50). FRANK LATTUCA, EXAMINING ATTORNEY

SN 77-158,835. SHANE BAUM, COSTA MESA, CA. FILED 4-17-2007.

BY ORDER OF THE ROYAL AND ANCIENT LEISURE SOCIETY

THE MARK CONSISTS OF STANDARD CHARACTERS WITHOUT CLAIM TO ANY PARTICULAR FONT, STYLE, SIZE, OR COLOR.

CLASS 9—ELECTRICAL AND SCIENTIFIC APPARATUS

FOR EYEWEAR, NAMELY SUNGLASSES, FRAMES AND CASES THEREFORE, PRESCRIPTION EYEGLASS FRAMES AND CASES THEREFORE (U.S. CLS. 21, 23, 26, 36 AND 38).

CLASS 14—JEWELRY

FOR WATCHES; STRAPS, BRACELETS, BUCKLES, ALL FOR WATCHES AND THEIR CASES (U.S. CLS. 2, 27, 28 AND 50).

CLASS 18—LEATHER GOODS

FOR HANDBAGS, ALL PURPOSE CARRYING BAGS, ATTACHES-CASES, BACKPACKS, TOTE BAGS, TRAVELING BAGS, SHOULDER BAGS, CLUTCH PURSES, ALL PURPOSE ATHLETIC BAGS, WALLETS, KEY CASES, LUGGAGE, CREDIT CARD CASES, GARMENT BAGS FOR TRAVEL, PASSPORT CASES, COIN PURSES AND COSMETIC BAGS SOLD EMPTY (U.S. CLS. 1, 2, 3, 22 AND 41). MARK PILARO, EXAMINING ATTORNEY

SN 77-158,886. SYNWORLDS LIMITED, LAS VEGAS, NV. FILED 4-17-2007.

Virtual Worlds. Real Play.

THE MARK CONSISTS OF STANDARD CHARACTERS WITHOUT CLAIM TO ANY PARTICULAR FONT, STYLE, SIZE, OR COLOR.

NO CLAIM IS MADE TO THE EXCLUSIVE RIGHT TO USE "REAL PLAY" AS TO CLASSES 9 AND 41, APART FROM THE MARK AS SHOWN.

CLASS 9—ELECTRICAL AND SCIENTIFIC APPARATUS

FOR COMPUTER GAME DISCS; COMPUTER GAME PROGRAMS; COMPUTER GAME SOFTWARE; COMPUTER GAME SOFTWARE, NAMELY A COMPUTER CRAPS GAME; DOWNLOADABLE COMPUTER PROGRAMS FEATURING POSITIONABLE GAME PIECE FIGURES FOR USE IN THE FIELD OF COMPUTER GAMES; INTERACTIVE MULTIMEDIA COMPUTER GAME PROGRAM (U.S. CLS. 21, 23, 26, 36 AND 38).

CLASS 16—PAPER GOODS AND PRINTED MATTER

FOR COMPUTER GAME INSTRUCTION MANUALS (U.S. CLS. 2, 5, 22, 23, 29, 37, 38 AND 50).

CLASS 35—ADVERTISING AND BUSINESS

FOR ADVERTISING AND BUSINESS MANAGEMENT CONSULTANCY; BUSINESS CONSULTATION; BUSINESS CONSULTATION AND MANAGEMENT REGARDING MARKETING ACTIVITIES AND LAUNCHING OF NEW PRODUCTS; BUSINESS CONSULTATION SERVICES; BUSINESS CONSULTATION SERVICES TO ASSIST NON-PROFIT ORGANIZATIONS IN PLANNING, MANAGING, AND CONDUCTING FUND RAISING ACTIVITIES VIA A GLOBAL COMPUTER NETWORK; BUSINESS CONSULTING AND BUSINESS INFORMATION FOR ENTERPRISES; BUSINESS CONSULTING, MANAGEMENT, PLANNING AND SUPERVISION; BUSINESS MANAGEMENT AND CONSULTATION; BUSINESS MANAGEMENT CONSULTANCY AND ADVISORY SERVICES; BUSINESS MANAGEMENT CONSULTANCY SERVICES; BUSINESS MANAGEMENT CONSULTATION; BUSINESS MANAGEMENT CONSULTING WITH RELATION TO STRATEGY, MARKETING, PRODUCTION, PERSONNEL AND RETAIL SALE MATTERS; BUSINESS MARKETING AND DIRECT MAIL CONSULTING SERVICES; BUSINESS MARKETING CONSULTING SERVICES; COMMERCIAL CONSULTANCY; CONSULTANCY SERVICES REGARDING BUSINESS STRATEGIES; CONSULTATION IN THE FIELD OF COMMERCIALS OR INFOMERCIALS; CONSULTING SERVICES RELATING TO PUBLICITY; DEMOGRAPHIC CONSULTATION; DEMOGRAPHIC CONSULTATION AND STUDIES; ECONOMIC CONSULTING AND INFORMATION FOR THE INDUSTRIAL AND COMMERCIAL SECTORS FOR PLANNING, ORGANIZING, MONITORING AND CARRYING OUT UNIQUE AND COMPLEX PROJECTS IN DIFFERENT SECTORS OF ONE OR SEVERAL COMPANIES; MANAGEMENT AND BUSINESS CONSULTING SERVICES IN THE FIELD OF COMPUTER GAMES AND NETWORKED GAMES; MARKET RESEARCH CONSULTATION; MARKET SEGMENTATION CONSULTATION; MARKETING CONSULTATION IN THE FIELD OF COMPUTER GAMES AND NETWORKED GAMES; MARKETING CONSULTING; PROFESSIONAL BUSINESS CONSULTATION; PROVIDING BUSINESS MANAGEMENT INFORMATION IN CONNECTION WITH CONSULTING AND ADVISORY SERVICES IN THE FIELD OF STRATEGIC PLANNING (U.S. CLS. 100, 101 AND 102).

CLASS 38—COMMUNICATION

FOR RADIO BROADCASTING CONSULTATION; TELECOMMUNICATIONS CONSULTATION; TELEVISION BROADCASTING CONSULTATION (U.S. CLS. 100, 101 AND 104).

CLASS 41—EDUCATION AND ENTERTAINMENT

FOR ENTERTAINMENT SERVICES, NAMELY, PROVIDING AN ON-LINE COMPUTER GAME; ENTERTAINMENT SERVICES, NAMELY, PROVIDING ON-LINE COMPUTER GAMES; ENTERTAINMENT SERVICES, NAMELY, PROVIDING ON-LINE REVIEWS OF COMPUTER GAMES AND NETWORKED GAMES; PRODUCTION OF VIDEO AND COMPUTER GAME SOFTWARE; PROVIDING A COMPUTER GAME THAT MAY BE ACCESSED NETWORK-WIDE BY NETWORK USERS; PROVIDING INFORMATION ON-LINE RELATING TO COMPUTER GAMES AND COMPUTER ENHANCEMENTS FOR GAMES; CONSULTATION IN THE FIELD OF K-12 EDUCATIONAL SYSTEMS; PROVIDING ON-LINE NON-DOWNLOADABLE SOFTWARE FOR COMPUTER GAMES AND NETWORKED GAMES; PROVIDING TEMPORARY USE OF ON-LINE NON-DOWNLOADABLE SOFTWARE FOR COMPUTER GAMES AND NETWORKED GAMES (U.S. CLS. 100, 101 AND 107).

CLASS 42—SCIENTIFIC AND COMPUTER SERVICES

FOR COMPUTER CONSULTATION; COMPUTER SOFTWARE CONSULTANCY; COMPUTER SOFTWARE CONSULTATION; CONSULTANCY IN THE FIELD OF SOFTWARE DESIGN; CONSULTING SERVICES IN THE FIELD OF DESIGN, SELECTION, IMPLEMENTATION AND USE OF COMPUTER HARDWARE AND SOFTWARE SYSTEMS FOR OTHERS; RESEARCH AND DEVELOPMENT AND CONSULTATION RELATED THERETO IN THE FIELD OF COMPUTER GAMES AND NETWORKED GAMES (U.S. CLS. 100 AND 101).

PETER B. BROMAGHIM, EXAMINING ATTORNEY

SN 77-159,042. LIVE EARTH, LLC, BEVERLY HILLS, CA. FILED 4-17-2007.



NO CLAIM IS MADE TO THE EXCLUSIVE RIGHT TO USE "LIVE" IN REGARDS TO INTERNATIONAL CLASSES 09, 38 AND 41, APART FROM THE MARK AS SHOWN.

THE MARK CONSISTS OF A ROUND SHAPE WITH THE SKY AND CLOUDS INSIDE WITH BLANK HOLE IN THE MIDDLE. BELOW IS A SEQUENCE OF THREE DOTS, THREE DASHES AND THREE MORE DOTS. UNDERNEATH ARE THE WORDS "LIVE EARTH" AND BELOW THAT ARE THE WORDS "THE CONCERTS FOR A CLIMATE IN CRISIS" IN A SMALLER FONT.

CLASS 9—ELECTRICAL AND SCIENTIFIC APPARATUS

FOR PRERECORDED CDS AND DVDS, AUDIO AND VIDEO CASSETTES FEATURING MUSIC AND PERFORMANCES BY ARTISTS IN THE MUSIC INDUSTRY; DOWNLOADABLE MUSICAL PERFORMANCES VIA THE INTERNET AND WIRELESS DEVICES (U.S. CLS. 21, 23, 26, 36 AND 38).

CLASS 16—PAPER GOODS AND PRINTED MATTER

FOR PAPER PRODUCTS, NAMELY, BLANK PAPER NOTEBOOKS AND NOTE CARDS; PRINTED MATERIALS, NAMELY, NON-FICTION BOOKS RELATING TO THE ENVIRONMENT OR ENVIRONMENTAL ISSUES, PROGRAMS, BROCHURES AND BANNERS RELATING TO THE ENVIRONMENT, ENVIRONMENTAL ISSUES OR MUSICAL PERFORMANCES; CALENDARS, POSTERS, GREETING CARDS, NOTE CUBES, NAMELY, NOTE PAPER, NOTEPADS, AND FOLDERS (U.S. CLS. 2, 5, 22, 23, 29, 37, 38 AND 50).

CLASS 18—LEATHER GOODS

FOR BACKPACKS AND WALLETS; LEATHER KEY CHAINS (U.S. CLS. 1, 2, 3, 22 AND 41).

CLASS 20—FURNITURE AND ARTICLES NOT OTHERWISE CLASSIFIED

FOR NON-METAL KEY CHAINS; KEY FOBS, NOT OF METAL (U.S. CLS. 2, 13, 22, 25, 32 AND 50).

CLASS 21—HOUSEWARES AND GLASS

FOR HOUSE WARES, NAMELY, DRINKING GLASSES, VASES AND GLASS BOWLS, CERAMIC BOWLS, FLOWER POTS, PLANTERS FOR FLOWERS AND PLANTS; SHOT GLASSES AND MUGS (U.S. CLS. 2, 13, 23, 29, 30, 33, 40 AND 50).

CLASS 25—CLOTHING

FOR CLOTHING AND APPAREL, NAMELY, SHIRTS, T-SHIRTS, PANTS, SHORTS, DRESSES, JACKETS, SWEATSHIRTS, SWEAT PANTS, CLOTHING BELTS AND LEATHER BELTS, HATS, CAPS, VISORS AND BANDANAS (U.S. CLS. 22 AND 39).

CLASS 38—COMMUNICATION

FOR BROADCAST OF LIVE AND PRERECORDED PERFORMANCES BY MUSICAL ARTISTS OVER TELEVISION, RADIO, CABLE, SATELLITE, INTERNET (U.S. CLS. 100, 101 AND 104).

CLASS 41—EDUCATION AND ENTERTAINMENT

FOR ENTERTAINMENT SERVICES, NAMELY, LIVE PERFORMANCES BY MUSICAL PERFORMERS (U.S. CLS. 100, 101 AND 107).

DOMINIC FATHY, EXAMINING ATTORNEY

SN 77-159,362. QIAGEN GAITHERSBURG, INC., GAITHERSBURG, MD. FILED 4-18-2007.

ENSEMBLE

THE MARK CONSISTS OF STANDARD CHARACTERS WITHOUT CLAIM TO ANY PARTICULAR FONT, STYLE, SIZE, OR COLOR.

CLASS 1—CHEMICALS

FOR DIAGNOSTIC PREPARATIONS FOR SCIENTIFIC OR RESEARCH USE (U.S. CLS. 1, 5, 6, 10, 26 AND 46).

CLASS 5—PHARMACEUTICALS

FOR DIAGNOSTIC REAGENTS FOR CLINICAL OR MEDICAL LABORATORY USE (U.S. CLS. 6, 18, 44, 46, 51 AND 52).

CLASS 10—MEDICAL APPARATUS

FOR MEDICAL INSTRUMENTS FOR USE IN DIAGNOSIS AND SCREENING WITH REAGENTS (U.S. CLS. 26, 39 AND 44).

PAUL E. FAHRENKOPF, EXAMINING ATTORNEY

SN 77-159,701. COORS GLOBAL PROPERTIES, INC., GOLDEN, CO. FILED 4-18-2007.



OWNER OF U.S. REG. NO. 3,119,888.

CLASS 16—PAPER GOODS AND PRINTED MATTER

FOR PAPER BANNERS, POSTERS, PRINTED PAPER SIGNS, NAMELY, TABLE TENTS, PAPER DISPLAY CARDS, PAPER PENNANTS, PENS, STICKERS, COASTERS MADE OF PAPER, PAPER NAPKINS, CARDBOARD FLOOR DISPLAY UNITS FOR MERCHANDISING PRODUCTS AND NOTE PAPER (U.S. CLS. 2, 5, 22, 23, 29, 37, 38 AND 50).

FIRST USE 0-0-1995; IN COMMERCE 0-0-1995.

CLASS 21—HOUSEWARES AND GLASS

FOR BEVERAGE GLASSWARE, BOTTLE OPENERS, PITCHERS, PLASTIC BUCKETS, PLASTIC CUPS, SERVING TRAYS NOT OF PRECIOUS METAL, BOTTLE STANDS, MUGS, CUPS (U.S. CLS. 2, 13, 23, 29, 30, 33, 40 AND 50).

FIRST USE 1-0-1997; IN COMMERCE 1-0-1997.

CLASS 25—CLOTHING

FOR CLOTHING, NAMELY, SHIRTS, T-SHIRTS, GOLF SHIRTS, SWEATSHIRTS, DENIM SHIRTS, APRONS, TOPS, SHORTS, SWEATPANTS, TANK TOPS, JACKETS, WIND RESISTANT JACKETS, HATS AND CAPS, EXCLUDING CLOTHING FOR CHILDREN (U.S. CLS. 22 AND 39).

FIRST USE 1-0-1997; IN COMMERCE 1-0-1997.

CLASS 32—LIGHT BEVERAGES

FOR BEER (U.S. CLS. 45, 46 AND 48).
FIRST USE 0-0-1995; IN COMMERCE 0-0-1995.

MIDGE BUTLER, EXAMINING ATTORNEY

SN 77-161,478. SPC DIGITAL, INC., BIRMINGHAM, AL. FILED 4-20-2007.

SN 77-162,183. THE SOLARIA CORPORATION, FREMONT, CA. FILED 4-20-2007.

MYRECIPES.COM

THE MARK CONSISTS OF STANDARD CHARACTERS WITHOUT CLAIM TO ANY PARTICULAR FONT, STYLE, SIZE, OR COLOR.

CLASS 41—EDUCATION AND ENTERTAINMENT

FOR PROVIDING ONLINE INFORMATION IN THE FIELD OF ENTERTAINING IN THE NATURE OF PARTY PLANNING AND PREPARING FOR AND HOSTING DINNER PARTIES (U.S. CLS. 100, 101 AND 107).

CLASS 43—HOTEL AND RESTAURANT SERVICES

FOR PROVIDING ONLINE INFORMATION IN THE FIELD OF COOKING INFORMATION; PROVIDING A WEBSITE FEATURING A SEARCHABLE COLLECTION OF FOODS AND BEVERAGES TO PREPARE; PROVIDING ONLINE INFORMATION SERVICES IN THE FIELD OF FOODS AND BEVERAGE PREPARATION (U.S. CLS. 100 AND 101).
LYDIA BELZER, EXAMINING ATTORNEY

SN 77-161,488. SPC DIGITAL, INC., BIRMINGHAM, AL. FILED 4-20-2007.

MYRECIPES

THE MARK CONSISTS OF STANDARD CHARACTERS WITHOUT CLAIM TO ANY PARTICULAR FONT, STYLE, SIZE, OR COLOR.

CLASS 41—EDUCATION AND ENTERTAINMENT

FOR PROVIDING ONLINE INFORMATION IN THE FIELD OF ENTERTAINING IN THE NATURE OF PARTY PLANNING AND PREPARING FOR AND HOSTING DINNER PARTIES (U.S. CLS. 100, 101 AND 107).

CLASS 43—HOTEL AND RESTAURANT SERVICES

FOR PROVIDING ONLINE INFORMATION IN THE FIELD OF COOKING INFORMATION; PROVIDING A WEBSITE FEATURING A SEARCHABLE COLLECTION OF FOODS AND BEVERAGES TO PREPARE; PROVIDING ONLINE INFORMATION SERVICES IN THE FIELD OF FOODS AND BEVERAGE PREPARATION (U.S. CLS. 100 AND 101).
LYDIA BELZER, EXAMINING ATTORNEY



OWNER OF U.S. REG. NO. 2,494,100.
THE MARK CONSISTS OF THE WORD "SOLARIA" IN UPPER-CASE LETTERS FOLLOWED BY A CIRCULAR SUNBURST DESIGN.

CLASS 9—ELECTRICAL AND SCIENTIFIC APPARATUS

FOR SOLAR ENERGY PRODUCTS, NAMELY, PHOTOVOLTAIC SYSTEMS COMPRISED OF SOLAR CELLS, SOLAR PANELS, SOLAR MODULES, AND SOLAR CELL CONNECTORS (U.S. CLS. 21, 23, 26, 36 AND 38).

CLASS 37—CONSTRUCTION AND REPAIR

FOR INSTALLATION, REPAIR AND MAINTENANCE OF PHOTOVOLTAIC SYSTEMS, SOLAR POWER PLANTS AND SOLAR ENERGY PRODUCTS, NAMELY, SOLAR CELLS, SOLAR CELL PACKAGES, SOLAR PANELS, SOLAR MODULES AND SOLAR CELL CONNECTORS (U.S. CLS. 100, 103 AND 106).

CLASS 42—SCIENTIFIC AND COMPUTER SERVICES

FOR RESEARCH AND DEVELOPMENT, DESIGN, ENGINEERING, AND CONSULTING SERVICES FOR OTHERS IN THE FIELD OF SOLAR ENERGY (U.S. CLS. 100 AND 101).
JUSTINE D. PARKER, EXAMINING ATTORNEY

SN 77-162,373. HENDIAZAD, ANNOUSH, MORRIS PLAINS, NJ. FILED 4-20-2007.



NO CLAIM IS MADE TO THE EXCLUSIVE RIGHT TO USE "HAND CRAFTED", APART FROM THE MARK AS SHOWN.

THE MARK CONSISTS OF "SORELLE" INSIDE A DOUBLE OVAL CAPPED WITH A CROWN.
THE ENGLISH TRANSLATION OF THE WORD "SORELLE" IN THE MARK IS SISTERS.

CLASS 16—PAPER GOODS AND PRINTED MATTER

FOR FRAMED WALL PAINTINGS (U.S. CLS. 2, 5, 22, 23, 29, 37, 38 AND 50).
FIRST USE 7-1-2004; IN COMMERCE 7-1-2004.

CLASS 21—HOUSEWARES AND GLASS

FOR PORCELAIN AND CRYSTAL FIGURINES; PORCELAIN AND CRYSTAL DINNERWARE, NAMELY, VASES, BOWLS, CANDLESICKS (U.S. CLS. 2, 13, 23, 29, 30, 33, 40 AND 50).
FIRST USE 7-1-2004; IN COMMERCE 7-1-2004.
ALICE BENMAMAN, EXAMINING ATTORNEY

CLASS 38—COMMUNICATION

FOR SECURED OR UNSECURED TELECOMMUNICATION SERVICES, NAMELY, TRANSMISSION AND DELIVERY OF DIGITAL DATA, LIGHT FILES, SOUND FILES, DATA, INFORMATION AND IMAGE SIGNALS BY MEANS OF COMPUTER, CABLE RADIO AND SATELLITE, TRANSMISSIONS, ALL IN PARTICULAR FOR NAVIGATION SYSTEMS, ROUTE PLANNERS, AND THE USE OF ELECTRONIC MAPS; WIRELESS TRANSMISSION OF DATA, BY MEANS OF VIDEO-TEXT, THE INTERNET, GSM AND WAP; WIRELESS TRANSMISSION OF DIGITAL DATA; ELECTRONIC TRANSMISSION OF DATA AND DOCUMENTS VIA COMPUTER TERMINALS; RENTAL OF TELECOMMUNICATION EQUIPMENT; TECHNICAL CONSULTATION IN CONNECTION WITH ALL OF THE ABOVE (U.S. CLS. 100, 101 AND 104).

SN 77-162,879. TOMTOM INTERNATIONAL B.V., AMSTERDAM, NETHERLANDS, FILED 4-23-2007.

Mapshare

THE MARK CONSISTS OF STANDARD CHARACTERS WITHOUT CLAIM TO ANY PARTICULAR FONT, STYLE, SIZE, OR COLOR.

CLASS 9—ELECTRICAL AND SCIENTIFIC APPARATUS

FOR COMPUTER HARDWARE AND SOFTWARE TO BE USED WITH SATELLITE AND/OR GPS NAVIGATION SYSTEMS FOR NAVIGATION PURPOSES; COMPUTER SOFTWARE TO BE USED WITH ROUTE PLANNERS, ELECTRONIC MAPS, AND DIGITAL DICTIONARIES FOR NAVIGATION AND TRANSLATION PURPOSES; SOFTWARE FOR TRAVEL INFORMATION SYSTEMS FOR THE PROVISION OR RENDERING OF TRAVEL ADVICE AND/OR INFORMATION CONCERNING SERVICE STATIONS, CAR PARKS, RESTAURANTS, CAR DEALERS AND OTHER TRAVEL AND TRANSPORT RELATED INFORMATION; SOFTWARE FOR INFORMATION MANAGEMENT FOR THE TRANSPORT AND TRAFFIC INDUSTRIES; SOFTWARE TO BE USED FOR VIEWING ELECTRONIC MAPS; DOWNLOADABLE ELECTRONIC MAPS; SOFTWARE FOR OPERATING ROUTE PLANNERS; ROUTE PLANNERS IN THE NATURE OF HANDHELD PERSONAL COMPUTERS; SOFTWARE FOR OPERATING ELECTRONIC DIGITAL DICTIONARIES; ELECTRONIC DICTIONARIES; LOCATION, ORIENTATION AND NAVIGATION, AND GLOBAL POSITIONING SYSTEMS (GPS) CONSISTING OF COMPUTERS, COMPUTER SOFTWARE, TRANSMITTERS, GPS AND/OR SATELLITE RECEIVERS, NETWORK INTERFACE DEVICES, CONNECTION CABLES, AND PARTS AND FITTINGS THEREOF; HOLDERS FOR POCKET PERSONAL COMPUTERS; SATELLITE AND RADIO TRANSMISSION APPARATUS TECHNOLOGY, NAMELY, PROCESSORS, MOBILE TELEPHONES AND RECEIVERS; TELECOMMUNICATIONS INSTALLATIONS, NETWORKS AND APPARATUS, NAMELY, MOUNTING RACKS FOR TELECOMMUNICATIONS HARDWARE, TELECOMMUNICATION SWITCHES; COMPUTER TERMINALS, ALL IN PARTICULAR TO BE USED WITH NAVIGATION SYSTEMS, ROUTE PLANNERS AND/OR DIGITAL MAPS; BLANK MAGNETIC AND DISC SHAPED DATA CARRIERS; AUDIO AND VIDEO APPARATUS, NAMELY, AUDIO AND VIDEO RECEIVERS AND PROCESSORS; HANDHELD PERSONAL COMPUTERS; PERSONAL DIGITAL ASSISTANTS (U.S. CLS. 21, 23, 26, 36 AND 38).

CLASS 39—TRANSPORTATION AND STORAGE

FOR SECURED OR UNSECURED TELECOMMUNICATION SERVICES, NAMELY, ELECTRONIC STORAGE OF DIGITAL DATA, LIGHT FILES, SOUND FILES, DATA, INFORMATION AND IMAGE SIGNALS, ALL IN PARTICULAR FOR NAVIGATION SYSTEMS, ROUTE PLANNERS AND THE USE OF ELECTRONIC MAPS; PROVIDING NAVIGATION AND INFORMATION SERVICES, NAMELY, INFORMATION REGARDING TRAFFIC AND TRAFFIC CONGESTION; PROVISION OF INFORMATION REGARDING TRAVEL; PROVISION OF INFORMATION TO TRAVELLERS REGARDING FARES, TIME TABLES AND MEANS OF PUBLIC TRANSPORT; SERVICES OF A TRAVEL AGENCY, NAMELY, THE BOOKING OF RENTAL SERVICES OF CARS, BOATS AND OTHER VEHICLES; ALL OF THE AFORESAID SERVICES ALSO PROVIDED VIA A COMMUNICATIONS NETWORK OR A MOBILE TELEPHONE OR A WIRELESS NAVIGATION DEVICE (U.S. CLS. 100 AND 105).

CLASS 41—EDUCATION AND ENTERTAINMENT

FOR EDUCATION SERVICES, NAMELY, PROVIDING CLASSES AND SEMINARS REGARDING THE USE OF NAVIGATION SYSTEMS; TRAINING SERVICES IN THE FIELD OF NAVIGATION SYSTEMS; ENTERTAINMENT, NAMELY, THE PRODUCTION OF RADIO PROGRAMS AND TELEVISION PROGRAMS; ORGANIZING COMMUNITY CULTURAL ACTIVITIES AND SPORTING ACTIVITIES (U.S. CLS. 100, 101 AND 107).

CLASS 42—SCIENTIFIC AND COMPUTER SERVICES

FOR CONSULTATION IN THE FIELD OF COMPUTER SOFTWARE DESIGN; PROVIDING TEMPORARY USE OF NON-DOWNLOADABLE SOFTWARE WHICH PROVIDES GEOGRAPHICAL, MAP IMAGE AND TRIP ROUTING DATA OBTAINED WITH THE AID OF A GLOBAL POSITIONING SYSTEM (GPS) IN ORDER TO ENABLE THIRD PARTIES TO COME TO AN ACCURATE LOCATION OR ORIENTATION; DEVELOPMENT AND DESIGN OF NAVIGATION SYSTEMS, ROUTE PLANNERS, ELECTRONIC MAPS AND DIGITAL DICTIONARIES; COMPUTER SOFTWARE AND HARDWARE DESIGN; DEVELOPMENT AND DESIGN OF SOFTWARE FOR USE WITH NAVIGATION SYSTEMS, ROUTE PLANNERS AND THE USE OF ELECTRONIC MAPS AND DIGITAL DICTIONARIES; DEVELOPMENT AND DESIGN OF TELECOMMUNICATION AND DATA COMMUNICATION SERVICES AND NETWORKS (U.S. CLS. 100 AND 101).

CLASS 45—PERSONAL AND LEGAL SERVICES

FOR SECURITY SERVICES FOR THE PROTECTION OF PROPERTY AND INDIVIDUALS, NAMELY, THE TRACKING AND TRACING OF GOODS AND INDIVIDUALS IN THE CONTEXT OF SECURITY (U.S. CLS. 100 AND 101).

LA TONIA FISHER, EXAMINING ATTORNEY

CLASS 38—COMMUNICATION

FOR SECURED OR UNSECURED TELECOMMUNICATION SERVICES, NAMELY, TRANSMISSION AND DELIVERY OF DIGITAL DATA, LIGHT FILES, SOUND FILES, DATA, INFORMATION AND IMAGE SIGNALS BY MEANS OF COMPUTER, CABLE RADIO AND SATELLITE, TRANSMISSIONS, ALL IN PARTICULAR FOR NAVIGATION SYSTEMS, ROUTE PLANNERS, AND THE USE OF ELECTRONIC MAPS; WIRELESS TRANSMISSION OF DATA, BY MEANS OF VIDEO-TEXT, THE INTERNET, GSM AND WAP; WIRELESS TRANSMISSION OF DIGITAL DATA; ELECTRONIC TRANSMISSION OF DATA AND DOCUMENTS VIA COMPUTER TERMINALS; RENTAL OF TELECOMMUNICATION EQUIPMENT; TECHNICAL CONSULTATION IN CONNECTION WITH ALL OF THE ABOVE (U.S. CLS. 100, 101 AND 104).

SN 77-163,906. TOMTOM INTERNATIONAL B.V., AMSTERDAM, NETHERLANDS, FILED 4-24-2007.

TomTom Mapshare

THE MARK CONSISTS OF STANDARD CHARACTERS WITHOUT CLAIM TO ANY PARTICULAR FONT, STYLE, SIZE, OR COLOR.

CLASS 9—ELECTRICAL AND SCIENTIFIC APPARATUS

FOR COMPUTER HARDWARE AND SOFTWARE TO BE USED WITH SATELLITE AND/OR GPS NAVIGATION SYSTEMS FOR NAVIGATION PURPOSES; COMPUTER SOFTWARE TO BE USED WITH ROUTE PLANNERS, ELECTRONIC MAPS, AND DIGITAL DICTIONARIES FOR NAVIGATION AND TRANSLATION PURPOSES; SOFTWARE FOR TRAVEL INFORMATION SYSTEMS FOR THE PROVISION OR RENDERING OF TRAVEL ADVICE AND/OR INFORMATION CONCERNING SERVICE STATIONS, CAR PARKS, RESTAURANTS, CAR DEALERS AND OTHER TRAVEL AND TRANSPORT RELATED INFORMATION; SOFTWARE FOR INFORMATION MANAGEMENT FOR THE TRANSPORT AND TRAFFIC INDUSTRIES; SOFTWARE TO BE USED FOR VIEWING ELECTRONIC MAPS; DOWNLOADABLE ELECTRONIC MAPS; SOFTWARE FOR OPERATING ROUTE PLANNERS; ROUTE PLANNERS IN THE NATURE OF HANDHELD PERSONAL COMPUTERS; SOFTWARE FOR OPERATING ELECTRONIC DIGITAL DICTIONARIES; ELECTRONIC DICTIONARIES; LOCATION, ORIENTATION AND NAVIGATION, AND GLOBAL POSITIONING SYSTEMS (GPS) CONSISTING OF COMPUTERS, COMPUTER SOFTWARE, TRANSMITTERS, GPS AND/OR SATELLITE RECEIVERS, NETWORK INTERFACE DEVICES, CONNECTION CABLES, AND PARTS AND FITTINGS THEREOF; HOLDERS FOR POCKET PERSONAL COMPUTERS; SATELLITE AND RADIO TRANSMISSION APPARATUS TECHNOLOGY, NAMELY, PROCESSORS, MOBILE TELEPHONES AND RECEIVERS; TELECOMMUNICATIONS INSTALLATIONS, NETWORKS AND APPARATUS, NAMELY, MOUNTING RACKS FOR TELECOMMUNICATIONS HARDWARE, TELECOMMUNICATION SWITCHES; COMPUTER TERMINALS, ALL IN PARTICULAR TO BE USED WITH NAVIGATION SYSTEMS, ROUTE PLANNERS AND/OR DIGITAL MAPS; BLANK MAGNETIC AND DISC SHAPED DATA CARRIERS; AUDIO AND VIDEO APPARATUS, NAMELY, AUDIO AND VIDEO RECEIVERS AND PROCESSORS; HANDHELD PERSONAL COMPUTERS; PERSONAL DIGITAL ASSISTANTS (U.S. CLS. 21, 23, 26, 36 AND 38).

CLASS 39—TRANSPORTATION AND STORAGE

FOR SECURED OR UNSECURED TELECOMMUNICATION SERVICES, NAMELY, ELECTRONIC STORAGE OF DIGITAL DATA, LIGHT FILES, SOUND FILES, DATA, INFORMATION AND IMAGE SIGNALS, ALL IN PARTICULAR FOR NAVIGATION SYSTEMS, ROUTE PLANNERS AND THE USE OF ELECTRONIC MAPS; PROVIDING NAVIGATION AND INFORMATION SERVICES, NAMELY, INFORMATION REGARDING TRAFFIC AND TRAFFIC CONGESTION; PROVISION OF INFORMATION REGARDING TRAVEL; PROVISION OF INFORMATION TO TRAVELLERS REGARDING FARES, TIME TABLES AND MEANS OF PUBLIC TRANSPORT; SERVICES OF A TRAVEL AGENCY, NAMELY, THE BOOKING OF RENTAL SERVICES OF CARS, BOATS AND OTHER VEHICLES; ALL OF THE AFORESAID SERVICES ALSO PROVIDED VIA A COMMUNICATIONS NETWORK OR A MOBILE TELEPHONE OR A WIRELESS NAVIGATION DEVICE (U.S. CLS. 100 AND 105).

CLASS 41—EDUCATION AND ENTERTAINMENT

FOR EDUCATION SERVICES, NAMELY, PROVIDING CLASSES AND SEMINARS REGARDING THE USE OF NAVIGATION SYSTEMS; TRAINING SERVICES IN THE FIELD OF NAVIGATION SYSTEMS (U.S. CLS. 100, 101 AND 107).

CLASS 42—SCIENTIFIC AND COMPUTER SERVICES

FOR CONSULTATION IN THE FIELD OF COMPUTER SOFTWARE DESIGN; PROVIDING TEMPORARY USE OF NON-DOWNLOADABLE SOFTWARE WHICH PROVIDES GEOGRAPHICAL, MAP IMAGE AND TRIP ROUTING DATA OBTAINED WITH THE AID OF A GLOBAL POSITIONING SYSTEM (GPS) IN ORDER TO ENABLE THIRD PARTIES TO COME TO AN ACCURATE LOCATION OR ORIENTATION; DEVELOPMENT AND DESIGN OF NAVIGATION SYSTEMS, ROUTE PLANNERS, ELECTRONIC MAPS AND DIGITAL DICTIONARIES; COMPUTER SOFTWARE AND HARDWARE DESIGN; DEVELOPMENT AND DESIGN OF SOFTWARE FOR USE WITH NAVIGATION SYSTEMS, ROUTE PLANNERS AND THE USE OF ELECTRONIC MAPS AND DIGITAL DICTIONARIES; DEVELOPMENT AND DESIGN OF TELECOMMUNICATION AND DATA COMMUNICATION SERVICES AND NETWORKS (U.S. CLS. 100 AND 101).

CLASS 45—PERSONAL AND LEGAL SERVICES

FOR SECURITY SERVICES FOR THE PROTECTION OF PROPERTY AND INDIVIDUALS, NAMELY, THE TRACKING AND TRACING OF GOODS AND INDIVIDUALS IN THE CONTEXT OF SECURITY (U.S. CLS. 100 AND 101).

LA TONIA FISHER, EXAMINING ATTORNEY

SN 77-164,132. DISTRIBUTION PLUS, INC., WILMETTE, IL.
FILED 4-24-2007.

DPI SPECIALTY FOODS

THE MARK CONSISTS OF STANDARD CHARACTERS WITHOUT CLAIM TO ANY PARTICULAR FONT, STYLE, SIZE, OR COLOR.

OWNER OF U.S. REG. NO. 1,779,242.

NO CLAIM IS MADE TO THE EXCLUSIVE RIGHT TO USE "SPECIALTY FOODS", APART FROM THE MARK AS SHOWN.

CLASS 35—ADVERTISING AND BUSINESS

FOR WHOLESALE DISTRIBUTORSHIP SERVICES FEATURING SPECIALTY FOODS, DAIRY PRODUCTS AND DRY GOODS (U.S. CLS. 100, 101 AND 102).

CLASS 39—TRANSPORTATION AND STORAGE

FOR WAREHOUSE STORAGE SERVICES (U.S. CLS. 100 AND 105).
MELISSA VALLILLO, EXAMINING ATTORNEY

SN 77-164,304. IRENE BIZIOS, CHICAGO, IL. FILED 4-24-2007.

RESOURCE ROADRUNNER

THE MARK CONSISTS OF STANDARD CHARACTERS WITHOUT CLAIM TO ANY PARTICULAR FONT, STYLE, SIZE, OR COLOR.

CLASS 39—TRANSPORTATION AND STORAGE

FOR DELIVERY OF EDUCATIONAL RESOURCES TO ELEMENTARY, MIDDLE AND HIGH SCHOOLS, NAMELY, MANIPULATIVES, KITS, MODELS, LEARNING CARDS, INTERACTIVE ACTIVITY SETS, BOARD AIDS, PUZZLES, TALKING INSTRUCTIONAL BALLS, TEMPLATES, LEARNING GAMES, ELECTRONIC LEARNING DEVICES, ROBOTIC DEVICES, CD-ROMS, EDUCATIONAL BOOKS AND VIDEOS, CHARTS, PHOTOGRAPHIC AIDS, ACTIVITY BOOKS, PRIMARY SOURCE DOCUMENTS, MAPS, GLOBES, CD'S OF WORLD MUSIC AND MUSIC IN TEACHING CD'S AND REFERENCE BOOKS REGARDING THEMATIC UNITS (U.S. CLS. 100 AND 105).

FIRST USE 7-10-2007; IN COMMERCE 7-10-2007.

CLASS 41—EDUCATION AND ENTERTAINMENT

FOR RENTAL OF EDUCATIONAL RESOURCES TO ELEMENTARY, MIDDLE AND HIGH SCHOOLS, NAMELY, KITS AND TEMPLATES AND CD-ROMS FOR TEACHING SCIENCE, MATH, SOCIAL STUDIES, LITERATURE, ENGLISH AND ART, MANIPULATIVES, MODELS, LEARNING CARDS, INTERACTIVE ACTIVITY SETS, BOARD AIDS, PUZZLES, TALKING INSTRUCTIONAL BALLS, LEARNING GAMES, ELECTRONIC LEARNING GAMES AND AUDIO-VISUAL EQUIPMENT, ROBOTIC DEVICES, EDUCATIONAL BOOKS AND VIDEOS, CHARTS, PHOTOGRAPHIC AIDS, ACTIVITY BOOKS, PRIMARY SOURCE DOCUMENTS, NAMELY, PRINTED PUBLICATIONS AND TEXT FOR THE PURPOSE OF TEACHING IN THE CLASSROOM, MAPS, GLOBES, CD'S OF WORLD MUSIC AND MUSIC IN TEACHING CD'S AND REFERENCE BOOKS REGARDING THEMATIC UNITS (U.S. CLS. 100, 101 AND 107).

FIRST USE 7-10-2007; IN COMMERCE 7-10-2007.

HANNO RITTNER, EXAMINING ATTORNEY

SN 77-164,970. SCOTTISH AMERICAN MEDIA, LLC, VALLEY VILLAGE, CA. FILED 4-25-2007.

BATTLE OF THE STATES DANCE CONTEST

THE MARK CONSISTS OF STANDARD CHARACTERS WITHOUT CLAIM TO ANY PARTICULAR FONT, STYLE, SIZE, OR COLOR.

NO CLAIM IS MADE TO THE EXCLUSIVE RIGHT TO USE "DANCE CONTEST", APART FROM THE MARK AS SHOWN.

CLASS 9—ELECTRICAL AND SCIENTIFIC APPARATUS

FOR AUDIO, VIDEO, STILL AND MOVING IMAGES, AND DATA RECORDINGS IN COMPRESSED AND UNCOMPRESSED FORM, NAMELY, PRE-RECORDED AUDIOCASSETTE TAPES, VIDEO TAPES, DVDS, COMPACT DISCS, RECORDS, AND CD-ROMS FEATURING MUSIC, MUSICAL ENTERTAINMENT, DANCE INSTRUCTION, AND DANCE EDUCATION (U.S. CLS. 21, 23, 26, 36 AND 38).

CLASS 41—EDUCATION AND ENTERTAINMENT

FOR ENTERTAINMENT SERVICES, NAMELY, ORGANIZING COMPETITIONS, CONTESTS, GAMES, SHOWS, ROAD SHOWS, STAGE EVENTS, THEATRICAL PERFORMANCES, CONCERTS, LIVE PERFORMANCES, AND AUDIENCE PARTICIPATION BASED EVENTS, PERTAINING TO OR FEATURING INSTRUCTION, ENTERTAINMENT, AND INFORMATION IN THE FIELDS OF MUSIC AND DANCE; PRODUCTION AND RENTAL OF SOUND AND VIDEO RECORDINGS, AND MOTION PICTURE FILMS; PRODUCTION AND SYNDICATION OF TELEVISION AND RADIO PROGRAMS; PROVIDING ENTERTAINMENT INFORMATION IN THE FIELDS OF MUSIC, DANCE, AND TELEVISION AND RADIO PROGRAMS (U.S. CLS. 100, 101 AND 107).

REBECCA SMITH, EXAMINING ATTORNEY

SN 77-165,018. SCOTTISH AMERICAN MEDIA, LLC, VALLEY VILLAGE, CA. FILED 4-25-2007.

LEAVE IT TO LEN

THE MARK CONSISTS OF STANDARD CHARACTERS WITHOUT CLAIM TO ANY PARTICULAR FONT, STYLE, SIZE, OR COLOR.

CLASS 9—ELECTRICAL AND SCIENTIFIC APPARATUS

FOR APPARATUS FOR RECORDING, TRANSMISSION OR REPRODUCTION OF SOUND AND IMAGES, NAMELY, MP3 PLAYERS, COMPACT DISC PLAYERS, PORTABLE COMPACT DISC PLAYERS, VIDEO RECORDERS, TELEVISION SETS AND CAMCORDERS; BLANK MAGNETIC DATA CARRIERS, RECORDING DISCS, NAMELY, BLANK RECORDABLE COMPACT DISCS; BLANK VIDEO TAPES; PRE-RECORDED VIDEO TAPES, PRE-RECORDED LASER DISCS PRE-RECORDED COMPACT DISCS, AND PRE-RECORDED DVD'S FEATURING MUSIC, CHARACTERS, SCENES AND SITUATIONS RELATING TO A TELEVISION SERIES AS WELL AS MUSIC, SCENES, CHARACTERS AND SITUATIONS FROM AN INTERNET SITE RELATED TO A TELEVISION SERIES; ELECTRONIC GAME PROGRAMS; ELECTRONIC GAME PROGRAMS RECORDED ON COMPACT DISCS AND DVDS (U.S. CLS. 21, 23, 26, 36 AND 38).

CLASS 41—EDUCATION AND ENTERTAINMENT

FOR ENTERTAINMENT SERVICES IN THE NATURE OF AN ON-GOING REALITY-BASED TELEVISION PROGRAM BROADCAST OVER TELEVISION, SATELLITE, AUDIO AND VIDEO MEDIA; PROVIDING INFORMATION IN THE FIELD OF ENTERTAINMENT FEATURING INFORMATION ON REALITY-BASED TELEVISION BY MEANS OF A GLOBAL COMPUTER NETWORK (U.S. CLS. 100, 101 AND 107).

REBECCA SMITH, EXAMINING ATTORNEY

SN 77-165,326. SANOFI-AVENTIS, PARIS, FRANCE, FILED 4-25-2007.

NEXTRUS

THE MARK CONSISTS OF STANDARD CHARACTERS WITHOUT CLAIM TO ANY PARTICULAR FONT, STYLE, SIZE, OR COLOR.

PRIORITY CLAIMED UNDER SEC. 44(D) ON FRANCE APPLICATION NO. 063458859, FILED 10-25-2006, REG. NO. 063458859, DATED 10-25-2006, EXPIRES 10-25-2016.

CLASS 5—PHARMACEUTICALS

FOR INSULIN PREPARATIONS (U.S. CLS. 6, 18, 44, 46, 51 AND 52).

CLASS 10—MEDICAL APPARATUS

FOR MEDICAL DEVICES AND APPARATUS, NAMELY, DISPOSABLE INJECTOR PENS FOR INSULIN (U.S. CLS. 26, 39 AND 44).

CURTIS FRENCH, EXAMINING ATTORNEY

SN 77-165,346. SANOFI-AVENTIS, PARIS, FRANCE, FILED 4-25-2007.

SLIQEX

THE MARK CONSISTS OF STANDARD CHARACTERS WITHOUT CLAIM TO ANY PARTICULAR FONT, STYLE, SIZE, OR COLOR.

PRIORITY CLAIMED UNDER SEC. 44(D) ON FRANCE APPLICATION NO. 063458858, FILED 10-25-2006, REG. NO. 063458858, DATED 10-25-2006, EXPIRES 10-25-2016.

CLASS 5—PHARMACEUTICALS

FOR INSULIN PREPARATIONS (U.S. CLS. 6, 18, 44, 46, 51 AND 52).

CLASS 10—MEDICAL APPARATUS

FOR MEDICAL DEVICES AND APPARATUS, NAMELY, DISPOSABLE INJECTOR PENS FOR INSULIN (U.S. CLS. 26, 39 AND 44).

CURTIS FRENCH, EXAMINING ATTORNEY

SN 77-165,669. FUJIAN POWERLAND LEATHER CASE & PRODUCTS CO., LTD, PUTIAN CITY, CHINA, FILED 4-25-2007.



THE COLOR(S) BLACK AND RED IS/ARE CLAIMED AS A FEATURE OF THE MARK.

THE MARK CONSISTS OF A STYLIZED INVERTED LETTER "P" AND A STYLIZED UPRIGHT LETTER "P". THE INVERTED LETTER "P" IS RED AND THE UPRIGHT LETTER "P" IS BLACK.

CLASS 18—LEATHER GOODS

FOR ALL PURPOSE SPORT BAGS; ALL-PURPOSE CARRYING BAGS; ATTACHE CASES; BACKPACKS; BAGS AND HOLDALLS FOR SPORTS CLOTHING; BILLFOLDS; BOOK BAGS; BRIEFCASES; BRIEFCASE-TYPE PORTFOLIOS; BUSINESS CARD CASES; CANES; CARRYALLS; COSMETIC BAGS SOLD EMPTY; DUFFEL BAGS; FLEXIBLE BAGS FOR GARMENTS; FOOTLOCKERS; GUT FOR MAKING SAUSAGE CASINGS; HANDBAGS; HAVERSACKS; HOLDALLS; IMITATION LEATHER; KEY WALLETS; KNAPSACKS; LEATHER AND IMITATION LEATHER BAGS; LEATHER BAGS; SUITCASES AND WALLETS; LEATHER HANDBAGS; LEATHER PURSES; LEATHER STRAPS; LUGGAGE; PULLMANS; PURSES; RAINPROOF PARASOLS; ROLL BAGS; RUCKSACKS; SCHOOL BAGS; SCHOOLCHILDREN'S BACKPACKS; SHOULDER BAGS; SLING BAGS; STRAPS FOR HANDBAGS; SUIT BAGS; TOTE BAGS; TRAVEL BAGS; TRUNKS; UMBRELLAS; WALKING STICKS; WALLETS (U.S. CLS. 1, 2, 3, 22 AND 41).

CLASS 25—CLOTHING

FOR ATHLETIC FOOTWEAR; BASKETBALL SNEAKERS; BELTS; BLAZERS; BLOUSES; BOOTS; CANVAS SHOES; CAPRIS; CLOTH BIBS; COATS; DOWN JACKETS; DRESS SHIRTS; DRESSES; FOOTBALL SHOES; FOOTWEAR; FOOTWEAR FOR MEN AND WOMEN; FOOTWEAR FOR TRACK AND FIELD ATHLETICS; FOOTWEAR NOT FOR SPORTS; FUR COATS AND JACKETS; GLOVES; HATS; HIKING BOOTS; HOSIERY; HOUSECOATS; JACKETS; JEANS; LADIES' SUITS; LAYETTES; LEATHER BELTS; LEATHER SHOES; MEN AND WOMEN JACKETS; COATS; TROUSERS; VESTS; MITTENS; NECKTIES; OVER COATS; OVERSHOES; RAIN COATS; RUBBER SHOES; RUNNING SHOES; SANDALS; SASHES; SHIRTS; SHOES; SHORT-SLEEVED OR LONG-SLEEVED T-SHIRTS; SLACKS; SLIPPERS; SNEAKERS; SOCKS; STOCKINGS; SUITS; SWADDLING CLOTHES; SWEATERS; TENNIS SHOES; THONGS; TIES; TROUSERS; T-SHIRTS; WAIST BELTS; WIND COATS; WINTER BOOTS; WOMEN'S SHOES (U.S. CLS. 22 AND 39).

IRA J. GOODSaid, EXAMINING ATTORNEY

CLASS 18—LEATHER GOODS

FOR ALL PURPOSE SPORT BAGS; ALL-PURPOSE CARRYING BAGS; ATTACHE CASES; BACKPACKS; BAGS AND HOLDALLS FOR SPORTS CLOTHING; BILLFOLDS; BOOK BAGS; BRIEFCASES; BRIEFCASE-TYPE PORTFOLIOS; BUSINESS CARD CASES; CANES; CARRYALLS; COSMETIC BAGS SOLD EMPTY; DUFFEL BAGS; FLEXIBLE BAGS FOR GARMENTS; FOOTLOCKERS; GUT FOR MAKING SAUSAGE CASINGS; HANDBAGS; HAVERSACKS; HOLDALLS; IMITATION LEATHER; KEY WALLETS; KNAPSACKS; LEATHER AND IMITATION LEATHER BAGS; LEATHER BAGS; SUITCASES AND WALLETS; LEATHER HANDBAGS; LEATHER PURSES; LEATHER STRAPS; LUGGAGE; PULLMANS; PURSES; RAINPROOF PARASOLS; ROLL BAGS; RUCKSACKS; SCHOOL BAGS; SCHOOLCHILDREN'S BACKPACKS; SHOULDER BAGS; SLING BAGS; STRAPS FOR HANDBAGS; SUIT BAGS; TOTE BAGS; TRAVEL BAGS; TRUNKS; UMBRELLAS; WALKING STICKS; WALLETS (U.S. CLS. 1, 2, 3, 22 AND 41).

CLASS 25—CLOTHING

FOR ATHLETIC FOOTWEAR; BASKETBALL SNEAKERS; BELTS; BLAZERS; BLOUSES; BOOTS; CANVAS SHOES; CAPRIS; CLOTH BIBS; COATS; DOWN JACKETS; DRESS SHIRTS; DRESSES; FOOTBALL SHOES; FOOTWEAR; FOOTWEAR FOR MEN AND WOMEN; FOOTWEAR FOR TRACK AND FIELD ATHLETICS; FOOTWEAR NOT FOR SPORTS; FUR COATS AND JACKETS; GLOVES; HATS; HIKING BOOTS; HOSIERY; HOUSECOATS; JACKETS; JEANS; LADIES' SUITS; LAYETTES; LEATHER BELTS; LEATHER SHOES; MEN AND WOMEN JACKETS; COATS; TROUSERS; VESTS; MITTENS; NECKTIES; OVER COATS; OVERSHOES; RAIN COATS; RUBBER SHOES; RUNNING SHOES; SANDALS; SASHES; SHIRTS; SHOES; SHORT-SLEEVED OR LONG-SLEEVED T-SHIRTS; SLACKS; SLIPPERS; SNEAKERS; SOCKS; STOCKINGS; SUITS; SWADDLING CLOTHES; SWEATERS; TENNIS SHOES; THONGS; TIES; TROUSERS; T-SHIRTS; WAIST BELTS; WIND COATS; WINTER BOOTS; WOMEN'S SHOES (U.S. CLS. 22 AND 39).

IRA J. GOODSaid, EXAMINING ATTORNEY

SN 77-165,673. FUJIAN POWERLAND LEATHER CASE & PRODUCTS CO., LTD, PUTIAN CITY, CHINA, FILED 4-25-2007.



SN 77-167,155. TOMTOM INTERNATIONAL B.V., AMSTERDAM, NETHERLANDS, FILED 4-27-2007.

TomTom One Light

THE COLOR(S) BLACK AND RED IS/ARE CLAIMED AS A FEATURE OF THE MARK.

THE MARK CONSISTS IN PART OF A STYLIZED INVERTED LETTER "P" AND A STYLIZED UPRIGHT LETTER "P". THE INVERTED LETTER "P" IS RED AND "POWERLAND" IS BLACK.

THE MARK CONSISTS OF STANDARD CHARACTERS WITHOUT CLAIM TO ANY PARTICULAR FONT, STYLE, SIZE, OR COLOR.

CLASS 9—ELECTRICAL AND SCIENTIFIC APPARATUS

FOR COMPUTER HARDWARE AND SOFTWARE TO BE USED WITH SATELLITE AND/OR GPS NAVIGATION SYSTEMS FOR NAVIGATION PURPOSES; COMPUTER SOFTWARE TO BE USED WITH ROUTE PLANNERS, ELECTRONIC MAPS, AND DIGITAL DICTIONARIES FOR NAVIGATION AND TRANSLATION PURPOSES; SOFTWARE FOR TRAVEL INFORMATION SYSTEMS FOR THE PROVISION OR RENDERING OF TRAVEL ADVICE AND/OR INFORMATION CONCERNING SERVICE STATIONS, CAR PARKS, RESTAURANTS, CAR DEALERS AND OTHER TRAVEL AND TRANSPORT RELATED INFORMATION; SOFTWARE FOR INFORMATION MANAGEMENT FOR THE TRANSPORT AND TRAFFIC INDUSTRIES; SOFTWARE TO BE USED FOR VIEWING ELECTRONIC MAPS; DOWNLOADABLE ELECTRONIC MAPS; SOFTWARE FOR OPERATING ROUTE PLANNERS; ROUTE PLANNERS IN THE NATURE OF HANDHELD PERSONAL COMPUTERS; SOFTWARE FOR OPERATING ELECTRONIC DIGITAL DICTIONARIES; ELECTRONIC DICTIONARIES; LOCATION, ORIENTATION AND NAVIGATION, AND GLOBAL POSITIONING SYSTEMS (GPS) CONSISTING OF COMPUTERS, COMPUTER SOFTWARE, TRANSMITTERS, GPS AND/OR SATELLITE RECEIVERS, NETWORK INTERFACE DEVICES, CONNECTION CABLES, AND PARTS AND FITTINGS THEREOF; HOLDERS FOR POCKET PERSONAL COMPUTERS; SATELLITE AND RADIO TRANSMISSION APPARATUS TECHNOLOGY, NAMELY, PROCESSORS, MOBILE TELEPHONES AND RECEIVERS; TELECOMMUNICATIONS INSTALLATIONS, NETWORKS AND APPARATUS, NAMELY, MOUNTING RACKS FOR TELECOMMUNICATIONS HARDWARE, TELECOMMUNICATION SWITCHES; COMPUTER TERMINALS, ALL IN PARTICULAR TO BE USED WITH NAVIGATION SYSTEMS, ROUTE PLANNERS AND/OR DIGITAL MAPS; BLANK MAGNETIC AND DISC SHAPED DATA CARRIERS; AUDIO AND VIDEO APPARATUS, NAMELY, AUDIO AND VIDEO RECEIVERS AND PROCESSORS; HANDHELD PERSONAL COMPUTERS; PERSONAL DIGITAL ASSISTANTS (U.S. CLS. 21, 23, 26, 36 AND 38).

CLASS 38—COMMUNICATION

FOR SECURED OR UNSECURED TELECOMMUNICATION SERVICES, NAMELY, TRANSMISSION AND DELIVERY OF DIGITAL DATA, LIGHT FILES, SOUND FILES, DATA, INFORMATION AND IMAGE SIGNALS BY MEANS OF COMPUTER, CABLE RADIO AND SATELLITE, TRANSMISSIONS, ALL IN PARTICULAR FOR NAVIGATION SYSTEMS, ROUTE PLANNERS, AND THE USE OF ELECTRONIC MAPS; WIRELESS TRANSMISSION OF DATA, BY MEANS OF VIDEO-TEXT, THE INTERNET, GSM AND WAP; WIRELESS TRANSMISSION OF DIGITAL DATA; ELECTRONIC TRANSMISSION OF DATA AND DOCUMENTS VIA COMPUTER TERMINALS; RENTAL OF TELECOMMUNICATION EQUIPMENT; TECHNICAL CONSULTATION IN CONNECTION WITH ALL OF THE ABOVE (U.S. CLS. 100, 101 AND 104).

CLASS 39—TRANSPORTATION AND STORAGE

FOR SECURED OR UNSECURED TELECOMMUNICATION SERVICES, NAMELY, ELECTRONIC STORAGE OF DIGITAL DATA, LIGHT FILES, SOUND FILES, DATA, INFORMATION AND IMAGE SIGNALS, ALL IN PARTICULAR FOR NAVIGATION SYSTEMS, ROUTE PLANNERS AND THE USE OF ELECTRONIC MAPS; PROVIDING NAVIGATION AND INFORMATION SERVICES, NAMELY, INFORMATION REGARDING TRAFFIC AND TRAFFIC CONGESTION; PROVISION OF INFORMATION REGARDING TRAVEL; PROVISION OF INFORMATION TO TRAVELLERS REGARDING FARES, TIME TABLES AND MEANS OF PUBLIC TRANSPORT; SERVICES OF A TRAVEL AGENCY, NAMELY, THE BOOKING OF RENTAL SERVICES OF CARS, BOATS AND OTHER VEHICLES; ALL OF THE AFORESAID SERVICES ALSO PROVIDED VIA A COMMUNICATIONS NETWORK OR A MOBILE TELEPHONE OR A WIRELESS NAVIGATION DEVICE (U.S. CLS. 100 AND 105).

CLASS 41—EDUCATION AND ENTERTAINMENT

FOR EDUCATION SERVICES, NAMELY, PROVIDING CLASSES AND SEMINARS REGARDING THE USE OF NAVIGATION SYSTEMS; TRAINING SERVICES IN THE FIELD OF NAVIGATION SYSTEMS (U.S. CLS. 100, 101 AND 107).

CLASS 42—SCIENTIFIC AND COMPUTER SERVICES

FOR CONSULTATION IN THE FIELD OF COMPUTER SOFTWARE DESIGN; PROVIDING TEMPORARY USE OF NON-DOWNLOADABLE SOFTWARE WHICH PROVIDES GEOGRAPHICAL, MAP IMAGE AND TRIP ROUTING DATA OBTAINED WITH THE AID OF A GLOBAL POSITIONING SYSTEM (GPS) IN ORDER TO ENABLE THIRD PARTIES TO COME TO AN ACCURATE LOCATION OR ORIENTATION; DEVELOPMENT AND DESIGN OF NAVIGATION SYSTEMS, ROUTE PLANNERS, ELECTRONIC MAPS AND DIGITAL DICTIONARIES; COMPUTER SOFTWARE AND HARDWARE DESIGN; DEVELOPMENT AND DESIGN OF SOFTWARE FOR USE WITH NAVIGATION SYSTEMS, ROUTE PLANNERS AND THE USE OF ELECTRONIC MAPS AND DIGITAL DICTIONARIES; DEVELOPMENT AND DESIGN OF TELECOMMUNICATION AND DATA COMMUNICATION SERVICES AND NETWORKS (U.S. CLS. 100 AND 101).

CLASS 45—PERSONAL AND LEGAL SERVICES

FOR SECURITY SERVICES FOR THE PROTECTION OF PROPERTY AND INDIVIDUALS, NAMELY, THE TRACKING AND TRACING OF GOODS AND INDIVIDUALS IN THE CONTEXT OF SECURITY (U.S. CLS. 100 AND 101).

LA TONIA FISHER, EXAMINING ATTORNEY

SN 77-167,195. TOMTOM INTERNATIONAL B.V., AMSTERDAM, NETHERLANDS, FILED 4-27-2007.

TomTom One Next

THE MARK CONSISTS OF STANDARD CHARACTERS WITHOUT CLAIM TO ANY PARTICULAR FONT, STYLE, SIZE, OR COLOR.

CLASS 9—ELECTRICAL AND SCIENTIFIC APPARATUS

FOR COMPUTER HARDWARE AND SOFTWARE TO BE USED WITH SATELLITE AND/OR GPS NAVIGATION SYSTEMS FOR NAVIGATION PURPOSES; COMPUTER SOFTWARE TO BE USED WITH ROUTE PLANNERS, ELECTRONIC MAPS, AND DIGITAL DICTIONARIES FOR NAVIGATION AND TRANSLATION PURPOSES; SOFTWARE FOR TRAVEL INFORMATION SYSTEMS FOR THE PROVISION OR RENDERING OF TRAVEL ADVICE AND/OR INFORMATION CONCERNING SERVICE STATIONS, CAR PARKS, RESTAURANTS, CAR DEALERS AND OTHER TRAVEL AND TRANSPORT RELATED INFORMATION; SOFTWARE FOR INFORMATION MANAGEMENT FOR THE TRANSPORT AND TRAFFIC INDUSTRIES; SOFTWARE TO BE USED FOR VIEWING ELECTRONIC MAPS; DOWNLOADABLE ELECTRONIC MAPS; SOFTWARE FOR OPERATING ROUTE PLANNERS; ROUTE PLANNERS IN THE NATURE OF HANDHELD PERSONAL COMPUTERS; SOFTWARE FOR OPERATING ELECTRONIC DIGITAL DICTIONARIES; ELECTRONIC DICTIONARIES; LOCATION, ORIENTATION AND NAVIGATION, AND GLOBAL POSITIONING SYSTEMS (GPS) CONSISTING OF COMPUTERS, COMPUTER SOFTWARE, TRANSMITTERS, GPS AND/OR SATELLITE RECEIVERS, NETWORK INTERFACE DEVICES, CONNECTION CABLES, AND PARTS AND FITTINGS THEREOF; HOLDERS FOR POCKET PERSONAL COMPUTERS; SATELLITE AND RADIO TRANSMISSION APPARATUS TECHNOLOGY, NAMELY, PROCESSORS, MOBILE TELEPHONES AND RECEIVERS; TELECOMMUNICATIONS INSTALLATIONS, NETWORKS AND APPARATUS, NAMELY, MOUNTING RACKS FOR TELECOMMUNICATIONS HARDWARE, TELECOMMUNICATION SWITCHES; COMPUTER TERMINALS, ALL IN PARTICULAR TO BE USED WITH NAVIGATION SYSTEMS, ROUTE PLANNERS AND/OR DIGITAL MAPS; BLANK MAGNETIC AND DISC SHAPED DATA CARRIERS; AUDIO AND VIDEO APPARATUS, NAMELY, AUDIO AND VIDEO RECEIVERS AND PROCESSORS; HANDHELD PERSONAL COMPUTERS; PERSONAL DIGITAL ASSISTANTS (U.S. CLS. 21, 23, 26, 36 AND 38).

CLASS 38—COMMUNICATION

FOR SECURED OR UNSECURED TELECOMMUNICATION SERVICES, NAMELY, TRANSMISSION AND DELIVERY OF DIGITAL DATA, LIGHT FILES, SOUND FILES, DATA, INFORMATION AND IMAGE SIGNALS BY MEANS OF COMPUTER, CABLE RADIO AND SATELLITE, TRANSMISSIONS, ALL IN PARTICULAR FOR NAVIGATION SYSTEMS, ROUTE PLANNERS, AND THE USE OF ELECTRONIC MAPS; WIRELESS TRANSMISSION OF DATA, BY MEANS OF VIDEO-TEXT, THE INTERNET, GSM AND WAP; WIRELESS TRANSMISSION OF DIGITAL DATA; ELECTRONIC TRANSMISSION OF DATA AND DOCUMENTS VIA COMPUTER TERMINALS; RENTAL OF TELECOMMUNICATION EQUIPMENT; TECHNICAL CONSULTATION IN CONNECTION WITH ALL OF THE ABOVE (U.S. CLS. 100, 101 AND 104).

CLASS 39—TRANSPORTATION AND STORAGE

FOR SECURED OR UNSECURED TELECOMMUNICATION SERVICES, NAMELY, ELECTRONIC STORAGE OF DIGITAL DATA, LIGHT FILES, SOUND FILES, DATA, INFORMATION AND IMAGE SIGNALS, ALL IN PARTICULAR FOR NAVIGATION SYSTEMS, ROUTE PLANNERS AND THE USE OF ELECTRONIC MAPS; PROVIDING NAVIGATION AND INFORMATION SERVICES, NAMELY, INFORMATION REGARDING TRAFFIC AND TRAFFIC CONGESTION; PROVISION OF INFORMATION REGARDING TRAVEL; PROVISION OF INFORMATION TO TRAVELLERS REGARDING FARES, TIME TABLES AND MEANS OF PUBLIC TRANSPORT; SERVICES OF A TRAVEL AGENCY, NAMELY, THE BOOKING OF RENTAL SERVICES OF CARS, BOATS AND OTHER VEHICLES; ALL OF THE AFORESAID SERVICES ALSO PROVIDED VIA A COMMUNICATIONS NETWORK OR A MOBILE TELEPHONE OR A WIRELESS NAVIGATION DEVICE (U.S. CLS. 100 AND 105).

CLASS 41—EDUCATION AND ENTERTAINMENT

FOR EDUCATION SERVICES, NAMELY, PROVIDING CLASSES AND SEMINARS REGARDING THE USE OF NAVIGATION SYSTEMS; TRAINING SERVICES IN THE FIELD OF NAVIGATION SYSTEMS; ENTERTAINMENT, NAMELY, THE PRODUCTION OF RADIO PROGRAMS AND TELEVISION PROGRAMS; ORGANIZING COMMUNITY CULTURAL ACTIVITIES AND SPORTING ACTIVITIES (U.S. CLS. 100, 101 AND 107).

CLASS 42—SCIENTIFIC AND COMPUTER SERVICES

FOR CONSULTATION IN THE FIELD OF COMPUTER SOFTWARE DESIGN; PROVIDING TEMPORARY USE OF NON-DOWNLOADABLE SOFTWARE WHICH PROVIDES GEOGRAPHICAL, MAP IMAGE AND TRIP ROUTING DATA OBTAINED WITH THE AID OF A GLOBAL POSITIONING SYSTEM (GPS) IN ORDER TO ENABLE THIRD PARTIES TO COME TO AN ACCURATE LOCATION OR ORIENTATION; DEVELOPMENT AND DESIGN OF NAVIGATION SYSTEMS, ROUTE PLANNERS, ELECTRONIC MAPS AND DIGITAL DICTIONARIES; COMPUTER SOFTWARE AND HARDWARE DESIGN; DEVELOPMENT AND DESIGN OF SOFTWARE FOR USE WITH NAVIGATION SYSTEMS, ROUTE PLANNERS AND THE USE OF ELECTRONIC MAPS AND DIGITAL DICTIONARIES; DEVELOPMENT AND DESIGN OF TELECOMMUNICATION AND DATA COMMUNICATION SERVICES AND NETWORKS (U.S. CLS. 100 AND 101).

CLASS 45—PERSONAL AND LEGAL SERVICES

FOR SECURITY SERVICES FOR THE PROTECTION OF PROPERTY AND INDIVIDUALS, NAMELY, THE TRACKING AND TRACING OF GOODS AND INDIVIDUALS IN THE CONTEXT OF SECURITY (U.S. CLS. 100 AND 101).

LA TONIA FISHER, EXAMINING ATTORNEY

SN 77-167,285. THE PARKINSON ALLIANCE, KINGSTON, NJ. FILED 4-27-2007.

THE PARKINSON ALLIANCE

THE MARK CONSISTS OF STANDARD CHARACTERS WITHOUT CLAIM TO ANY PARTICULAR FONT, STYLE, SIZE, OR COLOR.

NO CLAIM IS MADE TO THE EXCLUSIVE RIGHT TO USE "PARKINSON", APART FROM THE MARK AS SHOWN.

CLASS 16—PAPER GOODS AND PRINTED MATTER

FOR PRINTED PUBLICATIONS, NAMELY, PAMPHLETS AND NEWSLETTERS ABOUT PARKINSON'S DISEASE (U.S. CLS. 2, 5, 22, 23, 29, 37, 38 AND 50).

FIRST USE 1-0-2000; IN COMMERCE 1-0-2000.

CLASS 25—CLOTHING

FOR CLOTHING, NAMELY, SHIRTS (U.S. CLS. 22 AND 39).

FIRST USE 1-0-2000; IN COMMERCE 1-0-2000.

CLASS 36—INSURANCE AND FINANCIAL

FOR CHARITABLE FUNDRAISING SERVICES FOR PARKINSON'S DISEASE RESEARCH; PROVIDING GRANTS TO ORGANIZATIONS AND RESEARCH INSTITUTIONS (U.S. CLS. 100, 101 AND 102).

FIRST USE 1-0-2000; IN COMMERCE 1-0-2000.

CLASS 41—EDUCATION AND ENTERTAINMENT

FOR PROVIDING ON-LINE PUBLICATIONS IN THE NATURE OF ELECTRONIC NEWSLETTERS IN THE FIELD OF PARKINSON'S DISEASE (U.S. CLS. 100, 101 AND 107).

FIRST USE 1-0-2000; IN COMMERCE 1-0-2000.
JAMES LOVELACE, EXAMINING ATTORNEY

CLASS 38—COMMUNICATION

FOR SECURED OR UNSECURED TELECOMMUNICATION SERVICES, NAMELY, TRANSMISSION AND DELIVERY OF DIGITAL DATA, LIGHT FILES, SOUND FILES, DATA, INFORMATION AND IMAGE SIGNALS BY MEANS OF COMPUTER, CABLE RADIO AND SATELLITE, TRANSMISSIONS, ALL IN PARTICULAR FOR NAVIGATION SYSTEMS, ROUTE PLANNERS, AND THE USE OF ELECTRONIC MAPS; WIRELESS TRANSMISSION OF DATA, BY MEANS OF VIDEO-TEXT, THE INTERNET, GSM AND WAP; WIRELESS TRANSMISSION OF DIGITAL DATA; ELECTRONIC TRANSMISSION OF DATA AND DOCUMENTS VIA COMPUTER TERMINALS; RENTAL OF TELECOMMUNICATION EQUIPMENT; TECHNICAL CONSULTATION IN CONNECTION WITH ALL OF THE ABOVE (U.S. CLS. 100, 101 AND 104).

SN 77-167,294. TOMTOM INTERNATIONAL, AMSTERDAM, NETHERLANDS, FILED 4-27-2007.

TomTom One X

THE MARK CONSISTS OF STANDARD CHARACTERS WITHOUT CLAIM TO ANY PARTICULAR FONT, STYLE, SIZE, OR COLOR.

CLASS 9—ELECTRICAL AND SCIENTIFIC APPARATUS

FOR COMPUTER HARDWARE AND SOFTWARE TO BE USED WITH SATELLITE AND/OR GPS NAVIGATION SYSTEMS FOR NAVIGATION PURPOSES; COMPUTER SOFTWARE TO BE USED WITH ROUTE PLANNERS, ELECTRONIC MAPS, AND DIGITAL DICTIONARIES FOR NAVIGATION AND TRANSLATION PURPOSES; SOFTWARE FOR TRAVEL INFORMATION SYSTEMS FOR THE PROVISION OR RENDERING OF TRAVEL ADVICE AND/OR INFORMATION CONCERNING SERVICE STATIONS, CAR PARKS, RESTAURANTS, CAR DEALERS AND OTHER TRAVEL AND TRANSPORT RELATED INFORMATION; SOFTWARE FOR INFORMATION MANAGEMENT FOR THE TRANSPORT AND TRAFFIC INDUSTRIES; SOFTWARE TO BE USED FOR VIEWING ELECTRONIC MAPS; DOWNLOADABLE ELECTRONIC MAPS; SOFTWARE FOR OPERATING ROUTE PLANNERS; ROUTE PLANNERS IN THE NATURE OF HANDHELD PERSONAL COMPUTERS; SOFTWARE FOR OPERATING ELECTRONIC DIGITAL DICTIONARIES; ELECTRONIC DICTIONARIES; LOCATION, ORIENTATION AND NAVIGATION, AND GLOBAL POSITIONING SYSTEMS (GPS) CONSISTING OF COMPUTERS, COMPUTER SOFTWARE, TRANSMITTERS, GPS AND/OR SATELLITE RECEIVERS, NETWORK INTERFACE DEVICES, CONNECTION CABLES, AND PARTS AND FITTINGS THEREOF; HOLDERS FOR POCKET PERSONAL COMPUTERS; SATELLITE AND RADIO TRANSMISSION APPARATUS TECHNOLOGY, NAMELY, PROCESSORS, MOBILE TELEPHONES AND RECEIVERS; TELECOMMUNICATIONS INSTALLATIONS, NETWORKS AND APPARATUS, NAMELY, MOUNTING RACKS FOR TELECOMMUNICATIONS HARDWARE, TELECOMMUNICATION SWITCHES; COMPUTER TERMINALS, ALL IN PARTICULAR TO BE USED WITH NAVIGATION SYSTEMS, ROUTE PLANNERS AND/OR DIGITAL MAPS; BLANK MAGNETIC AND DISC SHAPED DATA CARRIERS; AUDIO AND VIDEO APPARATUS, NAMELY, AUDIO AND VIDEO RECEIVERS AND PROCESSORS; HANDHELD PERSONAL COMPUTERS; PERSONAL DIGITAL ASSISTANTS (U.S. CLS. 21, 23, 26, 36 AND 38).

CLASS 39—TRANSPORTATION AND STORAGE

FOR SECURED OR UNSECURED TELECOMMUNICATION SERVICES, NAMELY, ELECTRONIC STORAGE OF DIGITAL DATA, LIGHT FILES, SOUND FILES, DATA, INFORMATION AND IMAGE SIGNALS, ALL IN PARTICULAR FOR NAVIGATION SYSTEMS, ROUTE PLANNERS AND THE USE OF ELECTRONIC MAPS; PROVIDING NAVIGATION AND INFORMATION SERVICES, NAMELY, INFORMATION REGARDING TRAFFIC AND TRAFFIC CONGESTION; PROVISION OF INFORMATION REGARDING TRAVEL; PROVISION OF INFORMATION TO TRAVELLERS REGARDING FARES, TIME TABLES AND MEANS OF PUBLIC TRANSPORT; SERVICES OF A TRAVEL AGENCY, NAMELY, THE BOOKING OF RENTAL SERVICES OF CARS, BOATS AND OTHER VEHICLES; ALL OF THE AFORESAID SERVICES ALSO PROVIDED VIA A COMMUNICATIONS NETWORK OR A MOBILE TELEPHONE OR A WIRELESS NAVIGATION DEVICE (U.S. CLS. 100 AND 105).

CLASS 41—EDUCATION AND ENTERTAINMENT

FOR EDUCATION SERVICES, NAMELY, PROVIDING CLASSES AND SEMINARS REGARDING THE USE OF NAVIGATION SYSTEMS; TRAINING SERVICES IN THE FIELD OF NAVIGATION SYSTEMS; ENTERTAINMENT, NAMELY, THE PRODUCTION OF RADIO PROGRAMS AND TELEVISION PROGRAMS; ORGANIZING COMMUNITY CULTURAL ACTIVITIES AND SPORTING ACTIVITIES (U.S. CLS. 100, 101 AND 107).

CLASS 42—SCIENTIFIC AND COMPUTER SERVICES

FOR CONSULTATION IN THE FIELD OF COMPUTER SOFTWARE DESIGN; PROVIDING TEMPORARY USE OF NON-DOWNLOADABLE SOFTWARE WHICH PROVIDES GEOGRAPHICAL, MAP IMAGE AND TRIP ROUTING DATA OBTAINED WITH THE AID OF A GLOBAL POSITIONING SYSTEM (GPS) IN ORDER TO ENABLE THIRD PARTIES TO COME TO AN ACCURATE LOCATION OR ORIENTATION; DEVELOPMENT AND DESIGN OF NAVIGATION SYSTEMS, ROUTE PLANNERS, ELECTRONIC MAPS AND DIGITAL DICTIONARIES; COMPUTER SOFTWARE AND HARDWARE DESIGN; DEVELOPMENT AND DESIGN OF SOFTWARE FOR USE WITH NAVIGATION SYSTEMS, ROUTE PLANNERS AND THE USE OF ELECTRONIC MAPS AND DIGITAL DICTIONARIES; DEVELOPMENT AND DESIGN OF TELECOMMUNICATION AND DATA COMMUNICATION SERVICES AND NETWORKS (U.S. CLS. 100 AND 101).

CLASS 45—PERSONAL AND LEGAL SERVICES

FOR SECURITY SERVICES FOR THE PROTECTION OF PROPERTY AND INDIVIDUALS, NAMELY, THE TRACKING AND TRACING OF GOODS AND INDIVIDUALS IN THE CONTEXT OF SECURITY (U.S. CLS. 100 AND 101).

LA TONIA FISHER, EXAMINING ATTORNEY

CLASS 38—COMMUNICATION

FOR SECURED OR UNSECURED TELECOMMUNICATION SERVICES, NAMELY, TRANSMISSION AND DELIVERY OF DIGITAL DATA, LIGHT FILES, SOUND FILES, DATA, INFORMATION AND IMAGE SIGNALS BY MEANS OF COMPUTER, CABLE RADIO AND SATELLITE, TRANSMISSIONS, ALL IN PARTICULAR FOR NAVIGATION SYSTEMS, ROUTE PLANNERS, AND THE USE OF ELECTRONIC MAPS; WIRELESS TRANSMISSION OF DATA, BY MEANS OF VIDEO-TEXT, THE INTERNET, GSM AND WAP; WIRELESS TRANSMISSION OF DIGITAL DATA; ELECTRONIC TRANSMISSION OF DATA AND DOCUMENTS VIA COMPUTER TERMINALS; RENTAL OF TELECOMMUNICATION EQUIPMENT; TECHNICAL CONSULTATION IN CONNECTION WITH ALL OF THE ABOVE (U.S. CLS. 100, 101 AND 104).

SN 77-167,345. TOMTOM INTERNATIONAL B.V., AMSTERDAM, NETHERLANDS, FILED 4-27-2007.

CLASS 39—TRANSPORTATION AND STORAGE

FOR SECURED OR UNSECURED TELECOMMUNICATION SERVICES, NAMELY, ELECTRONIC STORAGE OF DIGITAL DATA, LIGHT FILES, SOUND FILES, DATA, INFORMATION AND IMAGE SIGNALS, ALL IN PARTICULAR FOR NAVIGATION SYSTEMS, ROUTE PLANNERS AND THE USE OF ELECTRONIC MAPS; PROVIDING NAVIGATION AND INFORMATION SERVICES, NAMELY, INFORMATION REGARDING TRAFFIC AND TRAFFIC CONGESTION; PROVISION OF INFORMATION REGARDING TRAVEL; PROVISION OF INFORMATION TO TRAVELLERS REGARDING FARES, TIME TABLES AND MEANS OF PUBLIC TRANSPORT; SERVICES OF A TRAVEL AGENCY, NAMELY, THE BOOKING OF RENTAL SERVICES OF CARS, BOATS AND OTHER VEHICLES; ALL OF THE AFORESAID SERVICES ALSO PROVIDED VIA A COMMUNICATIONS NETWORK OR A MOBILE TELEPHONE OR A WIRELESS NAVIGATION DEVICE (U.S. CLS. 100 AND 105).

TomTom One Regular

THE MARK CONSISTS OF STANDARD CHARACTERS WITHOUT CLAIM TO ANY PARTICULAR FONT, STYLE, SIZE, OR COLOR.

CLASS 9—ELECTRICAL AND SCIENTIFIC APPARATUS

FOR COMPUTER HARDWARE AND SOFTWARE TO BE USED WITH SATELLITE AND/OR GPS NAVIGATION SYSTEMS FOR NAVIGATION PURPOSES; COMPUTER SOFTWARE TO BE USED WITH ROUTE PLANNERS, ELECTRONIC MAPS, AND DIGITAL DICTIONARIES FOR NAVIGATION AND TRANSLATION PURPOSES; SOFTWARE FOR TRAVEL INFORMATION SYSTEMS FOR THE PROVISION OR RENDERING OF TRAVEL ADVICE AND/OR INFORMATION CONCERNING SERVICE STATIONS, CAR PARKS, RESTAURANTS, CAR DEALERS AND OTHER TRAVEL AND TRANSPORT RELATED INFORMATION; SOFTWARE FOR INFORMATION MANAGEMENT FOR THE TRANSPORT AND TRAFFIC INDUSTRIES; SOFTWARE TO BE USED FOR VIEWING ELECTRONIC MAPS; DOWNLOADABLE ELECTRONIC MAPS; SOFTWARE FOR OPERATING ROUTE PLANNERS; ROUTE PLANNERS IN THE NATURE OF HANDHELD PERSONAL COMPUTERS; SOFTWARE FOR OPERATING ELECTRONIC DIGITAL DICTIONARIES; ELECTRONIC DICTIONARIES; LOCATION, ORIENTATION AND NAVIGATION, AND GLOBAL POSITIONING SYSTEMS (GPS) CONSISTING OF COMPUTERS, COMPUTER SOFTWARE, TRANSMITTERS, GPS AND/OR SATELLITE RECEIVERS, NETWORK INTERFACE DEVICES, CONNECTION CABLES, AND PARTS AND FITTINGS THEREOF; HOLDERS FOR POCKET PERSONAL COMPUTERS; SATELLITE AND RADIO TRANSMISSION APPARATUS TECHNOLOGY, NAMELY, PROCESSORS, MOBILE TELEPHONES AND RECEIVERS; TELECOMMUNICATIONS INSTALLATIONS, NETWORKS AND APPARATUS, NAMELY, MOUNTING RACKS FOR TELECOMMUNICATIONS HARDWARE, TELECOMMUNICATION SWITCHES; COMPUTER TERMINALS, ALL IN PARTICULAR TO BE USED WITH NAVIGATION SYSTEMS, ROUTE PLANNERS AND/OR DIGITAL MAPS; BLANK MAGNETIC AND DISC SHAPED DATA CARRIERS; AUDIO AND VIDEO APPARATUS, NAMELY, AUDIO AND VIDEO RECEIVERS AND PROCESSORS; HANDHELD PERSONAL COMPUTERS; PERSONAL DIGITAL ASSISTANTS (U.S. CLS. 21, 23, 26, 36 AND 38).

CLASS 41—EDUCATION AND ENTERTAINMENT

FOR EDUCATION SERVICES, NAMELY, PROVIDING CLASSES AND SEMINARS REGARDING THE USE OF NAVIGATION SYSTEMS; TRAINING SERVICES IN THE FIELD OF NAVIGATION SYSTEMS (U.S. CLS. 100, 101 AND 107).

CLASS 42—SCIENTIFIC AND COMPUTER SERVICES

FOR CONSULTATION IN THE FIELD OF COMPUTER SOFTWARE DESIGN; PROVIDING TEMPORARY USE OF NON-DOWNLOADABLE SOFTWARE WHICH PROVIDES GEOGRAPHICAL, MAP IMAGE AND TRIP ROUTING DATA OBTAINED WITH THE AID OF A GLOBAL POSITIONING SYSTEM (GPS) IN ORDER TO ENABLE THIRD PARTIES TO COME TO AN ACCURATE LOCATION OR ORIENTATION; DEVELOPMENT AND DESIGN OF NAVIGATION SYSTEMS, ROUTE PLANNERS, ELECTRONIC MAPS AND DIGITAL DICTIONARIES; COMPUTER SOFTWARE AND HARDWARE DESIGN; DEVELOPMENT AND DESIGN OF SOFTWARE FOR USE WITH NAVIGATION SYSTEMS, ROUTE PLANNERS AND THE USE OF ELECTRONIC MAPS AND DIGITAL DICTIONARIES; DEVELOPMENT AND DESIGN OF TELECOMMUNICATION AND DATA COMMUNICATION SERVICES AND NETWORKS (U.S. CLS. 100 AND 101).

CLASS 45—PERSONAL AND LEGAL SERVICES

FOR SECURITY SERVICES FOR THE PROTECTION OF PROPERTY AND INDIVIDUALS, NAMELY, THE TRACKING AND TRACING OF GOODS AND INDIVIDUALS IN THE CONTEXT OF SECURITY (U.S. CLS. 100 AND 101).

LA TONIA FISHER, EXAMINING ATTORNEY

SN 77-167,542. WORLD KUK SOOL ASSOCIATION, INC.,
TOMBALL, TX. FILED 4-27-2007.

SN 77-167,686. WILSON LANGUAGE TRAINING COR-
PORATION, NEWBURYPORT, MA. FILED 4-27-2007.



OWNER OF U.S. REG. NO. 1,234,948.
NO CLAIM IS MADE TO THE EXCLUSIVE RIGHT TO
USE THE NON-LATIN CHARACTER THAT TRANSLITE-
RATES INTO "WON" WHICH MEANS "INSTITUTE",
APART FROM THE MARK AS SHOWN.

THE MARK CONSISTS OF A PENTAGON WITH SCAL-
LOPED EDGES, WITHIN WHICH IS STYLIZED FIST
HOLDING A HORIZONTAL BAR SURROUNDED BY
TWO STYLIZED SWORDS BEGINNING BELOW THE FIST
AND CURVING UPWARD AND AROUND THE FIST ON
EACH SIDE. DIRECTLY BELOW THE FIST AND BETWEEN
THE SWORD HANDLES IS A BOX CONTAINING THREE
KOREAN LANGUAGE SYMBOLS: KUK; SOOL; AND WON.

THE NON-LATIN CHARACTER(S) IN THE MARK
TRANSLITERATES INTO KUK SOOL WON, AND THIS
MEANS COUNTRY SKILL INSTITUTE IN ENGLISH.

CLASS 16—PAPER GOODS AND PRINTED MATTER

FOR PRINTED GOODS, NAMELY, MEMBERSHIP
CARDS, EVALUATION FORMS, PRINTED PERFOR-
MANCE CERTIFICATES, PAMPHLETS IN THE FIELD
OF MARTIAL ARTS INSTRUCTION, PRINTED SIGNS
AND POSTERS OF PAPER; PRINTED SIGNS AND
POSTERS OF CARDBOARD (U.S. CLS. 2, 5, 22, 23, 29,
37, 38 AND 50).

FIRST USE 3-31-1961; IN COMMERCE 9-18-1974.

CLASS 25—CLOTHING

FOR CLOTHING, NAMELY, MARTIAL ARTS UNI-
FORMS, T-SHIRTS, VESTS, HEADBANDS AND BELTS
(U.S. CLS. 22 AND 39).

FIRST USE 3-31-1961; IN COMMERCE 9-18-1974.
THOMAS MANOR, EXAMINING ATTORNEY

WILSON

THE MARK CONSISTS OF STANDARD CHARACTERS
WITHOUT CLAIM TO ANY PARTICULAR FONT, STYLE,
SIZE, OR COLOR.

OWNER OF U.S. REG. NOS. 2,421,243, 2,421,269 AND
2,465,340.
SEC. 2(F).

CLASS 9—ELECTRICAL AND SCIENTIFIC APPARATUS

FOR PRERECORDED VIDEO TAPES FEATURING
READING, WRITING AND SPELLING INSTRUCTION;
COMPUTER SOFTWARE FOR USE IN INSTRUCTING
STUDENTS ON HOW TO READ, WRITE AND SPELL;
COMPUTER SOFTWARE FOR USE IN TEACHING
READING, WRITING AND SPELLING. FOR USE IN
INSTRUCTING STUDENTS ON HOW TO READ, WRITE
AND SPELL AND FOR USE IN TEACHING READING,
WRITING AND SPELLING (U.S. CLS. 21, 23, 26, 36 AND
38).

FIRST USE 1-1-1989; IN COMMERCE 1-1-1989.

CLASS 16—PAPER GOODS AND PRINTED MATTER

FOR INSTRUCTIONAL EDUCATIONAL BOOKS IN
THE FIELD OF READING, WRITING AND SPELLING;
INSTRUCTOR'S MANUALS FOR USE IN THE IN-
STRUCTION OF STUDENTS ON READING, WRITING
AND SPELLING; PRINTED TEACHING MATERIALS
FOR USE IN TEACHING READING, WRITING AND
SPELLING; AND WORKBOOKS FOR USE IN TEACH-
ING AND LEARNING READING, WRITING AND
SPELLING (U.S. CLS. 2, 5, 22, 23, 29, 37, 38 AND 50).

FIRST USE 1-1-1989; IN COMMERCE 1-1-1989.

CLASS 41—EDUCATION AND ENTERTAIN- MENT

FOR EDUCATIONAL SERVICES, NAMELY, CON-
DUCTING TRAINING CLASSES, SEMINARS, CONFER-
ENCES AND WORKSHOPS IN THE FIELD OF HOW TO
INSTRUCT STUDENTS WHO HAVE LEARNING DIFFI-
CULTIES IN READING, WRITING AND SPELLING
AND DISTRIBUTING COURSE MATERIALS IN CON-
NECTION THEREWITH; EDUCATIONAL SERVICES,
NAMELY, TEACHING READING AND WRITING AND
DISTRIBUTING COURSE MATERIALS IN CONNec-
TION THEREWITH (U.S. CLS. 100, 101 AND 107).

FIRST USE 1-1-1989; IN COMMERCE 1-1-1989.
MICHAEL SOUDERS, EXAMINING ATTORNEY

SN 77-167,719. WILSON LANGUAGE TRAINING CORPORATION, NEWBURYPORT, MA. FILED 4-27-2007.

SN 77-167,757. WILSON LANGUAGE TRAINING CORPORATION, NEWBURYPORT, MA. FILED 4-27-2007.

WILSON Academy

Wilson works.

OWNER OF U.S. REG. NOS. 2,421,243, 2,421,269 AND 2,465,340.

NO CLAIM IS MADE TO THE EXCLUSIVE RIGHT TO USE "ACADEMY", APART FROM THE MARK AS SHOWN. SEC. 2(F).

CLASS 9—ELECTRICAL AND SCIENTIFIC APPARATUS

FOR PRERECORDED VIDEO TAPES FEATURING READING, WRITING AND SPELLING INSTRUCTION; COMPUTER SOFTWARE FOR USE IN INSTRUCTING STUDENTS ON HOW TO READ, WRITE AND SPELL; COMPUTER SOFTWARE FOR USE IN TEACHING READING, WRITING AND SPELLING. FOR USE IN INSTRUCTING STUDENTS ON HOW TO READ, WRITE AND SPELL; AND FOR USE IN TEACHING READING, WRITING AND SPELLING (U.S. CLS. 21, 23, 26, 36 AND 38).

FIRST USE 2-22-2002; IN COMMERCE 2-22-2002.

CLASS 16—PAPER GOODS AND PRINTED MATTER

FOR INSTRUCTIONAL EDUCATIONAL BOOKS IN THE FIELD OF READING, WRITING AND SPELLING; INSTRUCTOR'S MANUALS FOR USE IN THE INSTRUCTION OF STUDENTS ON READING, WRITING AND SPELLING; PRINTED TEACHING MATERIALS FOR USE IN TEACHING READING, WRITING AND SPELLING; AND WORKBOOKS FOR USE IN TEACHING AND LEARNING READING, WRITING AND SPELLING (U.S. CLS. 2, 5, 22, 23, 29, 37, 38 AND 50).

FIRST USE 2-22-2002; IN COMMERCE 2-22-2002.

CLASS 41—EDUCATION AND ENTERTAINMENT

FOR EDUCATIONAL SERVICES, NAMELY, CONDUCTING TRAINING CLASSES, SEMINARS, CONFERENCES AND WORKSHOPS IN THE FIELD OF HOW TO INSTRUCT STUDENTS WHO HAVE LEARNING DIFFICULTIES IN READING, WRITING AND SPELLING AND DISTRIBUTING COURSE MATERIALS IN CONNECTION THEREWITH; EDUCATIONAL SERVICES, NAMELY, TEACHING READING AND WRITING AND DISTRIBUTING COURSE MATERIALS IN CONNECTION THEREWITH (U.S. CLS. 100, 101 AND 107).

FIRST USE 2-22-2002; IN COMMERCE 2-22-2002.

CLASS 42—SCIENTIFIC AND COMPUTER SERVICES

FOR PROVIDING ON-LINE NON-DOWNLOADABLE SOFTWARE FOR READING, WRITING AND SPELLING INSTRUCTION FOR USE IN INSTRUCTING STUDENTS ON HOW TO READ, WRITE AND SPELL AND FOR USE IN TEACHING READING, WRITING AND SPELLING (U.S. CLS. 100 AND 101).

FIRST USE 2-22-2002; IN COMMERCE 2-22-2002.
MICHAEL SOUDERS, EXAMINING ATTORNEY

OWNER OF U.S. REG. NOS. 2,421,243, 2,421,269 AND 2,465,340.

CLASS 9—ELECTRICAL AND SCIENTIFIC APPARATUS

FOR PRERECORDED VIDEO TAPES FEATURING READING, WRITING AND SPELLING INSTRUCTION; COMPUTER SOFTWARE FOR USE IN INSTRUCTING STUDENTS ON HOW TO READ, WRITE AND SPELL; COMPUTER SOFTWARE FOR USE IN TEACHING READING, WRITING AND SPELLING. FOR USE IN INSTRUCTING STUDENTS ON HOW TO READ, WRITE AND SPELL; AND FOR USE IN TEACHING READING, WRITING AND SPELLING (U.S. CLS. 21, 23, 26, 36 AND 38).

FIRST USE 4-24-2003; IN COMMERCE 4-24-2003.

CLASS 16—PAPER GOODS AND PRINTED MATTER

FOR INSTRUCTIONAL EDUCATIONAL BOOKS IN THE FIELD OF READING, WRITING AND SPELLING; INSTRUCTOR'S MANUALS FOR USE IN THE INSTRUCTION OF STUDENTS ON READING, WRITING AND SPELLING; PRINTED TEACHING MATERIALS FOR USE IN TEACHING READING, WRITING AND SPELLING; AND WORKBOOKS FOR USE IN TEACHING AND LEARNING READING, WRITING AND SPELLING (U.S. CLS. 2, 5, 22, 23, 29, 37, 38 AND 50).

FIRST USE 4-24-2003; IN COMMERCE 4-24-2003.
MICHAEL SOUDERS, EXAMINING ATTORNEY

SN 77-167,779. WILSON LANGUAGE TRAINING CORPORATION, NEWBURYPORT, MA. FILED 4-27-2007.

Wilson Cursive

OWNER OF U.S. REG. NOS. 2,421,243, 2,421,269 AND 2,465,340.

NO CLAIM IS MADE TO THE EXCLUSIVE RIGHT TO USE "CURSIVE", APART FROM THE MARK AS SHOWN.

CLASS 9—ELECTRICAL AND SCIENTIFIC APPARATUS

FOR PRERECORDED VIDEO TAPES FEATURING READING, WRITING AND SPELLING INSTRUCTION; COMPUTER SOFTWARE FOR USE IN INSTRUCTING STUDENTS ON HOW TO READ, WRITE AND SPELL; COMPUTER SOFTWARE FOR USE IN TEACHING READING, WRITING AND SPELLING, FOR USE IN INSTRUCTING STUDENTS ON HOW TO READ, WRITE AND SPELL AND FOR USE IN TEACHING READING, WRITING AND SPELLING (U.S. CLS. 21, 23, 26, 36 AND 38).

FIRST USE 9-15-2005; IN COMMERCE 9-15-2005.

CLASS 16—PAPER GOODS AND PRINTED MATTER

FOR INSTRUCTIONAL EDUCATIONAL BOOKS IN THE FIELD OF READING, WRITING AND SPELLING; INSTRUCTOR'S MANUALS FOR USE IN THE INSTRUCTION OF STUDENTS ON READING, WRITING AND SPELLING; PRINTED TEACHING MATERIALS FOR USE IN TEACHING READING, WRITING AND SPELLING; AND WORKBOOKS FOR USE IN TEACHING AND LEARNING READING, WRITING AND SPELLING (U.S. CLS. 2, 5, 22, 23, 29, 37, 38 AND 50).

FIRST USE 9-15-2005; IN COMMERCE 9-15-2005. MICHAEL SOUDERS, EXAMINING ATTORNEY

SN 77-168,090. WALSH, ROSEMARIE A., HUNTINGTON, NY, AND GINNETTY, CAROLE M., SMITHTOWN, NY. FILED 4-27-2007.

C.A.P. ORGANIZER

THE MARK CONSISTS OF STANDARD CHARACTERS WITHOUT CLAIM TO ANY PARTICULAR FONT, STYLE, SIZE, OR COLOR.

NO CLAIM IS MADE TO THE EXCLUSIVE RIGHT TO USE "ORGANIZER", APART FROM THE MARK AS SHOWN.

CLASS 16—PAPER GOODS AND PRINTED MATTER

FOR A PORTABLE EIGHT-POCKET PAPER FOLDER FOR ORGANIZING COLLEGE APPLICATION PROCESS INFORMATION AND MATERIALS (U.S. CLS. 2, 5, 22, 23, 29, 37, 38 AND 50).

CLASS 41—EDUCATION AND ENTERTAINMENT

FOR PROVIDING INFORMATION AND GUIDANCE IN THE COLLEGE APPLICATION PROCESS (U.S. CLS. 100, 101 AND 107).

ANTHONY RINKER, EXAMINING ATTORNEY

SN 77-167,847. WALSH, ROSEMARIE, A., HUNTINGTON, NY, AND GINNETTY, CAROLE M., SMITHTOWN, NY. FILED 4-27-2007.



NO CLAIM IS MADE TO THE EXCLUSIVE RIGHT TO USE "ORGANIZER", APART FROM THE MARK AS SHOWN.

THE MARK CONSISTS OF "C.A.P. ORGANIZER" IN A DIAMOND-SHAPED BOX WITH BORDER ON THE TWO RIGHT-HAND SIDES.

CLASS 16—PAPER GOODS AND PRINTED MATTER

FOR A PORTABLE EIGHT-POCKET PAPER FOLDER FOR ORGANIZING COLLEGE APPLICATION PROCESS INFORMATION AND MATERIALS (U.S. CLS. 2, 5, 22, 23, 29, 37, 38 AND 50).

CLASS 41—EDUCATION AND ENTERTAINMENT

FOR PROVIDING INFORMATION AND GUIDANCE IN THE COLLEGE APPLICATION PROCESS (U.S. CLS. 100, 101 AND 107).

ANTHONY RINKER, EXAMINING ATTORNEY

SN 77-169,068. DL3 REALTY, LP, CHICAGO, IL. FILED 4-30-2007.

DL3 REALTY

THE MARK CONSISTS OF STANDARD CHARACTERS WITHOUT CLAIM TO ANY PARTICULAR FONT, STYLE, SIZE, OR COLOR.

NO CLAIM IS MADE TO THE EXCLUSIVE RIGHT TO USE "REALTY", APART FROM THE MARK AS SHOWN.

CLASS 36—INSURANCE AND FINANCIAL

FOR REAL ESTATE CONSULTATION; REAL ESTATE MANAGEMENT (U.S. CLS. 100, 101 AND 102).

FIRST USE 12-31-1999; IN COMMERCE 12-31-1999.

CLASS 37—CONSTRUCTION AND REPAIR

FOR REAL ESTATE DEVELOPMENT (U.S. CLS. 100, 103 AND 106).

FIRST USE 12-31-1999; IN COMMERCE 12-31-1999. LINDA POWELL, EXAMINING ATTORNEY

SN 77-169,121. ANIMALAND, INC., LAS VEGAS, NV. FILED 4-30-2007.



OWNER OF U.S. REG. NOS. 2,892,994 AND 3,125,446.
NO CLAIM IS MADE TO THE EXCLUSIVE RIGHT TO USE "DRESS YOUR ANIMAL CREATE YOUR OWN COLLECTIBLE STUFFED ANIMAL", APART FROM THE MARK AS SHOWN.

THE MARK CONSISTS OF A CIRCLE WITH THE WORDS "ANIMALAND CREATE YOUR OWN COLLECTIBLE STUFFED ANIMAL" IN STANDARD LETTERS AROUND THE CIRCLE'S CIRCUMFERENCE AND "DRESS YOUR ANIMAL" IN STYLIZED LETTERS IN THE CENTER OF THE CIRCLE.

CLASS 7—MACHINERY

FOR WOOD AND METAL MACHINERY, NAMELY, MACHINE FOR STUFFING PLUSH TOYS AND PLUSH TOY ANIMALS (U.S. CLS. 13, 19, 21, 23, 31, 34 AND 35).
FIRST USE 11-23-2003; IN COMMERCE 4-29-2004.

CLASS 28—TOYS AND SPORTING GOODS

FOR PLUSH TOYS (U.S. CLS. 22, 23, 38 AND 50).
FIRST USE 11-23-2003; IN COMMERCE 4-29-2004.
DAVID I, EXAMINING ATTORNEY

SN 77-169,135. SCOTTISH AMERICAN MEDIA, LLC, VALLEY VILLAGE, CA. FILED 4-30-2007.

BATTLE OF THE STATES

THE MARK CONSISTS OF STANDARD CHARACTERS WITHOUT CLAIM TO ANY PARTICULAR FONT, STYLE, SIZE, OR COLOR.

CLASS 9—ELECTRICAL AND SCIENTIFIC APPARATUS

FOR AUDIO, VIDEO, STILL AND MOVING IMAGES, AND DATA RECORDINGS IN COMPRESSED AND UNCOMPRESSED FORM, NAMELY, PRE-RECORDED AUDIOCASSETTE TAPES, VIDEO TAPES, DVDS, COMPACT DISCS, RECORDS, AND CD-ROMS FEATURING MUSIC, MUSICAL ENTERTAINMENT, DANCE INSTRUCTION, AND DANCE EDUCATION (U.S. CLS. 21, 23, 26, 36 AND 38).

CLASS 41—EDUCATION AND ENTERTAINMENT

FOR ENTERTAINMENT SERVICES, NAMELY, ORGANIZING COMPETITIONS, CONTESTS, GAMES, SHOWS, ROAD SHOWS, STAGE EVENTS, THEATRICAL PERFORMANCES, CONCERTS, LIVE PERFORMANCES, AND AUDIENCE PARTICIPATION BASED EVENTS, PERTAINING TO OR FEATURING INSTRUCTION, ENTERTAINMENT, AND INFORMATION RELATING TO THE FIELDS OF MUSIC AND DANCE; PRODUCTION AND RENTAL OF SOUND AND VIDEO RECORDINGS, AND MOTION PICTURE FILMS; PRODUCTION AND SYNDICATION OF TELEVISION AND RADIO PROGRAMS; PROVIDING ENTERTAINMENT INFORMATION IN THE FIELDS OF MUSIC, DANCE, AND TELEVISION AND RADIO PROGRAMS (U.S. CLS. 100, 101 AND 107).

REBECCA SMITH, EXAMINING ATTORNEY

SN 77-169,325. DEACERO, S.A. DE C.V., SAN PEDRO GARZA GARCIA, MEXICO, FILED 4-30-2007.



OWNER OF U.S. REG. NO. 2,813,762.
NO CLAIM IS MADE TO THE EXCLUSIVE RIGHT TO USE "BEST IN CLASS WARRANTY 10 YEARS" AND "THE INDUSTRY'S ONLY 10 YEAR WARRANTY", APART FROM THE MARK AS SHOWN.

THE MARK CONSISTS OF THE WORDS "WARRANTY 10 YEARS" WITHIN AN ENCLOSURE, THE WORDS "BEST IN CLASS" APPEARING ABOVE, THE WORDS "STAY-TUFF THE INDUSTRY'S ONLY 10 YEAR WARRANTY" IN SPECIAL TYPE LETTERING APPEARING BELOW.

CLASS 6—METAL GOODS

FOR METAL WIRE FENCING, METAL FENCES, METAL FENCE GATES, AND PARTS THEREFORE (U.S. CLS. 2, 12, 13, 14, 23, 25 AND 50).

CLASS 36—INSURANCE AND FINANCIAL

FOR PROVIDING EXTENDED WARRANTIES ON METAL WIRE FENCING, METAL FENCES, METAL FENCE GATES, AND PARTS AND ACCESSORIES THEREFORE (U.S. CLS. 100, 101 AND 102).

RUSS HERMAN, EXAMINING ATTORNEY

SN 77-169,428. SPORTS CONCUSSION INSTITUTE, INC., MARINA DEL REY, CA. FILED 4-30-2007.



THE LIKENESS (OR, "PORTRAITS") IN THE MARK DO NOT IDENTIFY ANY LIVING INDIVIDUALS.

CLASS 41—EDUCATION AND ENTERTAINMENT

FOR EDUCATION SERVICES, NAMELY, PROVIDING SEMINARS IN THE FIELDS OF THE PREVENTION OF CONCUSSIONS AND HEAD INJURIES (U.S. CLS. 100, 101 AND 107).

FIRST USE 0-0-2005; IN COMMERCE 0-0-2005.

CLASS 44—MEDICAL, BEAUTY AND AGRICULTURAL SERVICES

FOR MEDICAL SERVICES (U.S. CLS. 100 AND 101). FIRST USE 0-0-2005; IN COMMERCE 0-0-2005. SIMON TENG, EXAMINING ATTORNEY

SN 77-169,562. TOMTOM INTERNATIONAL B.V., AMSTERDAM, NETHERLANDS, FILED 5-1-2007.

Crowd Sensing

THE MARK CONSISTS OF STANDARD CHARACTERS WITHOUT CLAIM TO ANY PARTICULAR FONT, STYLE, SIZE, OR COLOR.

CLASS 9—ELECTRICAL AND SCIENTIFIC APPARATUS

FOR COMPUTER HARDWARE AND SOFTWARE TO BE USED WITH SATELLITE AND/OR GPS NAVIGATION SYSTEMS FOR NAVIGATION PURPOSES; COMPUTER SOFTWARE TO BE USED WITH ROUTE PLANNERS, ELECTRONIC MAPS, AND DIGITAL DICTIONARIES FOR NAVIGATION AND TRANSLATION PURPOSES; SOFTWARE FOR TRAVEL INFORMATION SYSTEMS FOR THE PROVISION OR RENDERING OF TRAVEL ADVICE AND/OR INFORMATION CONCERNING SERVICE STATIONS, CAR PARKS, RESTAURANTS, CAR DEALERS AND OTHER TRAVEL AND TRANSPORT RELATED INFORMATION; SOFTWARE FOR INFORMATION MANAGEMENT FOR THE TRANSPORT AND TRAFFIC INDUSTRIES; SOFTWARE TO BE USED FOR VIEWING ELECTRONIC MAPS; DOWNLOADABLE ELECTRONIC MAPS; SOFTWARE FOR OPERATING ROUTE PLANNERS; ROUTE PLANNERS IN THE NATURE OF HANDHELD PERSONAL COMPUTERS; SOFTWARE FOR OPERATING ELECTRONIC DIGITAL DICTIONARIES; ELECTRONIC DICTIONARIES; LOCATION, ORIENTATION AND NAVIGATION, AND GLOBAL POSITIONING SYSTEMS (GPS) CONSISTING OF COMPUTERS, COMPUTER SOFTWARE, TRANSMITTERS, GPS AND/OR SATELLITE RECEIVERS, NETWORK INTERFACE DEVICES, CONNECTION CABLES, AND PARTS AND FITTINGS THEREOF; HOLDERS FOR POCKET PERSONAL COMPUTERS; SATELLITE AND RADIO TRANSMISSION APPARATUS TECHNOLOGY, NAMELY, PROCESSORS, MOBILE TELEPHONES AND RECEIVERS; TELECOMMUNICATIONS INSTALLATIONS, NETWORKS AND APPARATUS, NAMELY, MOUNTING RACKS FOR TELECOMMUNICATIONS HARDWARE, TELECOMMUNICATION SWITCHES; COMPUTER TERMINALS, ALL IN PARTICULAR TO BE USED WITH NAVIGATION SYSTEMS, ROUTE PLANNERS AND/OR DIGITAL MAPS; BLANK MAGNETIC AND DISC SHAPED DATA CARRIERS; AUDIO AND VIDEO APPARATUS, NAMELY, AUDIO AND VIDEO RECEIVERS AND PROCESSORS; HANDHELD PERSONAL COMPUTERS; PERSONAL DIGITAL ASSISTANTS (U.S. CLS. 21, 23, 26, 36 AND 38).

CLASS 38—COMMUNICATION

FOR SECURED OR UNSECURED TELECOMMUNICATION SERVICES, NAMELY, TRANSMISSION AND DELIVERY OF DIGITAL DATA, LIGHT FILES, SOUND FILES, DATA, INFORMATION AND IMAGE SIGNALS BY MEANS OF COMPUTER, CABLE RADIO AND SATELLITE, TRANSMISSIONS, ALL IN PARTICULAR FOR NAVIGATION SYSTEMS, ROUTE PLANNERS, AND THE USE OF ELECTRONIC MAPS; WIRELESS TRANSMISSION OF DATA, BY MEANS OF VIDEO-TEXT, THE INTERNET, GSM AND WAP; WIRELESS TRANSMISSION OF DIGITAL DATA; ELECTRONIC TRANSMISSION OF DATA AND DOCUMENTS VIA COMPUTER TERMINALS; RENTAL OF TELECOMMUNICATION EQUIPMENT; TECHNICAL CONSULTATION IN CONNECTION WITH ALL OF THE ABOVE (U.S. CLS. 100, 101 AND 104).

CLASS 39—TRANSPORTATION AND STORAGE

FOR SECURED OR UNSECURED TELECOMMUNICATION SERVICES, NAMELY, ELECTRONIC STORAGE OF DIGITAL DATA, LIGHT FILES, SOUND FILES, DATA, INFORMATION AND IMAGE SIGNALS, ALL IN PARTICULAR FOR NAVIGATION SYSTEMS, ROUTE PLANNERS AND THE USE OF ELECTRONIC MAPS; PROVIDING NAVIGATION AND INFORMATION SERVICES, NAMELY, INFORMATION REGARDING TRAFFIC AND TRAFFIC CONGESTION; PROVISION OF INFORMATION REGARDING TRAVEL; PROVISION OF INFORMATION TO TRAVELLERS REGARDING FARES, TIME TABLES AND MEANS OF PUBLIC TRANSPORT; SERVICES OF A TRAVEL AGENCY, NAMELY, THE BOOKING OF RENTAL SERVICES OF CARS, BOATS AND OTHER VEHICLES; ALL OF THE AFORESAID SERVICES ALSO PROVIDED VIA A COMMUNICATIONS NETWORK OR A MOBILE TELEPHONE OR A WIRELESS NAVIGATION DEVICE (U.S. CLS. 100 AND 105).

CLASS 41—EDUCATION AND ENTERTAINMENT

FOR EDUCATION SERVICES, NAMELY, PROVIDING CLASSES AND SEMINARS REGARDING THE USE OF NAVIGATION SYSTEMS; TRAINING SERVICES IN THE FIELD OF NAVIGATION SYSTEMS (U.S. CLS. 100, 101 AND 107).

CLASS 42—SCIENTIFIC AND COMPUTER SERVICES

FOR CONSULTATION IN THE FIELD OF COMPUTER SOFTWARE DESIGN; PROVIDING TEMPORARY USE OF NON-DOWNLOADABLE SOFTWARE WHICH PROVIDES GEOGRAPHICAL, MAP IMAGE AND TRIP ROUTING DATA OBTAINED WITH THE AID OF A GLOBAL POSITIONING SYSTEM (GPS) IN ORDER TO ENABLE THIRD PARTIES TO COME TO AN ACCURATE LOCATION OR ORIENTATION; DEVELOPMENT AND DESIGN OF NAVIGATION SYSTEMS, ROUTE PLANNERS, ELECTRONIC MAPS AND DIGITAL DICTIONARIES; COMPUTER SOFTWARE AND HARDWARE DESIGN; DEVELOPMENT AND DESIGN OF SOFTWARE FOR USE WITH NAVIGATION SYSTEMS, ROUTE PLANNERS AND THE USE OF ELECTRONIC MAPS AND DIGITAL DICTIONARIES; DEVELOPMENT AND DESIGN OF TELECOMMUNICATION AND DATA COMMUNICATION SERVICES AND NETWORKS (U.S. CLS. 100 AND 101).

CLASS 45—PERSONAL AND LEGAL SERVICES

FOR SECURITY SERVICES FOR THE PROTECTION OF PROPERTY AND INDIVIDUALS, NAMELY, THE TRACKING AND TRACING OF GOODS AND INDIVIDUALS IN THE CONTEXT OF SECURITY (U.S. CLS. 100 AND 101).

LA TONIA FISHER, EXAMINING ATTORNEY

CLASS 9—ELECTRICAL AND SCIENTIFIC APPARATUS

FOR COMPUTER HARDWARE AND SOFTWARE TO BE USED WITH SATELLITE AND/OR GPS NAVIGATION SYSTEMS FOR NAVIGATION PURPOSES; COMPUTER SOFTWARE TO BE USED WITH ROUTE PLANNERS, ELECTRONIC MAPS, AND DIGITAL DICTIONARIES FOR NAVIGATION AND TRANSLATION PURPOSES; SOFTWARE FOR TRAVEL INFORMATION SYSTEMS FOR THE PROVISION OR RENDERING OF TRAVEL ADVICE AND/OR INFORMATION CONCERNING SERVICE STATIONS, CAR PARKS, RESTAURANTS, CAR DEALERS AND OTHER TRAVEL AND TRANSPORT RELATED INFORMATION; SOFTWARE FOR INFORMATION MANAGEMENT FOR THE TRANSPORT AND TRAFFIC INDUSTRIES; SOFTWARE TO BE USED FOR VIEWING ELECTRONIC MAPS; DOWNLOADABLE ELECTRONIC MAPS; SOFTWARE FOR OPERATING ROUTE PLANNERS; ROUTE PLANNERS IN THE NATURE OF HANDHELD PERSONAL COMPUTERS; SOFTWARE FOR OPERATING ELECTRONIC DIGITAL DICTIONARIES; ELECTRONIC DICTIONARIES; LOCATION, ORIENTATION AND NAVIGATION, AND GLOBAL POSITIONING SYSTEMS (GPS) CONSISTING OF COMPUTERS, COMPUTER SOFTWARE, TRANSMITTERS, GPS AND/OR SATELLITE RECEIVERS, NETWORK INTERFACE DEVICES, CONNECTION CABLES, AND PARTS AND FITTINGS THEREOF; HOLDERS FOR POCKET PERSONAL COMPUTERS; SATELLITE AND RADIO TRANSMISSION APPARATUS TECHNOLOGY, NAMELY, PROCESSORS, MOBILE TELEPHONES AND RECEIVERS; TELECOMMUNICATIONS INSTALLATIONS, NETWORKS AND APPARATUS, NAMELY, MOUNTING RACKS FOR TELECOMMUNICATIONS HARDWARE, TELECOMMUNICATION SWITCHES; COMPUTER TERMINALS, ALL IN PARTICULAR TO BE USED WITH NAVIGATION SYSTEMS, ROUTE PLANNERS AND/OR DIGITAL MAPS; BLANK MAGNETIC AND DISC SHAPED DATA CARRIERS; AUDIO AND VIDEO APPARATUS, NAMELY, AUDIO AND VIDEO RECEIVERS AND PROCESSORS; HANDHELD PERSONAL COMPUTERS; PERSONAL DIGITAL ASSISTANTS (U.S. CLS. 21, 23, 26, 36 AND 38).

CLASS 38—COMMUNICATION

FOR SECURED OR UNSECURED TELECOMMUNICATION SERVICES, NAMELY, TRANSMISSION AND DELIVERY OF DIGITAL DATA, LIGHT FILES, SOUND FILES, DATA, INFORMATION AND IMAGE SIGNALS BY MEANS OF COMPUTER, CABLE RADIO AND SATELLITE, TRANSMISSIONS, ALL IN PARTICULAR FOR NAVIGATION SYSTEMS, ROUTE PLANNERS, AND THE USE OF ELECTRONIC MAPS; WIRELESS TRANSMISSION OF DATA, BY MEANS OF VIDEO-TEXT, THE INTERNET, GSM AND WAP; WIRELESS TRANSMISSION OF DIGITAL DATA; ELECTRONIC TRANSMISSION OF DATA AND DOCUMENTS VIA COMPUTER TERMINALS; RENTAL OF TELECOMMUNICATION EQUIPMENT; TECHNICAL CONSULTATION IN CONNECTION WITH ALL OF THE ABOVE (U.S. CLS. 100, 101 AND 104).

CLASS 39—TRANSPORTATION AND STORAGE

FOR SECURED OR UNSECURED TELECOMMUNICATION SERVICES, NAMELY, ELECTRONIC STORAGE OF DIGITAL DATA, LIGHT FILES, SOUND FILES, DATA, INFORMATION AND IMAGE SIGNALS, ALL IN PARTICULAR FOR NAVIGATION SYSTEMS, ROUTE PLANNERS AND THE USE OF ELECTRONIC MAPS; PROVIDING NAVIGATION AND INFORMATION SERVICES, NAMELY, INFORMATION REGARDING TRAFFIC AND TRAFFIC CONGESTION; PROVISION OF INFORMATION REGARDING TRAVEL; PROVISION OF INFORMATION TO TRAVELLERS REGARDING FARES, TIME TABLES AND MEANS OF PUBLIC TRANSPORT; SERVICES OF A TRAVEL AGENCY, NAMELY, THE BOOKING OF RENTAL SERVICES OF CARS, BOATS AND OTHER VEHICLES; ALL OF THE AFORESAID SERVICES ALSO PROVIDED VIA A COMMUNICATIONS NETWORK OR A MOBILE TELEPHONE OR A WIRELESS NAVIGATION DEVICE (U.S. CLS. 100 AND 105).

SN 77-169,676. TOMTOM INTERNATIONAL B.V., AMSTERDAM, NETHERLANDS, FILED 5-1-2007.

TomTom Work

THE MARK CONSISTS OF STANDARD CHARACTERS WITHOUT CLAIM TO ANY PARTICULAR FONT, STYLE, SIZE, OR COLOR.

CLASS 41—EDUCATION AND ENTERTAINMENT

FOR EDUCATION SERVICES, NAMELY, PROVIDING CLASSES AND SEMINARS REGARDING THE USE OF NAVIGATION SYSTEMS; TRAINING SERVICES IN THE FIELD OF NAVIGATION SYSTEMS; ENTERTAINMENT, NAMELY, THE PRODUCTION OF RADIO PROGRAMS AND TELEVISION PROGRAMS; ORGANIZING COMMUNITY CULTURAL ACTIVITIES AND SPORTING ACTIVITIES (U.S. CLS. 100, 101 AND 107).

CLASS 42—SCIENTIFIC AND COMPUTER SERVICES

FOR CONSULTATION IN THE FIELD OF COMPUTER SOFTWARE DESIGN; PROVIDING TEMPORARY USE OF NON-DOWNLOADABLE SOFTWARE WHICH PROVIDES GEOGRAPHICAL, MAP IMAGE AND TRIP ROUTING DATA OBTAINED WITH THE AID OF A GLOBAL POSITIONING SYSTEM (GPS) IN ORDER TO ENABLE THIRD PARTIES TO COME TO AN ACCURATE LOCATION OR ORIENTATION; DEVELOPMENT AND DESIGN OF NAVIGATION SYSTEMS, ROUTE PLANNERS, ELECTRONIC MAPS AND DIGITAL DICTIONARIES; COMPUTER SOFTWARE AND HARDWARE DESIGN; DEVELOPMENT AND DESIGN OF SOFTWARE FOR USE WITH NAVIGATION SYSTEMS, ROUTE PLANNERS AND THE USE OF ELECTRONIC MAPS AND DIGITAL DICTIONARIES; DEVELOPMENT AND DESIGN OF TELECOMMUNICATION AND DATA COMMUNICATION SERVICES AND NETWORKS (U.S. CLS. 100 AND 101).

CLASS 45—PERSONAL AND LEGAL SERVICES

FOR SECURITY SERVICES FOR THE PROTECTION OF PROPERTY AND INDIVIDUALS, NAMELY, THE TRACKING AND TRACING OF GOODS AND INDIVIDUALS IN THE CONTEXT OF SECURITY (U.S. CLS. 100 AND 101).

LA TONIA FISHER, EXAMINING ATTORNEY

SN 77-169,856. MEDIA PARTNERS, SEATTLE, WA. FILED 5-1-2007.

GIVE 'EM THE PICKLE!

THE MARK CONSISTS OF STANDARD CHARACTERS WITHOUT CLAIM TO ANY PARTICULAR FONT, STYLE, SIZE, OR COLOR.

CLASS 9—ELECTRICAL AND SCIENTIFIC APPARATUS

FOR PRE-RECORDED CDS, VIDEO TAPES, AND DVDS FEATURING BUSINESS AND CUSTOMER SERVICE TRAINING; PRE-RECORDED CDS, VIDEO TAPES, AND DVDS FEATURING A LEADERS GUIDE FOR BUSINESS AND CUSTOMER SERVICE TRAINING (U.S. CLS. 21, 23, 26, 36 AND 38).

FIRST USE 1-24-2002; IN COMMERCE 1-24-2002.

CLASS 16—PAPER GOODS AND PRINTED MATTER

FOR PRINTED PRODUCTS, NAMELY, POCKET REFERENCE CARDS IN THE FIELD OF BUSINESS AND CUSTOMER SERVICES TRAINING, BOOKS IN THE FIELDS OF BUSINESS AND CUSTOMER SERVICES TRAINING, ADHESIVE NOTE PADS, POSTERS, CERTIFICATES AND STICKERS (U.S. CLS. 2, 5, 22, 23, 29, 37, 38 AND 50).

FIRST USE 1-24-2002; IN COMMERCE 1-24-2002.
BILL DAWE, EXAMINING ATTORNEY

SN 77-170,255. LEGALMASTERS LLC, TEMPE, AZ. FILED 5-1-2007.

LEGALMASTERS

THE MARK CONSISTS OF STANDARD CHARACTERS WITHOUT CLAIM TO ANY PARTICULAR FONT, STYLE, SIZE, OR COLOR.

CLASS 16—PAPER GOODS AND PRINTED MATTER

FOR PARTIALLY PRINTED LEGAL FORMS CONTAINING BLANKS FOR A DO-IT-YOURSELF ESTATE PLAN, NAMELY, LIVING TRUSTS, WILLS, AND FINANCIAL AND MEDICAL POWERS OF ATTORNEY (U.S. CLS. 2, 5, 22, 23, 29, 37, 38 AND 50).

CLASS 45—PERSONAL AND LEGAL SERVICES

FOR PROVIDING AN ON-LINE COMPUTER DATABASE OF PARTIALLY PRINTED LEGAL FORMS CONTAINING BLANKS WITH INSTRUCTIONS FOR A DO-IT-YOURSELF PLANNING PACKAGE INCLUDING THE CREATION OF LIVING TRUSTS, WILLS, AND FINANCIAL AND MEDICAL POWERS OF ATTORNEY (U.S. CLS. 100 AND 101).

CHARISMA HAMPTON, EXAMINING ATTORNEY

SN 77-170,794. SIMONIZ USA, INC., BOLTON, CT. FILED 5-2-2007.

BLEND RITE

THE MARK CONSISTS OF STANDARD CHARACTERS WITHOUT CLAIM TO ANY PARTICULAR FONT, STYLE, SIZE, OR COLOR.

CLASS 3—COSMETICS AND CLEANING PREPARATIONS

FOR DEGREASING PREPARATIONS AND HARD SURFACE CLEANERS FOR HOUSEHOLD AND COMMERCIAL APPLICATIONS (U.S. CLS. 1, 4, 6, 50, 51 AND 52).

FIRST USE 10-13-2006; IN COMMERCE 10-13-2006.

CLASS 5—PHARMACEUTICALS

FOR ALL PURPOSE LIQUID DISINFECTANTS AND DEODORIZERS FOR HOUSEHOLD AND COMMERCIAL APPLICATIONS (U.S. CLS. 6, 18, 44, 46, 51 AND 52).
FIRST USE 1-31-2007; IN COMMERCE 1-31-2007.

CLASS 7—MACHINERY

FOR DEGREASERS FOR AUTOMOTIVE AND INDUSTRIAL APPLICATIONS (U.S. CLS. 13, 19, 21, 23, 31, 34 AND 35).
FIRST USE 12-28-2006; IN COMMERCE 12-28-2006.

CLASS 21—HOUSEWARES AND GLASS

FOR DISPENSERS FOR LIQUID CLEANERS, DEGREASERS, DEODORIZERS AND DISINFECTANTS (U.S. CLS. 2, 13, 23, 29, 30, 33, 40 AND 50).
FIRST USE 10-13-2006; IN COMMERCE 10-13-2006.
ARETHA SOMERVILLE, EXAMINING ATTORNEY

SN 77-171,159. DETROIT ENTERTAINMENT, L.L.C., DETROIT, MI. FILED 5-2-2007.



OWNER OF U.S. REG. NOS. 3,085,795, 3,190,362 AND OTHERS.
NO CLAIM IS MADE TO THE EXCLUSIVE RIGHT TO USE "CASINO HOTEL", APART FROM THE MARK AS SHOWN.
THE MARK CONSISTS OF THE STYLIZED WORDING "MOTORCITY" WITH THE WORDS "CASINO" AND "HOTEL" APPEARING BENEATH THE WORD "MOTOR".
SEC. 2(F) AS TO "MOTORCITY CASINO".

CLASS 39—TRANSPORTATION AND STORAGE

FOR TRANSPORTATION OF PASSENGERS BY SHUTTLE BUS, LIMOUSINE AND HOTEL PERSONNEL USING COMPANY OWNED MOTOR VEHICLES (U.S. CLS. 100 AND 105).

CLASS 41—EDUCATION AND ENTERTAINMENT

FOR HEALTH CLUB SERVICES, NAMELY, PROVIDING INSTRUCTION AND EQUIPMENT IN THE FIELD OF PHYSICAL EXERCISE (U.S. CLS. 100, 101 AND 107).

CLASS 43—HOTEL AND RESTAURANT SERVICES

FOR HOTEL SERVICES; SPA SERVICES, NAMELY, PROVIDING TEMPORARY ACCOMMODATIONS AND MEALS TO CLIENTS OF A HEALTH OR BEAUTY SPA; RESTAURANT, BAR AND LOUNGE SERVICES (U.S. CLS. 100 AND 101).

CLASS 44—MEDICAL, BEAUTY AND AGRICULTURAL SERVICES

FOR HEALTH AND BEAUTY SPA SERVICES, NAMELY, COSMETIC BODY CARE SERVICES (U.S. CLS. 100 AND 101).
KEVON CHISOLM, EXAMINING ATTORNEY

SN 77-171,181. DETROIT ENTERTAINMENT, L.L.C., DETROIT, MI. FILED 5-2-2007.



OWNER OF U.S. REG. NOS. 3,085,795, 3,190,362 AND OTHERS.
NO CLAIM IS MADE TO THE EXCLUSIVE RIGHT TO USE "CASINO HOTEL", APART FROM THE MARK AS SHOWN.
THE MARK CONSISTS OF THE STYLIZED WORDING MOTORCITY WITH THE WORDS CASINO AND HOTEL APPEARING BENEATH THE WORD MOTOR.
SEC. 2(F) AS TO "MOTORCITY CASINO".

CLASS 41—EDUCATION AND ENTERTAINMENT

FOR CASINO SERVICES; ENTERTAINMENT SERVICES, NAMELY LIVE PERFORMANCES FEATURING LIVE AND RECORDED MUSIC, PRERECORDED VIDEO, VARIETY SHOWS, SINGERS, DANCERS, MAGICIANS, ACTORS, ACROBATS, AND COMEDIANS (U.S. CLS. 100, 101 AND 107).

CLASS 43—HOTEL AND RESTAURANT SERVICES

FOR RESTAURANT, BAR AND LOUNGE SERVICES (U.S. CLS. 100 AND 101).
KEVON CHISOLM, EXAMINING ATTORNEY

SN 77-171,221. DETROIT ENTERTAINMENT, L.L.C., DETROIT, MI. FILED 5-2-2007.



THE COLOR(S) CHROME, BLUE AND BROWN IS/ARE CLAIMED AS A FEATURE OF THE MARK.
THE MARK CONSISTS OF THE STYLIZED LETTERS "MCC" IN CHROME WITH BLUE AND BROWN REFLECTIONS WITH THE LETTER M APPEARING INSIDE A DOUBLE C.

CLASS 39—TRANSPORTATION AND STORAGE

FOR TRANSPORTATION OF PASSENGERS BY SHUTTLE BUS, LIMOUSINE AND HOTEL PERSONNEL USING COMPANY OWNED MOTOR VEHICLES (U.S. CLS. 100 AND 105).

CLASS 41—EDUCATION AND ENTERTAINMENT

FOR HEALTH CLUB SERVICES, NAMELY, PROVIDING INSTRUCTION AND EQUIPMENT IN THE FIELD OF PHYSICAL EXERCISE (U.S. CLS. 100, 101 AND 107).

SN 77-171,278. DETROIT ENTERTAINMENT, L.L.C., DETROIT, MI. FILED 5-2-2007.

CLASS 43—HOTEL AND RESTAURANT SERVICES

FOR HOTEL SERVICES; SPA SERVICES, NAMELY, PROVIDING TEMPORARY ACCOMMODATIONS AND MEALS TO CLIENTS OF A HEALTH OR BEAUTY SPA; RESTAURANT, BAR AND LOUNGE SERVICES (U.S. CLS. 100 AND 101).

CLASS 44—MEDICAL, BEAUTY AND AGRICULTURAL SERVICES

FOR HEALTH AND BEAUTY SPA SERVICES, NAMELY, COSMETIC BODY CARE SERVICES (U.S. CLS. 100 AND 101).
KEVON CHISOLM, EXAMINING ATTORNEY



SN 77-171,231. SMART KIDS WITH LEARNING DISABILITIES, INC., WESTPORT, CT. FILED 5-2-2007.

SMART KIDS WITH LEARNING
DISABILITIES

THE MARK CONSISTS OF STANDARD CHARACTERS WITHOUT CLAIM TO ANY PARTICULAR FONT, STYLE, SIZE, OR COLOR.

OWNER OF U.S. REG. NOS. 3,085,795, 3,190,362 AND OTHERS.

NO CLAIM IS MADE TO THE EXCLUSIVE RIGHT TO USE "CASINO HOTEL", APART FROM THE MARK AS SHOWN.

THE COLOR(S) CHROME, BLUE, BROWN AND BLACK IS/ARE CLAIMED AS A FEATURE OF THE MARK.

THE MARK CONSISTS OF THE STYLIZED WORDING "MOTORCITY" IN CHROME WITH BLUE AND BROWN REFLECTIONS WITH THE WORDS "CASINO" AND "HOTEL" IN BLACK APPEARING BENEATH THE WORD "MOTORCITY".

SEC. 2(F) AS TO "MOTORCITY CASINO".

CLASS 16—PAPER GOODS AND PRINTED MATTER

FOR NEWSLETTERS FOR PARENTS OF CHILDREN WITH LEARNING DISABILITIES AND ATTENTION DEFICIT DISORDERS (U.S. CLS. 2, 5, 22, 23, 29, 37, 38 AND 50).

FIRST USE 4-0-2000; IN COMMERCE 4-0-2000.

CLASS 16—PAPER GOODS AND PRINTED MATTER

FOR STATIONERY, WRITING UTENSILS, APPOINTMENT BOOKS, NOTEBOOKS, POSTCARDS, CHILDREN'S ACTIVITY BOOKS, PEN AND PENCIL HOLDERS, RUBBER STAMPS, PAPER COASTERS (U.S. CLS. 2, 5, 22, 23, 29, 37, 38 AND 50).

CLASS 41—EDUCATION AND ENTERTAINMENT

FOR EDUCATIONAL SERVICES, NAMELY, PROVIDING LECTURES, WORKSHOPS, SEMINARS, AND CLASSES FOR PARENTS OF CHILDREN WITH LEARNING DISABILITIES AND ATTENTION DEFICIT DISORDERS (U.S. CLS. 100, 101 AND 107).

FIRST USE 1-0-2001; IN COMMERCE 1-0-2001.

CLASS 21—HOUSEWARES AND GLASS

FOR MUGS; DRINKING STEINS; DRINKING GLASSES; PLATES; SERVING TRAYS NOT OF PRECIOUS METAL; COOKIE JARS; BOTTLES SOLD EMPTY; BOTTLE OPENERS; CORK SCREWS; COASTERS NOT OF PAPER AND NOT BEING TABLE LINEN; GLASS, PORCELAIN, CERAMIC AND CRYSTAL DECORATIVE BOXES; HAIR BRUSHES; NON-METAL PIGGY BANKS (U.S. CLS. 2, 13, 23, 29, 30, 33, 40 AND 50).

CLASS 44—MEDICAL, BEAUTY AND AGRICULTURAL SERVICES

FOR INFORMATIONAL SERVICES FOR PARENTS ABOUT THE CAUSES, THERAPIES, DEFINITIONS, PSYCHOLOGICAL AND MEDICAL ISSUES CONCERNING CHILDREN WITH LEARNING DISABILITIES AND ATTENTION DEFICIT DISORDERS (U.S. CLS. 100 AND 101).

FIRST USE 1-0-2001; IN COMMERCE 1-0-2001.
G. MAYERSCHOFF, EXAMINING ATTORNEY

CLASS 25—CLOTHING

FOR CLOTHING, NAMELY T-SHIRTS, TANK TOPS, SHORTS, SHIRTS, PANTS, JACKETS, JOGGING SUITS, SWEAT SHIRTS, SWEAT PANTS, ROBES, SLEEPWEAR, ROMPERS, SCARVES, FOOTWEAR AND HEADWEAR (U.S. CLS. 22 AND 39).

JULIE WATSON, EXAMINING ATTORNEY

SN 77-171,302. DETROIT ENTERTAINMENT, L.L.C., DETROIT, MI. FILED 5-2-2007.

SN 77-171,376. DETROIT ENTERTAINMENT, L.L.C., DETROIT, MI. FILED 5-2-2007.



OWNER OF U.S. REG. NOS. 3,085,795, 3,182,145 AND 3,190,362.

NO CLAIM IS MADE TO THE EXCLUSIVE RIGHT TO USE "CASINO HOTEL", APART FROM THE MARK AS SHOWN.

THE MARK CONSISTS OF THE STYLIZED WORDING "MOTORCITY" WITH THE WORDS "CASINO" AND "HOTEL" APPEARING BENEATH THE WORD "MOTOR".

SEC. 2(F) AS TO "MOTORCITY CASINO".

CLASS 41—EDUCATION AND ENTERTAINMENT

FOR CASINO SERVICES; ENTERTAINMENT SERVICES, NAMELY, LIVE PERFORMANCES FEATURING LIVE AND RECORDED MUSIC, PRERECORDED VIDEO, VARIETY SHOWS, SINGERS, DANCERS, MAGICIANS, ACTORS, ACROBATS, AND COMEDIANS (U.S. CLS. 100, 101 AND 107).

CLASS 43—HOTEL AND RESTAURANT SERVICES

FOR RESTAURANT, BAR AND LOUNGE SERVICES (U.S. CLS. 100 AND 101).

JULIE WATSON, EXAMINING ATTORNEY

OWNER OF U.S. REG. NOS. 3,085,795, 3,190,362 AND OTHERS.

NO CLAIM IS MADE TO THE EXCLUSIVE RIGHT TO USE "CASINO HOTEL", APART FROM THE MARK AS SHOWN.

THE COLOR(S) CHROME, BLUE, BROWN AND BLACK IS/ARE CLAIMED AS A FEATURE OF THE MARK.

THE MARK CONSISTS OF THE STYLIZED WORDING "MOTORCITY" IN CHROME WITH BLUE AND BROWN REFLECTIONS WITH THE WORDS "CASINO" AND "HOTEL" IN BLACK APPEARING BENEATH THE WORD "MOTORCITY".

SEC. 2(F) AS TO "MOTORCITY CASINO".

SN 77-171,532. VANDELAY INDUSTRIES, LLC, LINCOLN, NE. FILED 5-2-2007.

CLASS 39—TRANSPORTATION AND STORAGE

FOR TRANSPORTATION OF PASSENGERS BY SHUTTLE BUS, LIMOUSINE AND HOTEL PERSONNEL USING COMPANY OWNED MOTOR VEHICLES (U.S. CLS. 100 AND 105).

CLASS 41—EDUCATION AND ENTERTAINMENT

FOR HEALTH CLUB SERVICES, NAMELY, PROVIDING INSTRUCTION AND EQUIPMENT IN THE FIELD OF PHYSICAL EXERCISE (U.S. CLS. 100, 101 AND 107).

CLASS 43—HOTEL AND RESTAURANT SERVICES

FOR HOTEL SERVICES; SPA SERVICES, NAMELY, PROVIDING TEMPORARY ACCOMMODATIONS AND MEALS TO CLIENTS OF A HEALTH OR BEAUTY SPA; RESTAURANT, BAR AND LOUNGE SERVICES (U.S. CLS. 100 AND 101).

CLASS 44—MEDICAL, BEAUTY AND AGRICULTURAL SERVICES

FOR HEALTH AND BEAUTY SPA SERVICES, NAMELY, COSMETIC BODY CARE SERVICES (U.S. CLS. 100 AND 101).

JULIE WATSON, EXAMINING ATTORNEY



THE MARK CONSISTS OF A TREE AND LEAVES.

CLASS 38—COMMUNICATION

FOR COMMUNICATIONS SERVICES, NAMELY, CONFERENCE CALLING SERVICES, WEBCASTING SERVICES, WEB VIDEO CONFERENCING SERVICES, PROVIDING ONLINE CHAT ROOMS AND ELECTRONIC BULLETIN BOARDS FOR TRANSMISSION OF MESSAGES AMONG USERS IN THE FIELD OF GENERAL INTEREST, AND PROVIDING EMAIL AND INSTANT MESSAGING SERVICES (U.S. CLS. 100, 101 AND 104).

CLASS 42—SCIENTIFIC AND COMPUTER SERVICES

FOR COMPUTER ONLINE EVENT INVITATION SERVICES, NAMELY, HOSTING ONLINE INTERACTIVE PUBLIC CALENDARS THAT ALLOW MULTIPLE PARTICIPANTS TO SHARE EVENT SCHEDULES AND FACILITY RESERVATIONS (U.S. CLS. 100 AND 101).

SEAN CROWLEY, EXAMINING ATTORNEY

SN 77-171,566. CRYSTALIER, LIMITED, EVERGREEN, CO. FILED 5-2-2007.

SN 77-172,320. ARES TRADING S.A., AUBONNE, SWITZERLAND, FILED 5-3-2007.

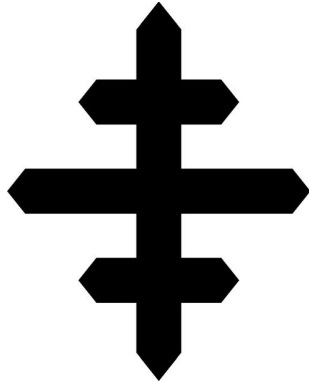

THE MARK CONSISTS OF A STYLIZED CROSS.

CLASS 21—HOUSEWARES AND GLASS

FOR CRYSTAL GLASSWARE, CUT CRYSTAL GLASSWARE, GLASSWARE, NAMELY VASES, BOWLS, AND BEVERAGEWARE, AND FIGURINES MADE OF CRYSTAL AND GLASS (U.S. CLS. 2, 13, 23, 29, 30, 33, 40 AND 50).

CLASS 35—ADVERTISING AND BUSINESS

FOR RETAIL STORE SERVICES, WHOLESALE STORE SERVICES, MAIL ORDER SERVICES, AND ON-LINE STORE SERVICES FEATURING CRYSTAL GLASSWARE, CUT CRYSTAL GLASSWARE, GLASSWARE, CHANDELIERS, AND FIGURINES MADE OF CRYSTAL AND GLASS (U.S. CLS. 100, 101 AND 102).
FRANK LATTUCA, EXAMINING ATTORNEY

SN 77-172,314. ARES TRADING S.A., AUBONNE, SWITZERLAND, FILED 5-3-2007.

AFFORDABLE ACCELERATED ACCESS

THE MARK CONSISTS OF STANDARD CHARACTERS WITHOUT CLAIM TO ANY PARTICULAR FONT, STYLE, SIZE, OR COLOR.

CLASS 36—INSURANCE AND FINANCIAL

FOR PROVIDING FINANCIAL SUPPORT SERVICES FOR PATIENTS AND FAMILIES OF PATIENTS, NAMELY, HELP WITH REIMBURSEMENT INSURANCE, PAYMENT AND FINANCING INFORMATION AND INSURANCE BENEFITS VERIFICATION (U.S. CLS. 100, 101 AND 102).

CLASS 44—MEDICAL, BEAUTY AND AGRICULTURAL SERVICES

FOR MEDICAL SERVICES (U.S. CLS. 100 AND 101).
KIMBERLY FRYE, EXAMINING ATTORNEY

A3

THE MARK CONSISTS OF STANDARD CHARACTERS WITHOUT CLAIM TO ANY PARTICULAR FONT, STYLE, SIZE, OR COLOR.

CLASS 36—INSURANCE AND FINANCIAL

FOR PROVIDING FINANCIAL SUPPORT SERVICES FOR PATIENTS AND FAMILIES OF PATIENTS, NAMELY, HELP WITH REIMBURSEMENT INSURANCE, PAYMENT AND FINANCING INFORMATION AND INSURANCE BENEFITS VERIFICATION (U.S. CLS. 100, 101 AND 102).

CLASS 44—MEDICAL, BEAUTY AND AGRICULTURAL SERVICES

FOR MEDICAL SERVICES (U.S. CLS. 100 AND 101).
KIMBERLY FRYE, EXAMINING ATTORNEY

SN 77-172,895. LINKPLACE LIMITED, TA OAKWOOD REMEDIES, HARROW HA2 0DH, UNITED KINGDOM, FILED 5-4-2007.

NITTY GRITTY

THE MARK CONSISTS OF STANDARD CHARACTERS WITHOUT CLAIM TO ANY PARTICULAR FONT, STYLE, SIZE, OR COLOR.

CLASS 3—COSMETICS AND CLEANING PREPARATIONS

FOR BLEACHING PREPARATIONS FOR COSMETIC PURPOSES; SKIN ABRASIVE PREPARATIONS; SOAPS; PERFUMERY, ESSENTIAL OILS, COSMETICS, HAIR LOTIONS; DENTIFRICES; SHAMPOOS (U.S. CLS. 1, 4, 6, 50, 51 AND 52).

CLASS 5—PHARMACEUTICALS

FOR PHARMACEUTICAL AND VETERINARY PREPARATIONS FOR THE TREATMENT OF HAIR LICE; SANITARY PREPARATIONS FOR MEDICAL PURPOSES; DIETETIC FOODS ADAPTED FOR MEDICAL USE, FOOD FOR BABIES; MEDICAL PLASTERS; DRESSINGS FOR WOUNDS, BURNS AND SURGERIES; MATERIAL FOR STOPPING TEETH, DENTAL WAX; PREPARATIONS FOR DESTROYING VERMIN; FUNGICIDES, HERBICIDES; PREPARATIONS FOR TREATING HEAD LICE IN HAIR (U.S. CLS. 6, 18, 44, 46, 51 AND 52).

CLASS 21—HOUSEWARES AND GLASS

FOR HOUSEHOLD OR KITCHEN UTENSILS, NAMELY, GRATERS, SIEVES, SPATULAS, STRAINERS, GRILLS, ROLLING PINS; CONTAINERS FOR HOUSEHOLD AND KITCHEN USE; COMBS; BRUSHES FOR HAIR; BRUSH-MAKING MATERIALS FOR HAIR BRUSHES; UN-WORKED OR SEMI-WORKED GLASS; BEVERAGE GLASSWARE; PORCELAIN AND EARTH-ENWARE MUGS, FIGURES AND SCULPTURES (U.S. CLS. 2, 13, 23, 29, 30, 33, 40 AND 50).

WENDY GOODMAN, EXAMINING ATTORNEY

CLASS 35—ADVERTISING AND BUSINESS

FOR BUSINESS MANAGEMENT ASSISTANCE, BUSINESS MANAGEMENT AND ORGANIZATION CONSULTANCY, BUSINESS CONSULTANCY, COMMERCIAL OR INDUSTRIAL MANAGEMENT ASSISTANCE, SYSTEMIZATION OF INFORMATION INTO COMPUTER DATABASES, COMPILATION OF INFORMATION INTO COMPUTER DATABASES, DATA SEARCH IN COMPUTER FILES FOR OTHERS, NAMELY, DATAMINING FROM ANY DATABASE SYSTEMS, ESPECIALLY LARGE DATA VOLUMES (U.S. CLS. 100, 101 AND 102).

CLASS 42—SCIENTIFIC AND COMPUTER SERVICES

FOR INSTALLATION AND UPDATING OF COMPUTER SOFTWARE, INSTALLATION AND DUPLICATION OF COMPUTER SOFTWARE, COMPUTER SOFTWARE CONSULTANCY, COMPUTER RENTAL, RENTAL OF WEB SERVERS, CREATING AND MAINTAINING WEB SITES FOR OTHERS, RECOVERY AND COMPUTER DATA, UPDATING AND MAINTENANCE OF COMPUTER SOFTWARE, COMPUTER SOFTWARE DESIGN, COMPUTER SYSTEM DESIGN FOR PROFESSIONAL OFFICES, COMPUTER SYSTEMS ANALYSIS, CONSULTANCY IN THE FIELD OF COMPUTER HARDWARE, SOFTWARE DESIGN, RENTAL OF COMPUTER SOFTWARE, CONVERSION OF DATA OR DOCUMENTS FROM PHYSICAL TO ELECTRONIC MEDIA, CONVERSION OF COMPUTER PROGRAMS AND DATA, MAINTENANCE OF COMPUTER SOFTWARE, CALIBRATION (U.S. CLS. 100 AND 101).

CLASS 45—PERSONAL AND LEGAL SERVICES

FOR CONSULTING SERVICES IN THE FIELD OF MAINTAINING THE SECURITY AND INTEGRITY OF DATABASES AND PROCESSES, MONITORING OF BURGLAR AND SECURITY ALARMS, LICENSING OF COMPUTER SOFTWARE AND LEGAL SERVICES, INSPECTION OF FACTORIES FOR SAFETY PURPOSES (U.S. CLS. 100 AND 101).

ANTHONY RINKER, EXAMINING ATTORNEY

SN 77-174,088. SALFORD S.R.O., BRNO, CZECH REPUBLIC, FILED 5-7-2007.

ALTWORX

THE MARK CONSISTS OF STANDARD CHARACTERS WITHOUT CLAIM TO ANY PARTICULAR FONT, STYLE, SIZE, OR COLOR.

PRIORITY CLAIMED UNDER SEC. 44(D) ON CZECH REPUBLIC APPLICATION NO. 445124, FILED 2-5-2007, REG. NO. 291140, DATED 6-27-2007, EXPIRES 2-5-2017.

CLASS 9—ELECTRICAL AND SCIENTIFIC APPARATUS

FOR ALARMS, NAMELY, ELECTRONIC INTRUDER ALARMS NOT FOR AUTOMOBILES, BASED ON ELECTRONIC SENSING DEVICES, SMOKE DETECTORS, INDICATORS, NAMELY, ELECTRONICS INDICATORS OF STATUS OF A TECHNOLOGY AND A BUSINESS COMPONENTS, FIRE ALARMS, ELECTRICITY INDICATORS, NAMELY, BLINKERS, FLASHING LIGHTS, ELECTROMECHANICAL APPARATUS, ELECTRIC POWER LOSS INDICATORS, COVERS FOR ELECTRIC OUTLETS, PHOTOVOLTAIC CELLS, INTEGRATED CIRCUIT CARDS, MAGNETICALLY CODED IDENTITY CARDS, AUDIO AND VIDEO INTERCOMMUNICATION APPARATUSES, NAMELY, DOOR TELEPHONES AND AN APPARATUS FOR COMMUNICATING BETWEEN TWO SIDES OF A BARRIER, DEVICES FOR INTERNAL CONNECTIONS, NAMELY, ROUTERS, WIRE OR WIRELESS DATA TRANSMITTERS AND RECEIVERS, PRECISION MEASURING APPARATUS, NAMELY, LASERS, ELECTRIC MONITORING APPARATUS, NAMELY, FOR ACCESS CONTROL AND ALARM, CCTV SYSTEMS, JUNCTION SLEEVES FOR ELECTRIC CABLES, ELECTRIC DOOR OPENERS, OBSERVATION INSTRUMENTS, NAMELY, ELECTRONICS OBSERVATION SYSTEMS, CCTV SYSTEMS USED FOR TECHNOLOGY, SAFETY AND SECURITY OBSERVATION, FLASHING SAFETY LIGHTS, BLINKERS, NAMELY, ELECTRONIC INDICATOR BOARDS, COMPUTERS, VIDEO SCREENS, DATA PROCESSING APPARATUS, NAMELY, CENTRAL PROCESSING UNITS, COMPUTER SOFTWARE FOR USE IN DATABASE MANAGEMENT, USE AS A SPREADSHEET AND SOFTWARE FOR CONTROL AND MANAGEMENT OF SECURITY AND BUSINESS PROCESSES, COMPUTER PROGRAMS WITH DOWNLOADABLE SOFTWARE AND RECORDED PROGRAMS FOR CONTROL AND MANAGEMENT OF BUSINESS PROCESSES WITH FOCUS TO SECURITY AND SAFETY OF THESE PROCESSES, OPTICAL CHARACTER READERS, ACOUSTIC FIRE ALARMS, ELECTRIC CURRENT REGULATING APPARATUS AND HEAT REGULATING APPARATUS, NAMELY, THERMOSTATS, ELECTRIC CONTROL PANELS, ANTI-THEFT WARNING APPARATUS, NAMELY, ALARMS NOT FOR AUTOMOBILES, ELECTRIC LOCKS, ELECTRIC DOOR CLOSERS (U.S. CLS. 21, 23, 26, 36 AND 38).

SN 77-174,928. RICCOR REALIZATION, LLC, FARMINGTON, UT. FILED 5-7-2007.

REALIZATION

THE MARK CONSISTS OF STANDARD CHARACTERS WITHOUT CLAIM TO ANY PARTICULAR FONT, STYLE, SIZE, OR COLOR.

CLASS 5—PHARMACEUTICALS

FOR DIETARY SUPPLEMENTS; NUTRITIONAL SUPPLEMENTS (U.S. CLS. 6, 18, 44, 46, 51 AND 52).

CLASS 44—MEDICAL, BEAUTY AND AGRICULTURAL SERVICES

FOR DIETARY AND NUTRITIONAL GUIDANCE; PROVIDING INFORMATION ABOUT NUTRITION AND DIET (U.S. CLS. 100 AND 101).

JOHN GARTNER, EXAMINING ATTORNEY

SN 77-174,936. RICCOR REALIZATION, LLC, FARMINGTON, UT. FILED 5-7-2007.

SN 77-175,177. THE BEAR STEARNS COMPANIES INC., NEW YORK, NY. FILED 5-8-2007.

BEARVIEW

ULTIMATE-SELF REALIZATION

THE MARK CONSISTS OF STANDARD CHARACTERS WITHOUT CLAIM TO ANY PARTICULAR FONT, STYLE, SIZE, OR COLOR.

CLASS 5—PHARMACEUTICALS

FOR DIETARY SUPPLEMENTS; NUTRITIONAL SUPPLEMENTS (U.S. CLS. 6, 18, 44, 46, 51 AND 52).

CLASS 44—MEDICAL, BEAUTY AND AGRICULTURAL SERVICES

FOR DIETARY AND NUTRITIONAL GUIDANCE; PROVIDING INFORMATION ABOUT NUTRITION AND DIET (U.S. CLS. 100 AND 101).
JOHN GARTNER, EXAMINING ATTORNEY

SN 77-175,086. NORTHSTAR TRAVEL MEDIA, LLC, SECAUCUS, NJ. FILED 5-8-2007.

WORLD OF LUXURY

THE MARK CONSISTS OF STANDARD CHARACTERS WITHOUT CLAIM TO ANY PARTICULAR FONT, STYLE, SIZE, OR COLOR.

CLASS 16—PAPER GOODS AND PRINTED MATTER

FOR MAGAZINES FEATURING TRAVEL AND INFORMATION CONCERNING HOTELS, CRUISES, TOUR OPERATORS, AIRLINES AND PRIVATE JETS (U.S. CLS. 2, 5, 22, 23, 29, 37, 38 AND 50).
FIRST USE 12-17-2007; IN COMMERCE 12-17-2007.

CLASS 41—EDUCATION AND ENTERTAINMENT

FOR ON-LINE PUBLICATION OF MAGAZINES FEATURING TRAVEL AND INFORMATION CONCERNING HOTELS, CRUISES, TOUR OPERATORS, AIRLINES AND PRIVATE JETS (U.S. CLS. 100, 101 AND 107).
FIRST USE 12-17-2007; IN COMMERCE 12-17-2007.
KELLEY WELLS, EXAMINING ATTORNEY

THE MARK CONSISTS OF STANDARD CHARACTERS WITHOUT CLAIM TO ANY PARTICULAR FONT, STYLE, SIZE, OR COLOR.

OWNER OF U.S. REG. NOS. 1,868,600, 3,212,317 AND OTHERS.

CLASS 35—ADVERTISING AND BUSINESS

FOR CUSTOMER RELATIONSHIP MANAGEMENT (U.S. CLS. 100, 101 AND 102).

CLASS 36—INSURANCE AND FINANCIAL

FOR FINANCIAL SERVICES, NAMELY, PROVIDING FINANCIAL PLANNING, FINANCIAL ANALYSIS, RISK MANAGEMENT, RESEARCH, PROVIDING FINANCIAL TRADING TOOLS FOR OTHERS, FINANCIAL CLEARING HOUSES IN THE FIELD OF SECURITIES, COMMODITIES, FUTURES, AND DERIVATIVES, AND HEDGE FUND AND PRIVATE EQUITY INVESTMENTS (U.S. CLS. 100, 101 AND 102).

CLASS 42—SCIENTIFIC AND COMPUTER SERVICES

FOR PROVIDING TEMPORARY USE OF ON-LINE NON-DOWNLOADABLE SOFTWARE FOR FINANCIAL PLANNING, ANALYSIS, RISK MANAGEMENT, RESEARCH, CLIENT RELATIONSHIP MANAGEMENT, TRADING, TRADE EXECUTION, OPERATIONAL WORK FLOW AND CLEARING IN THE FIELD OF SECURITIES, COMMODITIES, FUTURES, AND DERIVATIVES, AND HEDGE FUND AND PRIVATE EQUITY FUND INVESTMENTS (U.S. CLS. 100 AND 101).
LINDA M. KING, EXAMINING ATTORNEY

SN 77-175,223. CALIFORNIA DEPARTMENT OF PARKS AND RECREATION, SACRAMENTO, CA. FILED 5-8-2007.

CASA DE BANDINI

THE MARK CONSISTS OF STANDARD CHARACTERS WITHOUT CLAIM TO ANY PARTICULAR FONT, STYLE, SIZE, OR COLOR.

THE FOREIGN WORDING IN THE MARK TRANSLATES INTO ENGLISH AS HOUSE OF.

CLASS 9—ELECTRICAL AND SCIENTIFIC APPARATUS

FOR DOWNLOADABLE PODCASTS IN THE FIELD OF THE HISTORY OF CALIFORNIA; MOTION PICTURES IN THE FIELD OF THE HISTORY OF CALIFORNIA (U.S. CLS. 21, 23, 26, 36 AND 38).

CLASS 14—JEWELRY

FOR JEWELRY (U.S. CLS. 2, 27, 28 AND 50).

CLASS 16—PAPER GOODS AND PRINTED MATTER

FOR PRINTED ART REPRODUCTIONS, NAMELY, REPRODUCTIONS OF HISTORICAL PHOTOGRAPHS, COOKBOOKS, MAPS, BOOKS, BROCHURES, AND POSTCARDS (U.S. CLS. 2, 5, 22, 23, 29, 37, 38 AND 50).

CLASS 24—FABRICS

FOR DINING LINENS, BED LINENS, CURTAINS, AND TOWELS (U.S. CLS. 42 AND 50).

CLASS 27—FLOOR COVERINGS

FOR CARPETS, RUGS, FLOOR MATS AND HISTORICAL REPRODUCTION WALLPAPER (U.S. CLS. 19, 20, 37, 42 AND 50).

WON TEAK OH, EXAMINING ATTORNEY

SN 77-175,476. YSI INCORPORATED, YELLOW SPRINGS, OH. FILED 5-8-2007.

AMJ ENVIRONMENTAL

THE MARK CONSISTS OF STANDARD CHARACTERS WITHOUT CLAIM TO ANY PARTICULAR FONT, STYLE, SIZE, OR COLOR.

NO CLAIM IS MADE TO THE EXCLUSIVE RIGHT TO USE "ENVIRONMENTAL", APART FROM THE MARK AS SHOWN.

CLASS 35—ADVERTISING AND BUSINESS

FOR CONSULTING SERVICES IN THE FIELD OF NATURAL RESOURCE MANAGEMENT; AND CONSULTING SERVICES IN THE FIELD OF NATURAL RESOURCE MANAGEMENT, NAMELY, WATER QUALITY MONITORING, WATER QUALITY DATA COLLECTION, WATER QUALITY DATA MANAGEMENT, WATER QUALITY MONITORING INSTRUMENTATION, WATER DISCHARGE AND HYDROLOGY MEASUREMENTS (U.S. CLS. 100, 101 AND 102).

CLASS 37—CONSTRUCTION AND REPAIR

FOR CONSTRUCTION SERVICES IN THE FIELD OF NATURAL RESOURCE MANAGEMENT, NAMELY CONSTRUCTION OF WALKWAYS AND STRUCTURAL PLATFORMS FOR INSTALLING, AND GAINING ACCESS TO, WATER QUALITY MONITORING EQUIPMENT (U.S. CLS. 100, 103 AND 106).

CLASS 42—SCIENTIFIC AND COMPUTER SERVICES

FOR CUSTOMIZED INTEGRATION OF WATER QUALITY MONITORING EQUIPMENT AND WATER QUALITY MONITORING SOFTWARE FOR OTHERS; AND ENVIRONMENTAL SERVICES, NAMELY, TECHNICAL CONSULTATION IN THE FIELD OF ENVIRONMENTAL SCIENCE AND ENGINEERING SERVICES (U.S. CLS. 100 AND 101).

JILL C. ALT, EXAMINING ATTORNEY

SN 77-176,848. PREFERRED HOTEL GROUP, INC., CHICAGO, IL. FILED 5-9-2007.

PREFERRED HOTEL GROUP

THE MARK CONSISTS OF STANDARD CHARACTERS WITHOUT CLAIM TO ANY PARTICULAR FONT, STYLE, SIZE, OR COLOR.

OWNER OF U.S. REG. NOS. 1,227,080, 2,409,197 AND OTHERS.

NO CLAIM IS MADE TO THE EXCLUSIVE RIGHT TO USE "HOTEL GROUP", APART FROM THE MARK AS SHOWN.

SEC. 2(F) AS TO "PREFERRED".

CLASS 36—INSURANCE AND FINANCIAL

FOR REAL ESTATE SERVICES, NAMELY, CONDOMINIUM AND VACATION HOME TIME-SHARING; VACATION REAL ESTATE TIME-SHARING; REAL ESTATE TIME-SHARE AND FRACTIONAL OWNERSHIP EXCHANGE SERVICES (U.S. CLS. 100, 101 AND 102).

FIRST USE 5-0-2004; IN COMMERCE 5-0-2004.

CLASS 43—HOTEL AND RESTAURANT SERVICES

FOR HOTEL SERVICES (U.S. CLS. 100 AND 101).
FIRST USE 1-0-2001; IN COMMERCE 1-0-2001.
LINDA LAVACHE, EXAMINING ATTORNEY

SN 77-176,904. PREFERRED HOTEL GROUP, INC., CHICAGO, IL. FILED 5-9-2007.



OWNER OF U.S. REG. NOS. 1,227,080, 2,409,197 AND OTHERS.

NO CLAIM IS MADE TO THE EXCLUSIVE RIGHT TO USE "HOTEL GROUP", APART FROM THE MARK AS SHOWN.

THE MARK CONSISTS OF THE WORDS "PREFERRED" AND "HOTEL GROUP" STACKED OFFSET IN STYLIZED LETTERS WITH A CALLIGRAPHIC STROKE AT THE BOTTOM AND A PINEAPPLE/PINECONE/LOTUS FLOWER DESIGN AT THE RIGHT.

SEC. 2(F) AS TO "PREFERRED".

CLASS 36—INSURANCE AND FINANCIAL

FOR REAL ESTATE SERVICES, NAMELY, CONDOMINIUM AND VACATION HOME TIME-SHARING; VACATION REAL ESTATE TIME-SHARING; REAL ESTATE TIME-SHARE AND FRACTIONAL OWNERSHIP EXCHANGE SERVICES (U.S. CLS. 100, 101 AND 102).

FIRST USE 5-0-2004; IN COMMERCE 5-0-2004.

CLASS 43—HOTEL AND RESTAURANT SERVICES

FOR HOTEL SERVICES (U.S. CLS. 100 AND 101).
FIRST USE 1-0-2001; IN COMMERCE 1-0-2001.
LINDA LAVACHE, EXAMINING ATTORNEY

SN 77-176,998. H NU PHOTONICS LLC, WAILUKU, HI.
FILED 5-9-2007.

HNU SOLAR

THE MARK CONSISTS OF STANDARD CHARACTERS WITHOUT CLAIM TO ANY PARTICULAR FONT, STYLE, SIZE, OR COLOR.

NO CLAIM IS MADE TO THE EXCLUSIVE RIGHT TO USE "SOLAR", APART FROM THE MARK AS SHOWN.

CLASS 7—MACHINERY

FOR SOLAR-ELECTRIC POWER GENERATORS FOR DOMESTIC AND COMMERCIAL USE (U.S. CLS. 13, 19, 21, 23, 31, 34 AND 35).

CLASS 9—ELECTRICAL AND SCIENTIFIC APPARATUS

FOR PHOTOVOLTAIC AND NON-PHOTOVOLTAIC SOLAR MODULES; SOLAR POWER PRODUCTS, NAMELY, ENERGY BATTERIES FOR STORING SOLAR ENERGY, APPARATUS FOR CONVERTING ELECTRONIC RADIATION TO ELECTRICAL ENERGY, NAMELY, PHOTOVOLTAIC AND NON-PHOTOVOLTAIC SOLAR MODULES; SOLAR ELECTRIC MODULES FOR CONVERTING SUNLIGHT INTO ELECTRICITY, SOLAR MODULES FOR STORING ELECTRICITY; ELECTRONIC POWER CONVERSION DEVICES, NAMELY, DC-AC POWER INVERTER UNITS; ELECTRONIC CONNECTORS; KITS CONSISTING OF WIRING ACCESSORIES FOR SOLAR ENERGY INSTALLATION, NAMELY, FUSE HOLDERS AND BREAKERS, ELECTRICAL COMBINATION BOXES, CABLE CLIPS, RECEPTACLES, LUGS, TERMINALS, TUBING, CABLES, STRAIN RELIEFS, INVERTERS, DISCONNECT SWITCHES AND ELECTRICAL CONNECTORS; KITS CONSISTING OF MECHANICAL ACCESSORIES FOR SOLAR ENERGY INSTALLATION, NAMELY, MOUNTING BRACKETS, MOUNTING CLIPS, MOUNTING RAILS, SPLICE BARS, SPLICE PLATES, FLASHING, CABLE TIES, SHIMS AND MOUNTING POLES; SOLAR PV ELECTRIC PANELS (U.S. CLS. 21, 23, 26, 36 AND 38).

CLASS 11—ENVIRONMENTAL CONTROL APPARATUS

FOR SOLAR LIGHT FIXTURES, NAMELY, INDOOR AND OUTDOOR SOLAR POWERED LIGHTING UNITS AND FIXTURES; SOLAR COLLECTORS AND SOLAR HEAT COLLECTION PANELS; SOLAR ELECTRIC MODULES FOR COLLECTING SUNLIGHT; SOLAR POWER PLANTS (U.S. CLS. 13, 21, 23, 31 AND 34).

JAMES A. RAUEN, EXAMINING ATTORNEY

SN 77-178,887. CBS BROADCASTING INC., NEW YORK, NY.
FILED 5-11-2007.

YOURTAKE

THE MARK CONSISTS OF STANDARD CHARACTERS WITHOUT CLAIM TO ANY PARTICULAR FONT, STYLE, SIZE, OR COLOR.

CLASS 38—COMMUNICATION

FOR PROVIDING ELECTRONIC, ELECTRIC AND DIGITAL TRANSMISSION AND STREAMING DIGITAL AUDIO, VIDEO, GRAPHICS, TEXT AND DATA; PROVIDING ONLINE CHAT ROOMS AND BULLETIN BOARDS FOR ELECTRONIC TRANSMISSION OF MESSAGES AMONG USERS (U.S. CLS. 100, 101 AND 104).

CLASS 42—SCIENTIFIC AND COMPUTER SERVICES

FOR COMPUTER SERVICES, NAMELY, CREATING AN ONLINE COMMUNITY FOR REGISTERED USERS TO ENGAGE IN SOCIAL NETWORKING (U.S. CLS. 100 AND 101).

CHRIS WELLS, EXAMINING ATTORNEY

SN 77-178,902. MONTEFIORE MEDICAL CENTER INC.,
BRONX, NY. FILED 5-11-2007.

MOVING SMART

THE MARK CONSISTS OF STANDARD CHARACTERS WITHOUT CLAIM TO ANY PARTICULAR FONT, STYLE, SIZE, OR COLOR.

CLASS 41—EDUCATION AND ENTERTAINMENT

FOR EDUCATIONAL SERVICES, NAMELY, DEVELOPING AND PROVIDING INSTRUCTION FOR OTHERS AND DEVELOPING CURRICULUM FOR OTHERS, ALL IN THE FIELDS OF OBESITY, DIETARY AND NUTRITIONAL GUIDANCE INTEGRATING PHYSICAL ACTIVITIES WITH ACADEMIC AND SCHOLASTIC OBJECTIVES (U.S. CLS. 100, 101 AND 107).

CLASS 44—MEDICAL, BEAUTY AND AGRICULTURAL SERVICES

FOR PROVIDING AN ONLINE INTERACTIVE WEBSITE IN THE FIELD OF HEALTH AND WELLNESS INFORMATION AND FEATURING THE USE OF INTERACTIVE ONLINE ACTIVITIES AND AUDIO-VISUAL EXHIBITS AND MATERIALS (U.S. CLS. 100 AND 101).

ELIZABETH HUGHITT, EXAMINING ATTORNEY

SN 77-180,229. PHARMAVITE LLC, MISSION HILLS, CA.
FILED 5-14-2007.

REAL IS REVOLUTIONARY

THE MARK CONSISTS OF STANDARD CHARACTERS WITHOUT CLAIM TO ANY PARTICULAR FONT, STYLE, SIZE, OR COLOR.

CLASS 5—PHARMACEUTICALS

FOR VITAMIN AND MINERALS FORMED AND PACKAGED AS NUTRITION BARS (U.S. CLS. 6, 18, 44, 46, 51 AND 52).

CLASS 29—MEATS AND PROCESSED FOODS

FOR SOY-BASED FOOD BARS (U.S. CL. 46).
MARK RADEMACHER, EXAMINING ATTORNEY

SN 77-180,929. QATAR AIRWAYS, DOHA, QATAR, FILED 5-15-2007.

SN 77-180,918. QATAR AIRWAYS, DOHA, QATAR, FILED 5-15-2007.



OWNER OF QATAR REG. NO. 22348, DATED 9-9-2003, EXPIRES 2-16-2010.

OWNER OF QATAR REG. NO. 22662, DATED 9-9-2003, EXPIRES 2-16-2010.

NO CLAIM IS MADE TO THE EXCLUSIVE RIGHT TO USE "QATAR AIRWAYS" AND "CLUB" AND THE ARABIC CHARACTERS FOR THOSE TERMS, APART FROM THE MARK AS SHOWN.

THE MARK CONSISTS OF THE WORDING "QATAR AIRWAYS PRIVILEGE CLUB" IN ENGLISH AND ARABIC AND A CIRCLE MADE UP OF PARALLEL HORIZONTAL LINES IN WHICH APPEARS AN IMAGE OF THE PROFILE OF AN ANIMAL WITH LONG HORNS.

THE ARABIC CHARACTERS IN THE MARK TRANSLITERATE TO "QATAR AIRWAYS" AND "PRIVILEGE CLUB" AND HAVE NO SEPARATE MEANING IN ENGLISH.

CLASS 16—PAPER GOODS AND PRINTED MATTER

FOR BROCHURES, TIMETABLES AND MAPS, ALL RELATING TO AIR TRANSPORT (U.S. CLS. 2, 5, 22, 23, 29, 37, 38 AND 50).

CLASS 39—TRANSPORTATION AND STORAGE

FOR TRANSPORT, STORAGE AND DELIVERY OF GOODS; TRAVEL ARRANGEMENT (U.S. CLS. 100 AND 105).

EDWARD NELSON, EXAMINING ATTORNEY

OWNER OF QATAR REG. NO. 29632, DATED 12-9-2004, EXPIRES 4-27-2013.

OWNER OF QATAR REG. NO. 29631, DATED 12-9-2004, EXPIRES 4-27-2013.

NO CLAIM IS MADE TO THE EXCLUSIVE RIGHT TO USE "QATAR AIRWAYS" AND THE ARABIC CHARACTERS WHICH TRANSLATE TO QATAR AIRWAYS", APART FROM THE MARK AS SHOWN.

THE MARK CONSISTS OF THE WORDING "QATAR AIRWAYS HOLIDAYS TAKING YOU PLACES" IN ENGLISH AND ARABIC WITH THE O OF HOLIDAYS REPLACED BY A CIRCLE WITH PARALLEL HORIZONTAL LINES IN WHICH APPEARS THE SIDE PROFILE OF AN ANIMAL WITH LONG HORNS.

THE NON-LATIN CHARACTERS IN THE MARK TRANSLITERATE TO AL KHOTOUT AL QATARIEH AND HOLIDAYS AND TAKING YOU PLACES AND THIS MEANS "QATAR AIRWAYS, HOLIDAYS AND TAKING YOU PLACES IN ENGLISH."

CLASS 16—PAPER GOODS AND PRINTED MATTER

FOR BROCHURES, TIMETABLES AND MAPS, ALL RELATING TO AIR TRANSPORT (U.S. CLS. 2, 5, 22, 23, 29, 37, 38 AND 50).

CLASS 39—TRANSPORTATION AND STORAGE

FOR AIR TRANSPORT SERVICES; PACKAGING ARTICLES FOR TRANSPORTATION; AIR TRANSPORT AND STORAGE OF GOODS; TRAVEL ARRANGEMENT (U.S. CLS. 100 AND 105).

EDWARD NELSON, EXAMINING ATTORNEY

SN 77-181,390. UNITED STATES BOWLING CONGRESS, INC., GREENDALE, WI. FILED 5-15-2007.



OWNER OF U.S. REG. NOS. 1,703,804 AND 2,651,766. THE LINING IS A FEATURE OF THE MARK AND DOES NOT INDICATE COLOR.

THE MARK CONSISTS OF THE WORD "QUEENS" WITH THE LETTER "Q" BEING LARGER AND HAVING THE OUTLINE OF A FEMALE BOWLER INSIDE THE LETTER; THE LETTERS "USBC" ABOVE THE WORD AND A STAR WITH A BOWLING PIN AND HORIZONTAL LINES ON THE RIGHT HALF ABOVE THE LETTERS; THE LETTERS "UEENS" BEING UNDERLINED.

CLASS 35—ADVERTISING AND BUSINESS

FOR ASSOCIATION SERVICES, NAMELY, PROMOTING BOWLING LEAGUES AND TOURNAMENTS FOR OTHERS (U.S. CLS. 100, 101 AND 102).

FIRST USE 10-0-2005; IN COMMERCE 10-0-2005.

CLASS 41—EDUCATION AND ENTERTAINMENT

FOR ENTERTAINMENT SERVICES, NAMELY, CONDUCTING AND ORGANIZING BOWLING LEAGUES AND TOURNAMENTS; PROMULGATING, MAINTAINING AND ENFORCING RULES AND REGULATIONS FOR BOWLING LEAGUE EVENTS (U.S. CLS. 100, 101 AND 107).

FIRST USE 10-0-2005; IN COMMERCE 10-0-2005.
RICHARD A. STRASER, EXAMINING ATTORNEY

SN 77-181,419. UNITED STATES BOWLING CONGRESS, INC., GREENDALE, WI. FILED 5-15-2007.



OWNER OF U.S. REG. NOS. 1,703,804, 2,651,766 AND 2,981,420.

THE LINING IS A FEATURE OF THE MARK AND DOES NOT INDICATE COLOR.

THE MARK CONSISTS OF THE WORD "QUEENS" WITH THE LETTER "Q" BEING LARGER AND HAVING THE OUTLINE OF A FEMALE BOWLER INSIDE THE LETTER; THE WORD "SENIOR" ABOVE THE WORD; THE LETTERS "USBC" ABOVE THAT AND A STAR WITH A BOWLING PIN AND HORIZONTAL LINES ON THE RIGHT HALF ABOVE THE LETTERS; THREE LINES EXTENDING TO THE RIGHT FROM THE LETTER "Q".

CLASS 35—ADVERTISING AND BUSINESS

FOR ASSOCIATION SERVICES, NAMELY, PROMOTING BOWLING LEAGUES AND TOURNAMENTS FOR OTHERS (U.S. CLS. 100, 101 AND 102).

FIRST USE 10-0-2005; IN COMMERCE 10-0-2005.

CLASS 41—EDUCATION AND ENTERTAINMENT

FOR ENTERTAINMENT SERVICES, NAMELY, CONDUCTING AND ORGANIZING BOWLING LEAGUES AND TOURNAMENTS; PROMULGATING, MAINTAINING AND ENFORCING RULES AND REGULATIONS FOR BOWLING LEAGUE EVENTS (U.S. CLS. 100, 101 AND 107).

FIRST USE 10-0-2005; IN COMMERCE 10-0-2005.
RICHARD A. STRASER, EXAMINING ATTORNEY

SN 77-181,504. SWATCHBOX TECHNOLOGIES, INC., NORTHBOROUGH, MA. FILED 5-15-2007.

SWATCHBOX

THE MARK CONSISTS OF STANDARD CHARACTERS WITHOUT CLAIM TO ANY PARTICULAR FONT, STYLE, SIZE, OR COLOR.

CLASS 9—ELECTRICAL AND SCIENTIFIC APPARATUS

FOR COMPUTER SOFTWARE FOR INTERIOR DECORATING AND DESIGN, NAMELY, FOR THE PLANNING, CONFIGURATION AND DESIGN OF ROOM LAYOUTS (U.S. CLS. 21, 23, 26, 36 AND 38).

CLASS 42—SCIENTIFIC AND COMPUTER SERVICES

FOR DESIGN, DEVELOPMENT AND IMPLEMENTATION OF SOFTWARE (U.S. CLS. 100 AND 101).
JANICE KIM, EXAMINING ATTORNEY

SN 77-182,059. ROBINSON, TRACEY L., PLAINFIELD, NJ. FILED 5-16-2007.

LADY DIBBLE

THE MARK CONSISTS OF STANDARD CHARACTERS WITHOUT CLAIM TO ANY PARTICULAR FONT, STYLE, SIZE, OR COLOR.

THE NAME "LADY DIBBLE" DOES NOT IDENTIFY A LIVING INDIVIDUAL.

CLASS 16—PAPER GOODS AND PRINTED MATTER

FOR PRINTED MATTER, NAMELY, A SERIES OF FICTION BOOKS AND CHILDREN'S BOOKS FOR CHILDREN OF ALL AGES; CHILDREN'S COLORING BOOKS AND ACTIVITY BOOKS, BOOKMARKS, POSTCARDS, STATIONERY, WRITING PAPER, ENVELOPES, PRINTED INVITATIONS, PENCILS, PENS, PAPER NAPKINS, PAPER PLACE MATS, AND PAPER TABLECLOTHS FOR PARTIES (U.S. CLS. 2, 5, 22, 23, 29, 37, 38 AND 50).

CLASS 41—EDUCATION AND ENTERTAINMENT

FOR RADIO ENTERTAINMENT SERVICES, NAMELY, RADIO PROGRAMS FEATURING PERFORMANCES BY AN AUTHOR AND STORYTELLER, AND RADIO PROGRAMS HOSTED BY AN AUTHOR AND STORYTELLER; TELEVISION ENTERTAINMENT SERVICES, NAMELY, ON GOING TELEVISION PROGRAMS FEATURING CHILDREN'S STORIES HOSTED BY AN AUTHOR AND STORYTELLER; ENTERTAINMENT SERVICES, NAMELY, PERSONAL APPEARANCES BY AN AUTHOR AND STORYTELLER ON RADIO, TELEVISION, AT PUBLIC LIBRARIES, AND IN MOVIES; ENTERTAINMENT SERVICES, NAMELY, LIVE, TELEVIEW APPEARANCES BY A PROFESSIONAL ENTERTAINER (U.S. CLS. 100, 101 AND 107).

LOURDES AYALA, EXAMINING ATTORNEY

SN 77-182,624. MONTE REGALO LLC, RALEIGH, NC. FILED 5-16-2007.

MONTE REGALO

THE MARK CONSISTS OF STANDARD CHARACTERS WITHOUT CLAIM TO ANY PARTICULAR FONT, STYLE, SIZE, OR COLOR.

THE ENGLISH TRANSLATION OF THE WORD "MONTE REGALO" IN THE MARK IS "GIFT OF THE MOUNTAIN".

CLASS 19—NON-METALLIC BUILDING MATERIALS

FOR NON-METAL DOOR SURROUNDS; NON-METAL WINDOW SURROUNDS; FIREPLACE SURROUNDS; FIREPLACE MANTELS; BALUSTRADES; NON-METAL ARCHITECTURAL ACCENTS, NAMELY, WALL MEDALLIONS, EAVE AND WALL BRACKETS, NEWELL POSTS FOR STAIRS, AND STAIR TREADS AND RISERS; NON-METAL GAZEBOS; NON-METAL BUILDING MATERIALS, NAMELY, COLUMNS, CAPITALS, CORNICES, MOUDLINGS, NICHEs, AND MEDALLIONS; NON-METAL GARDEN ADORNMENTS, NAMELY, COLUMNS AND STONE WALL MEDALLIONS (U.S. CLS. 1, 12, 33 AND 50).

FIRST USE 5-15-2007; IN COMMERCE 5-15-2007.

CLASS 42—SCIENTIFIC AND COMPUTER SERVICES

FOR ARCHITECTURAL DESIGN SERVICES, INTERIOR DESIGN SERVICES, INTERIOR DECORATION CONSULTATION, AND DESIGN FOR OTHERS IN THE FIELDS OF ARCHITECTURAL ACCENTS AND GARDEN ACCENTS (U.S. CLS. 100 AND 101).

FIRST USE 3-1-2007; IN COMMERCE 3-1-2007.
DORITT L. CARROLL, EXAMINING ATTORNEY

SN 77-182,641. CENTURYTEL, INC., MONROE, LA. FILED 5-16-2007.

SMARTLIVING HOME

THE MARK CONSISTS OF STANDARD CHARACTERS WITHOUT CLAIM TO ANY PARTICULAR FONT, STYLE, SIZE, OR COLOR.

NO CLAIM IS MADE TO THE EXCLUSIVE RIGHT TO USE HOME, APART FROM THE MARK AS SHOWN.

CLASS 38—COMMUNICATION

FOR TRANSMISSION OF SOUNDS, VOICES, IMAGES, SIGNALS AND DATA VIA A BUNDLE OF IN-HOUSE SECURITY SYSTEMS; RESIDENTIAL LOCAL AND LONG DISTANCE TELEPHONE SERVICES; PROVIDING A GROUP OF SPECIALIZED TELEPHONE SERVICES WITH CUSTOM CALLING FEATURES AND TELEPHONE CALLING PLANS; TELECOMMUNICATIONS SERVICES, NAMELY, LOCAL AND LONG DISTANCE TRANSMISSION OF VOICE, DATA, IMAGES, SIGNALS, SOUNDS, BY MEANS OF TELEPHONE, CABLE AND SATELLITE COMMUNICATIONS; TELECOMMUNICATIONS SERVICES, NAMELY, PROVIDING SATELLITE TELEVISION BROADCASTING, CABLE TELEVISION BROADCASTING AND SWITCHED DIGITAL TELEVISION; ETHERNET SERVICES, NAMELY, PROVIDING HIGH SPEED ACCESS TO A GLOBAL COMPUTER INFORMATION NETWORK; PROVIDING REMOTE AND HIGH SPEED INTERNET ACCESS (U.S. CLS. 100, 101 AND 104).

CLASS 42—SCIENTIFIC AND COMPUTER SERVICES

FOR PROVIDING IN-HOUSE OR REMOTE AUTOMATED HEATING AND COOLING MONITORING SERVICES FOR HOME APPARATUS (U.S. CLS. 100 AND 101).

CLASS 45—PERSONAL AND LEGAL SERVICES

FOR IN-HOUSE SECURITY SERVICES FOR BUILDINGS, NAMELY, PROVIDING PHYSICAL ACCESS TO PROPERTIES VIA A REMOTE CALL-IN LOCKING DEVICE (U.S. CLS. 100 AND 101).

ZACHARY BELLO, EXAMINING ATTORNEY

SN 77-183,987. VIJAYESHWARI TEXTILES LIMITED, KUNIAMUTHUR TAMIL NADU, INDIA, FILED 5-17-2007.



The logo for KottonDor features the brand name in a stylized, rounded font. A small graphic of a cotton plant with a flower is positioned above the letter 'o' in 'Dor'.

CLASS 23—YARNS AND THREADS

FOR YARN OF COTTON OR IN SUBSTANTIAL PART OF COTTON (U.S. CL. 43).

CLASS 24—FABRICS

FOR BED BLANKETS, BED SHEETS, BED SPREADS, COVERS FOR CUSHIONS, DUVET COVERS, PILLOW CASES, PILLOW COVERS, QUILTS, SHAMS, TABLE LINEN, THROWS, TOWELS, NECK ROLL PILLOW COVERS, ALL OF COTTON OR IN SUBSTANTIAL PART OF COTTON (U.S. CLS. 42 AND 50).

MARY CRAWFORD, EXAMINING ATTORNEY

SN 77-184,454. ALLEN-EDMONDS SHOE CORPORATION, PORT WASHINGTON, WI. FILED 5-18-2007.

WOODLORE

THE MARK CONSISTS OF STANDARD CHARACTERS WITHOUT CLAIM TO ANY PARTICULAR FONT, STYLE, SIZE, OR COLOR.

OWNER OF U.S. REG. NO. 1,506,749.

CLASS 3—COSMETICS AND CLEANING PREPARATIONS

FOR SACHETS CONTAINING CEDAR SHAVINGS (U.S. CLS. 1, 4, 6, 50, 51 AND 52).

FIRST USE 0-0-1987; IN COMMERCE 0-0-1987.

CLASS 5—PHARMACEUTICALS

FOR CEDAR WOOD BLOCKS FOR USE AS A CLOTHING PROTECTOR AND/OR DEODORIZER (U.S. CLS. 6, 18, 44, 46, 51 AND 52).

FIRST USE 0-0-1987; IN COMMERCE 0-0-1987.

CLASS 20—FURNITURE AND ARTICLES NOT OTHERWISE CLASSIFIED

FOR WOODEN SHOE RACKS (U.S. CLS. 2, 13, 22, 25, 32 AND 50).

FIRST USE 0-0-1987; IN COMMERCE 0-0-1987.

CLASS 21—HOUSEWARES AND GLASS

FOR WOODEN SHOE TREES (U.S. CLS. 2, 13, 23, 29, 30, 33, 40 AND 50).

FIRST USE 0-0-1987; IN COMMERCE 0-0-1987.

MICHAEL WEBSTER, EXAMINING ATTORNEY

SN 77-184,786. NOLBOO.CO., LTD., SEOUL, REPUBLIC OF KOREA, FILED 5-18-2007.

NBG

THE MARK CONSISTS OF STANDARD CHARACTERS WITHOUT CLAIM TO ANY PARTICULAR FONT, STYLE, SIZE, OR COLOR.

CLASS 30—STAPLE FOODS

FOR COFFEE, TEA, SUGAR, MOLASSES FOR FOOD, CAKES, PIES, FLOUR, PREPARATIONS MADE FROM CEREALS, NAMELY, CEREAL-BASED SNACK FOOD, READY TO EAT CEREAL DERIVED FOOD BARS AND BREAKFAST CEREALS, POTATO FLOUR FOR FOOD, EDIBLE FLAVORED ICES, SEASONING, FOOD LEAVENING AGENTS, FLAVORING, MEAT TENDERIZERS FOR HOUSEHOLD PURPOSES (U.S. CL. 46).

CLASS 43—HOTEL AND RESTAURANT SERVICES

FOR CANTEN SERVICES, RESTAURANT SERVICES, BUFFET RESTAURANT SERVICES, HOTEL SERVICES, TEA ROOMS, PROVIDING CAMPGROUND FACILITIES, BOARDING FOR ANIMALS, RENTAL OF CHAIRS, TABLES, TABLE LINEN, GLASSWARE, PROVIDING ELDER DAY CARE SERVICES (U.S. CLS. 100 AND 101).

NORA BUCHANAN WILL, EXAMINING ATTORNEY

SN 77-185,340. ERIC SCOTT LEATHERS, LTD., SAINTE GENEVIEVE, MO. FILED 5-19-2007.

OWNER OF U.S. REG. NO. 2,765,118.

THE NAME "ERIC SCOTT" IDENTIFIES A LIVING INDIVIDUAL WHOSE CONSENT IS OF RECORD.

THE MARK CONSISTS OF ERIC SCOTT IN SCRIPT.

CLASS 16—PAPER GOODS AND PRINTED MATTER

FOR CHECK BOOK HOLDERS, PHOTO ALBUMS, NOTE PAD HOLDERS, PAPERWEIGHTS (U.S. CLS. 2, 5, 22, 23, 29, 37, 38 AND 50).

FIRST USE 10-0-1985; IN COMMERCE 10-0-1985.

CLASS 18—LEATHER GOODS

FOR PURSES, COSMETIC CASES SOLD EMPTY, LUGGAGE TAGS, WALLETS, COIN PURSES, KEY CHAINS, WRIST BAGS, TRAVEL WALLETS, HANDBAGS, SHOULDER BAGS, TOTE BAGS, CELL PHONE CASES (U.S. CLS. 1, 2, 3, 22 AND 41).

FIRST USE 10-0-1985; IN COMMERCE 10-0-1985.

LAURIE KAUFMAN, EXAMINING ATTORNEY

SN 77-185,341. ERIC SCOTT LEATHERS, LTD., SAINTE GENEVIEVE, MO. FILED 5-19-2007.

ERIC SCOTT

THE MARK CONSISTS OF STANDARD CHARACTERS WITHOUT CLAIM TO ANY PARTICULAR FONT, STYLE, SIZE, OR COLOR.

OWNER OF U.S. REG. NO. 2,765,118.

THE NAME "ERIC SCOTT" IDENTIFIES A LIVING INDIVIDUAL WHOSE CONSENT IS OF RECORD.

CLASS 16—PAPER GOODS AND PRINTED MATTER

FOR CHECK BOOK HOLDERS, PHOTO ALBUMS, NOTE PAD HOLDERS, PAPERWEIGHTS (U.S. CLS. 2, 5, 22, 23, 29, 37, 38 AND 50).
FIRST USE 10-0-1985; IN COMMERCE 10-0-1985.

CLASS 18—LEATHER GOODS

FOR PURSES, COSMETIC CASES SOLD EMPTY, LUGGAGE TAGS, WALLETS, COIN PURSES, KEY CHAINS, WRIST BAGS, TRAVEL WALLETS, HANDBAGS, SHOULDER BAGS, TOTE BAGS, CELL PHONE CASES (U.S. CLS. 1, 2, 3, 22 AND 41).
FIRST USE 10-0-1985; IN COMMERCE 10-0-1985.
LAURIE KAUFMAN, EXAMINING ATTORNEY

CLASS 11—ENVIRONMENTAL CONTROL APPARATUS

FOR ELECTRIC AND NON-ELECTRIC FONDUE SETS COMPRISED OF ELECTRIC AND NON-ELECTRIC FONDUE POTS; ELECTRIC WATER KETTLES (U.S. CLS. 13, 21, 23, 31 AND 34).

CLASS 21—HOUSEWARES AND GLASS

FOR PANS; POTS; NON-ELECTRIC COOKING UTENSILS, NAMELY, NON-ELECTRIC GRATERS AND GRILLS; FISH PANS; NON-ELECTRIC WOKS; NON-ELECTRIC WATER KETTLES; COOKING POTS; KITCHEN AND HOUSEHOLD CONTAINERS; THERMAL INSULATED CONTAINERS FOR PREPARING, PRESERVING, KEEPING HOT AND SERVING FOOD AND BEVERAGES (U.S. CLS. 2, 13, 23, 29, 30, 33, 40 AND 50).
DAVID MURRAY, EXAMINING ATTORNEY

SN 77-186,845. PLANET HOLLYWOOD (REGION IV), INC., ORLANDO, FL. FILED 5-22-2007.



NO CLAIM IS MADE TO THE EXCLUSIVE RIGHT TO USE "TOWERS", APART FROM THE MARK AS SHOWN.
THE COLOR(S) BLACK AND WHITE IS/ARE CLAIMED AS A FEATURE OF THE MARK.
THE MARK CONSISTS OF TWO BLACK LOWER CASE LETTERS, "PH", THAT ARE PLACED WITHIN TWO CONCENTRIC SEMI-CIRCLES OF DIFFERENT DIAMETERS. UNDERNEATH IS THE WORD "TOWERS" IN UPPER CASE BLACK LETTERS WITH WHITE OUTLINES.

CLASS 36—INSURANCE AND FINANCIAL

FOR VACATION REAL ESTATE TIMESHARE SERVICES, NAMELY, FINANCING, MANAGEMENT, BROKERAGE AND LEASING OF TIMESHARE PROPERTIES (U.S. CLS. 100, 101 AND 102).
FIRST USE 12-1-2006; IN COMMERCE 12-1-2006.

CLASS 43—HOTEL AND RESTAURANT SERVICES

FOR HOTEL, RESTAURANT AND BAR SERVICES (U.S. CLS. 100 AND 101).
STEVEN JACKSON, EXAMINING ATTORNEY

SN 77-187,898. DE VLEESCHOUWER, ESTHER, OOSTENDE, BELGIUM, FILED 5-23-2007.

GREENPAN

THE MARK CONSISTS OF STANDARD CHARACTERS WITHOUT CLAIM TO ANY PARTICULAR FONT, STYLE, SIZE, OR COLOR.
PRIORITY CLAIMED UNDER SEC. 44(D) ON BENELUX APPLICATION NO. 1132702, FILED 4-4-2007, REG. NO. 0821490, DATED 7-5-2007, EXPIRES 4-4-2017.

SN 77-188,981. ARES, EDDIE, KENNESAW, GA. FILED 5-23-2007.

ACADEMY BALLROOM

THE MARK CONSISTS OF STANDARD CHARACTERS WITHOUT CLAIM TO ANY PARTICULAR FONT, STYLE, SIZE, OR COLOR.

NO CLAIM IS MADE TO THE EXCLUSIVE RIGHT TO USE "BALLROOM", APART FROM THE MARK AS SHOWN.

CLASS 35—ADVERTISING AND BUSINESS

FOR PROMOTING PUBLIC AWARENESS OF BALLROOM DANCE AS A COMPETITIVE SPORT AND AS A HEALTHY, RECREATIONAL ACTIVITY (U.S. CLS. 100, 101 AND 102).
FIRST USE 4-11-2006; IN COMMERCE 4-11-2006.

CLASS 41—EDUCATION AND ENTERTAINMENT

FOR ENTERTAINMENT SERVICES, NAMELY, ORGANIZING AND CONDUCTING BALLROOM DANCE COMPETITIONS; ENTERTAINMENT SERVICES IN THE NATURE OF ORGANIZING AND CONDUCTING DANCE EVENTS, NAMELY, SOCIAL DANCES, DANCE PARTIES, DANCE PERFORMANCES AND DANCE EXHIBITIONS; EDUCATIONAL SERVICES, NAMELY, PROVIDING WORKSHOPS, SEMINARS, TEACHER TRAINING PROGRAMS AND INDIVIDUAL AND GROUP CLASSES IN THE FIELD OF DANCE (U.S. CLS. 100, 101 AND 107).
FIRST USE 4-11-2006; IN COMMERCE 4-11-2006.
MICHAEL GAAFAR, EXAMINING ATTORNEY

SN 77-189,417. ROBONICA (PTY) LTD., CENTURION, SOUTH AFRICA, FILED 5-24-2007.

RoboCombat- THE GAME

THE MARK CONSISTS OF STANDARD CHARACTERS WITHOUT CLAIM TO ANY PARTICULAR FONT, STYLE, SIZE, OR COLOR.

CLASS 9—ELECTRICAL AND SCIENTIFIC APPARATUS

FOR REMOTE CONTROL UNITS, COMPUTER PROGRAMS AND DOWNLOADABLE SOFTWARE, ALL FOR USE IN OPERATING REMOTE AND RADIO CONTROLLABLE ROBOTIC TOYS AND THEIR PARTS (U.S. CLS. 21, 23, 26, 36 AND 38).

CLASS 28—TOYS AND SPORTING GOODS

FOR ACTION SKILL GAMES; REMOTE CONTROLLABLE ROBOTIC TOYS AND PARTS AND ACCESSORIES THEREFOR; CONSTRUCTION KITS FOR CONSTRUCTING REMOTE CONTROLLABLE ROBOTIC TOYS; PARTS AND ACCESSORIES FOR USE WITH REMOTE CONTROLLABLE ROBOTIC TOYS SOLD AS A UNIT THERETO (U.S. CLS. 22, 23, 38 AND 50).
WILLIAM VERHOSEK, EXAMINING ATTORNEY

SN 77-189,447. STERLING INTERNATIONAL INC., SPOKANE, WA. FILED 5-24-2007.



THE MARK CONSISTS OF STYLIZED LETTERS "WHY".

CLASS 21—HOUSEWARES AND GLASS

FOR INSECT TRAPS; PEST CONTROL TRAPS (U.S. CLS. 2, 13, 23, 29, 30, 33, 40 AND 50).

CLASS 37—CONSTRUCTION AND REPAIR

FOR INDUSTRIAL, COMMERCIAL, AND RESIDENTIAL PEST CONTROL SERVICES FOR OTHERS, NAMELY, THE SELECTION, IMPLEMENTATION, AND USE OF PEST CONTROL TECHNOLOGY; PROVIDING ONLINE INFORMATION IN THE FIELD OF INDUSTRIAL, COMMERCIAL, AND RESIDENTIAL PEST CONTROL (U.S. CLS. 100, 103 AND 106).

CLASS 42—SCIENTIFIC AND COMPUTER SERVICES

FOR DESIGN AND DEVELOPMENT OF PEST CONTROL TECHNOLOGY (U.S. CLS. 100 AND 101).

CLASS 44—MEDICAL, BEAUTY AND AGRICULTURAL SERVICES

FOR AGRICULTURAL PEST CONTROL SERVICES FOR OTHERS, NAMELY, THE SELECTION, IMPLEMENTATION, AND USE OF PEST CONTROL TECHNOLOGY; PROVIDING ONLINE INFORMATION IN THE FIELD OF AGRICULTURAL PEST CONTROL (U.S. CLS. 100 AND 101).
JIM RINGLE, EXAMINING ATTORNEY

SN 77-190,227. SCOTTISH AMERICAN MEDIA, LLC, VALLEY VILLAGE, CA. FILED 5-25-2007.

AMERICA DANCES -- BATTLE OF THE STATES

THE MARK CONSISTS OF STANDARD CHARACTERS WITHOUT CLAIM TO ANY PARTICULAR FONT, STYLE, SIZE, OR COLOR.

CLASS 9—ELECTRICAL AND SCIENTIFIC APPARATUS

FOR AUDIO, VIDEO, STILL AND MOVING IMAGES, AND DATA RECORDINGS IN COMPRESSED AND UNCOMPRESSED FORM, NAMELY, PRE-RECORDED AUDIOCASSETTE TAPES, VIDEO TAPES, DVDS, COMPACT DISCS, RECORDS, AND CD-ROMS FEATURING MUSIC, MUSICAL ENTERTAINMENT, DANCE INSTRUCTION, AND DANCE EDUCATION (U.S. CLS. 21, 23, 26, 36 AND 38).

CLASS 41—EDUCATION AND ENTERTAINMENT

FOR ENTERTAINMENT SERVICES, NAMELY, ORGANIZING COMPETITIONS, CONTESTS, GAMES, SHOWS, ROAD SHOWS, STAGE EVENTS, THEATRICAL PERFORMANCES, CONCERTS, LIVE PERFORMANCES, AND AUDIENCE PARTICIPATION BASED EVENTS, PERTAINING TO OR FEATURING INSTRUCTION, ENTERTAINMENT, AND INFORMATION RELATING TO THE FIELDS OF MUSIC AND DANCE; PRODUCTION AND RENTAL OF SOUND AND VIDEO RECORDINGS, AND MOTION PICTURE FILMS; PRODUCTION AND SYNDICATION OF TELEVISION AND RADIO PROGRAMS; PROVIDING ENTERTAINMENT INFORMATION IN THE FIELDS OF MUSIC, DANCE, AND TELEVISION AND RADIO PROGRAMS (U.S. CLS. 100, 101 AND 107).

REBECCA SMITH, EXAMINING ATTORNEY

SN 77-190,816. SPC DIGITAL, INC., BIRMINGHAM, AL. FILED 5-25-2007.

MY HOME IDEAS

THE MARK CONSISTS OF STANDARD CHARACTERS WITHOUT CLAIM TO ANY PARTICULAR FONT, STYLE, SIZE, OR COLOR.

NO CLAIM IS MADE TO THE EXCLUSIVE RIGHT TO USE "HOME", APART FROM THE MARK AS SHOWN.

CLASS 36—INSURANCE AND FINANCIAL

FOR PROVIDING ONLINE INFORMATION IN THE FIELDS OF REAL ESTATE LISTINGS AND REAL ESTATE AGENCIES (U.S. CLS. 100, 101 AND 102).

CLASS 37—CONSTRUCTION AND REPAIR

FOR PROVIDING ONLINE INFORMATION IN THE FIELD OF REMODELING OF HOMES (U.S. CLS. 100, 103 AND 106).

CLASS 41—EDUCATION AND ENTERTAINMENT

FOR PROVIDING ONLINE INFORMATION IN THE FIELD OF ENTERTAINING LIFESTYLES IN THE NATURE OF PARTY PLANNING AND PREPARING FOR AND HOSTING DINNER PARTIES (U.S. CLS. 100, 101 AND 107).

CLASS 42—SCIENTIFIC AND COMPUTER SERVICES

FOR PROVIDING ONLINE INFORMATION IN THE FIELDS OF HOME INTERIOR DECORATING, HOME ARCHITECTURAL DESIGN AND LANDSCAPE ARCHITECTURAL DESIGN (U.S. CLS. 100 AND 101).

CLASS 44—MEDICAL, BEAUTY AND AGRICULTURAL SERVICES

FOR PROVIDING ONLINE INFORMATION IN THE FIELDS OF LANDSCAPE DESIGN, LANDSCAPE GARDENING, GARDEN CARE SERVICES, AND GARDENER AND GARDENING SERVICES (U.S. CLS. 100 AND 101).

CLASS 45—PERSONAL AND LEGAL SERVICES

FOR PROVIDING ONLINE INFORMATION IN THE FIELDS OF DIFFERENT HUMAN PERSONAL LIFESTYLES; PROVIDING ONLINE INFORMATION IN THE FIELD OF REAL ESTATE CLOSING SERVICES (U.S. CLS. 100 AND 101).

LYDIA BELZER, EXAMINING ATTORNEY

SN 77-190,822. SPC DIGITAL, INC., BIRMINGHAM, AL. FILED 5-25-2007.

MYHOMEIDEAS.COM

THE MARK CONSISTS OF STANDARD CHARACTERS WITHOUT CLAIM TO ANY PARTICULAR FONT, STYLE, SIZE, OR COLOR.

CLASS 36—INSURANCE AND FINANCIAL

FOR PROVIDING ONLINE INFORMATION IN THE FIELDS OF REAL ESTATE LISTINGS AND REAL ESTATE AGENCIES (U.S. CLS. 100, 101 AND 102).

CLASS 37—CONSTRUCTION AND REPAIR

FOR PROVIDING ONLINE INFORMATION IN THE FIELD OF REMODELING OF HOMES (U.S. CLS. 100, 103 AND 106).

CLASS 41—EDUCATION AND ENTERTAINMENT

FOR PROVIDING ONLINE INFORMATION IN THE FIELD OF ENTERTAINING LIFESTYLES IN THE NATURE OF PARTY PLANNING AND PREPARING FOR AND HOSTING DINNER PARTIES (U.S. CLS. 100, 101 AND 107).

CLASS 42—SCIENTIFIC AND COMPUTER SERVICES

FOR PROVIDING ONLINE INFORMATION IN THE FIELDS OF HOME INTERIOR DECORATING, HOME ARCHITECTURAL DESIGN AND LANDSCAPE ARCHITECTURAL DESIGN (U.S. CLS. 100 AND 101).

CLASS 44—MEDICAL, BEAUTY AND AGRICULTURAL SERVICES

FOR PROVIDING ONLINE INFORMATION IN THE FIELDS OF LANDSCAPE DESIGN, LANDSCAPE GARDENING, GARDEN CARE SERVICES, AND GARDENER AND GARDENING SERVICES (U.S. CLS. 100 AND 101).

CLASS 45—PERSONAL AND LEGAL SERVICES

FOR PROVIDING ONLINE INFORMATION IN THE FIELDS OF DIFFERENT HUMAN PERSONAL LIFESTYLES; PROVIDING ONLINE INFORMATION IN THE FIELD OF REAL ESTATE CLOSING SERVICES (U.S. CLS. 100 AND 101).

LYDIA BELZER, EXAMINING ATTORNEY

SN 77-191,816. WARBIRD ENTERTAINMENT, LLC, ATLANTA, GA. FILED 5-29-2007.

Warbird Entertainment

THE MARK CONSISTS OF STANDARD CHARACTERS WITHOUT CLAIM TO ANY PARTICULAR FONT, STYLE, SIZE, OR COLOR.

NO CLAIM IS MADE TO THE EXCLUSIVE RIGHT TO USE "ENTERTAINMENT", APART FROM THE MARK AS SHOWN.

CLASS 9—ELECTRICAL AND SCIENTIFIC APPARATUS

FOR COMPACT DISCS, CASSETTES AND TAPES FEATURING PRE-RECORDED MUSIC AND MUSICAL SOUND RECORDINGS; VIDEO CASSETTES AND LASER VIDEO DISCS FEATURING MUSIC AND MUSICAL PERFORMANCES (U.S. CLS. 21, 23, 26, 36 AND 38).

FIRST USE 7-15-2007; IN COMMERCE 7-15-2007.

CLASS 41—EDUCATION AND ENTERTAINMENT

FOR ENTERTAINMENT SERVICES IN THE NATURE OF MUSIC PRODUCTION SERVICES, NAMELY, RECORDING AND PRODUCING PERFORMANCES BY MUSICAL BANDS AND LIVE MUSIC CONCERTS (U.S. CLS. 100, 101 AND 107).

FIRST USE 7-15-2007; IN COMMERCE 7-15-2007.

CAROLYN CATALDO, EXAMINING ATTORNEY

SN 77-192,030. TERME DI SATURNIA S.R.L., SATURNIA, ITALY, FILED 5-29-2007.

SN 77-195,432. R.P. SCHERER TECHNOLOGIES, INC., LAS VEGAS, NV. FILED 6-1-2007.

SATURNIA SATELLITE



THE MARK CONSISTS OF STANDARD CHARACTERS WITHOUT CLAIM TO ANY PARTICULAR FONT, STYLE, SIZE, OR COLOR.

OWNER OF ERPN CMNTY TM OFC REG. NO. 1058726, DATED 3-17-2000, EXPIRES 1-29-2009.

OWNER OF U.S. REG. NOS. 2,436,257, 2,998,451 AND 3,018,120.

SEC. 2(F) AS TO "SATURNIA".

CLASS 41—EDUCATION AND ENTERTAINMENT

FOR ARRANGING CONFERENCES, MEETINGS AND SPECIAL EVENTS IN THE DIETETIC FOOD AND COSMETIC FIELDS (U.S. CLS. 100, 101 AND 107).

CLASS 44—MEDICAL, BEAUTY AND AGRICULTURAL SERVICES

FOR PROVIDING MEDICAL SERVICES; BEAUTY SALON SERVICES; BEAUTY SALON SERVICES FEATURING THERMAL AESTHETICAL TREATMENTS; PROVIDING THERMAL TREATMENT FOR HEALTH; VETERINARY SERVICES AND PROVIDING AGRICULTURAL ADVICE (U.S. CLS. 100 AND 101).

RUSS HERMAN, EXAMINING ATTORNEY

THE MARK CONSISTS OF THE LITERAL ELEMENT "CATALENT" WITH TWO TRIANGULAR-SHAPED FIGURES POSITIONED ON THE RIGHT SHOULDER OF THE LITERAL ELEMENT AND A SMALLER TRIANGULAR-SHAPED FIGURE POSITIONED BENEATH THE LETTERS "NT" IN THE LITERAL ELEMENT.

CLASS 35—ADVERTISING AND BUSINESS

FOR ADVERTISING; BUSINESS MANAGEMENT; BUSINESS ADMINISTRATION; OFFICE FUNCTIONS; BUSINESS CONSULTING SERVICES RELATING TO PRODUCT DISTRIBUTION, OPERATIONS MANAGEMENT SERVICES, LOGISTICS, REVERSE LOGISTICS, SUPPLY CHAIN, AND PRODUCTION SYSTEMS AND DISTRIBUTION SOLUTIONS; BUSINESS MANAGEMENT SERVICES, NAMELY, MANAGING LOGISTICS, REVERSE LOGISTICS, SUPPLY CHAIN SERVICES, SUPPLY CHAIN VISIBILITY AND SYNCHRONIZATION, SUPPLY AND DEMAND FORECASTING AND PRODUCT DISTRIBUTION PROCESSES FOR OTHERS; BUSINESS CONSULTING SERVICES IN THE FIELD OF COMMERCIALIZATION OF PHARMACEUTICAL PRODUCTS; DISTRIBUTORSHIP SERVICES IN THE FIELD OF PHARMACEUTICALS, BIOPHARMACEUTICALS, RADIOPHARMACEUTICALS, HEALTH CARE PRODUCTS AND MEDICAL PRODUCTS; INVOICING SERVICES; ORDER FULFILLMENT SERVICES; CUSTOMER SERVICE IN THE FIELD OF PHARMACEUTICAL PRODUCT DISTRIBUTION AND LOGISTICS; ELECTRONIC CUSTOMER ORDERING SERVICES FOR PHARMACEUTICALS, PHARMACEUTICAL PRODUCTS, MEDICAL PRODUCTS AND EQUIPMENT, LABORATORY SUPPLIES AND EQUIPMENT; COMPUTERIZED PHARMACEUTICAL RECORD-KEEPING AND PHARMACEUTICAL INVENTORY CONTROL SERVICES; INVENTORY MANAGEMENT IN THE FIELD OF PHARMACEUTICALS AND PHARMACEUTICAL PRODUCTS; COMPUTERIZED TRACKING AND TRACING OF PACKAGES IN TRANSIT; OPERATION OF A TELEPHONE CALL CENTER FOR OTHERS TO ASSIST IN LOCATING AND DELIVERING COMPLEX PHARMACEUTICALS AND RADIOPHARMACEUTICALS; PACKAGING OF CLINICAL, PHARMACEUTICAL AND HEALTH CARE PRODUCTS TO THE ORDER AND SPECIFICATION OF OTHERS (U.S. CLS. 100, 101 AND 102).

CLASS 39—TRANSPORTATION AND STORAGE

FOR WAREHOUSING SERVICES, NAMELY, STORAGE, DISTRIBUTION, PICK-UP, PACKING, AND SHIPPING OF PHARMACEUTICALS, BIOPHARMACEUTICALS, RADIOPHARMACEUTICALS, PHARMACEUTICAL PRODUCTS, HEALTH CARE PRODUCTS AND MEDICAL PRODUCTS; SUPPLY CHAIN, LOGISTICS AND REVERSE LOGISTICS SERVICES, NAMELY, STORAGE, TRANSPORTATION AND DELIVERY OF PHARMACEUTICALS AND PHARMACEUTICAL PRODUCTS FOR OTHERS BY AIR, RAIL, SHIP OR TRUCK (U.S. CLS. 100 AND 105).

SN 77-193,696. TABLETOPS UNLIMITED INC., CARSON, CA. FILED 5-30-2007.

Easy Life

THE MARK CONSISTS OF STANDARD CHARACTERS WITHOUT CLAIM TO ANY PARTICULAR FONT, STYLE, SIZE, OR COLOR.

CLASS 8—HAND TOOLS

FOR TABLE KNIVES, NON-ELECTRIC KITCHEN KNIVES (U.S. CLS. 23, 28 AND 44).

CLASS 21—HOUSEWARES AND GLASS

FOR PLATES, CUPS, SERVING TRAYS, CUTTING BOARDS, CANISTER SETS (U.S. CLS. 2, 13, 23, 29, 30, 33, 40 AND 50).

ELISSA GARBER KON, EXAMINING ATTORNEY

CLASS 40—MATERIAL TREATMENT

FOR TREATMENT OF MATERIALS, NAMELY, PHARMACEUTICAL AND CHEMICAL PRODUCTS AND THEIR COMPONENTS USED IN THE MANUFACTURE OF PHARMACEUTICALS, BIOPHARMACEUTICALS, NUTRACEUTICALS AND VITAMINS; MANUFACTURE OF PHARMACEUTICALS, BIOPHARMACEUTICALS, NUTRACEUTICALS AND VITAMINS TO THE ORDER AND/OR SPECIFICATION OF OTHERS (U.S. CLS. 100, 103 AND 106).

CLASS 42—SCIENTIFIC AND COMPUTER SERVICES

FOR SCIENTIFIC AND TECHNOLOGICAL CONSULTING SERVICES IN THE PHARMACEUTICAL INDUSTRY, AND RESEARCH AND DESIGN RELATING THERETO; INDUSTRIAL ANALYSIS AND RESEARCH SERVICES; DESIGN AND DEVELOPMENT OF COMPUTER HARDWARE AND SOFTWARE; PHARMACEUTICAL AND BIOPHARMACEUTICAL DRUG DEVELOPMENT SERVICES; PHARMACEUTICAL AND BIOPHARMACEUTICAL RESEARCH AND DEVELOPMENT; DEVELOPMENT OF PHARMACEUTICALS, BIOPHARMACEUTICALS, RADIOPHARMACEUTICALS, PHARMACEUTICAL PREPARATIONS, VITAMINS, MEDICINES, PHARMACEUTICAL PACKAGING AND DRUG DELIVERY TECHNOLOGIES; RESEARCH AND DEVELOPMENT OF NEW PRODUCTS FOR OTHERS; PRODUCT DEVELOPMENT CONSULTATION; PRODUCT RESEARCH SERVICES, NAMELY, PROVIDING ANALYTICAL TESTING, BIOSAFETY TESTING, REPORTING AND LABORATORY SERVICES FOR OTHERS; SCIENTIFIC AND TECHNICAL CONSULTING AND RESEARCH SERVICES FOR THE PHARMACEUTICAL INDUSTRY; CONSULTATION IN THE FIELD OF PHARMACEUTICAL DRUG DELIVERY AND DOSAGE TECHNOLOGIES; CUSTOM DESIGN AND DEVELOPMENT OF CHEMICAL REAGENTS AND BIOCHEMICAL ASSAYS (U.S. CLS. 100 AND 101).

ELISSA GARBER KON, EXAMINING ATTORNEY

SN 77-196,874. CLAWSON CUSTOM CUES, INC., JACKSONVILLE, FL. FILED 6-4-2007.

ARSENIC

THE MARK CONSISTS OF STANDARD CHARACTERS WITHOUT CLAIM TO ANY PARTICULAR FONT, STYLE, SIZE, OR COLOR.

CLASS 25—CLOTHING

FOR CLOTHING, NAMELY, SHIRTS, T-SHIRTS, SWEATSHIRTS, PANTS, SWEATPANTS, SHORTS, JACKETS, HATS AND CAPS (U.S. CLS. 22 AND 39).

CLASS 28—TOYS AND SPORTING GOODS

FOR POOL CUES AND CUE SHAFTS, BILLIARD CUES AND CUE SHAFTS, POOL TABLES, BILLIARD AND POOL ACCESSORIES, NAMELY, JOINT PROTECTORS AND CUE CASES (U.S. CLS. 22, 23, 38 AND 50).

MICHELE SWAIN, EXAMINING ATTORNEY

SN 77-202,282. RAMPAGE MMA, INC., IRVINE, CA. FILED 6-10-2007.

QUINTON "RAMPAGE" JACKSON

THE MARK CONSISTS OF STANDARD CHARACTERS WITHOUT CLAIM TO ANY PARTICULAR FONT, STYLE, SIZE, OR COLOR.

"THE NAME(S), PORTRAIT(S), AND/OR SIGNATURE(S) SHOWN IN THE MARK IDENTIFIES QUINTON JACKSON, WHOSE CONSENT(S) TO REGISTER IS SUBMITTED."

CLASS 9—ELECTRICAL AND SCIENTIFIC APPARATUS

FOR PRE-RECORDED VIDEO CASSETTES, DIGITAL VIDEO DISCS, DIGITAL VERSATILE DISCS, ALL FEATURING SPORTS AND ENTERTAINMENT IN THE NATURE OF FIGHTING AND MIXED MARTIAL ARTS CONTESTS; VIDEO GAME CARTRIDGES AND DISCS; COMPUTER GAME CARTRIDGES AND DISCS (U.S. CLS. 21, 23, 26, 36 AND 38).

FIRST USE 1-1-2004; IN COMMERCE 1-1-2004.

CLASS 16—PAPER GOODS AND PRINTED MATTER

FOR POSTERS; EVENT AND COMPETITION PROGRAMS; PHOTOGRAPHS; POSTCARDS; TRADING CARDS; STICKERS, SCRAPBOOK ALBUMS, ADDRESS BOOKS, AUTOGRAPH BOOKS, LOOSE LEAF BINDERS, DRY TRANSFER CHARACTERS, COMPUTER GAME INSTRUCTION MANUALS, DECALS, GIFT WRAPPING PAPER, NOTEBOOKS, FOLDERS, MAGAZINES FEATURING MIXED MARTIAL ARTS, TRIVIA CARDS, PAPER LUNCH SACKS (U.S. CLS. 2, 5, 22, 23, 29, 37, 38 AND 50).

FIRST USE 1-1-2004; IN COMMERCE 1-1-2004.

CLASS 25—CLOTHING

FOR WEARING APPAREL NAMELY, WARM-UP SUITS, SWEATSHIRTS, TEE-SHIRTS; MUSCLE SHIRTS; SPORTS SHIRTS; TANK TOPS; BATHING SUITS; BEACH WEAR; JOGGING SUITS; SHORTS; SHIRTS; GLOVES; UNDERWEAR; JERSEYS; HEADWEAR; FOOTWEAR; BELTS, SOCKS, HATS; CAPS; WORKOUT AND SPORTS APPAREL, NAMELY, SHORTS AND SHIRTS (U.S. CLS. 22 AND 39).

FIRST USE 1-1-2004; IN COMMERCE 1-1-2004.

CLASS 28—TOYS AND SPORTING GOODS

FOR MARTIAL ARTS GLOVES; KARATE GLOVES; WRESTLING GLOVES; BOXING GLOVES, TOY ACTION FIGURES, BOARD GAMES, CARD GAMES, TRADING CARD GAMES, DISK-TYPE TOSS TOYS, TOY BOWS AND ARROWS, BEACH BALLS, VOLLEY BALLS, FOOTBALLS, BASEBALLS, SOCCER BALLS, BOWLING BALLS, DOLLS, PLUSH TOYS, TOY VEHICLES, TOY CARS, TOY TRUCKS, TOY BUCKET AND SHOVEL SETS, TOY FIGURINES, PUPPETS, SKATEBOARDS, TOY SCOOTERS, ORNAMENTAL MASKS, AND SPORTS FACE MASKS FOR LAND ACTIVITIES, PLAYING CARDS AND HAND-HELD UNITS FOR PLAYING ELECTRONIC AND VIDEO GAMES (U.S. CLS. 22, 38 AND 50).

FIRST USE 1-1-2004; IN COMMERCE 1-1-2004.

CLASS 41—EDUCATION AND ENTERTAINMENT

FOR ENTERTAINMENT SERVICES RENDERED BY A PROFESSIONAL MIXED MARTIAL ARTS ATHLETE IN THE NATURE OF PERSONAL APPEARANCES, MIXED MARTIAL ARTS MATCHES, LIVE STAGE SHOWS AND PERFORMANCES FEATURING MIXED MARTIAL ARTS (U.S. CLS. 100, 101 AND 107).

FIRST USE 1-1-2004; IN COMMERCE 1-1-2004.
MELVIN AXILBUND, EXAMINING ATTORNEY

SN 77-202,283. RAMPAGE MMA, INC., IRVINE, CA. FILED 6-10-2007.

BLACK ASS

THE MARK CONSISTS OF STANDARD CHARACTERS WITHOUT CLAIM TO ANY PARTICULAR FONT, STYLE, SIZE, OR COLOR.

CLASS 9—ELECTRICAL AND SCIENTIFIC APPARATUS

FOR PRE-RECORDED VIDEO CASSETTES, DIGITAL VIDEO DISCS, DIGITAL VERSATILE DISCS, ALL FEATURING SPORTS AND ENTERTAINMENT IN THE NATURE OF FIGHTING AND MIXED MARTIAL ARTS CONTESTS; VIDEO GAME CARTRIDGES AND DISCS; COMPUTER GAME CARTRIDGES AND DISCS (U.S. CLS. 21, 23, 26, 36 AND 38).

CLASS 25—CLOTHING

FOR WEARING APPAREL, NAMELY, WARM-UP SUITS, SWEATSHIRTS, TEE-SHIRTS; MUSCLE SHIRTS; SPORTS SHIRTS; TANK TOPS; BATHING SUITS; BEACH WEAR; JOGGING SUITS; SHORTS; SHIRTS; GLOVES; UNDERWEAR; JERSEYS; HEADWEAR; FOOTWEAR, BELTS, SOCKS, HATS; CAPS; WORKOUT AND SPORTS APPAREL, NAMELY, SHORTS AND SHIRTS (U.S. CLS. 22 AND 39).

CLASS 41—EDUCATION AND ENTERTAINMENT

FOR ENTERTAINMENT SERVICES RENDERED BY A PROFESSIONAL MIXED MARTIAL ARTS ATHLETE IN THE NATURE OF PERSONAL APPEARANCES, MIXED MARTIAL ARTS MATCHES, LIVE STAGE SHOWS AND PERFORMANCES FEATURING MIXED MARTIAL ARTS (U.S. CLS. 100, 101 AND 107).

MELVIN AXILBUND, EXAMINING ATTORNEY

SN 77-203,341. YARD HOUSE USA, LLC, IRVINE, CA. FILED 6-11-2007.

YARD HOUSE TO YOUR HOUSE

THE MARK CONSISTS OF STANDARD CHARACTERS WITHOUT CLAIM TO ANY PARTICULAR FONT, STYLE, SIZE, OR COLOR.

OWNER OF U.S. REG. NOS. 2,441,608 AND 2,620,238.

CLASS 29—MEATS AND PROCESSED FOODS

FOR FROZEN, PREPARED AND PACKAGED MEALS CONSISTING PRIMARILY OF CHICKEN, FISH, SHELLFISH, BEEF, CALAMARI, AND TURKEY; FROZEN, PREPARED AND PACKAGED SNACK DIPS CONSISTING PRIMARILY OF VEGETABLES, CHEESE, AND SHELLFISH (U.S. CL. 46).

CLASS 30—STAPLE FOODS

FOR FROZEN, PREPARED AND PACKAGED ENTREES CONSISTING PRIMARILY OF PASTA SERVED WITH CHICKEN, CHEESE, FISH, OR SHELLFISH; FROZEN, PREPARED AND PACKAGED PIZZAS; FROZEN, PREPARED AND PACKAGED ENCHILADAS; FROZEN, PREPARED AND PACKAGED POT PIES; FROZEN, PREPARED AND PACKAGED EGG ROLLS; FROZEN, PREPARED AND PACKAGED BAKERY DESERTS AND CUSTARDS (U.S. CL. 46).

NELSON SNYDER, EXAMINING ATTORNEY

SN 77-203,350. MOVEABLE CUBICLE, INC., SAN CLEMENTE, CA. FILED 6-11-2007.

NO CLAIM IS MADE TO THE EXCLUSIVE RIGHT TO USE "CONTAINERS", APART FROM THE MARK AS SHOWN.

THE COLOR(S) RED, BLACK IS/ARE CLAIMED AS A FEATURE OF THE MARK.

THE MARK CONSISTS OF THE WORD "BOXT" IN RED LETTERS WITH BLACK SHADOWING OVER THE WORD "CONTAINERS" IN BLACK LETTERING.

CLASS 6—METAL GOODS

FOR METAL CONTAINERS FOR THE TRANSPORTATION AND STORAGE OF GOODS; METAL PORTABLE STORAGE UNITS, NAMELY CONTAINERS; PORTABLE MOBILE METAL OFFICE BUILDINGS (U.S. CLS. 2, 12, 13, 14, 23, 25 AND 50).

FIRST USE 1-1-2006; IN COMMERCE 1-1-2006.

CLASS 39—TRANSPORTATION AND STORAGE

FOR RENTING OR LEASING OF PORTABLE STORAGE UNITS, NAMELY, CONTAINERS AND TRAILERS FOR INDUSTRIAL OR COMMERCIAL USE (U.S. CLS. 100 AND 105).

FIRST USE 1-1-2006; IN COMMERCE 1-1-2006.

KATHERINE M. DUBRAY, EXAMINING ATTORNEY

SN 77-203,365. JONES, KEITH WILLIAM, SCOTTSDALE, AZ.
FILED 6-11-2007.

TO BE RE

THE MARK CONSISTS OF STANDARD CHARACTERS WITHOUT CLAIM TO ANY PARTICULAR FONT, STYLE, SIZE, OR COLOR.

CLASS 41—EDUCATION AND ENTERTAINMENT

FOR CONDUCTING SEMINARS AND WORKSHOPS IN THE FIELDS OF FITNESS, EXERCISE, NUTRITION AND RECIPES, MEDITATION, STRENGTH AND CARDIOVASCULAR TRAINING, IMPROVING MOTIVATION AND PERSONAL AND SPIRITUAL WELL BEING; ON-LINE JOURNALS, NAMELY, BLOGS FEATURING FITNESS, EXERCISE, NUTRITION AND RECIPES, MEDITATION, STRENGTH AND CARDIOVASCULAR TRAINING, IMPROVING MOTIVATION AND PERSONAL AND SPIRITUAL WELL BEING; PROVIDING AN ON-LINE COMPUTER DATABASE FEATURING INFORMATION REGARDING FITNESS AND EXERCISE; PROVIDING ASSISTANCE, PERSONAL TRAINING, AND PHYSICAL FITNESS CONSULTATION (U.S. CLS. 100, 101 AND 107).

CLASS 44—MEDICAL, BEAUTY AND AGRICULTURAL SERVICES

FOR PROVIDING AN ON-LINE COMPUTER DATABASE FEATURING INFORMATION REGARDING NUTRITION (U.S. CLS. 100 AND 101).
CHRIS WELLS, EXAMINING ATTORNEY

SN 77-203,368. JONES, KEITH WILLIAM, SCOTTSDALE, AZ.
FILED 6-11-2007.

REDISCOVER YOUR PERFECT BODY

THE MARK CONSISTS OF STANDARD CHARACTERS WITHOUT CLAIM TO ANY PARTICULAR FONT, STYLE, SIZE, OR COLOR.

CLASS 41—EDUCATION AND ENTERTAINMENT

FOR CONDUCTING SEMINARS AND WORKSHOPS IN THE FIELDS OF FITNESS, EXERCISE, NUTRITION AND RECIPES, MEDITATION, STRENGTH AND CARDIOVASCULAR TRAINING, IMPROVING MOTIVATION AND PERSONAL AND SPIRITUAL WELL BEING; ON-LINE JOURNALS, NAMELY, BLOGS FEATURING FITNESS, EXERCISE, NUTRITION AND RECIPES, MEDITATION, STRENGTH AND CARDIOVASCULAR TRAINING, IMPROVING MOTIVATION AND PERSONAL AND SPIRITUAL WELL BEING; PROVIDING AN ON-LINE COMPUTER DATABASE FEATURING INFORMATION REGARDING FITNESS AND EXERCISE; PROVIDING ASSISTANCE, PERSONAL TRAINING, AND PHYSICAL FITNESS CONSULTATION (U.S. CLS. 100, 101 AND 107).

CLASS 44—MEDICAL, BEAUTY AND AGRICULTURAL SERVICES

FOR PROVIDING AN ON-LINE COMPUTER DATABASE FEATURING INFORMATION REGARDING NUTRITION (U.S. CLS. 100 AND 101).
CHRIS WELLS, EXAMINING ATTORNEY

SN 77-203,597. JOSHUA BAILLON, 1071 CHEXBRES, SWITZERLAND, FILED 6-12-2007.

MEMOVIA STUDIOS

THE MARK CONSISTS OF STANDARD CHARACTERS WITHOUT CLAIM TO ANY PARTICULAR FONT, STYLE, SIZE, OR COLOR.

NO CLAIM IS MADE TO THE EXCLUSIVE RIGHT TO USE "STUDIOS", APART FROM THE MARK AS SHOWN.

CLASS 40—MATERIAL TREATMENT

FOR DIGITAL RESTORATION AND/OR ENHANCEMENT OF PHOTOGRAPHS; PHOTOGRAPHIC PROCESSING AND RETOUCHING; ELECTRONIC DIGITIZING OF PHOTOGRAPHS OR VIDEOS INTO A COMPUTER READABLE MEDIA OR INTO A DOWNLOADABLE FORMAT; CUSTOM MANUFACTURE OF PHOTOGRAPH POP-UP BOOKS (U.S. CLS. 100, 103 AND 106).

CLASS 41—EDUCATION AND ENTERTAINMENT

FOR PHOTOGRAPHIC AND VIDEO SERVICES, NAMELY, PHOTOGRAPHIC AND VIDEO CAPTURE; PHOTO EDITING (U.S. CLS. 100, 101 AND 107).
SHANNON TWOHIG, EXAMINING ATTORNEY

SN 77-204,380. MOVEABLE CUBICLE, INC., SAN CLEMENTE, CA. FILED 6-12-2007.

boxt \$59.99
CONTAINERS PER MONTH RENTAL
OR CALL FOR PURCHASE PRICE
PICK-UP & DELIVERY NOT INCLUDED

NO CLAIM IS MADE TO THE EXCLUSIVE RIGHT TO USE "CONTAINERS \$59.99 PER MONTH RENTAL OR CALL FOR PURCHASE PRICE PICK-UP AND DELIVERY NOT INCLUDED", APART FROM THE MARK AS SHOWN.

THE COLOR(S) RED, BLACK IS/ARE CLAIMED AS A FEATURE OF THE MARK.

THE MARK CONSISTS OF THE WORD "BOXT" IN RED LETTERS WITH BLACK SHADOWING OVER THE WORD "CONTAINERS" IN BLACK LETTERING IN A COLUMN NEXT TO THE WORDS/NUMERALS IN BLACK "\$59.99" OVER THE WORDS "PER MONTH RENTAL" OVER THE WORDS "OR CALL FOR PURCHASE PRICE". BOTH COLUMNS OVER THE WORDS "PICK-UP AND DELIVERY NOT INCLUDED".

CLASS 6—METAL GOODS

FOR METAL CONTAINERS FOR THE TRANSPORTATION AND STORAGE OF GOODS; METAL PORTABLE STORAGE UNITS, NAMELY CONTAINERS; PORTABLE MOBILE METAL OFFICE BUILDINGS (U.S. CLS. 2, 12, 13, 14, 23, 25 AND 50).

FIRST USE 1-1-2006; IN COMMERCE 1-1-2006.

CLASS 39—TRANSPORTATION AND STORAGE

FOR RENTING AND LEASING OF PORTABLE STORAGE UNITS, NAMELY CONTAINERS AND TRAILERS FOR INDUSTRIAL OR COMMERCIAL USE (U.S. CLS. 100 AND 105).

FIRST USE 1-1-2006; IN COMMERCE 1-1-2006.
KATHERINE M. DUBRAY, EXAMINING ATTORNEY

SN 77-205,059. THOMPSON, SYLVIA ANN, PORT ANGELES, WA. FILED 6-13-2007.

THERAPEUTIC WORKS

THE MARK CONSISTS OF STANDARD CHARACTERS WITHOUT CLAIM TO ANY PARTICULAR FONT, STYLE, SIZE, OR COLOR.

NO CLAIM IS MADE TO THE EXCLUSIVE RIGHT TO USE "THERAPEUTIC", APART FROM THE MARK AS SHOWN.

CLASS 40—MATERIAL TREATMENT

FOR CUSTOM MANUFACTURE OF PRESCRIPTIVE AND NON-PRESCRIPTIVE ORTHOTICS AND SHOES (U.S. CLS. 100, 103 AND 106).

FIRST USE 1-30-2004; IN COMMERCE 1-30-2004.

CLASS 42—SCIENTIFIC AND COMPUTER SERVICES

FOR DESIGN FOR OTHERS OF PRESCRIPTIVE AND NON-PRESCRIPTIVE ORTHOTICS AND SHOES (U.S. CLS. 100 AND 101).

FIRST USE 1-30-2004; IN COMMERCE 1-30-2004.

CLASS 44—MEDICAL, BEAUTY AND AGRICULTURAL SERVICES

FOR PEDORTHIC MEDICAL SERVICES FEATURING BIOMECHANICAL ASSESSMENTS, VIDEO GAIT ANALYSIS, PLANNING AND IMPLEMENTING PEDORTHIC ADJUSTMENTS TO ALLEVIATE PAIN FROM DISEASE PROCESS AND / OR DEFORMITY AND TO INCREASE AMBULATORY ABILITIES, PRESSURE MAPPING AND DISPENSING OF BRACES; FITTING OF MEDICAL ORTHOTICS AND SHOES; HEALTH CARE SERVICES FOR WOUNDS AND FEET UTILIZING SEPERATE STERILE AUTOCLAVED MEDICAL INSTRUMENTS AND EQUIPMENT PACKETS FOR EACH PATIENT (U.S. CLS. 100 AND 101).

FIRST USE 1-30-2004; IN COMMERCE 1-30-2004.
MARY BOAGNI, EXAMINING ATTORNEY

SN 77-205,545. 20/10 PERFECT VISION OPTISCHE GERAETE GMBH, HEIDELBERG, FED REP GERMANY, FILED 6-13-2007.

CUSTOMSHAPE

THE MARK CONSISTS OF STANDARD CHARACTERS WITHOUT CLAIM TO ANY PARTICULAR FONT, STYLE, SIZE, OR COLOR.

CLASS 9—ELECTRICAL AND SCIENTIFIC APPARATUS

FOR COMPUTER SOFTWARE FOR CONTROL OF OPHTHALMIC AND OPTOMETRIC APPARATUS, NAMELY, MEDICAL LASERS, INTRAOCULAR DEVICES AND SYSTEMS FOR VISION CORRECTION AND VISION ENHANCEMENT (U.S. CLS. 21, 23, 26, 36 AND 38).

CLASS 10—MEDICAL APPARATUS

FOR OPHTHALMOLOGICAL AND OPTOMETRIC APPARATUS FOR DIAGNOSTICS AND MEDICAL TREATMENT, NAMELY, REFRACTOMETERS, KERATOMETERS, OPHTHALMOMETERS, TOPOMETERS, ABERROMETERS, REFRACTIVE SURGICAL LASERS; INTRAOCULAR APPARATUS FOR VISION CORRECTION AND VISION ENHANCEMENT, NAMELY, INTRAOCULAR LENSES (U.S. CLS. 26, 39 AND 44).

EVELYN BRADLEY, EXAMINING ATTORNEY

SN 77-205,714. GEORGIA-PACIFIC CONSUMER PRODUCTS LP, ATLANTA, GA. FILED 6-14-2007.

GREEN BY DESIGN AND DESIRE

THE MARK CONSISTS OF STANDARD CHARACTERS WITHOUT CLAIM TO ANY PARTICULAR FONT, STYLE, SIZE, OR COLOR.

NO CLAIM IS MADE TO THE EXCLUSIVE RIGHT TO USE "GREEN", APART FROM THE MARK AS SHOWN.

CLASS 3—COSMETICS AND CLEANING PREPARATIONS

FOR HAND SOAPS (U.S. CLS. 1, 4, 6, 50, 51 AND 52).

CLASS 5—PHARMACEUTICALS

FOR AIR FRESHENERS (U.S. CLS. 6, 18, 44, 46, 51 AND 52).

CLASS 21—HOUSEWARES AND GLASS

FOR DISPENSERS FOR LIQUID SOAP (U.S. CLS. 2, 13, 23, 29, 30, 33, 40 AND 50).

ROBERT C. CLARK JR., EXAMINING ATTORNEY

SN 77-206,705. GLOBAL SPORTS, INC., PERTH AMBOY, NJ. FILED 6-14-2007.



OWNER OF U.S. REG. NO. 2,966,967.
NO CLAIM IS MADE TO THE EXCLUSIVE RIGHT TO USE "SPORTS & ENTERTAINMENT AGENCY", APART FROM THE MARK AS SHOWN.
THE MARK CONSISTS OF GLOBE(IMAGE) - GSEA(STYLE TEXT) GLOBAL SPORTS & ENTERTAINMENT AGENCY (TEXT).

CLASS 35—ADVERTISING AND BUSINESS

FOR ADVERTISING AND PROMOTION SERVICES AND RELATED CONSULTING; DISTRIBUTION OF ADVERTISEMENTS AND COMMERCIAL ANNOUNCEMENTS; MANAGEMENT OF PROFESSIONAL ATHLETES; TALENT AGENCIES (U.S. CLS. 100, 101 AND 102).

FIRST USE 3-1-2007; IN COMMERCE 5-15-2007.

CLASS 41—EDUCATION AND ENTERTAINMENT

FOR POST-PRODUCTION EDITING SERVICES IN THE FIELD OF MUSIC, VIDEOS AND FILMS; PRODUCTION OF SOUND AND MUSIC VIDEO RECORDINGS; TRAINING SERVICES IN THE FIELD OF ATHLETICS (U.S. CLS. 100, 101 AND 107).

FIRST USE 3-1-2007; IN COMMERCE 5-15-2007.
KYLE PEETE, EXAMINING ATTORNEY

SN 77-208,172. JAVA KOFFEE, INC., SOMERSET, NJ. FILED 6-18-2007.

Java Pro

THE MARK CONSISTS OF STANDARD CHARACTERS WITHOUT CLAIM TO ANY PARTICULAR FONT, STYLE, SIZE, OR COLOR.

NO CLAIM IS MADE TO THE EXCLUSIVE RIGHT TO USE "JAVA", APART FROM THE MARK AS SHOWN.

CLASS 11—ENVIRONMENTAL CONTROL APPARATUS

FOR ELECTRIC COFFEE MAKING MACHINE, NAMELY, MACHINE THAT BREWS, ROASTS AND GRINDS COFFEE; COFFEE ROASTERS; ELECTRIC EXPRESSO MACHINES (U.S. CLS. 13, 21, 23, 31 AND 34).

CLASS 30—STAPLE FOODS

FOR GREEN COFFEE BEANS (U.S. CL. 46).
MARK SPARACINO, EXAMINING ATTORNEY

SN 77-209,508. MIVA, INC., FORT MYERS, FL. FILED 6-19-2007.



THE MARK CONSISTS OF THE TERM "ALOT" IN A STYLIZED FORM.

CLASS 9—ELECTRICAL AND SCIENTIFIC APPARATUS

FOR DOWNLOADABLE COMPUTER SOFTWARE FOR OPERATING SEARCH ENGINES THROUGH A HOSTED CUSTOMIZED BROWSER TOOLBAR; DOWNLOADABLE COMPUTER SOFTWARE FOR USE IN INCREASING PERSONAL PRODUCTIVITY AND ACCESSING INFORMATION FROM A GLOBAL COMPUTER NETWORK; COMPUTER SEARCH ENGINE SOFTWARE; COMPUTER SHAREWARE FOR USE WITH THE WORLD WIDE WEB, NAMELY, FOR USE IN INCREASING PERSONAL PRODUCTIVITY AND ACCESSING INFORMATION FROM A GLOBAL COMPUTER NETWORK; COMPUTER SOFTWARE PLATFORMS FOR NETWORK APPLICATIONS, NAMELY, FOR THE INTEGRATION, PROVISIONING, AND EFFICIENT ADMINISTRATION OF MULTIPLE COMPUTER SOFTWARE APPLICATIONS BEING WEB-BASED APPLICATIONS, SERVER-BASED APPLICATIONS AND THIRD PARTY HOSTED APPLICATIONS (U.S. CLS. 21, 23, 26, 36 AND 38).

FIRST USE 8-17-2007; IN COMMERCE 8-17-2007.

CLASS 42—SCIENTIFIC AND COMPUTER SERVICES

FOR COMPUTER SERVICES, NAMELY, PROVIDING SEARCH ENGINES FOR OBTAINING DATA ON A GLOBAL COMPUTER NETWORK (U.S. CLS. 100 AND 101).

FIRST USE 8-17-2007; IN COMMERCE 8-17-2007.
ELLEN BURNS, EXAMINING ATTORNEY

SN 77-210,545. IRON MOUNTAIN INCORPORATED, BOSTON, MA. FILED 6-20-2007.



NO CLAIM IS MADE TO THE EXCLUSIVE RIGHT TO USE "DIGITAL", APART FROM THE MARK AS SHOWN.

CLASS 38—COMMUNICATION

FOR TRANSMISSION SERVICES, NAMELY, ONLINE DOCUMENT, ELECTRONIC RECORDS, AND EMAIL DELIVERY VIA A GLOBAL COMPUTER NETWORK; TRANSMISSION SERVICES, NAMELY, DOCUMENT DATA TRANSFER SERVICES VIA GLOBAL COMPUTER NETWORK AND E-MAIL IN THE FIELD OF BUSINESS RECORDS, ELECTRONIC BUSINESS RECORDS, FILM MEDIA, SOUND TRACKS, IMAGES AND DATA RECORDS (U.S. CLS. 100, 101 AND 104).

CLASS 39—TRANSPORTATION AND STORAGE

FOR RETENTION SERVICES, NAMELY, ELECTRONIC STORAGE OF BUSINESS RECORDS, EMAILS, INSTANT MESSAGES, FILM MEDIA, SOUND TRACKS, IMAGES, DATA RECORDS, AND DOMAIN NAME AND OTHER RECORDS AND DOCUMENTS; DOCUMENT DELIVERY SERVICES VIA NON-ELECTRONIC MEANS FOR DOCUMENTS IN HARD COPY AND IN DIGITAL MEDIA FORMAT, NAMELY, CDS, DVDS, AND MAGNETIC DATA CARRIERS; COMPUTER SERVICES IN THE NATURE OF TECHNOLOGY ESCROW SERVICES NAMELY PROVIDING ELECTRONIC STORAGE OF TECHNOLOGY RECORDS FOR OTHERS; EMAIL ARCHIVING SERVICES; RECORD RETENTION IN COMPLIANCE WITH FEDERAL, STATE AND INTERNATIONAL LAWS AND PRIVACY STANDARDS IN COMPLIANCE WITH FEDERAL, STATE AND INTERNATIONAL LAWS (U.S. CLS. 100 AND 105).

CLASS 40—MATERIAL TREATMENT

FOR DOCUMENT DESTRUCTION SERVICES (U.S. CLS. 100, 103 AND 106).

CLASS 42—SCIENTIFIC AND COMPUTER SERVICES

FOR COMPUTER SERVICES, NAMELY, DATA RECOVERY AND DATA ENCRYPTION SERVICES OF ELECTRONIC BUSINESS RECORDS, EMAILS, FILM MEDIA, SOUND TRACKS, IMAGES, DATA RECORDS AND DOMAIN NAME AND OTHER RECORDS; EMAIL SEARCHING AND RETRIEVAL SERVICES; PUBLIC DOCUMENT RETRIEVAL SERVICES; TECHNICAL SUPPORT, NAMELY, PROVIDING BACK-UP COMPUTER PROGRAMS AND FACILITIES FOR PC'S, LAPTOPS, DESKTOPS AND SERVERS; DOCUMENT DATA TRANSFER SERVICES, NAMELY, THE TRANSFER OF DOCUMENT DATA FROM ONE COMPUTER FORMAT TO ANOTHER; PHYSICAL CONVERSION SERVICES IN THE FIELD OF BUSINESS RECORDS, ELECTRONIC BUSINESS RECORDS, FILM MEDIA, SOUND TRACKS, IMAGES AND DATA RECORDS, NAMELY, THE CONVERSION OF DATA OR DOCUMENTS FROM PHYSICAL TO ELECTRONIC MEDIA; BACKUP AND DATA RECOVERY SERVICES IN THE FIELD OF BUSINESS RECORDS, ELECTRONIC BUSINESS RECORDS, EMAILS, FILM MEDIA, SOUND TRACKS, IMAGES, DATA RECORDS, AND DOMAIN NAME AND OTHER ELECTRONIC RECORDS AND DOCUMENTS; DATA WAREHOUSING SERVICES, NAMELY, ONLINE DATA MANAGEMENT ESCROW SERVICES FOR ELECTRONIC BUSINESS RECORDS, EMAILS, INSTANT MESSAGES, FILM MEDIA, SOUND TRACKS, IMAGES, DATA RECORDS, TECHNOLOGY RECORDS, AND DOMAIN NAME AND OTHER RECORDS AND DOCUMENTS (U.S. CLS. 100 AND 101).

CLASS 45—PERSONAL AND LEGAL SERVICES

FOR CONSULTING SERVICES IN THE FIELDS OF ELECTRONIC DISCOVERY IN COMPLIANCE WITH THE FEDERAL RULES OF CIVIL AND CRIMINAL PROCEDURE (U.S. CLS. 100 AND 101).
ANGELA GAW, EXAMINING ATTORNEY

SN 77-210,689. BCD TRAVEL USA LLC, ATLANTA, GA.
FILED 6-20-2007.

TRIPSOURCE

THE MARK CONSISTS OF STANDARD CHARACTERS WITHOUT CLAIM TO ANY PARTICULAR FONT, STYLE, SIZE, OR COLOR.

CLASS 9—ELECTRICAL AND SCIENTIFIC APPARATUS

FOR COMPUTER SOFTWARE FOR USE BY OTHERS TO MAKE TRAVEL RESERVATIONS, TO STORE AND ACCESS TRAVEL INFORMATION, AND TO MANAGE TRAVEL INFORMATION, ALL OF THE FOREGOING FOR USE BY BUSINESS CUSTOMERS (U.S. CLS. 21, 23, 26, 36 AND 38).

CLASS 42—SCIENTIFIC AND COMPUTER SERVICES

FOR PROVIDING TEMPORARY USE OF NON-DOWNLOADABLE SOFTWARE FOR USE BY OTHERS TO MAKE TRAVEL RESERVATIONS, TO STORE AND ACCESS TRAVEL INFORMATION, AND TO MANAGE TRAVEL INFORMATION, ALL OF THE FOREGOING FOR USE BY BUSINESS CUSTOMERS (U.S. CLS. 100 AND 101).

LINDA E. BLOHM, EXAMINING ATTORNEY

SN 77-213,207. AQUASCAPES UNLIMITED, INC., PIPERSVILLE, PA. FILED 6-22-2007.

BUG OUT

THE MARK CONSISTS OF STANDARD CHARACTERS WITHOUT CLAIM TO ANY PARTICULAR FONT, STYLE, SIZE, OR COLOR.

CLASS 21—HOUSEWARES AND GLASS

FOR INDOOR TERRARIUMS FOR PLANTS (U.S. CLS. 2, 13, 23, 29, 30, 33, 40 AND 50).
FIRST USE 3-1-2007; IN COMMERCE 3-1-2007.

CLASS 31—NATURAL AGRICULTURAL PRODUCTS

FOR LIVE PLANTS (U.S. CLS. 1 AND 46).
FIRST USE 3-1-2007; IN COMMERCE 3-1-2007.
PATRICIA EVANKO, EXAMINING ATTORNEY

SN 77-213,512. GS ADMINISTRATORS, INC., HOUSTON, TX. FILED 6-22-2007.



THE COLOR(S) BLACK, BLUE, WHITE, AND GRAY IS/ ARE CLAIMED AS A FEATURE OF THE MARK.
 THE MARK CONSISTS OF A CIRCULAR DESIGN ELEMENT THAT IS COMPRISED OF GEOMETRIC FIGURES, WHICH APPEAR IN THE COLORS BLACK AND BLUE AND HAVE GRAY AND WHITE EDGES. A GRAY SHADOW APPEARS AROUND THE DESIGN ELEMENT.

CLASS 9—ELECTRICAL AND SCIENTIFIC APPARATUS

FOR COMPUTER SOFTWARE, NAMELY, COMPUTER SOFTWARE FOR USE IN PRICING VEHICLE FINANCING AND VEHICLE INSURANCE PRODUCTS (U.S. CLS. 21, 23, 26, 36 AND 38).

CLASS 35—ADVERTISING AND BUSINESS

FOR PROVIDING A GUARANTEED PRICING PROGRAM SERVICE IN THE FIELD OF AUTOMOBILE SALES AND LEASING (U.S. CLS. 100, 101 AND 102).

CLASS 36—INSURANCE AND FINANCIAL

FOR FINANCIAL INFORMATION PROVIDED BY ELECTRONIC MEANS (U.S. CLS. 100, 101 AND 102).
 ROBERT LAVACHE, EXAMINING ATTORNEY

SN 77-214,606. SONY CHEMICALS CORPORATION OF AMERICA, MOUNT PLEASANT, PA. FILED 6-25-2007.

THE POWER OF ONE

THE MARK CONSISTS OF STANDARD CHARACTERS WITHOUT CLAIM TO ANY PARTICULAR FONT, STYLE, SIZE, OR COLOR.

CLASS 16—PAPER GOODS AND PRINTED MATTER

FOR PRINTER RIBBONS (U.S. CLS. 2, 5, 22, 23, 29, 37, 38 AND 50).

CLASS 35—ADVERTISING AND BUSINESS

FOR COMPUTERIZED ONLINE ORDERING SERVICES FEATURING PRINTER RIBBONS, AND PROVIDING BUSINESS-RELATED AND PROMOTIONAL INFORMATION IN THE FIELD OF PRINTER RIBBONS (U.S. CLS. 100, 101 AND 102).
 WILLIAM ROSSMAN, EXAMINING ATTORNEY

SN 77-214,880. ELITE PERSONAL FITNESS LTD., NEW YORK, NY. FILED 6-25-2007.

Your Body Your Life Your
 BodyWorks

THE MARK CONSISTS OF STANDARD CHARACTERS WITHOUT CLAIM TO ANY PARTICULAR FONT, STYLE, SIZE, OR COLOR.
 NO CLAIM IS MADE TO THE EXCLUSIVE RIGHT TO USE "BODYWORKS", APART FROM THE MARK AS SHOWN.

CLASS 41—EDUCATION AND ENTERTAINMENT

FOR PERSONAL TRAINING, NAMELY STRENGTH AND CONDITIONING SERVICES; EDUCATIONAL SERVICES, NAMELY PROVIDING COURSES IN THE FIELD OF WEIGHT MANAGEMENT (U.S. CLS. 100, 101 AND 107).
 FIRST USE 3-1-2007; IN COMMERCE 4-11-2007.

CLASS 44—MEDICAL, BEAUTY AND AGRICULTURAL SERVICES

FOR MASSAGE THERAPY SERVICES; WEIGHT MANAGEMENT AND NUTRITION COUNSELING (U.S. CLS. 100 AND 101).
 FIRST USE 3-1-2007; IN COMMERCE 4-11-2007.
 PAM WILLIS, EXAMINING ATTORNEY

SN 77-214,980. DLJJ & ASSOCIATES, LLC, BEVERLY HILLS, CA. FILED 6-25-2007.



THE MARK CONSISTS OF THE STYLIZED LETTER "P", WHICH FORMS THE NOSE OF AND A RING AROUND THE LEFT EYE OF A PUPPY.

CLASS 18—LEATHER GOODS

FOR PET CLOTHING; HANDBAGS; PET CARRIERS; DOG CARRIERS; PET COLLARS; PET LEASHES; LEATHER AND IMITATION LEATHER KEY CHAINS; PET ACCESSORIES, NAMELY, CANVAS, VINYL AND LEATHER POUCHES FOR HOLDING DISPOSABLE BAGS TO PLACE PET WASTE IN, SPECIALLY DESIGNED CANVAS, VINYL OR LEATHER BAGS ATTACHED TO ANIMAL LEASHES FOR HOLDING SMALL ITEMS SUCH AS KEYS, CREDIT CARDS, MONEY OR DISPOSABLE BAGS FOR DISPOSING OF PET WASTE, AND BOWS AND CHARMS FOR COLLARS (U.S. CLS. 1, 2, 3, 22 AND 41).

CLASS 20—FURNITURE AND ARTICLES NOT OTHERWISE CLASSIFIED

FOR PET BEDS; NON-METAL AND NON-LEATHER KEY CHAINS (U.S. CLS. 2, 13, 22, 25, 32 AND 50).

CLASS 21—HOUSEWARES AND GLASS

FOR PET FEEDING DISHES, NAMELY, DOG BOWLS; MUGS (U.S. CLS. 2, 13, 23, 29, 30, 33, 40 AND 50).

CLASS 31—NATURAL AGRICULTURAL PRODUCTS

FOR DOG BISCUITS, PET TREATS, PET FOOD; EXPLOSIVE SNIFFING DOGS FOR USE IN COUNTER-TERRORISM EFFORTS (U.S. CLS. 1 AND 46).
MICHAEL WEBSTER, EXAMINING ATTORNEY

SN 77-218,699. CONAGRA FOODS FEEDING CHILDREN BETTER FOUNDATION, OMAHA, NE. FILED 6-29-2007.

NOURISH TODAY, FLOURISH
TOMORROW

THE MARK CONSISTS OF STANDARD CHARACTERS WITHOUT CLAIM TO ANY PARTICULAR FONT, STYLE, SIZE, OR COLOR.

CLASS 41—EDUCATION AND ENTERTAINMENT

FOR NUTRITION EDUCATION FOR CHILDREN RENDERED THROUGH WORKSHOPS AND CLASSES (U.S. CLS. 100, 101 AND 107).

CLASS 43—HOTEL AND RESTAURANT SERVICES

FOR CHARITABLE SERVICES, NAMELY, PROVIDING FOOD FOR NEEDY CHILDREN (U.S. CLS. 100 AND 101).
C. DIONNE CLYBURN, EXAMINING ATTORNEY

SN 77-219,131. SPADAC INC., MCLEAN, VA. FILED 6-29-2007.

EARTHWEAVER

THE MARK CONSISTS OF STANDARD CHARACTERS WITHOUT CLAIM TO ANY PARTICULAR FONT, STYLE, SIZE, OR COLOR.

CLASS 9—ELECTRICAL AND SCIENTIFIC APPARATUS

FOR COMPUTER SOFTWARE PLATFORMS FOR THE DEVELOPMENT, COMPOSITION AND MAINTENANCE OF ENTERPRISE SOFTWARE IN THE FIELD OF GEOSPATIAL SYSTEMS AND RELATED ANALYTICAL ASSESSMENTS; COMPUTER SOFTWARE FOR CREATING SEARCHABLE DATABASES OF INFORMATION, DATA, WEB SERVICES AND DATA FORMATS; COMPUTER SOFTWARE FOR SPATIAL ANALYSIS DATA COMPILING AND ANALYZING FOR MILITARY AND BUSINESS PURPOSES; COMPUTER SOFTWARE FOR THE COLLECTION, EDITING, ORGANIZING, MODIFYING, BOOK MARKING, TRANSMISSION, STORAGE AND SHARING OF DATA AND INFORMATION; COMPUTER SOFTWARE THAT PROVIDES REAL-TIME, INTEGRATED BUSINESS MANAGEMENT INTELLIGENCE BY COMBINING INFORMATION FROM VARIOUS DATABASES AND PRESENTING IT IN AN EASY-TO-UNDERSTAND USER INTERFACE (U.S. CLS. 21, 23, 26, 36 AND 38).

CLASS 35—ADVERTISING AND BUSINESS

FOR COLLECTION, PREPARATION, COMPOSITION, PROCESSING, ACQUISITION AND PROVISION OF BUSINESS INFORMATION, DATA, STATISTICS AND INDICES; COMPILATION AND SYSTEMATIZATION OF INFORMATION IN THE NATURE OF WRITTEN COMMUNICATIONS AND RECORDINGS, AS WELL AS THE COMPILATION OF MATHEMATICAL, GEOSPATIAL OR STATISTICAL DATA IN DATABANKS; INFORMATION SERVICES RELATING TO BUSINESS MATTERS; PROVIDING STATISTICAL INFORMATION FOR BUSINESS OR COMMERCIAL PURPOSES; BUSINESS ADVISORY SERVICES, CONSULTANCY AND INFORMATION; BUSINESS INFORMATION MANAGEMENT (U.S. CLS. 100, 101 AND 102).

CLASS 39—TRANSPORTATION AND STORAGE

FOR STORAGE OF ELECTRONIC MEDIA, NAMELY, IMAGES, TEXT, AND AUDIO DATA IN THE NATURE OF BUSINESS INFORMATION, GEOSPATIAL INFORMATION, STATISTICS AND INDICES (U.S. CLS. 100 AND 105).

CLASS 42—SCIENTIFIC AND COMPUTER SERVICES

FOR DESIGN AND DEVELOPMENT OF INFORMATION AND DATA BASES; DATA WAREHOUSING; DATA MINING; INFORMATION TECHNOLOGY CONSULTATION; TECHNOLOGY CONSULTATION IN THE FIELDS OF GEOSPATIAL SYSTEMS, SYSTEMS ENGINEERING AND DATABASE SYSTEMS; COMPUTER SOFTWARE DEVELOPMENT AND DESIGN FOR OTHERS (U.S. CLS. 100 AND 101).
JESSICA A. POWERS, EXAMINING ATTORNEY

SN 77-219,244. SALLY'S CHOCOLATE LLC, HUNTINGTON, NY. FILED 6-29-2007.

SN 77-219,283. SALLY'S CHOCOLATE LLC, HUNTINGTON, NY. FILED 6-29-2007.

SALLY'S COCOFE

THE MARK CONSISTS OF STANDARD CHARACTERS WITHOUT CLAIM TO ANY PARTICULAR FONT, STYLE, SIZE, OR COLOR.

THE NAME "SALLY" DOES NOT IDENTIFY A LIVING INDIVIDUAL.

THE WORDING "COCOFE" HAS NO MEANING IN ENGLISH.

CLASS 35—ADVERTISING AND BUSINESS

FOR RETAIL STORE SERVICES FEATURING CHOCOLATE, COFFEE AND OTHER FOODS AND BEVERAGES; STAND AND COUNTER SERVICES, BOTH IN THE NATURE OF CONCESSION STANDS AND FOOD AND BEVERAGE KIOSKS IN THE FIELDS OF FEATURING CHOCOLATE, COFFEE, AND OTHER FOODS AND BEVERAGE, ALL FEATURED IN RETAIL STORES, AIRPORTS, MALLS AND OTHER LARGE PUBLIC PLACES (U.S. CLS. 100, 101 AND 102).

CLASS 43—HOTEL AND RESTAURANT SERVICES

FOR CAFES AND RESTAURANTS FEATURING CHOCOLATE, COFFEE AND OTHER FOODS AND BEVERAGES (U.S. CLS. 100 AND 101).

MAUREEN DALL, EXAMINING ATTORNEY

SN 77-219,266. SALLY'S CHOCOLATE LLC, HUNTINGTON, NY. FILED 6-29-2007.

COCOFE

THE MARK CONSISTS OF STANDARD CHARACTERS WITHOUT CLAIM TO ANY PARTICULAR FONT, STYLE, SIZE, OR COLOR.

THE WORDING "COCOFE" HAS NO MEANING IN ENGLISH.

CLASS 35—ADVERTISING AND BUSINESS

FOR RETAIL STORE SERVICES FEATURING CHOCOLATE, COFFEE AND OTHER FOODS AND BEVERAGES; STAND AND COUNTER SERVICES, BOTH IN THE NATURE OF CONCESSION STANDS AND FOOD AND BEVERAGE KIOSKS IN THE FIELDS OF FEATURING CHOCOLATE, COFFEE, AND OTHER FOODS AND BEVERAGE, ALL FEATURED IN RETAIL STORES, AIRPORTS, MALLS AND OTHER LARGE PUBLIC PLACES (U.S. CLS. 100, 101 AND 102).

CLASS 43—HOTEL AND RESTAURANT SERVICES

FOR CAFES AND RESTAURANTS FEATURING CHOCOLATE, COFFEE AND OTHER FOODS AND BEVERAGES (U.S. CLS. 100 AND 101).

MAUREEN DALL, EXAMINING ATTORNEY

SALLY'S COCOFE FOR THE LOVE OF CHOCOLATE

THE MARK CONSISTS OF STANDARD CHARACTERS WITHOUT CLAIM TO ANY PARTICULAR FONT, STYLE, SIZE, OR COLOR.

THE NAME "SALLY" DOES NOT IDENTIFY A LIVING INDIVIDUAL.

THE WORDING "COCOFE" HAS NO MEANING IN ENGLISH.

CLASS 35—ADVERTISING AND BUSINESS

FOR RETAIL STORE SERVICES FEATURING CHOCOLATE, COFFEE AND OTHER FOODS AND BEVERAGES; STAND AND COUNTER SERVICES, BOTH IN THE NATURE OF CONCESSION STANDS AND FOOD AND BEVERAGE KIOSKS IN THE FIELDS OF FEATURING CHOCOLATE, COFFEE, AND OTHER FOODS AND BEVERAGE, ALL FEATURED IN RETAIL STORES, AIRPORTS, MALLS AND OTHER LARGE PUBLIC PLACES (U.S. CLS. 100, 101 AND 102).

CLASS 43—HOTEL AND RESTAURANT SERVICES

FOR CAFES AND RESTAURANTS FEATURING CHOCOLATE, COFFEE AND OTHER FOODS AND BEVERAGES (U.S. CLS. 100 AND 101).

MAUREEN DALL, EXAMINING ATTORNEY

SN 77-220,205. CENTER FOR FAITH AND FREEDOM, INC., SARASOTA, FL. FILED 7-2-2007.



NO CLAIM IS MADE TO THE EXCLUSIVE RIGHT TO USE "PRODUCTIONS", APART FROM THE MARK AS SHOWN.

CLASS 35—ADVERTISING AND BUSINESS

FOR PRODUCTION OF TELEVISION COMMERCIALS AND PUBLIC SERVICE ANNOUNCEMENTS FOR SELECTED NONPROFIT ORGANIZATIONS; PRODUCING PROMOTIONAL VIDEOTAPES, VIDEO DISCS, AND AUDIO VISUAL RECORDINGS; PRODUCTION AND DISTRIBUTION OF PROMOTIONS FOR SELECTED NONPROFIT ORGANIZATIONS IN THE NATURE OF RADIO AND TELEVISION COMMERCIALS (U.S. CLS. 100, 101 AND 102).

FIRST USE 6-1-1998; IN COMMERCE 6-1-1998.

CLASS 41—EDUCATION AND ENTERTAINMENT

FOR PRODUCTION OF AUDIO AND VIDEO DISCS AND TAPES; EDITING OF AUDIO AND VIDEO RECORDINGS; PRODUCTION OF AUDIO AND VIDEO TAPES AND DVDS FOR SELECTED NONPROFIT ORGANIZATIONS TO HIGHLIGHT THEIR CHARITABLE MISSIONS (U.S. CLS. 100, 101 AND 107).

FIRST USE 6-1-1998; IN COMMERCE 6-1-1998.
CHRISTINE COOPER, EXAMINING ATTORNEY

SN 77-221,786. PEARSON EDUCATION, INC., UPPER SADDLE RIVER, NJ. FILED 7-3-2007.

POPTROPICA

THE MARK CONSISTS OF STANDARD CHARACTERS WITHOUT CLAIM TO ANY PARTICULAR FONT, STYLE, SIZE, OR COLOR.

CLASS 38—COMMUNICATION

FOR PROVIDING ON-LINE CHAT ROOMS AND ELECTRONIC BULLETIN BOARDS FOR TRANSMISSION OF MESSAGES AMONG USERS IN THE FIELD OF GENERAL INTEREST; PROVIDING EMAIL AND INSTANT MESSAGING SERVICES (U.S. CLS. 100, 101 AND 104).

CLASS 41—EDUCATION AND ENTERTAINMENT

FOR ENTERTAINMENT SERVICES, NAMELY, PROVIDING VIDEOS FEATURING ANIMATION, PRE-RECORDED MUSICAL RECORDINGS, VIDEO RECORDINGS FEATURING CARTOONS, AND ON-LINE INTERACTIVE SINGLE AND MULTI-PLAYER COMPUTER GAMES, VIA COMPUTER NETWORKS AND GLOBAL COMMUNICATIONS NETWORKS; EDUCATIONAL SERVICES, NAMELY, PROVIDING A WEBSITE FEATURING INTERACTIVE EDUCATIONAL INFORMATION AND QUIZZES FOR CHILDREN (U.S. CLS. 100, 101 AND 107).

CLASS 45—PERSONAL AND LEGAL SERVICES

FOR INTERNET BASED SOCIAL NETWORKING SERVICES (U.S. CLS. 100 AND 101).
JIM RINGLE, EXAMINING ATTORNEY

SN 77-221,870. JIBBITZ, LLC, BOULDER, CO. FILED 7-3-2007.

JIBBITZ

THE MARK CONSISTS OF STANDARD CHARACTERS WITHOUT CLAIM TO ANY PARTICULAR FONT, STYLE, SIZE, OR COLOR.

OWNER OF U.S. REG. NOS. 3,180,450, 3,183,379 AND 3,183,380.

CLASS 16—PAPER GOODS AND PRINTED MATTER

FOR LUNCH BAGS (U.S. CLS. 2, 5, 22, 23, 29, 37, 38 AND 50).

CLASS 18—LEATHER GOODS

FOR LUGGAGE AND LUGGAGE STRAPS, BAGS, NAMELY, PURSES, SHOULDER BAGS, MESSENGER BAGS, BACKPACKS, TOTE BAGS, DIAPER BAGS (U.S. CLS. 1, 2, 3, 22 AND 41).

MATTHEW PAPPAS, EXAMINING ATTORNEY

SN 77-222,939. NISSAN FORKLIFT CORPORATION, NORTH AMERICA, MARENGO, IL. FILED 7-5-2007.

DURA-LIFT

THE MARK CONSISTS OF STANDARD CHARACTERS WITHOUT CLAIM TO ANY PARTICULAR FONT, STYLE, SIZE, OR COLOR.

CLASS 3—COSMETICS AND CLEANING PREPARATIONS

FOR CLEANING PREPARATIONS FOR USE WITH FORKLIFT PARTS (U.S. CLS. 1, 4, 6, 50, 51 AND 52).
FIRST USE 0-0-1988; IN COMMERCE 0-0-1988.

CLASS 4—LUBRICANTS AND FUELS

FOR MINERAL OIL, GREASES AND LUBRICANTS FOR USE WITH FORKLIFT PRODUCTS (U.S. CLS. 1, 6 AND 15).

FIRST USE 0-0-1988; IN COMMERCE 0-0-1988.

CLASS 7—MACHINERY

FOR FORKLIFT PARTS, NAMELY, TUNE-UP KITS, COMPRISING CONTACT POINTS, SPARK PLUGS AND VOLTAGE CONDENSERS; HYDRAULIC JACKS FOR FORKLIFTS; FORKLIFT ENGINES AND PARTS THEREFOR (U.S. CLS. 13, 19, 21, 23, 31, 34 AND 35).

FIRST USE 0-0-1988; IN COMMERCE 0-0-1988.

KATINA MISTER, EXAMINING ATTORNEY

SN 77-223,947. SAPPAY, INC., SEATTLE, WA. FILED 7-6-2007.

Virtucard

THE MARK CONSISTS OF STANDARD CHARACTERS WITHOUT CLAIM TO ANY PARTICULAR FONT, STYLE, SIZE, OR COLOR.

CLASS 35—ADVERTISING AND BUSINESS

FOR OPERATING ON-LINE MARKETPLACES FOR SELLERS OF GOODS AND/OR SERVICES; ADMINISTRATION, BILLING, AND RECONCILIATION OF ACCOUNTS ON BEHALF OF OTHERS; MEDIATION OF AGREEMENTS REGARDING THE SALE AND PURCHASE OF GOODS AND SERVICES BETWEEN BUYERS AND SELLERS (U.S. CLS. 100, 101 AND 102).

SN 77-224,955. INSTITUTE OF MANAGEMENT ACCOUNTANTS, MONTVALE, NJ. FILED 7-9-2007.

IMA FINANCE GRC RESEARCH
PRACTICE

CLASS 36—INSURANCE AND FINANCIAL

FOR ELECTRONIC COMMERCE PAYMENT SERVICES, NAMELY, ESTABLISHING ACCOUNTS USED TO PURCHASE GOODS AND SERVICES FROM SELECTED PROVIDERS ON THE INTERNET; ELECTRONIC FUNDS TRANSFER, NAMELY, ACCEPTING PAYMENTS ON BEHALF OF PROVIDERS OF GOODS AND SERVICES; ELECTRONIC PAYMENT, NAMELY, ELECTRONIC PROCESSING AND TRANSMISSION OF BILL PAYMENT DATA (U.S. CLS. 100, 101 AND 102).

MORGAN WYNNE, EXAMINING ATTORNEY

THE MARK CONSISTS OF STANDARD CHARACTERS WITHOUT CLAIM TO ANY PARTICULAR FONT, STYLE, SIZE, OR COLOR.

OWNER OF U.S. REG. NOS. 1,811,163 AND 2,285,425.

NO CLAIM IS MADE TO THE EXCLUSIVE RIGHT TO USE "FINANCE GRC RESEARCH PRACTICE", APART FROM THE MARK AS SHOWN.

CLASS 9—ELECTRICAL AND SCIENTIFIC APPARATUS

FOR PRE-RECORDED AUDIO/VIDEO RECORDINGS, NAMELY, TAPES, CDS, DVDS, CD ROMS, CONTAINING COURSES OF INSTRUCTION FOR FINANCIAL SERVICES PROFESSIONALS ABOUT GOVERNANCE, RISK, AND COMPLIANCE ISSUES (U.S. CLS. 21, 23, 26, 36 AND 38).

CLASS 41—EDUCATION AND ENTERTAINMENT

FOR EDUCATIONAL SERVICES, NAMELY, PROVIDING COURSES OF INSTRUCTION, CONFERENCES, MEETINGS, AND WEBINARS FOR FINANCIAL SERVICES PROFESSIONALS ABOUT GOVERNANCE, RISK, AND COMPLIANCE ISSUES, AND DISTRIBUTING ONLINE COURSE MATERIAL IN CONNECTION THEREWITH; EDUCATIONAL SERVICES, NAMELY, PROVIDING COURSES OF INSTRUCTION AND WEBINARS IN THE FIELD OF EXAMINATION PREPARATION FOR FINANCIAL SERVICES PROFESSIONALS ABOUT GOVERNANCE, RISK, AND COMPLIANCE ISSUES; EDUCATIONAL TESTING (U.S. CLS. 100, 101 AND 107).

SARA THOMAS, EXAMINING ATTORNEY

SN 77-224,853. NORCROSS SAFETY PRODUCTS L.L.C., ROCK ISLAND, IL. FILED 7-9-2007.



OWNER OF U.S. REG. NO. 2,284,072.
NO CLAIM IS MADE TO THE EXCLUSIVE RIGHT TO USE "CO.", APART FROM THE MARK AS SHOWN.

THE MARK CONSISTS OF THE WORDS "MUCK BOOT CO." WITHIN AN ELONGATED OVAL WITH A LINE AROUND THE PERIMETER OF THE OVAL.

CLASS 7—MACHINERY

FOR POWER LAWN AND GARDEN TOOLS, NAMELY, CHIPPERS AND SHREDDERS (U.S. CLS. 13, 19, 21, 23, 31, 34 AND 35).

CLASS 8—HAND TOOLS

FOR LAWN AND GARDEN TOOLS, NAMELY, WEEDING FORKS, RAKES, MANUAL CLIPPERS, CULTIVATORS, EDGERS, TROWELS, FORKS, HOES; POCKET KNIVES; HAND TOOLS FOR HORSE CARE, NAMELY, HOOF PICKS; PET GROOMING PRODUCTS, NAMELY, CLIPPERS AND SCISSORS (U.S. CLS. 23, 28 AND 44).

LEE-ANNE BERNS, EXAMINING ATTORNEY

SN 77-225,301. TANFORAN LLC, LOS ALAMITOS, CA. FILED 7-9-2007.



NO CLAIM IS MADE TO THE EXCLUSIVE RIGHT TO USE "CYPRESS", APART FROM THE MARK AS SHOWN.

CLASS 18—LEATHER GOODS

FOR FUR, LEATHER BAGS, LEATHER CASES; LEATHER BRIEF CASES; LEATHER KEY CHAINS; LEATHER PURSES; LEATHER STRAPS; LEATHER POUCHES; TRAVELING CASES OF LEATHER (U.S. CLS. 1, 2, 3, 22 AND 41).

FIRST USE 0-0-1995; IN COMMERCE 0-0-1995.

CLASS 25—CLOTHING

FOR FUR COATS, FUR JACKETS, FUR HATS, FUR MUFFS, FUR GLOVES, AND LEATHER BELTS (U.S. CLS. 22 AND 39).

FIRST USE 0-0-1995; IN COMMERCE 0-0-1995.
MELVIN AXILBUND, EXAMINING ATTORNEY

SN 77-225,465. NORCROSS SAFETY PRODUCTS L.L.C.,
ROCK ISLAND, IL. FILED 7-10-2007.

THE ORIGINAL MUCK BOOT
COMPANY

THE MARK CONSISTS OF STANDARD CHARACTERS WITHOUT CLAIM TO ANY PARTICULAR FONT, STYLE, SIZE, OR COLOR.

OWNER OF U.S. REG. NO. 2,284,072.

NO CLAIM IS MADE TO THE EXCLUSIVE RIGHT TO USE "ORIGINAL" AND "COMPANY", APART FROM THE MARK AS SHOWN.

CLASS 7—MACHINERY

FOR POWER LAWN AND GARDEN TOOLS, NAMELY, CHIPPERS AND SHREDDERS (U.S. CLS. 13, 19, 21, 23, 31, 34 AND 35).

CLASS 8—HAND TOOLS

FOR LAWN AND GARDEN TOOLS, NAMELY, WEEDING FORKS, RAKES, MANUAL CLIPPERS, CULTIVATORS, EDGERS, TROWELS, FORKS, HOES; POCKET KNIVES; HAND TOOLS FOR HORSE CARE, NAMELY, HOOF PICKS; PET GROOMING PRODUCTS, NAMELY, CLIPPERS AND SCISSORS (U.S. CLS. 23, 28 AND 44).

LEE-ANNE BERNS, EXAMINING ATTORNEY

SN 77-226,497. LYMABEAN, LLC, HUNTINGTON BEACH,
CA. FILED 7-11-2007.

LYMABEAN

THE MARK CONSISTS OF STANDARD CHARACTERS WITHOUT CLAIM TO ANY PARTICULAR FONT, STYLE, SIZE, OR COLOR.

CLASS 35—ADVERTISING AND BUSINESS

FOR ON-LINE ADVERTISING ON COMPUTER COMMUNICATION NETWORKS; PROMOTING, ADVERTISING AND MARKETING OF THE ON-LINE WEBSITES OF OTHERS; PROMOTION, ADVERTISING AND MARKETING OF ON-LINE WEBSITES; PROVIDING SPACE AT A WEB SITE FOR THE ADVERTISEMENT OF THE GOODS AND SERVICES OF OTHERS; DISSEMINATION OF ADVERTISING FOR OTHERS VIA AN ON-LINE COMMUNICATIONS NETWORK ON THE INTERNET; DISSEMINATION OF ADVERTISING FOR OTHERS VIA THE INTERNET; ON-LINE ADVERTISING AND MARKETING SERVICES; DISSEMINATION OF ADVERTISING, SCHEDULING AND MANAGING OF TRAINING COURSES AND PROGRAMS FOR OTHERS VIA A GLOBAL COMPUTER NETWORK; PROMOTING THE GOODS AND SERVICES OF OTHERS VIA A GLOBAL COMPUTER NETWORK; PROVIDING A WEB SITE WHICH FEATURES ADVERTISEMENTS FOR THE GOODS AND SERVICES OF OTHERS ON A GLOBAL COMPUTER NETWORK (U.S. CLS. 100, 101 AND 102).

CLASS 45—PERSONAL AND LEGAL SERVICES

FOR ONLINE SOCIAL NETWORKING SERVICES (U.S. CLS. 100 AND 101).

GEORGE LORENZO, EXAMINING ATTORNEY

SN 77-226,587. YESVIDEO, INC., SANTA CLARA, CA. FILED
7-11-2007.

YESLAW

THE MARK CONSISTS OF STANDARD CHARACTERS WITHOUT CLAIM TO ANY PARTICULAR FONT, STYLE, SIZE, OR COLOR.

CLASS 9—ELECTRICAL AND SCIENTIFIC APPARATUS

FOR COMPUTER HARDWARE AND SOFTWARE FOR VIEWING, EDITING, SYNCHRONIZING AND ENCODING VIDEO (U.S. CLS. 21, 23, 26, 36 AND 38).

FIRST USE 10-0-2002; IN COMMERCE 10-0-2002.

CLASS 38—COMMUNICATION

FOR STREAMING OF VIDEO MATERIAL ON THE INTERNET (U.S. CLS. 100, 101 AND 104).

FIRST USE 4-22-2007; IN COMMERCE 4-22-2007.

CLASS 42—SCIENTIFIC AND COMPUTER SERVICES

FOR VIDEO SYNCHRONIZATION SERVICES, NAMELY, DIGITAL TRANSFER SERVICES TRANSFERRING VIDEO INTO DIGITAL FORMAT; VIDEO HOSTING OF DIGITAL CONTENT ON THE INTERNET (U.S. CLS. 100 AND 101).

FIRST USE 10-0-2002; IN COMMERCE 10-0-2002.
SUSAN STIGLITZ, EXAMINING ATTORNEY

SN 77-226,858. HELEN ROSS M.D., PC, NOGALES, AZ.
FILED 7-11-2007.

HEMP, HEMP HOORAY!

THE MARK CONSISTS OF STANDARD CHARACTERS WITHOUT CLAIM TO ANY PARTICULAR FONT, STYLE, SIZE, OR COLOR.

NO CLAIM IS MADE TO THE EXCLUSIVE RIGHT TO USE "HEMP, HEMP", APART FROM THE MARK AS SHOWN.

CLASS 25—CLOTHING

FOR SHIRTS, BLOUSES, DRESSES, SKIRTS, JACKETS, COATS, HATS, SHAWLS, GLOVES, SHOES, SOCKS, AND UNDERWEAR MADE WHOLLY OR SUBSTANTIALLY IN PART OF HEMP (U.S. CLS. 22 AND 39).

CLASS 35—ADVERTISING AND BUSINESS

FOR ON-LINE RETAIL STORE SERVICES FEATURING MEDICAL AND BEAUTY PRODUCTS, SPECIFICALLY SKIN, HAIR, AND NAIL PRODUCTS, LIPSTICKS, LIP BALMS, SHAMPOOS/CONDITIONERS AND OTHER HAIR, SKIN AND NAIL PRODUCTS; RETAIL STORE SERVICES FEATURING MEDICAL AND BEAUTY PRODUCTS, SPECIFICALLY SKIN, HAIR, AND NAIL PRODUCTS, LIPSTICKS, LIP BALMS, SHAMPOOS/CONDITIONERS AND OTHER HAIR, SKIN AND NAIL PRODUCTS; AND WHOLESALE STORES FEATURING MEDICAL AND BEAUTY PRODUCTS, SPECIFICALLY SKIN, HAIR, AND NAIL PRODUCTS, LIPSTICKS, LIP BALMS, SHAMPOOS/CONDITIONERS AND OTHER HAIR, SKIN AND NAIL PRODUCTS (U.S. CLS. 100, 101 AND 102).

JULIE WATSON, EXAMINING ATTORNEY

SN 77-228,844. MARGARET CHIU, CENTRAL, HONG KONG, FILED 7-13-2007.

H+

THE MARK CONSISTS OF STANDARD CHARACTERS WITHOUT CLAIM TO ANY PARTICULAR FONT, STYLE, SIZE, OR COLOR.

CLASS 7—MACHINERY

FOR MACHINE FOR DISPENSING AND PRODUCING HYDROGEN PLUS WATER; MACHINE FOR DISPENSING AND PRODUCING STRUCTURE WATER WITH HYDROGEN UNIT TECHNOLOGY TO PURIFY AND PRODUCE FLAVORED AND FUNCTIONAL WATER AND ACTIVE HYDROGEN PLUS WATER; ALL FOR PERSONAL, HOUSEHOLD AND INDUSTRIAL USE (U.S. CLS. 13, 19, 21, 23, 31, 34 AND 35).

CLASS 32—LIGHT BEVERAGES

FOR BOTTLED DRINKING WATER; BOTTLED WATER; BOTTLED MINERAL WATER; BOTTLED MINERAL WATER WITH HYDROGEN PLUS; BOTTLED PURIFIED WATER WITH HYDROGEN PLUS; BOTTLED ACTIVE HYDROGEN PLUS WATER AND BOTTLED HYDROGEN PLUS WATER; FLAVORED WATERS; DISTILLED DRINKING WATER; ENERGY DRINKS; FRUIT-FLAVORED BEVERAGES; MINERAL WATER; NON-ALCOHOLIC BEVERAGES, NAMELY, CARBONATED BEVERAGES; SPRING WATER; STILL WATER; ALL FOR PERSONAL, AND HOUSEHOLD USE (U.S. CLS. 45, 46 AND 48).

GINA HAYES, EXAMINING ATTORNEY

SN 77-229,026. FLEETCOR TECHNOLOGIES OPERATING COMPANY, LLC, NORCROSS, GA. FILED 7-13-2007.

THE FIRST AND ONLY SOURCE FOR GROWING YOUR FLEET CARD BUSINESS

THE MARK CONSISTS OF STANDARD CHARACTERS WITHOUT CLAIM TO ANY PARTICULAR FONT, STYLE, SIZE, OR COLOR.

OWNER OF U.S. REG. NO. 1,364,841.

CLASS 35—ADVERTISING AND BUSINESS

FOR RETAIL MOTOR FUEL SUPPLY SERVICES FOR VEHICLE FLEET OWNERS; PREPARING BUSINESS REPORTS FOR THE TRANSPORTATION AND VEHICLE FLEET INDUSTRIES; BILLING AND DATA PROCESSING SERVICES FOR THE TRANSPORTATION AND VEHICLE FLEET INDUSTRIES; BUSINESS MANAGEMENT, INVENTORY CONTROL, AND BOOKKEEPING FOR TRANSPORTATION AND VEHICLE FLEET INDUSTRIES; AND WHOLESALE DISTRIBUTORSHIPS FEATURING MOTOR VEHICLE FUELS, LUBRICANTS, AND PETROLEUM PRODUCTS (U.S. CLS. 100, 101 AND 102).

FIRST USE 6-25-2006; IN COMMERCE 6-25-2006.

CLASS 36—INSURANCE AND FINANCIAL

FOR CREDIT CARD SERVICES FOR THE PURPOSE OF PURCHASING MOTOR FUELS, PETROLEUM PRODUCTS, AND VEHICLE MAINTENANCE, OPERATING THROUGH RETAIL FUEL STATIONS, TRUCK STOPS, AND AUTOMATED FUELING OUTLETS (U.S. CLS. 100, 101 AND 102).

FIRST USE 6-25-2006; IN COMMERCE 6-25-2006.

DAVID TOOLEY, EXAMINING ATTORNEY

SN 77-229,638. IKO PRODUCTIONS, INC., ALTAMONTE SPRINGS, FL. FILED 7-13-2007.

Because you don't have to
be a superhero to save the
world.

THE MARK CONSISTS OF STANDARD CHARACTERS WITHOUT CLAIM TO ANY PARTICULAR FONT, STYLE, SIZE, OR COLOR.

CLASS 16—PAPER GOODS AND PRINTED MATTER

FOR GROCERY BAGS (U.S. CLS. 2, 5, 22, 23, 29, 37, 38 AND 50).
FIRST USE 1-28-2007; IN COMMERCE 2-1-2007.

CLASS 18—LEATHER GOODS

FOR ALL PURPOSE CARRYING BAGS (U.S. CLS. 1, 2, 3, 22 AND 41).
FIRST USE 1-28-2007; IN COMMERCE 2-1-2007.
ESTHER A. BORSUK, EXAMINING ATTORNEY

SN 77-229,704. OURSPACE.COM MEDIA, LLC, TOWSON, MD. FILED 7-13-2007.

OURSPACE.COM

THE MARK CONSISTS OF STANDARD CHARACTERS WITHOUT CLAIM TO ANY PARTICULAR FONT, STYLE, SIZE, OR COLOR.

CLASS 9—ELECTRICAL AND SCIENTIFIC APPARATUS

FOR DOWNLOADABLE RINGTONES VIA THE INTERNET AND WIRELESS DEVICES, NAMELY, MOBILE PHONES (U.S. CLS. 21, 23, 26, 36 AND 38).

CLASS 35—ADVERTISING AND BUSINESS

FOR ADVERTISING, NAMELY, ONLINE ADVERTISING ON COMPUTER NETWORKS FOR OTHERS, AND PROMOTING THE GOODS, SERVICES, BRAND IDENTITY AND COMMERCIAL INFORMATION AND NEWS OF OTHERS THROUGH THE ONLINE MEDIUM; RENTAL OF ADVERTISING SPACE ON THE INTERNET; ADVERTISING AND MARKETING ON A DIGITAL NETWORK; MARKET RESEARCH; SAMPLE DISTRIBUTION FOR ADVERTISING PURPOSES; SALES PROMOTION SERVICES; PUBLIC RELATIONS; COMPILATION AND SYSTEMIZATION OF INFORMATION INTO COMPUTER DATABASES; AND ON-LINE RETAIL STORE SERVICES FEATURING RING TONES WHICH ARE TRANSMITTED TO MOBILE PHONES; AND ON-LINE RETAIL STORE SERVICES FEATURING DOWNLOADABLE RING TONES (U.S. CLS. 100, 101 AND 102).

CLASS 38—COMMUNICATION

FOR TELECOMMUNICATION SERVICES, NAMELY, ELECTRONIC TRANSMISSION OF STREAMED AND DOWNLOADABLE AUDIO AND VIDEO FILES AND MOVIES VIA COMPUTER NETWORKS; PROVIDING MULTIPLE USE ACCESS TO GLOBAL COMPUTER INFORMATION NETWORKS FOR THE DISSEMINATION OF MOVIES, MUSIC AND VIDEO INFORMATION VIA AN INTERNET-BASED DATABASE; PROVIDING ONLINE CHAT ROOMS, ELECTRONIC BULLETIN BOARDS AND ONLINE COMMUNITY FORUMS FOR THE TRANSMISSION OF MESSAGES AMONG COMPUTER USERS CONCERNING ENTERTAINMENT, MUSIC, CONCERTS, VIDEOS, RADIO, TELEVISION, FILM, NEWS, SPORTS, GAMES AND CULTURAL EVENTS; WEB CASTING SERVICES; DELIVERY OF MESSAGES BY ELECTRONIC TRANSMISSION; AND PROVISION OF FRAME RELAY CONNECTIVITY SERVICES AND ACCESS TO ELECTRONIC COMMUNICATIONS NETWORKS, FOR TRANSMISSION OR RECEPTION OF AUDIO, VIDEO, MOVIES AND/OR MULTIMEDIA CONTENT (U.S. CLS. 100, 101 AND 104).

CLASS 41—EDUCATION AND ENTERTAINMENT

FOR ENTERTAINMENT SERVICES, NAMELY, ARRANGING AND CONDUCTING ONLINE CONTESTS ABOUT ENTERTAINMENT, MUSIC, CONCERTS, VIDEOS, RADIO, TELEVISION, FILM, NEWS, SPORTS, GAMES AND CULTURAL EVENTS; ELECTRONIC PUBLISHING SERVICES, NAMELY, PUBLICATION OF AUDIO, TEXT AND GRAPHIC WORKS OF OTHERS ONLINE FEATURING ENTERTAINMENT, MUSIC, CONCERTS, VIDEOS, RADIO, TELEVISION, FILM, NEWS, SPORTS, GAMES, CULTURAL EVENTS AND UNIVERSITY CAMPUS EVENTS; ELECTRONIC PUBLISHING SERVICES, NAMELY, PUBLICATION OF BOOKS, NEWSLETTERS, NEWSPAPERS, MAGAZINES, MUSIC FILES AND PERIODICALS ONLINE FEATURING ENTERTAINMENT, MUSIC, CONCERTS, VIDEOS, RADIO, TELEVISION, FILM, NEWS, SPORTS, GAMES, CULTURAL EVENTS AND UNIVERSITY CAMPUS EVENTS; PROVIDING AUDIO AND VIDEO STUDIOS FOR ONLINE AUDIO AND VIDEO PRODUCTION; AUDIO RECORDING AND PRODUCTION FEATURING RINGTONES; AND ENTERTAINMENT SERVICES, NAMELY, PROVIDING NON-DOWNLOADABLE RINGTONES VIA A GLOBAL COMPUTER NETWORK (U.S. CLS. 100, 101 AND 107).

CLASS 42—SCIENTIFIC AND COMPUTER SERVICES

FOR PROVIDING SEARCH ENGINES FOR OBTAINING DATA ON A GLOBAL COMPUTER NETWORK; PROVIDING TEMPORARY USE OF ONLINE NON-DOWNLOADABLE SOFTWARE TO ENABLE USERS TO PROGRAM AUDIO, VIDEO, MOVIES, TEXT AND OTHER MULTIMEDIA CONTENT; INTERNET SERVICES, NAMELY, CREATING INDEXES OF INFORMATION, SITES AND OTHER RESOURCES AVAILABLE ON GLOBAL COMPUTER NETWORKS FOR OTHERS; SEARCHING, BROWSING AND RETRIEVING INFORMATION, SITES, AND OTHER RESOURCES AVAILABLE ON GLOBAL COMPUTER NETWORKS AND OTHER COMMUNICATION NETWORKS FOR OTHERS; PROVIDING ONLINE NON-DOWNLOADABLE INTERACTIVE COMPUTER PROGRAM THAT ENABLES USERS TO COMPOSE, PLAY BACK AND DOWNLOAD SONGS BASED ON A DATABASE COMPRISING AN AUDIO MIXER, MUSIC SEQUENCER, AUDIO SAMPLER, SOUND AND LOOP LIBRARIES, AND USER-PROVIDED DIGITAL MATERIALS; DESIGN OF MOBILE PHONE RINGTONES; AND COMPUTER SERVICES, NAMELY, HOSTING ONLINE WEB FACILITIES WHICH ENABLES USERS TO PROGRAM AND CREATE AUDIO, VIDEO, TEXT AND OTHER MULTIMEDIA CONTENT, INCLUDING MUSIC, RING TONES, CONCERTS, VIDEOS, RADIO, TELEVISION, NEWS, SPORTS, GAMES, CULTURAL EVENTS, AND ENTERTAINMENT-RELATED PROGRAMS (U.S. CLS. 100 AND 101).

CLASS 45—PERSONAL AND LEGAL SERVICES

FOR INTERNET BASED DATING, INTRODUCTION AND SOCIAL NETWORKING SERVICES (U.S. CLS. 100 AND 101).

MICHAEL WEBSTER, EXAMINING ATTORNEY

SN 77-230,203. DOODY MASTER, INC., DANSVILLE, NY.
FILED 7-16-2007.

SN 77-232,137. WILD, JOHN D., SHERWOOD, OR. FILED 7-17-2007.

DOODY MASTER

THE MARK CONSISTS OF STANDARD CHARACTERS WITHOUT CLAIM TO ANY PARTICULAR FONT, STYLE, SIZE, OR COLOR.

NO CLAIM IS MADE TO THE EXCLUSIVE RIGHT TO USE "DOODY", APART FROM THE MARK AS SHOWN.

CLASS 35—ADVERTISING AND BUSINESS

FOR ISSUING GIFT CERTIFICATES WHICH MAY THEN BE REDEEMED FOR PET WASTE REMOVAL SERVICES (U.S. CLS. 100, 101 AND 102).

CLASS 37—CONSTRUCTION AND REPAIR

FOR PET WASTE REMOVAL SERVICES (U.S. CLS. 100, 103 AND 106).

WILLIAM ROSSMAN, EXAMINING ATTORNEY

J. DANIEL W.

THE MARK CONSISTS OF STANDARD CHARACTERS WITHOUT CLAIM TO ANY PARTICULAR FONT, STYLE, SIZE, OR COLOR.

THE NAME "JOHN D. WILD" IDENTIFIES A LIVING INDIVIDUAL WHOSE CONSENT IS OF RECORD.

CLASS 16—PAPER GOODS AND PRINTED MATTER

FOR PRINTED MOTIVATIONAL CARDS AND NOTE CARDS CONTAINING RELIGIOUS MESSAGES; PRINTED INFORMATIONAL CARDS IN THE FIELD OF RELIGION (U.S. CLS. 2, 5, 22, 23, 29, 37, 38 AND 50).

CLASS 28—TOYS AND SPORTING GOODS

FOR WOODEN BUILDING BLOCK GAMES (U.S. CLS. 22, 23, 38 AND 50).

BARBARA BROWN, EXAMINING ATTORNEY

SN 77-232,123. EJJ PUBLICATIONS, LLC, DBA CALABASAS LIFE AT ITS BEST, CALABASAS, CA. FILED 7-17-2007.

SN 77-232,309. NOBLIS, INC., FALLS CHURCH, VA. FILED 7-18-2007.

Statement

FOR THE BEST OF REASONS

THE MARK CONSISTS OF STANDARD CHARACTERS WITHOUT CLAIM TO ANY PARTICULAR FONT, STYLE, SIZE, OR COLOR.

CLASS 41—EDUCATION AND ENTERTAINMENT

FOR ENTERTAINMENT SERVICES NAMELY PRODUCING AND DISTRIBUTING ONGOING TELEVISION SERIES; CONDUCTING LIVE EVENTS FEATURING APPEARANCES BY CELEBRITIES AND AWARD CEREMONIES RECOGNIZING EXCELLENCE IN THE FIELDS OF ENTERTAINMENT, FASHION AND DESIGN; ONLINE WEBSITE FEATURING CELEBRITY INFORMATION; PUBLISHING A LIFESTYLE MAGAZINE (U.S. CLS. 100, 101 AND 107).

FIRST USE 1-1-2007; IN COMMERCE 2-1-2007.

CLASS 45—PERSONAL AND LEGAL SERVICES

FOR ONLINE WEBSITE FEATURING LIFESTYLE INFORMATION (U.S. CLS. 100 AND 101).

FIRST USE 1-1-2007; IN COMMERCE 2-1-2007.
BRENDAN REGAN, EXAMINING ATTORNEY

THE MARK CONSISTS OF STANDARD CHARACTERS WITHOUT CLAIM TO ANY PARTICULAR FONT, STYLE, SIZE, OR COLOR.

CLASS 35—ADVERTISING AND BUSINESS

FOR CONSULTING SERVICES IN THE COST AND PAYMENT MANAGEMENT OF HEALTH CARE; MANAGEMENT OF HEALTH CARE CLINICS FOR OTHERS; BUSINESS RISK MANAGEMENT CONSULTING; TRANSPORTATION MANAGEMENT SERVICES (U.S. CLS. 100, 101 AND 102).

FIRST USE 2-21-2007; IN COMMERCE 2-21-2007.

CLASS 38—COMMUNICATION

FOR CONSULTATION IN THE FIELD OF TELECOMMUNICATIONS (U.S. CLS. 100, 101 AND 104).

FIRST USE 2-21-2007; IN COMMERCE 2-21-2007.

CLASS 40—MATERIAL TREATMENT

FOR CONSULTATION IN THE FIELDS OF ENERGY GENERATION AND ENVIRONMENTAL RADIATION (U.S. CLS. 100, 103 AND 106).

FIRST USE 2-21-2007; IN COMMERCE 2-21-2007.

CLASS 42—SCIENTIFIC AND COMPUTER SERVICES

FOR ENGINEERING IN THE FIELD OF TELECOMMUNICATIONS SYSTEMS, OCEANOGRAPHY, ATMOSPHERIC, SPACE AND ENVIRONMENTAL SCIENCE; SCIENTIFIC RESEARCH; COMPUTER SERVICES, NAMELY, COMPUTER PROGRAMMING AND SOFTWARE DESIGN FOR OTHER; TECHNICAL CONSULTATION IN THE FIELDS OF OCEANOGRAPHY, ATMOSPHERIC, SPACE AND ENVIRONMENTAL SCIENCE; CONSULTATION IN THE FIELD OF INFORMATION TECHNOLOGY SYSTEMS; CONSULTATION IN THE FIELD OF TOXICOLOGY (U.S. CLS. 100 AND 101).

FIRST USE 2-21-2007; IN COMMERCE 2-21-2007.

CLASS 45—PERSONAL AND LEGAL SERVICES

FOR CONSULTATION SERVICES IN THE FIELDS OF CRIMINAL JUSTICE LAW, HOMELAND SAFETY AND SECURITY (U.S. CLS. 100 AND 101).

FIRST USE 2-21-2007; IN COMMERCE 2-21-2007.

MARGERY A. TIERNEY, EXAMINING ATTORNEY

SN 77-232,374. NOBLIS, INC., FALLS CHURCH, VA. FILED 7-18-2007.

NOBLIS

SN 77-232,368. SWIMLABS & REHAB HOLDING COMPANY, INC., HIGHLANDS RANCH, CO. FILED 7-18-2007.



NO CLAIM IS MADE TO THE EXCLUSIVE RIGHT TO USE "SWIM", APART FROM THE MARK AS SHOWN.

THE COLOR(S) NAVY BLUE, LIGHT BLUE, WHITE AND RED IS/ARE CLAIMED AS A FEATURE OF THE MARK.

THE COLORS NAVY BLUE AND LIGHT BLUE APPEAR IN THE WORDS "SWIMLABS". THE COLOR WHITE APPEARS IN THE WAVE DESIGN WHICH APPEARS IN THE WORD "SWIMLABS". THE COLOR RED APPEARS IN THE WORDS "SWIM FASTER...FASTER".

CLASS 9—ELECTRICAL AND SCIENTIFIC APPARATUS

FOR DOWNLOADABLE DIGITAL VIDEO RECORDINGS FEATURING INSTRUCTION IN SWIMMING AND PHYSICAL THERAPY REHABILITATION; EDUCATIONAL RECORDED MATERIALS IN THE NATURE OF DVD'S FEATURING INSTRUCTION IN SWIMMING AND PHYSICAL THERAPY REHABILITATION (U.S. CLS. 21, 23, 26, 36 AND 38).

FIRST USE 11-1-2006; IN COMMERCE 11-1-2006.

CLASS 25—CLOTHING

FOR APPAREL, NAMELY, T-SHIRTS, SWIM SUITS, SWIM CAPS, SWEATSHIRTS AND WARM-UP SUITS (U.S. CLS. 22 AND 39).

FIRST USE 11-1-2006; IN COMMERCE 11-7-2006.

CLASS 41—EDUCATION AND ENTERTAINMENT

FOR EDUCATIONAL SERVICES, NAMELY, CONDUCTING SWIM LESSONS, CLINICS, CLASSES AND SEMINARS IN THE FIELD OF SWIMMING; SWIMMING INSTRUCTION (U.S. CLS. 100, 101 AND 107).

FIRST USE 11-1-2006; IN COMMERCE 11-1-2006.
EVELYN BRADLEY, EXAMINING ATTORNEY

THE MARK CONSISTS OF STANDARD CHARACTERS WITHOUT CLAIM TO ANY PARTICULAR FONT, STYLE, SIZE, OR COLOR.

CLASS 35—ADVERTISING AND BUSINESS

FOR CONSULTING SERVICES IN THE COST AND PAYMENT MANAGEMENT OF HEALTH CARE; MANAGEMENT OF HEALTH CARE CLINICS FOR OTHERS; BUSINESS RISK MANAGEMENT CONSULTING; TRANSPORTATION MANAGEMENT SERVICES (U.S. CLS. 100, 101 AND 102).

FIRST USE 2-21-2007; IN COMMERCE 2-21-2007.

CLASS 38—COMMUNICATION

FOR CONSULTATION IN THE FIELD OF TELECOMMUNICATIONS (U.S. CLS. 100, 101 AND 104).

FIRST USE 2-21-2007; IN COMMERCE 2-21-2007.

CLASS 40—MATERIAL TREATMENT

FOR CONSULTATION IN THE FIELDS OF ENERGY GENERATION AND ENVIRONMENTAL RADIATION (U.S. CLS. 100, 103 AND 106).

FIRST USE 2-21-2007; IN COMMERCE 2-21-2007.

CLASS 42—SCIENTIFIC AND COMPUTER SERVICES

FOR ENGINEERING IN THE FIELD OF TELECOMMUNICATIONS SYSTEMS, OCEANOGRAPHY, ATMOSPHERIC, SPACE AND ENVIRONMENTAL SCIENCE; SCIENTIFIC RESEARCH; COMPUTER SERVICES, NAMELY, COMPUTER PROGRAMMING AND SOFTWARE DESIGN FOR OTHER; TECHNICAL CONSULTATION IN THE FIELDS OF OCEANOGRAPHY, ATMOSPHERIC, SPACE AND ENVIRONMENTAL SCIENCE; CONSULTATION IN THE FIELD OF INFORMATION TECHNOLOGY SYSTEMS; CONSULTATION IN THE FIELD OF TOXICOLOGY (U.S. CLS. 100 AND 101).

FIRST USE 2-21-2007; IN COMMERCE 2-21-2007.

CLASS 45—PERSONAL AND LEGAL SERVICES

FOR CONSULTATION SERVICES IN THE FIELDS OF CRIMINAL JUSTICE LAW, HOMELAND SAFETY AND SECURITY (U.S. CLS. 100 AND 101).

FIRST USE 2-21-2007; IN COMMERCE 2-21-2007.
MARGERY A. TIERNEY, EXAMINING ATTORNEY

SN 77-232,410. NOBLIS, INC., FALLS CHURCH, VA. FILED 7-18-2007.

SN 77-232,949. BEN CARTER PROPERTIES, LLC, ATLANTA, GA. FILED 7-18-2007.



THE COLOR(S) BLUE AND GREEN IS/ARE CLAIMED AS A FEATURE OF THE MARK.

THE MARK CONSISTS OF THE WORD "NOBLIS" IN BLUE WITH A STYLIZED DOT ON THE "I" IN GREEN.

CLASS 35—ADVERTISING AND BUSINESS

FOR CONSULTING SERVICES IN THE COST AND PAYMENT MANAGEMENT OF HEALTH CARE; MANAGEMENT OF HEALTH CARE CLINICS FOR OTHERS; BUSINESS RISK MANAGEMENT CONSULTING; TRANSPORTATION MANAGEMENT SERVICES (U.S. CLS. 100, 101 AND 102).

FIRST USE 2-21-2007; IN COMMERCE 2-21-2007.

CLASS 38—COMMUNICATION

FOR CONSULTATION IN THE FIELD OF TELECOMMUNICATIONS (U.S. CLS. 100, 101 AND 104).

FIRST USE 2-21-2007; IN COMMERCE 2-21-2007.

CLASS 40—MATERIAL TREATMENT

FOR CONSULTATION IN THE FIELDS OF ENERGY GENERATION AND ENVIRONMENTAL RADIATION (U.S. CLS. 100, 103 AND 106).

FIRST USE 2-21-2007; IN COMMERCE 2-21-2007.

CLASS 42—SCIENTIFIC AND COMPUTER SERVICES

FOR ENGINEERING IN THE FIELD OF TELECOMMUNICATIONS SYSTEMS, OCEANOGRAPHY, ATMOSPHERIC, SPACE AND ENVIRONMENTAL SCIENCE; SCIENTIFIC RESEARCH; COMPUTER SERVICES, NAMELY, COMPUTER PROGRAMMING AND SOFTWARE DESIGN FOR OTHER; TECHNICAL CONSULTATION IN THE FIELDS OF OCEANOGRAPHY, ATMOSPHERIC, SPACE AND ENVIRONMENTAL SCIENCE; CONSULTATION IN THE FIELD OF INFORMATION TECHNOLOGY SYSTEMS; CONSULTATION IN THE FIELD OF TOXICOLOGY (U.S. CLS. 100 AND 101).

FIRST USE 2-21-2007; IN COMMERCE 2-21-2007.

CLASS 45—PERSONAL AND LEGAL SERVICES

FOR CONSULTATION SERVICES IN THE FIELDS OF CRIMINAL JUSTICE LAW, HOMELAND SAFETY AND SECURITY (U.S. CLS. 100 AND 101).

FIRST USE 2-21-2007; IN COMMERCE 2-21-2007.

MARGERY A. TIERNEY, EXAMINING ATTORNEY

THE STREETS OF BUCKHEAD

THE MARK CONSISTS OF STANDARD CHARACTERS WITHOUT CLAIM TO ANY PARTICULAR FONT, STYLE, SIZE, OR COLOR.

NO CLAIM IS MADE TO THE EXCLUSIVE RIGHT TO USE "BUCKHEAD", APART FROM THE MARK AS SHOWN.

CLASS 36—INSURANCE AND FINANCIAL

FOR REAL ESTATE LEASING SERVICES (U.S. CLS. 100, 101 AND 102).

CLASS 37—CONSTRUCTION AND REPAIR

FOR REAL ESTATE DEVELOPMENT SERVICES (U.S. CLS. 100, 103 AND 106).

JAY BESCH, EXAMINING ATTORNEY

SN 77-233,276. HACHETTE FILIPACCHI MEDIA U.S., INC., NEW YORK, NY. FILED 7-19-2007.

VISIONS OF ROCK

THE MARK CONSISTS OF STANDARD CHARACTERS WITHOUT CLAIM TO ANY PARTICULAR FONT, STYLE, SIZE, OR COLOR.

CLASS 16—PAPER GOODS AND PRINTED MATTER

FOR MAGAZINES AND PRINTED PUBLICATIONS, NAMELY, A PERIODIC PUBLICATION IN THE FIELD OF PHOTOGRAPHY (U.S. CLS. 2, 5, 22, 23, 29, 37, 38 AND 50).

CLASS 41—EDUCATION AND ENTERTAINMENT

FOR PUBLICATION OF ELECTRONIC MAGAZINES IN THE FIELD OF PHOTOGRAPHY; EDUCATIONAL AND ENTERTAINMENT SERVICES, NAMELY, CONDUCTING CLASSES, SEMINARS, CONFERENCES, WORKSHOPS AND TRAINING IN THE FIELD OF PHOTOGRAPHY; SPONSORING PHOTOGRAPHY EVENTS, LECTURES, SEMINARS, EDUCATIONAL CLASSES AND MUSICAL PERFORMANCES; SPONSORING PHOTOGRAPHY EXHIBITIONS AND MUSICAL PERFORMANCES; PHOTO GALLERY SERVICES, NAMELY, PROVIDING PHOTO GALLERY OF ENTERTAINMENT, EDUCATIONAL AND CULTURAL EXHIBITIONS; ENTERTAINMENT SERVICES, NAMELY, CONDUCTING CONTESTS (U.S. CLS. 100, 101 AND 107).

FIRST USE 6-15-2007; IN COMMERCE 6-15-2007.

NAAKWAMA ANKRAH, EXAMINING ATTORNEY

SN 77-233,626. TEFAL, RUMILLY, FRANCE, FILED 7-19-2007.



OWNER OF U.S. REG. NOS. 713,017 AND 2,398,176.
THE MARK CONSISTS OF THE WORD "T-FAL" OVER THE WORDS "SIMPLY SMART" FOLLOWED ON THE SAME LINE WITH A LIGHT BULB DESIGN.

CLASS 7—MACHINERY

FOR ELECTRIC JUICE EXTRACTORS FOR HOUSEHOLD PURPOSES, ELECTRIC BLENDERS FOR HOUSEHOLD PURPOSES, ELECTRIC FRUITS AND VEGETABLES JUICER MIXER, ELECTRIC FOOD MIXER FOR HOUSEHOLD PURPOSES, ELECTRIC KNIFE FOR HOUSEHOLD PURPOSES, ELECTRIC KNIVES, ELECTRIC COFFEE GRINDER FOR HOUSEHOLD PURPOSES, AND ELECTRIC CAN OPENERS (U.S. CLS. 13, 19, 21, 23, 31, 34 AND 35).

CLASS 9—ELECTRICAL AND SCIENTIFIC APPARATUS

FOR ELECTRIC FLAT IRONS, ANTI-SCALE CARTRIDGES FOR USE WITH ELECTRIC IRONS, SOLEPLATES ADAPTED FOR USE WITH ELECTRIC CLOTHES IRONS, BATHROOM SCALES, AND KITCHEN SCALES (U.S. CLS. 21, 23, 26, 36 AND 38).

CLASS 11—ENVIRONMENTAL CONTROL APPARATUS

FOR OVENS, ELECTRIC COOKING STOVES, ELECTRIC FRYING PANS, ELECTRIC GRILL PANS, ELECTRIC COOKING STEAMERS, ELECTRIC PRESSURE COOKERS, ELECTRIC FOOD WARMERS, ELECTRIC STONE TOP GRILL, ELECTRIC BARBECUES GRILLS, ELECTRIC ROASTERS, ELECTRIC TAJINE COOKING APPARATUS FOR PREPARING MOROCCAN TAJINE, ELECTRIC SANDWICH MAKERS, ELECTRIC RALETTE COOKING APPARATUS FOR MELTING CHEESE IN TRAYS, ELECTRIC FONDUE POTS, ELECTRIC PANCAKE MAKERS, ELECTRIC WAFFLE IRONS, ELECTRIC RICE COOKERS, ELECTRIC EGGS COOKERS, ELECTRIC TOASTERS, ELECTRIC KETTLES, ELECTRIC COFFEE MAKERS, ELECTRIC COFFEE PERCOLATORS, ELECTRIC TEAPOTS, AND ELECTRIC DEEP FRYERS (U.S. CLS. 13, 21, 23, 31 AND 34).
GISELLE AGOSTO, EXAMINING ATTORNEY

SN 77-233,849. COVIDIEN AG, NEUHAUSEN AM RHEINFALL, SWITZERLAND, FILED 7-19-2007.



THE MARK CONSISTS OF TWO BLOCK LETTER CS, WITH ONE REVERSED SO THEY ARE FACING EACH OTHER AND WITH SQUARES FILLING IN THE SPACE BETWEEN THE CS, COMBINED WITH THE DESIGNATION COVIDIEN.

CLASS 3—COSMETICS AND CLEANING PREPARATIONS

FOR DISPOSABLE CLEANSING WASHCLOTHS AND WIPES IMPREGNATED WITH CLEANSING COMPOUNDS FOR PERSONAL HYGIENE USE; CLEANING PREPARATIONS, STRIPPING PREPARATIONS AND RESIDUE REMOVING PREPARATIONS USED IN THE MANUFACTURE OF MICROELECTRONICS (U.S. CLS. 1, 4, 6, 50, 51 AND 52).

CLASS 25—CLOTHING

FOR TRAVEL SOCKS (U.S. CLS. 22 AND 39).

CLASS 35—ADVERTISING AND BUSINESS

FOR NUCLEAR PHARMACY SERVICES (U.S. CLS. 100, 101 AND 102).

CLASS 37—CONSTRUCTION AND REPAIR

FOR MEDICAL WASTE DISPOSAL SERVICES VIA MAIL (U.S. CLS. 100, 103 AND 106).

CLASS 40—MATERIAL TREATMENT

FOR CUSTOM CHEMICAL AND PHARMACEUTICAL MANUFACTURING SERVICES (U.S. CLS. 100, 103 AND 106).

DANIEL CAPSHAW, EXAMINING ATTORNEY

SN 77-234,993. PRESCRIPTIVE MUSIC, LLC, WOODLAND HILLS, CA. FILED 7-20-2007.



OWNER OF U.S. REG. NO. 2,988,518.
NO CLAIM IS MADE TO THE EXCLUSIVE RIGHT TO USE "MUSIC", APART FROM THE MARK AS SHOWN.

CLASS 35—ADVERTISING AND BUSINESS

FOR PROVIDING ADVERTISING, MARKETING AND PROMOTIONAL SERVICES TO THE HOSPITALITY INDUSTRY (U.S. CLS. 100, 101 AND 102).
FIRST USE 7-0-1999; IN COMMERCE 7-0-1999.

CLASS 41—EDUCATION AND ENTERTAINMENT

FOR MUSIC PRODUCTION SERVICES (U.S. CLS. 100, 101 AND 107).
FIRST USE 7-0-1999; IN COMMERCE 7-0-1999.

CLASS 42—SCIENTIFIC AND COMPUTER SERVICES

FOR GRAPHIC ART DESIGN; WEBSITE DESIGN; DESIGN OF COMPACT DISC ARTWORK; DESIGN OF STATIONERY, BUSINESS CARDS AND LETTERHEADS; FINE ART DESIGN (U.S. CLS. 100 AND 101).
FIRST USE 7-0-1999; IN COMMERCE 7-0-1999.
ELLEN BURNS, EXAMINING ATTORNEY

SN 77-234,997. PRESCRIPTIVE MUSIC, LLC, WOODLAND HILLS, CA. FILED 7-20-2007.

 **Prescriptive Music**

OWNER OF U.S. REG. NO. 2,988,518.
NO CLAIM IS MADE TO THE EXCLUSIVE RIGHT TO USE "MUSIC", APART FROM THE MARK AS SHOWN.

CLASS 9—ELECTRICAL AND SCIENTIFIC APPARATUS

FOR SOUND RECORDINGS FEATURING MUSIC; SOUND RECORDINGS FEATURING VOICE RECORDING IN THE FIELD OF MUSIC; AUDIO RECORDINGS FEATURING MUSIC FOR WEBSITES; AUDIO RECORDINGS FEATURING MUSIC FOR PRESENTATIONS; COMPUTER HARDWARE AND ASSOCIATED SOFTWARE FOR USE IN AUDIO INTEGRATION; AUDIO AND VIDEO RECORDINGS FEATURING MUSIC; PRE-RECORDED COMPACT DISCS FEATURING MUSIC; DOWNLOADABLE AUDIO, SOUND AND VIDEO RECORDINGS FEATURING MUSIC; DOWNLOADABLE PODCASTS IN THE FIELDS OF MUSIC, MUSIC COMMENTARY, LIFESTYLE TOPICS AND TRENDS, HOME IMPROVEMENT, FINANCE, FASHION, BOOKS, SPORTS, RESTAURANTS, AND TOPICS OF INTEREST TO PROFESSIONALS IN THE HOSPITALITY INDUSTRY; COMPUTER HARDWARE (U.S. CLS. 21, 23, 26, 36 AND 38).

FIRST USE 7-0-1999; IN COMMERCE 7-0-1999.

CLASS 41—EDUCATION AND ENTERTAINMENT

FOR CONSULTING SERVICES IN THE FIELD OF MUSIC (U.S. CLS. 100, 101 AND 107).
FIRST USE 7-0-1999; IN COMMERCE 7-0-1999.
ELLEN BURNS, EXAMINING ATTORNEY

SN 77-234,999. PRESCRIPTIVE MUSIC, LLC, WOODLAND HILLS, CA. FILED 7-20-2007.



OWNER OF U.S. REG. NO. 2,988,518.

CLASS 35—ADVERTISING AND BUSINESS

FOR PROVIDING ADVERTISING, MARKETING AND PROMOTIONAL SERVICES TO THE HOSPITALITY INDUSTRY (U.S. CLS. 100, 101 AND 102).
FIRST USE 7-0-1999; IN COMMERCE 7-0-1999.

CLASS 41—EDUCATION AND ENTERTAINMENT

FOR MUSIC PRODUCTION SERVICES (U.S. CLS. 100, 101 AND 107).
FIRST USE 7-0-1999; IN COMMERCE 7-0-1999.

CLASS 42—SCIENTIFIC AND COMPUTER SERVICES

FOR GRAPHIC ART DESIGN; WEBSITE DESIGN; DESIGN OF COMPACT DISC ARTWORK; DESIGN OF STATIONERY, BUSINESS CARDS AND LETTERHEADS; FINE ART DESIGN (U.S. CLS. 100 AND 101).
FIRST USE 7-0-1999; IN COMMERCE 7-0-1999.
ELLEN BURNS, EXAMINING ATTORNEY

SN 77-235,007. PRESCRIPTIVE MUSIC, LLC, WOODLAND HILLS, CA. FILED 7-20-2007.



OWNER OF U.S. REG. NO. 2,988,518.

CLASS 9—ELECTRICAL AND SCIENTIFIC APPARATUS

FOR SOUND RECORDINGS FEATURING MUSIC; SOUND RECORDINGS FEATURING VOICE RECORDING IN THE FIELD OF MUSIC; AUDIO RECORDINGS FEATURING MUSIC FOR WEBSITES; AUDIO RECORDINGS FEATURING MUSIC FOR PRESENTATIONS; COMPUTER HARDWARE AND ASSOCIATED SOFTWARE FOR USE IN AUDIO INTEGRATION; AUDIO AND VIDEO RECORDINGS FEATURING MUSIC; PRE-RECORDED COMPACT DISCS FEATURING MUSIC; DOWNLOADABLE AUDIO, SOUND AND VIDEO RECORDINGS FEATURING MUSIC; DOWNLOADABLE PODCASTS IN THE FIELDS OF MUSIC, MUSIC COMMENTARY, LIFESTYLE TOPICS AND TRENDS, HOME IMPROVEMENT, FINANCE, FASHION, BOOKS, SPORTS, RESTAURANTS, AND TOPICS OF INTEREST TO PROFESSIONALS IN THE HOSPITALITY INDUSTRY; COMPUTER HARDWARE (U.S. CLS. 21, 23, 26, 36 AND 38).

FIRST USE 7-0-1999; IN COMMERCE 7-0-1999.

CLASS 41—EDUCATION AND ENTERTAINMENT

FOR CONSULTING SERVICES IN THE FIELD OF MUSIC (U.S. CLS. 100, 101 AND 107).
FIRST USE 7-0-1999; IN COMMERCE 7-0-1999.
ELLEN BURNS, EXAMINING ATTORNEY

SN 77-235,467. LITTLE GEMS AUSTALIA PTY. LTD., VIC
3162, AUSTRALIA, FILED 7-21-2007.

LITTLE GEMS

THE MARK CONSISTS OF STANDARD CHARACTERS WITHOUT CLAIM TO ANY PARTICULAR FONT, STYLE, SIZE, OR COLOR.

CLASS 25—CLOTHING

FOR CHILDREN'S CLOTHING, NAMELY, SHIRTS, DRESSES, SKIRTS, SUITS, SHOES, HOSIERY, SLEEPWEAR; DANCE WEAR, NAMELY, TIGHTS, LEOTARDS, DANCE COSTUMES, DANCE SHOES, BODY SUITS, TUTUS; UNDERWEAR, HEADWEAR, SHORTS; COSTUMES, NAMELY, MASQUERADE COSTUMES AND MASKS SOLD IN CONNECTION THEREWITH AND HALLOWEEN COSTUMES AND MASKS SOLD IN CONNECTION THEREWITH (U.S. CLS. 22 AND 39).

FIRST USE 7-0-2004; IN COMMERCE 7-0-2004.

CLASS 35—ADVERTISING AND BUSINESS

FOR MAIL ORDER CATALOGS SERVICES FEATURING CHILDREN'S CLOTHING (U.S. CLS. 100, 101 AND 102).

FIRST USE 7-0-2004; IN COMMERCE 7-0-2004.
JOHN DALIER, EXAMINING ATTORNEY

SN 77-235,732. YOUR OWN TRIP, LLC, HILLSBORO BEACH,
FL. FILED 7-23-2007.

Commonality

THE MARK CONSISTS OF STANDARD CHARACTERS WITHOUT CLAIM TO ANY PARTICULAR FONT, STYLE, SIZE, OR COLOR.

CLASS 35—ADVERTISING AND BUSINESS

FOR ADVERTISING, INCLUDING PROMOTION RELATING TO THE SALE OF ARTICLES AND SERVICES FOR THIRD PARTIES BY THE TRANSMISSION OF ADVERTISING MATERIAL AND THE DISSEMINATION OF ADVERTISING MESSAGES ON COMPUTER NETWORKS; ARRANGING AND CONDUCTING AUCTIONS IN THE FIELD OF GENERAL CONSUMER MERCHANDISE; AUCTION MANAGEMENT SERVICES PROVIDED TO OTHERS OVER AN ON-LINE WEB SITE ACCESSED THROUGH A GLOBAL COMPUTER NETWORK; ADVERTISING BY TRANSMISSION OF ON-LINE PUBLICITY FOR THIRD PARTIES THROUGH ELECTRONIC COMMUNICATIONS NETWORKS; ADVERTISING PARTICULARLY SERVICES FOR THE PROMOTION OF GOODS; BUSINESS NETWORKING; BUSINESS SERVICES, NAMELY, PROVIDING COMPUTER DATABASES REGARDING THE PURCHASE AND SALE OF A WIDE VARIETY OF PRODUCTS AND SERVICES OF OTHERS; COMPUTERIZED ON-LINE ORDERING FEATURING GENERAL MERCHANDISE AND GENERAL CONSUMER GOODS; DISSEMINATION OF ADVERTISING FOR OTHERS VIA AN ON-LINE COMMUNICATIONS NETWORK ON THE INTERNET; GENERAL BUSINESS NETWORKING REFERRAL SERVICES, NAMELY, PROMOTING THE GOODS AND SERVICES OF OTHERS BY PASSING BUSINESS LEADS AND REFERRALS AMONG GROUP MEMBERS; MATCHING CONSUMERS WITH REAL ESTATE PROFESSIONALS IN THE FIELD OF REAL ESTATE SERVICES VIA COMPUTER NETWORK; ON-LINE ADVERTISING ON COMPUTER COMMUNICATION NETWORKS; ON-LINE TRADING SERVICES IN WHICH SELLER POSTS PRODUCTS TO BE AUCTIONED AND BIDDING IS DONE VIA THE INTERNET; OPERATING ON-LINE MARKETPLACES FOR SELLERS OF GOODS AND/OR SERVICES; PROMOTING THE GOODS AND SERVICES OF OTHERS BY PROVIDING HYPERTEXT LINKS TO THE WEB SITES OF OTHERS; PROVIDING A WEB SITE AT WHICH USERS CAN OFFER GOODS FOR SALE AND BUY GOODS OFFERED BY OTHERS; PROVIDING A WEB SITE WHICH FEATURES ADVERTISEMENTS FOR THE GOODS AND SERVICES OF OTHERS ON A GLOBAL COMPUTER NETWORK; PROVIDING SPACE AT A WEB SITE FOR THE ADVERTISEMENT OF THE GOODS AND SERVICES OF OTHERS (U.S. CLS. 100, 101 AND 102).

CLASS 38—COMMUNICATION

FOR ELECTRONIC DELIVERY OF IMAGES AND PHOTOGRAPHS VIA A GLOBAL COMPUTER NETWORK; PROVIDING ON-LINE CHAT ROOMS AND ELECTRONIC BULLETIN BOARDS FOR TRANSMISSION OF MESSAGES AMONG USERS IN THE FIELD OF GENERAL INTEREST; PROVIDING ON-LINE CHAT ROOMS FOR TRANSMISSION OF MESSAGES AMONG COMPUTER USERS CONCERNING SIMILAR INTERESTS AND GOODS AND SERVICES OFFERED FOR SALE (U.S. CLS. 100, 101 AND 104).

CLASS 39—TRANSPORTATION AND STORAGE

FOR ONLINE TRAVEL AGENCY SERVICES, NAMELY, MAKING RESERVATIONS AND BOOKINGS FOR TRANSPORTATION, AIRFARE AND RENTAL CARS, AND PROVIDING INFORMATION AND REVIEWS CONCERNING TRAVEL BY MEANS OF A TELEPHONE, FACSIMILE, THE MAILS, COURIER OR OVER COMPUTER NETWORKS AND GLOBAL COMMUNICATION NETWORKS; PROVIDING A WEBSITE AND WEBSITE LINKS TO GEOGRAPHIC INFORMATION, MAPS, MAP IMAGES AND TRIP ROUTING; ORGANIZING AND ARRANGING TRAVEL ACTIVITIES, NAMELY, TOURS, TRAVEL TO EVENTS AND

TRAVEL TO ATTRACTIONS; MAKING RESERVATIONS FOR TRAVEL ACTIVITIES, NAMELY, FOR TOURS, TRAVEL TO EVENTS AND TRAVEL TO ATTRACTIONS; PROVIDING INFORMATION ABOUT TOURS AND TRAVEL TO EVENTS AND ATTRACTIONS; ORGANIZING SIGHT-SEEING TOURS; TRAVEL AGENCY SERVICES, NAMELY, MAKING RESERVATIONS AND BOOKINGS FOR TRANSPORTATION; TRAVEL AND TOUR INFORMATION SERVICES; TRAVEL AND TOUR TICKET RESERVATION SERVICES; ARRANGING BOOKINGS OF DAY TRIPS AND SIGHT-SEEING TOURS (U.S. CLS. 100 AND 105).

SN 77-236,396. KAREN KANE, INC., LOS ANGELES, CA. FILED 7-23-2007.

CLASS 42—SCIENTIFIC AND COMPUTER SERVICES

FOR COMPUTER SERVICES, NAMELY, CREATING AN ONLINE COMMUNITY FOR REGISTERED USERS TO PARTICIPATE IN COMPETITIONS, SHOWCASE THEIR SKILLS, GET FEEDBACK FROM THEIR PEERS, FORM VIRTUAL COMMUNITIES, ENGAGE IN SOCIAL NETWORKING AND IMPROVE THEIR TALENT; COMPUTER SERVICES, NAMELY, HOSTING ON-LINE WEB FACILITIES FOR OTHERS FOR ORGANIZING AND CONDUCTING ONLINE MEETINGS, GATHERINGS, AND INTERACTIVE DISCUSSIONS (U.S. CLS. 100 AND 101).

CLASS 45—PERSONAL AND LEGAL SERVICES

FOR INTERNET BASED SOCIAL NETWORKING, INTRODUCTION, AND DATING SERVICES; ONLINE SOCIAL NETWORKING SERVICES; PROVIDING AN INTERACTIVE WEBSITE FOR PERSONS TO LOCATE OTHER INDIVIDUALS WITH SIMILAR INTERESTS TO PARTICIPATE WITH THEM IN, OR ACCOMPANY THEM TO, EVENTS AND ACTIVITIES (U.S. CLS. 100 AND 101).

JOHN DALIER, EXAMINING ATTORNEY

SN 77-236,088. BENTALL CAPITAL LIMITED PARTNERSHIP, VANCOUVER, B.C., CANADA, FILED 7-23-2007.

BENTALL

THE MARK CONSISTS OF STANDARD CHARACTERS WITHOUT CLAIM TO ANY PARTICULAR FONT, STYLE, SIZE, OR COLOR.

OWNER OF U.S. REG. NOS. 1,649,676 AND 1,649,698. SEC. 2(F).

CLASS 36—INSURANCE AND FINANCIAL

FOR COMMERCIAL REAL ESTATE MANAGEMENT AND LEASING SERVICES (U.S. CLS. 100, 101 AND 102). FIRST USE 4-21-1989; IN COMMERCE 4-21-1989.

CLASS 37—CONSTRUCTION AND REPAIR

FOR COMMERCIAL REAL ESTATE DEVELOPMENT (U.S. CLS. 100, 103 AND 106). FIRST USE 4-21-1989; IN COMMERCE 4-21-1989. ROBERT C. CLARK JR., EXAMINING ATTORNEY

KAREN KANE

THE MARK CONSISTS OF STANDARD CHARACTERS WITHOUT CLAIM TO ANY PARTICULAR FONT, STYLE, SIZE, OR COLOR.

OWNER OF U.S. REG. NOS. 1,303,865, 3,118,386 AND OTHERS.

THE NAME(S), PORTRAIT(S), AND/OR SIGNATURE(S) SHOWN IN THE MARK IDENTIFIES "KAREN KANE", WHOSE CONSENT(S) TO REGISTER IS SUBMITTED.

CLASS 9—ELECTRICAL AND SCIENTIFIC APPARATUS

FOR CASES FOR SPECTACLES AND SUNGLASSES; SUNGLASSES (U.S. CLS. 21, 23, 26, 36 AND 38).

CLASS 14—JEWELRY

FOR LEATHER JEWELRY AND ACCESSORY BOXES (U.S. CLS. 2, 27, 28 AND 50).

CLASS 18—LEATHER GOODS

FOR BRIEFCASES; IMITATION LEATHER; IMITATION LEATHER KEY CHAINS; KEY-CASES OF LEATHER AND SKINS; LEATHER AND IMITATION LEATHER; LEATHER AND IMITATION LEATHER BAGS; LEATHER BAGS, SUITCASES AND WALLETS; LEATHER BRIEFCASES; LEATHER CASES; LEATHER CASES FOR KEYS; LEATHER KEY CHAINS; LEATHER SHOPPING BAGS; POUCHES OF LEATHER; TRAVELING CASES OF LEATHER; CHANGE PURSES; CLUTCH PURSES; COIN PURSES; MULTI-PURPOSE PURSES; PURSES; PURSES AND WALLETS OF PRECIOUS METAL; SMALL CLUTCH PURSES; SMALL PURSES; WRIST MOUNTED PURSES; KEY WALLETS; POCKET WALLETS; WALLETS WITH CARD COMPARTMENTS; EVENING HANDBAGS; HANDBAGS (U.S. CLS. 1, 2, 3, 22 AND 41).

CLASS 20—FURNITURE AND ARTICLES NOT OTHERWISE CLASSIFIED

FOR LEATHER PICTURE FRAMES (U.S. CLS. 2, 13, 22, 25, 32 AND 50).

CLASS 25—CLOTHING

FOR LEATHER BELTS (U.S. CLS. 22 AND 39). WON TEAK OH, EXAMINING ATTORNEY

SN 77-236,775. RANSOM INTERNATIONAL LLC, SANTA FE, NM. FILED 7-24-2007.

RANSOM INTERNATIONAL

THE MARK CONSISTS OF STANDARD CHARACTERS WITHOUT CLAIM TO ANY PARTICULAR FONT, STYLE, SIZE, OR COLOR.

NO CLAIM IS MADE TO THE EXCLUSIVE RIGHT TO USE "INTERNATIONAL", APART FROM THE MARK AS SHOWN.

CLASS 9—ELECTRICAL AND SCIENTIFIC APPARATUS

FOR EYEGLASS CASES; PROTECTIVE CARRYING CASES FOR PORTABLE MUSIC PLAYERS; CELL PHONE COVERS (U.S. CLS. 21, 23, 26, 36 AND 38).

CLASS 18—LEATHER GOODS

FOR FASHION ACCESSORIES, NAMELY, PURSES, CLUTCH PURSES, WALLETS, COIN PURSES, TOTE BAGS, COSMETIC CASES SOLD EMPTY (U.S. CLS. 1, 2, 3, 22 AND 41).

TEJBIR SINGH, EXAMINING ATTORNEY

SN 77-236,902. QUINTILES TRANSNATIONAL CORP., DURHAM, NC. FILED 7-24-2007.



OWNER OF U.S. REG. NO. 2,340,026.

CLASS 35—ADVERTISING AND BUSINESS

FOR COMPUTERIZED DATABASE MANAGEMENT AND DATA PROCESSING SERVICES IN THE FIELDS OF PHARMACEUTICAL, VETERINARY, PHARMACOGENOMIC, BIOTECHNICAL AND MEDICAL PRODUCTS AND DEVICES; MANUFACTURERS' AND INDEPENDENT SALES REPRESENTATIVES IN THE FIELDS OF PHARMACEUTICALS, VETERINARY, PHARMACOGENOMIC, BIOTECHNICAL, DENTAL, AND MEDICAL PRODUCTS AND DEVICES; MARKETING SERVICES FOR OTHERS, NAMELY, CREATING AND MANAGING PRODUCT SALES AND PRODUCT LAUNCH PROGRAMS IN THE FIELDS OF PHARMACEUTICALS, VETERINARY, PHARMACOGENOMIC, BIOTECHNICAL, DENTAL, AND MEDICAL PRODUCTS AND DEVICES; BUSINESS MARKETING CONSULTING SERVICES IN THE FIELDS OF PHARMACEUTICALS, VETERINARY, PHARMACOGENOMIC, BIOTECHNICAL, DENTAL, AND MEDICAL PRODUCTS AND DEVICES; MARKET RESEARCH AND ANALYSIS SERVICES IN THE FIELDS OF PHARMACEUTICALS, VETERINARY, PHARMACOGENOMIC, BIOTECHNICAL, DENTAL, AND MEDICAL PRODUCTS AND DEVICES; PERSONNEL RECRUITMENT AND PLACEMENT; PROVIDING BUSINESS INFORMATION, NAMELY, INFORMATION USEFUL FOR ACHIEVING AND MAINTAINING REGULATORY APPROVAL AND MARKET INTRODUCTION OF DRUGS, DEVICES AND BIOLOGICS (U.S. CLS. 100, 101 AND 102).

CLASS 41—EDUCATION AND ENTERTAINMENT

FOR EDUCATIONAL AND TRAINING SERVICES, NAMELY, CONDUCTING TRAINING PROGRAMS, SEMINARS, CLASSES, CONFERENCES AND WORKSHOPS IN THE FIELDS OF HEALTH CARE, HEALTH MANAGEMENT AND DISEASE MANAGEMENT, PHARMACEUTICAL SALES SKILLS, AND PHARMACEUTICAL AND HEALTH PRODUCTS, AND DISTRIBUTING COURSE MATERIALS IN CONNECTION THEREWITH (U.S. CLS. 100, 101 AND 107).

CLASS 42—SCIENTIFIC AND COMPUTER SERVICES

FOR CLINICAL RESEARCH AND TESTING SERVICES IN THE FIELDS OF PHARMACEUTICALS, VETERINARY, PHARMACOGENOMIC, BIOTECHNICAL, DENTAL, AND MEDICAL PRODUCTS AND DEVICES; PRODUCT DEVELOPMENT CONSULTATION IN THE FIELDS OF MEDICAL PRODUCTS AND DEVICES; HEALTHCARE POLICY RESEARCH AND DEVELOPMENT SERVICES; LABORATORY TESTING SERVICES IN THE FIELDS OF PHARMACEUTICAL, VETERINARY, PHARMACOGENOMIC, BIOTECHNICAL AND MEDICAL PRODUCTS AND DEVICES; CONSULTANCY PERTAINING TO PHARMACOLOGY AND BIOTECHNICAL RESEARCH; MANAGING, MONITORING AND COORDINATING CLINICAL STUDIES ON HUMAN SUBJECTS FOR OTHERS (U.S. CLS. 100 AND 101).

CLASS 44—MEDICAL, BEAUTY AND AGRICULTURAL SERVICES

FOR PROVIDING HEALTH, MEDICAL, DENTAL, PHARMACEUTICAL, HEALTH MANAGEMENT AND DISEASE MANAGEMENT INFORMATION TO OTHERS; MEDICAL EVALUATION SERVICES, NAMELY, DEVELOPING AND IMPLEMENTING DISEASE MANAGEMENT AND TREATMENT PROTOCOLS AND PATIENT OUTCOME ANALYSIS SERVICES; CONSULTING SERVICES IN THE FIELDS OF HEALTH CARE, MEDICAL AND PHARMACEUTICALS, VETERINARY, AND DENTAL SERVICES (U.S. CLS. 100 AND 101).

CLASS 45—PERSONAL AND LEGAL SERVICES

FOR REGULATORY RESEARCH IN THE PHARMACEUTICAL INDUSTRY, BIOTECHNOLOGY INDUSTRY AND THE MEDICAL AND DIAGNOSTICS INDUSTRY; CONSULTATION SERVICES IN THE FIELD OF COMPLIANCE EVALUATION TO INSURE VALIDITY AND ACCURACY OF REGULATORY SUBMISSIONS TO THE FDA BY LIFE SCIENCES COMPANIES; CONDUCTING REGULATORY AND COMPLIANCE AUDITS FOR OTHERS IN THE FIELDS OF PHARMACEUTICAL, VETERINARY, PHARMACOGENOMIC, BIOTECHNICAL AND MEDICAL PRODUCTS AND DEVICES; CONSULTING SERVICES IN THE FIELDS OF REGULATORY AFFAIRS, MANUFACTURING COMPLIANCE AND VALIDATION; PROVIDING REGULATORY INFORMATION AND IMPLEMENTATION SERVICES RELATING TO THE DEVELOPMENT AND VALIDATION OF DRUGS, DEVICES AND BIOLOGICS (U.S. CLS. 100 AND 101).

LINDSEY RUBIN, EXAMINING ATTORNEY

SN 77-237,233. ASSOCIATION OF INSURANCE AND RE-INSURANCE RUN-OFF COMPANIES, DBA AIRROC, ALPHARETTA, GA. FILED 7-24-2007.

SOLUTIONS MATTER

THE MARK CONSISTS OF STANDARD CHARACTERS WITHOUT CLAIM TO ANY PARTICULAR FONT, STYLE, SIZE, OR COLOR.

CLASS 35—ADVERTISING AND BUSINESS

FOR ASSOCIATION SERVICES, NAMELY, PROMOTING THE INTERESTS OF INSURANCE AND REINSURANCE RUN-OFF COMPANIES (U.S. CLS. 100, 101 AND 102).

CLASS 41—EDUCATION AND ENTERTAINMENT

FOR EDUCATIONAL SERVICES, NAMELY, PROVIDING SEMINARS AND WORKSHOPS TO INSURANCE AND REINSURANCE RUN-OFF COMPANIES (U.S. CLS. 100, 101 AND 107).

FLORENTINA BLANDU, EXAMINING ATTORNEY

SN 77-237,571. HOUSEMAXX INTERNATIONAL INC., CALGARY, ALBERTA, FILED 7-24-2007.

HOUSEMAXX

THE MARK CONSISTS OF STANDARD CHARACTERS WITHOUT CLAIM TO ANY PARTICULAR FONT, STYLE, SIZE, OR COLOR.

CLASS 16—PAPER GOODS AND PRINTED MATTER

FOR REAL ESTATE SALES KITS CONSISTING OF PRINTED EDUCATIONAL AND MARKETING GUIDES AND REAL ESTATE MANUALS, SAMPLE AND BLANK PAPER REAL ESTATE TRANSACTION DOCUMENTS, MANUALS, AND INFORMATION KITS CONSISTING OF PRINTED BROCHURES AND FORMS RELATING TO REAL PROPERTY SALES FOR PROPERTY OWNERS, AND PRINTED PLASTIC REAL ESTATE SIGNAGE, SOLD AS A UNIT (U.S. CLS. 2, 5, 22, 23, 29, 37, 38 AND 50).

CLASS 35—ADVERTISING AND BUSINESS

FOR PRIVATE HOME OWNER REAL ESTATE ADVERTISING SERVICES TO ASSIST PEOPLE TO SELL OR RENT THEIR OWN HOME OR PROPERTY WITHOUT COMMISSION VIA DISTRIBUTION OF MAGAZINES, AN INTERNET WEBSITE TO ADVERTISE CLIENTS' PROPERTIES FOR SALE OR RENT, PROFESSIONAL SIGNAGE TO ADVERTISE CLIENTS' PROPERTIES, AND DISTRIBUTION OF BOOKLETS ABOUT CLIENTS' PROPERTIES AND HOMES FOR PROSPECTIVE BUYERS AND RENTERS (U.S. CLS. 100, 101 AND 102).

CYNTHIA SLOAN, EXAMINING ATTORNEY

SN 77-238,153. PRODUCT PARTNERS LLC, BEVERLY HILLS, CA. FILED 7-25-2007.

SHAUN T'S SHOWTIME

THE MARK CONSISTS OF STANDARD CHARACTERS WITHOUT CLAIM TO ANY PARTICULAR FONT, STYLE, SIZE, OR COLOR.

THE NAME "SHAUN T" IDENTIFIES A LIVING INDIVIDUAL WHOSE CONSENT IS OF RECORD.

CLASS 9—ELECTRICAL AND SCIENTIFIC APPARATUS

FOR PRE-RECORDED VIDEO TAPES, CASSETTES, DVDS, AND CDS, FEATURING EXERCISE, FITNESS, DIETARY INFORMATION AND INSTRUCTION (U.S. CLS. 21, 23, 26, 36 AND 38).

CLASS 41—EDUCATION AND ENTERTAINMENT

FOR PROVIDING A WEB SITE FEATURING ON-LINE INSTRUCTION IN THE FIELD OF PHYSICAL EXERCISE AND NUTRITION AND INSTRUCTION ON HOW TO TRACK THE PROGRESS OF WORKOUTS; EDUCATIONAL SERVICES AND ON-LINE EDUCATIONAL SERVICES, NAMELY, PROVIDING INSTRUCTION IN THE FIELDS OF EXERCISE EQUIPMENT, PHYSICAL EXERCISE AND NUTRITION, AND INSTRUCTIONAL MATERIALS DISTRIBUTED IN CONNECTION THEREWITH (U.S. CLS. 100, 101 AND 107).

MELISSA VALLILLO, EXAMINING ATTORNEY

SN 77-238,385. ADRIENNE ANN ETKIN, RIDGEWOOD, NJ.
FILED 7-25-2007.



NO CLAIM IS MADE TO THE EXCLUSIVE RIGHT TO USE "TEA", APART FROM THE MARK AS SHOWN.

THE MARK CONSISTS OF THE WORDING "ADMARI TEA" AROUND A BOX CONTAINING A STYLIZED IMAGE OF LEAVES.

CLASS 30—STAPLE FOODS

FOR TEA (U.S. CL. 46).

CLASS 35—ADVERTISING AND BUSINESS

FOR ON-LINE RETAIL STORE SERVICES FEATURING TEA AND TEA RELATED MERCHANDISE; RETAIL SHOPS FEATURING TEA AND TEA RELATED MERCHANDISE (U.S. CLS. 100, 101 AND 102).

CLASS 43—HOTEL AND RESTAURANT SERVICES

FOR PROVIDING A WEBSITE FEATURING INFORMATION ABOUT TEA; RESTAURANT SERVICES; CAFE-RESTAURANTS; TEA ROOMS (U.S. CLS. 100 AND 101).

KAREN K. BUSH, EXAMINING ATTORNEY

SN 77-238,396. TUGENDHAT, ERNST, TUBINGEN, FED REP GERMANY, AND GUGGENHEIM-TUGENDHAT, RUTH, ZURICH, SWITZERLAND, AND HAMMER-TUGENDHAT, DANIELA, WIEN, AUSTRIA, FILED 7-25-2007.

VILLA TUGENDHAT

THE MARK CONSISTS OF STANDARD CHARACTERS WITHOUT CLAIM TO ANY PARTICULAR FONT, STYLE, SIZE, OR COLOR.

CLASS 16—PAPER GOODS AND PRINTED MATTER

FOR PRINTED MATTER, NAMELY, CATALOGS, LEAFLETS, BROCHURES, AND MAGAZINES IN THE FIELD OF ARCHITECTURE; POSTERS; PAPER BAGS (U.S. CLS. 2, 5, 22, 23, 29, 37, 38 AND 50).

CLASS 35—ADVERTISING AND BUSINESS

FOR ADVERTISING SERVICES (U.S. CLS. 100, 101 AND 102).

CLASS 41—EDUCATION AND ENTERTAINMENT

FOR ARRANGING FOR AND CONDUCTING EXHIBITIONS, PRESENTATIONS, EDUCATIONAL LECTURES, SEMINARS, AND CONFERENCES IN THE FIELD OF ARCHITECTURE; MUSEUMS IN THE FIELD OF ARCHITECTURE; EDITING OF BOOKS; PRODUCTION OF VIDEO DISCS AND TAPES FEATURING MOVIES; MOTION PICTURE FILM PRODUCTION (U.S. CLS. 100, 101 AND 107).

MICHAEL SOUDERS, EXAMINING ATTORNEY

SN 77-238,653. ASSOCIATION OF INSURANCE AND REINSURANCE RUN-OFF COMPANIES D/B/A AIRROC, ALPHARETTA, GA. FILED 7-25-2007.

AIRROC

THE MARK CONSISTS OF STANDARD CHARACTERS WITHOUT CLAIM TO ANY PARTICULAR FONT, STYLE, SIZE, OR COLOR.

CLASS 35—ADVERTISING AND BUSINESS

FOR ASSOCIATION SERVICES, NAMELY, PROMOTING THE INTERESTS OF INSURANCE AND REINSURANCE RUN-OFF COMPANIES (U.S. CLS. 100, 101 AND 102).

FIRST USE 1-31-2005; IN COMMERCE 1-31-2005.

CLASS 41—EDUCATION AND ENTERTAINMENT

FOR EDUCATIONAL SERVICES, NAMELY, PROVIDING SEMINARS AND WORKSHOPS TO INSURANCE AND REINSURANCE RUN-OFF COMPANIES (U.S. CLS. 100, 101 AND 107).

FIRST USE 1-31-2005; IN COMMERCE 1-31-2005.

FLORENTINA BLANDU, EXAMINING ATTORNEY

SN 77-238,698. ASSOCIATION OF INSURANCE AND REINSURANCE RUN-OFF COMPANIES D/B/A AIRROC, ALPHARETTA, GA. FILED 7-25-2007.



THE MARK CONSISTS OF THE UNDERLINED WORD "AIRROC" UNDER A TRI-ANGLE.

CLASS 35—ADVERTISING AND BUSINESS

FOR ASSOCIATION SERVICES, NAMELY, PROMOTING THE INTERESTS OF INSURANCE AND REINSURANCE RUN-OFF COMPANIES (U.S. CLS. 100, 101 AND 102).

FIRST USE 1-31-2005; IN COMMERCE 1-31-2005.

CLASS 41—EDUCATION AND ENTERTAINMENT

FOR EDUCATIONAL SERVICES, NAMELY, PROVIDING SEMINARS AND WORKSHOPS TO INSURANCE AND REINSURANCE RUN-OFF COMPANIES (U.S. CLS. 100, 101 AND 107).

FIRST USE 1-31-2005; IN COMMERCE 1-31-2005.
FLORENTINA BLANDU, EXAMINING ATTORNEY

SN 77-238,705. C.S.F. CORP., WILMINGTON, DE. FILED 7-25-2007.

RIGHT FIT BY FASHION BUG

THE MARK CONSISTS OF STANDARD CHARACTERS WITHOUT CLAIM TO ANY PARTICULAR FONT, STYLE, SIZE, OR COLOR.

OWNER OF U.S. REG. NOS. 942,143, 2,618,031 AND OTHERS.

NO CLAIM IS MADE TO THE EXCLUSIVE RIGHT TO USE "FASHION", APART FROM THE MARK AS SHOWN.

CLASS 25—CLOTHING

FOR WOMEN'S WEARING APPAREL, NAMELY, BELTS, BLAZERS, BLOUSES, BODYSUITS, BRAS, COATS, CAMISOLES, CONTROL UNDERGARMENTS, DRESSES, GLOVES, HATS, HOSIERY, JACKETS, JEANS, LINGERIE, PAJAMAS, PANTS, PANTIES, PANTSUITS, ROBES, SCARVES, SHIRTS, SHORTS, SKIRTS, SLEEP SHIRTS, SLIPS, SOCKS, SUITS, SWEATERS, SWEAT-PANTS, SWEATSHIRTS, SWIMWEAR, T-SHIRTS, TANK TOPS, TROUSERS, TUNICS, UNDERWEAR, AND VESTS (U.S. CLS. 22 AND 39).

CLASS 35—ADVERTISING AND BUSINESS

FOR RETAIL STORE SERVICES FEATURING WOMEN'S WEARING APPAREL AND ACCESSORIES; COMPUTERIZED ON-LINE RETAIL STORE SERVICES FEATURING WOMEN'S WEARING APPAREL AND ACCESSORIES; MAIL ORDER CATALOG SERVICES FEATURING WOMEN'S WEARING APPAREL AND ACCESSORIES (U.S. CLS. 100, 101 AND 102).

DAVID TAYLOR, EXAMINING ATTORNEY

SN 77-239,601. MERIDIOS, LTD., COSHOCTON, OH. FILED 7-26-2007.

MERIDIOS

THE MARK CONSISTS OF STANDARD CHARACTERS WITHOUT CLAIM TO ANY PARTICULAR FONT, STYLE, SIZE, OR COLOR.

CLASS 42—SCIENTIFIC AND COMPUTER SERVICES

FOR COMPUTER PROJECT MANAGEMENT OF HEALTH CARE SERVICES; CONSULTATION SERVICES IN THE FIELDS OF SELECTION, IMPLEMENTATION AND USE OF COMPUTER HARDWARE AND SOFTWARE SYSTEMS FOR OTHERS; DESIGN, DEVELOPMENT AND IMPLEMENTATION OF SOFTWARE; APPLICATION SERVICE PROVIDER PLANNING IN THE FIELD OF AMBULATORY ELECTRONIC MEDIAL RECORD APPLICATIONS, NAMELY, THE PLANNING, DEVELOPMENT, LAUNCH AND SUBSEQUENT SUPPORT OF AMBULATORY HEALTH APPLICATION SERVICE PROVIDERS (U.S. CLS. 100 AND 101).

FIRST USE 7-1-2005; IN COMMERCE 7-1-2005.

CLASS 44—MEDICAL, BEAUTY AND AGRICULTURAL SERVICES

FOR HEALTH CARE SERVICES, NAMELY, DISEASE MANAGEMENT PROGRAMS; PROVIDING MEDICAL INFORMATION, CONSULTANCY AND ADVISORY SERVICES (U.S. CLS. 100 AND 101).

FIRST USE 7-1-2005; IN COMMERCE 7-1-2005.
CAROLYN GRAY, EXAMINING ATTORNEY

SN 77-241,227. RYAN ROWE LLC, MILL VALLEY, CA. FILED 7-27-2007.

RYAN ROWE

THE MARK CONSISTS OF THE WORDS "RYAN ROWE" WITH A STYLIZED SQUARE SYMBOL BETWEEN AND "RYAN" IS UPSIDE DOWN.

CLASS 18—LEATHER GOODS

FOR BRIEFCASES; CHANGE PURSES; CLUTCH PURSES; COIN PURSES; EVENING HANDBAGS; HANDBAGS; HANDBAGS FOR MEN; IMITATION LEATHER; KEY WALLETS; LEATHER; LEATHER AND IMITATION LEATHER; LEATHER AND IMITATION LEATHER BAGS; LEATHER BAGS FOR MERCHANDISE PACKAGING; LEATHER BAGS, SUITCASES AND WALLETS; LEATHER BRIEFCASES; LEATHER CASES; LEATHER CASES FOR KEYS; LEATHER FOR FURNITURE; LEATHER FOR SHOES; LEATHER HANDBAGS; LEATHER KEY CASES; LEATHER KEY CHAINS; LEATHER PURSES; LEATHER SHOPPING BAGS; LUGGAGE; LUGGAGE TAGS; MULTI-PURPOSE PURSES; PET ACCESSORIES, NAMELY, CANVAS, VINYL AND LEATHER POUCHES FOR HOLDING DISPOSABLE BAGS TO PLACE PET WASTE IN; POCKET WALLETS; PURSES; SUITCASES; TANNED LEATHER; THONGS; TRUNKS; WALLETS; WALLETS WITH CARD COMPARTMENTS; ALL PURPOSE SPORT BAGS; ALL-PURPOSE ATHLETIC BAGS; ALL-PURPOSE CARRYING BAGS; CANVAS SHOPPING BAGS; CARRY-ALL BAGS; CARRY-ON BAGS; DIAPER BAGS; DUFFLE BAGS; DUFFLE BAGS; GARMENT BAGS FOR TRAVEL; GENERAL PURPOSE BAGS FOR CARRYING YOGA EQUIPMENT; MAKE-UP BAGS SOLD EMPTY; MEN'S CLUTCH BAGS; MESSENGER BAGS; OVERNIGHT BAGS; SCHOOL BAGS; SHOULDER BAGS; SLING BAGS; SPORTS BAGS; SUIT BAGS; TOTE BAGS; WHEELED DUFFLE BAGS; WHEELED MESSENGER BAGS; WHEELED TOTE BAGS; WINE BAGS WITH HANDLES FOR CARRYING OR HOLDING WINE (U.S. CLS. 1, 2, 3, 22 AND 41).

CLASS 25—CLOTHING

FOR FOOTWEAR; FOOTWEAR FOR MEN; FOOTWEAR NOT FOR SPORTS; INSOLES; INSOLES; SANDALS; SHOE SOLES; SHOES (BASED ON INTENT TO USE) ATHLETIC FOOTWEAR; ATHLETIC SHOES; BATHING SUITS; BEACH FOOTWEAR; BEACH SHOES; BELTS; BELTS MADE OF LEATHER; BELTS OF TEXTILE; BERMUDA SHORTS; BLOUSES; BOARD SHORTS; BODY SUITS; BOWLING SHOES; BOXER SHORTS; BOXING SHOES; CAMP SHIRTS; CANVAS SHOES; CAPRI PANTS; CAPS; CARGO PANTS; CLOTH BIBS; COATS; CYCLING SHOES; DECK-SHOES; DENIMS; DOWN JACKETS; DRESS SHIRTS; DRESS SUITS; DRESSES; DRESSING GOWNS; DUSTERS; EVENING DRESSES; EVENING GOWNS; DRIVERS; FLIP FLOPS; FOOTBALL SHOES; FOOTWEAR FOR MEN AND WOMEN; FOOTWEAR FOR WOMEN; FOOTWEAR, NAMELY, PUMPS; FUR COATS; FUR COATS AND JACKETS; GOLF SHIRTS; HATS; HEEL PIECES FOR SHOES; HOODS; HOODS; INFANT AND TODDLER ONE PIECE CLOTHING; INFANTS' SHOES AND BOOTS; JACKETS; JERSEYS; JOGGING PANTS; KNIT SHIRTS; KNITTED CAPS; LADIES' SUITS; LEATHER BELTS; LEATHER COATS; LEATHER JACKETS; LEATHER PANTS; LEATHER SHOES; MEN AND WOMEN JACKETS, COATS, TROUSERS, VESTS; MEN'S SUITS; MEN'S SUITS, WOMEN'S SUITS; NIGHT GOWNS; OVER COATS; PANTIES, SHORTS AND BRIEFS; PANTS; PARTS OF CLOTHING, NAMELY, GUSSETS FOR TIGHTS, GUSSETS FOR STOCKINGS, GUSSETS FOR BATHING SUITS, GUSSETS FOR UNDERWEAR, GUSSETS FOR LEOTARDS AND GUSSETS FOR FOOTLETS; PIQUE SHIRTS; POLO SHIRTS; PUMPS; RAIN COATS; RIDING COATS; RUBBER SHOES; RUNNING SHOES; SHIRTS; SHIRTS; SHIRTS FOR SUITS; SHORT TROUSERS; SHORT-SLEEVED OR LONG-SLEEVED T-SHIRTS; SHORT-SLEEVED SHIRTS; SHORTS; SHOULDER WRAPS; SKI JACKETS; SKI PANTS; SKI SUITS; SKIRT SUITS; SKIRTS; SKIRTS AND DRESSES; SKULL CAPS; SLEEVED OR SLEEVELESS JACKETS; SLEEVELESS JERSEYS; SMOKING JACKETS; SNOW BOARDING SUITS; SNOW PANTS; SNOW SUITS; SNOWBOARD PANTS; SOCCER SHOES; SPORT COATS; SPORT SHIRTS; SPORTS JACKETS; SPORTS JERSEYS; SPORTS SHIRTS; SUEDE JACKETS; SUITS; SWEAT PANTS; SWEAT SHIRTS; SWEAT SHORTS; SWEAT SUITS; SWIM CAPS; T-SHIRTS; TANK TOPS; TEE SHIRTS; TENNIS SHOES; THONGS; TIES; TOP COATS; TOPS; TRACK AND FIELD SHOES; TRACK PANTS; TRACK SUITS; UNDERWEAR, NAMELY, BOY SHORTS; VOLLEYBALL SHOES; WALKING SHORTS; WEDDING DRESSES; WEDDING GOWNS; WIND-JACKETS; WOMEN'S SHOES; WRAPS; YOGA PANTS; BRIEFS; LADIES' UNDERWEAR; THERMAL UNDERWEAR; THONGS; UNDERWEAR; WOMEN'S UNDERWEAR; WOVEN OR KNITTED UNDERWEAR; MEN'S SOCKS; SOCKS; SCARVES; LEG WARMERS; LEGGINGS; LEOTARDS AND TIGHTS FOR WOMEN, MEN AND CHILDREN OF NYLON, COTTON OR OTHER TEXTILE FIBERS; TIGHTS; VESTS; CREWNECK SWEATERS; SWEATERS; TURTLENECK SWEATERS; V-NECK SWEATERS; CAPRIS; INFANTS' TROUSERS; TROUSERS; BOOTS; HIKING BOOTS; HORSE-RIDING BOOTS; LADIES' BOOTS; RAIN BOOTS; RIDING BOOTS; SOCCER BOOTS; WINTER BOOTS; WORK SHOES AND BOOTS; MOCCASINS; CHILDREN'S HEADWEAR; HEELS (U.S. CLS. 22 AND 39).

FIRST USE 5-10-2007; IN COMMERCE 6-25-2007.
SUZANNE BLANE, EXAMINING ATTORNEY

SN 77-242,436. AQUAVAN TECHNOLOGY INC., BURNABY, CANADA, FILED 7-30-2007.

**CLASS 7—MACHINERY**

FOR AQUARIUM PUMPS; ELECTRIC PUMPS FOR AQUARIUM; POND AND WATER GARDEN AERATION SYSTEMS COMPRISING WATER PUMPS, AIR COMPRESSORS, AIR BLOWERS AND A FINNED WHEEL FOR PRESSURIZING AND AERATING PONDS AND AQUARIUMS; MECHANIZED AUTOMATIC FISH AND SHRIMP FEEDERS CONTAINING OPERATOR INTERFACES, SENSORS AND MICROCOMPUTERS TO CONTROL AND MONITOR EQUIPMENT; BUBBLE GENERATING DEVICES CONSISTING OF MOTORS, PUMPS, WATER AND AIR MIXING DEVICES, CONTROL SWITCHES AND OVERCURRENT PROTECTION SWITCHES FOR USE IN INCREASING OXYGEN IN CULTURED PONDS; AERATORS IN THE NATURE OF AIR-LIFT DEVICES COMPRISING MOTORS, PUMPS, AIR EXCHANGE DEVICES, CONTROL SWITCHES AND SOLAR HEAT COLLECTION PANELS FOR USE IN CIRCULATING OXYGEN BETWEEN UPPER AND DEEPER WATER (U.S. CLS. 13, 19, 21, 23, 31, 34 AND 35).

CLASS 9—ELECTRICAL AND SCIENTIFIC APPARATUS

FOR BIOCHIPS, NAMELY, BIOLOGICALLY ENCODED DNA CHIPS; DNA CHIPS (U.S. CLS. 21, 23, 26, 36 AND 38).

COLLEEN KEARNEY, EXAMINING ATTORNEY

SN 77-242,668. GEORGIA-PACIFIC CONSUMER PRODUCTS LP, ATLANTA, GA. FILED 7-31-2007.

GREEN BY DESIGN

THE MARK CONSISTS OF STANDARD CHARACTERS WITHOUT CLAIM TO ANY PARTICULAR FONT, STYLE, SIZE, OR COLOR.

NO CLAIM IS MADE TO THE EXCLUSIVE RIGHT TO USE "GREEN", APART FROM THE MARK AS SHOWN.

CLASS 3—COSMETICS AND CLEANING PREPARATIONS

FOR HAND SOAPS (U.S. CLS. 1, 4, 6, 50, 51 AND 52).

CLASS 5—PHARMACEUTICALS

FOR AIR FRESHENERS (U.S. CLS. 6, 18, 44, 46, 51 AND 52).

ROBERT C. CLARK JR., EXAMINING ATTORNEY

SN 77-243,085. VAN ZEELAND, INC., NEW YORK, NY.
FILED 7-31-2007.

SOPHIA CAPERELLI

THE MARK CONSISTS OF STANDARD CHARACTERS WITHOUT CLAIM TO ANY PARTICULAR FONT, STYLE, SIZE, OR COLOR.

THE NAME(S), PORTRAIT(S), AND/OR SIGNATURE(S) SHOWN IN THE MARK DOES NOT IDENTIFY A PARTICULAR LIVING INDIVIDUAL.

CLASS 9—ELECTRICAL AND SCIENTIFIC APPARATUS

FOR SUNGLASSES (U.S. CLS. 21, 23, 26, 36 AND 38).

CLASS 14—JEWELRY

FOR JEWELRY, NAMELY, COSTUME JEWELRY (U.S. CLS. 2, 27, 28 AND 50).

CLASS 18—LEATHER GOODS

FOR HANDBAGS, POCKETBOOKS, EVENING BAGS, PURSES, CLUTCHES, CLUTCH PURSES, TRAVEL BAGS, TOTES, TOTE BAGS, DUFFEL BAGS, BEACH BAGS, DIAPER AND NAPPY BAGS, COSMETIC BAGS SOLD EMPTY, COSMETIC CASES SOLD EMPTY, TOILETRY CASES SOLD EMPTY, SCHOOL BAGS, KNAPSACKS, SLING BACKPACKS, BACKPACKS, WAIST PACKS, WALLETS, BILLFOLDS, BUSINESS CARD CASES, CREDIT CARD CASES, KEY CASES, CHANGE PURSES, AND LUGGAGE ALL MADE FROM LEATHER, IMITATION LEATHER AND OTHER MATERIALS; AND UMBRELLAS (U.S. CLS. 1, 2, 3, 22 AND 41).
ALICIA COLLINS, EXAMINING ATTORNEY

SN 77-243,646. DHEALTH INSTITUTE, INC., SCOTTS VALLEY, CA. FILED 7-31-2007.

DHEALTH

THE MARK CONSISTS OF STANDARD CHARACTERS WITHOUT CLAIM TO ANY PARTICULAR FONT, STYLE, SIZE, OR COLOR.

CLASS 41—EDUCATION AND ENTERTAINMENT

FOR PROVIDING ASSISTANCE, PERSONAL TRAINING AND PHYSICAL FITNESS CONSULTATION TO PEOPLE TO HELP THEM MAKE PHYSICAL FITNESS, STRENGTH, CONDITIONING, AND EXERCISE ALTERATIONS IN THEIR DAILY LIVING; PROVIDING INFORMATION IN THE FIELD OF EXERCISE VIA TELEPHONE, THE INTERNET AND WIRELESS DEVICES (U.S. CLS. 100, 101 AND 107).

CLASS 42—SCIENTIFIC AND COMPUTER SERVICES

FOR PROVIDING TEMPORARY USE OF ON-LINE NON-DOWNLOADABLE SOFTWARE FOR MONITORING A PERSON'S BODY MOTION, DISTANCE COVERED ON FOOT, BLOOD PRESSURE, BLOOD SUGAR, BODY FAT, SLEEP AND SIMILAR HEALTH INDICATORS; COMPUTER SERVICES, NAMELY, CREATING AN ONLINE COMMUNITY FOR REGISTERED USERS TO PARTICIPATE IN MONITORING THEIR HEALTH, EXERCISE AND WELLNESS, AND TO GET FEEDBACK FROM THEIR PEERS, FROM VIRTUAL COMMUNITIES, ENGAGE IN SOCIAL NETWORKING AND IMPROVE THEIR HEALTH, EXERCISE AND WELLNESS; TEMPORARY USE OF ONLINE, NON-DOWNLOADABLE SOFTWARE FOR USE IN CREATING, ENHANCING, MODIFYING, TRANSMITTING, RECEIVING, EXCHANGING, STORING AND SYNCHRONIZING INFORMATION, MESSAGES, AND MULTIMEDIA FILES; TEMPORARY USE OF ONLINE, NON-DOWNLOADABLE SOFTWARE FOR USE IN CONNECTING TO AND EXCHANGING INFORMATION OVER LOCAL AREA, WIDE AREA, ENTERPRISE, GLOBAL COMMUNICATIONS AND WIRELESS NETWORKS; COMPUTER SERVICES, NAMELY, DATABASE DEVELOPMENT SERVICES (U.S. CLS. 100 AND 101).

CLASS 44—MEDICAL, BEAUTY AND AGRICULTURAL SERVICES

FOR PROVIDING HEALTH INFORMATION; PROVIDING A WEBSITE FEATURING INFORMATION IN THE FIELD OF HEALTH AND WELLNESS; PROVIDING INFORMATION IN THE FIELD OF HEALTH AND WELLNESS VIA TELEPHONE, THE INTERNET AND WIRELESS DEVICES; CONSULTING SERVICES IN THE FIELD OF HEALTH AND WELLNESS (U.S. CLS. 100 AND 101).

DAVID MURRAY, EXAMINING ATTORNEY

SN 77-244,438. QUINTILES TRANSNATIONAL CORP., DURHAM, NC. FILED 8-1-2007.

QUINTILES

THE MARK CONSISTS OF STANDARD CHARACTERS WITHOUT CLAIM TO ANY PARTICULAR FONT, STYLE, SIZE, OR COLOR.

OWNER OF U.S. REG. NO. 2,340,026.

CLASS 35—ADVERTISING AND BUSINESS

FOR COMPUTERIZED DATABASE MANAGEMENT AND DATA PROCESSING SERVICES IN THE FIELDS OF PHARMACEUTICAL, VETERINARY, PHARMACOGENOMIC, BIOTECHNICAL AND MEDICAL PRODUCTS AND DEVICES; MANUFACTURERS' AND INDEPENDENT SALES REPRESENTATIVES IN THE FIELDS OF PHARMACEUTICALS, VETERINARY, PHARMACOGENOMIC, BIOTECHNICAL, DENTAL, AND MEDICAL PRODUCTS AND DEVICES; MARKETING SERVICES FOR OTHERS, NAMELY, CREATING AND MANAGING PRODUCT SALES AND PRODUCT LAUNCH PROGRAMS IN THE FIELDS OF PHARMACEUTICALS, VETERINARY, PHARMACOGENOMIC, BIOTECHNICAL, DENTAL, AND MEDICAL PRODUCTS AND DEVICES; BUSINESS MARKETING CONSULTING SERVICES IN THE FIELDS OF PHARMACEUTICALS, VETERINARY, PHARMACOGENOMIC, BIOTECHNICAL, DENTAL, AND MEDICAL PRODUCTS AND DEVICES; MARKET RESEARCH AND ANALYSIS SERVICES IN THE FIELDS OF PHARMACEUTICALS, VETERINARY, PHARMACOGENOMIC, BIOTECHNICAL, DENTAL, AND MEDICAL PRODUCTS AND DEVICES; PERSONNEL RECRUITMENT AND PLACEMENT; PROVIDING BUSINESS INFORMATION, NAMELY, INFORMATION USEFUL FOR ACHIEVING AND MAINTAINING REGULATORY APPROVAL AND MARKET INTRODUCTION OF DRUGS, DEVICES AND BIOLOGICS (U.S. CLS. 100, 101 AND 102).

CLASS 41—EDUCATION AND ENTERTAINMENT

FOR EDUCATIONAL AND TRAINING SERVICES, NAMELY, CONDUCTING TRAINING PROGRAMS, SEMINARS, CLASSES, CONFERENCES AND WORKSHOPS IN THE FIELDS OF HEALTH CARE, HEALTH MANAGEMENT AND DISEASE MANAGEMENT, PHARMACEUTICAL SALES SKILLS, AND PHARMACEUTICAL AND HEALTH PRODUCTS, AND DISTRIBUTING COURSE MATERIALS IN CONNECTION THEREWITH (U.S. CLS. 100, 101 AND 107).

CLASS 42—SCIENTIFIC AND COMPUTER SERVICES

FOR CLINICAL RESEARCH AND TESTING SERVICES IN THE FIELDS OF PHARMACEUTICALS, VETERINARY, PHARMACOGENOMIC, BIOTECHNICAL, DENTAL, AND MEDICAL PRODUCTS AND DEVICES; PRODUCT DEVELOPMENT CONSULTATION IN THE FIELDS OF MEDICAL PRODUCTS AND DEVICES; HEALTHCARE POLICY RESEARCH AND DEVELOPMENT SERVICES; LABORATORY TESTING SERVICES IN THE FIELDS OF PHARMACEUTICAL, VETERINARY, PHARMACOGENOMIC, BIOTECHNICAL AND MEDICAL PRODUCTS AND DEVICES; CONSULTANCY PERTAINING TO PHARMACOLOGY AND BIOTECHNICAL RESEARCH; MANAGING, MONITORING AND COORDINATING CLINICAL STUDIES ON HUMAN SUBJECTS FOR OTHERS (U.S. CLS. 100 AND 101).

CLASS 44—MEDICAL, BEAUTY AND AGRICULTURAL SERVICES

FOR PROVIDING HEALTH, MEDICAL, DENTAL, PHARMACEUTICAL, HEALTH MANAGEMENT AND DISEASE MANAGEMENT INFORMATION TO OTHERS; MEDICAL EVALUATION SERVICES, NAMELY, DEVELOPING AND IMPLEMENTING DISEASE MANAGEMENT AND TREATMENT PROTOCOLS AND PATIENT OUTCOME ANALYSIS SERVICES; CONSULTING SERVICES IN THE FIELDS OF HEALTH CARE, MEDICAL AND PHARMACEUTICALS, VETERINARY, AND DENTAL SERVICES (U.S. CLS. 100 AND 101).

CLASS 45—PERSONAL AND LEGAL SERVICES

FOR REGULATORY RESEARCH IN THE PHARMACEUTICAL INDUSTRY, BIOTECHNOLOGY INDUSTRY AND THE MEDICAL AND DIAGNOSTICS INDUSTRY; CONSULTATION SERVICES IN THE FIELD OF COMPLIANCE EVALUATION TO INSURE VALIDITY AND ACCURACY OF REGULATORY SUBMISSIONS TO THE FDA BY LIFE SCIENCES COMPANIES; CONDUCTING REGULATORY AND COMPLIANCE AUDITS FOR OTHERS IN THE FIELDS OF PHARMACEUTICAL, VETERINARY, PHARMACOGENOMIC, BIOTECHNICAL AND MEDICAL PRODUCTS AND DEVICES; CONSULTING SERVICES IN THE FIELDS OF REGULATORY AFFAIRS, MANUFACTURING COMPLIANCE AND VALIDATION; PROVIDING REGULATORY INFORMATION AND IMPLEMENTATION SERVICES RELATING TO THE DEVELOPMENT AND VALIDATION OF DRUGS, DEVICES AND BIOLOGICS (U.S. CLS. 100 AND 101).

LINDSEY RUBIN, EXAMINING ATTORNEY

SN 77-244,646. FREELANCE FOOD, LLC, ENGLEWOOD, NJ. FILED 8-1-2007.

FREELANCE FOOD

THE MARK CONSISTS OF STANDARD CHARACTERS WITHOUT CLAIM TO ANY PARTICULAR FONT, STYLE, SIZE, OR COLOR.

NO CLAIM IS MADE TO THE EXCLUSIVE RIGHT TO USE FOOD, APART FROM THE MARK AS SHOWN.

CLASS 16—PAPER GOODS AND PRINTED MATTER

FOR COOK BOOKS (U.S. CLS. 2, 5, 22, 23, 29, 37, 38 AND 50).

CLASS 43—HOTEL AND RESTAURANT SERVICES

FOR CONSULTING SERVICES IN THE FIELD OF CULINARY ARTS (U.S. CLS. 100 AND 101).

FIRST USE 7-31-1994; IN COMMERCE 7-31-1994.
MARK SPARACINO, EXAMINING ATTORNEY

SN 77-245,291. GLOBEFUNDER VENTURES, INC., KALAMAZOO, MI. FILED 8-2-2007.



glogefunder

THE MARK CONSISTS OF THE LITERAL ELEMENT AND A DESIGN OF CIRCLES WITHIN A CIRCLE.

CLASS 35—ADVERTISING AND BUSINESS

FOR OPERATING AN ONLINE MARKETPLACE FOR LENDERS AND BORROWERS (U.S. CLS. 100, 101 AND 102).

CLASS 42—SCIENTIFIC AND COMPUTER SERVICES

FOR PROVIDING ONLINE NONDOWNLOADABLE SOFTWARE FOR LOAN APPLICATION, APPROVAL AND REPAYMENT PROCESS (U.S. CLS. 100 AND 101).
ZACHARY BELLO, EXAMINING ATTORNEY

SN 77-246,646. TEXTSTYLE, LLC, CINCINNATI, OH. FILED 8-3-2007.

GREEN HOUSE

THE MARK CONSISTS OF STANDARD CHARACTERS WITHOUT CLAIM TO ANY PARTICULAR FONT, STYLE, SIZE, OR COLOR.

CLASS 20—FURNITURE AND ARTICLES NOT OTHERWISE CLASSIFIED

FOR DECORATIVE PILLOWS (U.S. CLS. 2, 13, 22, 25, 32 AND 50).

CLASS 24—FABRICS

FOR TEXTILE FABRICS FOR THE MANUFACTURE OF WINDOW COVERINGS, NAMELY, CURTAINS AND DRAPERIES (U.S. CLS. 42 AND 50).
LINDA M. KING, EXAMINING ATTORNEY

SN 77-246,652. CURANT COMMUNICATIONS, INC., LOS ANGELES, CA. FILED 8-3-2007.

RT FOR DECISION MAKERS IN RESPIRATORY CARE

THE MARK CONSISTS OF STANDARD CHARACTERS WITHOUT CLAIM TO ANY PARTICULAR FONT, STYLE, SIZE, OR COLOR.

OWNER OF U.S. REG. NOS. 2,454,512, 2,470,908 AND 2,503,445.

NO CLAIM IS MADE TO THE EXCLUSIVE RIGHT TO USE "FOR DECISION MAKERS IN RESPIRATORY CARE", APART FROM THE MARK AS SHOWN.

SEC. 2(F) AS TO RT.

CLASS 16—PAPER GOODS AND PRINTED MATTER

FOR PRINTED MAGAZINE AND JOURNAL ON CLINICAL AND CURRENT HEALTH ISSUES IN THE FIELDS RELATED TO RESPIRATORY CARE (U.S. CLS. 2, 5, 22, 23, 29, 37, 38 AND 50).

FIRST USE 11-0-2006; IN COMMERCE 11-0-2006.

CLASS 35—ADVERTISING AND BUSINESS

FOR ADVERTISING SERVICES, NAMELY, DISSEMINATING ADVERTISING FOR OTHERS AND PROMOTING GOODS AND/OR SERVICES IN FIELDS THAT PROVIDE A VARIETY OF RESPIRATORY CARE AND OTHER GOODS AND SERVICES BY PROVIDING SPACE IN A PERIODICAL (U.S. CLS. 100, 101 AND 102).

FIRST USE 11-0-2006; IN COMMERCE 11-0-2006.

CLASS 41—EDUCATION AND ENTERTAINMENT

FOR ONLINE PUBLICATION OF MAGAZINES AND ARTICLES IN THE FIELD OF RESPIRATORY PULMONARY CARE (U.S. CLS. 100, 101 AND 107).

FIRST USE 11-0-2006; IN COMMERCE 11-0-2006.

LINDA M. KING, EXAMINING ATTORNEY

SN 77-246,914. J.T. RONNEFELDT KG, FRANKFURT, FED REP GERMANY, FILED 8-3-2007.

RONNEFELDT

THE MARK CONSISTS OF STANDARD CHARACTERS WITHOUT CLAIM TO ANY PARTICULAR FONT, STYLE, SIZE, OR COLOR.

OWNER OF ERPN CMNTY TM OFC REG. NO. 003429611, DATED 5-27-2005, EXPIRES 10-22-2013.

CLASS 16—PAPER GOODS AND PRINTED MATTER

FOR GOODS OF PAPER AND CARDBOARD, NAMELY, PACKAGING; TEA FILTERS OF PAPER (U.S. CLS. 2, 5, 22, 23, 29, 37, 38 AND 50).

CLASS 21—HOUSEWARES AND GLASS

FOR PORCELAIN TEAPOTS AND PORCELAIN TEACUPS; EARTHENWARE TEAPOTS AND EARTHENWARE TEACUPS (U.S. CLS. 2, 13, 23, 29, 30, 33, 40 AND 50).

CLASS 30—STAPLE FOODS

FOR TEA: FRUIT TEAS; HERBAL TEAS; TEA-TYPE PRODUCTS, NAMELY, TEA LEAVES AND TEA SUBSTITUTES (U.S. CL. 46).

DANIEL BRODY, EXAMINING ATTORNEY



ROAD TO HANA

CLASS 6—METAL GOODS

FOR METAL KEY CHAINS (U.S. CLS. 2, 12, 13, 14, 23, 25 AND 50).
FIRST USE 6-1-2004; IN COMMERCE 6-1-2004.

CLASS 9—ELECTRICAL AND SCIENTIFIC APPARATUS

FOR MOUSE PADS (U.S. CLS. 21, 23, 26, 36 AND 38).
FIRST USE 6-1-2004; IN COMMERCE 6-1-2004.

CLASS 16—PAPER GOODS AND PRINTED MATTER

FOR POSTERS; STICKERS (U.S. CLS. 2, 5, 22, 23, 29, 37, 38 AND 50).
FIRST USE 6-1-2004; IN COMMERCE 6-1-2004.

CLASS 18—LEATHER GOODS

FOR BACKPACKS; PET CLOTHING (U.S. CLS. 1, 2, 3, 22 AND 41).
FIRST USE 6-1-2004; IN COMMERCE 6-1-2004.

CLASS 25—CLOTHING

FOR SHIRTS; HEADGEAR, NAMELY, HATS, CAPS, AND BEANIES; PANTS; UNDERWEAR; CREEPERS (U.S. CLS. 22 AND 39).
FIRST USE 6-1-2004; IN COMMERCE 6-1-2004.

CLASS 26—FANCY GOODS

FOR CLOTH PATCHES FOR CLOTHING; EMBROIDERED PATCHES FOR CLOTHING (U.S. CLS. 37, 39, 40, 42 AND 50).
FIRST USE 6-1-2004; IN COMMERCE 6-1-2004.
MARIA-VICTORIA SUAREZ, EXAMINING ATTORNEY

THE MARK CONSISTS OF STANDARD CHARACTERS WITHOUT CLAIM TO ANY PARTICULAR FONT, STYLE, SIZE, OR COLOR.

NO CLAIM IS MADE TO THE EXCLUSIVE RIGHT TO USE "HANA", APART FROM THE MARK AS SHOWN.

CLASS 3—COSMETICS AND CLEANING PREPARATIONS

FOR BEAUTY GELS; BEAUTY CREAMS; BEAUTY LOTIONS; SOAPS FOR BODY CARE; BAR SOAPS; BODY AND BEAUTY CARE COSMETICS; COSMETIC OILS; COSMETIC CREAMS; FRAGRANCES FOR PERSONAL USE (U.S. CLS. 1, 4, 6, 50, 51 AND 52).

CLASS 4—LUBRICANTS AND FUELS

FOR CANDLES (U.S. CLS. 1, 6 AND 15).

CLASS 21—HOUSEWARES AND GLASS

FOR COFFEE CUPS; COFFEE SERVICES; TEA SERVICES (U.S. CLS. 2, 13, 23, 29, 30, 33, 40 AND 50).

CLASS 30—STAPLE FOODS

FOR BEVERAGES MADE OF COFFEE; COFFEE; COFFEE BEANS; BEVERAGES MADE OF TEA; TEA; PREPARED COCOA AND COCOA-BASED BEVERAGES (U.S. CL. 46).

CLASS 32—LIGHT BEVERAGES

FOR NON-ALCOHOLIC BEVERAGES CONTAINING FRUIT JUICES (U.S. CLS. 45, 46 AND 48).
KATHERINE CONNOLLY, EXAMINING ATTORNEY

SN 77-247,427. GEORGE T. PHELPS, CINCINNATI, OH.
FILED 8-5-2007.



NO CLAIM IS MADE TO THE EXCLUSIVE RIGHT TO USE "CHILI", APART FROM THE MARK AS SHOWN.

THE COLOR(S) YELLOW, BLUE, GREEN, RED, AND BLACK IS/ARE CLAIMED AS A FEATURE OF THE MARK.

THE MARK CONSISTS OF A YELLOW CHILI PEPPER WITH GREEN STEM, A RED FIREFIGHTER'S HELMET OUTLINED IN BLACK WITH A BLACK EMBLEM ON THE FRONT OF THE HELMET, A BLACK OUTLINED CAULDRON WITH A BLUE AND GREEN DEPICTION OF THE PLANET EARTH ON THE SIDE OF THE CAULDRON TOPPED WITH A WITH YELLOW FIRE THAT IS OUTLINED ON ITS TOP IN RED, A RED PEPPER WITH A GREEN STEM AT THE BOTTOM OF THE DRAWING, AND THE WORDING "CHILI ROCK CAFE" ALL IN BLACK.

CLASS 25—CLOTHING

FOR HATS; T-SHIRTS (U.S. CLS. 22 AND 39).

CLASS 29—MEATS AND PROCESSED FOODS

FOR CHILI (U.S. CL. 46).

CLASS 30—STAPLE FOODS

FOR CHILI PASTE FOR USE AS A SEASONING; CHILI POWDERS; CHILI SAUCE; CHILI SEASONING; DRIED CHILI PEPPERS (U.S. CL. 46).

DOMINIC J. FERRAIUOLO, EXAMINING ATTORNEY

SN 77-248,494. MOONALICE, LLC, MENLO PARK, CA.
FILED 8-6-2007.

MOONALICE

THE MARK CONSISTS OF STANDARD CHARACTERS WITHOUT CLAIM TO ANY PARTICULAR FONT, STYLE, SIZE, OR COLOR.

CLASS 9—ELECTRICAL AND SCIENTIFIC APPARATUS

FOR MUSICAL SOUND RECORDINGS (U.S. CLS. 21, 23, 26, 36 AND 38).
FIRST USE 5-5-2007; IN COMMERCE 5-5-2007.

CLASS 16—PAPER GOODS AND PRINTED MATTER

FOR POSTERS (U.S. CLS. 2, 5, 22, 23, 29, 37, 38 AND 50).
FIRST USE 5-5-2007; IN COMMERCE 5-5-2007.

CLASS 41—EDUCATION AND ENTERTAINMENT

FOR ENTERTAINMENT, NAMELY, LIVE MUSIC CONCERTS (U.S. CLS. 100, 101 AND 107).
FIRST USE 5-5-2007; IN COMMERCE 5-5-2007.
JORDAN BAKER, EXAMINING ATTORNEY

SN 77-249,389. MOONALICE, LLC, MENLO PARK, CA.
FILED 8-7-2007.



THE MARK CONSISTS OF WORDS WITH CRESCENT OF MOON.

CLASS 9—ELECTRICAL AND SCIENTIFIC APPARATUS

FOR MUSICAL SOUND RECORDINGS (U.S. CLS. 21, 23, 26, 36 AND 38).
FIRST USE 5-5-2007; IN COMMERCE 5-5-2007.

CLASS 16—PAPER GOODS AND PRINTED MATTER

FOR POSTERS (U.S. CLS. 2, 5, 22, 23, 29, 37, 38 AND 50).
FIRST USE 5-5-2007; IN COMMERCE 5-5-2007.

CLASS 41—EDUCATION AND ENTERTAINMENT

FOR ENTERTAINMENT SERVICES, NAMELY, LIVE MUSIC CONCERTS (U.S. CLS. 100, 101 AND 107).
FIRST USE 5-5-2007; IN COMMERCE 5-5-2007.
JORDAN BAKER, EXAMINING ATTORNEY

SN 77-250,305. J.T. RONNEFELDT KG, FRANKFURT, FED REP GERMANY, FILED 8-8-2007.

Lemon Sky

THE MARK CONSISTS OF STANDARD CHARACTERS WITHOUT CLAIM TO ANY PARTICULAR FONT, STYLE, SIZE, OR COLOR.

OWNER OF FED REP GERMANY REG. NO. 30245057, DATED 12-9-2002, EXPIRES 9-30-2012.

NO CLAIM IS MADE TO THE EXCLUSIVE RIGHT TO USE "LEMON", APART FROM THE MARK AS SHOWN.

CLASS 16—PAPER GOODS AND PRINTED MATTER

FOR PACKING MATERIALS, NAMELY, PAPER AND CARDBOARD (U.S. CLS. 2, 5, 22, 23, 29, 37, 38 AND 50).

CLASS 30—STAPLE FOODS

FOR TEA, FRUIT TEA, HERBAL TEA NOT FOR MEDICAL PURPOSES AND TEA TYPE PRODUCTS, NAMELY, TEA LEAVES AND TEA SUBSTITUTES (U.S. CL. 46).

Laura Hammel, Examining Attorney

CLASS 25—CLOTHING

FOR SWIMWEAR FOR WOMEN, NAMELY, BIKINIS, ONE-PIECE SWIMSUITS, TANKINIS, BATHING SUIT COVER-UPS, BATHING SUIT WRAPS; DRESSES, SKIRTS AND RESORT WEAR, NAMELY, CAFTANS, TUNICS, SANDALS, LOUNGEWEAR, SUNDRESSES, SARONGS AND PULLOVERS (U.S. CLS. 22 AND 39).

First Use 1-1-1997; In Commerce 1-1-1997.
Erin Falk, Examining Attorney

SN 77-251,578. LEUCADIA CELLARS & ESTATES, LLC, DBA LEUCADIA CELLARS & ESTATES, LLC, SAN FRANCISCO, CA. FILED 8-9-2007.

SN 77-253,645. BCD TRAVEL USA LLC, ATLANTA, GA. FILED 8-13-2007.

THE SOURCE PLATFORM

Soleil du Midi

THE MARK CONSISTS OF STANDARD CHARACTERS WITHOUT CLAIM TO ANY PARTICULAR FONT, STYLE, SIZE, OR COLOR.

THE MARK CONSISTS OF STANDARD CHARACTERS WITHOUT CLAIM TO ANY PARTICULAR FONT, STYLE, SIZE, OR COLOR.

THE ENGLISH TRANSLATION OF THE WORD "SOLEIL DU MIDI" IN THE MARK IS MIDDAY SUN.

CLASS 9—ELECTRICAL AND SCIENTIFIC APPARATUS

FOR COMPUTER SOFTWARE FOR USE BY OTHERS TO MAKE TRAVEL RESERVATIONS, TO STORE AND ACCESS TRAVEL INFORMATION, AND TO MANAGE TRAVEL INFORMATION (U.S. CLS. 21, 23, 26, 36 AND 38).

First Use 7-22-2007; In Commerce 7-22-2007.

CLASS 32—LIGHT BEVERAGES

FOR DE-ALCOHOLIZED WINES; NON-ALCOHOLIZED WINES (U.S. CLS. 45, 46 AND 48).

CLASS 35—ADVERTISING AND BUSINESS

FOR PROVIDING INFORMATION TO BUSINESSES REGARDING EFFICIENCY AND EFFECTIVENESS OF TRAVEL PROGRAMS AND REGARDING MANAGEMENT OF TRAVELER BEHAVIOR, TRAVEL POLICY COMPLIANCE AND TRAVELER SECURITY MANAGEMENT AND CONSULTATION IN CONNECTION THEREWITH (U.S. CLS. 100, 101 AND 102).

First Use 7-22-2007; In Commerce 7-22-2007.

CLASS 33—WINES AND SPIRITS

FOR APERITIF WINES; APERITIFS WITH A WINE BASE; COOKING WINE; FRUIT WINE; GRAPE WINE; NATURAL SPARKLING WINES; PORT WINES; PREPARED WINE COCKTAILS; RED WINE; SPARKLING FRUIT WINE; SPARKLING GRAPE WINE; SPARKLING WINES; SWEET WINES; TABLE WINES; WHITE WINE; WINE; WINE COOLERS; WINE PUNCH; WINE PUNCHES; WINES (U.S. CLS. 47 AND 49).

Beryl Gardner, Examining Attorney

CLASS 42—SCIENTIFIC AND COMPUTER SERVICES

FOR PROVIDING TEMPORARY USE OF NON-DOWNLOADABLE SOFTWARE FOR USE BY OTHERS TO MAKE TRAVEL RESERVATIONS, TO STORE AND ACCESS TRAVEL INFORMATION, AND TO MANAGE TRAVEL INFORMATION (U.S. CLS. 100 AND 101).

First Use 7-22-2007; In Commerce 7-22-2007.
Linda E. Blohm, Examining Attorney

SN 77-252,207. GAETANO, INC., DBA LISA CURRAN SWIM, HOBOKEN, NJ. FILED 8-10-2007.

SN 77-254,096. ICHANGE, INC., SANTA BARBARA, CA. FILED 8-13-2007.

LISA CURRAN

Do you know where your mask is?

THE MARK CONSISTS OF STANDARD CHARACTERS WITHOUT CLAIM TO ANY PARTICULAR FONT, STYLE, SIZE, OR COLOR.

THE NAME "LISA CURRAN" IDENTIFIES A LIVING INDIVIDUAL WHOSE CONSENT IS OF RECORD. SEC. 2(F).

CLASS 24—FABRICS

FOR BEACH TOWELS (U.S. CLS. 42 AND 50). FIRST USE 1-1-1997; IN COMMERCE 1-1-1997.

THE MARK CONSISTS OF STANDARD CHARACTERS WITHOUT CLAIM TO ANY PARTICULAR FONT, STYLE, SIZE, OR COLOR.

CLASS 9—ELECTRICAL AND SCIENTIFIC APPARATUS

FOR DUST MASKS BUILT IN TO NECKLINE OF T-SHIRTS FOR EASY DEPLOYMENT (U.S. CLS. 21, 23, 26, 36 AND 38).

FIRST USE 7-1-2006; IN COMMERCE 11-15-2006.

CLASS 25—CLOTHING

FOR T-SHIRTS WITH BUILT IN DUST MASKS THAT ARE STORED IN NECKLINE OF SHIRTS FOR EASY DEPLOYMENT (U.S. CLS. 22 AND 39).

FIRST USE 7-1-2006; IN COMMERCE 11-15-2006.

AMY GEARIN, EXAMINING ATTORNEY

SN 77-254,142. EFUN TECHNOLOGY CO., LTD., TAINAN CITY, TAIWAN, FILED 8-13-2007.

EFUN

THE MARK CONSISTS OF STANDARD CHARACTERS WITHOUT CLAIM TO ANY PARTICULAR FONT, STYLE, SIZE, OR COLOR.

CLASS 9—ELECTRICAL AND SCIENTIFIC APPARATUS

FOR PRISM SHEETS FOR BACK LIGHT MODULE OF LIQUID CRYSTAL DISPLAY (U.S. CLS. 21, 23, 26, 36 AND 38).

CLASS 11—ENVIRONMENTAL CONTROL APPARATUS

FOR DIFFUSERS FOR BACK LIGHT MODULES OF LIGHT CRYSTAL DISPLAYS (U.S. CLS. 13, 21, 23, 31 AND 34).

PATRICIA EVANKO, EXAMINING ATTORNEY

SN 77-254,293. LELOND, MARCEL, DBA BUDDHA BRANDS, MILLERSVILLE, MD. FILED 8-13-2007.



NO CLAIM IS MADE TO THE EXCLUSIVE RIGHT TO USE "BRANDS", APART FROM THE MARK AS SHOWN.

THE COLOR(S) BLACK, WHITE, RED IS/ARE CLAIMED AS A FEATURE OF THE MARK.

THE COLOR BLACK APPEARS IN THE WORDING "BUDDHA BRANDS" AND IN THE DESIGN OF THE BUDDHA AND AS THE COLOR OF THE CHINESE CHARACTERS. THE COLOR RED APPEARS IN THE MARK AS THE COLOR OF THE PRAYER BEADS IN THE BUDDHA'S HAND. THE COLOR WHITE IS THE BACKGROUND COLOR OF THE MARK.

THE NON-LATIN CHARACTERS IN THE MARK TRANSLITERATE TO "PU SA PAI" AND THIS MEANS "BUDDHA BRANDS" IN ENGLISH.

CLASS 14—JEWELRY

FOR BODY-PIERCING RINGS; RINGS; RINGS BEING JEWELRY; ANKLE BRACELETS; BRACELETS; BRACELETS OF PRECIOUS METAL; RUBBER OR SILICON WRISTBANDS IN THE NATURE OF A BRACELET; NECKLACES; CLIP EARRINGS; EAR CLIPS; EAR STUDS; EARRINGS (U.S. CLS. 2, 27, 28 AND 50).

CLASS 18—LEATHER GOODS

FOR BACKPACKS; BACKPACKS; POUCHES AND BAGS SOLD EMPTY FOR ATTACHMENT TO BACKPACKS; SCHOOLCHILDREN'S BACKPACKS; SMALL BACKPACKS; HANDBAGS; HANDBAGS FOR MEN; LEATHER HANDBAGS (U.S. CLS. 1, 2, 3, 22 AND 41).

CLASS 25—CLOTHING

FOR SHORT-SLEEVED OR LONG-SLEEVED T-SHIRTS; T-SHIRTS; FLIP FLOPS; SANDAL-CLOGS; SANDALS (U.S. CLS. 22 AND 39).

KATINA MISTER, EXAMINING ATTORNEY

SN 77-254,492. CURB YOUR CRAVINGS, LLC, BELLMORE, NY. FILED 8-14-2007.

CURB MY CRAVINGS

THE MARK CONSISTS OF STANDARD CHARACTERS WITHOUT CLAIM TO ANY PARTICULAR FONT, STYLE, SIZE, OR COLOR.

OWNER OF U.S. REG. NO. 2,818,519.

CLASS 35—ADVERTISING AND BUSINESS

FOR COMPUTERIZED ONLINE ORDERING OF DIETARY SUPPLEMENTS (U.S. CLS. 100, 101 AND 102).

CLASS 38—COMMUNICATION

FOR PROVIDING ONLINE CHAT ROOMS AND MESSAGE BOARDS FOR TRANSMISSION OF MESSAGES AMONG COMPUTER USERS CONCERNING HEALTH, NUTRITION, FOOD, DIET AND PHYSICAL FITNESS (U.S. CLS. 100, 101 AND 104).

CLASS 41—EDUCATION AND ENTERTAINMENT

FOR PROVIDING PHYSICAL FITNESS INFORMATION; ONLINE JOURNALS, NAMELY, BLOGS ABOUT HEALTH, NUTRITION, FOOD, DIET AND PHYSICAL FITNESS (U.S. CLS. 100, 101 AND 107).

CLASS 42—SCIENTIFIC AND COMPUTER SERVICES

FOR COMPUTER SERVICES, NAMELY, HOSTING ONLINE WEB FACILITIES FOR OTHERS FOR ORGANIZING AND CONDUCTING INTERACTIVE DISCUSSION GROUPS CONCERNING HEALTH, NUTRITION, FOOD, DIET AND PHYSICAL FITNESS (U.S. CLS. 100 AND 101).

CLASS 44—MEDICAL, BEAUTY AND AGRICULTURAL SERVICES

FOR PROVIDING INFORMATION VIA THE INTERNET IN THE FIELD OF HEALTH, NUTRITION, DIETARY SUPPLEMENTS AND DIET (U.S. CLS. 100 AND 101).

WON TEAK OH, EXAMINING ATTORNEY

SN 77-255,569. JACQUART FABRIC PRODUCTS, INC., IRONWOOD, MI. FILED 8-15-2007.

A FROSTY HEAD ONLY LOOKS
GOOD ON BEER

THE MARK CONSISTS OF STANDARD CHARACTERS WITHOUT CLAIM TO ANY PARTICULAR FONT, STYLE, SIZE, OR COLOR.

SN 77-255,364. OLU YEMISI & COMPANY, ADELPHI, MD. FILED 8-14-2007.



NO CLAIM IS MADE TO THE EXCLUSIVE RIGHT TO USE "& COMPANY", APART FROM THE MARK AS SHOWN.

CLASS 19—NON-METALLIC BUILDING MATERIALS

FOR NON-LUMINOUS, NON-MECHANISM SIGNS NOT MADE OF METAL (U.S. CLS. 1, 12, 33 AND 50).

CLASS 21—HOUSEWARES AND GLASS

FOR MUGS; BEER DRINKING GLASSES; SERVING TRAYS; COASTERS NOT OF PAPER AND NOT BEING TABLE LINEN; PORTABLE COOLERS (U.S. CLS. 2, 13, 23, 29, 30, 33, 40 AND 50).

BARBARA RUTLAND, EXAMINING ATTORNEY

CLASS 25—CLOTHING

FOR SHIRTS PANTS; HATS; SHOES; WAIST BELTS; HEAD WEAR; HUNTING BOOT BAGS; SKI BOOT BAGS; SOCKS; SKIRTS AND DRESSES; SKIRTS (U.S. CLS. 22 AND 39).

FIRST USE 11-1-2000; IN COMMERCE 11-1-2000.

SN 77-255,807. AACE INTERNATIONAL, MORGANTOWN, WV. FILED 8-15-2007.

CLASS 41—EDUCATION AND ENTERTAINMENT

FOR ENTERTAINMENT IN THE NATURE OF DANCE PERFORMANCES; ENTERTAINMENT IN THE NATURE OF THEATER PRODUCTIONS; ENTERTAINMENT IN THE NATURE OF VISUAL AND AUDIO PERFORMANCES, NAMELY, MUSICAL BAND, ROCK GROUP, GYMNASTIC, DANCE, AND BALLET PERFORMANCES; ENTERTAINMENT, NAMELY, LIVE PERFORMANCES BY A MUSICAL BAND; ENTERTAINMENT SERVICES, NAMELY, CONDUCTING PARTIES; ENTERTAINMENT SERVICES, NAMELY, CONDUCTING PARTIES FOR THE PURPOSE OF DATING AND SOCIAL INTRODUCTION FOR ADULTS; ENTERTAINMENT SERVICES, NAMELY, CONTEST AND INCENTIVE AWARD PROGRAMS DESIGNED TO REWARD PROGRAM PARTICIPANTS WHO EXERCISE, MAKE HEALTHY EATING CHOICES, AND ENGAGING IN OTHER HEALTH-PROMOTING ACTIVITIES; PROVIDING ADVICE AND INFORMATION IN THE FIELD OF EDUCATIONAL AND ENTERTAINMENT ACTIVITIES AND EVENTS FOR CHILDREN; PROVIDING ADVICE AND INFORMATION TO ADULT FAMILY MEMBERS ON APPROPRIATE ENTERTAINMENT AND LEISURE ACTIVITIES FOR YOUNGER FAMILY MEMBERS; PROVIDING INFORMATION, NEWS AND COMMENTARY IN THE FIELD OF ENTERTAINMENT; ORGANIZING COMMUNITY FESTIVALS FEATURING A VARIETY OF ACTIVITIES, NAMELY, SPORTING EVENTS, ART EXHIBITIONS, FLEA MARKETS, ETHNIC DANCES AND THE LIKE; ORGANIZING COMMUNITY FESTIVALS FEATURING A VARIETY OF ACTIVITIES, NAMELY, ART EXHIBITIONS, HERITAGE MARKETS, ETHNIC DANCES, AND THE LIKE; PROVIDING INFORMATION ABOUT AMERICAN FOLK ART VIA A GLOBAL COMPUTER NETWORK; EDUCATING AT UNIVERSITY OR COLLEGES; EDUCATIONAL AND ENTERTAINMENT SERVICES, NAMELY, PROVIDING MOTIVATIONAL AND EDUCATIONAL SPEAKERS (U.S. CLS. 100, 101 AND 107).

FIRST USE 11-1-2000; IN COMMERCE 11-1-2000.
MELVIN AXILBUND, EXAMINING ATTORNEY

AACE

THE MARK CONSISTS OF STANDARD CHARACTERS WITHOUT CLAIM TO ANY PARTICULAR FONT, STYLE, SIZE, OR COLOR.

CLASS 6—METAL GOODS

FOR METAL KEY CHAINS (U.S. CLS. 2, 12, 13, 14, 23, 25 AND 50).

FIRST USE 1-2-1989; IN COMMERCE 1-2-1989.

CLASS 16—PAPER GOODS AND PRINTED MATTER

FOR TECHNICAL JOURNALS, REFERENCE BOOKS, MONOGRAPHS, TEXTBOOKS, BROCHURES, PAMPHLETS, BOOKLETS, NEWSLETTERS IN THE FIELDS OF COST ENGINEERING AND PROJECT MANAGEMENT; PRINTED PAPER DIPLOMAS AND PRINTED CERTIFICATES (U.S. CLS. 2, 5, 22, 23, 29, 37, 38 AND 50).

FIRST USE 1-2-1989; IN COMMERCE 1-2-1989.

CLASS 18—LEATHER GOODS

FOR LUGGAGE TAGS (U.S. CLS. 1, 2, 3, 22 AND 41).

FIRST USE 1-2-1989; IN COMMERCE 1-2-1989.

CLASS 20—FURNITURE AND ARTICLES NOT OTHERWISE CLASSIFIED

FOR PICTURE FRAMES (U.S. CLS. 2, 13, 22, 25, 32 AND 50).

FIRST USE 1-2-1989; IN COMMERCE 1-2-1989.

CLASS 21—HOUSEWARES AND GLASS

FOR MUGS (U.S. CLS. 2, 13, 23, 29, 30, 33, 40 AND 50).
FIRST USE 1-2-1989; IN COMMERCE 1-2-1989.

SN 77-256,343. BNG ENTERPRISES, INC., PHOENIX, AZ.
FILED 8-15-2007.

CLASS 25—CLOTHING

FOR CAPS AND SHIRTS (U.S. CLS. 22 AND 39).
FIRST USE 1-2-1989; IN COMMERCE 1-2-1989.
WON TEAK OH, EXAMINING ATTORNEY

GENTLE CARE

THE MARK CONSISTS OF STANDARD CHARACTERS
WITHOUT CLAIM TO ANY PARTICULAR FONT, STYLE,
SIZE, OR COLOR.

OWNER OF U.S. REG. NO. 2,960,253.

SN 77-255,831. AACE INTERNATIONAL, MORGANTOWN,
WV. FILED 8-15-2007.



THE MARK CONSISTS OF THE LOWER CASE ITALIZED
LETTERS AACE.

CLASS 3—COSMETICS AND CLEANING PREPARATIONS

FOR SOAPS FOR BODY CARE, NAMELY, SOAPS FOR
BABIES AND CHILDREN; BABY POWDER; NON-MEDI-
CATED SKIN BALMS FOR BABIES AND CHILDREN
(U.S. CLS. 1, 4, 6, 50, 51 AND 52).

FIRST USE 9-1-2006; IN COMMERCE 9-1-2006.

CLASS 5—PHARMACEUTICALS

FOR DIETARY SUPPLEMENTS FOR USE AS A SLEEP
AID FOR BABIES AND CHILDREN; MEDICATED DIA-
PER RASH OINTMENTS AND LOTIONS; DIETARY
SUPPLEMENTS, NAMELY, GRIPE WATER PREPARA-
TION FOR USE IN THE TREATMENT OF INFANT
COLIC, GAS, TEETHING AND GENERAL DISCOM-
FORT (U.S. CLS. 6, 18, 44, 46, 51 AND 52).

FIRST USE 6-1-2003; IN COMMERCE 6-1-2003.

EVERLYN BRADLEY, EXAMINING ATTORNEY

CLASS 6—METAL GOODS

FOR METAL KEY CHAINS (U.S. CLS. 2, 12, 13, 14, 23,
25 AND 50).

FIRST USE 1-2-1989; IN COMMERCE 1-2-1989.

SN 77-256,434. BNG ENTERPRISES, INC., PHOENIX, AZ.
FILED 8-15-2007.

CLASS 16—PAPER GOODS AND PRINTED MATTER

FOR TECHNICAL JOURNALS, REFERENCE BOOKS,
MONOGRAPHS, TEXTBOOKS, BROCHURES, PAMPH-
LETS, BOOKLETS, NEWSLETTERS IN THE FIELDS OF
COST ENGINEERING AND PROJECT MANAGEMENT;
PRINTED PAPER DIPLOMAS AND PRINTED CERTIFI-
CATES (U.S. CLS. 2, 5, 22, 23, 29, 37, 38 AND 50).

FIRST USE 1-2-1989; IN COMMERCE 1-2-1989.

GENTLE CARE

THE MARK CONSISTS OF STANDARD CHARACTERS
WITHOUT CLAIM TO ANY PARTICULAR FONT, STYLE,
SIZE, OR COLOR.

OWNER OF U.S. REG. NO. 2,960,253.

CLASS 18—LEATHER GOODS

FOR LUGGAGE TAGS (U.S. CLS. 1, 2, 3, 22 AND 41).

FIRST USE 1-2-1989; IN COMMERCE 1-2-1989.

CLASS 20—FURNITURE AND ARTICLES NOT OTHERWISE CLASSIFIED

FOR PICTURE FRAMES (U.S. CLS. 2, 13, 22, 25, 32
AND 50).

FIRST USE 1-2-1989; IN COMMERCE 1-2-1989.

CLASS 3—COSMETICS AND CLEANING PREPARATIONS

FOR BODY LOTION; BABY LOTION; SOAPS FOR
BABIES AND CHILDREN; HAIR CARE PREPARATIONS
FOR BABIES AND CHILDREN, NAMELY, SHAMPOOS
AND CONDITIONERS; NON-MEDICATED SKIN
CREAM TO BE USED IN THE TREATMENT OF ECZ-
EMA; NON-MEDICATED SKIN CREAM TO BE USED IN
THE TREATMENT OF CHEST CONGESTION (U.S. CLS.
1, 4, 6, 50, 51 AND 52).

CLASS 21—HOUSEWARES AND GLASS

FOR MUGS (U.S. CLS. 2, 13, 23, 29, 30, 33, 40 AND 50).
FIRST USE 1-2-1989; IN COMMERCE 1-2-1989.

CLASS 5—PHARMACEUTICALS

FOR DIETARY SUPPLEMENTS; TOPICAL LIQUID
ANESTHETIC FOR TEETHING PURPOSES; EAR DROPS
(U.S. CLS. 6, 18, 44, 46, 51 AND 52).

EVERLYN BRADLEY, EXAMINING ATTORNEY

CLASS 25—CLOTHING

FOR CAPS AND SHIRTS (U.S. CLS. 22 AND 39).
FIRST USE 1-2-1989; IN COMMERCE 1-2-1989.
WON TEAK OH, EXAMINING ATTORNEY

SN 77-256,667. ATI MODEL PRODUCTS, INC., FARMINGDALE, NY. FILED 8-16-2007.

MODEL POWER

THE MARK CONSISTS OF STANDARD CHARACTERS WITHOUT CLAIM TO ANY PARTICULAR FONT, STYLE, SIZE, OR COLOR.

NO CLAIM IS MADE TO THE EXCLUSIVE RIGHT TO USE "MODEL", APART FROM THE MARK AS SHOWN.

CLASS 28—TOYS AND SPORTING GOODS

FOR SCALE MODEL TRAINS, MODEL TRAIN SETS, MODEL TRAIN SET ACCESSORIES, NAMELY, LIGHTS, ARTIFICIAL TREES, BUILDINGS AND TOY HUMAN FIGURES; SCALE MODEL CARS; SCALE MODEL AIRCRAFT (U.S. CLS. 22, 23, 38 AND 50).

FIRST USE 1-1-1967; IN COMMERCE 1-1-1967.

CLASS 35—ADVERTISING AND BUSINESS

FOR ONLINE RETAIL STORE SERVICES FEATURING MODEL TRAINS, MODEL TRAIN SETS, MODEL TRAIN ACCESSORIES, NAMELY, LIGHTS, ARTIFICIAL TREES, BUILDINGS AND TOY HUMAN FIGURES; MODEL CARS; MODEL AIRCRAFT (U.S. CLS. 100, 101 AND 102).

FIRST USE 3-11-1998; IN COMMERCE 3-11-1998.
LAURA KOVALSKY, EXAMINING ATTORNEY

SN 77-256,795. ATI MODEL PRODUCTS, INC., FARMINGDALE, NY. FILED 8-16-2007.



NO CLAIM IS MADE TO THE EXCLUSIVE RIGHT TO USE "MODEL", APART FROM THE MARK AS SHOWN.

THE MARK CONSISTS OF THE WORDS "MODEL POWER" PLACED INSIDE OF AN OVAL.

CLASS 28—TOYS AND SPORTING GOODS

FOR SCALE MODEL TRAINS, MODEL TRAIN SETS, MODEL TRAIN SET ACCESSORIES, NAMELY, LIGHTS, ARTIFICIAL TREES, BUILDINGS AND TOY HUMAN FIGURES; SCALE MODEL CARS, SCALE MODEL AIRCRAFT (U.S. CLS. 22, 23, 38 AND 50).

FIRST USE 1-1-1967; IN COMMERCE 1-1-1967.

CLASS 35—ADVERTISING AND BUSINESS

FOR ONLINE RETAIL STORE SERVICES FEATURING MODEL TRAINS, MODEL TRAIN SETS, MODEL TRAIN ACCESSORIES, NAMELY, LIGHTS, ARTIFICIAL TREES, BUILDINGS AND TOY HUMAN FIGURES; MODEL CARS; MODEL AIRCRAFT (U.S. CLS. 100, 101 AND 102).

FIRST USE 3-11-1998; IN COMMERCE 3-11-1998.
LAURA KOVALSKY, EXAMINING ATTORNEY

SN 77-257,879. METHUSELAH FOUNDATION, SPRINGFIELD, VA. FILED 8-17-2007.

Methuselah Foundation

THE MARK CONSISTS OF STANDARD CHARACTERS WITHOUT CLAIM TO ANY PARTICULAR FONT, STYLE, SIZE, OR COLOR.

NO CLAIM IS MADE TO THE EXCLUSIVE RIGHT TO USE "FOUNDATION", APART FROM THE MARK AS SHOWN.

CLASS 41—EDUCATION AND ENTERTAINMENT

FOR ARRANGING AND CONDUCTING EDUCATIONAL CONFERENCES; ARRANGING OF EXHIBITIONS, SEMINARS AND CONFERENCES; ARRANGING OF SEMINARS AND CONFERENCES; ON-LINE JOURNALS, NAMELY, BLOGS FEATURING ANTI-AGING MEDICINE; ON-LINE PUBLICATION OF ANTI-AGING MEDICINE; ORGANISATION OF CONFERENCES AND SYMPOSIA IN THE FIELD OF MEDICAL SCIENCE; ORGANIZATION OF SEMINARS, WORKING GROUPS, RESEARCH GROUPS AND CONVENTIONS, IN THE FIELD OF MEDICINE; PUBLICATION AND EDITING OF PRINTED MATTER; PUBLICATION OF BOOKS; PUBLICATION OF BOOKS, MAGAZINES, ALMANACS AND JOURNALS; PUBLICATION OF BOOKS, OF MAGAZINES, OF JOURNALS, OF NEWSPAPERS, OF PERIODICALS, OF CATALOGS, OF BROCHURES; PUBLICATION OF BROCHURES; PUBLICATION OF DOCUMENTS IN THE FIELD OF TRAINING, SCIENCE, PUBLIC LAW AND SOCIAL AFFAIRS; PUBLICATION OF ELECTRONIC MAGAZINES; PUBLICATION OF JOURNALS; PUBLICATION OF MAGAZINES; PUBLICATION OF MANUALS; PUBLICATION OF PERIODICALS; PUBLICATION OF PRINTED MATTER; PUBLICATION OF TEXTS, BOOKS, JOURNALS; PUBLICATION OF TEXTS, BOOKS, MAGAZINES AND OTHER PRINTED MATTER; PUBLICATION OF THE EDITORIAL CONTENT OF SITES ACCESSIBLE VIA A GLOBAL COMPUTER NETWORK; PUBLISHING OF ELECTRONIC PUBLICATIONS; ORGANIZING EXHIBITIONS FOR HEALTH, RESEARCH, GERONTOLOGICAL AND BIOMEDICAL EDUCATIONAL PURPOSES; CONTINUING PUBLIC SERVICE PROGRAMS IN THE FIELD OF ANTI-AGING MEDICINE PRODUCED AND DISTRIBUTED OVER TELEVISION, SATELLITE, FILM, AUDIO, VIDEO, INTERNET, AND 3-D VIRTUAL REALITY MEDIA (U.S. CLS. 100, 101 AND 107).

CLASS 42—SCIENTIFIC AND COMPUTER SERVICES

FOR CHEMICAL, BIOCHEMICAL, BIOLOGICAL AND BACTERIOLOGICAL RESEARCH AND ANALYSIS; COMPILING DATA FOR RESEARCH PURPOSES IN THE FIELD OF MEDICAL SCIENCE AND MEDICAL CONSULTANCY; INFORMATION ON THE SUBJECT OF SCIENTIFIC RESEARCH IN THE FIELD OF BIOCHEMISTRY AND BIOTECHNOLOGY; LABORATORY RESEARCH IN THE FIELD OF BIOLOGY; MEDICAL AND SCIENTIFIC RESEARCH IN THE FIELD OF ANTI-AGING; MEDICAL AND SCIENTIFIC RESEARCH INFORMATION IN THE FIELD OF ANTI-AGING; MEDICAL RESEARCH; SCIENTIFIC RESEARCH; SCIENTIFIC RESEARCH AND DEVELOPMENT; SCIENTIFIC RESEARCH IN THE FIELD OF GENETICS AND GENETIC ENGINEERING (U.S. CLS. 100 AND 101).

CIMMERIAN COLEMAN, EXAMINING ATTORNEY

SN 77-258,404. PROPEL SOFTWARE CORPORATION, SAN JOSE, CA. FILED 8-17-2007.

PBM

THE MARK CONSISTS OF STANDARD CHARACTERS WITHOUT CLAIM TO ANY PARTICULAR FONT, STYLE, SIZE, OR COLOR.

CLASS 9—ELECTRICAL AND SCIENTIFIC APPARATUS

FOR DOWNLOADABLE SOFTWARE FOR OPTIMIZING DATA FLOW IN A TELECOMMUNICATIONS NETWORK AND FOR ANALYSIS, MONITORING AND REPORTING ON TRAFFIC IN A TELECOMMUNICATIONS NETWORK (U.S. CLS. 21, 23, 26, 36 AND 38).

CLASS 42—SCIENTIFIC AND COMPUTER SERVICES

FOR COMPUTER SERVICES THAT OPTIMIZES DATA FLOW IN A TELECOMMUNICATIONS NETWORK AND THAT ANALYZES, MONITORS AND REPORTS ON TRAFFIC IN A TELECOMMUNICATIONS NETWORK (U.S. CLS. 100 AND 101).

KAREN BRACEY, EXAMINING ATTORNEY

SN 77-258,789. GARZA, RAYNALDO, MONARCH BEACH, CA. FILED 8-19-2007.

Glamór

THE MARK CONSISTS OF STANDARD CHARACTERS WITHOUT CLAIM TO ANY PARTICULAR FONT, STYLE, SIZE, OR COLOR.

CLASS 3—COSMETICS AND CLEANING PREPARATIONS

FOR BEAUTY CREAMS FOR BODY CARE, BODY AND BEAUTY CARE COSMETICS, ADHESIVES FOR COSMETIC USE, AFTER-SUN GELS, AFTER-SUN MILKS, AFTER-SUN OILS, ALOE VERA GEL FOR COSMETIC PURPOSES, ASTRINGENTS FOR COSMETIC PURPOSES, BATH OILS FOR COSMETIC PURPOSES, BLEACHING PREPARATIONS FOR COSMETIC PURPOSES, CHALK FOR COSMETIC USE, CLEANER FOR COSMETIC BRUSHES, CLEANSING CREAMS, COCOA BUTTER FOR COSMETIC PURPOSES, COLORING PREPARATIONS FOR COSMETIC PURPOSES, COSMETIC CONCEALERS, COSMETIC BALLS, COSMETIC CREAMS, COSMETIC CREAMS FOR SKIN CARE, COSMETIC FACIAL BLOTTING PAPERS, COSMETIC MILKS, COSMETIC OILS, COSMETIC OILS FOR THE EPIDERMIS, COSMETIC PADS, COSMETIC PENCILS, COSMETIC PREPARATIONS FOR SKIN RENEWAL, COSMETIC PREPARATIONS AGAINST SUNBURN, COSMETIC PREPARATIONS FOR BODY CARE, COSMETIC PREPARATIONS FOR EYE LASHES, COSMETIC PREPARATIONS FOR THE CARE OF MOUTH AND TEETH, COSMETIC PRODUCTS IN THE FORM OF AEROSOLS FOR SKINCARE, COSMETIC ROUGES, COSMETIC SOAPS, COSMETIC SUNTAN LOTIONS, COSMETIC SUN-PROTECTING PREPARATIONS, COSMETIC SUN-TANNING PREPARATIONS, COSMETICS, COSMETICS FOR ANIMALS, COSMETICS NAMELY, COMPACTS, COSMETICS, NAMELY LIP PRIMER, COSMETICS, NAMELY, LIP REPAIRERS, COTTON BALLS FOR COSMETIC PURPOSES, COTTON BUDS FOR COSMETIC PURPOSES, COTTON FOR COSMETIC PURPOSES, COTTON PUFFS FOR COSMETIC PURPOSES, COTTON STICKS FOR COSMETIC PURPOSES, COTTON SWABS FOR COSMETIC PURPOSES, DECORATIVE TRANSFERS AND SKIN JEWELS FOR COSMETIC PURPOSES, EYE COMPRESSES FOR COSMETIC PURPOSES, FACE CREAMS FOR COSMETIC USE, FOAMS CONTAINING COSMETICS AND SUNSCREENS, GAUZE FOR COSMETIC PURPOSES, GREASES FOR COSMETIC PURPOSES, HENNA FOR COSMETIC PURPOSES, MAKE-UP KITS COMPRISED OF LIPSTICK, LIP GLOSS, EYELINERS, BLUSH, NAIL VARNISH FOR COSMETIC PURPOSES, NUTRITIONAL OILS FOR COSMETIC PURPOSES, PAPER TISSUES FOR COSMETIC USE, PARAFFIN WAX FOR COSMETIC PURPOSES, PENCILS FOR COSMETIC PURPOSES, PERFUME OILS FOR THE MANUFACTURE OF COSMETIC PREPARATIONS, PETROLEUM JELLY FOR COSMETIC PURPOSES, PRE-MOISTENED COSMETIC TISSUES, PRE-MOISTENED COSMETIC TOWELETTES, PRE-MOISTENED COSMETIC WIPES, RETINOL CREAM FOR COSMETIC PURPOSES, ROSE OIL FOR COSMETIC PURPOSES, SKIN AND BODY TOPICAL LOTIONS, CREAMS AND OILS FOR COSMETIC USE, COSMETIC SOAPS, TANNING AND AFTER-SUN MILKS, GELS AND OILS, TANNING MILKS, TANNING OILS, TISSUES IMPREGNATED WITH COSMETIC LOTIONS, COSMETIC TONERS, TOPICAL SKIN SPRAYS FOR COSMETIC PURPOSES, ALMOND SOAPS, ANTIBACTERIAL SKIN SOAPS, ANTIBACTERIAL SOAP, BAR SOAP, BATH SOAPS, BATH SOAPS IN LIQUID, SOLID OR GEL FORM, BODY CREAM SOAP, CREAM SOAPS, DEODORANT SOAP, DETERGENT SOAP, DISINFECTANT SOAPS, DISINFECTING PERFUMED SOAPS, GRANULATED SOAPS, HAND SOAPS, INDUSTRIAL SOAP, LAUNDRY SOAP, LIQUID BATH SOAPS, LIQUID SOAP, LIQUID SOAP USED IN FOOT BATH, LIQUID SOAPS, LIQUID SOAPS FOR HANDS, FACE AND BODY LIQUID SOAPS FOR HANDS AND FACE, MEDICATED SOAP, MEDICATED SOAPS, PERFUMED SOAP, PERFUMED SOAPS, SADDLE SOAP, SHAVING SOAP, SKIN SOAP, SOAP POWDER, SOAPS AND DETERGENTS, SOAPS FOR BODY CARE, SOAPS FOR HOUSEHOLD USE, SOAPS FOR PERSONAL USE, SOAPS FOR TOILET PURPOSES, TOILET SOAP, TOILET SOAPS, WATERLESS SOAP, ADHESIVES FOR AFFIXING FALSE HAIR, ADHESIVES FOR FALSE EYELASHES, HAIR AND NAILS, BABY HAIR CONDITIONER, BODY DEODORANT IN PILL FORM, BODY SPRAY USED AS A PERSONAL DEODORANT AND AS FRAGRANCE, DEODORANT FOR PERSONAL USE, DEODORANT SOAP, DEODORANTS AND ANTIPERSPIRANTS, DEODORANTS FOR ANIMALS, DEODORANTS FOR BODY CARE, FEMININE DEODORANT SPRAYS, FEMININE DEODORANT SUPPOSITORIES, FOOT DEODORANT SPRAY, PERSONAL DEODORANTS, HAIR CONDI-

TIONERS, EXPHOLIANTS FOR HAIR, SKIN, FACE, BODY, BEARDS, GEL FOR HAIR, SCULPTING, EYE, BEARDS, HAIR BALSAM, HAIR BLEACH, HAIR BLEACHES, HAIR BLEACHING PREPARATIONS, HAIR CARE CREAMS, HAIR CARE KITS COMPRISING NON-MEDICATED HAIR CARE PREPARATIONS, NAMELY, SHAMPOO, CONDITIONER, GEL, HAIR CARE LOTIONS, HAIR CARE PREPARATIONS, HAIR CLEANING PREPARATIONS, HAIR COLOR, HAIR COLOR REMOVERS, HAIR COLORANTS, HAIR COLORING PREPARATIONS, HAIR CONDITIONER, HAIR CONDITIONERS, HAIR CONDITIONERS FOR BABIES, HAIR CREAMS, HAIR DECOLORANTS, HAIR DRESSINGS FOR MEN, HAIR DRESSINGS FOR WOMEN, HAIR DYE, HAIR DYES, HAIR EMOLLIENTS, HAIR FIXERS, HAIR FROSTS, HAIR GEL, HAIR GELS, HAIR LACQUERS, HAIR LIGHTENERS, HAIR LOTIONS, HAIR MASCARA, HAIR MOUSSE, HAIR MOUSSES, HAIR NOURISHERS, HAIR OILS, HAIR PIECE BONDING GLUE, HAIR RELAXERS, HAIR RELAXING PREPARATIONS, HAIR REMOVING CREAM, HAIR RINSES, HAIR SHAMPOO, HAIR SPRAY, HAIR STRAIGHTENING PREPARATIONS, HAIR STYLING FIXATIVE IN THE NATURE OF HAIR WAX, HAIR STYLING GEL, HAIR STYLING PREPARATIONS, HAIR STYLING SPRAY, HAIR TONIC, HAIR TONICS, HAIR WAVING LOTION, HAIR-WASHING POWDER, HYDROGEN PEROXIDE FOR USE ON THE HAIR, JAPANESE HAIR FIXING OIL, LOTIONS FOR SKIN, HAIR, FACE, BODY, HAIR WAVING, MOUSSE FOR HAIR, SKIN FACIAL, BEARDS, OIL BATHS FOR HAIR CARE, OILS FOR HAIR CONDITIONING, POMADES FOR HAIR, LIP, WAX FOR REMOVING BODY HAIR, WAX STRIPS FOR REMOVING BODY HAIR, 2-IN 1 HAIR CONDITIONERS, 2-IN 1 HAIR SHAMPOOS, 3-IN-1 HAIR CONDITIONERS, 3-IN-1 HAIR SHAMPOOS, HAIR CARE CONDITIONERS, HAIR CARE CREAMS, HAIR CARE KITS COMPRISING NON-MEDICATED HAIR CARE PREPARATIONS, NAMELY, SHAMPOO, CONDITIONER AND GEL, SHAVING CREAMS, SHAVING LOTION, SHAVING GEL, EAU DE PERFUME, ESSENTIAL OILS AS PERFUME FOR LAUNDRY PURPOSES, LIQUID PERFUMES, PERFUME, PERFUMES, PERFUME OILS, PERFUME OILS FOR THE MANUFACTURE OF COSMETIC PREPARATIONS, PERFUMED EXTRACTS FOR TISSUES AND PERFUMES; NON-MEDICATED FOOT POWDER (U.S. CLS. 1, 4, 6, 50, 51 AND 52).

CLASS 18—LEATHER GOODS

FOR SMALL PURSES, WRIST MOUNTED PURSES, DINNER PURSES, CLOTH PURSES, CHAIN MESH PURSES, CHANGE PURSES, CLUTCH PURSES, CLUTCHES, COIN PURSES, NOT OF PRECIOUS METALS, LEATHER PURSES, MULTI-PURPOSE PURSES, PURSE FRAMES, PURSES, PURSES AND WALLETS OF PRECIOUS METAL, PURSES MADE OF PRECIOUS METAL, PURSES NOT MADE OF PRECIOUS METAL, SMALL CLUTCH PURSES, KEY CHAIN PURSES (U.S. CLS. 1, 2, 3, 22 AND 41).

FIRST USE 11-25-2005; IN COMMERCE 2-17-2007.

CLASS 25—CLOTHING

FOR CLOTHING, NAMELY, PULLOVERS, SKIRTS, DRESSES, BLOUSES, JEANS, PANTS, TROUSERS, JACKETS, COATS, RAINCOATS, ANORAKS, SWEATERS, POLO SHIRTS, DRESS SHIRTS, SHIRTS, GOLF SHIRTS, SKIRTS, T-SHIRTS, SWEATSHIRTS, SWEAT SUITS, JOGGING SUITS, JERSEYS, SUITS, SHORTS, OVERALLS, DENIM SHIRTS, DENIM PANTS, UNDERCLOTHING, UNDERGARMENTS, BODICES, BRASIERES, CAMISOLES, UNDERPANTS, DRESSING GOWNS, BATH ROBES, BATHING SUITS, PAJAMAS, GLOVES, SKI SUITS, STOCKINGS; BELTS; TIES, FOU-LARDS, NECKTIES, SHAWLS, SCARVES, MUFFLERS, NECK SCARVES, SARONGS, COLLARS FOR DRESSES, MANIPLES, MUFFS, SUSPENDERS, BRACES FOR CLOTHING, BLAZERS, SPORTS JACKETS, GARTERS, TANK TOPS, LOUNGEWEAR, LINGERIE, VESTS, SOCKS, PANTIES, SWEATPANTS, HEADGEAR, NAMELY BANDANAS, HEADBANDS, CAPS, HATS, BEANIES, HATS, KNITTED CAPS, BERETS, COWBOY HATS, TUXEDO HATS, DINNER WEAR HATS, VISORS; HEADBANDS AND WRIST BANDS, FOOTWEAR, NAMELY ATHLETIC SHOES; SNEAKERS, BOOTS, SANDALS, BEACH SHOES, BOAT SHOES, SLIPPERS, SNOW

BOOTS, FLIP FLOPS, BEACH COVER-UPS, BEACH-WEAR, BELTS, BODY SHAPERS, BOXER SHORTS, GOWNS, HALTER TOPS, HEADBANDS, HOSIERY, KNEE HIGHS, KNIT SHIRTS, KNIT TOPS, LEOTARDS, MITTENS, NEGLIGEEES, NIGHT GOWNS, NIGHT SHIRTS, PANTYHOSE, SLACKS, SLEEPWEAR, SLIPS, SOCKS, SWEAT SHORTS, SWIM WEAR, TAP PANTS, TEDDIES, TIGHTS, UNDERSHIRTS, UNDERWEAR, LINGERIE ACCESSORIES, NAMELY, REMOVABLE SILICONE BREAST ENHANCER PADS USED IN A BRA, MATERNITY LINGERIE; SPORTSWEAR, NAMELY, SPORTS JACKETS; BEACH CLOTHES, NAMELY, SWIMMING TRUNKS; KNITWEAR, NAMELY, KNIT SHIRTS; CLOTH BIBS, CLOTH DIAPERS; BANDS, NAMELY, HAT BANDS, SPORTS SHOES, NAMELY, BASEBALL, SOCCER, FOOTBALL AND BASKETBALL, SHOES (U.S. CLS. 22 AND 39).

FIRST USE 11-25-2005; IN COMMERCE 2-17-2007.

DAVID MURRAY, EXAMINING ATTORNEY

SN 77-260,923. FISH WINDOW CLEANING SERVICES, INC., MANCHESTER, MO. FILED 8-21-2007.

BRIGHTEN YOUR WORLD

THE MARK CONSISTS OF STANDARD CHARACTERS WITHOUT CLAIM TO ANY PARTICULAR FONT, STYLE, SIZE, OR COLOR.

CLASS 35—ADVERTISING AND BUSINESS

FOR FRANCHISING SERVICES, NAMELY, OFFERING TECHNICAL AND BUSINESS ASSISTANCE IN THE ESTABLISHMENT AND OPERATION OF FRANCHISES SPECIALIZING IN THE SALE OF WINDOW CLEANING SERVICES FOR COMMERCIAL AND RESIDENTIAL BUILDINGS, INCLUDING CLEANING SERVICES FOR GUTTERS, SKYLIGHTS, MIRRORS AND LIGHT FIXTURES (U.S. CLS. 100, 101 AND 102).

CLASS 37—CONSTRUCTION AND REPAIR

FOR CLEANING OF COMMERCIAL AND RESIDENTIAL BUILDING WINDOWS, GUTTERS, SKYLIGHTS, MIRRORS AND LIGHT FIXTURES (U.S. CLS. 100, 103 AND 106).

HEATHER BIDDULPH, EXAMINING ATTORNEY

SN 77-261,313. CANDYRIFIC, LLC, LOUISVILLE, KY. FILED 8-22-2007.

CANDYRIFIC

THE MARK CONSISTS OF STANDARD CHARACTERS WITHOUT CLAIM TO ANY PARTICULAR FONT, STYLE, SIZE, OR COLOR.

CLASS 28—TOYS AND SPORTING GOODS

FOR NOVELTY ITEMS, NAMELY, PLASTIC ELECTRIC ACTION TOYS PACKAGED WITH CANDY AND SOLD AS A UNIT; NOVELTY ITEMS, NAMELY, PLASTIC MECHANICAL ACTION TOYS PACKAGED WITH CANDY AND SOLD AS A UNIT (U.S. CLS. 22, 23, 38 AND 50).

FIRST USE 8-0-2000; IN COMMERCE 8-0-2000.

CLASS 30—STAPLE FOODS

FOR CANDY (U.S. CL. 46).
FIRST USE 8-0-2000; IN COMMERCE 8-0-2000.
JESSICA A. POWERS, EXAMINING ATTORNEY

SN 77-261,660. THE DEAL, LLC, NEW YORK, NY. FILED 8-22-2007.

Deal Diary

THE MARK CONSISTS OF STANDARD CHARACTERS WITHOUT CLAIM TO ANY PARTICULAR FONT, STYLE, SIZE, OR COLOR.

OWNER OF U.S. REG. NO. 2,521,361.
SEC. 2(F).

CLASS 16—PAPER GOODS AND PRINTED MATTER

FOR (BASED ON USE IN COMMERCE) MAGAZINE COLUMNS FEATURING INFORMATION CONCERNING THE FINANCIAL AND LEGAL FIELDS (U.S. CLS. 2, 5, 22, 23, 29, 37, 38 AND 50).

FIRST USE 9-0-1999; IN COMMERCE 9-0-1999.

CLASS 41—EDUCATION AND ENTERTAINMENT

FOR (BASED ON USE IN COMMERCE) PROVIDING ON-LINE PUBLICATIONS IN THE NATURE OF MAGAZINE COLUMNS IN THE FIELD OF FINANCE AND THE LAW (U.S. CLS. 100, 101 AND 107).

FIRST USE 9-0-1999; IN COMMERCE 9-0-1999.
MICHELLE DUBOIS, EXAMINING ATTORNEY

SN 77-262,487. DORSAND MANAGEMENT, INDIANAPOLIS, IN. FILED 8-23-2007.

SANDOR

THE MARK CONSISTS OF STANDARD CHARACTERS WITHOUT CLAIM TO ANY PARTICULAR FONT, STYLE, SIZE, OR COLOR.

CLASS 36—INSURANCE AND FINANCIAL

FOR COMMERCIAL AND RETAIL REAL ESTATE LEASING AND MANAGEMENT (U.S. CLS. 100, 101 AND 102).

FIRST USE 0-0-1963; IN COMMERCE 0-0-1963.

CLASS 37—CONSTRUCTION AND REPAIR

FOR COMMERCIAL AND RETAIL REAL ESTATE DEVELOPMENT (U.S. CLS. 100, 103 AND 106).

FIRST USE 0-0-1963; IN COMMERCE 0-0-1963.
JOHN HWANG, EXAMINING ATTORNEY

SN 77-262,501. DORSAND MANAGEMENT, INDIANAPOLIS, IN. FILED 8-23-2007.

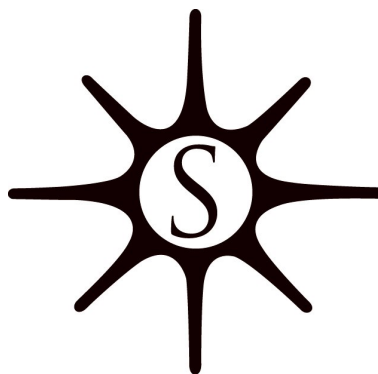

THE MARK CONSISTS OF THE LETTER "S" INSIDE A STAR.

CLASS 36—INSURANCE AND FINANCIAL

FOR COMMERCIAL AND RETAIL REAL ESTATE LEASING AND MANAGEMENT (U.S. CLS. 100, 101 AND 102).

FIRST USE 0-0-1963; IN COMMERCE 0-0-1963.

CLASS 37—CONSTRUCTION AND REPAIR

FOR COMMERCIAL AND RETAIL REAL ESTATE DEVELOPMENT (U.S. CLS. 100, 103 AND 106).

FIRST USE 0-0-1963; IN COMMERCE 0-0-1963.
JOHN HWANG, EXAMINING ATTORNEY

SN 77-262,690. CRAFTS MEDIA, LLC, CINCINNATI, OH. FILED 8-23-2007.



NO CLAIM IS MADE TO THE EXCLUSIVE RIGHT TO USE "QUILTERS CLUB OF AMERICA", APART FROM THE MARK AS SHOWN.

THE MARK CONSISTS OF THE WORDS "QUILTERS CLUB OF AMERICA" ON THE LEFT AND A BOX ON THE RIGHT WITHIN WHICH THERE IS A CIRCLE CONTAINING A STAR PATTERN.

CLASS 16—PAPER GOODS AND PRINTED MATTER

FOR PRINTED PERIODICALS IN THE FIELD OF QUILTING (U.S. CLS. 2, 5, 22, 23, 29, 37, 38 AND 50).

CLASS 35—ADVERTISING AND BUSINESS

FOR CLUB SERVICES, NAMELY, PROMOTING THE INTERESTS OF QUILTERS (U.S. CLS. 100, 101 AND 102).

CLASS 41—EDUCATION AND ENTERTAINMENT

FOR PROVIDING ONLINE PUBLICATIONS IN THE NATURE OF MAGAZINES, DIGITAL PERIODICALS AND NEWSLETTERS IN THE FIELD OF QUILTING (U.S. CLS. 100, 101 AND 107).

BILL DAWE, EXAMINING ATTORNEY

SN 77-262,782. SCHUSSLER CREATIVE, INC., GOLDEN VALLEY, MN. FILED 8-23-2007.

ART OF MUSTARD

THE MARK CONSISTS OF STANDARD CHARACTERS WITHOUT CLAIM TO ANY PARTICULAR FONT, STYLE, SIZE, OR COLOR.

NO CLAIM IS MADE TO THE EXCLUSIVE RIGHT TO USE "MUSTARD", APART FROM THE MARK AS SHOWN.

CLASS 30—STAPLE FOODS

FOR MUSTARDS AND DIPPING SAUCES (U.S. CL. 46).

CLASS 43—HOTEL AND RESTAURANT SERVICES

FOR RESTAURANT SERVICES FOR CONSUMPTION ON THE PREMISES (U.S. CLS. 100 AND 101).

SETH A. RAPPAPORT, EXAMINING ATTORNEY

SN 77-263,533. NORDCO INC., OAK CREEK, WI. FILED 8-24-2007.

NORDCO SERVICE FROM THE GROUND UP

THE MARK CONSISTS OF STANDARD CHARACTERS WITHOUT CLAIM TO ANY PARTICULAR FONT, STYLE, SIZE, OR COLOR.

OWNER OF U.S. REG. NOS. 2,115,591 AND 3,071,877.

CLASS 7—MACHINERY

FOR RAILROAD TRACK MAINTENANCE MACHINES, NAMELY, ANCHOR APPLICATORS, ANCHOR REMOVERS, MULTI-FUNCTION RAILWAY MAINTENANCE MACHINES, RAIL GAUGING MACHINES, RAIL GRINDERS, RAIL DRILLS, RAIL PRE-GAGERS, RAIL LIFTERS, RAIL SCREW SPIKE DRIVERS, RAIL SCREW SPIKE PULLERS, SPIKE FEEDERS, SPIKE DRIVERS, SPIKE PULLERS, TIE ADZERS, TIE BORERS, TIE PLATE LAYING MACHINES, TRACK INSPECTORS AND REPAIR PARTS FOR THE ABOVE PRODUCTS (U.S. CLS. 13, 19, 21, 23, 31, 34 AND 35).

CLASS 25—CLOTHING

FOR SHIRTS, HATS AND JACKETS (U.S. CLS. 22 AND 39).

CLASS 37—CONSTRUCTION AND REPAIR

FOR REPAIR, MAINTENANCE AND THE REFURBISHMENT OF RAILWAY MAINTENANCE EQUIPMENT (U.S. CLS. 100, 103 AND 106).

CLASS 42—SCIENTIFIC AND COMPUTER SERVICES

FOR DIAGNOSTIC SERVICES IN THE FIELD OF RAILWAY TRACKS (U.S. CLS. 100 AND 101).

SHARON MEIER, EXAMINING ATTORNEY

SN 77-265,091. SCT PERFORMANCE, LLC, LONGWOOD, FL. FILED 8-27-2007.

MORE POWER! LESS FUEL!

THE MARK CONSISTS OF STANDARD CHARACTERS WITHOUT CLAIM TO ANY PARTICULAR FONT, STYLE, SIZE, OR COLOR.

CLASS 9—ELECTRICAL AND SCIENTIFIC APPARATUS

FOR ELECTRONIC AUTOMOTIVE TUNING DEVICE AND SOFTWARE, NAMELY, ELECTRONIC CONTROL HARDWARE UNIT AND DOWNLOADABLE SOFTWARE PROVIDED VIA THE INTERNET FOR REPROGRAMMING AUTOMOTIVE DRIVE TRAIN COMPUTERS FOR THE PURPOSE OF INCREASING SPEED, HORSEPOWER, AND FUEL EFFICIENCY (U.S. CLS. 21, 23, 26, 36 AND 38).

FIRST USE 9-15-2006; IN COMMERCE 9-15-2006.

CLASS 41—EDUCATION AND ENTERTAINMENT

FOR EDUCATIONAL SERVICES, NAMELY, CLASSES IN THE FIELD OF AUTOMOTIVE PERFORMANCE ENHANCEMENT (U.S. CLS. 100, 101 AND 107).

FIRST USE 9-15-2006; IN COMMERCE 9-15-2006.

DAVID TOOLEY, EXAMINING ATTORNEY

SN 77-265,575. CHAMPION REALTY, LTD., LOS ANGELES, CA. FILED 8-27-2007.

CHAMPION REAL ESTATE GROUP

THE MARK CONSISTS OF STANDARD CHARACTERS WITHOUT CLAIM TO ANY PARTICULAR FONT, STYLE, SIZE, OR COLOR.

NO CLAIM IS MADE TO THE EXCLUSIVE RIGHT TO USE "REAL ESTATE GROUP", APART FROM THE MARK AS SHOWN.

CLASS 36—INSURANCE AND FINANCIAL

FOR REAL ESTATE ACQUISITION SERVICES (U.S. CLS. 100, 101 AND 102).
FIRST USE 8-22-2007; IN COMMERCE 8-22-2007.

CLASS 37—CONSTRUCTION AND REPAIR

FOR DEVELOPMENT, CONSTRUCTION AND RENOVATION OF NEW AND EXISTING COMMERCIAL AND RESIDENTIAL BUILDINGS AND BUILDING UNITS (U.S. CLS. 100, 103 AND 106).
FIRST USE 8-22-2007; IN COMMERCE 8-22-2007.
WILLIAM P. SHANAHAN, EXAMINING ATTORNEY

SN 77-265,576. CHAMPION REALTY, LTD., LOS ANGELES, CA. FILED 8-27-2007.

DEFINING THE ART OF REAL ESTATE

THE MARK CONSISTS OF STANDARD CHARACTERS WITHOUT CLAIM TO ANY PARTICULAR FONT, STYLE, SIZE, OR COLOR.

NO CLAIM IS MADE TO THE EXCLUSIVE RIGHT TO USE "REAL ESTATE", APART FROM THE MARK AS SHOWN.

CLASS 36—INSURANCE AND FINANCIAL

FOR REAL ESTATE ACQUISITION SERVICES (U.S. CLS. 100, 101 AND 102).
FIRST USE 8-22-2007; IN COMMERCE 8-22-2007.

CLASS 37—CONSTRUCTION AND REPAIR

FOR DEVELOPMENT, CONSTRUCTION AND RENOVATION OF NEW AND EXISTING COMMERCIAL AND RESIDENTIAL BUILDINGS AND BUILDING UNITS (U.S. CLS. 100, 103 AND 106).
FIRST USE 8-22-2007; IN COMMERCE 8-22-2007.
WILLIAM P. SHANAHAN, EXAMINING ATTORNEY

SN 77-265,942. MCWHINNEY HOLDING COMPANY, LLLP, LOVELAND, CO. FILED 8-28-2007.

CENTERRA SHINE

THE MARK CONSISTS OF STANDARD CHARACTERS WITHOUT CLAIM TO ANY PARTICULAR FONT, STYLE, SIZE, OR COLOR.

OWNER OF U.S. REG. NOS. 3,088,197, 3,218,060 AND 3,348,113.

CLASS 16—PAPER GOODS AND PRINTED MATTER

FOR MAGAZINES IN THE FIELD OF REAL ESTATE, REAL PROPERTY, SHOPPING CENTERS AND LAND DEVELOPMENT (U.S. CLS. 2, 5, 22, 23, 29, 37, 38 AND 50).
FIRST USE 11-7-2007; IN COMMERCE 11-7-2007.

CLASS 36—INSURANCE AND FINANCIAL

FOR REAL ESTATE MANAGEMENT; REAL ESTATE LISTING; REAL ESTATE BROKERAGE; REAL ESTATE AGENCIES; REAL ESTATE INVESTMENT; LEASING OF REAL PROPERTY; LEASING OF RESIDENTIAL AND COMMERCIAL REAL ESTATE; SHOPPING CENTER SERVICES, NAMELY, RENTAL OF SHOPPING CENTER SPACE; LEASING OF SHOPPING MALL SPACE (U.S. CLS. 100, 101 AND 102).
FIRST USE 8-0-2006; IN COMMERCE 8-0-2006.

CLASS 37—CONSTRUCTION AND REPAIR

FOR REAL ESTATE DEVELOPMENT SERVICES; LAND DEVELOPMENT SERVICES, NAMELY, PLANNING AND LAYING OUT OF COMMERCIAL AND RESIDENTIAL COMMUNITIES; RESIDENTIAL AND COMMERCIAL BUILDING CONSTRUCTION AND REPAIR; CUSTOM CONSTRUCTION AND BUILDING RENOVATION; SHOPPING CENTER REAL ESTATE DEVELOPMENT, CONSTRUCTION AND REPAIR; RESIDENTIAL REAL ESTATE DEVELOPMENT, CONSTRUCTION AND REPAIR; COMMERCIAL REAL ESTATE DEVELOPMENT, CONSTRUCTION AND REPAIR (U.S. CLS. 100, 103 AND 106).
FIRST USE 8-0-2006; IN COMMERCE 8-0-2006.
DAWN FELDMAN, EXAMINING ATTORNEY

SN 77-266,200. FIRST IMPRESSION INTERACTIVE, INC., CHICAGO, IL. FILED 8-28-2007.



THE COLOR(S) BLACK, WHITE, RED, GREEN AND GRAY IS/ARE CLAIMED AS A FEATURE OF THE MARK. THE MARK CONSISTS OF THE WORDS "LOOP" AND "AROUND" IN BLACK LETTERING WITH A MARTINI GLASS APPEARING BETWEEN THE TWO WORDS. THE MARTINI GLASS IS OUTLINED IN BLACK EXCEPT FOR THE TOP WHICH HAS A RED RIM. THERE IS A GREEN OLIVE INSIDE THE GLASS AND GRAY SHADING IN THE GLASS. THE LETTERS ".COM" APPEAR IN LIGHT GREEN UNDER THE "N" AND "D" OF THE WORD "AROUND".

CLASS 38—COMMUNICATION

FOR PROVIDING AN ONLINE BULLETIN BOARD FOR TRANSMISSION OF MESSAGES AMONG USERS OF BARS AND RESTAURANTS (U.S. CLS. 100, 101 AND 104).
FIRST USE 6-9-2006; IN COMMERCE 6-9-2006.

CLASS 43—HOTEL AND RESTAURANT SERVICES

FOR PROVIDING AN ONLINE SEARCHING DATABASE FEATURING RESTAURANTS AND BARS (U.S. CLS. 100 AND 101).
FIRST USE 6-9-2006; IN COMMERCE 6-9-2006.
TIMOTHY FINNEGAN, EXAMINING ATTORNEY

SN 77-266,798. THE CONSULTATIVE GROUP TO ASSIST THE POOR, WASHINGTON, DC. FILED 8-29-2007.

CGAP

THE MARK CONSISTS OF STANDARD CHARACTERS WITHOUT CLAIM TO ANY PARTICULAR FONT, STYLE, SIZE, OR COLOR.

CLASS 16—PAPER GOODS AND PRINTED MATTER

FOR PUBLICATIONS, NAMELY, BOOKS, REPORTS AND PAMPHLETS CONCERNING TECHNICAL ASPECTS OF MICROFINANCE (U.S. CLS. 2, 5, 22, 23, 29, 37, 38 AND 50).

FIRST USE 0-0-1998; IN COMMERCE 0-0-1998.

CLASS 35—ADVERTISING AND BUSINESS

FOR PROVIDING TECHNICAL ASSISTANCE IN THE ESTABLISHMENT AND/OR OPERATION OF MICROFINANCE INSTITUTIONS TO COMMERCIAL BANKS, INTERNATIONAL FINANCE NETWORKS, AND SERVICE PROVIDERS IN THE FIELD OF MICROFINANCE; BUSINESS CONSULTATION AND BUSINESS EVALUATION OF MICROFINANCE PROGRAMS, NAMELY, MONITORING THE PERFORMANCE OF DEVELOPMENT AGENCIES IN THE AREA OF MICROFINANCE, EVALUATING THEIR EFFECTIVENESS AND MAKING RECOMMENDATIONS FOR IMPROVEMENTS IN THEIR MICROFINANCE PROGRAMS; PROMOTING PUBLIC AWARENESS OF THE NEED FOR UNIFORM STANDARDS AND BEST PRACTICES AMONGST MICROFINANCE INSTITUTIONS, SERVICE PROVIDERS AND FUNDERS; PROMOTING ON-LINE PUBLICATIONS OF OTHERS CONCERNING TECHNICAL ASPECTS OF MICROFINANCE; PROMOTING THE ECONOMIC DEVELOPMENT OF EUROPE, ASIA, AFRICA AND THE AMERICAS BY DEVELOPMENT OF FINANCIAL MARKETS (U.S. CLS. 100, 101 AND 102).

FIRST USE 0-0-1995; IN COMMERCE 0-0-1995.

CLASS 36—INSURANCE AND FINANCIAL

FOR PROVISION OF MICROFINANCE FINANCIAL SERVICES, NAMELY, CREDIT CONSULTATION NAMELY, PROVIDING LOANS, SAVINGS ACCOUNT SERVICES, INSURANCE UNDERWRITING, MONEY LENDING AND MONEY TRANSFERS, TO POOR PEOPLE AROUND THE WORLD; INFORMATION, ADVISORY, AND CONSULTANCY SERVICES IN THE FIELD OF MICROFINANCE; PROVIDING A WEBSITE FEATURING INFORMATION AND NEWS IN THE FIELD OF MICROFINANCE; PROVIDING A WEBSITE THROUGH WHICH USERS CAN OBTAIN INFORMATION RELATING TO MICROFINANCE; PROVIDING ON-LINE INFORMATION AND NEWS IN THE FIELD OF MICROFINANCE (U.S. CLS. 100, 101 AND 102).

FIRST USE 0-0-1995; IN COMMERCE 0-0-1995.

CLASS 41—EDUCATION AND ENTERTAINMENT

FOR DEVELOPING EDUCATIONAL MATERIALS FOR OTHERS IN THE FIELD OF MICROFINANCE; EDUCATIONAL SERVICES, NAMELY, SPONSORING, DEVELOPING, ARRANGING, AND CONDUCTING EDUCATIONAL CONFERENCES, WORKSHOPS AND PROGRAMS AND PROVIDING COURSES OF INSTRUCTION IN THE FIELD OF MICROFINANCE; PUBLICATION OF BOOKS, PAPERS, PAMPHLETS, AND REPORTS IN THE FIELD OF MICROFINANCE; PROVIDING TRAINING IN THE FIELD OF MICROFINANCE FOR MICROFINANCE MANAGERS AND FOR DEVELOPMENT AGENCIES THAT PROVIDE FUNDING TO MICROFINANCE; ARRANGING AND CONDUCTING EDUCATIONAL CONFERENCES IN THE FIELD OF MICROFINANCE (U.S. CLS. 100, 101 AND 107).

FIRST USE 0-0-1995; IN COMMERCE 0-0-1995.
BARBARA BROWN, EXAMINING ATTORNEY

SN 77-267,105. REED, MELANIE, NEW ORLEANS, LA. FILED 8-29-2007.

POWER FLUTIST

THE MARK CONSISTS OF STANDARD CHARACTERS WITHOUT CLAIM TO ANY PARTICULAR FONT, STYLE, SIZE, OR COLOR.

NO CLAIM IS MADE TO THE EXCLUSIVE RIGHT TO USE FLUTIST, APART FROM THE MARK AS SHOWN.

CLASS 9—ELECTRICAL AND SCIENTIFIC APPARATUS

FOR (BASED ON USE IN COMMERCE) MUSICAL SOUND RECORDINGS (U.S. CLS. 21, 23, 26, 36 AND 38).

FIRST USE 1-1-1994; IN COMMERCE 5-28-1995.

CLASS 41—EDUCATION AND ENTERTAINMENT

FOR (BASED ON USE IN COMMERCE) ENTERTAINMENT IN THE NATURE OF LIVE PERFORMANCES BY A MUSICAL ENTERTAINER (U.S. CLS. 100, 101 AND 107).

FIRST USE 1-1-1994; IN COMMERCE 5-28-1995.
ALLISON HOLTZ, EXAMINING ATTORNEY

SN 77-267,712. TULMEISTER, LLC, MARINA DEL REY, CA. FILED 8-29-2007.

ROLLMAN TOOLS

THE MARK CONSISTS OF STANDARD CHARACTERS WITHOUT CLAIM TO ANY PARTICULAR FONT, STYLE, SIZE, OR COLOR.

NO CLAIM IS MADE TO THE EXCLUSIVE RIGHT TO USE "TOOLS", APART FROM THE MARK AS SHOWN.

CLASS 7—MACHINERY

FOR POWER TOOLS, NAMELY, CIRCULAR SAWS, JIGSAWS, ZALL SAWS, AND ROUTERS; ACCESSORIES AND COMPONENTS FOR POWER TOOLS, NAMELY, SAW PLATES AND SHOES, CUTTING GUIDES, AND POWER TOOL ADJUSTMENT MECHANISMS (U.S. CLS. 13, 19, 21, 23, 31, 34 AND 35).

CLASS 8—HAND TOOLS

FOR HAND HELD CUTTING TOOLS, NAMELY, KNIVES AND SAWS AND ADJUSTMENT MECHANISMS FOR THE KNIVES AND SAWS, NOT SOLD SEPARATELY (U.S. CLS. 23, 28 AND 44).
DAWN FELDMAN, EXAMINING ATTORNEY

SN 77-268,366. SWIFT BRANDS COMPANY, GREELEY, CO.
FILED 8-30-2007.

JBS Swift & Company

THE MARK CONSISTS OF STANDARD CHARACTERS WITHOUT CLAIM TO ANY PARTICULAR FONT, STYLE, SIZE, OR COLOR.

OWNER OF U.S. REG. NOS. 1,208,732, 2,854,613 AND OTHERS.

NO CLAIM IS MADE TO THE EXCLUSIVE RIGHT TO USE "& COMPANY", APART FROM THE MARK AS SHOWN.

CLASS 29—MEATS AND PROCESSED FOODS

FOR FRESH, FROZEN, GROUND, PRECOOKED, SEASONED, MARINATED AND PROCESSED BEEF, PORK AND LAMB; MEAT; MEAT CUTS AND MEAT ORGANS (U.S. CL. 46).

CLASS 40—MATERIAL TREATMENT

FOR BEEF AND PORK PROCESSING SERVICES (U.S. CLS. 100, 103 AND 106).
FRANK LATTUCA, EXAMINING ATTORNEY

SN 77-269,252. QUALISYS MEDICAL NETWORK SERVICES, LLC, HANOVER, MD. FILED 8-31-2007.



THE MARK CONSISTS OF A MAGNIFYING GLASS AND SEVERAL BOXES.

CLASS 44—MEDICAL, BEAUTY AND AGRICULTURAL SERVICES

FOR MEDICAL SERVICES, NAMELY, PRE-EMPLOYMENT DRUG SCREENING (U.S. CLS. 100 AND 101).
FIRST USE 4-20-2007; IN COMMERCE 4-20-2007.

CLASS 45—PERSONAL AND LEGAL SERVICES

FOR PRE-EMPLOYMENT BACKGROUND SCREENING (U.S. CLS. 100 AND 101).
FIRST USE 4-20-2007; IN COMMERCE 4-20-2007.
JOHN DALIER, EXAMINING ATTORNEY

SN 77-269,862. VECTRIX CORPORATION, MIDDLETOWN, RI. FILED 8-31-2007.

VEC TECH

THE MARK CONSISTS OF STANDARD CHARACTERS WITHOUT CLAIM TO ANY PARTICULAR FONT, STYLE, SIZE, OR COLOR.

NO CLAIM IS MADE TO THE EXCLUSIVE RIGHT TO USE "TECH", APART FROM THE MARK AS SHOWN.

CLASS 37—CONSTRUCTION AND REPAIR

FOR VEHICLE REPAIR AND MAINTENANCE (U.S. CLS. 100, 103 AND 106).

CLASS 39—TRANSPORTATION AND STORAGE

FOR TRANSPORT AND DELIVERY OF MOTORIZED SCOOTERS (U.S. CLS. 100 AND 105).
JIM RINGLE, EXAMINING ATTORNEY

SN 77-270,289. THE CENTER FOR OCEANIC AWARENESS, RESEARCH, AND EDUCATION, INC., OAKLAND, CA. FILED 9-2-2007.

COARE

THE MARK CONSISTS OF STANDARD CHARACTERS WITHOUT CLAIM TO ANY PARTICULAR FONT, STYLE, SIZE, OR COLOR.

CLASS 35—ADVERTISING AND BUSINESS

FOR PUBLIC ADVOCACY TO PROMOTE AWARENESS OF OCEANIC ECOSYSTEMS AND CONSERVATION (U.S. CLS. 100, 101 AND 102).
FIRST USE 5-20-2006; IN COMMERCE 5-20-2006.

CLASS 36—INSURANCE AND FINANCIAL

FOR CHARITABLE FUND RAISING (U.S. CLS. 100, 101 AND 102).
FIRST USE 5-20-2006; IN COMMERCE 5-20-2006.

CLASS 42—SCIENTIFIC AND COMPUTER SERVICES

FOR SCIENTIFIC RESEARCH (U.S. CLS. 100 AND 101).
FIRST USE 5-20-2006; IN COMMERCE 5-20-2006.
CARYN GLASSER, EXAMINING ATTORNEY

SN 77-270,312. EBERSOLE, GARY, SANTA FE, NM. FILED 9-2-2007.

Knowledge Reef

THE MARK CONSISTS OF STANDARD CHARACTERS WITHOUT CLAIM TO ANY PARTICULAR FONT, STYLE, SIZE, OR COLOR.

NO CLAIM IS MADE TO THE EXCLUSIVE RIGHT TO USE "KNOWLEDGE", APART FROM THE MARK AS SHOWN.

CLASS 9—ELECTRICAL AND SCIENTIFIC APPARATUS

FOR COMPUTER SOFTWARE FOR CREATING SEARCHABLE DATABASES OF INFORMATION AND DATA; COMPUTER SOFTWARE FOR CREATING AND MANAGING SOCIAL NETWORKS; COMPUTER SOFTWARE PLATFORMS FOR CREATING AND MANAGING SOCIAL NETWORKS (U.S. CLS. 21, 23, 26, 36 AND 38).

CLASS 42—SCIENTIFIC AND COMPUTER SERVICES

FOR APPLICATION SERVICE PROVIDER (ASP) FEATURING SOFTWARE FOR USE IN CREATING AND MANAGING SOCIAL NETWORKS (U.S. CLS. 100 AND 101).

MICHELE SWAIN, EXAMINING ATTORNEY

SN 77-270,679. OLYMPUSAT, INC., WEST PALM BEACH, FL. FILED 9-4-2007.

UPLIFTTV

THE MARK CONSISTS OF STANDARD CHARACTERS WITHOUT CLAIM TO ANY PARTICULAR FONT, STYLE, SIZE, OR COLOR.

CLASS 35—ADVERTISING AND BUSINESS

FOR ADVERTISING SERVICES FOR OTHERS IN THE FIELD OF TELEVISION PROGRAMMING (U.S. CLS. 100, 101 AND 102).

CLASS 38—COMMUNICATION

FOR BROADCASTING SERVICES IN THE NATURE OF TRANSMISSION OF PROGRAMS AND RELIGIOUS CONTENT DISTRIBUTED VIA BROADCAST TELEVISION, CABLE TELEVISION, SATELLITE, WIRELESS, INTERNET, AND BROADBAND (U.S. CLS. 100, 101 AND 104).

CLASS 41—EDUCATION AND ENTERTAINMENT

FOR ENTERTAINMENT SERVICES, NAMELY, PROVIDING TELEVISION PROGRAMS IN THE FIELD OF RELIGION DISTRIBUTED VIA BROADCAST TELEVISION, CABLE TELEVISION, SATELLITE, WIRELESS, INTERNET, AND BROADBAND (U.S. CLS. 100, 101 AND 107).

KEVIN CORWIN, EXAMINING ATTORNEY

SN 77-271,620. QUINTILES TRANSNATIONAL CORP., DURHAM, NC. FILED 9-5-2007.

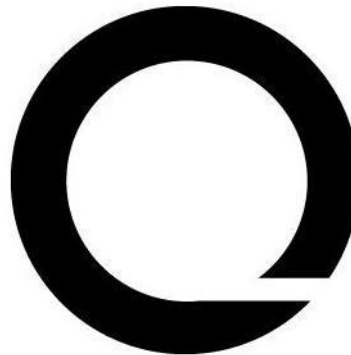

CLASS 35—ADVERTISING AND BUSINESS

FOR COMPUTERIZED DATABASE MANAGEMENT AND DATA PROCESSING SERVICES IN THE FIELDS OF PHARMACEUTICAL, VETERINARY, PHARMACOGENOMIC, BIOTECHNICAL AND MEDICAL PRODUCTS AND DEVICES; MANUFACTURERS' AND INDEPENDENT SALES REPRESENTATIVES IN THE FIELDS OF PHARMACEUTICALS, VETERINARY, PHARMACOGENOMIC, BIOTECHNICAL, DENTAL, AND MEDICAL PRODUCTS AND DEVICES; MARKETING SERVICES FOR OTHERS, NAMELY CREATING AND MANAGING PRODUCT SALES AND PRODUCT LAUNCH PROGRAMS IN THE FIELDS OF PHARMACEUTICALS, VETERINARY, PHARMACOGENOMIC, BIOTECHNICAL, DENTAL, AND MEDICAL PRODUCTS AND DEVICES; BUSINESS MARKETING CONSULTING SERVICES IN THE FIELDS OF PHARMACEUTICALS, VETERINARY, PHARMACOGENOMIC, BIOTECHNICAL, DENTAL, AND MEDICAL PRODUCTS AND DEVICES; MARKET RESEARCH AND ANALYSIS SERVICES IN THE FIELDS OF PHARMACEUTICALS, VETERINARY, PHARMACOGENOMIC, BIOTECHNICAL, DENTAL, AND MEDICAL PRODUCTS AND DEVICES; PERSONNEL RECRUITMENT AND PLACEMENT; PROVIDING BUSINESS INFORMATION, NAMELY, INFORMATION USEFUL FOR ACHIEVING AND MAINTAINING REGULATORY APPROVAL AND MARKET INTRODUCTION OF DRUGS, DEVICES AND BIOLOGICS (U.S. CLS. 100, 101 AND 102).

CLASS 41—EDUCATION AND ENTERTAINMENT

FOR EDUCATIONAL AND TRAINING SERVICES, NAMELY, CONDUCTING TRAINING PROGRAMS, SEMINARS, CLASSES, CONFERENCES AND WORKSHOPS IN THE FIELDS OF HEALTH CARE, HEALTH MANAGEMENT AND DISEASE MANAGEMENT, PHARMACEUTICAL SALES SKILLS, AND PHARMACEUTICAL AND HEALTH PRODUCTS, AND DISTRIBUTING COURSE MATERIALS IN CONNECTION THEREWITH (U.S. CLS. 100, 101 AND 107).

CLASS 42—SCIENTIFIC AND COMPUTER SERVICES

FOR CLINICAL RESEARCH AND TESTING SERVICES IN THE FIELDS OF PHARMACEUTICALS, VETERINARY, PHARMACOGENOMIC, BIOTECHNICAL, DENTAL, AND MEDICAL PRODUCTS AND DEVICES; PRODUCT DEVELOPMENT CONSULTATION IN THE FIELDS OF MEDICAL PRODUCTS AND DEVICES; HEALTHCARE POLICY RESEARCH AND DEVELOPMENT SERVICES; LABORATORY TESTING SERVICES IN THE FIELDS OF PHARMACEUTICAL, VETERINARY, PHARMACOGENOMIC, BIOTECHNICAL AND MEDICAL PRODUCTS AND DEVICES; CONSULTANCY PERTAINING TO PHARMACOLOGY AND BIOTECHNICAL RESEARCH; MANAGING, MONITORING AND COORDINATING CLINICAL STUDIES ON HUMAN SUBJECTS FOR OTHERS (U.S. CLS. 100 AND 101).

CLASS 44—MEDICAL, BEAUTY AND AGRICULTURAL SERVICES

FOR PROVIDING HEALTH, MEDICAL, DENTAL, PHARMACEUTICAL, HEALTH MANAGEMENT AND DISEASE MANAGEMENT INFORMATION TO OTHERS; MEDICAL EVALUATION SERVICES, NAMELY, DEVELOPING AND IMPLEMENTING DISEASE MANAGEMENT AND TREATMENT PROTOCOLS AND PATIENT OUTCOME ANALYSIS SERVICES; CONSULTING SERVICES IN THE FIELDS OF HEALTH CARE, MEDICAL AND PHARMACEUTICALS, VETERINARY, AND DENTAL SERVICES (U.S. CLS. 100 AND 101).

CLASS 45—PERSONAL AND LEGAL SERVICES

FOR REGULATORY RESEARCH IN THE PHARMACEUTICAL INDUSTRY, BIOTECHNOLOGY INDUSTRY AND THE MEDICAL AND DIAGNOSTICS INDUSTRY; CONSULTATION SERVICES IN THE FIELD OF COMPLIANCE EVALUATION TO INSURE VALIDITY AND ACCURACY OF REGULATORY SUBMISSIONS TO THE FDA BY LIFE SCIENCES COMPANIES; CONDUCTING REGULATORY AND COMPLIANCE AUDITS FOR OTHERS IN THE FIELDS OF PHARMACEUTICAL, VETERINARY, PHARMACOGENOMIC, BIOTECHNICAL AND MEDICAL PRODUCTS AND DEVICES; CONSULTING SERVICES IN THE FIELDS OF REGULATORY AFFAIRS, MANUFACTURING COMPLIANCE AND VALIDATION; PROVIDING REGULATORY INFORMATION AND IMPLEMENTATION SERVICES RELATING TO THE DEVELOPMENT AND VALIDATION OF DRUGS, DEVICES AND BIOLOGICS (U.S. CLS. 100 AND 101).

LINDSEY RUBIN, EXAMINING ATTORNEY

SN 77-271,696. THE CARTOON NETWORK, INC., ATLANTA, GA. FILED 9-5-2007.

AYW

THE MARK CONSISTS OF STANDARD CHARACTERS WITHOUT CLAIM TO ANY PARTICULAR FONT, STYLE, SIZE, OR COLOR.

OWNER OF U.S. REG. NO. 2,534,371.

CLASS 9—ELECTRICAL AND SCIENTIFIC APPARATUS

FOR PROVIDING DOWNLOADABLE EDUCATIONAL SOFTWARE FOR EDUCATORS AND YOUTH ORGANIZATIONS, NAMELY, SOFTWARE FOR CREATING ANIMATION (U.S. CLS. 21, 23, 26, 36 AND 38).

FIRST USE 4-7-1999; IN COMMERCE 8-7-1999.

CLASS 41—EDUCATION AND ENTERTAINMENT

FOR EDUCATIONAL SERVICES, NAMELY, PROVIDING AN INSTRUCTIONAL ON-LINE INTERACTIVE WEBSITE FOR EDUCATORS AND YOUTH ORGANIZATIONS IN THE FIELDS OF HOW ANIMATION IS CREATED AND CREATIVE IDEAS IN THE USE OF ANIMATION, AND PRINTABLE INSTRUCTIONAL MATERIAL DISTRIBUTED THEREWITH (U.S. CLS. 100, 101 AND 107).

FIRST USE 4-7-1999; IN COMMERCE 8-7-1999.

JEAN IM, EXAMINING ATTORNEY

SN 77-271,880. T-SYSTEMS INTERNATIONAL, INC., SAN DIEGO, CA. FILED 9-5-2007.



OWNER OF U.S. REG. NOS. 1,105,584, 1,118,172 AND 1,652,307.

THE COLOR(S) BLUE, GREEN AND BROWN IS/ARE CLAIMED AS A FEATURE OF THE MARK.

THE MARK CONSISTS OF A WAVE DESIGN CONSISTING OF GREEN, BLUE AND BROWN STACKED WAVES FOLLOWED BY THE WORDING "T-TAPE" IN THE COLOR BLUE AND "TOTAL" IN THE COLOR GREEN.

CLASS 9—ELECTRICAL AND SCIENTIFIC APPARATUS

FOR SOIL MOISTURE SENSORS AND ELECTRONIC CONTROLLERS FOR REGULATING MOISTURE CONTENT (U.S. CLS. 21, 23, 26, 36 AND 38).

CLASS 44—MEDICAL, BEAUTY AND AGRICULTURAL SERVICES

FOR ADVISORY SERVICES IN THE FIELDS OF IRRIGATION AND FERTIGATION, NAMELY, FERTILIZATION VIA IRRIGATION; GENERATING REPORTS TO ASSIST FARMERS IN THE FIELDS OF IRRIGATION AND FERTIGATION (U.S. CLS. 100 AND 101).

TINA L. SNAPP, EXAMINING ATTORNEY

SN 77-272,590. ARBONNE INTERNATIONAL, LLC, IRVINE, CA. FILED 9-5-2007.

SKINJECTIBLES

THE MARK CONSISTS OF STANDARD CHARACTERS WITHOUT CLAIM TO ANY PARTICULAR FONT, STYLE, SIZE, OR COLOR.

CLASS 3—COSMETICS AND CLEANING PREPARATIONS

FOR NON-MEDICATED SKIN CARE PREPARATIONS; HAIR CARE PREPARATIONS; COSMETICS; AND NON-MEDICATED SUN CARE PREPARATIONS; NON-MEDICATED ANTI-AGING SKIN CARE PREPARATIONS; NON-MEDICATED ANTI-ACNE SKIN CARE PREPARATIONS (U.S. CLS. 1, 4, 6, 50, 51 AND 52).

CLASS 5—PHARMACEUTICALS

FOR ANTI-AGING SUPPLEMENTS (U.S. CLS. 6, 18, 44, 46, 51 AND 52).
KIMBERLY FRYE, EXAMINING ATTORNEY

CLASS 38—COMMUNICATION

FOR PROVIDING ON-LINE CHAT ROOMS AND ELECTRONIC BULLETIN BOARDS FOR TRANSMISSION OF MESSAGES AMONG USERS IN THE FIELD OF OSTOMY AND CONTINENCE ISSUES (U.S. CLS. 100, 101 AND 104).

CLASS 44—MEDICAL, BEAUTY AND AGRICULTURAL SERVICES

FOR PROVIDING INFORMATION REGARDING OSTOMY AND CONTINENCE ISSUES; PROVIDING AN INTERACTIVE WEBSITE REGARDING OSTOMY AND CONTINENCE ISSUES (U.S. CLS. 100 AND 101).
G. MAYERSCHOFF, EXAMINING ATTORNEY

SN 77-273,252. HOLLISTER INCORPORATED, LIBERTYVILLE, IL. FILED 9-6-2007.

SN 77-273,637. CASH PRACTICE, INC., SAN DIEGO, CA. FILED 9-6-2007.

C3life

THE MARK CONSISTS OF STANDARD CHARACTERS WITHOUT CLAIM TO ANY PARTICULAR FONT, STYLE, SIZE, OR COLOR.

CLASS 38—COMMUNICATION

FOR PROVIDING ON-LINE CHAT ROOMS AND ELECTRONIC BULLETIN BOARDS FOR TRANSMISSION OF MESSAGES AMONG USERS IN THE FIELD OF OSTOMY AND CONTINENCE ISSUES (U.S. CLS. 100, 101 AND 104).

CLASS 44—MEDICAL, BEAUTY AND AGRICULTURAL SERVICES

FOR PROVIDING INFORMATION REGARDING OSTOMY AND CONTINENCE ISSUES; PROVIDING AN INTERACTIVE WEBSITE REGARDING OSTOMY AND CONTINENCE ISSUES (U.S. CLS. 100 AND 101).
G. MAYERSCHOFF, EXAMINING ATTORNEY

SN 77-273,257. HOLLISTER INCORPORATED, LIBERTYVILLE, IL. FILED 9-6-2007.



THE MARK CONSISTS OF STYLIZED TREE FORMED WITH THE WORDS "LIVE MY LIFE LOVE MY LIFE".

Cash Practice

THE MARK CONSISTS OF STANDARD CHARACTERS WITHOUT CLAIM TO ANY PARTICULAR FONT, STYLE, SIZE, OR COLOR.

NO CLAIM IS MADE TO THE EXCLUSIVE RIGHT TO USE "CASH", APART FROM THE MARK AS SHOWN.

CLASS 36—INSURANCE AND FINANCIAL

FOR PROVIDING ON-LINE NON-DOWNLOADABLE SOFTWARE FOR USE IN DEVELOPING CONTRACT FORMS AND PROCESSING AUTOMATED RECURRING FINANCIAL TRANSACTIONS (U.S. CLS. 100, 101 AND 102).

FIRST USE 10-25-2002; IN COMMERCE 10-25-2002.

CLASS 42—SCIENTIFIC AND COMPUTER SERVICES

FOR PROVIDING TEMPORARY USE OF ON-LINE NON-DOWNLOADABLE SOFTWARE FOR USE IN DEVELOPING CONTRACT FORMS AND PROCESSING AUTOMATED RECURRING FINANCIAL TRANSACTION AND PROVIDING TEMPORARY USE OF ON-LINE NON-DOWNLOADABLE SOFTWARE FOR USE IN DATA COMMUNICATION BY ELECTRONIC MAIL (U.S. CLS. 100 AND 101).

FIRST USE 10-25-2002; IN COMMERCE 10-25-2002.
LESLEY LAMOTHE, EXAMINING ATTORNEY

SN 77-273,775. BANCVue, LTD., AUSTIN, TX. FILED 9-7-2007.

RealCharity

THE MARK CONSISTS OF STANDARD CHARACTERS WITHOUT CLAIM TO ANY PARTICULAR FONT, STYLE, SIZE, OR COLOR.

CLASS 9—ELECTRICAL AND SCIENTIFIC APPARATUS

FOR COMPUTER SOFTWARE FOR FINANCIAL INSTITUTIONS TO MANAGE ACCOUNTS FOR THE PURPOSE OF INCREASING PROFITABILITY (U.S. CLS. 21, 23, 26, 36 AND 38).

CLASS 35—ADVERTISING AND BUSINESS

FOR PROVIDING PROMOTIONAL MARKETING SERVICES TO FINANCIAL INSTITUTIONS (U.S. CLS. 100, 101 AND 102).

CLASS 36—INSURANCE AND FINANCIAL

FOR FINANCIAL SERVICES, NAMELY, PROVIDING FINANCIAL CONSULTING TO INSTITUTIONS TO INCREASE PROFITABILITY (U.S. CLS. 100, 101 AND 102).
EMILY CARLSEN, EXAMINING ATTORNEY

CLASS 9—ELECTRICAL AND SCIENTIFIC APPARATUS

FOR COMPUTER SOFTWARE FOR FINANCIAL INSTITUTIONS TO MANAGE ACCOUNTS FOR THE PURPOSE OF INCREASING PROFITABILITY (U.S. CLS. 21, 23, 26, 36 AND 38).

CLASS 35—ADVERTISING AND BUSINESS

FOR PROVIDING PROMOTIONAL MARKETING SERVICES TO FINANCIAL INSTITUTIONS (U.S. CLS. 100, 101 AND 102).

CLASS 36—INSURANCE AND FINANCIAL

FOR FINANCIAL SERVICES, NAMELY, PROVIDING FINANCIAL CONSULTING TO INSTITUTIONS TO INCREASE PROFITABILITY (U.S. CLS. 100, 101 AND 102).
EMILY CARLSEN, EXAMINING ATTORNEY

SN 77-273,778. BANCVue, LTD., AUSTIN, TX. FILED 9-7-2007.

SN 77-273,785. BANCVue, LTD., AUSTIN, TX. FILED 9-7-2007.

RealPatriot

THE MARK CONSISTS OF STANDARD CHARACTERS WITHOUT CLAIM TO ANY PARTICULAR FONT, STYLE, SIZE, OR COLOR.

CLASS 9—ELECTRICAL AND SCIENTIFIC APPARATUS

FOR COMPUTER SOFTWARE FOR FINANCIAL INSTITUTIONS TO MANAGE ACCOUNTS FOR THE PURPOSE OF INCREASING PROFITABILITY (U.S. CLS. 21, 23, 26, 36 AND 38).

CLASS 35—ADVERTISING AND BUSINESS

FOR PROVIDING PROMOTIONAL MARKETING SERVICES TO FINANCIAL INSTITUTIONS (U.S. CLS. 100, 101 AND 102).

CLASS 36—INSURANCE AND FINANCIAL

FOR FINANCIAL SERVICES, NAMELY, PROVIDING FINANCIAL CONSULTING TO INSTITUTIONS TO INCREASE PROFITABILITY (U.S. CLS. 100, 101 AND 102).
CAROLYN CATALDO, EXAMINING ATTORNEY

SN 77-273,783. BANCVue, LTD., AUSTIN, TX. FILED 9-7-2007.

RealEducation

THE MARK CONSISTS OF STANDARD CHARACTERS WITHOUT CLAIM TO ANY PARTICULAR FONT, STYLE, SIZE, OR COLOR.

RealLearning

THE MARK CONSISTS OF STANDARD CHARACTERS WITHOUT CLAIM TO ANY PARTICULAR FONT, STYLE, SIZE, OR COLOR.

CLASS 9—ELECTRICAL AND SCIENTIFIC APPARATUS

FOR COMPUTER SOFTWARE FOR FINANCIAL INSTITUTIONS TO MANAGE ACCOUNTS FOR THE PURPOSE OF INCREASING PROFITABILITY (U.S. CLS. 21, 23, 26, 36 AND 38).

CLASS 35—ADVERTISING AND BUSINESS

FOR PROVIDING PROMOTIONAL MARKETING SERVICES TO FINANCIAL INSTITUTIONS (U.S. CLS. 100, 101 AND 102).

CLASS 36—INSURANCE AND FINANCIAL

FOR FINANCIAL SERVICES, NAMELY, PROVIDING FINANCIAL CONSULTING TO INSTITUTIONS TO INCREASE PROFITABILITY (U.S. CLS. 100, 101 AND 102).
CAROLYN CATALDO, EXAMINING ATTORNEY

SN 77-273,788. BANCVue, LTD., AUSTIN, TX. FILED 9-7-2007.

RealInterest

THE MARK CONSISTS OF STANDARD CHARACTERS WITHOUT CLAIM TO ANY PARTICULAR FONT, STYLE, SIZE, OR COLOR.

CLASS 9—ELECTRICAL AND SCIENTIFIC APPARATUS

FOR COMPUTER SOFTWARE FOR FINANCIAL INSTITUTIONS TO MANAGE ACCOUNTS FOR THE PURPOSE OF INCREASING PROFITABILITY (U.S. CLS. 21, 23, 26, 36 AND 38).

CLASS 35—ADVERTISING AND BUSINESS

FOR PROVIDING PROMOTIONAL MARKETING SERVICES TO FINANCIAL INSTITUTIONS (U.S. CLS. 100, 101 AND 102).

CLASS 36—INSURANCE AND FINANCIAL

FOR FINANCIAL SERVICES, NAMELY, PROVIDING FINANCIAL CONSULTING TO INSTITUTIONS TO INCREASE PROFITABILITY (U.S. CLS. 100, 101 AND 102).
EMILY CARLSEN, EXAMINING ATTORNEY

CLASS 9—ELECTRICAL AND SCIENTIFIC APPARATUS

FOR COMPUTER SOFTWARE FOR FINANCIAL INSTITUTIONS TO MANAGE ACCOUNTS FOR THE PURPOSE OF INCREASING PROFITABILITY (U.S. CLS. 21, 23, 26, 36 AND 38).

CLASS 35—ADVERTISING AND BUSINESS

FOR PROVIDING PROMOTIONAL MARKETING SERVICES TO FINANCIAL INSTITUTIONS (U.S. CLS. 100, 101 AND 102).

CLASS 36—INSURANCE AND FINANCIAL

FOR FINANCIAL SERVICES, NAMELY, PROVIDING FINANCIAL CONSULTING TO INSTITUTIONS TO INCREASE PROFITABILITY (U.S. CLS. 100, 101 AND 102).
CAROLYN CATALDO, EXAMINING ATTORNEY

SN 77-274,081. LIGHTBULB COMMUNICATIONS, LLC,
VIENNA, VA. FILED 9-7-2007.

Team Lightbulb

THE MARK CONSISTS OF STANDARD CHARACTERS WITHOUT CLAIM TO ANY PARTICULAR FONT, STYLE, SIZE, OR COLOR.

CLASS 35—ADVERTISING AND BUSINESS

FOR ARRANGING EXHIBITIONS, CONFERENCES AND TRADE SHOWS IN THE FIELDS OF TELECOMMUNICATIONS, BROADCASTING AND EMERGING MEDIA (U.S. CLS. 100, 101 AND 102).

CLASS 41—EDUCATION AND ENTERTAINMENT

FOR ARRANGING SEMINARS, MEETINGS AND WEBINARS IN THE FIELDS OF TELECOMMUNICATIONS, BROADCASTING AND EMERGING MEDIA (U.S. CLS. 100, 101 AND 107).
KIM SAITO, EXAMINING ATTORNEY

SN 77-274,203. BANCVIEW, LTD., AUSTIN, TX. FILED 9-7-2007.

RealChecking

THE MARK CONSISTS OF STANDARD CHARACTERS WITHOUT CLAIM TO ANY PARTICULAR FONT, STYLE, SIZE, OR COLOR.

SN 77-274,262. VONAGE MARKETING INC., HOLMDEL, NJ.
FILED 9-7-2007.

VONAGE MOBILE

THE MARK CONSISTS OF STANDARD CHARACTERS WITHOUT CLAIM TO ANY PARTICULAR FONT, STYLE, SIZE, OR COLOR.

OWNER OF U.S. REG. NOS. 2,614,773, 2,848,258 AND OTHERS.

NO CLAIM IS MADE TO THE EXCLUSIVE RIGHT TO USE "MOBILE", APART FROM THE MARK AS SHOWN.

CLASS 9—ELECTRICAL AND SCIENTIFIC APPARATUS

FOR WIRELESS TELECOMMUNICATIONS DEVICES, NAMELY, CELLULAR TELEPHONES, DUAL-MODE TELEPHONES, CELLULAR TELEPHONE APPARATUS, CELLULAR COMPUTER MODEMS, AND DUAL-MODE COMPUTER MODEMS THAT PROVIDE WIRELESS TRANSMISSION OF E-MAIL, TEXT, MUSIC, VIDEO, VOICE, STILL IMAGES, INFORMATION, DATA, AND OTHER CONTENT AND WIRELESS ACCESS TO GLOBAL COMPUTER NETWORK (U.S. CLS. 21, 23, 26, 36 AND 38).

CLASS 38—COMMUNICATION

FOR WIRELESS TELECOMMUNICATIONS, NAMELY, WIRELESS PHONE SERVICE (U.S. CLS. 100, 101 AND 104).
SETH A. RAPPAPORT, EXAMINING ATTORNEY

SN 77-275,398. IDC RESEARCH, INC., FRAMINGHAM, MA.
FILED 9-10-2007.

Tech X.0

THE MARK CONSISTS OF STANDARD CHARACTERS WITHOUT CLAIM TO ANY PARTICULAR FONT, STYLE, SIZE, OR COLOR.

NO CLAIM IS MADE TO THE EXCLUSIVE RIGHT TO USE "TECH", APART FROM THE MARK AS SHOWN.

CLASS 35—ADVERTISING AND BUSINESS

FOR ARRANGING AND CONDUCTING BUSINESS CONFERENCES (U.S. CLS. 100, 101 AND 102).

CLASS 41—EDUCATION AND ENTERTAINMENT

FOR ARRANGING OF EXHIBITIONS, SEMINARS AND CONFERENCES; ARRANGING OF SEMINARS AND CONFERENCES (U.S. CLS. 100, 101 AND 107).

TASNEEM HUSSAIN, EXAMINING ATTORNEY

SN 77-275,523. PETHANY DESIGN STUDIO, TAIPEI CITY, TAIWAN, FILED 9-10-2007.

Pethany  Larsen

CLASS 16—PAPER GOODS AND PRINTED MATTER

FOR BOOKMARKS; CHRISTMAS CARDS; DESK CALENDARS; FOLDERS; GREETING CARDS; GIFT CARDS; HOLIDAY CARDS; INVITATION CARDS; NOTEBOOKS; PAPER BAGS; PAPER CONTAINERS; PAPER FOLDERS; PAPER GIFT BAGS; POSTCARDS; SKETCHBOOKS; WRAPPING PAPER (U.S. CLS. 2, 5, 22, 23, 29, 37, 38 AND 50).

FIRST USE 4-21-2006; IN COMMERCE 4-21-2006.

CLASS 21—HOUSEWARES AND GLASS

FOR CANDLE HOLDERS; CHOPSTICKS; COFFEE CUPS; COMMEMORATIVE PLATES; CUPS; DINNERWARE; FABRIC BOXES FOR STORING GREETING CARDS; FLOWER VASES AND BOWLS; MUGS; NAPKIN HOLDERS; NAPKIN RINGS; PLATES; PORCELAIN KNOBS; PORCELAIN MUGS; SOUVENIR PLATES; TOOTHBRUSH HOLDERS(BASED ON INTENT TO USE) BOWLS; GLASS BOWLS; SALAD BOWLS (U.S. CLS. 2, 13, 23, 29, 30, 33, 40 AND 50).

FIRST USE 4-21-2006; IN COMMERCE 4-21-2006.

CLASS 24—FABRICS

FOR BATH TOWELS; BED BLANKETS; CHILDREN'S BLANKETS; CHILDREN'S TOWELS; BEACH TOWELS; BED LINEN; BED SHEETS; BED SPREADS; BLANKET THROWS; CASHMERE FABRIC; COMFORTERS; COTTON FABRIC; DUVET COVERS; DUVETS; FACE TOWELS; FELTS; HAND TOWELS; HOODED TOWELS; KITCHEN TOWELS; MATTRESS COVERS; PILLOW CASES; PILLOW COVERS; SHOWER CURTAINS; SILK BED BLANKETS; TABLE LINEN; TEXTILE NAPKINS; THROWS; TOWEL SETS; TOWELS; WASHCLOTHS; WOOLLEN BLANKETS (U.S. CLS. 42 AND 50).

FIRST USE 4-21-2006; IN COMMERCE 4-21-2006.

JOHN WILKE, EXAMINING ATTORNEY

SN 77-275,677. EUGENE A. GORAB, SOUTH NORWALK, CT.
FILED 9-10-2007.



THE MARK CONSISTS OF STYLIZED V.

CLASS 35—ADVERTISING AND BUSINESS

FOR BUSINESS MANAGEMENT SERVICES, NAMELY, AIRCRAFT MANAGEMENT FOR OTHERS; OPERATION OF ASSOCIATED PASSENGER TERMINALS AND FLIGHT CREW FACILITIES; ADMINISTRATIVE MANAGEMENT OF AIRCRAFT, NAMELY, ARRANGING AIRCRAFT REFUELING, HANGARING, TIE-DOWN SERVICES AND GROUND HANDLING (U.S. CLS. 100, 101 AND 102).

CLASS 36—INSURANCE AND FINANCIAL

FOR AIRCRAFT BROKERAGE (U.S. CLS. 100, 101 AND 102).

CLASS 37—CONSTRUCTION AND REPAIR

FOR AIRCRAFT MAINTENANCE, REPAIR, OVERHAULING AND SERVICING; GENERAL AVIATION SERVICES, NAMELY, AIRCRAFT REFUELING SERVICES (U.S. CLS. 100, 103 AND 106).

CLASS 39—TRANSPORTATION AND STORAGE

FOR CHARTERING AND LEASING AIRCRAFT (U.S. CLS. 100 AND 105).

CLASS 42—SCIENTIFIC AND COMPUTER SERVICES

FOR INSPECTIONS OF AIRCRAFTS (U.S. CLS. 100 AND 101).

KEVON CHISOLM, EXAMINING ATTORNEY

SN 77-275,732. OSBORNE, JAMES J., AMBLER, PA. FILED 9-10-2007.

SN 77-277,181. PACIFIC RIM NOODLE HOUSE, ARCATA, CA. FILED 9-12-2007.

EZ BRANDS

THE MARK CONSISTS OF STANDARD CHARACTERS WITHOUT CLAIM TO ANY PARTICULAR FONT, STYLE, SIZE, OR COLOR.

NO CLAIM IS MADE TO THE EXCLUSIVE RIGHT TO USE "BRANDS", APART FROM THE MARK AS SHOWN.

CLASS 3—COSMETICS AND CLEANING PREPARATIONS

FOR BATH SOAPS IN LIQUID, SOLID OR GEL FORM; BODY WASHES; SHAMPOO-CONDITIONERS; SHAMPOOS (U.S. CLS. 1, 4, 6, 50, 51 AND 52).

CLASS 9—ELECTRICAL AND SCIENTIFIC APPARATUS

FOR CARRYING CASES FOR CELL PHONES; CARRYING CASES FOR RADIO PAGERS; CASES FOR MOBILE PHONES; CASES FOR SPECTACLES AND SUNGLASSES; CELL PHONE COVERS; CELL PHONES; DIGITAL AUDIO PLAYERS; DIGITAL CAMERAS; ELECTRIC HAIR CURLING IRONS; ELECTRIC HAIR STRAIGHTENER; ELECTRONIC PERSONAL ORGANIZER; PERSONAL DIGITAL ASSISTANTS (PDA); PORTABLE LISTENING DEVICES, NAMELY, MP3 PLAYERS; PORTABLE MEDIA PLAYERS; PORTABLE RADIOS; PROTECTIVE CARRYING CASES FOR PORTABLE MUSIC PLAYERS NAMELY MP3 PLAYERS; PROTECTIVE CARRYING CASES SPECIALLY ADAPTED FOR GLOBAL POSITIONING SYSTEM (GPS) APPARATUS; PROTECTIVE CARRYING CASES SPECIALLY ADAPTED FOR PERSONAL DIGITAL ASSISTANTS (PDA); REMOTE CONTROLS FOR TELEVISION (U.S. CLS. 21, 23, 26, 36 AND 38).

CLASS 16—PAPER GOODS AND PRINTED MATTER

FOR CARDBOARD BOXES; CARDBOARD CONTAINERS; CARDBOARD MAILING TUBES; CARDBOARD PACKAGING; CLIP BOARDS; DOCUMENT HOLDERS; LOOSE-LEAF PADS; MARKERS; MEMO PADS; MERCHANDISE BAGS; NOTE PADS; PAPER BAGS FOR PACKAGING; PENCILS; PENS; PLASTIC BAGS FOR PACKAGING; STATIONERY (U.S. CLS. 2, 5, 22, 23, 29, 37, 38 AND 50).

CLASS 21—HOUSEWARES AND GLASS

FOR ABRASIVE PADS FOR KITCHEN OR DOMESTIC PURPOSES; BATH BRUSHES; BATH SPONGES; BROOMS; CLEANING PADS; CLEANING RAGS; COMBS; DISPENSERS FOR LIQUID SOAP; DUSTING BRUSHES; HAIR BRUSHES; HOUSEHOLD UTENSILS, NAMELY, SPATULAS; MOPS; PLASTIC BATH RACKS; PLASTIC BUCKETS; POT CLEANING BRUSHES; SCRUBBING BRUSHES; SOAP DISHES; SPONGES FOR HOUSEHOLD PURPOSES; SQUEEGEES; TOOTHBRUSHES; TOWEL RACKS (U.S. CLS. 2, 13, 23, 29, 30, 33, 40 AND 50).

CURTIS FRENCH, EXAMINING ATTORNEY



NO CLAIM IS MADE TO THE EXCLUSIVE RIGHT TO USE "NOODLE HOUSE", APART FROM THE MARK AS SHOWN.

THE STIPLING IS A FEATURE OF THE MARK AND DOES NOT INDICATE COLOR.

THE MARK CONSISTS OF A STRIDING HUMAN FIGURE WITHIN A HOUSE AND CARRYING A BOWL WITH STEAM RISING.

CLASS 29—MEATS AND PROCESSED FOODS

FOR FERMENTED VEGETABLES; GARDEN SALADS; MARINATED VEGETABLES; PRE-CUT VEGETABLE SALAD; PRE-PACKAGED DINNERS CONSISTING OF VEGETABLES AND/OR NOODLES AND/OR RICE; SALADS EXCEPT MACARONI, RICE, AND PASTA SALAD; SEASONED VEGETABLES; SOUPS; VEGETABLE SALADS; VEGETABLE-BASED SPREADS; PREPARED AND/OR PACKAGED ENTREES CONSISTING PRIMARILY OF MEAT, FISH, POULTRY OR VEGETABLES; PREPARED AND/OR PACKAGED MEALS CONSISTING PRIMARILY OF MEAT, FISH, POULTRY OR VEGETABLES; PREPARED AND/OR PACKAGED VEGETABLE-BASED ENTREES; CHEESE SPREADS; COMBINATION MEAL CONSISTING PRIMARILY OF A MEAT OR VEGETABLE-BASED ENTREE AND A SOUP OR SALAD FOR CONSUMPTION ON OR OFF THE PREMISES; FISH CAKES; HUMMUS (U.S. CL. 46).

FIRST USE 4-17-1995; IN COMMERCE 12-4-1995.

CLASS 30—STAPLE FOODS

FOR MARINADES; NOODLES, SAUCE, AND SEASONING TOPPINGS COMBINED IN UNITARY PACKAGES; NOODLES, SAUCE, AND TOPPING COMBINED IN UNITARY PACKAGES; READY-MADE SAUCES; RICE SALAD; RICE, SEASONINGS, AND FLAVORINGS COMBINED IN UNITARY PACKAGES; SALAD DRESSINGS; SALAD SAUCES; SAUCES; SPRING ROLLS; SUSHI; PREPARED AND/OR PACKAGED ENTREES CONSISTING PRIMARILY OF PASTA OR RICE; PREPARED AND/OR PACKAGED MEALS CONSISTING PRIMARILY OF PASTA OR RICE; FISH SAUCE (U.S. CL. 46).

FIRST USE 4-17-1995; IN COMMERCE 12-4-1995.

DANIEL BRODY, EXAMINING ATTORNEY

SN 77-277,501. TERRESTAR NETWORKS INC., RESTON, VA. FILED 9-12-2007.

MOBILE COMMUNICATIONS REDEFINED

THE MARK CONSISTS OF STANDARD CHARACTERS WITHOUT CLAIM TO ANY PARTICULAR FONT, STYLE, SIZE, OR COLOR.

NO CLAIM IS MADE TO THE EXCLUSIVE RIGHT TO USE "MOBILE COMMUNICATIONS", APART FROM THE MARK AS SHOWN.

CLASS 9—ELECTRICAL AND SCIENTIFIC APPARATUS

FOR TELECOMMUNICATIONS EQUIPMENT, NAMELY, TELEPHONES AND WIRELESS AND MOBILE TELEPHONES FOR VOICE, DATA, AND FAX COMMUNICATIONS; TELEMATICS APPARATUS, NAMELY, HAND-HELD DEVICES FOR WIRELESS ACCESS TO GLOBAL COMMUNICATIONS NETWORKS AND E-MAIL; PAGERS; WIRELESS TELEPHONES; COMPUTERS, COMPUTER TERMINALS, COMPUTER SERVERS, COMPUTER BUFFERS, AND COMPUTER HARDWARE FOR USE IN THE TELECOMMUNICATIONS INDUSTRY; TELEPHONE MODEMS AND RADIO MODEMS; INTEGRATED CIRCUIT MEMORIES; COMPUTER SOFTWARE FOR OPERATING HARDWARE, TRANSLATING DIGITAL SIGNALS, TRANSMITTING DIGITAL DATA AND SIGNALS, ELECTRONIC MESSAGING, DATA MANAGEMENT, HARDWARE AND NETWORK SECURITY, AND ACCESS TO THE INTERNET FOR USE IN WIRELESS COMMUNICATIONS SYSTEMS; COMPUTER PROGRAMS UTILIZING RADIO COMMUNICATIONS NETWORKS, LOCAL AND/OR WIDE AREA COMMUNICATION NETWORKS, TERMINALS AND PAGERS FOR FACILITATING WIRELESS RADIO COMMUNICATION; COMPUTER PROGRAMS FOR RECORDING, PROCESSING, RECEIVING, REPRODUCING, TRANSMITTING, MODIFYING, COMPRESSING, BROADCASTING, MERGING OR ENHANCING DATA FOR USE IN WIRELESS COMMUNICATIONS; DATA COMPRESSION SOFTWARE (U.S. CLS. 21, 23, 26, 36 AND 38).

CLASS 16—PAPER GOODS AND PRINTED MATTER

FOR PUBLICATIONS, NAMELY, BOOKS, MAGAZINES, PAMPHLETS, BROCHURES, CIRCULARS, ALL FEATURING INFORMATION REGARDING THE TELECOMMUNICATIONS INDUSTRY (U.S. CLS. 2, 5, 22, 23, 29, 37, 38 AND 50).

CLASS 35—ADVERTISING AND BUSINESS

FOR BUSINESS CONSULTING SERVICES IN THE FIELD OF TELECOMMUNICATIONS; PROMOTING THE GOODS AND SERVICES OF OTHERS THROUGH THE PROVISION OF BUSINESS CONSULTING SERVICES IN THE FIELD OF WIRELESS COMMUNICATIONS; PROVIDING BUSINESS AND COMMERCIAL CONSULTATION AND ADVISORY SERVICES RELATING TO COMPUTERS, COMPUTER SOFTWARE, AND COMMUNICATIONS NETWORKS AND INFORMATION TECHNOLOGY USED IN THE FIELD OF TELECOMMUNICATIONS GENERALLY AND WIRELESS COMMUNICATIONS; ARRANGING AND CONDUCTING BUSINESS AND COMMERCIAL SEMINARS, CONVENTIONS AND CONFERENCES RELATED TO WIRELESS COMMUNICATIONS AND THE TELECOMMUNICATIONS INDUSTRY; PROVIDING COMPUTERIZED BUSINESS INFORMATION VIA A WIRELESS COMMUNICATIONS NETWORK (U.S. CLS. 100, 101 AND 102).

CLASS 38—COMMUNICATION

FOR SATELLITE TELECOMMUNICATIONS SERVICES, NAMELY, THE PROVISION AND TRANSMISSION OF SATELLITE AND TERRESTRIAL TELECOMMUNICATIONS SERVICES; PROVIDING SATELLITE AND TERRESTRIAL SERVICES FOR MOBILE USERS FOR VOICE, DATA AND FAX COMMUNICATIONS; RADIO COMMUNICATIONS SERVICES; PROVIDING COMPUTER COMMUNICATIONS AND DATA TRANSMISSION SERVICES VIA RADIO AT REMOTE LOCATIONS; WIRELESS TRANSMISSION AND NETWORKING OF MESSAGES, COMMUNICATIONS AND OF DATA; COMPUTER INTERCOMMUNICATION SERVICES; ELECTRONIC MAIL SERVICES; PAGING SERVICES; RENTAL OF COMMUNICATIONS APPARATUS EQUIPMENT AND OF ELECTRONIC MAIL-BOXES; DATA COMMUNICATION SERVICES, NAMELY, WIRELESS DATA COMMUNICATIONS SERVICES; AND PROVIDING VIA GLOBAL COMPUTER NETWORKS INFORMATION ADVISORY SERVICES RELATING TO THE FOREGOING; AND CONSULTING AND ADVISORY SERVICES IN THE FIELD OF TELECOMMUNICATIONS, WIRELESS COMMUNICATIONS, AND COMMUNICATIONS NETWORKS; COMPUTER INTERCOMMUNICATION SERVICES, NAMELY, THE PROVISION OF CONSULTING SERVICES IN THE FIELD OF WIRELESS TELECOMMUNICATIONS (U.S. CLS. 100, 101 AND 104).

CLASS 42—SCIENTIFIC AND COMPUTER SERVICES

FOR CONSULTING AND ADVISORY SERVICES IN THE FIELD OF COMPUTERS, COMPUTER SOFTWARE, COMPUTER AND COMMUNICATIONS NETWORKS AND INFORMATION TECHNOLOGY; COMPUTER SYSTEM INTEGRATION SERVICES (U.S. CLS. 100 AND 101).
MIDGE BUTLER, EXAMINING ATTORNEY

SN 77-277,686. ABBOTT LABORATORIES, ABBOTT PARK, IL. FILED 9-12-2007.

PROTIVA

THE MARK CONSISTS OF STANDARD CHARACTERS WITHOUT CLAIM TO ANY PARTICULAR FONT, STYLE, SIZE, OR COLOR.

CLASS 5—PHARMACEUTICALS

FOR NUTRITIONAL PRODUCTS FOR NON-MEDICAL PURPOSES, NAMELY, NUTRITIONAL SHAKES FOR USE AS A MEAL SUBSTITUTE; NUTRITIONALLY FORTIFIED BEVERAGES, VITAMIN FORTIFIED BEVERAGES (U.S. CLS. 6, 18, 44, 46, 51 AND 52).

CLASS 32—LIGHT BEVERAGES

FOR SOY BASED BEVERAGES NOT BEING MILK SUBSTITUTES; NON-ALCOHOLIC BEVERAGES CONTAINING FRUIT JUICES (U.S. CLS. 45, 46 AND 48).
JOHN DWYER, EXAMINING ATTORNEY

SN 77-277,698. ABBOTT LABORATORIES, ABBOTT PARK, IL. FILED 9-12-2007.

SN 77-278,247. VULTAGGIO/NAPOLITAN BEVERAGE CO, LLC, LAS VEGAS, NV. FILED 9-12-2007.

PROTIVO

THE MARK CONSISTS OF STANDARD CHARACTERS WITHOUT CLAIM TO ANY PARTICULAR FONT, STYLE, SIZE, OR COLOR.

CLASS 5—PHARMACEUTICALS

FOR NUTRITIONAL PRODUCTS FOR NON-MEDICAL PURPOSES, NAMELY, NUTRITIONAL SHAKES FOR USE AS MEAL SUBSTITUTE; NUTRITIONALLY FORTIFIED BEVERAGES, VITAMIN-FORTIFIED BEVERAGES (U.S. CLS. 6, 18, 44, 46, 51 AND 52).

CLASS 32—LIGHT BEVERAGES

FOR SOY BASED BEVERAGES NOT BEING MILK SUBSTITUTES; NON-ALCOHOLIC BEVERAGES CONTAINING FRUIT JUICES (U.S. CLS. 45, 46 AND 48).
JOHN DWYER, EXAMINING ATTORNEY

SN 77-278,031. MARIO GABRIEL LIMITED, BERHAMPORE, WELLINGTON, NEW ZEALAND, FILED 9-12-2007.

MUSACUS

THE MARK CONSISTS OF STANDARD CHARACTERS WITHOUT CLAIM TO ANY PARTICULAR FONT, STYLE, SIZE, OR COLOR.

CLASS 9—ELECTRICAL AND SCIENTIFIC APPARATUS

FOR ELECTRONIC APPARATUS FOR TEACHING MUSIC, NAMELY, ELECTRONIC APPARATUS FOR THE REPRODUCTION OF SOUND; ELECTRONIC APPARATUS FOR CALCULATING MUSICAL SCALES AND CHORDS AND FOR DETERMINING MUSICAL TRANSPOSITIONS (U.S. CLS. 21, 23, 26, 36 AND 38).

CLASS 16—PAPER GOODS AND PRINTED MATTER

FOR PRINTED CHARTS FOR THE TEACHING OF MUSIC; PRINTED CHARTS FOR CALCULATING SCALES AND DETERMINING MUSICAL TRANSPOSITIONS (U.S. CLS. 2, 5, 22, 23, 29, 37, 38 AND 50).
KELLEY WELLS, EXAMINING ATTORNEY

CHROME

THE MARK CONSISTS OF STANDARD CHARACTERS WITHOUT CLAIM TO ANY PARTICULAR FONT, STYLE, SIZE, OR COLOR.

CLASS 30—STAPLE FOODS

FOR BEVERAGES MADE OF COFFEE; COFFEE; PREPARED COFFEE AND COFFEE-BASED BEVERAGES; COFFEE-BASED BEVERAGE CONTAINING MILK (U.S. CL. 46).

CLASS 32—LIGHT BEVERAGES

FOR BOTTLED DRINKING WATER; FLAVORED WATERS; MINERAL WATER; SPARKLING WATER; COLAS; ENERGY DRINKS; FRUIT FLAVORED SOFT DRINKS; POP; SOFT DRINKS (U.S. CLS. 45, 46 AND 48).
JULIE GUTTADAURO, EXAMINING ATTORNEY

SN 77-278,446. FORCE, SANDRA J., SANTA BARBARA, CA. FILED 9-13-2007.



CLASS 16—PAPER GOODS AND PRINTED MATTER

FOR APPLIQUES IN THE FORM OF DECALS; DECALS (U.S. CLS. 2, 5, 22, 23, 29, 37, 38 AND 50).

CLASS 25—CLOTHING

FOR SHIRTS; HATS; PANTS; SOCKS; GOLF CAPS; GOLF SHIRTS; GOLF SHOES; GOLF TROUSERS; VISORS (U.S. CLS. 22 AND 39).

CLASS 28—TOYS AND SPORTING GOODS

FOR BAGS FOR SKATEBOARDS; BALL BEARINGS FOR SKATEBOARDS; NUTS AND BOLTS FOR SKATEBOARDS; SKATEBOARD DECKS; SKATEBOARD GRIP TAPES; SKATEBOARD RAILS; SKATEBOARD RISER PADS; SKATEBOARD TRUCKS; SKATEBOARD WHEELS; SKATEBOARDS (U.S. CLS. 22, 23, 38 AND 50).
MORGAN WYNNE, EXAMINING ATTORNEY

SN 77-278,582. LEVENTHAL, KAREN J., POMPANO BEACH, FL. FILED 9-13-2007.

Supersize
Your
123s

NO CLAIM IS MADE TO THE EXCLUSIVE RIGHT TO USE "123S", APART FROM THE MARK AS SHOWN.

THE COLOR(S) RED, BLUE, YELLOW IS/ARE CLAIMED AS A FEATURE OF THE MARK.

THE MARK CONSISTS OF THE WORD "SUPERSIZE" IN STYLIZED RED LETTERS; THE WORD "YOUR" IN STYLIZED BLUE LETTERS; THE NUMBERS "123S" WITH THE "1" AND THE "S" IN STYLIZED RED, "2" IN STYLIZED YELLOW, AND "3" BLUE LETTERS ACCORDINGLY.

CLASS 16—PAPER GOODS AND PRINTED MATTER

FOR CHILDREN'S BOOKS (U.S. CLS. 2, 5, 22, 23, 29, 37, 38 AND 50).

CLASS 41—EDUCATION AND ENTERTAINMENT

FOR PUBLICATION OF CHILDREN'S BOOKS (U.S. CLS. 100, 101 AND 107).
NAAKWAMA ANKRAH, EXAMINING ATTORNEY

SN 77-278,588. KAREN J. LEVENTHAL, POMPANO BEACH, FL. FILED 9-13-2007.

Supersize
Your
ABCs

NO CLAIM IS MADE TO THE EXCLUSIVE RIGHT TO USE "ABCs", APART FROM THE MARK AS SHOWN.

THE COLOR(S) RED, BLUE, YELLOW IS/ARE CLAIMED AS A FEATURE OF THE MARK.

THE COLOR(S) MARK CONSISTS OF THE WORD "SUPERSIZE" IN STYLIZED RED LETTERS; THE WORD "YOUR" IN STYLIZED BLUE LETTERS; THE NUMBERS "ABCs" WITH THE "A" AND THE "S" IN STYLIZED RED, "B" IN STYLIZED YELLOW, AND "C" BLUE LETTERS ACCORDINGLY.

CLASS 16—PAPER GOODS AND PRINTED MATTER

FOR CHILDREN'S BOOKS (U.S. CLS. 2, 5, 22, 23, 29, 37, 38 AND 50).

CLASS 41—EDUCATION AND ENTERTAINMENT

FOR PUBLICATION OF CHILDREN'S BOOKS (U.S. CLS. 100, 101 AND 107).
NAAKWAMA ANKRAH, EXAMINING ATTORNEY

SN 77-279,889. SUN EDISON LLC, BELTSVILLE, MD. FILED 9-14-2007.

SIMPLIFYING SOLAR

THE MARK CONSISTS OF STANDARD CHARACTERS WITHOUT CLAIM TO ANY PARTICULAR FONT, STYLE, SIZE, OR COLOR.

NO CLAIM IS MADE TO THE EXCLUSIVE RIGHT TO USE "SOLAR", APART FROM THE MARK AS SHOWN.

CLASS 35—ADVERTISING AND BUSINESS

FOR OPERATING SOLAR ENERGY PRODUCTION FACILITIES FOR OTHERS (U.S. CLS. 100, 101 AND 102).
FIRST USE 4-18-2003; IN COMMERCE 3-0-2004.

CLASS 36—INSURANCE AND FINANCIAL

FOR FINANCING POWER GENERATION, TRANSMISSION AND DISTRIBUTION FACILITIES FOR OTHERS; PURCHASING ENERGY-RELATED FINANCIAL COMMODITIES FOR OTHERS (U.S. CLS. 100, 101 AND 102).
FIRST USE 4-18-2003; IN COMMERCE 12-0-2003.

CLASS 37—CONSTRUCTION AND REPAIR

FOR INSTALLATION, MAINTENANCE AND REPAIR OF ELECTRICITY GENERATING SYSTEMS FOR OTHERS (U.S. CLS. 100, 103 AND 106).
FIRST USE 4-18-2003; IN COMMERCE 12-0-2003.

CLASS 39—TRANSPORTATION AND STORAGE

FOR UTILITY SERVICES IN THE NATURE OF TRANSMITTING AND DISTRIBUTING ELECTRICITY TO OTHERS (U.S. CLS. 100 AND 105).
FIRST USE 4-18-2003; IN COMMERCE 3-0-2004.

CLASS 40—MATERIAL TREATMENT

FOR UTILITY SERVICES IN THE NATURE OF GENERATING ELECTRICITY TO OTHERS; GENERATING ELECTRICITY; LEASING ELECTRICITY GENERATING SYSTEMS (U.S. CLS. 100, 103 AND 106).
FIRST USE 4-18-2003; IN COMMERCE 3-0-2004.
DAVID COLLIER, EXAMINING ATTORNEY

SN 77-279,943. ARAGON SURGICAL, INC., PALO ALTO, CA.
FILED 9-14-2007.

OF COURSE

THE MARK CONSISTS OF STANDARD CHARACTERS WITHOUT CLAIM TO ANY PARTICULAR FONT, STYLE, SIZE, OR COLOR.

CLASS 10—MEDICAL APPARATUS

FOR MEDICAL DEVICE FOR USE IN FACILITATING PASSAGE OF THE VERESS NEEDLE OR TROCAR; MEDICAL DEVICE FOR USE IN FACILITATING THE CREATION OF A PNEUMOPERITONEUM; MEDICAL AND SURGICAL DEVICES TO ASSIST IN THE OPERATIVE SEALING AND DIVISION OF TISSUES (U.S. CLS. 26, 39 AND 44).

CLASS 44—MEDICAL, BEAUTY AND AGRICULTURAL SERVICES

FOR PROVIDING INFORMATION IN THE AREA OF MEDICAL DEVICES, MEDICAL PROCEDURES AND HEALTH CARE (U.S. CLS. 100 AND 101).
SAMUEL E. SHARPER JR., EXAMINING ATTORNEY

SN 77-280,482. FENTROP, NIKOLAS, MUNICH, FED REP GERMANY, FILED 9-15-2007.

adicare

THE MARK CONSISTS OF STANDARD CHARACTERS WITHOUT CLAIM TO ANY PARTICULAR FONT, STYLE, SIZE, OR COLOR.

CLASS 9—ELECTRICAL AND SCIENTIFIC APPARATUS

FOR SCALES; WEIGHING EQUIPMENT, NAMELY, SCALES AND BALANCES (U.S. CLS. 21, 23, 26, 36 AND 38).
FIRST USE 9-11-2007; IN COMMERCE 9-11-2007.

CLASS 10—MEDICAL APPARATUS

FOR ROLLATORS; INVALID WALKERS; TOILETS ADAPTED FOR MEDICAL PATIENTS OR FOR USE BY HANDICAPPED PERSONS; WALKING AIDS FOR HANDICAPPED PERSONS, NAMELY, WALKING FRAMES; CANES FOR MEDICAL PURPOSES; CRUTCHES; CRUTCHES AND TIPS THEREFOR; MEDICAL PATIENT TREATMENT CHAIRS; BED PANS; BEDPANS; DISSECTING TABLES; MASSAGE TABLES; OPERATING TABLES; PATIENT EXAMINATION AND/OR TREATMENT TABLES; PATIENT EXAMINATION TABLES; PATIENT TREATMENT TABLES; ABDOMINAL BELTS; AIR MATTRESSES FOR MEDICAL PURPOSES; BELTS FOR MEDICAL PURPOSES; MEDICAL BRACES FOR ANKLES, ELBOWS AND KNEES; MEDICAL COMPRESSION STOCKINGS AND TIGHTS; WALKING AIDS; MEDICAL PRODUCTS, NAMELY, THERAPEUTIC MATTRESS SUPPORT (U.S. CLS. 26, 39 AND 44).
FIRST USE 9-11-2007; IN COMMERCE 9-11-2007.

CLASS 11—ENVIRONMENTAL CONTROL APPARATUS

FOR LAVATORY SEATS; MULTIPLE POSITION BATH SEATS; PORTABLE BATH SEAT; TOILET SEATS; TOILET STOOL UNITS WITH A WASHING WATER SQUIRTER (U.S. CLS. 13, 21, 23, 31 AND 34).
FIRST USE 9-11-2007; IN COMMERCE 9-11-2007.

CLASS 12—VEHICLES

FOR TRACKED WHEELCHAIRS; WHEELCHAIR CUSHIONS; WHEELCHAIR PADS; WHEELCHAIRS; BICYCLE FRAMES; BICYCLE SADDLE COVERS; BICYCLE SADDLES; BICYCLES; FRAMES FOR BICYCLES; SADDLE COVERS FOR BICYCLES; SADDLES FOR BICYCLES (U.S. CLS. 19, 21, 23, 31, 35 AND 44).
FIRST USE 9-11-2007; IN COMMERCE 9-11-2007.

CLASS 20—FURNITURE AND ARTICLES NOT OTHERWISE CLASSIFIED

FOR OFFICE SEATS; SEAT CUSHIONS; SEATING FURNITURE; SEATS; SHOWER SEATS; HAND-HELD MIRRORS; BATHTUB GRAB BARS NOT MADE OF METAL; BATHTUB RAILS NOT MADE OF METAL; BED RAILS; SHOWER CURTAIN RODS; SHOWER GRAB BARS NOT OF METAL; SHOWER RODS; FOOTSTOOLS; FOOT STOOLS; STEP STOOLS; STOOLS; CHAIR CUSHIONS; CHAIR PADS; CHAIRS; EASY-CHAIRS; LOUNGE CHAIRS; OFFICE CHAIRS; RECLINING CHAIRS; BED FRAMES; FOLDING BEDS; HOSPITAL BEDS; RODS FOR BEDS; BEDS; SOFA BEDS; ARMCHAIRS; OFFICE ARMCHAIRS; RECLINING ARMCHAIRS; MATTRESS CUSHIONS; MATTRESSES (U.S. CLS. 2, 13, 22, 25, 32 AND 50).
FIRST USE 9-11-2007; IN COMMERCE 9-11-2007.
DAWN HAN, EXAMINING ATTORNEY

SN 77-280,706. FLOOD BROTHERS, INC., ATLANTA, GA.
FILED 9-17-2007.

Flood Brothers Our Business Is Moving Your Business

THE MARK CONSISTS OF STANDARD CHARACTERS WITHOUT CLAIM TO ANY PARTICULAR FONT, STYLE, SIZE, OR COLOR.

THE NAME(S), PORTRAIT(S), AND/OR SIGNATURE(S) SHOWN IN THE MARK IDENTIFIES FLOOD, WHOSE CONSENT(S) TO REGISTER IS MADE OF RECORD.

CLASS 35—ADVERTISING AND BUSINESS

FOR MOVING AND RELOCATION SERVICES, NAMELY PLANNING AND IMPLEMENTING MOVES OF HOMES AND OFFICES (U.S. CLS. 100, 101 AND 102).
FIRST USE 1-1-2001; IN COMMERCE 1-1-2001.

CLASS 37—CONSTRUCTION AND REPAIR

FOR INSTALLATION, MAINTENANCE AND REPAIR OF OFFICE FURNITURE (U.S. CLS. 100, 103 AND 106).
FIRST USE 1-1-2001; IN COMMERCE 1-1-2001.
RONALD AIKENS, EXAMINING ATTORNEY

SN 77-281,010. SUPER-NATURALBODIES, INC., CANTON, MA. FILED 9-17-2007.

SUPER-NATURALBODIES

THE MARK CONSISTS OF STANDARD CHARACTERS WITHOUT CLAIM TO ANY PARTICULAR FONT, STYLE, SIZE, OR COLOR.

CLASS 5—PHARMACEUTICALS

FOR VITAMIN AND MINERAL SUPPLEMENTS (U.S. CLS. 6, 18, 44, 46, 51 AND 52).

CLASS 9—ELECTRICAL AND SCIENTIFIC APPARATUS

FOR ELECTRONIC PUBLICATIONS, NAMELY, BOOKS, BOOKLETS, PAMPHLETS, AND GRAPHICAL CARDS FEATURING EXERCISE AND WORKOUT INSTRUCTION RECORDED ON COMPUTER MEDIA (U.S. CLS. 21, 23, 26, 36 AND 38).

CLASS 28—TOYS AND SPORTING GOODS

FOR EXERCISE EQUIPMENT, NAMELY, MANUALLY OPERATED JOGGING MACHINES; EXERCISE EQUIPMENT, NAMELY, ROWING MACHINES; EXERCISING EQUIPMENT, NAMELY, POWERED TREADMILLS FOR RUNNING; EXERCISING EQUIPMENT, NAMELY, WEIGHT LIFTING MACHINES; BAR-BELLS; DUMB-BELL SHAFTS; DUMB-BELLS; LEG WEIGHTS FOR EXERCISING; WEIGHT LIFTING BELTS; WEIGHT LIFTING BENCHES; WEIGHT LIFTING GLOVES; WRIST AND ANKLE WEIGHTS FOR EXERCISE (U.S. CLS. 22, 23, 38 AND 50).

JILL C. ALT, EXAMINING ATTORNEY

SN 77-281,929. AMERICAN THORACIC SOCIETY, NEW YORK, NY. FILED 9-18-2007.

ATS

THE MARK CONSISTS OF STANDARD CHARACTERS WITHOUT CLAIM TO ANY PARTICULAR FONT, STYLE, SIZE, OR COLOR.
OWNER OF U.S. REG. NO. 2,587,597.

CLASS 16—PAPER GOODS AND PRINTED MATTER

FOR JOURNALS AND NEWSLETTERS IN THE FIELD OF RESPIRATORY DISEASES (U.S. CLS. 2, 5, 22, 23, 29, 37, 38 AND 50).

FIRST USE 0-0-1960; IN COMMERCE 0-0-1960.

CLASS 35—ADVERTISING AND BUSINESS

FOR ASSOCIATION SERVICES, NAMELY, PROMOTING THE NEED TO HELP PREVENT AND FIGHT RESPIRATORY DISEASE AROUND THE WORLD THROUGH RESEARCH, EDUCATION, PATIENT CARE, AND ADVOCACY AND DECREASE MORBIDITY AND MORTALITY FROM RESPIRATORY DISORDERS AND LIFE-THREATENING ACUTE ILLNESSES (U.S. CLS. 100, 101 AND 102).

FIRST USE 0-0-1960; IN COMMERCE 0-0-1960.

CLASS 41—EDUCATION AND ENTERTAINMENT

FOR EDUCATIONAL SERVICES, NAMELY, CONDUCTING MEETINGS, CONFERENCES, AND SEMINARS IN THE FIELD OF RESPIRATORY DISEASES (U.S. CLS. 100, 101 AND 107).

FIRST USE 0-0-1960; IN COMMERCE 0-0-1960.

KELLY BOULTON, EXAMINING ATTORNEY

SN 77-282,033. SHARON S. GALLOWAY, DBA IN THE MIST OF ANGELS, NEW PALESTINE, IN. FILED 9-18-2007.

THINK OVARIAN CANCER FIRST
NOT LAST

THE MARK CONSISTS OF STANDARD CHARACTERS WITHOUT CLAIM TO ANY PARTICULAR FONT, STYLE, SIZE, OR COLOR.

CLASS 35—ADVERTISING AND BUSINESS

FOR PUBLIC ADVOCACY TO PROMOTE AWARENESS OF OVARIAN AND GYNECOLOGIC CANCER (U.S. CLS. 100, 101 AND 102).

FIRST USE 2-12-2006; IN COMMERCE 2-12-2006.

CLASS 41—EDUCATION AND ENTERTAINMENT

FOR EDUCATION SERVICES, NAMELY, CONDUCTING GRAND ROUNDS AT HOSPITALS IN THE FIELDS OF OVARIAN AND GYNECOLOGIC CANCER (U.S. CLS. 100, 101 AND 107).

FIRST USE 3-16-2007; IN COMMERCE 3-16-2007.

ROBIN MITTLER, EXAMINING ATTORNEY

SN 77-282,173. FIONDA PC, LLC, SANTA BARBARA, CA. FILED 9-18-2007.

OVATION CASH

THE MARK CONSISTS OF STANDARD CHARACTERS WITHOUT CLAIM TO ANY PARTICULAR FONT, STYLE, SIZE, OR COLOR.

NO CLAIM IS MADE TO THE EXCLUSIVE RIGHT TO USE "CASH", APART FROM THE MARK AS SHOWN.

CLASS 9—ELECTRICAL AND SCIENTIFIC APPARATUS

FOR ELECTRICAL AND SCIENTIFIC APPARATUS, NAMELY, MAGNETICALLY ENCODED DEBIT CARDS, MAGNETICALLY ENCODED STORED VALUE CARDS (U.S. CLS. 21, 23, 26, 36 AND 38).

CLASS 36—INSURANCE AND FINANCIAL

FOR FINANCIAL SERVICES, NAMELY, DEBIT CARD SERVICES, STORED VALUE CARD SERVICES, ISSUING DEBIT CARDS, ISSUING STORED VALUE CARDS (U.S. CLS. 100, 101 AND 102).

DAVID HOFFMAN, EXAMINING ATTORNEY

SN 77-282,464. BAMBINI CARINI INC., CEDARHURST, NY. FILED 9-18-2007.

BAMBINI PICCOLINI

THE MARK CONSISTS OF STANDARD CHARACTERS WITHOUT CLAIM TO ANY PARTICULAR FONT, STYLE, SIZE, OR COLOR.

NO CLAIM IS MADE TO THE EXCLUSIVE RIGHT TO USE "BAMBINI", APART FROM THE MARK AS SHOWN.

THE ENGLISH TRANSLATION OF "BAMBINI PICCOLINI" IS LITTLE CHILDREN.

CLASS 24—FABRICS

FOR BURP CLOTHS; CHILDREN'S BLANKETS; TOWELS (U.S. CLS. 42 AND 50).

CLASS 25—CLOTHING

FOR BABY BIBS NOT OF PAPER; BIB OVERALLS; BOOTIES; CAPS; CHILDREN'S HEADWEAR; CLOTH BIBS; HATS; HEADWEAR; INFANT AND TODDLER ONE PIECE CLOTHING; INFANTWEAR; LOUNGEWEAR; ROBES (U.S. CLS. 22 AND 39).

TOBY BULLOFF, EXAMINING ATTORNEY

SN 77-282,476. MISYS HEALTHCARE SYSTEMS, LLC, RALEIGH, NC. FILED 9-18-2007.



NO CLAIM IS MADE TO THE EXCLUSIVE RIGHT TO USE "CENTER FOR COMMUNITY HEALTH LEADERSHIP", APART FROM THE MARK AS SHOWN.

THE MARK CONSISTS OF THE WORDS "CENTER FOR COMMUNITY HEALTH LEADERSHIP" SURROUNDED BY TWO OVERLAPPING OVALS.

CLASS 16—PAPER GOODS AND PRINTED MATTER

FOR PRINTED PUBLICATIONS, NAMELY, NEWSLETTERS CONCERNING SOLUTIONS TO IMPROVE COMMUNICATIONS ABOUT HEALTH INFORMATION AMONG HEALTHCARE PROVIDERS (U.S. CLS. 2, 5, 22, 23, 29, 37, 38 AND 50).

CLASS 35—ADVERTISING AND BUSINESS

FOR ASSOCIATION SERVICES, NAMELY, PROMOTING PUBLIC AWARENESS OF THE NEED FOR FACILITATING THE DEVELOPMENT OF MEANS FOR COMMUNICATING HEALTH INFORMATION BETWEEN AND AMONG HEALTHCARE PROVIDERS (U.S. CLS. 100, 101 AND 102).

CLASS 41—EDUCATION AND ENTERTAINMENT

FOR EDUCATIONAL SERVICES, NAMELY, CONDUCTING SYMPOSIA IN THE FIELD OF SOLUTIONS TO IMPROVE COMMUNICATIONS ABOUT HEALTH INFORMATION AMONG HEALTHCARE PROVIDERS (U.S. CLS. 100, 101 AND 107).

JAY FLOWERS, EXAMINING ATTORNEY

SN 77-282,653. NEUROSOURCE INC., CHICAGO, IL. FILED 9-18-2007.

NEUROSOURCE

THE MARK CONSISTS OF STANDARD CHARACTERS WITHOUT CLAIM TO ANY PARTICULAR FONT, STYLE, SIZE, OR COLOR.

OWNER OF U.S. REG. NOS. 2,056,822 AND 2,211,265.

CLASS 35—ADVERTISING AND BUSINESS

FOR MEDICAL BUSINESS MANAGEMENT SERVICES FOR HOSPITALS AND PHYSICIAN PRACTICES IN THE FIELDS OF NEUROLOGICAL SURGERY AND ORTHOPEDIC SURGERY AND TREATMENT OF NEUROLOGICAL AND ORTHOPEDIC AILMENTS; BUSINESS DEVELOPMENT OF NEUROSCIENCE CENTERS FOR HOSPITALS, NAMELY, PROVIDING START-UP SUPPORT FOR THE BUSINESSES OF OTHERS; DEVELOPMENT OF NEUROSCIENCE CENTERS FOR HOSPITALS, NAMELY, DEVELOPMENT OF HOSPITAL MANAGEMENT SYSTEMS; MEDICAL BILLING SUPPORT SERVICES, BUSINESS CONSULTATION SERVICES (U.S. CLS. 100, 101 AND 102).

FIRST USE 8-1-1997; IN COMMERCE 8-1-1997.

CLASS 36—INSURANCE AND FINANCIAL

FOR FINANCIAL SERVICES CONSULTATION IN THE FIELD OF EVALUATION OF FINANCIAL PERFORMANCE AND ACCOUNTS RECEIVABLE COLLECTION FOR ORTHOPEDIC AND NEUROSURGICAL DEPARTMENTS; EQUIPMENT FINANCING SERVICES FOR HOSPITALS AND PHYSICIAN PRACTICES (U.S. CLS. 100, 101 AND 102).

FIRST USE 8-1-1997; IN COMMERCE 8-1-1997.

CLASS 42—SCIENTIFIC AND COMPUTER SERVICES

FOR TECHNOLOGY CONSULTATION IN THE FIELD OF MEDICAL EQUIPMENT, NAMELY, ANALYSIS AND PROJECTION OF FUTURE EQUIPMENT NEEDS FOR HOSPITALS AND PHYSICIAN PRACTICES (U.S. CLS. 100 AND 101).

FIRST USE 8-1-1997; IN COMMERCE 8-1-1997.

TOBY BULLOFF, EXAMINING ATTORNEY

SN 77-283,477. AXA ENTERPRISES CORP, VERNON, CA.
FILED 9-19-2007.



THE COLOR(S) RED, BLUE, AND GRAY IS/ARE CLAIMED AS A FEATURE OF THE MARK.

THE MARK CONSISTS OF THE WORD "BRITE" WRITTEN IN BLUE LETTERS WITH A RED SHADOW. THE FONT OF THE LETTERS REPLICATES HANDWRITING OR WRITING WITH A PAINT BRUSH. THE DIACRITIC DOT OVER THE LETTER "I" COMPRISES A RED STAR. THE BACKGROUND OF THE LETTERING COMPRISES A GRAY STRIPE IN THE MANNER OF A PAINT BRUSH BEING BRUSHED ACROSS THE PAGE.

CLASS 8—HAND TOOLS

FOR CHISELS; FILES; HAMMERS; HAND HELD CUTTING TOOLS; HAND SAWS, NAMELY, WOOD SAWS; HAND TOOLS, NAMELY, FILES; HAND TOOLS, NAMELY, HAMMERS; HAND TOOLS, NAMELY, RATCHET WRENCHES; HAND TOOLS, NAMELY, SAWS; HAND TOOLS, NAMELY, SCRAPERS; HAND TOOLS, NAMELY, SCREWDRIVERS; HAND TOOLS, NAMELY, SOCKET SETS; HAND TOOLS, NAMELY, WRENCHES; HAND TOOLS, NAMELY, HEX KEYS WRENCHES; HAND TOOLS, NAMELY, NAIL SETS; HAND TOOLS, NAMELY, NUT DRIVERS; HAND TOOLS, NAMELY, SANDERS; HAND TOOLS, NAMELY, WIRE CUTTERS; HAND TOOLS, NAMELY, WIRE NIPPERS; HAND TOOLS, NAMELY, WIRE STRIPPERS; HAND-OPERATED SHEARS; HAND-OPERATED TOOLS, NAMELY, CHISELS; TOOL HOLDERS (U.S. CLS. 23, 28 AND 44).

CLASS 16—PAPER GOODS AND PRINTED MATTER

FOR BLANK PAPER NOTEBOOKS; NOTEBOOK PAPER; NOTEBOOKS; PAPER NOTEBOOKS; SCHOOL SUPPLY KITS CONTAINING VARIOUS COMBINATIONS OF SELECTED SCHOOL SUPPLIES, NAMELY, WRITING INSTRUMENTS, PENS, PENCILS, MECHANICAL PENCILS, ERASERS, MARKERS, CRAYONS, HIGHLIGHTERS, FOLDERS, NOTEBOOKS, PAPER, GRADUATED RULERS, PROTRACTORS, PAPER CLIPS, PENCIL SHARPENERS, WRITING GRIPS, GLUE AND BOOK MARKS; WIRE-BOUND NOTEBOOKS; ADHESIVE NOTE PAPER; ART PAPER; BOXES OF PAPER; CONSTRUCTION PAPER; COPY PAPER; DRAWING PAPER; FACSIMILE TRANSMISSION PAPER; FILLER PAPER; GIFT WRAP PAPER; LOOSE LEAF PAPER; PAPER CLIPS; PAPER STAPLERS; PAPER STAPLES; PAPER STATIONERY; RULED PAPER; WRAPPING PAPER (U.S. CLS. 2, 5, 22, 23, 29, 37, 38 AND 50).

CLASS 21—HOUSEWARES AND GLASS

FOR DISPOSABLE GLOVES FOR HOME USE; ABRASIVE PADS FOR KITCHEN OR DOMESTIC PURPOSES; CHOPPING BOARDS FOR KITCHEN USE; CONTAINERS FOR HOUSEHOLD OR KITCHEN USE NOT OF PRECIOUS METAL; KITCHEN LADLES; PORTABLE PLASTIC CONTAINERS FOR STORING HOUSEHOLD AND KITCHEN GOODS; WOOD CHOPPING BOARDS FOR KITCHEN USE; COOKING UTENSILS, NAMELY, WIRE BASKETS; HOUSEHOLD UTENSILS, NAMELY, POT AND PAN SCRAPERS, ROLLING PINS, SPATULAS, TURNERS, AND WHISKS; SERVING TONGS; DINNERWARE, NAMELY, PLATES, CUPS, AND SAUCERS; PAPER PLATES; BATH SPONGES; CLEANING SPONGES; SCOURING SPONGES; SCRUB SPONGES; TOILET SPONGES; STEEL WOOL FOR CLEANING; BROOMS; MOPS (U.S. CLS. 2, 13, 23, 29, 30, 33, 40 AND 50).

CLASS 24—FABRICS

FOR BATH TOWELS; BEACH TOWELS; HAND TOWELS; LARGE BATH TOWELS; TOWEL SETS; TOWELS (U.S. CLS. 42 AND 50).

CLASS 25—CLOTHING

FOR HATS; SOCKS; BANDANAS (U.S. CLS. 22 AND 39).

CLASS 28—TOYS AND SPORTING GOODS

FOR SPORT BALLS; BASKET BALLS; BEACH BALLS; FOOT BALLS; GOLF BALLS; HAND BALLS; RACKET BALLS; RUBBER BALLS; SOCCER BALLS; TABLE TENNIS BALLS; TABLE-TENNIS BALLS; TENNIS BALLS; VOLLEY BALLS (U.S. CLS. 22, 23, 38 AND 50).

KELLY MCCOY, EXAMINING ATTORNEY

SN 77-283,501. MYKO INC., INGLEWOOD, CA. FILED 9-19-2007.

Lettuce Know!

THE MARK CONSISTS OF STANDARD CHARACTERS WITHOUT CLAIM TO ANY PARTICULAR FONT, STYLE, SIZE, OR COLOR.

CLASS 35—ADVERTISING AND BUSINESS

FOR RESTAURANT FRANCHISING (U.S. CLS. 100, 101 AND 102).

CLASS 43—HOTEL AND RESTAURANT SERVICES

FOR CARRY-OUT RESTAURANTS (U.S. CLS. 100 AND 101).

YAT SYE, LEE, EXAMINING ATTORNEY

SN 77-283,677. TOMTOM INTERNATIONAL B.V., AMSTERDAM, NETHERLANDS, FILED 9-19-2007.

GO CONFIDENTIALLY

THE MARK CONSISTS OF STANDARD CHARACTERS WITHOUT CLAIM TO ANY PARTICULAR FONT, STYLE, SIZE, OR COLOR.

CLASS 9—ELECTRICAL AND SCIENTIFIC APPARATUS

FOR COMPUTER HARDWARE AND SOFTWARE TO BE USED WITH SATELLITE AND/OR GPS NAVIGATION SYSTEMS FOR NAVIGATION PURPOSES; COMPUTER SOFTWARE TO BE USED WITH ROUTE PLANNERS, ELECTRONIC MAPS, AND DIGITAL DICTIONARIES FOR NAVIGATION AND TRANSLATION PURPOSES; SOFTWARE FOR TRAVEL INFORMATION SYSTEMS FOR THE PROVISION OR RENDERING OF TRAVEL ADVICE AND/OR INFORMATION CONCERNING SERVICE STATIONS, CAR PARKS, RESTAURANTS, CAR DEALERS AND OTHER TRAVEL AND TRANSPORT RELATED INFORMATION; SOFTWARE FOR INFORMATION MANAGEMENT FOR THE TRANSPORT AND TRAFFIC INDUSTRIES; SOFTWARE TO BE USED FOR VIEWING ELECTRONIC MAPS; DOWNLOADABLE ELECTRONIC MAPS; SOFTWARE FOR OPERATING ROUTE PLANNERS; ROUTE PLANNERS IN THE NATURE OF HANDHELD PERSONAL COMPUTERS; SOFTWARE FOR OPERATING ELECTRONIC DIGITAL DICTIONARIES; ELECTRONIC DICTIONARIES; LOCATION, ORIENTATION AND NAVIGATION, AND GLOBAL POSITIONING SYSTEMS (GPS) CONSISTING OF COMPUTERS, COMPUTER SOFTWARE, TRANSMITTERS, GPS AND/OR SATELLITE RECEIVERS, NETWORK INTERFACE DEVICES, CONNECTION CABLES, AND PARTS AND FITTINGS THEREOF; HOLDERS FOR POCKET PERSONAL COMPUTERS; SATELLITE AND RADIO TRANSMISSION APPARATUS TECHNOLOGY, NAMELY, PROCESSORS, MOBILE TELEPHONES AND RECEIVERS; TELECOMMUNICATIONS INSTALLATIONS, NETWORKS AND APPARATUS, NAMELY, MOUNTING RACKS FOR TELECOMMUNICATIONS HARDWARE, TELECOMMUNICATION SWITCHES; COMPUTER TERMINALS, ALL IN PARTICULAR TO BE USED WITH NAVIGATION SYSTEMS, ROUTE PLANNERS AND/OR DIGITAL MAPS; BLANK MAGNETIC AND DISC SHAPED DATA CARRIERS; AUDIO AND VIDEO APPARATUS, NAMELY, AUDIO AND VIDEO RECEIVERS AND PROCESSORS; HANDHELD PERSONAL COMPUTERS; PERSONAL DIGITAL ASSISTANTS (U.S. CLS. 21, 23, 26, 36 AND 38).

CLASS 39—TRANSPORTATION AND STORAGE

FOR SECURED TELECOMMUNICATIONS SERVICES, NAMELY, ELECTRONIC STORAGE OF DIGITAL DATA, LIGHT FILES, SOUND FILES, DATA, INFORMATION AND IMAGE SIGNALS ALL IN PARTICULAR FOR NAVIGATION SYSTEMS, ROUTE PLANNERS AND THE USE OF ELECTRONIC MAPS (U.S. CLS. 100 AND 105).

YAT SYE, LEE, EXAMINING ATTORNEY

SN 77-283,950. PRUDDEN, SUZY, BEVERLY HILLS, CA. FILED 9-19-2007.

CLASS 9—ELECTRICAL AND SCIENTIFIC APPARATUS

FOR DIGITAL MATERIALS, NAMELY, CDS, DVDS, DOWNLOADABLE AUDIO FILES FEATURING EDUCATIONAL INFORMATION IN THE FIELD OF HEALTH, PHYSICAL FITNESS, NUTRITION, SELF-CONTROL AND SELF-AWARENESS; DIGITAL MEDIA, NAMELY, CDS, DVDS AND DOWNLOADABLE AUDIO FILES FEATURING EDUCATIONAL INFORMATION IN THE FIELD OF HEALTH, PHYSICAL FITNESS, NUTRITION, SELF-CONTROL AND SELF-AWARENESS; PRE-RECORDED CDS, VIDEO TAPES, LASER DISKS AND DVDS FEATURING EDUCATIONAL INFORMATION IN THE FIELD OF HEALTH, PHYSICAL FITNESS, NUTRITION, SELF-CONTROL AND SELF-AWARENESS; DOWNLOADABLE VIDEO RECORDINGS FEATURING EDUCATIONAL INFORMATION IN THE FIELD OF HEALTH, PHYSICAL FITNESS, NUTRITION, SELF-CONTROL AND SELF-AWARENESS; EDUCATIONAL SOFTWARE FEATURING INSTRUCTION IN THE FIELD OF HEALTH, PHYSICAL FITNESS, NUTRITION, SELF-CONTROL AND SELF-AWARENESS (U.S. CLS. 21, 23, 26, 36 AND 38).

CLASS 41—EDUCATION AND ENTERTAINMENT

FOR HEALTH CLUB SERVICES, NAMELY, PROVIDING INSTRUCTION AND EQUIPMENT IN THE FIELD OF PHYSICAL EXERCISE; ARRANGING AND CONDUCTING EDUCATIONAL CONFERENCES; CONDUCTING EDUCATIONAL EXHIBITIONS IN THE NATURE OF COURSES, WORKSHOPS, AND SEMINARS FEATURING EDUCATIONAL INFORMATION IN THE FIELD OF HEALTH, PHYSICAL FITNESS, NUTRITION, SELF-CONTROL AND SELF-AWARENESS; EDUCATION SERVICES, NAMELY, PROVIDING LIVE AND ON-LINE COURSES, WORKSHOPS, AND SEMINARS FEATURING EDUCATIONAL INFORMATION IN THE FIELD OF HEALTH, PHYSICAL FITNESS, NUTRITION, SELF-CONTROL AND SELF-AWARENESS; EDUCATIONAL AND ENTERTAINMENT SERVICES, NAMELY, PROVIDING MOTIVATIONAL AND EDUCATIONAL SPEAKERS; EDUCATIONAL AND ENTERTAINMENT SERVICES, NAMELY, A CONTINUING PROGRAM ABOUT HEALTH, NUTRITION AND SELF-IMPROVEMENT ACCESSIBLE BY RADIO, TELEVISION, SATELLITE, AUDIO, VIDEO AND COMPUTER NETWORKS; EDUCATIONAL SERVICES, NAMELY, CONDUCTING LECTURES, COURSES, WORKSHOPS, AND SEMINARS FEATURING EDUCATIONAL INFORMATION IN THE FIELD OF HEALTH, PHYSICAL FITNESS, NUTRITION, SELF-CONTROL AND SELF-AWARENESS; EDUCATIONAL SERVICES, NAMELY, CONDUCTING INFORMAL ON-LINE PROGRAMS IN THE FIELDS OF HEALTH, PHYSICAL FITNESS, NUTRITION, SELF-CONTROL AND SELF-AWARENESS, AND PRINTABLE MATERIALS DISTRIBUTED THEREWITH (U.S. CLS. 100, 101 AND 107).

PAUL MORENO, EXAMINING ATTORNEY

SN 77-284,467. VICTORIA'S SECRET BRAND MANAGEMENT, INC., REYNOLDSBURG, OH. FILED 9-20-2007.

AFFIRMATIONS

THE MARK CONSISTS OF STANDARD CHARACTERS WITHOUT CLAIM TO ANY PARTICULAR FONT, STYLE, SIZE, OR COLOR.

SUN-THRU

THE MARK CONSISTS OF STANDARD CHARACTERS WITHOUT CLAIM TO ANY PARTICULAR FONT, STYLE, SIZE, OR COLOR.

CLASS 25—CLOTHING

FOR BATHING SUITS (U.S. CLS. 22 AND 39).

SN 77-284,820. GIORGIO FOODS, INC., TEMPLE, PA. FILED 9-20-2007.

CLASS 35—ADVERTISING AND BUSINESS

FOR RETAIL STORE, MAIL ORDER CATALOG AND ON-LINE ORDERING SERVICES FOR LINGERIE CLEANING PREPARATIONS, PERSONAL SKIN, BODY AND HAIR CARE PREPARATIONS, PERFUMES, CANDLES, COSMETICS, PERFUME APPLICATORS, WOMEN'S LINGERIE, UNDERGARMENTS, AND CLOTHING (U.S. CLS. 100, 101 AND 102).

LAURIE MAYES, EXAMINING ATTORNEY

WAISTLINE FRIENDLY

THE MARK CONSISTS OF STANDARD CHARACTERS WITHOUT CLAIM TO ANY PARTICULAR FONT, STYLE, SIZE, OR COLOR.

CLASS 29—MEATS AND PROCESSED FOODS

FOR FROZEN CHEESE STICKS; CANNED AND JARRED MUSHROOMS (U.S. CL. 46).

CLASS 30—STAPLE FOODS

FOR FROZEN FOOD, NAMELY, EMPANADAS, QUESADILLAS, PIZZA, STROMBOLI, CALZONES, AND PIEROGIES (U.S. CL. 46).

CLASS 31—NATURAL AGRICULTURAL PRODUCTS

FOR FRESH MUSHROOMS (U.S. CLS. 1 AND 46).
ANTHONY RINKER, EXAMINING ATTORNEY

SN 77-284,797. PEARL FIELD SERVICES, LLC, LAKEWOOD, CO. FILED 9-20-2007.

PEARL FIELD SERVICES COMPANY
LAND, PERMITTING, ENGINEERING, CONSTRUCTION, DRILLING & OPERATIONS

SN 77-284,829. GENENTECH, INC., SOUTH SAN FRANCISCO, CA. FILED 9-20-2007.

NO CLAIM IS MADE TO THE EXCLUSIVE RIGHT TO USE "FIELD SERVICES COMPANY" AND "LAND, PERMITTING, ENGINEERING, CONSTRUCTION, DRILLING & OPERATIONS", APART FROM THE MARK AS SHOWN.

THE MARK CONSISTS OF THE WORDS "PEARL FIELD SERVICES COMPANY" ABOVE A LINE AND THE WORDS "LAND, PERMITTING, ENGINEERING, CONSTRUCTION, DRILLING & OPERATIONS" BELOW THE LINE.



The logo for Access Solutions features the word "Access" in a bold, sans-serif font, followed by a stylized arrow pointing to the right, and then the word "Solutions" in a similar font.

CLASS 35—ADVERTISING AND BUSINESS

FOR PROJECT MANAGEMENT SERVICES FOR OTHERS IN THE FIELD OF NATURAL RESOURCE EXPLORATION AND PRODUCTION, NAMELY, LOGISTICS MANAGEMENT IN THE FIELD OF OIL AND GAS EXPLORATION PROJECTS (U.S. CLS. 100, 101 AND 102).

NO CLAIM IS MADE TO THE EXCLUSIVE RIGHT TO USE "ACCESS" AND "SOLUTIONS", APART FROM THE MARK AS SHOWN.

CLASS 37—CONSTRUCTION AND REPAIR

FOR LAND RECLAMATION; CONSTRUCTION OF PIPELINES, ROADS AND ELECTRICAL POWER LINES FOR NATURAL RESOURCE PRODUCTION FACILITIES; OIL AND GAS DRILLING; WELL DRILLING (U.S. CLS. 100, 103 AND 106).

CLASS 16—PAPER GOODS AND PRINTED MATTER

FOR PRINTED MATERIALS, NAMELY, BOOKS, PAMPHLETS, MAGAZINES, TECHNICAL REPORTS, TUTORIAL BOOKS, MANUALS, REPORTS ON CONFERENCE SEMINARS AND DISCUSSIONS, TRANSCRIPTS OF CONFERENCE SEMINARS AND DISCUSSIONS, SUMMARY REPORTS ON CONFERENCE SEMINARS AND DISCUSSIONS, NEWSLETTERS, REFERENCE GUIDES, BULLETINS, BROCHURES, TRAINING MATERIALS, INSTRUCTION SHEETS, GUIDES, LEAFLETS, AND MANUALS, ALL OF THE FOREGOING ON THE SUBJECTS OF BILLING, HEALTH CARE INSURANCE, HEALTH CARE REIMBURSEMENTS, AND INFORMATION ABOUT PRESCRIPTION DRUGS (U.S. CLS. 2, 5, 22, 23, 29, 37, 38 AND 50).

CLASS 40—MATERIAL TREATMENT

FOR GAS PRODUCTION SERVICES; OIL PRODUCTION SERVICES (U.S. CLS. 100, 103 AND 106).

CLASS 42—SCIENTIFIC AND COMPUTER SERVICES

FOR ENGINEERING SERVICES, NAMELY, ENGINEERING FOR THE NATURAL RESOURCES INDUSTRY; GEOLOGICAL ESTIMATIONS AND RESEARCH; GEOLOGICAL PROSPECTING; GEOLOGICAL SURVEYING (U.S. CLS. 100 AND 101).

LINDA POWELL, EXAMINING ATTORNEY

CLASS 35—ADVERTISING AND BUSINESS

FOR BILLING SERVICES; PROVIDING ON-LINE INFORMATION IN THE NATURE OF BILLING SERVICES INFORMATION (U.S. CLS. 100, 101 AND 102).

CLASS 36—INSURANCE AND FINANCIAL

FOR PRESCRIPTION DRUG CLAIMS ADMINISTRATION SERVICES, NAMELY, FACILITATING AUTHORIZATION OF HEALTH CARE INSURANCE COVERAGE, CLAIM SUBMISSION AND PAYOR REIMBURSEMENT FOR PRESCRIPTION DRUGS, ADMINISTRATION OF PATIENT REIMBURSEMENT PROGRAMS; PROVIDING ON-LINE INFORMATION IN THE NATURE OF ADMINISTRATION OF PATIENT REIMBURSEMENT PROGRAM INFORMATION FOR HEALTH INSURANCE PROGRAMS (U.S. CLS. 100, 101 AND 102).

ANNE FARRELL, EXAMINING ATTORNEY

SN 77-285,563. YOUNIQUE INVESTING LLC, LITHIA, FL. FILED 9-21-2007.

YOUNIQUE INVESTING & ADVISOR BRAINTRUST

THE MARK CONSISTS OF STANDARD CHARACTERS WITHOUT CLAIM TO ANY PARTICULAR FONT, STYLE, SIZE, OR COLOR.

NO CLAIM IS MADE TO THE EXCLUSIVE RIGHT TO USE "INVESTING & ADVISOR", APART FROM THE MARK AS SHOWN.

SN 77-284,836. GENENTECH, INC., SOUTH SAN FRANCISCO, CA. FILED 9-20-2007.

CLASS 35—ADVERTISING AND BUSINESS

FOR BUSINESS ADMINISTRATION AND MANAGEMENT WITH RESPECT TO SELF-DIRECTED RETIREMENT PLANS (U.S. CLS. 100, 101 AND 102).

CLASS 36—INSURANCE AND FINANCIAL

FOR ADVICE RELATING TO INVESTMENTS IN REAL ESTATE, STOCKS, BONDS, NOTES, DEBT INSTRUMENTS, PUBLIC COMPANIES AND PRIVATE COMPANIES; INVESTMENT CONSULTATION AND MANAGEMENT; FINANCIAL INVESTMENTS FOR OTHERS IN THE FIELD OF REAL ESTATE; FINANCIAL PLANNING FOR RETIREMENT (U.S. CLS. 100, 101 AND 102).

STEVEN R. FINE, EXAMINING ATTORNEY



NO CLAIM IS MADE TO THE EXCLUSIVE RIGHT TO USE "ACCESS" AND "SOLUTIONS", APART FROM THE MARK AS SHOWN.

CLASS 16—PAPER GOODS AND PRINTED MATTER

FOR PRINTED MATERIALS, NAMELY, BOOKS, PAMPHLETS, MAGAZINES, TECHNICAL REPORTS, TUTORIAL BOOKS, MANUALS, REPORTS ON CONFERENCE SEMINARS AND DISCUSSIONS, TRANSCRIPTS OF CONFERENCE SEMINARS AND DISCUSSIONS, SUMMARY REPORTS ON CONFERENCE SEMINARS AND DISCUSSIONS, NEWSLETTERS, REFERENCE GUIDES, BULLETINS, BROCHURES, TRAINING MATERIALS, INSTRUCTION SHEETS, GUIDES, LEAFLETS, AND MANUALS, ALL OF THE FOREGOING ON THE SUBJECTS OF BILLING, HEALTH CARE INSURANCE, HEALTH CARE REIMBURSEMENTS, AND INFORMATION ABOUT PRESCRIPTION DRUGS (U.S. CLS. 2, 5, 22, 23, 29, 37, 38 AND 50).

CLASS 35—ADVERTISING AND BUSINESS

FOR BILLING SERVICES; PROVIDING ON-LINE INFORMATION IN THE NATURE OF BILLING SERVICES INFORMATION (U.S. CLS. 100, 101 AND 102).

CLASS 36—INSURANCE AND FINANCIAL

FOR PRESCRIPTION DRUG CLAIMS ADMINISTRATION SERVICES, NAMELY, FACILITATING AUTHORIZATION OF HEALTH CARE INSURANCE COVERAGE, CLAIM SUBMISSION AND PAYOR REIMBURSEMENT FOR PRESCRIPTION DRUGS, ADMINISTRATION OF PATIENT REIMBURSEMENT PROGRAMS; PROVIDING ON-LINE INFORMATION IN THE NATURE OF ADMINISTRATION OF PATIENT REIMBURSEMENT PROGRAM INFORMATION FOR HEALTH INSURANCE PROGRAMS (U.S. CLS. 100, 101 AND 102).

ANNE FARRELL, EXAMINING ATTORNEY

SN 77-285,619. RICON, INC., DBA CITRUS SPRINGS, CHESTERFIELD, MO. FILED 9-21-2007.

Madrina's Horchata

THE MARK CONSISTS OF STANDARD CHARACTERS WITHOUT CLAIM TO ANY PARTICULAR FONT, STYLE, SIZE, OR COLOR.

NO CLAIM IS MADE TO THE EXCLUSIVE RIGHT TO USE "HORCHATA", APART FROM THE MARK AS SHOWN.

CLASS 29—MEATS AND PROCESSED FOODS

FOR DAIRY BASED BEVERAGES, NAMELY, HORCHATA (U.S. CL. 46).
FIRST USE 9-14-2007; IN COMMERCE 9-17-2007.

CLASS 32—LIGHT BEVERAGES

FOR SYRUPS FOR MAKING WHEY BASED BEVERAGES, NAMELY, HORCHATA AND CONCENTRATES OF HORCHATA (U.S. CLS. 45, 46 AND 48).
FIRST USE 9-14-2007; IN COMMERCE 9-17-2007.
PAUL E. FAHRENKOPF, EXAMINING ATTORNEY

SN 77-285,747. MEIJER, INC., GRAND RAPIDS, MI. FILED 9-21-2007.



NO CLAIM IS MADE TO THE EXCLUSIVE RIGHT TO USE "ORGANICS", APART FROM THE MARK AS SHOWN. THE MARK CONSISTS OF THE LETTERS "A" AND "H" EACH ENCOMPASSED IN A CIRCLE, WHERE THE CIRCLES OVERLAP ONE ANOTHER, WITH THE WORD "ORGANICS" BELOW.

CLASS 20—FURNITURE AND ARTICLES NOT OTHERWISE CLASSIFIED

FOR PILLOWS (U.S. CLS. 2, 13, 22, 25, 32 AND 50).

CLASS 24—FABRICS

FOR BED SHEETS; PILLOWCASES; BATH TOWELS; WASHCLOTHS; HAND TOWELS (U.S. CLS. 42 AND 50).
ROBIN CHOSID, EXAMINING ATTORNEY

SN 77-285,870. SOCCIO, JACK J, HENDERSON, NV. FILED 9-21-2007.



NO CLAIM IS MADE TO THE EXCLUSIVE RIGHT TO USE "PRO GALA", APART FROM THE MARK AS SHOWN. THE COLOR(S) BLACK, GOLD/BROZE AND WHITE IS/ARE CLAIMED AS A FEATURE OF THE MARK.

THE MARK CONSISTS OF BLACK BACKGROUND, A STYLIZED FONT CALLED NEW BEROLINA FOR THE LETTERS "PRO GALA" THAT ARE OUTLINED IN WHITE AND ARE A GOLDEN/BRONZE COLOR THAT IS ON A GRADIENT GOING FROM LIGHTER TO DARKER WITHIN EACH LETTER. CAPITALIZED "P" LOWER CASE "RO" SPACE CAPITALIZED "G" LOWER CASE "ALA" WITH THE WORD "PRO" BEING IN THE UPPER LEFT QUADRANT AND SMALLER THAN THE WORD "GALA" AND THE LETTER "G" BEING CENTER AND LARGER FOLLOWED BY A SMALLER "ALA".

CLASS 35—ADVERTISING AND BUSINESS

FOR ARRANGING AND CONDUCTING MARKETING PROMOTIONAL EVENTS FOR OTHERS; PROMOTING SPORTS COMPETITIONS AND/OR EVENTS OF OTHERS; PROMOTING THE PARTIES AND SPECIAL EVENTS OF OTHERS (U.S. CLS. 100, 101 AND 102).

CLASS 41—EDUCATION AND ENTERTAINMENT

FOR SPECIAL EVENT PLANNING; SPECIAL EVENT PLANNING CONSULTATION (U.S. CLS. 100, 101 AND 107).
CAROLYN CATALDO, EXAMINING ATTORNEY

SN 77-286,293. COGENT, INC., SO. PASADENA, CA. FILED 9-21-2007.



OWNER OF U.S. REG. NOS. 3,227,211 AND 3,227,213.

THE MARK CONSISTS OF TWO INVERTED CRESCENTS WITH THE ENDS FACING EACH OTHER. THE CRESCENTS ARE SOLID EXCEPT FOR A SMALL PORTION IN THE MIDDLE. THE RIGHT CRESCENT BEING LOWER THAN THE LEFT.

CLASS 9—ELECTRICAL AND SCIENTIFIC APPARATUS

FOR COMPUTER SOFTWARE AND HARDWARE FOR BIOMETRIC IDENTIFICATION AND VERIFICATION; AND SCIENTIFIC INSTRUMENT, NAMELY, BIOLOGICAL APPARATUS FOR BIOMETRIC IDENTIFICATION AND VERIFICATION (U.S. CLS. 21, 23, 26, 36 AND 38).

CLASS 10—MEDICAL APPARATUS

FOR ANALYTICAL APPARATUS FOR MEDICAL PURPOSE, NAMELY, BIOLOGICAL APPARATUS FOR BIOMETRIC IDENTIFICATION AND VERIFICATION (U.S. CLS. 26, 39 AND 44).

CLASS 42—SCIENTIFIC AND COMPUTER SERVICES

FOR COMPUTER SOFTWARE AND HARDWARE DEVELOPMENT FOR BIOMETRIC IDENTIFICATION AND VERIFICATION (U.S. CLS. 100 AND 101).

KELLY BOULTON, EXAMINING ATTORNEY

SN 77-286,482. CONSCIOUS CREATIVE, INC., BERKELEY, CA. FILED 9-22-2007.



NO CLAIM IS MADE TO THE EXCLUSIVE RIGHT TO USE "CREATIVE", APART FROM THE MARK AS SHOWN. THE COLOR(S) PURPLE AND ORANGE IS/ARE CLAIMED AS A FEATURE OF THE MARK.

THE COLOR PURPLE APPEARS IN THE TERM "CONSCIOUS" AND THE SLOGAN "CREATIVE SERVICES, SUSTAINABLE SOLUTIONS", AND THE COLOR ORANGE APPEARS IN THE TERM "CREATIVE".

CLASS 35—ADVERTISING AND BUSINESS

FOR CREATIVE MARKETING DESIGN SERVICES; ADVERTISING AND PUBLICITY SERVICES, NAMELY, PROMOTING THE GOODS, SERVICES, BRAND IDENTITY AND COMMERCIAL INFORMATION AND NEWS OF THIRD PARTIES THROUGH PRINT, AUDIO, VIDEO, DIGITAL AND ON-LINE MEDIUM (U.S. CLS. 100, 101 AND 102).

FIRST USE 7-1-2004; IN COMMERCE 7-1-2004.

CLASS 41—EDUCATION AND ENTERTAINMENT

FOR PHOTOGRAPHY SERVICES (U.S. CLS. 100, 101 AND 107).
FIRST USE 7-1-2004; IN COMMERCE 7-1-2004.

CLASS 42—SCIENTIFIC AND COMPUTER SERVICES

FOR DESIGN OF HOMEPAGES AND WEBSITES; DESIGN, CREATION, HOSTING AND MAINTENANCE OF INTERNET SITES FOR THIRD PARTIES; GRAPHIC DESIGN SERVICES (U.S. CLS. 100 AND 101).
FIRST USE 7-1-2004; IN COMMERCE 7-1-2004.
LINDA M. KING, EXAMINING ATTORNEY

SN 77-286,703. COMMUNITY CONNECT INC., NEW YORK, NY. FILED 9-24-2007.

@asianave.com

CLASS 38—COMMUNICATION

FOR ELECTRONIC MAIL SERVICES; PROVIDING ON-LINE CHAT ROOMS FOR TRANSMISSION OF MESSAGES AMONG COMPUTER USERS CONCERNING TOPICS OF GENERAL INTEREST TO INDIVIDUALS OF COMMON CULTURAL HERITAGE (U.S. CLS. 100, 101 AND 104).

CLASS 41—EDUCATION AND ENTERTAINMENT

FOR ENTERTAINMENT SERVICES, NAMELY, PROVIDING WEB SITES FEATURING MUSICAL PERFORMANCES, FILM CLIPS, PHOTOGRAPHS, AND OTHER MULTIMEDIA MATERIALS; PROVIDING NEWS AND INFORMATION IN THE FIELDS OF ENTERTAINMENT AND CURRENT EVENTS OF INTEREST TO INDIVIDUALS OF COMMON CULTURAL HERITAGE VIA THE INTERNET (U.S. CLS. 100, 101 AND 107).
HEATHER SAPP, EXAMINING ATTORNEY

SN 77-286,826. MINNESOTA VIKINGS FOOTBALL, LLC, EDEN PRAIRIE, MN. FILED 9-24-2007.

WEAREVIKINGSFANS.COM

THE MARK CONSISTS OF STANDARD CHARACTERS WITHOUT CLAIM TO ANY PARTICULAR FONT, STYLE, SIZE, OR COLOR.

CLASS 41—EDUCATION AND ENTERTAINMENT

FOR INFORMATION SERVICES IN THE FIELD OF SPORTS; ENTERTAINMENT SERVICES, NAMELY PROVIDING A WEB SITE FEATURING COMMENTARY, VIDEOS, CLIPS, PHOTOGRAPHS AND OTHER MULTIMEDIA MATERIALS RELATED TO SPORTS (U.S. CLS. 100, 101 AND 107).
FIRST USE 9-25-2007; IN COMMERCE 9-25-2007.

CLASS 45—PERSONAL AND LEGAL SERVICES

FOR ONLINE SOCIAL NETWORKING SERVICES (U.S. CLS. 100 AND 101).
FIRST USE 9-25-2007; IN COMMERCE 9-25-2007.
RUSS HERMAN, EXAMINING ATTORNEY

SN 77-286,987. BEST VENDORS MANAGEMENT, INC., MINNEAPOLIS, MN. FILED 9-24-2007.



THE MARK CONSISTS OF THE STYLIZED LETTERS "bv" WITHIN A CIRCLE, AND A SEMICIRCLE TO THE RIGHT OF THE CIRCLE, AND A VERTICAL RECTANGLE TO THE RIGHT OF THE SEMICIRCLE.

CLASS 35—ADVERTISING AND BUSINESS

FOR VENDING MACHINE MANAGEMENT SERVICES; INVOICE, BILLING AND COMMISSION CONSOLIDATION SERVICES (U.S. CLS. 100, 101 AND 102).
FIRST USE 9-0-2004; IN COMMERCE 9-0-2004.

CLASS 36—INSURANCE AND FINANCIAL

FOR SERVICES CONSISTING OF COLLECTION OF MONETARY CHARITABLE CONTRIBUTIONS FOR OTHERS (U.S. CLS. 100, 101 AND 102).
FIRST USE 5-23-2006; IN COMMERCE 3-19-2007.
KELLY BOULTON, EXAMINING ATTORNEY

SN 77-287,262. THE BROADWAY LEAGUE INC., NEW YORK, NY. FILED 9-24-2007.

NOW THAT'S BROADWAY

THE MARK CONSISTS OF STANDARD CHARACTERS WITHOUT CLAIM TO ANY PARTICULAR FONT, STYLE, SIZE, OR COLOR.

CLASS 35—ADVERTISING AND BUSINESS

FOR PROMOTING THE LIVE THEATRICAL SHOWS OF OTHERS; TRADE ASSOCIATION SERVICES, NAMELY, PROMOTING THE INTERESTS OF LIVE THEATER AND PROFESSIONALS WHO WORK IN LIVE THEATER (U.S. CLS. 100, 101 AND 102).

CLASS 41—EDUCATION AND ENTERTAINMENT

FOR PROVIDING INFORMATION AND INTERVIEWS ABOUT LIVE THEATER (U.S. CLS. 100, 101 AND 107).
AISHA CLARKE, EXAMINING ATTORNEY

SN 77-287,789. FORUM ANALYTICS, L.L.C., CHICAGO, IL.
FILED 9-25-2007.

VEXRAY

THE MARK CONSISTS OF STANDARD CHARACTERS WITHOUT CLAIM TO ANY PARTICULAR FONT, STYLE, SIZE, OR COLOR.

THE TERM "VEXRAY" HAS NO MEANING IN A FOREIGN LANGUAGE.

CLASS 35—ADVERTISING AND BUSINESS

FOR MATCHING COMMERCIAL RETAIL BUYERS AND LEASEES WITH REAL ESTATE PROFESSIONALS, SELLERS AND LEASORS IN THE FIELD OF REAL ESTATE SERVICES VIA COMPUTER NETWORK; REAL ESTATE MARKETING SERVICES IN THE FIELD OF CONSUMER ORIENTED COMMERCIAL REAL ESTATE, NAMELY, RETAIL, MALL AND GENERAL OFFICE SPACE (U.S. CLS. 100, 101 AND 102).

CLASS 36—INSURANCE AND FINANCIAL

FOR PROVIDING INFORMATION IN THE FIELD OF REAL ESTATE VIA THE INTERNET INCLUDING SPACE AVAILABILITY, BUILDING CHARACTERISTICS, PROPERTY FOR SALE OR LEASE, SALES COMPARABLES, CONTACT INFORMATION, AND REAL ESTATE CONSULTATION SERVICES (U.S. CLS. 100, 101 AND 102).

NELSON SNYDER, EXAMINING ATTORNEY

SN 77-288,274. LEIGH FOX, DBA INSIDE FIRST NUTRITION, CORDOVA, TN. FILED 9-25-2007.



THE MARK CONSISTS OF A DRAWING IN THE SHAPE OF A HEART WITH THE LETTERS "IF" WRITTEN ON THE INSIDE OF THE HEART AND THE WORDS "INSIDE FIRST" WRITTEN ALONG THE TOP CURVED PORTION OF THE HEART.

CLASS 41—EDUCATION AND ENTERTAINMENT

FOR PHYSICAL FITNESS CONSULTATION; PHYSICAL FITNESS INSTRUCTION; PROVIDING ASSISTANCE, PERSONAL TRAINING AND PHYSICAL FITNESS CONSULTATION TO INDIVIDUALS TO HELP THEM MAKE PHYSICAL FITNESS, STRENGTH, CONDITIONING, AND EXERCISE IMPROVEMENT IN THEIR DAILY LIVING (U.S. CLS. 100, 101 AND 107).
FIRST USE 2-16-2006; IN COMMERCE 9-1-2006.

CLASS 44—MEDICAL, BEAUTY AND AGRICULTURAL SERVICES

FOR DIETARY AND NUTRITIONAL GUIDANCE; FOOD NUTRITION CONSULTATION; NUTRITION COUNSELING; PROVIDING INFORMATION ABOUT DIETARY SUPPLEMENTS AND NUTRITION (U.S. CLS. 100 AND 101).

FIRST USE 2-16-2006; IN COMMERCE 9-1-2006.
ELLEN BURNS, EXAMINING ATTORNEY

SN 77-288,296. WOUND SYSTEMS, LLC, ATLANTA, GA.
FILED 9-25-2007.

Dolphin Technology

THE MARK CONSISTS OF STANDARD CHARACTERS WITHOUT CLAIM TO ANY PARTICULAR FONT, STYLE, SIZE, OR COLOR.

NO CLAIM IS MADE TO THE EXCLUSIVE RIGHT TO USE "TECHNOLOGY", APART FROM THE MARK AS SHOWN.

CLASS 10—MEDICAL APPARATUS

FOR AIR MATTRESSES FOR MEDICAL PURPOSES (U.S. CLS. 26, 39 AND 44).

CLASS 12—VEHICLES

FOR WHEELCHAIR CUSHIONS (U.S. CLS. 19, 21, 23, 31, 35 AND 44).

EDWARD FENNESSY, EXAMINING ATTORNEY

SN 77-288,344. CONTENT MANAGEMENT ASSOCIATES, INC., OREGON CITY, OR. FILED 9-25-2007.

INDIVIDUALITY MATTERS

THE MARK CONSISTS OF STANDARD CHARACTERS WITHOUT CLAIM TO ANY PARTICULAR FONT, STYLE, SIZE, OR COLOR.

CLASS 9—ELECTRICAL AND SCIENTIFIC APPARATUS

FOR COMPUTER SOFTWARE FOR MANAGING, CUSTOMIZING, PERSONALIZING AND DISTRIBUTING INFORMATION ON HEALTHCARE AND PENSION PLANS (U.S. CLS. 21, 23, 26, 36 AND 38).

CLASS 35—ADVERTISING AND BUSINESS

FOR ELECTRONIC PROCESSING OF HEALTHCARE AND PENSION PLAN APPLICATIONS (U.S. CLS. 100, 101 AND 102).
ROBIN MITTLER, EXAMINING ATTORNEY

SN 77-289,079. SOFTLIGHT DEVELOPMENT, INC, IRVING, TX. FILED 9-26-2007.

SN 77-288,349. CONTENT MANAGEMENT ASSOCIATES, INC., OREGON CITY, OR. FILED 9-25-2007.

ORINDI

THE MARK CONSISTS OF STANDARD CHARACTERS WITHOUT CLAIM TO ANY PARTICULAR FONT, STYLE, SIZE, OR COLOR.

CLASS 9—ELECTRICAL AND SCIENTIFIC APPARATUS

FOR COMPUTER SOFTWARE FOR MANAGING, CUSTOMIZING, PERSONALIZING AND DISTRIBUTING INFORMATION ON HEALTHCARE AND PENSION PLANS (U.S. CLS. 21, 23, 26, 36 AND 38).

CLASS 35—ADVERTISING AND BUSINESS

FOR ELECTRONIC PROCESSING OF HEALTHCARE AND PENSION PLAN APPLICATIONS (U.S. CLS. 100, 101 AND 102).
ROBIN MITTLER, EXAMINING ATTORNEY

SN 77-288,929. CHOE, YEONSOOK, RICHARDSON, TX. FILED 9-26-2007.

COOKIN'MOBILE

THE MARK CONSISTS OF STANDARD CHARACTERS WITHOUT CLAIM TO ANY PARTICULAR FONT, STYLE, SIZE, OR COLOR.

CLASS 9—ELECTRICAL AND SCIENTIFIC APPARATUS

FOR COMPUTER APPLICATION SOFTWARE FOR MOBILE PHONES (U.S. CLS. 21, 23, 26, 36 AND 38).

CLASS 43—HOTEL AND RESTAURANT SERVICES

FOR PROVIDING A DATABASE IN THE FIELD OF RECIPES AND COOKING INFORMATION (U.S. CLS. 100 AND 101).
DEZMONA MIZELLE, EXAMINING ATTORNEY



THE COLOR(S) DARK PURPLE, LIGHT PURPLE, ORANGE IS/ARE CLAIMED AS A FEATURE OF THE MARK.

THE MARK CONSISTS OF THE WORDING "MANAGE MY" IN ORANGE, AND THE WORDING "PRACTICE" IN LIGHT PURPLE AND A DESIGN CONSISTING OF SEVERAL DIAMONDS CONTAINING THE COLORS DARK PURPLE, LIGHT PURPLE AND ORANGE.

CLASS 9—ELECTRICAL AND SCIENTIFIC APPARATUS

FOR COMPUTER SOFTWARE FOR CONTROLLING AND MANAGING PATIENT MEDICAL INFORMATION (U.S. CLS. 21, 23, 26, 36 AND 38).

CLASS 44—MEDICAL, BEAUTY AND AGRICULTURAL SERVICES

FOR PROVIDING AN INTERNET WEBSITE FOR MEDICAL PROFESSIONALS AND MEDICAL PATIENTS THAT ALLOWS FOR THE EXCHANGE OF INFORMATION FROM REMOTE LOCATIONS USING ELECTRONIC PATIENT MONITORING DEVICES THAT FEED INFORMATION TO THE WEBSITE THAT CAN BE ACCESSED IN REAL-TIME BY MEDICAL PROFESSIONALS FOR PURPOSES OF MONITORING AND DIAGNOSING MEDICAL CONDITIONS (U.S. CLS. 100 AND 101).
MONIQUE MILLER, EXAMINING ATTORNEY

SN 77-289,456. THE PROCTER & GAMBLE COMPANY, CINCINNATI, OH. FILED 9-26-2007.

WINDS & SPRINGTIME

THE MARK CONSISTS OF STANDARD CHARACTERS WITHOUT CLAIM TO ANY PARTICULAR FONT, STYLE, SIZE, OR COLOR.

CLASS 3—COSMETICS AND CLEANING PREPARATIONS

FOR AROMATHERAPY PRODUCTS, NAMELY, AROMATHERAPY OILS USED IN ELECTRICAL SCENT DISPENSERS (U.S. CLS. 1, 4, 6, 50, 51 AND 52).

CLASS 4—LUBRICANTS AND FUELS

FOR CANDLES (U.S. CLS. 1, 6 AND 15).

CLASS 5—PHARMACEUTICALS

FOR AIR FRESHENERS AND ROOM DEODORIZERS
(U.S. CLS. 6, 18, 44, 46, 51 AND 52).
BARBARA RUTLAND, EXAMINING ATTORNEY

SN 77-289,584. BLUE BUFFALO COMPANY, LTD., WILTON,
CT. FILED 9-26-2007.

SN 77-289,509. THE GRANDMA GEBHARD COMPANY,
EDINA, MN. FILED 9-26-2007.



THE COLOR(S) PURPLE IN THE WORD "ZEBÄ", THE
COLOR ORANGE IN THE WORD "SHAKE" AND A RED
HEART IS/ARE CLAIMED AS A FEATURE OF THE MARK.
THE MARK CONSISTS OF THE WORDING "ZEBÄ-
SHAKE" AND A HEART DESIGN.

BLUE BOTANICALS

THE MARK CONSISTS OF STANDARD CHARACTERS
WITHOUT CLAIM TO ANY PARTICULAR FONT, STYLE,
SIZE, OR COLOR.

NO CLAIM IS MADE TO THE EXCLUSIVE RIGHT TO
USE "BOTANICALS", APART FROM THE MARK AS
SHOWN.

CLASS 5—PHARMACEUTICALS

FOR DIETARY AND NUTRITIONAL SUPPLEMENTS
(U.S. CLS. 6, 18, 44, 46, 51 AND 52).

CLASS 3—COSMETICS AND CLEANING PREPARATIONS

FOR PET GROOMING ITEMS, NAMELY, NON-MEDI-
CATED SHAMPOO, CONDITIONER, COLOGNE, PET
CLEANING PREPARATIONS, DEODORIZERS FOR
PETS, SOAP AND NON-MEDICATED PAW BALM (U.S.
CLS. 1, 4, 6, 50, 51 AND 52).

CLASS 30—STAPLE FOODS

FOR BASES FOR MILK SHAKES (U.S. CL. 46).
PAM WILLIS, EXAMINING ATTORNEY

CLASS 18—LEATHER GOODS

FOR PET CARE ITEMS, NAMELY, PET COLLARS,
LEASHES, PET HARNESSSES, PET TOTE BAGS, PET
GARMENT AND ANIMAL CARRIERS (U.S. CLS. 1, 2,
3, 22 AND 41).

BARBARA RUTLAND, EXAMINING ATTORNEY

SN 77-289,513. PHD WEALTH LLC, MUKILTEO, WA. FILED
9-26-2007.

PHD WEALTH

THE MARK CONSISTS OF STANDARD CHARACTERS
WITHOUT CLAIM TO ANY PARTICULAR FONT, STYLE,
SIZE, OR COLOR.

NO CLAIM IS MADE TO THE EXCLUSIVE RIGHT TO
USE "WEALTH", APART FROM THE MARK AS SHOWN.

SN 77-289,627. MO STEEL FABRICATOR & ERECTOR, INC.,
NORTH MIAMI, FL. FILED 9-26-2007.

MO STEEL**CLASS 35—ADVERTISING AND BUSINESS**

FOR FRANCHISE SERVICES, NAMELY, OFFERING
TECHNICAL AND BUSINESS MANAGEMENT ASSIS-
TANCE IN THE ESTABLISHMENT AND OPERATION
OF INSURANCE AND FINANCIAL PLANNING (U.S.
CLS. 100, 101 AND 102).

THE MARK CONSISTS OF STANDARD CHARACTERS
WITHOUT CLAIM TO ANY PARTICULAR FONT, STYLE,
SIZE, OR COLOR.

NO CLAIM IS MADE TO THE EXCLUSIVE RIGHT TO
USE "STEEL", APART FROM THE MARK AS SHOWN.

CLASS 36—INSURANCE AND FINANCIAL

FOR INSURANCE CONSULTATION (U.S. CLS. 100, 101
AND 102).

CLASS 37—CONSTRUCTION AND REPAIR

FOR INSTALLATION OF STRUCTURAL STEEL (U.S.
CLS. 100, 103 AND 106).
FIRST USE 11-30-2003; IN COMMERCE 11-30-2003.

CLASS 41—EDUCATION AND ENTERTAINMENT

FOR CONDUCTING WORKSHOPS AND SEMINARS
IN INSURANCE AND FINANCIAL PLANNING (U.S.
CLS. 100, 101 AND 107).
ZACHARY BELLO, EXAMINING ATTORNEY

CLASS 40—MATERIAL TREATMENT

FOR STEEL FABRICATION SERVICES (U.S. CLS. 100,
103 AND 106).
FIRST USE 11-30-2003; IN COMMERCE 11-30-2003.
SAMUEL E. SHARPER JR., EXAMINING ATTORNEY

SN 77-289,992. VIETNAM AIRLINES CORPORATION, HANOI, VIETNAM, FILED 9-26-2007.

SN 77-290,122. SPENCER, SABINA, EAST MOLESEY, UNITED KINGDOM, FILED 9-27-2007.



OWNER OF VIETNAM REG. NO. 30628, DATED 4-3-1999, EXPIRES 11-17-2017.

NO CLAIM IS MADE TO THE EXCLUSIVE RIGHT TO USE "VIETNAM AIRLINES", APART FROM THE MARK AS SHOWN.

THE MARK CONSISTS OF WORD PART IS "VIETNAM AIRLINES" AND DEVICE PART IS A LOTUS.

CLASS 35—ADVERTISING AND BUSINESS

FOR ADVERTISING AND ADVERTISEMENT SERVICES; ADVERTISING AND BUSINESS SERVICES, NAMELY, SECURING AIRTIME ON ALL FORMS OF MEDIA COMMUNICATIONS STATIONS, SYSTEMS, NETWORKS, AND SERVICES FOR THE PURPOSE OF PROMOTING THE GOODS AND SERVICES OF OTHERS; ADVERTISING AND COMMERCIAL INFORMATION SERVICES, VIA THE INTERNET; ADVERTISING AND PUBLICITY SERVICES; ADVERTISING AND PUBLICITY SERVICES, NAMELY, PROMOTING THE GOODS, SERVICES, BRAND IDENTITY AND COMMERCIAL INFORMATION AND NEWS OF THIRD PARTIES THROUGH PRINT, AUDIO, VIDEO, DIGITAL AND ON-LINE MEDIUM; ADVERTISING PARTICULARLY SERVICES FOR THE PROMOTION OF GOODS; ADVERTISING THROUGH ALL PUBLIC COMMUNICATION MEANS; ADVERTISING VIA ELECTRONIC MEDIA AND SPECIFICALLY THE INTERNET; ADVERTISING, MARKETING AND PROMOTION SERVICES; ARRANGING AND CONDUCTING OF FAIRS AND EXHIBITIONS FOR BUSINESS AND ADVERTISING PURPOSES; CUSTOMER LOYALTY SERVICES AND CUSTOMER CLUB SERVICES, FOR COMMERCIAL, PROMOTIONAL AND ADVERTISING PURPOSES; DISTRIBUTION AND DISSEMINATION OF ADVERTISEMENTS AND OF ADVERTISING MATERIAL NAMELY, FLYERS, BROCHURES, LEAFLETS, PROSPECTUSES, PRINTED MATERIAL AND SAMPLES; ON-LINE ADVERTISING AND MARKETING SERVICES; PROMOTION, ADVERTISING AND MARKETING OF ON-LINE WEBSITES; EXPORT AND IMPORT AGENCIES (U.S. CLS. 100, 101 AND 102).

CLASS 37—CONSTRUCTION AND REPAIR

FOR AIRCRAFT REPAIR AND MAINTENANCE; AIRPLANE DEICING SERVICES (U.S. CLS. 100, 103 AND 106).

CLASS 41—EDUCATION AND ENTERTAINMENT

FOR ARRANGING PROFESSIONAL WORKSHOP AND TRAINING COURSES (U.S. CLS. 100, 101 AND 107).

CLASS 42—SCIENTIFIC AND COMPUTER SERVICES

FOR DEVELOPMENT, DESIGN AND UPDATING OF HOME PAGES (U.S. CLS. 100 AND 101).
CAROLYN CATALDO, EXAMINING ATTORNEY

Purple Planet

THE MARK CONSISTS OF STANDARD CHARACTERS WITHOUT CLAIM TO ANY PARTICULAR FONT, STYLE, SIZE, OR COLOR.

CLASS 9—ELECTRICAL AND SCIENTIFIC APPARATUS

FOR MOTION PICTURE FILMS ABOUT AN ANIMATED FANTASY ADVENTURE TAKING PLACE IN ANOTHER GALAXY INVOLVING SOME HUMAN CHILDREN AND BEINGS FROM OTHER WORLDS; COMPUTER GAMES SOFTWARE; COMPUTER GAME DISCS; VIDEO GAME DISCS (U.S. CLS. 21, 23, 26, 36 AND 38).

CLASS 28—TOYS AND SPORTING GOODS

FOR PLUSH TOYS; PLASTIC TOYS, NAMELY, DOLLS, TOY ACTION FIGURES AND TOY ACTION VEHICLES; PAPER DOLLS; AND HANDHELD UNITS FOR PLAYING ELECTRONIC GAMES (U.S. CLS. 22, 23, 38 AND 50).

BRIAN PINO, EXAMINING ATTORNEY

SN 77-290,256. KRONIC UNDERGROUND, COCOA, FL. FILED 9-27-2007.



THE MARK CONSISTS OF STYLIZED TEXT "KRONIC UNDERGROUND", WITH THE "O" IN "KRONIC" DEPICTED AS A RECORD.

CLASS 35—ADVERTISING AND BUSINESS

FOR RETAIL STORE SERVICES FEATURING DJ GEAR, MIXERS, HEADPHONES, AMPS, TURNTABLES, CLUB LIGHTING, DANCE VINYL, COMPACT DISCS, DVDS, SMOKING ACCESSORIES, GLASS, PLASTIC AND ACRYLIC PIPES, WATER PIPES, VAPORIZERS, CIGAR AND CIGARETTE ROLLING PAPERS, GRINDERS, SHIRTS, HATS, BAGS, PURSES, JEANS, INCENSE AND INCENSE HOLDERS, BODY JEWELRY, POSTERS AND SKATEBOARDS (U.S. CLS. 100, 101 AND 102).

CLASS 41—EDUCATION AND ENTERTAINMENT

FOR ENTERTAINMENT, NAMELY, LIVE PERFORMANCES BY MUSICAL BANDS (U.S. CLS. 100, 101 AND 107).
SANJEEV VOHRA, EXAMINING ATTORNEY

SN 77-290,345. LIN, GUANG, GREER, SC. FILED 9-27-2007.

Ever Torch

NO CLAIM IS MADE TO THE EXCLUSIVE RIGHT TO USE "TORCH", APART FROM THE MARK AS SHOWN.

CLASS 9—ELECTRICAL AND SCIENTIFIC APPARATUS

FOR CIGAR LIGHTERS FOR AUTOMOBILES; ELECTRIC CIGARETTE LIGHTERS FOR LAND VEHICLES (U.S. CLS. 21, 23, 26, 36 AND 38).

CLASS 34—SMOKERS' ARTICLES

FOR CIGAR LIGHTERS; CIGARETTE LIGHTERS NOT OF PRECIOUS METAL; CIGARETTE LIGHTERS OF PRECIOUS METAL; LIGHTERS FOR SMOKERS; LIGHTERS NOT OF PRECIOUS METAL; NONELECTRIC CIGAR LIGHTERS NOT OF PRECIOUS METAL; CIGARETTE LIGHTERS NOT FOR LAND VEHICLES; FLINTS FOR LIGHTERS; HOLDER FOR A CIGARETTE PACK AND LIGHTER; LIGHTER FLINTS; LIQUEFIED GAS CYLINDERS FOR CIGARETTE LIGHTERS (U.S. CLS. 2, 8, 9 AND 17).

ALICE SUE CARRUTHERS, EXAMINING ATTORNEY

SN 77-290,395. DELTA COMPRESIÓN, S.R.L., ESCOBAR, ARGENTINA, FILED 9-27-2007.



OWNER OF ARGENTINA REG. NO. 1.763.493, DATED 12-4-2000, EXPIRES 11-23-2009.

OWNER OF ARGENTINA REG. NO. 1.763.348, DATED 12-4-2000, EXPIRES 11-23-2009.

OWNER OF ARGENTINA REG. NO. 1.763.347, DATED 12-4-2000, EXPIRES 11-23-2009.

THE COLOR(S) BLUE, ORANGE AND WHITE IS/ARE CLAIMED AS A FEATURE OF THE MARK.

THE MARK CONSISTS OF THE STYLIZED WORD "ASPRO" IN BLUE UNDERNEATH A RECTANGLE SPLIT IN THE MIDDLE WITH A CURVED WHITE PATH SEPARATING BLUE ON THE LEFT AND ORANGE ON THE RIGHT.

CLASS 6—METAL GOODS

FOR METAL CONTAINERS FOR COMPRESSED GAS OR LIQUID AIR (U.S. CLS. 2, 12, 13, 14, 23, 25 AND 50).

CLASS 7—MACHINERY

FOR GAS COMPRESSORS; PROTECTIVE METAL CONTAINERS BEING PARTS OF GAS COMPRESSORS (U.S. CLS. 13, 19, 21, 23, 31, 34 AND 35).

CLASS 9—ELECTRICAL AND SCIENTIFIC APPARATUS

FOR FUEL PUMPS FOR SERVICE STATIONS; AUTOMATED PROCESS CONTROL SYSTEM, NAMELY, MICRO-PROCESSOR BASED HARDWARE AND SOFTWARE USED TO MONITOR THE STATUS OF INDUSTRIAL MACHINERY, NAMELY TURBINES, GENERATORS AND COMPRESSORS (U.S. CLS. 21, 23, 26, 36 AND 38).

SAIMA MAKHDOOM, EXAMINING ATTORNEY

SN 77-290,417. CONTECH STORMWATER SOLUTIONS INC., WEST CHESTER, OH. FILED 9-27-2007.

DYODS

THE MARK CONSISTS OF STANDARD CHARACTERS WITHOUT CLAIM TO ANY PARTICULAR FONT, STYLE, SIZE, OR COLOR.

CLASS 9—ELECTRICAL AND SCIENTIFIC APPARATUS

FOR DOWNLOADABLE SOFTWARE FOR THE DESIGN OF STORMWATER DETENTION SYSTEMS (U.S. CLS. 21, 23, 26, 36 AND 38).

FIRST USE 8-17-2007; IN COMMERCE 8-17-2007.

CLASS 37—CONSTRUCTION AND REPAIR

FOR INSTALLATION OF STORMWATER DETENTION SYSTEMS (U.S. CLS. 100, 103 AND 106).

CLASS 42—SCIENTIFIC AND COMPUTER SERVICES

FOR ENGINEERING; CUSTOM DESIGN OF STORMWATER DETENTION SYSTEMS TO THE REQUIREMENTS OF OTHERS (U.S. CLS. 100 AND 101).

SAIMA MAKHDOOM, EXAMINING ATTORNEY

SN 77-290,485. BLUE BUFFALO COMPANY, LTD., WILTON, CT. FILED 9-27-2007.

BLUE ESSENTIALS

THE MARK CONSISTS OF STANDARD CHARACTERS WITHOUT CLAIM TO ANY PARTICULAR FONT, STYLE, SIZE, OR COLOR.

THE WORDING "BLUE" HAS NO MEANING IN A FOREIGN LANGUAGE.

CLASS 3—COSMETICS AND CLEANING PREPARATIONS

FOR PET GROOMING ITEMS, NAMELY, NON-MEDICATED SHAMPOO, CONDITIONER, COLOGNE, PET CLEANING PREPARATIONS, DEODORIZERS FOR PETS, SOAP AND NON-MEDICATED PAW BALM (U.S. CLS. 1, 4, 6, 50, 51 AND 52).

CLASS 18—LEATHER GOODS

FOR PET CARE ITEMS, NAMELY, PET COLLARS, LEASHES, PET HARNESSSES, PET TOTE BAGS, PET GARMENT AND ANIMAL CARRIERS (U.S. CLS. 1, 2, 3, 22 AND 41).

BARBARA RUTLAND, EXAMINING ATTORNEY

SN 77-290,526. SCHOOL APPAREL, SAN BRUNO, CA. FILED 9-27-2007.

A+ SCHOOLWEAR

THE MARK CONSISTS OF STANDARD CHARACTERS WITHOUT CLAIM TO ANY PARTICULAR FONT, STYLE, SIZE, OR COLOR.

OWNER OF U.S. REG. NOS. 2,231,320 AND 3,324,131.

NO CLAIM IS MADE TO THE EXCLUSIVE RIGHT TO USE "SCHOOLWEAR", APART FROM THE MARK AS SHOWN.

CLASS 25—CLOTHING

FOR CLOTHING FOR MEN, WOMEN, BOYS AND GIRLS, NAMELY, SCHOOL, CAREER, CASUAL AND CUSTOM APPAREL COMPRISED OF SHIRTS AND BLOUSES, PANTS, TROUSERS, SLACKS, SHORTS, SKIRTS, JUMPERS, SKORTS, CULOTTES AND SOCKS; OUTERWEAR, NAMELY, OVERSHIRTS, TURTLENECKS, SWEATERS, VESTS AND JACKETS; ACTIVE AND GYM WEAR, NAMELY, SWEATSHIRTS, SWEATPANTS, SHORTS, T-SHIRTS AND SOCKS (U.S. CLS. 22 AND 39).

CLASS 40—MATERIAL TREATMENT

FOR CUSTOM MANUFACTURE OF CLOTHING FEATURING EMBROIDERY, SPECIALTY STITCHING AND CUSTOM IMPRINTING OF CLOTHING WITH DECORATIVE DESIGN (U.S. CLS. 100, 103 AND 106).

SHARON MEIER, EXAMINING ATTORNEY

SN 77-290,579. COOKING BUDDIES, INC., IRVINE, CA. FILED 9-27-2007.

SEE SMELL TASTE

THE MARK CONSISTS OF STANDARD CHARACTERS WITHOUT CLAIM TO ANY PARTICULAR FONT, STYLE, SIZE, OR COLOR.

CLASS 29—MEATS AND PROCESSED FOODS

FOR COOKING OIL (U.S. CL. 46).

CLASS 30—STAPLE FOODS

FOR SPICES;VINEGAR; RICE (U.S. CL. 46).

CLASS 31—NATURAL AGRICULTURAL PRODUCTS

FOR FRESH HERBS (U.S. CLS. 1 AND 46).

JAY BESCH, EXAMINING ATTORNEY

SN 77-290,590. RODRIGUEZ, ANTHONY G, WHITTIER, CA. FILED 9-27-2007.

starving student

THE MARK CONSISTS OF STANDARD CHARACTERS WITHOUT CLAIM TO ANY PARTICULAR FONT, STYLE, SIZE, OR COLOR.

NO CLAIM IS MADE TO THE EXCLUSIVE RIGHT TO USE "STUDENT", APART FROM THE MARK AS SHOWN.

CLASS 16—PAPER GOODS AND PRINTED MATTER

FOR EDUCATIONAL PUBLICATIONS, NAMELY, EDUCATIONAL LEARNING CARDS, FLASH CARDS, ACTIVITY CARDS, WORKBOOKS, TEXTBOOKS, ACTIVITY BOOKS, STORY BOOKS, PUZZLE BOOKS, PUZZLES, TEACHER GUIDES, MANUALS, POSTERS, EDUCATIONAL CARD GAMES AND EDUCATIONAL BOOKLETS IN THE FIELD OF COLLEGE PLANNING (U.S. CLS. 2, 5, 22, 23, 29, 37, 38 AND 50).

CLASS 35—ADVERTISING AND BUSINESS

FOR PROMOTING THE GOODS AND SERVICES OF OTHERS BY PROVIDING A WEB SITE FEATURING COUPONS, REBATES, PRICE-COMPARISON INFORMATION, PRODUCT REVIEWS, LINKS TO THE RETAIL WEB SITES OF OTHERS, AND DISCOUNT INFORMATION (U.S. CLS. 100, 101 AND 102).

CLASS 40—MATERIAL TREATMENT

FOR IMPRINTING MESSAGES ON WEARING APPAREL, ACCESSORIES AND MUGS (U.S. CLS. 100, 103 AND 106).

CLASS 41—EDUCATION AND ENTERTAINMENT

FOR SOCIAL CLUB SERVICES, NAMELY, ARRANGING, ORGANIZING, AND HOSTING SOCIAL EVENTS, GET-TOGETHERS AND PARTIES FOR CLUB MEMBERS (U.S. CLS. 100, 101 AND 107).

CLASS 42—SCIENTIFIC AND COMPUTER SERVICES

FOR PROVIDING A WEB SITE THAT GIVES COMPUTER USERS THE ABILITY TO UPLOAD, EXCHANGE AND SHARE PHOTOS, VIDEOS AND VIDEO LOGS (U.S. CLS. 100 AND 101).

JAY FLOWERS, EXAMINING ATTORNEY

SN 77-290,823. HILLHOUSE, SARAH, BURLINGAME, CA. FILED 9-27-2007.

SN 77-290,909. QTASK, BURBANK, CA. FILED 9-27-2007.



NO CLAIM IS MADE TO THE EXCLUSIVE RIGHT TO USE "GROUP", APART FROM THE MARK AS SHOWN.

THE MARK CONSISTS OF A HOUSE ON THE UPPER LEFT HAND CORNER WITH THE WORD "HILLHOUSEGROUP" IN A STYLIZED TEXT.

CLASS 36—INSURANCE AND FINANCIAL

FOR REAL ESTATE CONSULTATION (U.S. CLS. 100, 101 AND 102).

FIRST USE 1-1-2006; IN COMMERCE 1-1-2006.

CLASS 42—SCIENTIFIC AND COMPUTER SERVICES

FOR INTERIOR DESIGN SERVICES (U.S. CLS. 100 AND 101).

FIRST USE 1-1-2006; IN COMMERCE 1-1-2006.

CAROLYN GRAY, EXAMINING ATTORNEY

SN 77-290,903. CHEMDIV, INC, DBA CHEMICAL DIVERSITY, SAN DIEGO, CA. FILED 9-27-2007.

Drug Discovery Anywhere

THE MARK CONSISTS OF STANDARD CHARACTERS WITHOUT CLAIM TO ANY PARTICULAR FONT, STYLE, SIZE, OR COLOR.

CLASS 1—CHEMICALS

FOR CHEMICAL REAGENTS FOR NON-MEDICAL PURPOSES; REAGENT FOR CHEMICAL ANALYSES; REAGENTS FOR USE IN SCIENTIFIC APPARATUS FOR CHEMICAL OR BIOLOGICAL ANALYSIS (U.S. CLS. 1, 5, 6, 10, 26 AND 46).

CLASS 42—SCIENTIFIC AND COMPUTER SERVICES

FOR ANALYSIS OF THE MODE OF ACTION OF CHEMICAL COMBINATIONS ON ANIMALS; CHEMICAL ANALYSIS; CHEMICAL LABORATORIES; CHEMICAL RESEARCH; CHEMICAL, BIOCHEMICAL, BIOLOGICAL AND BACTERIOLOGICAL RESEARCH AND ANALYSIS; DEVELOPMENT AND TEST OF CHEMICAL PRODUCTION METHODS; DEVELOPMENT OF PHARMACEUTICAL PREPARATIONS AND MEDICINES; PHARMACEUTICAL DRUG DEVELOPMENT SERVICES; PHARMACEUTICAL RESEARCH AND DEVELOPMENT; PHARMACEUTICAL RESEARCH SERVICES; RESEARCH AND DEVELOPMENT FOR NEW PRODUCTS FOR OTHERS; RESEARCH ON THE SUBJECT OF PHARMACEUTICALS; SCIENTIFIC RESEARCH AND DEVELOPMENT (U.S. CLS. 100 AND 101).

ROSELLE HERRERA, EXAMINING ATTORNEY

OWNER OF U.S. REG. NO. 3,097,572.

THE COLOR(S) GREEN AND DARK GRAY IS/ARE CLAIMED AS A FEATURE OF THE MARK.

THE COLOR GREEN APPEARS IN THE LETTER "Q" AND THE FIVE SQUARE BOXES THAT MAKE UP THE CHECK MARK. THE COLOR DARK GRAY APPEARS IN THE LETTERS "T", "A", "S" AND "K".

CLASS 38—COMMUNICATION

FOR PROVIDING E-MAIL SERVICES, INSTANT MESSAGING SERVICES, AND PRIVATE, ENCRYPTED CHAT ROOMS FOR TRANSMISSION OF MESSAGES AMONG COMPUTER USERS CONCERNING WORK-RELATED AND GENERAL INTEREST TOPICS (U.S. CLS. 100, 101 AND 104).

FIRST USE 7-1-2007; IN COMMERCE 7-1-2007.

CLASS 42—SCIENTIFIC AND COMPUTER SERVICES

FOR PROVIDING TEMPORARY USE OF ON-LINE, NON-DOWNLOADABLE SOFTWARE FOR ONLINE TASK TRACKING, PROJECT MANAGEMENT, ELECTRONIC FILE SHARING, FILTERING OF UNWANTED E-MAILS, SOCIAL NETWORK MANAGEMENT, SCHEDULING, SCHEDULE MANAGEMENT, CUSTOMER RELATIONSHIP MANAGEMENT, AND ACCOUNTABILITY ENFORCEMENT OF PROJECT MEMBERS (U.S. CLS. 100 AND 101).

FIRST USE 7-1-2007; IN COMMERCE 7-1-2007.

BRIAN CALLAGHAN, EXAMINING ATTORNEY

SN 77-290,930. CHEMDIV, INC, DBA CHEMICAL DIVERSITY, SAN DIEGO, CA. FILED 9-27-2007.

Biology Anywhere

THE MARK CONSISTS OF STANDARD CHARACTERS WITHOUT CLAIM TO ANY PARTICULAR FONT, STYLE, SIZE, OR COLOR.

CLASS 1—CHEMICALS

FOR CHEMICAL REAGENTS FOR NON-MEDICAL PURPOSES; REAGENT FOR CHEMICAL ANALYSES; REAGENTS FOR USE IN SCIENTIFIC APPARATUS FOR CHEMICAL OR BIOLOGICAL ANALYSIS (U.S. CLS. 1, 5, 6, 10, 26 AND 46).

CLASS 42—SCIENTIFIC AND COMPUTER SERVICES

FOR CHEMICAL ANALYSIS; CHEMICAL LABORATORIES; CHEMICAL RESEARCH; CHEMICAL, BIOCHEMICAL, BIOLOGICAL AND BACTERIOLOGICAL RESEARCH AND ANALYSIS; DEVELOPMENT AND TEST OF CHEMICAL PRODUCTION METHODS; DEVELOPMENT OF PHARMACEUTICAL PREPARATIONS AND MEDICINES; PHARMACEUTICAL DRUG DEVELOPMENT SERVICES; PHARMACEUTICAL RESEARCH AND DEVELOPMENT; PHARMACEUTICAL RESEARCH SERVICES; RESEARCH AND DEVELOPMENT FOR NEW PRODUCTS FOR OTHERS; RESEARCH ON THE SUBJECT OF PHARMACEUTICALS; SCIENTIFIC RESEARCH AND DEVELOPMENT; ANALYSIS OF THE MODE OF ACTION OF CHEMICAL COMBINATIONS ON ANIMALS (U.S. CLS. 100 AND 101).

ROSELLE HERRERA, EXAMINING ATTORNEY

SN 77-291,117. NORTHEAST ENTREPRENEUR FUND, INC., VIRGINIA, MN. FILED 9-28-2007.

GREENSTONE GROUP

THE MARK CONSISTS OF STANDARD CHARACTERS WITHOUT CLAIM TO ANY PARTICULAR FONT, STYLE, SIZE, OR COLOR.

NO CLAIM IS MADE TO THE EXCLUSIVE RIGHT TO USE "GROUP", APART FROM THE MARK AS SHOWN.

SN 77-290,961. BRIGHT NOW! DENTAL, INC., SANTA ANA, CA. FILED 9-27-2007.

1 LEVEL OF SERVICE

THE MARK CONSISTS OF STANDARD CHARACTERS WITHOUT CLAIM TO ANY PARTICULAR FONT, STYLE, SIZE, OR COLOR.

CLASS 35—ADVERTISING AND BUSINESS

FOR DENTAL PRACTICE MANAGEMENT FOR OTHERS (U.S. CLS. 100, 101 AND 102).

CLASS 44—MEDICAL, BEAUTY AND AGRICULTURAL SERVICES

FOR DENTIST SERVICES (U.S. CLS. 100 AND 101).
CHARLES L. JENKINS, EXAMINING ATTORNEY

CLASS 35—ADVERTISING AND BUSINESS

FOR PROVIDING AN ONLINE DIRECTORY OF SERVICE PROVIDERS FOR ENTREPRENEURS TO ASSIST IN BUSINESS DEVELOPMENT (U.S. CLS. 100, 101 AND 102).

CLASS 41—EDUCATION AND ENTERTAINMENT

FOR EDUCATIONAL SERVICES, NAMELY, PROVIDING GROUP AND INDIVIDUAL TRAINING AND MENTORING TO OWNERS OF EXISTING AND START-UP BUSINESSES FOR THE PURPOSE OF TEACHING ENTREPRENEURIAL SKILLS TO FOSTER BUSINESS DEVELOPMENT AND GROWTH AND ASSISTING EDUCATIONAL INSTITUTIONS IN THE DEVELOPMENT OF CURRICULUM WHICH TEACHES ENTREPRENEURIAL SKILLS (U.S. CLS. 100, 101 AND 107).

KATINA MISTER, EXAMINING ATTORNEY

SN 77-291,115. AERO DESIGN AND MANUFACTURING COMPANY, INC., DULUTH, MN. FILED 9-28-2007.

WHEN IN DOUBT, RIDE.

THE MARK CONSISTS OF STANDARD CHARACTERS WITHOUT CLAIM TO ANY PARTICULAR FONT, STYLE, SIZE, OR COLOR.

CLASS 25—CLOTHING

FOR CLOTHING, NAMELY, T-SHIRTS (U.S. CLS. 22 AND 39).

CLASS 35—ADVERTISING AND BUSINESS

FOR MAIL ORDER AND ELECTRONIC CATALOG SERVICES FEATURING CLOTHING AND ACCESSORIES FOR MOTORCYCLE RIDERS (U.S. CLS. 100, 101 AND 102).

KATINA MISTER, EXAMINING ATTORNEY

SN 77-291,179. JUNO MANUFACTURING, INC., DES PLAINES, IL. FILED 9-28-2007.

LIGHTS ON

THE MARK CONSISTS OF STANDARD CHARACTERS WITHOUT CLAIM TO ANY PARTICULAR FONT, STYLE, SIZE, OR COLOR.

NO CLAIM IS MADE TO THE EXCLUSIVE RIGHT TO USE "LIGHTS", APART FROM THE MARK AS SHOWN.

CLASS 9—ELECTRICAL AND SCIENTIFIC APPARATUS

FOR EMERGENCY WARNING LIGHTS; ILLUMINATED EXIT AND EMERGENCY SIGNS; LUMINOUS SIGNS; BATTERY BACKUP POWER SUPPLIES; POWER SUPPLIES; ELECTRIC VOLTAGE TRANSFORMERS; ELECTRICAL CONNECTORS; ELECTRIC CONTROL PANELS FOR LIGHTING APPARATUS; LIGHTING BALLASTS; ELECTRIC LIGHT SWITCHES; ELECTRIC LIGHT DIMMERS; ELECTRIC LIGHT INTENSITY CONTROLLERS; ELECTRIC SWITCH PLATES; ELECTRICAL OUTLET PLATES; ELECTRIC WIRE AND CABLE, ELECTRIC WIRE AND CABLE HARNESSSES AND MOUNTING BRACKETS (U.S. CLS. 21, 23, 26, 36 AND 38).

CLASS 11—ENVIRONMENTAL CONTROL APPARATUS

FOR ELECTRIC LIGHTING FIXTURES; ELECTRIC TRACK LIGHTING UNITS; RECESSED LIGHTING FIXTURES; FLUORESCENT LIGHTING FIXTURES; LIGHTING FIXTURES; LAMPS; FLUORESCENT LAMPS; LAMP REFLECTORS; LIGHTING TRACKS; SOCKETS FOR ELECTRIC LIGHTS; STRUCTURAL COMPONENTS, FITTINGS AND PARTS OF ELECTRIC LIGHTING FIXTURES, NAMELY, TRIM ASSEMBLIES, MOUNTS, HANGERS, POSITIONERS, BAFFLES, AND LAMP FITTINGS (U.S. CLS. 13, 21, 23, 31 AND 34).

CLASS 36—INSURANCE AND FINANCIAL

FOR PROVIDING EXTENDED WARRANTIES ON LIGHTING PRODUCTS (U.S. CLS. 100, 101 AND 102).

CLASS 37—CONSTRUCTION AND REPAIR

FOR MAINTENANCE AND/OR REPAIR OF LIGHTING PRODUCTS (U.S. CLS. 100, 103 AND 106).
DAVID HOFFMAN, EXAMINING ATTORNEY

SN 77-291,222. SUNPUPPY INVESTMENTS CORPORATION, CALGARY, CANADA, FILED 9-28-2007.

SUNPUPPY

THE MARK CONSISTS OF STANDARD CHARACTERS WITHOUT CLAIM TO ANY PARTICULAR FONT, STYLE, SIZE, OR COLOR.

CLASS 14—JEWELRY

FOR JEWELRY (U.S. CLS. 2, 27, 28 AND 50).

CLASS 43—HOTEL AND RESTAURANT SERVICES

FOR RESORT LODGING SERVICES (U.S. CLS. 100 AND 101).
YAT SYE, LEE, EXAMINING ATTORNEY

SN 77-291,282. VENICE FOUNDATION FOR THE ARTS, DBA VENICE COMMUNITY TRUST, VENICE, CA. FILED 9-28-2007.

V-SCAPE

THE MARK CONSISTS OF STANDARD CHARACTERS WITHOUT CLAIM TO ANY PARTICULAR FONT, STYLE, SIZE, OR COLOR.

CLASS 35—ADVERTISING AND BUSINESS

FOR ARRANGING AND CONDUCTING TRADE SHOW EXHIBITIONS IN THE FIELD OF ART PERFORMANCE AND EDUCATION; CONDUCTING TRADE SHOWS IN THE FIELD OF ART PERFORMANCE AND EDUCATION; ARRANGING AND CONDUCTING TRADE SHOWS IN THE FIELD OF ART PERFORMANCE AND EDUCATION (U.S. CLS. 100, 101 AND 102).

CLASS 41—EDUCATION AND ENTERTAINMENT

FOR ART EXHIBITIONS; CONDUCTING WORKSHOPS AND SEMINARS IN ART PERFORMANCE AND EDUCATION; ORGANIZING COMMUNITY FESTIVALS FEATURING A VARIETY OF ACTIVITIES, NAMELY, ART EXHIBITIONS, HERITAGE MARKETS, ETHNIC DANCES, AND THE LIKE; WORKSHOPS AND SEMINARS IN THE FIELD OF ART PERFORMANCE AND EDUCATION (U.S. CLS. 100, 101 AND 107).

ROBERT STRUCK, EXAMINING ATTORNEY

SN 77-291,289. FLOWERY BEAUTY PRODUCTS, INC., DANBURY, CT. FILED 9-28-2007.



flowery

OWNER OF U.S. REG. NO. 1,293,707.

THE MARK CONSISTS OF THE WORD FLOWERY, WITH A STYLIZED LETTER "W" EXTENDING UP INTO A TULIP..

CLASS 3—COSMETICS AND CLEANING PREPARATIONS

FOR EMERY BOARDS; PUMICE STONES FOR PERSONAL USE; NAIL CARE PREPARATIONS; CUTICLE CONDITIONERS; CUTICLE CREAM; CUTICLE REMOVING PREPARATIONS; DEPILATORIES (U.S. CLS. 1, 4, 6, 50, 51 AND 52).

FIRST USE 1-1-1999; IN COMMERCE 1-1-1999.

CLASS 5—PHARMACEUTICALS

FOR STYPTIC PENCILS (U.S. CLS. 6, 18, 44, 46, 51 AND 52).

FIRST USE 1-1-1999; IN COMMERCE 1-1-1999.

CLASS 8—HAND TOOLS

FOR MANICURE IMPLEMENTS, NAMELY, NAIL FILES, CUTICLE PUSHERS AND NAIL BUFFERS.; PEDICURE IMPLEMENTS, NAMELY, NAIL FILES, CUTICLE PUSHERS, NAIL BUFFERS AND FOOT FILES (U.S. CLS. 23, 28 AND 44).

FIRST USE 1-1-1999; IN COMMERCE 1-1-1999.

SETH A. RAPPAPORT, EXAMINING ATTORNEY

SN 77-291,372. WILLIAMS, SAMUEL S., RENO, NV. FILED 9-28-2007.

SN 77-291,450. EAGLEEYE ANALYTICS, INC., COLUMBIA, SC. FILED 9-28-2007.

Game Fuel

THE MARK CONSISTS OF STANDARD CHARACTERS WITHOUT CLAIM TO ANY PARTICULAR FONT, STYLE, SIZE, OR COLOR.

CLASS 25—CLOTHING

FOR T-SHIRTS; SWEAT SHIRTS; HATS; PANTS; JACKETS (U.S. CLS. 22 AND 39).

CLASS 30—STAPLE FOODS

FOR CANDY; CANDY BARS; CANDY WITH COCOA; CHOCOLATE CANDIES; CHOCOLATE BARS; CHOCOLATE COVERED NUTS; CHOCOLATE-BASED READY-TO-EAT FOOD BARS; GRAIN-BASED FOOD BARS ALSO CONTAINING CHOCOLATE (U.S. CL. 46).

SUSAN LESLIE DUBOIS, EXAMINING ATTORNEY

SN 77-291,403. AFM CORPORATION, BURNSVILLE, MN. FILED 9-28-2007.



OWNER OF U.S. REG. NOS. 1,413,370, 2,372,312 AND 2,392,830.

CLASS 17—RUBBER GOODS

FOR STRUCTURAL FOAM INSULATION PANELS, RIGID FOAM INSULATION PANELS AND ROOF INSULATION PANELS, ALL BEING STRUCTURAL INSULATED CONSTRUCTION PANELS (U.S. CLS. 1, 5, 12, 13, 35 AND 50).

CLASS 19—NON-METALLIC BUILDING MATERIALS

FOR BUILDING MATERIALS, NAMELY, EXPANDED POLYSTYRENE LAMINATED BUILDING PANELS; BUILDING MATERIALS, NAMELY, PLASTIC FORM TIES FOR COMPOSITE FOAM AND CONCRETE FORMS, FOR USE IN SECURING COMPOSITE FOAM AND CONCRETE FORMS DURING THE CONSTRUCTION PROCESS; BUILDING MATERIALS, NAMELY, ORIENTED STRAND BOARD WITH FIRE RESISTANT FINISH USED AS A CONSTRUCTION MATERIAL; BUILDING MATERIALS, NAMELY, NON-METAL NAIL BASE PANELS (U.S. CLS. 1, 12, 33 AND 50).

SHAILA SETTLES, EXAMINING ATTORNEY

CLEAR SIGHT

THE MARK CONSISTS OF STANDARD CHARACTERS WITHOUT CLAIM TO ANY PARTICULAR FONT, STYLE, SIZE, OR COLOR.

CLASS 9—ELECTRICAL AND SCIENTIFIC APPARATUS

FOR COMPUTER SOFTWARE FOR PROVIDING PREDICTIVE ANALYTICAL ABILITIES TO THE INSURANCE AND FINANCIAL SERVICES INDUSTRIES (U.S. CLS. 21, 23, 26, 36 AND 38).

CLASS 42—SCIENTIFIC AND COMPUTER SERVICES

FOR APPLICATION SERVICE PROVIDER (ASP) FEATURING SOFTWARE FOR USE IN PROVIDING PREDICTIVE ANALYTICAL ABILITIES TO THE INSURANCE AND FINANCIAL SERVICES INDUSTRIES (U.S. CLS. 100 AND 101).

MELISSA VALLILLO, EXAMINING ATTORNEY

SN 77-291,459. EAGLEEYE ANALYTICS, INC., COLUMBIA, SC. FILED 9-28-2007.

ONSIGHT

THE MARK CONSISTS OF STANDARD CHARACTERS WITHOUT CLAIM TO ANY PARTICULAR FONT, STYLE, SIZE, OR COLOR.

CLASS 9—ELECTRICAL AND SCIENTIFIC APPARATUS

FOR COMPUTER SOFTWARE FOR PROVIDING PREDICTIVE ANALYTICAL ABILITIES TO THE INSURANCE AND FINANCIAL SERVICES INDUSTRIES (U.S. CLS. 21, 23, 26, 36 AND 38).

CLASS 42—SCIENTIFIC AND COMPUTER SERVICES

FOR APPLICATION SERVICE PROVIDER (ASP) FEATURING SOFTWARE FOR USE IN PROVIDING PREDICTIVE ANALYTICAL ABILITIES TO THE INSURANCE AND FINANCIAL SERVICES INDUSTRIES (U.S. CLS. 100 AND 101).

MELISSA VALLILLO, EXAMINING ATTORNEY

SN 77-291,503. EAGLEEYE ANALYTICS, INC., COLUMBIA, SC. FILED 9-28-2007.

OVERSIGHT

THE MARK CONSISTS OF STANDARD CHARACTERS WITHOUT CLAIM TO ANY PARTICULAR FONT, STYLE, SIZE, OR COLOR.

CLASS 9—ELECTRICAL AND SCIENTIFIC APPARATUS

FOR COMPUTER SOFTWARE FOR PROVIDING PREDICTIVE ANALYTICAL ABILITIES TO THE INSURANCE AND FINANCIAL SERVICES INDUSTRIES (U.S. CLS. 21, 23, 26, 36 AND 38).

CLASS 42—SCIENTIFIC AND COMPUTER SERVICES

FOR APPLICATION SERVICE PROVIDER (ASP) FEATURING SOFTWARE FOR USE IN PROVIDING PREDICTIVE ANALYTICAL ABILITIES TO THE INSURANCE AND FINANCIAL SERVICES INDUSTRIES (U.S. CLS. 100 AND 101).

MELISSA VALLILLO, EXAMINING ATTORNEY

SN 77-291,576. FLOOR 84 STUDIO, LLC, NORTH HOLLYWOOD, CA. FILED 9-28-2007.

A Division of Floor 84 Studio, LLC

NO CLAIM IS MADE TO THE EXCLUSIVE RIGHT TO USE "A DIVISION OF" AND "STUDIO, LLC", APART FROM THE MARK AS SHOWN.

THE MARK CONSISTS OF A STYLIZED LETTER "F", STYLIZED NUMBER "8" AND STYLIZED NUMBER "4" AND THE PHRASE "A DIVISION OF FLOOR 84 STUDIO, LLC" BELOW THEM.

CLASS 9—ELECTRICAL AND SCIENTIFIC APPARATUS

FOR APPARATUS FOR RECORDING, TRANSMISSION OR REPRODUCTION OF SOUND AND IMAGES; APPARATUS FOR SPEECH RECORDING AND REPLAYING; APPARATUS FOR TRANSMISSION OF COMMUNICATION; APPARATUS FOR TRANSMITTING AND REPRODUCING SOUND OR IMAGES; VIDEO TRANSMISSION APPARATUS; SOUND RECORDING APPARATUS; SOUND RECORDING APPARATUS AND INSTRUMENTS (U.S. CLS. 21, 23, 26, 36 AND 38).

CLASS 41—EDUCATION AND ENTERTAINMENT

FOR EDUCATIONAL AND ENTERTAINMENT SERVICES, NAMELY, A CONTINUING PROGRAM ABOUT INDEPENDENT MUSICAL ARTISTS AND MULTIMEDIA ARTISTS ACCESSIBLE BY RADIO, TELEVISION, SATELLITE, AUDIO, VIDEO AND COMPUTER NETWORKS; ENTERTAINMENT SERVICES, NAMELY, PROVIDING A WEBSITE FEATURING PHOTOGRAPHIC, AUDIO, VIDEO AND PROSE PRESENTATIONS FEATURING INDEPENDENT MUSICAL ARTISTS AND MULTIMEDIA ARTISTS; ENTERTAINMENT IN THE NATURE OF AN ON-GOING SPECIAL VARIETY, NEWS, MUSIC OR COMEDY SHOW FEATURING INDEPENDENT MUSICAL ARTISTS AND MULTIMEDIA ARTISTS BROADCAST OVER TELEVISION, SATELLITE, AUDIO, AND VIDEO MEDIA; ENTERTAINMENT IN THE NATURE OF LIVE PERFORMANCES BY INDEPENDENT MUSICAL ARTISTS AND MULTIMEDIA ARTISTS; ENTERTAINMENT IN THE NATURE OF VISUAL AND AUDIO PERFORMANCES, AND MUSICAL, VARIETY, NEWS AND COMEDY SHOWS; ENTERTAINMENT IN THE NATURE OF VISUAL AND AUDIO PERFORMANCES, NAMELY, MUSICAL BAND, ROCK GROUP, GYMNASTIC, DANCE, AND BALLET PERFORMANCES; ENTERTAINMENT SERVICES, NAMELY, NON-DOWNLOADABLE RINGTONES, PRE-RECORDED MUSIC, VIDEO AND GRAPHICS PRESENTED TO MOBILE COMMUNICATIONS DEVICES VIA A GLOBAL COMPUTER NETWORK AND WIRELESS NETWORKS; ENTERTAINMENT SERVICES, NAMELY, PROVIDING A WEB SITE FEATURING MUSICAL PERFORMANCES, MUSICAL VIDEOS, RELATED FILM CLIPS, PHOTOGRAPHS, AND OTHER MULTIMEDIA MATERIALS; ENTERTAINMENT SERVICES, NAMELY, PROVIDING ON-LINE REVIEWS OF INDEPENDENT MUSICAL ARTISTS AND MULTIMEDIA ARTISTS; ENTERTAINMENT SERVICES, NAMELY, PROVIDING PRERECORDED MUSIC, INFORMATION IN THE FIELD OF MUSIC, AND COMMENTARY AND ARTICLES ABOUT MUSIC, ALL ON-LINE VIA A GLOBAL COMPUTER NETWORK; MULTIMEDIA ENTERTAINMENT SERVICES IN THE NATURE OF RECORDING, PRODUCTION AND POST-PRODUCTION SERVICES IN THE FIELDS OF MUSIC, VIDEO, AND FILMS; PROVIDING A WEB SITE WHERE USERS CAN POST RATINGS, REVIEWS AND RECOMMENDATIONS ON EVENTS AND ACTIVITIES IN THE FIELD OF ENTERTAINMENT AND EDUCATION; PROVIDING INFORMATION, NEWS AND COMMENTARY IN THE FIELD OF ENTERTAINMENT (U.S. CLS. 100, 101 AND 107).

TARAH HARDY, EXAMINING ATTORNEY

SN 77-291,597. MARCATEL COM, S.A. DE C.V., MONTERREY, MEXICO, FILED 9-28-2007.

HONESTEL

THE MARK CONSISTS OF STANDARD CHARACTERS WITHOUT CLAIM TO ANY PARTICULAR FONT, STYLE, SIZE, OR COLOR.

CLASS 9—ELECTRICAL AND SCIENTIFIC APPARATUS

FOR MAGNETICALLY ENCODED TELEPHONE CALLING CARDS (U.S. CLS. 21, 23, 26, 36 AND 38).

CLASS 16—PAPER GOODS AND PRINTED MATTER

FOR NON-MAGNETICALLY ENCODED TELEPHONE CALLING CARDS (U.S. CLS. 2, 5, 22, 23, 29, 37, 38 AND 50).

BRIAN PINO, EXAMINING ATTORNEY

SN 77-291,615. MY RECORDS TO GO CORP., MIAMI, FL. FILED 9-28-2007.

eRecords ToGo

THE MARK CONSISTS OF STANDARD CHARACTERS WITHOUT CLAIM TO ANY PARTICULAR FONT, STYLE, SIZE, OR COLOR.

NO CLAIM IS MADE TO THE EXCLUSIVE RIGHT TO USE "ERECORDS", APART FROM THE MARK AS SHOWN.

CLASS 9—ELECTRICAL AND SCIENTIFIC APPARATUS

FOR COMPUTER STORAGE DEVICES, NAMELY, FLASH DRIVES (U.S. CLS. 21, 23, 26, 36 AND 38).

CLASS 39—TRANSPORTATION AND STORAGE

FOR ELECTRONIC STORAGE OF MEDICAL RECORDS, FINANCIAL RECORDS, PERSONAL RECORDS, EMERGENCY RECORDS, AND LEGAL RECORDS, ACCESSIBLE ONLINE (U.S. CLS. 100 AND 105).

ALLISON SCHRODY, EXAMINING ATTORNEY

SN 77-291,621. CLK BEAUTY CONCEPTS, INC., CHICAGO, IL. FILED 9-28-2007.



NO CLAIM IS MADE TO THE EXCLUSIVE RIGHT TO USE "HAIR", APART FROM THE MARK AS SHOWN.

THE COLOR(S) PINK AND BROWN IS/ARE CLAIMED AS A FEATURE OF THE MARK.

THE MARK CONSISTS OF THE LITERAL ELEMENTS "HAIR A LA CARTE" AND INTEGRATED DESIGN. THE LITERAL ELEMENTS APPEAR IN THE COLOR BROWN. THE DESIGN ALSO APPEARS IN THE COLOR BROWN AND IS A FANCIFUL REPRESENTATION OF A WOMAN'S PROFILE, COMPRISED OF HAIR AND A HUMAN EYE, WHICH ALSO FORMS THE DOT IN THE LETTER "I". THE MARK IS IN A CIRCULAR SHAPE AND PINK IS CLAIMED AS THE BACKGROUND COLOR.

CLASS 25—CLOTHING

FOR (BASED ON INTENT TO USE) HEAD SCARVES, HEADBANDS (U.S. CLS. 22 AND 39).

CLASS 26—FANCY GOODS

FOR (BASED ON USE IN COMMERCE) HAIR PIECES, WIGS, BARRETTES, HAIR CLIPS, PONYTAIL HOLDERS (U.S. CLS. 37, 39, 40, 42 AND 50).

FIRST USE 8-1-2006; IN COMMERCE 8-1-2006.

JUDITH HELFMAN, EXAMINING ATTORNEY

SN 77-291,643. MY RECORDS TO GO CORP., MIAMI, FL. FILED 9-28-2007.



NO CLAIM IS MADE TO THE EXCLUSIVE RIGHT TO USE "ERECORDS", APART FROM THE MARK AS SHOWN.

THE MARK CONSISTS OF THE WORDS "ERECORDS TOGO" WITH A RIBBON EXTENDING FROM THE TAIL OF THE STYLIZED "E" BEFORE THE WORD "RECORDS" OVER THE WORDS "RECORDS" AND "TO" TO THE TOP OF THE "G". THE FIRST LETTER "E" AND THE WORDS "TO GO" ARE STYLIZED.

CLASS 9—ELECTRICAL AND SCIENTIFIC APPARATUS

FOR COMPUTER STORAGE DEVICES, NAMELY, FLASH DRIVES (U.S. CLS. 21, 23, 26, 36 AND 38).

CLASS 39—TRANSPORTATION AND STORAGE

FOR ELECTRONIC STORAGE OF MEDICAL RECORDS, FINANCIAL RECORDS, PERSONAL RECORDS, EMERGENCY RECORDS, AND LEGAL RECORDS, ACCESSIBLE ONLINE (U.S. CLS. 100 AND 105).

ALLISON SCHRODY, EXAMINING ATTORNEY

SN 77-291,686. SOL SIMPLE L.L.C., CHICAGO, IL. FILED 9-28-2007.

Sol Simple

THE MARK CONSISTS OF STANDARD CHARACTERS WITHOUT CLAIM TO ANY PARTICULAR FONT, STYLE, SIZE, OR COLOR.

THE ENGLISH TRANSLATION OF THE WORD "SOL" IN THE MARK IS "SUN".

CLASS 29—MEATS AND PROCESSED FOODS

FOR DRIED FRUITS; DRIED VEGETABLES; PROCESSED NUTS; ROASTED NUTS; SHELLED NUTS; SNACK MIX CONSISTING PRIMARILY OF PROCESSED FRUITS, PROCESSED NUTS AND/OR RAISINS (U.S. CL. 46).

CLASS 30—STAPLE FOODS

FOR COFFEE; COFFEE BEANS; GROUND COFFEE BEANS (U.S. CL. 46).

CLASS 31—NATURAL AGRICULTURAL PRODUCTS

FOR RAW NUTS; UNPROCESSED NUTS (U.S. CLS. 1 AND 46).
BARBARA BROWN, EXAMINING ATTORNEY

SN 77-291,710. CORNERSTONE MANAGEMENT SOLUTIONS, INC., RUMSON, NJ. FILED 9-28-2007.

SNAPLENDER

THE MARK CONSISTS OF STANDARD CHARACTERS WITHOUT CLAIM TO ANY PARTICULAR FONT, STYLE, SIZE, OR COLOR.

OWNER OF U.S. REG. NOS. 2,622,251, 3,110,357 AND 3,289,045.

CLASS 9—ELECTRICAL AND SCIENTIFIC APPARATUS

FOR COMPUTER SOFTWARE SYSTEM FOR CONNECTING LENDERS AND MORTGAGE BROKERS VIA THE WORLDWIDE WEB TO PROVIDERS OF REAL ESTATE TITLE INFORMATION, SEARCHES AND TITLE INSURANCE (U.S. CLS. 21, 23, 26, 36 AND 38).

CLASS 35—ADVERTISING AND BUSINESS

FOR CONNECTING LENDERS AND MORTGAGE BROKERS WITH PROVIDERS OF REAL ESTATE TITLE INFORMATION, SEARCHES AND TITLE INSURANCE VIA COMPUTER NETWORKS AND THE WORLDWIDE WEB (U.S. CLS. 100, 101 AND 102).

LAURA KOVALSKY, EXAMINING ATTORNEY

SN 77-291,916. ELM COURT HOSPITALITY, LLC, STOCKBRIDGE, MA. FILED 9-28-2007.

VANDERBILT-SLOANE ESTATE

THE MARK CONSISTS OF STANDARD CHARACTERS WITHOUT CLAIM TO ANY PARTICULAR FONT, STYLE, SIZE, OR COLOR.

CLASS 16—PAPER GOODS AND PRINTED MATTER

FOR PAPERWEIGHTS; LETTER OPENERS; STATIONERY; DOCUMENT PORTFOLIOS; LETTER PADS; FOLDERS HOLDING NOTE PAPER PADS; POSTERS; PRINTS; BROCHURES, LEAFLETS AND BOOKS, ALL ABOUT THE HISTORY AND ARCHITECTURE OF ELM COURT; PEN SETS; TEXTILE AND PAPER GIFT BAGS (U.S. CLS. 2, 5, 22, 23, 29, 37, 38 AND 50).

CLASS 18—LEATHER GOODS

FOR ALL-PURPOSE SPORTS BAGS, UMBRELLAS, LUGGAGE TAGS, MEN'S AND WOMEN'S VALET BAGS, TOTE BAGS, DUFFLE BAGS, LUGGAGE CANVAS BAGS (U.S. CLS. 1, 2, 3, 22 AND 41).

CLASS 24—FABRICS

FOR HOME, BED AND BATH LINENS (U.S. CLS. 42 AND 50).

CLASS 25—CLOTHING

FOR CLOTHING; NAMELY, VISORS, GOLF CAPS, ROBES FOR USE BY AND SALE TO RESORT GUESTS, GOLF SHIRTS, TENNIS SHIRTS, SHORTS, SKIRTS, T-SHIRTS, SWEAT PANTS, SWEAT SHIRTS, WARM-UP SUITS (U.S. CLS. 22 AND 39).

CLASS 43—HOTEL AND RESTAURANT SERVICES

FOR RESORT AND LODGING SERVICES; RESERVATION SERVICES FOR ACCOMMODATIONS FOR OTHERS; PROVISION OF GENERAL-PURPOSE FACILITIES FOR MEETINGS, CONFERENCES AND EXHIBITIONS; PROVISION OF BANQUET AND SOCIAL FUNCTION FACILITIES; RESTAURANT, CATERING, BAR AND LOUNGE SERVICES (U.S. CLS. 100 AND 101).

CLASS 44—MEDICAL, BEAUTY AND AGRICULTURAL SERVICES

FOR HEALTH SPA SERVICES, NAMELY, PROVIDING FACIAL, HAIR, SKIN AND BODY TREATMENTS, MANICURE AND PEDICURE SERVICES, MASSAGE SERVICES, BODY WAXING SERVICES AND BEAUTY SALON SERVICES (U.S. CLS. 100 AND 101).

BENJAMIN ALLEN, EXAMINING ATTORNEY

SN 77-291,922. ELM COURT HOSPITALITY, LLC, STOCKBRIDGE, MA. FILED 9-28-2007.

ELM COURT SPA & RESORT

THE MARK CONSISTS OF STANDARD CHARACTERS WITHOUT CLAIM TO ANY PARTICULAR FONT, STYLE, SIZE, OR COLOR.

NO CLAIM IS MADE TO THE EXCLUSIVE RIGHT TO USE "SPA & RESORT", APART FROM THE MARK AS SHOWN.

CLASS 16—PAPER GOODS AND PRINTED MATTER

FOR PAPERWEIGHTS; LETTER OPENERS; STATIONERY; DOCUMENT PORTFOLIOS; LETTER PADS; FOLDERS HOLDING NOTE PAPER PADS; POSTERS; PRINTS; BROCHURES, LEAFLETS AND BOOKS, ALL ABOUT THE HISTORY AND ARCHITECTURE OF ELM COURT; PEN SETS; TEXTILE AND PAPER GIFT BAGS (U.S. CLS. 2, 5, 22, 23, 29, 37, 38 AND 50).

CLASS 18—LEATHER GOODS

FOR ALL-PURPOSE SPORTS BAGS, UMBRELLAS, LUGGAGE TAGS, MEN'S AND WOMEN'S VALET BAGS, TOTE BAGS, DUFFLE BAGS, LUGGAGE CANVAS BAGS (U.S. CLS. 1, 2, 3, 22 AND 41).

CLASS 24—FABRICS

FOR HOME, BED AND BATH LINENS (U.S. CLS. 42 AND 50).

CLASS 25—CLOTHING

FOR CLOTHING, NAMELY, VISORS, GOLF CAPS, ROBES FOR USE BY AND SALE TO RESORT GUESTS, GOLF SHIRTS, TENNIS SHIRTS, SHORTS, SKIRTS, T-SHIRTS, SWEAT PANTS, SWEAT SHIRTS, WARM-UP SUITS (U.S. CLS. 22 AND 39).

CLASS 43—HOTEL AND RESTAURANT SERVICES

FOR RESORT AND LODGING SERVICES; RESERVATION SERVICES FOR ACCOMMODATIONS FOR OTHERS; PROVISION OF GENERAL-PURPOSE FACILITIES FOR MEETINGS, CONFERENCES AND EXHIBITIONS; PROVISION OF BANQUET AND SOCIAL FUNCTION FACILITIES; RESTAURANT, CATERING, BAR AND LOUNGE SERVICES (U.S. CLS. 100 AND 101).

CLASS 44—MEDICAL, BEAUTY AND AGRICULTURAL SERVICES

FOR HEALTH SPA SERVICES, NAMELY, PROVIDING FACIAL, HAIR, SKIN AND BODY TREATMENTS, MANICURE AND PEDICURE SERVICES, MASSAGE SERVICES, BODY WAXING SERVICES AND BEAUTY SALON SERVICES (U.S. CLS. 100 AND 101).
BENJAMIN ALLEN, EXAMINING ATTORNEY

SN 77-291,927. ELM COURT HOSPITALITY, LLC, STOCKBRIDGE, MA. FILED 9-28-2007.

ELM COURT ESTATE

THE MARK CONSISTS OF STANDARD CHARACTERS WITHOUT CLAIM TO ANY PARTICULAR FONT, STYLE, SIZE, OR COLOR.

CLASS 16—PAPER GOODS AND PRINTED MATTER

FOR PAPERWEIGHTS; LETTER OPENERS; STATIONERY; DOCUMENT PORTFOLIOS; LETTER PADS; FOLDERS HOLDING NOTE PAPER PADS; POSTERS; PRINTS; BROCHURES, LEAFLETS AND BOOKS, ALL ABOUT THE HISTORY AND ARCHITECTURE OF ELM COURT; PEN SETS; TEXTILE AND PAPER GIFT BAGS (U.S. CLS. 2, 5, 22, 23, 29, 37, 38 AND 50).

CLASS 18—LEATHER GOODS

FOR ALL-PURPOSE SPORTS BAGS, UMBRELLAS, LUGGAGE TAGS, MEN'S AND WOMEN'S VALET BAGS, TOTE BAGS, DUFFLE BAGS, LUGGAGE CANVAS BAGS (U.S. CLS. 1, 2, 3, 22 AND 41).

CLASS 24—FABRICS

FOR HOME, BED AND BATH LINENS (U.S. CLS. 42 AND 50).

CLASS 25—CLOTHING

FOR CLOTHING, NAMELY, VISORS, GOLF CAPS, ROBES FOR USE BY AND SALE TO RESORT GUESTS, GOLF SHIRTS, TENNIS SHIRTS, SHORTS, SKIRTS, T-SHIRTS, SWEAT PANTS, SWEAT SHIRTS, WARM-UP SUITS (U.S. CLS. 22 AND 39).

CLASS 43—HOTEL AND RESTAURANT SERVICES

FOR RESORT AND LODGING SERVICES; RESERVATION SERVICES FOR ACCOMMODATIONS FOR OTHERS; PROVISION OF GENERAL-PURPOSE FACILITIES FOR MEETINGS, CONFERENCES AND EXHIBITIONS; PROVISION OF BANQUET AND SOCIAL FUNCTION FACILITIES; RESTAURANT, CATERING, BAR AND LOUNGE SERVICES (U.S. CLS. 100 AND 101).

CLASS 44—MEDICAL, BEAUTY AND AGRICULTURAL SERVICES

FOR HEALTH SPA SERVICES, NAMELY, PROVIDING FACIAL, HAIR, SKIN AND BODY TREATMENTS, MANICURE AND PEDICURE SERVICES, MASSAGE SERVICES, BODY WAXING SERVICES AND BEAUTY SALON SERVICES (U.S. CLS. 100 AND 101).
BENJAMIN ALLEN, EXAMINING ATTORNEY

SN 77-291,929. ELM COURT HOSPITALITY, LLC, STOCKBRIDGE, MA. FILED 9-28-2007.

VANDERBILT ELM COURT ESTATE

THE MARK CONSISTS OF STANDARD CHARACTERS WITHOUT CLAIM TO ANY PARTICULAR FONT, STYLE, SIZE, OR COLOR.

CLASS 16—PAPER GOODS AND PRINTED MATTER

FOR PAPERWEIGHTS; LETTER OPENERS; STATIONERY; DOCUMENT PORTFOLIOS; LETTER PADS; FOLDERS HOLDING NOTE PAPER PADS; POSTERS; PRINTS; BROCHURES, LEAFLETS AND BOOKS, ALL ABOUT THE HISTORY AND ARCHITECTURE OF ELM COURT; PEN SETS; TEXTILE AND PAPER GIFT BAGS (U.S. CLS. 2, 5, 22, 23, 29, 37, 38 AND 50).

CLASS 18—LEATHER GOODS

FOR ALL-PURPOSE SPORTS BAGS, UMBRELLAS, LUGGAGE TAGS, MEN'S AND WOMEN'S VALET BAGS, TOTE BAGS, DUFFLE BAGS, LUGGAGE CANVAS BAGS (U.S. CLS. 1, 2, 3, 22 AND 41).

CLASS 24—FABRICS

FOR HOME, BED AND BATH LINENS (U.S. CLS. 42 AND 50).

CLASS 25—CLOTHING

FOR CLOTHING, NAMELY, VISORS, GOLF CAPS, ROBES FOR USE BY AND SALE TO RESORT GUESTS, GOLF SHIRTS, TENNIS SHIRTS, SHORTS, SKIRTS, T-SHIRTS, SWEAT PANTS, SWEAT SHIRTS, WARM-UP SUITS (U.S. CLS. 22 AND 39).

CLASS 43—HOTEL AND RESTAURANT SERVICES

FOR RESORT AND LODGING SERVICES; RESERVATION SERVICES FOR ACCOMMODATIONS FOR OTHERS; PROVISION OF GENERAL-PURPOSE FACILITIES FOR MEETINGS, CONFERENCES AND EXHIBITIONS; PROVISION OF BANQUET AND SOCIAL FUNCTION FACILITIES; RESTAURANT, CATERING, BAR AND LOUNGE SERVICES (U.S. CLS. 100 AND 101).

CLASS 44—MEDICAL, BEAUTY AND AGRICULTURAL SERVICES

FOR HEALTH SPA SERVICES, NAMELY, PROVIDING FACIAL, HAIR, SKIN AND BODY TREATMENTS, MANICURE AND PEDICURE SERVICES, MASSAGE SERVICES, BODY WAXING SERVICES AND BEAUTY SALON SERVICES (U.S. CLS. 100 AND 101).
BENJAMIN ALLEN, EXAMINING ATTORNEY

SN 77-291,956. THE MENTAL HEALTH ASSOCIATION IN MICHIGAN, SOUTHFIELD, MI. FILED 9-28-2007.

SCHIZOPHRENICS ANONYMOUS

THE MARK CONSISTS OF STANDARD CHARACTERS WITHOUT CLAIM TO ANY PARTICULAR FONT, STYLE, SIZE, OR COLOR.

NO CLAIM IS MADE TO THE EXCLUSIVE RIGHT TO USE "SCHIZOPHRENICS", APART FROM THE MARK AS SHOWN.

CLASS 35—ADVERTISING AND BUSINESS

FOR PROMOTING PUBLIC AWARENESS OF THE IMPORTANCE OF EDUCATION REGARDING SCHIZOPHRENIA AND RELATED DISORDERS (U.S. CLS. 100, 101 AND 102).

FIRST USE 9-1-1985; IN COMMERCE 7-1-1987.

CLASS 44—MEDICAL, BEAUTY AND AGRICULTURAL SERVICES

FOR GROUP THERAPY AND COUNSELING MEETINGS FOR PERSONS WITH SCHIZOPHRENIA AND RELATED DISORDERS (U.S. CLS. 100 AND 101).

FIRST USE 9-1-1985; IN COMMERCE 7-1-1987.
BENJAMIN ALLEN, EXAMINING ATTORNEY

SN 77-291,957. SENSIBLE SENIOR HOMECARE AGENCY, VICTORVILLE, CA. FILED 9-28-2007.

SENSIBLE SENIOR HOMECARE

THE MARK CONSISTS OF STANDARD CHARACTERS WITHOUT CLAIM TO ANY PARTICULAR FONT, STYLE, SIZE, OR COLOR.

NO CLAIM IS MADE TO THE EXCLUSIVE RIGHT TO USE "SENIOR HOMECARE", APART FROM THE MARK AS SHOWN.

CLASS 16—PAPER GOODS AND PRINTED MATTER

FOR NEWSLETTERS FEATURING SENIOR HOME CARE INFORMATION FOR THE ELDERLY (U.S. CLS. 2, 5, 22, 23, 29, 37, 38 AND 50).

CLASS 35—ADVERTISING AND BUSINESS

FOR REFERRALS IN THE FIELD OF CONNECTING CARE PROVIDERS WITH THE ELDERLY IN NEED OF NON-MEDICAL INDIVIDUALIZED CARE (U.S. CLS. 100, 101 AND 102).

CLASS 37—CONSTRUCTION AND REPAIR

FOR HOUSEHOLD ASSISTANCE, NAMELY, HOUSE KEEPING MAID SERVICES AND HANDYMAN SERVICES IN THE NATURE OF BUILDING MAINTENANCE AND REPAIR, PLUMBING, ELECTRICAL CONTRACTING AND INSTALLATION AND REPAIR AND MAINTENANCE OF HEATING EQUIPMENT AND AIR CONDITIONING APPARATUS (U.S. CLS. 100, 103 AND 106).

CLASS 39—TRANSPORTATION AND STORAGE

FOR TRAVEL PLANNING, NAMELY, PROVIDING TRAVEL INFORMATION AND ARRANGING TRAVEL TOURS; FURNITURE MOVING AND PACKING FURNITURE AND PERSONAL ARTICLES OF OTHERS FOR TRANSPORTATION; TRANSPORTATION SERVICES, NAMELY, PROVIDING PERSONAL CHAUFFEUR SERVICES (U.S. CLS. 100 AND 105).

CLASS 45—PERSONAL AND LEGAL SERVICES

FOR KITCHEN ASSISTANCE IN THE NATURE OF PERSONAL CHEF SERVICES; IN-HOME SUPPORT SERVICES, NAMELY, PROVIDING NON-MEDICAL INDIVIDUAL ASSISTED LIVING SERVICES FOR PERSONAL PURPOSES IN THE NATURE OF SCHEDULING APPOINTMENTS, ANSWERING THE TELEPHONE, CHECKING MESSAGES, MAIL SORTING, HANDLING AND RECEIVING AND SECRETARIAL AND CLERICAL SERVICES TO ALLOW THE ELDERLY TO REMAIN SAFE AND COMFORTABLE AT HOME; SOCIAL SERVICES, NAMELY, COMPANIONSHIP SERVICES FOR THE ELDERLY TO AVOID AND DELAY RESIDENCE AT A NURSING HOME OR ASSISTED LIVING (U.S. CLS. 100 AND 101).

DAVID YONTEF, EXAMINING ATTORNEY

SN 77-292,075. SPOTLIGHT SURGICAL, INC., SAN FRANCISCO, CA. FILED 9-28-2007.

INVUITY

THE MARK CONSISTS OF STANDARD CHARACTERS WITHOUT CLAIM TO ANY PARTICULAR FONT, STYLE, SIZE, OR COLOR.

CLASS 10—MEDICAL APPARATUS

FOR MEDICAL AND SURGICAL DEVICES, NAMELY, SURGICAL RETRACTORS AND SURGICAL INSTRUMENTS AND APPARATUS FOR USE IN MEDICAL PROCEDURES (U.S. CLS. 26, 39 AND 44).

CLASS 42—SCIENTIFIC AND COMPUTER SERVICES

FOR DESIGN AND DEVELOPMENT FOR OTHERS IN THE FIELD OF MEDICAL AND SURGICAL DEVICES (U.S. CLS. 100 AND 101).

TASNEEM HUSSAIN, EXAMINING ATTORNEY

SN 77-292,199. FRIEDMAN, KEVIN SCOTT, CHARLOTTE, NC. FILED 9-28-2007.

SN 77-292,086. SPOTLIGHT SURGICAL, INC., SAN FRANCISCO, CA. FILED 9-28-2007.

BRITEFIELD

THE MARK CONSISTS OF STANDARD CHARACTERS WITHOUT CLAIM TO ANY PARTICULAR FONT, STYLE, SIZE, OR COLOR.

CLASS 10—MEDICAL APPARATUS

FOR MEDICAL AND SURGICAL DEVICES, NAMELY, SURGICAL RETRACTORS AND SURGICAL INSTRUMENTS AND APPARATUS FOR USE IN MEDICAL PROCEDURES (U.S. CLS. 26, 39 AND 44).

CLASS 42—SCIENTIFIC AND COMPUTER SERVICES

FOR DESIGN AND DEVELOPMENT FOR OTHERS IN THE FIELD OF MEDICAL AND SURGICAL DEVICES (U.S. CLS. 100 AND 101).

TASNEEM HUSSAIN, EXAMINING ATTORNEY

SN 77-292,163. SHRINK STOPPERS, L.L.C., HOUSTON, TX. FILED 9-28-2007.

ASAP SECURITY SERVICES

THE MARK CONSISTS OF STANDARD CHARACTERS WITHOUT CLAIM TO ANY PARTICULAR FONT, STYLE, SIZE, OR COLOR.

NO CLAIM IS MADE TO THE EXCLUSIVE RIGHT TO USE "SECURITY SERVICES", APART FROM THE MARK AS SHOWN.

CLASS 37—CONSTRUCTION AND REPAIR

FOR INSTALLATION, MAINTENANCE AND REPAIR OF INTRUSION DETECTION SYSTEMS, FIRE ALARM SYSTEMS, ACCESS CONTROL SYSTEMS, CCTV SYSTEMS, AND MOBILE SECURITY SYSTEMS (U.S. CLS. 100, 103 AND 106).

FIRST USE 1-0-2004; IN COMMERCE 1-0-2004.

CLASS 45—PERSONAL AND LEGAL SERVICES

FOR MONITORING ALARMS; MONITORING BURGLAR AND SECURITY ALARMS (U.S. CLS. 100 AND 101).

FIRST USE 1-0-2004; IN COMMERCE 1-0-2004.
KATINA MISTER, EXAMINING ATTORNEY

Neighborology

THE COLOR(S) PURPLE AND WHITE IS/ARE CLAIMED AS A FEATURE OF THE MARK.

THE MARK CONSISTS OF THE WORD "NEIGHBORLOGY" IN PURPLE LETTERS WITH THREE SMILING FACES FOR THE LETTER "O", ALL AGAINST A WHITE BACKGROUND.

CLASS 35—ADVERTISING AND BUSINESS

FOR (BASED ON USE IN COMMERCE) PROMOTING THE GOODS AND SERVICES OF OTHERS BY PROVIDING HYPERTEXT LINKS TO THE WEB SITES OF OTHERS; PROVIDING A WEB SITE AT WHICH USERS CAN OFFER GOODS FOR SALE AND BUY GOODS OFFERED BY OTHERS; PROVIDING A WEB SITE THAT ENABLES USERS TO POST ITEMS FOR SALE THROUGH ON-LINE CLASSIFIED ADVERTISEMENTS; PROVIDING A WEB SITE WHERE USERS CAN POST RATINGS, REVIEWS AND RECOMMENDATIONS ON PRODUCTS AND SERVICES; PROVIDING A WEB SITE WHICH FEATURES ADVERTISEMENTS FOR THE GOODS AND SERVICES OF OTHERS ON A GLOBAL COMPUTER NETWORK; PROVIDING ON-LINE DIRECTORY INFORMATION SERVICES ALSO FEATURING HYPERLINKS TO OTHER WEB SITES; PROVIDING SPACE AT A WEB SITE FOR THE ADVERTISEMENT OF THE GOODS AND SERVICES OF OTHERS; RENTAL OF ADVERTISING SPACE ON WEB SITES (U.S. CLS. 100, 101 AND 102).

FIRST USE 1-5-2007; IN COMMERCE 2-4-2007.

CLASS 42—SCIENTIFIC AND COMPUTER SERVICES

FOR (BASED ON USE IN COMMERCE) COMPUTER SERVICES IN THE NATURE OF CUSTOMIZED WEB PAGES FEATURING USER-DEFINED INFORMATION, PERSONAL PROFILES AND INFORMATION; COMPUTER SERVICES, NAMELY, DESIGNING AND IMPLEMENTING NETWORK WEB PAGES FOR OTHERS; CREATION AND PROVISION OF WEB PAGES TO AND FOR THIRD PARTIES; DESIGN OF HOME PAGES, COMPUTER SOFTWARE AND WEB SITES; DESIGN OF HOMEPAGES AND WEB-SITES; DISPLAYING THE WEB SITES AND IMAGES OF OTHERS ON A COMPUTER SERVER; PROVIDING CUSTOMIZED ON-LINE WEB PAGES FEATURING USER-DEFINED INFORMATION, WHICH INCLUDES SEARCH ENGINES AND ON-LINE WEB LINKS TO OTHER WEB SITES; PROVIDING A WEBSITE THAT GIVES COMPUTER USERS THE ABILITY TO UPLOAD, EXCHANGE AND SHARE PHOTOS, VIDEOS AND VIDEO LOGS (U.S. CLS. 100 AND 101).

FIRST USE 1-5-2007; IN COMMERCE 2-4-2007.

CLASS 45—PERSONAL AND LEGAL SERVICES

FOR (BASED ON USE IN COMMERCE) INTERNET BASED SOCIAL NETWORKING, INTRODUCTION, AND DATING SERVICES; ONLINE SOCIAL NETWORKING SERVICES (U.S. CLS. 100 AND 101).

FIRST USE 1-5-2007; IN COMMERCE 2-4-2007.
REBECCA SMITH, EXAMINING ATTORNEY

SN 77-292,328. GOLDEN POND, LLC, GREENVILLE, SC. FILED 9-29-2007.

SN 77-292,393. PICOZZI III, MICHAEL, MORRISTOWN, NJ. FILED 9-30-2007.

B22E MOBILE FINANCIAL SERVICES

THE MARK CONSISTS OF STANDARD CHARACTERS WITHOUT CLAIM TO ANY PARTICULAR FONT, STYLE, SIZE, OR COLOR.

NO CLAIM IS MADE TO THE EXCLUSIVE RIGHT TO USE "MOBILE FINANCIAL SERVICES", APART FROM THE MARK AS SHOWN.

CLASS 35—ADVERTISING AND BUSINESS

FOR PROVIDING NON-TRADITIONAL FINANCIAL SERVICES THROUGH A MOBILE PLATFORM, NAMELY, PAYROLL DELIVERY SERVICES IN THE NATURE OF THE ADMINISTRATION OF BUSINESS PAYROLL FOR OTHERS, AND PAYROLL FULFILLMENT SERVICES IN THE NATURE OF PAYROLL PROCESSING SERVICES (U.S. CLS. 100, 101 AND 102).

CLASS 36—INSURANCE AND FINANCIAL

FOR PROVIDING NON-TRADITIONAL FINANCIAL SERVICES THROUGH A MOBILE PLATFORM, NAMELY, PROVIDING REMOTE CHECK CASHING, AUTOMATED TELLER MACHINES (ATMS), AND PREPAID DEBIT CARDS (U.S. CLS. 100, 101 AND 102).
 JAMES MACFARLANE, EXAMINING ATTORNEY

SN 77-292,329. GOLDEN POND, LLC, GREENVILLE, SC. FILED 9-29-2007.



NO CLAIM IS MADE TO THE EXCLUSIVE RIGHT TO USE "MOBILE FINANCIAL SERVICES", APART FROM THE MARK AS SHOWN.

THE MARK CONSISTS OF STYLIZED "B22E" WITH TEXT "MOBILE FINANCIAL SERVICES".

CLASS 35—ADVERTISING AND BUSINESS

FOR PROVIDING NON-TRADITIONAL FINANCIAL SERVICES THROUGH A MOBILE PLATFORM, NAMELY, PAYROLL DELIVERY SERVICES IN THE NATURE OF THE ADMINISTRATION OF BUSINESS PAYROLL FOR OTHERS, AND PAYROLL FULFILLMENT SERVICES IN THE NATURE OF PAYROLL PROCESSING SERVICES (U.S. CLS. 100, 101 AND 102).

CLASS 36—INSURANCE AND FINANCIAL

FOR PROVIDING NON-TRADITIONAL FINANCIAL SERVICES THROUGH A MOBILE PLATFORM, NAMELY, PROVIDING REMOTE CHECK CASHING, AUTOMATED TELLER MACHINES (ATMS), AND PREPAID DEBIT CARDS (U.S. CLS. 100, 101 AND 102).
 JAMES MACFARLANE, EXAMINING ATTORNEY



THE MARK CONSISTS OF THE SHOWING OF A STYLIZED CROSS WITHIN A CIRCLE THE HORIZONTAL ARM OF THE CROSS BEARING THE TERM "ANIMUS" AND THE TERM "FEROCITAS EST INVICTUS" IN THE LOWER PORTION OF THE CIRCLE.

THE FOREIGN WORDING IN THE MARK TRANSLATES INTO ENGLISH AS FIERCENESS IS INVINCIBLE.

CLASS 25—CLOTHING

FOR SPORT SHIRTS; T-SHIRTS; POLO SHIRTS; SHIRTS (U.S. CLS. 22 AND 39).

CLASS 32—LIGHT BEVERAGES

FOR DRINKING WATER; ENERGY DRINKS; ISOTONIC DRINKS; SOFT DRINKS; SPORTS DRINKS (U.S. CLS. 45, 46 AND 48).
 RAUL CORDOVA, EXAMINING ATTORNEY

SN 77-292,463. FD & D LLC, HOWELL, NJ. FILED 9-30-2007.

Beat My Beat

THE MARK CONSISTS OF STANDARD CHARACTERS WITHOUT CLAIM TO ANY PARTICULAR FONT, STYLE, SIZE, OR COLOR.

CLASS 9—ELECTRICAL AND SCIENTIFIC APPARATUS

FOR AUDIO RECORDINGS FEATURING MUSIC, MUSIC LESSONS, MUSIC PRODUCTION LESSONS, MUSICIANS; COMPUTER SOFTWARE FOR PROCESSING DIGITAL MUSIC FILES; DOWNLOADABLE MP3 FILES, MP3 RECORDINGS, ONLINE DISCUSSION BOARDS, WEBCASTS AND PODCASTS FEATURING MUSIC, AUDIO BOOKS AND NEWS BROADCASTS; DOWNLOADABLE MUSICAL SOUND RECORDINGS; DOWNLOADABLE RING TONES, GRAPHICS AND MUSIC VIA A GLOBAL COMPUTER NETWORK AND WIRELESS DEVICES; DOWNLOADABLE VIDEO RECORDINGS FEATURING MUSIC, MUSIC LESSONS, MUSIC PRODUCTION LESSONS, MUSICIANS; MUSIC-COMPOSITION SOFTWARE; MUSICAL SOUND RECORDINGS; MUSICAL VIDEO RECORDINGS; SOUND RECORDINGS FEATURING MUSIC, MUSIC LESSONS, MUSIC PRODUCTION LESSONS, MUSICIANS; VIDEO RECORDINGS FEATURING MUSIC, MUSIC LESSONS, MUSIC PRODUCTION LESSONS, MUSICIANS (U.S. CLS. 21, 23, 26, 36 AND 38).

CLASS 35—ADVERTISING AND BUSINESS

FOR ARRANGING PERSONAL APPEARANCES BY PERSONS WORKING IN THE FIELD OF FILM, MUSIC, TELEVISION, ENTERTAINMENT OR SPORT; MUSIC SELECTION SERVICES FOR USE IN ADVERTISING; ON-LINE RETAIL STORE SERVICES FEATURING DOWNLOADABLE PRE-RECORDED MUSIC AND VIDEO; PERSONAL MANAGEMENT SERVICES FOR MUSICAL PERFORMERS; PROVIDING SOUND AND MUSIC LISTENING EQUIPMENT IN RETAIL STORES FOR CUSTOMERS TO PREVIEW COMPACT DISCS, TAPES, DVD'S, DVR'S, AND OTHER MEDIA PRIOR TO PURCHASE; RETAIL MUSIC AND RECORD STORES (U.S. CLS. 100, 101 AND 102).

CLASS 36—INSURANCE AND FINANCIAL

FOR CHARITABLE FUND RAISING SERVICES BY MEANS OF MUSICAL CONCERTS; COLLECTING LICENSE FEES ON BEHALF OF INDEPENDENT WRITERS AND PUBLISHERS AND MAKING PAYMENTS TO THE COPYRIGHT OWNERS OF THE MUSIC (U.S. CLS. 100, 101 AND 102).

CLASS 41—EDUCATION AND ENTERTAINMENT

FOR ENTERTAINMENT IN THE NATURE OF AN ONGOING SPECIAL VARIETY, NEWS, MUSIC OR COMEDY SHOW FEATURING MUSIC BROADCAST OVER TELEVISION, SATELLITE, AUDIO, AND VIDEO MEDIA; ENTERTAINMENT IN THE NATURE OF VISUAL AND AUDIO PERFORMANCES, NAMELY, MUSICAL BAND, ROCK GROUP, GYMNASIAC, DANCE, AND BALLET PERFORMANCES; ENTERTAINMENT NAMELY, LIVE PERFORMANCES BY A MUSICAL BAND; ENTERTAINMENT SERVICES, NAMELY, AN ONLINE ACTIVITY WHERE YOU CREATE YOUR OWN MUSIC VIDEOS; ENTERTAINMENT SERVICES, NAMELY, NON-DOWNLOADABLE RINGTONES, PRE-RECORDED MUSIC, VIDEO AND GRAPHICS PRESENTED TO MOBILE COMMUNICATIONS DEVICES VIA A GLOBAL COMPUTER NETWORK AND WIRELESS NETWORKS; ENTERTAINMENT SERVICES, NAMELY, PROVIDING A WEB SITE FEATURING MUSICAL PERFORMANCES, MUSICAL VIDEOS, RELATED FILM CLIPS, PHOTOGRAPHS, AND OTHER MULTIMEDIA MATERIALS; ENTERTAINMENT SERVICES, NAMELY, PROVIDING ON-LINE REVIEWS OF MUSICIANS, MUSIC; ENTERTAINMENT SERVICES, NAMELY, PROVIDING PRERECORDED MUSIC, INFORMATION IN THE FIELD OF MUSIC, AND COMMENTARY AND ARTICLES ABOUT MUSIC, ALL ONLINE VIA A GLOBAL COMPUTER NETWORK; ENTERTAINMENT, NAMELY LIVE MUSIC CONCERTS; ENTERTAINMENT, NAMELY LIVE PERFORMANCES BY MUSICAL BANDS; HOSTING A BACK TO SCHOOL EVENT IN A SHOPPING CENTER FEATURING PRIZES, GAMES, MUSIC, AND A FASHION SHOW; INSTRUCTION IN THE FIELD OF MUSIC; MULTIMEDIA ENTERTAINMENT SERVICES IN THE NATURE OF

RECORDING, PRODUCTION AND POST-PRODUCTION SERVICES IN THE FIELDS OF MUSIC, VIDEO, AND FILMS; MULTIMEDIA PUBLISHING OF BOOKS, MAGAZINES, JOURNALS, SOFTWARE, GAMES, MUSIC, AND ELECTRONIC PUBLICATIONS; MUSIC PRODUCTION SERVICES; MUSIC PUBLISHING SERVICES; MUSIC SELECTION SERVICES FOR USE IN TV, FILM, RADIO AND VIDEO GAMES; PLANNING ARRANGEMENT OF SHOWING MOVIES, SHOWS, PLAYS OR MUSICAL PERFORMANCES; POST-PRODUCTION EDITING SERVICES IN THE FIELD OF MUSIC, VIDEOS AND FILMS; PRESENTATION OF MUSICAL PERFORMANCE; PRODUCTION OF SOUND AND MUSIC VIDEO RECORDINGS; PROVIDING FACILITIES FOR MOVIES, SHOWS, PLAYS, MUSIC OR EDUCATIONAL TRAINING; PROVIDING RATINGS FOR TELEVISION, MOVIE, MUSIC, VIDEO AND VIDEO GAME CONTENT; PUBLICATION OF MUSICAL TEXTS; RENTAL OF PHONOGRAPHIC AND MUSIC RECORDINGS; TEACHING IN THE FIELD OF MUSIC (U.S. CLS. 100, 101 AND 107).

CLASS 42—SCIENTIFIC AND COMPUTER SERVICES

FOR COMPUTER SERVICES, NAMELY, DIGITAL FORMATTING AND COMPRESSION OF MUSIC AND IMAGES, NAMELY, PROCESSING OF DIGITAL MUSIC AND VIDEO IMAGES INTO DOWNLOADABLE PRODUCTS; COMPUTER SERVICES, NAMELY, UPLOADING MUSIC TO THE INTERNET FOR OTHERS (U.S. CLS. 100 AND 101).

KATHERINE E. HALMEN, EXAMINING ATTORNEY

SN 77-292,514. MRESULT CORPORATION, NEW LONDON, CT. FILED 10-1-2007.

MRESULT

THE MARK CONSISTS OF STANDARD CHARACTERS WITHOUT CLAIM TO ANY PARTICULAR FONT, STYLE, SIZE, OR COLOR.

CLASS 35—ADVERTISING AND BUSINESS

FOR BUSINESS MANAGEMENT CONSULTANCY AS WELL AS DEVELOPMENT OF PROCESSES FOR THE ANALYSIS AND THE IMPLEMENTATION OF STRATEGY PLANS AND MANAGEMENT PROJECTS; INFORMATION AND DATA COMPILING AND ANALYZING RELATING TO BUSINESS MANAGEMENT (U.S. CLS. 100, 101 AND 102).

FIRST USE 6-0-2004; IN COMMERCE 6-0-2004.

CLASS 42—SCIENTIFIC AND COMPUTER SERVICES

FOR COMPUTER SOFTWARE DEVELOPMENT (U.S. CLS. 100 AND 101).

FIRST USE 6-0-2004; IN COMMERCE 6-0-2004.
EMILY CARLSEN, EXAMINING ATTORNEY

SN 77-292,551. THE FIRST MARBLEHEAD CORPORATION, BOSTON, MA. FILED 10-1-2007.

SN 77-292,577. E2E MATERIALS, LLC, ITHACA, NY. FILED 10-1-2007.

ASTRIVE ADVANTAGE

THE MARK CONSISTS OF STANDARD CHARACTERS WITHOUT CLAIM TO ANY PARTICULAR FONT, STYLE, SIZE, OR COLOR.
OWNER OF U.S. REG. NO. 3,091,602.

CLASS 35—ADVERTISING AND BUSINESS

FOR ADVERTISING, MARKETING AND COORDINATION OF STUDENT LOAN PROGRAMS FOR OTHERS (U.S. CLS. 100, 101 AND 102).

CLASS 36—INSURANCE AND FINANCIAL

FOR STUDENT LOAN FINANCING SERVICES (U.S. CLS. 100, 101 AND 102).
SUSAN LESLIE DUBOIS, EXAMINING ATTORNEY

SN 77-292,573. E2E MATERIALS, LLC, ITHACA, NY. FILED 10-1-2007.

E2E MATERIALS

THE MARK CONSISTS OF STANDARD CHARACTERS WITHOUT CLAIM TO ANY PARTICULAR FONT, STYLE, SIZE, OR COLOR.

NO CLAIM IS MADE TO THE EXCLUSIVE RIGHT TO USE "MATERIALS", APART FROM THE MARK AS SHOWN.

CLASS 19—NON-METALLIC BUILDING MATERIALS

FOR NON-METALLIC BOARDS FOR CONSTRUCTION INCLUDING BIODEGRADABLE BOARDS (U.S. CLS. 1, 12, 33 AND 50).

CLASS 20—FURNITURE AND ARTICLES NOT OTHERWISE CLASSIFIED

FOR FURNITURE AND CABINETS, NAMELY, BIODEGRADABLE FURNITURE AND CABINETS (U.S. CLS. 2, 13, 22, 25, 32 AND 50).

CLASS 28—TOYS AND SPORTING GOODS

FOR SKATEBOARDS INCLUDING BIODEGRADABLE SKATEBOARD DECKS (U.S. CLS. 22, 23, 38 AND 50).
JUDITH HELFMAN, EXAMINING ATTORNEY

e2e Materials

NO CLAIM IS MADE TO THE EXCLUSIVE RIGHT TO USE "MATERIALS", APART FROM THE MARK AS SHOWN.

CLASS 19—NON-METALLIC BUILDING MATERIALS

FOR NON-METALLIC BOARDS FOR CONSTRUCTION INCLUDING BIODEGRADABLE BOARDS (U.S. CLS. 1, 12, 33 AND 50).

CLASS 20—FURNITURE AND ARTICLES NOT OTHERWISE CLASSIFIED

FOR FURNITURE AND CABINETS, NAMELY BIODEGRADABLE FURNITURE AND CABINETS (U.S. CLS. 2, 13, 22, 25, 32 AND 50).

CLASS 28—TOYS AND SPORTING GOODS

FOR SKATEBOARDS INCLUDING BIODEGRADABLE SKATEBOARD DECKS (U.S. CLS. 22, 23, 38 AND 50).
JUDITH HELFMAN, EXAMINING ATTORNEY

SN 77-292,583. ELIFECARE ENTERPRISES, ALPHARETTA, GA. FILED 10-1-2007.

Reinventing the Way Healthcare Works

THE MARK CONSISTS OF STANDARD CHARACTERS WITHOUT CLAIM TO ANY PARTICULAR FONT, STYLE, SIZE, OR COLOR.

CLASS 35—ADVERTISING AND BUSINESS

FOR MANAGEMENT AND BUSINESS CONSULTING SERVICES IN THE FIELD OF HEALTHCARE (U.S. CLS. 100, 101 AND 102).
FIRST USE 7-1-2007; IN COMMERCE 7-1-2007.

CLASS 42—SCIENTIFIC AND COMPUTER SERVICES

FOR CONSULTING SERVICES IN THE FIELD OF DESIGN, SELECTION, IMPLEMENTATION AND USE OF COMPUTER HARDWARE AND SOFTWARE SYSTEMS FOR OTHERS; COMPUTER SOFTWARE DEVELOPMENT (U.S. CLS. 100 AND 101).
FIRST USE 7-1-2007; IN COMMERCE 7-1-2007.
MIDGE BUTLER, EXAMINING ATTORNEY

SN 77-292,599. ALSCAN, INC., BIRMINGHAM, AL. FILED 10-1-2007.

SN 77-292,636. SYLVIA C. MACKEY, BALTIMORE, MD. AND LAURA J. MACKEY, BALTIMORE, MD. FILED 10-1-2007.

ALSCAN

THE MARK CONSISTS OF STANDARD CHARACTERS WITHOUT CLAIM TO ANY PARTICULAR FONT, STYLE, SIZE, OR COLOR.

CLASS 35—ADVERTISING AND BUSINESS

FOR DISTRIBUTORSHIP SERVICES IN THE FIELD OF COMMUNICATIONS SYSTEMS (U.S. CLS. 100, 101 AND 102).
FIRST USE 5-1-1981; IN COMMERCE 5-1-1981.

CLASS 37—CONSTRUCTION AND REPAIR

FOR REPAIR, SERVICING AND MAINTENANCE OF COMMUNICATIONS SYSTEMS (U.S. CLS. 100, 103 AND 106).
FIRST USE 5-1-1981; IN COMMERCE 5-1-1981.
LINDA E. BLOHM, EXAMINING ATTORNEY

SN 77-292,606. ORPHANED ENTERPRISES, LLC, DALLAS, TX. FILED 10-1-2007.

INACANGREETINGS.COM

THE MARK CONSISTS OF STANDARD CHARACTERS WITHOUT CLAIM TO ANY PARTICULAR FONT, STYLE, SIZE, OR COLOR.

CLASS 16—PAPER GOODS AND PRINTED MATTER

FOR GREETING CARDS (U.S. CLS. 2, 5, 22, 23, 29, 37, 38 AND 50).

CLASS 30—STAPLE FOODS

FOR GIFT SETS COMPRISING CANS FILLED PRIMARILY WITH CANDY, COOKIES, CRACKERS, BARBECUE SAUCE, STEAK SAUCE AND BARBECUE DRY RUBS IN ADDITION TO A COMBINATION OF SAUSAGE, CHEESE, SNACK DIP MIXES, DRINK MIXES, SMALL TOYS AND NOVELTY ITEMS (U.S. CL. 46).

CLASS 35—ADVERTISING AND BUSINESS

FOR ONLINE ORDERING AND MAIL ORDER SERVICES FEATURING GIFT SETS PACKAGED IN CANS (U.S. CLS. 100, 101 AND 102).
LINDA MICKLEBURGH, EXAMINING ATTORNEY

SCORE BIG IN LIFE!

THE MARK CONSISTS OF STANDARD CHARACTERS WITHOUT CLAIM TO ANY PARTICULAR FONT, STYLE, SIZE, OR COLOR.

CLASS 14—JEWELRY

FOR RUBBER OR SILICON WRISTBANDS IN THE NATURE OF A BRACELET (U.S. CLS. 2, 27, 28 AND 50).

CLASS 21—HOUSEWARES AND GLASS

FOR CUPS; MUGS (U.S. CLS. 2, 13, 23, 29, 30, 33, 40 AND 50).

CLASS 24—FABRICS

FOR PILLOWCASES (U.S. CLS. 42 AND 50).

CLASS 25—CLOTHING

FOR SHIRTS; SHORT-SLEEVED OR LONG-SLEEVED T-SHIRTS; SPORTS SHIRTS; SWEAT SHIRTS (U.S. CLS. 22 AND 39).
STEVEN JACKSON, EXAMINING ATTORNEY

SN 77-292,641. TRAK-1 TECHNOLOGY, INC., TULSA, OK. FILED 10-1-2007.



NO CLAIM IS MADE TO THE EXCLUSIVE RIGHT TO USE "TECHNOLOGY", APART FROM THE MARK AS SHOWN.

THE MARK CONSISTS OF THE WORDS "TRAK-1" AND "TECHNOLOGY" WRITTEN IN STYLIZED SCRIPT WITH A FINGERPRINT AND MAGNIFYING GLASS APPEARING ABOVE THE WORDS "TRAK-1" AND "TECHNOLOGY".

CLASS 35—ADVERTISING AND BUSINESS

FOR BUSINESS ENQUIRIES AND INVESTIGATIONS; BUSINESS INVESTIGATIONS; BUSINESS INVESTIGATIONS, EVALUATIONS, EXPERT APPRAISALS, INFORMATION AND RESEARCH; COMPUTERIZED ON-LINE ORDERING SERVICES IN THE FIELD OF PUBLIC INFORMATION GATHERING ABOUT PEOPLE AND BUSINESS ENTITIES, EMPLOYMENT AND PREEMPLOYMENT SCREENING SERVICES, AND BACKGROUND INVESTIGATION SERVICES; ON-LINE ORDERING SERVICES FEATURING PUBLIC INFORMATION GATHERING ABOUT PEOPLE AND BUSINESS ENTITIES, EMPLOYMENT AND PREEMPLOYMENT SCREENING SERVICES, AND BACKGROUND INVESTIGATION SERVICES (U.S. CLS. 100, 101 AND 102).
FIRST USE 1-1-2006; IN COMMERCE 1-1-2006.

CLASS 42—SCIENTIFIC AND COMPUTER SERVICES

FOR COMPUTER SERVICES, NAMELY, HOSTING AND MAINTAINING AN ONLINE WEBSITE FOR OTHERS TO GATHER PUBLIC INFORMATION ABOUT PEOPLE AND BUSINESS ENTITIES, CONDUCT RESIDENT SCREENING, CONDUCT EMPLOYMENT AND PREEMPLOYMENT SCREENING, CONDUCT BACKGROUND INVESTIGATIONS, AND OBTAIN AND VERIFY DATA ABOUT PEOPLE AND BUSINESS ENTITIES; PROVIDING TEMPORARY USE OF ON-LINE NON-DOWNLOADABLE SOFTWARE FOR GATHERING PUBLIC INFORMATION ABOUT PEOPLE AND BUSINESS ENTITIES, RESIDENT SCREENING SERVICES, EMPLOYMENT AND PREEMPLOYMENT SCREENING SERVICES, BACKGROUND INVESTIGATION SERVICES, AND OBTAINING AND VERIFYING DATA ABOUT PEOPLE AND BUSINESS ENTITIES THIS DOES NOT INCLUDE PROVIDING ON-LINE COMPUTER GAMES THAT ARE PLAYED ON-LINE (U.S. CLS. 100 AND 101).
FIRST USE 1-1-2006; IN COMMERCE 1-1-2006.

CLASS 45—PERSONAL AND LEGAL SERVICES

FOR BACKGROUND INVESTIGATION AND RESEARCH SERVICES; INVESTIGATION OR SURVEILLANCE ON BACKGROUND PROFILES; PREEMPLOYMENT BACKGROUND INVESTIGATION SERVICES; PRE-EMPLOYMENT BACKGROUND SCREENING (U.S. CLS. 100 AND 101).
FIRST USE 1-1-2006; IN COMMERCE 1-1-2006.
BRENDAN MCCAULEY, EXAMINING ATTORNEY

SN 77-292,703. HANDI-FOIL CORPORATION, WHEELING, IL. FILED 10-1-2007.

BAKE AMERICAN

THE MARK CONSISTS OF STANDARD CHARACTERS WITHOUT CLAIM TO ANY PARTICULAR FONT, STYLE, SIZE, OR COLOR.

NO CLAIM IS MADE TO THE EXCLUSIVE RIGHT TO USE "BAKE", APART FROM THE MARK AS SHOWN.

CLASS 6—METAL GOODS

FOR ALUMINUM FOIL AND ALUMINUM FOIL PAPER (U.S. CLS. 2, 12, 13, 14, 23, 25 AND 50).

CLASS 21—HOUSEWARES AND GLASS

FOR NON-ELECTRIC ALUMINUM AND ROASTING PANS, CONTAINERS FORMED OF ALUMINUM FOIL WITH PLASTIC LIDS FOR HOUSEHOLD USE, PANS FORMED OF ALUMINUM FOIL WITH WIRE HANDLES (U.S. CLS. 2, 13, 23, 29, 30, 33, 40 AND 50).
REBECCA SMITH, EXAMINING ATTORNEY

SN 77-292,728. ZATARAIN'S PARTNERSHIP, L.P., GRETN, LA. FILED 10-1-2007.

ZATA-BITES

THE MARK CONSISTS OF STANDARD CHARACTERS WITHOUT CLAIM TO ANY PARTICULAR FONT, STYLE, SIZE, OR COLOR.

CLASS 29—MEATS AND PROCESSED FOODS

FOR FROZEN APPETIZERS CONSISTING PRIMARILY OF CHICKEN OR SEAFOOD (U.S. CL. 46).

CLASS 30—STAPLE FOODS

FOR FROZEN APPETIZERS CONSISTING PRIMARILY OF CORNMEAL (U.S. CL. 46).
BRENDAN MCCAULEY, EXAMINING ATTORNEY

SN 77-292,746. SHELTON, LINDA, BAR HARBOR, ME. FILED 10-1-2007.

Life In Tow

THE MARK CONSISTS OF STANDARD CHARACTERS WITHOUT CLAIM TO ANY PARTICULAR FONT, STYLE, SIZE, OR COLOR.

CLASS 16—PAPER GOODS AND PRINTED MATTER

FOR PRINTED MATTER AND ART WORKS, NAMELY, POSTERS, GREETING CARDS, STATIONARY, POST CARDS, BUMPER STICKERS, PRINTS, PAINTINGS, AND PHOTOGRAPHS (U.S. CLS. 2, 5, 22, 23, 29, 37, 38 AND 50).

CLASS 25—CLOTHING

FOR CLOTHING, NAMELY, T-SHIRTS, SHIRTS, SWEATSHIRTS, FLEECE PULLOVERS, POLO SHIRTS, RUGBY SHIRTS, SHORTS, PANTS, HATS, CAPS, VISORS, JACKETS, SWEATERS, SCARVES, TIES, SOCKS, BOXER SHORTS, SLEEPWEAR, AND UNDERGARMENTS (U.S. CLS. 22 AND 39).
BRIAN CALLAGHAN, EXAMINING ATTORNEY

SN 77-292,754. MATCHMINE LLC, NEEDHAM, MA. FILED 10-1-2007.

SN 77-292,795. THE FARM TO CONSUMER LEGAL DEFENSE FUND, FALLS CHURCH, VA. FILED 10-1-2007.



THE MARK CONSISTS OF DESIGN OF MATCHSTICK ON A CIRCLE BACKGROUND.

CLASS 9—ELECTRICAL AND SCIENTIFIC APPARATUS

FOR COMPUTER SOFTWARE FOR IDENTIFYING, ACQUIRING, AND DELIVERING DIGITAL CONTENT TO ELECTRONIC DEVICES AND PERSONAL COMPUTERS BASED ON UNIQUE USER INTERESTS AND TASTES, AND ACCOMPANYING USER DOCUMENTATION AND PREFERENCE IDENTIFICATION SCHEMA (U.S. CLS. 21, 23, 26, 36 AND 38).

CLASS 42—SCIENTIFIC AND COMPUTER SERVICES

FOR COMPUTER SERVICES, NAMELY, PROVIDING TEMPORARY USE OF NON-DOWNLOADABLE SOFTWARE INTERFACES THAT DELIVER PERSONALIZED DIGITAL CONTENT BASED ON UNIQUE USER INTERESTS AND TASTES VIA THE INTERNET (U.S. CLS. 100 AND 101).

ADA HAN, EXAMINING ATTORNEY

SN 77-292,757. DEL RIO, JASON, HIALEAH, FL. FILED 10-1-2007.

J Da High

THE MARK CONSISTS OF STANDARD CHARACTERS WITHOUT CLAIM TO ANY PARTICULAR FONT, STYLE, SIZE, OR COLOR.

CLASS 9—ELECTRICAL AND SCIENTIFIC APPARATUS

FOR PRE-RECORDED CDS, VIDEO TAPES, LASER DISKS AND DVDS FEATURING MUSIC (U.S. CLS. 21, 23, 26, 36 AND 38).

CLASS 41—EDUCATION AND ENTERTAINMENT

FOR ENTERTAINMENT IN THE NATURE OF LIVE PERFORMANCES BY A RAPPER (U.S. CLS. 100, 101 AND 107).

ADA HAN, EXAMINING ATTORNEY



THE MARK CONSISTS OF THE SILHOUETTE OF A BARN SITUATED TO THE LEFT OF THE SILHOUETTE OF A CITY THAT SITS BEYOND A HILL. ALL OF WHICH IS ON TOP OF A PEDESTAL AND IS ENCLOSED WITHIN A CIRCLE.

CLASS 35—ADVERTISING AND BUSINESS

FOR LOBBYING SERVICES, NAMELY PROMOTING THE INTERESTS OF FARMERS IN THE FIELDS OF LEGISLATION AND REGULATION; MANAGEMENT AND BUSINESS CONSULTING SERVICES IN THE FIELD OF FARMING (U.S. CLS. 100, 101 AND 102).

FIRST USE 7-4-2007; IN COMMERCE 7-4-2007.

CLASS 45—PERSONAL AND LEGAL SERVICES

FOR LEGAL SERVICES: PROVIDING INFORMATION RELATING TO LEGAL AFFAIRS (U.S. CLS. 100 AND 101).

FIRST USE 7-4-2007; IN COMMERCE 7-4-2007.

JENNY PARK, EXAMINING ATTORNEY

SN 77-292,796. BARRETT SPORTS GROUP, LLC, MANHATTAN BEACH, CA. FILED 10-1-2007.

BARRETT SPORTS GROUP

THE MARK CONSISTS OF STANDARD CHARACTERS WITHOUT CLAIM TO ANY PARTICULAR FONT, STYLE, SIZE, OR COLOR.

NO CLAIM IS MADE TO THE EXCLUSIVE RIGHT TO USE "SPORTS GROUP", APART FROM THE MARK AS SHOWN.

CLASS 35—ADVERTISING AND BUSINESS

FOR BUSINESS MANAGEMENT CONSULTING AND ADVISORY SERVICES; PROVIDING BUSINESS MANAGEMENT INFORMATION IN CONNECTION WITH CONSULTING AND ADVISORY SERVICES IN THE FIELD OF STRATEGIC PLANNING; NEGOTIATION AND SETTLEMENT OF COMMERCIAL TRANSACTIONS FOR THIRD PARTIES; ACQUISITION AND MERGER CONSULTATION; BUSINESS SERVICES, NAMELY, FACILITIES MANAGEMENT OF TECHNICAL OPERATIONS; CONDUCTING MARKETING STUDIES; MARKET RESEARCH STUDIES; MARKET ANALYSIS; MARKET REPORTS AND STUDIES; ECONOMIC FORECASTING AND ANALYSIS; PROVIDING INFORMATION AND ANALYSIS IN THE FIELDS OF ECONOMICS AND BUSINESS (U.S. CLS. 100, 101 AND 102).

FIRST USE 3-21-2000; IN COMMERCE 3-21-2000.

CLASS 36—INSURANCE AND FINANCIAL

FOR FINANCIAL VALUATION OF PERSONAL PROPERTY AND REAL ESTATE; FISCAL VALUATIONS AND ASSESSMENTS; FINANCIAL DUE DILIGENCE; FINANCIAL ANALYSIS AND CONSULTATION; FINANCIAL CONSULTATION IN THE FIELD OF THE SPORTS AND ENTERTAINMENT INDUSTRY (U.S. CLS. 100, 101 AND 102).

FIRST USE 3-21-2000; IN COMMERCE 3-21-2000.
JENNY PARK, EXAMINING ATTORNEY

SN 77-292,991. F10 ENTERPRISES, INC., BURBANK, CA.
FILED 10-1-2007.



THE MARK CONSISTS OF A STYLIZED OCTOPUS WITH FOUR LEGS. THE FIRST LEG HAS 4 SUCTION CUPS ON IT AND 2 DRIPS COMING OFF IT. THE SECOND LEG HAS 5 SUCTION CUPS. THE THIRD LEG HAS 4 SUCTION CUPS AND ONE DRIP, AND THE FOURTH LEG HAS FOUR SUCTION CUPS AND 2 DRIPS; THERE IS A BANNER ACROSS THE BODY OF THE OCTOPUS. IT HAS THE STYLIZED LETTERING "SUGI" ON IT. THERE IS A DRIP OFF THE "U" AND THE "I". THERE ARE WINGS COMING OFF THE LEFT AND RIGHT SIDE OF THE BANNER; THE OCTOPUS HAS TWO EYES WITH EYEBROWS ABOVE AND A SMALL MOUTH BELOW.

SN 77-292,804. PERLMAN ERIC, GRANADA HILLS, CA.
FILED 10-1-2007.

GiftGrinder

THE MARK CONSISTS OF STANDARD CHARACTERS WITHOUT CLAIM TO ANY PARTICULAR FONT, STYLE, SIZE, OR COLOR.

CLASS 35—ADVERTISING AND BUSINESS

FOR COMPUTERIZED ON-LINE GIFT ORDERING SERVICE WHICH MATCHES THE GIFT GIVER'S REQUIREMENTS WITH THE GIFT RECIPIENT'S WANTS AND NEEDS (U.S. CLS. 100, 101 AND 102).

CLASS 42—SCIENTIFIC AND COMPUTER SERVICES

FOR COMPUTER SERVICES, NAMELY, HOSTING ON-LINE INTERACTIVE PUBLIC CALENDARS THAT ALLOW MULTIPLE PARTICIPANTS TO SHARE EVENT SCHEDULES, FACILITY RESERVATIONS, AND TRANSPORTATION REQUESTS (U.S. CLS. 100 AND 101).
JORDAN BAKER, EXAMINING ATTORNEY

CLASS 14—JEWELRY

FOR (BASED ON INTENT TO USE) JEWELRY, BRACELETS, NECKLACES, EARRINGS, WATCHES, CUFFLINKS (U.S. CLS. 2, 27, 28 AND 50).

CLASS 18—LEATHER GOODS

FOR (BASED ON INTENT TO USE) BACKPACKS, WALLETS, TRAVELING BAGS, PURSES, HANDBAGS, COIN PURSES (U.S. CLS. 1, 2, 3, 22 AND 41).

CLASS 20—FURNITURE AND ARTICLES NOT OTHERWISE CLASSIFIED

FOR (BASED ON INTENT TO USE) PILLOWS (U.S. CLS. 2, 13, 22, 25, 32 AND 50).

CLASS 25—CLOTHING

FOR CLOTHING, NAMELY, SHIRTS, T-SHIRTS, SHOES, JEANS, SKIRTS, SHORTS, SWEATSHIRTS, SCARVES, PAJAMAS, DRESSES, PANTS, SOCKS, UNDERWEAR, SWEATPANTS, COATS, JACKETS, FLEECE TOPS, BATHING SUITS (U.S. CLS. 22 AND 39).
FIRST USE 3-30-2005; IN COMMERCE 3-30-2005.

CLASS 28—TOYS AND SPORTING GOODS

FOR (BASED ON INTENT TO USE) PLUSH TOYS, VINYL ACTION FIGURES (U.S. CLS. 22, 23, 38 AND 50).
JOHN GARTNER, EXAMINING ATTORNEY

SN 77-293,004. FOOD SAFETY NET SERVICES, LTD., SAN ANTONIO, TX. FILED 10-1-2007.



NO CLAIM IS MADE TO THE EXCLUSIVE RIGHT TO USE "FOOD SAFETY NET SERVICES", APART FROM THE MARK AS SHOWN.

THE COLOR(S) MAROON, BLACK, AND WHITE IS/ARE CLAIMED AS A FEATURE OF THE MARK.

THE MARK CONSISTS OF THE COLOR MAROON IN THE LETTERS "FSNS" AND IN THE WORD "SAFETY"; THE COLOR BLACK IN THE WORDS "FOOD", "NET", AND "SERVICES"; THE COLOR WHITE FOR THE ONE-DIMENSIONAL CIRCUMFERENCE OF THE GLOBE GRAPHIC; THE COLOR MAROON IN THE GLOBE GRAPHIC, ILLUSTRATED AS WATER; THE COLOR WHITE IN THE GLOBE GRAPHIC, ILLUSTRATED AS LAND; AND THE COLOR BLACK AS THE ONE-DIMENSIONAL BEAKER THAT ENCLOSES THE GLOBE GRAPHIC.

CLASS 41—EDUCATION AND ENTERTAINMENT

FOR CONDUCTING WORKSHOPS AND SEMINARS IN FOOD SAFETY TESTING AND COMPLIANCE; DEVELOPING EDUCATIONAL MANUALS FOR OTHERS IN THE FIELD OF FOOD SAFETY; EDUCATION SERVICES, NAMELY, PROVIDING CLASSES, SEMINARS, AND WORKSHOPS IN THE FIELD OF FOOD SAFETY; EDUCATIONAL SERVICES, NAMELY, CONDUCTING CLASSES, SEMINARS, AND WORKSHOPS IN THE FIELD OF FOOD SAFETY AND DISTRIBUTION OF COURSE MATERIAL IN CONNECTION THEREWITH; EDUCATIONAL SERVICES, NAMELY, DEVELOPING, ARRANGING, AND CONDUCTING EDUCATIONAL CONFERENCES AND PROGRAMS AND PROVIDING COURSES OF INSTRUCTION IN THE FIELD OF FOOD SAFETY (U.S. CLS. 100, 101 AND 107).

FIRST USE 5-31-2007; IN COMMERCE 5-31-2007.

CLASS 42—SCIENTIFIC AND COMPUTER SERVICES

FOR FOOD SAFETY TESTING AND CONSULTATION; RESEARCH AND DEVELOPMENT AND CONSULTATION RELATED THERETO IN THE FIELD OF FOOD SAFETY; SCIENTIFIC AND TECHNICAL CONSULTING AND RESEARCH SERVICES RELATING TO FOODS AND DIETARY SUPPLEMENTS; TESTING, ANALYSIS AND EVALUATION OF THE GOODS AND SERVICES OF OTHERS FOR THE PURPOSE OF CERTIFICATION (U.S. CLS. 100 AND 101).

FIRST USE 5-31-2007; IN COMMERCE 5-31-2007.

ALEXANDER L. POWERS, EXAMINING ATTORNEY

SN 77-293,012. ANDIN INTERNATIONAL, INC., NEW YORK, NY. FILED 10-1-2007.

Frame It

THE MARK CONSISTS OF STANDARD CHARACTERS WITHOUT CLAIM TO ANY PARTICULAR FONT, STYLE, SIZE, OR COLOR.

CLASS 14—JEWELRY

FOR DIAMOND JEWELRY; GEMSTONE JEWELRY; JEWELRY (U.S. CLS. 2, 27, 28 AND 50).

CLASS 35—ADVERTISING AND BUSINESS

FOR ADVERTISING AND PUBLICITY SERVICES, NAMELY, PROMOTING THE GOODS, SERVICES, BRAND IDENTITY AND COMMERCIAL INFORMATION AND NEWS OF THIRD PARTIES THROUGH PRINT, AUDIO, VIDEO, DIGITAL AND ON-LINE MEDIUM; ADVERTISING SERVICES, FOR THIRD PARTIES, IN CONNECTION WITH THE COMMERCIALIZATION AND SALE OF PERFUMERY AND COSMETIC ARTICLES, PRODUCTS FOR HOUSEHOLD PURPOSES, OPTICAL PRODUCTS, CLOCKS AND TIMEPIECES, JEWELLERY, FURNISHING ARTICLES; CREATION OF MARKETING TOOLS DESIGNED TO INCREASE A CLIENT COMPANY'S KNOWLEDGE OF CUSTOMER NEEDS, AND ITS COMPETITORS' PRODUCTS AND SERVICES, PRICING, ADVERTISING STRATEGY AND SALES STRATEGY (U.S. CLS. 100, 101 AND 102).

SALLY SHIH, EXAMINING ATTORNEY

SN 77-293,016. WEASELWIRE, INC., CHARLESTOWN, MA. FILED 10-1-2007.

WeaselWire

THE MARK CONSISTS OF STANDARD CHARACTERS WITHOUT CLAIM TO ANY PARTICULAR FONT, STYLE, SIZE, OR COLOR.

CLASS 36—INSURANCE AND FINANCIAL

FOR FINANCIAL SERVICES, NAMELY, PROVIDING INFORMATION, RESEARCH, RECOMMENDATIONS, COMMENTARY AND STRATEGIES RELATING TO FINANCIAL INVESTMENTS VIA A WEBSITE (U.S. CLS. 100, 101 AND 102).

CLASS 42—SCIENTIFIC AND COMPUTER SERVICES

FOR COMPUTER SERVICES, NAMELY, HOSTING AN ONLINE COMMUNITY WEBSITE FEATURING THE SHARING OF INFORMATION, RESEARCH, RECOMMENDATIONS, COMMENTARY AND STRATEGIES RELATING TO FINANCIAL INVESTMENTS (U.S. CLS. 100 AND 101).

SALLY SHIH, EXAMINING ATTORNEY

SN 77-293,042. LENNY & LARRY'S, INC., ENCINO, CA. FILED 10-1-2007.

MUSCLE SNACKS

THE MARK CONSISTS OF STANDARD CHARACTERS WITHOUT CLAIM TO ANY PARTICULAR FONT, STYLE, SIZE, OR COLOR.

NO CLAIM IS MADE TO THE EXCLUSIVE RIGHT TO USE "SNACKS", APART FROM THE MARK AS SHOWN.

CLASS 5—PHARMACEUTICALS

FOR MEAL REPLACEMENT BARS; NUTRITIONAL ENERGY BARS FOR USE AS A MEAL SUBSTITUTE (U.S. CLS. 6, 18, 44, 46, 51 AND 52).

CLASS 30—STAPLE FOODS

FOR GRANOLA SNACKS; GRANOLA-BASED SNACK BARS; SNACK MIX CONSISTING PRIMARILY OF CRACKERS, PRETZELS, CANDIED NUTS AND/OR POPPED POPCORN; CEREAL-BASED SNACK FOODS; COOKIES; BROWNIES; GRANOLA; MUFFINS; BREAD; CEREAL BASED SNACK FOOD; BAKERY DESSERTS; BAKERY GOODS (U.S. CL. 46).

JESSICA A. POWERS, EXAMINING ATTORNEY

SN 77-293,050. JG GAMES HOLDINGS, LLC, CHICAGO, IL. FILED 10-1-2007.

WEB WARS

THE MARK CONSISTS OF STANDARD CHARACTERS WITHOUT CLAIM TO ANY PARTICULAR FONT, STYLE, SIZE, OR COLOR.

NO CLAIM IS MADE TO THE EXCLUSIVE RIGHT TO USE "WEB", APART FROM THE MARK AS SHOWN.

CLASS 9—ELECTRICAL AND SCIENTIFIC APPARATUS

FOR DOWNLOADABLE COMPUTER GAME SOFTWARE (U.S. CLS. 21, 23, 26, 36 AND 38).

CLASS 38—COMMUNICATION

FOR PROVIDING ONLINE CHAT ROOMS FOR TRANSMISSION OF MESSAGES AMONG COMPUTER USERS CONCERNING TOPICS OF COMPUTER GAMING ENTERTAINMENT; PROVIDING ONLINE ELECTRONIC BULLETIN BOARDS FOR TRANSMISSION OF MESSAGES AMONG COMPUTER USERS CONCERNING TOPICS RELATED TO COMPUTER GAMES (U.S. CLS. 100, 101 AND 104).

CLASS 41—EDUCATION AND ENTERTAINMENT

FOR PROVIDING ONLINE NETWORKED AND INTERACTIVE COMPUTER GAMES VIA THE INTERNET (U.S. CLS. 100, 101 AND 107).

AISHA SALEM, EXAMINING ATTORNEY

SN 77-293,069. KENNEL VACCINE VET SUPPLY COMPANY, DAVID CITY, NE. FILED 10-1-2007.

Range Falls

THE MARK CONSISTS OF STANDARD CHARACTERS WITHOUT CLAIM TO ANY PARTICULAR FONT, STYLE, SIZE, OR COLOR.

CLASS 1—CHEMICALS

FOR CHEMICAL SPRAYS USED TO AID IN HOUSE-BREAKING DOGS; HORTICULTURAL PRODUCTS, NAMELY, SOIL AMENDMENTS THAT ARE INCORPORATED INTO OR ONTO A TURF, LAWN OR SOIL PROFILE FOR CREATING A HEALTH MEDIUM FOR INCREASED ROOT GROWTH AND/OR A SMOOTHER TURF OR LAWN SURFACE CUT OR APPEARANCE; SOIL AMENDMENTS (U.S. CLS. 1, 5, 6, 10, 26 AND 46).

CLASS 3—COSMETICS AND CLEANING PREPARATIONS

FOR PET SHAMPOO; SKIN CLEANSERS; PET ODOR REMOVERS; PET STAIN REMOVERS; CREAMS FOR LEATHER; HAND CREAMS; SHOE CREAM; BOOT CREAM; SHOE AND BOOT CREAM; SKIN CREAMS; LIQUID SOAPS; HAIR CONDITIONERS; DEODORIZERS FOR PETS; COMBINATION CLEANER AND DEODORIZER FOR LITTER BOXES; ANTIBACTERIAL SOAP; SKIN LOTIONS (U.S. CLS. 1, 4, 6, 50, 51 AND 52).

CLASS 5—PHARMACEUTICALS

FOR DIETARY AND NUTRITIONAL SUPPLEMENTS; DIETARY FOOD SUPPLEMENTS; DIETARY SUPPLEMENTS; DIETARY SUPPLEMENTS FOR ANIMALS; NUTRACEUTICALS FOR USE AS A DIETARY SUPPLEMENT; NUTRITIONAL SUPPLEMENTS; VITAMIN SUPPLEMENTS; MINERAL SUPPLEMENTS; VITAMIN AND MINERAL SUPPLEMENTS; HERBAL SUPPLEMENTS; HOMEOPATHIC SUPPLEMENTS; ANIMAL FEED SUPPLEMENTS; FEED SUPPLEMENTS FOR PETS, HORSES AND LIVESTOCK; ANIMAL REPELLENTS; ANIMAL REPELLENTS, NAMELY, SPRAYS USED TO TRAIN DOGS TO KEEP OFF FURNITURE; DOG REPELLENTS; GRANULAR REPELLENT FOR BURROWING PESTS; INSECT REPELLENTS; VACCINES; VACCINES FOR CATTLE; VACCINES FOR HORSES; VETERINARY VACCINES; BANDAGES FOR SKIN WOUNDS; MEDICAL CLEANSERS FOR SKIN AND WOUNDS; WOUND DRESSINGS; EAR DROPS; EYE DROPS; MEDICATED SHAMPOO; MEDICATED BRUSH-ON ORAL CARE GELS; PRODUCTS AND PREPARATIONS FOR CLEANSING THE SKIN FOR MEDICAL USE; MEDICATED SKIN CARE PREPARATIONS; MEDICINAL CREAMS FOR SKIN CARE; PHARMACEUTICAL PRODUCTS FOR SKIN CARE FOR ANIMALS; ANTIBACTERIAL CLEANERS; ANTIBACTERIAL HAND LOTIONS; ANTIBACTERIAL HANDWASH; ANTIBACTERIAL SPRAY; ANTIBACTERIAL SUBSTANCES FOR MEDICAL PURPOSES; EYE WASHES; PHARMACEUTICAL PREPARATIONS FOR THE TREATMENT OF EYE DISEASES AND CONDITIONS; FLEA COLLARS; FLEA POWDERS; FLY PAPER; FLY COMBATING PREPARATIONS; ANTI-INSECT SPRAY; DEODORIZERS FOR HOUSEHOLD PET LITTER BOXES; HOUSEHOLD DEODORIZER; CARPET DEODORIZERS; ANTI-ITCH CREAM; ANTI-ITCH OINTMENT; HERBAL ANTI-ITCH AND SORE SKIN OINTMENT FOR PETS; DOMESTIC PESTICIDES; HERBICIDES, INSECTICIDES, PESTICIDES AND FUNGICIDES FOR HOME, GARDEN AND LAWN USE AND FOR PROFESSIONAL USE; PESTICIDES; INSECTICIDES; INSECTICIDES FOR DOMESTIC USE; HERBICIDES FOR DOMESTIC USE; FUNGICIDES; FUNGICIDES FOR DOMESTIC USE; FUNGICIDES FOR MEDICAL USE; ANTIBIOTIC CREAMS; ANTIBIOTIC HANDWASH; ANTIBIOTIC OINTMENTS; ANTIBIOTIC PREPARATIONS; ANTIBIOTICS; MEDICINAL PREPARATIONS FOR THE MOUTH AND AS SPRAYS; ANTIFUNGAL CREAMS FOR MEDICAL USE; HYDROCORTISONE; HYDROCORTISONE CREAM; PHARMACEUTICAL SKIN LOTIONS; MULTIPURPOSE MEDICATED ANTIBIOTIC CREAM, ANALGESIC BALM AND MENTHOLATED SALVE; PREPARATIONS FOR DESTROYING PARASITES; POULTICES; ODOR NEUTRALIZING PREPARATIONS FOR USE ON CARPET AND FURNITURE; TOPICAL FIRST AID GEL; ALL PURPOSE DISINFECTANTS (U.S. CLS. 6, 18, 44, 46, 51 AND 52).

CLASS 6—METAL GOODS

FOR METAL DOG TAGS; METAL PET DOORS; METAL CAGES FOR WILD ANIMALS (U.S. CLS. 2, 12, 13, 14, 23, 25 AND 50).

CLASS 8—HAND TOOLS

FOR BLADES AND BRUSHES FOR ELECTRIC HAIR CLIPPERS AND TRIMMERS; DOG CLIPPERS; ELECTRIC HAIR CLIPPERS; NAIL CLIPPERS (U.S. CLS. 23, 28 AND 44).

CLASS 9—ELECTRICAL AND SCIENTIFIC APPARATUS

FOR DOG WHISTLES; LIFESAVING VESTS FOR USE BY DOGS; COMPUTER HARDWARE AND SOFTWARE SYSTEM FOR TRACKING PEOPLE, OBJECTS AND PETS USING GPS DATA ON A DEVICE ON THE TRACKED PEOPLE, OBJECTS AND PETS; ELECTRONIC DEVICES FOR ANIMAL LOCATING AND TRACKING PROGRAMMED TO USE GLOBAL POSITIONING SYSTEMS (GPS) AND CELLULAR COMMUNICATIONS; TRANSMITTER AND RECEIVER USED TO LOCATE LOST PETS (U.S. CLS. 21, 23, 26, 36 AND 38).

CLASS 10—MEDICAL APPARATUS

FOR VETERINARY PROTECTIVE BOOTS FOR HORSES AFTER A SURGICAL PROCEDURE; SURGICAL SKIN STAPLERS; VIBRATING MASSAGE MITTS FOR PETS; SYNTHETIC PLASTIC MEDICATED PROTECTIVE BOOTS FOR EQUINE HOOF; MEDICAL SYRINGES (U.S. CLS. 26, 39 AND 44).

CLASS 11—ENVIRONMENTAL CONTROL APPARATUS

FOR HEATING INSERTS FOR PET BEDS; TOILETS FOR CATS THAT ARE CONNECTED TO HOUSEHOLD PLUMBING SYSTEMS (U.S. CLS. 13, 21, 23, 31 AND 34).

CLASS 12—VEHICLES

FOR CAR SEATS FOR PETS; PET SAFETY SEATS FOR USE IN VEHICLES (U.S. CLS. 19, 21, 23, 31, 35 AND 44).

CLASS 16—PAPER GOODS AND PRINTED MATTER

FOR DISPOSABLE HOUSEBREAKING PADS FOR PETS; PAPER PET CRATE MATS; PLASTIC BAGS FOR DISPOSING OF PET WASTE; CAT BOX LINERS IN THE FORM OF PLASTIC BAGS (U.S. CLS. 2, 5, 22, 23, 29, 37, 38 AND 50).

CLASS 18—LEATHER GOODS

FOR PET ACCESSORIES, NAMELY, CANVAS, VINYL AND LEATHER POUCHES FOR HOLDING DISPOSABLE BAGS TO PLACE PET WASTE IN; DIAPERS FOR DOGS; DOG APPAREL; DOG LEASHES; DOG PARKAS; RAWHIDE CHEWS FOR DOGS; HORSE BLANKETS; HORSE BRIDLES; HORSE FLANKS AND SHANKS, NAMELY, HORSE PROTECTIVE PADDING, BRACES, AND LEG BOOTS FOR THE FLANKS AND LEGS; HORSE FLY VEILS FOR HORSES; HORSE HALTERS; HORSE TAIL BAGS; HORSE TAIL WRAPS; PADS FOR HORSE SADDLES; SADDLES; TRAINING FORKS FOR HORSES; TRAINING LEADS FOR HORSES; COLLARS

FOR PETS; DOG COLLARS; ELECTRONIC PET COLLARS; HORSE COLLARS; COLLARS FOR PETS BEARING MEDICAL INFORMATION; PET COLLAR ACCESSORIES, NAMELY, BOWS AND CHARMS; DISPOSABLE PET DIAPERS; PET CLOTHING; PET PRODUCTS IN THE NATURE OF A RESTRAINING DEVICE, NAMELY, TIE-OUT STAKES AND TIE-OUT CHAINS; EQUINE LEG WRAPS; FACE MASKS FOR EQUINES; BITTER TASTING PET TRAINING AID IN THE FORM OF A SPRAY TO PREVENT PETS FROM LICKING, CHEWING AND BITING ON OBJECTS; BITS; HARNESSSES; REINS (U.S. CLS. 1, 2, 3, 22 AND 41).

CLASS 19—NON-METALLIC BUILDING MATERIALS

FOR NONMETAL PET DOORS; MODULAR DOG HOUSES; PRE-FABRICATED DOG HOUSES (U.S. CLS. 1, 12, 33 AND 50).

CLASS 20—FURNITURE AND ARTICLES NOT OTHERWISE CLASSIFIED

FOR NON-METAL DOG TAGS; PET CRATES; SCRATCHING POSTS; DOG BEDS; BEDS FOR HOUSEHOLD PETS; DOG KENNELS; CRATE COVERS FOR PETS; DEVICE FOR SCRATCHING PETS AND HUMANS, NAMELY, A GLOVE FOR SCRATCHING PETS AND HUMANS; NON-METAL PORTABLE STAIRS FOR USE BY PETS FOR POOLS AND WATER SPAS; PET CASKETS; PET CUSHIONS; PET RAMP; PLAYHOUSES FOR PETS (U.S. CLS. 2, 13, 22, 25, 32 AND 50).

CLASS 21—HOUSEWARES AND GLASS

FOR BIRD CAGES FOR DOMESTIC BIRDS; CAGES FOR PETS; GRAVEL PAPER FOR BIRD CAGES; INSECT COLLECTING CAGES; PERCHES FOR BIRD CAGES; SCOOPS FOR THE DISPOSAL OF PET WASTE; ABRASIVE LINER FOR CAT LITTER BOXES; CAT LITTER BOXES; CAT LITTER PANS; DOG FOOD SCOOPS; HORSE BRUSHES; MANE BRUSHES; PET BRUSHES; PET GROOMING DEVICE COMPRISING A BUILT IN BRUSH HEAD AND AN ATTACHMENT THAT CONNECTS TO VACUUMS; ELECTRIC PET BRUSHES; BATH BRUSHES; FLY CATCHERS; FLY TRAPS; INSECT TRAPS; FEEDING VESSELS FOR PETS; PET FEEDING DISHES; EMPTY SPRAY BOTTLES; PLASTIC SPRAY NOZZLES; BOWLS (U.S. CLS. 2, 13, 23, 29, 30, 33, 40 AND 50).

CLASS 28—TOYS AND SPORTING GOODS

FOR CLICKERS FOR TRAINING DOGS; PET TOYS; PET TOYS CONTAINING CATNIP; PET TOYS MADE OF ROPE; DOG TOYS; CAT TOYS (U.S. CLS. 22, 23, 38 AND 50).

CLASS 31—NATURAL AGRICULTURAL PRODUCTS

FOR CAT LITTER; SANDED PAPER FOR PETS; CAT TREATS; DOG TREATS; EDIBLE HORSE TREATS; PET TREATS; DIGESTIBLE CHEWING BONES FOR DOGS; EDIBLE CHEWS FOR ANIMALS; DOG BISCUITS; DOG FOOD; CAT FOOD; DRINKING WATER FOR DOGS; PET FOOD; PET BEVERAGES; CONSUMABLE PET CHEWS; AROMATIC SAND FOR PETS; GRASS SEED (U.S. CLS. 1 AND 46).

CLASS 35—ADVERTISING AND BUSINESS

FOR COMPUTER SERVICES, NAMELY, PROVIDING CONSUMER INFORMATION IN THE FIELD OF ANIMALS AND PETS RELATING TO PET PRODUCTS, PET TREATS AND PET TOYS; ON-LINE RETAIL STORE SERVICES FEATURING HEALTH CARE PRODUCTS FOR PEOPLE AND ANIMAL CARE PRODUCTS; RETAIL STORE SERVICES FEATURING HEALTH CARE PRODUCTS FOR PEOPLE AND ANIMAL CARE PRODUCTS; CATALOG ORDERING SERVICE FEATURING HEALTH CARE PRODUCTS FOR PEOPLE AND ANIMAL CARE PRODUCTS (U.S. CLS. 100, 101 AND 102).

TRACY WHITTAKER-BROWN, EXAMINING ATTORNEY

SN 77-293,162. AMERICA'S CHOICE, INC., WASHINGTON, DC. FILED 10-1-2007.

AMERICA'S CHOICE WRITING AVIATOR

THE MARK CONSISTS OF STANDARD CHARACTERS WITHOUT CLAIM TO ANY PARTICULAR FONT, STYLE, SIZE, OR COLOR.

OWNER OF U.S. REG. NOS. 2,451,365 AND 2,489,368.

NO CLAIM IS MADE TO THE EXCLUSIVE RIGHT TO USE "WRITING", APART FROM THE MARK AS SHOWN.

CLASS 9—ELECTRICAL AND SCIENTIFIC APPARATUS

FOR PRE-RECORDED COMPACT DISCS, ALL FEATURING EDUCATIONAL INSTRUCTION IN THE FIELD OF WRITING; COMPUTER SOFTWARE THAT PROVIDES EDUCATIONAL INSTRUCTION IN THE FIELD OF WRITING; MULTIMEDIA SOFTWARE RECORDED ON CD-ROM FEATURING EDUCATIONAL INSTRUCTION IN THE FIELD OF WRITING (U.S. CLS. 21, 23, 26, 36 AND 38).

CLASS 16—PAPER GOODS AND PRINTED MATTER

FOR BINDERS, FILE FOLDERS, PAPER FILE JACKETS, PRINTED LECTURES, STATIONERY-TYPE PORTFOLIOS AND STUDY GUIDES, ALL FOR USE IN THE FIELD OF WRITING INSTRUCTION AND EDUCATION; BOOKS, BOOKLETS, BROCHURES, INFORMATIONAL FLYERS, INFORMATIONAL LETTERS, LEAFLETS, QUESTIONNAIRES, WORKBOOKS, AND PRINTED TEACHING MATERIALS, ALL ON THE SUBJECT OF WRITING INSTRUCTION AND EDUCATION (U.S. CLS. 2, 5, 22, 23, 29, 37, 38 AND 50).

CLASS 41—EDUCATION AND ENTERTAINMENT

FOR EDUCATIONAL SERVICES, NAMELY, EDUCATIONAL TESTING, EDUCATIONAL ASSESSMENT IN THE NATURE OF ANALYZING EDUCATIONAL TEST SCORES AND DATA FOR OTHERS, DEVELOPMENT OF CURRICULUM AND INSTRUCTIONAL MANUALS FOR OTHERS, EDUCATIONAL CONSULTATION SERVICES, EDUCATIONAL TRAINING SERVICES, AND EDUCATIONAL RESEARCH SERVICES, ALL IN THE FIELD OF WRITING INSTRUCTION AND EDUCATION (U.S. CLS. 100, 101 AND 107).

MARTHA FROMM, EXAMINING ATTORNEY



THE MARK CONSISTS OF A STYLIZED DRAWING OF A STAR WITHIN A SPADE.

CLASS 9—ELECTRICAL AND SCIENTIFIC APPARATUS

FOR DOWNLOADABLE COMPUTER CARD GAME SOFTWARE AND COMPUTER GAMBLING GAME SOFTWARE (U.S. CLS. 21, 23, 26, 36 AND 38).

CLASS 41—EDUCATION AND ENTERTAINMENT

FOR ON-LINE ENTERTAINMENT IN THE NATURE OF CARD GAMES AND GAMBLING TOURNAMENTS AND COMPETITIONS; CASINO ON-LINE SERVICES FEATURING INTERACTIVE MULTI-PLAYER CARD GAMES AND GAMBLING; ORGANIZATION OF AND ADMINISTRATION OF CARD GAMES AND CONTESTS, INTERACTIVE GAMING, ON-LINE CARD GAMES AND GAMBLING CONTESTS, AND ON-LINE GAMING FOR ENTERTAINMENT PURPOSES; PROVIDING NEWSLETTERS IN THE FIELD OF ON-LINE AND OFF-LINE GAMBLING VIA EMAIL; PROVIDING INFORMATION ON-LINE RELATED TO INTERNET GAMBLING AND COMPUTER GAMING (U.S. CLS. 100, 101 AND 107).

ZACHARY BELLO, EXAMINING ATTORNEY

SN 77-293,168. AMERICA'S CHOICE, INC., WASHINGTON, DC. FILED 10-1-2007.

AMERICA'S CHOICE READING AVIATOR

THE MARK CONSISTS OF STANDARD CHARACTERS WITHOUT CLAIM TO ANY PARTICULAR FONT, STYLE, SIZE, OR COLOR.

OWNER OF U.S. REG. NOS. 2,451,365 AND 2,489,368.

NO CLAIM IS MADE TO THE EXCLUSIVE RIGHT TO USE "READING", APART FROM THE MARK AS SHOWN.

CLASS 9—ELECTRICAL AND SCIENTIFIC APPARATUS

FOR PRE-RECORDED COMPACT DISCS, ALL FEATURING EDUCATIONAL INSTRUCTION IN THE FIELD OF READING; COMPUTER SOFTWARE THAT PROVIDES EDUCATIONAL INSTRUCTION IN THE FIELD OF READING; MULTIMEDIA SOFTWARE RECORDED ON CD-ROM FEATURING EDUCATIONAL INSTRUCTION IN THE FIELD OF READING (U.S. CLS. 21, 23, 26, 36 AND 38).

CLASS 16—PAPER GOODS AND PRINTED MATTER

FOR BINDERS, FILE FOLDERS, PAPER FILE JACKETS, PRINTED LECTURES, STATIONERY-TYPE PORTFOLIOS AND STUDY GUIDES, ALL FOR USE IN THE FIELD OF READING EDUCATION; BOOKS, BOOKLETS, BROCHURES, INFORMATIONAL FLYERS, INFORMATIONAL LETTERS, LEAFLETS, QUESTIONNAIRES, WORKBOOKS, AND PRINTED TEACHING MATERIALS, ALL ON THE SUBJECT OF READING EDUCATION (U.S. CLS. 2, 5, 22, 23, 29, 37, 38 AND 50).

CLASS 41—EDUCATION AND ENTERTAINMENT

FOR EDUCATIONAL SERVICES, NAMELY, EDUCATIONAL TESTING, EDUCATIONAL ASSESSMENT IN THE NATURE OF ANALYZING EDUCATIONAL TEST SCORES AND DATA FOR OTHERS, DEVELOPMENT OF CURRICULUM AND INSTRUCTIONAL MANUALS FOR OTHERS, EDUCATIONAL CONSULTATION SERVICES, EDUCATIONAL TRAINING SERVICES, AND EDUCATIONAL RESEARCH SERVICES, ALL IN THE FIELD OF READING EDUCATION (U.S. CLS. 100, 101 AND 107).
MARTHA FROMM, EXAMINING ATTORNEY

CLASS 16—PAPER GOODS AND PRINTED MATTER

FOR BINDERS, FILE FOLDERS, PAPER FILE JACKETS, PRINTED LECTURES, STATIONERY-TYPE PORTFOLIOS AND STUDY GUIDES, ALL FOR USE IN THE FIELD OF MATHEMATICS EDUCATION; BOOKS, BOOKLETS, BROCHURES, INFORMATIONAL FLYERS, INFORMATIONAL LETTERS, LEAFLETS, QUESTIONNAIRES, WORKBOOKS, AND PRINTED TEACHING MATERIALS, ALL ON THE SUBJECT OF MATHEMATICS EDUCATION (U.S. CLS. 2, 5, 22, 23, 29, 37, 38 AND 50).

CLASS 41—EDUCATION AND ENTERTAINMENT

FOR EDUCATIONAL SERVICES, NAMELY, EDUCATIONAL TESTING, EDUCATIONAL ASSESSMENT IN THE NATURE OF ANALYZING EDUCATIONAL TEST SCORES AND DATA FOR OTHERS, DEVELOPMENT OF CURRICULUM AND INSTRUCTIONAL MANUALS FOR OTHERS, EDUCATIONAL CONSULTATION SERVICES, EDUCATIONAL TRAINING SERVICES, EDUCATIONAL RESEARCH SERVICES, AND THE PROVISION OF ONLINE TUTORIAL ASSISTANCE AND EDUCATIONAL INFORMATION, ALL IN THE FIELD OF MATHEMATICS EDUCATION (U.S. CLS. 100, 101 AND 107).
MARTHA FROMM, EXAMINING ATTORNEY

SN 77-293,266. FINCH LANE ENTERTAINMENT, LLC, NEW YORK, NY. FILED 10-1-2007.

WARM FUZZ

THE MARK CONSISTS OF STANDARD CHARACTERS WITHOUT CLAIM TO ANY PARTICULAR FONT, STYLE, SIZE, OR COLOR.

CLASS 9—ELECTRICAL AND SCIENTIFIC APPARATUS

FOR PRE-RECORDED CDS AND DVDS, ALL FEATURING CHILDREN'S FILMS, MUSIC AND/OR CHILDREN'S STORIES; COMPUTER GAME PROGRAMS (U.S. CLS. 21, 23, 26, 36 AND 38).

CLASS 16—PAPER GOODS AND PRINTED MATTER

FOR BOOKS, NAMELY, A SERIES OF FICTIONAL STORY BOOKS, NOTEBOOKS, AUTOGRAPH BOOKS, EXERCISE BOOKS, EDUCATIONAL PICTURE BOOKS, CHILDREN'S ACTIVITY BOOKS, COLORING BOOKS, CHILDREN'S BOOKS, SCRAP BOOKS, ADDRESS BOOKS, PHOTO ALBUMS, DIARIES, STATIONERY; PHOTOGRAPHS, PICTURES, STICKERS AND POSTERS; WRAPPING PAPER, INVITATION CARDS, ACCEPTANCE CARDS, PAPER AND PLASTIC GIFT WRAP; BOXES OF PAPER OR CARDBOARD AND CONTAINERS OF PAPER OR CARDBOARD FOR PACKAGING OR STORAGE, MAGAZINES FEATURING CHILDREN'S STORIES (U.S. CLS. 2, 5, 22, 23, 29, 37, 38 AND 50).

CLASS 24—FABRICS

FOR BED BLANKETS; THROW BLANKETS; CHILDREN'S BLANKETS; COMFORTERS (U.S. CLS. 42 AND 50).

SN 77-293,172. AMERICA'S CHOICE, INC., WASHINGTON, DC. FILED 10-1-2007.

AMERICA'S CHOICE MATH AVIATOR

THE MARK CONSISTS OF STANDARD CHARACTERS WITHOUT CLAIM TO ANY PARTICULAR FONT, STYLE, SIZE, OR COLOR.

OWNER OF U.S. REG. NOS. 2,451,365 AND 2,489,368.
NO CLAIM IS MADE TO THE EXCLUSIVE RIGHT TO USE "MATH", APART FROM THE MARK AS SHOWN.

CLASS 9—ELECTRICAL AND SCIENTIFIC APPARATUS

FOR PRE-RECORDED COMPACT DISCS, ALL FEATURING EDUCATIONAL INSTRUCTION IN THE FIELD OF MATHEMATICS; COMPUTER SOFTWARE THAT PROVIDES EDUCATIONAL INSTRUCTION IN THE FIELD OF MATHEMATICS; MULTIMEDIA SOFTWARE RECORDED ON CD-ROM FEATURING EDUCATIONAL INSTRUCTION IN THE FIELD OF MATHEMATICS (U.S. CLS. 21, 23, 26, 36 AND 38).

CLASS 28—TOYS AND SPORTING GOODS

FOR TOYS, NAMELY, PLUSH, SOFT TOYS, TOY FIGURES AND TOY ACTION FIGURES AND ACCESSORIES FOR USE IN CONNECTION THEREWITH; JIGSAW PUZZLES AND PUZZLES (U.S. CLS. 22, 23, 38 AND 50).

SN 77-293,453. GROSSMAN, RONALD SCOTT, SPOKANE VALLEY, WA. FILED 10-2-2007.

CLASS 41—EDUCATION AND ENTERTAINMENT

FOR ENTERTAINMENT SERVICES, NAMELY, PROVIDING A WEBSITE FEATURING PHOTOGRAPHIC, AUDIO, VIDEO AND PROSE PRESENTATIONS AND ONLINE GAMES RELATED TO ENTERTAINMENT FOR CHILDREN (U.S. CLS. 100, 101 AND 107).

KEVIN DINALLO, EXAMINING ATTORNEY

BariSweet

THE MARK CONSISTS OF STANDARD CHARACTERS WITHOUT CLAIM TO ANY PARTICULAR FONT, STYLE, SIZE, OR COLOR.

SN 77-293,267. FARRIS, ROY W., GILBERT, AZ. FILED 10-1-2007.

The Patriot

THE MARK CONSISTS OF STANDARD CHARACTERS WITHOUT CLAIM TO ANY PARTICULAR FONT, STYLE, SIZE, OR COLOR.

CLASS 5—PHARMACEUTICALS

FOR DIETARY SUPPLEMENTS (U.S. CLS. 6, 18, 44, 46, 51 AND 52).

CLASS 30—STAPLE FOODS

FOR NATURAL SWEETENER (U.S. CL. 46).
RONALD MCMORROW, EXAMINING ATTORNEY

CLASS 9—ELECTRICAL AND SCIENTIFIC APPARATUS

FOR PRERECORDED DIGITAL VIDEO DISKS FEATURING WRESTLING (U.S. CLS. 21, 23, 26, 36 AND 38).

SN 77-293,648. GRAYMONT (PA) INC., PLEASANT GAP, PA. FILED 10-2-2007.

CLASS 41—EDUCATION AND ENTERTAINMENT

FOR ENTERTAINMENT IN THE NATURE OF WRESTLING CONTESTS (U.S. CLS. 100, 101 AND 107).
INGA ERVIN, EXAMINING ATTORNEY

BELL MINE

SN 77-293,353. ZILA PHARMACEUTICALS, INC., PHOENIX, AZ. FILED 10-1-2007.



THE MARK CONSISTS OF STANDARD CHARACTERS WITHOUT CLAIM TO ANY PARTICULAR FONT, STYLE, SIZE, OR COLOR.

CLASS 1—CHEMICALS

FOR AGRICULTURAL LIMESTONE AND AGRICULTURAL LIMESTONE BYPRODUCTS, NAMELY, PULVERIZED LIMESTONE, LIME, QUICKLIME, HYDRATED LIME, KILN DUST AND CALCIUM HYDROXIDE (U.S. CLS. 1, 5, 6, 10, 26 AND 46).
FIRST USE 12-31-1986; IN COMMERCE 12-31-1986.

CLASS 5—PHARMACEUTICALS

FOR DENTAL RINSE (U.S. CLS. 6, 18, 44, 46, 51 AND 52).
FIRST USE 8-26-2004; IN COMMERCE 6-1-2007.

CLASS 19—NON-METALLIC BUILDING MATERIALS

FOR LIMESTONE AND NON-AGRICULTURAL LIMESTONE BYPRODUCTS, NAMELY, LIME, QUICKLIME, HYDRATED LIME, AND CALCIUM CARBONATE; CONCRETE, ASPHALT AND CONSTRUCTION AGGREGATES, NAMELY, SAND, STONE AND GRAVEL (U.S. CLS. 1, 12, 33 AND 50).
FIRST USE 12-31-1986; IN COMMERCE 12-31-1986.

CLASS 10—MEDICAL APPARATUS

FOR DENTAL APPARATUS, NAMELY, INTRA-ORAL LIGHT SYSTEMS (U.S. CLS. 26, 39 AND 44).
FIRST USE 8-26-2004; IN COMMERCE 6-1-2007.
GRETTA YAO, EXAMINING ATTORNEY

FIRST USE 12-31-1986; IN COMMERCE 12-31-1986.
KAREN BRACEY, EXAMINING ATTORNEY

SN 77-293,722. 110 ENTERTAINMENT, LLC, BOWLING GREEN, KY. FILED 10-2-2007.

CAGE THE ELEPHANT

THE MARK CONSISTS OF STANDARD CHARACTERS WITHOUT CLAIM TO ANY PARTICULAR FONT, STYLE, SIZE, OR COLOR.

CLASS 9—ELECTRICAL AND SCIENTIFIC APPARATUS

FOR COMPACT DISCS FEATURING MUSIC; DVDS FEATURING MUSIC; SOUND RECORDINGS FEATURING MUSIC; DIGITAL MATERIALS, NAMELY, DOWNLOADABLE AUDIO FILES FEATURING MUSIC (U.S. CLS. 21, 23, 26, 36 AND 38).

CLASS 16—PAPER GOODS AND PRINTED MATTER

FOR BUMPER STICKERS; CALENDARS; POSTERS; STICKERS (U.S. CLS. 2, 5, 22, 23, 29, 37, 38 AND 50).

CLASS 25—CLOTHING

FOR CAPS; JACKETS; JEANS; PANTS; SHORTS; SWEAT SHIRTS; T-SHIRTS (U.S. CLS. 22 AND 39).
SCOTT SISUN, EXAMINING ATTORNEY

SN 77-293,739. PROGRESSIVE JEWISH ALLIANCE, LOS ANGELES, CA. FILED 10-2-2007.



THE COLOR(S) WHITE AND BLUE IS/ARE CLAIMED AS A FEATURE OF THE MARK.

THE MARK CONSISTS OF A WHITE HAND IN A BLUE CIRCLE WITH A BLUE BALL IN ITS PALM.

CLASS 16—PAPER GOODS AND PRINTED MATTER

FOR PUBLICATIONS, NAMELY, BOOKLETS IN THE FIELD OF SOCIAL JUSTICE; NEWSLETTERS IN THE FIELD OF SOCIAL JUSTICE (U.S. CLS. 2, 5, 22, 23, 29, 37, 38 AND 50).

FIRST USE 0-0-2005; IN COMMERCE 0-0-2005.

CLASS 35—ADVERTISING AND BUSINESS

FOR PROMOTING PUBLIC AWARENESS OF THE NEED FOR SOCIAL JUSTICE AND SOCIAL JUSTICE ISSUES (U.S. CLS. 100, 101 AND 102).

FIRST USE 0-0-2005; IN COMMERCE 0-0-2005.

CLASS 36—INSURANCE AND FINANCIAL

FOR CHARITABLE FUNDRAISING (U.S. CLS. 100, 101 AND 102).

FIRST USE 0-0-2006; IN COMMERCE 0-0-2006.

CLASS 41—EDUCATION AND ENTERTAINMENT

FOR EDUCATIONAL SERVICES, NAMELY, CLASSES AND SEMINARS IN THE FIELD OF RELIGION, RELIGIOUS HISTORY, AND SOCIAL JUSTICE (U.S. CLS. 100, 101 AND 107).

FIRST USE 0-0-2006; IN COMMERCE 0-0-2006.

DAWN FELDMAN, EXAMINING ATTORNEY

SN 77-293,769. OOO "AKELLA", MOSCOW, RUSSIAN FED., FILED 10-2-2007.

RENAISSANCE

THE MARK CONSISTS OF STANDARD CHARACTERS WITHOUT CLAIM TO ANY PARTICULAR FONT, STYLE, SIZE, OR COLOR.

CLASS 9—ELECTRICAL AND SCIENTIFIC APPARATUS

FOR COMPUTER GAME SOFTWARE; DOWNLOADABLE ELECTRONIC GAMES VIA THE INTERNET AND WIRELESS DEVICES; ELECTRONIC GAME SOFTWARE FOR HANDHELD ELECTRONIC DEVICES; ELECTRONIC GAME SOFTWARE FOR WIRELESS DEVICES; VIDEO GAME SOFTWARE (U.S. CLS. 21, 23, 26, 36 AND 38).

CLASS 41—EDUCATION AND ENTERTAINMENT

FOR ENTERTAINMENT SERVICES, NAMELY, PROVIDING AN ON-LINE COMPUTER GAME (U.S. CLS. 100, 101 AND 107).

JAMES A. RAUEN, EXAMINING ATTORNEY

SN 77-293,840. PROGRESSIVE JEWISH ALLIANCE, LOS ANGELES, CA. FILED 10-2-2007.

PJA

THE MARK CONSISTS OF STANDARD CHARACTERS WITHOUT CLAIM TO ANY PARTICULAR FONT, STYLE, SIZE, OR COLOR.

CLASS 16—PAPER GOODS AND PRINTED MATTER

FOR PUBLICATIONS, NAMELY, BOOKLETS IN THE FIELD OF SOCIAL JUSTICE; NEWSLETTERS IN THE FIELD OF SOCIAL JUSTICE (U.S. CLS. 2, 5, 22, 23, 29, 37, 38 AND 50).

FIRST USE 0-0-2004; IN COMMERCE 0-0-2004.

CLASS 35—ADVERTISING AND BUSINESS

FOR PROMOTING PUBLIC AWARENESS OF THE NEED FOR SOCIAL JUSTICE AND SOCIAL JUSTICE ISSUES (U.S. CLS. 100, 101 AND 102).

FIRST USE 0-0-2000; IN COMMERCE 0-0-2000.

CLASS 36—INSURANCE AND FINANCIAL

FOR CHARITABLE FUNDRAISING (U.S. CLS. 100, 101 AND 102).

FIRST USE 0-0-2000; IN COMMERCE 0-0-2000.

CLASS 41—EDUCATION AND ENTERTAINMENT

FOR EDUCATIONAL SERVICES, NAMELY, CLASSES AND SEMINARS IN THE FIELD OF RELIGION, RELIGIOUS HISTORY, AND SOCIAL JUSTICE (U.S. CLS. 100, 101 AND 107).

FIRST USE 0-0-2000; IN COMMERCE 0-0-2000.
DAWN FELDMAN, EXAMINING ATTORNEY

SN 77-293,906. OOO "AKELLA", MOSCOW, RUSSIAN FED., FILED 10-2-2007.

QUARANTINE

THE MARK CONSISTS OF STANDARD CHARACTERS WITHOUT CLAIM TO ANY PARTICULAR FONT, STYLE, SIZE, OR COLOR.

CLASS 9—ELECTRICAL AND SCIENTIFIC APPARATUS

FOR COMPUTER GAME SOFTWARE; DOWNLOADABLE ELECTRONIC GAMES VIA THE INTERNET AND WIRELESS DEVICES; ELECTRONIC GAME SOFTWARE FOR HANDHELD ELECTRONIC DEVICES; ELECTRONIC GAME SOFTWARE FOR WIRELESS DEVICES; VIDEO GAME SOFTWARE (U.S. CLS. 21, 23, 26, 36 AND 38).

CLASS 41—EDUCATION AND ENTERTAINMENT

FOR ENTERTAINMENT SERVICES, NAMELY, PROVIDING AN ON-LINE COMPUTER GAME (U.S. CLS. 100, 101 AND 107).

JAMES A. RAUEN, EXAMINING ATTORNEY

SN 77-293,949. INTEGRATED DEVICE TECHNOLOGY, INC., SAN JOSE, CA. FILED 10-2-2007.



The logo for myIDT features the word "my" in a lowercase, cursive-style font, followed by a stylized circular icon containing a vertical bar, and then the letters "IDT" in a bold, uppercase, sans-serif font.

OWNER OF U.S. REG. NOS. 2,300,863, 3,159,809 AND OTHERS.

CLASS 35—ADVERTISING AND BUSINESS

FOR PROVIDING BUSINESS ADVICE AND INFORMATION ABOUT CUSTOMER SERVICES, PRODUCT MANAGEMENT AND PRICES ON WEBSITES IN CONNECTION WITH PURCHASES VIA THE INTERNET; ASSISTANCE WITH BUSINESS MANAGEMENT; AND BUSINESS INFORMATION AND INQUIRIES (U.S. CLS. 100, 101 AND 102).

FIRST USE 5-0-2005; IN COMMERCE 5-0-2005.

CLASS 38—COMMUNICATION

FOR PROVIDING ACCESS TO AN ELECTRONIC SITE THAT ALLOWS FOR CUSTOMIZATION OF INFORMATION REGARDING INTEGRATED CIRCUITS AND RELATED ELECTRONIC GOODS (U.S. CLS. 100, 101 AND 104).

FIRST USE 5-0-2005; IN COMMERCE 5-0-2005.

CLASS 41—EDUCATION AND ENTERTAINMENT

FOR PROVIDING ON-LINE TRAINING IN THE FORM OF PRESENTATIONS, COURSES, SEMINARS, REFERENCE GUIDES, MANUALS, ARTICLES AND LIBRARIES FOR THE MARKETING, SALE AND APPLICATION OF SEMICONDUCTOR PRODUCTS AND TECHNOLOGY (U.S. CLS. 100, 101 AND 107).

FIRST USE 5-0-2005; IN COMMERCE 5-0-2005.

CLASS 42—SCIENTIFIC AND COMPUTER SERVICES

FOR PROVIDING TEMPORARY USE OF ON-LINE NON-DOWNLOADABLE SOFTWARE FOR CUSTOMERS TO USE ON A WEBSITE THAT ALLOWS CUSTOMERS TO SEARCH PRODUCT DATABASES, RETRIEVE SPECIFICATIONS, AND EVALUATE PRODUCT FUNCTIONALITY (U.S. CLS. 100 AND 101).

FIRST USE 5-0-2005; IN COMMERCE 5-0-2005.

PATRICIA EVANKO, EXAMINING ATTORNEY

SN 77-293,969. GLU MOBILE INC., SAN MATEO, CA. FILED 10-2-2007.

POPPIN PANDA

THE MARK CONSISTS OF STANDARD CHARACTERS WITHOUT CLAIM TO ANY PARTICULAR FONT, STYLE, SIZE, OR COLOR.

CLASS 9—ELECTRICAL AND SCIENTIFIC APPARATUS

FOR COMPUTER GAME SOFTWARE AND ENTERTAINMENT SOFTWARE, NAMELY, COMPUTER GAME SOFTWARE, SCREEN SAVER SOFTWARE, SOFTWARE TO ENABLE TEXT-MESSAGING, MULTIMEDIA ENTERTAINMENT SOFTWARE FOR PLAYING AUDIO, VIDEO AND MUSIC, ALL FOR USE ON MOBILE DEVICES, NAMELY, HANDHELD COMPUTERS, PERSONAL DIGITAL ASSISTANTS AND CELLULAR TELEPHONES; DOWNLOADABLE RING-TONES, WALLPAPER GRAPHICS AND GRAPHICAL ICONS PROVIDED VIA MOBILE DEVICES, NAMELY, HANDHELD COMPUTERS, PERSONAL DIGITAL ASSISTANTS AND CELLULAR TELEPHONES (U.S. CLS. 21, 23, 26, 36 AND 38).

CLASS 41—EDUCATION AND ENTERTAINMENT

FOR PROVIDING A COMPUTER GAME THAT MAY BE ACCESSED NETWORK-WIDE BY NETWORK USERS; PROVIDING AN ONLINE COMPUTER GAME ACCESSED AND PLAYED VIA MOBILE AND CELLULAR PHONES AND OTHER WIRELESS DEVICE (U.S. CLS. 100, 101 AND 107).

JILL PRATER, EXAMINING ATTORNEY

SN 77-294,016. JARROW FORMULAS, INC., LOS ANGELES, CA. FILED 10-2-2007.

POMEZOTIC

THE MARK CONSISTS OF STANDARD CHARACTERS WITHOUT CLAIM TO ANY PARTICULAR FONT, STYLE, SIZE, OR COLOR.

CLASS 5—PHARMACEUTICALS

FOR DIETARY AND NUTRITIONAL SUPPLEMENTS (U.S. CLS. 6, 18, 44, 46, 51 AND 52).

CLASS 32—LIGHT BEVERAGES

FOR FRUIT JUICES, FRUIT DRINKS AND FRUIT JUICE CONCENTRATES (U.S. CLS. 45, 46 AND 48).

JAMES STEIN, EXAMINING ATTORNEY

SN 77-294,098. NEW PENDULUM CORP., WILMINGTON, DE. FILED 10-2-2007.

FAT MAT

THE MARK CONSISTS OF STANDARD CHARACTERS WITHOUT CLAIM TO ANY PARTICULAR FONT, STYLE, SIZE, OR COLOR.

OWNER OF U.S. REG. NOS. 2,240,173 AND 2,679,781. NO CLAIM IS MADE TO THE EXCLUSIVE RIGHT TO USE "MAT", APART FROM THE MARK AS SHOWN.

CLASS 17—RUBBER GOODS

FOR TEXTILES SOLD IN ROLLS AND PADS FOR ABSORBING INDUSTRIAL OIL, COOLANT AND SOLVENT SPILLS (U.S. CLS. 1, 5, 12, 13, 35 AND 50).

CLASS 21—HOUSEWARES AND GLASS

FOR CLEANING PADS AND WIPES MADE OF SYNTHETIC AND NATURAL ABSORBENT TEXTILES FOR ABSORBING INDUSTRIAL LIQUIDS (U.S. CLS. 2, 13, 23, 29, 30, 33, 40 AND 50).

CLASS 27—FLOOR COVERINGS

FOR TEXTILE FLOOR MATS FOR ABSORBING LIQUID SPILLS FOR INDUSTRIAL AND COMMERCIAL USE (U.S. CLS. 19, 20, 37, 42 AND 50).

BENJAMIN ALLEN, EXAMINING ATTORNEY

SN 77-294,156. A-LIST CORPORATE LIMITED, BANGKOK METROPOLIS, THAILAND, FILED 10-2-2007.

Disaya

THE MARK CONSISTS OF STYLIZED SPELLING OF THE WORD "DISAYA".

THE WORDING IN THE MARK HAS NO FOREIGN LANGUAGE MEANING.

CLASS 14—JEWELRY

FOR BRACELETS; COSTUME JEWELRY; EARRINGS; JEWELRY; JEWELRY BOXES OF PRECIOUS METAL; JEWELRY CHAINS; KEY CHAINS OF PRECIOUS METAL; KEY RINGS OF PRECIOUS METAL; ORNAMENTS OF PRECIOUS METAL; PEARLS; PRECIOUS GEMSTONES; PRECIOUS STONES; RINGS BEING JEWELRY; TIE CLIPS (U.S. CLS. 2, 27, 28 AND 50).

CLASS 25—CLOTHING

FOR BATH SLIPPERS; BATHING SUITS; BATHING TRUNKS; BEACH COVERUPS; BEACH SHOES; BELTS; BODY SUITS; BOOTS; BRAS; CAMISOLES; CAPS; COATS; CROP TOPS; HATS; JACKETS; JERSEYS; JUMPERS; KNIT SHIRTS; KNITTED UNDERWEAR; LACE BOOTS; LEATHER COATS; LEATHER JACKETS; LEATHER PANTS; LINGERIE; OVER COATS; PAJAMAS; PANTIES; PANTS; ROBES; SANDALS; SCARVES; SHIRTS; SHOES; SKIRTS; SLIPPERS; STOCKINGS; SUITS; SWEATERS; SWIMSUITS; T-SHIRTS; TANK TOPS; TROUSERS; UNDERPANTS; UNDERWEAR (U.S. CLS. 22 AND 39).

JESSICA A. POWERS, EXAMINING ATTORNEY

SN 77-294,197. FPL GROUP, INC., JUNO BEACH, FL. FILED 10-2-2007.

SN 77-294,240. ESSENTIAL LIVING, LLC, WAVERLY, PA. FILED 10-2-2007.

SOLTERRA

THE MARK CONSISTS OF STANDARD CHARACTERS WITHOUT CLAIM TO ANY PARTICULAR FONT, STYLE, SIZE, OR COLOR.

CLASS 9—ELECTRICAL AND SCIENTIFIC APPARATUS

FOR COMPUTER SOFTWARE FOR STUDYING, MODELING, AND FORECASTING METEOROLOGICAL AIR-FLOW (U.S. CLS. 21, 23, 26, 36 AND 38).

CLASS 35—ADVERTISING AND BUSINESS

FOR BUSINESS MANAGEMENT FOR POWER AND ELECTRICITY GENERATING FACILITIES; OPERATION OF A BUSINESS FOR OTHERS, NAMELY, OPERATION OF POWER AND ELECTRICITY GENERATING FACILITIES; MANAGING AND OPERATING POWER AND ELECTRICITY GENERATING FACILITIES OF OTHERS; PROCUREMENT, NAMELY PURCHASING ELECTRICITY ENERGY FOR RETAIL AND WHOLESALE CUSTOMERS (U.S. CLS. 100, 101 AND 102).

CLASS 36—INSURANCE AND FINANCIAL

FOR BROKERAGE IN THE FIELD OF ENVIRONMENTAL CREDITS RESULTING FROM THE PURCHASE, GENERATION, OR USE OF ENERGY, OR THE AVOIDANCE OF EMISSIONS OF ANY GAS, CHEMICAL OR OTHER SUBSTANCE TO THE AIR, SOIL OR WATER; CONSULTANCY CONCERNING FINANCING OF ENERGY PROJECTS, NAMELY, POWER GENERATING FACILITIES (U.S. CLS. 100, 101 AND 102).

CLASS 37—CONSTRUCTION AND REPAIR

FOR CONSULTING SERVICES IN THE FIELD OF LAND DEVELOPMENT, NAMELY, PLANNING AND LAYING OUT OF POWER AND ELECTRICITY GENERATING FACILITIES IN COMMERCIAL COMMUNITIES; CONSULTING SERVICES IN THE FIELD OF CONSTRUCTION OF POWER GENERATING FACILITIES; MAINTENANCE AND REPAIR OF BUILDINGS, NAMELY, POWER AND ELECTRICITY GENERATING FACILITIES (U.S. CLS. 100, 103 AND 106).

CLASS 39—TRANSPORTATION AND STORAGE

FOR PUBLIC UTILITY ELECTRIC SERVICES (U.S. CLS. 100 AND 105).

CLASS 42—SCIENTIFIC AND COMPUTER SERVICES

FOR CONSULTANCY SERVICES IN THE FIELD OF STUDYING, MODELING AND FORECASTING METEOROLOGICAL AIR FLOW; CONSULTING SERVICES IN THE FIELD OF ENVIRONMENTAL ASSESSMENT, COMPLIANCE AND PLANNING, NAMELY, ANALYZING AND EVALUATING ENVIRONMENTAL EFFECTS OF CREDITS, BENEFITS, REDUCTIONS, OFFSETS AND ALLOWANCES OF OTHERS RESULTING FROM THE PURCHASE, GENERATION, OR USE OF ENERGY, OR THE AVOIDANCE OF EMISSIONS OF ANY GAS, CHEMICAL OR OTHER SUBSTANCE TO THE AIR, SOIL OR WATER (U.S. CLS. 100 AND 101).

ROBIN MITTLER, EXAMINING ATTORNEY

ESSENTIAL EATING

THE MARK CONSISTS OF STANDARD CHARACTERS WITHOUT CLAIM TO ANY PARTICULAR FONT, STYLE, SIZE, OR COLOR.

OWNER OF U.S. REG. NO. 3,247,669.

CLASS 29—MEATS AND PROCESSED FOODS

FOR PROCESSED FRUIT- AND NUT-BASED FOOD BARS; FRUIT-BASED ORGANIC FOOD BARS, ALSO CONTAINING DRIED FRUIT, NUTS, SEEDS, AND SPROUTED FLOUR; PROCESSED EDIBLE SEEDS; PROCESSED PUMPKIN SEEDS; PROCESSED BEANS; NUT FLOURS; PROCESSED NUTS (U.S. CL. 46).

CLASS 30—STAPLE FOODS

FOR BREAD; BREAD DOUGH; BREAD ROLLS; BREAD STICKS; ROLLS; PRETZELS; CAKES; CUP CAKES; TORTILLA SHELLS; TORTILLAS; BAGELS; MUFFINS; PIZZA CRUST; PIZZA DOUGH; COOKIES; CRACKERS; DRIED PASTA; FRESH PASTA; PASTA; FLOUR-BASED CHIPS (U.S. CL. 46).

CAROLINE WOOD, EXAMINING ATTORNEY

SN 77-294,261. STREAMSCALE LIMITED, BOLTON, GREAT BRITAIN, FILED 10-2-2007.

StreamScale

THE MARK CONSISTS OF STANDARD CHARACTERS WITHOUT CLAIM TO ANY PARTICULAR FONT, STYLE, SIZE, OR COLOR.

CLASS 9—ELECTRICAL AND SCIENTIFIC APPARATUS

FOR APPARATUS FOR RECORDING, TRANSMISSION OR REPRODUCTION OF SOUND AND IMAGES; BUILDING SECURITY SYSTEMS COMPRISING SOFTWARE AND HARDWARE FOR PROVIDING PICTURE, VIDEO, ALARM STATUS, BUILDING PLANS, AND OTHER INFORMATION TO A REMOTE STATION; DIGITAL VIDEO RECORDERS; ELECTRIC AND ELECTRONIC VIDEO SURVEILLANCE INSTALLATIONS; VIDEO MULTIPLEXERS; VIDEO TRANSMISSION APPARATUS; TELECOMMUNICATIONS AND DATA NETWORKING HARDWARE, NAMELY, DEVICES FOR TRANSPORTING AND AGGREGATING VOICE, DATA, AND VIDEO COMMUNICATIONS ACROSS MULTIPLE NETWORK INFRASTRUCTURES AND COMMUNICATIONS PROTOCOLS (U.S. CLS. 21, 23, 26, 36 AND 38).

CLASS 42—SCIENTIFIC AND COMPUTER SERVICES

FOR PROCESSING OF VIDEO DATA, NAMELY, INTERPRETING VIDEO CONTENT AND IDENTIFYING SEGMENTS THAT CONTAIN PREDEFINED KEY EVENTS (U.S. CLS. 100 AND 101).

HENRY S. ZAK, EXAMINING ATTORNEY

SN 77-294,284. FPL GROUP, INC., JUNO BEACH, FL. FILED 10-2-2007.

SN 77-294,374. ANSON & HIGGINS PLASTIC SURGERY ASSOCIATES, LLP, LAS VEGAS, NV. FILED 10-2-2007.

NEXTERA

THE MARK CONSISTS OF STANDARD CHARACTERS WITHOUT CLAIM TO ANY PARTICULAR FONT, STYLE, SIZE, OR COLOR.

CLASS 9—ELECTRICAL AND SCIENTIFIC APPARATUS

FOR COMPUTER SOFTWARE FOR STUDYING, MODELING AND FORECASTING METEOROLOGICAL AIR FLOW (U.S. CLS. 21, 23, 26, 36 AND 38).

CLASS 35—ADVERTISING AND BUSINESS

FOR BUSINESS MANAGEMENT FOR POWER AND ELECTRICITY GENERATING FACILITIES; OPERATION OF A BUSINESS FOR OTHERS, NAMELY, OPERATION OF POWER AND ELECTRICITY GENERATING FACILITIES; MANAGING AND OPERATING POWER AND ELECTRICITY GENERATING FACILITIES OF OTHERS; PROCUREMENT, NAMELY PURCHASING ELECTRIC ENERGY FOR RETAIL AND WHOLESALE CUSTOMERS (U.S. CLS. 100, 101 AND 102).

CLASS 36—INSURANCE AND FINANCIAL

FOR BROKERAGE IN THE FIELD OF ENVIRONMENTAL CREDITS RESULTING FROM THE PURCHASE, GENERATION, OR USE OF ENERGY, OR THE AVOIDANCE OF EMISSIONS OF ANY GAS, CHEMICAL OR OTHER SUBSTANCE TO THE AIR, SOIL OR WATER; CONSULTANCY CONCERNING FINANCING OF ENERGY PROJECTS, NAMELY, POWER GENERATING FACILITIES (U.S. CLS. 100, 101 AND 102).

CLASS 37—CONSTRUCTION AND REPAIR

FOR CONSULTING SERVICES IN THE FIELD OF LAND DEVELOPMENT, NAMELY, PLANNING AND LAYING OUT OF POWER AND ELECTRICITY GENERATING FACILITIES IN COMMERCIAL COMMUNITIES; CONSULTING SERVICES IN THE FIELD OF CONSTRUCTION OF POWER GENERATING FACILITIES; MAINTENANCE AND REPAIR OF BUILDINGS, NAMELY, POWER AND ELECTRICITY GENERATING FACILITIES (U.S. CLS. 100, 103 AND 106).

CLASS 39—TRANSPORTATION AND STORAGE

FOR PUBLIC UTILITY ELECTRIC SERVICES (U.S. CLS. 100 AND 105).

CLASS 42—SCIENTIFIC AND COMPUTER SERVICES

FOR CONSULTANCY SERVICES IN THE FIELD OF STUDYING, MODELING AND FORECASTING METEOROLOGICAL AIR FLOW; CONSULTING SERVICES IN THE FIELD OF ENVIRONMENTAL ASSESSMENT, COMPLIANCE AND PLANNING, NAMELY, ANALYZING AND EVALUATING ENVIRONMENTAL EFFECTS OF CREDITS, BENEFITS, REDUCTIONS, OFFSETS AND ALLOWANCES OF OTHERS RESULTING FROM THE PURCHASE, GENERATION, OR USE OF ENERGY, OR THE AVOIDANCE OF EMISSIONS OF ANY GAS, CHEMICAL OR OTHER SUBSTANCE TO THE AIR, SOIL OR WATER (U.S. CLS. 100 AND 101).

ROBIN MITTLER, EXAMINING ATTORNEY

NATURE REDEFINED

THE MARK CONSISTS OF STANDARD CHARACTERS WITHOUT CLAIM TO ANY PARTICULAR FONT, STYLE, SIZE, OR COLOR.

CLASS 5—PHARMACEUTICALS

FOR PHARMACEUTICAL PRODUCTS AND PREPARATIONS FOR USE IN COSMETIC AND PLASTIC SURGERY AND TREATMENTS (U.S. CLS. 6, 18, 44, 46, 51 AND 52).

FIRST USE 3-30-2006; IN COMMERCE 3-30-2006.

CLASS 44—MEDICAL, BEAUTY AND AGRICULTURAL SERVICES

FOR COSMETIC AND PLASTIC SURGERY (U.S. CLS. 100 AND 101).

FIRST USE 1-31-2002; IN COMMERCE 1-31-2002.

GINA FINK, EXAMINING ATTORNEY

SN 77-294,413. ANSON & HIGGINS PLASTIC SURGERY ASSOCIATES, LLP, LAS VEGAS, NV. FILED 10-2-2007.



THE MARK CONSISTS OF FLEUR DE LIS AND ROSE PETAL DESIGN.

CLASS 5—PHARMACEUTICALS

FOR PHARMACEUTICAL PRODUCTS AND PREPARATIONS FOR USE IN COSMETIC AND PLASTIC SURGERY AND TREATMENTS (U.S. CLS. 6, 18, 44, 46, 51 AND 52).

CLASS 44—MEDICAL, BEAUTY AND AGRICULTURAL SERVICES

FOR COSMETIC AND PLASTIC SURGERY (U.S. CLS. 100 AND 101).

FIRST USE 9-18-2006; IN COMMERCE 9-18-2006.

GINA FINK, EXAMINING ATTORNEY

SN 77-294,440. 55 HOCKEY PRODUCTS INC., OSHAWA, CANADA, FILED 10-2-2007.

UNLEASH THE FURY

THE MARK CONSISTS OF STANDARD CHARACTERS WITHOUT CLAIM TO ANY PARTICULAR FONT, STYLE, SIZE, OR COLOR.

OWNER OF U.S. REG. NO. 3,293,559.

CLASS 9—ELECTRICAL AND SCIENTIFIC APPARATUS

FOR ICE HOCKEY HELMETS; ICE HOCKEY GOALIE MASKS (U.S. CLS. 21, 23, 26, 36 AND 38).

CLASS 18—LEATHER GOODS

FOR HOCKEY AND HOCKEY STICK BAGS, NAMELY, SPORTS BAGS (U.S. CLS. 1, 2, 3, 22 AND 41).

CLASS 25—CLOTHING

FOR HOCKEY PANTS; LACROSSE GOALIE PANTS; GOLF SHIRTS; BALL CAPS; TOQUE; HOCKEY SHIRTS; TRACK SUITS; T-SHIRTS; UNDERGARMENTS FOR ATHLETIC USE; SWEAT SHIRTS; AND WRIST AND HEAD BANDS; GARTER BELTS AND SUSPENDERS FOR ATHLETIC USE (U.S. CLS. 22 AND 39).

CLASS 28—TOYS AND SPORTING GOODS

FOR HOCKEY AND HOCKEY STICK BAGS, NAMELY, BAGS SPECIALLY ADAPTED FOR SPORTS EQUIPMENT; HOCKEY GLOVES; ICE HOCKEY STICKS; LACROSSE GOALIE GLOVES; BLADES FOR HOCKEY SKATES; CHEST PROTECTORS, ELBOW PADS, SHOULDER PADS, AND SHIN PADS, ALL FOR ATHLETIC USE; ATHLETIC SUPPORTERS; ICE HOCKEY GOALIE PADS; ICE HOCKEY GOALIE GLOVES AND BLOCKERS; MINI HOCKEY STICKS; PUCKS; AND BASEBALL BATS AND GLOVES (U.S. CLS. 22, 23, 38 AND 50).

SALLY SHIH, EXAMINING ATTORNEY

SN 77-294,450. PAWLITSKI, SUESAN L., SANTA BARBARA, CA. FILED 10-2-2007.



The logo for 'Yachtie Girl' features the word 'Yachtie' in a blue, cursive script, followed by a small red and white sailboat icon, and the word 'Girl' in a larger, blue, cursive script.

NO CLAIM IS MADE TO THE EXCLUSIVE RIGHT TO USE "GIRL", APART FROM THE MARK AS SHOWN.

THE COLOR(S) NAVY BLUE, RED, LIGHT BLUE IS/ARE CLAIMED AS A FEATURE OF THE MARK.

THE MARK CONSISTS OF THE LETTERS ARE ALL IN NAVY BLUE, THE HYPHEN IN THE MIDDLE IS NAVY BLUE, THE SAIL BOAT ABOVE THE HYPHEN IS RED, THE WIND MARK IN THE SAIL BOAT IS LIGHT BLUE.

CLASS 18—LEATHER GOODS

FOR (BASED ON INTENT TO USE) TOTE BAGS, COSMETIC BAGS SOLD EMPTY; BEACH BAGS (U.S. CLS. 1, 2, 3, 22 AND 41).

CLASS 25—CLOTHING

FOR (BASED ON USE IN COMMERCE) SHORT-SLEEVED OR LONG-SLEEVED T-SHIRTS; HEADWEAR; WOMEN'S UNDERWEAR; JACKETS; SWEAT SHIRTS (U.S. CLS. 22 AND 39).

FIRST USE 11-0-2005; IN COMMERCE 12-0-2005.
SIMON TENG, EXAMINING ATTORNEY

SN 77-294,499. RAYMOND R. BETZ INTEREST, INC., HOUSTON, TX. FILED 10-2-2007.



The logo for 'BETZ' consists of the word 'BETZ' in a large, bold, black, serif font.

THE MARK CONSISTS OF STANDARD CHARACTERS WITHOUT CLAIM TO ANY PARTICULAR FONT, STYLE, SIZE, OR COLOR.
SEC. 2(F).

CLASS 36—INSURANCE AND FINANCIAL

FOR ASSESSMENT AND MANAGEMENT OF REAL ESTATE; LAND ACQUISITION, NAMELY, REAL ESTATE BROKERAGE; LEASING OF REAL ESTATE; REAL ESTATE ACQUISITION SERVICES; REAL ESTATE BROKERAGE; REAL ESTATE CONSULTATION; REAL ESTATE INVESTMENT; REAL ESTATE MANAGEMENT (U.S. CLS. 100, 101 AND 102).

FIRST USE 12-31-1976; IN COMMERCE 12-31-1976.

CLASS 37—CONSTRUCTION AND REPAIR

FOR REAL ESTATE DEVELOPMENT; REAL ESTATE SITE SELECTION (U.S. CLS. 100, 103 AND 106).

FIRST USE 12-31-1976; IN COMMERCE 12-31-1976.

JAMES MACFARLANE, EXAMINING ATTORNEY

SN 77-294,567. MASON & MASON REAL ESTATE APPRAISERS AND CONSULTANTS, INC., MONTROSE, CA. FILED 10-2-2007.



The logo for 'MASON2' consists of the word 'MASON2' in a bold, black, serif font.

THE MARK CONSISTS OF STANDARD CHARACTERS WITHOUT CLAIM TO ANY PARTICULAR FONT, STYLE, SIZE, OR COLOR.

CLASS 36—INSURANCE AND FINANCIAL

FOR APPRAISAL SERVICES AND PROPERTY MANAGEMENT OF REAL ESTATE, NAMELY, RELATED TO RIGHT OF WAY ACQUISITIONS, EMINENT DOMAIN, INVERSE CONDEMNATION AND OTHER TRANSFERS OF REAL ESTATE PROPERTY RIGHTS (U.S. CLS. 100, 101 AND 102).

CLASS 45—PERSONAL AND LEGAL SERVICES

FOR CONSULTING, EXPERT WITNESS SERVICES AND LITIGATION SUPPORT IN CONNECTION WITH LEGAL MATTERS IN THE FIELD OF REAL ESTATE PROPERTY RIGHTS, NAMELY, RELATED TO RIGHT OF WAY ACQUISITIONS, EMINENT DOMAIN, INVERSE CONDEMNATION AND OTHER TRANSFERS OF REAL ESTATE PROPERTY RIGHTS (U.S. CLS. 100 AND 101).

DAVID H. STINE, EXAMINING ATTORNEY

CLASS 41—EDUCATION AND ENTERTAINMENT

FOR EDUCATION SERVICES, NAMELY, PROVIDING WORKSHOPS AND SEMINARS IN THE FIELD OF PERSONAL GROWTH AND DEVELOPMENT, SOCIAL DEVELOPMENT AND GROWTH, DEVELOPMENT OF SOCIAL AND COMMUNICATION SKILLS, CHANGE AND TRANSITION MANAGEMENT, LEARNING TECHNIQUES AND PSYCHOLOGICAL DEVELOPMENT AND DEVELOPMENT OF LISTENING SKILLS; EDUCATIONAL ASSESSMENT; EDUCATIONAL RESEARCH; EDUCATIONAL SERVICES, NAMELY, DEVELOPING CURRICULUM FOR OTHERS IN THE FIELD OF PERSONAL GROWTH AND DEVELOPMENT, SOCIAL DEVELOPMENT AND GROWTH, DEVELOPMENT OF SOCIAL AND COMMUNICATION SKILLS, CHANGE AND TRANSITION MANAGEMENT, LEARNING TECHNIQUES AND PSYCHOLOGICAL DEVELOPMENT AND DEVELOPMENT OF LISTENING SKILLS (U.S. CLS. 100, 101 AND 107).

FIRST USE 0-0-1981; IN COMMERCE 0-0-1981.
WARREN L. OLANDRIA, EXAMINING ATTORNEY

SN 77-294,573. CALDWELL WILLIAMS, LOS ANGELES, CA. FILED 10-2-2007.

SN 77-294,619. CHECKMATE HOLDING COMPANY, LLC, VENTURA, CA. FILED 10-2-2007.

GOALTENDERS

THE MARK CONSISTS OF STANDARD CHARACTERS WITHOUT CLAIM TO ANY PARTICULAR FONT, STYLE, SIZE, OR COLOR.

CLASS 16—PAPER GOODS AND PRINTED MATTER

FOR CHILDREN'S INTERACTIVE EDUCATIONAL BOOKS; WORKBOOKS DIRECTED TO PERSONAL GROWTH AND DEVELOPMENT, SOCIAL DEVELOPMENT AND GROWTH, DEVELOPMENT OF SOCIAL AND COMMUNICATION SKILLS, CHANGE AND TRANSITION MANAGEMENT, LEARNING TECHNIQUES AND PSYCHOLOGICAL DEVELOPMENT AND DEVELOPMENT OF LISTENING SKILLS; PRINTED INSTRUCTIONAL, EDUCATIONAL, AND TEACHING MATERIALS IN THE FIELD OF PERSONAL GROWTH AND DEVELOPMENT, SOCIAL DEVELOPMENT AND GROWTH, DEVELOPMENT OF SOCIAL AND COMMUNICATION SKILLS, CHANGE AND TRANSITION MANAGEMENT, LEARNING TECHNIQUES AND PSYCHOLOGICAL DEVELOPMENT AND DEVELOPMENT OF LISTENING SKILLS; PRINTED TEACHING MATERIALS IN THE FIELD OF PERSONAL GROWTH AND DEVELOPMENT, SOCIAL DEVELOPMENT AND GROWTH, DEVELOPMENT OF SOCIAL AND COMMUNICATION SKILLS, CHANGE AND TRANSITION MANAGEMENT, LEARNING TECHNIQUES AND PSYCHOLOGICAL DEVELOPMENT AND DEVELOPMENT OF LISTENING SKILLS; PUBLICATIONS, NAMELY, BROCHURES, BOOKLETS, AND TEACHING MATERIALS IN THE FIELD OF PERSONAL GROWTH AND DEVELOPMENT, SOCIAL DEVELOPMENT AND GROWTH, DEVELOPMENT OF SOCIAL AND COMMUNICATION SKILLS, CHANGE AND TRANSITION MANAGEMENT, LEARNING TECHNIQUES AND PSYCHOLOGICAL DEVELOPMENT AND DEVELOPMENT OF LISTENING SKILLS (U.S. CLS. 2, 5, 22, 23, 29, 37, 38 AND 50).

FIRST USE 0-0-1981; IN COMMERCE 0-0-1981.

Night Moves

THE MARK CONSISTS OF STANDARD CHARACTERS WITHOUT CLAIM TO ANY PARTICULAR FONT, STYLE, SIZE, OR COLOR.

CLASS 10—MEDICAL APPARATUS

FOR ORTHODONTIC PRODUCTS, NAMELY, ORTHODONTIC APPLIANCES (U.S. CLS. 26, 39 AND 44).

CLASS 44—MEDICAL, BEAUTY AND AGRICULTURAL SERVICES

FOR ORTHODONTIC FITTING SERVICES (U.S. CLS. 100 AND 101).
MARIAM MAHMOUDI, EXAMINING ATTORNEY

SN 77-294,805. CAPPELLI STRAWORLD, INC., MIAMI, FL. FILED 10-3-2007.

GREEN PALMS

THE MARK CONSISTS OF STANDARD CHARACTERS WITHOUT CLAIM TO ANY PARTICULAR FONT, STYLE, SIZE, OR COLOR.

CLASS 18—LEATHER GOODS

FOR HANDBAGS (U.S. CLS. 1, 2, 3, 22 AND 41).

CLASS 25—CLOTHING

FOR HATS (U.S. CLS. 22 AND 39).
BARBARA BROWN, EXAMINING ATTORNEY

SN 77-294,879, MARIE ANDERSON, SCOTTSDALE, AZ.
FILED 10-3-2007.

SN 77-294,923, FARALLON CONSULTING, LLC, ISSAQUAH,
WA. FILED 10-3-2007.



NO CLAIM IS MADE TO THE EXCLUSIVE RIGHT TO USE "STUDIO", APART FROM THE MARK AS SHOWN.

THE COLOR(S) BROWN IS/ARE CLAIMED AS A FEATURE OF THE MARK.

THE MARK CONSISTS OF A BROWN DRAWING OF A HEAD, FACE AND NECK WITH LONG CURLY HAIR AND A BAND ACROSS THE FOREHEAD, WITH THE WORDS "STUDIO GALATEA" IN BROWN CURVED AROUND THE LEFT SIDE; A DOT IN THE MIDDLE SEPARATES EACH LETTER OF THE WORDS.

CLASS 9—ELECTRICAL AND SCIENTIFIC APPARATUS

FOR MUSICAL SOUND RECORDINGS (U.S. CLS. 21, 23, 26, 36 AND 38).

CLASS 14—JEWELRY

FOR NECKLACES; BRACELETS; CUFF-LINKS (U.S. CLS. 2, 27, 28 AND 50).

CLASS 16—PAPER GOODS AND PRINTED MATTER

FOR BLANK WRITING JOURNALS (U.S. CLS. 2, 5, 22, 23, 29, 37, 38 AND 50).

CLASS 25—CLOTHING

FOR SHIRTS; HATS (U.S. CLS. 22 AND 39).

CLASS 41—EDUCATION AND ENTERTAINMENT

FOR EDUCATIONAL AND ENTERTAINMENT SERVICES, NAMELY, PROVIDING MOTIVATIONAL AND EDUCATIONAL SPEAKERS; ARRANGING AND CONDUCTING EDUCATIONAL CONFERENCES; WORKSHOPS AND SEMINARS IN THE FIELD OF SELF ESTEEM; EDUCATION SERVICES, NAMELY, PROVIDING SEMINARS IN THE FIELD OF SELF ESTEEM; EDUCATIONAL SERVICES, NAMELY, DEVELOPING, ARRANGING, AND CONDUCTING EDUCATIONAL CONFERENCES AND PROGRAMS AND PROVIDING COURSES OF INSTRUCTION IN THE FIELD OF SELF ESTEEM; EDUCATIONAL SERVICES, NAMELY, CONDUCTING WORKSHOPS AND SEMINARS IN THE FIELD OF SELF ESTEEM (U.S. CLS. 100, 101 AND 107).
JOHN WILKE, EXAMINING ATTORNEY

FARALLON

THE MARK CONSISTS OF STANDARD CHARACTERS WITHOUT CLAIM TO ANY PARTICULAR FONT, STYLE, SIZE, OR COLOR.

CLASS 9—ELECTRICAL AND SCIENTIFIC APPARATUS

FOR APPARATUS FOR TESTING GAS, LIQUIDS AND SOLIDS (U.S. CLS. 21, 23, 26, 36 AND 38).
FIRST USE 11-0-2003; IN COMMERCE 11-0-2003.

CLASS 42—SCIENTIFIC AND COMPUTER SERVICES

FOR CONSULTING SERVICES IN THE FIELD OF ENVIRONMENTAL ASSESSMENT, COMPLIANCE AND PLANNING; ENGINEERING SERVICES FOR BUILDING AND PROPERTY CONDITION ASSESSMENT, FACILITY MANAGEMENT, REPAIR AND RESTORATION, BUILDING INSTRUMENTATION AND MONITORING, AND ENVIRONMENTAL CONSULTING (U.S. CLS. 100 AND 101).

FIRST USE 12-17-1998; IN COMMERCE 12-17-1998.
VIVIAN MICZNIK FIRST, EXAMINING ATTORNEY

SN 77-295,035, MULTIPLAYER GAMING TECHNOLOGIES LLC, ELK GROVE VILLAGE, IL. FILED 10-3-2007.

TRIBAL POKER NETWORK

THE MARK CONSISTS OF STANDARD CHARACTERS WITHOUT CLAIM TO ANY PARTICULAR FONT, STYLE, SIZE, OR COLOR.

NO CLAIM IS MADE TO THE EXCLUSIVE RIGHT TO USE "POKER NETWORK", APART FROM THE MARK AS SHOWN.

CLASS 9—ELECTRICAL AND SCIENTIFIC APPARATUS

FOR COMPUTER HARDWARE (U.S. CLS. 21, 23, 26, 36 AND 38).

CLASS 41—EDUCATION AND ENTERTAINMENT

FOR NETWORK GAMING SERVICES, NAMELY, PROVIDING A COMPUTER GAME THAT MAY BE ACCESSED NETWORK-WIDE BY NETWORK USERS (U.S. CLS. 100, 101 AND 107).
JANET LEE, EXAMINING ATTORNEY

SN 77-295,043. N LINK CO., LTD., TOKYO, JAPAN, FILED 10-3-2007.



THE COLOR(S) ORANGE/RED, PINK AND CREAM IS/ ARE CLAIMED AS A FEATURE OF THE MARK.
THE MARK CONSISTS OF ORANGE/RED, PINK, CREAM FAN DESIGN WITH ORANGE/RED SUN IN CENTER.

CLASS 29—MEATS AND PROCESSED FOODS

FOR PREPARED MEALS CONSISTING PRIMARILY OF MEATS, FISH, SHELLFISH OR POULTRY AND ONE OR MORE VEGETABLES AND STARCHES; SOUPS (U.S. CL. 46).

CLASS 30—STAPLE FOODS

FOR PREPARED MEALS CONSISTING PRIMARILY OF RICE OR PASTA; SUSHI; BOXED LUNCHES CONSISTING PRIMARILY OF RICE OR PASTA (U.S. CL. 46).

CLASS 43—HOTEL AND RESTAURANT SERVICES

FOR RESTAURANT SERVICES, NAMELY, PROVIDING FOODS BASED ON JAPANESE CUISINE (U.S. CLS. 100 AND 101).
JILL C. ALT, EXAMINING ATTORNEY

SN 77-295,180. KIRSTEN GOULD, DBA PUNKADOO, COSTA MESA, CA. FILED 10-3-2007.



THE MARK CONSISTS OF THE STYLIZED WORDING "PUNKADOO.COM" INSIDE THE DESIGN OF AN OUTLINE OF A GIFT BOX HAVING A BOW ON TOP AND RIBBON DOWN THE CENTER OF THE BOX, AND THE STYLIZED WORDING "THE ONE STOP GIFT SHOP!" BELOW THE DESIGN OF THE GIFT BOX, ALL INSIDE A SHADED SQUARE.

CLASS 18—LEATHER GOODS

FOR BAGS FOR CARRYING BABIES' ACCESSORIES; PET ACCESSORIES, NAMELY, SPECIALLY DESIGNED CANVAS, VINYL OR LEATHER BAGS ATTACHED TO ANIMAL LEASHES FOR HOLDING SMALL ITEMS SUCH AS KEYS, CREDIT CARDS, MONEY OR DISPOSABLE BAGS FOR DISPOSING OF PET WASTE; PET ACCESSORIES, NAMELY, CANVAS, VINYL AND LEATHER POUCHES FOR HOLDING DISPOSABLE BAGS TO PLACE PET WASTE IN; PET COLLAR ACCESSORIES, NAMELY, BOWS AND CHARMS; HANDBAGS; DOG APPAREL (U.S. CLS. 1, 2, 3, 22 AND 41).

CLASS 25—CLOTHING

FOR INFANT AND TODDLER ONE PIECE CLOTHING; INFANT WEAR; BABY BIBS NOT OF PAPER; SCARVES (U.S. CLS. 22 AND 39).
JAY BESCH, EXAMINING ATTORNEY

SN 77-295,233. EDWIN JOSEPH SPENCE, GULF SHORES, AL. AND DAVID PATRICK CAHOON, GULF SHORES, AL. FILED 10-3-2007.

SRIMP BASKET

THE MARK CONSISTS OF STANDARD CHARACTERS WITHOUT CLAIM TO ANY PARTICULAR FONT, STYLE, SIZE, OR COLOR.
NO CLAIM IS MADE TO THE EXCLUSIVE RIGHT TO USE "SHRIMP", APART FROM THE MARK AS SHOWN.

CLASS 30—STAPLE FOODS

FOR SAUCES; TARTAR SAUCE; READY-MADE SAUCES; DIPPING SAUCES (U.S. CL. 46).

CLASS 43—HOTEL AND RESTAURANT SERVICES

FOR CARRY-OUT RESTAURANTS; RESTAURANTS (U.S. CLS. 100 AND 101).
DANIEL CAPSHAW, EXAMINING ATTORNEY

SN 77-295,339. THE GODFREY CONVEYOR COMPANY, INC., ELKHART, IN. FILED 10-3-2007.



NO CLAIM IS MADE TO THE EXCLUSIVE RIGHT TO USE "GLOBAL GROUP", APART FROM THE MARK AS SHOWN.

CLASS 12—VEHICLES

FOR VEHICLES, NAMELY, BOATS (U.S. CLS. 19, 21, 23, 31, 35 AND 44).

CLASS 35—ADVERTISING AND BUSINESS

FOR BUSINESS MANAGEMENT, BUSINESS ADMINISTRATION AND OFFICE FUNCTIONS (U.S. CLS. 100, 101 AND 102).

ANDREA HACK, EXAMINING ATTORNEY

SN 77-295,379. TOMOPAL, INC., SACRAMENTO, CA. FILED 10-3-2007.

TOMOPAL

THE MARK CONSISTS OF STANDARD CHARACTERS WITHOUT CLAIM TO ANY PARTICULAR FONT, STYLE, SIZE, OR COLOR.

CLASS 9—ELECTRICAL AND SCIENTIFIC APPARATUS

FOR DISPENSER SYRINGES FOR LABORATORY USE (U.S. CLS. 21, 23, 26, 36 AND 38).

CLASS 35—ADVERTISING AND BUSINESS

FOR EXPORT AND IMPORT AGENCIES AND DISTRIBUTORSHIP SERVICES IN THE FIELD OF EQUIPMENT, INSTRUMENTS, AND ACCESSORIES FOR LABORATORY USE (U.S. CLS. 100, 101 AND 102).

ERNEST SHOSHO, EXAMINING ATTORNEY

SN 77-295,447. CROWN BUILDING MAINTENANCE CO., DBA ABLE SERVICES, SAN FRANCISCO, CA. FILED 10-3-2007.



OWNER OF U.S. REG. NO. 2,001,495.
THE COLOR(S) GREEN AND RED IS/ARE CLAIMED AS A FEATURE OF THE MARK.

THE MARK CONSISTS OF THE WORDING "GREEN-ABLE" IN WHICH THE WORD "GREEN" APPEARS IN THE COLOR GREEN, AND THE WORD "ABLE" APPEARS IN RED.

CLASS 37—CONSTRUCTION AND REPAIR

FOR JANITORIAL SERVICES (U.S. CLS. 100, 103 AND 106).

CLASS 42—SCIENTIFIC AND COMPUTER SERVICES

FOR ENGINEERING SERVICES FOR BUILDING AND PROPERTY CONDITION ASSESSMENT, FACILITY MANAGEMENT, REPAIR AND RESTORATION, BUILDING INSTRUMENTATION AND MONITORING, AND ENVIRONMENTAL CONSULTING (U.S. CLS. 100 AND 101).

HANNO RITTNER, EXAMINING ATTORNEY

SN 77-295,449. BOSS CREATIONS, LLC, ANNAPOLIS, MD. FILED 10-3-2007.

BOSS CREATIONS

THE MARK CONSISTS OF STANDARD CHARACTERS WITHOUT CLAIM TO ANY PARTICULAR FONT, STYLE, SIZE, OR COLOR.

NO CLAIM IS MADE TO THE EXCLUSIVE RIGHT TO USE "CREATIONS", APART FROM THE MARK AS SHOWN.

CLASS 35—ADVERTISING AND BUSINESS

FOR ON-LINE RETAIL STORE SERVICES FEATURING CHRISTMAS TREES, CHRISTMAS TREE ACCESSORIES, CHRISTMAS DECORATIONS, AND GIFTS; RETAIL STORE SERVICES FEATURING CHRISTMAS TREES, CHRISTMAS TREE ACCESSORIES, CHRISTMAS DECORATIONS, AND GIFTS (U.S. CLS. 100, 101 AND 102).

CLASS 42—SCIENTIFIC AND COMPUTER SERVICES

FOR DESIGN AND TESTING FOR NEW PRODUCT DEVELOPMENT; PRODUCT DEVELOPMENT; PRODUCT DEVELOPMENT FOR OTHERS; DESIGN AND TESTING OF NEW PRODUCTS FOR OTHERS; PRODUCT DEVELOPMENT CONSULTATION; PRODUCT RESEARCH AND DEVELOPMENT; RESEARCH AND DEVELOPMENT FOR NEW PRODUCTS FOR OTHERS (U.S. CLS. 100 AND 101).

HANNO RITTNER, EXAMINING ATTORNEY

SN 77-295,518. BROOKSTONE COMPANY, INC., MERRIMACK, NH. FILED 10-3-2007.

Brookstone DESIGN USA

OWNER OF U.S. REG. NOS. 1,338,831, 2,334,207 AND OTHERS.

NO CLAIM IS MADE TO THE EXCLUSIVE RIGHT TO USE "DESIGN USA", APART FROM THE MARK AS SHOWN.

THE MARK CONSISTS OF THE WORDS "BROOKSTONE DESIGN USA" IN STYLIZED FONT AND FORMAT.

CLASS 9—ELECTRICAL AND SCIENTIFIC APPARATUS

FOR PERSONAL STEREO; HEADPHONES; EAR PHONES; PORTABLE RADIOS; CD PLAYERS; DVD PLAYERS; MP3 PLAYERS; CORDLESS TELEPHONES; HEADSETS FOR TELEPHONES; TELEPHONES; AUDIO SPEAKERS (U.S. CLS. 21, 23, 26, 36 AND 38).

CLASS 10—MEDICAL APPARATUS

FOR MASSAGE APPARATUS; MASSAGING APPARATUS FOR PERSONAL USE (U.S. CLS. 26, 39 AND 44).
ALEX KEAM, EXAMINING ATTORNEY

SN 77-295,582. INKJET INTERNATIONAL LLP, DALLAS, TX. FILED 10-3-2007.

GREEN-FLEX

THE MARK CONSISTS OF STANDARD CHARACTERS WITHOUT CLAIM TO ANY PARTICULAR FONT, STYLE, SIZE, OR COLOR.

CLASS 17—RUBBER GOODS

FOR VINYL SUBSTRATES USED BY OUTDOOR ADVERTISING INDUSTRY FOR BILLBOARDS AND THE LIKE (U.S. CLS. 1, 5, 12, 13, 35 AND 50).

CLASS 20—FURNITURE AND ARTICLES NOT OTHERWISE CLASSIFIED

FOR PLASTIC BANNERS (U.S. CLS. 2, 13, 22, 25, 32 AND 50).
IRA J. GOODSaid, EXAMINING ATTORNEY

SN 77-295,550. DIGIDEAL CORPORATION, SPOKANE, WA. FILED 10-3-2007.



THE COLOR(S) RED-ORANGE, GOLD, ORANGE, LIGHT ORANGE, YELLOW, TURQUOISE, WHITE, MAGENTA AND PURPLE IS/ARE CLAIMED AS A FEATURE OF THE MARK.

THE MARK CONSISTS OF THE WORDS "DRAGON" AND "BACC" WHICH ARE IN RED-ORANGE COLOR WITH GOLD ACCENTS ALONG THE PERIPHERAL BORDERS AND TOOTHED INTERIOR SEGMENTS. THE GEOMETRIC ARCH APPEARING OVER THE DRAGON FIGURE IS A MIX OF RED-ORANGE, LIGHT ORANGE AND YELLOW WHICH TRANSITION DOWNWARDLY. THE BODY OF THE DRAGON BODY AND ARMS ARE TURQUOISE WITH WHITE CLAWS. THE DORSAL FIN OF THE DRAGON IS YELLOW AND CHANGING TO ORANGE NEAR THE TOP AND RIGHT AS SHOWN IN THE DRAWING. THE TAIL OF THE DRAGON IS RED-ORANGE. THE FAN BEHIND THE HEAD OF THE DRAGON IS ORANGE FADING TO YELLOW. THE BEARD, MUSTACHE AND EYEBROWS OF THE DRAGON ARE YELLOW. THE TOP HORNS, EAR HORNS AND TEETH ARE WHITE. THE EARS AND TONGUE ARE MAGENTA. THE EYES ARE PURPLE WITH TURQUOISE IRISES AND WHITE OUTER EYEBALLS.

CLASS 9—ELECTRICAL AND SCIENTIFIC APPARATUS

FOR ELECTRONIC AND ELECTRO-MECHANICAL GAMING TABLES WITH VIDEO OUTPUT (U.S. CLS. 21, 23, 26, 36 AND 38).

CLASS 41—EDUCATION AND ENTERTAINMENT

FOR LEASING OF ELECTRONIC GAMING MACHINES (U.S. CLS. 100, 101 AND 107).
MICHAEL WEBSTER, EXAMINING ATTORNEY

SN 77-295,609. TIED TO THE TRACKS FILMS, INC., CAMBRIDGE, MA. FILED 10-3-2007.

TIED TO THE TRACKS FILMS

THE MARK CONSISTS OF STANDARD CHARACTERS WITHOUT CLAIM TO ANY PARTICULAR FONT, STYLE, SIZE, OR COLOR.

NO CLAIM IS MADE TO THE EXCLUSIVE RIGHT TO USE "FILMS", APART FROM THE MARK AS SHOWN.

CLASS 9—ELECTRICAL AND SCIENTIFIC APPARATUS

FOR PRE-RECORDED CDS, VIDEO TAPES, AND DVDS AND MOTION PICTURE FILMS FEATURING EDUCATIONAL SUBJECTS, NAMELY, DOCUMENTARIES AND DRAMATIC PRESENTATIONS OF SOCIALLY RELEVANT SUBJECT MATTER (U.S. CLS. 21, 23, 26, 36 AND 38).
FIRST USE 12-30-1991; IN COMMERCE 12-30-1991.

CLASS 41—EDUCATION AND ENTERTAINMENT

FOR MOTION PICTURE FILM PRODUCTION (U.S. CLS. 100, 101 AND 107).
FIRST USE 12-30-1991; IN COMMERCE 12-30-1991.
MELVIN AXILBUND, EXAMINING ATTORNEY

SN 77-295,610. YOGA WORKS, INC., SANTA MONICA, CA.
FILED 10-3-2007.

KIDSWORKS

THE MARK CONSISTS OF STANDARD CHARACTERS WITHOUT CLAIM TO ANY PARTICULAR FONT, STYLE, SIZE, OR COLOR.

OWNER OF U.S. REG. NOS. 2,022,243, 2,066,984 AND 2,991,794.

CLASS 41—EDUCATION AND ENTERTAINMENT

FOR YOGA INSTRUCTION (U.S. CLS. 100, 101 AND 107).

CLASS 43—HOTEL AND RESTAURANT SERVICES

FOR CHILD CARE (U.S. CLS. 100 AND 101).
ANNE E. GUSTASON, EXAMINING ATTORNEY

SN 77-295,716. GIRGIS, PORFIRIA, DBA JARAN STUDIOS,
WINSTON SALEM, NC. FILED 10-3-2007.

DREAD FORCE

THE MARK CONSISTS OF STANDARD CHARACTERS WITHOUT CLAIM TO ANY PARTICULAR FONT, STYLE, SIZE, OR COLOR.

CLASS 9—ELECTRICAL AND SCIENTIFIC APPARATUS

FOR SOFTWARE; DOWNLOADABLE VIDEO RECORDINGS FEATURING TRANSFORMABLE ROBOTS; VIDEO DISKS AND VIDEO TAPES WITH RECORDED ANIMATED CARTOONS; VIDEO GAME CARTRIDGES; VIDEO GAME DISCS; VIDEO GAME SOFTWARE; VIDEO RECORDINGS FEATURING TRANSFORMABLE ROBOTS; CINEMATOGRAPHIC FILMS TRANSFORMABLE ROBOTS; DOWNLOADABLE MOTION PICTURES AND TV SHOWS ABOUT TRANSFORMABLE ROBOTS; DVDS FEATURING TRANSFORMABLE ROBOTS; MOTION PICTURE FILMS ABOUT TRANSFORMABLE ROBOTS; VIDEOTAPES AND VIDEO DISKS RECORDED WITH ANIMATION (U.S. CLS. 21, 23, 26, 36 AND 38).

CLASS 16—PAPER GOODS AND PRINTED MATTER

FOR ALBUMS FOR STICKERS; CHILDREN'S ACTIVITY BOOKS; COLORING BOOKS; COMIC BOOKS; POSTERS; POSTERS MADE OF PAPER; FOLDERS; NOTEBOOKS; STICKERS; STORY BOOKS; ART PICTURES; CALENDARS; GRAPHIC ART REPRODUCTIONS; GRAPHIC NOVELS; ILLUSTRATED NOTEPADS; ILLUSTRATIONS; LITHOGRAPHS; POSTCARDS; SKETCHBOOKS; THREE-RING BINDERS; TRADING CARDS (U.S. CLS. 2, 5, 22, 23, 29, 37, 38 AND 50).

CLASS 28—TOYS AND SPORTING GOODS

FOR COIN-OPERATED VIDEO GAMES; CARD GAMES; COLLECTABLE TOY FIGURES; COSTUME MASKS; TOY ACTION FIGURES AND ACCESSORIES THEREFOR; TOY MODEL HOBBYCRAFT KITS; TOY ROBOTS; TOY VEHICLES WITH TRANSFORMING PARTS; TOY WATCHES; TOY WEAPONS; TRANSFORMING ROBOTIC TOY VEHICLES; TRANSFORMING ROBOTIC TOYS; ARCADE-TYPE ELECTRONIC VIDEO GAMES; BALLS FOR GAMES; BATTERY OPERATED ACTION TOYS; BOARD GAMES; LCD GAME MACHINES; PINBALL-TYPE GAMES; SKATEBOARDS (U.S. CLS. 22, 23, 38 AND 50).

CLASS 41—EDUCATION AND ENTERTAINMENT

FOR PRODUCTION AND DISTRIBUTION OF MOTION PICTURES; PROVIDING A COMPUTER GAME THAT MAY BE ACCESSED NETWORK-WIDE BY NETWORK USERS; PUBLISHING OF BOOKS, MAGAZINES; DISTRIBUTION OF TELEVISION PROGRAMS FOR OTHERS; ENTERTAINMENT NAMELY, PRODUCTION OF A TELEVISION SHOW FEATURING TRANSFORMABLE ROBOTS; ENTERTAINMENT, NAMELY A CONTINUING ANIMATED SHOW BROADCAST OVER TELEVISION, SATELLITE, AUDIO, AND VIDEO MEDIA; ENTERTAINMENT SERVICES IN THE NATURE OF ON-GOING TELEVISION PROGRAMS IN THE FIELD OF CHILDREN'S ENTERTAINMENT; FILM DISTRIBUTION; PRODUCTION AND DISTRIBUTION OF TELEVISION SHOWS AND MOVIES; MOTION PICTURE FILM PRODUCTION; PUBLICATION OF BOOKS; TELEVISION PROGRAM SYNDICATION; PRODUCTION OF VIDEO DISCS AND TAPES; PUBLISHING OF WEB MAGAZINES; VIDEOTAPE PRODUCTION; ENTERTAINMENT SERVICES NAMELY PROVIDING A WEBSITE FEATURING PHOTOGRAPHIC, AUDIO, VIDEO AND PROSE PRESENTATIONS FEATURING TRANSFORMABLE ROBOTS (U.S. CLS. 100, 101 AND 107).

GINA HAYES, EXAMINING ATTORNEY

SN 77-295,802. TELEMEDICINE MANAGEMENT, INC.,
FLEMINGTON, NJ. FILED 10-4-2007.

SWIFTMD

THE MARK CONSISTS OF STANDARD CHARACTERS WITHOUT CLAIM TO ANY PARTICULAR FONT, STYLE, SIZE, OR COLOR.

CLASS 35—ADVERTISING AND BUSINESS

FOR BUSINESS MARKETING SERVICES; ACCOUNTING SERVICES; PUBLICITY AND SALES PROMOTION SERVICES (U.S. CLS. 100, 101 AND 102).

CLASS 44—MEDICAL, BEAUTY AND AGRICULTURAL SERVICES

FOR HEALTH CARE; TELEMEDICINE SERVICES (U.S. CLS. 100 AND 101).
EDWARD FENNESSY, EXAMINING ATTORNEY

SN 77-295,819. ALVAMAR, INC. DBA ALVAMAR COUNTRY CLUB, LAWRENCE, KS. FILED 10-4-2007.



THE MARK CONSISTS OF A QUAIL ALMOST COMPLETELY CIRCLED BY A LINE THAT EXTENDS TO THE LEFT AND RIGHT SIDE OF THE MARK. BELOW THE QUAIL AND THE LINE IS THE WORD "ALVAMAR".

CLASS 37—CONSTRUCTION AND REPAIR

FOR REAL ESTATE DEVELOPMENT (U.S. CLS. 100, 103 AND 106).

CLASS 41—EDUCATION AND ENTERTAINMENT

FOR GOLF COURSES; GOLF DRIVING RANGE SERVICES; PROVIDING GOLF FACILITIES; COUNTRY CLUBS (U.S. CLS. 100, 101 AND 107).
ELLEN PERKINS, EXAMINING ATTORNEY

SN 77-295,853. INSTITUTE OF CONSTRUCTION MANAGEMENT & TECHNOLOGY LLC, PHOENIX, AZ. FILED 10-4-2007.



NO CLAIM IS MADE TO THE EXCLUSIVE RIGHT TO USE "INSTITUTE OF CONSTRUCTION MANAGEMENT & TECHNOLOGY" AND "2006", APART FROM THE MARK AS SHOWN.

CLASS 16—PAPER GOODS AND PRINTED MATTER

FOR PRINTED INSTRUCTIONAL, EDUCATIONAL, AND TEACHING MATERIALS IN THE FIELD OF BUILDING CONSTRUCTION; PRINTED INSTRUCTIONAL, EDUCATIONAL, AND TEACHING MATERIALS IN THE FIELD OF BUILDING CONSTRUCTION MANAGEMENT AND TECHNOLOGY, COMMERCIAL BUILDING CONSTRUCTION, RESIDENTIAL BUILDING CONSTRUCTION, AND LAND MANAGEMENT; PUBLICATIONS, NAMELY, BOOKLETS AND PRINTED TEACHING MATERIALS RELATING TO THE BUILDING CONSTRUCTION INDUSTRY; EDUCATIONAL PUBLICATIONS, NAMELY, TRAINING MANUALS IN THE FIELDS OF CONSTRUCTION MANAGEMENT AND CONSTRUCTION TECHNOLOGY; PAPER GOODS, NAMELY, WRITING PAPER AND ENVELOPES; PENS; PEN SETS; DESK SETS; CALENDARS; BINDERS; NOTEBOOKS; PENCILS; PAPER NAPKINS, LETTER OPENERS; PHOTO ALBUMS (U.S. CLS. 2, 5, 22, 23, 29, 37, 38 AND 50).

CLASS 25—CLOTHING

FOR CLOTHING, NAMELY, SWEATSHIRTS, T-SHIRTS, SOCKS, JACKETS, SHORTS, PONCHOS AND PANTS (U.S. CLS. 22 AND 39).

CLASS 41—EDUCATION AND ENTERTAINMENT

FOR EDUCATION SERVICES, NAMELY, CONDUCTING AND PROVIDING LIVE AND ON-LINE CLASSES AND SEMINARS IN THE FIELDS OF CONSTRUCTION MANAGEMENT AND CONSTRUCTION TECHNOLOGY, AND DISTRIBUTION OF COURSE MATERIAL IN CONNECTION THEREWITH; ONLINE LIBRARY SERVICES, NAMELY, PROVIDING ELECTRONIC LIBRARY SERVICES WHICH FEATURE PUBLICATIONS AND TRAINING MATERIALS AND TRAINING INFORMATION PERTAINING TO THE BUILDING CONSTRUCTION INDUSTRIES VIA AN ON-LINE COMPUTER NETWORK; TRAINING IN THE MANAGEMENT OF BUILDING CONSTRUCTION PROJECTS; TRAINING IN THE FIELD OF MANAGEMENT OF BUILDING CONSTRUCTION PROJECTS RENDERED THROUGH CORRESPONDENCE COURSES VIA THE GLOBAL COMPUTER NETWORK AND OTHER MASS MEDIA (U.S. CLS. 100, 101 AND 107).

FIRST USE 11-1-2006; IN COMMERCE 11-1-2006.
FRED CARL, EXAMINING ATTORNEY

SN 77-295,899. HECHO LATINO, INC., DALLAS, TX. FILED 10-4-2007.

WE ARE ALL ONE UNDER THE
SAME SUN

THE MARK CONSISTS OF STANDARD CHARACTERS WITHOUT CLAIM TO ANY PARTICULAR FONT, STYLE, SIZE, OR COLOR.

CLASS 14—JEWELRY

FOR JEWELRY, NAMELY BRACELETS AND NECKLACES (U.S. CLS. 2, 27, 28 AND 50).

CLASS 25—CLOTHING

FOR CLOTHING, NAMELY HATS, CAPS, VISORS, SHIRTS, T-SHIRTS, TANK-TOPS, KNIT TOPS, WOVEN TOPS, HALTER TOPS, SWIMWEAR, UNDERWEAR, BOXER SHORTS, DRESSES, SKIRTS, BELTS, FOOTWEAR, SWEATERS, VESTS, SCARVES AND TIES (U.S. CLS. 22 AND 39).

CLASS 35—ADVERTISING AND BUSINESS

FOR RETAIL STORE SERVICES FEATURING CLOTHING AND JEWELRY PROVIDED IN APPLICANT'S STORES, CATALOGS AND ONLINE WEBSITE (U.S. CLS. 100, 101 AND 102).

MATTHEW PAPPAS, EXAMINING ATTORNEY

SN 77-295,926. CLOS-ETTE LLC, NEW YORK, NY. FILED 10-4-2007.

ASPIRATIONAL LUXURY

THE MARK CONSISTS OF STANDARD CHARACTERS WITHOUT CLAIM TO ANY PARTICULAR FONT, STYLE, SIZE, OR COLOR.

CLASS 14—JEWELRY

FOR JEWELRY CASES NOT OF PRECIOUS METAL (U.S. CLS. 2, 27, 28 AND 50).

CLASS 20—FURNITURE AND ARTICLES NOT OTHERWISE CLASSIFIED

FOR CLOTHES HANGERS (U.S. CLS. 2, 13, 22, 25, 32 AND 50).

CLASS 35—ADVERTISING AND BUSINESS

FOR RETAIL STORE SERVICES FEATURING CLOTHES HANGERS, JEWELRY CASES, HOUSEHOLD DÉCOR AND STORAGE ITEMS, CONTAINERS FOR STORING CLOTHING AND SHOES, SHOE TREES, SACHETS, AND HOUSEHOLD STORAGE CONTAINERS; ONLINE RETAIL STORE SERVICES FEATURING CLOTHES HANGERS, JEWELRY CASES, HOUSEHOLD DÉCOR AND STORAGE ITEMS, CONTAINERS FOR STORING CLOTHING AND SHOES, SHOE TREES, SACHETS, AND HOUSEHOLD STORAGE CONTAINERS (U.S. CLS. 100, 101 AND 102).

CLASS 37—CONSTRUCTION AND REPAIR

FOR CUSTOM INSTALLATION OF FURNITURE AND CONTAINERS (U.S. CLS. 100, 103 AND 106).

CLASS 42—SCIENTIFIC AND COMPUTER SERVICES

FOR INTERIOR DESIGN, HOME DESIGN, APARTMENT DESIGN, STYLING SERVICES IN THE NATURE OF INTERIOR DECORATING SERVICES (U.S. CLS. 100 AND 101).

GRETTA YAO, EXAMINING ATTORNEY

SN 77-295,937. CENTER FOR THE STUDY OF EXPERTISE IN TEACHING AND LEARNING, INC. D/B/A, DBA COMMUNITIES FOR LEARNING; LEADING LASTING CHANGE, FLORAL PARK, NY. FILED 10-4-2007.



THE MARK CONSISTS OF A FANCIFUL DESIGN OF A HEXAGON WITH CURVED SIDES SURROUNDED BY SIX TEARDROP SHAPED CIRCLES, AND THE WORDS COMMUNITIES FOR LEARNING LEADING LASTING CHANGE TO THE RIGHT OF THE DESIGN.

CLASS 35—ADVERTISING AND BUSINESS

FOR PROVIDING ORGANIZATIONAL DEVELOPMENT CONSULTING SERVICES; EDUCATIONAL LEADERSHIP DEVELOPMENT (U.S. CLS. 100, 101 AND 102).

CLASS 41—EDUCATION AND ENTERTAINMENT

FOR CONSULTING AND DEVELOPMENT SERVICES PROVIDED TO PROFESSIONAL LEARNING COMMUNITIES IN SCHOOLS AND OTHER EDUCATIONAL ORGANIZATIONS FOR THE PURPOSES OF IMPROVING TEACHING AND LEARNING; DEVELOPMENT OF EDUCATIONAL MATERIALS INCLUDING MEASURES, PROCESSES AND TOOLS FOR PROFESSIONAL LEARNING COMMUNITIES IN THE FIELDS OF TEACHING AND LEARNING (U.S. CLS. 100, 101 AND 107).

TASNEEM HUSSAIN, EXAMINING ATTORNEY

SN 77-295,955. CENTER FOR THE STUDY OF EXPERTISE IN TEACHING AND LEARNING, INC., DBA COMMUNITIES FOR LEARNING; LEADING LASTING CHANGE, FLORAL PARK, NY. FILED 10-4-2007.

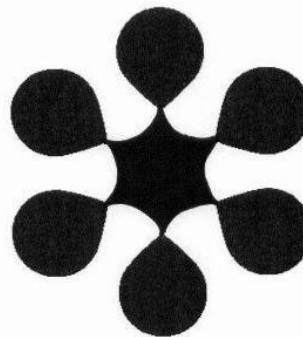

THE MARK CONSISTS OF A FANCIFUL DESIGN OF A HEXAGON WITH CURVED SIDES SURROUNDED BY SIX TEARDROP SHAPED CIRCLES.

CLASS 35—ADVERTISING AND BUSINESS

FOR PROVIDING ORGANIZATIONAL DEVELOPMENT CONSULTING SERVICES; EDUCATIONAL LEADERSHIP DEVELOPMENT (U.S. CLS. 100, 101 AND 102).

CLASS 41—EDUCATION AND ENTERTAINMENT

FOR CONSULTING AND DEVELOPMENT SERVICES PROVIDED TO PROFESSIONAL LEARNING COMMUNITIES IN SCHOOLS AND OTHER EDUCATIONAL ORGANIZATIONS FOR THE PURPOSES OF IMPROVING TEACHING AND LEARNING; DEVELOPMENT OF EDUCATIONAL MATERIALS INCLUDING MEASURES, PROCESSES AND TOOLS FOR PROFESSIONAL LEARNING COMMUNITIES IN THE FIELDS OF TEACHING AND LEARNING (U.S. CLS. 100, 101 AND 107).
LINDA E. BLOHM, EXAMINING ATTORNEY

CLASS 25—CLOTHING

FOR CLOTHING, NAMELY, T-SHIRTS, HEADGEAR, CAPS, HATS, FOOTWEAR (U.S. CLS. 22 AND 39).

CLASS 41—EDUCATION AND ENTERTAINMENT

FOR PRODUCTION OF MUSICAL SOUND RECORDINGS (U.S. CLS. 100, 101 AND 107).
GIANCARLO CASTRO, EXAMINING ATTORNEY

SN 77-296,018. DOYLE, STEPHEN, READING, MA. FILED 10-4-2007.

SN 77-296,110. RICKS, VERNON L JR., VIRGINIA BEACH, VA. AND THOMAS, AUTHERTON, STATEN ISLAND, NY. FILED 10-4-2007.

Hey! Hawaia!

THE MARK CONSISTS OF STANDARD CHARACTERS WITHOUT CLAIM TO ANY PARTICULAR FONT, STYLE, SIZE, OR COLOR.

CLASS 25—CLOTHING

FOR HATS; JACKETS; PANTS; SHIRTS (U.S. CLS. 22 AND 39).

CLASS 32—LIGHT BEVERAGES

FOR NON-ALCOHOLIC FRUIT JUICE BEVERAGES; SODA POPS (U.S. CLS. 45, 46 AND 48).
KAELIE KUNG, EXAMINING ATTORNEY

SN 77-296,035. RICKS, VERNON L JR., VIRGINIA BEACH, VA. AND THOMAS, AUTHERTON, STATEN ISLAND, NY. FILED 10-4-2007.

KHIZMAN RECORDS

THE MARK CONSISTS OF STANDARD CHARACTERS WITHOUT CLAIM TO ANY PARTICULAR FONT, STYLE, SIZE, OR COLOR.

NO CLAIM IS MADE TO THE EXCLUSIVE RIGHT TO USE "RECORDS", APART FROM THE MARK AS SHOWN.

CLASS 9—ELECTRICAL AND SCIENTIFIC APPARATUS

FOR MUSICAL SOUND RECORDINGS, PRE-RECORDED COMPACT DISCS FEATURING MUSICAL SOUND RECORDINGS (U.S. CLS. 21, 23, 26, 36 AND 38).

CLASS 16—PAPER GOODS AND PRINTED MATTER

FOR PAPER PRODUCTS, NAMELY, POSTERS, STATIONERY, CALENDARS, PHOTOGRAPHS, BOOKS IN THE FIELD OF MUSIC AND STICKERS (U.S. CLS. 2, 5, 22, 23, 29, 37, 38 AND 50).

TROPHY WINNER

THE MARK CONSISTS OF STANDARD CHARACTERS WITHOUT CLAIM TO ANY PARTICULAR FONT, STYLE, SIZE, OR COLOR.

CLASS 9—ELECTRICAL AND SCIENTIFIC APPARATUS

FOR MUSICAL SOUND RECORDINGS, PRE-RECORDED COMPACT DISCS FEATURING MUSICAL SOUND RECORDINGS (U.S. CLS. 21, 23, 26, 36 AND 38).

CLASS 16—PAPER GOODS AND PRINTED MATTER

FOR PAPER PRODUCTS, NAMELY, POSTERS, STATIONERY, CALENDARS, PHOTOGRAPHS, BOOKS IN THE FIELD OF MUSIC (U.S. CLS. 2, 5, 22, 23, 29, 37, 38 AND 50).

CLASS 25—CLOTHING

FOR CLOTHING, NAMELY, T-SHIRTS, HEADGEAR, CAPS, HATS, FOOTWEAR (U.S. CLS. 22 AND 39).

CLASS 41—EDUCATION AND ENTERTAINMENT

FOR PRODUCTION OF MUSICAL SOUND RECORDINGS (U.S. CLS. 100, 101 AND 107).
GIANCARLO CASTRO, EXAMINING ATTORNEY

SN 77-296,130. RICKS, VERNON L JR., VIRGINIA BEACH, VA. AND THOMAS, AUTHERTON, STATEN ISLAND, NY. FILED 10-4-2007.

MUDDY CAVALEERZ

THE MARK CONSISTS OF STANDARD CHARACTERS WITHOUT CLAIM TO ANY PARTICULAR FONT, STYLE, SIZE, OR COLOR.

CLASS 9—ELECTRICAL AND SCIENTIFIC APPARATUS

FOR MUSICAL SOUND RECORDINGS, PRE-RECORDED COMPACT DISCS FEATURING MUSICAL SOUND RECORDINGS (U.S. CLS. 21, 23, 26, 36 AND 38).

CLASS 16—PAPER GOODS AND PRINTED MATTER

FOR PAPER PRODUCTS, NAMELY, POSTERS, STATIONERY, CALENDARS, PHOTOGRAPHS AND BOOKS IN THE FIELD OF MUSIC (U.S. CLS. 2, 5, 22, 23, 29, 37, 38 AND 50).

CLASS 25—CLOTHING

FOR CLOTHING, NAMELY, T-SHIRTS, HEADGEAR, CAPS, HATS, FOOTWEAR (U.S. CLS. 22 AND 39).

CLASS 41—EDUCATION AND ENTERTAINMENT

FOR PRODUCTION OF MUSICAL SOUND RECORDINGS (U.S. CLS. 100, 101 AND 107).
GIANCARLO CASTRO, EXAMINING ATTORNEY

SN 77-296,138. SAFC CARLSBAD, INC., DBA SAFC PHARMA, CARLSBAD, CA. FILED 10-4-2007.

AdV1

THE MARK CONSISTS OF STANDARD CHARACTERS WITHOUT CLAIM TO ANY PARTICULAR FONT, STYLE, SIZE, OR COLOR.

CLASS 5—PHARMACEUTICALS

FOR (BASED ON INTENT TO USE) BIOLOGICAL PREPARATIONS FOR MEDICAL PURPOSES (U.S. CLS. 6, 18, 44, 46, 51 AND 52).

CLASS 42—SCIENTIFIC AND COMPUTER SERVICES

FOR (BASED ON INTENT TO USE) DEVELOPMENT OF NEW TECHNOLOGY FOR OTHERS IN THE FIELD OF BIOTECHNOLOGY; RESEARCH AND DEVELOPMENT OF VACCINES AND MEDICINES (U.S. CLS. 100 AND 101).

THEODORE MCBRIDE, EXAMINING ATTORNEY

SN 77-296,223. RICHARD AND ANGELA GILL, PEABODY, MA. FILED 10-4-2007.

Good and YOU?

THE MARK CONSISTS OF STANDARD CHARACTERS WITHOUT CLAIM TO ANY PARTICULAR FONT, STYLE, SIZE, OR COLOR.

CLASS 25—CLOTHING

FOR BUTTON-FRONT ALOHA SHIRTS; GOLF SHIRTS; POLO SHIRTS; SHIRT FRONTS; SHIRTS; SHORT-SLEEVED OR LONG-SLEEVED T-SHIRTS; SWEAT SHIRTS (U.S. CLS. 22 AND 39).

CLASS 40—MATERIAL TREATMENT

FOR T-SHIRT EMBROIDERING SERVICES (U.S. CLS. 100, 103 AND 106).
LOURDES AYALA, EXAMINING ATTORNEY

SN 77-296,241. ACXIOM CORPORATION, LITTLE ROCK, AR. FILED 10-4-2007.

WE MAKE INFORMATION INTELLIGENT

THE MARK CONSISTS OF STANDARD CHARACTERS WITHOUT CLAIM TO ANY PARTICULAR FONT, STYLE, SIZE, OR COLOR.

CLASS 35—ADVERTISING AND BUSINESS

FOR DIRECT MARKETING SERVICES FOR OTHERS, NAMELY, MARKETING LIST SELECTION, ACQUISITION, AND MAINTENANCE; MARKETING LIST HYGIENE IN THE NATURE OF REMOVING DUPLICATE DATA FROM DIRECT MARKETING LISTS AND CORRECTING ERRONEOUS DATA IN DIRECT MARKETING LISTS; MARKETING LIST ENHANCEMENT IN THE NATURE OF ADDING SUPPLEMENTAL OR UPDATED DATA TO DIRECT MARKETING LISTS; DIRECT MARKETING CAMPAIGN MANAGEMENT; DATA PROCESSING FOR OTHERS; BUSINESS MARKETING SERVICES, NAMELY, MARKET MODELING FOR ADVERTISING OR SALES PROMOTION, NAMELY, MARKETING DATA MODELING; MARKET ANALYSIS, NAMELY, SCORING AND ANALYSIS OF MARKETING DATA FOR OTHERS; MARKET ANALYSIS AND RESEARCH, NAMELY, CUSTOMER AND PROSPECTIVE CUSTOMER ANALYSIS AND TARGETING FOR OTHERS; BUSINESS CONSULTATION SERVICES IN THE FIELDS OF DIRECT MARKETING AND CONSUMER INFORMATION PRIVACY; AND INFORMATION TECHNOLOGY OUTSOURCING FOR OTHERS (U.S. CLS. 100, 101 AND 102).

CLASS 42—SCIENTIFIC AND COMPUTER SERVICES

FOR TECHNICAL SUPPORT SERVICES, NAMELY, TROUBLESHOOTING OF COMPUTER HARDWARE AND SOFTWARE PROBLEMS AND MONITORING OF NETWORK SYSTEMS AND CLIENT SERVER SYSTEMS; AND HELP DESK SERVICES IN THE FIELD OF COMPUTER HARDWARE AND SOFTWARE (U.S. CLS. 100 AND 101).

VERNA BETH RIRIE, EXAMINING ATTORNEY

SN 77-296,265. SANTA FE COMMUNICATIONS, INC., SANTA ROSA VALLEY, CA. FILED 10-4-2007.

SN 77-296,409. BOUDREAUX & THIBODEAUX, INTERNATIONAL, LLC, BATON ROUGE, LA. FILED 10-4-2007.

Aztepacá

BOUDREAUX & THIBODEAUX

THE MARK CONSISTS OF STANDARD CHARACTERS WITHOUT CLAIM TO ANY PARTICULAR FONT, STYLE, SIZE, OR COLOR.

THE MARK CONSISTS OF STANDARD CHARACTERS WITHOUT CLAIM TO ANY PARTICULAR FONT, STYLE, SIZE, OR COLOR.

CLASS 35—ADVERTISING AND BUSINESS

FOR ADVERTISING SERVICES AND DIRECT MARKETING SERVICES, NAMELY, PROMOTING THE GOODS AND SERVICES OF OTHERS BY PREPARING AND PLACING ADVERTISEMENTS AND OTHER COMMUNICATIONS FOR DISSEMINATION THROUGH PRODUCT PLACEMENT IN TELEVISION PROGRAMS, INFOMERCIALS, TELEVISION COMMERCIALS, RADIO COMMERCIALS, PRINT PUBLICATIONS, BILLBOARDS, IN-STORE PROMOTIONS, THE INTERNET AND OTHER ELECTRONIC MEDIA; BUSINESS CONSULTATION SERVICES IN THE FIELD OF BRAND MANAGEMENT AND STRATEGY, MARKETING COMMUNICATIONS, AND PRODUCT MARKETING AND PROMOTION (U.S. CLS. 100, 101 AND 102).

CLASS 25—CLOTHING

FOR SHORT-SLEEVED AND LONG-SLEEVED SHIRTS, AND BASEBALL CAPS (U.S. CLS. 22 AND 39). FIRST USE 7-13-2007; IN COMMERCE 7-13-2007.

CLASS 43—HOTEL AND RESTAURANT SERVICES

FOR RESTAURANT AND BAR SERVICES (U.S. CLS. 100 AND 101). FIRST USE 7-13-2007; IN COMMERCE 7-13-2007. JENNIFER MARTIN, EXAMINING ATTORNEY

CLASS 41—EDUCATION AND ENTERTAINMENT

FOR ENTERTAINMENT SERVICES NAMELY PRODUCTION AND DISTRIBUTION OF TELEVISION PROGRAMS (U.S. CLS. 100, 101 AND 107). DAVID HOFFMAN, EXAMINING ATTORNEY

SN 77-296,522. VIRIATHUS HOLDINGS LLC, NEW YORK, NY. FILED 10-4-2007.

SN 77-296,346. ERELATING, LLC, ALPHARETTA, GA. FILED 10-4-2007.

VIRIATHUS

ERELATING

THE MARK CONSISTS OF STANDARD CHARACTERS WITHOUT CLAIM TO ANY PARTICULAR FONT, STYLE, SIZE, OR COLOR.

THE MARK CONSISTS OF STANDARD CHARACTERS WITHOUT CLAIM TO ANY PARTICULAR FONT, STYLE, SIZE, OR COLOR.

CLASS 35—ADVERTISING AND BUSINESS

FOR (BASED ON USE IN COMMERCE) BUSINESS MARKETING CONSULTING SERVICES (BASED ON INTENT TO USE) PROVIDING ON-LINE FACILITIES FEATURING TRANSACTION ORDER ENTRY, ORDER DIRECTING AND ORDER CONFIRMATION SERVICES TO CUSTOMERS IN THE FIELD OF INVESTING; ADVICE IN THE FIELD OF BUSINESS MANAGEMENT AND MARKETING; ANALYZING AND COMPILING DATA FOR MEASURING THE PERFORMANCE OF FINANCIAL MARKETS; ARRANGING AND CONDUCTING MARKETING PROMOTIONAL EVENTS FOR OTHERS; BUSINESS ADVICE AND ANALYSIS OF MARKETS; BUSINESS CONSULTATION AND MANAGEMENT REGARDING MARKETING ACTIVITIES AND LAUNCHING OF NEW PRODUCTS; BUSINESS MANAGEMENT CONSULTING WITH RELATION TO STRATEGY, MARKETING, PRODUCTION, PERSONNEL AND RETAIL SALE MATTERS; BUSINESS MARKETING SERVICES; MARKET ANALYSIS; MARKET REPORTS AND STUDIES; MARKET RESEARCH; MARKET RESEARCH SERVICES; MARKET RESEARCH STUDIES (U.S. CLS. 100, 101 AND 102). FIRST USE 1-2-2007; IN COMMERCE 1-2-2007.

CLASS 35—ADVERTISING AND BUSINESS

FOR ON-LINE RETAIL STORE SERVICES FEATURING SELF-HELP AND SELF-IMPROVEMENT PRODUCTS (U.S. CLS. 100, 101 AND 102).

CLASS 41—EDUCATION AND ENTERTAINMENT

FOR EDUCATION SERVICES, NAMELY, PROVIDING ONLINE COURSES IN THE FIELD OF SELF-HELP, SELF-IMPROVEMENT, RELATIONSHIPS, AND CAREERS (U.S. CLS. 100, 101 AND 107). SALLY SHIH, EXAMINING ATTORNEY

CLASS 36—INSURANCE AND FINANCIAL

FOR (BASED ON INTENT TO USE) BANKING CONSULTATION; BANKING SERVICES; CAPITAL INVESTMENT CONSULTATION; CONSULTATION IN ART AS AN INVESTMENT; EQUITY CAPITAL INVESTMENT; FINANCIAL AND INVESTMENT SERVICES, NAMELY, MANAGEMENT AND BROKERAGE IN THE FIELDS OF STOCKS, BONDS, OPTIONS, COMMODITIES, FUTURES AND OTHER SECURITIES, AND THE INVESTMENT OF FUNDS OF OTHERS; FINANCIAL INVESTMENT IN THE FIELD OF SECURITIES; FINANCIAL PLANNING AND INVESTMENT ADVISORY SERVICES; FINANCIAL SERVICES IN THE NATURE OF AN INVESTMENT SECURITY; FINANCIAL SERVICES, NAMELY, A TOTAL PORTFOLIO OFFERING FOR HIGH NET WORTH CLIENTS CONSISTING OF BOTH SEPARATE ACCOUNTS AND MUTUAL FUNDS FOR EQUITY AND FIXED INCOME INVESTMENTS; FINANCIAL SERVICES, NAMELY, INVESTMENT FUND TRANSFER AND TRANSACTION SERVICES; FUND INVESTMENT CONSULTATION; FUNDS INVESTMENT; HEDGE FUND INVESTMENT SERVICES; INVESTMENT ADVICE; INVESTMENT ADVISORY SERVICES; INVESTMENT BANKING SERVICES; INVESTMENT BROKERAGE; INVESTMENT CONSULTATION; INVESTMENT MANAGEMENT SERVICES IN THE FIELD OF ACQUIRING JOINT VENTURES; INVESTMENT OF FUNDS FOR OTHERS; INVESTMENT SERVICES, NAMELY, ASSET ACQUISITION, CONSULTATION, DEVELOPMENT AND MANAGEMENT SERVICES; PRIVATE EQUITY FUND INVESTMENT SERVICES; FINANCIAL ANALYSIS AND CONSULTATION; FINANCIAL RESEARCH; FINANCIAL RISK MANAGEMENT CONSULTATION (U.S. CLS. 100, 101 AND 102).

CHRISTINA SOBRAL, EXAMINING ATTORNEY

SN 77-296,548. NEWSMAX.COM, WEST PALM BEACH, FL. FILED 10-4-2007.

MAXNEWS

THE MARK CONSISTS OF STANDARD CHARACTERS WITHOUT CLAIM TO ANY PARTICULAR FONT, STYLE, SIZE, OR COLOR.

CLASS 16—PAPER GOODS AND PRINTED MATTER

FOR MAGAZINES FEATURING NEWS, ENTERTAINMENT NEWS AND FEATURES ON HEALTH, LIFESTYLE, POLITICS AND FAMILY; SECTION OF A MAGAZINE FEATURING NEWS, ENTERTAINMENT NEWS AND FEATURES ON HEALTH, LIFESTYLE, POLITICS AND FAMILY (U.S. CLS. 2, 5, 22, 23, 29, 37, 38 AND 50).

CLASS 41—EDUCATION AND ENTERTAINMENT

FOR ENTERTAINMENT IN THE NATURE OF TELEVISION NEWS SHOWS; ENTERTAINMENT SERVICES, NAMELY, PROVIDING A RADIO PROGRAM IN THE FIELD OF NEWS AND ENTERTAINMENT NEWS VIA A GLOBAL COMPUTER NETWORK; ENTERTAINMENT SERVICES, NAMELY, PROVIDING ON-LINE REVIEWS OF MOVIES, BOOKS, AND MUSIC; ENTERTAINMENT, NAMELY, A CONTINUING NEWS AND ENTERTAINMENT NEWS SHOW BROADCAST OVER TELEVISION, RADIO, SATELLITE, AUDIO, AND VIDEO MEDIA; ON-LINE PUBLICATION OF A NEWS AND ENTERTAINMENT MAGAZINE; ONLINE JOURNALS, NAMELY, BLOGS FEATURING NEWS AND ENTERTAINMENT NEWS; PROVIDING NEWS IN THE NATURE OF CURRENT EVENT REPORTING VIA THE INTERNET (U.S. CLS. 100, 101 AND 107).

MICHAEL ENGEL, EXAMINING ATTORNEY

SN 77-296,558. CHOUVALIS, EMILY, BOCA RATON, FL. FILED 10-4-2007.

BEAUTIFUL UNITY

THE MARK CONSISTS OF STANDARD CHARACTERS WITHOUT CLAIM TO ANY PARTICULAR FONT, STYLE, SIZE, OR COLOR.

CLASS 14—JEWELRY

FOR JEWELRY (U.S. CLS. 2, 27, 28 AND 50).

CLASS 16—PAPER GOODS AND PRINTED MATTER

FOR BOOKS, PAMPHLETS, BROCHURES, AND NEWSLETTERS IN THE FIELD OF MENTAL, PHYSICAL AND SPIRITUAL HEALTH AND WELL-BEING AND PERSONAL DEVELOPMENT, NOTE CARDS, POSTCARDS, POSTERS, AND PAINTINGS (U.S. CLS. 2, 5, 22, 23, 29, 37, 38 AND 50).

G. MAYERSCHOFF, EXAMINING ATTORNEY

SN 77-296,559. HLASKA INC, BURLINGAME, CA. FILED 10-4-2007.

HLASKA

THE MARK CONSISTS OF STANDARD CHARACTERS WITHOUT CLAIM TO ANY PARTICULAR FONT, STYLE, SIZE, OR COLOR.

OWNER OF U.S. REG. NO. 3,165,025.

CLASS 6—METAL GOODS

FOR METAL KEY RINGS (U.S. CLS. 2, 12, 13, 14, 23, 25 AND 50).

CLASS 9—ELECTRICAL AND SCIENTIFIC APPARATUS

FOR CAMERAS; CELL PHONES (U.S. CLS. 21, 23, 26, 36 AND 38).

SN 77-296,589. TONA COMMUNICATIONS JAPAN K.K., TOKYO, JAPAN, FILED 10-4-2007.

CLASS 14—JEWELRY

FOR CUFF-LINKS; WATCHES (U.S. CLS. 2, 27, 28 AND 50).

CLASS 18—LEATHER GOODS

FOR BACKPACKS; BRIEFCASE-TYPE PORTFOLIOS; BRIEFCASES; COSMETIC CASES SOLD EMPTY; DUFFLE BAGS; HANDBAGS; LEATHER BRIEFCASES; LEATHER HANDBAGS; LUGGAGE; LUGGAGE TAGS; TOTE BAGS; WALLETS; LEATHER BAGS, SUITCASES AND WALLETS (U.S. CLS. 1, 2, 3, 22 AND 41).

FIRST USE 8-5-2005; IN COMMERCE 8-29-2005.

CLASS 20—FURNITURE AND ARTICLES NOT OTHERWISE CLASSIFIED

FOR NON-METAL KEY RINGS (U.S. CLS. 2, 13, 22, 25, 32 AND 50).

CLASS 25—CLOTHING

FOR HATS; JACKETS; LEATHER BELTS; SHOES; TIES (U.S. CLS. 22 AND 39).

JUDITH HELFMAN, EXAMINING ATTORNEY

TONA

SN 77-296,562. CHOUVALIS, EMILY, BOCA RATON, FL. FILED 10-4-2007.

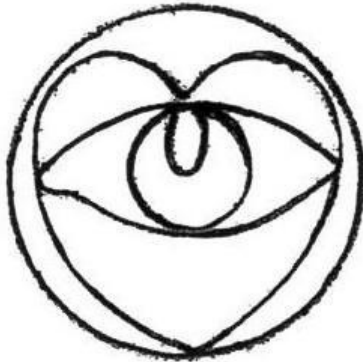

THE MARK CONSISTS OF AN IMAGE OF A CIRCLE SURROUNDING THE IMAGE OF A HEART SHAPE, INSIDE OF WHICH IS THE IMAGE OF AN EYE.

THE MARK CONSISTS OF STANDARD CHARACTERS WITHOUT CLAIM TO ANY PARTICULAR FONT, STYLE, SIZE, OR COLOR.

CLASS 14—JEWELRY

FOR JEWELRY (U.S. CLS. 2, 27, 28 AND 50).

CLASS 35—ADVERTISING AND BUSINESS

FOR ONLINE BUSINESS NETWORKING SERVICES; PROVIDING AN ONLINE DIRECTORY INFORMATION SERVICE FEATURING INFORMATION REGARDING, AND IN THE NATURE OF, CLASSIFIEDS, VIRTUAL COMMUNITY AND SOCIAL NETWORKING. ADVERTISING AND INFORMATION DISTRIBUTION SERVICES, NAMELY, PROVIDING CLASSIFIED ADVERTISING SPACE VIA THE INTERNET; PROMOTING THE GOODS AND SERVICES OF OTHERS OVER THE GLOBAL COMPUTER NETWORK; PROVIDING ON-LINE COMPUTER DATABASES AND ON-LINE SEARCHABLE DATABASES FEATURING CLASSIFIED LISTINGS AND WANT ADS (U.S. CLS. 100, 101 AND 102).

CLASS 16—PAPER GOODS AND PRINTED MATTER

FOR BOOKS, PAMPHLETS, BROCHURES, AND NEWSLETTERS IN THE FIELD OF MENTAL, PHYSICAL AND SPIRITUAL HEALTH AND WELL-BEING AND PERSONAL DEVELOPMENT, NOTE CARDS, POSTCARDS, POSTERS, AND PAINTINGS (U.S. CLS. 2, 5, 22, 23, 29, 37, 38 AND 50).

G. MAYERSCHOFF, EXAMINING ATTORNEY

CLASS 36—INSURANCE AND FINANCIAL

FOR TELEPHONE CALLING CARD SERVICES; MAKING PAYMENTS ON PRE-PAID LONG DISTANCE CALLING CARDS FOR RECHARGING MINUTES; PRE-PAID TELECOMMUNICATIONS CALLING CARD SERVICES. FINANCIAL TRANSACTION PROCESSING SERVICES, NAMELY, CLEARING AND RECONCILING FINANCIAL TRANSACTIONS VIA A GLOBAL COMPUTER NETWORK; ELECTRONIC PROCESSING AND TRANSMISSION OF BILL PAYMENT DATA FOR USERS OF A GLOBAL COMMUNICATIONS NETWORK; BILL PAYMENT SERVICES (U.S. CLS. 100, 101 AND 102).

CLASS 38—COMMUNICATION

FOR TELEPHONY COMMUNICATION SERVICES; PROVIDING VOICE COMMUNICATION SERVICES VIA THE INTERNET; TELECOMMUNICATION SERVICES, NAMELY, LOCAL AND LONG DISTANCE TRANSMISSION OF VOICE AND DATA BY MEANS OF TELEPHONE AND INTERNET; ELECTRONIC EXCHANGE OF VOICE, DATA, AND GRAPHICS ACCESSIBLE VIA COMPUTERS AND TELECOMMUNICATION NETWORKS. INTERNET TELEPHONY SERVICES. STREAMING OF AUDIO AND VIDEO MATERIAL ON THE INTERNET, VOICE MAIL SERVICES, CALL FORWARDING SERVICES, TELEPHONE CONFERENCING SERVICES, TELEPHONY CALL ROUTING SERVICES, AND TELEPHONE COMMUNICATIONS SERVICES. PROVIDING VOICE-OVER-INTERNET PROTOTOCOL (VOIP) SERVICES, AND ELECTRONIC TRANSMISSION OF DATA AND DOCUMENTS OVER COMPUTER TERMINALS; INTERNATIONAL TELEPHONE SERVICES VIA VOICE-OVER-INTERNET PROTOTOCOL (VOIP); MOBILE TELEPHONE COMMUNICATION SERVICES, LOCAL AND LONG DISTANCE TRANSMISSION OF VOICE, DATA, AND GRAPHICS VIA COMPUTER AND TELECOMMUNICATIONS NETWORKS. TELECOMMUNICATION SERVICES, NAMELY PERSONAL COMMUNICATION SERVICES; DATA TRANSMISSION AND RECEPTION SERVICES VIA TELECOMMUNICATION MEANS; CONSULTING FOR THE AFOREMENTIONED TELECOMMUNICATION SERVICES. ELECTRONIC EMAIL SERVICES; INSTANT MESSAGING SERVICES. PROVIDING ONLINE CHAT ROOMS AND ELECTRONIC BULLETIN BOARDS FOR REGISTERED USERS FOR TRANSMISSION OF MESSAGES AMONG USERS IN THE FIELDS OF GENERAL INTEREST, CLASSIFIEDS, VIRTUAL COMMUNITY, AND SOCIAL NETWORKING. VIDEO AND AUDIO CONFERENCING SERVICES CONDUCTED VIA THE WEB AND MOBILE DEVICES; COMMUNICATIONS BY COMPUTER TERMINALS (U.S. CLS. 100, 101 AND 104).

CLASS 45—PERSONAL AND LEGAL SERVICES

FOR INTERNET BASED DATING, INTRODUCTION, AND SOCIAL NETWORKING SERVICES (U.S. CLS. 100 AND 101).

JULIE WATSON, EXAMINING ATTORNEY

SN 77-296,785. CLOS-ETTE LLC, NEW YORK, NY. FILED 10-4-2007.

REASSURINGLY EXPENSIVE

THE MARK CONSISTS OF STANDARD CHARACTERS WITHOUT CLAIM TO ANY PARTICULAR FONT, STYLE, SIZE, OR COLOR.

CLASS 14—JEWELRY

FOR JEWELRY CASES NOT OF PRECIOUS METAL (U.S. CLS. 2, 27, 28 AND 50).

CLASS 20—FURNITURE AND ARTICLES NOT OTHERWISE CLASSIFIED

FOR CLOTHES HANGERS (U.S. CLS. 2, 13, 22, 25, 32 AND 50).

CLASS 35—ADVERTISING AND BUSINESS

FOR RETAIL STORE SERVICES FEATURING CLOTHES HANGERS, JEWELRY CASES, HOUSEHOLD DÉCOR AND STORAGE ITEMS, CONTAINERS FOR STORING CLOTHING AND SHOES, SHOE TREES, SACHETS, AND HOUSEHOLD STORAGE CONTAINERS; ONLINE RETAIL STORE SERVICES FEATURING CLOTHES HANGERS, JEWELRY CASES, HOUSEHOLD DÉCOR AND STORAGE ITEMS, CONTAINERS FOR STORING CLOTHING AND SHOES, SHOE TREES, SACHETS, AND HOUSEHOLD STORAGE CONTAINERS (U.S. CLS. 100, 101 AND 102).

CLASS 37—CONSTRUCTION AND REPAIR

FOR CUSTOM INSTALLATION OF FURNITURE AND CONTAINERS (U.S. CLS. 100, 103 AND 106).

CLASS 42—SCIENTIFIC AND COMPUTER SERVICES

FOR INTERIOR DESIGN, HOME DESIGN, APARTMENT DESIGN, STYLING SERVICES IN THE NATURE OF INTERIOR DECORATING SERVICES (U.S. CLS. 100 AND 101).

GRETTA YAO, EXAMINING ATTORNEY

SN 77-296,788. CLOS-ETTE LLC, NEW YORK, NY. FILED 10-4-2007.

YOUR HANGER WEARS YOUR CLOTHES

THE MARK CONSISTS OF STANDARD CHARACTERS WITHOUT CLAIM TO ANY PARTICULAR FONT, STYLE, SIZE, OR COLOR.

CLASS 14—JEWELRY

FOR JEWELRY CASES NOT OF PRECIOUS METAL (U.S. CLS. 2, 27, 28 AND 50).

CLASS 20—FURNITURE AND ARTICLES NOT OTHERWISE CLASSIFIED

FOR CLOTHES HANGERS (U.S. CLS. 2, 13, 22, 25, 32 AND 50).

CLASS 35—ADVERTISING AND BUSINESS

FOR RETAIL STORE SERVICES FEATURING CLOTHES HANGERS, JEWELRY CASES, HOUSEHOLD DÉCOR AND STORAGE ITEMS, CONTAINERS FOR STORING CLOTHING AND SHOES, SHOE TREES, SACHETS, AND HOUSEHOLD STORAGE CONTAINERS; ONLINE RETAIL STORE SERVICES FEATURING CLOTHES HANGERS, JEWELRY CASES, HOUSEHOLD DÉCOR AND STORAGE ITEMS, CONTAINERS FOR STORING CLOTHING AND SHOES, SHOE TREES, SACHETS, AND HOUSEHOLD STORAGE CONTAINERS (U.S. CLS. 100, 101 AND 102).

CLASS 37—CONSTRUCTION AND REPAIR

FOR CUSTOM INSTALLATION OF FURNITURE AND CONTAINERS (U.S. CLS. 100, 103 AND 106).

CLASS 42—SCIENTIFIC AND COMPUTER SERVICES

FOR INTERIOR DESIGN, HOME DESIGN, APARTMENT DESIGN, STYLING SERVICES IN THE NATURE OF INTERIOR DECORATING SERVICES (U.S. CLS. 100 AND 101).

GRETTA YAO, EXAMINING ATTORNEY

SN 77-297,218. NIHON KOHDEN AMERICA, FOOTHILL RANCH, CA. FILED 10-5-2007.

Prefense

SN 77-297,186. DR. REDDY'S LABORATORIES, INC., BRIDGEWATER, NJ. FILED 10-5-2007.

THE MARK CONSISTS OF STANDARD CHARACTERS WITHOUT CLAIM TO ANY PARTICULAR FONT, STYLE, SIZE, OR COLOR.

PROMIUS PHARMA

THE MARK CONSISTS OF STANDARD CHARACTERS WITHOUT CLAIM TO ANY PARTICULAR FONT, STYLE, SIZE, OR COLOR.

NO CLAIM IS MADE TO THE EXCLUSIVE RIGHT TO USE "PHARMA", APART FROM THE MARK AS SHOWN.

CLASS 9—ELECTRICAL AND SCIENTIFIC APPARATUS

FOR COMPUTER HARDWARE AND SOFTWARE, FOR USE WITH MEDICAL PATIENT MONITORING EQUIPMENT, FOR RECEIVING, PROCESSING, TRANSMITTING AND DISPLAYING DATA; INTERACTIVE MULTIMEDIA SOFTWARE FEATURING AUDIO AND VIDEO INFORMATION FOR PATIENTS ON THE SUBJECT OF TREATMENTS, PROCEDURES AND ALTERNATIVES RELATED TO DENTISTRY (U.S. CLS. 21, 23, 26, 36 AND 38).

CLASS 5—PHARMACEUTICALS

FOR PHARMACEUTICAL PREPARATIONS FOR USE IN DERMATOLOGY (U.S. CLS. 6, 18, 44, 46, 51 AND 52).

CLASS 10—MEDICAL APPARATUS

FOR BLOOD PRESSURE MONITORS; HEART MONITORS; PATIENT MEDICAL MONITORS, NAMELY, MONITORS FOR SURGICAL STIMULATION, ANALGESIA AND HYPNOTIC RELATED RESPONSES; PATIENT MONITORING SENSORS AND ALARMS; RESPIRATION MONITORS (U.S. CLS. 26, 39 AND 44).

KIMBERLY FRYE, EXAMINING ATTORNEY

CLASS 42—SCIENTIFIC AND COMPUTER SERVICES

FOR DEVELOPMENT OF PHARMACEUTICAL PREPARATIONS AND MEDICINES (U.S. CLS. 100 AND 101).
NICHOLAS ALTREE, EXAMINING ATTORNEY

SN 77-297,202. DR. REDDY'S LABORATORIES, INC., BRIDGEWATER, NJ. FILED 10-5-2007.

SN 77-297,236. DR. REDDY'S LABORATORIES, INC., BRIDGEWATER, NJ. FILED 10-5-2007.

PROMIUS THERAPEUTICS

THE MARK CONSISTS OF STANDARD CHARACTERS WITHOUT CLAIM TO ANY PARTICULAR FONT, STYLE, SIZE, OR COLOR.

NO CLAIM IS MADE TO THE EXCLUSIVE RIGHT TO USE "THERAPEUTICS", APART FROM THE MARK AS SHOWN.

PROMIUS PHARMACEUTICALS

THE MARK CONSISTS OF STANDARD CHARACTERS WITHOUT CLAIM TO ANY PARTICULAR FONT, STYLE, SIZE, OR COLOR.

NO CLAIM IS MADE TO THE EXCLUSIVE RIGHT TO USE "PHARMACEUTICALS", APART FROM THE MARK AS SHOWN.

CLASS 5—PHARMACEUTICALS

FOR PHARMACEUTICAL PREPARATIONS FOR USE IN DERMATOLOGY (U.S. CLS. 6, 18, 44, 46, 51 AND 52).

CLASS 5—PHARMACEUTICALS

FOR PHARMACEUTICAL PREPARATIONS FOR USE IN DERMATOLOGY (U.S. CLS. 6, 18, 44, 46, 51 AND 52).

CLASS 42—SCIENTIFIC AND COMPUTER SERVICES

FOR DEVELOPMENT OF PHARMACEUTICAL PREPARATIONS AND MEDICINES (U.S. CLS. 100 AND 101).
NICHOLAS ALTREE, EXAMINING ATTORNEY

CLASS 42—SCIENTIFIC AND COMPUTER SERVICES

FOR DEVELOPMENT OF PHARMACEUTICAL PREPARATIONS AND MEDICINES (U.S. CLS. 100 AND 101).
NICHOLAS ALTREE, EXAMINING ATTORNEY

SN 77-297,240. DEAN DEGAETANO, BRONX, NY. AND GORDON WINCHESTER, YONKERS, NY. AND KIERAN FLEMING, YONKERS, NY. AND MIKE BARBIERE, YORKTOWN HEIGHTS, NY. FILED 10-5-2007.

SN 77-297,341. KOETTER WOODWORKING, INC., BORDEN, IN. FILED 10-5-2007.

ONSLAWT

THE MARK CONSISTS OF STANDARD CHARACTERS WITHOUT CLAIM TO ANY PARTICULAR FONT, STYLE, SIZE, OR COLOR.

CLASS 25—CLOTHING

FOR SHIRTS; TOPS; SWEATERS; PANTS; SHORTS; SKIRTS; JACKETS; COATS; SWIMWEAR; SLEEPWEAR; LOUNGEWEAR; UNDERWEAR; SOCKS; BELTS; SCARVES; SWEATBANDS; WRISTBANDS; GLOVES; SNOW SUITS; SNOW PANTS; SKI SUITS; SKI WEAR; SURF WEAR (U.S. CLS. 22 AND 39).

CLASS 28—TOYS AND SPORTING GOODS

FOR SKATEBOARDS; SNOWBOARDS; SURFBOARDS; BODY BOARDS; ICE SKATES; ROLLER SKATES; SKIS; SKI POLES; SKI BAGS; HOCKEY GLOVES; HOCKEY PUCKS; HOCKEY STICKS; KNEE PADS FOR ATHLETIC USE; ELBOW PADS FOR ATHLETIC USE; SHIN PADS FOR ATHLETIC USE; FACE MASKS FOR SNOW SPORTS; KITES (U.S. CLS. 22, 23, 38 AND 50).
KELLY MCCOY, EXAMINING ATTORNEY

SN 77-297,321. BALBOA BABY & CO., LLC, NEWPORT BEACH, CA. FILED 10-5-2007.

BALBOA BABY

THE MARK CONSISTS OF STANDARD CHARACTERS WITHOUT CLAIM TO ANY PARTICULAR FONT, STYLE, SIZE, OR COLOR.

NO CLAIM IS MADE TO THE EXCLUSIVE RIGHT TO USE "BABY", APART FROM THE MARK AS SHOWN.

CLASS 18—LEATHER GOODS

FOR FABRIC INFANT CARRIERS WORN ON THE BODY; COLLAPSIBLE INFANT CARRIERS WORN ON THE BODY; AND SASH, POUCH OR SLING-TYPE INFANT CARRIERS FOR HOLDING AND CARRYING INFANTS (U.S. CLS. 1, 2, 3, 22 AND 41).

CLASS 24—FABRICS

FOR BED LINENS, NAMELY, DUVETS, COMFORTERS, SHAMS, BED SKIRTS, PILLOWS, PILLOW CASES, SHEETS, CRIB SHEETS, BLANKETS, QUILTS; DRAPES, CURTAINS, FABRIC VALANCES; AND BATHROOM TEXTILES, NAMELY, TOWELS AND WASHCLOTHS (U.S. CLS. 42 AND 50).
JOHN WILKE, EXAMINING ATTORNEY

Insidesign

See Beyond the Blueprint.

THE MARK CONSISTS OF THE WORDS "SEE BEYOND THE BLUEPRINT" APPEARING BELOW THE WORD "INSIDesign".

CLASS 35—ADVERTISING AND BUSINESS

FOR RETAIL STORE SERVICES FEATURING CABINETS, HARDWOOD FLOORING, TRIM, DOORS, STAIR PARTS, AND ACCESSORIES; PROJECT MANAGEMENT SERVICES FOR OTHERS IN THE FIELD OF INSTALLING CABINETS, HARDWOOD FLOORING, TRIM, DOORS, STAIR PARTS, AND ACCESSORIES (U.S. CLS. 100, 101 AND 102).

CLASS 37—CONSTRUCTION AND REPAIR

FOR INSTALLATION OF CABINETS, HARDWOOD FLOORING, TRIM, DOORS, STAIR PARTS AND ACCESSORIES (U.S. CLS. 100, 103 AND 106).
SUSAN LESLIE DUBOIS, EXAMINING ATTORNEY

SN 77-297,349. SWITCHFAST TECHNOLOGIES, LLC, CHICAGO, IL. FILED 10-5-2007.

SWITCHFAST

THE MARK CONSISTS OF STANDARD CHARACTERS WITHOUT CLAIM TO ANY PARTICULAR FONT, STYLE, SIZE, OR COLOR.

CLASS 37—CONSTRUCTION AND REPAIR

FOR INSTALLATION OF TELECOMMUNICATION NETWORKS, SYSTEMS, CABLES, AND HARDWARE (U.S. CLS. 100, 103 AND 106).
FIRST USE 8-26-2005; IN COMMERCE 8-26-2005.

CLASS 38—COMMUNICATION

FOR VOICE OVER IP SERVICES; TELECOMMUNICATIONS CONSULTATION; TELECOMMUNICATION ACCESS SERVICES (U.S. CLS. 100, 101 AND 104).
FIRST USE 8-26-2005; IN COMMERCE 8-26-2005.
G. MAYERSCHOFF, EXAMINING ATTORNEY

SN 77-297,563. PARKER RANCH, INC., KAMUELA, HI. FILED 10-5-2007.

SN 77-297,786. NIHON KOHDEN AMERICA, Foothill Ranch, CA. FILED 10-5-2007.



OWNER OF U.S. REG. NOS. 2,566,879 AND 2,878,183. NO CLAIM IS MADE TO THE EXCLUSIVE RIGHT TO USE "KAMUELA HAWAII" AND "ESTAB. 1847", APART FROM THE MARK AS SHOWN.

THE MARK CONSISTS OF A DRAWING OF A COWBOY ON HORSEBACK ROPING A STEER UNDER THE WORDS "PARKER RANCH" AND ABOVE THE WORDS "KAMUELA HAWAII ESTAB. 1847" ALL FRAMED IN A SQUARE WITH HORSESHOES AND RIBBON AND LEAF MOTIFS.

CLASS 29—MEATS AND PROCESSED FOODS

FOR DRIED BEEF; DRIED FRUIT MIXES; DESICATED COCONUT (U.S. CL. 46). FIRST USE 12-15-2000; IN COMMERCE 12-15-2000.

CLASS 30—STAPLE FOODS

FOR COFFEE; COFFEE BEANS; COOKIES (U.S. CL. 46). FIRST USE 8-15-2000; IN COMMERCE 8-15-2000. JENNIFER VASQUEZ, EXAMINING ATTORNEY

SN 77-297,650. ROBIN LEONG, DBA AVA AMERICAN VIOLIN ALLIANCE, HONOLULU, HI. AND ROBERT L. RAY, DBA AVA AMERICAN VIOLIN ALLIANCE, OLYMPIA, WA. AND ROLAND FELLER, DBA AVA AMERICAN VIOLIN ALLIANCE, SAN FRANCISCO, CA. AND WILLIAM GAILES, DBA AVA AMERICAN VIOLIN ALLIANCE, COLLEGE PARK, MD. FILED 10-5-2007.

AVA

THE MARK CONSISTS OF STANDARD CHARACTERS WITHOUT CLAIM TO ANY PARTICULAR FONT, STYLE, SIZE, OR COLOR.

CLASS 15—MUSICAL INSTRUMENTS

FOR BOWS FOR MUSICAL INSTRUMENTS; MUSICAL INSTRUMENTS; STRING INSTRUMENTS (U.S. CLS. 2, 21 AND 36).

CLASS 35—ADVERTISING AND BUSINESS

FOR WHOLESALE ORDERING SERVICES IN THE FIELD OF MUSICAL INSTRUMENTS; RETAIL STORES FEATURING MUSICAL INSTRUMENTS; WHOLESALE DISTRIBUTORSHIPS FEATURING MUSICAL INSTRUMENTS (U.S. CLS. 100, 101 AND 102). AMY MCMENAMIN, EXAMINING ATTORNEY

Defensive Monitoring

THE MARK CONSISTS OF STANDARD CHARACTERS WITHOUT CLAIM TO ANY PARTICULAR FONT, STYLE, SIZE, OR COLOR.

NO CLAIM IS MADE TO THE EXCLUSIVE RIGHT TO USE "MONITORING", APART FROM THE MARK AS SHOWN.

CLASS 9—ELECTRICAL AND SCIENTIFIC APPARATUS

FOR COMPUTER HARDWARE AND SOFTWARE, FOR USE WITH MEDICAL PATIENT MONITORING EQUIPMENT, FOR RECEIVING, PROCESSING, TRANSMITTING AND DISPLAYING DATA (U.S. CLS. 21, 23, 26, 36 AND 38).

CLASS 10—MEDICAL APPARATUS

FOR BLOOD PRESSURE MONITORS; PATIENT MEDICAL MONITORS, NAMELY, MONITORS FOR SURGICAL STIMULATION, ANALGESIA AND HYPNOTIC RELATED RESPONSES; PATIENT MONITORING SENSORS AND ALARMS (U.S. CLS. 26, 39 AND 44). RENEE MCCRAY, EXAMINING ATTORNEY

SN 77-297,824. COGENT, INC., SO. PASADENA, CA. FILED 10-5-2007.



THE MARK CONSISTS OF TWO INVERTED CRESCENTS WITH THE ENDS FACING EACH OTHER. THE CRESCENTS ARE SOLID EXCEPT FOR A SMALL PORTION IN THE MIDDLE. THE RIGHT CRESCENT BEING LOWER THAN THE LEFT.

CLASS 9—ELECTRICAL AND SCIENTIFIC APPARATUS

FOR COMPUTER SOFTWARE AND HARDWARE FOR BIOMETRIC IDENTIFICATION AND VERIFICATION; AND SCIENTIFIC INSTRUMENT, NAMELY, BIOLOGICAL APPARATUS FOR BIOMETRIC IDENTIFICATION AND VERIFICATION (U.S. CLS. 21, 23, 26, 36 AND 38). FIRST USE 10-15-2000; IN COMMERCE 10-15-2000.

CLASS 10—MEDICAL APPARATUS

FOR ANALYTICAL APPARATUS FOR MEDICAL PURPOSE, NAMELY, BIOLOGICAL APPARATUS FOR BIOMETRIC IDENTIFICATION AND VERIFICATION (U.S. CLS. 26, 39 AND 44). FIRST USE 10-15-2004; IN COMMERCE 10-15-2004. KELLY BOULTON, EXAMINING ATTORNEY

SN 77-298,692. PROPEL SOFTWARE CORPORATION, SAN JOSE, CA. FILED 10-8-2007.

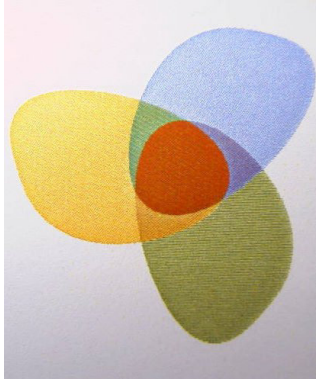

OWNER OF U.S. REG. NOS. 2,532,027 AND 2,532,028.
THE COLOR(S) BLUE, GOLD, GREEN AND RED IS/ARE CLAIMED AS A FEATURE OF THE MARK.
THE MARK CONSISTS OF A PROPELLER WITH A BLUE BLADE, A GOLD BLADE, A GREEN BLADE AND HAVING A RED REGION WHERE THE BLADES TOTALLY OVERLAP.

CLASS 9—ELECTRICAL AND SCIENTIFIC APPARATUS

FOR DOWNLOADABLE SOFTWARE FOR ACCELERATING DATA FLOW IN A TELECOMMUNICATIONS NETWORK (U.S. CLS. 21, 23, 26, 36 AND 38).
FIRST USE 3-22-2001; IN COMMERCE 3-22-2001.

CLASS 42—SCIENTIFIC AND COMPUTER SERVICES

FOR COMPUTER SERVICES THAT OPTIMIZES DATA FLOW IN A TELECOMMUNICATIONS NETWORK AND THAT ANALYZES, MONITORS AND REPORTS ON TRAFFIC IN A TELECOMMUNICATIONS NETWORK (U.S. CLS. 100 AND 101).
FIRST USE 3-22-2001; IN COMMERCE 3-22-2001.
KAREN BRACEY, EXAMINING ATTORNEY

SN 77-298,775. PROPEL SOFTWARE CORPORATION, SAN JOSE, CA. FILED 10-8-2007.

PROPEL PBM

THE MARK CONSISTS OF STANDARD CHARACTERS WITHOUT CLAIM TO ANY PARTICULAR FONT, STYLE, SIZE, OR COLOR.
OWNER OF U.S. REG. NOS. 2,041,848, 2,467,518 AND 2,474,494.

CLASS 9—ELECTRICAL AND SCIENTIFIC APPARATUS

FOR DOWNLOADABLE SOFTWARE FOR PRIORITIZING NETWORK TRAFFIC ON A COMPUTER OR OTHER COMMUNICATIONS TERMINAL CONNECTED TO A COMMUNICATIONS NETWORK (U.S. CLS. 21, 23, 26, 36 AND 38).
FIRST USE 9-24-2007; IN COMMERCE 9-24-2007.

CLASS 42—SCIENTIFIC AND COMPUTER SERVICES

FOR COMPUTER SERVICES THAT OPTIMIZES DATA FLOW IN A TELECOMMUNICATIONS NETWORK AND THAT ANALYZES, MONITORS AND REPORTS ON TRAFFIC IN A TELECOMMUNICATIONS NETWORK (U.S. CLS. 100 AND 101).
KAREN BRACEY, EXAMINING ATTORNEY

SN 77-300,190. UNILEVER SUPPLY CHAIN, INC., CLINTON, CT. FILED 10-10-2007.

VASELINE WARM CARE

THE MARK CONSISTS OF STANDARD CHARACTERS WITHOUT CLAIM TO ANY PARTICULAR FONT, STYLE, SIZE, OR COLOR.
OWNER OF U.S. REG. NOS. 140,345, 3,295,224 AND OTHERS.
NO CLAIM IS MADE TO THE EXCLUSIVE RIGHT TO USE "WARM", APART FROM THE MARK AS SHOWN.

CLASS 3—COSMETICS AND CLEANING PREPARATIONS

FOR BODY WASHES (U.S. CLS. 1, 4, 6, 50, 51 AND 52).

CLASS 11—ENVIRONMENTAL CONTROL APPARATUS

FOR BODY LOTION HEATING DEVICE, NAMELY, PERSONAL ELECTRIC WARMER FOR WARMING LOTION FOR USE ON THE SKIN (U.S. CLS. 13, 21, 23, 31 AND 34).
C. DIONNE CLYBURN, EXAMINING ATTORNEY

SN 77-300,412. DAVID ALLEN & CO., OJAI, CA. FILED 10-10-2007.

GEAR FOR WORK AND LIFE

THE MARK CONSISTS OF STANDARD CHARACTERS WITHOUT CLAIM TO ANY PARTICULAR FONT, STYLE, SIZE, OR COLOR.

CLASS 9—ELECTRICAL AND SCIENTIFIC APPARATUS

FOR DVDS, CDS, AND SOFTWARE FEATURING INFORMATION AND INSTRUCTION ON THE DEVELOPMENT OF MANAGEMENT AND BUSINESS SKILLS, EFFICIENT WORK HABITS, PLANNING AND ORGANIZATIONAL TECHNIQUES, AND PERSONAL PRODUCTIVITY GROWTH; AND PRERECORDED VIDEO AND AUDIO CASSETTE TAPES FEATURING INFORMATION AND INSTRUCTION ON THE DEVELOPMENT OF MANAGEMENT AND BUSINESS SKILLS, EFFICIENT WORK HABITS, PLANNING AND ORGANIZATIONAL TECHNIQUES, AND PERSONAL PRODUCTIVITY AND GROWTH (U.S. CLS. 21, 23, 26, 36 AND 38).
FIRST USE 1-15-2005; IN COMMERCE 1-15-2005.

CLASS 18—LEATHER GOODS

FOR WALLETS; PURSES; HANDBAGS; BRIEFCASES; BRIEFCASE-TYPE PORTFOLIOS; VALISES; KEY CASES; CREDIT CARD CASES; TOTE BAGS; AND LUGGAGE (U.S. CLS. 1, 2, 3, 22 AND 41).
FIRST USE 1-15-2005; IN COMMERCE 1-15-2005.

CLASS 20—FURNITURE AND ARTICLES NOT OTHERWISE CLASSIFIED

FOR FURNITURE; OFFICE FURNITURE; FILING CABINETS; FURNITURE CABINETS; BOOKCASES; CHAIRS; AND DESKS (U.S. CLS. 2, 13, 22, 25, 32 AND 50).
FIRST USE 1-15-2005; IN COMMERCE 1-15-2005.
KATHRYN COWARD, EXAMINING ATTORNEY

CLASS 17—RUBBER GOODS

FOR NON-CONDUCTING COMPOSITIONS WITHIN THE BUILDING INDUSTRY AND THE MARINE INDUSTRY, NAMELY, INSULATION AGAINST FIRE, CONDENSATION, ACOUSTICS AS WELL AS THERMAL INSULATION (U.S. CLS. 1, 5, 12, 13, 35 AND 50).

CLASS 37—CONSTRUCTION AND REPAIR

FOR CONSTRUCTION AND ERECTION OF BUILDINGS AND MARINE CONSTRUCTION AS WELL AS REPAIR AND MAINTENANCE OF BUILDINGS SUCH AS INSULATION AGAINST FIRE, CONDENSATION, ACOUSTICS AND THERMAL INSULATION; SHIP BUILDING SERVICES REGARDING INSULATION AGAINST FIRE, CONDENSATION, ACOUSTICS AND THERMAL INSULATION (U.S. CLS. 100, 103 AND 106).
ROBIN CHOSID, EXAMINING ATTORNEY

SN 77-300,741. HEALTHCARE LOGISTICS SOLUTIONS, LLC, WESTERVILLE, OH. FILED 10-10-2007.

SHIPPRO

SN 77-301,639. OVACON AB, TROSA, SWEDEN, FILED 10-11-2007.

THE MARK CONSISTS OF STANDARD CHARACTERS WITHOUT CLAIM TO ANY PARTICULAR FONT, STYLE, SIZE, OR COLOR.

CLASS 35—ADVERTISING AND BUSINESS

FOR INFORMATION SERVICES VIA THE INTERNET, NAMELY, QUOTING SHIPPING PRICES AND TRACKING OF PACKAGE SHIPMENTS (U.S. CLS. 100, 101 AND 102).

CLASS 39—TRANSPORTATION AND STORAGE

FOR INFORMATION SERVICES VIA THE INTERNET, NAMELY, RECOMMENDING ALTERNATIVE SHIPPING OPTIONS AND PROVIDING INFORMATION SPECIFIC TO ALTERNATIVE SHIPPING OPTIONS, NAMELY, MODES OF TRANSPORTATION (U.S. CLS. 100 AND 105).
KATHERINE CHANG, EXAMINING ATTORNEY

SN 77-301,567. OVACON AB, TROSA, SWEDEN, FILED 10-11-2007.

SPREFIX

THE MARK CONSISTS OF STANDARD CHARACTERS WITHOUT CLAIM TO ANY PARTICULAR FONT, STYLE, SIZE, OR COLOR.

CLASS 7—MACHINERY

FOR MACHINES FOR SPRAY-ON NON-CONDUCTING COMPOSITIONS (U.S. CLS. 13, 19, 21, 23, 31, 34 AND 35).

CLASS 7—MACHINERY

FOR MACHINES FOR SPRAY-ON NON-CONDUCTING COMPOSITIONS (U.S. CLS. 13, 19, 21, 23, 31, 34 AND 35).

CLASS 17—RUBBER GOODS

FOR NON-CONDUCTING COMPOSITIONS WITHIN THE BUILDING INDUSTRY AND THE MARINE INDUSTRY, NAMELY, INSULATION AGAINST FIRE, CONDENSATION, ACOUSTICS AS WELL AS THERMAL INSULATION (U.S. CLS. 1, 5, 12, 13, 35 AND 50).

CLASS 37—CONSTRUCTION AND REPAIR

FOR CONSTRUCTION AND ERECTION OF BUILDINGS AND MARINE CONSTRUCTION AS WELL AS REPAIR AND MAINTENANCE OF BUILDINGS SUCH AS INSULATION AGAINST FIRE, CONDENSATION, ACOUSTICS AND THERMAL INSULATION; SHIP BUILDING SERVICES REGARDING INSULATION AGAINST FIRE, CONDENSATION, ACOUSTICS AND THERMAL INSULATION (U.S. CLS. 100, 103 AND 106).
ROBIN CHOSID, EXAMINING ATTORNEY

SN 77-301,644. NEWMAN AND SONS, SIMI VALLEY, CA.
FILED 10-11-2007.

SN 77-303,274. NATALIE PORTMAN, NEW YORK, NY.
FILED 10-12-2007.



NO CLAIM IS MADE TO THE EXCLUSIVE RIGHT TO USE "RECYCLED AGGREGATE MATERIALS COMPANY INC.", APART FROM THE MARK AS SHOWN.

THE COLOR(S) BLACK, GOLD AND SILVER IS/ARE CLAIMED AS A FEATURE OF THE MARK.

THE MARK CONSISTS OF THE STYLIZED LETTERS NS IN SILVER WITH BLACK OUTLINES AND A BLACK STRIPE RUNNING THROUGH THE LETTERS. A SILVER TRIANGLE OUTLINED IN BLACK SURROUNDED BY A GOLD SPECKLED PATTERN ABOVE THE NAME NEWMAN AND SONS IN BLACK, FOLLOWED BY RECYCLED AGGREGATE MATERIALS COMPANY INC. IN BLACK.

CLASS 19—NON-METALLIC BUILDING MATERIALS

FOR AGGREGATE MATERIAL COMPOSED OF CONCRETE AND ASPHALT FOR RECYCLING AND CMB AND CLASS II BASE FOR THE CONSTRUCTION INDUSTRY (U.S. CLS. 1, 12, 33 AND 50).

FIRST USE 1-1-1972; IN COMMERCE 1-1-1972.

CLASS 36—INSURANCE AND FINANCIAL

FOR BUILDING LEASING; LEASING OF REAL ESTATE; LEASING OF LAND; LEASING OR RENTING OF BUILDINGS (U.S. CLS. 100, 101 AND 102).

FIRST USE 1-1-1972; IN COMMERCE 1-1-1972.

CLASS 37—CONSTRUCTION AND REPAIR

FOR LEASING OF CONSTRUCTION EQUIPMENT (U.S. CLS. 100, 103 AND 106).

FIRST USE 1-1-1972; IN COMMERCE 1-1-1972.
ROBIN CHOSID, EXAMINING ATTORNEY

SN 77-302,011. MORRISON HOLDING COMPANY, LAS VEGAS, NV. FILED 10-11-2007.

GREAT STARTS HERE

THE MARK CONSISTS OF STANDARD CHARACTERS WITHOUT CLAIM TO ANY PARTICULAR FONT, STYLE, SIZE, OR COLOR.

CLASS 43—HOTEL AND RESTAURANT SERVICES

FOR CONTRACT FOOD SERVICES; FOOD PREPARATION SERVICES (U.S. CLS. 100 AND 101).

CLASS 44—MEDICAL, BEAUTY AND AGRICULTURAL SERVICES

FOR NUTRITION COUNSELING (U.S. CLS. 100 AND 101).
MARK PILARO, EXAMINING ATTORNEY

HANDSOMECHARLIE FILMS

THE MARK CONSISTS OF STANDARD CHARACTERS WITHOUT CLAIM TO ANY PARTICULAR FONT, STYLE, SIZE, OR COLOR.

NO CLAIM IS MADE TO THE EXCLUSIVE RIGHT TO USE "FILMS", APART FROM THE MARK AS SHOWN.

CLASS 9—ELECTRICAL AND SCIENTIFIC APPARATUS

FOR MOTION PICTURE FILMS IN THE FIELD OF DOCUMENTARIES AND EDUCATION; MOTION PICTURE FILMS FEATURING ENTERTAINMENT, NAMELY, COMEDY, DRAMA, ANIMATION, ROMANCE AND/OR ACTION/ADVENTURE; PRE-RECORDED VIDEO TAPES, VIDEO DISCS AND DVDS FEATURING ENTERTAINMENT, COMEDY, DRAMA, ANIMATION, ROMANCE, AND/OR ACTION/ADVENTURE; CINEMATOGRAPHIC FILMS FOR TELEVISION BROADCAST AND THEATRICAL EXHIBITION (U.S. CLS. 21, 23, 26, 36 AND 38).

CLASS 41—EDUCATION AND ENTERTAINMENT

FOR PRODUCTION AND DISTRIBUTION OF MOTION PICTURE FILMS SUITABLE FOR DISTRIBUTION IN ALL MEDIA; INTERNET SERVICES, PROVIDING INFORMATION VIA AN ELECTRONIC GLOBAL COMPUTER NETWORK IN THE FIELD OF ENTERTAINMENT RELATING SPECIFICALLY TO ENTERTAINMENT MOVIES AND/OR TELEVISION; PROVIDING INFORMATION RELATING TO SPECIFIC ITEMS OF ENTERTAINMENT VIA AN ELECTRONIC GLOBAL COMMUNICATIONS NETWORK IN THE NATURE OF LIVE-ACTION, COMEDY, DRAMA AND ANIMATED PROGRAMS AND RELATING TO PRODUCTION OF LIVE-ACTION COMEDY, ACTION AND ANIMATED MOTION PICTURE FILMS (U.S. CLS. 100, 101 AND 107).

MICHAEL SOUDERS, EXAMINING ATTORNEY

SN 77-303,312. ABBYY SOFTWARE LTD., NICOSIA, CYPRUS, FILED 10-12-2007.

ADRT

THE MARK CONSISTS OF STANDARD CHARACTERS WITHOUT CLAIM TO ANY PARTICULAR FONT, STYLE, SIZE, OR COLOR.

CLASS 9—ELECTRICAL AND SCIENTIFIC APPARATUS

FOR OPTICAL CHARACTER RECOGNITION APPARATUS (OCR); SOFTWARE FOR OPTICAL CHARACTER RECOGNITION (U.S. CLS. 21, 23, 26, 36 AND 38).

CLASS 35—ADVERTISING AND BUSINESS

FOR BUSINESS MANAGEMENT AND CONSULTATION (U.S. CLS. 100, 101 AND 102).

CLASS 42—SCIENTIFIC AND COMPUTER SERVICES

FOR COMPUTER SOFTWARE CONSULTATION; CONVERSION OF DATA OR DOCUMENTS FROM PHYSICAL TO ELECTRONIC MEDIA; COMPUTER SOFTWARE DESIGN FOR OTHERS (U.S. CLS. 100 AND 101).

MICHAEL LITZAU, EXAMINING ATTORNEY

SN 77-303,503. E2E MATERIALS, LLC, ITHACA, NY. FILED 10-13-2007.



THE COLOR(S) BLUE, YELLOW, GREEN, BLACK AND ORANGE IS/ARE CLAIMED AS A FEATURE OF THE MARK.

THE MARK CONSISTS OF LOWERCASE LETTER "E" COLORED IN BLUE AND OUTLINED IN BLACK. THE LOWERCASE LETTER "E" IS OVAL IN SHAPE AND CONTAINS AN UPPER SEMI-OVAL ENCLOSURE AND A LOWER SEMI-OVAL ENCLOSURE. INSIDE THE UPPER ENCLOSURE IS AN ORANGE SUN WITH ORANGE AND YELLOW RAYS ON THE HORIZON. INSIDE THE LOWER ENCLOSURE ARE GREEN CULTIVATED FIELDS LINED IN BLACK. NO EXTERIOR BACKGROUND COLOR IS CLAIMED.

CLASS 19—NON-METALLIC BUILDING MATERIALS

FOR NON-METALIC BOARDS FOR CONSTRUCTION INCLUDING BIODEGRADABLE BOARDS (U.S. CLS. 1, 12, 33 AND 50).

CLASS 20—FURNITURE AND ARTICLES NOT OTHERWISE CLASSIFIED

FOR FURNITURE AND CABINETS, NAMELY, BIODEGRADABLE FURNITURE AND CABINETS (U.S. CLS. 2, 13, 22, 25, 32 AND 50).

CLASS 28—TOYS AND SPORTING GOODS

FOR SKATEBOARDS INCLUDING BIODEGRADABLE SKATEBOARD DECKS (U.S. CLS. 22, 23, 38 AND 50).
JUDITH HELFMAN, EXAMINING ATTORNEY

SN 77-305,184. BACANI, SHARON L., ANTIOCH, CA. FILED 10-16-2007.

DON'T BE A BASTARD

THE MARK CONSISTS OF STANDARD CHARACTERS WITHOUT CLAIM TO ANY PARTICULAR FONT, STYLE, SIZE, OR COLOR.

CLASS 16—PAPER GOODS AND PRINTED MATTER

FOR STICKERS; POSTERS; PAPER HANG TAGS (U.S. CLS. 2, 5, 22, 23, 29, 37, 38 AND 50).

CLASS 25—CLOTHING

FOR SHIRTS; HATS; PANTS; JACKETS; UNDERWEAR; SWEATERS; BELTS; SWEAT BANDS; HEADBANDS AGAINST SWEATING (U.S. CLS. 22 AND 39).
ALEXANDER L. POWERS, EXAMINING ATTORNEY

SN 77-308,737. SHE TEES GOLFWEAR, LLC, GRANGER, IN. FILED 10-19-2007.

Wear to Win

THE MARK CONSISTS OF STANDARD CHARACTERS WITHOUT CLAIM TO ANY PARTICULAR FONT, STYLE, SIZE, OR COLOR.

CLASS 18—LEATHER GOODS

FOR PURSES, CLUTCH PURSES, COIN PURSES, ALL PURPOSE SPORT BAGS, ALL-PURPOSE ATHLETIC BAGS, ALL-PURPOSE CARRYING BAGS, WALLETS (U.S. CLS. 1, 2, 3, 22 AND 41).

CLASS 25—CLOTHING

FOR CLOTHING, NAMELY, SKORTS, SHORTS, SHIRTS, PANTS, CAPS, HATS, VISORS, POLO SHIRTS, JACKETS, COATS, SWEATERS, SWEATSHIRTS (U.S. CLS. 22 AND 39).
MORGAN WYNNE, EXAMINING ATTORNEY

SN 77-310,615. MARIE ANDERSON, SCOTTSDALE, AZ. FILED 10-23-2007.

The Way of Beauty

THE MARK CONSISTS OF STANDARD CHARACTERS WITHOUT CLAIM TO ANY PARTICULAR FONT, STYLE, SIZE, OR COLOR.

CLASS 9—ELECTRICAL AND SCIENTIFIC APPARATUS

FOR MUSICAL SOUND RECORDINGS (U.S. CLS. 21, 23, 26, 36 AND 38).

CLASS 14—JEWELRY

FOR NECKLACES; BRACELETS; CUFF-LINKS (U.S. CLS. 2, 27, 28 AND 50).

CLASS 16—PAPER GOODS AND PRINTED MATTER

FOR BLANK WRITING JOURNALS (U.S. CLS. 2, 5, 22, 23, 29, 37, 38 AND 50).

CLASS 25—CLOTHING

FOR SHIRTS; HATS (U.S. CLS. 22 AND 39).

CLASS 41—EDUCATION AND ENTERTAINMENT

FOR EDUCATIONAL SERVICES, NAMELY, DEVELOPING, ARRANGING, AND CONDUCTING EDUCATIONAL CONFERENCES AND PROGRAMS AND PROVIDING COURSES OF INSTRUCTION IN THE FIELD OF SELF ESTEEM; ARRANGING AND CONDUCTING EDUCATIONAL CONFERENCES; CONDUCTING WORKSHOPS AND SEMINARS IN SELF ESTEEM; EDUCATIONAL AND ENTERTAINMENT SERVICES, NAMELY, PROVIDING MOTIVATIONAL AND EDUCATIONAL SPEAKERS (U.S. CLS. 100, 101 AND 107).

JOHN WILKE, EXAMINING ATTORNEY

CLASS 41—EDUCATION AND ENTERTAINMENT

FOR EDUCATIONAL AND ENTERTAINMENT SERVICES, NAMELY, PROVIDING MOTIVATIONAL AND EDUCATIONAL SPEAKERS; EDUCATIONAL SERVICES, NAMELY, DEVELOPING, ARRANGING, AND CONDUCTING EDUCATIONAL CONFERENCES AND PROGRAMS AND PROVIDING COURSES OF INSTRUCTION IN THE FIELD OF SELF ESTEEM; EDUCATION SERVICES, NAMELY, PROVIDING WORKSHOPS AND SEMINARS IN THE FIELD OF SELF ESTEEM; ARRANGING AND CONDUCTING EDUCATIONAL CONFERENCES (U.S. CLS. 100, 101 AND 107).

JOHN WILKE, EXAMINING ATTORNEY

SN 77-310,642. MARIE ANDERSON, SCOTTSDALE, AZ. FILED 10-23-2007.

Fashion Modeling 101

THE MARK CONSISTS OF STANDARD CHARACTERS WITHOUT CLAIM TO ANY PARTICULAR FONT, STYLE, SIZE, OR COLOR.

NO CLAIM IS MADE TO THE EXCLUSIVE RIGHT TO USE "FASHION MODELING", APART FROM THE MARK AS SHOWN.

CLASS 25—CLOTHING

FOR SHIRTS; HATS (U.S. CLS. 22 AND 39).

CLASS 41—EDUCATION AND ENTERTAINMENT

FOR EDUCATIONAL AND ENTERTAINMENT SERVICES, NAMELY, PROVIDING MOTIVATIONAL AND EDUCATIONAL SPEAKERS; ARRANGING AND CONDUCTING EDUCATIONAL CONFERENCES; CONDUCTING WORKSHOPS AND SEMINARS IN SELF ESTEEM; EDUCATION SERVICES, NAMELY, PROVIDING WORKSHOPS AND SEMINARS IN THE FIELD OF SELF ESTEEM (U.S. CLS. 100, 101 AND 107).

JOHN WILKE, EXAMINING ATTORNEY

SN 77-310,677. SMITHKLINE BEECHAM CORPORATION, PHILADELPHIA, PA. FILED 10-23-2007.

The Aesthetic Edge

THE MARK CONSISTS OF STANDARD CHARACTERS WITHOUT CLAIM TO ANY PARTICULAR FONT, STYLE, SIZE, OR COLOR.

CLASS 9—ELECTRICAL AND SCIENTIFIC APPARATUS

FOR MUSICAL SOUND RECORDINGS (U.S. CLS. 21, 23, 26, 36 AND 38).

CLASS 14—JEWELRY

FOR NECKLACES; BRACELETS; CUFF-LINKS (U.S. CLS. 2, 27, 28 AND 50).

CLASS 16—PAPER GOODS AND PRINTED MATTER

FOR BLANK WRITING JOURNALS (U.S. CLS. 2, 5, 22, 23, 29, 37, 38 AND 50).

CLASS 25—CLOTHING

FOR HATS; SHIRTS (U.S. CLS. 22 AND 39).

AQUAFRESH AMAZING

THE MARK CONSISTS OF STANDARD CHARACTERS WITHOUT CLAIM TO ANY PARTICULAR FONT, STYLE, SIZE, OR COLOR.

OWNER OF U.S. REG. NOS. 1,006,821, 2,505,479 AND OTHERS.

CLASS 3—COSMETICS AND CLEANING PREPARATIONS

SN 77-311,082. MARIE ANDERSON, SCOTTSDALE, AZ. FILED 10-23-2007.

FOR ORAL CARE PREPARATIONS, NAMELY, DENTIFRICES, MOUTHWASHES AND BREATH FRESHENERS, DENTAL BLEACHING AND CLEANING GELS, BLEACHING PREPARATIONS FOR COSMETIC PURPOSES, TOOTH POLISHING PREPARATIONS, TOOTH WHITENING PREPARATIONS, ACCELERATORS AND STAIN REMOVAL PREPARATIONS FOR COSMETIC PURPOSES (U.S. CLS. 1, 4, 6, 50, 51 AND 52).

Hunting Caribou

CLASS 5—PHARMACEUTICALS

FOR MEDICATED ORAL CARE PRODUCTS, NAMELY, MEDICATED MOUTHWASHES, MEDICATED TOOTH POLISHING PREPARATIONS, MEDICATED TOOTH WHITENING PREPARATIONS, MEDICATED BLEACHING PREPARATIONS FOR COSMETIC PURPOSES, MEDICATED CHEWING GUM AND LOZENGES FOR DENTAL HYGIENE (U.S. CLS. 6, 18, 44, 46, 51 AND 52).

THE MARK CONSISTS OF STANDARD CHARACTERS WITHOUT CLAIM TO ANY PARTICULAR FONT, STYLE, SIZE, OR COLOR.

NO CLAIM IS MADE TO THE EXCLUSIVE RIGHT TO USE "CARIBOU", APART FROM THE MARK AS SHOWN.

CLASS 21—HOUSEWARES AND GLASS

FOR TOOTHBRUSHES, TOOTHPICKS, DENTAL FLOSS FOR USE IN ORAL CARE (U.S. CLS. 2, 13, 23, 29, 30, 33, 40 AND 50).

SETH A. RAPPAPORT, EXAMINING ATTORNEY

CLASS 9—ELECTRICAL AND SCIENTIFIC APPARATUS

FOR SOUND RECORDINGS FEATURING MUSIC AND/ OR SPOKEN WORD (U.S. CLS. 21, 23, 26, 36 AND 38).

CLASS 25—CLOTHING

FOR SHIRTS; HATS (U.S. CLS. 22 AND 39).

SN 77-311,063. MARIE ANDERSON, SCOTTSDALE, AZ. FILED 10-23-2007.

The Wizard of Editorial

CLASS 41—EDUCATION AND ENTERTAINMENT

FOR EDUCATIONAL AND ENTERTAINMENT SERVICES, NAMELY, PROVIDING MOTIVATIONAL AND EDUCATIONAL SPEAKERS; ARRANGING AND CONDUCTING EDUCATIONAL CONFERENCES; EDUCATION SERVICES, NAMELY, PROVIDING WORKSHOPS AND SEMINARS IN THE FIELD OF SELF ESTEEM; EDUCATIONAL SERVICES, NAMELY, DEVELOPING, ARRANGING, AND CONDUCTING EDUCATIONAL CONFERENCES AND PROGRAMS AND PROVIDING COURSES OF INSTRUCTION IN THE FIELD OF SELF ESTEEM (U.S. CLS. 100, 101 AND 107).

JOHN WILKE, EXAMINING ATTORNEY

THE MARK CONSISTS OF STANDARD CHARACTERS WITHOUT CLAIM TO ANY PARTICULAR FONT, STYLE, SIZE, OR COLOR.

SN 77-311,133. MARIE ANDERSON, SCOTTSDALE, AZ. FILED 10-23-2007.

CLASS 9—ELECTRICAL AND SCIENTIFIC APPARATUS

FOR SOUND RECORDINGS FEATURING MUSIC AND/ OR SPOKEN WORDS (U.S. CLS. 21, 23, 26, 36 AND 38).

The Architecture of My Human Heart

CLASS 25—CLOTHING

FOR HATS; SHIRTS (U.S. CLS. 22 AND 39).

THE MARK CONSISTS OF STANDARD CHARACTERS WITHOUT CLAIM TO ANY PARTICULAR FONT, STYLE, SIZE, OR COLOR.

CLASS 41—EDUCATION AND ENTERTAINMENT

FOR EDUCATIONAL AND ENTERTAINMENT SERVICES, NAMELY, PROVIDING MOTIVATIONAL AND EDUCATIONAL SPEAKERS; ARRANGING AND CONDUCTING EDUCATIONAL CONFERENCES; EDUCATION SERVICES, NAMELY, PROVIDING WORKSHOPS AND SEMINARS IN THE FIELDS OF SELF ESTEEM; EDUCATIONAL SERVICES, NAMELY, DEVELOPING, ARRANGING, AND CONDUCTING EDUCATIONAL CONFERENCES AND PROGRAMS AND PROVIDING COURSES OF INSTRUCTION IN THE FIELD OF SELF ESTEEM (U.S. CLS. 100, 101 AND 107).

JOHN WILKE, EXAMINING ATTORNEY

CLASS 9—ELECTRICAL AND SCIENTIFIC APPARATUS

FOR SOUND RECORDINGS FEATURING MUSIC AND/ OR SPOKEN WORDS (U.S. CLS. 21, 23, 26, 36 AND 38).

CLASS 25—CLOTHING

FOR HATS; SHIRTS (U.S. CLS. 22 AND 39).

CLASS 41—EDUCATION AND ENTERTAINMENT

SN 77-311,509. JXTWO, INC., VENICE, CA. FILED 10-23-2007.

FOR EDUCATIONAL AND ENTERTAINMENT SERVICES, NAMELY, PROVIDING MOTIVATIONAL AND EDUCATIONAL SPEAKERS; ARRANGING AND CONDUCTING EDUCATIONAL CONFERENCES; EDUCATION SERVICES, NAMELY, PROVIDING WORKSHOPS AND SEMINARS IN THE FIELD OF SELF ESTEEM; WORKSHOPS AND SEMINARS IN THE FIELD OF SELF ESTEEM; EDUCATIONAL SERVICES, NAMELY, DEVELOPING, ARRANGING, AND CONDUCTING EDUCATIONAL CONFERENCES AND PROGRAMS AND PROVIDING COURSES OF INSTRUCTION IN THE FIELD OF SELF ESTEEM (U.S. CLS. 100, 101 AND 107).
JOHN WILKE, EXAMINING ATTORNEY



SN 77-311,452. JXTWO, INC., VENICE, CA. FILED 10-23-2007.

BLUE HOWLIE

THE MARK CONSISTS OF STANDARD CHARACTERS WITHOUT CLAIM TO ANY PARTICULAR FONT, STYLE, SIZE, OR COLOR.

THE COLOR(S) BLUE, BLACK AND WHITE IS/ARE CLAIMED AS A FEATURE OF THE MARK.

THE MARK CONSISTS OF A FANCIFUL CREATURE IN THE COLOR BLUE OUTLINED IN BLACK WITH A BLACK WAVE DESIGN ACROSS ITS CHEST. THE CREATURE'S EYES ARE WHITE AND OUTLINED IN BLACK.

CLASS 3—COSMETICS AND CLEANING PREPARATIONS**CLASS 3—COSMETICS AND CLEANING PREPARATIONS**

FOR COSMETIC AND PERSONAL CARE PRODUCTS, NAMELY, CLEANERS FOR THE SKIN, SHAMPOOS, HAIR CONDITIONERS, MOISTURIZING SKIN LOTIONS, MOISTURIZING SKIN CREAMS AND MOISTURIZING GELS, HAIRSPRAY, SHOWER GELS, SOAPS, AND SKIN TONERS, NON-MEDICATED SKIN CARE PREPARATIONS, NAMELY, ULTRAVIOLET SUN-BLOCK LOTIONS, SUN CREAMS, AFTER-SUN GELS AND AFTER-SUN OILS; SUNTAN PREPARATIONS, NAMELY, SKIN GELS FOR ACCELERATING TANS, SUN TAN CREAMS, SUN TAN GELS, AND SUN TAN OILS, SUNLESS SELF TANNING PREPARATIONS, AFTER-SUN MOISTURIZING LOTIONS, CHILDREN'S, MEN'S AND WOMEN'S FRAGRANCES, NAMELY, EAU DE TOILETTE AND EAU DE COLOGNE, PRE-SHAVE LOTIONS, AFTER-SHAVE LOTIONS, DEODORANTS AND ANTI-PERSPIRANTS; SKIN CLEANSERS TO REMOVE TEMPORARY TATTOOS, ADHESIVES, ADHESIVE RESIDUE, TAPES, BANDAGES, CHEMICALS, INK, MARKERS, PERMANENT MARKERS, DYES, FOOD COLORING, TAR, PAINT, AND SAP; BREATH FRESHENER, MOUTHWASH AND TOOTHPASTES (U.S. CLS. 1, 4, 6, 50, 51 AND 52).

FOR COSMETIC AND PERSONAL CARE PRODUCTS, NAMELY, CLEANERS FOR THE SKIN, SHAMPOOS, HAIR CONDITIONERS, MOISTURIZING SKIN LOTIONS, MOISTURIZING SKIN CREAMS AND MOISTURIZING GELS, HAIRSPRAY, SHOWER GELS, SOAPS, AND SKIN TONERS, NON-MEDICATED SKIN CARE PREPARATIONS, NAMELY, ULTRAVIOLET SUN-BLOCK LOTIONS, SUN CREAMS, AFTER-SUN GELS AND AFTER-SUN OILS; SKIN GELS FOR ACCELERATING TANS, SUN TAN LOTIONS, SUN TAN CREAMS, SUN TAN GELS, AND SUN TAN OILS, SUNLESS SELF TANNING PREPARATIONS, AFTER-SUN MOISTURIZING LOTIONS, CHILDREN'S, MEN'S AND WOMEN'S FRAGRANCES, NAMELY, EAU DE TOILETTE AND EAU DE COLOGNE, PRE-SHAVE LOTIONS, AFTER-SHAVE LOTIONS, DEODORANTS AND ANTI-PERSPIRANTS; SKIN CLEANSERS, NAMELY, SKIN CLEANSERS TO REMOVE TEMPORARY TATTOOS, ADHESIVES, ADHESIVE RESIDUE, TAPES, BANDAGES, CHEMICALS, INK, MARKERS, PERMANENT MARKERS, DYES, FOOD COLORING, TAR, PAINT, AND SAP; BREATH FRESHENER, MOUTHWASH AND TOOTHPASTES (U.S. CLS. 1, 4, 6, 50, 51 AND 52).

CLASS 5—PHARMACEUTICALS**CLASS 5—PHARMACEUTICALS**

FOR COTTON FOR MEDICAL PURPOSES, NAMELY, COTTON PLUGS FOR ALLEVIATING BLOODY NOSES (U.S. CLS. 6, 18, 44, 46, 51 AND 52).
JAMES LOVELACE, EXAMINING ATTORNEY

FOR COTTON FOR MEDICAL PURPOSES, NAMELY, COTTON PLUGS FOR ALLEVIATING BLOODY NOSES; MEDICATED SKIN CARE PREPARATIONS, NAMELY, CREAMS FOR NUMBING THE SKIN TO REMOVE SPLINTERS AND GLASS SHARDS (U.S. CLS. 6, 18, 44, 46, 51 AND 52).
JAMES LOVELACE, EXAMINING ATTORNEY

SN 77-312,162. FAST FORWARD ENERGY, INC., BEVERLY SHORES, IN. FILED 10-24-2007.

BEAN & BODY

THE COLOR(S) BROWN AND BLACK IS/ARE CLAIMED AS A FEATURE OF THE MARK.

THE MARK CONSISTS OF BLACK UPPERCASE "BEAN" AND "BODY" WORDS WITH A BROWN AMPERSAND SPLITTING THE TWO WORDS.

CLASS 30—STAPLE FOODS

FOR (BASED ON USE IN COMMERCE) BEVERAGES MADE OF COFFEE; BEVERAGES MADE OF TEA; COFFEE; COFFEE-BASED BEVERAGE CONTAINING MILK; HERBAL FOOD BEVERAGES; PREPARED COFFEE AND COFFEE-BASED BEVERAGES; (BASED ON INTENT TO USE) ARTIFICIAL COFFEE; CAFFEINE-FREE COFFEE; CANDY CONTAINING ALCOHOLIC BEVERAGE CONTENT AND FLAVOR; CHICORY BASED COFFEE SUBSTITUTE; CHOCOLATE FOOD BEVERAGES NOT BEING DAIRY-BASED OR VEGETABLE BASED; COCOA BEVERAGES WITH MILK; COFFEE BEANS; COFFEE FLAVORED SYRUP USED IN MAKING FOOD BEVERAGES; COFFEE PODS; COFFEE SUBSTITUTES; CORN STARCH BASED DRINK, IN THE NATURE OF A FOOD BEVERAGE CONSISTING PRIMARILY OF MAIZE AND PORRIDGE; FLAVOR ENHANCERS USED IN FOOD AND BEVERAGE PRODUCTS; FLAVORINGS FOR BEVERAGES; GRAIN-BASED BEVERAGES; GRAIN-BASED FOOD BEVERAGES; GROUND COFFEE BEANS; INSTANT COFFEE; MIXES IN THE NATURE OF CONCENTRATES, SYRUPS OR POWDERS USED IN THE PREPARATION OF TEA BASED BEVERAGES; PREPARED COCOA AND COCOA-BASED BEVERAGES; ROASTED COFFEE BEANS; SCENTED WATER FOR FLAVORING BEVERAGES; SUGAR-COATED COFFEE BEANS; TEA-BASED BEVERAGES WITH FRUIT FLAVORING (U.S. CL. 46).

FIRST USE 9-1-2007; IN COMMERCE 9-1-2007.

CLASS 32—LIGHT BEVERAGES

FOR (BASED ON USE) FRUIT-FLAVORED BEVERAGES; NON-ALCOHOLIC BEVERAGES CONTAINING FRUIT JUICES, (BASED ON INTENT TO USE) BREWED MALT-BASED ALCOHOLIC BEVERAGE IN THE NATURE OF A BEER; COFFEE-FLAVORED ALE; COFFEE-FLAVORED BEER; COFFEE-FLAVORED SOFT DRINK; CORN-BASED BEVERAGES NOT FOR FOOD PURPOSES (CHICHA MORADA); FROZEN FRUIT BEVERAGES; FROZEN FRUIT-BASED BEVERAGES; FRUIT BEVERAGES; FRUIT CONCENTRATES AND PUREES USED AS INGREDIENTS OF BEVERAGES; FRUIT-FLAVOURED BEVERAGES; GRAPE JUICE BEVERAGES; ICED FRUIT BEVERAGES; KVAASS; MALT SYRUP FOR BEVERAGES; NON-ALCOHOLIC BEVERAGES WITH TEA FLAVOR; NON-ALCOHOLIC BEVERAGES, NAMELY, CARBONATED BEVERAGES; NON-ALCOHOLIC FRUIT EXTRACTS USED IN THE PREPARATION OF BEVERAGES; NON-ALCOHOLIC FRUIT JUICE BEVERAGES; NON-ALCOHOLIC HONEY-BASED BEVERAGES; NON-ALCOHOLIC MALT BEVERAGE; NON-CARBONATED, NON-ALCOHOLIC FROZEN FLAVORED BEVERAGES; ORANGE JUICE BEVERAGES; PINEAPPLE JUICE BEVERAGES; POWDERS USED IN THE PREPARATION OF ISOTONIC SPORTS DRINKS AND SPORTS BEVERAGES; PREPARATIONS FOR MAKING BEVERAGES, CONSISTING OF COFFEE; SARSAPARILLA; SCENTED WATER FOR MAKING BEVERAGES; SHERBETS; SMOOTHIES; SORBETS IN THE FORM OF BEVERAGES; SOY-BASED BEVERAGES NOT BEING MILK SUBSTITUTES; SYRUPS FOR BEVERAGES; SYRUPS FOR MAKING BEVERAGES; SYRUPS FOR MAKING WHEY-BASED BEVERAGES; TOMATO JUICE; TOMATO JUICE BEVERAGES; VEGETABLE JUICE; VEGETABLE JUICES; WHEY BEVERAGES (U.S. CLS. 45, 46 AND 48).

AMY HELLA, EXAMINING ATTORNEY

SN 77-312,745. TELEMEDICINE MANAGEMENT, INC., FLEMINGTON, NJ. FILED 10-24-2007.

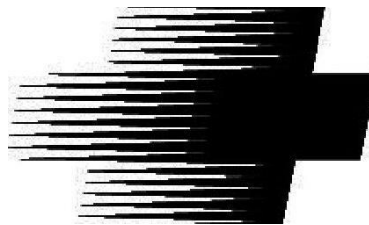

THE MARK CONSISTS OF A STYLIZED CROSS DESIGNED TO APPEAR AS IF THE CROSS IS IN MOTION.

CLASS 35—ADVERTISING AND BUSINESS

FOR BUSINESS MARKETING SERVICES; ACCOUNTING SERVICES; PUBLICITY AND SALES PROMOTION SERVICES (U.S. CLS. 100, 101 AND 102).

CLASS 44—MEDICAL, BEAUTY AND AGRICULTURAL SERVICES

FOR HEALTH CARE; TELEMEDICINE SERVICES (U.S. CLS. 100 AND 101).

EDWARD FENNESSY, EXAMINING ATTORNEY

SN 77-312,758. CARE WEST INSURANCE COMPANY, ROCKLIN, CA. FILED 10-24-2007.

SN 77-313,081. JUNO MANUFACTURING, INC., DES PLAINES, IL. FILED 10-25-2007.



NO CLAIM IS MADE TO THE EXCLUSIVE RIGHT TO USE "INSURANCE COMPANY", APART FROM THE MARK AS SHOWN.

THE MARK CONSISTS OF THE STYLIZED TEXT "CW" WITH A SURROUND; "CARE WEST" (MEDIUM FONT) AND "INSURANCE COMPANY" (SMALLER FONT) ARE TO THE RIGHT OF THE LOGO.

CLASS 35—ADVERTISING AND BUSINESS

FOR BUSINESS RISK MANAGEMENT (U.S. CLS. 100, 101 AND 102).
FIRST USE 1-1-1997; IN COMMERCE 1-1-1997.

CLASS 36—INSURANCE AND FINANCIAL

FOR CLAIMS ADMINISTRATION IN THE FIELD OF WORKERS' COMPENSATION; INSURANCE CLAIMS ADMINISTRATION; INSURANCE UNDERWRITING IN THE FIELD OF WORKER'S COMPENSATION AND LIABILITY (U.S. CLS. 100, 101 AND 102).
FIRST USE 1-1-1997; IN COMMERCE 1-1-1997.
MICHAEL ENGEL, EXAMINING ATTORNEY

SN 77-313,052. JUNO MANUFACTURING, INC., DES PLAINES, IL. FILED 10-25-2007.

MONOLINE

THE MARK CONSISTS OF STANDARD CHARACTERS WITHOUT CLAIM TO ANY PARTICULAR FONT, STYLE, SIZE, OR COLOR.

CLASS 9—ELECTRICAL AND SCIENTIFIC APPARATUS

FOR ELECTRIC VOLTAGE TRANSFORMERS; LIGHTING BALLASTS (U.S. CLS. 21, 23, 26, 36 AND 38).

CLASS 11—ENVIRONMENTAL CONTROL APPARATUS

FOR ELECTRIC LIGHTING FIXTURES; ELECTRIC TRACK LIGHTING UNITS; RECESSED LIGHTING FIXTURES; FLUORESCENT LIGHTING FIXTURES; LIGHTING FIXTURES; LAMPS; FLUORESCENT LAMPS; LAMP REFLECTORS; LIGHTING TRACKS; SOCKETS FOR ELECTRIC LIGHTS; STRUCTURAL COMPONENTS, FITTINGS AND PARTS OF ELECTRIC LIGHTING FIXTURES, NAMELY, TRIM ASSEMBLIES, MOUNTS, HANGERS, POSITIONERS, BAFFLES, AND LAMP FITTINGS (U.S. CLS. 13, 21, 23, 31 AND 34).
DAVID HOFFMAN, EXAMINING ATTORNEY

XANADU

THE MARK CONSISTS OF STANDARD CHARACTERS WITHOUT CLAIM TO ANY PARTICULAR FONT, STYLE, SIZE, OR COLOR.

CLASS 9—ELECTRICAL AND SCIENTIFIC APPARATUS

FOR ELECTRIC VOLTAGE TRANSFORMERS; LIGHTING BALLASTS (U.S. CLS. 21, 23, 26, 36 AND 38).

CLASS 11—ENVIRONMENTAL CONTROL APPARATUS

FOR ELECTRIC LIGHTING FIXTURES; ELECTRIC TRACK LIGHTING UNITS; RECESSED LIGHTING FIXTURES; FLUORESCENT LIGHTING FIXTURES; LIGHTING FIXTURES; LAMPS; FLUORESCENT LAMPS; LAMP REFLECTORS; LIGHTING TRACKS; SOCKETS FOR ELECTRIC LIGHTS; STRUCTURAL COMPONENTS, FITTINGS AND PARTS OF ELECTRIC LIGHTING FIXTURES, NAMELY, TRIM ASSEMBLIES, MOUNTS, HANGERS, POSITIONERS, BAFFLES, AND LAMP FITTINGS (U.S. CLS. 13, 21, 23, 31 AND 34).
DAVID HOFFMAN, EXAMINING ATTORNEY

SN 77-313,090. KRAFT FOODS HOLDINGS, INC., NORTHFIELD, IL. FILED 10-25-2007.

FOLLOW YOUR INSTINCTS

THE MARK CONSISTS OF STANDARD CHARACTERS WITHOUT CLAIM TO ANY PARTICULAR FONT, STYLE, SIZE, OR COLOR.

CLASS 29—MEATS AND PROCESSED FOODS

FOR SHELLED NUTS (U.S. CL. 46).

CLASS 30—STAPLE FOODS

FOR COOKIES; CRACKERS; GRANOLA; BREAKFAST CEREALS; READY TO EAT, CEREAL DERIVED FOOD BARS; GRAIN-BASED FOOD BARS ALSO CONTAINING DRIED FRUITS AND NUTS (U.S. CL. 46).
STEVEN JACKSON, EXAMINING ATTORNEY

SN 77-314,215. JUNO MANUFACTURING, INC., DES PLAINES, IL. FILED 10-26-2007.

SN 77-314,248. JUNO MANUFACTURING, INC., DES PLAINES, IL. FILED 10-26-2007.

CUBIX

THE MARK CONSISTS OF STANDARD CHARACTERS WITHOUT CLAIM TO ANY PARTICULAR FONT, STYLE, SIZE, OR COLOR.

CLASS 9—ELECTRICAL AND SCIENTIFIC APPARATUS

FOR ELECTRIC VOLTAGE TRANSFORMERS; LIGHTING BALLASTS (U.S. CLS. 21, 23, 26, 36 AND 38).

CLASS 11—ENVIRONMENTAL CONTROL APPARATUS

FOR ELECTRIC LIGHTING FIXTURES; ELECTRIC TRACK LIGHTING UNITS; RECESSED LIGHTING FIXTURES; FLUORESCENT LIGHTING FIXTURES; LIGHTING FIXTURES; LAMPS; FLUORESCENT LAMPS; LAMP REFLECTORS; LIGHTING TRACKS; SOCKETS FOR ELECTRIC LIGHTS; STRUCTURAL COMPONENTS, FITTINGS AND PARTS OF ELECTRIC LIGHTING FIXTURES, NAMELY, TRIM ASSEMBLIES, MOUNTS, HANGERS, POSITIONERS, BAFFLES, AND LAMP FITTINGS (U.S. CLS. 13, 21, 23, 31 AND 34).
DAVID HOFFMAN, EXAMINING ATTORNEY

GLACIS

THE MARK CONSISTS OF STANDARD CHARACTERS WITHOUT CLAIM TO ANY PARTICULAR FONT, STYLE, SIZE, OR COLOR.

CLASS 9—ELECTRICAL AND SCIENTIFIC APPARATUS

FOR ELECTRIC VOLTAGE TRANSFORMERS; LIGHTING BALLASTS (U.S. CLS. 21, 23, 26, 36 AND 38).

CLASS 11—ENVIRONMENTAL CONTROL APPARATUS

FOR ELECTRIC LIGHTING FIXTURES; ELECTRIC TRACK LIGHTING UNITS; RECESSED LIGHTING FIXTURES; FLUORESCENT LIGHTING FIXTURES; LIGHTING FIXTURES; LAMPS; FLUORESCENT LAMPS; LAMP REFLECTORS; LIGHTING TRACKS; SOCKETS FOR ELECTRIC LIGHTS; STRUCTURAL COMPONENTS, FITTINGS AND PARTS OF ELECTRIC LIGHTING FIXTURES, NAMELY, TRIM ASSEMBLIES, MOUNTS, HANGERS, POSITIONERS, BAFFLES, AND LAMP FITTINGS (U.S. CLS. 13, 21, 23, 31 AND 34).
DAVID HOFFMAN, EXAMINING ATTORNEY

SN 77-314,250. JUNO MANUFACTURING, INC., DES PLAINES, IL. FILED 10-26-2007.

SN 77-314,244. JBC GLOBAL DIVERSITY AND INCLUSION INSTITUTE, GREENSBORO, NC. FILED 10-26-2007.

POWERGIRLS

THE MARK CONSISTS OF STANDARD CHARACTERS WITHOUT CLAIM TO ANY PARTICULAR FONT, STYLE, SIZE, OR COLOR.

CLASS 16—PAPER GOODS AND PRINTED MATTER

FOR MAGAZINE FEATURING CONTENT IN THE FIELD OF LEADERSHIP AND EDUCATION (U.S. CLS. 2, 5, 22, 23, 29, 37, 38 AND 50).

CLASS 41—EDUCATION AND ENTERTAINMENT

FOR LEADERSHIP TRAINING SERVICES (U.S. CLS. 100, 101 AND 107).
FIRST USE 1-0-2005; IN COMMERCE 1-0-2005.
DAVID MILLER, EXAMINING ATTORNEY

FACET

THE MARK CONSISTS OF STANDARD CHARACTERS WITHOUT CLAIM TO ANY PARTICULAR FONT, STYLE, SIZE, OR COLOR.

CLASS 9—ELECTRICAL AND SCIENTIFIC APPARATUS

FOR ELECTRIC VOLTAGE TRANSFORMERS; LIGHTING BALLASTS (U.S. CLS. 21, 23, 26, 36 AND 38).

CLASS 11—ENVIRONMENTAL CONTROL APPARATUS

FOR ELECTRIC LIGHTING FIXTURES; ELECTRIC TRACK LIGHTING UNITS; RECESSED LIGHTING FIXTURES; FLUORESCENT LIGHTING FIXTURES; LIGHTING FIXTURES; LAMPS; FLUORESCENT LAMPS; LAMP REFLECTORS; LIGHTING TRACKS; SOCKETS FOR ELECTRIC LIGHTS; STRUCTURAL COMPONENTS, FITTINGS AND PARTS OF ELECTRIC LIGHTING FIXTURES, NAMELY, TRIM ASSEMBLIES, MOUNTS, HANGERS, POSITIONERS, BAFFLES, AND LAMP FITTINGS (U.S. CLS. 13, 21, 23, 31 AND 34).
DAVID HOFFMAN, EXAMINING ATTORNEY

SN 77-314,253. JUNO MANUFACTURING, INC., DES PLAINES, IL. FILED 10-26-2007.

SN 77-315,945. SPENCE, EDWIN JOSEPH, GULF SHORES, AL. AND CAHOON, DAVID PATRICK, GULF SHORES, AL. FILED 10-29-2007.

MAMBA

THE MARK CONSISTS OF STANDARD CHARACTERS WITHOUT CLAIM TO ANY PARTICULAR FONT, STYLE, SIZE, OR COLOR.

CLASS 9—ELECTRICAL AND SCIENTIFIC APPARATUS

FOR ELECTRIC VOLTAGE TRANSFORMERS; LIGHTING BALLASTS (U.S. CLS. 21, 23, 26, 36 AND 38).

CLASS 11—ENVIRONMENTAL CONTROL APPARATUS

FOR ELECTRIC LIGHTING FIXTURES; ELECTRIC TRACK LIGHTING UNITS; RECESSED LIGHTING FIXTURES; FLUORESCENT LIGHTING FIXTURES; LIGHTING FIXTURES; LAMPS; FLUORESCENT LAMPS; LAMP REFLECTORS; LIGHTING TRACKS; SOCKETS FOR ELECTRIC LIGHTS; STRUCTURAL COMPONENTS, FITTINGS AND PARTS OF ELECTRIC LIGHTING FIXTURES, NAMELY, TRIM ASSEMBLIES, MOUNTS, HANGERS, POSITIONERS, BAFFLES, AND LAMP FITTINGS (U.S. CLS. 13, 21, 23, 31 AND 34).

DAVID HOFFMAN, EXAMINING ATTORNEY

SHRIMP BASKET

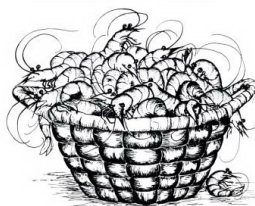

NO CLAIM IS MADE TO THE EXCLUSIVE RIGHT TO USE "SHRIMP", APART FROM THE MARK AS SHOWN. THE MARK CONSISTS OF THE TEXT "SHRIMP BASKET" ABOVE A BASKET OF SHRIMP.

CLASS 30—STAPLE FOODS

FOR DIPPING SAUCES; READY-MADE SAUCES; TARTAR SAUCE; SAUCES (U.S. CL. 46).

CLASS 43—HOTEL AND RESTAURANT SERVICES

FOR CARRY-OUT RESTAURANTS; RESTAURANTS (U.S. CLS. 100 AND 101).

DANIEL CAPSHAW, EXAMINING ATTORNEY

SN 77-314,949. MY PET MD LLC, SCOTTSDALE, AZ. FILED 10-26-2007.



THE MARK CONSISTS OF THE STYLIZED WORDING "MYPETMD" INSIDE OF THE DESIGN OF SHADED RECTANGLE WITH CURVED EDGES, AND TO THE LEFT OF THE RECTANGLE IS THE DESIGN OF A SHADED SQUARE WITH CURVED EDGES CONTAINING A PAW PRINT WITH A GREEK CROSS INSIDE OF THE PAW PRINT.

CLASS 35—ADVERTISING AND BUSINESS

FOR ON-LINE BUSINESS DIRECTORIES FEATURING ANIMAL RELATED SERVICE PROVIDERS; PROVIDING AND RENTAL OF ADVERTISING SPACE ON THE INTERNET (U.S. CLS. 100, 101 AND 102).

CLASS 44—MEDICAL, BEAUTY AND AGRICULTURAL SERVICES

FOR PROVIDING A WEBSITE FEATURING ANIMAL HEALTH INFORMATION (U.S. CLS. 100 AND 101).

JAY BESCH, EXAMINING ATTORNEY

SN 77-316,814. ASTROCHEF, INC., LOS ANGELES, CA. FILED 10-30-2007.

Melrose Kitchen

THE MARK CONSISTS OF STANDARD CHARACTERS WITHOUT CLAIM TO ANY PARTICULAR FONT, STYLE, SIZE, OR COLOR.

NO CLAIM IS MADE TO THE EXCLUSIVE RIGHT TO USE "KITCHEN", APART FROM THE MARK AS SHOWN.

CLASS 29—MEATS AND PROCESSED FOODS

FOR FROZEN FOOD PRODUCTS, NAMELY, PRE-PACKAGED ENTREES OR APPETIZERS COMPRISING PRIMARILY MEAT, POULTRY, SEAFOOD, OR VEGETABLES (U.S. CL. 46).

CLASS 30—STAPLE FOODS

FOR FROZEN FOOD PRODUCTS, NAMELY, PRE-PACKAGED ENTREES OR APPETIZERS COMPRISING PRIMARILY PASTA, RICE, BREAD, OR CRUSTS (U.S. CL. 46).

ELLEN BURNS, EXAMINING ATTORNEY

SN 77-317,040. ELOQUA CORPORATION, TORONTO, ONTARIO, CANADA, FILED 10-30-2007.

DIGITAL BODY LANGUAGE

THE MARK CONSISTS OF STANDARD CHARACTERS WITHOUT CLAIM TO ANY PARTICULAR FONT, STYLE, SIZE, OR COLOR.

CLASS 35—ADVERTISING AND BUSINESS

FOR CONSULTING SERVICES WITH RESPECT TO THE MANAGEMENT, OPTIMIZATION, MEASUREMENT AND AUTOMATION OF MARKETING PROCESSES OVER THE GLOBAL COMPUTER INFORMATION NETWORK; CONSULTING SERVICES WITH RESPECT TO THE FACILITATION OF THE SEGMENTATION AND TARGETING OF LEADS AND POTENTIAL CUSTOMERS FOR MARKETING PURPOSES; CONSULTING SERVICES WITH RESPECT TO THE MANAGEMENT AND MEASUREMENT OF THE MARKETING AND SALE OF GOODS AND SERVICES OF OTHERS; CONSULTING SERVICES WITH RESPECT TO INCREASING EFFICIENCY AND PROFESSIONALISM OF THE MARKETING PROCESS AND SALE OF GOODS AND SERVICES OF OTHERS; CONSULTING SERVICES WITH RESPECT TO DEMONSTRATING VALUE AND ACCOUNTABILITY WITHIN THE MARKETING AND SALE OF GOODS AND SERVICES OF OTHERS; CONSULTING SERVICES WITH RESPECT TO THE ALIGNMENT OF THE MARKETING AND SALE OF GOODS AND SERVICES OF OTHERS (U.S. CLS. 100, 101 AND 102).

CLASS 42—SCIENTIFIC AND COMPUTER SERVICES

FOR CONSULTING SERVICES WITH RESPECT TO COMPUTER SOFTWARE DESIGNED TO MANAGE, MEASURE AND OPTIMIZE THE MARKETING PROCESSES AND SALE OF GOODS AND SERVICES OF OTHERS OVER THE GLOBAL COMPUTER INFORMATION NETWORK; CONSULTING SERVICES WITH RESPECT TO COMPUTER SOFTWARE DESIGNED TO FACILITATE THE SEGMENTATION AND TARGETING OF CURRENT AND POTENTIAL CUSTOMERS FOR MARKETING AND SALE PURPOSES; CONSULTING SERVICES IN THE FIELD OF LEAD GENERATION COMPUTER SOFTWARE FOR INCREASING REVENUE OF OTHERS (U.S. CLS. 100 AND 101).

DANIEL CAPSHAW, EXAMINING ATTORNEY

SN 77-318,609. 3FORM, INC., SALT LAKE CITY, UT. FILED 10-31-2007.



OWNER OF U.S. REG. NOS. 2,984,748, 3,210,526 AND 3,217,126.

THE MARK CONSISTS OF THE WORD "3FORM" WHEREIN THE "3" IS STYLIZED BEING BOLD TYPE AND OVERSIZE RELATIVE TO "FORM" AND HAVING THE BOTTOM THEREOF TRUNCATED.

CLASS 17—RUBBER GOODS

FOR PLASTIC SHEETS AND PANELS FOR USE IN CONSTRUCTION AND GENERAL USE (U.S. CLS. 1, 5, 12, 13, 35 AND 50).

FIRST USE 8-25-2004; IN COMMERCE 8-25-2004.

CLASS 19—NON-METALLIC BUILDING MATERIALS

FOR BUILDING MATERIALS, NAMELY, NONMETAL PANELS FOR INTERIOR AND EXTERIOR USE (U.S. CLS. 1, 12, 33 AND 50).

FIRST USE 8-25-2004; IN COMMERCE 8-25-2004.

MARIAM MAHMOUDI, EXAMINING ATTORNEY

SN 77-319,119. E. & J. GALLO WINERY, MODESTO, CA. FILED 11-1-2007.



OWNER OF U.S. REG. NOS. 2,320,063, 3,210,839 AND OTHERS.

CLASS 18—LEATHER GOODS

FOR TOTE BAGS, WHEELED TOTE BAGS, BOOK BAGS, WINE BAGS WITH HANDLES FOR CARRYING OR HOLDING WINE (U.S. CLS. 1, 2, 3, 22 AND 41).

FIRST USE 10-1-2007; IN COMMERCE 10-1-2007.

CLASS 21—HOUSEWARES AND GLASS

FOR COFFEE CUPS, MUGS, CORK PULLERS, CORK-SCREWS (U.S. CLS. 2, 13, 23, 29, 30, 33, 40 AND 50).

FIRST USE 10-1-2007; IN COMMERCE 10-1-2007.

CLASS 25—CLOTHING

FOR APRONS, CAPS, JACKETS, SHIRTS, SHORTS AND SWEATSHIRTS (U.S. CLS. 22 AND 39).

FIRST USE 3-31-2006; IN COMMERCE 3-31-2006.

MICHAEL KAZAZIAN, EXAMINING ATTORNEY

SN 77-320,930. J&H CONCEPTS, INC., DBA STERLING PEAR, NEW YORK, NY. FILED 11-4-2007.



THE MARK CONSISTS OF MINIMALISTIC SILHOUETTE OF PEAR WITH LEAF SET IN CENTER OF BLACK CIRCLE WITH BLACK BORDER SURROUNDING CIRCLE.

CLASS 16—PAPER GOODS AND PRINTED MATTER

FOR CHRISTMAS TREE ORNAMENT KITS COMPRISED PRIMARILY OF BOXES FOR ORNAMENT STORAGE, MADE OF HEAVY CARDBOARD COVERED WITH PAPER ON WHICH ARTWORK IS REPRODUCED (U.S. CLS. 2, 5, 22, 23, 29, 37, 38 AND 50).

CLASS 18—LEATHER GOODS

FOR CHRISTMAS TREE ORNAMENT KITS COMPRISED PRIMARILY OF BOXES FOR ORNAMENT STORAGE, MADE OF LEATHER AND IMITATION LEATHER, ON WHICH ARTWORK IS REPRODUCED (U.S. CLS. 1, 2, 3, 22 AND 41).

CLASS 28—TOYS AND SPORTING GOODS

FOR CHRISTMAS TREE ORNAMENTS AND CHRISTMAS TREE ORNAMENT KITS CONTAINING ORNAMENTS, STOCKINGS, TREE SKIRTS, AND HANGING HARDWARE, ALL IN VARIOUS HOLIDAY THEMES (U.S. CLS. 22, 23, 38 AND 50).

JOHN WILKE, EXAMINING ATTORNEY

SN 77-322,712. DR. REDDY'S LABORATORIES, INC., BRIDGEWATER, NJ. FILED 11-6-2007.

**PROMIUS
P H A R M A**

NO CLAIM IS MADE TO THE EXCLUSIVE RIGHT TO USE "PHARMA", APART FROM THE MARK AS SHOWN. THE MARK CONSISTS OF THE WORDS "PROMIUS" AND "PHARMA".

CLASS 5—PHARMACEUTICALS

FOR PHARMACEUTICAL PREPARATIONS FOR USE IN DERMATOLOGY (U.S. CLS. 6, 18, 44, 46, 51 AND 52).

CLASS 42—SCIENTIFIC AND COMPUTER SERVICES

FOR DEVELOPMENT OF PHARMACEUTICAL PREPARATIONS AND MEDICINES (U.S. CLS. 100 AND 101). NICHOLAS ALTREE, EXAMINING ATTORNEY

SN 77-323,712. U.S. DEPARTMENT OF HEALTH AND HUMAN SERVICES, BETHESDA, MD. FILED 11-7-2007.

**PATIENT-REPORTED OUTCOMES
MEASUREMENT INFORMATION
SYSTEM**

THE MARK CONSISTS OF STANDARD CHARACTERS WITHOUT CLAIM TO ANY PARTICULAR FONT, STYLE, SIZE, OR COLOR.

NO CLAIM IS MADE TO THE EXCLUSIVE RIGHT TO USE "PATIENT-REPORTED" AND "INFORMATION SYSTEM", APART FROM THE MARK AS SHOWN.

CLASS 9—ELECTRICAL AND SCIENTIFIC APPARATUS

FOR COMPUTER SOFTWARE USED TO PROVIDE COMPUTERIZED ADAPTIVE TESTS REGARDING PATIENT SYMPTOMS AND OUTCOMES IN CLINICAL PRACTICE AND RESEARCH; DOWNLOADABLE SCIENTIFIC AND MEDICAL DATA VIA THE INTERNET; AND DOWNLOADABLE QUESTIONNAIRES IN CONNECTION WITH PATIENT SELF-REPORTED DATA TO BE USED AS TOOLS FOR MEASUREMENT OF PATIENT REPORTED SYMPTOMS AND OTHER HEALTH OUTCOMES IN CLINICAL PRACTICE AND RESEARCH (U.S. CLS. 21, 23, 26, 36 AND 38).

CLASS 16—PAPER GOODS AND PRINTED MATTER

FOR PRINTED QUESTIONNAIRES AND PRINTED PUBLICATIONS IN THE FORM OF REPORTS AND PRINTED SUMMARIES IN CONNECTION WITH PATIENT SELF-REPORTED DATA TO BE USED AS TOOLS FOR MEASUREMENT OF PATIENT REPORTED SYMPTOMS AND OTHER HEALTH OUTCOMES IN CLINICAL PRACTICE AND RESEARCH (U.S. CLS. 2, 5, 22, 23, 29, 37, 38 AND 50).

CLASS 35—ADVERTISING AND BUSINESS

FOR SERVICES CONSISTING OF COLLECTION, TRANSCRIPTION, COMPILATION, AND SYSTEMIZATION OF WRITTEN MEDICAL COMMUNICATIONS AND SCIENTIFIC DATA (U.S. CLS. 100, 101 AND 102).

CLASS 42—SCIENTIFIC AND COMPUTER SERVICES

FOR MEDICAL AND SCIENTIFIC RESEARCH IN THE FIELD OF CHRONIC DISEASES (U.S. CLS. 100 AND 101).

CLASS 44—MEDICAL, BEAUTY AND AGRICULTURAL SERVICES

FOR PROVIDING A DATABASE IN THE FIELD OF CHRONIC DISEASE INFORMATION THAT ALLOWS THE COLLECTION OF DATA AND INFORMATION ALL FOR TREATMENT DIAGNOSTIC PURPOSES AND RESEARCH AND RESOURCES FOR MEASUREMENT OF PATIENT REPORT SYMPTOMS AND OTHER HEALTH OUTCOMES IN CLINICAL PRACTICE AND RESEARCH (U.S. CLS. 100 AND 101).

JOHN HWANG, EXAMINING ATTORNEY

SN 77-323,755. THE DIXIE GROUP, INC., CHATTANOOGA, TN. FILED 11-7-2007.

WHITESPACE

THE MARK CONSISTS OF STANDARD CHARACTERS WITHOUT CLAIM TO ANY PARTICULAR FONT, STYLE, SIZE, OR COLOR.

CLASS 27—FLOOR COVERINGS

FOR CARPETING (U.S. CLS. 19, 20, 37, 42 AND 50).

CLASS 35—ADVERTISING AND BUSINESS

FOR ON-LINE RETAIL STORE SERVICES FOR CARPETING (U.S. CLS. 100, 101 AND 102).

REBECCA GILBERT, EXAMINING ATTORNEY

SN 77-323,858. SENTRY SECURITY SYSTEMS, LLC, COLUMBIA, SC. FILED 11-7-2007.



CLASS 37—CONSTRUCTION AND REPAIR

FOR INSTALLATION AND MAINTENANCE OF PERIMETER SECURITY SYSTEMS COMPRISED OF ELECTRICALLY CHARGED WIRES SUPPORTED BY A STEEL AND FIBERGLASS FRAME, A PROGRAMMABLE VOLTAGE METER, AN ELECTRONIC ALARM THAT TRANSMITS SIGNALS VIA TELEPHONE TO A CENTRAL MONITORING STATION AND AN ELECTRONIC KEYPAD FOR ACTIVATING AND DEACTIVATING THE SYSTEM (U.S. CLS. 100, 103 AND 106).

FIRST USE 6-25-1991; IN COMMERCE 6-25-1991.

CLASS 42—SCIENTIFIC AND COMPUTER SERVICES

FOR CUSTOM DESIGN OF PERIMETER SECURITY SYSTEMS COMPRISED OF ELECTRICALLY CHARGED WIRES SUPPORTED BY A STEEL AND FIBERGLASS FRAME, A PROGRAMMABLE VOLTAGE METER, AN ELECTRONIC ALARM THAT TRANSMITS SIGNALS VIA TELEPHONE TO A CENTRAL MONITORING STATION AND AN ELECTRONIC KEYPAD FOR ACTIVATING AND DEACTIVATING THE SYSTEM (U.S. CLS. 100 AND 101).

FIRST USE 6-25-1991; IN COMMERCE 6-25-1991.

CLASS 45—PERSONAL AND LEGAL SERVICES

FOR MONITORING PERIMETER SECURITY SYSTEMS COMPRISED OF ELECTRICALLY CHARGED WIRES SUPPORTED BY A STEEL AND FIBERGLASS FRAME, A PROGRAMMABLE VOLTAGE METER, AN ELECTRONIC ALARM THAT TRANSMITS SIGNALS VIA TELEPHONE TO A CENTRAL MONITORING STATION AND AN ELECTRONIC KEYPAD FOR ACTIVATING AND DEACTIVATING THE SYSTEM (U.S. CLS. 100 AND 101).

FIRST USE 6-25-1991; IN COMMERCE 6-25-1991.
DAVID YONTEF, EXAMINING ATTORNEY

SN 77-324,002. NAMCO BANDAI GAMES INC., TOKYO, JAPAN, FILED 11-7-2007.

NOBY NOBY BOY

THE MARK CONSISTS OF STANDARD CHARACTERS WITHOUT CLAIM TO ANY PARTICULAR FONT, STYLE, SIZE, OR COLOR.

CLASS 9—ELECTRICAL AND SCIENTIFIC APPARATUS

FOR VIDEO GAME CARTRIDGES, COMPUTER GAME PROGRAMS (U.S. CLS. 21, 23, 26, 36 AND 38).

CLASS 28—TOYS AND SPORTING GOODS

FOR COIN-OPERATED AMUSEMENT GAME MACHINES (U.S. CLS. 22, 23, 38 AND 50).

CLASS 41—EDUCATION AND ENTERTAINMENT

FOR ENTERTAINMENT, NAMELY, PROVIDING A COMPUTER GAME THAT MAY BE ACCESSED NETWORK-WIDE BY NETWORK USERS VIA MOBILE PHONES AND COMPUTERS; PROVIDING COMPUTER GAMES VIA NETWORK BETWEEN COMMUNICATIONS NETWORKS AND COMPUTERS (U.S. CLS. 100, 101 AND 107).

ELISSA GARBER KON, EXAMINING ATTORNEY

SN 77-324,169. JOHN MUIR HEALTH, WALNUT CREEK, CA. FILED 11-7-2007.

JOHN MUIR WOMEN'S HEALTH CENTER

THE MARK CONSISTS OF STANDARD CHARACTERS WITHOUT CLAIM TO ANY PARTICULAR FONT, STYLE, SIZE, OR COLOR.

OWNER OF U.S. REG. NOS. 1,726,478, 3,341,367 AND OTHERS.

NO CLAIM IS MADE TO THE EXCLUSIVE RIGHT TO USE "WOMEN'S HEALTH CENTER", APART FROM THE MARK AS SHOWN.

THE NAME(S), PORTRAIT(S), AND/OR SIGNATURE(S) SHOWN IN THE MARK DOES NOT IDENTIFY A PARTICULAR LIVING INDIVIDUAL.

CLASS 41—EDUCATION AND ENTERTAINMENT

FOR EDUCATIONAL SERVICES, NAMELY, PROVIDING CLASSES, SEMINARS, WORKSHOPS AND OUT-REACH PROGRAMS IN THE FIELDS OF WOMEN'S HEALTH, CARDIAC DISEASE, STRESS MANAGEMENT, MID-LIFE EDUCATION, MENOPAUSE, CHILDBIRTH, PARENTING, AND LIFE TRANSITIONS (U.S. CLS. 100, 101 AND 107).

FIRST USE 1-1-2006; IN COMMERCE 1-1-2006.

CLASS 44—MEDICAL, BEAUTY AND AGRICULTURAL SERVICES

FOR MEDICAL SERVICES; HEALTH CARE SERVICES; PHYSICIAN SERVICES; WOMEN'S HEALTH SERVICES; MEDICAL TESTING AND MEDICAL SCREENING SERVICES (U.S. CLS. 100 AND 101).

FIRST USE 1-1-2006; IN COMMERCE 1-1-2006.

MELVIN AXILBUND, EXAMINING ATTORNEY

SN 77-324,262. SMITHKLINE BEECHAM CORPORATION, PHILADELPHIA, PA. FILED 11-8-2007.

FEELING OF CLEAN IS EPIC

THE MARK CONSISTS OF STANDARD CHARACTERS WITHOUT CLAIM TO ANY PARTICULAR FONT, STYLE, SIZE, OR COLOR.

CLASS 3—COSMETICS AND CLEANING PREPARATIONS

FOR ORAL CARE PREPARATIONS, NAMELY, DENTIFRICES, MOUTHWASHES AND BREATH FRESHENERS, DENTAL BLEACHING AND CLEANING GELS, BLEACHING PREPARATIONS FOR COSMETIC PURPOSES, TOOTH POLISHING PREPARATIONS, TOOTH WHITENING PREPARATIONS, ACCELERATORS AND STAIN REMOVAL PREPARATIONS FOR COSMETIC PURPOSES (U.S. CLS. 1, 4, 6, 50, 51 AND 52).

CLASS 5—PHARMACEUTICALS

FOR MEDICATED ORAL CARE PRODUCTS, NAMELY, MEDICATED MOUTHWASHES, MEDICATED TOOTH POLISHING PREPARATIONS, MEDICATED TOOTH WHITENING PREPARATIONS, MEDICATED BLEACHING PREPARATIONS FOR COSMETIC PURPOSES, MEDICATED CHEWING GUM AND LOZENGES FOR DENTAL HYGIENE (U.S. CLS. 6, 18, 44, 46, 51 AND 52).

CLASS 10—MEDICAL APPARATUS

FOR DENTAL AND ORAL CARE TRAYS, NAMELY, FLEXIBLE AND DISPOSABLE DENTAL BITE TRAYS (U.S. CLS. 26, 39 AND 44).

CLASS 21—HOUSEWARES AND GLASS

FOR TOOTHBRUSHES, TOOTHPICKS, DENTAL FLOSS, BRUSHES AND SPONGES, HOLDERS AND APPLICATORS FOR USE IN ORAL CARE (U.S. CLS. 2, 13, 23, 29, 30, 33, 40 AND 50).

SETH A. RAPPAPORT, EXAMINING ATTORNEY

SN 77-324,264. SMITHKLINE BEECHAM CORPORATION, PHILADELPHIA, PA. FILED 11-8-2007.

A FEELING OF CLEAN LIKE NOTHING ELSE

THE MARK CONSISTS OF STANDARD CHARACTERS WITHOUT CLAIM TO ANY PARTICULAR FONT, STYLE, SIZE, OR COLOR.

CLASS 3—COSMETICS AND CLEANING PREPARATIONS

FOR ORAL CARE PREPARATIONS, NAMELY, DENTIFRICES, MOUTHWASHES AND BREATH FRESHENERS, DENTAL BLEACHING AND CLEANING GELS, BLEACHING PREPARATIONS FOR COSMETIC PURPOSES, TOOTH POLISHING PREPARATIONS, TOOTH WHITENING PREPARATIONS, ACCELERATORS AND STAIN REMOVAL PREPARATIONS FOR COSMETIC PURPOSES (U.S. CLS. 1, 4, 6, 50, 51 AND 52).

CLASS 5—PHARMACEUTICALS

FOR MEDICATED ORAL CARE PRODUCTS, NAMELY, MEDICATED MOUTHWASHES, MEDICATED TOOTH POLISHING PREPARATIONS, MEDICATED TOOTH WHITENING PREPARATIONS, MEDICATED BLEACHING PREPARATIONS FOR COSMETIC PURPOSES, MEDICATED CHEWING GUM AND LOZENGES FOR DENTAL HYGIENE (U.S. CLS. 6, 18, 44, 46, 51 AND 52).

CLASS 10—MEDICAL APPARATUS

FOR DENTAL AND ORAL CARE TRAYS, NAMELY, FLEXIBLE AND DISPOSABLE DENTAL BITE TRAYS (U.S. CLS. 26, 39 AND 44).

CLASS 21—HOUSEWARES AND GLASS

FOR TOOTHBRUSHES, TOOTHPICKS, DENTAL FLOSS, BRUSHES AND SPONGES, HOLDERS AND APPLICATORS FOR USE IN ORAL CARE (U.S. CLS. 2, 13, 23, 29, 30, 33, 40 AND 50).

SETH A. RAPPAPORT, EXAMINING ATTORNEY

SN 77-325,783. RED.COM, INC., EASTSOUND, WA. FILED 11-9-2007.

JANNARD

THE MARK CONSISTS OF STANDARD CHARACTERS WITHOUT CLAIM TO ANY PARTICULAR FONT, STYLE, SIZE, OR COLOR.

CLASS 9—ELECTRICAL AND SCIENTIFIC APPARATUS

FOR PROTECTIVE EYEWEAR, NAMELY, SPECTACLES, PRESCRIPTION EYEWEAR, ANTI GLARE GLASSES AND SUNGLASSES AND THEIR PARTS AND ACCESSORIES, NAMELY, REPLACEMENT LENSES, FRAMES, EARSTEMS, AND NOSE PIECES; CASES SPECIALLY ADAPTED FOR SPECTACLES AND SUNGLASSES AND PARTS THEREOF (U.S. CLS. 21, 23, 26, 36 AND 38).

CLASS 14—JEWELRY

FOR JEWELRY AND TIME PIECES, NAMELY, CLOCKS, WATCHES AND COMPONENT PARTS THEREOF (U.S. CLS. 2, 27, 28 AND 50).

CLASS 25—CLOTHING

FOR CLOTHING, NAMELY, T-SHIRTS, BEACHWEAR, BLOUSES, SPORTS SHIRTS, JERSEYS, SWIMWEAR, SWIMTRUNKS, SHORTS, UNDERWEAR, SHIRTS, PANTS, RACING PANTS, SKI AND SNOWBOARD PANTS AND JACKETS, JEANS, VESTS, JACKETS, WETSUITS, SWEATERS, PULLOVERS, COATS, SWEATPANTS, HEADWEAR, NAMELY, HATS, CAPS, VISORS AND FOOTWEAR, NAMELY, WETSUIT BOOTIES, SHOES, SANDALS, ATHLETIC FOOTWEAR, ALL PURPOSE SPORTS FOOTWEAR, THONGS AND BOOTS (U.S. CLS. 22 AND 39).

EVELYN BRADLEY, EXAMINING ATTORNEY

SN 77-325,809. AM GENERAL LLC, SOUTH BEND, IN. FILED 11-9-2007.

IF THE JLTV TRUCK WAS JUST
ANOTHER TRUCK, ANYONE
COULD BUILD IT

THE MARK CONSISTS OF STANDARD CHARACTERS WITHOUT CLAIM TO ANY PARTICULAR FONT, STYLE, SIZE, OR COLOR.

CLASS 40—MATERIAL TREATMENT

FOR VEHICLE PRODUCTION SERVICES, NAMELY, ASSEMBLING OF VEHICLES FOR OTHERS (U.S. CLS. 100, 103 AND 106).

CLASS 42—SCIENTIFIC AND COMPUTER SERVICES

FOR DEVELOPMENT OF VEHICLES FOR OTHERS; DESIGN OF VEHICLES FOR OTHERS (U.S. CLS. 100 AND 101).

ANTHONY RINKER, EXAMINING ATTORNEY

SN 77-325,974. BROOKSTONE PURCHASING, INC., MERRIMACK, NH. FILED 11-9-2007.

Max Force

THE MARK CONSISTS OF STANDARD CHARACTERS WITHOUT CLAIM TO ANY PARTICULAR FONT, STYLE, SIZE, OR COLOR.

CLASS 10—MEDICAL APPARATUS

FOR ELECTRIC MASSAGE APPARATUS FOR HOUSEHOLD USE; MASSAGING APPARATUS FOR PERSONAL USE (U.S. CLS. 26, 39 AND 44).

CLASS 28—TOYS AND SPORTING GOODS

FOR VIBRATING APPARATUS USED IN FITNESS AND EXERCISE PROGRAMS TO STIMULATE MUSCLES AND INCREASE STRENGTH AND PHYSICAL PERFORMANCE (U.S. CLS. 22, 23, 38 AND 50).

RICHARD WHITE, EXAMINING ATTORNEY

SN 77-326,104. CHAIN DRUG MARKETING ASSOCIATION, INC., NOVI, MI. FILED 11-9-2007.

QUALITY CHOICE

THE MARK CONSISTS OF STANDARD CHARACTERS WITHOUT CLAIM TO ANY PARTICULAR FONT, STYLE, SIZE, OR COLOR.

OWNER OF U.S. REG. NOS. 2,144,847 AND 2,964,690.

CLASS 3—COSMETICS AND CLEANING PREPARATIONS

FOR COTTON BALLS FOR COSMETIC PURPOSES; COTTON PUFFS FOR COSMETIC PURPOSES (U.S. CLS. 1, 4, 6, 50, 51 AND 52).

FIRST USE 1-1-1998; IN COMMERCE 1-1-1998.

CLASS 9—ELECTRICAL AND SCIENTIFIC APPARATUS

FOR DISPOSABLE CAMERAS (U.S. CLS. 21, 23, 26, 36 AND 38).

FIRST USE 1-1-2002; IN COMMERCE 1-1-2002.

CLASS 10—MEDICAL APPARATUS

FOR MEDICAL SYRINGES; LANCETS; PILL SPLITTERS FOR DISPENSING UNIT DOSES OF MEDICINE (U.S. CLS. 26, 39 AND 44).

FIRST USE 1-1-2000; IN COMMERCE 1-1-2000.

CLASS 20—FURNITURE AND ARTICLES NOT OTHERWISE CLASSIFIED

FOR DISPENSERS FOR PILLS OR CAPSULES SOLD EMPTY (U.S. CLS. 2, 13, 22, 25, 32 AND 50).

FIRST USE 1-1-2005; IN COMMERCE 1-1-2005.

MARY BOAGNI, EXAMINING ATTORNEY

SN 77-327,847. PENDLETON WOOLEN MILLS, INC., PORTLAND, OR. FILED 11-13-2007.

SN 77-330,513. OOO "AKELLA", MOSCOW, RUSSIAN FED., FILED 11-15-2007.

PENDLETON ECO-WISE

THE MARK CONSISTS OF STANDARD CHARACTERS WITHOUT CLAIM TO ANY PARTICULAR FONT, STYLE, SIZE, OR COLOR.

OWNER OF U.S. REG. NOS. 514,710, 2,059,665 AND OTHERS.

CLASS 24—FABRICS

FOR BLANKETS, NAMELY, BED BLANKETS, HOUSEHOLD BLANKETS, CHILDREN'S BLANKETS, BLANKETS FOR OUTDOOR USE AND WOOLEN BLANKETS; BLANKET THROWS; LINENS; TOWELS; PILLOWS; PILLOW SHAMS; CURTAINS; WOOLEN FABRIC; TEXTILE WALL HANGINGS; CLOTH COASTERS; FABRIC TABLE RUNNERS; OVEN MITTS; FIRE-PLACE MITTS (U.S. CLS. 42 AND 50).

CLASS 25—CLOTHING

FOR CLOTHING, NAMELY, COATS, JACKETS, SHIRTS, SUITS, BLOUSES, SWEATERS, SWEATSHIRTS, SKIRTS, DRESSES, SHORTS, PANTS, SLACKS, TROUSERS, SHAWLS, ROBES, VESTS, CAPS, HATS, TIES, KNIT SHIRTS, OVERCOATS, AND SPORT COATS; CLOTHING ACCESSORIES, NAMELY, MUFFLERS, SLIPPERS, SOCKS, AND CAPS (U.S. CLS. 22 AND 39).
FRANK LATTUCA, EXAMINING ATTORNEY

SN 77-329,256. PLANET VENTURES, INC., PORTAND, ME. FILED 11-14-2007.

Sit for treats. Stand for adoption.

THE MARK CONSISTS OF STANDARD CHARACTERS WITHOUT CLAIM TO ANY PARTICULAR FONT, STYLE, SIZE, OR COLOR.

CLASS 35—ADVERTISING AND BUSINESS

FOR RETAIL STORE SERVICES, MAIL ORDER CATALOG SERVICES, AND ON-LINE RETAIL STORE SERVICES, ALL IN THE FIELD OF ITEMS RELATED TO AND FOR DOGS (U.S. CLS. 100, 101 AND 102).

CLASS 41—EDUCATION AND ENTERTAINMENT

FOR EDUCATIONAL SERVICES, NAMELY, CLASSES, SEMINARS AND WORKSHOPS RELATED TO THE ADOPTION OF DOGS (U.S. CLS. 100, 101 AND 107).
LAURA KOVALSKY, EXAMINING ATTORNEY

CATHARSIS

THE MARK CONSISTS OF STANDARD CHARACTERS WITHOUT CLAIM TO ANY PARTICULAR FONT, STYLE, SIZE, OR COLOR.

CLASS 9—ELECTRICAL AND SCIENTIFIC APPARATUS

FOR COMPUTER GAME SOFTWARE; DOWNLOADABLE ELECTRONIC GAMES VIA THE INTERNET AND WIRELESS DEVICES; ELECTRONIC GAME SOFTWARE FOR HANDHELD ELECTRONIC DEVICES; ELECTRONIC GAME SOFTWARE FOR WIRELESS DEVICES; VIDEO GAME SOFTWARE (U.S. CLS. 21, 23, 26, 36 AND 38).

CLASS 41—EDUCATION AND ENTERTAINMENT

FOR ENTERTAINMENT SERVICES, NAMELY, PROVIDING AN ON-LINE COMPUTER GAME (U.S. CLS. 100, 101 AND 107).
JAMES A. RAUEN, EXAMINING ATTORNEY

SN 77-331,171. WEASELWIRE, INC., CHARLESTOWN, MA. FILED 11-16-2007.

ProVestorWire

THE MARK CONSISTS OF STANDARD CHARACTERS WITHOUT CLAIM TO ANY PARTICULAR FONT, STYLE, SIZE, OR COLOR.

CLASS 36—INSURANCE AND FINANCIAL

FOR FINANCIAL SERVICES, NAMELY, PROVIDING INFORMATION, RESEARCH, RECOMMENDATIONS, COMMENTARY AND STRATEGIES RELATING TO FINANCIAL INVESTMENTS VIA A WEBSITE (U.S. CLS. 100, 101 AND 102).

CLASS 42—SCIENTIFIC AND COMPUTER SERVICES

FOR COMPUTER SERVICES, NAMELY, HOSTING AN ONLINE COMMUNITY WEBSITE FEATURING THE SHARING OF INFORMATION, RESEARCH, RECOMMENDATIONS, COMMENTARY AND STRATEGIES RELATING TO FINANCIAL INVESTMENTS (U.S. CLS. 100 AND 101).
SALLY SHIH, EXAMINING ATTORNEY

SN 77-334,876. LISA FRANK, INC., TUSCON, AZ. FILED 11-21-2007.

STYLIN' STATIONERY SET

THE MARK CONSISTS OF STANDARD CHARACTERS WITHOUT CLAIM TO ANY PARTICULAR FONT, STYLE, SIZE, OR COLOR.

NO CLAIM IS MADE TO THE EXCLUSIVE RIGHT TO USE "STATIONERY SET", APART FROM THE MARK AS SHOWN.

CLASS 16—PAPER GOODS AND PRINTED MATTER

FOR ACTIVITY KIT, NAMELY, STATIONERY SET CONSISTING OF TWO OR MORE OF THE FOLLOWING ITEMS— STATIONERY, NOTECARDS, ENVELOPES, ADHESIVE TAPE AND ADHESIVE TAPE DISPENSERS, BOTH FOR STATIONERY OR HOUSEHOLD PURPOSES, MARKERS, PENCIL SHARPENERS, STICKERS, PENCILS, STAMPS, STAMP PADS AND ERASERS, AND PICTURE FRAMES AND KEY CHAINS USED FOR THE PURPOSE OF HOUSING THE AFOREMENTIONED DECORATIVE STATIONERY ITEMS, ALL SOLD AS A UNIT (U.S. CLS. 2, 5, 22, 23, 29, 37, 38 AND 50).

FIRST USE 12-31-1998; IN COMMERCE 12-31-1998.

CLASS 28—TOYS AND SPORTING GOODS

FOR ACTIVITY KIT FOR THE PURPOSE OF PLAYING DRESS-UP COMPRISED OF TOY COMBS AND MIRRORS, ALL SOLD AS A UNIT (U.S. CLS. 22, 23, 38 AND 50).

FIRST USE 12-31-1998; IN COMMERCE 12-31-1998.
WENDY GOODMAN, EXAMINING ATTORNEY

SN 77-335,345. DREAMWORKS ANIMATION L.L.C., GLENDALE, CA. FILED 11-21-2007.

MASTER SHIFU

THE MARK CONSISTS OF STANDARD CHARACTERS WITHOUT CLAIM TO ANY PARTICULAR FONT, STYLE, SIZE, OR COLOR.

THE ENGLISH TRANSLATION OF "SHIFU" IN THE MARK IS "TEACHER."

CLASS 9—ELECTRICAL AND SCIENTIFIC APPARATUS

FOR COMPUTER PERIPHERAL, NAMELY, MOUSE PADS; HOLDERS FOR COMPACT DISCS; COMPUTER GAME CARTRIDGES; COMPUTER GAME CASSETTES AND COMPUTER GAME TAPES; VIDEO GAME CARTRIDGES, VIDEO GAME CASSETTES; PRERECORDED AUDIO CASSETTES FEATURING MOTION PICTURE SOUNDTRACKS; PRERECORDED VIDEO CASSETTES FEATURING ANIMATED MOTION PICTURES; PRERECORDED AUDIO TAPES FEATURING MOTION PICTURE SOUNDTRACKS; PRERECORDED VIDEO TAPES FEATURING ANIMATED MOTION PICTURES; PRERECORDED DVDS FEATURING ANIMATED MOTION PICTURES; PRERECORDED CDS FEATURING MUSIC AND MOTION PICTURE SOUND TRACKS; MULTIMEDIA SOFTWARE RECORDED ON CD ROM; AND PRERECORDED DVDS FEATURING MUSIC AND MOTION PICTURE SOUND TRACKS; COMPUTER OPERATING SYSTEM SOFTWARE; PRERECORDED COMPUTER SOFTWARE PROGRAMS FEATURING MUSIC AND MOTION PICTURE SOUND TRACKS; INTERACTIVE MULTIMEDIA SOFTWARE PROGRAMS CONTAINING MOTION PICTURES FOR ENTERTAINMENT; INTERACTIVE MULTI-MEDIA SOFTWARE FOR PLAYING GAMES; MAGNETS AND SUNGLASSES (U.S. CLS. 21, 23, 26, 36 AND 38).

CLASS 16—PAPER GOODS AND PRINTED MATTER

FOR PAPER PARTY DECORATIONS; PAPER PARTY SUPPLIES, NAMELY, PAPER PARTY HATS, PAPER NAPKINS, PAPER PLACE MATS, GIFTWRAPPING PAPER AND PAPER GIFT WRAPPING RIBBONS, PAPER GIFT WRAP BOWS, PAPER TABLE CLOTHS AND PAPER PARTY BAGS; CHILDREN'S ACTIVITY BOOKS, CHILDREN'S STORYBOOKS, COMIC BOOKS, COLORING BOOKS, BOOK MARKS, LOOSE LEAF BINDERS, STATIONERY-TYPE PORTFOLIOS, WIRE-BOUND NOTEBOOKS, NOTE PADS OR WRITING PADS, DIARIES, DAILY PLANNERS, CALENDARS, SCRAPBOOK ALBUMS, SKETCHBOOK ALBUMS, PHOTOGRAPH ALBUMS, STICKER ALBUMS, STICKERS, DECALS, STAMP PADS OR INKING PADS, RUBBER STAMPS, HEAT APPLIED APPLIQUES IN THE FORM OF DECALS MADE OF PAPER, TEMPORARY TATTOOS, SLATEBOARDS FOR WRITING, PENCILS, PENS, PENCIL ERASERS, DECORATIVE PENCIL-TOP ORNAMENTS, PEN CASES AND PENCIL CASES, PEN BOXES AND PENCIL BOXES, PENCIL SHARPENERS, CHALK, MARKERS, POSTERS, POSTCARDS, TRADING CARDS, GREETING CARDS, PENNANTS MADE OF PAPER, PAINTING SETS FOR CHILDREN; ARTS AND CRAFTS PAINT KITS; STUDY KITS, CONSISTING OF PENCIL ERASERS, DRAWING RULERS, PENCIL SHARPENERS AND PENCIL CASE; STATIONERY PACKS CONSISTING OF WRITING PAPER, ENVELOPES, MARKERS, AND STENCILS; AND ACTIVITY KITS CONSISTING OF STICKERS AND RUBBER STAMPS (U.S. CLS. 2, 5, 22, 23, 29, 37, 38 AND 50).

CLASS 25—CLOTHING

FOR SHIRTS AND TOPS, DRESSES, SKIRTS, PANTS, TROUSERS, JEANS, SHORTS, ROMPERS, OVERALLS, SWEATSHIRTS AND SWEAT PANTS, SWEATSUITS, CAPS AND HATS, GLOVES, SUSPENDERS, TIES, COATS AND JACKETS, HOSIERY, SHOES, BOOTS, SLIPPERS, PAJAMAS, ROBES, SLEEPSHIRTS, SLEEPWEAR, UNDERWEAR, HALLOWEEN COSTUMES AND CLOTH BABY BIBS (U.S. CLS. 22 AND 39).

CLASS 28—TOYS AND SPORTING GOODS

FOR ACTION FIGURES AND ACCESSORIES THEREFOR, BATHTUB TOYS, KITES, TOY BUILDING BLOCKS, BOARD GAMES, COSTUME MASKS, HANDHELD UNIT FOR PLAYING ELECTRONIC GAMES, DIE CAST MINIATURE TOY VEHICLES, DOLLS, DOLL ACCESSORIES, DOLL CLOTHING, BEAN BAG DOLLS, BENDABLE PLAY FIGURES, FLYING DISCS, INFLATABLE VINYL PLAY FIGURES, JIGSAW PUZZLES, MARBLES, PLUSH TOYS, PUPPETS, RIDE-ON TOYS, SKATEBOARDS, BALLOONS, ROLLERSKATES, TOY BANKS, WATER SQUIRTING TOYS, STUFFED TOYS, TOY VEHICLES, CHRISTMAS TREE ORNAMENTS; PINBALL MACHINES AND MODEL CRAFT KITS OF TOY FIGURES; AND PLAYING CARDS (U.S. CLS. 22, 23, 38 AND 50).

ZACHARY BELLO, EXAMINING ATTORNEY

CLASS 6—METAL GOODS

FOR ALUMINUM FOIL AND ALUMINUM FOIL PAPER (U.S. CLS. 2, 12, 13, 14, 23, 25 AND 50).

CLASS 21—HOUSEWARES AND GLASS

FOR NON-ELECTRIC ALUMINUM AND ROASTING PANS, CONTAINERS FORMED OF ALUMINUM FOIL WITH PLASTIC LIDS FOR HOUSEHOLD USE, PANS FORMED OF ALUMINUM FOIL WITH WIRE HANDLES (U.S. CLS. 2, 13, 23, 29, 30, 33, 40 AND 50).

FIRST USE 11-9-2007; IN COMMERCE 11-9-2007.
REBECCA SMITH, EXAMINING ATTORNEY

SN 77-340,953. HANDI-FOIL CORPORATION, WHEELING, IL. FILED 11-30-2007.

SN 77-338,300. WHOLESALE MAILING LISTS, INC., SHERMAN OAKS, CA. FILED 11-27-2007.

LISTTEAM.COM

THE MARK CONSISTS OF STANDARD CHARACTERS WITHOUT CLAIM TO ANY PARTICULAR FONT, STYLE, SIZE, OR COLOR.

CLASS 35—ADVERTISING AND BUSINESS

FOR DISSEMINATION OF ADVERTISING MATERIAL; PREPARING MAILING LISTS; ADVERTISING SERVICES (U.S. CLS. 100, 101 AND 102).

FIRST USE 4-1-1984; IN COMMERCE 4-1-1984.

CLASS 36—INSURANCE AND FINANCIAL

FOR MAILING LIST BROKERAGE SERVICES (U.S. CLS. 100, 101 AND 102).

FIRST USE 4-1-1984; IN COMMERCE 4-1-1984.

CLASS 40—MATERIAL TREATMENT

FOR PRINTING (U.S. CLS. 100, 103 AND 106).
FIRST USE 4-1-1984; IN COMMERCE 4-1-1984.

CLASS 42—SCIENTIFIC AND COMPUTER SERVICES

FOR GRAPHIC DESIGN SERVICES (U.S. CLS. 100 AND 101).

FIRST USE 4-1-1984; IN COMMERCE 4-1-1984.
TEJBIR SINGH, EXAMINING ATTORNEY

FASHION FOIL

THE MARK CONSISTS OF STANDARD CHARACTERS WITHOUT CLAIM TO ANY PARTICULAR FONT, STYLE, SIZE, OR COLOR.

NO CLAIM IS MADE TO THE EXCLUSIVE RIGHT TO USE "FOIL", APART FROM THE MARK AS SHOWN.

CLASS 6—METAL GOODS

FOR ALUMINUM FOIL AND ALUMINUM FOIL PAPER (U.S. CLS. 2, 12, 13, 14, 23, 25 AND 50).

CLASS 21—HOUSEWARES AND GLASS

FOR NON-ELECTRIC ALUMINUM AND ROASTING PANS, CONTAINERS FORMED OF ALUMINUM FOIL WITH PLASTIC LIDS FOR HOUSEHOLD USE, PANS FORMED OF ALUMINUM FOIL WITH WIRE HANDLES (U.S. CLS. 2, 13, 23, 29, 30, 33, 40 AND 50).

REBECCA SMITH, EXAMINING ATTORNEY

SN 77-340,962. HANDI-FOIL CORPORATION, WHEELING, IL. FILED 11-30-2007.

MIDNIGHT GOLD

THE MARK CONSISTS OF STANDARD CHARACTERS WITHOUT CLAIM TO ANY PARTICULAR FONT, STYLE, SIZE, OR COLOR.

CLASS 6—METAL GOODS

FOR ALUMINUM FOIL AND ALUMINUM FOIL PAPER (U.S. CLS. 2, 12, 13, 14, 23, 25 AND 50).

CLASS 21—HOUSEWARES AND GLASS

FOR NON-ELECTRIC ALUMINUM AND ROASTING PANS, CONTAINERS FORMED OF ALUMINUM FOIL WITH PLASTIC LIDS FOR HOUSEHOLD USE, PANS FORMED OF ALUMINUM FOIL WITH WIRE HANDLES (U.S. CLS. 2, 13, 23, 29, 30, 33, 40 AND 50).

REBECCA SMITH, EXAMINING ATTORNEY

SN 77-338,697. HANDI-FOIL CORPORATION, WHEELING, IL. FILED 11-28-2007.

BAKE AMERICA

NO CLAIM IS MADE TO THE EXCLUSIVE RIGHT TO USE "BAKE", APART FROM THE MARK AS SHOWN.
THE MARK CONSISTS OF A PLURALITY OF STARS POSITIONED UNDER THE WORDING "BAKE AMERICA".

SN 77-341,174. GLU MOBILE INC., SAN MATEO, CA. FILED 11-30-2007.

GET COOKIN'

THE MARK CONSISTS OF STANDARD CHARACTERS WITHOUT CLAIM TO ANY PARTICULAR FONT, STYLE, SIZE, OR COLOR.

CLASS 9—ELECTRICAL AND SCIENTIFIC APPARATUS

FOR COMPUTER GAME SOFTWARE AND ENTERTAINMENT SOFTWARE, NAMELY, COMPUTER GAME SOFTWARE, SCREEN SAVER SOFTWARE, SOFTWARE TO ENABLE TEXT-MESSAGING, MULTIMEDIA ENTERTAINMENT SOFTWARE FOR PLAYING AUDIO, VIDEO AND MUSIC, ALL FOR USE ON MOBILE DEVICES, NAMELY, HANDHELD COMPUTERS, PERSONAL DIGITAL ASSISTANTS AND CELLULAR TELEPHONES (U.S. CLS. 21, 23, 26, 36 AND 38).

CLASS 41—EDUCATION AND ENTERTAINMENT

FOR PROVIDING ON-LINE COMPUTER GAMES (U.S. CLS. 100, 101 AND 107).
JILL PRATER, EXAMINING ATTORNEY

SN 77-343,963. NATIONAL PORK BOARD, CLIVE, IA. FILED 12-4-2007.

PQA PLUS

THE MARK CONSISTS OF STANDARD CHARACTERS WITHOUT CLAIM TO ANY PARTICULAR FONT, STYLE, SIZE, OR COLOR.

CLASS 9—ELECTRICAL AND SCIENTIFIC APPARATUS

FOR DVDS FEATURING INFORMATION ABOUT PORK RELATED TOPICS (U.S. CLS. 21, 23, 26, 36 AND 38).
FIRST USE 1-22-2007; IN COMMERCE 1-22-2007.

CLASS 16—PAPER GOODS AND PRINTED MATTER

FOR PRINTED MATERIALS, NAMELY, BROCHURES AND BOOKLETS CONTAINING INFORMATION FOR PORK PRODUCERS (U.S. CLS. 2, 5, 22, 23, 29, 37, 38 AND 50).
FIRST USE 1-22-2007; IN COMMERCE 1-22-2007.

CLASS 35—ADVERTISING AND BUSINESS

FOR PROVIDING A WEBSITE FEATURING BUSINESS MANAGEMENT INFORMATION ABOUT PORK RELATED TOPICS (U.S. CLS. 100, 101 AND 102).
FIRST USE 1-22-2007; IN COMMERCE 1-22-2007.

CLASS 41—EDUCATION AND ENTERTAINMENT

FOR EDUCATIONAL SERVICES FOR PORK PRODUCERS, NAMELY, CONDUCTING SEMINARS, CLASSES AND WORKSHOPS TO IMPROVE MANAGEMENT PRACTICES, TO AVOID VIOLATIVE DRUG RESIDUES, TO DECREASE PRODUCTION COSTS, AND TO INCREASE AWARENESS OF FOOD SAFETY CONCERNS (U.S. CLS. 100, 101 AND 107).
FIRST USE 1-22-2007; IN COMMERCE 1-22-2007.

CLASS 42—SCIENTIFIC AND COMPUTER SERVICES

FOR FARM-SITE TESTING, ANALYSIS AND EVALUATION OF PORK PRODUCTION FOR THE PURPOSE OF CERTIFICATION; PROVIDING A WEBSITE FEATURING SCIENTIFIC AND TECHNICAL INFORMATION ABOUT PORK RELATED TOPICS (U.S. CLS. 100 AND 101).
FIRST USE 1-22-2007; IN COMMERCE 1-22-2007.
CYNTHIA SLOAN, EXAMINING ATTORNEY

SN 77-344,299. AM GENERAL LLC, SOUTH BEND, IN. FILED 12-5-2007.

IF THE JLTV WAS JUST ANOTHER TRUCK, ANYONE COULD BUILD IT

THE MARK CONSISTS OF STANDARD CHARACTERS WITHOUT CLAIM TO ANY PARTICULAR FONT, STYLE, SIZE, OR COLOR.

CLASS 40—MATERIAL TREATMENT

FOR VEHICLE PRODUCTION SERVICES, NAMELY, ASSEMBLING OF VEHICLES FOR OTHERS (U.S. CLS. 100, 103 AND 106).

CLASS 42—SCIENTIFIC AND COMPUTER SERVICES

FOR DEVELOPMENT OF VEHICLES FOR OTHERS; DESIGN OF VEHICLES FOR OTHERS (U.S. CLS. 100 AND 101).
ANTHONY RINKER, EXAMINING ATTORNEY

SN 77-346,856. BULLSEYE TELECOM, INC., OAK PARK, MI. FILED 12-7-2007.

BullsEye

THE MARK CONSISTS OF STANDARD CHARACTERS WITHOUT CLAIM TO ANY PARTICULAR FONT, STYLE, SIZE, OR COLOR.
OWNER OF U.S. REG. NOS. 2,762,094, 3,016,531 AND OTHERS.

CLASS 35—ADVERTISING AND BUSINESS

FOR BUSINESS CONSULTATION IN THE FIELD OF TELECOMMUNICATIONS EXPENSE MANAGEMENT; BUSINESS MANAGEMENT AND CONSULTATION IN THE FIELD OF TELECOMMUNICATIONS AND INFORMATION TECHNOLOGY (U.S. CLS. 100, 101 AND 102).
FIRST USE 2-0-2003; IN COMMERCE 2-0-2003.

CLASS 38—COMMUNICATION

FOR INTERNET SERVICE PROVIDER (ISP); LOCAL AND LONG DISTANCE TELEPHONE SERVICES; VOICE OVER INTERNET PROTOCOL (VOIP) SERVICES; TELECOMMUNICATIONS CONSULTATION (U.S. CLS. 100, 101 AND 104).
FIRST USE 5-0-1999; IN COMMERCE 5-0-1999.
JOHN WILKE, EXAMINING ATTORNEY

SN 77-348,520. THE CLOROX PET PRODUCTS COMPANY, OAKLAND, CA. FILED 12-10-2007.

PRO-ACTIVES

THE MARK CONSISTS OF STANDARD CHARACTERS WITHOUT CLAIM TO ANY PARTICULAR FONT, STYLE, SIZE, OR COLOR.

CLASS 16—PAPER GOODS AND PRINTED MATTER

FOR CAT BOX LINERS IN THE FORM OF PLASTIC BAGS (U.S. CLS. 2, 5, 22, 23, 29, 37, 38 AND 50).

CLASS 31—NATURAL AGRICULTURAL PRODUCTS

FOR CAT LITTER (U.S. CLS. 1 AND 46).
MICHAEL TANNER, EXAMINING ATTORNEY

SN 77-357,267. LONG TRAIL BREWING COMPANY, BRIDGEWATER CORNERS, VT. FILED 12-20-2007.

TAKE A HIKE!

THE MARK CONSISTS OF STANDARD CHARACTERS WITHOUT CLAIM TO ANY PARTICULAR FONT, STYLE, SIZE, OR COLOR.
OWNER OF U.S. REG. NO. 2,015,088.

CLASS 29—MEATS AND PROCESSED FOODS

FOR TRAIL MIX, NAMELY, A SNACK MIX CONSISTING PRIMARILY OF PROCESSED FRUITS, PROCESSED NUTS AND/OR RAISINS (U.S. CL. 46).
FIRST USE 6-10-2005; IN COMMERCE 6-10-2005.

CLASS 32—LIGHT BEVERAGES

FOR BEER, ALE (U.S. CLS. 45, 46 AND 48).
FIRST USE 0-0-1994; IN COMMERCE 0-0-1994.
KRISTIN DAHLING, EXAMINING ATTORNEY

SN 78-023,319. ALLIANCE DATA SYSTEMS CORPORATION, DALLAS, TX. FILED 8-28-2000.

**CLASS 35—ADVERTISING AND BUSINESS**

FOR MARKETING MANAGEMENT SERVICES, NAMELY, MARKET RESEARCH, COOPERATIVE ADVERTISING AND MARKETING SERVICES, NAMELY, THE PROVISION OF STATISTICAL ANALYSIS AND CONSULTATION IN THE MARKETING OF THE GOODS AND SERVICES OF OTHERS AND PROVIDING INFORMATION ON THE PURCHASING PATTERNS OF CONSUMERS AND BUSINESSES; CONDUCTING EMPLOYEE INCENTIVE AWARDS PROGRAMS RELATING TO EMPLOYEES' MOTIVATION AND PERFORMANCE; PROVIDING INFORMATION ABOUT THE GOODS AND SERVICES OF OTHERS IN CONNECTION WITH LOYALTY PROGRAMS AND PROMOTIONAL INCENTIVE SCHEMES THROUGH A GLOBAL COMPUTER NETWORK; BUSINESS CONSULTING, NAMELY, CONSULTING WITH RESPECT TO DATA MINING ABOUT CONSUMERS' PREFERENCES (U.S. CLS. 100, 101 AND 102).

CLASS 39—TRANSPORTATION AND STORAGE

FOR ELECTRONIC STORAGE OF DATA (U.S. CLS. 100 AND 105).
WILLIAM BRECKENFELD, EXAMINING ATTORNEY

SN 78-062,785. @HAND SOFTWARE CORPORATION, AUSTIN, TX. FILED 5-9-2001.

M-TIER**CLASS 9—ELECTRICAL AND SCIENTIFIC APPARATUS**

FOR COMPUTER SOFTWARE FOR DEVELOPING, DEPLOYING, AND MANAGING SOFTWARE APPLICATIONS FOR USE WITH AND ON COMPUTING DEVICES; COMPUTER SOFTWARE FOR CONNECTING COMPUTING DEVICES WITH BACK-END COMPUTER SYSTEMS (U.S. CLS. 21, 23, 26, 36 AND 38).
FIRST USE 4-0-2002; IN COMMERCE 4-0-2002.

CLASS 42—SCIENTIFIC AND COMPUTER SERVICES

FOR CONSULTING SERVICES FOR THE DEVELOPMENT AND INTEGRATION OF SYSTEMS FOR COMPUTING DEVICES; CONSULTING SERVICES FOR THE DEVELOPMENT AND INTEGRATION OF COMPUTER SOFTWARE; DEVELOPMENT OF COMPUTER SOFTWARE (U.S. CLS. 100 AND 101).

FIRST USE 3-0-2002; IN COMMERCE 3-0-2002.

RON FAIRBANKS, EXAMINING ATTORNEY

CLASS 41—EDUCATION AND ENTERTAINMENT

FOR EDUCATIONAL SERVICES, NAMELY, PROVIDING TRAINING FOR SPORTS; ORGANIZING AND CONDUCTING SPORTING AND CULTURAL ACTIVITIES, NAMELY, SOCCER GAMES, BASKETBALL EXHIBITIONS, ART SHOWS, LIVE MUSICAL CONCERTS; ENTERTAINMENT SERVICES, NAMELY, PROVIDING TELEVISION AND RADIO PROGRAMS IN THE FIELDS OF SPORTS; TELEVISION AND RADIO GAME SHOWS; ORGANIZATION OF EDUCATIONAL AND ENTERTAINING DISCUSSIONS, CONFERENCES, CONVENTIONS, SEMINARS AND SYMPOSIUMS IN THE FIELDS OF ENDORSEMENTS AND TAXES FOR ATHLETES AND PUBLIC FIGURES; UNIVERSITY EDUCATION, NAMELY EDUCATION SERVICES IN THE NATURE OF COURSES AT THE UNIVERSITY LEVEL; PROVIDING ENTERTAINMENT INFORMATION RELATED WITH SPORTS; SPORTS EVENT ORGANIZATION; PROVIDING FACILITIES AND FIELDS FOR SPORT ACTIVITIES AND TRAINING; PROVIDING INFORMATION ABOUT CULTURAL AND SPORTING ACTIVITIES THROUGH WORLD WIDE WEBS (U.S. CLS. 100, 101 AND 107).

B. PARADEWELAI, EXAMINING ATTORNEY

SN 78-285,765. FUTBOL CLUB BARCELONA, BARCELONA, SPAIN, FILED 8-11-2003.



OWNER OF ERPN CMNTY TM OFC REG. NO. 198598, DATED 9-20-1999, EXPIRES 9-20-2009.

COLOR IS NOT CLAIMED AS A FEATURE OF THE MARK.

CLASS 25—CLOTHING

FOR CLOTHING, NAMELY, JUMPERS, TROUSERS; SOCKS, STOCKINGS, GLOVES; BOOTS, SHOES AND SLIPPERS; CAPS, BERETS, SHIRTS, T-SHIRTS, SWEAT-SHIRTS, SWEAT-PANTS, SHORTS, BLOUSES, JERKINS, JACKETS, SOCK SUSPENDERS, UNDERWEAR, SUDORIFEROUS UNDERWEAR, PAJAMAS, NIGHT GOWNS, WAISTCOAT, CAPES, SCARVES, COATS, SHAWLS, PULLOVERS, SKIRTS, DRESSES, TIES, BELT OF TEXTILE, TROUSER SUSPENDERS, BATHING SUITS; SPORT CLOTHING INCLUDED IN THIS CLASS, NAMELY, BASKETBALL JERSEYS, FUTBOL/SOCCER SHORTS AND JERSEYS, CLOTH NAPPIES, BOAS FOR WEARING AROUND THE NECK; NON-ELECTRIC FOOT MUFFS AND BIRETTA; CLOTH BIBS; HALF BELTS, GLOVES FOR SPORTS, INCLUDED IN THIS CLASS, NAMELY, SKI GLOVES, SKATEBOARD GLOVES, AND RIDING GLOVES; STOLEES, BRASIERES, LIVERIES, SHIRT FRONTS, PELISSES; PELERINES; SUITS, HAT FRAMES, SLIPS, HEADWEAR, HOSIERY; HEADWEAR ARTICLES, NAMELY, HEAD BANDS (U.S. CLS. 22 AND 39).

CLASS 28—TOYS AND SPORTING GOODS

FOR PAPER DRESSES FOR DOLLS; GYMNASTIC AND SPORTING ARTICLES NOT INCLUDED IN OTHER CLASSES, NAMELY, FOOTBALLS, SOCCER BALLS, GLOVES FOR GOALKEEPERS, HOCKEY GOLF GLOVES; GAMES AND PLAYTHINGS, SPECIALLY THOSE PLAYS AND PLAYTHINGS RELATED WITH SPORTS INCLUDED IN THIS CLASS, NAMELY, FOOTBALLS, SOCCER BALLS, BASKETBALLS, BASKETBALL NETS, TENNIS EQUIPMENT, NAMELY, TENNIS BALLS, NETS, RACKETS, RACKET COVERS, RACKET STRINGS, RACKET PRESSES AND UPRIGHTS; SPORTING ARTICLES RELATED TO FUTBOL, NAMELY, FUTBOL KNEE PADS, LEG PADS, ELBOW PADS AND GOAL NETS; HEADWEAR ARTICLES, NAMELY, HEADGUARDS FOR KARATE; ORNAMENTS AND DECORATIONS FOR CHRISTMAS TREES, NAMELY, BELLS AND MINIATURE FIGURINES (U.S. CLS. 22, 23, 38 AND 50).

SN 78-291,798. HANS GROHE AG, D-77761 SCHILTACH, FED REP GERMANY, FILED 8-25-2003.

HELIS

PRIORITY CLAIMED UNDER SEC. 44(D) ON FED REP GERMANY APPLICATION NO. 30311013, FILED 2-28-2003, REG. NO. 30311013, DATED 5-30-2003, EXPIRES 2-28-2013.

CLASS 6—METAL GOODS

FOR METAL PIPE FITTINGS, NAMELY, ROSETTES, CONNECTORS; TUBE CONNECTORS MADE OF METAL, PIPES GENERALLY MADE OF METAL; HOSES PRIMARILY MADE OF METAL FOR PLUMBING USE; SANITARY HOSES, NAMELY, METAL HOSES FOR PLUMBING USE AND SANITARY HOSES AS SHOWER COMPONENTS; METAL SUPPLY AND DISCHARGE PIPES FOR WATER; METAL FITTINGS FOR WATER SUPPLY, NAMELY, METAL HOSE FITTINGS AND METAL PIPE FITTINGS; MANUALLY OPERATED METAL VALVES; METAL PLUG-IN COUPLINGS FOR USE WITH PLUMBING HOSES; METAL SEALS; METAL COUPLINGS FOR USE WITH HOSES PRIMARILY MADE OF METAL FOR PLUMBING USE; METAL PIPE COUPLINGS, METAL SHOWER GRAB BARS (U.S. CLS. 2, 12, 13, 14, 23, 25 AND 50).

CLASS 11—ENVIRONMENTAL CONTROL APPARATUS

FOR APPARATUS FOR LIGHTING, HEATING, STEAM GENERATING, DRYING, VENTILATING, WATER SUPPLY AND SANITARY PURPOSES, NAMELY, ELECTRIC LIGHTING FIXTURES, STEAM GENERATORS, ELECTRIC HAIR DRYERS AND TOWEL DRYERS, WATER PURIFIERS AND FILTERS, PLUMBING FITTINGS, NAMELY, VALVES, SHOWER SPRAYERS, TOILETS, BIDETS; WATER REFINEMENT INSTALLATIONS, NAMELY, FILTERING UNITS FOR PRODUCING POTABLE WATER FOR DOMESTIC USE, WATER PURIFIERS; PLUMBING FITTINGS, NAMELY, MIXING VALVES, MANUALLY AND AUTOMATICALLY OPERATED MIXING VALVES, MIXER TAPS FOR WASH STANDS, BIDETS, SINKS, BATH TUBS AND SHOWER TUBS; HYDRO MASSAGE APPARATUS, NAMELY, BATH TUBS; SANITARY TUBS, BATH TUBS, SHOWER TUBS, WHIRLPOOL TUBS, BIDETS, SHOWERS AND SHOWER CABINS BEING SHOWER ENCLOSURES; SHOWER AND SHOWER COMBINATIONS, NAMELY, OVERHEAD SHOWERS, LATERAL SHOWERS AND HAND SHOWERS; SHOWER NOZZLES, NAMELY, SHOWER HEADS; PRE-ASSEMBLED MULTIFUNCTIONAL SHOWERS; MULTIFUNCTIONAL SHOWER CABINS BEING SHOWER ENCLOSURES; SUPPLY AND DISCHARGE FITTINGS FOR SANITARY BASINS, WASH STANDS, SINKS, BIDETS, BATH TUBS AND SHOWER TUBS, NAMELY, TRAPS, VALVES, TUB AND SHOWER CONTROL VALVES, SPOUTS, AERATORS FOR FAUCETS; PLUMBING SUPPLY FITTINGS, NAMELY, TRAPS FOR THE DRAINING OF WATER FOR SANITARY BASINS, WASH STANDS, SINKS, BIDETS, BATH TUBS AND SHOWER TUBS; SUPPLY AND DISCHARGE PIPES BEING PARTS OF SANITARY FACILITIES; ELECTRIC LIGHTING FIXTURES FOR SANITARY FIGMENTS; METAL FITTINGS FOR WATER SUPPLY, NAMELY, BIBS, COCKS, TRAPS, VALVES, SHOWER CONTROL VALVES, TUB CONTROL VALVES, ALL FOR PLUMBING; CASINGS AND REVETMENTS PRIMARILY MADE OF METAL AS PARTS OF SANITARY INSTALLATIONS, NAMELY, SHOWER DOORS AND SHOWER ENCLOSURES; NON METALLIC CONSTRUCTION MATERIALS, NAMELY, PARTITIONS FOR SHOWER CABINS AND BATH TUBS; DOOR CASINGS AND REVETMENTS FOR SANITARY INSTALLATIONS, PRIMARILY MADE OF NON-METALLIC MATERIALS, NAMELY, SHOWER DOORS AND SHOWER ENCLOSURES; PARTS AND ACCESSORIES FOR SHOWER DOORS, AND SHOWER ENCLOSURES, NAMELY, GLASS SHEETS AND PARTITION WALLS (U.S. CLS. 13, 21, 23, 31 AND 34).

CLASS 17—RUBBER GOODS

FOR NON-METAL HOSES, PRIMARILY MADE OF PLASTIC FOR USE IN PLUMBING; NON-METAL HOSES, PRIMARILY MADE OF RUBBER FOR USE IN PLUMBING; NON-METAL SEALS FOR USE IN PLUMBING; INSULATION MATERIALS, NAMELY, BUILDING, FIBERGLASS, ACOUSTICAL, FOAM, GLASS FIBER AND GLASS WOOL INSULATION; PIPE INSULATION FOR INSULATING UNDERGROUND PIPES; NON-METAL PLUG-IN COUPLINGS FOR USE WITH METAL HOSES AND NON-METAL HOSES; NON-METAL PIPE COUPLINGS; RUBBER TUBE CONNECTORS (U.S. CLS. 1, 5, 12, 13, 35 AND 50).

CLASS 19—NON-METALLIC BUILDING MATERIALS

FOR NON-METAL WATER PIPES AND TUBES; NON-METALLIC CONSTRUCTION MATERIALS, NAMELY, WALL, HARDWOOD, DECKING, WOOD AND PARTICLE BOARDS (U.S. CLS. 1, 12, 33 AND 50).

DANIEL CAPSHAW, EXAMINING ATTORNEY

SN 78-351,140. SCI GAMES LIMITED, LONDON, UNITED KINGDOM, FILED 1-13-2004.

CONFLICT: VIETNAM

THE MARK CONSISTS OF STANDARD CHARACTERS WITHOUT CLAIM TO ANY PARTICULAR FONT, STYLE, SIZE, OR COLOR.

OWNER OF UNITED KINGDOM REG. NO. 003236891, DATED 7-12-2004, EXPIRES 6-20-2013.

NO CLAIM IS MADE TO THE EXCLUSIVE RIGHT TO USE "VIETNAM", APART FROM THE MARK AS SHOWN.

CLASS 9—ELECTRICAL AND SCIENTIFIC APPARATUS

FOR COMPUTER GAMES SOFTWARE; ELECTRONIC GAMES; COMPUTER GAMES SOFTWARE AND ELECTRONIC GAMES ADAPTED FOR USE WITH TELEVISION RECEIVERS AND COMPUTERS; APPARATUS FOR COMPUTER AND ELECTRONIC GAMES ADAPTED FOR USE WITH TELEVISION RECEIVERS AND COMPUTERS; GAME MACHINES FOR USE WITH TELEVISION RECEIVERS, VIDEO OUTPUT GAME MACHINES FOR USE WITH TELEVISION RECEIVERS, VIDEO RECORDINGS FEATURING MOVIES AND MOTION PICTURES; SOUND RECORDINGS FEATURING MUSIC OR SPOKEN WORD; RECORDS, COMPACT DISCS; CD-ROMS, AUDIO TAPES, CASSETTES AND CARTRIDGES, VIDEO TAPES, CASSETTES ALL SOLD BLANK; VIDEO GAME DISCS AND VIDEO GAME JOYSTICKS; SUNGLASSES AND SPECTACLES (U.S. CLS. 21, 23, 26, 36 AND 38).

CLASS 16—PAPER GOODS AND PRINTED MATTER

FOR PRINTED MATTER, BOOKS, BOOK COVERS, NEWSPAPERS, PAMPHLETS, JOURNALS, MAGAZINES AND PERIODICAL PUBLICATIONS, ALL RELATING TO COMPUTER GAMES, ELECTRONIC GAMES AND VIDEO GAMES; STATIONERY; PENCILS; PROGRAMS AND CHARTS, POSTERS; PENS; PAPER TISSUES, GIFT WRAPPING AND PACKAGING MATERIALS, NAMELY, WRAPPING PAPER, PAPER DECORATIVE RIBBON; CRAYONS, WRITING IMPLEMENTS, NAMELY, WRITING BRUSHES, WRITING INK; STICKERS, DECALCOMANIAS, DIARIES, DRAWING INSTRUMENTS, NAMELY, PENS AND PENCILS; GREETING CARDS, ADDRESS BOOKS, CATALOGUES, FEATURING COMPUTER GAME INFORMATION; EVENTS PROGRAMS AND BINDERS (U.S. CLS. 2, 5, 22, 23, 29, 37, 38 AND 50).

CLASS 28—TOYS AND SPORTING GOODS

FOR GAMES AND PLAYTHINGS, NAMELY HAND HELD UNIT FOR PLAYING ELECTRONIC GAMES, HANDHELD COMPUTER GAMES; GAME MACHINES, NAMELY, STAND ALONE VIDEO GAME MACHINES; PLAYING CARDS; COIN OPERATED VIDEO GAMES (U.S. CLS. 22, 23, 38 AND 50).

CLASS 41—EDUCATION AND ENTERTAINMENT

FOR ENTERTAINMENT SERVICES, NAMELY, PROVIDING ONLINE COMPUTER GAMES; GAMES, INTERACTIVE GAMES, AND VIDEO GAMES PROVIDED ONLINE FOR DATABASES OR WEBSITES AND GLOBAL COMPUTER NETWORK; LIVE-ACTION, COMEDY, DRAMA, AND/OR ANIMATED ON-GOING TELEVISION PROGRAMS; PRODUCTION OF LIVE-ACTION, COMEDY, DRAMA, AND/OR ANIMATED TELEVISION PROGRAMS; ENTERTAINMENT SERVICES IN THE NATURE OF LIVE-ACTION, COMEDY, DRAMA, AND/OR ANIMATED MOTION PICTURE THEATRICAL FILMS; PRODUCTION OF LIVE-ACTION, COMEDY, DRAMA AND/OR ANIMATED MOTION PICTURE THEATRICAL FILMS; PUBLICATION OF BOOKS, MAGAZINES AND MANUALS RELATING TO COMPUTER GAMES, ELECTRONIC GAMES AND VIDEO GAMES (U.S. CLS. 100, 101 AND 107).

NAAKWAMA ANKRAH, EXAMINING ATTORNEY

CLASS 9—ELECTRICAL AND SCIENTIFIC APPARATUS

FOR APPARATUS FOR RECORDING, TRANSMISSION OR REPRODUCTION OF SOUND OR IMAGES, NAMELY, MOBILE TELEPHONES, PDA'S, AND DATACARDS; BLANK MAGNETIC DATA CARRIERS; PRE-RECORDED MAGNETIC DATA CARRIERS FEATURING CUSTOMER RELATED INFORMATION OR CUSTOMER SERVICE RELATED INFORMATION FEATURING MUSIC OR STILL/MOVING IMAGES; VIDEO RECORDING DISCS FEATURING CUSTOMER RELATED INFORMATION OR CUSTOMER SERVICE RELATED FEATURING MUSIC OR STILL/MOVING IMAGES; AUTOMATIC VENDING MACHINES AND MECHANISMS FOR COIN CHANGERS; CASH REGISTERS; CALCULATING MACHINES; DATA PROCESSING EQUIPMENT, NAMELY, MOBILE TELEPHONES, PDA'S, DATACARDS; COMPUTERS; COMMUNICATIONS AND TELECOMMUNICATIONS APPARATUS AND INSTRUMENTS, NAMELY, MOBILE TELEPHONES, PDA'S, DATACARDS, MOBILE PHONES; ELECTRICAL AND ELECTRONIC APPARATUS AND INSTRUMENTS ALL FOR PROCESSING, LOGGING, STORING, TRANSMISSION, RETRIEVAL OR RECEPTION OF DATA, NAMELY, MOBILE TELEPHONES, PDA'S, DATACARDS; COMPUTER HARDWARE USED IN MOBILE TELEPHONES, PDA'S, DATACARDS; COMPUTER PROGRAMMES, NAMELY OPERATING SYSTEM SOFTWARE AND SOFTWARE FOR EMAIL, PERSONAL ORGANIZATION, CALENDERING, AND INTERNET USAGE USED IN MOBILE TELEPHONES, PDA'S, DATACARDS; COMPUTER PERIPHERAL APPARATUS AND EQUIPMENT NAMELY, MOBILE TELEPHONES, PDA'S, DATACARDS; TELEPHONES; MOBILE TELEPHONES; FACSIMILE MACHINES; TELEPHONE ANSWERING MACHINES; TELEPHONE HANDSETS; ACCESSORIES FOR TELEPHONES AND TELEPHONE HANDSETS, NAMELY, HEADSETS, SPEAKERS, COVERS, CASES, SOFTWARE, CAMERAS, BATTERIES AND CHARGERS; ADAPTERS FOR USE WITH TELEPHONES; BATTERY CHARGERS FOR USE WITH TELEPHONES; AERIALS; BATTERIES; KEYBOARDS; MODEMS (U.S. CLS. 21, 23, 26, 36 AND 38).

SN 78-391,883. FREEMOVE, AMSTERDAM, NETHERLANDS, FILED 3-26-2004.

FREEMOVE

THE MARK CONSISTS OF STANDARD CHARACTERS WITHOUT CLAIM TO ANY PARTICULAR FONT, STYLE, SIZE, OR COLOR.

PRIORITY CLAIMED UNDER SEC. 44(D) ON BENELUX APPLICATION NO. 751251, FILED 3-25-2004, REG. NO. 751251, DATED 3-25-2004, EXPIRES 3-25-2014.

CLASS 38—COMMUNICATION

FOR COMMUNICATION SERVICES, NAMELY, ELECTRONIC TRANSMISSION OF SOUND, IMAGES AND DATA AMONG USERS OF MOBILE COMMUNICATION DEVICES; TELECOMMUNICATIONS SERVICES, NAMELY, THE TRANSMISSION OF SOUND AND IMAGES BETWEEN USERS OF COMMUNICATION DEVICES; PROVIDING MULTIPLE USER ACCESS TO A GLOBAL COMPUTER NETWORK; RENTAL OF TELECOMMUNICATIONS EQUIPMENT INCLUDING BUT NOT LIMITED TO, TELEPHONES AND FACSIMILE APPARATUS; COMMUNICATION BY COMPUTER TERMINALS; COMPUTER-AIDED TRANSMISSION OF MESSAGES AND IMAGES; CELLULAR TELEPHONE COMMUNICATION; ROUTING AND LINK-UP FOR TELECOMMUNICATIONS; TELEPHONE, FACSIMILE, ELECTRONIC VOICE MESSAGING, NAMELY, THE RECORDING AND SUBSEQUENT TRANSMISSION OF VOICE MESSAGES BY TELEPHONE; MOBILE DEVICE COMMUNICATION SERVICES; TELEPHONE VOICE AND DATA MESSAGING SERVICES; RADIO PAGING AND ELECTRONIC MAIL SERVICES; TRANSMISSION AND RECEPTION OF DATA AND INFORMATION BY RADIO OR SATELLITE; TRANSFER OF DATA BY TELECOMMUNICATION; SATELLITE COMMUNICATION SERVICES; ADVISORY, CONSULTANCY AND INFORMATION SERVICES ALL RELATING TO THE AFORESAID (U.S. CLS. 100, 101 AND 104).

CLASS 42—SCIENTIFIC AND COMPUTER SERVICES

FOR SCIENTIFIC RESEARCH AND TECHNOLOGICAL SERVICES, NAMELY, TECHNOLOGY CONSULTATION IN THE FIELD OF MOBILE COMMUNICATIONS; AND SCIENTIFIC RESEARCH AND DESIGN RELATING THERETO; INDUSTRIAL DESIGN ANALYSIS AND SCIENTIFIC RESEARCH SERVICES; DESIGN AND DEVELOPMENT OF COMPUTERS AND SOFTWARE FOR OTHERS; RECONSTRUCTION OF DATABASES; CREATION AND MAINTENANCE OF WEBPAGES FOR OTHERS; LEGAL SERVICES; ENGINEERING SERVICES PROVIDED BY ENGINEERS DEALING WITH APPRAISALS, VALUATIONS, RESEARCH AND REPORTS IN THE SCIENTIFIC AND TECHNOLOGICAL FIELDS; COMPUTER PROGRAMMING FOR OTHERS; CONSULTANCY, DESIGN, TESTING, RESEARCH AND ADVISORY SERVICES, ALL RELATING TO COMPUTING AND COMPUTER PROGRAMMING; COMPUTER SYSTEMS ANALYSIS; RESEARCH AND DEVELOPMENT OF COMPUTER HARDWARE AND SOFTWARE, TELECOMMUNICATIONS APPARATUS AND INSTRUMENTS; TECHNICAL SUPPORT SERVICES, NAMELY MONITORING OF NETWORK SYSTEMS RELATING TO COMPUTERS, COMPUTER SOFTWARE, TELECOMMUNICATIONS APPARATUS AND INSTRUMENTS AND TELECOMMUNICATION SERVICES; RENTAL AND LEASING OF COMPUTER AND MOBILE COMMUNICATION APPARATUS AND INSTRUMENTS; PROVIDING AN ONLINE COMPUTER DATABASE IN THE FIELD OF COMPUTERS; COMPUTER SOFTWARE DESIGN FOR OTHERS; ADVISORY, CONSULTANCY AND INFORMATION SERVICES ALL RELATING TO THE AFORESAID (U.S. CLS. 100 AND 101).

CYNTHIA SLOAN, EXAMINING ATTORNEY

SN 78-397,152. SONY NETSERVICES GMBH, ANIF, AUSTRIA, FILED 4-6-2004.



PRIORITY CLAIMED UNDER SEC. 44(D) ON ERPN CMNTY TM OFC APPLICATION NO. 003402641, FILED 10-6-2003, REG. NO. 003402641, DATED 3-11-2005, EXPIRES 10-6-2013.

THE MARK COMPRISES A CIRCLE DESIGN IN COMBINATION WITH A WAVE DESIGN.

CLASS 9—ELECTRICAL AND SCIENTIFIC APPARATUS

FOR APPARATUS FOR RECORDING, TRANSMISSION OR REPRODUCTION OF SOUND OR IMAGES, NAMELY, COMPUTERS AND OTHER MEMORY BASED PLAYER DEVICES, NAMELY, MP3 PLAYERS, PERSONAL DIGITAL ASSISTANTS, ELECTRONIC ORGANIZERS, DATA PROCESSING DEVICES, TELEPHONES, CELLULAR TELEPHONES, VIDEO GAMING DEVICES, SET TOP BOXES, RADIOS, DIGITAL RADIOS, ANALOG AND/OR DIGITAL RECEIVERS, DIGITAL CAMERAS AND DIGITAL VIDEO CAMERAS; DATA PROCESSING EQUIPMENT, NAMELY, SET TOP BOXES AND HANDHELD DEVICES FOR PROVIDING ACCESS TO AUDIO AND VIDEO CONTENT, GAMES AND INFORMATION AND FOR THE CREATION AND MANAGEMENT OF PERSONAL AND BUSINESS INFORMATION AND MULTIMEDIA CONTENT; COMPUTER HARDWARE AND COMPUTER SOFTWARE FOR PROVIDING ACCESS TO AUDIO AND VIDEO CONTENT, GAMES AND INFORMATION AND FOR THE CREATION AND MANAGEMENT OF PERSONAL AND BUSINESS INFORMATION AND MULTIMEDIA CONTENT (U.S. CLS. 21, 23, 26, 36 AND 38).

CLASS 16—PAPER GOODS AND PRINTED MATTER

FOR PAPER, CARDBOARDS AND GOODS MADE FROM THESE MATERIALS, NAMELY, BOXES, TAGS, STICKERS, BAGS, POUCHES, SLEEVES, COVERS, WRAPPERS; PRINTED MATTER, NAMELY, FORMS, PAMPHLETS, GUIDES, BROCHURES, PAPER LABELS, MANUALS, TABLES, BOOKLETS, MAGAZINES, ALL RELATED TO ENTERTAINMENT, FILM, SPORT, MUSIC, GAMES, COMPUTERS, MEDIA AND/OR LIFESTYLE (U.S. CLS. 2, 5, 22, 23, 29, 37, 38 AND 50).

CLASS 41—EDUCATION AND ENTERTAINMENT

FOR ENTERTAINMENT SERVICES, NAMELY, PROVIDING MUSIC, PICTURE, VIDEO, GAMES, NEWS SERVICES AND INFORMATION RELATING TO ENTERTAINMENT, MUSIC, PICTURES, VIDEO, MOVIES, TELEVISION, GAMES, CELEBRITIES AND CURRENT EVENTS AND ENTERTAINMENT NEWS; PROVIDING INFORMATION IN THE FIELD OF ENTERTAINMENT RELATING SPECIFICALLY TO MUSIC, MOVIES, TELEVISION, GAMES, CELEBRITIES AND CURRENT EVENT AND ENTERTAINMENT NEWS (U.S. CLS. 100, 101 AND 107).

SN 78-395,142. TANEJA, INC., MOUNTAIN VIEW, CA. FILED 4-1-2004.

PASSAGE TO INDIA

THE MARK CONSISTS OF STANDARD CHARACTERS WITHOUT CLAIM TO ANY PARTICULAR FONT, STYLE, SIZE, OR COLOR.

APPLICANT CLAIMS THE EXCLUSIVE RIGHT TO USE THE MARK IN THE AREA COMPRISING THE GEOGRAPHIC AREA WEST OF THE MISSISSIPPI RIVER, NAMELY, THE STATES OF ALASKA, ARIZONA, CALIFORNIA, ARKANSAS, COLORADO, IDAHO, MONTANA, WYOMING, NEW MEXICO, NEVADA, OREGON, MINNESOTA, TEXAS, OKLAHOMA, NEBRASKA, UTAH, NORTH DAKOTA, SOUTH DAKOTA, HAWAII, WASHINGTON, IOWA, KANSAS, MISSOURI AND LOUISIANA.

CLASS 30—STAPLE FOODS

FOR BAKERY DESSERTS; BAKERY GOODS; BAKERY PRODUCTS; CAKES; PASTRIES; COOKIES; PIZZA; SWEETS SUBSTANTIALLY CONSISTING OF FLOUR, SUGAR, MILK, NUTS, RAISINS, CARDAMOM SEEDS, PISTACHIOS, ALMONDS, AND CANDIES; BREADS AND ROLLS; SPRING ROLLS; SANDWICHES, NAMELY, HAMBURGER, KABAB SANDWICHES, VEGETABLE WRAPS, CHICKEN WRAPS, TURKEY WRAPS AND LAMB WRAPS; ICE CREAM; SNACKS, NAMELY, SAMOSAS (U.S. CL. 46).

FIRST USE 6-1-2002; IN COMMERCE 6-1-2002.

CLASS 43—HOTEL AND RESTAURANT SERVICES

FOR RESTAURANT AND BAR SERVICES; CARRY-OUT RESTAURANT SERVICES; CATERING (U.S. CLS. 100 AND 101).

FIRST USE 1-1-1989; IN COMMERCE 1-1-1989. PAULA MAHONEY, EXAMINING ATTORNEY

CLASS 42—SCIENTIFIC AND COMPUTER SERVICES

FOR SCIENTIFIC AND TECHNOLOGICAL SERVICES, NAMELY, RESEARCH AND DEVELOPMENT FOR NEW PRODUCTS AND/OR SERVICES; TECHNICAL CONSULTING AND RESEARCH IN THE FIELD OF NETWORK DESIGN, NAMELY, WIRELESS PRODUCTS AND/OR SERVICES; DESIGN AND TESTING OF NEW PRODUCTS AND/OR SERVICES (U.S. CLS. 100 AND 101).

KATHRYN COWARD, EXAMINING ATTORNEY

SN 78-518,927. ADMINISTRADORA DE MARCAS RD, S. DE R.L. DE C.V., C.P. 11320, MEXICO, D.F., MEXICO, FILED 11-17-2004.

DIRECTO DE TELCEL

SN 78-490,319. THE NEW YORK TIMES COMPANY, NEW YORK, NY. FILED 9-27-2004.

THE NEW YORK TIMES

THE MARK CONSISTS OF STANDARD CHARACTERS WITHOUT CLAIM TO ANY PARTICULAR FONT, STYLE, SIZE, OR COLOR.

PRIORITY CLAIMED UNDER SEC. 44(D) ON MEXICO APPLICATION NO. 684929, FILED 10-28-2004, REG. NO. 860668, DATED 10-28-2004, EXPIRES 10-28-2014.

OWNER OF MEXICO REG. NO. 859988, DATED 10-28-2004, EXPIRES 10-28-2014.

OWNER OF MEXICO REG. NO. 870859, DATED 10-28-2004, EXPIRES 10-28-2014.

OWNER OF MEXICO REG. NO. 859517, DATED 10-28-2004, EXPIRES 10-28-2014.

OWNER OF MEXICO REG. NO. 860666, DATED 10-28-2004, EXPIRES 10-28-2014.

OWNER OF MEXICO REG. NO. 860667, DATED 10-28-2004, EXPIRES 10-28-2014.

OWNER OF U.S. REG. NO. 1,474,007.

THE ENGLISH TRANSLATION OF THE WORD "DIRECTO DE" IN THE MARK IS "DIRECT OF".

CLASS 9—ELECTRICAL AND SCIENTIFIC APPARATUS

FOR TELECOMMUNICATION PRODUCTS, NAMELY, TELEPHONES, CELLULAR TELEPHONES AND TELEPHONE ANSWERING MACHINES; APPARATUS FOR RECORDING, TRANSMISSION REPRODUCTION OF SOUND OR IMAGES, NAMELY, PHONOGRAPH RECORDS, CD AND DVD PLAYERS, AUDIO AND VIDEO TAPE RECORDERS; BLANK AUDIO AND VIDEO TAPES AND CDS; STEREO RECEIVERS, AMPLIFIERS, AND TUNERS; BLANK MAGNETIC DATA CARRIERS, DATA PROCESSORS AND COMPUTERS; COMPUTER HARDWARE, NAMELY, MEMORY CARDS, MODEMS, COMPUTER INTERFACE BOARDS, BLANK MAGNETIC COMPUTER TAPES, FAX MACHINES, FIBER OPTIC CABLES, COMPUTER AND ELECTRIC CABLES, OPTICAL CHARACTER RECOGNITION APPARATUS, BLANK OPTICAL DISCS, OPTICAL SCANNERS, MAGNETIC CODED CARDS FOR PREPAID TELECOMMUNICATIONS SERVICES; SATELLITES, BLANK DIGITAL OPTICAL DISCS, COMPUTER KEYBOARDS, PROCESS COMPUTERS, COMPUTERS FOR DATA AND WORD PROCESSING, COMPUTER TERMINALS, COMPUTER PRINTERS, COMPUTER MONITORS, INTEGRATED CIRCUITS AND COMPONENTS, NAMELY, COMPUTER CHIPS; ELECTRONIC CIRCUIT BOARDS, ELECTRONIC NOTICE BOARDS, INTEGRATED CIRCUIT CARDS (U.S. CLS. 21, 23, 26, 36 AND 38).

THE MARK CONSISTS OF STANDARD CHARACTERS WITHOUT CLAIM TO ANY PARTICULAR FONT, STYLE, SIZE, OR COLOR.

OWNER OF U.S. REG. NOS. 227,904 AND 2,120,865. SEC. 2(F).

CLASS 35—ADVERTISING AND BUSINESS

FOR ONLINE AND RETAIL BOOKSTORE SERVICES, FEATURING, AMONG OTHER THINGS, BOOKS, MAGAZINES, AND GENERAL GIFTWARE ITEMS (U.S. CLS. 100, 101 AND 102).

CLASS 43—HOTEL AND RESTAURANT SERVICES

FOR CAFE AND RESTAURANT SERVICES (U.S. CLS. 100 AND 101).

REBECCA SMITH, EXAMINING ATTORNEY

CLASS 16—PAPER GOODS AND PRINTED MATTER

FOR ADVERTISEMENT BOARDS OF PAPER OR CARDBOARD; PHOTO ALBUMS; BINDERS; BOOK BINDINGS; BOOKLETS RELATED TO TELECOMMUNICATIONS SERVICES; BOOK MARKERS; BOOKS RELATED TO TELECOMMUNICATIONS SERVICES; BOXES OF CARDBOARD OR PAPER; CALENDARS; CARDBOARD PACKAGING AND PRODUCTS MADE OF THIS MATERIAL, NAMELY, CARDBOARD ROLLS TO WHICH ADVERTISING MATERIAL IS ADHERED AND CARDBOARD STRUCTURES ON WHICH ADVERTISING MATERIAL IS PLACED; CATALOGS RELATED TO TELECOMMUNICATIONS PRODUCTS AND SERVICES; COASTERS OF PAPER DECALCOMANIA; ENVELOPES; FOUNTAIN PENS; GREETING CARDS; HANDBOOKS RELATED TO TELECOMMUNICATIONS PRODUCTS AND SERVICES; ADHESIVE LABELS; MANUALS IN CONNECTION WITH TELECOMMUNICATIONS PRODUCTS; NEWSPAPERS FOR GENERAL CIRCULATION; OFFICE SUPPLIES, NAMELY, ENVELOPES AND FOLDERS; PACKING PAPER BOND PAPER, PAPER SHEETS; PEN CASES; PENS; PENCILS; POSTCARDS; POSTERS; PRINTING BLOCKS; PRINTED PUBLICATIONS, NAMELY, BOOKS MAGAZINES, PAMPHLETS AND INSTRUCTIONAL MANUALS IN THE FIELD OF TELECOMMUNICATIONS; FLYERS, POSTERS, BOARDS OF PAPER OR CARDBOARD RELATED TO TELECOMMUNICATIONS PRODUCTS AND SERVICES; STATIONERY; STICKERS; WRITING PADS; WRITING PAPER (U.S. CLS. 2, 5, 22, 23, 29, 37, 38 AND 50).

CLASS 25—CLOTHING

FOR CLOTHING, NAMELY, SHIRTS, TROUSERS, BLOUSES, SKIRTS, PANTS, COATS AND JACKETS; FOOTWEAR, HEADGEAR, NAMELY, HATS, CAPS AND VISORS (U.S. CLS. 22 AND 39).

CLASS 35—ADVERTISING AND BUSINESS

FOR ADVERTISING, ADVERTISING BY MAIL, DISSEMINATION OF ADVERTISEMENT MATERIAL, BUSINESS INFORMATION RELATED TO TELECOMMUNICATIONS SERVICES, BUSINESS INFORMATION IN CONNECTION WITH TELECOMMUNICATIONS PRODUCTS AND SERVICES, BUSINESS MANAGEMENT, DEMONSTRATION OF PRODUCTS, ORGANIZING EXHIBITIONS IN THE FIELD OF TELECOMMUNICATIONS PRODUCTS AND SERVICES; RETAIL STORE SERVICES FEATURING GOODS RELATED TO CELLULAR TELEPHONES; TRACKING, LOCATING AND MONITORING OF VEHICLES FOR COMMERCIAL PURPOSES (U.S. CLS. 100, 101 AND 102).

CLASS 38—COMMUNICATION

FOR TELECOMMUNICATION SERVICES, NAMELY, PERSONAL COMMUNICATION SERVICES; TELE-MATIC SERVICES, NAMELY, TELECOMMUNICATION SERVICES, NAMELY, PROVISION OF MOBILE TELECOMMUNICATIONS SERVICES, NAMELY, VOICE AND DATA TRANSMISSIONS, ACCESSIBLE BY ACCESS CODE OR TERMINALS, TELEPHONE, TELEVISION, RADIO AND DATA TRANSMISSIONS ACCESSIBLE BY ACCESS CODE OR TERMINALS, TELEPHONE, TELEVISION, RADIO AND TELEPRINTER; ELECTRONIC TRANSMISSION OF MESSAGES AND CODED IMAGES; ELECTRONIC TRANSMISSION OF MESSAGE AND DATA; WIRELESS DIGITAL MESSAGING SERVICES, ELECTRONIC STORE-AND-FORWARD MESSAGING, ELECTRONIC TRANSMISSION OF DATA AND DOCUMENTS VIA COMPUTER TERMINALS, COMPUTER TELECOMMUNICATIONS, NAMELY, PROVIDING MULTIPLE USER ACCESS TO THE INTERNET; FACSIMILE TRANSMISSION, ELECTRONIC MAIL SERVICES, TELEPHONE COMMUNICATION SERVICES (U.S. CLS. 100, 101 AND 104).

CLASS 41—EDUCATION AND ENTERTAINMENT

FOR EDUCATIONAL SERVICES, NAMELY, CONDUCTING SEMINARS, CONFERENCES, WORKSHOPS, IN THE FIELD OF TELECOMMUNICATIONS SERVICES; ENTERTAINMENT, NAMELY, CONTEST RAFFLES AND COMPETITIONS IN THE FIELD OF TELECOMMUNICATIONS; PROVIDING INFORMATION IN THE FIELD OF ENTERTAINMENT, RECREATION AND EDUCATION (U.S. CLS. 100, 101 AND 107).
ESTHER A. BORSUK, EXAMINING ATTORNEY

SN 78-519,113. ADMINISTRADORA DE MARCAS RD, S. DE R.L. DE C.V., MEXICO, D.F., MEXICO, FILED 11-18-2004.

DIRECTO IDEAS

THE MARK CONSISTS OF STANDARD CHARACTERS WITHOUT CLAIM TO ANY PARTICULAR FONT, STYLE, SIZE, OR COLOR.

PRIORITY CLAIMED UNDER SEC. 44(D) ON MEXICO APPLICATION NO. 684905, FILED 10-28-2004, REG. NO. 859984, DATED 10-28-2004, EXPIRES 10-28-2014.

OWNER OF MEXICO REG. NO. 859979, DATED 10-28-2004, EXPIRES 10-28-2014.

OWNER OF MEXICO REG. NO. 859980, DATED 10-28-2004, EXPIRES 10-28-2014.

OWNER OF MEXICO REG. NO. 859981, DATED 10-28-2004, EXPIRES 10-28-2014.

OWNER OF MEXICO REG. NO. 859982, DATED 10-28-2004, EXPIRES 10-28-2014.

OWNER OF MEXICO REG. NO. 859983, DATED 10-28-2004, EXPIRES 10-28-2014.

THE ENGLISH TRANSLATION OF THE WORD "DIRECTO" IN THE MARK IS "DIRECT".

CLASS 9—ELECTRICAL AND SCIENTIFIC APPARATUS

FOR TELECOMMUNICATION PRODUCTS, NAMELY, TELEPHONES, CELLULAR TELEPHONES AND TELEPHONE ANSWERING MACHINES; APPARATUS FOR RECORDING, TRANSMISSION, REPRODUCTION OF SOUND OR IMAGES, NAMELY, PHONOGRAPH RECORDS, CD AND DVD PLAYERS, AUDIO AND VIDEO TAPE RECORDERS; BLANK AUDIO AND VIDEO TAPES AND CDS; STEREO RECEIVERS, AMPLIFIERS, AND TUNERS; BLANK MAGNETIC DATA CARRIERS, DATA PROCESSORS AND COMPUTERS; COMPUTER HARDWARE, NAMELY, MEMORY CARDS, MODEMS, COMPUTER INTERFACE BOARDS, BLANK MAGNETIC COMPUTER TAPES, FAX MACHINES, FIBER OPTIC CABLES, COMPUTER AND ELECTRIC CABLES, OPTICAL CHARACTER RECOGNITION APPARATUS, BLANK OPTICAL DISCS, OPTICAL SCANNERS, MAGNETIC CODED CARDS FOR PREPAID TELECOMMUNICATIONS SERVICES; SATELLITES, BLANK DIGITAL OPTICAL DISCS, COMPUTER KEYBOARDS, PROCESS COMPUTERS, COMPUTERS FOR DATA AND WORD PROCESSING, COMPUTER TERMINALS, COMPUTER PRINTERS, COMPUTER MONITORS, INTEGRATED CIRCUITS AND COMPONENTS, NAMELY, COMPUTER CHIPS; ELECTRONIC CIRCUIT BOARDS, ELECTRONIC NOTICE BOARDS, INTEGRATED CIRCUIT CARDS (U.S. CLS. 21, 23, 26, 36 AND 38).

CLASS 16—PAPER GOODS AND PRINTED MATTER

FOR ADVERTISEMENT BOARDS OF PAPER OR CARDBOARD; PHOTO ALBUMS; BINDERS; BOOK BINDINGS; BOOKLETS RELATED TO TELECOMMUNICATIONS SERVICES; BOOK MARKERS; BOOKS RELATED TO TELECOMMUNICATIONS SERVICES; BOXES OF CARDBOARD OR PAPER; CALENDARS; CARDBOARD PACKAGING AND PRODUCTS MADE OF THIS MATERIAL, NAMELY, CARDBOARD ROLLS TO WHICH ADVERTISING MATERIAL IS ADHERED AND CARDBOARD STRUCTURES ON WHICH ADVERTISING MATERIAL IS PLACED; CATALOGS RELATED TO TELECOMMUNICATIONS PRODUCTS AND SERVICES; COASTERS OF PAPER DECALCOMANIA; ENVELOPES; FOUNTAIN PENS; GREETING CARDS; HANDBOOKS RELATED TO TELECOMMUNICATIONS PRODUCTS AND SERVICES; ADHESIVE LABELS; MANUALS IN CONNECTION WITH TELECOMMUNICATIONS PRODUCTS; NEWSPAPERS FOR GENERAL CIRCULATION; OFFICE SUPPLIES, NAMELY, ENVELOPES AND FOLDERS; PACKING PAPER BOND PAPER, PAPER SHEETS; PEN CASES; PENS; PENCILS; POSTCARDS; POSTERS; PRINTING BLOCKS; PRINTED PUBLICATIONS, NAMELY, BOOKS MAGAZINES, PAMPHLETS AND INSTRUCTIONAL MANUALS IN THE FIELD OF TELECOMMUNICATIONS; FLYERS, POSTERS, BOARDS OF PAPER OR CARDBOARD RELATED TO TELECOMMUNICATIONS PRODUCTS AND SERVICES; STATIONERY; STICKERS; WRITING PADS; WRITING PAPER (U.S. CLS. 2, 5, 22, 23, 29, 37, 38 AND 50).

CLASS 25—CLOTHING

FOR CLOTHING, NAMELY, SHIRTS, TROUSERS, BLOUSES, SKIRTS, PANTS, COATS, AND JACKETS; FOOTWEAR, HEADGEAR, NAMELY, HATS, CAPS AND VISORS (U.S. CLS. 22 AND 39).

CLASS 35—ADVERTISING AND BUSINESS

FOR ADVERTISING, ADVERTISING BY MAIL, DISSEMINATION OF ADVERTISEMENT MATERIAL, BUSINESS INFORMATION RELATED TO TELECOMMUNICATIONS SERVICES, BUSINESS INFORMATION IN CONNECTION WITH TELECOMMUNICATIONS PRODUCTS AND SERVICES, BUSINESS MANAGEMENT, DEMONSTRATION OF PRODUCTS, ORGANIZING EXHIBITIONS IN THE FIELD OF TELECOMMUNICATIONS PRODUCTS AND SERVICES; RETAIL STORE SERVICES FEATURING GOODS RELATED TO CELLULAR TELEPHONES; TRACKING, LOCATING AND MONITORING OF VEHICLES FOR COMMERCIAL PURPOSES (U.S. CLS. 100, 101 AND 102).

CLASS 38—COMMUNICATION

FOR TELECOMMUNICATION SERVICES, NAMELY, PERSONAL COMMUNICATION SERVICES; TELE-MATIC SERVICES, NAMELY, TELECOMMUNICATION SERVICES, NAMELY, PROVISION OF MOBILE TELECOMMUNICATIONS SERVICES, NAMELY, VOICE AND DATA TRANSMISSIONS, ACCESSIBLE BY ACCESS CODE OR TERMINALS, TELEPHONE, TELEVISION, RADIO AND DATA TRANSMISSIONS ACCESSIBLE BY ACCESS CODE OR TERMINALS, TELEPHONE, TELEVISION, RADIO AND TELEPRINTER; ELECTRONIC TRANSMISSION OF MESSAGES AND CODED IMAGES; ELECTRONIC TRANSMISSION OF MESSAGE AND DATA; WIRELESS DIGITAL MESSAGING SERVICES, ELECTRONIC STORE-AND-FORWARD MESSAGING, ELECTRONIC TRANSMISSION OF DATA AND DOCUMENTS VIA COMPUTER TERMINALS, COMPUTER TELECOMMUNICATIONS, NAMELY, PROVIDING MULTIPLE USER ACCESS TO THE INTERNET; FACSIMILE TRANSMISSION, ELECTRONIC MAIL SERVICES, TELEPHONE COMMUNICATION SERVICES (U.S. CLS. 100, 101 AND 104).

CLASS 41—EDUCATION AND ENTERTAINMENT

FOR EDUCATIONAL SERVICES, NAMELY, CONDUCTING SEMINARS, CONFERENCES, WORKSHOPS, IN THE FIELD OF TELECOMMUNICATIONS SERVICES; ENTERTAINMENT, NAMELY, CONTEST RAFFLES AND COMPETITIONS IN THE FIELD OF TELECOMMUNICATIONS; PROVIDING INFORMATION IN THE FIELD OF ENTERTAINMENT, RECREATION AND EDUCATION (U.S. CLS. 100, 101 AND 107).
ESTHER A. BORSUK, EXAMINING ATTORNEY

SN 78-545,310. DANIEL F. YOUNG, INCORPORATED, JERSEY CITY, NJ. FILED 1-11-2005.

DF Young

THE MARK CONSISTS OF STANDARD CHARACTERS WITHOUT CLAIM TO ANY PARTICULAR FONT, STYLE, SIZE, OR COLOR.

THE NAME SHOWN IN THE MARK DOES NOT IDENTIFY A PARTICULAR LIVING INDIVIDUAL.

CLASS 35—ADVERTISING AND BUSINESS

FOR COST PRICE ANALYSIS; COMPUTERIZED DATABASE MANAGEMENT; RELOCATION SERVICES FOR BUSINESSES; NEGOTIATION AND SETTLEMENT OF COMMERCIAL TRANSACTIONS FOR THIRD PARTIES; DIRECT MAIL ADVERTISING; CUSTOMS CLEARANCE SERVICES FOR THIRD PARTIES; COMPUTERIZED TRACKING AND TRACING OF PACKAGES IN TRANSIT VIA THE INTERNET; INFORMATION MANAGEMENT SERVICES, NAMELY, SHIPMENT ORDER PROCESSING AND TRACKING DOCUMENTS, PACKAGES AND FREIGHT OVER THE INTERNET; TRANSPORTATION LOGISTICS SERVICES, NAMELY, PLANNING AND SCHEDULING SHIPMENTS FOR USERS OF TRANSPORTATION SERVICES; DATA PROCESSING SERVICES AND CONSULTATION RELATING THERETO (U.S. CLS. 100, 101 AND 102).
FIRST USE 7-1-1903; IN COMMERCE 7-1-1903.

CLASS 36—INSURANCE AND FINANCIAL

FOR INSURANCE BROKERAGE SERVICES IN THE FIELD OF TRANSPORTATION; CUSTOMS BROKERAGE SERVICES FOR THIRD PARTIES; ELECTRONIC PAYMENT SERVICES, NAMELY, ELECTRONIC PROCESSING AND TRANSMISSION OF BILL PAYMENT DATA; MONETARY EXCHANGE SERVICES; REAL ESTATE BROKERAGE SERVICES (U.S. CLS. 100, 101 AND 102).
FIRST USE 7-1-1903; IN COMMERCE 7-1-1903.

CLASS 38—COMMUNICATION

FOR (BASED ON INTENT TO USE) TELECOMMUNICATION ACCESS SERVICES; TECHNICAL CONSULTATION SERVICES IN THE FIELD OF TELECOMMUNICATIONS (U.S. CLS. 100, 101 AND 104).

CLASS 39—TRANSPORTATION AND STORAGE

SN 78-570,300. KHAN S.R.L., LUISAGO (COMO), ITALY, FILED 2-18-2005.

FOR PROVIDING A COMPUTERIZED DATABASE IN THE FIELDS OF FREIGHT FORWARDING, STORAGE AND SHIPMENT STATUS; TRANSPORTATION OF GOODS AND WARES VIA MOTOR VEHICLES, AUTOMOBILES, TRUCKS, RAILROADS, SHIPS AND AIRPLANES; WAREHOUSING SERVICES, NAMELY, STORAGE AND PACKING FOR SHIPMENT OF GOODS FOR OTHERS; TRANSPORTATION INFORMATION; FREIGHT BROKERAGE SERVICES; UNLOADING CARGO; WAREHOUSE STORAGE INFORMATION; COURIER SERVICES; SUPPLY CHAIN, LOGISTICS AND REVERSE LOGISTICS SERVICES, NAMELY, STORAGE, TRANSPORTATION AND DELIVERY OF DOCUMENTS, PARCELS, PACKETS, LETTERS AND PALLETS FOR OTHERS BY AIR, RAIL, SHIP OR TRUCK; WAREHOUSING SERVICES; RENTAL OF WAREHOUSE SPACE; RENTAL OF WAREHOUSE STORAGE CONTAINERS; ELECTRONIC STORAGE OF DATA FOR OTHERS; PROVIDING AN ON-LINE COMPUTER DATABASE IN THE FIELD OF TRANSPORTATION (U.S. CLS. 100 AND 105).

FIRST USE 7-1-1903; IN COMMERCE 7-1-1903.



OWNER OF ITALY REG. NO. 1043398, DATED 4-2-2007, EXPIRES 1-19-2015.

OWNER OF ITALY REG. NO. 00908495, DATED 9-22-2003, EXPIRES 5-23-2013.

OWNER OF ITALY REG. NO. 927557, DATED 4-20-2004, EXPIRES 1-9-2014.

OWNER OF U.S. REG. NO. 1,909,636.

"MANOUKIAN" AND "ARGON" HAS NO SIGNIFICANCE IN THE RELEVANT TRADE AND NO GEOGRAPHICAL SIGNIFICANCE OR MEANING IN A FOREIGN LANGUAGE.

CLASS 40—MATERIAL TREATMENT

FOR (BASED ON INTENT TO USE) ELECTRONIC IMAGING, SCANNING, DIGITALIZING, ALTERATION AND RETOUCHING OF PHOTOGRAPHIC IMAGES; DIGITAL COMPRESSION OF COMPUTER DATA (U.S. CLS. 100, 103 AND 106).

CLASS 1—CHEMICALS

FOR CHEMICALS, EMULSIFIERS, AND ADHESIVES USED IN THE MANUFACTURE OF PHOTSENSITIVE EMULSIONS, INKS, VARNISHES, LACQUERS, PASTES, DETERGENTS, DEGREASERS AND STRIPPERS TO BE USED IN THE TEXTILE INDUSTRY, PRINTING INDUSTRY AND GRAPHIC INDUSTRY (U.S. CLS. 1, 5, 6, 10, 26 AND 46).

CLASS 2—PAINTS

FOR PAINTS, VARNISHES AND LACQUERS, FOR SCREEN PRINTING, GRAPHIC ART DESIGN AND FOR TEXTILE PRINTING; PRINTING INKS; INKS FOR TEXTILE PRINTING; AND SUBLIMATION INKS FOR OFFSET, DIGITAL AND SCREEN PRINTING; PHOTSENSITIVE EMULSIONS FOR THE PREPARATION OF SCREENS FOR TEXTILE AND GRAPHIC PRINTS (U.S. CLS. 6, 11 AND 16).

CLASS 7—MACHINERY

FOR MACHINES FOR THE PRODUCTION OF PAINTS, VARNISHES, LACQUERS, INKS (U.S. CLS. 13, 19, 21, 23, 31, 34 AND 35).

CLASS 42—SCIENTIFIC AND COMPUTER SERVICES

FOR (BASED ON INTENT TO USE) DEVELOPING, UPDATING AND DESIGN OF COMPUTER SOFTWARE; DATA ADMINISTRATIONS OF SERVERS, NAMELY, DISPLAYING THE WEBSITES AND IMAGES OF OTHERS ON A COMPUTER SERVER; TECHNICAL CONSULTATIONS IN THE FIELD OF COMPUTER SOFTWARE; UPDATING AND INSTALLATION OF COMPUTER SOFTWARE; COMPUTER SERVICES, NAMELY, THE PROVIDING OF SEARCH ENGINES FOR OBTAINING DATA ON A GLOBAL COMPUTER NETWORK; COMPUTER SERVICES, NAMELY, CREATING INDEXES OF INFORMATION, WEBSITES AND OTHER RESOURCES AVAILABLE ON COMPUTER NETWORKS (U.S. CLS. 100 AND 101).

COLLEEN DOMBROW, EXAMINING ATTORNEY

CLASS 9—ELECTRICAL AND SCIENTIFIC APPARATUS

FOR TINTING PLANTS AND MIXING SYSTEMS COMPRISED OF MEASURING SCALES, COMPUTER HARDWARE FOR STORING RECEIPT DATA AND COLORS INFORMATION, AND APPARATUS AND INSTRUMENTS FOR MEASURING COLOR, NAMELY HANDHELD OR DESKTOP SPECTROPHOTOMETERS; COMPUTER OPERATING SOFTWARE OF EMBEDDED FIRMWARE FOR TINTING PLANTS, MIXING SYSTEMS, STORAGE SYSTEMS, HANDHELD OR DESKTOP SPECTROPHOTOMETERS, COLOR PROOFING, COLOR MATCHING AND COLOR CALIBRATION (COLOR PROFILE SYSTEMS - ICC); FEEDING UNITS FOR PLOTTERS AND DIGITAL PRINTERS AND AUTOMATING INKS FEEDING SYSTEMS WITH EMBEDDED MANAGEMENT SOFTWARE (U.S. CLS. 21, 23, 26, 36 AND 38).

CLASS 11—ENVIRONMENTAL CONTROL APPARATUS

FOR STEAM HEATING APPARATUS AND DRYERS FOR TEXTILE INDUSTRY, PRINTING INDUSTRY AND GRAPHIC INDUSTRY (U.S. CLS. 13, 21, 23, 31 AND 34).

CLASS 16—PAPER GOODS AND PRINTED MATTER

FOR PAPER FOR SCREEN PRINTING AND FOR SUBLIMATION DIGITAL PRINTING (U.S. CLS. 2, 5, 22, 23, 29, 37, 38 AND 50).

CLASS 35—ADVERTISING AND BUSINESS

FOR ADVERTISING AND BUSINESS MANAGEMENT CONSULTANCY IN THE FIELD OF THE PRINTING INDUSTRY; RETAIL STORE SERVICES FEATURING PAINTS, VARNISHES, LACQUERS AND INKS (U.S. CLS. 100, 101 AND 102).

CLASS 41—EDUCATION AND ENTERTAINMENT

FOR PROVIDING OF TRAINING IN THE FIELD OF PRINTING (U.S. CLS. 100, 101 AND 107).

CLASS 42—SCIENTIFIC AND COMPUTER SERVICES

FOR RESEARCH, DEVELOPMENT, PLANNING AND DESIGNING OF NEW INNOVATIVE SYSTEMS AND PRODUCTS FOR OTHERS IN THE PRINTING INDUSTRY (U.S. CLS. 100 AND 101).
TRACY CROSS, EXAMINING ATTORNEY

CLASS 42—SCIENTIFIC AND COMPUTER SERVICES

FOR PIPELINE INSPECTION, PIPELINE LOCATING, PIPELINE TRACING, DYE TESTING OF PIPES AND SEWER SYSTEMS (U.S. CLS. 100 AND 101).
FIRST USE 11-1-1986; IN COMMERCE 11-1-1986.
ALICE BENMAMAN, EXAMINING ATTORNEY

SN 78-577,730. ARM LIMITED, CAMBRIDGE, ENGLAND, FILED 3-1-2005.

SN 78-577,183. DRAIN BUSTERS, INC., GARFIELD, NJ. FILED 3-1-2005.

TRUSTZONE

DRAINBUSTERS

THE MARK CONSISTS OF STANDARD CHARACTERS WITHOUT CLAIM TO ANY PARTICULAR FONT, STYLE, SIZE, OR COLOR.

THE MARK CONSISTS OF STANDARD CHARACTERS WITHOUT CLAIM TO ANY PARTICULAR FONT, STYLE, SIZE, OR COLOR.

CLASS 37—CONSTRUCTION AND REPAIR

FOR RESIDENTIAL AND COMMERCIAL PLUMBING, SEWER, AND DRAIN CLEANING SERVICES, NAMELY, PIPE CLEANING, DRAIN CLEANING, SEWER JETTING, DRAIN JETTING, PIPE JETTING, DEBRIS REMOVAL FROM PIPES AND SEWER SYSTEMS, SILT REMOVAL FROM PIPES AND SEWER SYSTEMS, SCALE REMOVAL FROM PIPES AND SEWER SYSTEMS, GREASE REMOVAL FROM PIPES AND SEWER SYSTEMS, SEPTIC TANK PUMPING, SEPTIC TANK REPAIR, PIPE REPAIR, PIPE REPLACEMENT, WATER BLASTING OF PIPES AND SEWER SYSTEMS, WET ABRASIVE BLASTING OF PIPES AND SEWER SYSTEMS, CABLE SNAKING OF PIPES AND SEWER SYSTEMS, ROOT CONTROL OF PIPES AND SEWER SYSTEMS (U.S. CLS. 100, 103 AND 106).
FIRST USE 11-1-1986; IN COMMERCE 11-1-1986.

CLASS 9—ELECTRICAL AND SCIENTIFIC APPARATUS

FOR COMPUTER HARDWARE, NAMELY, SECURE INTEGRATED CIRCUITS; SECURE MICROPROCESSORS; AND SECURE MICROPROCESSOR CORES, ALL INTEGRATED WITH SECURE SOFTWARE (U.S. CLS. 21, 23, 26, 36 AND 38).

CLASS 16—PAPER GOODS AND PRINTED MATTER

FOR PRINTED INSTRUCTION AND DEVELOPMENT MANUALS ALL IN THE AREA OF THE DESIGN AND DEVELOPMENT OF SECURE INTEGRATED CIRCUITS; SECURE MICROPROCESSORS; AND SECURE MICROPROCESSOR CORES (U.S. CLS. 2, 5, 22, 23, 29, 37, 38 AND 50).
DAVID C. REIHNER, EXAMINING ATTORNEY

SN 78-588,871. EHOSTAR SATELLITE, LLC, ENGLEWOOD, CO. FILED S.R. 3-16-2005; AM. P.R. 1-3-2007.

SN 78-603,802. MARTIN CAPITAL INTERNATIONAL INC., TORONTO, CANADA, FILED 4-7-2005.

DISH

THE MARK CONSISTS OF STANDARD CHARACTERS WITHOUT CLAIM TO ANY PARTICULAR FONT, STYLE, SIZE, OR COLOR.
SEC. 2(F).

CLASS 9—ELECTRICAL AND SCIENTIFIC APPARATUS

FOR COMMUNICATIONS EQUIPMENT; NAMELY, SIGNAL FREQUENCY RECEIVERS, NOT IN THE NATURE OF ANTENNAS; COMMUNICATIONS SOFTWARE, NAMELY, SYSTEM APPLICATION AND OPERATING SOFTWARE FOR RESIDENTIAL AND COMMERCIAL SATELLITE RECEIVER SYSTEMS; COMMUNICATIONS SOFTWARE, NAMELY, NETWORKING SOFTWARE FOR RESIDENTIAL AND COMMERCIAL AUDIO, VIDEO AND TELEPHONY SYSTEMS; SATELLITE RECEIVERS NOT IN THE NATURE OF ANTENNAS, ROUTERS, HUBS, CABLING, AND PLUGS, ALL FOR RESIDENTIAL AND COMMERCIAL SATELLITE RECEIVER SYSTEMS; TELEVISIONS; LOW NOISE CONVERTERS, FEED HORNS, AMPLIFIERS, ACTUATORS, MODULATORS, COAXIAL/CUSTOM CABLES, DECODERS AND ENCRYPTION EQUIPMENT ALL FOR RESIDENTIAL AND COMMERCIAL SATELLITE RECEIVER SYSTEMS; OPTIONAL/PERIPHERAL MODULES FOR RESIDENTIAL AND COMMERCIAL SATELLITE RECEIVERS, PERSONAL COMPUTER RECEIVER CARDS; TELEPHONE EXTENSION CIRCUITRY; MICRO-PROCESSOR BASED PLASTIC CARDS WHICH INTERFACE WITH/COMPRISE THE RESIDENTIAL AND COMMERCIAL SATELLITE RECEIVER SECURITY SYSTEM, SOFTWARE REFLECTING THE ON-SCREEN LISTING OF AVAILABLE PROGRAMMING, UNIVERSAL REMOTE CONTROLS FOR HOME ELECTRONIC DEVICES, NAMELY, TELEVISIONS, VCRS, DVD PLAYERS, STEREO RECEIVERS, AND STEREO AMPLIFIERS, PARTS AND FITTING FOR THE FOREMENTIONED GOODS, OPERATOR MAINTENANCE AND INSTRUCTIONAL MANUALS DISTRIBUTED THEREWITH (U.S. CLS. 21, 23, 26, 36 AND 38).

FIRST USE 3-0-1996; IN COMMERCE 3-0-1996.

CLASS 38—COMMUNICATION

FOR TELECOMMUNICATION SERVICES, NAMELY, TRANSMISSION OF VIDEO, IMAGE, VOICE, AUDIO, DATA INFORMATION VIA TELEVISION, SATELLITE, CABLE, WIRELESS, FIBER OPTICS, AUDIO AND VIDEO MEDIA AND GLOBAL COMPUTER NETWORKS; TRANSMISSION OF TELEVISION BROADCASTING SERVICES VIA COMMUNICATION SATELLITES (U.S. CLS. 100, 101 AND 104).

FIRST USE 3-0-1996; IN COMMERCE 3-0-1996.
TARAH HARDY, EXAMINING ATTORNEY

RETROPLANET

THE MARK CONSISTS OF STANDARD CHARACTERS WITHOUT CLAIM TO ANY PARTICULAR FONT, STYLE, SIZE, OR COLOR.

PRIORITY CLAIMED UNDER SEC. 44(D) ON CANADA APPLICATION NO. 1233980, FILED 10-15-2004, REG. NO. TMA700,283, DATED 11-6-2007, EXPIRES 11-6-2022.

CLASS 41—EDUCATION AND ENTERTAINMENT

FOR INDOOR AMUSEMENT COMPLEXES FEATURING ENTERTAINMENT SERVICES IN THE NATURE OF PROVIDING SPORTING FACILITIES, VIDEO GAME CENTER SERVICES, CASINO SERVICES, PROVIDING FACILITIES FOR SINGING WITH PRERECORDED BACKGROUND MUSIC AND WITH LYRICS SHOWN ON A SCREEN, PROVIDING FACILITIES FOR BILLIARDS, SHUFFLE BOARD, VIRTUAL REALITY EXPERIENCE GAMES, CARNIVAL-STYLE GAMES, ELECTRONIC GAMES AND COIN OPERATED GAME MACHINES (U.S. CLS. 100, 101 AND 107).

CLASS 43—HOTEL AND RESTAURANT SERVICES

FOR RESTAURANT AND BAR SERVICES (U.S. CLS. 100 AND 101).

MELISSA VALLILLO, EXAMINING ATTORNEY

SN 78-613,854. JULIUS BLUM GMBH, HOCHST, AUSTRIA, FILED 4-21-2005.

AVENTOS

THE MARK CONSISTS OF STANDARD CHARACTERS WITHOUT CLAIM TO ANY PARTICULAR FONT, STYLE, SIZE, OR COLOR.

THE WORDING "AVENTOS" HAS NO MEANING IN A FOREIGN LANGUAGE.

CLASS 6—METAL GOODS

FOR FITTINGS FOR KITCHEN FURNITURE, WHOLLY OR MAINLY OF COMMON METAL, NAMELY, SUPPORT ARMS, METAL HINGES AND SPRING LOADED LIFTING MECHANISMS FOR LIFTING FURNITURE LIDS AND CABINET DOORS (U.S. CLS. 2, 12, 13, 14, 23, 25 AND 50).

CLASS 20—FURNITURE AND ARTICLES NOT OTHERWISE CLASSIFIED

FOR KITCHEN FURNITURE, NAMELY, CUPBOARDS, FURNITURE DOORS AND FURNITURE LIDS WITHOUT HANDLES (U.S. CLS. 2, 13, 22, 25, 32 AND 50).
SAIMA MAKHDOOM, EXAMINING ATTORNEY

SN 78-652,725. JUSTSYSTEM CORPORATION, TOKUSHIMA-KEN, JAPAN, FILED 6-17-2005.

xfy View Designer

THE MARK CONSISTS OF STANDARD CHARACTERS WITHOUT CLAIM TO ANY PARTICULAR FONT, STYLE, SIZE, OR COLOR.

OWNER OF JAPAN REG. NO. 5015352, DATED 1-5-2007, EXPIRES 1-5-2017.

NO CLAIM IS MADE TO THE EXCLUSIVE RIGHT TO USE "DESIGNER", APART FROM THE MARK AS SHOWN.

SN 78-619,843. CONTINENTAL TEVES AG & CO OHG, FRANKFURT, FED REP GERMANY, FILED 4-29-2005.

ATE

THE MARK CONSISTS OF STANDARD CHARACTERS WITHOUT CLAIM TO ANY PARTICULAR FONT, STYLE, SIZE, OR COLOR.

OWNER OF U.S. REG. NOS. 1,231,537 AND 1,565,796.

CLASS 9—ELECTRICAL AND SCIENTIFIC APPARATUS

FOR COMPUTER PROGRAMS, NAMELY, PROGRAMS TO DESIGN, CREATE, EDIT AND PUBLISH XML AND WORD PUBLISHING DOCUMENTS; COMPUTER PROGRAMS THAT ASSIST USERS IN DESIGNING, CREATING, EDITING, PUBLISHING AND COMPLETING XML AND WORD PROCESSING DOCUMENTS; COMPUTER PROGRAMS FOR ENHANCING THE CAPABILITIES OF WEB BROWSER SOFTWARE; COMPUTER PROGRAMS FOR DEVELOPING OTHER COMPUTER PROGRAMS; COMPILER PROGRAMS, EDITOR PROGRAMS, DEBUGGER PROGRAMS AND UTILITY PROGRAMS FOR CREATING AND TESTING OTHER COMPUTER PROGRAMS, CREATING INTERNAL NETWORK AND INTERNET APPLICATIONS; COMPUTER PROGRAMS FOR ASSISTING DEVELOPERS IN CREATING PROGRAM CODE FOR USE IN MULTIPLE APPLICATION PROGRAMS, INTERNAL COMPUTER NETWORKS AND THE INTERNET; COMPUTER PROGRAMS FOR RUNNING DEVELOPMENT PROGRAMS AND APPLICATION PROGRAMS; COMPUTER PROGRAMS FOR PROVIDING ACCESS TO XML DOCUMENTS AND FOR PROVIDING MANIPULATION CAPABILITIES OF XML DOCUMENTS; COMPUTER PROGRAMS FOR CREATION, MANAGEMENT AND DEVELOPMENT OF XML SCHEMA; COMPUTER PROGRAMS FOR EDITING THE CONTENTS OF XML DOCUMENTS, TRANSFORMING THE CONTENTS OF XML DOCUMENTS THROUGH STYLE SHEETS, DEFINING THE CONTENT MODELS FOR XML DOCUMENTS IN A SCHEMA, VALIDATING XML DOCUMENTS AGAINST THEIR SCHEMAS, PROVIDING DATA EXCHANGE FUNCTIONS BETWEEN XML DOCUMENTS AND RELATIONAL DATABASES, ANALYZING THE CONTENTS OF XML DOCUMENTS TO DERIVE SCHEMAS, FINDING DATA WITHIN XML DOCUMENTS OR REPOSITORIES, AND PROVIDING ELECTRONIC FORMS FOR EDITING XML DOCUMENTS; COMPUTER PROGRAMS FOR CONNECTING TO REMOTE COMPUTERS AND COMPUTER NETWORKS VIA GLOBAL COMMUNICATIONS NETWORKS TO ALLOW THE EXCHANGE OF INFORMATION AND DATA AND THE BROWSING OF WEBSITES; COMPUTER PROGRAMS FOR SEARCHING THE CONTENTS OF REMOTE COMPUTERS AND COMPUTER NETWORKS; COMPUTER PROGRAMS FOR ACCESSING, CREATING, EDITING AND MANAGING GENERAL USE DATABASES AND TRANSFERRING DATA TO AND FROM DATABASES; ELECTRONIC SPREADSHEET SOFTWARE; COMPUTER PROGRAMS FOR USE IN WORD PROCESSING, FOR ELECTRONIC MAIL, CALENDAR AND SCHEDULING, DESKTOP PUBLISHING, IMAGE EDITING, GRAPHICS CREATION AND EDITING, DRAWING, COMPUTER AIDED DESIGN AND DRAFTING, CREATION OF MULTIMEDIA PRESENTATIONS, PROJECT MANAGEMENT, CUSTOMER MANAGEMENT, BUSINESS PLANNING, DIRECT MAIL AND BUSINESS FINANCIAL MANAGEMENT; COMPUTER PROGRAMS FOR DESIGNING, CREATING, MAINTAINING AND ACCESSING CUSTOMIZED INTERNAL NETWORK SITES AND INTERNET SITES; COMPUTER PROGRAMS FOR MEETING AND EVENT SCHEDULING AND NOTIFICATION AND FOR POSTING ANNOUNCEMENTS ON INTERNAL NETWORK SITES AND INTERNET SITES; COMPUTER PROGRAMS FOR PROVIDING EN-

CLASS 1—CHEMICALS

FOR BRAKE FLUID (U.S. CLS. 1, 5, 6, 10, 26 AND 46).
FIRST USE 0-0-1989; IN COMMERCE 0-0-1989.

CLASS 4—LUBRICANTS AND FUELS

FOR AUTOMOBILE LUBRICANTS; AUTOMOBILE CORROSION INHIBITORS IN THE NATURE OF LUBRICANTS; BRAKE CYLINDER PASTE IN THE NATURE OF LUBRICANTS (U.S. CLS. 1, 6 AND 15).
FIRST USE 0-0-1989; IN COMMERCE 0-0-1989.

CLASS 8—HAND TOOLS

FOR HAND TOOLS FOR BRAKE ASSEMBLY, CLEANING, AND REPAIR, NAMELY BEDDING TOOLS, BLEEDER WRENCHES AND ADAPTORS, BRAKE PART INSTALLATION, ADJUSTMENT, AND REMOVAL TOOLS, PISTON RESETING AND TURNING TOOLS, BRAKE CALIPER WRENCHES, BRAKE FLUID FILLER GUNS AND TAPS, BRAKE CLEANING TOOLS, WRENCHES, PLIERS, DRIVERS, SPANNERS, REAMERS, PIPE CUTTERS, TUBING AND PIPE BENDING TOOLS, SOCKET SETS, FLARING TOOLS, FILES, AND PIPE DEBURRING TOOLS (U.S. CLS. 23, 28 AND 44).
FIRST USE 0-0-1989; IN COMMERCE 0-0-1989.

CLASS 9—ELECTRICAL AND SCIENTIFIC APPARATUS

FOR VEHICLE BRAKE TESTING EQUIPMENT; DIAL GAUGES FOR INDICATING PRESSURE OR MEASURED LENGTH; HIGH PRESSURE MANOMETERS; ELECTRICAL SWITCHES (U.S. CLS. 21, 23, 26, 36 AND 38).
FIRST USE 0-0-1989; IN COMMERCE 0-0-1989.

CLASS 12—VEHICLES

FOR BRAKE SYSTEMS FOR LAND VEHICLES AND REPLACEMENT COMPONENT PARTS THEREFOR; LAND VEHICLE CLUTCHES AND REPLACEMENT COMPONENT PARTS THEREFOR; LAND VEHICLE RETROFIT BRAKE KITS SOLD AS A UNIT (U.S. CLS. 19, 21, 23, 31, 35 AND 44).
FIRST USE 0-0-1989; IN COMMERCE 0-0-1989.

WILLIAM VERHOSEK, EXAMINING ATTORNEY

HANCED ELECTRONIC MAIL AND SCHEDULING CAPABILITIES; COMPUTER PROGRAMS FOR MANAGING, VIEWING, AND EDITING FILES, DOCUMENTS, ELECTRONIC MAIL MESSAGES AND PRIVATE NETWORK AND INTERNET COMMUNICATIONS; COMPUTER PROGRAMS FOR MEETING AND EVENT SCHEDULING, MANAGING GROUP CALENDARS, TASK DELEGATION AND REPORTING, RECORDING NOTES, TRANSFERRING DATA TO AND FROM DATA BASES AND TO AND FROM COMPUTER PROGRAMS AND COMPUTER FILES; OPERATING SYSTEM PROGRAMS, ADDRESS BOOK PROGRAMS, TELEPHONE DIALING PROGRAMS, PROGRAMS FOR CORRECTING TYPOGRAPHICAL AND CAPITALIZATION ERRORS, PROGRAMS FOR TALLYING VOTING RESPONSES, AND INSTRUCTION MANUALS THEREFOR SOLD AS A UNIT; COMPUTER PROGRAMS, NAMELY, GRAPHICS, IMAGING AND PRESENTATION PROGRAMS FOR PRINTED AND ELECTRONIC DOCUMENTS AND PRESENTATIONS, AND USER MANUALS SOLD TOGETHER WITH THE PROGRAMS AS A UNIT; COMPUTER PROGRAMS FOR CREATING, EDITING AND MANAGING WEB SITES AND INTRANET SITES; ELECTRONIC INTEGRATED CIRCUITS, BLANK MAGNETIC COMPUTER DISCS AND BLANK OPTICAL DISCS ON WHICH COMPUTER PROGRAMS ARE RECORDED, COMPUTERS, DOWNLOADABLE ELECTRONIC PUBLICATION, NAMELY, MAGAZINE AND MANUAL FEATURING INFORMATION ABOUT COMPUTER SOFTWARE (U.S. CLS. 21, 23, 26, 36 AND 38).

CLASS 38—COMMUNICATION

FOR COMMUNICATION BY MOBILE PHONES, COMMUNICATION BY COMPUTER TERMINALS, COMMUNICATION BY TELEPHONES, FACSIMILE TRANSMISSION AND RETRIEVAL, COMMUNICATION BY COMPUTER TERMINALS USING THE INTERNET, PROVIDING ON-LINE ELECTRONIC BULLETIN BOARDS FOR TRANSMISSION OF MESSAGES AMONG COMPUTER USERS CONCERNING COMPUTER SOFTWARE; ELECTRONIC MAIL SERVICES (U.S. CLS. 100, 101 AND 104).

CLASS 41—EDUCATION AND ENTERTAINMENT

FOR EDUCATIONAL SERVICES, NAMELY, ARRANGING AND CONDUCTING TRAINING CLASSES AND SEMINARS REGARDING OPERATION OF COMPUTER PROGRAMS; PUBLISHING ELECTRONIC PUBLICATIONS; EDUCATIONAL TESTING, NAMELY, CONDUCTING A LICENSING EXAMINATION IN THE FIELD OF COMPUTER PROGRAM OPERATION (U.S. CLS. 100, 101 AND 107).

CLASS 42—SCIENTIFIC AND COMPUTER SERVICES

FOR DESIGN OF COMPUTERS AND COMPUTER SOFTWARE FOR OTHERS; COMPUTER CONSULTATION; COMPUTER SOFTWARE MAINTENANCE; DEVELOPMENT OF COMPUTER PROGRAMS FOR DOCUMENT PROCESSING; TECHNICAL ADVICE CONCERNING PERFORMANCE AND OPERATION OF COMPUTERS AND COMPUTER PROGRAMS; RENTAL AND LEASING OF COMPUTERS, PROVIDING TEMPORARY USE OF NON-DOWNLOADABLE COMPUTER SOFTWARE FOR DOCUMENT PROCESSING; COMPUTER SOFTWARE CONSULTATION; TECHNICAL SUPPORT SERVICES, NAMELY, TROUBLESHOOTING OF COMPUTER HARDWARE AND SOFTWARE PROBLEMS; ACCREDITATION SERVICES, NAMELY, TESTING, ANALYSIS AND EVALUATION OF THE SERVICES OF OTHERS FOR THE PURPOSE OF CERTIFICATION IN COMPUTER PROGRAM OPERATION AND CERTIFYING THE PARTICIPANT'S LEVEL OF PROFESSIONAL KNOWLEDGE OF PROGRAMMING XML AND RELATED TECHNOLOGIES; DESIGNING AND MAINTENANCE OF WEB SITES FOR OTHERS (U.S. CLS. 100 AND 101).

MARK SPARACINO, EXAMINING ATTORNEY

SN 78-655,821. ORCHID CELLMARK INC., PRINCETON, NJ.
FILED 6-22-2005.

HERITAGEID

THE MARK CONSISTS OF STANDARD CHARACTERS WITHOUT CLAIM TO ANY PARTICULAR FONT, STYLE, SIZE, OR COLOR.

CLASS 16—PAPER GOODS AND PRINTED MATTER

FOR PRINTED CARD CONTAINING INDIVIDUAL SPECIFIC GENETIC PROFILE (U.S. CLS. 2, 5, 22, 23, 29, 37, 38 AND 50).

FIRST USE 5-30-2005; IN COMMERCE 5-30-2005.

CLASS 44—MEDICAL, BEAUTY AND AGRICULTURAL SERVICES

FOR GENETIC TESTING FOR MEDICAL, RELATIONSHIP OR GENEALOGICAL PURPOSES (U.S. CLS. 100 AND 101).

FIRST USE 5-30-2005; IN COMMERCE 5-30-2005.

ELLEN PERKINS, EXAMINING ATTORNEY

SN 78-659,289. STANISLAUS PARTNERS, STOCKTON, CA.
FILED 6-27-2005.

Palladio

THE MARK CONSISTS OF STANDARD CHARACTERS WITHOUT CLAIM TO ANY PARTICULAR FONT, STYLE, SIZE, OR COLOR.

THE FOREIGN WORDING IN THE MARK TRANSLATES INTO ENGLISH AS "PALLADIUM".

CLASS 29—MEATS AND PROCESSED FOODS

FOR PROCESSED VEGETABLES; CANNED VEGETABLES; CANNED TOMATOES; VEGETABLE PASTE; VEGETABLE PUREE; TOMATO PASTE; TOMATO PUREE (U.S. CL. 46).

CLASS 30—STAPLE FOODS

FOR SAUCES; TOMATO-BASED SAUCES; READY-MADE SAUCES; TOMATO SAUCE; CANNED TOMATO SAUCE; PIZZA SAUCE; SPAGHETTI AND PASTA SAUCE; MARINARA SAUCE; SALSA (U.S. CL. 46).

DAVID TOOLEY, EXAMINING ATTORNEY

SN 78-663,229. JO PUD, CAREFREE, AZ. FILED 7-2-2005.

SN 78-685,707. FARMER, DOUGLAS A., ROANOKE, IN. FILED 8-4-2005.

JO PUD

THE MARK CONSISTS OF STANDARD CHARACTERS WITHOUT CLAIM TO ANY PARTICULAR FONT, STYLE, SIZE, OR COLOR.

THE NAME "JO PUD" DOES NOT IDENTIFY A LIVING INDIVIDUAL.



CLASS 42—SCIENTIFIC AND COMPUTER SERVICES

FOR SCENT DESIGN SERVICES, NAMELY, DESIGNING SCENTS FOR OTHERS IN THE FIELD OF PERFUMERY (U.S. CLS. 100 AND 101).

CLASS 45—PERSONAL AND LEGAL SERVICES

FOR PREPARATION OF CUSTOMIZED GIFT BASKETS CONTAINING DRY HOT CHOCOLATE MIX, DRY CAPPUCCINO MIX, COFFEE, TEA, TEA BISCUITS, COOKIES, PANCAKE MIX, PANCAKE SYRUP, JAMS, JELLIES, CINNAMON ROLL MIX, CAKE, RUM CAKE, PASTRIES, MUGS (U.S. CLS. 100 AND 101).
MICHELLE DUBOIS, EXAMINING ATTORNEY

CLASS 25—CLOTHING

FOR APPAREL, NAMELY, HATS AND SHIRTS (U.S. CLS. 22 AND 39).

CLASS 32—LIGHT BEVERAGES

FOR BEER (U.S. CLS. 45, 46 AND 48).
NICHOLAS ALTREE, EXAMINING ATTORNEY

SN 78-681,663. NEW ACE US TRADEMARK LTD., MISSISSAUGA, ONTARIO, CANADA, FILED 7-29-2005.

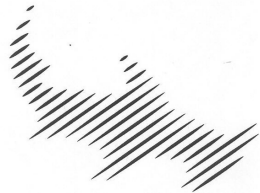

SN 78-697,410. KING RUTH ANNE, SAN DIEGO, CA. FILED 8-22-2005.

THE MARK CONSISTS OF A STYLIZED SHARK.

THE UGLY TRUTH ABOUT

CLASS 5—PHARMACEUTICALS

FOR DIETARY SUPPLEMENT (U.S. CLS. 6, 18, 44, 46, 51 AND 52).

CLASS 32—LIGHT BEVERAGES

FOR ENERGY DRINKS FEATURING ADDED NUTRIENTS (U.S. CLS. 45, 46 AND 48).
BARBARA RUTLAND, EXAMINING ATTORNEY

THE MARK CONSISTS OF STANDARD CHARACTERS WITHOUT CLAIM TO ANY PARTICULAR FONT, STYLE, SIZE, OR COLOR.

CLASS 9—ELECTRICAL AND SCIENTIFIC APPARATUS

FOR PRERECORDED EDUCATIONAL AUDIO AND AUDIO-VISUAL MATERIALS TAPES, DISKS, CASSETTES, DIGITAL VERSATILE DISCS, DIGITAL VIDEO DISCS, DVDS, COMPACT DISCS AND CDS, CD-ROM, MP3, DIGITAL RECORDINGS, DIGITAL TAPES, COMPUTER PROGRAMS AND SOFTWARE, COMPUTER GAME SOFTWARE, COMPUTER GAME TAPES, VIDEO GAME SOFTWARE, VIRTUAL REALITY GAME SOFTWARE, EDUCATIONAL SOFTWARE, DOWNLOADABLE EDUCATIONAL SOFTWARE, VIDEO CASSETTES, VIDEO TAPES, VIDEO DISKS, COMPUTER TELEPHONY SOFTWARE, ONLINE DOWNLOADABLE COMPUTER PROGRAMS, ONLINE DOWNLOADABLE TELEVISION AND RADIO PROGRAMS, HOME-STUDY COURSES ON AUDIO, AND ON ELECTRONIC GAMES AND ELECTRONIC MEDIA OF ALL FORMATS, AND PRERECORDED TELEVISION AND INTERNET SHOWS RECORDED ON TAPES, DISKS, CASSETTES, DIGITAL VERSATILE DISCS, DIGITAL VIDEO DISCS, DVDS, COMPACT DISCS AND CDS, CD-ROM, MP3, DIGITAL RECORDINGS, DIGITAL TAPES, COMPUTER PROGRAMS AND SOFTWARE, COMPUTER GAME SOFTWARE, COMPUTER GAME TAPES, VIDEO GAME SOFTWARE, VIRTUAL REALITY GAME SOFTWARE, EDUCATIONAL SOFTWARE, DOWNLOADABLE EDUCATIONAL SOFTWARE, VIDEO CASSETTES, VIDEO TAPES, VIDEO DISKS, COMPUTER TELEPHONY SOFTWARE, ONLINE DOWNLOADABLE COMPUTER PROGRAMS, ONLINE DOWNLOADABLE TELEVISION AND RADIO PROGRAMS, HOME-STUDY COURSES ON AUDIO, AND ON GAMES, NAMELY ELECTRONIC GAMES, AND ELECTRONIC MEDIA OF ALL FORMATS, ALL IN THE FIELD OF THE PROVIDING OF WISDOM, LIFE-LESSONS, ADVICE, HUMOR, AND INFORMATION FOR PERSONAL AND PROFESSIONAL GROWTH AND DEVELOPMENT, BUSINESS ASSESSMENT, ADVICE, AND SKILLS ENHANCEMENT (U.S. CLS. 21, 23, 26, 36 AND 38).

CLASS 16—PAPER GOODS AND PRINTED MATTER

FOR PRINTED MATERIALS NAMELY A SERIES OF NON-FICTION BOOKS, NEWSPAPERS AND MAGAZINES AND OTHER WRITTEN INSTRUCTIONAL AND EDUCATIONAL MATERIALS NAMELY EDUCATIONAL PERIODICALS, NEWSLETTERS, ARTICLES, BULLETINS, INSTRUCTIONAL MANUALS, PAMPHLETS, COURSE MATERIALS, CORRESPONDENCE COURSE MATERIALS, PRINTED TEACHING MATERIALS, GUIDEBOOKS AND BROCHURES IN THE FIELD OF THE PROVIDING OF WISDOM, LIFE-LESSONS, ADVICE, HUMOR, AND INFORMATION FOR PERSONAL AND PROFESSIONAL GROWTH AND DEVELOPMENT, BUSINESS ASSESSMENT, ADVICE, AND SKILLS ENHANCEMENT EDUCATIONAL PERIODICALS, NEWSLETTERS, ARTICLES, BULLETINS, INSTRUCTIONAL MANUALS, PAMPHLETS, COURSE MATERIALS, CORRESPONDENCE COURSE MATERIALS, PRINTED TEACHING MATERIALS, GUIDEBOOKS AND BROCHURES IN THE FIELD OF THE PROVIDING OF WISDOM, LIFE-LESSONS, ADVICE, HUMOR, AND INFORMATION FOR PERSONAL AND PROFESSIONAL GROWTH AND DEVELOPMENT, BUSINESS ASSESSMENT, ADVICE, AND SKILLS ENHANCEMENT (U.S. CLS. 2, 5, 22, 23, 29, 37, 38 AND 50).

CLASS 35—ADVERTISING AND BUSINESS

FOR ONLINE RETAIL STORE SERVICES FEATURING EDUCATIONAL MATERIALS TO FACILITATE LEARNING IN THE FIELDS OF WISDOM, LIFE-LESSONS, ADVICE, HUMOR, AND INFORMATION FOR PERSONAL AND PROFESSIONAL GROWTH AND DEVELOPMENT, BUSINESS ASSESSMENT, ADVICE, AND SKILLS ENHANCEMENT; PROVISION OF BUSINESS SERVICES IN THE FIELD OF THE PROVIDING OF WISDOM, LIFE-LESSONS, ADVICE, HUMOR, AND INFORMATION FOR PERSONAL AND PROFESSIONAL GROWTH AND DEVELOPMENT, BUSINESS ASSESSMENT, ADVICE, AND SKILLS ENHANCEMENT. (U.S. CLS. 100, 101 AND 102).

CLASS 41—EDUCATION AND ENTERTAINMENT

FOR PROVIDING ONLINE EDUCATION COURSES OF INSTRUCTION, LIVE CLASSES AND SEMINARS IN THE FIELD OF THE PROVIDING OF WISDOM, LIFE-LESSONS, ADVICE, HUMOR, AND INFORMATION FOR PERSONAL AND PROFESSIONAL GROWTH AND DEVELOPMENT, BUSINESS ASSESSMENT, ADVICE, AND SKILLS ENHANCEMENT; PROVIDING MOTIVATIONAL AND EDUCATIONAL SPEAKERS AND PROVIDING IN-PERSON AND ONLINE PERSONAL COACHING SERVICES IN THE FIELD OF THE PROVIDING OF WISDOM, LIFE-LESSONS, ADVICE, HUMOR, AND INFORMATION FOR PERSONAL AND PROFESSIONAL GROWTH AND DEVELOPMENT, BUSINESS ASSESSMENT, ADVICE, AND SKILLS ENHANCEMENT FOR INDIVIDUALS, GROUPS AND ORGANIZATIONS; PROVIDING CLASSES, INDIVIDUAL AND SMALL AND LARGE GROUP INSTRUCTION, AND LECTURES IN THE FIELD OF THE PROVIDING OF WISDOM, LIFE-LESSONS, ADVICE, HUMOR, AND INFORMATION FOR PERSONAL AND PROFESSIONAL GROWTH AND DEVELOPMENT, BUSINESS ASSESSMENT, ADVICE, AND SKILLS ENHANCEMENT; ARRANGING AND CONDUCTING EDUCATION CONFERENCES AND TELECONFERENCES IN THE FIELD OF THE PROVIDING OF WISDOM, LIFE-LESSONS, ADVICE, HUMOR, AND INFORMATION FOR PERSONAL AND PROFESSIONAL GROWTH AND DEVELOPMENT, BUSINESS ASSESSMENT, ADVICE, AND SKILLS ENHANCEMENT; PRODUCTION OF RADIO PROGRAMS; PRODUCTION OF EDUCATIONAL SATELLITE-LINKED PROGRAMS IN THE FIELD OF THE PROVIDING OF WISDOM, LIFE-LESSONS, ADVICE, HUMOR, AND INFORMATION FOR PERSONAL AND PROFESSIONAL GROWTH AND DEVELOPMENT, BUSINESS ASSESSMENT, ADVICE, AND SKILLS ENHANCEMENT; PROVIDING EDUCATIONAL E-LEARNING PROGRAMS IN THE FIELD OF THE PROVIDING OF WISDOM, LIFE-LESSONS, ADVICE, HUMOR, AND INFORMATION FOR PERSONAL AND PROFESSIONAL GROWTH AND DEVELOPMENT, BUSINESS ASSESSMENT, ADVICE, AND SKILLS ENHANCEMENT USING THE WORLD-WIDE-WEB; PROVIDING CLOSED-CIRCUIT EDUCATIONAL PROGRAMS IN THE FIELD OF THE PROVIDING OF WISDOM, LIFE-LESSONS, ADVICE, HUMOR, AND INFORMATION FOR PERSONAL AND PROFESSIONAL GROWTH AND DEVELOPMENT, BUSINESS ASSESSMENT, ADVICE, AND SKILLS ENHANCEMENT; PROVIDING EDUCATIONAL AUDIO-AND VIDEO-CONFERENCE PROGRAMS IN THE FIELD OF THE PROVIDING OF WISDOM, LIFE-LESSONS, ADVICE, HUMOR, AND INFORMATION FOR PERSONAL AND PROFESSIONAL GROWTH AND DEVELOPMENT, BUSINESS ASSESSMENT, ADVICE, AND SKILLS ENHANCEMENT; PROVIDING EDUCATIONAL IN-PERSON AND "VIRTUAL" RETREATS AND WORKSHOPS IN THE FIELD OF THE PROVIDING OF WISDOM, LIFE-LESSONS, ADVICE, HUMOR, AND INFORMATION FOR PERSONAL AND PROFESSIONAL GROWTH AND DEVELOPMENT, BUSINESS ASSESSMENT, ADVICE, AND SKILLS ENHANCEMENT; DISTRIBUTING COURSE MATERIALS IN CONNECTION THEREWITH; DEVELOPMENT AND DISSEMINATION OF EDUCATIONAL MATERIALS OF OTHERS IN THE FIELD OF THE PROVIDING OF WISDOM, LIFE-LESSONS, ADVICE, HUMOR, AND INFORMATION FOR PERSONAL AND PROFESSIONAL GROWTH AND DEVELOPMENT, BUSINESS ASSESSMENT, ADVICE, AND SKILLS ENHANCEMENT; CONDUCTING ON-LINE EDUCATIONAL AND ENTERTAINMENT PROGRAMMING IN THE FIELD OF THE PROVIDING OF WISDOM, LIFE-LESSONS, ADVICE, HUMOR, AND INFORMATION FOR PERSONAL AND PROFESSIONAL GROWTH AND DEVELOPMENT, BUSINESS ASSESSMENT, ADVICE, AND SKILLS ENHANCEMENT PROVIDING CUSTOMIZED TRAINING PROGRAMS IN THE FIELD OF THE PROVIDING OF WISDOM, LIFE-LESSONS, ADVICE, HUMOR, AND INFORMATION FOR PERSONAL AND PROFESSIONAL GROWTH AND DEVELOPMENT, BUSINESS ASSESSMENT, ADVICE, AND SKILLS ENHANCEMENT (U.S. CLS. 100, 101 AND 107).

BRIAN NEVILLE, EXAMINING ATTORNEY

SN 78-705,634. S-T-N HOLDINGS, INC., LAS VEGAS, NV.
FILED 9-1-2005.

PROTIM

THE MARK CONSISTS OF STANDARD CHARACTERS WITHOUT CLAIM TO ANY PARTICULAR FONT, STYLE, SIZE, OR COLOR.

THE WORDING "PROTIM" HAS NO MEANING IN A FOREIGN LANGUAGE.

CLASS 2—PAINTS

FOR WOOD PRESERVATIVE COMPOSITIONS; PRESERVATIVE CARTRIDGES FOR CONTROLLING DECAY IN WOOD; WOOD PRESERVATIVE BANDAGES; PRIMER-SEALERS FOR APPLICATION ON FIRE RETARDANT TREATED WOOD; WOOD STAINS AND WOOD TONERS; WOOD, MASONRY, AND STUCCO SEALERS; COLOR ADDITIVE COMPOSITIONS FOR USE WITH WOOD PRESERVATIVES FOR MAINTAINING AND ENHANCING THE COLOR OF WOOD; WOOD STAINS THAT ARE MIXED WITH WOOD PRESERVATIVES; CHEMICAL COMPOSITIONS FOR PRESERVING WOOD; CORROSION INHIBITING COATINGS FOR TREATED WOOD AND LUMBER; CORROSION INHIBITING COATINGS FOR PROTECTING STEEL PILING (U.S. CLS. 6, 11 AND 16).

CLASS 5—PHARMACEUTICALS

FOR FUNGICIDES (U.S. CLS. 6, 18, 44, 46, 51 AND 52).

CLASS 19—NON-METALLIC BUILDING MATERIALS

FOR TREATED WOOD (U.S. CLS. 1, 12, 33 AND 50).
LINDA ORNDORFF, EXAMINING ATTORNEY

SN 78-710,744. MCE TELEVISION NETWORKS, INC., EVERETT, WA. FILED 9-12-2005.

The Water Channel

THE MARK CONSISTS OF STANDARD CHARACTERS WITHOUT CLAIM TO ANY PARTICULAR FONT, STYLE, SIZE, OR COLOR.

NO CLAIM IS MADE TO THE EXCLUSIVE RIGHT TO USE "CHANNEL", APART FROM THE MARK AS SHOWN.

CLASS 35—ADVERTISING AND BUSINESS

FOR PROVIDING HOME SHOPPING SERVICES IN THE FIELD OF WATER LEISURE ACTIVITIES AND WATER SPORTS AND RELATED RECREATIONAL PRODUCTS, NAMELY, JEWELRY, SPORTS APPAREL, SWIMWEAR, VACATION AND LEISURE APPAREL, FISHING RODS, REELS, LURES, AND APPAREL, COOKWARE, DECORATIVE AND FINE ARTS, SWIMMING AND BOATING SAFETY EQUIPMENT, BOAT CLEANING AND REPAIR PRODUCTS, POOL CLEANING, MAINTENANCE AND REPAIR PRODUCTS, SHOES AND SANDALS, COOLERS, STORAGE BINS AND LOCKERS, BOATING ELECTRONICS, WATER SPORTS EQUIPMENT, BOAT ELECTRICAL EQUIPMENT, FLAGS, ENSIGNS AND SIGNALING EQUIPMENT, PURSES, HANDBAGS AND FANNY PACKS, SUN PROTECTION APPAREL AND PRODUCTS, ACCESSORIES, NAMELY, SWIMMING POOL ACCESSORIES, FISHING BOAT ACCESSORIES, AND SPORT BOATING ACCESSORIES, BY MEANS OF TELEVISION (U.S. CLS. 100, 101 AND 102).

CLASS 38—COMMUNICATION

FOR CABLE TELEVISION BROADCASTING; SATELLITE TELEVISION BROADCASTING (U.S. CLS. 100, 101 AND 104).

LYDIA BELZER, EXAMINING ATTORNEY

SN 78-740,045. HOTEL SACHER, EDUARD SACHER GMBH, 1010 VIENNA, AUSTRIA, FILED 10-25-2005.

SACHER

THE MARK CONSISTS OF STANDARD CHARACTERS WITHOUT CLAIM TO ANY PARTICULAR FONT, STYLE, SIZE, OR COLOR.

OWNER OF AUSTRIA REG. NO. 201909, DATED 2-5-2002, EXPIRES 2-5-2012.
SEC. 2(F).

CLASS 30—STAPLE FOODS

FOR COFFEE; TEA; COCOA; SUGAR; RICE; TAPIOCA; SAGO; ARTIFICIAL COFFEE; FLOUR; PREPARATIONS MADE FROM CEREALS, NAMELY, BREAKFAST CEREALS, CEREAL-BASED SNACK FOODS, PROCESSED CEREALS AND READY-TO-EAT, CEREAL-DERIVED FOOD BARS; BREAD; PASTRY; CONFECTIONERY, NAMELY, CANDIES, CONFECTIONERY CHIPS FOR BAKING, CRYSTAL SUGAR PIECES, PEANUT BUTTER CONFECTIONERY CHIPS AND PEPPERMINT FOR CONFECTIONERY; ICES; HONEY; TREACLE; YEAST; BAKING-POWDER; SALT; CONDIMENTS, NAMELY, MUSTARD AND VINEGAR; SAUCES; SPICES; ICE (U.S. CL. 46).

CLASS 43—HOTEL AND RESTAURANT SERVICES

FOR SERVICES FOR PROVIDING FOOD AND DRINK, NAMELY, SERVING OF FOOD AND DRINKS, CATERING OF FOOD AND DRINKS; PROVIDING TEMPORARY ACCOMMODATION (U.S. CLS. 100 AND 101).

GINA FINK, EXAMINING ATTORNEY

SN 78-741,804. THOMSON CANADA LIMITED, TORONTO, ONTARIO, CANADA, FILED 10-27-2005.

SN 78-758,073. JOY SOY PRODUCTS, LLC, CLIFTON, TN. FILED 11-21-2005.

JOY SOY

CARSWELL EREFERENCE LIBRARY

THE MARK CONSISTS OF STANDARD CHARACTERS WITHOUT CLAIM TO ANY PARTICULAR FONT, STYLE, SIZE, OR COLOR.

PRIORITY CLAIMED UNDER SEC. 44(D) ON CANADA APPLICATION NO. 1257033, FILED 5-10-2005, REG. NO. TMA665583, DATED 6-2-2006, EXPIRES 6-2-2021.

NO CLAIM IS MADE TO THE EXCLUSIVE RIGHT TO USE "EREFERENCE LIBRARY", APART FROM THE MARK AS SHOWN.

SEC. 2(F) AS TO "CARSWELL".

CLASS 35—ADVERTISING AND BUSINESS

FOR (BASED ON INTENT TO USE) 44(D) PRIORITY APPLICATION AND (BASED ON 44(E) ON-LINE SUBSCRIPTION SERVICE PROVIDING REGISTERED USERS WITH ACCESS TO ANALYTICAL COMMENTARY INFORMATION ON ACCOUNTING, HUMAN RESOURCE CONSULTATION, TAX CONSULTATION AND PAYROLL PRACTICES (U.S. CLS. 100, 101 AND 102).

CLASS 42—SCIENTIFIC AND COMPUTER SERVICES

FOR (BASED ON INTENT TO USE) 44(D) PRIORITY APPLICATION AND (BASED ON 44(E) ON-LINE SUBSCRIPTION SERVICE PROVIDING REGISTERED USERS WITH ACCESS TO ANALYTICAL COMMENTARY INFORMATION ON LEGAL ISSUES AND REGULATORY COMPLIANCE (U.S. CLS. 100 AND 101).

SUSAN LESLIE DUBOIS, EXAMINING ATTORNEY

SN 78-757,353. REPUBLIC PROPERTY TRUST, WASHINGTON, DC. FILED 11-18-2005.



CLASS 36—INSURANCE AND FINANCIAL

FOR REAL ESTATE INVESTMENT (U.S. CLS. 100, 101 AND 102).

FIRST USE 9-0-2005; IN COMMERCE 9-0-2005.

CLASS 37—CONSTRUCTION AND REPAIR

FOR REAL ESTATE DEVELOPMENT SERVICES (U.S. CLS. 100, 103 AND 106).

FIRST USE 9-0-2005; IN COMMERCE 9-0-2005.

HOWARD B. LEVINE, EXAMINING ATTORNEY

THE MARK CONSISTS OF STANDARD CHARACTERS WITHOUT CLAIM TO ANY PARTICULAR FONT, STYLE, SIZE, OR COLOR.

OWNER OF U.S. REG. NO. 2,667,486.

NO CLAIM IS MADE TO THE EXCLUSIVE RIGHT TO USE "SOY", APART FROM THE MARK AS SHOWN.

CLASS 29—MEATS AND PROCESSED FOODS

FOR VEGETABLE-BASED SNACK FOODS, BUTTER SUBSTITUTES, CHEESE SUBSTITUTES (U.S. CL. 46).

FIRST USE 2-1-2002; IN COMMERCE 2-1-2002.

CLASS 30—STAPLE FOODS

FOR SOY-BASED ICE CREAM SUBSTITUTES, CANDY, SALAD DRESSING (U.S. CL. 46).

FIRST USE 2-1-2002; IN COMMERCE 2-1-2002.

ELLEN PERKINS, EXAMINING ATTORNEY

SN 78-758,608. BC SPORTS, INC., PORTLAND, OR. FILED 11-21-2005.



OWNER OF U.S. REG. NO. 2,928,815.

THE MARK CONSISTS OF A STYLIZED FIVE-POINTED STAR ABOVE THE LITERAL ELEMENT IN STYLIZED LETTERING.

CLASS 18—LEATHER GOODS

FOR ALL PURPOSE SPORT BAGS; ALL-PURPOSE ATHLETIC BAGS; ALL-PURPOSE CARRYING BAGS; ATHLETIC BAGS; BAGS AND HOLDALLS FOR SPORTS CLOTHING; CARRY-ALL BAGS; DUFFEL BAGS; DUFFLE BAGS; GYM BAGS; SPORTS BAGS (U.S. CLS. 1, 2, 3, 22 AND 41).

CLASS 25—CLOTHING

FOR ANKLE SOCKS; ANKLETS ; ANTI-PERSPIRANT SOCKS; ATHLETIC FOOTWEAR; ATHLETIC SHOES; ATHLETIC UNIFORMS; BASEBALL CAPS; BASEBALL SHOES; BASKETBALL SNEAKERS; BATHING SUITS; BATHING SUITS FOR MEN; BATHING TRUNKS; BERMUDA SHORTS; BICYCLE GLOVES; BICYCLING GLOVES; BOARD SHORTS; BOARDSHORTS; BODY SHAPERS; BODY SUITS; BOWLING SHOES; BOXING SHOES; CAMP SHIRTS; CANVAS SHOES; CAP VISORS; CAPS ; CAPS WITH VISORS; CHILDREN'S HEADWEAR; CLEATS FOR ATTACHMENT TO SPORTS SHOES; CLOTHING FOR WEAR IN JUDO PRACTICES; CLOTHING FOR WEAR IN WRESTLING GAMES; CYCLING SHOES; CYCLISTS' JERSEYS; DOWN JACKETS; DRY SUITS; FOOTBALL BOOTS AND STUDS THEREFOR; FOOTBALL SHOES; FOOTWEAR; FOOTWEAR FOR MEN; FOOTWEAR FOR MEN AND WOMEN; FOOTWEAR FOR TRACK AND FIELD ATHLETICS; FOOTWEAR FOR WOMEN; GOLF CAPS; GOLF CLEATS;

GOLF SHIRTS; GOLF SHOES; GOLF TROUSERS; GYM SHORTS; GYM SUITS; GYMNAS TIC SHOES; HANDBALL SHOES; HATS; HEAD SWEATBANDS; HEADWEAR; HEADBANDS AGAINST SWEATING; HEADGEAR, NAMELY, HATS, CAPS, BEANIES, SKULL CAPS; HEADWEAR; HEAVY JACKETS; HOCKEY SHOES; JACKETS; JERSEYS ; JOGGING OUTFITS; JOGGING PANTS; JOGGING SUITS; JUDO SUITS; KARATE SUITS; KENDO OUTFITS; KNIT SHIRTS; KNITTED CAPS; LEOTARDS; LEOTARDS AND TIGHTS FOR WOMEN, MEN AND CHILDREN OF NYLON, COTTON OR OTHER TEXTILE FIBERS; LIGHT-REFLECTING COATS; LIGHT-REFLECTING JACKETS; LONG SLEEVED VESTS; MARTIAL ARTS UNIFORMS; MEN AND WOMEN JACKETS, COATS, TROUSERS, VESTS; MEN'S SOCKS; PANTS; PERSPIRATION ABSORBENT UNDERWEAR CLOTHING; PULLOVERS; QUILTED VESTS; RAINPROOF JACKETS; RAINWEAR; RUBBER SHOES; RUGBY SHOES; RUGBY SHORTS; RUGBY TOPS; SCHOOL UNIFORMS; SHIRTS; SHOES; SHORT SETS ; SHORT-SLEEVED OR LONG-SLEEVED T-SHIRTS; SHORT-SLEEVED SHIRTS; SHORTS; SKATING OUTFITS; SLEEVED OR SLEEVELESS JACKETS; SLEEVELESS JERSEYS; SMALL HATS; SNEAKERS; SOCCER BOOTS; SOCCER SHOES; SOCKS; SPORTS JACKETS; SPORTS JERSEYS AND BREECHES FOR SPORTS; SPORTS OVERUNIFORMS; SPORTS SHIRTS; SPORTS SHIRTS WITH SHORT SLEEVES; STOCKINGS; STOCKINGS (SWEAT-ABSORBENT); SWEAT BANDS; SWEAT PANTS; SWEAT SHIRTS; SWEAT SHORTS; SWEAT SUITS; SWEATBANDS; SWEATSOCKS; SWIM CAPS; SWIM TRUNKS; SWIM WEAR; SWIMMING CAPS; SWIMMING TRUNKS; SWIMSUITS; T-SHIRTS; TANK TOPS; TANK-TOPS; TENNIS SHOES; TENNIS WEAR; TRACK AND FIELD SHOES; TRACK PANTS; TRACK SUITS; TRACKSUITS; TRAINING SHOES; TRAINING SUITS; TROUSERS FOR SWEATING; TRUNKS; UNDER GARMENTS; UNDERCLOTHES; UNDERGARMENTS; UNDERPANTS; UNDERSHIRTS; UNIFORMS; UNITARDS; VESTS; VOLLEYBALL SHOES; WAIST BELTS; WARM UP SUITS; WATERPROOF JACKETS AND PANTS; WIND RESISTANT JACKETS; WIND-JACKETS; WOMEN'S SHOES (U.S. CLS. 22 AND 39).
SEAN CROWLEY, EXAMINING ATTORNEY

CLASS 12—VEHICLES

FOR AUTOMOBILES (U.S. CLS. 19, 21, 23, 31, 35 AND 44).
FIRST USE 1-1-1998; IN COMMERCE 1-1-1998.
YAT SYE, LEE, EXAMINING ATTORNEY

SN 78-759,188. VOLVO CAR CORPORATION (ALSO KNOWN AS VOLVO PERSONVAGNAR AB), GÖTEBORG, SWEDEN, FILED 11-22-2005.

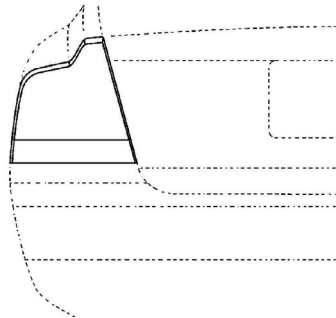

THE MARK CONSISTS OF A CONFIGURATION OF A VEHICLE TAILLIGHT DESIGN. THE MARK IS THREEDIMENSIONAL. BROKEN LINES INDICATE MATTER NOT CLAIMED AS PART OF THE MARK.
SEC. 2(F).

SN 78-759,147. VOLVO CAR CORPORATION (ALSO KNOWN AS VOLVO PERSONVAGNAR AB), GÖTEBORG, SWEDEN, FILED 11-22-2005.

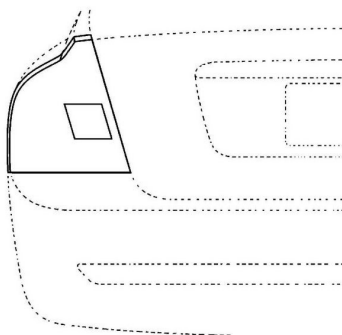

THE MARK CONSISTS OF A CONFIGURATION OF A VEHICLE TAILLIGHT DESIGN. THE MARK IS THREEDIMENSIONAL. BROKEN LINES INDICATE MATTER NOT CLAIMED AS PART OF THE MARK.
SEC. 2(F).

CLASS 11—ENVIRONMENTAL CONTROL APPARATUS

FOR TAILLIGHTS FOR AUTOMOBILES (U.S. CLS. 13, 21, 23, 31 AND 34).
FIRST USE 1-1-2001; IN COMMERCE 1-1-2001.

CLASS 11—ENVIRONMENTAL CONTROL APPARATUS

FOR TAILLIGHTS FOR AUTOMOBILES (U.S. CLS. 13, 21, 23, 31 AND 34).
FIRST USE 1-1-1998; IN COMMERCE 1-1-1998.

CLASS 12—VEHICLES

FOR AUTOMOBILES (U.S. CLS. 19, 21, 23, 31, 35 AND 44).
FIRST USE 1-1-2001; IN COMMERCE 1-1-2001.
YAT SYE, LEE, EXAMINING ATTORNEY

SN 78-759,251. VOLVO CAR CORPORATION (ALSO KNOWN AS VOLVO PERSONVAGNAR AB), GÖTEBORG, SWEDEN, FILED 11-22-2005.

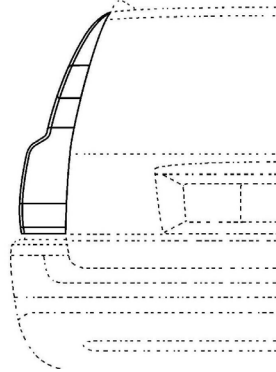

THE MARK CONSISTS OF A CONFIGURATION OF A VEHICLE TAILLIGHT DESIGN. THE MARK IS THREE-DIMENSIONAL. BROKEN LINES INDICATE MATTER NOT CLAIMED AS PART OF THE MARK. SEC. 2(F).

CLASS 11—ENVIRONMENTAL CONTROL APPARATUS

FOR TAILLIGHTS FOR AUTOMOBILES (U.S. CLS. 13, 21, 23, 31 AND 34).
FIRST USE 1-1-2001; IN COMMERCE 1-1-2001.

CLASS 12—VEHICLES

FOR AUTOMOBILES (U.S. CLS. 19, 21, 23, 31, 35 AND 44).
FIRST USE 1-1-2001; IN COMMERCE 1-1-2001.
YAT SYE, LEE, EXAMINING ATTORNEY

SN 78-763,830. EISEMAN, LEATRICE, BAINBRIDGE ISLAND, WA. FILED 11-30-2005.

MORE ALIVE WITH COLOR

THE MARK CONSISTS OF STANDARD CHARACTERS WITHOUT CLAIM TO ANY PARTICULAR FONT, STYLE, SIZE, OR COLOR.

CLASS 3—COSMETICS AND CLEANING PREPARATIONS

FOR COSMETICS; HAIR AND BODY CARE PREPARATIONS; FACE CARE PREPARATIONS, NAMELY, FACE LOTIONS, FACE CREAMS AND FACE POWDER; HAIR COLOR (U.S. CLS. 1, 4, 6, 50, 51 AND 52).

CLASS 16—PAPER GOODS AND PRINTED MATTER

FOR PRINTED COLOR PALETTES; PRINTED GUIDES FOR COLOR SELECTION; BOOKS IN THE FIELD OF COLOR SELECTION; PRINTED MATERIALS AND PUBLICATIONS, NAMELY, NEWSLETTERS, PAMPHLETS, BROCHURES, SYNDICATED NEWSPAPER COLUMNS, PERIODICAL COLUMNS, PRINTED EDUCATIONAL MATERIALS IN THE FIELD OF COLOR SELECTION AND THE USE OF COLOR (U.S. CLS. 2, 5, 22, 23, 29, 37, 38 AND 50).

CLASS 41—EDUCATION AND ENTERTAINMENT

FOR EDUCATIONAL SERVICES, NAMELY, PROVIDING CLASSES, SEMINARS, AND WORKSHOPS IN THE FIELDS OF COLOR SELECTION AND USE OF COLOR AND RELATED MATERIALS (U.S. CLS. 100, 101 AND 107).

CLASS 42—SCIENTIFIC AND COMPUTER SERVICES

FOR INDUSTRIAL DESIGN SERVICES; INTERIOR DECORATION CONSULTATION IN THE FIELD OF COLOR SELECTION (U.S. CLS. 100 AND 101).

CLASS 45—PERSONAL AND LEGAL SERVICES

FOR PERSONAL IMAGE DEVELOPMENT CONSULTATION (U.S. CLS. 100 AND 101).
RICHARD WHITE, EXAMINING ATTORNEY

SN 78-764,589. RACEWORKS, LLC, OAKLAND, CA. FILED 12-1-2005.



THE COLOR(S) ORANGE, YELLOW/ORANGE, RED/ORANGE AND BLUE IS/ARE CLAIMED AS A FEATURE OF THE MARK.

THE COLOR ORANGE APPEARS IN THE OUTLINE OF THE HELMET, THE COLOR YELLOW/ORANGE APPEARS IN THE TOP PORTION OF THE WING, THE COLOR ORANGE APPEARS IN THE MIDDLE PORTION OF THE WING, THE COLOR RED/ORANGE APPEARS IN THE BOTTOM PORTION OF THE WING AND THE COLOR BLUE APPEARS IN THE WORDING "RACEWORKS".

CLASS 35—ADVERTISING AND BUSINESS

FOR PROVIDING FACILITIES FOR BUSINESS MEETINGS; CONCESSION STANDS FEATURING SOUVENIRS, NOVELTIES, SUNDRIES, FAST FOOD AND BEVERAGES, AND EXCLUDING CLOTHING (U.S. CLS. 100, 101 AND 102).

CLASS 41—EDUCATION AND ENTERTAINMENT

FOR PROVIDING FACILITIES FOR RECREATION AND ENTERTAINMENT ACTIVITIES, NAMELY, AN INDOOR FACILITY FOR KART RENTAL AND RACING AND RACE EVENTS (U.S. CLS. 100, 101 AND 107).
MICHELE SWAIN, EXAMINING ATTORNEY

SN 78-764,595. RACEWORKS, LLC, OAKLAND, CA. FILED 12-1-2005.

SN 78-771,757. O'KEEFFE, JOEL, MELBOURNE, AUSTRALIA, AND O'KEEFFE, RYAN, MELBOURNE, AUSTRALIA, FILED 12-12-2005.

RACEWORKS

THE MARK CONSISTS OF STANDARD CHARACTERS WITHOUT CLAIM TO ANY PARTICULAR FONT, STYLE, SIZE, OR COLOR.

CLASS 35—ADVERTISING AND BUSINESS

FOR PROVIDING FACILITIES FOR BUSINESS MEETINGS; CONCESSION STANDS FEATURING SOUVENIRS, NOVELTIES, SUNDRIES, FAST FOOD AND BEVERAGES, AND EXCLUDING CLOTHING (U.S. CLS. 100, 101 AND 102).

CLASS 41—EDUCATION AND ENTERTAINMENT

FOR PROVIDING FACILITIES FOR RECREATION AND ENTERTAINMENT ACTIVITIES, NAMELY, AN INDOOR FACILITY FOR GO-KART RENTAL AND RACING AND RACE EVENTS (U.S. CLS. 100, 101 AND 107).

MICHELE SWAIN, EXAMINING ATTORNEY

SN 78-765,577. THE NOSTALGIA NETWORK, INC., WASHINGTON, DC. FILED 12-2-2005.

AMERICANLIFE NOSTALGIA TV

THE MARK CONSISTS OF STANDARD CHARACTERS WITHOUT CLAIM TO ANY PARTICULAR FONT, STYLE, SIZE, OR COLOR.

NO CLAIM IS MADE TO THE EXCLUSIVE RIGHT TO USE "TV", APART FROM THE MARK AS SHOWN.

CLASS 38—COMMUNICATION

FOR CABLE CASTING SERVICES (U.S. CLS. 100, 101 AND 104).

CLASS 41—EDUCATION AND ENTERTAINMENT

FOR TELEVISION PRODUCTION; ENTERTAINMENT IN THE NATURE OF ONGOING TELEVISION PROGRAMS IN THE FIELD OF DRAMA, COMEDIES, VARIETY, AND VARIETY NEWS SHOWS (U.S. CLS. 100, 101 AND 107).

WOODROW HARTZOG, EXAMINING ATTORNEY

Airbourne

THE MARK CONSISTS OF STANDARD CHARACTERS WITHOUT CLAIM TO ANY PARTICULAR FONT, STYLE, SIZE, OR COLOR.

CLASS 9—ELECTRICAL AND SCIENTIFIC APPARATUS

FOR SOUND AND/OR VIDEO RECORDINGS FEATURING MUSIC; RECORDS FEATURING MUSIC; COMPACT DISCS FEATURING MUSIC; AUDIO TAPES FEATURING MUSIC; DVDS FEATURING MUSIC; CASSETTES FEATURING MUSIC; CINEMAGRAPHIC FILM FEATURING MUSIC; VIDEO TAPES FEATURING MUSIC; CD-ROMS FEATURING MUSIC; COMPUTER SOFTWARE PROGRAMS FOR PROCESSING DIGITAL MUSIC FILES; COMPUTER GAME PROGRAMS FEATURING MUSIC; DOWNLOADABLE ONLINE SOUND AND/OR VIDEO RECORDINGS FEATURING MUSIC; PHONOGRAPHIC RECORD SLEEVES (U.S. CLS. 21, 23, 26, 36 AND 38).

CLASS 16—PAPER GOODS AND PRINTED MATTER

FOR GIFT CARDS, SHEET MUSIC, IRON-ON TRANSFERS, BOOKS FEATURING MUSIC AND/OR MUSICAL BANDS, NEWSPAPERS FEATURING MUSIC AND/OR MUSICAL BANDS, TOUR AND PROGRAM BOOKS FEATURING MUSIC AND/OR MUSICAL BANDS, PHOTOGRAPHS, INFORMATIONAL FLYERS FEATURING MUSIC AND/OR MUSICAL BANDS, CALENDERS FEATURING MUSIC AND/OR MUSICAL BANDS, PRINTED TICKETS FOR LIVE PERFORMANCES OF MUSICAL BANDS, PICTURES FEATURING MUSIC AND/OR MUSICAL BANDS, PAPER BANNERS FEATURING MUSIC AND/OR MUSICAL BANDS, MAGAZINES FEATURING MUSIC AND/OR MUSICAL BANDS, INSTRUCTIONAL AND TEACHING MATERIAL FEATURING MUSIC AND/OR BANDS, GREETING CARDS, POSTCARDS (U.S. CLS. 2, 5, 22, 23, 29, 37, 38 AND 50).

CLASS 25—CLOTHING

FOR CLOTHING, TO BE SOLD AS PROMOTIONAL MERCHANDISE FOR A MUSICAL GROUP, NAMELY, BELTS, BANDANNAS, WRISTBANDS, UNDERWEAR, JERSEYS, PULLOVERS, T-SHIRTS, JACKETS, SHIRTS, HEADGEAR INCLUDING HATS, CAPS (U.S. CLS. 22 AND 39).

CLASS 41—EDUCATION AND ENTERTAINMENT

FOR ENTERTAINMENT SERVICES, NAMELY, LIVE SHOWS AND LIVE CONCERTS FEATURING MUSIC PERFORMANCES BY BANDS, SINGERS AND/OR MUSICIANS, LIVE ENTERTAINMENT PERFORMANCES BY BANDS, SINGERS AND/OR MUSICIANS; RADIO PERFORMANCES; SHOWS FEATURING MUSIC; THEATRICAL PERFORMANCES; STAGE PERFORMANCES (U.S. CLS. 100, 101 AND 107).

NORA BUCHANAN WILL, EXAMINING ATTORNEY

SN 78-774,826. ESCAPE THE DAILY GRIND, LLC, WINCHESTER, VA. FILED 12-16-2005.



OWNER OF U.S. REG. NO. 1,370,435.

CLASS 30—STAPLE FOODS

FOR COFFEE (U.S. CL. 46).
FIRST USE 10-1-1995; IN COMMERCE 10-1-1995.

CLASS 43—HOTEL AND RESTAURANT SERVICES

FOR COFFEEHOUSE AND RESTAURANT SERVICES (U.S. CLS. 100 AND 101).
FIRST USE 10-1-1995; IN COMMERCE 10-1-1995.
KRISTIN DAHLING, EXAMINING ATTORNEY

SN 78-775,181. OOCL (LOGISTICS) HOLDINGS LIMITED, ROAD TOWN, TORTOLA, BR. VIRGIN ISLANDS, FILED 12-16-2005.

PODIUM

THE MARK CONSISTS OF STANDARD CHARACTERS WITHOUT CLAIM TO ANY PARTICULAR FONT, STYLE, SIZE, OR COLOR.

PRIORITY CLAIMED UNDER SEC. 44(D) ON HONG KONG APPLICATION NO. 300501524, FILED 9-27-2005, REG. NO. 300501524, DATED 9-27-2005, EXPIRES 9-26-2015.

CLASS 35—ADVERTISING AND BUSINESS

FOR CUSTOMS CLEARANCE SERVICES; COMPUTERIZED TRACKING AND TRACING OF CARGO, FREIGHT AND CARGO CONTAINERS WHILE IN TRANSIT; MONITORING AND TRACKING OF CARGO, FREIGHT, AND CARGO CONTAINER SHIPMENTS; ONLINE ORDERING SERVICES FEATURING CARGO, FREIGHT AND CARGO CONTAINER TRANSPORTATION AND STORAGE, WAREHOUSING (U.S. CLS. 100, 101 AND 102).

CLASS 36—INSURANCE AND FINANCIAL

FOR ELECTRONIC PAYMENT, NAMELY, ELECTRONIC PROCESSING AND TRANSMISSION OF BILL PAYMENT DATA (U.S. CLS. 100, 101 AND 102).

CLASS 38—COMMUNICATION

FOR ELECTRONIC DELIVERY AND RECEIPT OF SHIPPING INSTRUCTIONS; PROVIDING ON-LINE COMMUNICATIONS LINKS WHICH TRANSFER THE WEBSITE USER TO OTHER LOCAL AND GLOBAL WEB PAGES (U.S. CLS. 100, 101 AND 104).

CLASS 39—TRANSPORTATION AND STORAGE

FOR CARGO, FREIGHT AND CARGO CONTAINER TRANSPORTATION BY SHIP, RAIL AND TRUCK; TRANSPORTATION OF GOODS OF OTHERS BY SHIP, RAIL AND TRUCK; CARGO CONSOLIDATION AND HANDLING SERVICES FOR THE EFFICIENT PACKING OF CARGO CONTAINERS; UNLOADING CARGO, FREIGHT AND CARGO CONTAINERS; DELIVERY AND RECEIPT OF CARGO AND CARGO CONTAINERS TO AND FROM THE TERMINAL FACILITY THROUGH THE GATES, WAREHOUSE OR DEPOT; FREIGHT FORWARDING SERVICES; RENTAL OF WAREHOUSES; RENTAL OF WAREHOUSE SPACE; STORAGE OF CARGO CONTAINERS, FREIGHT AND CARGO; WAREHOUSING SERVICES; PROVIDING FACILITIES FOR CARGO CONSOLIDATION AND HANDLING, NAMELY, SHIPMENT OF CONTAINER GOODS BY SHIP, RAIL AND BY TRUCK; STEVEDORING FREIGHT, CARGO AND CARGO CONTAINERS TO AND FROM VESSELS; STORAGE OF CARGO CONTAINERS, FREIGHT AND CARGO FOR OTHERS AND WAREHOUSING SERVICES; CARGO CONTAINER LEASING SERVICES; WAREHOUSING SERVICES, INCLUDING, STORAGE, DISTRIBUTION, PICK-UP, AND PACKING FOR SHIPMENT OF CARGO, FREIGHT AND CARGO CONTAINERS FOR OTHERS; PROVIDING INFORMATION IN THE FIELD OF CARGO, FREIGHT AND CARGO CONTAINER TRANSPORTATION AND STORAGE BY ELECTRONIC MEANS; PROVIDING WAREHOUSING INFORMATION OVER COMPUTER NETWORKS, INTRANETS AND THE INTERNET; PROVIDING LINKS TO WEBSITES OF OTHERS FEATURING TRANSPORTATION OF GOODS BY SHIP, RAIL, AND TRUCK; ALL OF THE ABOVE SERVICES RELATING TO WAREHOUSING SERVICES, INCLUDING, STORAGE, DISTRIBUTION, PICK-UP, AND PACKING FOR SHIPMENT OF CARGO, FREIGHT AND CARGO CONTAINERS FOR OTHERS; ADVISORY AND CONSULTANCY SERVICES RELATING TO STORAGE, TRANSPORTATION AND DELIVERY OF FREIGHT, CARGO, AND CARGO CONTAINERS (U.S. CLS. 100 AND 105).

CLASS 42—SCIENTIFIC AND COMPUTER SERVICES

FOR COMPUTER SERVICES, NAMELY, MONITORING AND REPORTING ON THE PERFORMANCE, AVAILABILITY, AND ERRORS OF WEBSITES OF OTHERS; PROVIDING TEMPORARY USE OF NON-DOWNLOADABLE COMPUTER SOFTWARE FOR TRACKING FREIGHT, CARGO HANDLING AND TRANSPORTATION, PROCESSING SHIPMENTS, ARRANGING WAREHOUSING SERVICES, PREPARING SHIPPING DOCUMENTATION OVER COMPUTER NETWORKS, INTRANETS AND THE INTERNET; HOSTING OF INTERNET SITES FOR THIRD PARTIES; CONVERSION OF DATA OR DOCUMENTS FROM PHYSICAL TO ELECTRONIC MEDIA; COMPUTER SOFTWARE DESIGN; DATA CONVERSION OF COMPUTER PROGRAMS AND DATA; PROVIDING NON-DOWNLOADABLE INTERACTIVE COMPUTER SOFTWARE IN THE FIELD OF CARGO, FREIGHT AND CARGO CONTAINER TRANSPORTATION AND STORAGE, AND WAREHOUSING OVER COMPUTER NETWORKS, INTRANETS AND THE INTERNET (U.S. CLS. 100 AND 101).

JENNIFER VASQUEZ, EXAMINING ATTORNEY

SN 78-778,338. TENXC WIRELESS INC., OTTAWA, ONTARIO, CANADA, FILED 12-21-2005.

TENXC

THE MARK CONSISTS OF STANDARD CHARACTERS WITHOUT CLAIM TO ANY PARTICULAR FONT, STYLE, SIZE, OR COLOR.

CLASS 9—ELECTRICAL AND SCIENTIFIC APPARATUS

FOR RADIO FREQUENCY (RF) SPECTRALLY EFFICIENT AND PERFORMANCE ENHANCING SYSTEMS AND TECHNOLOGY FOR WIRELESS ACCESS NETWORKS, NAMELY, ELECTRONIC CARDS FOR ADAPTOR SPATIAL PROCESSING IN RADIO FREQUENCY SYSTEMS FOR SIGNAL TRANSMISSION, RECEPTION AND PROCESSING IN FIXED AND MOBILE WIRELESS ACCESS BASE STATIONS AND ACCESS POINTS; ANTENNAS AND ANTENNA ARRAYS FOR WIRELESS NETWORK ACCESS; COMPUTER SOFTWARE FOR USE IN CONTROLLING, OPERATING, MANAGING AND MAINTAINING THE FOREGOING WIRELESS COMMUNICATIONS SYSTEMS AND WIRELESS INFRASTRUCTURE EQUIPMENT, ANTENNAS AND ANTENNA ARRAYS (U.S. CLS. 21, 23, 26, 36 AND 38).

CLASS 37—CONSTRUCTION AND REPAIR

FOR INSTALLATION AND MAINTENANCE OF WIRELESS INFRASTRUCTURE SYSTEMS AND WIRELESS COMMUNICATIONS SYSTEMS FOR OTHERS (U.S. CLS. 100, 103 AND 106).

STEVEN R. FOSTER, EXAMINING ATTORNEY

SN 78-780,191. SITUATION PUBLISHING LTD., LONDON, UNITED KINGDOM, FILED 12-23-2005.



OWNER OF ERPN CMNTY TM OFC REG. NO. 3348381, DATED 9-11-2003, EXPIRES 9-11-2013.

NO CLAIM IS MADE TO THE EXCLUSIVE RIGHT TO USE "REGISTER", APART FROM THE MARK AS SHOWN.

CLASS 35—ADVERTISING AND BUSINESS

FOR ADVERTISING, PROMOTIONAL AND MARKETING SERVICES; BUSINESS PROJECT MANAGEMENT; DATABASE MANAGEMENT; DATA PROCESSING SERVICES; ELECTRONIC COMMERCE ADVISORY, CONSULTANCY, INFORMATION AND MANAGEMENT SERVICES, NAMELY, ELECTRONIC COMMERCE ADVISORY, CONSULTANCY, INFORMATION AND MANAGEMENT SERVICES NAMELY, PROFESSIONAL BUSINESS CONSULTANCY SERVICES RELATING TO THE IT INDUSTRY, IT BUSINESS INFORMATION SERVICES, IT BUSINESS RESEARCH SERVICES, IT PERSONNEL RECRUITMENT SERVICES; DATA COMPILATION AND PROVISION OF BUSINESS, COMMERCIAL AND STATISTICAL INFORMATION, ALL RELATING TO INFORMATION TECHNOLOGY; INFORMATION, ADVISORY AND CONSULTANCY SERVICES RELATING TO ALL THE AFORESAID SERVICES (U.S. CLS. 100, 101 AND 102).

CLASS 38—COMMUNICATION

FOR ELECTRONIC MAIL SERVICES; TRANSMISSION OF DATA AND INFORMATION BY FACSIMILE, ELECTRONIC COMPUTER, ELECTRONIC MAIL, TELEVISION, INTERNET AND TELEPHONE, ALL RELATING TO INFORMATION TECHNOLOGY; PROVISION OF TELECOMMUNICATIONS ACCESS AND LINKS TO COMPUTER DATABASE AND THE INTERNET; COMPUTER ON-LINE AND CONSULTING SERVICES RELATING TO COMPUTER COMMUNICATIONS FOR THE ELECTRONIC TRANSMISSION OF BUSINESS, COMMERCIAL AND STATISTICAL INFORMATION, ALL BY MEANS OF COMPUTER SYSTEMS, ELECTRONIC MAIL, INTERNET, RADIO, TELEVISION OR TELEPHONE, ALL RELATING TO INFORMATION TECHNOLOGY, NAMELY, ELECTRONIC BULLETIN BOARDS FEATURING INFORMATION IN THE FIELD OF INFORMATION TECHNOLOGY, TRANSMISSION OF NEWS RELATING TO INFORMATION TECHNOLOGY, AND ON-LINE DOCUMENT DELIVERY VIA A GLOBAL COMPUTER NETWORK; PROVIDING USER ACCESS TO COMMUNICATION SERVICES AND ELECTRONIC COMMUNICATION NETWORKS; PROVIDING ACCESS TO COMMERCIAL TRANSACTIONS OVER ELECTRONIC COMMUNICATIONS NETWORKS; PROVIDING USER ACCESS TO THE INTERNET AND OTHER COMPUTER USER ACCESS TO THE INTERNET AND OTHER COMPUTER NETWORKS; TELECOMMUNICATION AND DATA COMMUNICATION GATEWAY SERVICES; PROVIDING USER ACCESS TO THE INTERNET AND OTHER COMPUTER NETWORKS TO FACILITATE ELECTRONIC COMMERCE; INTERNET SERVICE PROVIDER SERVICES; E-MAIL SERVICES; INFORMATION, ADVISORY AND CONSULTANCY SERVICES RELATING TO ALL THE AFORESAID SERVICES (U.S. CLS. 100, 101 AND 104).

CLASS 39—TRANSPORTATION AND STORAGE

FOR ELECTRONIC COMPUTERIZED STORAGE OF BUSINESS, COMMERCIAL AND STATISTICAL INFORMATION, ALL RELATING TO INFORMATION TECHNOLOGY (U.S. CLS. 100 AND 105).

CLASS 41—EDUCATION AND ENTERTAINMENT

FOR PUBLISHING SERVICES INCLUDING ELECTRONIC PUBLISHING SERVICES, ALL RELATING TO INFORMATION TECHNOLOGY, NAMELY, PUBLISHING WEB MAGAZINES RELATING TO INFORMATION TECHNOLOGY; PUBLISHING OF INFORMATION ON INSTRUCTIONAL AND TEACHING MATERIALS RELATING TO INFORMATION TECHNOLOGY; PROVISION OF ON-LINE ELECTRONIC PUBLICATIONS IN THE NATURE OF ARTICLES, COMMENTS, REVIEWS, NEWSPAPERS, MAGAZINES, PHOTOGRAPHS AND PICTURES, ALL RELATING TO INFORMATION TECHNOLOGY; ELECTRONIC LIBRARY SERVICES RELATING TO INFORMATION TECHNOLOGY, NAMELY, PROVIDING ELECTRONIC LIBRARY SERVICES WHICH FEATURE NEWSPAPERS, MAGAZINES, PHOTOGRAPHS AND PICTURES VIA AN ON-LINE COMPUTER NETWORK; ONGOING TELEVISION NEWS PROGRAM ABOUT INFORMATION TECHNOLOGY; INFORMATION, ADVISORY AND CONSULTANCY SERVICES RELATING TO ALL THE AFORESAID SERVICES (U.S. CLS. 100, 101 AND 107).

CLASS 42—SCIENTIFIC AND COMPUTER SERVICES

FOR SEARCH ENGINE SERVICES; PROVISION OF ON-LINE NEWS, ALL RELATING TO INFORMATION TECHNOLOGY; PUBLIC DOCUMENT RETRIEVAL OF BUSINESS, COMMERCIAL AND STATISTICAL INFORMATION, ALL RELATING TO INFORMATION TECHNOLOGY; PROVIDING INTERACTIVE DATABASE INFORMATION SERVICES RELATING TO INFORMATION TECHNOLOGY; PROVIDING ELECTRONIC DATABASE SERVICES RELATING TO INFORMATION TECHNOLOGY; PROVISION OF INFORMATION FOR ACCESSING VIA COMMUNICATION AND COMPUTER NETWORKS INCLUDING THE INTERNET, ALL RELATING TO INFORMATION TECHNOLOGY (U.S. CLS. 100 AND 101).

BRIAN PINO, EXAMINING ATTORNEY

CLASS 41—EDUCATION AND ENTERTAINMENT

FOR CONDUCTING CLASSES, WORKSHOPS AND SEMINARS IN THE FIELDS OF COMPETITIVE SPORTS AND ATHLETICS AND SPORTS AND ATHLETIC TRAINING AND DISTRIBUTING COURSE MATERIALS IN CONNECTION THEREWITH; ENTERTAINMENT SERVICES IN THE NATURE OF A SERIES OF ONGOING TELEVISION PROGRAMS IN THE FIELDS OF COMPETITIVE SPORTS AND ATHLETICS AND SPORTS AND ATHLETIC TRAINING; ENTERTAINMENT SERVICES, NAMELY, PRODUCTION OF TELEVISION AND AUDIOVISUAL PROGRAMS IN THE FIELDS OF COMPETITIVE SPORTS AND ATHLETICS AND SPORTS AND ATHLETIC TRAINING; DISTRIBUTION OF TELEVISION PROGRAMS IN THE FIELDS OF COMPETITIVE SPORTS AND ATHLETICS AND SPORTS AND ATHLETIC TRAINING ON FREE, CABLE AND SATELLITE TELEVISION, AND THE INTERNET; PROVIDING A TELEVISION PROGRAM IN THE FIELDS OF COMPETITIVE SPORTS AND ATHLETICS AND SPORTS AND ATHLETIC TRAINING VIA A GLOBAL COMPUTER NETWORK; MAGAZINE PUBLISHING; ON-LINE PUBLICATION OF A MAGAZINE IN THE FIELDS OF COMPETITIVE SPORTS AND ATHLETICS AND SPORTS AND ATHLETIC TRAINING; OPERATION OF SPORTS CAMPS; PERSONAL TRAINING SERVICES, NAMELY, STRENGTH AND CONDITIONING TRAINING; PROVIDING INFORMATION IN THE FIELDS OF COMPETITIVE SPORTS AND ATHLETICS AND SPORTS AND ATHLETIC TRAINING VIA THE INTERNET; RATING OF COMPETITIVE ATHLETES BY ASSIGNING NUMERIC VALUE TO SEVERAL SPORTS AND ATHLETIC EVENTS AND COMBINING THEM INTO A SINGLE NUMBER THAT MEASURES AN ATHLETE'S OVERALL ATHLETICISM (U.S. CLS. 100, 101 AND 107).

SEAN CROWLEY, EXAMINING ATTORNEY

SN 78-787,495. BC SPORTS, INC., PORTLAND, OR. FILED 1-9-2006.



OWNER OF U.S. REG. NO. 2,928,815.

SN 78-787,501. BC SPORTS, INC., PORTLAND, OR. FILED 1-9-2006.

CLASS 9—ELECTRICAL AND SCIENTIFIC APPARATUS

FOR PRE-RECORDED AUDIO AND AUDIOVISUAL RECORDINGS IN THE FIELDS OF COMPETITIVE SPORTS AND ATHLETICS AND SPORTS AND ATHLETIC TRAINING; COMPACT DISCS, CASSETTE TAPES, DIGITAL VIDEO DISCS, VIDEOCASSETTE TAPES, AND DIGITAL VIDEO RECORDINGS IN THE FIELDS OF COMPETITIVE SPORTS AND ATHLETICS AND SPORTS AND ATHLETIC TRAINING (U.S. CLS. 21, 23, 26, 36 AND 38).

CLASS 16—PAPER GOODS AND PRINTED MATTER

FOR PRINTED MATTER, NAMELY, BOOKS, MAGAZINES, BOOKLETS, PAMPHLETS, LEAFLETS, AND BROCHURES IN THE FIELDS OF COMPETITIVE SPORTS AND ATHLETICS AND SPORTS AND ATHLETIC TRAINING; PRODUCT GUIDES FEATURING SPORTS AND ATHLETIC TRAINING EQUIPMENT; POSTERS; POSTCARDS; STATIONERY; NOTECARDS (U.S. CLS. 2, 5, 22, 23, 29, 37, 38 AND 50).

CLASS 28—TOYS AND SPORTING GOODS

FOR ATHLETIC EQUIPMENT, NAMELY, FOOTBALL, BASEBALL, SOFTBALL, BASKETBALL, SOCCER, RUNNING AND VOLLEYBALL TRAINING PRODUCTS FOR SPEED, AGILITY AND QUICKNESS (U.S. CLS. 22, 23, 38 AND 50).

FIRST USE 4-7-2004; IN COMMERCE 4-7-2004.

SPARQ

THE MARK CONSISTS OF STANDARD CHARACTERS WITHOUT CLAIM TO ANY PARTICULAR FONT, STYLE, SIZE, OR COLOR.

OWNER OF U.S. REG. NO. 2,928,815.

CLASS 18—LEATHER GOODS

FOR ALL PURPOSE SPORT BAGS; ALL-PURPOSE ATHLETIC BAGS; ALL-PURPOSE CARRYING BAGS; ATHLETIC BAGS; BAGS AND HOLDALLS FOR SPORTS CLOTHING; CARRY-ALL BAGS; DUFFEL BAGS; DUFFLE BAGS; GYM BAGS; SPORTS BAGS (U.S. CLS. 1, 2, 3, 22 AND 41).

CLASS 25—CLOTHING

FOR ANKLE SOCKS; ANKLETS; ANTI-PERSPIRANT SOCKS; ATHLETIC FOOTWEAR; ATHLETIC SHOES; ATHLETIC UNIFORMS; BASEBALL CAPS; BASEBALL SHOES; BASKETBALL SNEAKERS; BATHING SUITS; BATHING SUITS FOR MEN; BATHING TRUNKS; BERMUDA SHORTS; BICYCLE GLOVES; BICYCLING GLOVES; BOARD SHORTS; BOARDSHORTS; BODY SHAPERS; BODY SUITS; BOWLING SHOES; BOXING SHOES; CAMP SHIRTS; CANVAS SHOES; CAP VISORS; CAPS; CAPS WITH VISORS; CHILDREN'S HEADWEAR; CLEATS FOR ATTACHMENT TO SPORTS SHOES; CLOTHING FOR WEAR IN JUDO PRACTICES; CLOTHING FOR WEAR IN WRESTLING GAMES; CYCLING SHOES; CYCLISTS' JERSEYS; DOWN JACKETS; DRY SUITS; FOOTBALL BOOTS AND STUDS THEREFOR; FOOTBALL SHOES; FOOTWEAR; FOOTWEAR FOR MEN; FOOTWEAR FOR MEN AND WOMEN; FOOTWEAR FOR TRACK AND FIELD ATHLETICS; FOOTWEAR FOR WOMEN; GOLF CAPS; GOLF CLEATS; GOLF SHIRTS; GOLF SHOES; GOLF TROUSERS; GYM SHORTS; GYM SUITS; GYMNASIUM SHOES; HANDBALL SHOES; HATS; HEAD SWEATBANDS; HEADWEAR; HEADBANDS AGAINST SWEATING; HEADGEAR, NAMELY, HATS, CAPS, BEANIES, SKULL CAPS; HEADWEAR; HEAVY JACKETS; HOCKEY SHOES; JACKETS; JERSEYS; JOGGING OUTFITS; JOGGING PANTS; JOGGING SUITS; JUDO SUITS; KARATE SUITS; KENDO OUTFITS; KNIT SHIRTS; KNITTED CAPS; LEOTARDS; LEOTARDS AND TIGHTS FOR WOMEN, MEN AND CHILDREN OF NYLON, COTTON OR OTHER TEXTILE FIBERS; LIGHT-REFLECTING COATS; LIGHT-REFLECTING JACKETS; LONG SLEEVED VESTS; MARTIAL ARTS UNIFORMS; MEN AND WOMEN JACKETS, COATS, TROUSERS, VESTS; MEN'S SOCKS; PANTS; PERSPIRATION ABSORBENT UNDERWEAR CLOTHING; PULLOVERS; QUILTED VESTS; RAINPROOF JACKETS; RAINWEAR; RUBBER SHOES; RUGBY SHOES; RUGBY SHORTS; RUGBY TOPS; SCHOOL UNIFORMS; SHIRTS; SHOES; SHORT SETS; SHORT-SLEEVED OR LONG-SLEEVED T-SHIRTS; SHORT-SLEEVED SHIRTS; SHORTS; SKATING OUTFITS; SLEEVED OR SLEEVELESS JACKETS; SLEEVELESS JERSEYS; SMALL HATS; SNEAKERS; SOCCER BOOTS; SOCCER SHOES; SOCKS; SPORTS JACKETS; SPORTS JERSEYS AND BREECHES FOR SPORTS; SPORTS OVERUNIFORMS; SPORTS SHIRTS; SPORTS SHIRTS WITH SHORT SLEEVES; STOCKINGS; STOCKINGS (SWEAT-ABSORBENT); SWEAT BANDS; SWEAT PANTS; SWEAT SHIRTS; SWEAT SHORTS; SWEAT SUITS; SWEATBANDS; SWEATSOCKS; SWIM CAPS; SWIM TRUNKS; SWIM WEAR; SWIMMING CAPS; SWIMMING TRUNKS; SWIMSUITS; T-SHIRTS; TANK TOPS; TANK-TOPS; TENNIS SHOES; TENNIS WEAR; TRACK AND FIELD SHOES; TRACK PANTS; TRACK SUITS; TRACKSUITS; TRAINING SHOES; TRAINING SUITS; TROUSERS FOR SWEATING; TRUNKS; UNDERGARMENTS; UNDERCLOTHES; UNDERGARMENTS; UNDERPANTS; UNDERSHIRTS; UNIFORMS; UNITARDS; VESTS; VOLLEYBALL SHOES; WAIST BELTS; WARM UP SUITS; WATERPROOF JACKETS AND PANTS; WIND RESISTANT JACKETS; WIND-JACKETS; WOMEN'S SHOES (U.S. CLS. 22 AND 39).

SEAN CROWLEY, EXAMINING ATTORNEY

SN 78-795,065. PLAY LTD., ST. HELIER, JERSEY, FILED 1-19-2006.

PLAY USA

THE MARK CONSISTS OF STANDARD CHARACTERS WITHOUT CLAIM TO ANY PARTICULAR FONT, STYLE, SIZE, OR COLOR.

OWNER OF U.S. REG. NO. 2,691,785.

NO CLAIM IS MADE TO THE EXCLUSIVE RIGHT TO USE "USA", APART FROM THE MARK AS SHOWN.

CLASS 9—ELECTRICAL AND SCIENTIFIC APPARATUS

FOR COMPUTER HARDWARE AND COMPUTER SOFTWARE FOR PRODUCTION OF VIDEO, TELEVISION AND COMPUTER ENTERTAINMENT AND INFORMATION, NOT TO INCLUDE EROTIC ADULT ENTERTAINMENT (U.S. CLS. 21, 23, 26, 36 AND 38).

CLASS 16—PAPER GOODS AND PRINTED MATTER

FOR PRINTED MATTER, NAMELY, BOOKS, NEWSPAPERS AND MAGAZINES ON TOPICS OF GENERAL INTEREST IN THE FIELD OF MUSIC, COMPUTER GAMES, MOVIES, BOOKS, ELECTRONIC CONSUMER GOODS AND GADGETS; PHOTOGRAPHS; STATIONERY; ADHESIVES FOR STATIONERY OR HOUSEHOLD PURPOSES; PLASTIC, PAPER AND CARD MATERIALS FOR WRAPPING OR PACKAGING ARTICLES FOR PROTECTION DURING TRANSPORTATION, NAMELY, PLASTIC BUBBLE PACKS AND CORRUGATED OR PADDED PAPER OR PACKING CARDBOARD (U.S. CLS. 2, 5, 22, 23, 29, 37, 38 AND 50).

CLASS 35—ADVERTISING AND BUSINESS

FOR THE BRINGING TOGETHER, FOR THE BENEFIT OF OTHERS, OF A VARIETY OF GOODS, ENABLING CUSTOMERS TO CONVENIENTLY VIEW AND PURCHASE THOSE GOODS IN A GENERAL MERCHANDISE SHOP, OR IN A DEPARTMENT STORE; THE BRINGING TOGETHER, FOR THE BENEFIT OF OTHERS, OF A VARIETY OF GOODS, ENABLING CUSTOMERS TO CONVENIENTLY VIEW AND PURCHASE THOSE GOODS VIA A MAIL ORDER CATALOGUE, INTERNET WEBSITE OR VIA TELECOMMUNICATIONS, ALL SPECIALIZING IN GENERAL MERCHANDISING, MUSIC, VIDEO, ELECTRONICS OR ACCESSORIES, TOYS, CLOTHING, MOBILE PHONES, WATCHES, TIMEPIECES, COSMETICS, TOILETRIES, BEAUTY GOODS, FOOD, DRINK, SNACKS, CARS, VEHICLES, BIKES, TELEPHONES, BOOKS, GAMES OR TRAVEL GOODS (U.S. CLS. 100, 101 AND 102).

CLASS 38—COMMUNICATION

FOR BROADCASTING OF FILM, TELEVISION AND THEATRICAL CONTENT VIA DIGITAL BROADCAST MEDIUMS INCLUDING BUT NOT LIMITED TO THE INTERNET (U.S. CLS. 100, 101 AND 104).

CLASS 39—TRANSPORTATION AND STORAGE

FOR PACKAGING OF GOODS, NAMELY, PACKAGING ARTICLES FOR TRANSPORTATION; GIFT DELIVERY; WRAPPING, NAMELY, WRAPPING SERVICES FOR PACKAGE PROTECTION DURING TRAVEL; SHIPPING AND DELIVERY OF GOODS, NAMELY, DELIVERY OF PACKAGES AND LETTERS BY VARIOUS MODES OF TRANSPORTATION (U.S. CLS. 100 AND 105).

CLASS 41—EDUCATION AND ENTERTAINMENT

FOR PROVIDING ENTERTAINMENT, NAMELY, SPORTING AND CULTURAL EVENTS; ARRANGING FOR AND PROVIDING TICKET RESERVATIONS FOR SPORTS AND CULTURAL EVENTS; PRODUCING, WRITING, DIRECTING, AND SYNDICATION OF TELEVISION AND THEATRICAL CONTENT FOR DIGITAL BROADCAST MEDIUMS INCLUDING BUT NOT LIMITED TO THE INTERNET (U.S. CLS. 100, 101 AND 107).

CLASS 42—SCIENTIFIC AND COMPUTER SERVICES

FOR LICENSING OF TELEVISION AND THEATRICAL CONTENT FOR DIGITAL BROADCAST MEDIUMS INCLUDING BUT NOT LIMITED TO THE INTERNET (U.S. CLS. 100 AND 101).

ALLISON SCHRODY, EXAMINING ATTORNEY

SN 78-796,863. UNITEDHEALTH GROUP INCORPORATED, MINNETONKA, MN. FILED 1-23-2006.



UnitedHealth Group

OWNER OF U.S. REG. NOS. 2,635,728 AND 3,044,420. NO CLAIM IS MADE TO THE EXCLUSIVE RIGHT TO USE "GROUP", APART FROM THE MARK AS SHOWN.

CLASS 35—ADVERTISING AND BUSINESS

FOR COST MANAGEMENT SERVICES FOR HEALTH CARE BENEFIT AND DISABILITY PLANS OF OTHERS; COST MANAGEMENT OF PRE-PAID VISION BENEFIT PLANS OF OTHERS; COST MANAGEMENT SERVICES FOR PHARMACY BENEFIT AND PRESCRIPTION DRUG BENEFIT PLANS OF OTHERS; COST MANAGEMENT THROUGH APPROPRIATENESS AND TECHNOLOGY ASSESSMENT FOR TRANSPLANTATION PLAN BENEFITS; HEALTH CARE UTILIZATION AND REVIEW SERVICES; HEALTH CARE COST CONTAINMENT; MANAGED CARE SERVICES, NAMELY, ELECTRONIC PROCESSING OF HEALTH CARE INFORMATION; EMPLOYEE ASSISTANCE PROGRAMS CONSISTING OF REFERRAL SERVICES TO ASSIST EMPLOYEES WITH PERSONAL PROBLEMS; COST MANAGEMENT SERVICES FOR HEALTH CARE BENEFIT PLANS OF OTHERS PROVIDED VIA A GLOBAL COMPUTER NETWORK; HEALTH CARE UTILIZATION AND REVIEW SERVICES PROVIDED VIA A GLOBAL COMPUTER NETWORK; INVOICING SERVICES IN THE FIELD OF HEALTH CARE PROVIDED VIA A GLOBAL COMPUTER NETWORK; REFERRAL SERVICES FOR LEGAL ISSUES AND WORK AND FAMILY PROBLEMS; EMPLOYEE ASSISTANCE SERVICES IN THE NATURE OF PROVIDING REFERRALS FOR PHYSICAL AND MENTAL HEALTH AND SUBSTANCE ABUSE PROBLEMS; EMPLOYEE ASSISTANCE SERVICES, NAMELY, PROVIDING ON-LINE, TELEPHONIC, AND IN-PERSON REFERRALS FOR EMPLOYMENT-RELATED PROBLEMS IN THE FIELDS OF EMPLOYEE RELOCATION SUPPORT, CONTINUING EDUCATION, RETIREMENT, HOUSEHOLD SERVICES, CONCIERGE SERVICES, DIVORCE, ADOPTION, CHILD CUSTODY, AND COMMUNITY SUPPORT SERVICES, NAMELY, SERVICES DESIGNED TO PROMOTE THE MENTAL HEALTH AND INTEGRATION OF PEOPLE IN THE COMMUNITY OF THEIR CHOICE; ORGANIZING AND ADMINISTERING NETWORKS OF HEALTH CARE PROVIDERS AND HEALTH CARE SPECIALISTS; DRUG UTILIZATION REVIEW SERVICES; MEDICAL CASE MANAGEMENT SERVICES, NAMELY, MEDICAL REFERRAL OF INDIVIDUALS TO APPROPRIATE HEALTH MANAGEMENT PROGRAMS; MEDICATION MANAGEMENT SERVICES FOR COST CONTAINMENT PURPOSES, NAMELY, ASSESSING MEDICATION USE HISTORY AND PROVIDING INFORMATION REGARDING MEDICATION USE, OPTIONS, AND COST MANAGEMENT; ADMINISTRATION OF PHARMACY REIMBURSEMENT PROGRAMS (U.S. CLS. 100, 101 AND 102).

FIRST USE 1-0-1999; IN COMMERCE 1-0-1999.

CLASS 36—INSURANCE AND FINANCIAL

FOR ADMINISTRATION OF EMPLOYEE BENEFIT PLANS; ADMINISTRATION OF PRE-PAID HEALTH-CARE PLANS; ADMINISTRATION OF HEALTH CARE BENEFIT PLANS; ADMINISTRATION OF PRE-PAID VISION CARE PLANS; ADMINISTRATION OF PRE-PAID HEALTH CARE PLANS IN THE FIELDS OF CHIROPRACTIC, PHYSICAL MEDICINE, AND COMPLEMENTARY AND ALTERNATIVE MEDICINES; ADMINISTRATION AND MANAGEMENT OF PHARMACY BENEFIT AND PRESCRIPTION DRUG BENEFIT PROGRAMS; ADMINISTRATION OF PRE-PAID PHARMACY BENEFIT PLANS; PHARMACY BENEFIT MANAGEMENT SERVICES; CLAIMS ADMINISTRATION SERVICES FOR DISABILITY BENEFIT PLANS OF OTHERS; REINSURANCE FOR DISABILITY PLANS; STOP-LOSS INSURANCE FOR SELF-FUNDED HEALTH BENEFIT PLANS OF OTHERS; INSURANCE UNDERWRITING IN THE FIELD OF HEALTH FOR HEALTH CARE INSURANCE; INSURANCE UNDERWRITING IN THE FIELD OF DISABILITY INSURANCE; ELECTRONIC PROCESSING OF INSURANCE CLAIMS AND PAYMENT DATA, INCLUDING DISABILITY CLAIMS; DENTAL HEALTH INSURANCE UNDERWRITING AND ADMINISTRATION; ADMINISTRATION OF PRE-PAID DENTAL HEALTH PLANS; ADMINISTRATION OF EMPLOYEE BENEFIT DENTAL HEALTH PLANS; ADMINISTRATION OF PREFERRED PROVIDER PLANS IN THE FIELD OF HEALTH CARE; INSURANCE ACTUARIAL SERVICES IN THE FIELD OF HEALTH AND DISABILITY INSURANCE; PROVIDING LIFE, ACCIDENT AND CRITICAL ILLNESS BENEFIT PLANS; HEALTH CARE INSURANCE UNDERWRITING AND ADMINISTRATION PROVIDED VIA A GLOBAL COMPUTER NETWORK; VENTURE CAPITAL FUNDING SERVICES TO EMERGING AND START-UP COMPANIES; VENTURE CAPITAL SERVICES, NAMELY, PROVIDING FINANCING TO EMERGING AND START-UP COMPANIES; PROVIDING BENEFITS ADMINISTRATION SERVICES FOR OTHERS; EMPLOYEE ASSISTANCE SERVICES, NAMELY, PROVIDING ON-LINE, TELEPHONIC, AND IN-PERSON CONSULTATION, INFORMATION AND ASSESSMENT FOR EMPLOYMENT-RELATED PROBLEMS IN THE FIELDS OF RETIREMENT, LIFE-EVENT FINANCIAL PLANNING, AND CREDIT CARD AND OTHER DEBT (U.S. CLS. 100, 101 AND 102).

FIRST USE 1-0-1999; IN COMMERCE 1-0-1999.

CLASS 44—MEDICAL, BEAUTY AND AGRICULTURAL SERVICES

FOR MANAGED HEALTH CARE SERVICES; MANAGED VISION CARE SERVICES PROVIDED THROUGH A NETWORK OF VISION CARE PROVIDERS; MANAGED HEALTH CARE SERVICES IN THE FIELD OF VISION CARE; MANAGED HEALTH CARE SERVICES IN THE FIELD OF DISABILITY CARE; MANAGED HEALTH CARE SERVICES IN THE FIELD OF DENTAL CARE; MANAGED DENTAL HEALTH CARE SERVICES PROVIDED THROUGH A NETWORK OF DENTAL CARE PROVIDERS; MANAGED PHYSICAL THERAPY SERVICES PROVIDED THROUGH A NETWORK OF PHYSICAL THERAPY PROVIDERS; COMPLEMENTARY AND ALTERNATIVE MEDICINE SERVICES; MANAGED COMPLEMENTARY AND ALTERNATIVE MEDICINE SERVICES PROVIDED THROUGH A NETWORK OF COMPLEMENTARY AND ALTERNATIVE MEDICINE PROVIDERS TO HEALTH PLANS AND SELF-INSURED COMPANIES; NURSE TRIAGE AND NURSE CALL CENTERS PROVIDING INFORMATION REGARDING THE IDENTIFICATION OF SPECIFIC HEALTH RELATED CONCERNS AND GENERAL HEALTH ISSUES; PRE-TRANSPLANT MEDICAL REVIEW PROGRAM FOR REINSURANCE AND INSURANCE COMPANIES, SELF-FUNDED EMPLOYERS AND HEALTH MAINTENANCE ORGANIZATIONS, HMOS, TO ASSESS TRANSPLANT-RELATED TECHNOLOGY AND PROVIDE RECOMMENDATIONS FOR TRANSPLANTS; PROVIDING HEALTH CARE INFORMATION ON CARE GIVING SERVICES, CARE MANAGEMENT SERVICES, AND PHARMACY AND OVER-THE-COUNTER PRODUCTS AND SERVICES; HEALTH CARE IN THE NATURE OF HEALTH MAINTENANCE ORGANIZATIONS, HMOS, AND PREFERRED PROVIDER ORGANIZATIONS, PPOS; EMPLOYEE ASSISTANCE SERVICES, NAMELY, PROVIDING ON-LINE, TELEPHONIC, AND IN-PERSON

CONSULTATION, INFORMATION AND ASSESSMENT SERVICES FOR PHYSICAL HEALTH, MENTAL HEALTH AND SUBSTANCE ABUSE; HOME HEALTH CARE SERVICES; HOSPICE SERVICES; ARRANGING FOR MEDICAL CARE FOR NURSING HOME RESIDENTS; EMPLOYEE ASSISTANCE SERVICES, NAMELY, PROVIDING ON-LINE, TELEPHONIC, AND IN-PERSON CONSULTATION, INFORMATION AND ASSESSMENT FOR EMPLOYMENT-RELATED PROBLEMS IN THE FIELDS OF AGING, HEALTH AND WELLNESS, CHRONIC CONDITION SUPPORT, SPECIAL NEEDS ASSISTANCE AND PET CARE; EMPLOYEE ASSISTANCE SERVICES, NAMELY, PROVIDING ON-LINE, TELEPHONIC, AND IN-PERSON CONSULTATION, INFORMATION AND ASSESSMENT FOR EMPLOYMENT-RELATED PROBLEMS IN THE FIELDS OF PARENTING, CHILDCARE, ELDERCARE, AND DOMESTIC ABUSE AS THEY RELATE TO HEALTH AND WELL BEING (U.S. CLS. 100 AND 101).

FIRST USE 1-0-1999; IN COMMERCE 1-0-1999.
ELISSA GARBER KON, EXAMINING ATTORNEY

SN 78-797,057. SMITH, ERIC NORRIS, GLASGOW G74 5AH, SCOTLAND, FILED 1-23-2006.

THE MORSE COLLECTION

THE MARK CONSISTS OF STANDARD CHARACTERS WITHOUT CLAIM TO ANY PARTICULAR FONT, STYLE, SIZE, OR COLOR.

OWNER OF UNITED KINGDOM REG. NO. 2411580, DATED 1-20-2006, EXPIRES 1-20-2016.

NO CLAIM IS MADE TO THE EXCLUSIVE RIGHT TO USE "COLLECTION", APART FROM THE MARK AS SHOWN.

CLASS 14—JEWELRY

FOR PRECIOUS METALS AND THEIR ALLOYS; PRECIOUS STONES; GOODS MADE OF PRECIOUS METALS AND PRECIOUS STONES, NAMELY, JEWELRY, HOROLOGICAL AND CHRONOMETRIC INSTRUMENTS (U.S. CLS. 2, 27, 28 AND 50).

CLASS 42—SCIENTIFIC AND COMPUTER SERVICES

FOR DESIGN OF JEWELRY AND GOODS MADE FROM PRECIOUS STONES AND PRECIOUS METALS (U.S. CLS. 100 AND 101).

AMY ALFIERI, EXAMINING ATTORNEY

SN 78-799,316. BEYOND.COM, INC., KING OF PRUSSIA, PA. FILED 1-25-2006.

CAREERS. BUSINESS. LIFE. GO BEYOND!

THE MARK CONSISTS OF STANDARD CHARACTERS WITHOUT CLAIM TO ANY PARTICULAR FONT, STYLE, SIZE, OR COLOR.

OWNER OF U.S. REG. NO. 2,613,841.

CLASS 35—ADVERTISING AND BUSINESS

FOR PROVIDING COMPUTER ONLINE INFORMATION IN THE FIELDS OF EMPLOYMENT, RECRUITMENT, CAREERS, JOB RESOURCES, JOB LISTINGS, RESUMES AND PERSONAL ISSUES RELATED TO CAREERS AND WORK LIFE, NAMELY, EDUCATIONAL EMPLOYMENT OPPORTUNITIES, RESUME WRITING SERVICES, SAMPLE JOB DESCRIPTIONS, SALARY REPORTS AND RELOCATION SERVICES; PROVIDING ONLINE INTERACTIVE EMPLOYMENT COUNSELING AND PERSONNEL RECRUITMENT SERVICES; PROVIDING ONLINE EMPLOYMENT PLACEMENT SERVICES, NAMELY, RESUME MATCHING SERVICES VIA A GLOBAL COMPUTER NETWORK; EMPLOYMENT PLACEMENT AND STAFFING SERVICES; COMPUTER SERVICES, NAMELY, PROVIDING ONLINE SEARCHABLE DATABASES AND INDEXES OF INFORMATION FEATURING RECRUITMENT AND EMPLOYMENT INFORMATION, EMPLOYMENT AND JOB POSTING ADVERTISEMENTS, CAREER AND WORK LIFE INFORMATION AND RESOURCES, RESUME CREATION, EDUCATION, AND EMPLOYMENT INFORMATION REGARDING RESUME TRANSMITTALS AND COMMUNICATION OF RESPONSES THERETO; PROVIDING WORK LIFE SERVICES IN THE NATURE OF PROVIDING INFORMATION ON EMPLOYMENT AND GUIDANCE RELATING THERETO (U.S. CLS. 100, 101 AND 102).

FIRST USE 5-5-2005; IN COMMERCE 5-5-2005.

CLASS 38—COMMUNICATION

FOR PROVIDING ONLINE ELECTRONIC BULLETIN BOARDS FOR TRANSMISSION OF MESSAGES AMONG COMPUTER USERS CONCERNING EMPLOYMENT LISTINGS, EMPLOYMENT INFORMATION, CAREER DEVELOPMENT AND WORKLIFE OPPORTUNITIES (U.S. CLS. 100, 101 AND 104).

FIRST USE 5-5-2005; IN COMMERCE 5-5-2005.

CLASS 42—SCIENTIFIC AND COMPUTER SERVICES

FOR COMPUTER SERVICES, NAMELY, ACTING AS AN APPLICATION SERVICE PROVIDER IN THE FIELD OF EMPLOYMENT AND PERSONNEL RECRUITMENT TO HOST COMPUTER SOFTWARE FOR USE IN POSTING EMPLOYMENT OPPORTUNITIES AND JOB RELATED INFORMATION; COMPUTER SERVICE, NAMELY, ACTING AS AN APPLICATION SERVICE PROVIDER IN THE FIELD OF EMPLOYMENT AND PERSONNEL RECRUITMENT TO HOST COMPUTER SOFTWARE IN THE FIELD OF EMPLOYMENT AND PERSONNEL RECRUITMENT; COMPUTER SERVICE, NAMELY, ACTING AS AN APPLICATION SERVICE PROVIDER IN THE FIELD OF EMPLOYMENT AND PERSONNEL RECRUITMENT TO HOST COMPUTER SOFTWARE FOR EMPLOYERS TO COLLECT AND MANAGE JOB INFORMATION AND JOB APPLICANT INFORMATION; AND COMPUTER SERVICE, NAMELY, ACTING AS AN APPLICATION SERVICE PROVIDER IN THE FIELD OF EMPLOYMENT AND PERSONNEL RECRUITMENT TO HOST COMPUTER SOFTWARE FOR SEARCHING WORKLIFE-RELATED CONTENT AND INFORMATION; COMPUTER SERVICES FOR OTHERS, NAMELY, DEVELOPING, DESIGNING AND IMPLEMENTING NETWORK WEB PAGE FEATURING RECRUITMENT AND EMPLOYMENT INFORMATION, EMPLOYMENT AND JOB POSTING ADVERTISEMENTS, CAREER AND WORKLIFE INFORMATION AND RESOURCES, RESUME CREATION, EDUCATION, RESUME TRANSMITTALS AND COMMUNICATION OF RESPONSES THERETO; PROVIDING TEMPORARY USE OF ONLINE NON-DOWNLOADABLE SOFTWARE FOR SEARCHING THE INTERNET IN THE FIELD OF EMPLOYMENT AND PERSONNEL RECRUITMENT; PROVIDING TEMPORARY USE OF ONLINE NON-DOWNLOADABLE SOFTWARE FOR SCREENING APPLICANTS, SCHEDULING APPOINTMENTS AND INTERVIEWS AND MARKETING IN THE FIELD OF EMPLOYMENT AND PERSONNEL RECRUITMENT; PROVIDING TEMPORARY USE OF ONLINE NON-DOWNLOADABLE SOFTWARE FOR CREATING AND IMPLEMENTING EMPLOYEE MENTORING PROGRAMS; PROVIDING TEMPORARY USE OF ONLINE NON-DOWNLOADABLE SOFTWARE FOR EMPLOY-

MENT OUTSOURCING SERVICES; PROVIDING TEMPORARY USE OF ONLINE NON-DOWNLOADABLE SOFTWARE TO ALLOW COMPANIES TO CREATE A DATABASE OF JOB APPLICANT INFORMATION AND ENABLE THE SEARCH CAPABILITIES OF SAID DATABASE BASED ON VARIOUS CRITERIA (U.S. CLS. 100 AND 101).

FIRST USE 5-5-2005; IN COMMERCE 5-5-2005.
DOMINIC FATHY, EXAMINING ATTORNEY

SN 78-800,350. MASTRAD S.A., PARIS, FRANCE, FILED 1-26-2006.

MASTRAD

THE MARK CONSISTS OF STANDARD CHARACTERS WITHOUT CLAIM TO ANY PARTICULAR FONT, STYLE, SIZE, OR COLOR.

THE MARK HAS NO MEANING IN A FOREIGN LANGUAGE.

CLASS 6—METAL GOODS

FOR FOOD STORAGE BAG CLIPPERS IN THE NATURE OF BAG CLOSURES MADE OF METAL (U.S. CLS. 2, 12, 13, 14, 23, 25 AND 50).

CLASS 7—MACHINERY

FOR ELECTRIC EGG BEATERS, ELECTRIC CHOPPING MACHINES, ELECTRIC MIXERS FOR HOUSEHOLD AND PROFESSIONAL KITCHEN USE, ELECTRIC TIN OPENERS, ELECTRIC CITRUS FRUIT PRESSES FOR HOUSEHOLD PURPOSES, ELECTRIC FOOD PROCESSORS, ELECTRIC ICE-CREAM CHURNS, ELECTRIC JUICE EXTRACTORS, EDIBLE PASTES MAKING MACHINES, ELECTRIC GRATING MACHINES, ELECTRIC COFFEE MILLS, ELECTRIC FOOD SHAKERS, ELECTRIC KNIVES, ELECTRIC GARLIC SQUEEZERS, ELECTRIC WHISKS FOR HOUSEHOLD PURPOSES (U.S. CLS. 13, 19, 21, 23, 31, 34 AND 35).

CLASS 8—HAND TOOLS

FOR MORTARS, CARVING KNIVES, KITCHEN KNIVES AND BLADED PICKS; HAND OPERATED VEGETABLE PEELERS; KITCHEN FORKS, KITCHEN SPOONS, KNIVES AND ZESTERS; TABLEWARE, NAMELY, KNIVES, FORKS AND SPOONS; HAND OPERATED NUT CRACKERS; HAND OPERATED TIN OPENERS; BAG CUTTING SCISSORS; HAND SLICERS; FISHBONE TWEEZERS; HAND PIZZA CUTTERS; HAND CHEESE CUTTERS; HAND CHOPPERS; HAND CITRUS FRUIT CUTTERS; HAND FRUIT PEELERS; HAND FOOD PUNCHES; HOUSEHOLD KNIVES; SERVING KNIVES, HAND SCISSORS (U.S. CLS. 23, 28 AND 44).

CLASS 9—ELECTRICAL AND SCIENTIFIC APPARATUS

FOR MEASURING GLASSES (U.S. CLS. 21, 23, 26, 36 AND 38).

CLASS 11—ENVIRONMENTAL CONTROL APPARATUS

FOR REFRIGERATORS, FREEZERS, ELECTRIC COOKING RINGS, PLATE WARMERS, ELECTRIC KETTLES, ELECTRIC COFFEE MACHINES, ELECTRIC ESPRESSO MACHINES, ELECTRIC TOASTERS, ELECTRIC WAFFLE IRONS FOR HOUSEHOLD USE, ELECTRIC EGG BOILERS, ICE MACHINES, ICE-CUBE MACHINES, ELECTRIC COOKING PROBES, TAP WATER PURIFIERS, ELECTRIC TEAPOTS FOR HOUSEHOLD PURPOSES (U.S. CLS. 13, 21, 23, 31 AND 34).

CLASS 20—FURNITURE AND ARTICLES NOT OTHERWISE CLASSIFIED

FOR FOOD STORAGE BAG CLIPPERS IN THE NATURE OF BAG CLOSURES MADE OF NON-METAL AND NOT MADE OF PAPER (U.S. CLS. 2, 13, 22, 25, 32 AND 50).

CLASS 21—HOUSEWARES AND GLASS

FOR GLOVES FOR HOUSEHOLD PURPOSES, ICE-CUBES BUCKETS, SALAD BOWLS, EGG CUPS, CORK-SCREWS, BOWLS, SALAD SPINNERS, VINAIGRETTE STIRRERS, MULTIGRATER MANDOLINS, NAMELY, APPARATUS FOR CUTTING AND GRATING VEGETABLES AND FRUITS, NON-ELECTRIC ICE-CREAM CHURNS, BULB SHAPED BASTERS FOR SAUCES, HOUSEHOLD BRUSHES, CAKE PANS, ICE-CREAM MOULDS, SKIMMERS, WINE SERVERS, WINE COOLERS, NON-ELECTRIC STEAMERS, CLOTHES PEGS, CUTTING BOARDS, INSULATED BOTTLES, FUNNELS, TRAYS, RACKS, BASKETS AND BINS FOR HOUSEHOLD PURPOSES, KITCHEN CONTAINERS, JARS, JUGS, GLASS STOPPERS, CAP-POURERS, CHAMPAGNE STOPPERS AND POURERS, GLASS MARKERS, NAMELY, CHARMS FOR ATTACHMENT TO BEVERAGE GLASSWARE FOR IDENTIFICATION PURPOSES, SPICE MILLS, VEGETABLE MILLS, LADLES, SPATULAS, ROLLING PINS, WHISKS, CAP OPENERS, BOTTLE OPENERS, PASTRY BRUSHES, SPRAY ATOMIZERS, GARLIC PRESSES, SERVING PLATES FOR KEEPING FOODS COLD, DUSTERS, KITCHEN TURNERS IN THE NATURE OF SPATULA, HAND OPERATED ICE CREAM SCOOPS, COFFEE TONGS, HAND GRATERS, NON-ELECTRIC EGG BOILERS IN THE NATURE OF A POT FORM, COOKING FORKS, SERVING SPOONS AND FORKS, PLASTIC KITCHEN CONTAINERS, PLASTIC KITCHEN BOWLS (U.S. CLS. 2, 13, 23, 29, 30, 33, 40 AND 50).

CLASS 24—FABRICS

FOR HAND TOWELS, PLACEMATS MADE OF TEXTILE OR SILICONE; NAPKINS MADE OF TEXTILE, OVEN MITTS, BARBECUE MITTS, OVEN GLOVES, BARBECUE GLOVES, TEXTILE POT HOLDERS, TABLE MATS NOT MADE OF PAPER (U.S. CLS. 42 AND 50).

CLASS 25—CLOTHING

FOR CHEF HATS AND OVERALLS (U.S. CLS. 22 AND 39).

RICHARD A. STRASER, EXAMINING ATTORNEY

SN 78-801,087. MASTRAD S.A., PARIS, FRANCE, FILED 1-27-2006.

mastrad[®]

CLASS 6—METAL GOODS

FOR FOOD STORAGE BAG CLIPPERS IN THE NATURE OF BAG CLOSURES MADE OF METAL (U.S. CLS. 2, 12, 13, 14, 23, 25 AND 50).

CLASS 7—MACHINERY

FOR ELECTRIC EGG BEATERS, ELECTRIC CHOPPING MACHINES, ELECTRIC MIXERS FOR HOUSEHOLD AND PROFESSIONAL KITCHEN USE, ELECTRIC TIN OPENERS, ELECTRIC CITRUS FRUIT PRESSES FOR HOUSEHOLD PURPOSES, ELECTRIC FOOD PROCESSORS, ELECTRIC ICE-CREAM CHURNS, ELECTRIC JUICE EXTRACTORS, EDIBLE PASTES MAKING MACHINES, ELECTRIC GRATING MACHINES, ELECTRIC COFFEE MILLS, ELECTRIC FOODSHAKERS, ELECTRIC KNIVES, ELECTRIC GARLIC SQUEEZERS, ELECTRIC WHISKS FOR HOUSEHOLD PURPOSES (U.S. CLS. 13, 19, 21, 23, 31, 34 AND 35).

CLASS 8—HAND TOOLS

FOR MORTARS, CARVING KNIVES, KITCHEN KNIVES AND BLADED PICKS; HAND OPERATED VEGETABLE PEELERS; KITCHEN FORKS, KITCHEN SPOONS, KNIVES AND ZESTERS; TABLEWARE, NAMELY, KNIVES, FORKS AND SPOONS; HAND OPERATED NUT CRACKERS; HAND OPERATED TIN OPENERS; BAG CUTTING SCISSORS; HAND SLICERS; FISHBONE TWEEZERS; HAND PIZZA CUTTERS; HAND CHEESE CUTTERS; HAND CHOPPERS; HAND CITRUS FRUIT CUTTERS; HAND FRUIT PEELERS; HAND FOOD PUNCHES; HOUSEHOLD KNIVES; HAND SCISSORS (U.S. CLS. 23, 28 AND 44).

CLASS 9—ELECTRICAL AND SCIENTIFIC APPARATUS

FOR MEASURING GLASSES (U.S. CLS. 21, 23, 26, 36 AND 38).

CLASS 11—ENVIRONMENTAL CONTROL APPARATUS

FOR REFRIGERATORS, FREEZERS, ELECTRIC COOKING RINGS, PLATE WARMERS, ELECTRIC KETTLES, ELECTRIC COFFEE MACHINES, ELECTRIC ESPRESSO MACHINES, ELECTRIC TOASTERS, ELECTRIC WAFFLE IRONS FOR HOUSEHOLD USE, ELECTRIC EGG BOILERS, ICE MACHINES, ICE-CUBE MACHINES, ELECTRIC COOKING PROBES, TAP WATER PURIFIERS, ELECTRIC TEAPOTS FOR HOUSEHOLD PURPOSES (U.S. CLS. 13, 21, 23, 31 AND 34).

CLASS 20—FURNITURE AND ARTICLES NOT OTHERWISE CLASSIFIED

FOR FOOD STORAGE BAG CLIPPERS IN THE NATURE OF BAG CLOSURES MADE OF NON-METAL AND NOT MADE OF PAPER (U.S. CLS. 2, 13, 22, 25, 32 AND 50).

CLASS 21—HOUSEWARES AND GLASS

FOR GLOVES FOR HOUSEHOLD PURPOSES, ICE-CUBES BUCKETS, SALAD BOWLS, EGG CUPS, CORK-SCREWS, BOWLS, SALAD SPINNERS, VINAIGRETTE STIRRERS, MULTIGRATER MANDOLINS, NAMELY, APPARATUS FOR CUTTING AND GRATING VEGETABLES AND FRUITS, NON-ELECTRIC ICE-CREAM CHURNS, BULB SHAPED BASTERS FOR SAUCES, HOUSEHOLD BRUSHES, CAKE PANS, ICE-CREAM MOULDS, SKIMMERS, WINE SERVERS, WINE COOLERS, NON-ELECTRIC STEAMERS, CLOTHES PEGS, CUTTING BOARDS, INSULATED BOTTLES, FUNNELS, TRAYS, RACKS, BASKETS AND BINS FOR HOUSEHOLD PURPOSES, KITCHEN CONTAINERS, JARS, JUGS, GLASS STOPPERS, CAP-POURERS, CHAMPAGNE STOPPERS AND POURERS, GLASS MARKERS, NAMELY, CHARMS FOR ATTACHMENT TO BEVERAGE GLASSWARE FOR IDENTIFICATION PURPOSES, SPICE MILLS, VEGETABLE MILLS, LADLES, SPATULAS, ROLLING PINS, WHISKS, CAP OPENERS, BOTTLE OPENERS, PASTRY BRUSHES, SPRAY ATOMIZERS, GARLIC PRESSES, SERVING PLATES FOR KEEPING FOODS COLD, DUSTERS, KITCHEN TURNERS IN THE NATURE OF SPATULA, HAND OPERATED ICE CREAM SCOOPS, COFFEE TONGS, HAND GRATERS, NON-ELECTRIC EGG BOILERS IN THE NATURE OF A POT FORM, COOKING FORKS, SERVING SPOONS AND FORKS, PLASTIC KITCHEN CONTAINERS, PLASTIC KITCHEN BOWLS (U.S. CLS. 2, 13, 23, 29, 30, 33, 40 AND 50).

CLASS 24—FABRICS

FOR HAND TOWELS, PLACEMATS MADE OF TEXTILE OR SILICONE; NAPKINS MADE OF TEXTILE OR PAPER, OVEN MITTS, BARBECUE MITTS, OVEN GLOVES, BARBECUE GLOVES, TEXTILE POT HOLDERS, TABLE MATS NOT MADE OF PAPER (U.S. CLS. 42 AND 50).

CLASS 25—CLOTHING

FOR CHEF HATS AND OVERALLS (U.S. CLS. 22 AND 39).

RICHARD A. STRASER, EXAMINING ATTORNEY

SN 78-814,569. FINETOOTH ENTERPRISES, INC., AUSTIN, TX. FILED 2-14-2006.

FINETOOTH

THE MARK CONSISTS OF STANDARD CHARACTERS WITHOUT CLAIM TO ANY PARTICULAR FONT, STYLE, SIZE, OR COLOR.

CLASS 41—EDUCATION AND ENTERTAINMENT

FOR DOCUMENT PROCESSING SERVICES IN THE NATURE OF DIGITAL IMAGING SERVICES (U.S. CLS. 100, 101 AND 107).

FIRST USE 6-6-2005; IN COMMERCE 6-6-2005.

CLASS 42—SCIENTIFIC AND COMPUTER SERVICES

FOR DATA TRANSFER SERVICES, NAMELY, DOCUMENT DATA TRANSFER AND PHYSICAL CONVERSION SERVICES FROM ONE MEDIA TO ANOTHER (U.S. CLS. 100 AND 101).

FIRST USE 6-6-2005; IN COMMERCE 6-6-2005.
JANICE KIM, EXAMINING ATTORNEY

SN 78-816,061. ROYAL COUNTY OF BERKSHIRE POLO CLUB LTD., BERKSHIRE, UNITED KINGDOM, FILED 2-16-2006.

SN 78-818,815. UNITED PARCEL SERVICE OF AMERICA, INC., ATLANTA, GA. FILED 2-20-2006.



TUPSS

OWNER OF ERPN CMNTY TM OFC REG. NO. 22186, DATED 12-18-2000, EXPIRES 12-18-2010.

OWNER OF U.S. REG. NO. 2,525,322.

NO CLAIM IS MADE TO THE EXCLUSIVE RIGHT TO USE "ROYAL BERKSHIRE", APART FROM THE MARK AS SHOWN.

CLASS 3—COSMETICS AND CLEANING PREPARATIONS

FOR (BASED ON INTENT TO USE) NON-MEDICATED TOILETRIES, PERFUMERY, AFTERSHAVE, CLEANING, STYLING AND STRAIGHTENING PREPARATIONS FOR THE HAIR, SHAMPOO, SOAPS, ESSENTIAL OILS, COSMETICS, HAIR LOTION, PERSONAL DEODORANTS, EAU DE TOILETTE, BODY SPRAYS, BATH OILS, BUBBLE BATH, SHOWER GEL (U.S. CLS. 1, 4, 6, 50, 51 AND 52).

CLASS 14—JEWELRY

FOR (BASED ON 44(E)) WATCHES, CLOCKS, JEWELLERY, PRECIOUS STONES, PRECIOUS METALS, GOODS COATED WITH PRECIOUS METALS, NAMELY, ASHTRAYS, BADGES, BLAZER BUTTONS, CIGAR AND CIGARETTE BOXES, BUCKLES FOR CLOTHING, CANDLES, COSMETIC POWDER COMPACTS, CUFF LINKS, DESKTOP ORNAMENTS, FIGURINES, GOBLET, JEWELRY BOXES, KEY CHAINS, KEY RINGS, MEDALS, PERFUME FLASKS, PERFUME SPRAYERS, PICTURE FRAMES, RINGS, TRINKETS AND TROPHIES (U.S. CLS. 2, 27, 28 AND 50).

CLASS 18—LEATHER GOODS

FOR (BASED ON 44(E)) LEATHER GOODS AND IMITATION LEATHER GOODS, NAMELY, LEATHER AND IMITATION LEATHER BAGS, BRIEFCASES, CREDIT CARD HOLDERS, KEY CASES, LEASHES FOR ANIMALS, CASES, PORTFOLIOS, PURSES, TRAVELING SUITCASES, WALLETS, SPORTS BAGS, STRAPS AND TRAVELING BAGS; ARTICLES OF LUGGAGE; ATHLETIC BAGS, SHOPPING BAGS MADE OF SKIN, BEACH BAGS, COSMETIC BAGS SOLD EMPTY, DIAPER BAGS, DUFFEL BAGS, GARMENT BAGS FOR TRAVEL, GYM BAGS, MAKEUP BAGS SOLD EMPTY, OVERNIGHT BAGS, SCHOOL BAGS, SCHOOL BOOK BAGS, SHOULDER BAGS, SUIT BAGS, TOTE BAGS, TRAVEL BAGS AND UMBRELLA BAGS; TRUNKS, HOLDALLS, HANDBAGS, WALLETS, PURSES, BRIEFCASES, SUITCASES, RUCKSACKS, CARRY ALL BAGS AND CARRY-ON BAGS; UMBRELLAS, PARASOLS AND WALKING STICKS; WHIPS, HARNESSES AND SADDLERY (U.S. CLS. 1, 2, 3, 22 AND 41).

SARA THOMAS, EXAMINING ATTORNEY

THE MARK CONSISTS OF STANDARD CHARACTERS WITHOUT CLAIM TO ANY PARTICULAR FONT, STYLE, SIZE, OR COLOR.

OWNER OF U.S. REG. NOS. 514,285, 735,064 AND OTHERS.

CLASS 35—ADVERTISING AND BUSINESS

FOR ADVERTISING AND BUSINESS SERVICES, NAMELY, BUSINESS MANAGEMENT; FRANCHISING SERVICES, NAMELY, OFFERING TECHNICAL ASSISTANCE IN THE NATURE OF BUSINESS MANAGEMENT ASSISTANCE TO OPERATORS OF RETAIL MAILING, SHIPPING, PACKAGING, FAXING AND ELECTRONIC COMMUNICATIONS OUTLETS AND TECHNICAL ASSISTANCE IN THE ESTABLISHMENT AND OPERATION OF RETAIL MAILING, SHIPPING, PACKAGING, FAXING AND ELECTRONIC COMMUNICATIONS OUTLETS WITH RESPECT TO THE TRANSPORTATION AND DELIVERY OF PERSONAL PROPERTY FOR OTHERS; RETAIL STORE SERVICES OFFERING STAMPS AND OFFICE SUPPLIES; PHOTOCOPY SERVICES; DOCUMENT REPRODUCTION SERVICES; AND RECEIPT OF DOCUMENTS FOR OTHERS IN THE NATURE OF MAIL RECEIVING; OPERATION OF A BUSINESS FOR OTHERS, NAMELY, RETAIL MAILING, SHIPPING, PACKAGING, FAXING AND ELECTRONIC COMMUNICATIONS OUTLETS WITH RESPECT TO THE TRANSPORTATION AND DELIVERY OF PERSONAL PROPERTY FOR OTHERS (U.S. CLS. 100, 101 AND 102).

CLASS 39—TRANSPORTATION AND STORAGE

FOR FREIGHT FORWARDING; PACKAGING ARTICLES FOR TRANSPORTATION; TRANSPORTATION AND DELIVERY OF PERSONAL PROPERTY BY AIR, RAIL, BOAT AND MOTOR VEHICLE; WAREHOUSING, STORAGE, PACKING, DELIVERY AND RETURNS WITH RESPECT TO THE TRANSPORTATION AND DELIVERY OF PERSONAL PROPERTY; ARRANGING SHIP CHARTERS FOR OTHERS; DOCUMENT BOX RENTAL IN THE NATURE OF MAIL BOX RENTAL SERVICES; HARD-COPY DOCUMENT FORWARDING; DELIVERY OF DOCUMENTS FOR OTHERS; SHIPPING AND DELIVERY SERVICES, NAMELY, PICKUP, TRANSPORTATION, AND DELIVERY OF PACKAGES AND LETTERS BY VARIOUS MODES OF TRANSPORTATION; POSTAL SERVICES, NAMELY, PARCEL DELIVERY, PACKAGING ARTICLES FOR TRANSPORTATION, RENTAL OF MAIL BOXES (U.S. CLS. 100 AND 105).

CHARLOTTE CORWIN, EXAMINING ATTORNEY

SN 78-819,543. PITTIGLIO, RABIN, TODD & MCGRATH, INC., WALTHAM, MA. FILED 2-21-2006.

SN 78-821,844. HEMOFARM KONCERN A.D. PHARMACEUTICAL-CHEMICAL INDUSTRY VRŠAC, SERBIA AND MONTENEGRO, YUGOSLAVIA, FILED 2-23-2006.

PRTM

THE MARK CONSISTS OF STANDARD CHARACTERS WITHOUT CLAIM TO ANY PARTICULAR FONT, STYLE, SIZE, OR COLOR.

OWNER OF U.S. REG. NOS. 1,674,629 AND 2,341,525.

CLASS 16—PAPER GOODS AND PRINTED MATTER

FOR BOOKS, PERIODICALS, AND PRINTED INSTRUCTIONAL MATERIALS RELATING TO IMPROVING AND EXPEDITING PRODUCT DEVELOPMENT (U.S. CLS. 2, 5, 22, 23, 29, 37, 38 AND 50).

CLASS 35—ADVERTISING AND BUSINESS

FOR BUSINESS MANAGEMENT CONSULTING AND ADVISORY SERVICES (U.S. CLS. 100, 101 AND 102).

CLASS 36—INSURANCE AND FINANCIAL

FOR CONSULTATION IN THE FIELD OF FINANCIAL SERVICES (U.S. CLS. 100, 101 AND 102).

CLASS 41—EDUCATION AND ENTERTAINMENT

FOR PROVISION OF EDUCATIONAL, INSTRUCTIONAL AND TRAINING SERVICES BY WAY OF ARRANGING, CONDUCTING, AND ORGANIZING SEMINARS, WORKSHOPS AND CONFERENCES IN THE FIELDS OF BUSINESS MANAGEMENT, PRODUCT DEVELOPMENT, FINANCIAL SERVICES, TELECOMMUNICATIONS, SUPPLY CHAIN MANAGEMENT, SALES, MARKETING, CUSTOMER RELATIONSHIP MANAGEMENT, INFORMATION TECHNOLOGY, AND OPERATIONAL STRATEGY; TRAINING IN THE FIELD OF MEDICAL DEVICES AND DIAGNOSTICS, NAMELY, USE OF MEDICAL DIAGNOSTIC EQUIPMENT AND USE OF MEDICAL DEVICES IN MEDICAL PRACTICE (U.S. CLS. 100, 101 AND 107).

CLASS 42—SCIENTIFIC AND COMPUTER SERVICES

FOR PRODUCT DEVELOPMENT CONSULTATION; CONSULTATION SERVICES IN THE FIELD OF AEROSPACE AND DEFENSE TECHNOLOGIES; CONSULTATION SERVICES IN THE FIELD OF CHEMICALS AND APPLIED MATERIALS; CONSULTATION SERVICES IN THE FIELD OF COMPUTERS AND PERIPHERALS; CONSULTATION SERVICES IN THE FIELD OF DEVELOPMENT OF INDUSTRIAL PRODUCTS; CONSULTATION SERVICES IN THE FIELD OF MEDICAL DEVICES AND DIAGNOSTICS, NAMELY, DEVELOPMENT OF MEDICAL DEVICES; CONSULTATION SERVICES IN THE FIELD OF COMPUTER NETWORK EQUIPMENT; CONSULTATION SERVICES IN THE FIELD OF INFORMATION TECHNOLOGY; CONSULTATION SERVICES IN THE FIELD OF PRODUCT DEVELOPMENT OF PHARMACEUTICALS; CONSULTATION SERVICES IN THE FIELD OF BIOTECHNOLOGY; CONSULTATION SERVICES IN THE FIELD OF SEMICONDUCTOR DEVELOPMENT; CONSULTATION SERVICES IN THE FIELD OF COMPUTER SOFTWARE; COMPUTER PROGRAMMING SERVICES (U.S. CLS. 100 AND 101).

NAKIA HENRY, EXAMINING ATTORNEY



OWNER OF YUGOSLAVIA REG. NO. 38809, DATED 3-31-1995, EXPIRES 12-28-2014.

THE COLOR(S) ORANGE IS/ARE CLAIMED AS A FEATURE OF THE MARK.

THE MARK CONSISTS OF THE ENTIRE MARK, THE LITERAL ELEMENTS "HF" AND "HEMOFARM", THE CIRCULAR DESIGN AND THE PEDESTAL DESIGN WITHIN THE CIRCLE ARE ORANGE.

CLASS 5—PHARMACEUTICALS

FOR HOUSE MARK FOR A FULL LINE OF PHARMACEUTICAL AND VETERINARY PREPARATIONS; SANITARY PREPARATIONS FOR MEDICAL USE; DISINFECTANTS FOR HYGIENIC PURPOSES; DISINFECTANTS FOR MEDICAL INSTRUMENTS; DISINFECTANTS FOR SANITARY PURPOSES; DISINFECTING HAND WASH; ALL PURPOSE DISINFECTANTS; PESTICIDES, FUNGICIDES AND HERBICIDES FOR DOMESTIC, AGRICULTURAL AND MEDICAL USE (U.S. CLS. 6, 18, 44, 46, 51 AND 52).

CLASS 35—ADVERTISING AND BUSINESS

FOR ADVERTISING AND ADVERTISEMENT SERVICES; BUSINESS MANAGEMENT; BUSINESS ADMINISTRATION; PROVIDING OFFICE FUNCTIONS (U.S. CLS. 100, 101 AND 102).

JOHN DWYER, EXAMINING ATTORNEY

SN 78-842,649. SIMPSON, MARSHAL T., LOCH LLOYD, MO. FILED 3-21-2006.

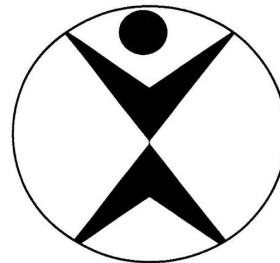

CLASS 25—CLOTHING

FOR CLOTHING, NAMELY, ATHLETIC UNIFORMS, BEACH WEAR, BOOTS, CAPS, COATS, FISHING VESTS, FISHING WADERS, FLIP FLOPS, GLOVES, HATS, HUNTING VESTS, JACKETS, JOGGING SUITS, JUMP SUITS, KARATE SUITS, ONE-PIECE SKI SUITS, OVERALLS, PANTS, RAIN WEAR, SANDALS, SARONGS, SHIRTS, SHOES, SHORTS, SKI BIBS, SKI GLOVES, SKI JACKETS, SKI HATS, SLEEP WEAR, SOCKS, SWEAT BANDS, SWEAT SHIRTS, SWEAT PANTS, SWIM SUIT COVERUPS, SWIM TRUNKS, SWIMSUITS, T-SHIRTS, TANK TOPS, VESTS, VISORS, WET SUITS (U.S. CLS. 22 AND 39).

CLASS 28—TOYS AND SPORTING GOODS

FOR MANUALLY OPERATED EXERCISE EQUIPMENT AND INSTRUCTION MANUAL FOR THE EXERCISE EQUIPMENT SOLD AS A UNIT (U.S. CLS. 22, 23, 38 AND 50).

FIRST USE 7-17-2005; IN COMMERCE 7-17-2005.
ARETHA SOMERVILLE, EXAMINING ATTORNEY

SN 78-846,842. CANADIAN AVALANCHE ASSOCIATION, REVELSTOKE, CANADA, FILED 3-27-2006.

AVALUATOR

THE MARK CONSISTS OF STANDARD CHARACTERS WITHOUT CLAIM TO ANY PARTICULAR FONT, STYLE, SIZE, OR COLOR.

OWNER OF CANADA REG. NO. TMA694681, DATED 8-24-2007, EXPIRES 8-24-2022.

SN 78-846,577. COM-PAC INTERNATIONAL, INC., CARBONDALE, IL. FILED 3-27-2006.

CLASS 16—PAPER GOODS AND PRINTED MATTER

FOR DECISION SUPPORT SYSTEM FOR TRAVELING IN AVALANCHE TERRAIN BASED ON ACCIDENT DATA IN THE FORM OF REFERENCE CARDS AND PRINTED COMPANION MATERIAL, NAMELY, STICKERS, POSTERS, BROCHURES AND BOOKS IN THE AREA OF INFORMATION FOR ASSESSING RISK IN THE BACK COUNTRY AND/OR AVALANCHE TERRAIN (U.S. CLS. 2, 5, 22, 23, 29, 37, 38 AND 50).

VACU-LOCK

THE MARK CONSISTS OF STANDARD CHARACTERS WITHOUT CLAIM TO ANY PARTICULAR FONT, STYLE, SIZE, OR COLOR.

CLASS 10—MEDICAL APPARATUS

FOR RESEALABLE PLASTIC STORAGE BAGS FOR MEDICAL USE (U.S. CLS. 26, 39 AND 44).

CLASS 45—PERSONAL AND LEGAL SERVICES

FOR PROVIDING INDIVIDUALS WITH THE INFORMATION TO ASSESS RISK IN THE BACK COUNTRY AND/OR AVALANCHE TERRAIN (U.S. CLS. 100 AND 101).

DOMINIC FATHY, EXAMINING ATTORNEY

CLASS 22—CORDAGE AND FIBERS

FOR RESEALABLE PLASTIC STORAGE BAGS FOR INDUSTRIAL USE (U.S. CLS. 1, 2, 7, 19, 22, 42 AND 50).
JILL PRATER, EXAMINING ATTORNEY

SN 78-849,692. MCCUAIG, RONALD, GLASGOW, UNITED KINGDOM, FILED 3-30-2006.

SN 78-846,585. COM-PAC INTERNATIONAL, INC., CARBONDALE, IL. FILED 3-27-2006.

VACU-LOK

THE MARK CONSISTS OF STANDARD CHARACTERS WITHOUT CLAIM TO ANY PARTICULAR FONT, STYLE, SIZE, OR COLOR.

CLASS 10—MEDICAL APPARATUS

FOR RESEALABLE PLASTIC STORAGE BAGS FOR MEDICAL USE (U.S. CLS. 26, 39 AND 44).

DREAM MOVER

THE MARK CONSISTS OF STANDARD CHARACTERS WITHOUT CLAIM TO ANY PARTICULAR FONT, STYLE, SIZE, OR COLOR.

OWNER OF UNITED KINGDOM REG. NO. 2236552, DATED 1-26-2001, EXPIRES 6-20-2010.

OWNER OF UNITED KINGDOM REG. NO. 2418094, DATED 12-15-2006, EXPIRES 3-30-2016.

CLASS 7—MACHINERY

FOR AUTOMATED ELECTRIC OR BATTERY OPERATED ROCKING APPARATUS FOR ROCKING PRAMS, PUSHCHAIRS, BUGGIES, STROLLERS, CRIBS, COTS, BABY CARRIERS AND BABIES' BASKETS; AUTOMATED APPARATUS FOR ROCKING PRAMS, PUSHCHAIRS, BUGGIES, STROLLERS, CRIBS, COTS, BABY CARRIERS AND BABIES' BASKETS; ELECTRIC OR BATTERY OPERATED ROCKING APPARATUS FOR CRADLES (U.S. CLS. 13, 19, 21, 23, 31, 34 AND 35).

CLASS 22—CORDAGE AND FIBERS

FOR RESEALABLE PLASTIC STORAGE BAGS FOR INDUSTRIAL USE (U.S. CLS. 1, 2, 7, 19, 22, 42 AND 50).
JILL PRATER, EXAMINING ATTORNEY

CLASS 20—FURNITURE AND ARTICLES NOT OTHERWISE CLASSIFIED

FOR CRADLES, COTS AND CRIBS; ROCKING CRADLES (U.S. CLS. 2, 13, 22, 25, 32 AND 50).
ALYSSA PALADINO, EXAMINING ATTORNEY

SN 78-849,848. ARTICULATE GLOBAL, INC., EAST HAMP-
TON, NY. FILED 3-30-2006.

Storyline

THE MARK CONSISTS OF STANDARD CHARACTERS WITHOUT CLAIM TO ANY PARTICULAR FONT, STYLE, SIZE, OR COLOR.

CLASS 9—ELECTRICAL AND SCIENTIFIC APPARATUS

FOR DOWNLOADABLE COMPUTER SOFTWARE USED TO DESIGN, DEVELOP AND MANAGE COURSES, QUIZZES, ASSESSMENTS AND SURVEYS IN THE FIELD OF ELECTRONIC LEARNING (U.S. CLS. 21, 23, 26, 36 AND 38).

CLASS 42—SCIENTIFIC AND COMPUTER SERVICES

FOR NON-DOWNLOADABLE COMPUTER SOFTWARE USED TO DESIGN, DEVELOP AND MANAGE COURSES, QUIZZES, ASSESSMENTS AND SURVEYS IN THE FIELD OF ELECTRONIC LEARNING (U.S. CLS. 100 AND 101).

KAPIL BHANOT, EXAMINING ATTORNEY

CLASS 35—ADVERTISING AND BUSINESS

FOR CREATING AND UPDATING CYBERNETIC ADVERTISING MATERIAL; ADVERTISING AND BUSINESS SERVICES, NAMELY, PREPARING AND PLACING OF ADVERTISEMENTS FOR OTHERS, PROMOTION SERVICES, DISTRIBUTION OF PRODUCTS FOR ADVERTISING PURPOSES; DISSEMINATION OF ADVERTISING FOR OTHERS VIA AN ON-LINE ELECTRONIC COMMUNICATIONS NETWORK ON THE INTERNET; DISSEMINATION OF ADVERTISING MATTER; DIRECT MAIL ADVERTISING; PROVIDING BUSINESS INFORMATION, NAMELY, PROVIDING BUSINESS MARKING INFORMATION; PROVIDING INFORMATION ABOUT COMMERCIAL BUSINESS AND COMMERCIAL INFORMATION VIA THE GLOBAL COMPUTER NETWORK; BUSINESS INFORMATION SERVICES IN THE NATURE OF PROVIDING INFORMATION ON BUSINESS OPPORTUNITIES, BUSINESS INVESTIGATIONS AND BUSINESS APPRAISALS ALL PROVIDED ON-LINE VIA A GLOBAL COMPUTER NETWORK; BUSINESS ADVISORY SERVICES, CONSULTANCY AND INFORMATION IN THE FIELD OF INTERNATIONAL COMMERCE; COMPUTERIZED FILE MANAGEMENT; DEMONSTRATION OF GOODS FOR ADVERTISING PURPOSES; CONDUCTING MARKETING STUDIES; ELECTRONIC PROCESSING OF ORDERS FOR OTHERS; PROVIDING INFORMATION IN THE FIELD OF BUSINESS MANAGEMENT AND TRADE INFORMATION BY FIBER OPTIC NETWORKS AND ELECTRONICS DATA INTERCHANGE MESSAGE SYSTEMS; INTERNET INFORMATION SERVICE FEATURING ADVERTISING AND COMMERCIAL INFORMATION; INFORMATION, ADVISORY AND CONSULTANCY SERVICES RELATING TO BUSINESS AND BUSINESS MANAGEMENT AND BUSINESS ADMINISTRATION; INFORMATION, ADVISORY AND CONSULTANCY SERVICES RELATING TO BUSINESS AND BUSINESS MANAGEMENT AND BUSINESS ADMINISTRATION, PROVIDED ON LINE OR VIA THE INTERNET; PROVIDING CONSUMER PRODUCT INFORMATION VIA THE INTERNET; PROVIDING AN INTERNET WEBSITE FOR SEARCHING AND SOURCING SERVICE, NAMELY, PROVIDING AN ON LINE COMMERCIAL INFORMATION DIRECTORY ON THE INTERNET; PROVIDING ON LINE DATABASES FEATURING ADVERTISEMENTS; DATA PROCESSING SERVICES (U.S. CLS. 100, 101 AND 102).

SN 78-851,441. GU TA INTERNET INFORMATION CO., LTD., TAICHUNG, TAIWAN, FILED 3-31-2006.



NO CLAIM IS MADE TO THE EXCLUSIVE RIGHT TO USE "B2B", APART FROM THE MARK AS SHOWN.

THE COLOR(S) RED, BLACK AND GRAY IS/ARE CLAIMED AS A FEATURE OF THE MARK.

THE COLOR RED APPEARS ON THE WORDING "B2B" AND ON THE ARROW DESIGN ELEMENT; THE COLOR BLACK APPEARS ON THE WORDING "MANUFACTURES" AND ON THE PARTIAL OVAL DESIGN ELEMENT; THE COLOR GRAY APPEARS ON THE WORDING ".COM".

CLASS 42—SCIENTIFIC AND COMPUTER SERVICES

FOR DESIGN OF COMPUTER PROGRAMS AND COMPUTER SOFTWARE FOR OTHERS; COMPUTER SOFTWARE DEVELOPMENT AND MAINTENANCE; CONSULTING SERVICES IN THE FIELD OF DESIGN, SELECTION, IMPLEMENTATION AND USE OF COMPUTER HARDWARE AND SOFTWARE SYSTEMS FOR OTHERS; COMPUTER PROGRAMMING; COMPUTER HARDWARE RENTAL; PROVIDING AN INTERNET WEBSITE FOR SEARCHING AND SOURCING SERVICE, NAMELY, PROVIDING SEARCH ENGINES FOR OBTAINING DATA ON A GLOBAL COMPUTER NETWORK, PROVIDING CUSTOMIZED ON-LINE WEB PAGES FEATURING USER-DEFINED INFORMATION, WHICH INCLUDES SEARCH ENGINES AND ON-LINE WEB LINKS TO OTHER WEB SITES; REGISTRATION OF DOMAIN NAMES FOR IDENTIFICATION OF USERS ON A GLOBAL COMPUTER NETWORK; COMPUTER PROJECT MANAGEMENT SERVICES; DESIGN OF HOMEPAGES AND WEBSITES; DESIGN, CREATION, HOSTING, MAINTENANCE OF WEBSITES FOR OTHERS; DESIGNING WEBSITES FOR ADVERTISING PURPOSES; CYBERNETIC ANIMATION DESIGN FOR OTHERS (U.S. CLS. 100 AND 101).

KAELIE KUNG, EXAMINING ATTORNEY

SN 78-859,699. SCHNEIDER, DONALD, 75009, PARIS, FRANCE, FILED 4-12-2006.

CATCH 22

THE MARK CONSISTS OF STANDARD CHARACTERS WITHOUT CLAIM TO ANY PARTICULAR FONT, STYLE, SIZE, OR COLOR.

OWNER OF FRANCE REG. NO. 053371405, DATED 7-21-2005, EXPIRES 7-21-2015.

CLASS 16—PAPER GOODS AND PRINTED MATTER

FOR PRINTED PAPER; NEWSPAPER; PRINTED PERIODICALS IN THE FIELDS OF PHOTOGRAPHY, FASHION, ARCHITECTURE REVIEWS; MAGAZINE DEVOTED TO PHOTOGRAPHY, FASHION, ARCHITECTURE; BOOKS IN THE FIELD OF PHOTOGRAPHY, PHOTOGRAPHS, FASHION AND ARCHITECTURE (U.S. CLS. 2, 5, 22, 23, 29, 37, 38 AND 50).

CLASS 41—EDUCATION AND ENTERTAINMENT

FOR ORGANIZATION OF SHOWS AND ENTERTAINMENT, NAMELY, SHOWS FEATURING FAMOUS BRANDS AND PERSONALITIES; ORGANIZATION OF CULTURAL EXHIBITIONS IN THE FIELDS OF FASHION, ART AND ARCHITECTURE; BOOK, REVIEW AND MAGAZINE PUBLISHING (U.S. CLS. 100, 101 AND 107).
SUNG IN, EXAMINING ATTORNEY

SN 78-860,089. PCG TRADING, LLC, PEABODY, MA. FILED 4-12-2006.

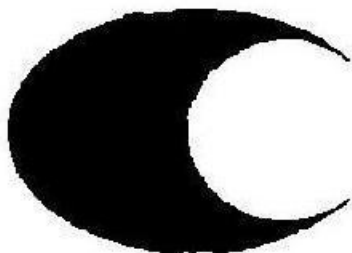

CLASS 35—ADVERTISING AND BUSINESS

FOR DISTRIBUTORSHIP SERVICES IN THE FIELD OF SEMICONDUCTORS, ELECTRONIC COMPONENTS, COMPUTER PRODUCTS, NETWORKING EQUIPMENT, TECHNOLOGY PRODUCTS AND SUPPLY CHAIN SERVICES, NAMELY, DISTRIBUTION OF SEMICONDUCTORS, ELECTRONIC COMPONENTS, COMPUTER PRODUCTS, NETWORKING EQUIPMENT, AND TECHNOLOGY PRODUCTS (U.S. CLS. 100, 101 AND 102).
FIRST USE 12-19-2000; IN COMMERCE 12-19-2000.

CLASS 39—TRANSPORTATION AND STORAGE

FOR DISTRIBUTION SERVICES, NAMELY, DELIVERY OF SEMICONDUCTORS, ELECTRONIC COMPONENTS, COMPUTER PRODUCTS, NETWORKING EQUIPMENT, TECHNOLOGY PRODUCTS AND SUPPLY CHAIN SERVICES, NAMELY, DELIVERY OF SEMICONDUCTORS, ELECTRONIC COMPONENTS, COMPUTER PRODUCTS, NETWORKING EQUIPMENT, AND TECHNOLOGY PRODUCTS (U.S. CLS. 100 AND 105).

FIRST USE 12-19-2000; IN COMMERCE 12-19-2000.
NAKIA HENRY, EXAMINING ATTORNEY

SN 78-861,891. TRAVELPORT INC., PARSIPPANY, NJ. FILED 4-14-2006.

TRAVELPORT

THE MARK CONSISTS OF STANDARD CHARACTERS WITHOUT CLAIM TO ANY PARTICULAR FONT, STYLE, SIZE, OR COLOR.

OWNER OF U.S. REG. NOS. 2,679,905, 2,679,926 AND 2,869,808.

CLASS 9—ELECTRICAL AND SCIENTIFIC APPARATUS

FOR COMPUTERS, DATA PROCESSORS, COMPUTER MONITORS, COMPUTER PRINTERS, AND PARTS THEREFOR; COMPUTER SOFTWARE FOR USE IN THE TRAVEL INDUSTRY, NAMELY, NETWORK LINKING, CONNECTION TO ON-LINE TRAVEL RESERVATION AND BOOKING NETWORKS AND DATABASE INTERROGATION, RESERVATION AND BOOKING OF TRAVEL ARRANGEMENTS, TRAVEL AGENCY OPERATIONS IN THE NATURE OF APPOINTMENT SCHEDULING AND SOFTWARE, TRAVEL AND BUSINESS EXPENSE ACCOUNTING AND REPORTING; COMPUTER PROGRAMS FOR CONNECTION TO ON-LINE TRAVEL RESERVATION AND BOOKING NETWORKS AND DATABASE INTERROGATION, FOR USE IN CONNECTION WITH TRAVEL, TRANSPORTATION, ENTERTAINMENT RESERVATION AND BOOKING, CAR RENTAL, DATA BASE ACCESS, INTERACTIVE DISPLAY OF RESERVATION AND BOOKING INFORMATION, AND REAL TIME ACCESS FOR RESERVATION AND BOOKING, MARKETING DATA, TRAVEL MANAGEMENT, INVENTORY MANAGEMENT, MARKET RESEARCH FOR THE TRAVEL INDUSTRY, BOOKING RECORDS, ADVERTISING, ON-LINE INFORMATION STORAGE AND RETRIEVAL, COMPUTER SOFTWARE IN THE NATURE OF A SPREADSHEET FOR USE IN TICKETING, HOTEL AND ACCOMMODATION RESERVATION AND DESCRIPTION IN THE FIELD OF TRAVEL MANAGEMENT; DOWNLOADABLE ELECTRONIC PUBLICATIONS IN THE NATURE OF TRAVEL DIRECTORIES AND MAPS; COMPUTER UTILITY SOFTWARE AND COMPUTER SOFTWARE FOR USE BY TRAVEL AGENCIES FOR MAKING TRANSPORTATION ARRANGEMENTS FOR CUSTOMERS, NAMELY, SPREADSHEETS, ACCOUNTING PROGRAMS, WORD PROCESSING PROGRAMS AND BUSINESS MANAGEMENT APPLICATIONS, NAMELY, APPOINTMENT SCHEDULING SOFTWARE FOR THE MANAGEMENT OF TRAVEL AGENCY OPERATION AND ACCOUNTING SOFTWARE FOR THE MANAGEMENT OF BUSINESS TRAVEL EXPENSES; MODEMS AND TELECOMMUNICATION APPARATUS AND INSTRUMENTS, NAMELY, COMPUTER MODEMS, COMPUTER HARDWARE AND RELATED PERIPHERALS; COMPUTER SOFTWARE AND PROGRAMS FOR BUSINESS EXPENSE REPORTING; SOFTWARE FOR PURPOSES OF ACCESSING TRAVEL BOOKING AND RESERVATION INFORMATION DATABASES (U.S. CLS. 21, 23, 26, 36 AND 38).

CLASS 16—PAPER GOODS AND PRINTED MATTER

FOR PRINTED PERIODICALS IN THE FIELD OF TRAVEL; INSTRUCTION MANUALS FOR OPERATING TRAVEL RESERVATION SOFTWARE; COMPUTER MANUALS FOR OPERATING TRAVEL RESERVATION SOFTWARE; PRINTED MATTER, NAMELY, PRINTED PUBLICATIONS IN THE NATURE OF BROCHURES, BOOKLETS AND TEACHING MATERIALS IN THE FIELDS OF COMPUTER AND COMPUTER SYSTEM REPAIR, COMPUTER PERIPHERALS, COMPUTER PROGRAMMING SERVICES, TRAVEL AND ENTERTAINMENT RESERVATION AND SCHEDULING; COMPUTER OPERATING AND USER MANUALS FOR TRAVEL RESERVATION COMPUTER HARDWARE AND SOFTWARE; PRINTED INSTRUCTIONAL AND TEACHING MATERIALS IN THE FIELD OF TRAVEL RESERVATION COMPUTER HARDWARE AND SOFTWARE; BOOKS IN THE FIELD OF TRAVEL; COMPUTER PRINTED CHARTS AND GRAPHS CONCERNING TRAVEL INFORMATION; NEWSLETTERS IN THE FIELD OF TRAVEL; NEWSPAPERS (U.S. CLS. 2, 5, 22, 23, 29, 37, 38 AND 50).

CLASS 35—ADVERTISING AND BUSINESS

FOR PROVIDING COMPUTERIZED OFFICE MANAGEMENT IN THE TRAVEL FIELD FOR OTHERS; PROVIDING BUSINESS MANAGEMENT SERVICES IN THE TRAVEL FIELD FOR OTHERS; COMPILATION AND PROVISION OF TRADE AND BUSINESS PRICE AND STATISTICAL INFORMATION IN THE TRAVEL FIELD FOR OTHERS; BUSINESS INFORMATION MANAGEMENT, NAMELY, BUSINESS INFORMATION RETRIEVAL IN THE TRAVEL FIELD FOR OTHERS; ELECTRONIC COLLECTION, PROCESSING AND PROVISION OF BUSINESS DATA AND IMAGES IN THE NATURE OF BUSINESS CHARTS AND GRAPHS; ELECTRONIC ON-LINE INFORMATION SERVICES, NAMELY, THE PROVISION OF ADVERTISEMENTS AND BUSINESS INFORMATION IN RESPECT OF TRAVEL, TOURISM AND ENTERTAINMENT THROUGH A COMPUTER DATABASE; ADVERTISING SERVICES AND PROMOTION SERVICES BY DATA COMMUNICATIONS FOR HOTELS, HOTELIERS, AIRLINES, CRUISE LINES, CAR RENTAL COMPANIES AND SERVICE PROVIDERS IN THE TRAVEL INDUSTRY; ON-LINE DIRECT ELECTRONIC MARKETING SERVICES AND ADVERTISING SERVICES FOR HOTELS, HOTELIERS, AIRLINES, CRUISE LINES, CAR RENTAL COMPANIES AND SERVICE PROVIDERS IN THE TRAVEL INDUSTRY, FOR OTHERS; PROVIDING AN ONLINE COMPUTER DATABASE IN THE FIELD OF RATING HOTEL ACCOMMODATIONS (U.S. CLS. 100, 101 AND 102).

CLASS 38—COMMUNICATION

FOR TELECOMMUNICATION SERVICES IN THE NATURE OF ELECTRONIC TRANSMISSION OF DATA, ELECTRONIC DATA TRANSFER SERVICES, AND ELECTRONIC EXCHANGE OF DATA STORED IN DATABASES ACCESSIBLE VIA TELECOMMUNICATION NETWORKS, ALL RELATING TO COMPUTERIZED INFORMATION RETRIEVAL SYSTEMS; COMMUNICATION SERVICES, NAMELY, PROVIDING ON-LINE ELECTRONIC DATA TRANSMISSION FOR THE COMMUNICATION AND DISTRIBUTION OF INFORMATION, IMAGES AND ELECTRONIC MESSAGES BY COMPUTERIZED DATABASES; DATA COMMUNICATION BY ELECTRONIC MAIL, AND PROVIDING ON-LINE ELECTRONIC BULLETIN BOARDS FOR TRANSMISSION OF MESSAGES AMONG COMPUTER USERS CONCERNING TRAVEL INFORMATION (U.S. CLS. 100, 101 AND 104).

CLASS 39—TRANSPORTATION AND STORAGE

FOR CAR RENTAL BOOKING AND RESERVATION SERVICES; TRANSPORTATION AND TRAVEL SERVICES, NAMELY, BOOKING AND RESERVATIONS SERVICES FOR TRANSPORTATION AND TRAVEL; TRAVEL AGENCY SERVICES, NAMELY, MAKING RESERVATIONS AND BOOKINGS FOR TRANSPORTATION; COMPUTERIZED TRAVEL AGENCY SERVICES, NAMELY, MAKING AND BOOKING RESERVATIONS FOR TRANSPORTATION AND TRAVEL VIA ELECTRONIC COMMUNICATIONS NETWORKS; AIRLINE TRANSPORTATION SERVICES, NAMELY, PROVIDING INFORMATION RELATING TO AIRLINE SEAT INVENTORY; PROVIDING TRAVEL RESERVATIONS AND TICKETING SERVICES FOR OTHERS; COMPUTERIZED TRAVEL DIRECTORY SERVICES FOR THE TRAVEL INDUSTRY, NAMELY, PROVIDING AN ON-LINE COMPUTER DATABASE IN THE FIELD OF TRAVEL INFORMATION SERVICES; CONSULTATION SERVICES IN THE FIELD OF ONLINE TRAVEL INFORMATION (U.S. CLS. 100 AND 105).

CLASS 42—SCIENTIFIC AND COMPUTER SERVICES

FOR COMPUTER PROGRAMMING FOR OTHERS RELATING TO INFORMATION COMPILATION, STORAGE AND RETRIEVAL SERVICES IN THE FIELD OF TRAVEL ACCOMMODATIONS; RENTAL OF DATABASE SERVER TO THIRD PARTIES; RENTAL OF COMPUTERS AND COMPUTER SOFTWARE FOR THE PURPOSES OF DATABASE INTERROGATION; COMPUTER TIME SHARING; LEASING OF COMPUTERS, NAMELY, COMPUTER EQUIPMENT, SYSTEMS, PROGRAMS AND SOFTWARE RELATING TO TRAVEL AGENCY SERVICES AND MAKING HOTEL AND ACCOMMODATION RESERVATIONS AND BOOKINGS FOR OTHERS; COMPUTERIZED DATABASE CONSULTATION AND TECHNICAL SUPPORT SERVICES, NAMELY, TROUBLESHOOTING OF COMPUTER HARDWARE AND SOFTWARE PROBLEMS VIA TELEPHONE, E-MAIL, WORKSHOP, AND ONSITE; COMPUTER TIME SHARING SERVICES (U.S. CLS. 100 AND 101).

CLASS 43—HOTEL AND RESTAURANT SERVICES

FOR PROVIDING AN ONLINE COMPUTER DATABASE IN THE FIELD OF ARRANGING AND PROVIDING TEMPORARY HOUSING ACCOMMODATIONS; HOTEL AND TEMPORARY LODGING ACCOMMODATION BOOKING AND RESERVATION SERVICES; PROVIDING A WEBSITE THAT FEATURES AN INTERACTIVE DISPLAY OF HOTEL ROOMS AND TEMPORARY LODGING ACCOMMODATION, NAMELY, DISPLAY OF LOCATION AND FACILITIES; TRAVEL SERVICES, NAMELY, THE PROVISION OF INFORMATION ABOUT BOOKING TEMPORARY HOUSING ACCOMMODATIONS; TRAVEL SERVICES, NAMELY, PROVIDING INFORMATION REGARDING ACCOMMODATION AVAILABILITY AND BOOKINGS OF RESERVATIONS FOR ACCOMMODATIONS; INTERACTIVE COMPUTERIZED TRAVEL AGENCY SERVICES, NAMELY, MAKING RESERVATIONS AND BOOKING FOR TEMPORARY LODGING (U.S. CLS. 100 AND 101).

TIMOTHY FINNEGAN, EXAMINING ATTORNEY

SN 78-862,608. MAGIC BROTHERS ASSOCIATE, INCORPORATED, DBA KOI PALACE, DALY CITY, CA. FILED 4-17-2006.



THE TRANSLITERATION OF THE FOREIGN CHARACTERS IN THE MARK IS LAY YU MOON.

THE CHINESE CHARACTERS IN THE MARK CAN HAVE MULTIPLE MEANINGS IN THE CHINESE LANGUAGE. ONE ENGLISH TRANSLATION OF THE MARK IS "KOI ENTRANCE."

CLASS 30—STAPLE FOODS

FOR FOOD PRODUCTS, NAMELY, MOON-CAKES AND DRAGON CANDY (U.S. CL. 46).
FIRST USE 12-0-1996; IN COMMERCE 12-0-1996.

CLASS 35—ADVERTISING AND BUSINESS

FOR RESTAURANT, FAST FOOD RESTAURANT, AND BAR MANAGEMENT FOR OTHERS, AND CONSULTING IN THE FIELD OF RESTAURANT AND BAR MANAGEMENT (U.S. CLS. 100, 101 AND 102).

CLASS 43—HOTEL AND RESTAURANT SERVICES

FOR RESTAURANT AND BAR SERVICES, FAST FOOD RESTAURANT SERVICES; TEA HOUSE RESTAURANT SERVICES; PROVIDING BANQUET AND SOCIAL FUNCTION FACILITIES FOR SPECIAL OCCASIONS (U.S. CLS. 100 AND 101).

FIRST USE 12-0-1996; IN COMMERCE 12-0-1996.
VIVIAN MICZNIK FIRST, EXAMINING ATTORNEY

SN 78-863,401. PET PALACE ENTERPRISES, INC., COLUMBUS, OH. FILED 4-18-2006.



NO CLAIM IS MADE TO THE EXCLUSIVE RIGHT TO USE "PET", APART FROM THE MARK AS SHOWN.

CLASS 43—HOTEL AND RESTAURANT SERVICES

FOR PET BOARDING AND DAY CARE SERVICES (U.S. CLS. 100 AND 101).

CLASS 44—MEDICAL, BEAUTY AND AGRICULTURAL SERVICES

FOR ANIMAL GROOMING (U.S. CLS. 100 AND 101).
MARK PILARO, EXAMINING ATTORNEY

SN 78-870,022. DECATHLON, VILLENEUVE D'ASCQ, FRANCE, FILED 4-26-2006.

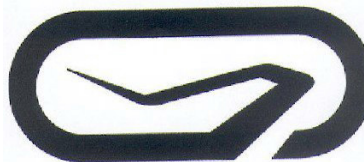

OWNER OF FRANCE REG. NO. 053386602, DATED 10-18-2005, EXPIRES 10-17-2015.

THE MARK CONSISTS OF AN OVAL DESIGN WITH AN INVERTED LINEAR ELEMENT.

CLASS 9—ELECTRICAL AND SCIENTIFIC APPARATUS

FOR APPARATUS FOR RECORDING, TRANSMITTING OR REPRODUCING SOUND OR IMAGES NAMELY, AUDIO-VIDEO RECEIVERS, COMPACT DISC PLAYERS, MP3 PLAYERS; DATA PROCESSORS, DATA PROCESSING APPARATUS, NAMELY, COMPUTERS, COMPUTER PROGRAMS FOR USE IN DATABASE MANAGEMENT, FOR USE AS A SPREADSHEET, FOR WORD PROCESSING, COMPUTER PRINTERS, COMPUTER SOFTWARE FOR WORD PROCESSING AND DATABASE MANAGEMENT, BLANK COMPACT-DISCS; APPARATUS FOR AMPLIFYING SOUND, NAMELY, AMPLIFIERS; PORTABLE RADIOS; PRE-RECORDED VIDEO TAPES, PRE-RECORDED AUDIO AND VIDEO COMPACT DISKS, PRE-RECORDED MAGNETIC DISKS, PRE-RECORDED OPTICAL DISKS, PRE-RECORDED OPTICAL COMPACT DISKS, PRE-RECORDED FLOPPY COMPUTER DISKS, ALL FEATURING SPORTS, TRAVEL, LEISURE AND OUTDOOR ACTIVITIES, PROJECTION SCREENS; MAGNETIC ENCODERS; SOUND RECORDING SUPPORT DEVICES, NAMELY, MEMORY CARDS, USB (UNIVERSAL SERIAL BUS) HARDWARE, INTERCOMMUNICATION APPARATUS, NAMELY, WALKIE-TALKIES, RADIOS; VIDEO GAME MACHINES FOR USE WITH TELEVISION RECEIVERS; PERSONAL SAFETY DEVICES FOR PROTECTION AGAINST ACCIDENTS, NAMELY, COMMERCIAL PROTECTIVE SAFETY NETS, SAFETY RESTRAINTS, OTHER THAN FOR VEHICLE SEATS OR SPORTS EQUIPMENT, RESCUE NETS, NAMELY, LIFE NETS, BULLET-PROOF VESTS, PROTECTIVE HELMETS, LIFE JACKETS; SIGHTING SPECTACLES FOR USE WITH FIRE ARMS; APPARATUS AND INSTRUMENTS FOR ASTRONOMY, NAMELY, TELESCOPES AND BINOCULARS; ELECTRICAL DEVICES FOR ATTRACTING AND DESTROYING INSECTS; SCALES, SAFETY EQUIPMENT NAMELY, LUMINOUS BEACON LIGHTS, BAROMETERS, ALTIMETERS, MARKER AND SIGNALING BUOYS, DIRECTIONAL COMPASSES, SWIMMING LIFE BELTS, LIVE-SAVING BELTS, WHISTLES FOR CALLING DOGS, DIVING OVERALLS, DIVING SUITS, DIVING GLOVES, DIVING MASKS, EAR PLUGS FOR DIVERS; PEDOMETERS, OPTICAL SPECTACLES, SUN GLASSES, SUNGLASSES FOR USE IN THE MOUNTAINS, SUNGLASSES FOR CLIMBERS; SWIMMING GOGGLES; SPECTACLE CASES; FIRE-EXTINGUISHERS; BULLET-PROOF JACKETS; HYDROMETERS, HYGROMETERS, BAROMETERS; GLOBAL POSITIONING SYSTEM (GPS) CONSISTING OF COMPUTERS, COMPUTER SOFTWARE, TRANSMITTERS, RECEIVERS AND NETWORK INTERFACE DEVICES; METEOROLOGICAL INFORMATION COLLECTION SYSTEMS CONSISTING OF COMPUTERS, COMPUTER SOFTWARE, TRANSMITTERS, RECEIVERS, WEATHER BALLOONS, AND NETWORK INTERFACE DEVICES; PRE-PAID AUTOMATIC GAMES WITH PRE-PAYMENT, NAMELY, MACHINES FOR PLAYING THE GAME OF CHANCE AND INTERACTIVE VIDEO GAME MACHINES FOR USE WITH

TELEVISIONS; BINOCULARS, OPTICAL SAFETY LAMPS, BATTERIES FOR FLASHLIGHTS; MEASURING INSTRUMENTS NAMELY, TAPE MEASURES; BREATHING APPARATUS FOR UNDERWATER SWIMMING; INSTRUMENTS FOR NAVIGATION NAMELY, SATELLITE NAVIGATIONAL SYSTEM CONSISTING OF A GLOBAL POSITIONING SYSTEM (GPS); PHOTOGRAPHIC CAMERAS; WATERPROOF PHOTOGRAPHIC CAMERAS; EXPOSED CAMERA FILMS; LIFE-SAVING RAFTS; AUTOMATIC REV COUNTING MACHINES FOR SPORTS, NAMELY, PEDOMETERS; SPEEDOMETERS; PROTECTIVE GUARDS FOR LIMBS OTHER THAN FOR SPORTING USE, NAMELY PROTECTIVE CLOTHING, PROTECTIVE FOOTWEAR, NAMELY, PROTECTIVE INDUSTRIAL BOOTS AND SHOES, PROTECTIVE WORK GLOVES FOR HAND PROTECTION; SPORT SNORKELS; PINCE-NEZ (U.S. CLS. 21, 23, 26, 36 AND 38).

CLASS 14—JEWELRY

FOR PRECIOUS METALS; PRECIOUS METAL ALLOYS; JEWELRY OF PRECIOUS METALS; CLOCKS; CHRONOMETRIC INSTRUMENTS; CHRONOMETERS; CHRONOMETERS PROVIDING MIDWAY TIMES; CHARMS IN THE NATURE OF JEWELRY; BRACELETS; TIE PINS; KEY RINGS OF PRECIOUS METAL; WATCHES AND WATCH BANDS; SUNDIALS; MEDALS; CUSTOM JEWELRY (U.S. CLS. 2, 27, 28 AND 50).

CLASS 18—LEATHER GOODS

FOR ANIMAL SKINS; GOODS MADE OF LEATHER OR IMITATIONS OF LEATHER, NAMELY, LEATHER SHOPPING BAGS, LUGGAGE; PURSES; HANDBAGS, TRAVELLING BAGS; SADDLERY; TRUNKS AND SUITCASES; UMBRELLAS; PARASOLS AND WALKING STICKS; WHIPS AND SADDLES; LEATHER POUCHES, SCHOOL BAGS; WALLETS; BRIEFCASES; KEY CASES; SCHOOL SATCHELS, ATTACHE CASES, PURSES NOT OF PRECIOUS METAL, BEACH BAGS; ALL-PURPOSE SPORTS BAGS FOR CLIMBERS; SPORT BAGS, NAMELY, BAGS FOR MAGNESIA AND ALL PURPOSE SPORT BAGS; MOUNTAINEERING STICKS; SADDLE TREES FOR HORSE SADDLES, FASTENING FOR HORSE-SADDLES; COVERS FOR HORSE-SADDLES, HORSE BRIDLES; ALL-PURPOSE BAGS FOR CAMPERS; HUNTER'S GAME BAGS; HORSE COLLARS; HALTERS FOR HORSES; SLING BAGS FOR CARRYING INFANTS, NAMELY, INFANT CARRIERS WORN ON THE BODY; HARNESSSES FOR ANIMALS; BITS FOR ANIMALS; RUCKSACKS; SPORTS BAGS; ALL PURPOSE SPORT-BAGS (U.S. CLS. 1, 2, 3, 22 AND 41).

CLASS 21—HOUSEWARES AND GLASS

FOR UTENSILS AND CONTAINERS FOR HOUSEHOLD PURPOSES NOT OF PRECIOUS METAL, NAMELY, BUCKETS, PAILS, VATS, BASKETS; DRINKING FLASKS NOT OF METAL; KITCHEN UTENSILS, NAMELY MIXING SPOONS, COOKING POT SETS, STEW-PANS, FRYING PANS; CONTAINERS FOR HOUSEHOLD OR KITCHEN USE NOT OF PRECIOUS METAL; PLATES NOT OF PRECIOUS METAL; GOBLETS NOT OF PRECIOUS METAL; DRINKING FLASKS FOR TRAVELERS; NON-ELECTRIC COFFEEPOTS NOT OF PRECIOUS METAL; COMBS; CLEANING SPONGES; SCRUBBING BRUSHES; HAND-OPERATED CLEANING INSTRUMENTS, NAMELY, BROOMS, CLEANING COMBS; STEEL WOOL FOR CLEANING; UN-WORKED OR SEMI-WORKED GLASS, NAMELY, UNWROUGHT GLASS; PORTABLE NON-ELECTRIC COLDBOXES; THERMAL INSULATED BOTTLES FOR FOOD OR BEVERAGE (U.S. CLS. 2, 13, 23, 29, 30, 33, 40 AND 50).

CLASS 25—CLOTHING

FOR CLOTHING FOR MEN, WOMEN AND CHILDREN, NAMELY, KNITWEAR IN THE NATURE OF KNITTED CAPS, KNITTED SHIRTS, KNITTED UNDERWEAR, UNDERCLOTHING, DRESSING GOWNS, BATHING SUITS; BATHING CAPS; BATH SANDALS; BATH SLIPPERS; PAJAMAS; CARDIGANS; SKIRTS, DRESSES, TROUSERS, JACKETS; COATS, PARKAS, SHIRTS, TEE-SHIRTS, LAYETTES; TIES; SCARVES; BELTS, GLOVES; WATERPROOF CLOTHING, NAMELY, COATS, RAIN-COATS, ANORAKS; COMBINATIONS FOR SKIING, NAMELY, SKI SUITS AND SKI WEAR; WET SUITS; HATS; CAPS; SOCKS; STOCKINGS; TIGHTS; SPATS FOR SKIING; SHOES, EXCEPT ORTHOPAEDIC SHOES, SLIPPERS, BOOTS; SPORT SHOES; BEACH SHOES, SKI BOOTS, SKI MASKS; SNOW BOOTS, SLIPPERS FOR CLIMBERS; SOLES FOR FOOTWEAR, CLOTHING FOR PRACTICING SPORTS EXCEPT DIVING CLOTHES, NAMELY, TROUSERS, JACKETS, SHORTS, TEE-SHIRTS; PULLOVERS; HEAD BANDS (U.S. CLS. 22 AND 39).

CLASS 28—TOYS AND SPORTING GOODS

FOR GAMES NAMELY, BOARD GAMES, DARTS GAMES, PLAYING CARDS, TOY BUILDING BLOCKS; TOYS, NAMELY, TOYS FOR DOMESTIC PETS, PLUSH TOYS, PLASTIC CHARACTER TOYS, INFLATABLE TOYS, WATER GAMES AND TOYS, NAMELY, WATER SLIDES AND PLAY SWIMMING POOLS; TOY SCOOTERS; PLAY BALLOONS; GYMNASTIC AND SPORT ARTICLES EXCEPT CLOTHES, SHOES AND MATS, NAMELY, SNOWBOARDS, SNOWBOARD BAGS, SNOW SURFBOARDS AND BAGS ESPECIALLY DESIGNED FOR SNOW SURFBOARDS; SNOW SLEDS FOR RECREATIONAL USE; BOB-SLEIGHS; SNOWSHOES; MOUTH GUARDS, SHIN GUARDS, ELBOW GUARDS AND KNEE GUARDS FOR ATHLETIC USE; SKATING BOOTS WITH SKATES ATTACHED; BOXING GLOVES; DELTA WINGS FOR HANG-GLIDERS; ARCHERY EQUIPMENT, NAMELY, BOWS FOR ARCHERY, CROSS-BOWS AND ARROWS, QUIVERS FOR BOWS FOR ARCHERY, TARGETS FOR ARCHERY; BOBSLEIGHS; KITES AND KITE REELS; STRINGS FOR RACKETS, GUTS FOR RACKETS, FRAMES FOR RACKETS, HANDLES FOR RACKET, RACKETS FOR RACKET SPORTS; SPORT BALLS; FISHING TACKLE, NAMELY, FISHING RODS AND FISHING IMPLEMENTS, NAMELY, FISHING REELS, LINES FOR FISHING, BITE INDICATORS FOR FISHING, FISH HOOKS, ARTIFICIAL FISHING BAITS AND DECOYS FOR FISHING; SAILBOARDS; SURFBOARDS WITHOUT ENGINES; NETS FOR BALL GAMES; GOLF CLUBS; SKIS; SKI FOR WATER SKIING, SKI EDGES, SKI BINDINGS; WEIGHTS AND DUMBBELLS FOR WEIGHTLIFTING; SCUBA EQUIPMENT, NAMELY, SPEARFISHING HARPOON GUNS; FLIPPERS FOR SWIMMING; SLIDES FOR SWIMMING POOLS; SKATEBOARDS; PLAYGROUND EQUIPMENT, NAMELY, SWINGS; BILLIARDS TABLES AND BILLIARDS BALLS, BILLIARD CUES; PHYSICAL EXERCISE EQUIPMENT, NAMELY, ABDOMINAL BOARDS, STATIONARY EXERCISE BICYCLES, EXERCISE TREADMILLS, STAIR-STEPPING MACHINES, EXERCISE EQUIPMENT, NAMELY, ROWING MACHINES, CHEST EXPANDERS; HOCKEY STICKS; SKITTLES AND PLAYING BALLS; PETANQUE GAME BALLS; TABLE FOR TABLE TENNIS; THEATRICAL MASKS, NAMELY, COSTUME MASKS; ORNAMENTS FOR CHRISTMAS TREES EXCEPT ILLUMINATION ARTICLES AND CONFECTIONERY; STRAPS FOR SKATES FOR ADDITIONAL ANKLE SUPPORT; BAGS FOR GOLF, BAGS FOR TENNIS AND RACKET SPORTS, BAGS FOR DIVING (U.S. CLS. 22, 23, 38 AND 50).

DAVID ELTON, EXAMINING ATTORNEY

SN 78-872,274. FLEXA HOLDING A/S, 8700 HORSENS, DENMARK, FILED 4-28-2006.

SN 78-873,030. MARLEY, KEVIN, M. SURPRISE, OR. AND WILKINSON, KAREN, R., BEAVERTON, OR. FILED 4-30-2006.

FLEXA

THE MARK CONSISTS OF STANDARD CHARACTERS WITHOUT CLAIM TO ANY PARTICULAR FONT, STYLE, SIZE, OR COLOR.

CLASS 20—FURNITURE AND ARTICLES NOT OTHERWISE CLASSIFIED

FOR FURNITURE; FURNITURE, NAMELY, CHILDREN'S FURNITURE; MATTRESSES; PILLOWS; BOXES OF WOOD FOR TOYS; COATHOOKS NOT OF METAL (U.S. CLS. 2, 13, 22, 25, 32 AND 50).

FIRST USE 1-1-1997; IN COMMERCE 7-1-1999.

CLASS 24—FABRICS

FOR TEXTILES AND TEXTILE GOODS, NAMELY, BED LINEN, EIDERDOWNS; TEXTILES IN THE FORM OF CURTAINS AND CANOPIES FOR BEDS (U.S. CLS. 42 AND 50).

FIRST USE 1-1-1997; IN COMMERCE 7-1-1999.

CLASS 35—ADVERTISING AND BUSINESS

FOR WHOLESALE AND RETAIL SERVICES, NAMELY, WHOLESALE DISTRIBUTORSHIPS, WHOLESALE ORDERING SERVICES, WHOLESALE STORES, RETAIL STORES, RETAIL SHOPS, ONLINE RETAIL ORDERING SERVICES, ALL FEATURING FURNITURE AND PARTS THEREFOR; RETAIL STORES AND RETAIL DEPARTMENT STORES FEATURING FURNITURE AND A WIDE VARIETY OF CONSUMER GOODS OF OTHERS (U.S. CLS. 100, 101 AND 102).

FIRST USE 1-1-1997; IN COMMERCE 7-1-1999.
TINA L. SNAPP, EXAMINING ATTORNEY

I  Seattle

NO CLAIM IS MADE TO THE EXCLUSIVE RIGHT TO USE "SEATTLE", APART FROM THE MARK AS SHOWN.

THE COLOR(S) BLACK AND RED IS/ARE CLAIMED AS A FEATURE OF THE MARK.

THE MARK CONSISTS OF AN "I" AND "SEATTLE" IN BLACK AND A RED HEART THAT INDICATES LOVE.

CLASS 25—CLOTHING

FOR T-SHIRTS, SWEAT SHIRTS, BANDANAS, BASEBALL CAPS, BEACHWEAR, BEANIES, BOXER BRIEFS, BOXER SHORTS, BRIEFS, CAPS, COATS, DENIM JACKETS, FLEECE PULLOVERS, FOOTWEAR, GYM SHORTS, GYM SUITS, HATS, HEAD BANDS, HEADWEAR, JACKETS, JEANS, JOGGING SUITS, LINGERIE, PANTS, POLO SHIRTS, SANDALS, SARONGS, SHORTS, SKIRTS, SNEAKERS, SUN VISORS, SWEAT PANTS, SWEAT SHORTS, SWEAT SUITS, SWEATERS, SWEAT SOCKS, SWIM TRUNKS, SWIM WEAR, TANK TOPS, THERMAL UNDERWEAR, T-SHIRTS, UNDERPANTS, UNDERSHIRTS, UNDERWEAR, VISORS, WARM UP SUITS AND FOOTWEAR (U.S. CLS. 22 AND 39).

CLASS 35—ADVERTISING AND BUSINESS

FOR RETAIL STORE SERVICES IN THE FIELD OF GIFTS AND MERCHANDISE, NAMELY, TOYS, NOVELTY ITEMS, SOUVENIRS, MUGS, KEY CHAINS, NOVELTY MAGNETS, JEWELRY, WATCHES, PENS, T-SHIRTS, HATS, SWEATSHIRTS, NECK TIES, PACKAGED SNACK FOODS, CANDY, MINTS, CHEWING GUM, NON-PRESCRIPTION MEDICINES, COSMETICS, TOILETRIES, BOOKS, MAGAZINES, PUBLICATIONS, PLAYING CARDS AND NEWSPAPERS (U.S. CLS. 100, 101 AND 102).

JULIE GUTTADAURO, EXAMINING ATTORNEY

SN 78-874,177. ORCHID CHEMICALS & PHARMACEUTICALS LIMITED, NUNGAMBAKKAM, CHENNAI, INDIA, FILED 5-2-2006.



NO CLAIM IS MADE TO THE EXCLUSIVE RIGHT TO USE "CHEMICALS AND PHARMACEUTICALS LTD.", APART FROM THE MARK AS SHOWN.

CLASS 1—CHEMICALS

FOR BULK CHEMICALS FOR USE IN THE MANUFACTURE OF PHARMACEUTICALS (U.S. CLS. 1, 5, 6, 10, 26 AND 46).

CLASS 5—PHARMACEUTICALS

FOR BULK DRUG SUBSTANCES IN THE NATURE OF PHARMACEUTICAL PREPARATIONS FOR USE IN THE TREATMENT OF INFECTIONS, ALLERGIES, AND ILLNESSES RELATING TO THE CARDIO VASCULAR SYSTEM, THE CENTRAL NERVOUS SYSTEM, THE GASTROINTESTINAL SYSTEM, THE GENITOURINARY TRACT, AND THE ENDOCRINE SYSTEM (U.S. CLS. 6, 18, 44, 46, 51 AND 52).

CLASS 40—MATERIAL TREATMENT

FOR CUSTOM MANUFACTURE OF PHARMACEUTICALS, PHARMACEUTICAL INGREDIENTS, AND CHEMICALS AND CHEMICAL INTERMEDIATES FOR OTHERS; CONSULTANCY SERVICES IN THE FIELD OF PHARMACEUTICAL AND CHEMICAL PRODUCTION (U.S. CLS. 100, 103 AND 106).

CLASS 42—SCIENTIFIC AND COMPUTER SERVICES

FOR PHARMACEUTICAL DRUG DEVELOPMENT SERVICES; CHEMICAL AND PHARMACEUTICAL RESEARCH AND DEVELOPMENT FOR OTHERS OF PROCESSES FOR PRODUCTION OF PHARMACEUTICALS, PHARMACEUTICAL INGREDIENTS, AND OTHER CHEMICALS; CHEMICAL ANALYSIS FOR OTHERS (U.S. CLS. 100 AND 101).

MARY MUNSON, EXAMINING ATTORNEY

CLASS 42—SCIENTIFIC AND COMPUTER SERVICES

FOR PHARMACEUTICAL DRUG DEVELOPMENT SERVICES; CHEMICAL AND PHARMACEUTICAL RESEARCH AND DEVELOPMENT FOR OTHERS OF PROCESSES FOR PRODUCTION OF PHARMACEUTICALS, PHARMACEUTICAL INGREDIENTS, AND OTHER CHEMICALS; CHEMICAL ANALYSIS FOR OTHERS (U.S. CLS. 100 AND 101).

MARY MUNSON, EXAMINING ATTORNEY

SN 78-874,182. ORCHID CHEMICALS & PHARMACEUTICALS LIMITED, NUNGAMBAKKAM, CHENNAI, INDIA, FILED 5-2-2006.



NO CLAIM IS MADE TO THE EXCLUSIVE RIGHT TO USE "HEALTHCARE", APART FROM THE MARK AS SHOWN.

CLASS 1—CHEMICALS

FOR BULK CHEMICALS FOR USE IN THE MANUFACTURE OF PHARMACEUTICALS (U.S. CLS. 1, 5, 6, 10, 26 AND 46).

CLASS 5—PHARMACEUTICALS

FOR BULK DRUG SUBSTANCES IN THE NATURE OF PHARMACEUTICAL PREPARATIONS FOR USE IN THE TREATMENT OF INFECTIONS, ALLERGIES, AND ILLNESSES RELATING TO THE CARDIO VASCULAR SYSTEM, THE CENTRAL NERVOUS SYSTEM, THE GASTROINTESTINAL SYSTEM, THE GENITOURINARY TRACT, AND THE ENDOCRINE SYSTEM (U.S. CLS. 6, 18, 44, 46, 51 AND 52).

CLASS 40—MATERIAL TREATMENT

FOR CUSTOM MANUFACTURE OF PHARMACEUTICALS, PHARMACEUTICAL INGREDIENTS, AND CHEMICALS AND CHEMICAL INTERMEDIATES FOR OTHERS; CONSULTANCY SERVICES IN THE FIELD OF PHARMACEUTICAL AND CHEMICAL PRODUCTION (U.S. CLS. 100, 103 AND 106).

SN 78-874,187. ORCHID CHEMICALS & PHARMACEUTICALS LIMITED, NUNGAMBAKKAM, CHENNAI, INDIA, FILED 5-2-2006.

**CLASS 1—CHEMICALS**

FOR BULK CHEMICALS FOR USE IN THE MANUFACTURE OF PHARMACEUTICALS (U.S. CLS. 1, 5, 6, 10, 26 AND 46).

CLASS 5—PHARMACEUTICALS

FOR BULK DRUG SUBSTANCES IN THE NATURE OF PHARMACEUTICAL PREPARATIONS FOR USE IN THE TREATMENT OF INFECTIONS, ALLERGIES, AND ILLNESSES RELATING TO THE CARDIO VASCULAR SYSTEM, THE CENTRAL NERVOUS SYSTEM, THE GASTROINTESTINAL SYSTEM, THE GENITOURINARY TRACT, AND THE ENDOCRINE SYSTEM (U.S. CLS. 6, 18, 44, 46, 51 AND 52).

CLASS 40—MATERIAL TREATMENT

FOR CUSTOM MANUFACTURE OF PHARMACEUTICALS, PHARMACEUTICAL INGREDIENTS, AND CHEMICALS AND CHEMICAL INTERMEDIATES FOR OTHERS; CONSULTANCY SERVICES IN THE FIELD OF PHARMACEUTICAL AND CHEMICAL PRODUCTION (U.S. CLS. 100, 103 AND 106).

CLASS 42—SCIENTIFIC AND COMPUTER SERVICES

FOR PHARMACEUTICAL DRUG DEVELOPMENT SERVICES; CHEMICAL AND PHARMACEUTICAL RESEARCH AND DEVELOPMENT FOR OTHERS OF PROCESSES FOR PRODUCTION OF PHARMACEUTICALS, PHARMACEUTICAL INGREDIENTS, AND OTHER CHEMICALS; CHEMICAL ANALYSIS FOR OTHERS (U.S. CLS. 100 AND 101).

MARY MUNSON, EXAMINING ATTORNEY

SN 78-876,242. AIR PRODUCTS AND CHEMICALS, INC., ALLENTOWN, PA. FILED 5-4-2006.

SN 78-884,680. RENSSELAER POLYTECHNIC INSTITUTE, TROY, NY. FILED 5-16-2006.

STABILIFE

THE MARK CONSISTS OF STANDARD CHARACTERS WITHOUT CLAIM TO ANY PARTICULAR FONT, STYLE, SIZE, OR COLOR.

THE TERM "STABILIFE" HAS NO MEANING IN FOREIGN LANGUAGE.

CLASS 1—CHEMICALS

FOR CHEMICALS FOR USE IN THE MANUFACTURE OF BATTERIES, ULTRACAPACITORS AND FUEL CELLS, NAMELY, BORATE CLUSTER SALTS, FORMULATED ELECTROLYTE SOLUTIONS AND SEPARATORS (U.S. CLS. 1, 5, 6, 10, 26 AND 46).

CLASS 9—ELECTRICAL AND SCIENTIFIC APPARATUS

FOR BATTERIES, ULTRACAPACITORS AND FUEL CELLS FOR USE IN PORTABLE ELECTRONIC DEVICES, NAMELY, PERSONAL HANDHELD COMPUTERS, CAMERAS, LAPTOPS, POWER TOOLS, HAND HELD GAMES, AUDIO DEVICES AND AUTOMOBILES INCLUDING HYBRID ELECTRIC VEHICLES; ELECTRODES FOR USE IN THE MANUFACTURE OF BATTERIES, ULTRACAPACITORS AND FUEL CELLS (U.S. CLS. 21, 23, 26, 36 AND 38).

AMY MCMENAMIN, EXAMINING ATTORNEY



OWNER OF U.S. REG. NOS. 1,237,743 AND 1,513,114. SEC. 2(F).

CLASS 9—ELECTRICAL AND SCIENTIFIC APPARATUS

FOR MAGNETS (U.S. CLS. 21, 23, 26, 36 AND 38). FIRST USE 9-16-1994; IN COMMERCE 9-16-1994.

CLASS 14—JEWELRY

FOR LAPEL PINS; ORNAMENTAL LAPEL PINS (U.S. CLS. 2, 27, 28 AND 50). FIRST USE 9-16-1994; IN COMMERCE 9-16-1994.

CLASS 16—PAPER GOODS AND PRINTED MATTER

FOR PAPER FLAGS (U.S. CLS. 2, 5, 22, 23, 29, 37, 38 AND 50). FIRST USE 9-16-1994; IN COMMERCE 9-16-1994.

CLASS 20—FURNITURE AND ARTICLES NOT OTHERWISE CLASSIFIED

FOR PLASTIC FLAGS (U.S. CLS. 2, 13, 22, 25, 32 AND 50). FIRST USE 9-16-1994; IN COMMERCE 9-16-1994.

CLASS 24—FABRICS

FOR CLOTH FLAGS; FABRIC FLAGS (U.S. CLS. 42 AND 50). FIRST USE 9-16-1994; IN COMMERCE 9-16-1994.

CLASS 41—EDUCATION AND ENTERTAINMENT

FOR EDUCATIONAL SERVICES, NAMELY, PROVIDING COURSES OF INSTRUCTION AT THE UNIVERSITY LEVEL (U.S. CLS. 100, 101 AND 107). FIRST USE 9-16-1994; IN COMMERCE 9-16-1994. SOPHIA S. KIM, EXAMINING ATTORNEY

SN 78-881,659. NAGHAVI M.D., RAY S., ROCKVILLE CENTER, NY. FILED 5-11-2006.

SLEEP IMPROVEMENT CENTER

THE MARK CONSISTS OF STANDARD CHARACTERS WITHOUT CLAIM TO ANY PARTICULAR FONT, STYLE, SIZE, OR COLOR.

NO CLAIM IS MADE TO THE EXCLUSIVE RIGHT TO USE CENTER, APART FROM THE MARK AS SHOWN. SEC. 2(F).

CLASS 10—MEDICAL APPARATUS

FOR ORAL AND NASAL APPLIANCES FOR KEEPING AIRWAY PASSAGES OPEN FOR THE TREATMENT OF SLEEP DISORDERS; MEDICAL APPARATUS FOR DIAGNOSING OR TREATING RESPIRATORY CONDITIONS IN THE NATURE OF CONTINUOUS POSITIVE AIRWAY PRESSURE MACHINES AND BILEVEL POSITIVE AIRWAY PRESSURE MACHINES FOR THE TREATMENT OF SLEEP DISORDERS (U.S. CLS. 26, 39 AND 44).

CLASS 44—MEDICAL, BEAUTY AND AGRICULTURAL SERVICES

FOR MEDICAL SERVICES, NAMELY, TREATMENT OF SLEEP DISORDERS (U.S. CLS. 100 AND 101). FIRST USE 5-10-2001; IN COMMERCE 5-10-2001. LYDIA BELZER, EXAMINING ATTORNEY

SN 78-885,723. SRA INTERNATIONAL, INC., FAIRFAX, VA.
FILED 5-17-2006.

ELITE Secure

THE MARK CONSISTS OF STANDARD CHARACTERS WITHOUT CLAIM TO ANY PARTICULAR FONT, STYLE, SIZE, OR COLOR.

OWNER OF U.S. REG. NO. 2,376,468.

NO CLAIM IS MADE TO THE EXCLUSIVE RIGHT TO USE "SECURE", APART FROM THE MARK AS SHOWN.

CLASS 35—ADVERTISING AND BUSINESS

FOR BUSINESS CONSULTING SERVICES IN THE FIELDS OF STRATEGIC PLANNING, BUSINESS PROCESS REENGINEERING, SPECIFICALLY IN ORDER TO ADDRESS COMPUTER SECURITY LIFECYCLES AND INFORMATION ASSURANCE AND SECURITY (U.S. CLS. 100, 101 AND 102).

CLASS 42—SCIENTIFIC AND COMPUTER SERVICES

FOR CONSULTING SERVICES RELATED TO COMPUTER SECURITY SYSTEM SOFTWARE DEVELOPMENT AND INTEGRATION, IMPLEMENTATION AND MAINTENANCE AND UNDERLYING PROGRAM MANAGEMENT PROCESSES, SPECIFICALLY IN ORDER TO ADDRESS COMPUTER SECURITY LIFECYCLES AND INFORMATION ASSURANCE AND SECURITY (U.S. CLS. 100 AND 101).

JERI J. FICKES, EXAMINING ATTORNEY

SN 78-887,017. RECKITT & COLMAN (OVERSEAS) LIMITED, HULL, UNITED KINGDOM, FILED 5-18-2006.



OWNER OF U.S. REG. NOS. 972,682, 1,808,772 AND 2,668,653.

CLASS 3—COSMETICS AND CLEANING PREPARATIONS

FOR CLEANING, SCOURING AND ABRASIVE PREPARATIONS FOR HOUSEHOLD PURPOSES; BLEACHING PREPARATIONS FOR HOUSEHOLD USE; DISH AND LAUNDRY DETERGENTS; PREPARATIONS FOR LAUNDRY USE, NAMELY, LAUNDRY DETERGENT, LAUNDRY SOAP, AND LAUNDRY BLEACH; DISPOSABLE WIPES AND TISSUES IMPREGNATED WITH CLEANING PREPARATIONS FOR HOUSEHOLD USE; NON-MEDICATED TOILETRIES; SOAPS; TALCUM POWDER; COSMETICS; NON-MEDICATED SKIN CARE PREPARATIONS; SHAMPOOS; HAIR SHAVING PREPARATIONS; SHAVING CREAMS, GELS SPRAYS, LOTIONS AND BALMS; AFTERSHAVE PREPARATIONS; AFTERSHAVE BALMS, GELS, SPRAYS, LOTIONS AND CREAMS; DEODORANTS FOR PERSONAL USE; DENTIFRICES; PREPARATIONS FOR USE IN ORAL HYGIENE, NAMELY, TOOTHPASTE AND NON-MEDICATED MOUTH WASH AND RINSE; PERFUMING PREPARATIONS FOR THE ATMOSPHERE, NAMELY, ROOM FRAGRANCES; ESSENTIAL OILS; MEDICATED SOAP (U.S. CLS. 1, 4, 6, 50, 51 AND 52).

CLASS 5—PHARMACEUTICALS

FOR PHARMACEUTICAL PREPARATIONS, NAMELY, PREPARATIONS FOR THE TREATMENT OF OPIATE, COCAINE AND ALCOHOL ADDICTION; ANALGESICS; PHARMACEUTICAL PREPARATIONS, NAMELY, ANTI-INFLAMMATORY AND ANTI-PYRETIC PREPARATIONS, ANTI-CONVULSANTS, CEREBRAL METABOLIC ACTIVATORS, PREPARATIONS FOR USE IN IMMOBILIZING AND REVIVING ANIMALS, AND MEDICATED PREPARATIONS FOR THE RELIEF OF COUGH AND COLD SYMPTOMS; GASTRIC REFLUX SUPPRESSANTS; LAXATIVES; ANTACIDS; MEDICATED BEVERAGES AND INGREDIENTS FOR MAKING SUCH BEVERAGES ALL FOR THE USE IN THE TREATMENT OF COLDS, COUGHS, INFLUENZA AND SORE THROATS; PREPARATIONS FOR MAKING MEDICATED BEVERAGES, NAMELY, COLDS, COUGHS, INFLUENZA AND SORE THROAT TREATMENT PREPARATIONS; NATURAL FIBER BULKING AGENTS, NAMELY, DIETARY FIBER AS AN ADDITIVE FOR FOOD PRODUCTS; HERBAL TEA FOR MEDICINAL PURPOSES; VETERINARY PREPARATIONS, NAMELY, ANTISEPTIC PREPARATIONS FOR TREATMENT OF CUTS, GRAZES, BITES AND STINGS AND SKIN AND SCALP CONDITIONS AND PAIN RELIEF MEDICATION; MEDICATED HAND WASH; MEDICATED HAIR CARE PREPARATIONS; MEDICATED MOUTHWASH; SANITARY PREPARATIONS FOR MEDICAL USE; DISINFECTANTS FOR SANITARY PURPOSES; ANTISEPTIC PREPARATIONS, ANTIBACTERIAL PREPARATIONS, NAMELY, ANTIBACTERIAL CLEANERS, HANDWASH, PHARMACEUTICALS AND SPRAY; DISINFECTING PREPARATIONS, NAMELY, DISINFECTANTS FOR HYGIENIC AND SANITARY PURPOSES; GERMICIDES; ARTICLES IMPREGNATED WITH A DISINFECTANT OR ANTIBACTERIAL PRODUCT, NAMELY, SANITIZING WIPES; INSECTICIDES AND MITICIDES FOR HOUSEHOLD USE; INSECT REPELLANTS; PREPARATIONS FOR DESTROYING AND REPELLING VERMIN; FUNGICIDES; AIR FRESHENING PREPARATIONS, AIR PURIFYING PREPARATIONS, NAMELY, AIR DEODORANTS AND AIR DEODORIZERS; ODOR NEUTRALIZERS FOR USE ON CARPETS, TEXTILES AND IN THE AIR; SPRAYS AND AEROSOLS FOR NEUTRALIZING, CONTROLLING AND REDUCING ALLERGENS; MEDICATED TOILETRIES; MEDICATED TALCUM POWDER; MEDICAL PLASTERS; MATERIALS FOR DRESSINGS, NAMELY, GAUZE AND MEDICAL ADHESIVE TAPE; CLOTHS, WIPES, TISSUES AND SPONGES IMPREGNATED WITH DISINFECTANT FOR CLEANING, NAMELY, SANITIZING WIPES; MEDICINAL DRINKS AND PREPARATIONS FOR MAKING UP SUCH DRINKS, NAMELY, DIETARY SUPPLEMENTAL DRINKS; MEDICATED BEVERAGES AND PREPARATIONS FOR MAKING MEDICATED BEVERAGES, NAMELY, NUTRITIONALLY FORTIFIED BEVERAGES; VITAMIN PREPARATIONS; MEDICATED PREPARATIONS FOR TREATMENT OF ORAL AILMENTS, NAMELY, MEDICATED MOUTHWASH; MINERAL PREPARATIONS FOR MEDICINAL USE; HERBAL PREPARATIONS FOR MEDICINAL USE, NAMELY,

HERBAL TEAS FOR MEDICINAL PURPOSES AND MEDICINAL HERBAL EXTRACTS FOR MEDICAL PURPOSES; PADS OR PATCHES IMPREGNATED WITH OR CONTAINING SUBSTANCES FOR THE RELIEF OF SYMPTOMS OF COLDS, AND INFLUENZA; DECONGESTANTS; PREPARATIONS FOR DISPERSING DECONGESTANTS, NAMELY, DECONGESTANT CAPSULES AND NASAL SPRAYS; MEDICATED THROAT LOZENGES; MEDICATED CONFECTIONERY; MEDICATED SKIN CARE PREPARATIONS (U.S. CLS. 6, 18, 44, 46, 51 AND 52).

ROBERT STRUCK, EXAMINING ATTORNEY

SN 78-892,374. SMALTEC INTERNATIONAL, LLC, NAPERVILLE, IL. FILED 5-25-2006.

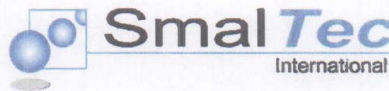

NO CLAIM IS MADE TO THE EXCLUSIVE RIGHT TO USE "INTERNATIONAL", APART FROM THE MARK AS SHOWN.

THE COLOR(S) BLACK, GREY, BLUE AND WHITE IS/ARE CLAIMED AS A FEATURE OF THE MARK.

THE COLOR BLACK APPEARS IN THE WORDS "SMAL" AND "INTERNATIONAL". THE COLOR WHITE APPEARS AS SHADING WITHIN THE 3 CIRCULAR DESIGNS. THE COLOR GREY APPEARS AS SHADING UNDERNEATH THE CIRCULAR DESIGN. THE COLOR BLUE APPEARS WITHIN THE THREE CIRCULAR DESIGNS, WITHIN THE WORD "TEC" AND AS OUTLINES OF THE SQUARE DESIGN AND THE LINE RUNNING THROUGH THE MIDDLE OF THE MARK.

THE MARK CONSISTS OF A SQUARE AND CIRCLE DESIGN THAT PRECEDES THE WORDS "SMALTEC INTERNATIONAL". THE WORD "SMALTEC" IS UNDERLINED WITH A LINE THAT EXTENDS FROM THE SQUARE.

SEC. 2(F).

SN 78-892,369. SMALTEC INTERNATIONAL, LLC, NAPERVILLE, IL. FILED 5-25-2006.

SMALTEC

THE MARK CONSISTS OF STANDARD CHARACTERS WITHOUT CLAIM TO ANY PARTICULAR FONT, STYLE, SIZE, OR COLOR.

SEC. 2(F).

CLASS 35—ADVERTISING AND BUSINESS

FOR DISTRIBUTORSHIP SERVICES IN THE FIELD OF MICRO MACHINES, NAMELY, MICRO-ELECTRIC DISCHARGE MACHINES AND MICRO-GRINDING MACHINES (U.S. CLS. 100, 101 AND 102).

FIRST USE 6-8-2006; IN COMMERCE 6-8-2006.

CLASS 40—MATERIAL TREATMENT

FOR MICROMACHINE PROTOTYPE SERVICES FOR THIRD PARTIES, NAMELY, CUSTOM MANUFACTURING OF MICROMACHINES AND RELATED PARTS FOR OTHERS USING MICRO-ELECTRIC DISCHARGE MACHINE (MICRO-EDM) TECHNOLOGY, CONTRACT MANUFACTURING OF MICROMACHINES AND RELATED PARTS FOR OTHERS USING MICRO-ELECTRIC DISCHARGE MACHINE (MICRO-EDM) TECHNOLOGY, AND CONSULTATION PROVIDED WITH ALL OF THE AFORESAID SERVICES (U.S. CLS. 100, 103 AND 106).

FIRST USE 12-31-2002; IN COMMERCE 12-31-2002.

DAVID COLLIER, EXAMINING ATTORNEY

CLASS 35—ADVERTISING AND BUSINESS

FOR DISTRIBUTORSHIP SERVICES IN THE FIELD OF MICRO MACHINES, NAMELY, MICRO-ELECTRIC DISCHARGE MACHINES AND MICRO-GRINDING MACHINES (U.S. CLS. 100, 101 AND 102).

FIRST USE 6-8-2006; IN COMMERCE 6-8-2006.

CLASS 40—MATERIAL TREATMENT

FOR MICROMACHINE PROTOTYPE SERVICES FOR THIRD PARTIES, NAMELY, CUSTOM MANUFACTURING OF MICROMACHINES AND RELATED PARTS FOR OTHERS USING MICRO-ELECTRIC DISCHARGE MACHINE (MICRO-EDM) TECHNOLOGY, CONTRACT MANUFACTURING OF MICROMACHINES AND RELATED PARTS FOR OTHERS USING MICRO-ELECTRIC DISCHARGE MACHINE (MICRO-EDM) TECHNOLOGY, AND CONSULTATION PROVIDED WITH ALL OF THE AFORESAID SERVICES (U.S. CLS. 100, 103 AND 106).

FIRST USE 12-31-2002; IN COMMERCE 12-31-2002.

DAVID COLLIER, EXAMINING ATTORNEY

SN 78-896,945. UNION STAR INTERNATIONAL LIMITED, CENTRAL, HONG KONG, FILED 5-31-2006.



THE MARK CONSISTS OF THE TERM "DFON" WITH THE LETTER "D" SUPERIMPOSED WITHIN A CIRCLE.

CLASS 9—ELECTRICAL AND SCIENTIFIC APPARATUS

FOR INTERFACE CARDS FOR DATA PROCESSING EQUIPMENT IN THE FORM OF PRINTED CIRCUITS; COMPUTERS; ELECTRICAL AND ELECTRONIC DEVICES, NAMELY, USB PHONE, INTERNET PROTOCOL PHONE, INTERNET PROTOCOL CONVERTER, FOREIGN EXCHANGE OFFICE, ALL FOR USE IN CONNECTION WITH TELEPHONY COMMUNICATION SERVICES; COMPUTER HARDWARE; COMPUTER HARDWARE AND COMPUTER SOFTWARE FOR USE IN CONNECTION WITH TELEPHONY COMMUNICATIONS; COMPUTER INTEGRATED CIRCUITS; SOFTWARE FOR CONTROLLING AND USING INTEGRATED CIRCUITS; COMPUTER SOFTWARE FOR VOICEOVER INTERNET PROTOCOL TECHNOLOGY; SOFTWARE FOR ALLOWING INTERNET USERS TO USE THE INTERNET AS A TELEPHONE; VOICE COMPRESSION HARDWARE AND COMPUTER SOFTWARE FOR USE IN CONNECTION WITH TELEPHONY COMMUNICATIONS; COMPUTER INTEGRATED CIRCUITS; SOFTWARE FOR CONTROLLING AND USING INTEGRATED CIRCUITS; COMPUTER SOFTWARE FOR VOICE OVER INTERNET PROTOCOL TECHNOLOGY; SOFTWARE FOR ALLOWING INTERNET USERS TO USE THE INTERNET AS A TELEPHONE; VOICE COMPRESSION HARDWARE AND SOFTWARE; MOBILE TELEPHONES; MAGNETICALLY ENCODED PREPAID TELEPHONE CARDS; TELEPHONE APPARATUS WITH PREPAYMENT BY MAGNETIC CARD, NAMELY, PUBLIC PAY PHONE; MAGNETICALLY ENCODED CARDS, NAMELY, CREDIT CARDS, DEBIT CARDS, STORED VALUE CARDS, MEMBERSHIP AND LOYALTY PROGRAM CARDS, BLANK SMART CARDS; APPARATUS FOR RECORDING, TRANSMISSION OR REPRODUCTION OF SOUND AND IMAGES AND DATA, NAMELY, BILLING AND MULTIMEDIA RECORDER; PRE-RECORDED MAGNETIC DATA CARRIERS CONTAINING BILLING AND CALL DATA RECORD; RECORDING DISCS, NAMELY, BLANK CD-ROMS FOR SOUND AND VIDEO RECORDING, BILLING AND CALL DATA RECORD; TELECOMMUNICATION APPARATUS, NAMELY, ROUTERS, SWITCHES, NETWORK DEVICES; CIRCUITRY, NAMELY, TIME DIVISION MULTIPLEXING AND INTERNET PROTOCOL BASED NETWORKS AND CIRCUIT BOARDS; CABLES, NAMELY, COAXIAL CABLES, COMPUTER CABLES, FIBER CABLES AND UNSEALED TWISTED PAIR CABLES; OPTICAL LINKS, ALL FOR TELECOMMUNICATIONS; PARTS AND FITTINGS FOR ALL THE AFORESAID GOODS (U.S. CLS. 21, 23, 26, 36 AND 38).

CLASS 38—COMMUNICATION

FOR TELECOMMUNICATION SERVICES, NAMELY, PROVIDING IP-BASED VOICE TELECOMMUNICATION SERVICES TO INDIVIDUALS AND CORPORATIONS; RADIO BROADCASTING; CELLULAR TELEPHONE COMMUNICATION; COMMUNICATIONS BY COMPUTER TERMINALS; COMPUTER AIDED TRANSMISSION OF MESSAGES AND IMAGES; ELECTRONIC MAIL SERVICES; FACSIMILE TRANSMISSION; RENTAL OF COMMUNICATION EQUIPMENT; RENTAL OF TELEPHONES; TELEPHONE SERVICES, NAMELY, CELLULAR PHONE SERVICES, INTERNATIONAL TELEPHONE SERVICES, LOCAL AND LONG DISTANCE TELEPHONE SERVICES, INTERNET TELEPHONE SERVICES; NEWS AGENCIES, NAMELY, THE TRANSMISSION OF NEWS ITEMS TO NEWS REPORTING ORGANIZATIONS; TRANSMISSION OF NEWS; TELEPHONY COMMUNICATION SERVICES, NAMELY, INTERNET AND WIRELESS TELEPHONY COMMUNICATION SERVICES; PROVIDING COMMUNICATIONS SERVICES, NAMELY, VOICE OVER INTERNET PROTOCOL (VOIP) PEER-TO-PEER COMMUNICATIONS; ELECTRONIC TRANSMISSION OF DATA AND DOCUMENTS OVER COMPUTER TERMINALS AND INSTANT MESSAGING SERVICES (U.S. CLS. 100, 101 AND 104).

CLASS 42—SCIENTIFIC AND COMPUTER SERVICES

FOR SCIENTIFIC AND TECHNOLOGICAL SERVICES, NAMELY, SCIENTIFIC AND TECHNOLOGICAL CONSULTING SERVICES IN THE FIELD OF IP COMMUNICATION AND INTERNET TELEPHONY; RESEARCH AND DESIGN RELATED TO THE DESIGN OF COMPUTERS, INTEGRATED CIRCUITS, COMMUNICATIONS HARDWARE AND SOFTWARE AND NETWORKS FOR OTHERS; SCIENTIFIC CONSULTING SERVICES RELATING TO COMMUNICATIONS NETWORKS AND SYSTEMS; TESTING SERVICES OF INTERNET TRAFFIC CONTROL OF WEBSITES OF OTHERS RELATING TO COMMUNICATIONS NETWORKS AND SYSTEMS, EXCHANGE EQUIPMENT, INFORMATION SYSTEMS, SOUND, IMAGE, INFORMATION AND DATA PROCESSING, ELECTRONIC DATABASES, MESSAGE HANDLING, ELECTRONIC DATA LINKS, SIGNALLING SYSTEMS; RESEARCH AND DEVELOPMENT SERVICES OF COMMUNICATION NETWORKS AND SYSTEMS, DESIGN OF COMMUNICATION NETWORKS AND SYSTEMS; SCIENTIFIC CONSULTING SERVICES RELATING TO INFORMATION SYSTEMS, SOUND, IMAGE, INFORMATION AND DATA PROCESSING; RESEARCH AND DEVELOPMENT SERVICES OF INFORMATION SYSTEMS, SOUND IMAGE, INFORMATION AND DATA PROCESSING; DESIGN OF INFORMATION SYSTEMS, SOUND, IMAGE, INFORMATION AND DATA PROCESSING; COMPUTER AND TELECOMMUNICATIONS SYSTEMS AND NETWORK ANALYSIS; DESIGN FOR OTHERS IN THE FIELD OF ENGINEERING; TECHNOLOGY CONSULTATION FOR OTHERS IN THE FIELD OF ENGINEERING; CUSTOM DESIGN OF CABLES, NAMELY, COAXIAL CABLES, COMPUTER CABLES, FIBER CABLES, UT CABLES; TECHNICAL PROJECT STUDIES RELATING TO NETWORKING; HOSTING OF COMPUTER WEBSITES OF OTHERS; COMPUTER SERVICES, NAMELY, CREATING AN ONLINE COMMUNITY FOR REGISTERED USERS TO PARTICIPATE IN SOCIAL NETWORKS, NAMELY, PEER-TO-PEER COMMUNICATION VIA THE INTERNET (U.S. CLS. 100 AND 101).

NAKIA HENRY, EXAMINING ATTORNEY

SN 78-899,731. MOM INVENTORS, INC., WALNUT CREEK, CA. FILED 6-2-2006.

MOMS HELPING MOMS

THE MARK CONSISTS OF STANDARD CHARACTERS WITHOUT CLAIM TO ANY PARTICULAR FONT, STYLE, SIZE, OR COLOR.

CLASS 41—EDUCATION AND ENTERTAINMENT

FOR PROVIDING NEWSLETTERS IN THE FIELD OF PRODUCT CREATION, DEVELOPMENT, MARKETING, WOMEN'S ENTREPRENEURSHIP AND THE EXCHANGE OF CREATIVE IDEAS VIA EMAIL (U.S. CLS. 100, 101 AND 107).

FIRST USE 6-2-2006; IN COMMERCE 6-2-2006.

CLASS 42—SCIENTIFIC AND COMPUTER SERVICES

FOR PROVIDING RESOURCE INFORMATION VIA A WEB SITE IN THE FIELD OF PRODUCT DEVELOPMENT TO ENABLE USERS TO CORRESPOND WITH EACH OTHER AND/OR INTERACT AND EXCHANGE INFORMATION AND/OR IDEAS REGARDING PRODUCT DEVELOPMENT (U.S. CLS. 100 AND 101).

FIRST USE 6-2-2006; IN COMMERCE 6-2-2006.
ROBIN CHOSID, EXAMINING ATTORNEY

SN 78-900,897. JOOVY, LLC, DALLAS, TX. FILED 6-6-2006.

JOOVY

THE MARK CONSISTS OF STANDARD CHARACTERS WITHOUT CLAIM TO ANY PARTICULAR FONT, STYLE, SIZE, OR COLOR.

CLASS 12—VEHICLES

FOR JUVENILE PRODUCTS, NAMELY, BABY STROLLERS AND CHILDREN'S CAR SEATS (U.S. CLS. 19, 21, 23, 31, 35 AND 44).

FIRST USE 2-0-2005; IN COMMERCE 2-0-2005.

CLASS 28—TOYS AND SPORTING GOODS

FOR DOLL TOYS, NAMELY, DOLL CAR SEATS AND DOLL STROLLERS; PLAY YARDS IN THE NATURE OF INDOOR OR OUTDOOR PLAY STRUCTURES (U.S. CLS. 22, 23, 38 AND 50).

FIRST USE 2-0-2005; IN COMMERCE 2-0-2005.
ROBIN CHOSID, EXAMINING ATTORNEY

SN 78-901,152. AUSTRALIA ZOO PTY LTD, BEERWAH, QUEENSLAND, AUSTRALIA, FILED 6-5-2006.

CRIQUEY

THE MARK CONSISTS OF STANDARD CHARACTERS WITHOUT CLAIM TO ANY PARTICULAR FONT, STYLE, SIZE, OR COLOR.

PRIORITY CLAIMED UNDER SEC. 44(D) ON AUSTRALIA APPLICATION NO. 1108114, FILED 4-11-2006, REG. NO. 1108114, DATED 4-11-2006, EXPIRES 4-11-2016.

PRIORITY CLAIMED UNDER SEC. 44(D) ON AUSTRALIA APPLICATION NO. 1108114, FILED 4-11-2006.

CLASS 20—FURNITURE AND ARTICLES NOT OTHERWISE CLASSIFIED

FOR FURNITURE, NAMELY, WALL UNITS, PARTITIONS, ARMCHAIRS, BEDS, BED HEADBOARDS, BENCHES, NON-METAL BINS, BABY BOLSTERS, BOTTLE RACKS, WOOD AND PLASTIC BOXES, CABINETS, CHAIRS, CHESTS, COAT STANDS, PACKING CONTAINERS OF PLASTIC MATERIAL, CUPBOARDS, CUSHIONS, DECK CHAIRS, DESKS, DINING SETS IN THE NATURE OF TABLES AND CHAIRS, DISPLAY BOARDS, METAL DISPLAY STANDS, DIVANS, DRAWERS, DRESSING TABLES, FILING CABINETS, FOOTSTOOLS, NON-METAL FURNITURE TRESTLES FOR SUPPORTING TABLES, OFFICE FURNITURE, FURNITURE SHELVES, HAT STANDS, LETTER BOXES NOT OF METAL, LOUNGE CHAIRS, MAGAZINE RACKS, MIRRORS, PLASTIC MODULAR FURNITURE NESTING BOXES, OCCASIONAL FURNITURE, OTTOMANS, OUTDOOR FURNITURE, PACKAGING CONTAINERS OF PLASTIC, PARTITIONS, PICTURE FRAMES, PILLOWS, RECLINERS, ROOM DIVIDERS NOT OF METAL, SEATS, SETTEES, SHELVES, SHOWCASES IN THE NATURE OF DISPLAY CASES, SIDEBARDS, SOFAS, SOFA-BEDS, SLEEPING BAGS FOR CAMPING, NON-METAL PLANT STANDS, STATUES OF WOOD, WAX, PLASTER AND PLASTIC, STOOLS, STORAGE TABLES, TABLES, TEA CARTS, TEA SERVING TROLLEYS, UMBRELLA STANDS, WALL UNITS, WARDROBES, NON-METAL WINE RACKS, KEY RINGS, NOT OF METAL; JEWELRY CASES, NOT OF PRECIOUS METAL, DRINKING STRAWS, BADGES FOR WEAR, NOT OF PRECIOUS METAL, IN THE NATURE OF POLICE BADGES (U.S. CLS. 2, 13, 22, 25, 32 AND 50).

CLASS 21—HOUSEWARES AND GLASS

FOR FOAM HOLDERS FOR DRINK BOTTLES AND DRINK CANS; LUNCH BOXES; DRINK BOTTLES SOLD EMPTY; PORTABLE COOLERS AND THERMAL INSULATED CONTAINERS FOR FOOD AND BEVERAGES; BEER MUGS; COMBS AND BRUSHES FOR CLEANING PETS; COMBS AND BRUSHES FOR HAIR GROOMING PURPOSES; ICE CUBE MOLDS AND COOKERY MOLDS; FIGURINES AND STATUES OF CHINA, CRYSTAL, EARTHENWARE, GLASS AND PORCELAIN; TOOTHBRUSHES; STANDS, NAMELY, POT STANDS AND DISH STANDS, DRINKING AND EATING IMPLEMENTS, NAMELY, CHOPSTICKS, POTS, PLATES, DISHES, BOWLS, DRINKING GLASSES, MUGS, DRINKING HORNS, TANKARDS NOT OF PRECIOUS METAL, DISPOSABLE PLATES AND DISPOSABLE CUPS; BEVERAGE GLASSWARE FOR DRINKING AND CRYSTAL BEVERAGE GLASSWARE; PORCELAIN AND EARTHENWARE GOODS, NAMELY, PORCELAIN AND EARTHENWARE VESSELS, CUPS, POTS AND PANS; POTS AND CONTAINERS, NAMELY, COOKING POTS, TEA POTS NOT OF PRECIOUS METAL, COFFEEPOTS NOT OF PRECIOUS METAL, BOTTLES SOLD EMPTY, BREAD BOXES, HOUSEHOLD PLASTIC FOOD STORAGE BOXES, HOUSEHOLD CONTAINERS FOR HERBS, HOUSEHOLD CONTAINERS FOR SPICES, FOOD BASKETS IN THE NATURE OF WIRE BASKETS FOR COOKING, AND FOOD PRESERVING JARS OF GLASS; CORK SCREWS; COOKING AND KITCHEN UTENSILS, NAMELY, BAKING TINS, BAKING TRAYS, BASTING BRUSHES, BASTING SPOONS, FOOD BASTING SYRINGES, NON-ELECTRIC EGG BEATERS, BOTTLE OPENERS, BREADBOARDS, BISCUIT CUTTERS, COOKING SKEWERS, CAULDRONS, CHEESE GRATERS, COLANDERS, CHOPSTICKS, CUTTING BOARDS, CRUMB TRAYS, COOKERY MOLDS, PASTRY CUTTERS, COOKING POTS, COOKING PANS, DECANTERS, DRIP TRAYS FOR TEA, EGG PIERCERS, RINGS FOR COOKING EGGS, NON-ELECTRIC FRUIT PRESSES FOR HOUSEHOLD PURPOSES, FRYING PANS, FUNNELS, GARLIC PRESSES, CHEESE GRATERS, GRIDDLES, CAMPING GRILLS, HOT POTS, ICE BUCKETS, ICE CUBE MOLDS, KETTLES, KNIFE RESTS, LEMON SQUEEZERS, MIXING BOWLS, MIXING SPOONS, PEPPER MILLS, PASTRY CUTTERS, PIE SERVERS, POTATO MASHERS, ROLLING PINS, SIEVES, SKILLETS, SLOTTED SPOONS, HOUSEHOLD UTENSILS IN THE NATURE OF SPATULAS, HOUSEHOLD UTENSILS IN THE NATURE OF STRAINERS, SCOOPS, SALT AND PEPPER SHAKERS, COOKING SIFTERS, SIPHONS IN THE NATURE OF WINE TASTERS, STEW-PANS, SERVING TONGS, WHISKS, WOKS AND WOODEN

MIXING SPOONS, TRAYS, WASTE BASKETS, FLOWER AND PLANT BASKETS, FITTED PICNIC BASKETS, BASKETS OF WICKER, STRAW, AND WOOD (U.S. CLS. 2, 13, 23, 29, 30, 33, 40 AND 50).

CLASS 26—FANCY GOODS

FOR ORNAMENTAL NOVELTY BUTTONS; HAIR BANDS; BELT CLASPS, BROOCHES AND BUCKLES NOT OF PRECIOUS METAL; ORNAMENTS FOR HAIR AND HATS, NAMELY, ARTIFICIAL FLOWERS, ARTIFICIAL GARLANDS, BROOCHES NOT OF PRECIOUS METAL, PATCHES FOR HATS, NAMELY, EMBROIDERED PATCHES AND ORNAMENTAL HEAT ADHESIVE CLOTH PATCHES, FEATHERS, BARRETTES, HAIR SLIDES, BOWS FOR THE HAIR, FALSE HAIR IN THE NATURE OF TOUPEES, HAIR EXTENSIONS, LACE TRIMMINGS, TASSELS, RIBBONS AND BRAIDS, FABRIC COVERS FOR KITCHEN APPLIANCES, NEEDLES (U.S. CLS. 37, 39, 40, 42 AND 50).

CLASS 28—TOYS AND SPORTING GOODS

FOR GAMES AND PLAYTHINGS, NAMELY, BOARD GAMES, PUZZLE GAMES, TRIVIA CARD GAMES, CARD GAMES, TOY BUILDING BLOCK GAMES, PLAY BALLOONS, HOBBY CRAFT KITS COMPRISING DOLLS, FIGURINES, MODEL ANIMALS AND MODEL WILDLIFE HABITATS, GAMES TABLES, ARCADE GAMES, PARLOR GAMES, ARCADE-TYPE ELECTRONIC VIDEO GAMES, COIN-OPERATED GAMES MACHINES, OUTDOORS PLAY EQUIPMENT IN THE NATURE OF SWINGS AND SLIDES, AMUSEMENT PARK RIDES, AND PLAY ARTICLES IN THE NATURE OF SWIM FLOATS FOR RECREATIONAL USE IN SWIMMING POOLS; TOYS, NAMELY, PLUSH TOYS, DOLLS, ACCESSORIES FOR DOLLS, ACTION FIGURES, FLYING DISCS, KALEIDOSCOPES, KITES, REELS FOR KITES, MARIONETTE PUPPETS, TOY MOBILES, SNOW GLOBES, TOY ANIMALS, PUPPETS, TEDDY BEARS, TOY JEWELRY, TOY MASKS, TOYS FOR DOMESTIC PETS, TOY SOAP BUBBLES FEATURING WAND AND SOLUTION, SPINNING TOPS, DARTS, TARGETS, SHUTTLECOCKS FOR BADMINTON, SKITTLES, PLAYING CARDS, AND YO-YOS; SPORTING ARTICLES, NAMELY, BASEBALL BATS, SPORT BALLS, GOLF CLUBS, BASEBALL GLOVES, SURF BOARDS, TENNIS NETS, CAPS FOR TOY PISTOLS, WATERFOWL HUNTING DECOYS, FISHING LURES, FISHING TACKLE, GYMNASIUM APPARATUS, BAGS AND COVERS ESPECIALLY DESIGNED FOR BASEBALL BATS, TENNIS BALLS, SURFBOARDS AND SPORTS EQUIPMENT; DECORATIONS FOR CHRISTMAS TREES, NOVELTIES FOR PARTIES, NAMELY, CONFETTI, MAGIC TRICKS AND PIÑATAS; TOY MASKS, TINSEL FOR DECORATING CHRISTMAS TREES, FISHING CREELS (U.S. CLS. 22, 23, 38 AND 50).

CLASS 41—EDUCATION AND ENTERTAINMENT

FOR EDUCATION SERVICES NAMELY, CONDUCTING CLASSES AND WORKSHOPS IN THE FIELDS OF ANIMALS NAMELY WILDLIFE, THE ENVIRONMENT, CONSERVATION, BIODIVERSITY, SUSTAINABILITY, REHABILITATION, ZOOLOGY AND BOTANY; CONDUCTING EDUCATIONAL EXHIBITIONS AND DEMONSTRATIONS RELATING TO WILDLIFE, THE ENVIRONMENT, CONSERVATION, BIODIVERSITY, SUSTAINABILITY, REHABILITATION, ZOOLOGY AND BOTANY; GUIDED TOURS AT WILDLIFE PARKS, GARDENS AND MUSEUMS; ENTERTAINMENT SERVICES, NAMELY ON-GOING TELEVISION AND RADIO PROGRAMS IN THE FIELD OF WILDLIFE, THE ENVIRONMENT, CONSERVATION, BIODIVERSITY, SUSTAINABILITY, REHABILITATION, ZOOLOGY AND BOTANY, ANIMAL EXHIBITIONS; ONLINE JOURNALS, NAMELY BLOGS RELATING TO A THEME PARK, ANIMAL WILDLIFE, THE ENVIRONMENT, CONSERVATION, BIODIVERSITY, SUSTAINABILITY, REHABILITATION, ZOOLOGY AND BOTANY; ORGANIZING COMMUNITY CULTURAL EVENTS RELATING TO AUSTRALIAN CUSTOMS, TRADITIONS, CEREMONIES, HISTORY AND ART; PROVIDING AMUSEMENT PARKS AND THEME PARK SERVICES FEATURING ANIMALS IN SPECIALLY DESIGNED HABITATS; AMU-

SEMENTS PARK RIDES, FAN CLUB SERVICES; ANIMAL TRAINING AND EXHIBITIONS; ARRANGING AND CONDUCTING OF EDUCATIONAL CONFERENCES OR SEMINARS ON TOPICS RELATING TO WILDLIFE, THE ENVIRONMENT, CONSERVATION, BIODIVERSITY, SUSTAINABILITY, REHABILITATION, ZOOLOGY AND BOTANY; INSTRUCTIONAL SERVICES, NAMELY, PROVIDING INSTRUCTION IN THE FIELDS OF HANDLING ANIMALS, FEEDING ANIMALS, SAFETY AROUND ANIMALS, AND TRAINING ANIMALS; ZOOLOGICAL PARKS AND EDUCATION COURSES IN RELATION TO ZOOLOGY AND ANIMAL LIFE GENERALLY; BOTANICAL GARDENS (U.S. CLS. 100, 101 AND 107).

PAULA MAHONEY, EXAMINING ATTORNEY

SN 78-902,616. 48FILL, LLC, RICHMOND, VA. FILED 6-7-2006.

48FILL

THE MARK CONSISTS OF STANDARD CHARACTERS WITHOUT CLAIM TO ANY PARTICULAR FONT, STYLE, SIZE, OR COLOR.

CLASS 35—ADVERTISING AND BUSINESS

FOR PROMOTION AND MARKETING SERVICES FOR OTHERS (U.S. CLS. 100, 101 AND 102).
FIRST USE 3-1-2006; IN COMMERCE 4-1-2006.

CLASS 42—SCIENTIFIC AND COMPUTER SERVICES

FOR DATA AUTOMATION AND COLLECTION SERVICE USING PROPRIETARY SOFTWARE TO COLLECT AND EVALUATE DATA (U.S. CLS. 100 AND 101).
FIRST USE 3-1-2006; IN COMMERCE 4-1-2006.
CIMMERIAN COLEMAN, EXAMINING ATTORNEY

SN 78-903,810. INTER FONCTION LTD., SHERBROOKE, CANADA, FILED 6-8-2006.



kadriumdesign

PRIORITY CLAIMED UNDER SEC. 44(D) ON CANADA APPLICATION NO. 1303243, FILED 5-29-2006, REG. NO. TMA700861, DATED 11-15-2007, EXPIRES 11-15-2022.

CLASS 19—NON-METALLIC BUILDING MATERIALS

FOR NON-METAL DOORS FOR CLOSETS (U.S. CLS. 1, 12, 33 AND 50).
FIRST USE 1-11-2006; IN COMMERCE 1-11-2006.

CLASS 20—FURNITURE AND ARTICLES NOT OTHERWISE CLASSIFIED

FOR DOORS FOR FURNITURE, NAMELY, CABINET DOORS; FURNITURE DOORS; CLOSET AND CUPBOARD ORGANIZERS, NAMELY, SHOE RACKS, CLOTHING BARS, SLIDING CLOTHES RAILS, BELT RACKS; TABLES; BEDROOM FURNITURE; COMPUTER FURNITURE; DINING ROOM FURNITURE; LIVING ROOM FURNITURE; OFFICE FURNITURE; SHELVES MADE OF GLASS, ALUMINUM AND METAL (U.S. CLS. 2, 13, 22, 25, 32 AND 50).

FIRST USE 1-11-2006; IN COMMERCE 1-11-2006.
LAURA HAMMEL, EXAMINING ATTORNEY

SN 78-906,767. AT&T DELAWARE INTELLECTUAL PROPERTY, INC., WILMINGTON, DE. FILED 6-13-2006.

GOT IP?

THE MARK CONSISTS OF STANDARD CHARACTERS WITHOUT CLAIM TO ANY PARTICULAR FONT, STYLE, SIZE, OR COLOR.

NO CLAIM IS MADE TO THE EXCLUSIVE RIGHT TO USE "IP", APART FROM THE MARK AS SHOWN.

CLASS 35—ADVERTISING AND BUSINESS

FOR BUSINESS MARKETING CONSULTING SERVICES FOR MARKETING INTELLECTUAL PROPERTY, NAMELY, PATENTS, TRADEMARKS, COPYRIGHTS AND PROPRIETARY INFORMATION OF OTHERS; CONSULTING SERVICES IN THE FIELD OF MANAGING INTELLECTUAL PROPERTIES; INTELLECTUAL PROPERTY CONSULTATION IN THE FIELD OF MARKETING OF INTELLECTUAL PROPERTY CONSISTING OF PATENTS, TRADEMARKS, COPYRIGHTS AND PROPRIETARY INFORMATION (U.S. CLS. 100, 101 AND 102).

SN 78-904,804. KANE, FRANCIS C, TAMPA, FL. FILED 6-9-2006.

**CLASS 42—SCIENTIFIC AND COMPUTER SERVICES**

FOR INTELLECTUAL PROPERTY CONSULTATION IN THE FIELD OF LICENSING AND PROTECTION OF INTELLECTUAL PROPERTY CONSISTING OF PATENTS, TRADEMARKS, COPYRIGHTS AND PROPRIETARY INFORMATION; LICENSING OF INTELLECTUAL PROPERTY CONSISTING OF PATENTS, TRADEMARKS, COPYRIGHTS AND PROPRIETARY INFORMATION; INTELLECTUAL PROPERTY WATCH SERVICES (U.S. CLS. 100 AND 101).

KATHERINE M. DUBRAY, EXAMINING ATTORNEY

NO CLAIM IS MADE TO THE EXCLUSIVE RIGHT TO USE "BIKES", APART FROM THE MARK AS SHOWN.

THE COLOR(S) BLUE, ORANGE, BLACK, GREEN, WHITE AND RED IS/ARE CLAIMED AS A FEATURE OF THE MARK.

THE COLOR BLUE APPEARS IN THE BODY OF THE FISH AND IN THE FISH EYE. THE COLOR ORANGE APPEARS IN THE LARGE FINS AND SMALL FIN ON THE HEAD AND THE TAIL OF THE FISH. THE COLOR YELLOW APPEARS IN THE SMALL FINS, THE STRIPE, THE BIKE FRAME AND THE CAP ON THE HEAD OF THE FISH. THE COLOR BLACK APPEARS IN THE WORDING, THE DOTS, THE STRIPES IN THE FINS, THE SEAT, PEDALS AND WHEELS ON THE BIKE, THE STRAP AND DOT ON THE CAP AND THE OUTLINING. THE COLOR GREEN APPEARS IN THE CAP. THE COLOR WHITE APPEARS IN THE BIKE FRAME AND IN THE FISH EYE. THE COLOR RED APPEARS IN THE TONGUE AND THE CIRCLE IN THE WHEELS.

CLASS 35—ADVERTISING AND BUSINESS

FOR RETAIL STORE SERVICES FEATURING BICYCLES AND BICYCLE ACCESSORIES (U.S. CLS. 100, 101 AND 102).

FIRST USE 5-6-2006; IN COMMERCE 5-15-2006.

CLASS 37—CONSTRUCTION AND REPAIR

FOR BICYCLE REPAIR SERVICES (U.S. CLS. 100, 103 AND 106).

FIRST USE 5-6-2006; IN COMMERCE 5-15-2006.
KELLEY WELLS, EXAMINING ATTORNEY

SN 78-906,774. AT&T DELAWARE INTELLECTUAL PROPERTY, INC., WILMINGTON, DE. FILED 6-13-2006.

INNOVATION-->INTELLECTUAL PROPERTY-->PROFITS

THE MARK CONSISTS OF STANDARD CHARACTERS WITHOUT CLAIM TO ANY PARTICULAR FONT, STYLE, SIZE, OR COLOR.

NO CLAIM IS MADE TO THE EXCLUSIVE RIGHT TO USE "INTELLECTUAL PROPERTY", APART FROM THE MARK AS SHOWN.

CLASS 35—ADVERTISING AND BUSINESS

FOR BUSINESS MARKETING CONSULTING SERVICES FOR MARKETING INTELLECTUAL PROPERTY OF OTHERS, NAMELY, PATENTS, TRADEMARKS, COPYRIGHTS AND PROPRIETARY INFORMATION TO OTHERS; INTELLECTUAL PROPERTY CONSULTATION IN THE FIELD OF MARKETING OF INTELLECTUAL PROPERTY CONSISTING OF PATENTS, TRADEMARKS, COPYRIGHTS AND PROPRIETARY INFORMATION (U.S. CLS. 100, 101 AND 102).

CLASS 42—SCIENTIFIC AND COMPUTER SERVICES

FOR INTELLECTUAL PROPERTY CONSULTATION IN THE FIELD OF LICENSING AND PROTECTION OF INTELLECTUAL PROPERTY CONSISTING OF PATENTS, TRADEMARKS, COPYRIGHTS AND PROPRIETARY INFORMATION; LICENSING OF INTELLECTUAL PROPERTY CONSISTING OF PATENTS, TRADEMARKS, COPYRIGHTS AND PROPRIETARY INFORMATION; INTELLECTUAL PROPERTY WATCH SERVICES (U.S. CLS. 100 AND 101).

KATHERINE M. DUBRAY, EXAMINING ATTORNEY

SN 78-906,786. AT&T DELAWARE INTELLECTUAL PROPERTY, INC., WILMINGTON, DE. FILED 6-13-2006.

SURROUNDING THE LAKE

THE MARK CONSISTS OF STANDARD CHARACTERS WITHOUT CLAIM TO ANY PARTICULAR FONT, STYLE, SIZE, OR COLOR.

CLASS 35—ADVERTISING AND BUSINESS

FOR BUSINESS MARKETING CONSULTING SERVICES FOR MARKETING INTELLECTUAL PROPERTY, NAMELY, PATENTS, TRADEMARKS, COPYRIGHTS AND PROPRIETARY INFORMATION; CONSULTING SERVICES IN THE FIELD OF MANAGING INTELLECTUAL PROPERTIES; INTELLECTUAL PROPERTY CONSULTATION IN THE FIELD OF MARKETING OF INTELLECTUAL PROPERTY CONSISTING OF PATENTS, TRADEMARKS, COPYRIGHTS AND PROPRIETARY INFORMATION (U.S. CLS. 100, 101 AND 102).

CLASS 42—SCIENTIFIC AND COMPUTER SERVICES

FOR INTELLECTUAL PROPERTY CONSULTATION IN THE FIELD OF LICENSING AND PROTECTION OF INTELLECTUAL PROPERTY CONSISTING OF PATENTS, TRADEMARKS, COPYRIGHTS AND PROPRIETARY INFORMATION; LICENSING OF INTELLECTUAL PROPERTY CONSISTING OF PATENTS, TRADEMARKS, COPYRIGHTS AND PROPRIETARY INFORMATION; INTELLECTUAL PROPERTY WATCH SERVICES (U.S. CLS. 100 AND 101).

KATHERINE M. DUBRAY, EXAMINING ATTORNEY

SN 78-906,805. AT&T DELAWARE INTELLECTUAL PROPERTY, INC., WILMINGTON, DE. FILED 6-13-2006.

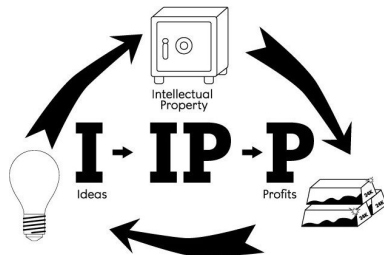

NO CLAIM IS MADE TO THE EXCLUSIVE RIGHT TO USE "INTELLECTUAL PROPERTY" AND "IP", APART FROM THE MARK AS SHOWN.

CLASS 35—ADVERTISING AND BUSINESS

FOR BUSINESS MARKETING CONSULTING SERVICES FOR MARKETING INTELLECTUAL PROPERTY OF OTHERS, NAMELY, PATENTS, TRADEMARKS, COPYRIGHTS AND PROPRIETARY INFORMATION TO OTHERS; INTELLECTUAL PROPERTY CONSULTATION IN THE FIELD OF MARKETING OF INTELLECTUAL PROPERTY CONSISTING OF PATENTS, TRADEMARKS, COPYRIGHTS AND PROPRIETARY INFORMATION (U.S. CLS. 100, 101 AND 102).

CLASS 42—SCIENTIFIC AND COMPUTER SERVICES

FOR INTELLECTUAL PROPERTY CONSULTATION IN THE FIELD OF LICENSING AND PROTECTION OF INTELLECTUAL PROPERTY CONSISTING OF PATENTS, TRADEMARKS, COPYRIGHTS AND PROPRIETARY INFORMATION; LICENSING OF INTELLECTUAL PROPERTY CONSISTING OF PATENTS, TRADEMARKS, COPYRIGHTS AND PROPRIETARY INFORMATION; INTELLECTUAL PROPERTY WATCH SERVICES (U.S. CLS. 100 AND 101).

KATHERINE M. DUBRAY, EXAMINING ATTORNEY

SN 78-907,090. APAC CUSTOMER SERVICES, INC., DEERFIELD, IL. FILED 6-13-2006.

atHOME SERVICE

THE MARK CONSISTS OF STANDARD CHARACTERS WITHOUT CLAIM TO ANY PARTICULAR FONT, STYLE, SIZE, OR COLOR.

NO CLAIM IS MADE TO THE EXCLUSIVE RIGHT TO USE "SERVICE", APART FROM THE MARK AS SHOWN.

CLASS 35—ADVERTISING AND BUSINESS

FOR (BASED ON USE IN COMMERCE) CUSTOMER SERVICES, NAMELY, ORDER FULFILLMENT SERVICES FOR OTHERS; OPERATION OF TELEPHONE CALL CENTERS FOR OTHERS; CUSTOMER SERVICE IN THE FIELDS OF HEALTHCARE, COMMUNICATIONS, PUBLISHING, LOGISTICS, FINANCE, TRAVEL, AND HOSPITALITY (U.S. CLS. 100, 101 AND 102).

FIRST USE 2-28-2006; IN COMMERCE 4-30-2006.

CLASS 38—COMMUNICATION

FOR (BASED ON INTENT TO USE) ELECTRONIC MESSAGE SENDING AND TRANSMISSION SERVICES AND PROVIDING EMAIL SERVICES FOR OTHERS (U.S. CLS. 100, 101 AND 104).

MARK T. MULLEN, EXAMINING ATTORNEY

SN 78-908,487. JEON, SEONG-HWAN, ULSAN CITY, REPUBLIC OF KOREA, FILED 6-14-2006.

AVH

OWNER OF REPUBLIC OF KOREA REG. NO. 0630375, DATED 9-7-2005, EXPIRES 9-7-2015.

OWNER OF REPUBLIC OF KOREA REG. NO. 0634064, DATED 10-7-2005, EXPIRES 10-7-2015.

CLASS 18—LEATHER GOODS

FOR KEY CASES OF LEATHER, DIAPER BAGS, BACKPACKS, SCHOOLCHILDREN'S BACKPACKS, BUSINESS CARD CASES, BOSTON BAGS, PURSES NOT OF PRECIOUS METAL, BEACH BAGS, BRIEFCASES, SUITCASES, CASES FOR CREDIT CARDS, TRAVELING BAGS, LUGGAGE IN THE NATURE OF TRUNKS FOR TRAVELING, SCHOOL BAGS, HANDBAGS (U.S. CLS. 1, 2, 3, 22 AND 41).

CLASS 25—CLOTHING

FOR KNEE LENGTH TROUSERS, HALF-COATS, BLOUSONS, SARIS, SAFARI SUITS, SUITS, SMOCKS, SKIRTS, SLACKS, MENS' SUITS, ANORAKS NOT INTENDED FOR USE WHILE EXERCISING, TROUSERS, OVERALLS, OVERCOATS, ONE PIECE SUITS, EVENING DRESSES, JACKETS, WORKING CLOTHING, NAMELY, JEANS AND OVERALLS, JUMPERS AND SHIRT FRONTS, BLUE JEANS, CAPES, TOPCOATS, TWO PIECE SUITS, TUNICS, PARKAS, GIRDLES, NIGHTGOWNS, NEGLIGEEES, DRESSING GOWNS, BRASSIERES, BLOUSES, SHOWER CAPS, SHIRT YOKES, UNDERWEAR, UNDERSHIRTS, UNDERPANTS, BATHING CAPS, SWIMSUITS, BATHING TRUNKS, CHEMISES, SWEATERS, SWEAT SHIRTS, SWEAT PANTS, SPORTS SHIRTS, WHITE SHIRTS, TANK TOPS, TRACKSUITS, PANTYHOSE, PETTICOATS, POLO SHIRTS, PULL-OVERS, NECKTIES, HEADWEAR, NAMELY, CAPS (U.S. CLS. 22 AND 39).

JORDAN BAKER, EXAMINING ATTORNEY

SN 78-914,331. PLAY FRONTIERS LTD., TEL-AVIV, ISRAEL, FILED 6-22-2006.

FRONTIERS

THE MARK CONSISTS OF STANDARD CHARACTERS WITHOUT CLAIM TO ANY PARTICULAR FONT, STYLE, SIZE, OR COLOR.

CLASS 9—ELECTRICAL AND SCIENTIFIC APPARATUS

FOR VIDEO BOARD GAMES, NAMELY, INTERACTIVE VIDEO BOARD GAMES OF VIRTUAL REALITY COMPRISED OF COMPUTER HARDWARE AND SOFTWARE; COMPUTER GAME SOFTWARE FOR BOARD GAMES, CHESS GAMES, CHESS VARIANTS GAMES, STRATEGY GAMES AND TACTIC GAMES; AND COMPUTER CHESS VARIANTS GAME PROGRAMS; ELECTRONIC CHESS AND CHESS VARIANTS GAMES; ELECTRONIC STRATEGY AND TACTICS GAMES (U.S. CLS. 21, 23, 26, 36 AND 38).

CLASS 28—TOYS AND SPORTING GOODS

FOR GAMES AND PLAYTHINGS, NAMELY, BOARD GAMES, CHESS SETS, CHESS BOARD GAMES, CHESS VARIANTS BOARD GAMES, STRATEGY BOARD GAMES, TACTIC BOARD GAMES, HAND-HELD ELECTRONIC CHESS AND CHESS VARIANTS GAME UNITS, HAND-HELD ELECTRONIC STRATEGY AND TACTIC GAME UNITS (U.S. CLS. 22, 23, 38 AND 50).

CLASS 41—EDUCATION AND ENTERTAINMENT

FOR EDUCATIONAL AND ENTERTAINMENT SERVICES RELATING TO STRATEGY BOARD GAMES, CHESS GAMES AND CHESS VARIANTS GAMES, NAMELY, ARRANGING AND CONDUCTING INSTRUCTIONAL CLASSES, SEMINARS, WORKSHOPS AND DISTRIBUTING COURSE MATERIALS IN CONNECTION WITH STRATEGY BOARD GAMES; AND ARRANGING AND CONDUCTING STRATEGY BOARD GAMES EXHIBITIONS AND STRATEGY BOARD GAMES TOURNAMENTS; ENTERTAINMENT SERVICES, NAMELY, PROVIDING ON-LINE COMPUTER GAMES AND ORGANIZATION OF GAME CONTESTS (U.S. CLS. 100, 101 AND 107).

DOMINICK J. SALEMI, EXAMINING ATTORNEY

SN 78-914,465. PLAY FRONTIERS LTD., TEL-AVIV, ISRAEL, FILED 6-22-2006.

PLAY FRONTIERS

THE MARK CONSISTS OF STANDARD CHARACTERS WITHOUT CLAIM TO ANY PARTICULAR FONT, STYLE, SIZE, OR COLOR.

CLASS 9—ELECTRICAL AND SCIENTIFIC APPARATUS

FOR VIDEO BOARD GAMES, NAMELY, INTERACTIVE VIDEO BOARD GAMES OF VIRTUAL REALITY COMPRISED OF COMPUTER HARDWARE AND SOFTWARE; COMPUTER GAME SOFTWARE FOR BOARD GAMES, CHESS GAMES, CHESS VARIANTS GAMES, STRATEGY GAMES AND TACTIC GAMES; AND COMPUTER CHESS VARIANTS GAME PROGRAMS; ELECTRONIC CHESS AND CHESS VARIANTS GAMES; AND ELECTRONIC STRATEGY AND TACTICS GAMES (U.S. CLS. 21, 23, 26, 36 AND 38).

CLASS 28—TOYS AND SPORTING GOODS

FOR GAMES AND PLAYTHINGS, NAMELY, BOARD GAMES, CHESS SETS, CHESS BOARD GAMES, CHESS VARIANTS BOARD GAMES, STRATEGY BOARD GAMES, TACTIC BOARD GAMES, HAND-HELD ELECTRONIC CHESS AND CHESS VARIANTS GAME UNITS, HAND-HELD ELECTRONIC STRATEGY AND TACTIC GAME UNITS (U.S. CLS. 22, 23, 38 AND 50).

CLASS 41—EDUCATION AND ENTERTAINMENT

FOR EDUCATIONAL AND ENTERTAINMENT SERVICES RELATING TO STRATEGY BOARD GAMES, CHESS GAMES AND CHESS VARIANTS GAMES, NAMELY, ARRANGING AND CONDUCTING INSTRUCTIONAL CLASSES, SEMINARS, WORKSHOPS AND DISTRIBUTING COURSE MATERIALS IN CONNECTION WITH STRATEGY BOARD GAMES; AND ARRANGING AND CONDUCTING STRATEGY BOARD GAMES EXHIBITIONS AND STRATEGY BOARD GAMES TOURNAMENTS; ENTERTAINMENT SERVICES, NAMELY, PROVIDING ON-LINE COMPUTER GAMES AND ORGANIZATION OF GAME CONTESTS (U.S. CLS. 100, 101 AND 107).

DOMINICK J. SALEMI, EXAMINING ATTORNEY

SN 78-920,647. THE ESPOMA COMPANY, MILLVILLE, NJ. FILED 6-30-2006.

NATURAL GARDENING SOLUTIONS

THE MARK CONSISTS OF STANDARD CHARACTERS WITHOUT CLAIM TO ANY PARTICULAR FONT, STYLE, SIZE, OR COLOR.

NO CLAIM IS MADE TO THE EXCLUSIVE RIGHT TO USE "NATURAL GARDENING", APART FROM THE MARK AS SHOWN.

CLASS 1—CHEMICALS

FOR PLANT FOODS, POTTING SOILS, PLANTING MIXES, NAMELY, SOIL CONDITIONERS FOR DOMESTIC USE, GROWING MEDIA FOR PLANTS, PEAT, COMPOST, HUMUS, LOAMS AND MANURE, NATURAL ORGANIC MATERIALS CONSISTING OF LOAM, FIBROUS ORGANICS, COMPOST AND SAND, GROWING MEDIA FOR PLANTS AND GROWING MEDIA FOR PLANTS WITH ADDED FERTILIZER FOR HORTICULTURAL AND DOMESTIC USE (U.S. CLS. 1, 5, 6, 10, 26 AND 46).

CLASS 5—PHARMACEUTICALS

FOR PESTICIDES (U.S. CLS. 6, 18, 44, 46, 51 AND 52). LINDA MICKLEBURGH, EXAMINING ATTORNEY

SN 78-922,624. NISSEI ELECTRIC CO., LTD., SHIZUOKA-KEN, JAPAN, FILED 7-5-2006.

LIKAL

THE MARK CONSISTS OF STANDARD CHARACTERS WITHOUT CLAIM TO ANY PARTICULAR FONT, STYLE, SIZE, OR COLOR.

CLASS 9—ELECTRICAL AND SCIENTIFIC APPARATUS

FOR ELECTRIC WIRES, ELECTRIC CABLES, TELECOMMUNICATION CABLES, POWER CABLES, OPTICAL FIBER CABLES (U.S. CLS. 21, 23, 26, 36 AND 38).

CLASS 17—RUBBER GOODS

FOR PLASTIC AND RUBBER FLEXIBLE TUBES FOR MANUFACTURING, AND GENERAL INDUSTRIAL AND COMMERCIAL USE; PACKING, STOPPING AND INSULATING MATERIALS, NAMELY, PLASTIC AND FOAM SHEETING AND TAPE IN THE NATURE OF ELECTRICAL INSULATING TAPE AND ADHESIVE TAPE FOR INDUSTRIAL AND COMMERCIAL USE; RUBBER (U.S. CLS. 1, 5, 12, 13, 35 AND 50).

LEE-ANNE BERNS, EXAMINING ATTORNEY

SN 78-923,704. EL UNIVERSAL COMPANIA PERIODISTICA NACIONAL S.A. DE C.V., COL. CENTRO, MEXICO, FILED 7-6-2006.

AVISO OPORTUNO

THE MARK CONSISTS OF STANDARD CHARACTERS WITHOUT CLAIM TO ANY PARTICULAR FONT, STYLE, SIZE, OR COLOR.

THE FOREIGN WORDING IN THE MARK TRANSLATES INTO ENGLISH AS OPPORTUNE WARNING.

CLASS 16—PAPER GOODS AND PRINTED MATTER

FOR PRINTED PUBLICATIONS, NAMELY, CLASSIFIED LISTINGS AND CLASSIFIED DIRECTORIES FEATURING A WIDE VARIETY OF TOPICS OF GENERAL INTEREST TO THE SPANISH-SPEAKING COMMUNITY (U.S. CLS. 2, 5, 22, 23, 29, 37, 38 AND 50).

CLASS 41—EDUCATION AND ENTERTAINMENT

FOR COMPUTER SERVICES, NAMELY, PROVIDING ON-LINE PUBLICATIONS IN THE NATURE OF CLASSIFIED LISTINGS AND CLASSIFIED DIRECTORIES FEATURING A WIDE VARIETY OF TOPICS OF GENERAL INTEREST TO THE SPANISH-SPEAKING COMMUNITY (U.S. CLS. 100, 101 AND 107).

KATHLEEN LORENZO, EXAMINING ATTORNEY

SN 78-925,818. PIDILITE USA, INC., HAZELTON, PA. FILED 7-10-2006.

SOLAIRE

THE MARK CONSISTS OF STANDARD CHARACTERS WITHOUT CLAIM TO ANY PARTICULAR FONT, STYLE, SIZE, OR COLOR.

THE FOREIGN WORDING IN THE MARK TRANSLATES INTO ENGLISH AS "SOLAR."

CLASS 2—PAINTS

FOR PAINTS FOR ARTS AND CRAFTS. (U.S. CLS. 6, 11 AND 16).

CLASS 16—PAPER GOODS AND PRINTED MATTER

FOR HOBBY AND CRAFT SUPPLIES, NAMELY, PAINT KITS, PAINT BRUSHES, CHALK, CHALK ERASERS, PENCILS, MARKERS, OIL PASTELS, MODELING CLAYS, SCULPTING MATERIAL, NAMELY, MODELING COMPOUND, CRAYONS, AND GLUES. (U.S. CLS. 2, 5, 22, 23, 29, 37, 38 AND 50).

CLASS 21—HOUSEWARES AND GLASS

FOR PLASTIC CUPS AND PLASTIC BOTTLES, SOLD EMPTY, FOR USE IN ARTS AND CRAFTS PROJECTS (U.S. CLS. 2, 13, 23, 29, 30, 33, 40 AND 50).

CLASS 25—CLOTHING

FOR PAINT SMOCKS AND APRONS. (U.S. CLS. 22 AND 39).

CLASS 28—TOYS AND SPORTING GOODS

FOR TOY MODEL HOBBY CRAFT KITS. (U.S. CLS. 22, 23, 38 AND 50).
MARK SPARACINO, EXAMINING ATTORNEY

SN 78-926,230. PIDILITE USA, INC., HAZELTON, PA. FILED 7-10-2006.



NO CLAIM IS MADE TO THE EXCLUSIVE RIGHT TO USE "HOBBY", APART FROM THE MARK AS SHOWN.

THE COLOR(S) RED, PASTEL RED, PASTEL ORANGE, PASTEL ORANGE, PASTEL YELLOW AND BLACK IS/ARE CLAIMED AS A FEATURE OF THE MARK.

THE MARK CONSISTS OF A GROUPING OF ADJACENT AND OVERLAPPING GEOMETRIC SHAPES, OF WHICH FOUR ARE QUADRILATERALS AND THREE ARE OVALS; THE THREE OVALS ARE RED AND ARE OF DIMINISHING SIZE AND ONLY THE LARGEST OVAL OVERLAPS A QUADRILATERAL AND THE TWO SMALLER OVALS ARE SPACED ABOVE AND TO THE RIGHT OF THE LARGEST OVAL; THE WORDS "HOBBY IDEAS" ARE IN BLACK STYLIZED SCRIPT AND ARE SUPERIMPOSED OVER AND CENTERED WITHIN THE CENTER GROUPING OF SHAPES; THE LEFTMOST QUADRILATERAL IS PASTEL RED, THE CENTER QUADRILATERAL IS PASTEL ORANGE, THE RIGHTMOST ONE IS PASTEL YELLOW, AND AN ELONGATED QUADRILATERAL THAT SEEMS TO UNDERLINE THE LITERAL ELEMENT IS RED.

CLASS 35—ADVERTISING AND BUSINESS

FOR RETAIL STORE SERVICES FEATURING HOBBY AND ART SUPPLIES, HOME DECOR ITEMS, ARTIFICIAL FLOWERS, AND PARTY, SEASONAL, AND HOLIDAY MERCHANDISE (U.S. CLS. 100, 101 AND 102).

CLASS 41—EDUCATION AND ENTERTAINMENT

FOR WORKSHOPS IN THE FIELD OF ARTS AND CRAFTS (U.S. CLS. 100, 101 AND 107).
MARK SPARACINO, EXAMINING ATTORNEY

SN 78-928,438. MCGUIRE, MAXWELL F, PORTLAND, OR. FILED 7-13-2006.

ECOTruth

THE MARK CONSISTS OF STANDARD CHARACTERS WITHOUT CLAIM TO ANY PARTICULAR FONT, STYLE, SIZE, OR COLOR.

CLASS 16—PAPER GOODS AND PRINTED MATTER

FOR PRINTED EDUCATION AND INFORMATION MATERIALS, NAMELY, BOOKS, BROCHURES AND NEWSLETTERS, IN THE FIELD OF ENVIRONMENTAL SUSTAINABILITY AND ECONOMICS (U.S. CLS. 2, 5, 22, 23, 29, 37, 38 AND 50).

CLASS 42—SCIENTIFIC AND COMPUTER SERVICES

FOR PROVIDING INFORMATION ON-LINE IN THE FIELD OF ENVIRONMENTAL SCIENCE AND SUSTAINABILITY (U.S. CLS. 100 AND 101).
KATHERINE CHANG, EXAMINING ATTORNEY

SN 78-929,333. POLYTEX ENVIRONMENTAL INKS LTD., BRONX, NY. FILED 7-13-2006.

AquaPuff

THE MARK CONSISTS OF STANDARD CHARACTERS WITHOUT CLAIM TO ANY PARTICULAR FONT, STYLE, SIZE, OR COLOR.

CLASS 1—CHEMICALS

FOR CHEMICAL AGENTS FOR IMPREGNATING, BINDING OR COATING OF TEXTILES, FURS AND LEATHER, NON-WOVENS AND FABRICS, IN THE NATURE OF COATINGS WITH EXPANDABLE QUALITIES THAT PRODUCE A TACTILE SOFT TOUCH AND NON-SKID FINISH, USED IN INDUSTRY; POLYMER COATING AGENTS FOR PAPER AND NON-WOVENS IN THE NATURE OF COATINGS WITH EXPANDABLE QUALITIES THAT PRODUCE A RAISED TACTILE SOFT TOUCH AND NON-SKID FINISH WITH INSULATING QUALITIES USED IN INDUSTRY FOR DECORATIVE AND FUNCTIONAL APPLICATIONS (U.S. CLS. 1, 5, 6, 10, 26 AND 46).

FIRST USE 1-1-2005; IN COMMERCE 1-1-2005.

CLASS 2—PAINTS

FOR PRINTING INKS WITH EXPANDABLE TACTILE QUALITIES FOR USE IN DECORATIVE AND FUNCTIONAL APPLICATIONS (U.S. CLS. 6, 11 AND 16).
FIRST USE 1-1-2005; IN COMMERCE 1-1-2005.
KATHERINE CONNOLLY, EXAMINING ATTORNEY

SN 78-932,085. KSIN LUXEMBOURG III, S.AR.L., L-1628, LUXEMBOURG, FILED 7-18-2006.



OWNER OF U.S. REG. NOS. 118,709, 787,684 AND OTHERS.

CLASS 7—MACHINERY

FOR SEWING MACHINES AND PARTS THEREFORE; ACCESSORIES TO SEWING MACHINES, NAMELY, MACHINE CONTROLS, PRESSER FEET AND PERIPHERAL UNITS ATTACHABLE TO SEWING MACHINES (U.S. CLS. 13, 19, 21, 23, 31, 34 AND 35).

CLASS 26—FANCY GOODS

FOR SEWING MACHINE NEEDLES (U.S. CLS. 37, 39, 40, 42 AND 50).
SUSAN RICHARDS, EXAMINING ATTORNEY

SN 78-932,183. RODNEY ROONEY PRODUCTIONS, INC., COSTA MESA, CA. FILED 7-18-2006.

INSTA-BUY

THE MARK CONSISTS OF STANDARD CHARACTERS WITHOUT CLAIM TO ANY PARTICULAR FONT, STYLE, SIZE, OR COLOR.

CLASS 9—ELECTRICAL AND SCIENTIFIC APPARATUS

FOR SOFTWARE AND VIDEO PLAYERS FOR ALLOWING SIMULTANEOUS BROADCASTS OF CONTENT WHILE SIMULTANEOUSLY ENABLING CONSUMERS TO MAKE TRANSACTIONS, PURCHASES, AND RESERVATIONS ON-LINE OR BY CELL PHONE (U.S. CLS. 21, 23, 26, 36 AND 38).

CLASS 35—ADVERTISING AND BUSINESS

FOR ON-LINE MARKETING AND RETAIL STORE SERVICES, NAMELY, PROVIDING VIDEO PLAYER UNITS CAPABLE OF SIMULTANEOUSLY DISPLAYING VIDEO SEGMENTS, COMMERCIALS, SHOWS, FILMED PROGRAMMING, AND ADVERTISING WHILE ALSO OFFERING INFORMATION ABOUT THE DISPLAYED MATERIALS ON-LINE OR BY CELL PHONE AND OFFERING TRANSACTIONAL SERVICES, NAMELY, MAKING TRANSACTIONS, PURCHASES, AND RESERVATIONS IN RELATION TO THE DISPLAYED MATERIALS AVAILABLE ON-LINE OR VIA CELL PHONE (U.S. CLS. 100, 101 AND 102).
JAMES A. RAUEN, EXAMINING ATTORNEY

SN 78-932,246. KSIN LUXEMBOURG III, S.AR.L., L-1628, LUXEMBOURG, FILED 7-18-2006.



OWNER OF U.S. REG. NOS. 118,709, 787,684 AND OTHERS.

CLASS 7—MACHINERY

FOR SEWING MACHINES AND PARTS THEREFORE; ACCESSORIES TO SEWING MACHINES, NAMELY, MACHINE CONTROLS, PRESSER FEET AND PERIPHERAL UNITS ATTACHABLE TO SEWING MACHINES (U.S. CLS. 13, 19, 21, 23, 31, 34 AND 35).

CLASS 26—FANCY GOODS

FOR SEWING MACHINE NEEDLES (U.S. CLS. 37, 39, 40, 42 AND 50).
SUSAN RICHARDS, EXAMINING ATTORNEY

SN 78-933,303. THILKEN, WILLIAM ANTHONY, CAPISTRANO BEACH, CA. FILED 7-19-2006.

JILL DON'T NEED JACK

THE MARK CONSISTS OF STANDARD CHARACTERS WITHOUT CLAIM TO ANY PARTICULAR FONT, STYLE, SIZE, OR COLOR.

CLASS 8—HAND TOOLS

FOR HAND TOOLS, NAMELY, MANUALLY OPERATED TOOLS AND ATTACHMENTS THEREFORE, NAMELY, HAMMERS, PLIERS, SCREWDRIVERS, WRENCHES, CHANNEL LOCKS, LUG WRENCHES, SPRING CLAMPS, DRAIN AUGERS, STUD FINGERS, AND BAR CLAMPS, SQUARES, TOOL HOLSTERS, TOOL HOLDERS, TOOL HOLDERS IN THE NATURE OF WORK APRONS; TOOL BELTS, PUNCHES, CLAMPS, C-CLAMPS, V-BLOCKS, V-BLOCKS AND C-CLAMP SETS, MAULS, UTILITY KNIVES AND BLADES, HATCHETS, SLEDGES, SPLITTING WEDGES, NAIL PULLERS AND BARS, CROW BARS, WRECKING BARS, MATTOCKS, LOPPING SHEARS, PUNCHES, TIN SNIPS, SHAPING PLANES, FILES, SHAPING FILES, ROUND SHAPING FILES, TAP AND DIE SETS, TOTE SHOVELS, SOCKET WRENCHES AND SOCKETS, RATCHET WRENCHES, SPINNER HANDLES FOR SOCKET WRENCHES, EXTENSION BARS, COMBINATION WRENCHES, IGNITION WRENCHES, HEX KEYS WRENCHES, SAWS, WOOD SAWS, HACKSAWS AND CRIMPING TOOLS; NAIL APRONS (U.S. CLS. 23, 28 AND 44).

CLASS 25—CLOTHING

FOR CLOTHING AND WEARING APPAREL, NAMELY, SHIRTS, T-SHIRTS, CAPS, HATS, HEAD WEAR, OVERALLS, WORK SHIRTS, COVERALLS, JEANS, WORKPANTS, COATS, JACKETS, VESTS, T-SHIRTS, FLEECE TOPS AND WOVEN SHIRTS, FOOTWEAR, AND APRONS (U.S. CLS. 22 AND 39).
PRISCILLA MILTON, EXAMINING ATTORNEY

SN 78-933,648. ORGANON USA INC., ROSELAND, NJ.
FILED 7-20-2006.

ORGANON BIOSCIENCES

THE MARK CONSISTS OF STANDARD CHARACTERS WITHOUT CLAIM TO ANY PARTICULAR FONT, STYLE, SIZE, OR COLOR.

OWNER OF U.S. REG. NO. 709,884.

NO CLAIM IS MADE TO THE EXCLUSIVE RIGHT TO USE "BIOSCIENCES", APART FROM THE MARK AS SHOWN.

CLASS 5—PHARMACEUTICALS

FOR A FULL LINE OF PHARMACEUTICAL PREPARATIONS FOR VETERINARY USE IN THE TREATMENT OF LIVESTOCK, DOMESTIC PETS, FISH AND SHELLFISH, AND FEED ADDITIVES (U.S. CLS. 6, 18, 44, 46, 51 AND 52).

CLASS 10—MEDICAL APPARATUS

FOR MEDICAL INSTRUMENTS AND APPARATUS FOR VETERINARY USE, NAMELY, INJECTING EQUIPMENT FOR VETERINARY PHARMACEUTICALS AND PREPARATIONS (U.S. CLS. 26, 39 AND 44).

CLASS 44—MEDICAL, BEAUTY AND AGRICULTURAL SERVICES

FOR VETERINARY SERVICES (U.S. CLS. 100 AND 101).
RON FAIRBANKS, EXAMINING ATTORNEY

SN 78-933,782. BRUNDERMAN, PAMELA J., WHITE PLAINS, NY. FILED 7-20-2006.

MAKING ROOMS WORK

THE MARK CONSISTS OF STANDARD CHARACTERS WITHOUT CLAIM TO ANY PARTICULAR FONT, STYLE, SIZE, OR COLOR.

CLASS 35—ADVERTISING AND BUSINESS

FOR PROVIDING ORGANIZING SERVICES FOR BELONGINGS AND SPACES IN AN OFFICE SUCH AS FURNITURE, PAPERS AND TIME; PROVIDING ORGANIZING SERVICES FOR INDIVIDUALS AT HOME, IN HOME OFFICES AND IN BUSINESS OFFICES, THAT PROVIDES HELP WITH TIME AND PAPER MANAGEMENT (U.S. CLS. 100, 101 AND 102).

CLASS 41—EDUCATION AND ENTERTAINMENT

FOR EDUCATIONAL AND INSTRUCTIONAL SERVICES, NAMELY, ARRANGING AND CONDUCTING SEMINARS, CONFERENCES, WORKSHOPS, AND LECTURES FEATURING INTERIOR DESIGN AND INTERIOR DECORATION AND HOME AND OFFICE ORGANIZING; ENTERTAINMENT SERVICES, NAMELY, THE PRESENTATION OF LIVE SPEAKING PERFORMANCES BY INTERIOR DESIGNERS ON INTERIOR DECORATION, AND HOME AND OFFICE ORGANIZATION; EDUCATIONAL AND ENTERTAINMENT SERVICES, NAMELY, PROVIDING EDUCATIONAL SPEAKERS ON INTERIOR DESIGN AND INTERIOR DECORATION, AND HOME AND OFFICE ORGANIZING (U.S. CLS. 100, 101 AND 107).

CLASS 42—SCIENTIFIC AND COMPUTER SERVICES

FOR INTERIOR DESIGN AND INTERIOR DECORATION CONSULTATION FOR HOME AND OFFICE; FURNITURE DESIGN; FENG SHUI CONSULTATION; INTERIOR DECORATION CONSULTATION IN THE FIELD OF FURNITURE (U.S. CLS. 100 AND 101).

CLASS 45—PERSONAL AND LEGAL SERVICES

FOR ORGANIZATIONAL SERVICES FOR HOME OR PERSONAL PURPOSES, NAMELY, ORGANIZING ATTIC, BASEMENT, CLOSET AND GARAGE SPACE, PERSONAL SCHEDULES; PROVIDING INFORMATION IN THE FIELD OF TIME MANAGEMENT TO INDIVIDUALS FOR PERSONAL PURPOSES (U.S. CLS. 100 AND 101).
SKYE YOUNG, EXAMINING ATTORNEY

SN 78-933,847. LAVIPHARM GROUP HOLDING S.A., LUXEMBOURG, LUXEMBOURG, FILED 7-20-2006.

SN 78-934,814. ROYSONS CORPORATION, ROCKAWAY, NJ, FILED 7-21-2006.

MEDITERRANEAN CHOICES

THE MARK CONSISTS OF STANDARD CHARACTERS WITHOUT CLAIM TO ANY PARTICULAR FONT, STYLE, SIZE, OR COLOR.

NO CLAIM IS MADE TO THE EXCLUSIVE RIGHT TO USE "MEDITERRANEAN", APART FROM THE MARK AS SHOWN.

CLASS 3—COSMETICS AND CLEANING PREPARATIONS

FOR COSMETICS, SOAPS FOR PERSONAL USE, FRAGRANCES FOR PERSONAL USE (U.S. CLS. 1, 4, 6, 50, 51 AND 52).

CLASS 5—PHARMACEUTICALS

FOR HERBAL SUPPLEMENTS, VITAMINS, DIETARY SUPPLEMENTS, AND DIETARY FOOD SUPPLEMENTS FOR WEIGHT LOSS PURPOSES (U.S. CLS. 6, 18, 44, 46, 51 AND 52).

PETER B. BROMAGHIM, EXAMINING ATTORNEY

SN 78-934,325. BOWEN, ADAM, SAN FRANCISCO, CA. AND MONSEES, JAMES, SAN FRANCISCO, CA. FILED 7-20-2006.

PLOOM

THE MARK CONSISTS OF STANDARD CHARACTERS WITHOUT CLAIM TO ANY PARTICULAR FONT, STYLE, SIZE, OR COLOR.

THE WORDING "PLOOM" HAS NO MEANING IN A FOREIGN LANGUAGE.

CLASS 11—ENVIRONMENTAL CONTROL APPARATUS

FOR ELECTRIC VAPORIZERS FOR THE VAPORIZATION OF TOBACCO (U.S. CLS. 13, 21, 23, 31 AND 34).

CLASS 31—NATURAL AGRICULTURAL PRODUCTS

FOR UNPROCESSED TOBACCO PODS (U.S. CLS. 1 AND 46).

CLASS 34—SMOKERS' ARTICLES

FOR COMPRESSED TOBACCO; SMOKELESS TOBACCO; TOBACCO; SMOKING PIPES NOT OF PRECIOUS METAL; CIGARETTES; PRESSURIZED TOBACCO; PROCESSED TOBACCO PODS; CIGARETTE HOLDERS NOT OF PRECIOUS METAL (U.S. CLS. 2, 8, 9 AND 17).

SHARON MEIER, EXAMINING ATTORNEY

DREAM IT ... PRINT IT ... HANG IT

THE MARK CONSISTS OF STANDARD CHARACTERS WITHOUT CLAIM TO ANY PARTICULAR FONT, STYLE, SIZE, OR COLOR.

CLASS 16—PAPER GOODS AND PRINTED MATTER

FOR PAPER OR PAPER COATED WITH VINYL PLASTIC FOR USE AS WALL COVERINGS AND PRINTING FOUNDATIONS; PRINTED PAPER SIGNAGE FOUNDATIONS AND PRINTED PAPER BANNER FOUNDATIONS (U.S. CLS. 2, 5, 22, 23, 29, 37, 38 AND 50).

CLASS 17—RUBBER GOODS

FOR VINYL SUBSTRATES FOR USE AS WALL COVERINGS AND PRINTING FOUNDATIONS (U.S. CLS. 1, 5, 12, 13, 35 AND 50).

CLASS 24—FABRICS

FOR WOVEN AND NON-WOVEN FABRIC FOR USE AS WALL COVERINGS AND PRINTING FOUNDATIONS (U.S. CLS. 42 AND 50).

ANNE E. GUSTASON, EXAMINING ATTORNEY

SN 78-936,170. BIOCOL-LABORATORIOS FARMACO E COSMETICO, LDA, ALCABIDECHÉ, PORTUGAL, FILED 7-24-2006.

SACIE SLIM

THE MARK CONSISTS OF STANDARD CHARACTERS WITHOUT CLAIM TO ANY PARTICULAR FONT, STYLE, SIZE, OR COLOR.

"SACIE" HAS NO MEANING IN A FOREIGN LANGUAGE.

CLASS 1—CHEMICALS

FOR FATTY ACIDS FOR USE AS A FOOD ADDITIVE (U.S. CLS. 1, 5, 6, 10, 26 AND 46).

CLASS 5—PHARMACEUTICALS

FOR CAPSULES AND PILLS FOR PROMOTING WEIGHT LOSS; PILLS AND CAPSULES USED AS A DIETARY SUPPLEMENT; MINERALS AND VITAMINS; DIETARY SOY SUPPLEMENTS; DRINK MIXES USED AS A MEAL REPLACEMENT FOR PEOPLE WITH SPECIFIC DIETARY NEEDS; MEDICINAL TEAS AND MEDICINAL HERBAL INFUSIONS; VITAMINS AND MINERALS IN POWDER FORM FOR DIETARY FOOD SUPPLEMENTS; FATTY ACIDS IN LIQUID OR CAPSULE FOR PROMOTING WEIGHT LOSS; NUTRITIONAL FOOD SUPPLEMENTS FROM FATTY ACIDS; CEREAL-BASED MEAL REPLACEMENT BARS; CARBOHYDRATE AND DIETARY FIBER-BASED NUTRITIONAL SUPPLEMENTS AND DIETARY FOOD; MALTED MILK BEVERAGES FOR MEDICAL PURPOSES; MEAL REPLACEMENT SHAKES; DIETARY FIBER BASED NUTRITIONAL SUPPLEMENTS; DIETARY FOOD; GRAPE SEED OIL (U.S. CLS. 6, 18, 44, 46, 51 AND 52).

CLASS 29—MEATS AND PROCESSED FOODS

FOR MILK-BASED DRINKS AND PREPARATIONS AND POWDERS TO MAKE THOSE DRINKS; MILK; MILK POWDERS; PROTEIN FOR USE AS A FOOD ADDITIVE; PROTEINS BEING FOODSTUFFS FOR HUMAN CONSUMPTION; PROTEIN FOR USE AS A FOOD FILLER; PROCESSED BEE POLLEN FOR FOOD PURPOSES; VEGETABLE FAT; EDIBLE FATS (U.S. CL. 46).

CLASS 30—STAPLE FOODS

FOR YEAST IN PILL FORM; SOYA FLOUR; PROCESSED CEREAL CONTAINING FLOUR (U.S. CL. 46).
ESTHER A. BORSUK, EXAMINING ATTORNEY

SN 78-937,834. ROMET LIMITED, MISSISSAUGA, CANADA,
FILED 7-26-2006.

ROMET

THE MARK CONSISTS OF STANDARD CHARACTERS WITHOUT CLAIM TO ANY PARTICULAR FONT, STYLE, SIZE, OR COLOR.

CLASS 9—ELECTRICAL AND SCIENTIFIC APPARATUS

FOR MECHANICAL AND ELECTRONIC POSITIVE DISPLACEMENT ROTARY METERS, AND PARTS THEREFOR, FOR MEASURING THE VOLUME OF NATURAL GAS, HYDROCARBONS OR AIR; ELECTRONIC VOLUME CORRECTORS, AND PARTS THEREFOR, FOR CORRECTING VOLUME MEASUREMENTS OF GAS, HYDROCARBONS OR AIR; AND DYNAMIC SIMULATORS, AND PARTS THEREFOR, FOR ELECTRONICALLY SIMULATING A FLOW OF NATURAL GAS, HYDROCARBONS, OR AIR (U.S. CLS. 21, 23, 26, 36 AND 38).

FIRST USE 12-31-1980; IN COMMERCE 12-31-1980.

CLASS 40—MATERIAL TREATMENT

FOR CUSTOM MANUFACTURE OF METERS, MODULES AND ELECTRONIC VOLUME CORRECTORS FOR NATURAL GAS, HYDROCARBONS OR AIR, AND AUXILIARY PRODUCTS AND TEST EQUIPMENT FOR METERS, MODULES AND ELECTRONIC VOLUME CORRECTORS; CONTRACT MANUFACTURING IN THE NATURE OF APPLYING ANODIZING AND CHROMATE CONVERSION FINISHES (U.S. CLS. 100, 103 AND 106).

FIRST USE 12-31-1980; IN COMMERCE 12-31-1980.

MICHAEL SOUDERS, EXAMINING ATTORNEY

SN 78-937,837. ROMET LIMITED, MISSISSAUGA, CANADA,
FILED 7-26-2006.

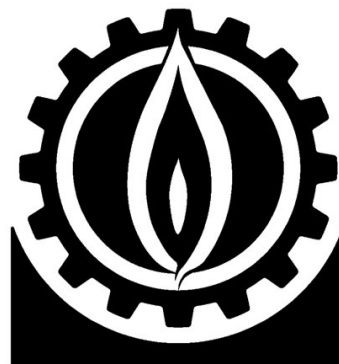

THE MARK CONSISTS OF A FLAME WITHIN A CIRCULAR GEAR.

CLASS 9—ELECTRICAL AND SCIENTIFIC APPARATUS

FOR MECHANICAL AND ELECTRONIC POSITIVE DISPLACEMENT ROTARY METERS, AND PARTS THEREFOR, FOR MEASURING THE VOLUME OF NATURAL GAS, HYDROCARBONS OR AIR; ELECTRONIC VOLUME CORRECTORS, AND PARTS THEREFOR, FOR CORRECTING VOLUME MEASUREMENTS OF GAS, HYDROCARBONS OR AIR; AND DYNAMIC SIMULATORS, AND PARTS THEREFOR, FOR ELECTRONICALLY SIMULATING A FLOW OF NATURAL GAS, HYDROCARBONS, OR AIR (U.S. CLS. 21, 23, 26, 36 AND 38).

FIRST USE 12-31-1980; IN COMMERCE 12-31-1980.

CLASS 40—MATERIAL TREATMENT

FOR CUSTOM MANUFACTURE OF METERS, MODULES AND ELECTRONIC VOLUME CORRECTORS FOR NATURAL GAS, HYDROCARBONS OR AIR, AND AUXILIARY PRODUCTS AND TEST EQUIPMENT FOR METERS, MODULES AND ELECTRONIC VOLUME CORRECTORS; CONTRACT MANUFACTURING IN THE NATURE OF APPLYING ANODIZING AND CHROMATE CONVERSION FINISHES (U.S. CLS. 100, 103 AND 106).

FIRST USE 12-31-1980; IN COMMERCE 12-31-1980.

MICHAEL SOUDERS, EXAMINING ATTORNEY

SN 78-937,891. RUSSO, ROGER A., POMONA, NY. FILED 7-26-2006.



NO CLAIM IS MADE TO THE EXCLUSIVE RIGHT TO USE "SENIORS", APART FROM THE MARK AS SHOWN.

THE MARK CONSISTS OF THE WORDING "STAY FIT SENIORS" ON TWO LINES WITH A COMMON LARGE "S" SHARED BY "STAY" AND "SENIORS" WITH TWO STYLIZED AND SHADED FIGURES IN THE UPPER RIGHT CORNER OF THE MARK.

CLASS 35—ADVERTISING AND BUSINESS

FOR BUSINESS MANAGEMENT, BILLING AND MARKETING PROGRAM FOR CHIROPRACTIC AND HEALTH CARE SERVICES; RETAIL AND WHOLESALE STORE SERVICES IN THE FIELD OF HEALTH CARE PRODUCTS AND HEALTH CARE PRINTED MATERIALS; FRANCHISING, NAMELY, OFFERING TECHNICAL ASSISTANCE IN THE ESTABLISHMENT AND/OR OPERATION OF PAIN TREATMENT AND CHIROPRACTIC CLINICS, AND BUSINESS CONSULTATION SERVICES RELATED THERETO (U.S. CLS. 100, 101 AND 102).

CLASS 44—MEDICAL, BEAUTY AND AGRICULTURAL SERVICES

FOR CHIROPRACTIC CONSULTATION SERVICES; CHIROPRACTIC AND HEALTH CARE SERVICES; PHYSICAL THERAPY; MASSAGE THERAPY (U.S. CLS. 100 AND 101).

ALICE SUE CARRUTHERS, EXAMINING ATTORNEY

SN 78-938,257. BIOCOL-LABORATORIOS FARMACO E COSMETICO, LDA, ALCABIDECHÉ, PORTUGAL, FILED 7-26-2006.

DRENAFAST

THE MARK CONSISTS OF STANDARD CHARACTERS WITHOUT CLAIM TO ANY PARTICULAR FONT, STYLE, SIZE, OR COLOR.

CLASS 1—CHEMICALS

FOR FATTY ACIDS FOR USE AS A FOOD ADDITIVE (U.S. CLS. 1, 5, 6, 10, 26 AND 46).

CLASS 5—PHARMACEUTICALS

FOR CAPSULES AND PILLS FOR PROMOTING WEIGHT LOSS; PILLS AND CAPSULES USED AS A DIETARY SUPPLEMENT; MINERALS AND VITAMINS; DIETARY SOY SUPPLEMENTS; DRINK MIXES USED AS A MEAL REPLACEMENT FOR PEOPLE WITH SPECIFIC DIETARY NEEDS; MEDICINAL TEAS AND MEDICINAL HERBAL INFUSIONS; VITAMINS AND MINERALS IN POWDER FORM FOR DIETARY FOOD SUPPLEMENTS; FATTY ACIDS IN LIQUID OR CAPSULE FOR PROMOTING WEIGHT LOSS; NUTRITIONAL FOOD SUPPLEMENTS FROM FATTY ACIDS; CEREAL-BASED MEAL REPLACEMENT BARS; CARBOHYDRATE AND DIETARY FIBER-BASED NUTRITIONAL SUPPLEMENTS AND DIETARY FOOD; MALTED MILK BEVERAGES FOR MEDICAL PURPOSES; MEAL REPLACEMENT SHAKES; DIETARY FIBER BASED NUTRITIONAL SUPPLEMENTS; DIETARY FOOD; GRAPE SEED OIL (U.S. CLS. 6, 18, 44, 46, 51 AND 52).

CLASS 29—MEATS AND PROCESSED FOODS

FOR MILK-BASED DRINKS AND PREPARATIONS AND POWDERS TO MAKE THOSE DRINKS; MILK; MILK POWDERS; PROTEIN FOR USE AS A FOOD ADDITIVE; PROTEINS BEING FOODSTUFFS FOR HUMAN CONSUMPTION; PROTEIN FOR USE AS A FOOD FILLER; PROCESSED BEE POLLEN FOR FOOD PURPOSES; VEGETABLE FAT; EDIBLE FATS (U.S. CL. 46).

CLASS 30—STAPLE FOODS

FOR YEAST IN PILL FORM; SOYA FLOUR; PROCESSED CEREAL CONTAINING FLOUR (U.S. CL. 46).
ESTHER A. BORSUK, EXAMINING ATTORNEY

SN 78-939,707. PORTAGA INC., WHITE PLAINS, NY. FILED 7-28-2006.

TRIPSYNC

THE MARK CONSISTS OF STANDARD CHARACTERS WITHOUT CLAIM TO ANY PARTICULAR FONT, STYLE, SIZE, OR COLOR.

CLASS 9—ELECTRICAL AND SCIENTIFIC APPARATUS

FOR COMPUTER SOFTWARE FOR USE TO PLAN TRAVELS (U.S. CLS. 21, 23, 26, 36 AND 38).
FIRST USE 7-26-2006; IN COMMERCE 7-26-2006.

CLASS 39—TRANSPORTATION AND STORAGE

FOR TRAVEL AGENCY SERVICES, NAMELY, MAKING RESERVATIONS AND BOOKINGS FOR TRANSPORTATION (U.S. CLS. 100 AND 105).
FIRST USE 7-26-2006; IN COMMERCE 7-26-2006.
GIANCARLO CASTRO, EXAMINING ATTORNEY

SN 78-939,817. RICHARDSON COMPANY, PHILADELPHIA, PA. FILED 7-28-2006.

THE RICHARDSON COMPANY

THE MARK CONSISTS OF STANDARD CHARACTERS WITHOUT CLAIM TO ANY PARTICULAR FONT, STYLE, SIZE, OR COLOR.

OWNER OF U.S. REG. NO. 3,312,525.
NO CLAIM IS MADE TO THE EXCLUSIVE RIGHT TO USE "COMPANY", APART FROM THE MARK AS SHOWN. SEC. 2(F).

CLASS 16—PAPER GOODS AND PRINTED MATTER

FOR PRINTED NEWSLETTERS, EDUCATIONAL MATERIALS, AND PERIODICALS ALL IN THE FIELD OF SALES AND SALES TECHNIQUES (U.S. CLS. 2, 5, 22, 23, 29, 37, 38 AND 50).

FIRST USE 2-1-1986; IN COMMERCE 2-1-1986.

CLASS 41—EDUCATION AND ENTERTAINMENT

FOR EDUCATIONAL SERVICES, NAMELY, PROVIDING CLASSES, SEMINARS, CONFERENCES, AND WORKSHOPS IN THE FIELD OF SALES AND SALES TECHNIQUES AND DISTRIBUTING COURSE MATERIALS IN CONNECTION THEREWITH; EDUCATIONAL SERVICES, NAMELY, PROVIDING DISTANCE LEARNING INSTRUCTION IN THE FIELD OF SALES AND SALES TECHNIQUES AND DISTRIBUTING COURSE MATERIALS (U.S. CLS. 100, 101 AND 107).

FIRST USE 2-1-1986; IN COMMERCE 2-1-1986.

JANICE L. MCMORROW, EXAMINING ATTORNEY

SN 78-941,367. ESPN, INC., BRISTOL, CT. FILED 7-31-2006.

EXPN

THE MARK CONSISTS OF STANDARD CHARACTERS WITHOUT CLAIM TO ANY PARTICULAR FONT, STYLE, SIZE, OR COLOR.

OWNER OF U.S. REG. NOS. 1,437,972, 2,724,603 AND OTHERS.

CLASS 18—LEATHER GOODS

FOR LUGGAGE, FANNY PACKS, ALL-PURPOSE ATHLETIC BAGS, SPORTS BAGS, BACKPACKS, DUFFLE BAGS, TOTE BAGS, TRAVELING BAGS, GARMENT BAGS, TOTE BAGS, OVERNIGHT BAGS, HANDBAGS, SHOULDER BAGS, ATTACHE CASES, BRIEFCASES, BEACH BAGS, BOOK BAGS, MESSENGER BAGS, COSMETIC BAGS SOLD EMPTY (U.S. CLS. 1, 2, 3, 22 AND 41).

CLASS 25—CLOTHING

FOR CLOTHING, NAMELY, SHIRTS, BLOUSES, SWEATERS, CARDIGANS, TURTLENECKS, VESTS, SWEAT SHIRTS, TANK TOPS, JERSEYS, BASEBALL SHIRTS, GOLF SHIRTS, JOGGING SHIRTS, SKIRTS, SHORTS, GYM SHORTS, TENNIS SHORTS, JEANS, PANTS, WORK PANTS, TROUSERS, SLACKS, TUNICS, DRESSES, JUMPERS, SUITS, SUN SUITS, COVER-ALLS, OVERALLS, SWEAT PANTS, SWEAT SUITS, WARM-UP SUITS, BLAZERS, GLOVES, MITTENS, SCARVES, COATS, SHAWLS, SKI JACKETS, SKI PANTS, PARKAS, CAPES, PONCHOS, RUNNING SUITS, SMOCKS, JUMP SUITS, RAIN WEAR, UNDERWEAR, LINGERIE, HOSIERY, SOCKS, TIGHTS, LEGGINGS, LEG WARMERS, NECKWEAR NAMELY NECK TIES, HALLOWEEN COSTUMES, MASQUERADE COSTUMES, SLEEPWEAR, ROBES, DRESSING GOWNS, SWIMWEAR, INFANT APPAREL AND FOOTWEAR, NAMELY, SHIRTS, SOCKS, PANTS, CLOTH BIBS, CLOTH DIAPERS, SLEEPERS, SHOES, AND BOOTS, SNOWBOARD PANTS AND SNOWBOARD JACKETS, SKATEBOARD PANTS, SKATEBOARD SHORTS; BELTS, BANDANNAS, NECKBANDS, WRISTBANDS, SUSPENDERS, BEACH WEAR, SHOES, SNEAKERS, ATHLETIC SHOES, BOOTS, SANDALS, SKATEBOARD FOOTWEAR, SLIPPERS, BOOTIES, HATS, BEANIES, HEADBANDS, SWEATBANDS, BANDANNAS, EAR MUFFS, SUN VISORS, BICYCLE GLOVES, SKI BOOTS (U.S. CLS. 22 AND 39).

GENE MACIOL, EXAMINING ATTORNEY

SN 78-941,491. PURELY ENTERPRISES, LLC, KNOXVILLE, TN. FILED 7-31-2006.

Purely UV

THE MARK CONSISTS OF STANDARD CHARACTERS WITHOUT CLAIM TO ANY PARTICULAR FONT, STYLE, SIZE, OR COLOR.

NO CLAIM IS MADE TO THE EXCLUSIVE RIGHT TO USE "UV", APART FROM THE MARK AS SHOWN.

CLASS 10—MEDICAL APPARATUS

FOR MERCURY ARC GERMICIDAL ULTRAVIOLET LAMPS FOR USE IN MEDICAL FACILITIES FOR STERILIZATION AND PURIFICATION (U.S. CLS. 26, 39 AND 44).

FIRST USE 6-20-2006; IN COMMERCE 7-1-2006.

CLASS 11—ENVIRONMENTAL CONTROL APPARATUS

FOR MERCURY ARC GERMICIDAL ULTRAVIOLET LAMPS FOR HOME AND OFFICE USE, INCLUDING USE FOR AQUARIUM PURIFICATION (U.S. CLS. 13, 21, 23, 31 AND 34).

FIRST USE 6-20-2006; IN COMMERCE 7-1-2006.

TINA KUAN, EXAMINING ATTORNEY

SN 78-943,108. GB TOOLS AND SUPPLIES, INC., MILWAU-
KEE, WI. FILED 8-2-2006.

CALTERM

THE MARK CONSISTS OF STANDARD CHARACTERS
WITHOUT CLAIM TO ANY PARTICULAR FONT, STYLE,
SIZE, OR COLOR.

OWNER OF U.S. REG. NO. 1,365,263.

CLASS 8—HAND TOOLS

FOR WIRE STRIPPERS, WIRE CRIMPERS, AND WIRE
CUTTERS (U.S. CLS. 23, 28 AND 44).

FIRST USE 10-25-1973; IN COMMERCE 10-30-1973.

CLASS 9—ELECTRICAL AND SCIENTIFIC APPARATUS

FOR ELECTRICAL EQUIPMENT AND PARTS,
NAMELY, SOLDERLESS CONNECTORS, TEST CLIPS,
INSULATED CLIPS, CHARGING CLIPS, CONNECTORS,
WIRE JOINTS, FUSE HOLDERS, LINE TAPS, WIRE
SPLICES, CABLES, TIES, HEAT SHRINK TUBING TO
REPAIR AND INSULATE ELECTRICAL WIRES, FLEX-
IBLE TUBING AND WRAP TO HOLD AND PROTECT
ELECTRICAL WIRES, BOX CONNECTORS, SOCKETS,
VOLTAGE REGULATORS, CIRCUIT BREAKERS AND
TESTERS, GROUND CLIPS, CLAMPS, WIRE, RELAYS,
PREINSULATED TERMINALS, SPLICES, RINGS,
SPADES AND DISCONNECTS FOR WIRE GAUGES;
SWITCHES AND SWITCH PANELS; BATTERY ACCE-
SORIES, NAMELY, TERMINALS, POSTS, BATTERY
ANALYZERS, RINGS, BOOSTER CLIPS, CHARGERS,
MOUNTINGS AND TESTERS; FUSE BLOCKS,
HOLDERS AND TAPS (U.S. CLS. 21, 23, 26, 36 AND 38).

FIRST USE 10-25-1973; IN COMMERCE 10-30-1973.

CLASS 17—RUBBER GOODS

FOR ELECTRICAL TAPE (U.S. CLS. 1, 5, 12, 13, 35
AND 50).

FIRST USE 10-25-1973; IN COMMERCE 10-30-1973.
SKYE YOUNG, EXAMINING ATTORNEY

SN 78-943,737. PÖPPELMANN HOLDING GMBH & CO. KG,
LOHNE, FED REP GERMANY, FILED 8-3-2006.

TEKUVISION

THE MARK CONSISTS OF STANDARD CHARACTERS
WITHOUT CLAIM TO ANY PARTICULAR FONT, STYLE,
SIZE, OR COLOR.

PRIORITY CLAIMED UNDER SEC. 44(D) ON ERP
CMNTY TM OFC APPLICATION NO. 005217021, FILED 7-
24-2006, REG. NO. 005217021, DATED 5-8-2007, EXPIRES 7-24-
2016.

CLASS 20—FURNITURE AND ARTICLES NOT OTHERWISE CLASSIFIED

FOR PLASTIC PACKING CONTAINERS; PLASTIC
TRANSPORT PALLETS, ESPECIALLY FOR CULTIVA-
TION, TRANSPORTATION AND STORAGE OF PLANTS;
PLASTIC STANDS FOR FLOWER POTS; PLASTIC
PLANT CULTIVATION AND TRANSPORT PLATTERS
(U.S. CLS. 2, 13, 22, 25, 32 AND 50).

CLASS 21—HOUSEWARES AND GLASS

FOR FLOWER POTS, PLANT POTS, PLANT CON-
TAINERS, PLANTERS AND COASTERS OUT OF PLAS-
TIC (U.S. CLS. 2, 13, 23, 29, 30, 33, 40 AND 50).

CLASS 40—MATERIAL TREATMENT

FOR CUSTOM PRESSWORK ON PLASTIC PRO-
DUCTS, NAMELY, IMPRINTING PLASTIC PRODUCTS
FROM PATTERNS (U.S. CLS. 100, 103 AND 106).

MATTHEW PAPPAS, EXAMINING ATTORNEY

SN 78-944,060. DIVERSITECH CORPORATION, DULUTH,
GA. FILED 8-3-2006.

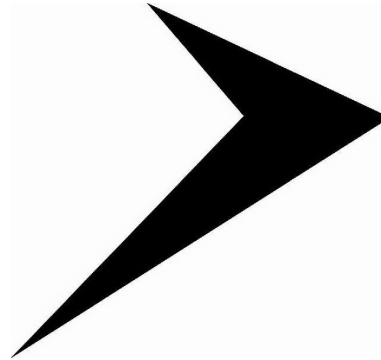

CLASS 1—CHEMICALS

FOR CHEMICALS USED IN HVAC UNITS, NAMELY,
PAN TABLETS, CHEMICAL LEAK DETECTORS AND
REFRIGERATION CHEMICALS (U.S. CLS. 1, 5, 6, 10, 26
AND 46).

FIRST USE 0-0-1992; IN COMMERCE 0-0-1992.

CLASS 3—COSMETICS AND CLEANING PRE- PARATIONS

FOR LIQUID AIR CONDITIONER COIL CLEANER
(U.S. CLS. 1, 4, 6, 50, 51 AND 52).

FIRST USE 0-0-1992; IN COMMERCE 0-0-1992.

CLASS 7—MACHINERY

FOR ELECTRIC MOTORS FOR MACHINES,
NAMELY, FRACTIONAL HORSE POWER ELECTRIC
MOTORS FOR HVAC/R MACHINES; HVAC PARTS
AND COMPONENTS, NAMELY, POWER-OPERATED
PIPE CLEANING GUNS (U.S. CLS. 13, 19, 21, 23, 31, 34
AND 35).

FIRST USE 0-0-2004; IN COMMERCE 0-0-2004.

CLASS 8—HAND TOOLS

FOR MANUALLY-OPERATED TOOLS, NAMELY, FIN
STRAIGHTENING TOOLS (U.S. CLS. 23, 28 AND 44).

FIRST USE 0-0-1998; IN COMMERCE 0-0-1998.

CLASS 9—ELECTRICAL AND SCIENTIFIC APPARATUS

FOR HVAC PARTS AND COMPONENTS, NAMELY, TIME DELAYS, VOLTAGE MONITORS AND HARD START CAPACITOR KITS COMPRISED OF CAPACITOR, POSITIVE TEMPERATURE COEFFICIENT RESISTOR, HOOKUP WARE AND PLASTIC HOUSING; FIBER CEMENT PROTECTIVE FIRE BLANKETS FOR USE ON DECKS, DOCKS AND PATIOS AND IN ASSOCIATION WITH GRILLS, FIREPLACES, FRYERS, FIREPITS, CHIMINEA, FRYERS AND HEATERS FOR USE IN PROTECTING FLOORS; ELECTRONIC DEVICES, NAMELY, ELECTRONIC SENSORS AND INTERRUPTERS TO DETECT THE PRESENCE OF CONDENSATE OVERFLOW WHICH WILL INTERRUPT THE CONTROL CIRCUIT OF AN AIR CONDITIONER, REFRIGERATION UNIT OR WATER COOLING SYSTEM (U.S. CLS. 21, 23, 26, 36 AND 38).

FIRST USE 0-0-2001; IN COMMERCE 0-0-2001.

CLASS 11—ENVIRONMENTAL CONTROL APPARATUS

FOR HVAC PARTS AND COMPONENTS, NAMELY, LINE TAP VALVES, ACCESS VALVES AND COPPER SPUN DRIERS (U.S. CLS. 13, 21, 23, 31 AND 34).

FIRST USE 0-0-1998; IN COMMERCE 0-0-1998.

CLASS 19—NON-METALLIC BUILDING MATERIALS

FOR CONCRETE COATED POLYSTYRENE FOAM BLOCKS (U.S. CLS. 1, 12, 33 AND 50).

FIRST USE 0-0-1992; IN COMMERCE 0-0-1992.

CLASS 35—ADVERTISING AND BUSINESS

FOR DISTRIBUTORSHIP SERVICES RELATED TO THE HVAC/R INDUSTRY FEATURING GRILL PADS AND PROTECTIVE EXTERIOR FLOOR COVERINGS IN THE NATURE OF FIBER CEMENT PROTECTIVE BLANKETS FOR USE ON DECKS, DOCKS AND PATIOS AND IN ASSOCIATION WITH GRILLS, FIREPLACES, FRYERS, FIREPITS, CHIMINEA, FRYERS AND HEATERS, ELECTRIC MOTORS FOR MACHINES, NAMELY, FRACTIONAL HORSE POWER ELECTRIC MOTORS FOR THE HVAC/R INDUSTRY, HVAC PARTS AND COMPONENTS, NAMELY, POWER-OPERATED PIPE CLEANING GUNS, CHEMICALS USED IN HVAC UNITS, NAMELY, PAN TABLETS, CHEMICAL LEAK DETECTORS AND REFRIGERATION CHEMICALS, FIN STRAIGHTENING TOOLS, HVAC PARTS AND COMPONENTS, NAMELY, TIME DELAYS, VOLTAGE MONITORS AND HARD START CAPACITOR KITS COMPRISED OF CAPACITOR, POSITIVE TEMPERATURE COEFFICIENT RESISTOR, HOOKUP WARE AND PLASTIC HOUSING, HVAC PARTS AND COMPONENTS, NAMELY, LINE TAP VALVES, ACCESS VALVES AND COPPER SPUN DRIERS, DEVICES TO DETECT THE PRESENCE OF CONDENSATE OVERFLOW WHICH WILL INTERRUPT THE CONTROL CIRCUIT OF AN AIR CONDITIONER, REFRIGERATION UNIT OR WATER COOLING SYSTEM, PROTECTIVE EXTERIOR FLOOR COVERINGS IN THE NATURE OF FIBER CEMENT PROTECTIVE BLANKETS FOR USE ON DECKS, DOCKS AND PATIOS AND IN ASSOCIATION WITH GRILLS, FIREPLACES, FRYERS, FIREPITS, CHIMINEA, FRYERS AND HEATERS, LIQUID AIR CONDITIONER COIL CLEANER, CONCRETE COATED POLYSTYRENE FOAM BLOCKS (U.S. CLS. 100, 101 AND 102).

FIRST USE 0-0-1999; IN COMMERCE 0-0-1999.
JERI J. FICKES, EXAMINING ATTORNEY

SN 78-947,475. SENSIS CORPORATION, EAST SYRACUSE, NY. FILED 8-8-2006.

SENSIS

THE MARK CONSISTS OF STANDARD CHARACTERS WITHOUT CLAIM TO ANY PARTICULAR FONT, STYLE, SIZE, OR COLOR.

OWNER OF U.S. REG. NOS. 2,337,480, 2,700,468 AND OTHERS.

CLASS 9—ELECTRICAL AND SCIENTIFIC APPARATUS

FOR COMPUTER-BASED APPARATUS AND COMPUTER SOFTWARE FOR DATA COLLECTION AND MANAGEMENT; COMPUTER-BASED APPARATUS AND COMPUTER SOFTWARE FOR DATA MONITORING; COMPUTER-BASED APPARATUS AND COMPUTER SOFTWARE FOR COLLECTION, PREPARATION, COMPILATION, STORAGE, PROCESSING, RETRIEVAL AND PROVISION OF BUSINESS INFORMATION; COMPUTER-BASED APPARATUS AND COMPUTER SOFTWARE FOR DATA ARCHIVING; COMPUTER-BASED APPARATUS AND COMPUTER SOFTWARE FOR DATA INTEGRATION; COMPUTER-BASED APPARATUS AND COMPUTER SOFTWARE FOR DATA CONDITIONING; COMPUTER-BASED APPARATUS AND COMPUTER SOFTWARE FOR DATA REPORTING; DATA FORMAT AND PROTOCOL CONVERTERS; INFORMATION MANAGEMENT SYSTEMS; COMPUTER-BASED APPARATUS AND COMPUTER SOFTWARE FOR COMPUTER-AIDED TRANSMISSION OF MESSAGES, DATA AND IMAGES; COMPUTER-BASED APPARATUS AND COMPUTER SOFTWARE FOR PUBLICATION OF INFORMATION IN ELECTRONIC FORM; COMPUTER-BASED APPARATUS AND COMPUTER SOFTWARE FOR CONVERTING DIGITAL RADAR DATA OUTPUT TO ANALOG VIDEO OUTPUT FOR USE IN LEGACY AUTOMATION DISPLAYS AND FOR USE IN LEGACY AUTOMATION COMPUTERS; COMPUTER-BASED APPARATUS AND COMPUTER SOFTWARE FOR AUTOMATIC DEPENDENT SURVEILLANCE; COMPUTER-BASED APPARATUS AND COMPUTER SOFTWARE FOR USER-CONFIGURABLE ANALYSIS AND REPORTING; COMPUTER-BASED APPARATUS AND COMPUTER SOFTWARE FOR SIGNAL PROCESSOR ENHANCEMENT; COMPUTER SOFTWARE DEVELOPMENT TOOLS; SURFACE MOVEMENT GUIDANCE AND CONTROL SYSTEMS COMPOSED OF COMPUTER HARDWARE AND SOFTWARE; MANAGEMENT AND SURVEILLANCE SYSTEMS COMPOSED OF COMPUTER HARDWARE AND SOFTWARE THAT ARE USED FOR AIR TRAFFIC CONTROL; COOPERATIVE SURVEILLANCE AND DATA LINK SYSTEM COMPOSED OF COMPUTER HARDWARE AND SOFTWARE THAT ARE USED FOR AIR TRAFFIC CONTROL; SYSTEMS COMPOSED OF COMPUTER HARDWARE AND SOFTWARE THAT DETERMINE SENSOR CONFIGURATIONS; RADAR STIMULATORS; SIGNAL PROCESSORS AND REPLACEMENT PARTS THEREFORE; RADAR PROCESSORS AND REPLACEMENT PARTS THEREFORE; VEHICLE LOCATING SYSTEMS COMPRISED OF AN ANTENNA AND RADIO TRANSMITTER TO BE PLACED ON OR IN A VEHICLE; SYSTEMS COMPOSED OF COMPUTER HARDWARE AND SOFTWARE THAT EXTRACT AND REPORT WEATHER CONTOURS FROM PRIMARY RADAR VIDEO SIGNALS, ALL AFORESAID GOODS USED FOR NON-MEDICAL PURPOSES (U.S. CLS. 21, 23, 26, 36 AND 38).

FIRST USE 6-0-1998; IN COMMERCE 6-0-1998.

CLASS 35—ADVERTISING AND BUSINESS

FOR BUSINESS DATA REPORTING SERVICES; COLLECTION, PREPARATION, COMPOSITION, STORAGE, PROCESSING, ACQUISITION AND PROVISION OF BUSINESS INFORMATION, MESSAGES, DATA AND IMAGES; BUSINESS ADVISORY SERVICES (U.S. CLS. 100, 101 AND 102).

FIRST USE 1-0-2003; IN COMMERCE 1-0-2003.

CLASS 37—CONSTRUCTION AND REPAIR

FOR MAINTENANCE AND REPAIR OF RADARS AND RADAR CONTROLS; MAINTENANCE AND REPAIR OF SIGNAL PROCESSORS (U.S. CLS. 100, 103 AND 106).

FIRST USE 6-0-1998; IN COMMERCE 6-0-1998.

CLASS 42—SCIENTIFIC AND COMPUTER SERVICES

FOR CONVERSION OF DIGITAL RADAR OUTPUT DATA INTO ANALOG VIDEO OUTPUT DATA FOR LEGACY AUTOMATION SYSTEMS; COMPUTER PROGRAMMING SERVICES; COMPUTER SOFTWARE DESIGN SERVICES; DESIGN AND DEVELOPMENT OF RADAR AND OTHER RADIO SIGNAL PROCESSOR REPLACEMENTS; DESIGN AND DEVELOPMENT OF RADAR AND RADAR CONTROL UPGRADES AND REPLACEMENTS; DESIGN AND DEVELOPMENT OF RADAR AND RADIO SIGNAL PROCESSOR ENHANCEMENTS; DESIGN AND DEVELOPMENT OF AUTOMATIC DEPENDENT SURVEILLANCE SYSTEMS; CONSULTING SERVICES IN THE FIELD OF RADAR AND AUTOMATIC DEPENDENT SURVEILLANCE; USER-CONFIGURABLE TECHNICAL ANALYSIS AND REPORTING RELATING TO SURVEILLANCE DATA, FLIGHT PLANS, AND OPERATIONAL DATA TECHNOLOGY, ALL AFORESAID SERVICES FOR NON-MEDICAL PURPOSES (U.S. CLS. 100 AND 101).

FIRST USE 6-0-1998; IN COMMERCE 6-0-1998.

TAMARA FRAZIER, EXAMINING ATTORNEY

SN 78-948,376. FIASCO GELATO CORP., CALGARY, ALBERTA, CANADA, FILED 8-9-2006.

FIASCO GELATO

THE MARK CONSISTS OF STANDARD CHARACTERS WITHOUT CLAIM TO ANY PARTICULAR FONT, STYLE, SIZE, OR COLOR.

PRIORITY CLAIMED UNDER SEC. 44(D) ON CANADA APPLICATION NO. 1298343, FILED 4-19-2006, REG. NO. TMA697988, DATED 10-5-2007, EXPIRES 10-5-2022.

NO CLAIM IS MADE TO THE EXCLUSIVE RIGHT TO USE "GELATO", APART FROM THE MARK AS SHOWN.

CLASS 30—STAPLE FOODS

FOR FROZEN DESSERTS, NAMELY, FROZEN YOGURT, ICE CREAM, ICE MILK, GELATO CAKES, FROZEN ICES, SHERBETS, SORBETS, SORBETTO, SORBETTO CAKES, GELATO; PACKAGED COFFEE; SANDWICHES, SANDWICH WRAPS, PANINIS, CREPES; BLENDED ICE CREAM DRINKS (U.S. CL. 46).

CLASS 35—ADVERTISING AND BUSINESS

FOR FRANCHISE SERVICES, NAMELY, OFFERING TECHNICAL AND BUSINESS MANAGEMENT ASSISTANCE IN THE ESTABLISHMENT AND OPERATION OF RESTAURANTS AND TAKE-OUT RESTAURANTS (U.S. CLS. 100, 101 AND 102).

CLASS 43—HOTEL AND RESTAURANT SERVICES

FOR RESTAURANT SERVICES; TAKE-OUT RESTAURANT SERVICES; AND CATERING SERVICES (U.S. CLS. 100 AND 101).

JAMES LOVELACE, EXAMINING ATTORNEY

SN 78-948,844. THECIRCLE.ORG, LLC, CINCINNATI, OH. FILED 8-9-2006.

THE CIRCLE

THE MARK CONSISTS OF STANDARD CHARACTERS WITHOUT CLAIM TO ANY PARTICULAR FONT, STYLE, SIZE, OR COLOR.

CLASS 41—EDUCATION AND ENTERTAINMENT

FOR EDUCATIONAL SERVICES, NAMELY, CONDUCTING CLASSES, SEMINARS AND WORKSHOPS IN THE FIELD OF PERSONAL IMPROVEMENT; ENTERTAINMENT IN THE NATURE OF ON-GOING TELEVISION AND RADIO PROGRAMS IN THE FIELD OF PERSONAL IMPROVEMENT (U.S. CLS. 100, 101 AND 107).

CLASS 45—PERSONAL AND LEGAL SERVICES

FOR PROVIDING A WEBSITE FEATURING INFORMATION IN THE FIELD OF PERSONAL IMPROVEMENT (U.S. CLS. 100 AND 101).

CHRISTINA SOBRAL, EXAMINING ATTORNEY

SN 78-948,881. THECIRCLE.ORG, LLC, CINCINNATI, OH. FILED 8-9-2006.

MY CIRCLE

THE MARK CONSISTS OF STANDARD CHARACTERS WITHOUT CLAIM TO ANY PARTICULAR FONT, STYLE, SIZE, OR COLOR.

CLASS 41—EDUCATION AND ENTERTAINMENT

FOR EDUCATIONAL SERVICES, NAMELY, CONDUCTING CLASSES, SEMINARS AND WORKSHOPS IN THE FIELD OF PERSONAL IMPROVEMENT; ENTERTAINMENT IN THE NATURE OF ON-GOING TELEVISION AND RADIO PROGRAMS IN THE FIELD OF PERSONAL IMPROVEMENT (U.S. CLS. 100, 101 AND 107).

CLASS 45—PERSONAL AND LEGAL SERVICES

FOR PROVIDING A WEBSITE FEATURING INFORMATION IN THE FIELD OF PERSONAL IMPROVEMENT (U.S. CLS. 100 AND 101).

CHRISTINA SOBRAL, EXAMINING ATTORNEY

SN 78-948,894. THECIRCLE.ORG, LLC, CINCINNATI, OH. FILED 8-9-2006.

CIRCLE

THE MARK CONSISTS OF STANDARD CHARACTERS WITHOUT CLAIM TO ANY PARTICULAR FONT, STYLE, SIZE, OR COLOR.

CLASS 41—EDUCATION AND ENTERTAINMENT

FOR EDUCATIONAL SERVICES, NAMELY, CONDUCTING CLASSES, SEMINARS AND WORKSHOPS IN THE FIELD OF PERSONAL IMPROVEMENT; ENTERTAINMENT IN THE NATURE OF ON-GOING TELEVISION AND RADIO PROGRAMS IN THE FIELD OF PERSONAL IMPROVEMENT (U.S. CLS. 100, 101 AND 107).

CLASS 45—PERSONAL AND LEGAL SERVICES

FOR PROVIDING A WEBSITE FEATURING INFORMATION IN THE FIELD OF PERSONAL IMPROVEMENT (U.S. CLS. 100 AND 101).

CHRISTINA SOBRAL, EXAMINING ATTORNEY

SN 78-949,509. TERANA, S.A., MEXICO, D.F., MEXICO, FILED 8-10-2006.

TERANA

THE MARK CONSISTS OF STANDARD CHARACTERS WITHOUT CLAIM TO ANY PARTICULAR FONT, STYLE, SIZE, OR COLOR.

PRIORITY CLAIMED UNDER SEC. 44(D) ON MEXICO APPLICATION NO. 792491, FILED 7-5-2006, REG. NO. 945698, DATED 7-5-2006, EXPIRES 7-5-2016.

OWNER OF MEXICO REG. NO. 505794, DATED 8-31-1995, RENEWED AS REG. NO. 74043/2005, DATED 8-31-2005, EXPIRES 8-31-2015.

OWNER OF MEXICO REG. NO. 505795, DATED 8-31-1995, RENEWED AS REG. NO. 75174/2005, DATED 8-31-2005, EXPIRES 8-31-2015.

CLASS 29—MEATS AND PROCESSED FOODS

FOR UNFLAVORED AND UNSWEETENED GELATIN; CANNED FOOD, NAMELY, JALAPENOS, VEGETABLES, MEAT, FISH, AND POULTRY; MEAT EXTRACT; CANNED, DRIED, AND COOKED FRUITS AND VEGETABLES; MARMALADES, COMPOTES, EGGS, MILK AND LACTIC ACID DRINKS, EDIBLE OILS AND FATS (U.S. CL. 46).

CLASS 30—STAPLE FOODS

FOR SPICES, PROCESSED CEREALS, COFFEE, TEA, COCOA, SUGAR, RICE, TAPIOCA, SAGE, COFFEE SUBSTITUTES, BREAD, BAKERY PRODUCTS, PASTRY, EDIBLE ICE CREAM, HONEY, MOLASSES SYRUP, YEAST, BAKING POWDERS, SALT, MUSTARD, VINEGAR, SEASONED SAUCES, SALSA, AND ICE; FLOUR AND PROCESSED CEREAL PREPARATIONS, NAMELY, BREAKFAST CEREALS, CEREAL BASED SNACK FOOD, READY-TO-EAT CEREALS AND FLOUR-BASED CHIPS (U.S. CL. 46).

CLASS 33—WINES AND SPIRITS

FOR ALCOHOLIC BEVERAGES, NAMELY, TEQUILA, RUM, VODKA AND WHISKEY EXCLUDING WINE (U.S. CLS. 47 AND 49).

DAVID TOOLEY, EXAMINING ATTORNEY

SN 78-951,575. KENNECOTT LAND COMPANY, SALT LAKE CITY, UT. FILED 8-14-2006.

THIS IS GETTING GOOD

THE MARK CONSISTS OF STANDARD CHARACTERS WITHOUT CLAIM TO ANY PARTICULAR FONT, STYLE, SIZE, OR COLOR.

CLASS 35—ADVERTISING AND BUSINESS

FOR NATURAL RESOURCE MANAGEMENT (U.S. CLS. 100, 101 AND 102).

CLASS 36—INSURANCE AND FINANCIAL

FOR LEASING OF REAL ESTATE; REAL ESTATE MANAGEMENT (U.S. CLS. 100, 101 AND 102).

CLASS 37—CONSTRUCTION AND REPAIR

FOR REAL ESTATE DEVELOPMENT (U.S. CLS. 100, 103 AND 106).

JACLYN KIDWELL, EXAMINING ATTORNEY

SN 78-954,803. TALBOT REAL ESTATE L.L.C., DBA BARKLEY COMPANY, BELLINGHAM, WA. FILED 8-17-2006.

BARKLEY COMPANY

THE MARK CONSISTS OF STANDARD CHARACTERS WITHOUT CLAIM TO ANY PARTICULAR FONT, STYLE, SIZE, OR COLOR.

NO CLAIM IS MADE TO THE EXCLUSIVE RIGHT TO USE "COMPANY", APART FROM THE MARK AS SHOWN. SEC. 2(F).

CLASS 36—INSURANCE AND FINANCIAL

FOR REAL ESTATE SERVICES, NAMELY, ASSESSMENT AND MANAGEMENT OF REAL ESTATE, LEASING OF REAL ESTATE, OPERATING MARKETPLACES FOR SELLERS OF GOODS AND/OR SERVICES, PROVIDING INFORMATION IN THE FIELD OF REAL ESTATE VIA THE INTERNET, REAL ESTATE LISTING, REAL ESTATE BROKERAGE, AND REAL ESTATE MANAGEMENT (U.S. CLS. 100, 101 AND 102).

FIRST USE 0-0-1996; IN COMMERCE 0-0-1996.

CLASS 37—CONSTRUCTION AND REPAIR

FOR REAL ESTATE DEVELOPMENT; LAND DEVELOPMENT SERVICES, NAMELY, PLANNING AND LAYING OUT OF RESIDENTIAL AND COMMERCIAL COMMUNITIES (U.S. CLS. 100, 103 AND 106).

FIRST USE 0-0-1996; IN COMMERCE 0-0-1996.

NATALIE POLZER, EXAMINING ATTORNEY

CLASS 39—TRANSPORTATION AND STORAGE

FOR PROVIDING TRAVEL INFORMATION SERVICES, ESPECIALLY FEATURING TRAVEL TO BENEFIT PHILANTHROPIC WORKS AND CHARITIES; TRAVEL AGENCY SERVICES, NAMELY, MAKING RESERVATIONS AND BOOKINGS FOR TRANSPORTATION BY LAND, AIR, AND SEA; ARRANGING CHARITABLE AND PHILANTHROPIC WORK TRAVEL TOURS; CHARITABLE SERVICES, NAMELY PROVIDING TRANSPORTATION TO BENEFIT THE NEEDY (U.S. CLS. 100 AND 105).

FIRST USE 9-6-2006; IN COMMERCE 9-6-2006.

CLASS 41—EDUCATION AND ENTERTAINMENT

FOR CHARITABLE SERVICES, NAMELY, ORGANIZING CHARITABLE PROJECTS IN THE NATURE OF EDUCATIONAL SERVICES, NAMELY, CONDUCTING PROGRAMS IN THE FIELDS OF CAMPGROUND AND NATURE PRESERVATION, LANGUAGE INSTRUCTION, BASIC HYGIENE INSTRUCTION, INSTRUCTION IN MUSIC, CHILDREN'S GAMES, ART, AND SPORTS, AND PROVIDING SCIENCE EDUCATIONAL MENTORING SERVICES AND PROGRAMS (U.S. CLS. 100, 101 AND 107).

FIRST USE 9-6-2006; IN COMMERCE 9-6-2006.

CLASS 42—SCIENTIFIC AND COMPUTER SERVICES

FOR CHARITABLE SERVICES, NAMELY, ORGANIZING CHARITABLE PROJECTS IN THE NATURE OF SCIENTIFIC RESEARCH AND DEVELOPMENT, ENGINEERING SERVICES FOR BUILDING AND PROPERTY CONDITION ASSESSMENT, FACILITY MANAGEMENT, REPAIR AND RESTORATION, BUILDING INSTRUMENTATION AND MONITORING, AND ENVIRONMENTAL CONSULTING, AND RESEARCH IN THE FIELD OF ENVIRONMENTAL PROTECTION (U.S. CLS. 100 AND 101).

FIRST USE 9-6-2006; IN COMMERCE 9-6-2006.

CLASS 44—MEDICAL, BEAUTY AND AGRICULTURAL SERVICES

FOR CHARITABLE SERVICES, NAMELY, ORGANIZING CHARITABLE MEDICAL CARE PROJECTS TO BENEFIT THE NEEDY (U.S. CLS. 100 AND 101).

FIRST USE 9-6-2006; IN COMMERCE 9-6-2006.

EVELYN BRADLEY, EXAMINING ATTORNEY

SN 78-957,508. TRAVELCITY.COM LP, SOUTHLAKE, TX.
FILED 8-22-2006.

TRAVEL FOR GOOD

THE MARK CONSISTS OF STANDARD CHARACTERS WITHOUT CLAIM TO ANY PARTICULAR FONT, STYLE, SIZE, OR COLOR.

NO CLAIM IS MADE TO THE EXCLUSIVE RIGHT TO USE TRAVEL, APART FROM THE MARK AS SHOWN.

CLASS 35—ADVERTISING AND BUSINESS

FOR RETAIL STORE SERVICES FEATURING TRAVEL-RELATED GOODS; CHARITABLE SERVICES, NAMELY, CHARITABLE PROMOTION AND ADVERTISING OF GOODS AND SERVICES OF OTHERS (U.S. CLS. 100, 101 AND 102).

FIRST USE 9-6-2006; IN COMMERCE 9-6-2006.

CLASS 36—INSURANCE AND FINANCIAL

FOR CHARITABLE FUNDRAISING; PROVIDING GRANTS AND MONETARY DONATIONS TO INDIVIDUALS AND ORGANIZATIONS FOR HUMANITARIAN, SCIENTIFIC, ENVIRONMENTAL, EDUCATIONAL, AND CULTURAL PROJECTS (U.S. CLS. 100, 101 AND 102).

FIRST USE 9-6-2006; IN COMMERCE 9-6-2006.

CLASS 37—CONSTRUCTION AND REPAIR

FOR CHARITABLE SERVICES, NAMELY, ORGANIZING CHARITABLE PROJECTS IN THE NATURE OF LAND DEVELOPMENT SERVICES, NAMELY, PLANNING AND LAYING OUT OF RESIDENTIAL, AGRICULTURAL AND/OR COMMERCIAL STRUCTURES AND COMMUNITIES, LAND RECLAMATION, BUILDING CONSTRUCTION, AND BUILDING MAINTENANCE, REPAIR, AND RESTORATION (U.S. CLS. 100, 103 AND 106).

FIRST USE 9-6-2006; IN COMMERCE 9-6-2006.

SN 78-957,696. SNAP-ON INCORPORATED, KENOSHA, WI.
FILED 8-22-2006.

**CLASS 9—ELECTRICAL AND SCIENTIFIC APPARATUS**

FOR VEHICLE DIAGNOSTIC SOFTWARE AND VEHICLE REPAIR SHOP MANAGEMENT SOFTWARE (U.S. CLS. 21, 23, 26, 36 AND 38).

CLASS 35—ADVERTISING AND BUSINESS

FOR ON-LINE ORDERING SERVICES FOR AUTOMOTIVE REPLACEMENT PARTS; PROVIDING CONSUMER INFORMATION REGARDING SUGGESTED AUTOMOTIVE MAINTENANCE AND REPAIR VIA E-MAIL, BY TELEPHONE AND BY MAIL (U.S. CLS. 100, 101 AND 102).

CLASS 37—CONSTRUCTION AND REPAIR

FOR VEHICLE REPAIR SERVICES (U.S. CLS. 100, 103 AND 106).

PAM WILLIS, EXAMINING ATTORNEY

SN 78-958,543. MOVENCY LIMITED, HERTSFORDSHIRE, UNITED KINGDOM, FILED 8-23-2006.

MOVENCY

THE MARK CONSISTS OF STANDARD CHARACTERS WITHOUT CLAIM TO ANY PARTICULAR FONT, STYLE, SIZE, OR COLOR.

PRIORITY CLAIMED UNDER SEC. 44(D) ON UNITED KINGDOM APPLICATION NO. 2414965, FILED 2-24-2006, REG. NO. 2414965, DATED 2-2-2007, EXPIRES 2-24-2016.

CLASS 9—ELECTRICAL AND SCIENTIFIC APPARATUS

FOR COMPUTERS, COMPUTER HARDWARE; COMPUTER FIRMWARE AND COMPUTER SOFTWARE FOR MESSAGING COLLABORATION AND DISTRIBUTED COMPUTING AMONG COMPUTERS; COMPUTER PERIPHERAL DEVICES, NAMELY, COMPUTER KEYBOARDS, COMPUTER MEMORIES, COMPUTER INTERFACE BOARDS, COMPUTER DISK DRIVES, ALL FOR USE IN THE NETWORKING OF COMPUTERS OR COMMUNICATION APPARATUS, FOR DATA EXCHANGE AND TRANSMISSION BETWEEN THEM AND FOR OPERATING AND CONTROLLING NETWORKS; BLANK MAGNETIC DATA CARRIERS; COMPUTER SOFTWARE DOWNLOADABLE FROM THE INTERNET IN THE FIELD OF COMPUTER NETWORKING TO ENABLE DISTRIBUTED COMPUTING BETWEEN COMPUTERS, MOBILE PHONES AND GAME CONSOLES; PRE-RECORDED COMPUTER PROGRAMS FOR PERSONAL INFORMATION MANAGEMENT, DATABASE MANAGEMENT, CHARACTER RECOGNITION, TELEPHONY MANAGEMENT, ELECTRONIC MAIL AND MESSAGING PAGING, MOBILE TELEPHONE DATA SYNCHRONIZATION; COMPUTER PROGRAMS FOR ACCESSING, BROWSING AND SEARCHING ONLINE DATABASES; COMPUTER SOFTWARE AND FIRMWARE, NAMELY, OPERATING SYSTEM PROGRAMS, DATA SYNCHRONIZATION PROGRAMS, AND APPLICATION DEVELOPMENT TOOL PROGRAMS FOR PERSONAL AND HANDHELD COMPUTERS; SOFTWARE FOR THE REDIRECTION OF MESSAGES, INTERNET E-MAIL, AND/OR OTHER DATA TO ONE OR MORE ELECTRONIC HANDHELD DEVICES FROM A DATA STORE ON OR ASSOCIATED WITH A PERSONAL COMPUTER OR A SERVER; TELECOMMUNICATION APPARATUS FOR COMMUNICATION WITH COMPUTERS FOR OPERATING, CONTROLLING, AND COMMUNICATING WITH COMMUNICATION AND TELECOMMUNICATIONS EQUIPMENT, NAMELY, MOBILE PHONES, MOBILE PHONES INCORPORATING SECONDARY FUNCTIONALITY, PORTABLE TELEPHONES, TELEPHONE RECEIVERS, TELEPHONE TRANSMITTERS, TELEPHONE HANDSETS, VIDEO TELEPHONES, MOBILE TELEPHONE COVERS; RADIO PAGERS, WALKIE-TALKIES, AND USER MANUALS FOR ALL THE AFORESAID GOODS (U.S. CLS. 21, 23, 26, 36 AND 38).

CLASS 35—ADVERTISING AND BUSINESS

FOR ADVERTISING AND ADVERTISEMENT SERVICES; BUSINESS ADMINISTRATION AND MANAGEMENT; CONSULTING SERVICES IN THE FIELD OF ADVERTISING AND BUSINESS; PROVIDING INFORMATION IN THE FIELD OF BUSINESS AND ADVERTISING; RETAIL STORE SERVICES CONNECTED WITH PRE RECORDED MUSICAL WORKS, AUDIO VISUAL WORKS, MUSIC RELATED ELECTRONIC PRODUCTS, COMPUTER GAMES, COMPUTER SOFTWARE, FILMS, MOVIES, TELEVISION PROGRAMMES, ALL BEING FOR ENTERTAINMENT, PROVIDED VIA THE INTERNET AND OTHER ELECTRONIC AND COMMUNICATION NETWORKS; COMPILATION OF INFORMATION INTO COMPUTER DATABASES; COMPUTERIZED FILE MANAGEMENT; COMPILATION OF DIRECTORIES FOR PUBLISHING ON THE INTERNET; PROVISION OF SPACE ON WEB SITES FOR ADVERTISING GOODS AND SERVICES ADVERTISING; PROVISION OF BUSINESS STATISTICAL INFORMATION; COMPUTERIZED ACCOUNTING; INDUSTRIAL MANAGEMENT CONSULTATION INCLUDING COST/YIELD ANALYSIS (U.S. CLS. 100, 101 AND 102).

CLASS 36—INSURANCE AND FINANCIAL

FOR ELECTRONIC PAYMENT, NAMELY, ELECTRONIC PROCESSING AND TRANSMISSION OF BILL PAYMENT DATA (U.S. CLS. 100, 101 AND 102).

CLASS 38—COMMUNICATION

FOR TELECOMMUNICATIONS SERVICES, NAMELY, TRANSMISSION OF LAND AND LONG DISTANCE TRANSMISSION OF VOICE, DATA AND GRAPHICS BY MEANS OF TELEPHONE, TELEGRAPHIC, CABLE AND SATELLITE TRANSMISSION; SATELLITE TELEVISION BROADCASTING OF MOTION PICTURE FILM, TELEVISION, VIDEO AND RADIO PROGRAMS AND CULTURAL SPORTING, MUSIC, OR OTHER ENTERTAINMENT EVENTS, INCLUDING VIA THE INTERNET OR THROUGH COMPUTERS; PROVISION OF TELECOMMUNICATION ACCESS AND LINKS TO COMPUTER DATABASES AND TO THE INTERNET; PROVIDING ACCESS TO AND LEASING ACCESS TIME TO COMPUTER DATABASES USING THE INTERNET; TRANSMISSION AND RECEPTION OF ELECTRONIC FINANCIAL TRANSACTIONS (U.S. CLS. 100, 101 AND 104).

CLASS 39—TRANSPORTATION AND STORAGE

FOR ELECTRONIC DATA STORAGE; COMPUTERIZED ELECTRONIC DATA STORAGE SERVICES; DATA STORAGE OF ELECTRONIC MUSIC (U.S. CLS. 100 AND 105).

CLASS 42—SCIENTIFIC AND COMPUTER SERVICES

FOR COMPUTER CONSULTING SERVICES; SCIENTIFIC AND TECHNOLOGICAL RESEARCH SERVICES; CONSULTING SERVICES IN THE FIELD OF COMPUTER, SCIENTIFIC, TECHNOLOGICAL, AND INDUSTRIAL RESEARCH; ADVISORY SERVICES IN THE FIELD OF COMPUTER, SCIENCE AND TECHNOLOGY; COMPUTER PROGRAMMING SERVICES; DESIGN, RESEARCH, DEVELOPMENT, TESTING, INSTALLATION AND MAINTENANCE OF COMPUTER SOFTWARE; DESIGN, RESEARCH, DEVELOPMENT AND TESTING OF TELECOMMUNICATION APPARATUS AND INSTRUMENTS, COMPUTER HARDWARE, DATA PROCESSING EQUIPMENT AND COMPUTER NETWORKING SYSTEMS; DESIGN AND MAINTENANCE OF COMPUTER SOFTWARE PARTICULARLY FOR THE DISTRIBUTION OF PROCESSING BETWEEN COMPUTERS OR ACROSS A NETWORK OF COMPUTERS OR FROM THE INTERNET OF INFORMATION, SOUND, MUSIC, IMAGES, GRAPHICS OR DATA; MULTIMEDIA AND AUDIO-VISUAL SOFTWARE CONSULTING SERVICES; PROVIDING SEARCH ENGINES FOR OBTAINING DATA VIA COMMUNICATIONS NETWORKS; APPLICATION SERVICE PROVIDER (ASP)

SERVICES FEATURING SOFTWARE FOR USE IN CONNECTION WITH ONLINE MUSIC SUBSCRIPTION SERVICE, SOFTWARE THAT ENABLES USERS TO PLAY AND PROGRAM MUSIC AND ENTERTAINMENT-RELATED AUDIO, VIDEO, TEXT AND MULTIMEDIA CONTENT, AND SOFTWARE FEATURING MUSICAL SOUND RECORDINGS, ENTERTAINMENT-RELATED AUDIO, VIDEO, TEXT AND MULTIMEDIA CONTENT; PROVIDING TEMPORARY USE OF ON-LINE NON-DOWNLOADABLE SOFTWARE TO ENABLE USERS TO PROGRAM AUDIO, VIDEO, TEXT AND OTHER MULTIMEDIA CONTENT, INCLUDING MUSIC, CONCERTS, VIDEOS, RADIO, TELEVISION, NEWS, SPORTS, GAMES, CULTURAL EVENTS, AND ENTERTAINMENT-RELATED PROGRAMS; PROVIDING ON-LINE FACILITIES, VIA A GLOBAL COMPUTER NETWORK, TO ENABLE USERS TO PROGRAM THE SCHEDULING OF AUDIO, VIDEO, TEXT AND OTHER MULTIMEDIA CONTENT, INCLUDING MUSIC, CONCERTS, VIDEOS, RADIO, TELEVISION, NEWS, SPORTS, GAMES, CULTURAL EVENTS, AND ENTERTAINMENT-RELATED PROGRAMS AS THEY WILL BE AIRED; PROVIDING SEARCH ENGINES FOR OBTAINING DATA ON A GLOBAL COMPUTER NETWORK; CREATING INDEXES OF INFORMATION, SITES AND OTHER RESOURCES AVAILABLE ON GLOBAL COMPUTER NETWORKS FOR OTHERS; PROVIDING USERS OF ELECTRONIC COMMUNICATIONS NETWORKS WITH MEANS OF IDENTIFYING, LOCATING, GROUPING, DISTRIBUTING, AND MANAGING DATA AND LINKS TO THIRD-PARTY COMPUTER SERVERS, COMPUTER PROCESSORS AND COMPUTER USERS; SEARCHING, BROWSING AND RETRIEVING INFORMATION, SITES, AND OTHER RESOURCES AVAILABLE ON GLOBAL COMPUTER NETWORKS FOR OTHERS; ORGANIZING CONTENT OF INFORMATION PROVIDED OVER A GLOBAL COMPUTER NETWORK ACCORDING TO USER PREFERENCE (U.S. CLS. 100 AND 101).

DAWN FELDMAN, EXAMINING ATTORNEY

CLASS 3—COSMETICS AND CLEANING PREPARATIONS

FOR LIP BALM, LIP GLOSS, LIP LINER, LIP STICK, LIP GLOSS PALETTE, MAKE-UP KITS COMPRISED OF GLOSS; EYE MAKE-UP, EYE LINER, EYE PENCILS, EYE SHADOW, EYE MAKE-UP CORRECTOR PEN, NAMELY, MAKEUP REMOVER IN THE FORM OF A PEN, MASCARA, MAKE-UP KITS COMPRISING OF EYE SHADOWS, MAKE-UP KITS COMPRISING OF MASCARA AND EYE LINER, BROW STENCILS, BROW GEL, BROW POWDER, BROW PENCILS; MAKE-UP KITS COMPRISING OF BLUSH; BLUSH, BODY POWDER, FACE POWDER, LOOSE FACE POWDER, MAKE-UP POWDER, PRESSED FACE POWDER, PERFUMED POWDER; CONCEALERS FOR FACE; NAIL ENAMEL, NAIL ENAMEL REMOVER, NAIL ENAMEL CORRECTOR PEN, NAMELY, NAIL ENAMEL REMOVER IN THE FORM OF A PEN; COSMETIC FACIAL BLOTTER PAPERS; PERFUME, PERFUME OILS, EAU DE PERFUME; FACE AND BODY SOAPS, BATH BEADS, BATH CRYSTALS, BATH FOAM, BATH GEL, BATH LOTION, BATH OIL, BATH SALTS, BUBBLE BATH, FOAM BATH, LIQUID BATH SOAPS, SHOWER AND BATH FOAM, SHOWER AND BATH GEL, SHOWER AND BATH SCRUB, BATH BEADS; BODY SCRUB, FACIAL SCRUB, BODY MASKS, FACIAL MASKS, SKIN MASKS; MASSAGE OIL; BODY CREAM, FACE AND BODY GLITTER, BODY LOTION, BODY OIL, BODY POWDER, SCENTED BODY SPRAY, FACE POWDER PASTE, NAMELY, SPARKLE PASTE; SCENTED ROOM SPRAY; WAX STRIPS FOR REMOVING BODY HAIR; SHAVING BALM, SHAVING CREAM, SHAVING FOAM, SHAVING GEL, SHAVING LOTION, SHAVING MOUSSE, SHAVING SOAP, AFTER-SHAVE, AFTER-SHAVE BALMS, AFTER-SHAVE CREAMS, AFTER-SHAVE EMULSIONS, AFTER-SHAVE GEL, AFTER-SHAVE LOTIONS, PRE-SHAVE CREAMS; ADHESIVES FOR AFFIXING FALSE EYELASHES, FALSE EYELASHES, FALSE EYELASH GLUE, KITS COMPRISING OF FALSE EYELASHES AND FALSE EYELASH GLUE (U.S. CLS. 1, 4, 6, 50, 51 AND 52).

CLASS 16—PAPER GOODS AND PRINTED MATTER

FOR COLOGNE SCENTED PAPER SHELF LINERS (U.S. CLS. 2, 5, 22, 23, 29, 37, 38 AND 50).
DORITT L. CARROLL, EXAMINING ATTORNEY

SN 78-959,294. HOME BOX OFFICE, INC., NEW YORK, NY.
FILED 8-24-2006.

SN 78-959,426. KIM, JIN-SEOK, SEOUL, REPUBLIC OF KOREA, FILED 8-24-2006.



YOGUR BERRY

SEX AND THE CITY

NO CLAIM IS MADE TO THE EXCLUSIVE RIGHT TO USE "YOGUR BERRY", APART FROM THE MARK AS SHOWN.

THE MARK CONSISTS OF THE WORDS "YOGUR BERRY" DISPOSED BELOW A SPIRAL DESIGN WHEREIN A BOTTOM PORTION OF THE SPIRAL DESIGN IS MISSING.

THE FOREIGN WORDING IN THE MARK TRANSLATES INTO ENGLISH AS YOGHURT.

THE MARK CONSISTS OF STANDARD CHARACTERS WITHOUT CLAIM TO ANY PARTICULAR FONT, STYLE, SIZE, OR COLOR.

OWNER OF U.S. REG. NOS. 2,513,906 AND 2,795,365.

CLASS 30—STAPLE FOODS

FOR ICE CREAM; ICE-CREAM CAKES (U.S. CL. 46).

CLASS 43—HOTEL AND RESTAURANT SERVICES

FOR RESTAURANTS (U.S. CLS. 100 AND 101).
SANI KHOURI, EXAMINING ATTORNEY

CLASS 25—CLOTHING

FOR CLOTHING, NAMELY, JEANS, SHIRTS, SKIRTS,
PANTS, DRESSES, AND SHORTS (U.S. CLS. 22 AND 39).
LAURA HAMMEL, EXAMINING ATTORNEY

SN 78-962,603. KSWB, INC., SAN DIEGO, CA. FILED 8-29-2006.

SN 78-962,628. LYRIC JEANS, INC., LOS ANGELES, CA.
FILED 8-29-2006.

YOVIO

THE MARK CONSISTS OF STANDARD CHARACTERS WITHOUT CLAIM TO ANY PARTICULAR FONT, STYLE, SIZE, OR COLOR.

CLASS 35—ADVERTISING AND BUSINESS

FOR ADVERTISING AND ADVERTISEMENT SERVICES (U.S. CLS. 100, 101 AND 102).

CLASS 38—COMMUNICATION

FOR VIDEO BROADCASTING SERVICES OVER THE INTERNET OR OTHER COMMUNICATIONS NETWORK, NAMELY, SHOWING, UPLOADING, DISPLAYING, AND ELECTRONICALLY TRANSMITTING AND TRANSFERRING VIDEO INFORMATION ABOUT ENTERTAINMENT, SPORTS, CULTURAL ACTIVITIES, CURRENT EVENTS, AND USER-GENERATED CONTENT TO CONSUMERS AND TELEVISION VIEWERS (U.S. CLS. 100, 101 AND 104).

CLASS 41—EDUCATION AND ENTERTAINMENT

FOR EDUCATION AND ENTERTAINMENT SERVICES, NAMELY ON-LINE JOURNALS FEATURING INFORMATION ON CURRENT EVENTS AND ENTERTAINMENT; PROVIDING AN INTERACTIVE WEB SITE FEATURING VIDEOS, PHOTOGRAPHS, USER-GENERATED CONTENT, AND OTHER MULTIMEDIA MATERIAL ON ENTERTAINMENT, SPORTS, HUMOR, FAMILY, CULTURAL ACTIVITIES, AND CURRENT EVENTS (U.S. CLS. 100, 101 AND 107).

CIMMERIAN COLEMAN, EXAMINING ATTORNEY

SN 78-962,611. LYRIC JEANS, INC., LOS ANGELES, CA.
FILED 8-29-2006.

LITTLE LYRICS

THE MARK CONSISTS OF STANDARD CHARACTERS WITHOUT CLAIM TO ANY PARTICULAR FONT, STYLE, SIZE, OR COLOR.

CLASS 18—LEATHER GOODS

FOR HANDBAGS, BACKPACKS, WALLETS, DUFFLE BAGS, GYM BAGS, AND LUGGAGE (U.S. CLS. 1, 2, 3, 22 AND 41).

LYRIC LATIN

THE MARK CONSISTS OF STANDARD CHARACTERS WITHOUT CLAIM TO ANY PARTICULAR FONT, STYLE, SIZE, OR COLOR.

CLASS 18—LEATHER GOODS

FOR HANDBAGS, BACKPACKS, WALLETS, DUFFLE BAGS, GYM BAGS, AND LUGGAGE (U.S. CLS. 1, 2, 3, 22 AND 41).

CLASS 25—CLOTHING

FOR CLOTHING, NAMELY, JEANS, SHIRTS, SKIRTS, DRESSES, PANTS AND SHORTS (U.S. CLS. 22 AND 39).
LAURA HAMMEL, EXAMINING ATTORNEY

SN 78-962,639. LYRIC JEANS, INC., LOS ANGELES, CA.
FILED 8-29-2006.

LYRIC KIDS

THE MARK CONSISTS OF STANDARD CHARACTERS WITHOUT CLAIM TO ANY PARTICULAR FONT, STYLE, SIZE, OR COLOR.

NO CLAIM IS MADE TO THE EXCLUSIVE RIGHT TO USE "KIDS", APART FROM THE MARK AS SHOWN.

CLASS 18—LEATHER GOODS

FOR HANDBAGS, BACKPACKS, WALLETS, DUFFLE BAGS, GYM BAGS, AND LUGGAGE (U.S. CLS. 1, 2, 3, 22 AND 41).

CLASS 25—CLOTHING

FOR CLOTHING, NAMELY, JEANS, SHIRTS, SKIRTS, DRESSES, PANTS AND SHORTS (U.S. CLS. 22 AND 39).
LAURA HAMMEL, EXAMINING ATTORNEY

SN 78-963,755. LYRIC JEANS, INC., LOS ANGELES, CA.
FILED 8-30-2006.



THE MARK CONSISTS OF THE WORDING "LYRIC CULTURE" AND A MUSICAL CLEF DESIGN WITH TWO DOTS TO THE RIGHT OF THE CLEF MARK.

CLASS 18—LEATHER GOODS

FOR HANDBAGS, BACKPACKS, WALLETS, DUFFLE BAGS, GYM BAGS, AND LUGGAGE (U.S. CLS. 1, 2, 3, 22 AND 41).

CLASS 25—CLOTHING

FOR CLOTHING, NAMELY, JEANS, SHIRTS, SKIRTS, DRESSES, PANTS AND SHORTS (U.S. CLS. 22 AND 39).
LAURA HAMMEL, EXAMINING ATTORNEY

SN 78-967,509. EVENT RENTALS, INC., EL SEGUNDO, CA.
FILED 9-5-2006.

CLASSIC PARTY RENTALS

THE MARK CONSISTS OF STANDARD CHARACTERS WITHOUT CLAIM TO ANY PARTICULAR FONT, STYLE, SIZE, OR COLOR.

NO CLAIM IS MADE TO THE EXCLUSIVE RIGHT TO USE "PARTY RENTALS", APART FROM THE MARK AS SHOWN.

CLASS 35—ADVERTISING AND BUSINESS

FOR RENTAL OF EXHIBITION BOOTHS COMPRISED OF PIPES AND DRAPES, INCLUDING RESPECTIVE EQUIPMENT, FOR USE AT SPECIAL EVENTS, PARTIES, CONVENTIONS, MEETINGS AND TRADESHOWS (U.S. CLS. 100, 101 AND 102).

FIRST USE 8-0-1981; IN COMMERCE 7-0-1992.

CLASS 39—TRANSPORTATION AND STORAGE

FOR RENTAL OF REFRIGERATORS FOR COMMERCIAL USE; RENTAL OF ELECTRICITY DISTRIBUTION EQUIPMENT FOR USE AT SPECIAL EVENTS, PARTIES, CONVENTIONS, MEETINGS AND TRADESHOWS; SHIPPING AND DELIVERY SERVICES, NAMELY, PICKUP, TRANSPORTATION, AND DELIVERY OF PIPING AND DRAPING, AIR CONDITIONING APPARATUS, SPACE HEATING AND COOLING APPARATUS, POWER-GENERATING EQUIPMENT, PORTABLE STAGES, DANCE FLOORS, EVENT SCENERY, NAMELY, ARCHES, FURNITURE, TENTS, CANOPIES, TABLE LINENS, FOOD SERVICE EQUIPMENT FOR CATERING, MACHINES AND APPARATUS FOR PROCESSING FOODS OR BEVERAGES, SILVERWARE, CHINA, GLASSWARE AND FLATWARE FOR USE AT SPECIAL EVENTS, PARTIES, CONVENTIONS, MEETINGS AND TRADESHOWS, BY VARIOUS MODES OF TRANSPORTATION (U.S. CLS. 100 AND 105).

FIRST USE 8-0-1981; IN COMMERCE 7-0-1992.

CLASS 40—MATERIAL TREATMENT

FOR RENTAL OF AIR CONDITIONING APPARATUS, SPACE HEATING AND COOLING APPARATUS, MACHINES AND APPARATUS FOR PROCESSING FOODS OR BEVERAGES, AND POWER-GENERATING EQUIPMENT, FOR USE AT SPECIAL EVENTS, PARTIES, CONVENTIONS, MEETINGS AND TRADESHOWS (U.S. CLS. 100, 103 AND 106).

FIRST USE 8-0-1981; IN COMMERCE 7-0-1992.

CLASS 41—EDUCATION AND ENTERTAINMENT

FOR RENTAL OF PORTABLE STAGES, DANCE FLOORS, LIGHTING PRODUCTION EQUIPMENT, AND EVENT SCENERY, NAMELY, TEMPORARY ARCHES, FOR USE AT SPECIAL EVENTS, PARTIES, CONVENTIONS, MEETINGS AND TRADESHOWS; RENTAL OF SHOW SCENERY, NAMELY, PIPING AND DRAPING FOR USE AT SPECIAL EVENTS, PARTIES, CONVENTIONS, MEETINGS AND TRADESHOWS (U.S. CLS. 100, 101 AND 107).

FIRST USE 8-0-1981; IN COMMERCE 7-0-1992.

CLASS 43—HOTEL AND RESTAURANT SERVICES

FOR RENTAL OF FURNITURE, TENTS, CANOPIES, TABLE LINENS, FOOD SERVICE EQUIPMENT FOR CATERING, SILVERWARE, CHINA, GLASSWARE AND FLATWARE, FOR USE AT SPECIAL EVENTS, PARTIES, CONVENTIONS, MEETINGS AND TRADESHOWS; RENTAL OF KITCHEN APPLIANCES, NAMELY, BARBECUES, ELECTRIC AND GAS GRILLS, ELECTRIC AND GAS COOKING OVENS, GRIDDLES, DEEP FRYING MACHINES AND APPARATUS FOR COOKING, NAMELY, COOKTOPS; RENTAL OF FOOD SERVICE EQUIPMENT, NAMELY, FOOD CARTS AND ROLLING BAKER'S RACKS (U.S. CLS. 100 AND 101).

FIRST USE 8-0-1981; IN COMMERCE 7-0-1992.

MICHAEL GAFFAR, EXAMINING ATTORNEY

SN 78-967,519. EVENT RENTALS, INC., EL SEGUNDO, CA.
FILED 9-5-2006.

CLASSIC TENTS

THE MARK CONSISTS OF STANDARD CHARACTERS WITHOUT CLAIM TO ANY PARTICULAR FONT, STYLE, SIZE, OR COLOR.

NO CLAIM IS MADE TO THE EXCLUSIVE RIGHT TO USE "TENTS", APART FROM THE MARK AS SHOWN.

CLASS 39—TRANSPORTATION AND STORAGE

FOR RENTAL OF REFRIGERATORS FOR COMMERCIAL USE; RENTAL OF ELECTRICITY DISTRIBUTION EQUIPMENT FOR USE AT SPECIAL EVENTS, PARTIES, CONVENTIONS, MEETINGS AND TRADESHOWS (U.S. CLS. 100 AND 105).

FIRST USE 11-0-2005; IN COMMERCE 11-0-2005.

CLASS 40—MATERIAL TREATMENT

FOR RENTAL OF AIR CONDITIONING APPARATUS, SPACE HEATING AND COOLING APPARATUS, MACHINES AND APPARATUS FOR PROCESSING FOODS OR BEVERAGES, AND POWER-GENERATING EQUIPMENT, FOR USE AT SPECIAL EVENTS, PARTIES, CONVENTIONS, MEETINGS AND TRADESHOWS (U.S. CLS. 100, 103 AND 106).

FIRST USE 11-0-2005; IN COMMERCE 11-0-2005.

CLASS 41—EDUCATION AND ENTERTAINMENT

FOR RENTAL OF VIDEO SCREENS, PORTABLE STAGES, DANCE FLOORS, LIGHTING PRODUCTION EQUIPMENT AND EVENT SCENERY, NAMELY, TEMPORARY ARCHES, FOR USE AT SPECIAL EVENTS, PARTIES, CONVENTIONS, MEETINGS AND TRADESHOWS (U.S. CLS. 100, 101 AND 107).

FIRST USE 11-0-2005; IN COMMERCE 11-0-2005.

CLASS 43—HOTEL AND RESTAURANT SERVICES

FOR RENTAL OF FURNITURE, TENTS, CANOPIES, TABLE LINENS, BED AND BATH LINENS, FOOD SERVICE EQUIPMENT FOR CATERING, SILVERWARE, CHINA, GLASSWARE AND FLATWARE, FOR USE AT SPECIAL EVENTS, PARTIES, CONVENTIONS, MEETINGS AND TRADESHOWS; RENTAL OF KITCHEN APPLIANCES, NAMELY, BARBECUES, ELECTRIC AND GAS GRILLS, ELECTRIC AND GAS COOKING OVENS, GRIDDLES, DEEP FRYING MACHINES, AND APPARATUS FOR COOKING, NAMELY, COOKTOPS; RENTAL OF FOOD SERVICE EQUIPMENT, NAMELY, FOOD CARTS AND ROLLING BAKER'S RACKS (U.S. CLS. 100 AND 101).

FIRST USE 11-0-2005; IN COMMERCE 11-0-2005.
MICHAEL GAAFAR, EXAMINING ATTORNEY

SN 78-967,529. EVENT RENTALS, INC., EL SEGUNDO, CA.
FILED 9-5-2006.

DUCKY-BOB'S

THE MARK CONSISTS OF STANDARD CHARACTERS WITHOUT CLAIM TO ANY PARTICULAR FONT, STYLE, SIZE, OR COLOR.

THE NAME(S), PORTRAIT(S), AND/OR SIGNATURE(S) SHOWN IN THE MARK DOES NOT IDENTIFY A PARTICULAR LIVING INDIVIDUAL.

CLASS 39—TRANSPORTATION AND STORAGE

FOR RENTAL OF REFRIGERATORS FOR COMMERCIAL USE; RENTAL OF ELECTRICITY DISTRIBUTION EQUIPMENT FOR USE AT SPECIAL EVENTS, PARTIES, CONVENTIONS, MEETINGS AND TRADESHOWS (U.S. CLS. 100 AND 105).

FIRST USE 1-0-1973; IN COMMERCE 5-0-1973.

CLASS 40—MATERIAL TREATMENT

FOR RENTAL OF AIR CONDITIONING APPARATUS, SPACE HEATING AND COOLING APPARATUS, MACHINES AND APPARATUS FOR PROCESSING FOODS OR BEVERAGES, AND POWER-GENERATING EQUIPMENT, FOR USE AT SPECIAL EVENTS, PARTIES, CONVENTIONS, MEETINGS AND TRADESHOWS (U.S. CLS. 100, 103 AND 106).

FIRST USE 1-0-1973; IN COMMERCE 5-0-1973.

CLASS 41—EDUCATION AND ENTERTAINMENT

FOR RENTAL OF PORTABLE STAGES, DANCE FLOORS, LIGHTING PRODUCTION EQUIPMENT AND EVENT SCENERY, NAMELY, TEMPORARY ARCHES, FOR USE AT SPECIAL EVENTS, PARTIES, CONVENTIONS, MEETINGS AND TRADESHOWS (U.S. CLS. 100, 101 AND 107).

FIRST USE 1-0-1973; IN COMMERCE 5-0-1973.

CLASS 43—HOTEL AND RESTAURANT SERVICES

FOR RENTAL OF FURNITURE, TENTS, CANOPIES, TABLE LINENS, FOOD SERVICE EQUIPMENT FOR CATERING, SILVERWARE, CHINA, GLASSWARE AND FLATWARE, FOR USE AT SPECIAL EVENTS, PARTIES, CONVENTIONS, MEETINGS AND TRADESHOWS; RENTAL OF KITCHEN APPLIANCES, NAMELY, BARBECUES, ELECTRIC AND GAS GRILLS, ELECTRIC AND GAS COOKING OVENS, GRIDDLES, DEEP FRYING MACHINES AND APPARATUS FOR COOKING, NAMELY, COOKTOPS; RENTAL OF FOOD SERVICE EQUIPMENT, NAMELY, FOOD CARTS AND ROLLING BAKER'S RACKS (U.S. CLS. 100 AND 101).

FIRST USE 1-0-1973; IN COMMERCE 5-0-1973.
MICHAEL GAAFAR, EXAMINING ATTORNEY

SN 78-967,963. EVENT RENTALS, INC., EL SEGUNDO, CA.
FILED 9-6-2006.

TRI-RENTALS

THE MARK CONSISTS OF STANDARD CHARACTERS WITHOUT CLAIM TO ANY PARTICULAR FONT, STYLE, SIZE, OR COLOR.

THE WORDING "TRI" OR "TRI-RENTALS" HAS NO MEANING IN A FOREIGN LANGUAGE.

CLASS 39—TRANSPORTATION AND STORAGE

FOR RENTAL OF REFRIGERATORS FOR COMMERCIAL USE; RENTAL OF ELECTRICITY DISTRIBUTION EQUIPMENT FOR USE AT SPECIAL EVENTS, PARTIES, CONVENTIONS, MEETINGS AND TRADESHOWS (U.S. CLS. 100 AND 105).

FIRST USE 7-0-1973; IN COMMERCE 10-0-1988.

CLASS 40—MATERIAL TREATMENT

FOR RENTAL OF AIR CONDITIONING APPARATUS, SPACE HEATING AND COOLING APPARATUS, MACHINES AND APPARATUS FOR PROCESSING FOODS OR BEVERAGES, AND POWER-GENERATING EQUIPMENT, FOR USE AT SPECIAL EVENTS, PARTIES, CONVENTIONS, MEETINGS AND TRADESHOWS (U.S. CLS. 100, 103 AND 106).

FIRST USE 7-0-1973; IN COMMERCE 10-0-1988.

CLASS 41—EDUCATION AND ENTERTAINMENT

FOR RENTAL OF PORTABLE STAGES, DANCE FLOORS, LIGHTING PRODUCTION EQUIPMENT AND EVENT SCENERY, NAMELY, TEMPORARY ARCHES, FOR USE AT SPECIAL EVENTS, PARTIES, CONVENTIONS, MEETINGS AND TRADESHOWS (U.S. CLS. 100, 101 AND 107).

FIRST USE 7-0-1973; IN COMMERCE 10-0-1988.

CLASS 43—HOTEL AND RESTAURANT SERVICES

FOR RENTAL OF FURNITURE, TENTS, CANOPIES, TABLE LINENS, FOOD SERVICE EQUIPMENT FOR CATERING, SILVERWARE, CHINA, GLASSWARE AND FLATWARE, FOR USE AT SPECIAL EVENTS, PARTIES, CONVENTIONS, MEETINGS AND TRADESHOWS; RENTAL OF KITCHEN APPLIANCES, NAMELY, BARBECUES, ELECTRIC AND GAS GRILLS, ELECTRIC AND GAS COOKING OVENS, GRIDDLES, DEEP FRYING MACHINES AND APPARATUS FOR COOKING, NAMELY, COOKTOPS; RENTAL OF FOOD SERVICE EQUIPMENT, NAMELY, FOOD CARTS AND ROLLING BAKER'S RACKS (U.S. CLS. 100 AND 101).

FIRST USE 7-0-1973; IN COMMERCE 10-0-1988.
MICHAEL GAFFAR, EXAMINING ATTORNEY

CLASS 43—HOTEL AND RESTAURANT SERVICES

FOR RENTAL OF FURNITURE, TENTS, CANOPIES, TABLE LINENS, FOOD SERVICE EQUIPMENT FOR CATERING, SILVERWARE, CHINA, GLASSWARE, AND FLATWARE, FOR USE AT SPECIAL EVENTS, PARTIES, CONVENTIONS, MEETINGS AND TRADESHOWS; RENTAL OF KITCHEN APPLIANCES, NAMELY, BARBECUES, ELECTRIC AND GAS GRILLS, ELECTRIC AND GAS COOKING OVENS, GRIDDLES, DEEP FRYING MACHINES AND APPARATUS FOR COOKING, NAMELY, COOKTOPS; RENTAL OF FOOD SERVICE EQUIPMENT, NAMELY, FOOD CARTS AND ROLLING BAKER'S RACKS (U.S. CLS. 100 AND 101).

FIRST USE 10-0-2004; IN COMMERCE 10-0-2004.
MICHAEL GAFFAR, EXAMINING ATTORNEY

SN 78-968,006. EVENT RENTALS, INC., EL SEGUNDO, CA.
FILED 9-6-2006.

SN 78-971,301. KEYTEL, S.A., BARCELONA, SPAIN, FILED
9-11-2006.

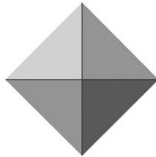
KEYTEL PRESTIGE HOTELS OF THE WORLD

THE MARK CONSISTS OF STANDARD CHARACTERS WITHOUT CLAIM TO ANY PARTICULAR FONT, STYLE, SIZE, OR COLOR.

PRIORITY CLAIMED UNDER SEC. 44(D) ON ERPNCMNTY TM OFC APPLICATION NO. 5235551, FILED 8-2-2006, REG. NO. 005235551, DATED 9-27-2007, EXPIRES 8-2-2016.

NO CLAIM IS MADE TO THE EXCLUSIVE RIGHT TO USE "HOTELS", APART FROM THE MARK AS SHOWN.

CLASS 39—TRANSPORTATION AND STORAGE

FOR RENTAL OF REFRIGERATORS FOR COMMERCIAL USE; RENTAL OF ELECTRICITY DISTRIBUTION EQUIPMENT FOR USE AT SPECIAL EVENTS, PARTIES, CONVENTIONS, MEETINGS AND TRADESHOWS (U.S. CLS. 100 AND 105).

FIRST USE 10-0-2004; IN COMMERCE 10-0-2004.

CLASS 40—MATERIAL TREATMENT

FOR RENTAL OF AIR CONDITIONING APPARATUS, SPACE HEATING AND COOLING APPARATUS, MACHINES AND APPARATUS FOR PROCESSING FOODS OR BEVERAGES AND POWER-GENERATING EQUIPMENT, FOR USE AT SPECIAL EVENTS, PARTIES, CONVENTIONS, MEETINGS AND TRADESHOWS (U.S. CLS. 100, 103 AND 106).

FIRST USE 10-0-2004; IN COMMERCE 10-0-2004.

CLASS 41—EDUCATION AND ENTERTAINMENT

FOR RENTAL OF PORTABLE STAGES, DANCE FLOORS, LIGHTING PRODUCTION EQUIPMENT AND EVENT SCENERY, NAMELY, TEMPORARY ARCHES, FOR USE AT SPECIAL EVENTS, PARTIES, CONVENTIONS, MEETINGS AND TRADESHOWS (U.S. CLS. 100, 101 AND 107).

FIRST USE 10-0-2004; IN COMMERCE 10-0-2004.

CLASS 35—ADVERTISING AND BUSINESS

FOR ADVERTISING SERVICES; BUSINESS MANAGEMENT; ORGANIZATION OF TRADE FAIRS AND EXHIBITIONS FOR COMMERCIAL OR ADVERTISING PURPOSES; RENTAL OF ADVERTISING SPACE; BUSINESS MANAGEMENT CONSULTANCY, IN PARTICULAR IN THE HOTEL SECTOR; ADMINISTRATIVE MANAGEMENT OF HOTELS; SALES PROMOTION OF HOTEL BOOKING FOR OTHERS; BUSINESS EVALUATION, MANAGEMENT AND CONSULTATION RELATING TO THE TRAVEL INDUSTRY AND HOTEL; RELOCATION SERVICES FOR BUSINESSES; DISSEMINATION OF ADVERTISING TEXTS; REPRESENTATIVES OF HOTELS, NAMELY, INDEPENDENT SALES REPRESENTATIVES IN THE FIELD OF HOTELS (U.S. CLS. 100, 101 AND 102).

CLASS 43—HOTEL AND RESTAURANT SERVICES

FOR HOTEL SERVICES; RENTAL AND RESERVATION OF HOTELS AND GUEST HOUSES; ACCOMMODATION SERVICES, NAMELY, PROVIDING TEMPORARY HOTEL AND LODGING ACCOMMODATIONS AND PROVIDING OF FOOD AND DRINK; TEMPORARY ACCOMMODATIONS; HOTEL ACCOMMODATION AGENCIES; TEMPORARY ACCOMMODATION RENTAL AND RESERVATIONS AND TRAVEL AGENCIES FOR MAKING TEMPORARY LODGING RESERVATIONS AND ACCOMMODATIONS AND INTERMEDIARIES WHO ASSURE RESERVATIONS FOR ACCOMMODATION, AND CONSULTANCY AND INFORMATION RELATING TO ACCOMMODATION; RENTAL OF MEETING ROOMS; BAR SERVICES; CAFÉ-RESTAURANTS; CAFETERIAS; SNACK-BARS (U.S. CLS. 100 AND 101).

RON FAIRBANKS, EXAMINING ATTORNEY

SN 78-972,299. MICHAEL GRAVES DESIGN GROUP, INC.,
PRINCETON, NJ. FILED 9-12-2006.

MICHAEL GRAVES SOLUTIONS

THE MARK CONSISTS OF STANDARD CHARACTERS WITHOUT CLAIM TO ANY PARTICULAR FONT, STYLE, SIZE, OR COLOR.

OWNER OF U.S. REG. NOS. 2,770,554, 3,164,407 AND OTHERS.

THE NAME "MICHAEL GRAVES" IDENTIFIES A LIVING INDIVIDUAL WHOSE CONSENT IS OF RECORD.

CLASS 6—METAL GOODS

FOR METAL BATH TUB RAILS AND COVERS SOLD BOTH INDIVIDUALLY AND AS A SET; METAL BED RAILS; METAL GRAB BARS FOR USE IN BATHROOMS (U.S. CLS. 2, 12, 13, 14, 23, 25 AND 50).

CLASS 8—HAND TOOLS

FOR PARING KNIVES; PIZZA CUTTERS; NON-ELECTRIC CAN OPENERS; CHEESE SLICERS (U.S. CLS. 23, 28 AND 44).

CLASS 10—MEDICAL APPARATUS

FOR INVALID WALKERS; ROLLATORS; POUCHES AND BASKETS FOR USE IN CONNECTION WITH INVALID WALKERS AND ROLLATORS; CANES FOR MEDICAL USE; CRUTCHES; MEDICAL INSTRUMENT STANDS; ELECTRICALLY ACTIVATED HEATING PADS FOR MEDICAL PURPOSES; BATH BOARDS, BATH TUB STOOLS, BATH CHAIRS, BATH BENCHES, SHOWER STOOLS, SHOWER CHAIRS BATH AND SHOWER TRANSFER BENCHES, ALL FOR MEDICAL PURPOSES (U.S. CLS. 26, 39 AND 44).

CLASS 11—ENVIRONMENTAL CONTROL APPARATUS

FOR SHOWER HEADS; SHOWER MASSAGERS; TOILETS; PORTABLE TOILETS; TOILET SEAT RAISERS; TOILET SEATS; SOFT CUSHIONS FOR TOILET CHAIRS; LAMPS (U.S. CLS. 13, 21, 23, 31 AND 34).

CLASS 12—VEHICLES

FOR MOTORIZED AND NON-MOTORIZED WHEELCHAIRS; MOTORIZED SCOOTERS; LIFT CHAIRS (U.S. CLS. 19, 21, 23, 31, 35 AND 44).

CLASS 20—FURNITURE AND ARTICLES NOT OTHERWISE CLASSIFIED

FOR HOSPITAL BEDS; HOMECARE BEDS; NON-METAL BATH TUB RAILS AND COVERS SOLD BOTH INDIVIDUALLY AND AS A SET; NON-METAL BED RAILS; NON-METAL GRAB BARS FOR USE IN BATHROOMS; BEDSIDE TABLES; TABLES FOR USE IN CONNECTION WITH HOSPITAL BEDS (U.S. CLS. 2, 13, 22, 25, 32 AND 50).

CLASS 21—HOUSEWARES AND GLASS

FOR COOKING TOOLS AND HOUSEHOLD UTENSILS, NAMELY, SPATULAS, WHISKS, GRATERS, NON-ELECTRIC FRUIT AND VEGETABLE PEELERS, GARLIC PRESSES, SERVING TONGS, SERVING LADLES, VEGETABLE MASHERS, AND BASTING, SERVING, AND MIXING COOKING SPOONS; DRESSING AIDS, NAMELY, EXTENDABLE SHOE HORNS, DRESSING STICKS, AND SOCK ASSIST DEVICES, ALL FOR MOBILITY-IMPAIRED INDIVIDUALS (U.S. CLS. 2, 13, 23, 29, 30, 33, 40 AND 50).

CLASS 26—FANCY GOODS

FOR DRESSING AIDS, NAMELY, CLOTHES FASTENERS, BUTTON HOOKS, AND ZIPPER PULLS, ALL FOR MOBILITY-IMPAIRED INDIVIDUALS (U.S. CLS. 37, 39, 40, 42 AND 50).

JEFF DEFORD, EXAMINING ATTORNEY

SN 78-972,308. MICHAEL GRAVES DESIGN GROUP, INC.,
PRINCETON, NJ. FILED 9-12-2006.

MG ORANGE ACTIVATES

THE MARK CONSISTS OF STANDARD CHARACTERS WITHOUT CLAIM TO ANY PARTICULAR FONT, STYLE, SIZE, OR COLOR.

OWNER OF U.S. REG. NOS. 2,770,554, 3,164,407 AND OTHERS.

CLASS 6—METAL GOODS

FOR METAL BATH TUB RAILS AND COVERS SOLD BOTH INDIVIDUALLY AND AS A SET; METAL BED RAILS; METAL GRAB BARS FOR USE IN BATHROOMS (U.S. CLS. 2, 12, 13, 14, 23, 25 AND 50).

CLASS 8—HAND TOOLS

FOR PARING KNIVES; PIZZA CUTTERS; NON-ELECTRIC CAN OPENERS; CHEESE SLICERS (U.S. CLS. 23, 28 AND 44).

CLASS 10—MEDICAL APPARATUS

FOR INVALID WALKERS; ROLLATORS; POUCHES AND BASKETS FOR USE IN CONNECTION WITH INVALID WALKERS AND ROLLATORS; CANES FOR MEDICAL USE; CRUTCHES; MEDICAL INSTRUMENT STANDS; ELECTRICALLY ACTIVATED HEATING PADS FOR MEDICAL PURPOSES; BATH BOARDS, BATH TUB STOOLS, BATH CHAIRS, BATH BENCHES, SHOWER STOOLS, SHOWER CHAIRS BATH AND SHOWER TRANSFER BENCHES, ALL FOR MEDICAL PURPOSES (U.S. CLS. 26, 39 AND 44).

CLASS 11—ENVIRONMENTAL CONTROL APPARATUS

FOR SHOWER HEADS; SHOWER MASSAGERS; TOILETS; PORTABLE TOILETS; TOILET SEAT RAISERS; TOILET SEATS; SOFT CUSHIONS FOR TOILET CHAIRS; LAMPS (U.S. CLS. 13, 21, 23, 31 AND 34).

CLASS 12—VEHICLES

FOR MOTORIZED AND NON-MOTORIZED WHEELCHAIRS; MOTORIZED SCOOTERS; LIFT CHAIRS (U.S. CLS. 19, 21, 23, 31, 35 AND 44).

CLASS 20—FURNITURE AND ARTICLES NOT OTHERWISE CLASSIFIED

FOR HOSPITAL BEDS; HOMECARE BEDS; NON-METAL BATH TUB RAILS AND COVERS SOLD BOTH INDIVIDUALLY AND AS A SET; NON-METAL BED RAILS; NON-METAL GRAB BARS FOR USE IN BATHROOMS; BEDSIDE TABLES; TABLES FOR USE IN CONNECTION WITH HOSPITAL BEDS (U.S. CLS. 2, 13, 22, 25, 32 AND 50).

CLASS 21—HOUSEWARES AND GLASS

FOR COOKING TOOLS AND HOUSEHOLD UTENSILS, NAMELY, SPATULAS, WHISKS, GRATERS, NON-ELECTRIC FRUIT AND VEGETABLE PEELERS, GARLIC PRESSES, SERVING TONGS, SERVING LADLES, VEGETABLE MASHERS, AND BASTING, SERVING, AND MIXING COOKING SPOONS; DRESSING AIDS, NAMELY, EXTENDABLE SHOE HORNS, DRESSING STICKS, AND SOCK ASSIST DEVICES, ALL FOR MOBILITY-IMPAIRED INDIVIDUALS (U.S. CLS. 2, 13, 23, 29, 30, 33, 40 AND 50).

CLASS 26—FANCY GOODS

FOR DRESSING AIDS, NAMELY, CLOTHES FASTENERS, BUTTON HOOKS, AND ZIPPER PULLS, ALL FOR MOBILITY-IMPAIRED INDIVIDUALS (U.S. CLS. 37, 39, 40, 42 AND 50).
JEFF DEFORD, EXAMINING ATTORNEY



SN 78-972,497. GLOCO ACCENTS INC., MONTREAL, QUEBEC, CANADA, FILED 9-12-2006.



PRIORITY CLAIMED UNDER SEC. 44(D) ON CANADA APPLICATION NO. 1314778, FILED 8-29-2006, REG. NO. TMA702944, DATED 12-12-2007, EXPIRES 12-12-2022.
THE FOREIGN WORDING IN THE MARK TRANSLATES INTO ENGLISH AS COLOR YOUR OCCASIONS.

CLASS 4—LUBRICANTS AND FUELS

FOR (BASED ON USE IN COMMERCE) (BASED ON 44(E)) COLOR FLAME AND REGULAR FLAME CANDLES; LAMP OIL (U.S. CLS. 1, 6 AND 15).
FIRST USE 5-18-2006; IN COMMERCE 5-18-2006.

CLASS 11—ENVIRONMENTAL CONTROL APPARATUS

FOR (BASED ON INTENT TO USE) (BASED ON 44(E)) TABLE LAMPS (U.S. CLS. 13, 21, 23, 31 AND 34).
ANGELA GAW, EXAMINING ATTORNEY

SN 78-973,016. ASIA ANIMATION LIMITED, KOWLOON, HONG KONG, FILED 9-13-2006.

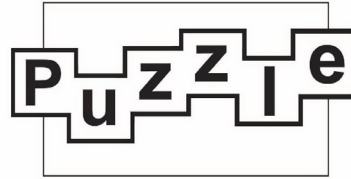

THE MARK CONSISTS OF THE WORD "PUZZLE" WITH THE LETTERS OUTLINED, THEN SURROUNDED BY A RECTANGLE.

CLASS 9—ELECTRICAL AND SCIENTIFIC APPARATUS

FOR VIDEO TAPES WITH ANIMATED CARTOONS; COMPUTER GAME SOFTWARE; VIDEO GAME SOFTWARE; SERIES OF PRE-RECORDED VIDEO AND AUDIO CASSETTES FEATURING CARTOONS; SERIES OF PRE-RECORDED COMPACT DISCS AND DIGITAL VIDEO DISCS FEATURING CARTOONS; ELECTRONIC PUBLICATIONS, NAMELY, MAGAZINES, BOOKS AND MANUALS IN THE FIELD OF VIDEO GAMES, COMPUTER GAMES AND CARTOONS (U.S. CLS. 21, 23, 26, 36 AND 38).

CLASS 41—EDUCATION AND ENTERTAINMENT

FOR PRODUCTION AND DISTRIBUTION OF ANIMATED AND MOTION PICTURE FILMS VIA TELEVISION, INTERNET, SATELLITE BROADCAST; PUBLICATION OF BOOKS, MAGAZINES, COMIC BOOKS; PRODUCTION AND DISTRIBUTION OF MOVIES AND ANIMATED CARTOON PICTURES (U.S. CLS. 100, 101 AND 107).
JIM RINGLE, EXAMINING ATTORNEY



SN 78-973,882. EDIBLE COMMUNITIES, INC., MISSOULA, MT. FILED 9-13-2006.

Edible Communities

THE MARK CONSISTS OF STANDARD CHARACTERS WITHOUT CLAIM TO ANY PARTICULAR FONT, STYLE, SIZE, OR COLOR.
OWNER OF U.S. REG. NO. 3,153,095.
NO CLAIM IS MADE TO THE EXCLUSIVE RIGHT TO USE "COMMUNITIES", APART FROM THE MARK AS SHOWN.

CLASS 9—ELECTRICAL AND SCIENTIFIC APPARATUS

FOR DOWNLOADABLE ELECTRONIC PUBLICATIONS IN THE NATURE OF MAGAZINES AND NEWSLETTERS IN FEATURING THE TOURISM, CULINARY AND AGRICULTURE INDUSTRIES; DOWNLOADABLE ELECTRONIC PUBLICATIONS IN THE NATURE OF MAGAZINES AND NEWSLETTERS FEATURING LOCAL GROWERS, FOOD RETAILERS, CHEFS AND FOOD ARTISANS; ELECTRONIC PUBLICATIONS, NAMELY, MAGAZINES AND NEWSLETTERS FEATURING THE TOURISM, CULINARY AND AGRICULTURE INDUSTRIES RECORDED ON COMPUTER MEDIA; ELECTRONIC PUBLICATIONS, NAMELY, MAGAZINES AND NEWSLETTERS FEATURING LOCAL GROWERS, FOOD RETAILERS, CHEFS AND FOOD ARTISANS RECORDED ON COMPUTER MEDIA (U.S. CLS. 21, 23, 26, 36 AND 38).

FIRST USE 5-4-2002; IN COMMERCE 5-4-2002.

CLASS 16—PAPER GOODS AND PRINTED MATTER

FOR PUBLICATIONS, NAMELY, MAGAZINES AND NEWSLETTERS FEATURING THE TOURISM, CULINARY AND AGRICULTURE INDUSTRIES; PUBLICATIONS, NAMELY, MAGAZINES AND NEWSLETTERS FEATURING LOCAL GROWERS, FOOD RETAILERS, CHEFS AND FOOD ARTISANS (U.S. CLS. 2, 5, 22, 23, 29, 37, 38 AND 50).

FIRST USE 5-4-2002; IN COMMERCE 5-4-2002.

CLASS 25—CLOTHING

FOR SHIRTS, T-SHIRTS, TANK-TOPS, APRONS, CAPS, TOPS (U.S. CLS. 22 AND 39).

FIRST USE 5-4-2002; IN COMMERCE 5-4-2002.

CLASS 41—EDUCATION AND ENTERTAINMENT

FOR PROVIDING ON-LINE PUBLICATIONS IN THE NATURE OF MAGAZINES AND NEWSLETTERS FEATURING THE TOURISM, CULINARY AND AGRICULTURE INDUSTRIES; PROVIDING ON-LINE PUBLICATIONS IN THE NATURE OF MAGAZINES AND NEWSLETTERS FEATURING LOCAL GROWERS, FOOD RETAILERS, CHEFS AND FOOD ARTISANS (U.S. CLS. 100, 101 AND 107).

FIRST USE 5-4-2002; IN COMMERCE 5-4-2002.

SAIMA MAKHDOOM, EXAMINING ATTORNEY

SN 78-974,181. IDEO INC., PALO ALTO, CA. FILED 9-14-2006.

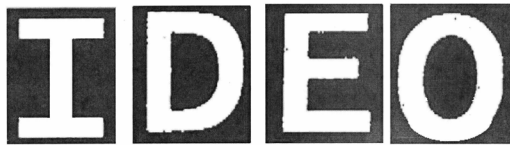

OWNER OF U.S. REG. NO. 2,329,001.

CLASS 35—ADVERTISING AND BUSINESS

FOR BUSINESS MANAGEMENT CONSULTATION SERVICES IN THE FIELD OF THE DESIGN AND DEVELOPMENT OF PROCESSES FOR THE ANALYSIS AND THE IMPLEMENTATION OF STRATEGY PLANS AND MANAGEMENT PROJECTS; CONSULTATION SERVICES IN THE FIELD OF BUSINESS PROCESS RE-ENGINEERING; BUSINESS ORGANIZATION AND OPERATION CONSULTANCY; BUSINESS CONSULTATION REGARDING MARKETING ACTIVITIES AND LAUNCHING OF NEW PRODUCTS (U.S. CLS. 100, 101 AND 102).

FIRST USE 1-0-2002; IN COMMERCE 1-0-2002.

CLASS 41—EDUCATION AND ENTERTAINMENT

FOR EDUCATIONAL SERVICES IN THE NATURE OF SEMINARS, WORKSHOPS, AND CONFERENCES IN THE FIELD OF BUSINESS PROCESS RE-ENGINEERING, NEW PRODUCT DESIGN, DEVELOPMENT AND TESTING, NEW PRODUCT MARKETING, INTERIOR RETAIL SPACE AND MERCHANDISE DISPLAY DESIGN (U.S. CLS. 100, 101 AND 107).

FIRST USE 1-0-2002; IN COMMERCE 1-0-2002.

CLASS 42—SCIENTIFIC AND COMPUTER SERVICES

FOR CONSULTANCY IN THE FIELD OF SOFTWARE DESIGN; CONSULTING SERVICES IN THE FIELD OF THE DESIGN AND DEVELOPMENT OF MULTIMEDIA PRODUCTS; CONSULTING SERVICES IN THE FIELD OF NEW PRODUCT DESIGN AND DEVELOPMENT; CONSULTING SERVICES IN THE FIELD OF THE DESIGN OF MECHANICAL AND ELECTROMECHANICAL APPARATUS AND INSTRUMENTS; TECHNOLOGY CONSULTATION IN THE FIELD OF CONSUMER ELECTRONICS AND COMPUTERS (U.S. CLS. 100 AND 101).

FIRST USE 1-0-2002; IN COMMERCE 1-0-2002.

DAVID COLLIER, EXAMINING ATTORNEY

SN 78-977,864. RICOH COMPANY, LTD., TOKYO, JAPAN, FILED 1-25-2006.

CREATE, SHARE & THINK AS
ONE

THE MARK CONSISTS OF STANDARD CHARACTERS WITHOUT CLAIM TO ANY PARTICULAR FONT, STYLE, SIZE, OR COLOR.

PRIORITY CLAIMED UNDER SEC. 44(D) ON JAPAN APPLICATION NO. 2006-004533, FILED 1-23-2006, REG. NO. 5083018, DATED 10-12-2007, EXPIRES 10-12-2017.

CLASS 35—ADVERTISING AND BUSINESS

FOR ADVERTISING AND PUBLICITY; BUSINESS MANAGEMENT ANALYSIS AND BUSINESS CONSULTANCY REGARDING INFORMATION SECURITIES MANAGEMENT SYSTEM; BUSINESS CONSULTANCY REGARDING INTRODUCTION OF INFORMATION TECHNOLOGY; BUSINESS MANAGEMENT ANALYSIS AND BUSINESS CONSULTANCY; MARKETING RESEARCH; PROVIDING INFORMATION ON COMMODITY SALES REGARDING PRINTERS, FACSIMILE MACHINES, ELECTRONIC COPYING MACHINES WITH MULTI-FUNCTIONS OF PRINTER, SCANNER AND FACSIMILE MACHINE AND COMPUTER SOFTWARE FOR ELECTRONIC COPYING MACHINES AND PRINTERS; RECORDS MANAGEMENT SERVICES, NAMELY, DOCUMENT INDEXING; RENTAL OF OFFICE EQUIPMENT, NAMELY, TYPEWRITERS AND COPYING MACHINES/WORD PROCESSORS (U.S. CLS. 100, 101 AND 102).

CLASS 42—SCIENTIFIC AND COMPUTER SERVICES

FOR DESIGN, PROGRAMMING AND MAINTENANCE OF COMPUTER SOFTWARE FOR ELECTRONIC COPYING MACHINES; INK-JET PRINTERS AND LASER-BEAM PRINTERS; COMPUTER SOFTWARE DESIGN, COMPUTER PROGRAMMING, MAINTENANCE OF COMPUTER SOFTWARE; CONSULTANCY REGARDING DESIGN AND CREATION OF COMPUTER SYSTEMS FOR ELECTRONIC COPYING MACHINES; RENTAL OF COMPUTERS; PROVIDING ON-LINE NON-DOWNLOADABLE SOFTWARE FOR CONNECTING PERSONAL COMPUTERS WITH PRINTERS, FACSIMILE MACHINES AND ELECTRONIC COPYING MACHINES WITH MULTI-FUNCTIONS OF PRINTER, SCANNER AND FACSIMILE MACHINE (U.S. CLS. 100 AND 101).

CURTIS FRENCH, EXAMINING ATTORNEY

SN 78-979,304. LEÓN, MAYER & CO., MIAMI, FL. FILED 1-25-2006.

LM

THE MARK CONSISTS OF STANDARD CHARACTERS WITHOUT CLAIM TO ANY PARTICULAR FONT, STYLE, SIZE, OR COLOR.

CLASS 43—HOTEL AND RESTAURANT SERVICES

FOR HOTELS; HOTEL SERVICES; CONDOMINIUM HOTELS; RESTAURANTS; BARS; SPA SERVICES, NAMELY, PROVIDING TEMPORARY ACCOMMODATIONS AND FOOD OR DRINK TO CLIENTS OF A SPA (U.S. CLS. 100 AND 101).

CLASS 44—MEDICAL, BEAUTY AND AGRICULTURAL SERVICES

FOR SPA SERVICES, NAMELY, SPA HYGIENIC OR BEAUTY CARE FOR HUMAN BEINGS OR ANIMALS (U.S. CLS. 100 AND 101).

JULIE WATSON, EXAMINING ATTORNEY

SN 78-979,653. RETAIL LICENSING COMPANY, LAS VEGAS, NV. FILED 10-19-2005.

M+O

THE MARK CONSISTS OF STANDARD CHARACTERS WITHOUT CLAIM TO ANY PARTICULAR FONT, STYLE, SIZE, OR COLOR.

CLASS 3—COSMETICS AND CLEANING PREPARATIONS

FOR PERSONAL CARE PRODUCTS AND COSMETICS, NAMELY, SHAVING BALM, SHAVING CREAM, SHAVING GEL, SHAVING LOTION, SHOWER GEL, NON-MEDICATED LIP BALM, LIP GLOSS, LIPSTICK, BATH GEL, BATH OIL, BATH POWDER, NON-MEDICATED BATH SALTS, BEAUTY MASKS, BLUSHER, BODY CREAM, BODY OIL, BODY POWDER, BUBBLE BATH, COSMETICS, NAMELY, COMPACTS, HAIR CONDITIONERS, HAND CREAM, NIGHT CREAM, SKIN CLEANSING CREAM, SKIN CREAM, DEODORANT SOAP, PERSONAL DEODORANTS, DEODORANTS AND ANTIPERSPIRANTS, EMERY BOARDS, NAIL ENAMEL, NAIL POLISH, EYE CREAM, EYE MAKEUP, EYE PENCILS, EYELINERS, MASCARA, FACIAL SCRUBS, HAIR LOTIONS, FACIAL LOTIONS, BODY LOTIONS, HAIR WAVING LOTIONS, MAKEUP, FACIAL MAKEUP, MASSAGE OIL, ESSENTIAL OIL FOR PERSONAL USE, FACE POWDER, TALCUM POWDER, HAIR SHAMPOO, SKIN CLARIFIERS, SKIN CLEANSING CREAM, SKIN CLEANSING LOTION, SKIN LOTIONS, SKIN MOISTURIZERS, SKIN SOAP, LIQUID SOAPS FOR HANDS, FACE AND BODY, SUN BLOCK PREPARATIONS, SUN SCREEN PREPARATIONS AND FRAGRANCES, NAMELY, PERFUME AND COLOGNE (U.S. CLS. 1, 4, 6, 50, 51 AND 52).

CLASS 14—JEWELRY

FOR JEWELRY; WATCHES, NAMELY, STOP WATCHES AND WRISTWATCHES; MONEY CLIPS MADE OF PRECIOUS METAL; CLOCKS (U.S. CLS. 2, 27, 28 AND 50).

CLASS 18—LEATHER GOODS

FOR ATHLETIC BAGS, ALL PURPOSE ATHLETIC BAGS, BABY BACKPACKS, BABY CARRIERS WORN ON THE BODY, BACKPACKS, ALL PURPOSE SPORTS BAGS, BEACH BAGS, BOOK BAGS, CARRY-ON BAGS, DIAPER BAGS, DUFFEL BAGS, GYM BAGS, OVERNIGHT BAGS, TOTE BAGS, TRAVEL BAGS, TRAVELING BAGS, CLUTCH BAGS, CLUTCH PURSES, CLUTCHES, PURSES, COIN PURSES, WAIST PACKS, POCKETBOOKS, BRIEFCASE-TYPE PORTFOLIOS, CHANGE PURSES, RUCKSACKS, SCHOOL BOOK BAGS, SHOULDER BAGS, DRAWSTRING POUCHES, FANNY PACKS, HANDBAGS, HAVERSACKS, KNAPSACKS, BOSTON BAGS AND BRIEFCASES; WALLETS, BILLFOLDS, BUSINESS CARD CASES, CALLING CARD CASES, DOCUMENT CASES, OVERNIGHT CASES, BANK NOTE HOLDERS AND WALLETS AND CREDIT CARD CASES; COSMETIC CASES SOLD EMPTY, TOILETRY CASES SOLD EMPTY; LUGGAGE, SUITCASES, AND LUGGAGE TAGS; UMBRELLAS AND GOLF UMBRELLAS (U.S. CLS. 1, 2, 3, 22 AND 41).

CLASS 28—TOYS AND SPORTING GOODS

FOR TOYS, GAMES, AND SPORTING GOODS, NAMELY, SNOWBOARDS, SKATEBOARDS, YO YO'S, FOOTBAGS, BOOMERANGS AND THROWABLE DISC-SHAPED TOY PROJECTILES (U.S. CLS. 22, 23, 38 AND 50).

CLASS 35—ADVERTISING AND BUSINESS

FOR RETAIL STORE SERVICES, MAIL ORDER SERVICES, CATALOG ORDERING SERVICES AND ELECTRONIC RETAIL STORE SERVICES USING A GLOBAL COMPUTER AND COMMUNICATIONS NETWORK ALL IN THE FIELD OF LUGGAGE, BACKPACKS, WAISTPACKS, ATHLETIC BAGS, PURSES, WALLETS, UMBRELLAS, PERFUME AND FRAGRANCES, TOILETRIES, COSMETICS, HAIR CARE PREPARATIONS, SHAMPOOS, CONDITIONERS, HAIR BRUSHES, SKIN LOTIONS, BODY SOAPS AND CLEANSERS, PERSONAL CARE PRODUCTS, SUNGLASSES, CANDLES, TOYS, GAMES, SPORTING GOODS, WRISTWATCHES, JEWELRY, STATIONERY, POSTERS, PICTORIAL, ART AND COLOR PRINTS, CALENDARS AND TRAVEL DIARIES, PENS, PENCILS, PORTFOLIOS, NOTEPADS, GREETING CARDS, NOTE CARDS, AUDIO PLAYERS AND RECORDERS, COMPASSES, THERMOMETERS FOR MEASURING ENVIRONMENTAL TEMPERATURE AND FLASHLIGHTS (U.S. CLS. 100, 101 AND 102).

CLASS 36—INSURANCE AND FINANCIAL

FOR FINANCIAL, FINANCIALLY-RELATED, ELECTRONIC AND ONLINE-IMPLEMENTED FINANCIAL AND CARD-IMPLEMENTED SERVICES, NAMELY, CHARGE CARD SERVICES, CREDIT CARD SERVICES, ISSUING STORED-VALUE CARDS, ELECTRONIC FUNDS TRANSFER SERVICES, ELECTRONIC DEBIT AND CREDIT TRANSACTION SERVICES, ELECTRONIC CASH TRANSACTION SERVICES, CASH DISBURSEMENT SERVICES, ELECTRONIC CASH DEPOSIT TRANSACTION SERVICES, ELECTRONIC PAYMENT SERVICES IN THE NATURE OF ELECTRONIC PROCESSING AND TRANSMISSION OF BILL PAYMENT DATA, ELECTRONIC CURRENCY EXCHANGE SERVICES, POINT-OF-SALE AND POINT-OF-TRANSACTION ELECTRONIC PAYMENT SERVICES IN THE NATURE OF ELECTRONIC PROCESSING AND TRANSMISSION OF BILL PAYMENT DATA (U.S. CLS. 100, 101 AND 102).
DAVID YONTEF, EXAMINING ATTORNEY

SN 78-979,677. TRG ACCESSORIES, LLC, ST. LOUIS, MO. FILED 5-4-2006.

ETA

THE MARK CONSISTS OF STANDARD CHARACTERS WITHOUT CLAIM TO ANY PARTICULAR FONT, STYLE, SIZE, OR COLOR.

CLASS 6—METAL GOODS

FOR TRAVEL ACCESSORIES, NAMELY, METAL LOCKS (U.S. CLS. 2, 12, 13, 14, 23, 25 AND 50).

CLASS 9—ELECTRICAL AND SCIENTIFIC APPARATUS

FOR TRAVEL ACCESSORIES, NAMELY, ELECTRIC VOLTAGE TRANSFORMERS, ELECTRIC VOLTAGE CONVERTERS AND PLUG ADAPTORS, ELECTRIC PLUGS, ELECTRIC CORDS, ELECTRIC TRAVEL IRONS, GARMENT STEAMERS, COMPUTER CARRYING CASES, EAR PLUGS FOR SOUNDPROOFING (U.S. CLS. 21, 23, 26, 36 AND 38).

CLASS 14—JEWELRY

FOR TRAVEL ACCESSORIES, NAMELY, CLOCKS (U.S. CLS. 2, 27, 28 AND 50).

CLASS 18—LEATHER GOODS

FOR TRAVEL BAGS, NAMELY, GARMENT BAGS, SHOE BAGS, CARRY-ON BAGS, DUFFLE BAGS, TOILETRY BAGS, TOTE BAGS; FABRIC PACKING CUBES AND FOLDERS, NAMELY, TRAVELING CASES FOR HOLDING SMALL CLOTHING ITEMS WHICH CAN THEN BE PACKED IN LARGER PIECES OF LUGGAGE, AND PACKING SLEEVES USED TO HOLD FOLDED GARMENTS; MONO BAGS, NAMELY, MONO-STRAP SLING BAGS; BUSINESS CASES; LUGGAGE TAGS AND STRAPS FOR TRAVEL; UMBRELLAS; TRAVEL WALLETS; SECURITY NECK POUCHES; NON-MOTORIZED, COLLAPSIBLE LUGGAGE CARTS (U.S. CLS. 1, 2, 3, 22 AND 41).

CLASS 20—FURNITURE AND ARTICLES NOT OTHERWISE CLASSIFIED

FOR TRAVEL PILLOWS (U.S. CLS. 2, 13, 22, 25, 32 AND 50).

CLASS 21—HOUSEWARES AND GLASS

FOR TRAVEL BOTTLES, SOLD EMPTY (U.S. CLS. 2, 13, 23, 29, 30, 33, 40 AND 50).

CLASS 22—CORDAGE AND FIBERS

FOR LAUNDRY BAGS (U.S. CLS. 1, 2, 7, 19, 22, 42 AND 50).
MICHAEL SOUDERS, EXAMINING ATTORNEY

SN 79-003,519. CHATRENET YVES, F-74700 SALLANCHES, FRANCE, FILED 4-29-2004.

ACTIBACK

THE MARK CONSISTS OF STANDARD CHARACTERS WITHOUT CLAIM TO ANY PARTICULAR FONT, STYLE, SIZE, OR COLOR.

PRIORITY DATE OF 11-3-2003 IS CLAIMED.
OWNER OF INTERNATIONAL REGISTRATION 0827893 DATED 4-29-2004, EXPIRES 4-29-2014.

CLASS 10—MEDICAL APPARATUS

FOR SURGICAL, MEDICAL, DENTAL AND VETERINARY APPARATUS AND INSTRUMENTS, NAMELY, MEDICAL APPARATUS FOR DIAGNOSIS AND TESTING BLOOD SAMPLES AND EYE SAMPLES, SURGICAL INSTRUMENTS IN THE NATURE OF SURGICAL CATHETERS, ARTIFICIAL LIMBS AND EYES, SURGICAL SUTURES, MASSAGE APPARATUS FOR MEDICAL PURPOSES, MASSAGE CHAIRS, MASSAGE BELTS, MASSAGE MATTRESSES AND CUSHIONS, BACK MASSAGE CUSHIONS, ESTHETIC MASSAGE APPARATUS, ORTHOSIS AND PROSTHESES, ARTIFICIAL IMPLANTS, ARMCHAIRS FOR MEDICAL OR DENTAL PURPOSES, SURGICAL DRAPES, BED PANS FOR MEDICAL USE, FURNITURE, NAMELY, FURNITURE ESPECIALLY MADE FOR MEDICAL PURPOSES, MEDICAL APPARATUS FOR FUNCTIONAL REHABILITATION, PHYSICAL EXERCISE APPARATUS FOR MEDICAL PURPOSES, MEDICAL APPARATUS FOR ALLOWING ONE TO OBSERVE THE HUMAN BODY, ORTHOPEDIC ARTICLES, NAMELY, DEVICES TO HELP PEOPLE TO MOVE, NAMELY, ORTHOPEDIC WALKERS, MEDICAL SEATINGS AND BEDS, NAMELY, ARTICLES ESPECIALLY MADE FOR SUPPORTING SPINAL COLUMN AND LIMBS, BANDAGES FOR ANATOMICAL JOINTS, BODY COMPRESSION ARTICLES, NAMELY, SETTING ARTICLES FOR SPINAL COLUMN AND LIMBS (U.S. CLS. 26, 39 AND 44).

CLASS 28—TOYS AND SPORTING GOODS

FOR ACTION GAMES AND TOYS, NAMELY, THOSE ENABLING ONE TO DEVELOP PHYSICAL CAPABILITY, NAMELY, SEESAWS, CLIMBERS, TRAMPOLINES, ROCKERS, LADDERS, KID ROBOTS AND ARMS, KITES, BOOMERANGS, JUMP ROPES, WOODEN HORSES, PHYSICAL TRAINING APPARATUS, NAMELY, STATIONARY EXERCISE ROWINGS AND BICYCLES, DIVING-BOARD, EXERCISE BENCHES, BALLS, RINGS AND STRETCH BANDS FOR PHYSICAL EXERCISES, EXERCISE MACHINES, BODY BUILDING APPARATUS, NAMELY, CHESS EXPANDERS, WEIGHTS, DUMBBELLS, PRESS AND SQUAT APPARATUS (U.S. CLS. 22, 23, 38 AND 50).

INGA ERVIN, EXAMINING ATTORNEY

SN 79-010,834. GABEL S.R.L., ITALY, FILED 11-29-2004.



OWNER OF INTERNATIONAL REGISTRATION 0849388 DATED 11-29-2004, EXPIRES 11-29-2014.

CLASS 25—CLOTHING

FOR FOOTWEAR AND MOUNTAIN CLOTHING ARTICLES, NAMELY, SWEATSHIRTS, T-SHIRTS, POLO-SHIRTS, SWEATERS, WIND JACKETS, WATER PROOF TROUSERS, GLOVES (U.S. CLS. 22 AND 39).

CLASS 28—TOYS AND SPORTING GOODS

FOR SKI POLES AND TREKKING POLES FOR SPORTS RELATED HIKING ACTIVITIES; GYMNASTIC AND FITNESS APPARATUSES, NAMELY, GYMNASTIC PARALLEL BARS, RUNNING VAULTING POLES AND WALKING POLES FOR SPORTS RELATED POWER WALKING ACTIVITIES (U.S. CLS. 22, 23, 38 AND 50).

CLASS 41—EDUCATION AND ENTERTAINMENT

FOR ORGANIZING COURSES OF INSTRUCTION IN PHYSICAL FITNESS AND AEROBICS (U.S. CLS. 100, 101 AND 107).

WILLIAM VERHOSEK, EXAMINING ATTORNEY

SN 79-013,232. LABORATOIRE DE CHIMIE ET DE BIOLOGIE-LCB, FRANCE, FILED 6-22-2005.

ULTRAD

THE MARK CONSISTS OF STANDARD CHARACTERS WITHOUT CLAIM TO ANY PARTICULAR FONT, STYLE, SIZE, OR COLOR.

PRIORITY DATE OF 12-28-2004 IS CLAIMED.

OWNER OF INTERNATIONAL REGISTRATION 0856420 DATED 6-22-2005, EXPIRES 6-22-2015.

CLASS 1—CHEMICALS

FOR CHEMICALS FOR AGRICULTURE, HORTICULTURE, SYLVICULTURE AND ARBORICULTURE USE, NAMELY, ADJUVANTS FOR USE IN THE MANUFACTURE OF BIOCIDES, INSECTICIDES, BACTERICIDES AND FUNGICIDES; CHEMICAL ADJUVANTS FOR USE WITH PESTICIDES IN THE AGRICULTURE, HORTICULTURE, SYLVICULTURE AND ARBORICULTURE FIELDS (U.S. CLS. 1, 5, 6, 10, 26 AND 46).

CLASS 5—PHARMACEUTICALS

FOR CHEMICAL PREPARATIONS FOR SANITARY PURPOSES; INSECTICIDE PREPARATIONS, NAMELY, INSECTICIDES AND INSECTICIDE FUMIGANTS; FUNGICIDE PREPARATIONS, NAMELY, FUNGICIDES AND FUNGICIDE FUMIGANTS; BACTERICIDES IN THE NATURE OF ALL PURPOSE DISINFECTANTS; DISINFECTANT PREPARATIONS, NAMELY, DISINFECTANTS FOR SANITARY PURPOSES, ALL PURPOSE DISINFECTANTS, ALL PURPOSE DISINFECTANTS FOR USE IN THE FARM PRODUCE, HARVESTING, FOODSTUFFS AND ANIMAL BREEDING AND FOOD-PROCESSING INDUSTRIES, DISINFECTANT FUMIGANTS, AND DISINFECTANT LIQUIDS, NAMELY, LIQUID DISINFECTANTS FOR HYGIENIC AND SANITARY PURPOSES; ANTISEPTIC PREPARATIONS, DISINFECTANT PREPARATIONS FOR SANITARY PURPOSES (U.S. CLS. 6, 18, 44, 46, 51 AND 52).

STEVEN PEREZ, EXAMINING ATTORNEY

SN 79-014,582. LORO PIANA S.P.A., ITALY, FILED 6-6-2005.

PECORA NERA

THE MARK CONSISTS OF STANDARD CHARACTERS WITHOUT CLAIM TO ANY PARTICULAR FONT, STYLE, SIZE, OR COLOR.

PRIORITY DATE OF 4-7-2005 IS CLAIMED.

OWNER OF INTERNATIONAL REGISTRATION 0859674 DATED 6-6-2005, EXPIRES 6-6-2015.

THE ENGLISH TRANSLATION OF THE WORDS "PECORA NERA" IN THE MARK IS "BLACK SHEEP".

CLASS 23—YARNS AND THREADS

FOR YARNS AND THREADS (U.S. CL. 43).

CLASS 24—FABRICS

FOR TEXTILES AND TEXTILE GOODS, NAMELY FABRICS FOR THE MANUFACTURE OF CLOTHING, BEDDING NAMELY BLANKETS, DUVET COVERS, MATTRESS COVERS, AND PILLOW COVERS, FABRIC TABLE CLOTHS, TEXTILE NAPKINS AND PLACEMATS (U.S. CLS. 42 AND 50).

ADA HAN, EXAMINING ATTORNEY

SN 79-016,465. BORA CREATIONS S.L., E-51001 CEUTA, SPAIN, FILED 6-2-2005.



PRIORITY DATE OF 12-3-2004 IS CLAIMED.
OWNER OF INTERNATIONAL REGISTRATION 0865131
DATED 6-2-2005, EXPIRES 6-2-2015.

CLASS 8—HAND TOOLS

FOR MANUAL TOOLS AND INSTRUMENTS FOR COSMETICS AND FOR DECORATING FINGER AND TOE NAILS, NAMELY, NAIL FILES, SCISSORS AND TWEEZERS FOR THE NAILS, AND NAIL CLIPPERS FOR GIVING SHAPE TO THE NAILS (U.S. CLS. 23, 28 AND 44).

CLASS 16—PAPER GOODS AND PRINTED MATTER

FOR FINGER NAIL STICKERS (U.S. CLS. 2, 5, 22, 23, 29, 37, 38 AND 50).

CLASS 21—HOUSEWARES AND GLASS

FOR HAIR COMBS AND HAIR BRUSHES, COSMETIC SPONGES, COSMETIC BRUSHES, SMALL WOODEN AND PLASTIC APPLICATOR STICKS FOR APPLYING MAKEUP (U.S. CLS. 2, 13, 23, 29, 30, 33, 40 AND 50).

CLASS 26—FANCY GOODS

FOR DECORATIVE ARTICLES FOR THE HAIR, NAMELY, HAIR CLIPS, HAIR BANDS AND GARLANDS FOR THE HAIR (U.S. CLS. 37, 39, 40, 42 AND 50).

CLASS 35—ADVERTISING AND BUSINESS

FOR RETAIL STORE SERVICES FEATURING COSMETIC PRODUCTS AND ARTICLES AND PERFUMERY PRODUCTS (U.S. CLS. 100, 101 AND 102).
DANIEL BRODY, EXAMINING ATTORNEY

SN 79-017,765. GULLIVER INTERNATIONAL CO., LTD., TOKYO 100-0005, JAPAN, FILED 9-28-2004.

OWNER OF INTERNATIONAL REGISTRATION 0868557
DATED 9-28-2004, EXPIRES 9-28-2014.

CLASS 12—VEHICLES

FOR VESSELS AND THEIR STRUCTURAL PARTS; AIRCRAFT AND THEIR STRUCTURAL PARTS; RAILWAY ROLLING STOCK AND THEIR STRUCTURAL PARTS; AUTOMOBILES AND THEIR STRUCTURAL PARTS; TWO-WHEELED MOTOR VEHICLES; BICYCLES AND THEIR STRUCTURAL PARTS; WHEELBARROWS; CARTS; HORSE-DRAWN CARRIAGES; BICYCLE TRAILERS IN THE NATURE OF RIYAKAH; TRACTORS; NON-ELECTRIC PRIME MOVERS FOR LAND VEHICLES NOT INCLUDING THEIR PARTS; AC MOTORS OR DC MOTORS FOR LAND VEHICLES NOT INCLUDING THEIR PARTS; ANTI-THEFT ALARMS FOR VEHICLES; SHAFTS, AXELS OR SPINDLES FOR LAND VEHICLES; BEARINGS FOR LAND VEHICLES; SHAFT COUPLINGS OR CONNECTORS FOR LAND VEHICLES; POWER TRANSMISSION AND GEARINGS FOR LAND VEHICLES; IDLING PULLEYS FOR LAND VEHICLES; CAMS IN THE NATURE OF MACHINE ELEMENTS FOR LAND VEHICLES; REVERSING GEARS FOR LAND VEHICLES; REDUCTION GEARS FOR LAND VEHICLES; BELT PULLEYS FOR LAND VEHICLES; POWER TRANSMISSION BELTS FOR LAND VEHICLES; TOOTHED WHEELS OR GEARS FOR LAND VEHICLES; SPEED CHANGE GEARS FOR LAND VEHICLES; FLUID COUPLINGS FOR LAND VEHICLES; HYDRAULIC TORQUE CONVERTERS FOR LAND VEHICLES; LINKS FOR LAND VEHICLES; ROLLER CHAINS FOR LAND VEHICLES; SHOCK ABSORBERS FOR LAND VEHICLES; PNEUMATIC SHOCK ABSORBERS IN THE NATURE OF AIR SPRINGS FOR LAND VEHICLES; SPRING SHOCK ABSORBERS FOR LAND VEHICLES; SPRING-ASSISTED HYDRAULIC SHOCK ABSORBERS FOR LAND VEHICLES; SPRINGS FOR LAND VEHICLES; SPIRAL SPRINGS FOR LAND VEHICLES; LAMINATED LEAF-SPRINGS FOR LAND VEHICLES; COILED SPRINGS FOR LAND VEHICLES; BRAKES FOR LAND VEHICLES; CONE BRAKES FOR LAND VEHICLES; DISC BRAKES FOR LAND VEHICLES; BAND BRAKES FOR LAND VEHICLES; BLOCK BRAKES FOR LAND VEHICLES (U.S. CLS. 19, 21, 23, 31, 35 AND 44).

CLASS 35—ADVERTISING AND BUSINESS

FOR ADVERTISING AND PUBLICITY SERVICES; BUSINESS MANAGEMENT ANALYSIS OR BUSINESS CONSULTANCY; MARKETING RESEARCH; PROVIDING INFORMATION ABOUT AUTOMOBILES FOR SALES BY MEANS OF THE INTERNET, STORES, MAIL ORDER AND DOOR TO DOOR SHOPPING SERVICES; PROVIDING INFORMATION ON THE SALES OF OTHER GOODS, NAMELY, STRUCTURAL PARTS FOR AUTOMOBILES, AUDIO CASSETTE TAPES, COMPACT DISK PLAYERS, MINIDISK PLAYERS, AUDIO SPEAKERS, BRACKETS FOR ELECTRICAL WIRING, METAL AND NON-METAL SHELF BRACKETS, DVD PLAYERS, TELEVISION MONITORS, CAR NAVIGATION EQUIPMENT, ELECTRONIC TOLL COLLECTION SYSTEMS, BURGLAR SECURITY SYSTEMS, MOTOR OIL, BATTERIES, CAR WAX, CARPET CLEANER FOR AUTOMOBILES, AUTOMOBILE CLEANERS, CHILDREN'S SAFETY SEATS FOR VEHICLES, SEAT COVERS FOR VEHICLES, CUSHIONS, MATS, CURTAINS FOR USE IN AUTOMOBILES, SKI CARRIERS FOR VEHICLES, LUGGAGE CARRIERS FOR VEHICLES, TIRES FOR AUTOMOBILES, WHEELS FOR AUTOMOBILES, BICYCLES, MOTORCYCLES, DAILY GOODS, NAMELY, COSMETICS, FIRST AID KITS, HOME CLEANING PRODUCTS AND PET CARE PRODUCTS, TOYS, BOOKS, APPAREL, AND GROCERIES; AUCTIONEERING OF USED-CARS AND AUCTIONEERING OF OTHER GOODS; IMPORT-EXPORT AGENCIES; AND RENTAL OF PUBLICITY MATERIALS (U.S. CLS. 100, 101 AND 102).

CLASS 36—INSURANCE AND FINANCIAL

FOR LOAN FINANCING; PROVIDING INFORMATION RELATING TO FINANCE; PROVIDING STOCK MARKET INFORMATION; AGENCIES FOR NON-LIFE INSURANCE, CLAIM ADJUSTMENT FOR NON-LIFE INSURANCE; REAL ESTATE MANAGEMENT, NAMELY, BUILDING MANAGEMENT; AGENCIES OR BROKERAGE FOR RENTING OF BUILDINGS; LEASING OR RENTAL OF BUILDINGS; AGENCIES OR BROKERAGE FOR PURCHASE AND SALE OF BUILDINGS; REAL ESTATE APPRAISAL; ANTIQUE APPRAISAL; ART APPRAISAL; PRECIOUS STONE APPRAISAL; USED-CAR APPRAISAL (U.S. CLS. 100, 101 AND 102).
MATTHEW PAPPAS, EXAMINING ATTORNEY

SN 79-019,804. FREE, FRANCE, FILED 8-11-2005.



PRIORITY DATE OF 2-17-2005 IS CLAIMED.
OWNER OF INTERNATIONAL REGISTRATION 0873795
DATED 8-11-2005, EXPIRES 8-11-2015.

NO CLAIM IS MADE TO THE EXCLUSIVE RIGHT TO USE "FREE" AND "BOX", APART FROM THE MARK AS SHOWN.

CLASS 9—ELECTRICAL AND SCIENTIFIC APPARATUS

FOR TELEPHONE APPARATUS; TELEPHONE TRANSMITTERS; TELECOMMUNICATION TERMINALS, NAMELY, TELEPHONE TERMINALS, TERMINALS FOR RADIO TELEPHONES; TELEPHONE APPARATUS AND SETS PARTICULARLY FOR PUBLIC, PERSONAL, MOBILE, HANDS FREE OR VOICE-OPERATED USE; FACSIMILE MACHINES; SOFTWARE FOR MANAGING THE TRANSMISSION AND THE RECEPTION OF DATA ON THE INTERNET IN THE FIELD OF TELECOMMUNICATION EQUIPMENT; DATABASE CREATION, MANAGEMENT, UPDATING AND USE SOFTWARE FOR GENERAL USE; SOFTWARE PROVIDING ACCESS TO AN ELECTRONIC MAIL SERVICE; COMPUTERS; COMPUTER SERVERS; COMPUTER, COMPUTER DATA COMMUNICATION AND TELEPHONE TERMINALS PARTICULARLY FOR GLOBAL COMMUNICATION NETWORKS SIMILAR TO THE INTERNET; MODEMS; MULTIFUNCTION MODEMS; MODEMS ROUTERS; TELECOMMUNICATIONS MODEMS; ELECTRICAL CABLES; OPTICAL CABLES; COMMUNICATION TRANSMITTERS AND RECEIVERS, NAMELY, RADIO, TELEVISION, TELEPHONE TRANSMITTERS AND RECEIVERS, AUDIO-VIDEO RECEIVERS, VOICEMAIL RECEIVERS AND TRANSMITTERS, AND FACSIMILE TRANSMITTERS AND RECEIVERS; AUTOMATIC SWITCHBOARDS; SOFTWARE FOR PROVISION OF ACCESS TO A COMPUTER OR DATA TRANSMISSION NETWORK, PARTICULARLY TO GLOBAL COMMUNICATION NETWORKS SIMILAR TO THE INTERNET; ELECTRONIC TELEVISION DECODERS; APPARATUS AND INSTRUMENTS FOR RECORDING, TRANSMITTING, REPRODUCING, STORING, ENCRYPTING, DECRYPTING, TRANSFORMING AND PROCESSING SOUND OR IMAGES, NAMELY, TELEPHONES, RADIO TELEPHONES, TELEVISIONS; DEVICES FOR ACCESSING AND CONTROLLING ACCESS TO DATA PROCESSING APPARATUS, NAMELY, KEYBOARDS, INFRARED REMOTE CONTROL, FINGERPRINT, VOICE AND PUPIL DETECTORS; AUTHENTICATION DEVICES FOR TELECOMMUNICATION NETWORKS, NAMELY, KEYBOARDS, INFRARED REMOTE CONTROL, FINGERPRINT, VOICE AND PUPIL DETECTORS; SIGNAL SCRAMBLING, DE-SCRAMBLING AND RETRANSMITTING APPARATUS, NAMELY, SET TOP BOX CONNECTING TO SIGNALS, TELEVISION DECODERS; DIGITAL COMPUTER TERMINALS; CHIP BOARDS, NAMELY, CIRCUIT BOARDS;

ELECTRONIC CARDS FOR IDENTIFYING PARTICULAR USERS OF COMPUTERS, MOBILE TELEPHONES AND MULTIFUNCTION MODEMS; ELECTRONIC CARD READERS; ELECTRONIC COMPONENTS, NAMELY, TELECOMMUNICATIONS CABLES, TELECOMMUNICATIONS TRANSMITTERS, TELECOMMUNICATION SWITCHES; TELEVISION SCREENS, NAMELY, TELEVISION MONITORS; DIGITAL SUBSCRIBER LINE ACCESS MULTIPLEXERS; MULTIMEDIA TERMINAL, NAMELY, COMPUTER TERMINALS USED FOR TELEVISIONS; INTERNET AND TELEPHONE (U.S. CLS. 21, 23, 26, 36 AND 38).

CLASS 35—ADVERTISING AND BUSINESS

FOR ADVERTISING; BUSINESS MANAGEMENT; SUBSCRIPTION SERVICES TO TELEPHONE AND DATA COMMUNICATION SERVICES, TO DATABASES, TO A DATABASE SERVER; SUBSCRIPTION SERVICES TO A DATA TRANSMISSION OR COMPUTER NETWORK PROVIDER PARTICULARLY FOR GLOBAL COMMUNICATION SIMILAR TO THE INTERNET; SUBSCRIPTION SERVICES TO ELECTRONIC JOURNALS, TO TELECOMMUNICATION SERVICES; SUBSCRIPTION SERVICES TO TELEVISION PROGRAMS; COMPUTERIZED FILE MANAGEMENT; SUBSCRIPTION SERVICES TO PRIVATE ACCESS AUDIOVISUAL PROGRAMS; COMPUTER FILE RENTAL, NAMELY, SUBSCRIPTION TO COMPUTER FILES; MARKETING RESEARCH (U.S. CLS. 100, 101 AND 102).

CLASS 38—COMMUNICATION

FOR TELEPHONE, TELECOMMUNICATION ACCESS AND RADIO COMMUNICATION, AS WELL AS MOBILE TELEPHONE SERVICES, PARTICULARLY CALL TRANSFER SERVICES, CALL FORWARDING, TELEPHONE DIRECTORIES SERVICES IN THE NATURE OF TELEPHONE CALL COMPLETION SERVICES FOR DIRECTORY ASSISTANCE CUSTOMERS; VOICEMAIL; TRANSMISSION AND DISTRIBUTION OF DATA, SOUNDS AND IMAGES; COMPUTER-ASSISTED TRANSMISSION AND DISTRIBUTION OF DATA, SOUNDS AND IMAGES VIA TELECOMMUNICATION NETWORKS; COMMUNICATIONS VIA COMPUTER TERMINALS; INFORMATION TRANSMISSION SERVICES BY ACCESS CODES TO COMPUTING OR DATA COMMUNICATION DATABASES AND DATABASE SERVER CENTERS; ELECTRONIC MAIL AND INFORMATION DISTRIBUTION, NAMELY, ELECTRONIC MESSAGE AND DATA TRANSMISSION; RENTAL SERVICES FOR DATA TRANSMISSION AND RECEIVING APPARATUS; PRESS AND INFORMATION AGENCIES, NAMELY, THE TRANSMISSION OF NEWS ITEMS TO NEWS REPORTING ORGANIZATIONS; TELECOMMUNICATIONS BY ALL TECHNOLOGICAL MEANS INCLUDING VIA SATELLITE OR BY OPTICAL FIBERS, NAMELY, SATELLITE TELECOMMUNICATION AND OPTICAL FIBER TELECOMMUNICATION; INFORMATION TRANSMISSION VIA COMPUTER COMMUNICATIONS NETWORKS; CABLE TELEVISION TRANSMISSIONS; TELEVISION BROADCASTING; RENTAL, LOAN, FREE TEMPORARY PROVISION FOR THIRD PARTIES OF MODEMS; TELECOMMUNICATIONS ACCESS SERVICES, NAMELY, PROVIDING CONNECTIONS TO A DATABASE SERVER CENTRE PARTICULARLY FOR ACCESS TO GLOBAL COMMUNICATION NETWORKS SIMILAR TO THE INTERNET (U.S. CLS. 100, 101 AND 104).

CLASS 41—EDUCATION AND ENTERTAINMENT

FOR DISTRIBUTION SERVICES FOR TELEVISION PROGRAMMES FOR OTHERS (U.S. CLS. 100, 101 AND 107).

CLASS 42—SCIENTIFIC AND COMPUTER SERVICES

FOR COMPUTER PROGRAMMING SERVICES FOR OTHERS; RENTAL OF COMPUTER SOFTWARE; COMPUTER SOFTWARE DESIGN AND DEVELOPMENT; ENGINEERING PROJECT STUDIES IN CONNECTION WITH TELECOMMUNICATIONS; TECHNICAL LABORATORIES, NAMELY, LABORATORY RESEARCH SERVICES IN THE FIELD OF TELECOMMUNICATIONS EQUIPMENT; DESIGN AND DEVELOPMENT OF ENCRYPTION, DECRYPTION AND ACCESS CONTROL SYSTEMS FOR TELEVISION AND BROADCAST PROGRAMMES, AS WELL AS FOR ALL TYPES OF INFORMATION TRANSMISSION; RESEARCH AND DEVELOPMENT OF ELECTRONIC, COMPUTING AND AUDIOVISUAL, SCRAMBLING AND ACCESS CONTROL SYSTEMS IN THE FIELDS OF TELEVISION, COMPUTING, TELECOMMUNICATIONS AND THE AUDIOVISUAL SECTOR; ENGINEERING SERVICES FOR THE TELECOMMUNICATIONS, COMPUTING AND AUDIOVISUAL SECTORS; RENTAL SERVICES FOR DATA PROCESSING APPARATUS (U.S. CLS. 100 AND 101).

MARK RADEMACHER, EXAMINING ATTORNEY

SN 79-019,970. FRONTER AS, NORWAY, FILED 3-10-2005.

FRONTER

THE MARK CONSISTS OF STANDARD CHARACTERS WITHOUT CLAIM TO ANY PARTICULAR FONT, STYLE, SIZE, OR COLOR.

PRIORITY DATE OF 1-28-2005 IS CLAIMED.
OWNER OF INTERNATIONAL REGISTRATION 0874339 DATED 3-10-2005, EXPIRES 3-10-2015.

CLASS 9—ELECTRICAL AND SCIENTIFIC APPARATUS

FOR APPARATUS FOR RECORDING, TRANSMISSION AND REPRODUCTION OF SOUND AND IMAGES; BLANK MAGNETIC DATA CARRIERS, PRERECORDED MAGNETIC DATA CARRIERS FEATURING E-LEARNING MANAGEMENT SOLUTIONS IN THE NATURE OF COMPUTER PROGRAMS FOR ON AND OFF CAMPUS LEARNING APPLICATIONS; INTERFACE CARDS FOR DATA PROCESSING EQUIPMENT IN THE FORM OF PRINTED CIRCUITS AND COMPUTERS; COMPUTER PERIPHERAL DEVICES; COMPUTER SOFTWARE FOR USE IN DATABASE MANAGEMENT AND FOR ONLINE E-LEARNING MANAGEMENT SOLUTIONS IN THE NATURE OF COMPUTER PROGRAMS FOR ON AND OFF CAMPUS LEARNING APPLICATIONS; SOFTWARE FOR COMPUTER GAMES (U.S. CLS. 21, 23, 26, 36 AND 38).

CLASS 41—EDUCATION AND ENTERTAINMENT

FOR EDUCATION SERVICES, NAMELY, PROVIDING ONLINE E-LEARNING MANAGEMENT SOLUTIONS IN THE NATURE OF INFORMAL ON-LINE PROGRAMS IN EDUCATION AND ACADEMIC FIELDS, NAMELY, MATHEMATICS, SCIENCE, TECHNOLOGY, ARTS, MUSIC, HUMANITIES, PHYSICAL EDUCATION, TRADE AND VOCATIONAL TRAINING IN THE FIELDS OF MECHANICS, BUILDING CONSTRUCTION, HEALTH CARE, PERSONAL CARE, REPAIR AND MAINTENANCE OF AUTOMOBILES, DRIVING LESSONS, AND COMPUTERS, BUSINESS AND COMMERCIAL FIELDS, NAMELY, BUSINESS MANAGEMENT, INDUSTRIAL, OPERATIONAL AND LOGISTICAL PROCESS MANAGE-

MENT, ACCOUNTING, TAX AND LEGAL AFFAIRS, AND IN GOVERNMENTAL FIELDS, NAMELY, GOVERNMENTAL ADMINISTRATION, BUDGETING, PROCUREMENT, TAXATION, HEALTH AND WELFARE, LABOR, DEFENSE, AND PUBLIC WORKS AND GRANT PROGRAM ADMINISTRATION; ORGANIZATION OF COURSES, COLLOQUIA, CONFERENCES, CONGRESSES, PRACTICAL SEMINARS, AND PRACTICAL TRAINING IN EDUCATION AND ACADEMIC FIELDS, NAMELY, MATHEMATICS, SCIENCE, TECHNOLOGY, ARTS, MUSIC, HUMANITIES, PHYSICAL EDUCATION, TRADE AND VOCATIONAL TRAINING IN THE FIELDS OF MECHANICS, BUILDING CONSTRUCTION, HEALTH CARE, PERSONAL CARE, REPAIR AND MAINTENANCE OF AUTOMOBILES, DRIVING LESSONS, AND COMPUTERS, BUSINESS AND COMMERCIAL FIELDS, NAMELY, BUSINESS MANAGEMENT, INDUSTRIAL, OPERATIONAL AND LOGISTICAL PROCESS MANAGEMENT, ACCOUNTING, TAX AND LEGAL AFFAIRS, AND IN GOVERNMENTAL FIELDS, NAMELY, GOVERNMENTAL ADMINISTRATION, BUDGETING, PROCUREMENT, TAXATION, HEALTH AND WELFARE, LABOR, DEFENSE, AND PUBLIC WORKS AND GRANT PROGRAM ADMINISTRATION; EDUCATIONAL SERVICES, NAMELY, CONDUCTING INTERNET BASED DISTANCE LEARNING INSTRUCTION FOR PRIMARY AND SECONDARY SCHOOLS, COLLEGES, UNIVERSITIES, ORGANIZATIONS, COMPANIES, MUNICIPALITIES AND COUNTRIES IN EDUCATION AND ACADEMIC FIELDS, NAMELY, MATHEMATICS, SCIENCE, TECHNOLOGY, ARTS, MUSIC, HUMANITIES, PHYSICAL EDUCATION, TRADE AND VOCATIONAL TRAINING IN THE FIELDS OF MECHANICS, BUILDING CONSTRUCTION, HEALTH CARE, PERSONAL CARE, REPAIR AND MAINTENANCE OF AUTOMOBILES, DRIVING LESSONS, AND COMPUTERS, BUSINESS AND COMMERCIAL FIELDS, NAMELY, BUSINESS MANAGEMENT, INDUSTRIAL, OPERATIONAL AND LOGISTICAL PROCESS MANAGEMENT, ACCOUNTING, TAX AND LEGAL AFFAIRS, AND IN GOVERNMENTAL FIELDS, NAMELY, GOVERNMENTAL ADMINISTRATION, BUDGETING, PROCUREMENT, TAXATION, HEALTH AND WELFARE, LABOR, DEFENSE, AND PUBLIC WORKS AND GRANT PROGRAM ADMINISTRATION (U.S. CLS. 100, 101 AND 107).

CLASS 42—SCIENTIFIC AND COMPUTER SERVICES

FOR SCIENTIFIC AND TECHNOLOGICAL SERVICES, NAMELY, CONSULTING IN THE FIELD OF COMPUTERS AND ON-LINE E-LEARNING MANAGEMENT SOLUTIONS IN THE NATURE OF COMPUTER PROGRAMMING FOR ON AND OFF CAMPUS LEARNING APPLICATIONS, AND SCIENTIFIC AND TECHNOLOGICAL RESEARCH AND DESIGN RELATING THERETO; DESIGN AND DEVELOPMENT OF COMPUTER HARDWARE AND SOFTWARE; DESIGN AND DEVELOPMENT OF INTERNET BASED LEARNING PLATFORMS; PROVIDING TEMPORARY USE OF NONDOWNLOADABLE SOFTWARE FOR COMPUTERS FOR USE IN TAKING ONLINE EDUCATIONAL PROGRAMS; TECHNICAL SUPPORT SERVICES RELATED TO COMPUTERS, NAMELY, TROUBLESHOOTING OF COMPUTER HARDWARE AND SOFTWARE PROBLEMS, MONITORING OF NETWORK SYSTEMS, PROVIDING BACK-UP COMPUTER PROGRAMS AND FACILITIES; REPAIR OF COMPUTER SOFTWARE AND INTERNET BASED SOFTWARE; HARDWARE AND SOFTWARE RENTAL; SOFTWARE INSTALLATION; CREATION AND MAINTENANCE OF WEB PAGES FOR OTHERS (U.S. CLS. 100 AND 101).

SIMON TENG, EXAMINING ATTORNEY

SN 79-020,497. INTELLECTUAL PROPERTY; COMMERCIALISATION PTY LTD, ROZELLE NSW 2039, AUSTRALIA, FILED 8-17-2004.

SILENCEAIR

THE MARK CONSISTS OF STANDARD CHARACTERS WITHOUT CLAIM TO ANY PARTICULAR FONT, STYLE, SIZE, OR COLOR.

OWNER OF INTERNATIONAL REGISTRATION 0875827 DATED 8-17-2004, EXPIRES 8-17-2014.

CLASS 7—MACHINERY

FOR SILENCING APPARATUS AND EQUIPMENT, NAMELY, MUFFLERS FOR USE IN GASEOUS VENTILATION PASSAGES IN THE INTERNAL AND EXTERNAL FABRIC, STRUCTURE, WALLS, PARTITIONS, FLOORS, ROOFS, WINDOWS AND DOORS OF FIXED, PORTABLE, MOVING AND MOVEABLE BUILDINGS AND INFRASTRUCTURE AND MANUFACTURING PLANTS AND MINES; NOISE ATTENUATION PARTS AND EQUIPMENT AND APPARATUS, NAMELY, MUFFLERS FOR USE IN THE HOUSING AND CASING AND STRUCTURE OF FIXED, PORTABLE, MOVING AND MOVEABLE MECHANICAL DEVICES, NAMELY, GENERATORS, COMPRESSORS, REFRIGERATORS, PUMPS, MOTORS, ENGINES, FANS, TURBINES, ELECTRICAL TRANSFORMERS AND SWITCHING GEAR, MANUFACTURING AND FABRICATION MACHINERY; NOISE ATTENUATION PARTS AND EQUIPMENT AND APPARATUS, NAMELY, MUFFLERS FOR USE IN THE GASEOUS INLETS AND GASEOUS OUTLETS OF FIXED, PORTABLE, MOVING AND MOVEABLE MECHANICAL DEVICES, NAMELY, GENERATORS, COMPRESSORS, REFRIGERATORS, PUMPS, MOTORS, ENGINES, FANS, TURBINES, ELECTRICAL TRANSFORMERS AND SWITCHING GEAR, MANUFACTURING AND FABRICATION MACHINERY (U.S. CLS. 13, 19, 21, 23, 31, 34 AND 35).

CLASS 11—ENVIRONMENTAL CONTROL APPARATUS

FOR SILENCING APPARATUS AND EQUIPMENT, NAMELY, MUFFLERS, FOR USE IN REDUCING NOISE LEVELS IN AIR CONDITIONING, AIR COOLING AND VENTILATOR PARTS AND EQUIPMENT AND INSTALLATIONS, NAMELY, RETURN AIR GRILLES, AIR OUTLETS, AIR INLETS, DUCTWORK, CROSS TALK VENTILATORS, THROUGH WALL VENTILATORS, THROUGH DOOR VENTILATORS, THROUGH CEILING VENTILATORS, SUPPLY AIR FANS, EXHAUST FANS, ACOUSTIC LOUVERS (U.S. CLS. 13, 21, 23, 31 AND 34).
MELISSA VALLILLO, EXAMINING ATTORNEY

SN 79-021,353. 3D AG, SWITZERLAND, FILED 8-11-2005.

Kaleidocode

THE MARK CONSISTS OF STANDARD CHARACTERS WITHOUT CLAIM TO ANY PARTICULAR FONT, STYLE, SIZE, OR COLOR.

PRIORITY DATE OF 2-18-2005 IS CLAIMED.
OWNER OF INTERNATIONAL REGISTRATION 0878124 DATED 8-11-2005, EXPIRES 8-11-2015.

CLASS 6—METAL GOODS

FOR METAL TOKENS FOR USE AS A SUBSTITUTE FOR MONEY; LAMINATED METAL FOILS AND METAL FILMS FOR PACKAGING PURPOSES; SEMI FINISHED LAMINATED METAL FOILS AND METAL FILMS FOR PACKAGING PURPOSES AND SEMI FINISHED METAL TOKENS FOR USE AS A SUBSTITUTE FOR MONEY (U.S. CLS. 2, 12, 13, 14, 23, 25 AND 50).

CLASS 7—MACHINERY

FOR DIE STAMPING MACHINES; EMBOSsing TOP DIES AND EMBOSsing BOTTOM DIES FOR USE IN EMBOSsing MACHINES (U.S. CLS. 13, 19, 21, 23, 31, 34 AND 35).

CLASS 9—ELECTRICAL AND SCIENTIFIC APPARATUS

FOR DIFFRACTIVE OPTICALLY VARIABLE IMAGE DEVICES ("DOVIDS"), NAMELY, DEVICES FOR CREATING HOLOGRAMS OR PATTERNS WITH DIFFRACTION EFFECT THAT ARE USED IN PARTICULAR FOR THE PURPOSE OF AUTHENTICITY IDENTIFICATION OR GENUINENESS OF LEGAL TENDER, BACK NOTES, BANK AND CREDIT CARDS, VOUCHERS, CHEQUES, AND SECURITIES (U.S. CLS. 21, 23, 26, 36 AND 38).

CLASS 16—PAPER GOODS AND PRINTED MATTER

FOR EMBOSSED REFLECTIVE SECURITY HOLOGRAMS FOR PACKAGING FOR PRODUCTS AND DECORATION OF PRODUCTS; PRINTED REFLECTIVE SECURITY HOLOGRAMS FOR PACKAGING FOR PRODUCTS AND DECORATION OF PRODUCTS; PACKING MATERIAL MADE OF PAPER; PACKING MATERIAL MADE OF PLASTIC, NAMELY, PLASTIC BAGS, PLASTIC BUBBLE PACKS AND PLASTIC PACKAGING FOILS (U.S. CLS. 2, 5, 22, 23, 29, 37, 38 AND 50).

CLASS 17—RUBBER GOODS

FOR FOILS AND FILMS, NAMELY, SELF ADHESIVE PLASTIC FOILS AND FILMS, NON-SELF ADHESIVE PLASTIC FOILS AND FILMS, PLASTIC LAMINATES, AND EMBOSSED FILMS PREDOMINANTLY CONTAINING NEUTRALIZED PLASTIC, ALL FOR USE IN THE PRODUCTION OF DIFFRACTIVE OPTICALLY VARIABLE IMAGE DEVICES ("DOVIDS") AND REFLECTIVE SECURITY HOLOGRAMS (U.S. CLS. 1, 5, 12, 13, 35 AND 50).

CLASS 40—MATERIAL TREATMENT

FOR APPLICATION OF OPTICAL SECURITY ELEMENTS, SUCH AS HOLOGRAMS, TO BANK-NOTES, BANK CARDS, CREDIT CARDS, VOUCHERS, CHEQUES, AND OTHER PAPER MONETARY INSTRUMENTS; APPLICATION OF OPTICAL SECURITY ELEMENTS, SUCH AS HOLOGRAMS, TO PACKAGING OF GOODS; CUSTOM MANUFACTURING OF TOOLS, NAMELY, EMBOSsing TOP DIES AND EMBOSsing BOTTOM DIES USED FOR THE PURPOSE OF EMBOSsing DIFFRACTIVE OPTICALLY VARIABLE IMAGE DEVICES ("DOVIDS") IN OBJECTS; CUSTOM MANUFACTURE OF DIES BY LASER-CUTTING AND GALVANIC METHODS USED FOR THE PURPOSE OF EMBOSsing DIFFRACTIVE OPTICALLY VARIABLE IMAGE DEVICES IN OBJECTS (U.S. CLS. 100, 103 AND 106).

CLASS 42—SCIENTIFIC AND COMPUTER SERVICES

FOR TECHNICAL AND SCIENTIFIC CONSULTING CONCERNING THE DEVELOPMENT AND DESIGN OF OPTICAL SECURITY ELEMENTS AND SUBSTITUTES FOR MONEY; TECHNICAL AND SCIENTIFIC CONSULTING FOR THE DESIGN AND DEVELOPMENT OF METHODS OF IDENTIFICATION AND AUTHENTICATION FOR OBJECTS; CREATING DESIGNS AND GRAPHICS FOR DIFFRACTIVE OPTICALLY VARIABLE IMAGE DEVICES ("DOVIDS"), SUCH AS SECURITY HOLOGRAMS, FOR OTHERS; CREATION OF HOLOGRAMS AND GRATINGS WITH VARIOUS DIFFRACTION EFFECTS FOR SECURITY PURPOSES FOR OTHERS; DESIGN OF COPIES OF HOLOGRAMS AND OTHER DESIGNS WHICH USE OPTICAL DIFFRACTION, BY MEANS OF THE ELECTROFORMING PROCESSES; RECOMBINATION OF HOLOGRAMS OR OF OTHER DIFFRACTION DESIGNS; DESIGN OF OPTICAL SECURITY ELEMENTS IN THE NATURE OF HOLOGRAMS AND OPTICAL DIFFRACTIVE PATTERNS FOR USE ON PRODUCT PACKAGES AND FOR USE ON MONEY AND ON TOKEN-MONEY (U.S. CLS. 100 AND 101).

LINDA LAVACHE, EXAMINING ATTORNEY

SN 79-025,655. ONESQUARED LIMITED, WELLINGTON, NEW ZEALAND, FILED 3-17-2006.

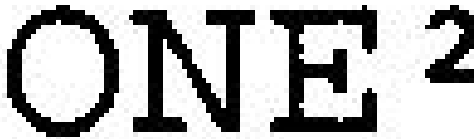

OWNER OF INTERNATIONAL REGISTRATION 0889775 DATED 3-17-2006, EXPIRES 3-17-2016.

CLASS 38—COMMUNICATION

FOR TELECOMMUNICATIONS SERVICES, NAMELY, PROVIDING ACCESS TO OTHERS OF TELECOMMUNICATION NETWORKS, NAMELY, CABLE, INTERNET AND WIRELESS COMMUNICATION SYSTEMS; INTERNET SERVICE PROVIDER SERVICES FOR OTHERS; PROVIDING EMAIL SERVICES FOR OTHERS; PROVIDING CABLE AND WIRELESS TELEPHONE AND MOBILE TELEPHONE COMMUNICATION SERVICES FOR SHORT AND LONG-DISTANCE CALLING FOR OTHERS; CONSULTANCY AND ADVISORY SERVICES RELATING TO THE FOREGOING TELECOMMUNICATION SERVICES (U.S. CLS. 100, 101 AND 104).

CLASS 42—SCIENTIFIC AND COMPUTER SERVICES

FOR COMPUTER SOFTWARE DESIGN FOR OTHERS AND PROGRAMMING FOR OTHERS, DESIGN AND DEVELOPMENT OF COMPUTER HARDWARE AND SOFTWARE FOR OTHERS; DOMAIN NAME REGISTRATION; WEBSITE HOSTING SERVICES; CREATING AND MAINTAINING WEBSITES AND WEB PAGES FOR OTHERS; DATA ENCRYPTION SERVICES; COMPUTER SECURITY SERVICES, NAMELY, RESTRICTING ACCESS TO AND BY COMPUTER NETWORKS TO AND OF WEBSITES, MEDIA AND INDIVIDUALS AND FACILITIES; COMPUTER CONSULTATION, NAMELY, ANALYSIS OF SOFTWARE, COMPUTERS, COMPUTER SYSTEMS AND/OR COMPUTER NETWORKS; TECHNICAL SUPPORT SERVICES, NAMELY, TROUBLESHOOTING OF PROBLEMS IN COMPUTER SOFTWARE, COMPUTERS; COMPUTER SYSTEMS AND/OR COMPUTER NETWORKS (U.S. CLS. 100 AND 101).

DORITT L. CARROLL, EXAMINING ATTORNEY

SN 79-025,970. ISEO HOLDING S.P.A., I-25055 PISOGNE (BRESCIA), ITALY, FILED 11-11-2005.

ISEO ZERO1

OWNER OF INTERNATIONAL REGISTRATION 0890619 DATED 11-11-2005, EXPIRES 11-11-2015.

THE TRADEMARK CONSISTS OF THE WORDING "ISEO ZERO1".

CLASS 6—METAL GOODS

FOR METAL LOCKS, METAL PADLOCKS; METAL KEYS FOR LOCKS; METAL RINGS FOR KEYS; METALLIC GATES AND DOORS; METAL ARMORED DOORS; METAL SAFES; ANTI-PANIC DEVICES FOR DOORS, NAMELY, METAL DOORS EQUIPPED WITH AN EMERGENCY FUNCTION THAT CLOSES AND LOCKS UPON PRESSING A PANIC BUTTON, AND PUSH-BARS, HANDLES AND LOCKS FOR SUCH DOORS; METAL DOOR HINGES; METAL SECURITY LOCK CYLINDERS (U.S. CLS. 2, 12, 13, 14, 23, 25 AND 50).

CLASS 9—ELECTRICAL AND SCIENTIFIC APPARATUS

FOR ELECTRIC LOCKS; RADIO CONTROLS, NAMELY, REMOTE CONTROLS TO OPEN OR CLOSE GATES AND DOORS; VIDEO CAMERAS; AUTOMATIC TRANSMITTERS, NAMELY, ELECTRIC APPARATUS USED TO AUTOMATICALLY OPERATE DOORS AND GATES IN THE FORM OF ELECTRONIC DOOR OPENERS (U.S. CLS. 21, 23, 26, 36 AND 38).

SUNG IN, EXAMINING ATTORNEY

SN 79-026,389. ONESPIN SOLUTIONS GMBH, 80339 MÜNCHEN, FED REP GERMANY, FILED 3-21-2006.

FormalDoublePASS

PRIORITY DATE OF 3-10-2006 IS CLAIMED.
OWNER OF INTERNATIONAL REGISTRATION 0891855 DATED 3-21-2006, EXPIRES 3-21-2016.

CLASS 9—ELECTRICAL AND SCIENTIFIC APPARATUS

FOR SCIENTIFIC, MEASURING, SIGNALING, CHECKING, SUPERVISION COMPUTER HARDWARE FOR USE IN THE FIELD OF SEMICONDUCTOR DESIGN; IMPLEMENTATION, VERIFICATION OR PRODUCTION; COMPUTER HARDWARE FOR CONDUCTING, SWITCHING, TRANSFORMING, ACCUMULATING, REGULATING OR CONTROLLING ELECTRICITY IN THE SEMICONDUCTOR AREA; COMPUTER HARDWARE FOR PROCESSING DATA; COMPUTER HARDWARE AND SOFTWARE FOR USE IN THE FIELD OF SEMICONDUCTOR DESIGN, IMPLEMENTATION, VERIFICATION OF INTEGRATED CIRCUITS OR PRODUCTION; COMPUTER VERIFICATION AND TEST PURPOSES, NAMELY, TESTERS, EMULATORS, ACCELERATORS, FPGA-BOARDS IN THE FIELD OF SEMICONDUCTOR PRODUCTION; COMPUTER SOFTWARE FOR THE FUNCTIONAL VERIFICATION OF INTEGRATED CIRCUITS (U.S. CLS. 21, 23, 26, 36 AND 38).

CLASS 41—EDUCATION AND ENTERTAINMENT

FOR PROVIDING, ARRANGING AND CONDUCTING OF WORKSHOPS, CONFERENCES, SEMINARS, TRAINING COURSES AND EDUCATIONAL SERVICES, NAMELY, COACHING AND TRAINING-ON-THE-JOB, IN THE FIELD OF SEMICONDUCTOR DESIGN, IMPLEMENTATION, VERIFICATION OR PRODUCTION (U.S. CLS. 100, 101 AND 107).

CLASS 42—SCIENTIFIC AND COMPUTER SERVICES

FOR SCIENTIFIC AND TECHNOLOGICAL RESEARCH, APPLICATIONS, DESIGNS AND PROGRAMMING SERVICES RELATING TO DESIGN, IMPLEMENTATION, VERIFICATION AND PRODUCTION OF INTEGRATED CIRCUITS AND RELATED SOFTWARE; DESIGN AND DEVELOPMENT OF COMPUTER HARDWARE AND SOFTWARE FOR OTHERS; DEVELOPMENT OF SOFTWARE TO VERIFY OR VALIDATE CHIP DESIGNS; LICENSING OF COMPUTER SOFTWARE; PROVIDING OF COMPUTER SOFTWARE TECHNICAL SUPPORT SERVICES, NAMELY, TROUBLESHOOTING OF COMPUTER HARDWARE AND SOFTWARE PROBLEMS; DESIGN AND DEVELOPMENT OF SOFTWARE FOR DESIGNING, VERIFICATION AND TESTING OF SEMICONDUCTORS (U.S. CLS. 100 AND 101).

LOURDES AYALA, EXAMINING ATTORNEY

SN 79-027,299. TIETOENATOR OYJ, FINLAND, FILED 11-23-2005.

TIETOENATOR

THE MARK CONSISTS OF STANDARD CHARACTERS WITHOUT CLAIM TO ANY PARTICULAR FONT, STYLE, SIZE, OR COLOR.

OWNER OF INTERNATIONAL REGISTRATION 0894469 DATED 11-23-2005, EXPIRES 11-23-2015.

CLASS 9—ELECTRICAL AND SCIENTIFIC APPARATUS

FOR APPARATUS FOR RECORDING, TRANSMITTING AND REPRODUCING SOUND AND IMAGES, NAMELY, DATA COLLECTION AND DISTRIBUTION NETWORKS, DATA PROCESSING EQUIPMENT, NAMELY, COMPUTERS, COMPUTER MEMORIES, VIEWING SCREENS, KEYBOARDS, PROCESSORS, PRINTERS AND SCANNERS; COMPUTER PROGRAMS, NAMELY, INFORMATION, CONTROL, OPERATIVE, ADMINISTRATIVE AND MANAGEMENT SYSTEMS IN THE FIELD OF BANKING, FINANCE, TELECOM AND MEDIA, PULP AND PAPER, FOREST AND OIL AND GAS INDUSTRIES STORED ON TAPES, DISCS, DISKETTES AND OTHER MACHINE READABLE MEDIA; ELECTRONIC PUBLICATIONS, NAMELY, ELECTRONICALLY READABLE MANUALS FEATURING TECHNICAL AND USER MANUALS FOR COMPUTER SYSTEMS RECORDED ON COMPUTER MEDIA (U.S. CLS. 21, 23, 26, 36 AND 38).

CLASS 16—PAPER GOODS AND PRINTED MATTER

FOR PRINTED PUBLICATIONS, NAMELY, MANUALS FEATURING TECHNICAL AND USER MANUALS FOR COMPUTER SYSTEMS; PRINTED TRAINING MATERIAL, NAMELY, TRAINING MATERIAL FOR COMPUTER USERS AND PROFESSIONALS (U.S. CLS. 2, 5, 22, 23, 29, 37, 38 AND 50).

CLASS 37—CONSTRUCTION AND REPAIR

FOR INSTALLATION, REPAIR AND MAINTENANCE OF COMPUTER SYSTEMS (U.S. CLS. 100, 103 AND 106).

CLASS 38—COMMUNICATION

FOR PROVIDING MULTIPLE-USER ACCESS TO A GLOBAL COMPUTER INFORMATION NETWORK DATA PROCESSING (U.S. CLS. 100, 101 AND 104).

CLASS 41—EDUCATION AND ENTERTAINMENT

FOR EDUCATIONAL SERVICES, NAMELY, CONDUCTING CLASSES, SEMINARS, CONFERENCES, WORK SHOPS AND PROFESSIONAL SERVICES, NAMELY, PROFESSIONAL COACHING SERVICES IN THE FIELD OF BANKING, FINANCE, TELECOM AND MEDIA, PULP AND PAPER, FOREST AND OIL AND GAS INDUSTRIES (U.S. CLS. 100, 101 AND 107).

CLASS 42—SCIENTIFIC AND COMPUTER SERVICES

FOR COMPUTER SERVICES, NAMELY, MAINTENANCE AND UPDATING OF COMPUTER SOFTWARE, DESIGNING COMPUTER SOFTWARE AND COMPUTER HARDWARE FOR OTHERS; COMPUTER PROGRAMMING FOR OTHERS; COMPUTER SYSTEM ANALYSIS, NAMELY, MONITORING THE COMPUTER SYSTEMS OF OTHERS FOR TECHNICAL PURPOSES AND PROVIDING BACK-UP COMPUTER PROGRAMS AND FACILITIES; CONSULTING SERVICES IN THE FIELD OF DESIGN, SELECTION, IMPLEMENTATION AND USE OF COMPUTER HARDWARE AND SOFTWARE SYSTEMS FOR OTHERS; RENTAL OF COMPUTER HARDWARE AND SOFTWARE (U.S. CLS. 100 AND 101).

KEVON CHISOLM, EXAMINING ATTORNEY

SN 79-027,800. THE BUZAN ORGANISATION LIMITED, UNITED KINGDOM, FILED 7-11-2006.

BUZAN

OWNER OF INTERNATIONAL REGISTRATION 0895789 DATED 7-11-2006, EXPIRES 7-11-2016. SEC. 2(F).

CLASS 9—ELECTRICAL AND SCIENTIFIC APPARATUS

FOR COMPUTER SOFTWARE, EDUCATIONAL SOFTWARE, AND PRERECORDED CDS, DVDS, VIDEOS, TAPES, AUDIO BOOKS, AUDIO/VISUAL RECORDINGS AND DOWNLOADABLE AND COMPRESSED FILES AND RECORDINGS, ALL PERTAINING TO SELF IMPROVEMENT, LEARNING, THOUGHT AND MEMORY ENHANCEMENT AND PERSONAL AND INTELLECTUAL AWARENESS (U.S. CLS. 21, 23, 26, 36 AND 38).

CLASS 16—PAPER GOODS AND PRINTED MATTER

FOR BOOKS, ALL PERTAINING TO SELF IMPROVEMENT, LEARNING, THOUGHT AND MEMORY ENHANCEMENT AND PERSONAL AND INTELLECTUAL AWARENESS (U.S. CLS. 2, 5, 22, 23, 29, 37, 38 AND 50).

CLASS 41—EDUCATION AND ENTERTAINMENT

FOR PERSONAL DEVELOPMENT TRAINING, TEACHING, TRAINING, PERSONAL COACHING AND INSTRUCTION SERVICES, LECTURING AND INSTRUCTIONAL SERVICES, ALL PERTAINING TO SELF IMPROVEMENT, LEARNING, THOUGHT AND MEMORY ENHANCEMENT AND PERSONAL AND INTELLECTUAL AWARENESS (U.S. CLS. 100, 101 AND 107).
KAREN K. BUSH, EXAMINING ATTORNEY

SN 79-028,057. SCHISCHEK GMBH, 90579 LANGENZENN, FED REP GERMANY, FILED 6-19-2006.

Schischek

THE MARK CONSISTS OF STANDARD CHARACTERS WITHOUT CLAIM TO ANY PARTICULAR FONT, STYLE, SIZE, OR COLOR.

OWNER OF INTERNATIONAL REGISTRATION 0896349 DATED 6-19-2006, EXPIRES 6-19-2016.

SN 79-028,004. ROBOSOFT, FRANCE, FILED 7-26-2006.

ROBOSOFT

THE MARK CONSISTS OF STANDARD CHARACTERS WITHOUT CLAIM TO ANY PARTICULAR FONT, STYLE, SIZE, OR COLOR.

PRIORITY DATE OF 1-30-2006 IS CLAIMED.

OWNER OF INTERNATIONAL REGISTRATION 0896219 DATED 7-26-2006, EXPIRES 7-26-2016.

CLASS 7—MACHINERY

FOR ACTUATORS, NAMELY, LINEAR ACTUATORS AND ROTARY ACTUATORS FOR MACHINES, ELECTRIC APPARATUS AND ENGINES, NAMELY, AIR DAMPERS, FIRE AND SMOKE DAMPERS, VOLUME CONTROL DAMPERS AND SYSTEMS (U.S. CLS. 13, 19, 21, 23, 31, 34 AND 35).

CLASS 7—MACHINERY

FOR INDUSTRIAL ROBOTS; CHECKING AND/OR SUPERVISION APPARATUS AND INSTRUMENTS, NAMELY, ROBOTS FOR SUPERVISION, ROBOTS FOR SUPERVISING PLANTS AND BUILDINGS, NAMELY, INDUSTRIAL ROBOTS (U.S. CLS. 13, 19, 21, 23, 31, 34 AND 35).

CLASS 9—ELECTRICAL AND SCIENTIFIC APPARATUS

FOR MEASURING DEVICES, NAMELY, ELECTRICAL AND ELECTRONIC SENSORS FOR MEASURING TEMPERATURE, HUMIDITY, PRESSURE, VOLUME, LEVEL, DISTANCE, SMOKE, TENSION, MOVEMENT, MOISTURE AND GAS CONCENTRATION; MAGNETS, NAMELY, MAGNETIC CLAMPS (U.S. CLS. 21, 23, 26, 36 AND 38).

TIMOTHY FINNEGAN, EXAMINING ATTORNEY

CLASS 9—ELECTRICAL AND SCIENTIFIC APPARATUS

FOR SCIENTIFIC APPARATUS AND INSTRUMENTS OTHER THAN MEDICAL, NAMELY, LABORATORY ROBOT, ENCODERS, CAMERAS, CALCULATORS, ACCUMULATORS, ELECTRIC CONNECTORS, ANTENNAS, ANTENNAS FOR WIRELESS COMMUNICATION APPARATUS, APPARATUS FOR TRANSMISSION OF COMMUNICATION, ELECTRIC MOTOR CONTROL FOR INDUSTRIAL ROBOTS, ELECTRIC OR ELECTRONIC NAVIGATIONAL INSTRUMENTS, ELECTRONIC DATA RELAYS FOR SENSORS, MOTION DETECTORS, ELECTRONIC TRANSMITTERS AND RECEIVERS FOR USE IN DETERMINING THE POSITION OF INDUSTRIAL ROBOTS; SURVEYING APPARATUS AND INSTRUMENTS, NAMELY, GYROSCOPES, GLOBAL POSITIONING SYSTEM, GPS DATA LOGGERS FOR RECORDING TRIPS AND CLASSIFYING THEM, NAVIGATING APPARATUS FOR VEHICLES, RADAR DETECTORS, SONARS AND ULTRASONIC SENSORS; OPTICAL APPARATUS AND INSTRUMENTS, NAMELY, LASER OBJECT DETECTORS FOR USE ON VEHICLES, INDUSTRIAL ROBOTS, LASER MEASURING SYSTEMS AND RADAR DETECTORS; MEASURING APPARATUS AND INSTRUMENTS, NAMELY, TESTERS FOR VOLTAGE, AMPERAGE, CONTINUITY, ACCELERATION SENSORS, ACCELEROMETERS, LASER MEASURING SYSTEMS, ULTRASONIC SENSORS, ULTRASONIC DETECTORS, SPEEDOMETERS, ECHO SOUNDING DEVICES; TEACHING APPARATUS AND INSTRUMENTS, NAMELY, LABORATORY ROBOTS FOR MUSEUM VISITS, ROBOTS FOR PERSONAL OR HOBBY USE (U.S. CLS. 21, 23, 26, 36 AND 38).

SN 79-028,109. MAGUS CREATIVA EUROPE, S.L., SPAIN, FILED 7-13-2006.



OWNER OF INTERNATIONAL REGISTRATION 0896508 DATED 7-13-2006, EXPIRES 7-13-2016.

CLASS 12—VEHICLES

FOR VEHICLES, NAMELY, AUTOMOBILES, TRUCKS, BUSES; APPARATUS FOR LOCOMOTION BY LAND, AIR OR WATER, NAMELY, AUTOMOBILES, TRUCKS, BUSES, TRAINS, AIRCRAFTS, BOATS; ELECTRIC VEHICLES, NAMELY, ELECTRIC CARS, INDUSTRIAL TRUCKS (U.S. CLS. 19, 21, 23, 31, 35 AND 44).
JOHN DWYER, EXAMINING ATTORNEY

CLASS 25—CLOTHING

FOR CLOTHING, NAMELY, T-SHIRTS AND SWEATSHIRTS; AND HEADGEAR, NAMELY, CAPS AND VISORS (U.S. CLS. 22 AND 39).

CLASS 28—TOYS AND SPORTING GOODS

FOR TOYS, NAMELY, CHILDREN'S MULTIPLE ACTIVITY TOYS, BATTERY OPERATED ACTION TOYS, BENDABLE TOYS, COLLECTIBLE TOY FIGURES, CONSTRUCTION TOYS, DISC TOSS TOYS, DRAWING TOYS, ELECTRIC ACTION TOYS, ELECTRONIC LEARNING TOYS, ELECTRONICALLY OPERATED TOY MOTOR VEHICLES, FANTASY CHARACTER TOYS, INFLATABLE RIDE-ON TOYS, MECHANICAL TOYS, MINIATURE TOY HELMETS, MODELED PLASTIC TOY FIGURINES, NON-RIDING TRANSPORTATION TOYS, PLASTIC CHARACTER TOYS, POSITIONABLE TOY FIGURES, RADIO CONTROLLED TOY VEHICLES, SKETCHING TOYS, SOFT SCULPTURE TOYS, SQUEEZE TOYS, STACKING TOYS, STUFFED TOY ANIMALS, TALKING TOYS, TOY AIRPLANES, TOY BANKS, TOY BOXES, TOY BUILDING BLOCKS, TOY GLIDERS, TOY GUNS, TOY MODEL CARS, TOY MODEL TRAIN SETS, TOY MUSIC BOXES, TOY ROBOTS, TOY ROCKETS, TOY SCOOTERS, TOY SNOW GLOBES, TOY VEHICLES, TOY WEAPONS, AND WIND-UP TOYS; GAMES, NAMELY, BOARD GAMES; PUZZLES; DOLLS AND PLUSH TOYS (U.S. CLS. 22, 23, 38 AND 50).

CLASS 41—EDUCATION AND ENTERTAINMENT

FOR ENTERTAINMENT SERVICES, NAMELY, PROVIDING THEME PARK AND AMUSEMENT PARK FACILITIES AND SERVICES, AMUSEMENT PARK SHOWS AND PLAY AREAS; EDUCATIONAL, TRAINING AND ENTERTAINMENT SERVICES IN THE NATURE OF A THEME PARK IN THE FORM OF A MINIATURE CITY IN WHICH CHILDREN CAN ROLE PLAY AS ADULTS LIVING AND WORKING IN THE CITY; AND ORGANIZING COMMUNITY SPORTING AND CULTURAL EVENTS (U.S. CLS. 100, 101 AND 107).
CHARLES L. JENKINS, EXAMINING ATTORNEY

SN 79-028,139. IDCAD CONSULTING INC., CANADA, FILED 7-5-2006.

idcad

OWNER OF INTERNATIONAL REGISTRATION 0896558 DATED 7-5-2006, EXPIRES 7-5-2016.

CLASS 9—ELECTRICAL AND SCIENTIFIC APPARATUS

FOR COMPUTER SOFTWARE FOR USE IN THE FIELD OF PRODUCT LIFECYCLE MANAGEMENT, NAMELY, COMPUTER SOFTWARE FOR USE IN MONITORING PRODUCTS WITH RESPECT TO BUSINESS COSTS AND SALES MEASURES; COMPUTER SOFTWARE FOR USE IN DESIGNING COMPUTER WEBSITES (U.S. CLS. 21, 23, 26, 36 AND 38).

CLASS 41—EDUCATION AND ENTERTAINMENT

FOR COMPUTER EDUCATION TRAINING (U.S. CLS. 100, 101 AND 107).

CLASS 42—SCIENTIFIC AND COMPUTER SERVICES

FOR CONSULTATION SERVICES IN THE FIELD OF COMPUTERS; COMPUTER CONSULTATION IN THE FIELDS OF PRODUCT LIFECYCLE MANAGEMENT, NAMELY, CONSULTATION REGARDING THE USE OF COMPUTER SOFTWARE FOR USE IN MONITORING PRODUCTS WITH RESPECT TO BUSINESS COSTS AND SALES MEASURES; COMPUTER CONSULTATION SERVICES IN THE FIELD OF COMPUTER WEBSITE DESIGN; COMPUTER CONSULTATION SERVICES IN THE FIELD OF THE USE OF COMPUTER SOFTWARE FOR ENGINEERING PROJECTS; COMPUTER CONSULTATION SERVICES IN THE FIELD OF COMPUTER ASSISTED MANUFACTURING, NAMELY, DEVELOPMENT OF COMPUTER PROGRAMS RECORDED ON DATA MEDIA DESIGNED FOR USE IN CONSTRUCTION AND AUTOMATED MANUFACTURING; CONSULTATION SERVICES IN THE FIELD OF COMPUTER SOFTWARE DEVELOPMENT FOR OTHERS; CONSULTATION SERVICES IN THE FIELDS OF MECHANICAL AND ELECTRICAL ENGINEERING (U.S. CLS. 100 AND 101).

DAVID MURRAY, EXAMINING ATTORNEY

SN 79-028,332. MÜTHING GMBH & CO. KG, FED REP GERMANY, FILED 12-6-2005.

MU-Farmer

THE MARK CONSISTS OF STANDARD CHARACTERS WITHOUT CLAIM TO ANY PARTICULAR FONT, STYLE, SIZE, OR COLOR.

PRIORITY DATE OF 6-22-2005 IS CLAIMED.
OWNER OF INTERNATIONAL REGISTRATION 0897014 DATED 12-6-2005, EXPIRES 12-6-2015.

CLASS 7—MACHINERY

FOR AGRICULTURE, FORESTRY, LANDSCAPING AND ENVIRONMENTAL PROTECTION MACHINES, NAMELY, FLAIL MOWERS, CHOPPERS AND CHOPPING UNITS, MULCHERS AND MULCHING UNITS, CULTIVATORS, HARVESTERS, DISK HARROWS, SEEDERS, AND PARTS THEREOF; AGRICULTURAL ATTACHMENTS OTHER THAN HAND-OPERATED, NAMELY, REAPERS, MOWERS, MULCHERS AND CHOPPERS (U.S. CLS. 13, 19, 21, 23, 31, 34 AND 35).

CLASS 42—SCIENTIFIC AND COMPUTER SERVICES

FOR TECHNICAL CONSULTANCY AND PROJECT PLANNING SERVICES OF ENGINEERS, NAMELY, TECHNICAL CONSULTANCY IN RELATION TO AGRICULTURE, FORESTRY, LANDSCAPING AND ENVIRONMENTAL PROTECTION, NAMELY, TECHNICAL CONSULTATION IN THE FIELD OF PRODUCTION, REPAIR, MAINTENANCE AND HANDLING BY USERS OF AGRICULTURAL, FORESTRY AND LANDSCAPING MACHINES AND OF MACHINES FOR MILLING, TREATMENT AND MIXING OF BIOMASS, HARVEST REFUSE, WOOD, SOIL AND STONY MATERIALS; ENGINEERING CONSULTANCY, EXCLUDING CONSULTANCY RELATED TO CANAL, SLUDGE AND WASTE DISPOSAL TECHNOLOGY; LANDSCAPE ARCHITECTURAL CONSULTING SERVICES; SURVEYING (U.S. CLS. 100 AND 101).

EDWARD FENNESSY, EXAMINING ATTORNEY

SN 79-028,662. JPM ROYALTY PARTNERS (L.L.C.), UNITED STATES, FILED 9-15-2005.

JPM JUAN PABLO MONTOYA

PRIORITY DATE OF 3-18-2005 IS CLAIMED.
OWNER OF INTERNATIONAL REGISTRATION 0898026
DATED 9-15-2005, EXPIRES 9-15-2015.

THE NAME(S), PORTRAIT(S), AND/OR SIGNATURE(S) SHOWN IN THE MARK IDENTIFIES "JUAN PABLO MONTOYA", WHOSE CONSENT(S) TO REGISTER IS SUBMITTED.

CLASS 3—COSMETICS AND CLEANING PREPARATIONS

FOR NON-MEDICATED TOILET PREPARATIONS, NAMELY, AFTER-SHAVE LOTIONS; COSMETICS; NON-MEDICATED TOILETRIES; LIP GLOSS; SOAPS; HAIR CARE PREPARATIONS, HAIR CLEANING PREPARATIONS, AND HAIR COLORING PREPARATIONS; DENTIFRICES; PREPARATIONS FOR CLEANING THE TEETH, NAMELY, TOOTHPASTE; PERFUME, COLOGNES, TOILET WATERS, EAU DE COLOGNES; DEODORANTS FOR PERSONAL USE; BATH POWDER, BODY POWDER; BUBBLE BATH; BODY LOTIONS, HAND LOTIONS; TOILET ARTICLES NAMELY TOILET SOAP AND TOILET WATER (U.S. CLS. 1, 4, 6, 50, 51 AND 52).

CLASS 9—ELECTRICAL AND SCIENTIFIC APPARATUS

FOR CLOTHING, FOOTWEAR, HEADGEAR, NAMELY, HELMETS, HELMETS, SCALE SAFETY HELMETS, PROTECTIVE GLOVES FOR USE IN THE FIELD OF AUTO RACING, BELTS FOR USE IN THE FIELD OF AUTO RACING, GOGGLES, ALL OF A PROTECTIVE NATURE; LUMINOUS AND MECHANICAL SIGNS; ANTI-GLARE VISORS; SUNGLASSES, SPECTACLES AND CASES THEREOF; THEFT ALARMS; ELECTRONIC REMOTE LOCKS; PERSONAL SECURITY APPARATUS, NAMELY, PERSONAL SECURITY ALARMS; ENCODED AND MAGNETIC CARDS, NAMELY, CREDIT CARDS, TELEPHONE CARDS, BONUS CARDS, CHARGE CARDS, AND CONTROLLING SOFTWARE CARDS; BATTERIES; APPARATUS FOR TRANSMISSION OF COMMUNICATION; RADIO RECEIVERS, STEREO RECEIVERS AND SATELLITE RECEIVERS; PRE-RECORDED VIDEO CASSETTES FOR EDUCATION, DOCUMENTARIES, ENTERTAINMENT IN THE FIELD OF AUTO RACING; PRE-RECORDED AUDIO CASSETTES FOR EDUCATION, DOCUMENTARIES, ENTERTAINMENT IN THE FIELD OF AUTO RACING; PRE-RECORDED COMPACT DISCS FOR EDUCATION, DOCUMENTARIES, ENTERTAINMENT IN THE FIELD OF AUTO RACING; PRE-RECORDED DISCS AND TAPES FEATURING BOOKS IN THE FIELD OF AUTO-RACING; FILM, NAMELY, CINEMATOGRAPHIC FILM, HARDWARE FOR COMPUTERS FEATURING AUTO RACING IN THE NATURE OF HARD DISCS; SOFTWARE FOR COMPUTERS FEATURING AUTO RACING OR GAMES; PHOTOGRAPHIC APPARATUS, NAMELY, CAMERAS AND CAMCORDERS; BINOCULARS; DOWNLOADABLE ON-LINE ELECTRONIC PUBLICATIONS, NAMELY, BOOKS, CATALOGUES, FACT SHEETS, NEWSPAPERS, MAGAZINES IN THE FIELD OF AUTO RACING; ELECTRONIC DATABASE IN THE FIELD OF AUTO RACING RECORDED ON COMPUTER MEDIA (U.S. CLS. 21, 23, 26, 36 AND 38).

CLASS 12—VEHICLES

FOR VEHICLES, NAMELY, LAND VEHICLES AND STRUCTURAL PARTS THEREFORE; VEHICLE ACCESSORIES, NAMELY, ANTI-THEFT DEVICES FOR VEHICLES, BUMPERS FOR AUTOMOBILES, HUB CAPS, MUDGUARDS, SAFETY BELTS FOR VEHICLE SEATS, SEAT COVERS FOR VEHICLES, SAFETY SEATS FOR CHILDREN IN VEHICLES, SUN-BLINDS ADAPTED FOR AUTOMOBILES, TYRES FOR VEHICLE WHEELS; APPARATUS FOR LOCOMOTION BY LAND, AIR OR WATER, NAMELY, CARS, AEROPLANES, BOATS, BICYCLES, TRUCKS (U.S. CLS. 19, 21, 23, 31, 35 AND 44).

CLASS 14—JEWELRY

FOR TIME PIECES AND CHRONOMETRIC INSTRUMENTS; WATCH BANDS, JEWELLERY AND IMITATION JEWELLERY; NON-MONETARY COINS, COLLECTIBLE COINS AND COMMEMORATIVE COINS; MEDALS; CUFFLINKS; TIE CLIPS AND PINS, MEDALLIONS; BADGES, BELT BUCKLES FOR CLOTHING, SHIRT STUDS, LAPEL BADGES, FIGURINES, BUSTS, CAMEOS, ASHTRAYS, SMOKERS' ARTICLES, NAMELY, CIGARETTE CASES, HAT AND SHOE ORNAMENTS, KEY-RINGS, COASTERS, PAPER WEIGHTS, DRINKING AND EATING ARTICLES, NAMELY, CRUET SETS, COFFEE SERVICES AND EGG CUPS, STORAGE CASES OF PRECIOUS METAL FOR JEWELLERY, TROPHIES, CAMEOS, ALL OF EITHER PRECIOUS OR SEMI-PRECIOUS METALS OR COATED WITH SAME (U.S. CLS. 2, 27, 28 AND 50).

CLASS 16—PAPER GOODS AND PRINTED MATTER

FOR STATIONERY; ADVERTISING SIGNS OF PAPER OR CARDBOARD; PICTURES; PHOTOGRAPHS; POSTERS; RUBBER STAMPS; BOOK COVERS AND BINDINGS; STATIONERY TYPE PORTFOLIOS; NEWSPAPERS; MAGAZINES FEATURING AUTO-RACING; COMIC BOOKS; PUBLICATIONS IN THE NATURE OF BOOKS, MAGAZINES, JOURNALS, NEWSPAPERS FEATURING AUTO-RACING; MANUALS FEATURING AUTO-RACING; CATALOGUES FEATURING AUTO-RACING; ANNUAL PUBLICATIONS, NAMELY, BOOKS ON AUTO-RACING; PRINTED PERIODICALS IN THE FIELD OF AUTO-RACING; ADDRESS BOOKS; PHOTO ALBUMS; AUTOGRAPH BOOKS; DIARIES; SCRAP BOOKS; WRITING PADS AND MEMO BLOCKS; BINDERS; CALENDARS; TIME PLANNERS; PERSONAL ORGANISERS; GREETING CARDS; IMITATION BANK NOTES; ROUTE MAPS; PRINTING, PAINTING AND DRAWING SETS; LETTER OPENERS; COMPUTER GAME INSTRUCTION MANUALS; STICKERS; STENCILS; PLASTIC TRANSFERS; PAPER AND METALLIC GIFT WRAPS AND STATIONERY; STATIONERY AND TABLEWARE, NAMELY, TABLE CLOTHS OF PAPER, NAPKINS OF PAPER; CARRYING CASES MADE OF PAPER, PAPER BAGS, PLASTIC BAGS FOR CARRYING ITEMS BOUGHT IN A SHOP, FOLDERS, HOLDERS, NAMELY, DOCUMENT HOLDERS, PAPER PACKAGING, PAPER BADGES, PAPER MATS ALL OF EITHER PAPER CARD OR PLASTIC; PAPIER MACHE BUSTS, PAPIER MACHE FIGURINES, ORNAMENTS, NAMELY, PARTY ORNAMENTS ALL OF EITHER PAPIER MACHE OR CARD (U.S. CLS. 2, 5, 22, 23, 29, 37, 38 AND 50).

CLASS 18—LEATHER GOODS

FOR LUGGAGE AND CASES, NAMELY, ATTACHÉ CASES; BACKPACKS; HANDBAGS; PURSES; SPORTS BAGS; SCHOOL BAGS; WRITING SET CASES; UMBRELLAS; SUNSHADES, NAMELY, PARASOLS; BRIEFCASE TYPE PORTFOLIOS; JEWELLERY BOXES ALL OF LEATHER OR IMITATION LEATHER, CASES AND WALLETS ALL OF LEATHER OR IMITATION LEATHER; HOLDERS, NAMELY, BANKNOTE HOLDERS MADE OF EITHER LEATHER OR IMITATION LEATHER, BOOK COVERS AND KEY FOBs, ALL OF EITHER LEATHER OR IMITATION LEATHER (U.S. CLS. 1, 2, 3, 22 AND 41).

CLASS 21—HOUSEWARES AND GLASS

FOR HOUSEHOLD AND KITCHEN UTENSILS AND CONTAINERS, NAMELY, POT AND PAN SCRAPERS, ROLLING PINS, SPATULAS, TURNERS, WHISKS, SKIMMERS, SIEVES, GRATERS, STRAINERS AND COLANDERS, CORKSCREWS; CHINAWARE, NAMELY, SERVING PLATTERS, PLATES, BOWLS, CUPS, MUGS, SERVING BOWLS, CROCKERY; GLASSWARE, NAMELY, GLASS JARS, GLASSES FOR DRINKING LIQUIDS OUT OF; PORCELAIN, NAMELY, FIGURINES, MUGS, DOOR KNOBS, CROCKERY; EARTHENWARE AND CHINA, NAMELY, FIGURINES, SCULPTURES, STATUETTES, CROCKERY; CROCKERY, NAMELY, FIGURINES, SCULPTURES, STATUETTES, GLASSWARE, DECANTERS; CROCKERY, NAMELY, PLATES, BOWLS, JUGS, CUPS, SAUCERS, MUGS; CUPS; MUGS; BOWLS; COOKIE JARS; LUNCH BOXES; DRINKING VESSELS; DISHES; PLATES; COASTERS NOT OF PAPER AND NOT BEING OF TABLE LINEN; DECANTERS; FIGURINES, STATUES AND STATUETTES MADE OF CHINA, CRYSTAL, EARTHENWARE, GLASS OR POTTERY; GOBLETS; STORAGE JARS MADE OF CHINA, GLASS OR EARTHENWARE; NAPKIN HOLDERS AND NAPKIN RINGS NOT MADE OF PRECIOUS METAL; SOAP DISHES, TRIVETS; VACUUM BOTTLES; TEA KETTLES; TOOTHBRUSHES AND HAIR BRUSHES, COMBS; WASTE PAPER BASKETS (U.S. CLS. 2, 13, 23, 29, 30, 33, 40 AND 50).

CLASS 24—FABRICS

FOR CLOTH BANNERS; CLOTH FLAGS; TOWELS; FACE FLANNELS; BED LINEN; DUVET COVERS; SLEEPING BAGS; CURTAINS; LINEN TABLEWARE, NAMELY, TABLECLOTHS, NAPKINS, COASTERS; FABRIC NAMELY COTTON, LINEN OR SILK; FABRIC BADGES AND LABELS; CURTAINS; KITCHEN LINEN, HANDKERCHIEFS; FRIEZES; PLASTIC TABLE MATS (U.S. CLS. 42 AND 50).

CLASS 25—CLOTHING

FOR CLOTHING, NAMELY, UNDERWEAR; TRACKSUITS; OVERALLS; COATS; MANTLES; SUITS; JACKETS; WAIST COATS; BATH ROBES; CLOTHING BELTS; GLOVES; JUMPERS; TROUSERS; SKIRTS; SHORTS; SHIRTS; POLO SHIRTS; T-SHIRTS; SWEAT SHIRTS; SWEAT BANDS; SCARVES; GLOVES; NECKWEAR; FOOTWEAR; HEADGEAR, NAMELY, HATS; CAPS; VISORS; BASEBALL CAPS; HEADBANDS (U.S. CLS. 22 AND 39).

CLASS 26—FANCY GOODS

FOR TEXTILE BADGES OR PATCHES FOR CLOTHING; EMBROIDERED BADGES AND PATCHES FOR CLOTHING; EMBROIDERY; EMBROIDERED MONOGRAM TABS; EMBROIDERED LABELS; EMBROIDERED LETTERING; EMBROIDERED ROSETTES; RIBBONS; HAT ORNAMENTS NOT OF PRECIOUS METALS, NAMELY, HAT AND HEAD BANDS; HAIR GRIPS (U.S. CLS. 37, 39, 40, 42 AND 50).

CLASS 27—FLOOR COVERINGS

FOR CARPETS, RUGS, MATS AND MATTING, NAMELY, BATH MATS, DOOR MATS, BEACH MATS; FLOOR COVERINGS, NAMELY, LINOLEUM AND OTHER MATERIALS FOR COVERING EXISTING FLOORS; NON-TEXTILE WALL HANGINGS (U.S. CLS. 19, 20, 37, 42 AND 50).

CLASS 28—TOYS AND SPORTING GOODS

FOR TOYS, NAMELY, PLUSH TOYS, STUFFED TOYS, SPINNING TOPS, BUILDING BLOCKS, DOLLS; PLAYTHINGS, NAMELY, BOARD GAMES, PLAYING CARDS, BALLS FOR GAMES; GAMES, NAMELY, DICE GAMES, HAND HELD UNIT FOR PLAYING ELECTRONIC GAMES, BOARD GAMES; SPORTING ARTICLES, NAMELY, ELBOW GUARDS, CHEST EXPANDERS FOR EXERCISING, GLOVES FOR GAMES, KNEE GUARDS, INLINE ROLLER SKATES; BAGS SPECIALLY ADAPTED FOR SPORT EQUIPMENT; PLAY BALLS; BATH TOYS; BOARD GAMES; CARD GAMES; CHRISTMAS NOVELTIES, NAMELY, CHRISTMAS TREE ORNAMENTS AND DECORATIONS; TOY CONSTRUCTION SETS; ELECTRONIC DART GAMES AND DART APPARATUS, NAMELY, DARTS, DART BOARDS, DART POINTS; DICE GAMES; EDUCATIONAL PLAYTHINGS, NAMELY, MANIPULATIVE GAMES, JIGSAW PUZZLES; PUZZLES; ELECTRONIC TOYS AND GAMES, NAMELY, AMUSEMENT GAME MACHINES; TOY FIGURINES; FOOTBALLS AND FOOTBALL APPARATUS, NAMELY, FOOTBALL ELBOW PADS, FOOTBALL KNEE PADS, NETS FOR SPORTS; SPORT GLOVES, NAMELY, BASEBALL GLOVES, BATTING GLOVES, BOXING GLOVES, GOLF GLOVES, FENCING GLOVES; FITNESS APPARATUS, NAMELY, EXERCISERS IN THE NATURE OF EXERCISE MACHINES, CROSS TRAINERS AND TREADMILLS, WEIGHT LIFTING BELTS, CHEST EXPANDERS, DUMB BELLS; INFLATABLE PLAYTHINGS, JIGSAW PUZZLES; KITES; TOY MODEL VEHICLES AND RELATED ACCESSORIES SOLD AS UNITS; TOY GARAGES; PAPER TOYS, NAMELY, PAPER AIRPLANES, PAPER DOLLS, PAPER MOBILES; PAPER STREAMERS; PLASTIC MODELS, NAMELY, TOY MODEL KIT CARS; PLAY TENTS; PLUSH AND SOFT TOYS; PUZZLES; RIDE-ON OR IN TOYS, NAMELY, TOY BICYCLES AND TOY VEHICLES; ROLLER SKATES; SKATE BOARDS; SAIL AND SURFBOARDS; BOBSLEIGHS; TOY VEHICLE TRACKS AND RACING SETS; TOY MONEY BOXES; PARTY NOVELTIES, NAMELY, PARTY FAVOURS IN THE NATURE OF SMALL TOYS; SCALE MOTOR VEHICLES IN THE NATURE OF MOTOR RACING CARS (U.S. CLS. 22, 23, 38 AND 50).

CLASS 30—STAPLE FOODS

FOR BISCUITS, CAKES; NON-MEDICATED CONFECTIONERY, NAMELY, CANDY BARS, CONFECTIONERY FOR DECORATING CHRISTMAS TREES, FRUIT JELLIES, LOZENGES; SNACK FOODS, NAMELY, CEREAL BASED SNACK FOODS, CHEESE FLAVORED PUFFED CORN SNACKS; BAKERY DESSERTS AND FILLING THEREFOR, NAMELY, FILLED CHOCOLATE, FONDANTS IN THE NATURE OF CHOCOLATE FONDANT; BAKERY GOODS, NAMELY, CAKES, MUFFINS, BISCUITS, COOKIES; PREPARED MEALS CONSISTING OF PRIMARILY PASTA, RICE, CEREALS, BREAD, PASTRY; BUBBLE GUM, CANDY CAKE DECORATIONS; CANDIED FRUIT SNACKS; CANDY; CORN CHIPS; CHOCOLATE; ICE CREAM; CONES FOR ICE CREAM; FROZEN CONFECTIONS; COOKIES; PASTRIES; POPCORN; PRETZELS; FROZEN YOGHURT; BREAKFAST CEREAL; MUESLI; MACARONI NOODLES; PASTA AND SPAGHETTI (U.S. CL. 46).

CLASS 32—LIGHT BEVERAGES

FOR NON-ALCOHOLIC DRINKS, NAMELY, SODA POPS, FRUIT JUICES, GINGER ALE, GINGER BEER, LEMONADE, AND PREPARATIONS FOR MAKING SUCH DRINKS, NAMELY, SODA WATER, FRUIT NECTARS, VEGETABLE JUICES; FRUIT DRINKS, FRUIT FLAVORED DRINKS; CARBONATED DRINKS, MINERAL AND AERATED WATERS; SPRING WATERS; FLAVORING FOR DRINKS IN THE NATURE OF LEMONADE, GINGER AND FRUIT; SYRUPS FOR MAKING LEMONADE, BEVERAGES IN THE NATURE OF LEMONADE AND GINGER BEER, NON-ALCOHOLIC COCKTAILS, SORBETS IN THE FORM OF BEVERAGES, CORDIALS AND SQUASHES, NAMELY, LEMON SQUASH, ORANGE SQUASH; PUNCHES; SPORT DRINKS; SMOOTHIES (U.S. CLS. 45, 46 AND 48).

CLASS 35—ADVERTISING AND BUSINESS

FOR COMMERCIAL ADMINISTRATION IN THE NATURE OF THE LICENSING OF GOODS AND SERVICES TO OTHERS (U.S. CLS. 100, 101 AND 102).

CLASS 41—EDUCATION AND ENTERTAINMENT

FOR PROVIDING INFORMATION ON EDUCATION IN THE FIELD OF AUTO-RACING FROM A COMPUTER DATABASE OR THE INTERNET; PROVIDING ENTERTAINMENT INFORMATION IN THE FIELD OF AUTO-RACING FROM A COMPUTER DATABASE OR THE INTERNET; ENTERTAINMENT SERVICES, NAMELY, PROVIDING ONLINE COMPUTER GAMES; PROVIDING NON-DOWNLOADABLE ONLINE PUBLICATIONS IN THE NATURE OF BOOKS, CATALOGUES, FACT SHEETS, NEWSPAPERS, MAGAZINES IN THE FIELD OF AUTO RACING; ELECTRONIC PUBLISHING SERVICES, NAMELY, ON-LINE PUBLICATION OF ELECTRONIC BOOKS OF OTHERS FEATURING AUTO RACING; ENTERTAINMENT SERVICES IN THE NATURE OF SPORTING AND CULTURAL ACTIVITIES, NAMELY, AUTO RACING; ENTERTAINMENT SERVICES IN THE NATURE OF LIVE ACTION, COMEDY, DRAMA, ANIMATED ON-GOING TELEVISION PROGRAMMES AND ANIMATED MOTION PICTURE CINEMATOGRAPHIC FILM IN THE FIELD OF AUTO-RACING; PRODUCTION OF ON-GOING LIVE ACTION, COMEDY, DRAMA, ANIMATED TELEVISION PROGRAMMES; PRODUCTION OF ANIMATED MOTION PICTURE FILMS; ENTERTAINMENT SERVICES IN THE NATURE OF PARTICIPATION OF AUTOMOBILE RACES AND RELATED EXHIBITIONS; PROVIDING FACILITIES FOR RECREATION ACTIVITIES IN THE NATURE OF GO-KART, OFF ROAD VEHICLES AND QUAD BIKES AND VEHICLE TRAINING; CONSULTANCY IN THE FIELD OF MOTOR SPORTS (U.S. CLS. 100, 101 AND 107).

Laurie Kaufman, Examining Attorney

CLASS 7—MACHINERY

FOR SECONDARY METAL FORMING MACHINES AND APPARATUS, NAMELY, WIRE FORMING MACHINES; HOISTING WINDING GEARS, NAMELY, WINCHES AND CAPSTANS, NOT FOR SHIPS OR BOATS; PLASTIC PROCESSING MACHINES AND APPARATUS, NAMELY, EXTRUSION MOLDING MACHINES AND INJECTION MOLDING MACHINES; SHOCK ABSORBERS FOR MACHINES, MACHINERY AND BUILDINGS, NAMELY, SPRING SHOCK ABSORBERS, SPRING-ASSISTED HYDRAULIC SHOCK ABSORBERS, AND PNEUMATIC SHOCK ABSORBERS IN THE NATURE OF AIR SPRINGS; SPRINGS FOR MACHINES, MACHINERY AND BUILDINGS, NAMELY, LAMINATED LEAF-SPRINGS; MACHINE VALVES, NAMELY, COCK VALVES (U.S. CLS. 13, 19, 21, 23, 31, 34 AND 35).

CLASS 9—ELECTRICAL AND SCIENTIFIC APPARATUS

FOR DERIVED-UNIT MEASURING MACHINES AND APPARATUS, NAMELY, VIBRATION METERS AND NOISE METERS; PRECISION MEASURING MACHINES AND INSTRUMENTS, NAMELY, INTERFEROMETERS; AUTOMATIC ADJUSTING/REGULATING MACHINES AND MEASURING INSTRUMENTS, NAMELY, AUTOMATIC FLUID COMPOSITION CONTROLS AND LIQUID LEVEL CONTROLS; POWER DISTRIBUTION OR CONTROL MACHINES AND APPARATUS, NAMELY, ELECTRICAL CONDUCTORS, POWER DISTRIBUTING BOXES AND PLUGBOARDS; ELECTRICAL CELLS AND BATTERIES; PHOTOVOLTAIC CELLS; ELECTRIC OR MAGNETIC METERS AND TESTERS, NAMELY, ANTENNA PARAMETER MEASURING APPARATUS, ELECTRICAL LEAKAGE DETECTORS, MAGNETOMETERS, FREQUENCY METERS, VACUUM TUBE CHARACTERISTIC TESTERS, WATT HOUR METERS, RESISTANCE MEASURING INSTRUMENTS, VOLTMETERS, WAVEMETERS, AMMETERS, WATTMETERS, OSCILLATORS, AND CAPACITY MEASURES, NAMELY, CAPACITORS, ELECTRIC CAPACITORS, CONDENSERS; ELECTRIC WIRES, NAMELY, RUBBER COVERED WIRES, SPECIAL COVERED WIRES, BARE WIRES, PLASTIC COVERED WIRES AND COILS; ELECTRIC CABLES; ELECTRIC TERMINAL BOXES, JUNCTION BOXES, AND JUNCTION SLEEVES FOR ELECTRIC CABLES, TELECOMMUNICATIONS CABLES, POWER CABLES AND OPTICAL FIBER CABLES; TELECOMMUNICATION TRANSMISSION MACHINES AND APPARATUS, NAMELY, CABLE TRANSMISSION MACHINES AND APPARATUS, POWER-LINE TRANSMISSION MACHINES AND APPARATUS, OPEN-WIRE TRANSMISSION MACHINES AND APPARATUS, AND TRANSMISSION AND REPEATING MACHINES AND APPARATUS; BROADCASTING MACHINES AND APPARATUS, NAMELY, TELEVISION RECEIVERS AND TELEVISION TRANSMITTERS; RADIO COMMUNICATION MACHINES AND APPARATUS, NAMELY, PORTABLE RADIOS; VEHICULAR RADIOS; MULTI-CHANNEL RADIO COMMUNICATION MACHINES AND APPARATUS FOR FIXED STATIONS, SINGLE-CHANNEL RADIO COMMUNICATION MACHINES AND APPARATUS FOR FIXED STATIONS; PARTS FOR TELECOMMUNICATION MACHINES AND APPARATUS, NAMELY, CONNECTORS AND PLUGBOARDS; SEMICONDUCTORS, NAMELY, DIODES AND TRANSISTORS; ELECTRONIC CIRCUITS, NAMELY, INTEGRATED CIRCUITS; MAGNETIC CORES; ELECTRICAL RESISTANCE WIRES; ELECTRODES (U.S. CLS. 21, 23, 26, 36 AND 38).

SN 79-028,978. SWCC SHOWA HOLDINGS CO., LTD., JAPAN, FILED 2-14-2006.



OWNER OF INTERNATIONAL REGISTRATION 0898704 DATED 2-14-2006, EXPIRES 2-14-2016.

OWNER OF U.S. REG. NO. 1,530,607.

NO CLAIM IS MADE TO THE EXCLUSIVE RIGHT TO USE "GROUP", APART FROM THE MARK AS SHOWN.

THE COLOR(S) RED AND BLACK IS/ARE CLAIMED AS A FEATURE OF THE MARK.

THE MARK CONSISTS OF THE TERM "SWCC" IN BLACK, THE TERM "GROUP" IN RED, AND THE DESIGN OF AN INCOMPLETE CIRCLE COMPRISED OF SOLID RED CIRCLES IN DECREASING SIZE ORDER.

CLASS 17—RUBBER GOODS

FOR ELECTRICAL INSULATORS, NAMELY, MOLDED, PORCELAIN AND POLYMER TYPE INSULATORS FOR ELECTRIC MAINS, FOR ELECTRICAL CABLES, FOR USE AS A BUILDING INSULATOR; ELECTRICAL INSULATING TAPES AND RUBBER PRODUCTS; INDUSTRIAL PACKAGING CONTAINERS OF RUBBER; PLASTIC PRODUCTS, NAMELY, SEMI-WORKED BOARDS AND PLATES, PLASTIC TAPES, STRIPS, PIPES AND TUBES FOR USE IN SOUND ABSORBERS AND VIBRATION ABSORBERS FOR MACHINES, MACHINERY AND BUILDINGS, PLASTIC LAMINATED BOARDS AND ADHESIVE-COATED PLASTIC SHEETS FOR USE IN SOUND ABSORBERS AND VIBRATION ABSORBERS; NATURAL RUBBER, NAMELY, RUBBER SHEETS, RUBBER TUBES AND PIPES, AND RUBBER BARS AND RODS (U.S. CLS. 1, 5, 12, 13, 35 AND 50).

BARBARA A. GOLD, EXAMINING ATTORNEY

SN 79-029,709. LEONHARD ROSENBERGER, ENGELSBERG, FED REP GERMANY, FILED 8-9-2006.



SN 79-029,687. L G HARRIS & CO LIMITED, UNITED KINGDOM, FILED 7-1-2006.

HARRIS

THE MARK CONSISTS OF STANDARD CHARACTERS WITHOUT CLAIM TO ANY PARTICULAR FONT, STYLE, SIZE, OR COLOR.

PRIORITY DATE OF 1-24-2006 IS CLAIMED.

OWNER OF INTERNATIONAL REGISTRATION 0900640 DATED 7-1-2006, EXPIRES 7-1-2016.

OWNER OF U.S. REG. NO. 743,358.
SEC. 2(F).

OWNER OF INTERNATIONAL REGISTRATION 0900215 DATED 8-9-2006, EXPIRES 8-9-2016.

THE WORDING "LALEVGA" HAS NO MEANING IN A FOREIGN LANGUAGE.

CLASS 14—JEWELRY

FOR JEWELRY, PRECIOUS STONES (U.S. CLS. 2, 27, 28 AND 50).

CLASS 25—CLOTHING

FOR CLOTHING, NAMELY, SUITS, COSTUMES, NAMELY, MASQUERADE, HALLOWEEN, DANCE COSTUMES; BATHING SUITS, BATHING TRUNKS, ROBES, BANDANNAS, WOMEN'S DRESSES, GYM CLOTHING, NAMELY, SHORTS, JERSEYS, LEGGINGS, SOCKS; SWEAT SUITS, TRICOT CLOTHING, NAMELY, SWEATERS, PANTS, SHORTS, TOPS; JERSEYS, T-SHIRTS, VESTS, WIND RESISTANT JACKETS, SCARVES, SHAWLS, BLOUSES, SHIRTS, TROUSERS, JACKETS, LEATHER CLOTHING, NAMELY, JACKETS, SHOES, PANTS, CAPS, HATS, BELTS; COATS, OVERALLS, PARKAS, PULLOVERS, BICYCLIST CLOTHING, NAMELY, SHORTS, TANK TOPS; RAINCOATS, SWEATERS, BELTS; FOOTWEAR, HEAD GEAR, NAMELY, HATS, CAPS, BATHING CAPS (U.S. CLS. 22 AND 39).

KAREN K. BUSH, EXAMINING ATTORNEY

CLASS 8—HAND TOOLS

FOR HAND TOOLS FOR USE IN PAINTING, DECORATING, PAPERHANGING AND TILING, NAMELY, SCRAPERS, WINDOW SCRAPERS, WALLPAPER STRIPPERS, PAINT SCRAPERS, SCISSORS AND KNIVES FOR USE IN WALLPAPERING AND HOUSEHOLD DECORATING, STRIPPING KNIVES, FILLING KNIVES AND TROWELS, CHISEL KNIVES, PUTTY KNIVES, WALLPAPER TRIMMING KNIVES, SEAM ROLLERS, WALLPAPER SMOOTHERS, SHAVE HOOKS IN THE NATURE OF KNIVES, PAINT GUARDS AND SHIELDS, PAINT CAN HOOKS IN THE NATURE OF PAINT CAN OPENERS, SANDERS, POLE SANDERS, STAPLE GUNS, GUNS FOR THE EXTRUSION OF MASTIC, CAULKING GUNS; REPLACEMENT PARTS FOR THE AFORESAID GOODS (U.S. CLS. 23, 28 AND 44).

SN 79-029,861. TNF GROUP PTY (ACN 100 768 054), AUSTRALIA, FILED 10-5-2006.

PERFORMAX

THE MARK CONSISTS OF STANDARD CHARACTERS WITHOUT CLAIM TO ANY PARTICULAR FONT, STYLE, SIZE, OR COLOR.

OWNER OF INTERNATIONAL REGISTRATION 0900459 DATED 10-5-2006, EXPIRES 10-5-2016.

CLASS 16—PAPER GOODS AND PRINTED MATTER

FOR BRUSHES FOR APPLYING POLISH, STAIN, VARNISH OR WALLPAPER PASTE; PAPER HANGING BRUSHES; ARTISTS BRUSHES; PAINT BRUSHES; PAINT APPLICATOR ROLLERS; PAINT ROLLER FRAMES, NAMELY, FRAMES FOR HOLDING PAINT ROLLER COVERS; EXTENSION POLES USED IN CONJUNCTION WITH PAINT APPLICATORS; PAINT APPLICATOR PADS; PAINT TRAYS; PAINT SCUTTLES, NAMELY, PAINT PAILS; PAINTING STENCILS; MASKING TAPE; REPLACEMENT PARTS FOR THE AFORESAID GOODS (U.S. CLS. 2, 5, 22, 23, 29, 37, 38 AND 50).

COLLEEN DOMBROW, EXAMINING ATTORNEY

CLASS 24—FABRICS

FOR FABRIC, NAMELY, NYLON, POLYESTER, ELASTIC FABRICS FOR CLOTHING, AND SYNTHETIC FIBER FABRICS (U.S. CLS. 42 AND 50).

CLASS 25—CLOTHING

FOR CLOTHING, NAMELY, T-SHIRTS, PANTS, SHIRTS, SKIRTS, BODYSUITS, LEOTARDS, SPORT JACKETS, TRACKSUITS, SWEATPANTS, SPORTS SHIRTS, LINGERIE, UNDERGARMENTS, AND SWIMWEAR; HEADGEAR, NAMELY, HATS, CAPS; AND FOOTWEAR (U.S. CLS. 22 AND 39).

ROSELLE HERRERA, EXAMINING ATTORNEY

SN 79-029,910. VENTILATORENFABRIK OELDE GMBH, 59302 OELDE, FED REP GERMANY, FILED 10-16-2006.



OWNER OF INTERNATIONAL REGISTRATION 0894340 DATED 5-31-2006, EXPIRES 5-31-2016.

THE COLOR(S) BLUE AND WHITE IS/ARE CLAIMED AS A FEATURE OF THE MARK.

THE WORDING "VENTI", SQUARE, CIRCLE AND, INVERTED TRIANGLE AND HORIZONTAL LINES APPEAR IN THE COLOR BLUE, THE FAN DESIGN APPEARS IN THE COLOR WHITE AND THE WORDING "OELDE" IS WHITE, OUTLINED IN BLUE.

THE WORDING "VENTI OELDE" HAS NO MEANING IN ENGLISH.

CLASS 4—LUBRICANTS AND FUELS

FOR DUST ABSORBING, WETTING AND BINDING COMPOSITIONS (U.S. CLS. 1, 6 AND 15).

CLASS 7—MACHINERY

FOR MACHINES, NAMELY, PAINT LINES, OIL AND EMULSION VAPOUR COLLECTORS, WATER SPRAY SEPARATORS, PAINT MIST REMOVAL INSTALLATIONS, RECYCLING INSTALLATIONS (U.S. CLS. 13, 19, 21, 23, 31, 34 AND 35).

CLASS 11—ENVIRONMENTAL CONTROL APPARATUS

FOR HEATING, COOLING, DRYING AND VENTILATION DEVICES, IN PARTICULAR FANS, FILTERS, DUST REMOVING INSTALLATIONS, DUST REMOVING INSTALLATIONS FOR THE WORKPLACE (U.S. CLS. 13, 21, 23, 31 AND 34).

MICHELE SWAIN, EXAMINING ATTORNEY

SN 79-029,987. FÉDÉRATION EQUESTRE INTERNATIONALE, SWITZERLAND, FILED 7-28-2006.



PRIORITY DATE OF 2-23-2006 IS CLAIMED. OWNER OF INTERNATIONAL REGISTRATION 0901242 DATED 7-28-2006, EXPIRES 7-28-2016.

NO CLAIM IS MADE TO THE EXCLUSIVE RIGHT TO USE "GAMES", APART FROM THE MARK AS SHOWN.

CLASS 9—ELECTRICAL AND SCIENTIFIC APPARATUS

FOR ELECTRONIC GAMES PROGRAMS; COMPUTER GAME SOFTWARE RECORDED ON COMPACT DISKS, DIGITAL VIDEO DISKS, MEMORY CARDS AND OTHER MEMORY SUPPORTS, NAMELY, FLASH MEMORY CARDS, RAM (RANDOM ACCESS MEMORY) CARDS (U.S. CLS. 21, 23, 26, 36 AND 38).

CLASS 14—JEWELRY

FOR JEWELLERY OF PRECIOUS METAL OR PLATED THEREWITH OR IMITATION JEWELLERY, TIE PINS, CHRONOMETRIC INSTRUMENTS AND WATCHES FOR THE PROMOTION OF EQUESTRIAN SPORT, EQUESTRIAN EVENTS AND EQUESTRIAN COMPETITIONS TAKING PLACE IN SEVERAL INDIVIDUAL COMPETITIONS ORGANIZED IN A SERIES LEADING TO SINGLE CLASSIFICATION OR QUALIFICATION FOR A FINAL (U.S. CLS. 2, 27, 28 AND 50).

CLASS 18—LEATHER GOODS

FOR GOODS FOR EQUESTRIAN SPORT, NAMELY, WHIPS, SADDLERY, SADDLES, SADDLE COVERS, HARNESSES; LEATHER AND IMITATIONS OF LEATHER, AND GOODS MADE OF THESE MATERIALS AND NOT INCLUDED IN OTHER CLASSES, NAMELY, HORSE BLANKETS, TRAVELING BAGS; UMBRELLAS, PARASOLS, WALKING STICKS (U.S. CLS. 1, 2, 3, 22 AND 41).

CLASS 25—CLOTHING

FOR CLOTHING, NAMELY, RIDING BREECHES, RIDING JACKETS, T-SHIRTS, CARDIGANS, JERSEYS, VESTS, BODY WARMERS, COATS, TURTLENECK PULLOVERS, GLOVES, BLOUSES; FOOTWEAR; HEADGEAR, NAMELY, HATS AND RIDING HATS FOR HORSEMAN AND HORSEWOMEN (U.S. CLS. 22 AND 39).

CLASS 26—FANCY GOODS

FOR LACE END EMBROIDERY, BRAIDS, BUTTONS FOR CLOTHING, NOVELTY BUTTONS, PRESS BUTTONS, BADGES AND RIBBONS THAT REPRESENT THE PRIZE WON DURING EQUESTRIAN SPORTS; HOOKS AND EYES; ORNAMENTAL NOVELTY PINS AND NEEDLES FOR THE PROMOTION OF EQUESTRIAN SPORTS AND EQUESTRIAN EVENTS AND EQUESTRIAN COMPETITIONS TAKING PLACE IN SEVERAL INDIVIDUAL CONTESTS ORGANIZED IN A SERIES LEADING TO A SINGLE CLASSIFICATION OR QUALIFICATION FOR A FINAL; ROSETTES, NAMELY, THOSE REPRESENTING A PRIZE WON IN EQUESTRIAN SPORTS (U.S. CLS. 37, 39, 40, 42 AND 50).

CLASS 28—TOYS AND SPORTING GOODS

FOR ELECTRONIC GAMES AND TOYS FEATURING EQUESTRIAN SPORTS, NAMELY, ELECTRONIC TOYS AND GAMES, NAMELY, ELECTRONIC LEARNING TOYS, ELECTRONICALLY OPERATED TOY MOTOR VEHICLES, ARCADE TYPE, ELECTRONIC VIDEO GAMES; CARD GAMES AND BOARD GAMES FEATURING EQUESTRIAN SPORT; TRAINING APPARATUS FOR USE IN GYMNASTICS AND EQUESTRIAN SPORTS, NAMELY, STEEPLECHASE HURDLES, OBSTACLES, NAMELY, OBSTACLES AND BRUSH JUMPS FOR EQUESTRIAN SPORT (U.S. CLS. 22, 23, 38 AND 50).

CLASS 31—NATURAL AGRICULTURAL PRODUCTS

FOR LIVE ANIMALS, IN PARTICULAR HORSES AND FOOD FOR HORSES (U.S. CLS. 1 AND 46).

CLASS 35—ADVERTISING AND BUSINESS

FOR RETAIL STORE SERVICES FEATURING ITEMS IN CONNECTION WITH HORSES; OPERATION OF IMPORT-EXPORT AGENCIES THAT FEATURE HORSES; ORGANIZATION OF EXHIBITIONS IN EQUESTRIAN SPORT FOR THE PROMOTION OF EQUESTRIAN SPORT FOR ADVERTISING AND COMMERCIAL PURPOSES; ARRANGING AND CONDUCTING MARKETING PROMOTIONAL EVENTS FOR OTHERS FEATURING EQUESTRIAN SPORTS; COMMERCIAL ASSISTANCE FOR CONCLUDING COMMERCIAL CONTRACTS FOR EQUESTRIAN SPORTSPERSONS; PROMOTING THE GOODS AND SERVICES OF OTHERS BY ARRANGING FOR SPONSORS TO AFFILIATE THEIR GOODS AND SERVICES WITH A SPECIFIC SPORTS COMPETITION (U.S. CLS. 100, 101 AND 102).

CLASS 36—INSURANCE AND FINANCIAL

FOR FINANCIAL SERVICES, NAMELY, FINANCING SERVICES, FINANCING CONSULTATION AND INSURANCE CONSULTATION; INSURANCE BROKERAGE; CHARITABLE FUND RAISING (U.S. CLS. 100, 101 AND 102).

CLASS 41—EDUCATION AND ENTERTAINMENT

FOR ORGANIZATION OF COMMUNITY FESTIVALS IN CONNECTION WITH A NUMBER OF ACTIVITIES, NAMELY, SPORTS EVENTS, GAMES, SPORTS AND CULTURAL ACTIVITIES; ENTERTAINMENT IN THE FORM OF EQUESTRIAN COMPETITIONS; HORSEBACK RIDING SCHOOLS, IN PARTICULAR FOR TRAINING HORSES; PROVIDING HORSEBACK RIDING AND DRESSAGE LESSONS (U.S. CLS. 100, 101 AND 107).

CLASS 42—SCIENTIFIC AND COMPUTER SERVICES

FOR SCIENTIFIC RESEARCH SERVICES IN CONNECTION WITH EQUESTRIAN SPORT; LEGAL SERVICES PRIMARILY IN THE CONTEXT OF LITIGATION IN CONNECTION WITH EQUESTRIAN SPORT; DESIGN AND DEVELOPMENT AND IMPLEMENTATION OF SOFTWARE CONCERNING DATABASES OF RIDERS, HORSES, COMPETITION RESULTS, CALENDARS OF EVENTS AND STATISTICS AND COMPUTER CONSULTING AND RECORDING DEVICES, ALL IN CONNECTION WITH EQUESTRIAN SPORT (U.S. CLS. 100 AND 101).

CLASS 44—MEDICAL, BEAUTY AND AGRICULTURAL SERVICES

FOR CONSULTING CONCERNING HORSE BREEDING; VETERINARY AND MEDICAL SERVICES; HORSE BREEDING; CONSULTING CONCERNING CARE OF HORSES (U.S. CLS. 100 AND 101).
DARRYL SPRUILL, EXAMINING ATTORNEY

SN 79-029,994. FÉDÉRATION EQUESTRE INTERNATIONALE, SWITZERLAND, FILED 7-28-2006.



PRIORITY DATE OF 2-23-2006 IS CLAIMED.
OWNER OF INTERNATIONAL REGISTRATION 0901259
DATED 7-28-2006, EXPIRES 7-28-2016.

NO CLAIM IS MADE TO THE EXCLUSIVE RIGHT TO USE "WORLD CUP", APART FROM THE MARK AS SHOWN.

CLASS 9—ELECTRICAL AND SCIENTIFIC APPARATUS

FOR ELECTRONIC GAMES PROGRAMS; COMPUTER GAME SOFTWARE RECORDED ON COMPACT DISKS, DIGITAL VIDEO DISKS, MEMORY CARDS AND OTHER MEMORY SUPPORTS, NAMELY, FLASH MEMORY CARDS, RAM (RANDOM ACCESS MEMORY) CARDS (U.S. CLS. 21, 23, 26, 36 AND 38).

CLASS 14—JEWELRY

FOR JEWELLERY OF PRECIOUS METAL OR PLATED THEREWITH OR IMITATION JEWELLERY, TIE PINS, CHRONOMETRIC INSTRUMENTS AND WATCHES FOR THE PROMOTION OF EQUESTRIAN SPORT, EQUESTRIAN EVENTS AND EQUESTRIAN COMPETITIONS TAKING PLACE IN SEVERAL INDIVIDUAL COMPETITIONS ORGANIZED IN A SERIES LEADING TO SINGLE CLASSIFICATION OR QUALIFICATION FOR A FINAL (U.S. CLS. 2, 27, 28 AND 50).

CLASS 18—LEATHER GOODS

FOR GOODS FOR EQUESTRIAN SPORT, NAMELY, WHIPS, SADDLERY, SADDLES, SADDLE COVERS, HARNESSSES; LEATHER AND IMITATIONS OF LEATHER, AND GOODS MADE OF THESE MATERIALS AND NOT INCLUDED IN OTHER CLASSES, NAMELY, HORSE BLANKETS, TRAVELING BAGS; UMBRELLAS, PARASOLS, WALKING STICKS (U.S. CLS. 1, 2, 3, 22 AND 41).

CLASS 25—CLOTHING

FOR CLOTHING, NAMELY, RIDING BREECHES, RIDING JACKETS, T-SHIRTS, CARDIGANS, JERSEYS, VESTS, BODY WARMERS, COATS, TURTLENECK PULLOVERS, GLOVES, BLOUSES; FOOTWEAR; HEADGEAR, NAMELY, HATS AND RIDING HATS FOR HORSEMAN AND HORSEWOMEN (U.S. CLS. 22 AND 39).

CLASS 26—FANCY GOODS

FOR LACE END EMBROIDERY, BRAIDS, BUTTONS FOR CLOTHING, NOVELTY BUTTONS, PRESS BUTTONS, BADGES AND RIBBONS THAT REPRESENT THE PRIZE WON DURING EQUESTRIAN SPORTS; HOOKS AND EYES; ORNAMENTAL NOVELTY PINS AND NEEDLES FOR THE PROMOTION OF EQUESTRIAN SPORTS AND EQUESTRIAN EVENTS AND EQUESTRIAN COMPETITIONS TAKING PLACE IN SEVERAL INDIVIDUAL CONTESTS ORGANIZED IN A SERIES LEADING TO A SINGLE CLASSIFICATION OR QUALIFICATION FOR A FINAL; ROSETTES, NAMELY, THOSE REPRESENTING A PRIZE WON IN EQUESTRIAN SPORTS (U.S. CLS. 37, 39, 40, 42 AND 50).

CLASS 28—TOYS AND SPORTING GOODS

FOR ELECTRONIC GAMES AND TOYS FEATURING EQUESTRIAN SPORTS, NAMELY, ELECTRONIC TOYS AND GAMES, NAMELY, ELECTRONIC LEARNING TOYS, ELECTRONICALLY OPERATED TOY MOTOR VEHICLES, ARCADE TYPE ELECTRONIC VIDEO GAMES; CARD GAMES AND BOARD GAMES FEATURING EQUESTRIAN SPORT; TRAINING APPARATUS FOR USE IN GYMNASTICS AND EQUESTRIAN SPORTS, NAMELY, STEEPLECHASE HURDLES, OBSTACLES, NAMELY, OBSTACLES AND BRUSH JUMPS FOR EQUESTRIAN SPORT (U.S. CLS. 22, 23, 38 AND 50).

CLASS 31—NATURAL AGRICULTURAL PRODUCTS

FOR LIVE ANIMALS, IN PARTICULAR HORSES AND FOOD FOR HORSES (U.S. CLS. 1 AND 46).

CLASS 35—ADVERTISING AND BUSINESS

FOR RETAIL STORE SERVICES FEATURING ITEMS IN CONNECTION WITH HORSES; OPERATION OF IMPORT-EXPORT AGENCIES THAT FEATURE HORSES; ORGANIZATION OF EXHIBITIONS IN EQUESTRIAN SPORT FOR THE PROMOTION OF EQUESTRIAN SPORT FOR ADVERTISING AND COMMERCIAL PURPOSES; ARRANGING AND CONDUCTING MARKETING PROMOTIONAL EVENTS FOR OTHERS FEATURING EQUESTRIAN SPORTS; COMMERCIAL ASSISTANCE FOR CONCLUDING COMMERCIAL CONTRACTS FOR EQUESTRIAN SPORTSPERSONS; PROMOTING THE GOODS AND SERVICES OF OTHERS BY ARRANGING FOR SPONSORS TO AFFILIATE THEIR GOODS AND SERVICES WITH A SPECIFIC SPORTS COMPETITION (U.S. CLS. 100, 101 AND 102).

CLASS 36—INSURANCE AND FINANCIAL

FOR FINANCIAL SERVICES, NAMELY, FINANCING SERVICES, FINANCING CONSULTATION AND INSURANCE CONSULTATION; INSURANCE BROKERAGE; CHARITABLE FUND RAISING (U.S. CLS. 100, 101 AND 102).

CLASS 41—EDUCATION AND ENTERTAINMENT

FOR ORGANIZATION OF COMMUNITY FESTIVALS IN CONNECTION WITH A NUMBER OF ACTIVITIES, NAMELY, SPORTS EVENTS, GAMES, SPORTS AND CULTURAL ACTIVITIES; ENTERTAINMENT IN THE FORM OF EQUESTRIAN COMPETITIONS; HORSEBACK RIDING SCHOOLS, IN PARTICULAR FOR TRAINING HORSES; PROVIDING HORSEBACK RIDING AND DRESSAGE LESSONS (U.S. CLS. 100, 101 AND 107).

CLASS 42—SCIENTIFIC AND COMPUTER SERVICES

FOR SCIENTIFIC RESEARCH SERVICES IN CONNECTION WITH EQUESTRIAN SPORT; LEGAL SERVICES PRIMARILY IN THE CONTEXT OF LITIGATION IN CONNECTION WITH EQUESTRIAN SPORT; DESIGN AND DEVELOPMENT AND IMPLEMENTATION OF SOFTWARE CONCERNING DATABASES OF RIDERS, HORSES, COMPETITION RESULTS, CALENDARS OF EVENTS AND STATISTICS AND COMPUTER CONSULTING AND RECORDING DEVICES, ALL IN CONNECTION WITH EQUESTRIAN SPORT (U.S. CLS. 100 AND 101).

CLASS 44—MEDICAL, BEAUTY AND AGRICULTURAL SERVICES

FOR CONSULTING CONCERNING HORSE BREEDING; VETERINARY AND MEDICAL SERVICES; HORSE BREEDING; CONSULTING CONCERNING CARE OF HORSES (U.S. CLS. 100 AND 101).

DARRYL SPRUILL, EXAMINING ATTORNEY

SN 79-030,011. GEFRAN S.P.A., ITALY, FILED 10-5-2006.



PRIORITY DATE OF 6-19-2006 IS CLAIMED.
OWNER OF INTERNATIONAL REGISTRATION 0901327
DATED 10-5-2006, EXPIRES 10-5-2016.
OWNER OF U.S. REG. NOS. 3,213,583 AND 3,213,584.
THE WORDING "GEFRAN SIEI" HAS NO MEANING IN A FOREIGN LANGUAGE.

CLASS 7—MACHINERY

FOR MACHINE AND MACHINE TOOLS, NAMELY, AUTOMATED MACHINES FOR THE PRODUCTION OF CUSTOMER SPECIFIED ELECTRONIC EQUIPMENT IN THE NATURE OF ELECTRICAL CONTROLLERS, PROGRAMMERS, INDICATORS, TIMERS, COUNTERS, ELECTRIC RELAYS AND COMPONENTS THEREOF; ELECTRIC MOTORS FOR MACHINES; ENGINES NOT FOR LAND VEHICLES; MACHINE COUPLING, MACHINE TRANSMISSION COMPONENTS, NAMELY, MECHANICAL GEARS; INCUBATORS FOR EGGS (U.S. CLS. 13, 19, 21, 23, 31, 34 AND 35).

CLASS 9—ELECTRICAL AND SCIENTIFIC APPARATUS

FOR ELECTRICAL, ELECTROMECHANICAL, ELECTROCHEMICAL, ELECTROPHYSICAL MEASURING EQUIPMENT FOR NON-ELECTRIC VALUES, NAMELY, ELECTRIC AND ELECTRONIC SENSORS FOR MEASURING HUMIDITY, HEAT, LIQUIDS, TENSION, MOVEMENT, PRESSURE, FORCE, PERFORMANCE; ELECTRICAL AND ELECTRONIC MEASURING, MONITORING AND CONTROLLING INSTRUMENTS FOR VARIOUS APPLICATIONS, INSTRUMENT RECORDERS FOR RESEARCH AND INDUSTRY, NAMELY, ELECTRICAL CONTROLLERS, ELECTRONIC SPEED CONTROLLERS, ELECTRONIC TIMERS; METEOROLOGICAL EQUIPMENT, NAMELY, ELECTRIC AND ELECTRONIC SENSORS FOR MEASURING HUMIDITY, HEAT, PRESSURE, FORCE; MECHANICAL MEASURING AND CONTROLLING INSTRUMENTS FOR PRESSURE, NAMELY HIGH PRESSURE MANOMETERS, ACCESSORIES AND WEIGHTS FOR SCALES, NAMELY, BALANCE AND COUNTERBALANCE WEIGHTS, TEMPERATURE MEASURING INSTRUMENTS, NAMELY, TEMPERATURE SENSORS; LEVEL MEASURING AND CONTROL EQUIPMENT FOR LIQUIDS, MOISTURE, SPECIFIC GRAVITY, PH, FLUID CONDUCTIVITY AND VISCOSITY MEASURING INSTRUMENTS, NAMELY, ELECTRIC AND ELECTRONIC SENSORS FOR MEASURING LIQUIDS, MOISTURE, GRAVITY, PH LEVELS, FLUID CONDUCTIVITY AND VISCOSITY; TEMPERATURE REGULATING AND CONTROL EQUIPMENT, MEASURING AND TESTING INSTRUMENTS, ELECTRIC AND ELECTRONIC, REGULATING AND CONTROL SYSTEMS AND EQUIPMENT, COMPONENTS AND ACCESSORIES FOR REGULATING AND CONTROLLING SYSTEMS AND EQUIPMENT, NAMELY, LEVEL INDICATORS, SPEED INDICATORS, TEMPERATURE INDICATORS, TIMERS, COUNTERS, ELECTRICAL RELAYS AND TRANSFORMERS, ELECTRONIC DATA RELAYS FOR SENSORS; APPARATUS AND INSTRUMENTS FOR CONDUCTION, SWITCHING, TRANSFORMING, ACCUMULATING, REGULATION OR CONTROLLING ELECTRICITY, NAMELY, AUTOMATIC SWITCHBOARDS, ELECTRICAL CONTROLLERS, STARTERS NOT FOR VEHICLES AND TEMPERATURE, SENSOR, POSITION AND FORCE REGULATORS; ELECTRIC PULSE COUNTERS, ELECTRIC RELAYS AND ELECTRONIC DATA RELAYS FOR SENSORS, SOLID STATE RELAYS, MODULAR POWER ELECTRICAL CONTROLLERS; APPARATUS FOR RECORDING, TRANSMISSION OR REPRODUCTION OF SOUND OR IMAGES; BLANK MAGNETIC DATA CARRIERS, BLANK CD-ROMS, DVDS, LASER DISCS AND RECORD DISCS, AUTOMATIC VENDING MACHINES, CASH REGISTERS, CALCULATORS, DATA PROCESSORS, COMPUTERS, FIRE EXTINGUISHERS (U.S. CLS. 21, 23, 26, 36 AND 38).

CLASS 42—SCIENTIFIC AND COMPUTER SERVICES

FOR SCIENTIFIC RESEARCH AND DEVELOPMENT; DESIGN AND TESTING OF NEW PRODUCTS FOR OTHERS; DESIGN AND DEVELOPMENT OF COMPUTER HARDWARE AND SOFTWARE FOR OTHERS; LEGAL SERVICES; CUSTOMIZED INDUSTRIAL ANALYSIS AND RESEARCH SERVICES ACCORDING TO CUSTOMER NEEDS, NAMELY, PRODUCT RESEARCH FOR LABORATORY AND TEST EQUIPMENT; INDUSTRIAL ANALYSIS AND RESEARCH SERVICES IN THE NATURE OF CALIBRATION SERVICES, NAMELY, TESTING AND EVALUATION OF THE CORRECT CALIBRATION FOR LABORATORY EQUIPMENT (U.S. CLS. 100 AND 101).

MICHAEL WEBSTER, EXAMINING ATTORNEY

SN 79-030,012. GEFRAN S.P.A., ITALY, FILED 10-8-2006.

GEFRAN SIEI

THE MARK CONSISTS OF STANDARD CHARACTERS WITHOUT CLAIM TO ANY PARTICULAR FONT, STYLE, SIZE, OR COLOR.

PRIORITY DATE OF 6-19-2006 IS CLAIMED.

OWNER OF INTERNATIONAL REGISTRATION 0901328 DATED 10-8-2006, EXPIRES 10-8-2016.

OWNER OF U.S. REG. NOS. 3,213,583 AND 3,213,584.

THE WORDING "GEFRAN SIEI" HAS NO MEANING IN A FOREIGN LANGUAGE.

CLASS 7—MACHINERY

FOR MACHINE AND MACHINE TOOLS, NAMELY, AUTOMATED MACHINES FOR THE PRODUCTION OF CUSTOMER SPECIFIED ELECTRONIC EQUIPMENT IN THE NATURE OF ELECTRICAL CONTROLLERS, PROGRAMMERS, INDICATORS, TIMERS, COUNTERS, ELECTRIC RELAYS AND COMPONENTS THEREOF; ELECTRIC MOTORS FOR MACHINES; ENGINES NOT FOR LAND VEHICLES; MACHINE COUPLING, MACHINE TRANSMISSION COMPONENTS, NAMELY, MECHANICAL GEARS; INCUBATORS FOR EGGS (U.S. CLS. 13, 19, 21, 23, 31, 34 AND 35).

CLASS 9—ELECTRICAL AND SCIENTIFIC APPARATUS

FOR ELECTRICAL, ELECTROMECHANICAL, ELECTROCHEMICAL, ELECTROPHYSICAL MEASURING EQUIPMENT FOR NON-ELECTRIC VALUES, NAMELY, ELECTRIC AND ELECTRONIC SENSORS FOR MEASURING HUMIDITY, HEAT, LIQUIDS, TENSION, MOVEMENT, PRESSURE, FORCE, PERFORMANCE; ELECTRICAL AND ELECTRONIC MEASURING, MONITORING AND CONTROLLING INSTRUMENTS FOR VARIOUS APPLICATIONS, INSTRUMENT RECORDERS FOR RESEARCH AND INDUSTRY, NAMELY, ELECTRICAL CONTROLLERS, ELECTRONIC SPEED CONTROLLERS, ELECTRONIC TIMERS; METEOROLOGICAL EQUIPMENT, NAMELY, ELECTRIC AND ELECTRONIC SENSORS FOR MEASURING HUMIDITY, HEAT, PRESSURE, FORCE; MECHANICAL MEASURING AND CONTROLLING INSTRUMENTS FOR PRESSURE, NAMELY, HIGH PRESSURE MANOMETERS, ACCESSORIES AND WEIGHTS FOR SCALES, NAMELY, BALANCE AND COUNTERBALANCE WEIGHTS, TEMPERATURE MEASURING INSTRUMENTS, NAMELY, TEMPERATURE SENSORS; LEVEL MEASURING AND CONTROL EQUIPMENT FOR LIQUIDS, MOISTURE, SPECIFIC GRAVITY, PH, FLUID CONDUCTIVITY AND VISCOSITY MEASURING INSTRUMENTS, NAMELY, ELECTRIC AND ELECTRONIC SENSORS FOR MEASURING LIQUIDS, MOISTURE, GRAVITY, PH LEVELS, FLUID CONDUCTIVITY AND VISCOSITY; TEMPERATURE REGULATING AND CONTROL EQUIPMENT, MEASURING AND TESTING INSTRUMENTS, ELECTRIC AND ELECTRONIC, REGULATING AND CONTROL SYSTEMS AND EQUIPMENT, COMPONENTS AND ACCESSORIES FOR REGULATING AND CONTROLLING SYSTEMS AND EQUIPMENT, NAMELY, LEVEL INDICATORS, SPEED INDICATORS, TEMPERATURE INDICATORS, TIMERS, COUNTERS, ELECTRICAL RELAYS AND TRANSFORMERS, ELECTRONIC DATA RELAYS FOR SENSORS; APPARATUS AND INSTRUMENTS FOR CONDUCTION, SWITCHING, TRANSFORMING, ACCUMULATING, REGULATION OR CONTROLLING ELECTRICITY, NAMELY, AUTOMATIC SWITCHBOARDS, ELECTRICAL CONTROLLERS, STARTERS NOT FOR VEHICLES AND TEMPERATURE, SENSOR, POSITION AND FORCE REGULATORS; ELECTRIC PULSE COUNTERS, ELECTRIC RELAYS AND ELECTRONIC DATA RELAYS FOR SENSORS, SOLID STATE RELAYS, MODULAR POWER ELECTRICAL CONTROLLERS; APPARATUS FOR RECORDING, TRANSMISSION OR REPRODUCTION OF SOUND OR IMAGES; BLANK MAGNETIC DATA CARRIERS, BLANK CD-ROMS, DVDS, LASER DISCS AND RECORD DISCS, AUTOMATIC VENDING

MACHINES, CASH REGISTERS, CALCULATORS, DATA PROCESSORS, COMPUTERS, FIRE EXTINGUISHERS (U.S. CLS. 21, 23, 26, 36 AND 38).

SN 79-030,139. ETABLISSEMENTS KEKLIKIAN, FRANCE, FILED 9-26-2006.

CLASS 42—SCIENTIFIC AND COMPUTER SERVICES

FOR SCIENTIFIC RESEARCH AND DEVELOPMENT; DESIGN AND TESTING OF NEW PRODUCTS FOR OTHERS; DESIGN AND DEVELOPMENT OF COMPUTER HARDWARE AND SOFTWARE FOR OTHERS; LEGAL SERVICES; CUSTOMIZED INDUSTRIAL ANALYSIS AND RESEARCH SERVICES ACCORDING TO CUSTOMER NEEDS, NAMELY, PRODUCT RESEARCH FOR LABORATORY AND TEST EQUIPMENT; INDUSTRIAL ANALYSIS AND RESEARCH SERVICES IN THE NATURE OF CALIBRATION SERVICES, NAMELY, TESTING AND EVALUATION OF THE CORRECT CALIBRATION FOR LABORATORY EQUIPMENT (U.S. CLS. 100 AND 101).

MICHAEL WEBSTER, EXAMINING ATTORNEY

k K.JACQUES
S TROPEZ

OWNER OF INTERNATIONAL REGISTRATION 0901665 DATED 9-26-2006, EXPIRES 9-26-2016.

NO CLAIM IS MADE TO THE EXCLUSIVE RIGHT TO USE "S TROPEZ", APART FROM THE MARK AS SHOWN.

THE NAME(S), PORTRAIT(S), AND/OR SIGNATURE(S) SHOWN IN THE MARK DOES NOT IDENTIFY A PARTICULAR LIVING INDIVIDUAL.

CLASS 18—LEATHER GOODS

FOR UNWORKED OR SEMI-WORKED LEATHER; LEATHER AND IMITATION LEATHER BAGS; LEATHER AND IMITATION LEATHER; LEATHER BAGS FOR MERCHANDISE PACKAGING; LEATHER BAGS, SUITCASES AND WALLETS; LEATHER BOXES FOR STORING GREETING CARDS; LEATHER BRIEFCASES; LEATHER CASES; LEATHER CASES FOR KEYS; LEATHER FOR FURNITURE; LEATHER FOR HARNESSES; LEATHER FOR SHOES; LEATHER HANDBAGS; LEATHER KEY CASES; LEATHER KEY CHAINS; LEATHER PURSES; LEATHER SHOPPING BAGS; LEATHER SOLD IN BULK; LEATHER TRAVELING BAGS (U.S. CLS. 1, 2, 3, 22 AND 41).

CLASS 25—CLOTHING

FOR CLOTHING, NAMELY, INFANTWEAR, BELTS, COATS, JACKETS, PANTS, T-SHIRTS, SHIRTS, DRESSES, SKIRTS, BATHING SUITS, PULLOVERS, POLO SHIRTS, SINGLET, SCARVES, SASHES FOR WEAR, UNDERWEAR, HEADWEAR; FOOTWEAR, SLIPPERS, SHOES; SPORTSWEAR, NAMELY, SPORTS JACKETS, SPORTS SHIRTS, SPORTS JERSEYS (U.S. CLS. 22 AND 39).

DEIRDRE ROBERTSON, EXAMINING ATTORNEY

SN 79-030,081. LODESTAR ANSTALT, FL-9490 VADUZ, LIECHTENSTEIN, FILED 6-22-2006.

WIRE ROAD

PRIORITY DATE OF 12-23-2005 IS CLAIMED.
OWNER OF INTERNATIONAL REGISTRATION 0901493 DATED 6-22-2006, EXPIRES 6-22-2016.
OWNER OF U.S. REG. NO. 2,623,065.
NO CLAIM IS MADE TO THE EXCLUSIVE RIGHT TO USE "WIRE", APART FROM THE MARK AS SHOWN.

CLASS 9—ELECTRICAL AND SCIENTIFIC APPARATUS

FOR PHOTOGRAPHIC APPARATUS AND INSTRUMENTS, NAMELY, CAMERAS, CASES FOR CAMERAS, DISPOSABLE CAMERAS, DIGITAL CAMERAS; CINEMATOGRAPHIC APPARATUS AND INSTRUMENTS, NAMELY, CINEMATOGRAPHIC FILM, SOUND RECORDING APPARATUS AND INSTRUMENTS, CINEMATOGRAPHIC PROJECTORS, CINEMATOGRAPHIC MACHINES AND APPARATUS, EXPOSED CINEMATOGRAPHIC FILM; OPTICAL APPARATUS AND INSTRUMENTS, NAMELY, SUNGLASSES, SUNGLASS LENSES, FRAMES FOR SUNGLASSES, CHAINS FOR SUNGLASSES, SPECTACLES, LENSES FOR SPECTACLES, SPECTACLE CASES, SPECTACLE FRAMES, CHAINS FOR SPECTACLES, BINOCULARS; APPARATUS FOR RECORDING, TRANSMISSION OR REPRODUCTION OF SOUND OR IMAGES; BLANK MAGNETIC DATA CARRIERS, BLANK RECORDING DISCS; DATA PROCESSORS AND COMPUTERS (U.S. CLS. 21, 23, 26, 36 AND 38).

CLASS 42—SCIENTIFIC AND COMPUTER SERVICES

FOR DESIGN AND DEVELOPMENT OF COMPUTER HARDWARE AND SOFTWARE (U.S. CLS. 100 AND 101).
KATHERINE E. HALMEN, EXAMINING ATTORNEY

SN 79-030,256. ODIOT, FRANCE, FILED 6-14-2006.

ODIOT

OWNER OF INTERNATIONAL REGISTRATION 0444438 DATED 5-7-1979, EXPIRES 5-7-2009.

THE WORDING "ODIOT" HAD NO MEANING IN A FOREIGN LANGUAGE.

CLASS 8—HAND TOOLS

FOR CUTLERY (U.S. CLS. 23, 28 AND 44).

CLASS 14—JEWELRY

FOR GOODS MADE OF OR COATED WITH PRECIOUS METALS OR THEIR ALLOYS, NAMELY, BASINS, BOWLS, BREAD PLATES, BUTTER DISHES, NON-ELECTRIC CANDELABRA, CANDLE HOLDERS, CANDLESTICKS, CAVIAR CUPS, CHAMPAGNE FLUTES, CONFECTIONERY CUPS, CONFECTIONERY DISHES, CUPS, DECANTERS, DESSERT DISHES, DINNER PLATES, DISHES, FIGURINES, FINGER BOWLS, FRUIT BASKETS, FRUIT BOWLS, FRUIT DISHES, GOBLET, HONEY POTS, HUMIDORS, KNIFE RESTS, LAMPS, LETTER OPENERS, MUSTARD POTS, TABLE PLACE CARD HOLDERS, NAPKIN RINGS, OIL AND VINEGAR CRUET SETS, PEN RESTS, PENCIL HOLDERS, PLATES, SALT CELLARS, SOUP TUREENS, SUGAR BOWLS, TABLE CENTERPIECES, TRINKET TRAYS, TUREENS, VASES, VEGETABLE TUREENS, VOTIVE CANDLE HOLDERS, WINE COASTERS, WINE COOLERS (U.S. CLS. 2, 27, 28 AND 50).

GILBERT SWIFT, EXAMINING ATTORNEY

SN 79-030,739. Q-MATIC AB, MÖLNDAL, SWEDEN, FILED 4-24-2006.



SN 79-030,611. MIDLAND BRAND LIMITED, UNITED KINGDOM, FILED 4-27-2006.



PRIORITY DATE OF 10-27-2005 IS CLAIMED.
OWNER OF INTERNATIONAL REGISTRATION 0902751
DATED 4-27-2006, EXPIRES 4-27-2016.

CLASS 6—METAL GOODS

FOR COMMON METALS AND THEIR ALLOYS, UNWROUGHT AND SEMI-WORKED, FOR FURTHER MANUFACTURE; IRON ORES; ORES OF METAL, NAMELY, COPPER ORES, CHROME IRON ORES, LEAD ORES, NICKEL ORES, TIN ORES, ZINC ORES (U.S. CLS. 2, 12, 13, 14, 23, 25 AND 50).

CLASS 36—INSURANCE AND FINANCIAL

FOR FINANCIAL AFFAIRS, NAMELY, FINANCIAL PLANNING, MANAGEMENT AND CONSULTATION; MONETARY AFFAIRS, NAMELY, FINANCING SERVICES, MONETARY EXCHANGE, ACQUISITION AND TRANSFER OF MONETARY CLAIMS; REAL ESTATE AFFAIRS, NAMELY, REAL ESTATE AGENCIES, REAL ESTATE BROKERAGE, REAL ESTATE INVESTMENT, REAL ESTATE CONSULTATION; INSURANCE SERVICES, NAMELY, AGENCIES, BROKERAGE, CONSULTATION, UNDERWRITING, ISSUING AND ADMINISTRATION SERVICES FOR ALL TYPES OF INSURANCE (U.S. CLS. 100, 101 AND 102).

CLASS 39—TRANSPORTATION AND STORAGE

FOR MARINE TRANSPORT; RIVER TRANSPORT BY BOAT (U.S. CLS. 100 AND 105).
ERNEST SHOSHO, EXAMINING ATTORNEY

OWNER OF INTERNATIONAL REGISTRATION 0754219
DATED 2-2-2001, EXPIRES 2-2-2011.

CLASS 9—ELECTRICAL AND SCIENTIFIC APPARATUS

FOR COMPUTER SOFTWARE FOR QUEUE MANAGEMENT AND INTERACTIVE RECEPTION SERVICE, AND CONNECTED COMPUTERS, INCLUDING CONNECTED PARTS AND ACCESSORIES, NAMELY, PRINTERS, TERMINALS, SCREENS AND CARD SENSORS (U.S. CLS. 21, 23, 26, 36 AND 38).

CLASS 16—PAPER GOODS AND PRINTED MATTER

FOR ENTRY AND PASSENGER QUEUE AND PRIORITY TICKETS MADE OF PAPER (U.S. CLS. 2, 5, 22, 23, 29, 37, 38 AND 50).
SEAN CROWLEY, EXAMINING ATTORNEY

SN 79-030,777. CONAX AS, NORWAY, FILED 2-1-2006.

THE MARK CONSISTS OF STANDARD CHARACTERS WITHOUT CLAIM TO ANY PARTICULAR FONT, STYLE, SIZE, OR COLOR.

OWNER OF INTERNATIONAL REGISTRATION 0903032
DATED 2-1-2006, EXPIRES 2-1-2016.

CLASS 9—ELECTRICAL AND SCIENTIFIC APPARATUS

FOR APPARATUS, DEVICES AND INSTRUMENTS FOR TELECOMMUNICATIONS SUBJECT TO RESTRICTED OR NON-RESTRICTED ACCESS, INCLUDING TELEVISION TRANSMISSION BY WAY OF SATELLITE, NAMELY, COMPUTER SERVERS, COMPUTER SERVERS USED FOR ENTITLEMENT MANAGEMENT MESSAGE INJECTION, COMPUTER SERVERS USED FOR ENTITLEMENT MESSAGE GENERATION, COMPUTER HARDWARE, SECURITY MODULES, ENCODED SMART CARDS CONTAINING PROGRAMMING USED TO CONTROL ACCESS TO DIGITAL BROADCASTING CONTENT, ENCODED CABLE CARDS CONTAINING PROGRAMMING USED TO DECODE DIGITAL BROADCASTING CONTENT, SET-TOP BOXES FOR TELEVISIONS, DIGITAL VIDEO BROADCASTING CHIPSETS, CONDITIONAL ACCESS MODULES FOR DIGITAL BROADCAST RECEIVERS; APPARATUS AND INSTRUMENTS FOR RECORDING, TRANSMISSION AND REPRODUCTION OF SOUND AND IMAGES; PRE-RECORDED MAGNETIC DATA CARRIERS FEATURING COMPUTER PROGRAMS FOR USE IN DATABASE MANAGEMENT, ENCRYPTION OF DIGITAL DATA, CONTROLLING ACCESS TO DIGITAL BROADCASTING CONTENT, CONTROLLING ACCESS SECURITY FOR DIGITAL BROADCASTING CONTENT, CONTROLLING DATA EXCHANGES FOR USE IN THE PAYMENT FOR DIGITAL BROADCASTING CONTENT, PROCESS CONTROL FOR TELECOMMUNICATIONS SYSTEMS, AND COMPUTER SYSTEMS INTEGRATION; COMPUTERS; RECORDED COMPUTER PROGRAMS FOR USE IN USE IN DATABASE MANAGEMENT, ENCRYPTION OF DIGITAL DATA, CONTROLLING ACCESS TO DIGITAL BROADCASTING CONTENT, CONTROLLING ACCESS SECURITY FOR DIGITAL BROADCASTING CONTENT, CONTROLLING DATA EXCHANGES FOR USE IN THE PAYMENT FOR DIGITAL BROADCASTING CONTENT, PROCESS CONTROL FOR TELECOMMUNICATIONS SYSTEMS, AND COMPUTER SYSTEMS INTEGRATION; DATA PROCESSORS (U.S. CLS. 21, 23, 26, 36 AND 38).

CLASS 16—PAPER GOODS AND PRINTED MATTER

FOR PRINTED MATTER, NAMELY, BOOKS, HANDBOOKS, BROCHURES AND EDUCATIONAL, INSTRUCTIONAL AND TEACHING MATERIAL ON THE SUBJECT OF TELECOMMUNICATIONS, DATA PROCESSING, COMPUTER TECHNOLOGY AND SOFTWARE, COMPUTER SECURITY, DIGITAL BROADCASTING, AND CONDITIONAL ACCESS TO BROADCASTING CONTENT. (U.S. CLS. 2, 5, 22, 23, 29, 37, 38 AND 50).

CLASS 38—COMMUNICATION

FOR TELECOMMUNICATIONS SERVICES, NAMELY, CONSULTATION IN THE FIELDS OF TELECOMMUNICATIONS, DIGITAL BROADCASTING, AND CONDITIONAL ACCESS TO BROADCASTING CONTENT; PROVIDING INFORMATION IN THE FIELDS OF TELECOMMUNICATIONS, DIGITAL BROADCASTING, AND CONDITIONAL ACCESS TO BROADCASTING CONTENT; BROADCASTING OF RADIO AND TELEVISION PROGRAMS; COMPUTER ASSISTED TRANSMISSION OF SOUND/AUDIO AND IMAGE SIGNALS; PROVIDING TELECOMMUNICATIONS CONNECTIONS TO INTERNET DATABASES (U.S. CLS. 100, 101 AND 104).

CLASS 41—EDUCATION AND ENTERTAINMENT

FOR EDUCATION SERVICES, NAMELY, PROVIDING PROGRAMS AND TRAINING IN THE FIELDS OF TELECOMMUNICATIONS AND DATA PROCESSING AND INSTRUCTION IN THE FIELDS OF TELECOMMUNICATIONS, DATA PROCESSING, COMPUTER TECHNOLOGY AND SOFTWARE, COMPUTER SECURITY, DIGITAL BROADCASTING, AND CONDITIONAL ACCESS TO BROADCASTING CONTENT. (U.S. CLS. 100, 101 AND 107).

CLASS 42—SCIENTIFIC AND COMPUTER SERVICES

FOR DEVELOPMENT OF TELECOMMUNICATIONS SYSTEMS SUBJECT TO RESTRICTED OR NON-RESTRICTED ACCESS, INCLUDING TELEVISION TRANSMISSION BY WAY OF SATELLITE; DEVELOPMENT OF COMPUTER SYSTEMS SUBJECT TO RESTRICTED OR NON-RESTRICTED ACCESS; DEVELOPMENT AND MAINTENANCE OF COMPUTER SOFTWARE; DEVELOPMENT AND MAINTENANCE OF COMPUTER SOFTWARE FOR USE IN DATA AND TRANSMISSION PROTOCOLS; GRAPHIC ARTS DESIGN SERVICES, NAMELY, PREPARATION OF GRAPHIC PRINTS FOR USE ON MAGNETIC CARDS AND SMART CARDS; COMPUTER PROGRAMMING; ENGINEERING CONSULTATION AND CONSULTATION IN THE FIELDS OF COMPUTER DATA PROGRAMMING AND COMPUTER TECHNOLOGY AND SOFTWARE, AND COMPUTER SECURITY; RESEARCH AND DEVELOPMENT OF NEW PRODUCTS FOR THIRD PARTIES (U.S. CLS. 100 AND 101).

JEFFERY COWARD, EXAMINING ATTORNEY

SN 79-030,941. YUKIGUNI MAITAKE CO., LTD., JAPAN, FILED 12-12-2005.

KLASMA

THE MARK CONSISTS OF STANDARD CHARACTERS WITHOUT CLAIM TO ANY PARTICULAR FONT, STYLE, SIZE, OR COLOR.

PRIORITY DATE OF 10-18-2005 IS CLAIMED.

OWNER OF INTERNATIONAL REGISTRATION 0903559 DATED 12-12-2005, EXPIRES 12-12-2015.

THE TERM "KLASMA" MEANS BROKEN PIECES OR FRAGMENTS.

CLASS 5—PHARMACEUTICALS

FOR MUSHROOM-BASED AND MUSHROOM EXTRACT-BASED DIETETIC FOODS ADAPTED FOR MEDICAL USE; DIETETIC FOODS ADAPTED FOR MEDICAL USE; DIETETIC BEVERAGES ADAPTED FOR MEDICAL PURPOSES; BABY FOOD; DIETARY SUPPLEMENTS FOR MEDICAL PURPOSES (U.S. CLS. 6, 18, 44, 46, 51 AND 52).

CLASS 29—MEATS AND PROCESSED FOODS

FOR MUSHROOM-BASED AND MUSHROOM EXTRACT-BASED FOODS IN THE FORM OF SOLUTIONS, EXCEPT FOR SOFT DRINKS AND BEVERAGES, POWDERS, TABLETS AND CAPSULES; PROCESSED VEGETABLES AND FRUITS CONTAINING MUSHROOMS AND PROCESSED VEGETABLES AND FRUITS CONTAINING MUSHROOM EXTRACTS; PROCESSED MUSHROOMS FOR FOOD PURPOSES; PROTEINS THAT CONTAIN MUSHROOMS BEING FOODSTUFFS FOR HUMAN CONSUMPTION AND PROTEINS THAT CONTAIN MUSHROOM EXTRACTS BEING FOODSTUFFS FOR HUMAN CONSUMPTION; MUSHROOM EXTRACTS AND MUSHROOM POWDER USED FOR INDUSTRIAL PURPOSES TO MANUFACTURE AND PROCESS FOODS, DIETETIC FOODS AND DIETARY SUPPLEMENTS (U.S. CL. 46).

CHRISTOPHER BUONGIORNO, EXAMINING ATTORNEY

SN 79-031,017. JUNGHEINRICH AG, FED REP GERMANY,
FILED 2-3-2006.

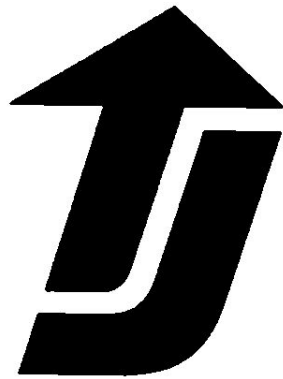

PRIORITY DATE OF 11-1-2005 IS CLAIMED.
OWNER OF INTERNATIONAL REGISTRATION 0903793
DATED 2-3-2006, EXPIRES 2-3-2016.

CLASS 6—METAL GOODS

FOR ALLOYED AND UNALLOYED COMMON METALS, NAMELY, ALUMINUM, LEAD, IRON, COPPER, MAGNESIUM, ZINC AND TIN; METAL BUILDING MATERIALS, NAMELY, METAL GIRDERS, METAL BUILDING BOARDS, METAL SHUTTERING FOR CONCRETE, METAL SHEETS AND PLATES, METAL ROOF COVERINGS, METAL ROOFING, METAL FRAMEWORK FOR BUILDING, METAL SCAFFOLDING, METAL POSTS; METAL TRANSPORTABLE BUILDINGS; METAL MATERIALS FOR RAILWAY CONSTRUCTION; CABLES AND WIRE OF COMMON METAL, NOT FOR ELECTRIC PURPOSES; ELECTRONIC COMPONENTS MADE OF METAL, NAMELY, BINDING SCREWS OF METAL FOR CABLES AND SEALING CAPS OF METAL; IRONMONGERY, NAMELY, HOOKS, SPRINGS, METAL VICE CLAWS, SLEEVES, BUCKLES, WIRE STRETCHERS, METAL CLIPS FOR CABLES AND PIPES; METAL NON-ELECTRIC LOCKS, METAL LOCKS FOR VEHICLES, METAL SPRING LOCKS FOR TOOLS, BAGS, BOXES, AND VEHICLES, METAL PADLOCKS, METAL LOCK BOLTS; METAL KEYS FOR LOCKS; RINGS OF COMMON METAL FOR KEYS; SMALL ITEMS OF METAL HARDWARE, NAMELY, BOLTS OF METAL, WIRES OF COMMON METAL, PEGS OF METAL, WALL PLUGS OF METAL; METAL HANDLES FOR DOORS, TOOLS AND KNIVES; METAL CASK STANDS; METAL PIPES; METAL SAFES; GOODS MADE OF METAL, NAMELY, METAL SIGNBOARDS, WIRE FOR AERIALS, METAL TANKS, METAL PACKAGING CONTAINERS, METAL REGISTRATION PLATES, METAL BADGES FOR VEHICLES, METAL STRAPS FOR HANDLING LOADS, METAL SLINGS FOR HANDLING LOADS, DUCTS OF METAL FOR VENTILATING AND AIR CONDITIONING INSTALLATIONS, METAL TOOL CHESTS; IRON ORES (U.S. CLS. 2, 12, 13, 14, 23, 25 AND 50).

CLASS 7—MACHINERY

FOR MACHINES, NAMELY, BAND CONVEYORS, ELEVATING APPARATUS FOR WORK PLATFORMS, POWER JACKS, HYDRAULIC JACKS, WRAPPING MACHINES, SIZING MACHINES FOR USE IN THE MANUFACTURE OF PAPER AND TEXTILES, LIFTING PLATFORMS FOR THE TRANSPORT OF PERSONS AND GOODS, HYDRAULIC PLATFORMS CAPABLE OF ELEVATION ABOVE GROUND LEVEL AND USED FOR STORAGE, MOBILE PALLET RACKING MACHINE, ELECTRICAL RACKING OPERATOR DEVICES FOR ENGAGING AND DISENGAGING ELECTRICAL POWER CIRCUIT BREAKERS, MACHINE TOOLS FOR THE CUTTING AND SHAPING OF MATERIALS TO BE USED FOR MAINTENANCE AND REPAIR OF INDUSTRIAL TRUCKS; LIFTING APPARATUS, NAMELY, LIFTING INSTALLATIONS FOR THE TRANSPORT OF PERSONS AND GOODS, AND POWER-OPERATED LIFTS USED TO TRANSPORT AND PLACE PORTABLE

STORAGE CONTAINERS; ELECTRIC MOTORS FOR MACHINES AND ENGINES NOT FOR LAND VEHICLES; MACHINE COUPLING AND TRANSMISSION COMPONENTS NOT FOR LAND VEHICLES, NAMELY, HYDRAULIC CONTROLS, PNEUMATIC CONTROLS, TRANSMISSION CHAINS, TRANSMISSION SHAFTS, TRANSMISSIONS FOR MACHINES; CRANK SHAFTS FOR USE IN ENGINES AND MOTORS; BEARINGS BEING PARTS OF MACHINES, BALL-BEARINGS FOR USE IN CONVEYORS, MOTORS, AND ENGINES; BEARING BRACKETS FOR MACHINES, NON-REMOVABLE JOURNALS AS PARTS OF MACHINES, ROLLER BEARINGS FOR MACHINES; AIR FILTERS FOR ENGINES; REGULATORS BEING PARTS OF MACHINES, SPEED GOVERNORS FOR MACHINES, ENGINES AND MOTORS; IGNITION MAGNETS FOR ENGINES; BRUSHES BEING PARTS OF OR FOR USE WITH CONVEYORS, ELEVATING APPARATUS FOR WORK PLATFORMS, POWER JACKS, HYDRAULIC JACKS, WRAPPING MACHINES, SIZING MACHINES FOR USE IN THE MANUFACTURE OF PAPER AND TEXTILES, ELECTRICALLY OPERATED BRUSHES, BEING PARTS OF MACHINES, DYNAMO BRUSHES; CARBON BRUSHES, BEING PARTS OF MACHINES; UNIVERSAL JOINTS, BEING PARTS OF MACHINES; CARDAN JOINTS, BEING PARTS OF MACHINES; METAL CLAMPS USED FOR HOLDING PIECE PARTS ON MACHINE TOOL TABLES; AGRICULTURAL IMPLEMENTS, NAMELY, DRAINAGE MACHINES, THRESHING MACHINES, AGRICULTURAL ELEVATORS; EARTH MOVING MACHINES, NAMELY, BACKHOES, GRADERS, LOADERS, SCARIFIERS, SCRAPERS, AND EXCAVATORS; NET HAULING MACHINES, FODDER PRESSES, REAPERS, FLOUR MILLS, STRAW CUTTING MACHINES, NOT HAND OPERATED, RAKING MACHINES, METAL AND WOOD PLANING MACHINES, WEEDING MACHINES, MECHANIZED LIVESTOCK-FEEDERS, MILKING MACHINES, SORTING MACHINES FOR AGRICULTURAL CROPS; SHEARING MACHINES FOR ANIMALS; INCUBATORS FOR EGGS (U.S. CLS. 13, 19, 21, 23, 31, 34 AND 35).

CLASS 9—ELECTRICAL AND SCIENTIFIC APPARATUS

FOR SCIENTIFIC APPARATUS AND INSTRUMENTS, NAMELY, GAS TESTING INSTRUMENTS, AIR ANALYSIS APPARATUS; ELECTRIC LOSS INDICATORS, SOUND RECORDING APPARATUS, LIGHTNING CONDUCTORS, TELESCOPES, COMPASSES, VACUUM GAUGES; SURVEYING APPARATUS AND INSTRUMENTS, NAMELY, DISTANCE RECORDING APPARATUS, SONARS, LEVEL MEASURING MACHINES, LEVELING RODS, MAGNETIC COMPASSES, SURVEYING CHAINS, SURVEYING COMPASS NEEDLES, TRANSITS, TRIPODS; PHOTOGRAPHIC APPARATUS AND INSTRUMENTS, NAMELY, EXPOSURE METERS FOR PHOTOGRAPHIC DEVICES; CINEMATOGRAPHIC APPARATUS AND INSTRUMENTS, NAMELY, CINEMATOGRAPHIC CAMERAS; MEASURING APPARATUS AND INSTRUMENTS, NAMELY, AEROMETERS, AMMETERS, SPEED INDICATORS, TEMPERATURE INDICATORS, WATER LEVEL INDICATORS, BAROMETERS, CHRONOGRAPHS FOR USE AS SPECIALIZED TIME RECORDING APPARATUSES, DENSIMETERS, PRESSURE MEASURING APPARATUS, SPEED CHECKING APPARATUS FOR VEHICLES, ALTIMETERS, HYGROMETERS, PHOTOMETERS, PLANIMETERS, VOLTMETERS, TACHOMETERS, SENSORS FOR THE DETERMINATION OF TEMPERATURES, POSITIONS AND DISTANCE MEASURING APPARATUS, PRECISION BALANCES FOR WEIGHING; SIGNALING APPARATUS AND INSTRUMENTS, NAMELY, ACOUSTIC SOUND ALARMS, AUTOMATIC INDICATORS OF LOW PRESSURE IN VEHICLE TIRES, FIRE ALARMS, SMOKE DETECTORS; LIFE-SAVING APPARATUS AND INSTRUMENTS, NAMELY, RESPIRATORS FOR FILTERING AIR, PROTECTIVE HELMETS; TEACHING APPARATUS AND INSTRUMENTS, NAMELY, SLIDE PROJECTORS; MECHANICAL REMOTE CONTROLS FOR MOTORS, RADIO TRANSMITTERS AND RECEIVERS FOR REMOTE CONTROLS, WIRELESS TELEPHONES, NAVIGATION APPARATUS FOR VEHICLES IN THE NATURE OF ONBOARD COMPUTERS, ELECTRIC NAVIGATIONAL INSTRUMENTS, APPARATUS AND INSTRUMENTS FOR CONDUCTING, SWITCHING, TRANSFORMING, ACCUMULATING, REGULATING OR CONTROLLING ELECTRICITY, NAMELY,

ELECTRICITY INDUCTORS, ELECTRICITY LIMITERS, ANTI-INTERFERENCE DEVICES, ELECTRICITY DISTRIBUTION CONSOLES, ELECTRICITY CONTROL PANELS, CELL SWITCHES; BLANK MAGNETIC DATA CARRIERS, BLANK RECORDING DISCS, VIDEO RECORDERS, CAMCORDERS, TAPE RECORDERS; MAGNETS; ELECTRIC LOCKS; VOLTAGE REGULATORS FOR VEHICLES, ELECTRIC LIGHT DIMMERS; SIGNS, NAMELY, MECHANICAL SIGNS, LUMINOUS SIGNS; BATTERY CHARGERS AND THEIR PARTS; ELECTRONIC DEVICES FOR RECORDING AND SAVING DATA FOR THE PURPOSE OF VEHICLE MAINTENANCE; ELECTRONIC COMPONENTS FOR VEHICLES AND THEIR ELECTRIC INDICATORS, NAMELY, ACCUMULATORS, ACOUSTIC COUPLERS, ELECTRIC COLLECTORS, ELECTRIC CONTACTS, PRESSURE INDICATOR PLUGS FOR VALVES; COMPUTER PROGRAMS RECORDED ON DATA CARRIERS, NAMELY, STORAGE AND ANALYSIS PROGRAMS FOR THE MANAGEMENT OF TOTAL STOCK ON HAND, THE DETECTION OF AVAILABLE STOCK, THE MATERIAL AND PRODUCT FLOW AND THE ORDERING OF SPARE PARTS; COMMUTATORS; ELECTRICAL CONNECTORS; PHOTOGRAPHIC FILTERS; CASH REGISTERS, CALCULATING MACHINES AND COMPUTERS, COMPUTER HARDWARE AND SOFTWARE FOR MANAGEMENT OF TOTAL STOCK ON HAND, THE DETECTION OF AVAILABLE STOCK AND THE MATERIAL AND PRODUCT FLOW; COMPUTER MONITORS AND VIDEO DISPLAY MONITORS; FIRE EXTINGUISHERS; ELECTRONIC COMPONENTS, NAMELY, ELECTRONIC TRANSISTORS, ELECTRONIC AGENDAS, ELECTRONIC POCKET TRANSLATORS, ELECTRONIC PENS FOR VISUAL DISPLAY UNITS, RFID TAGS (U.S. CLS. 21, 23, 26, 36 AND 38).

CLASS 12—VEHICLES

FOR VEHICLES, NAMELY, FORK LIFT TRUCKS WITH OR WITHOUT ELECTRIC DRIVING GEAR, STACKER VEHICLES WITH ELECTRIC OR DIESEL DRIVING GEAR, FORK-LIFT REACH TRUCKS, DRIVERLESS TOWING AND TRANSPORT VEHICLES, ALL WITH ELECTRIC DRIVING GEAR, TRAILERS, NAMELY, CARGO TRAILERS, EQUIPMENT TRAILERS, PARK TRAILERS, SEMI-TRACTOR TRAILERS, AND TRACTOR TRAILERS, PALLET TRUCKS, ELECTRIC COUNTERBALANCE TRUCKS FOR LIFTING AND STACKING GOODS, TOW TRACTORS, AUTOMOBILES, AMPHIBIOUS AIRPLANES, MOTOR BUSES, ROLLING STOCK FOR RAILWAYS, ELECTRIC VEHICLES, NAMELY, AUTOMOBILES, FORK LIFT TRUCKS, TOWING AND TRANSPORT VEHICLES, AND STACKER VEHICLES, BICYCLES, MOTOR CARS FOR TRANSPORT ON LAND, AEROPLANES, LIFTING CARS, YACHTS, CARTS, BARGES, VANS, MOPEDS, MOTORCYCLES, SNOWMOBILES, FORK LIFT TRUCKS, NAMELY, TRAVERSING MAST STACKERS AND HIGH RACK STACKERS; ENGINES FOR LAND VEHICLES; TRAILER HITCHES FOR VEHICLES AND TRANSMISSIONS FOR LAND VEHICLES; AIR CUSHION VEHICLES; FITTED VEHICLE COVERS; TRANSMISSION CHAINS FOR LAND VEHICLES; MOTORS FOR LAND VEHICLES; TRANSMISSION SHAFTS FOR LAND VEHICLES; TRANSMISSION SHAFT HINGES FOR LAND VEHICLES; BRAKING SYSTEM FOR LAND VEHICLES COMPRISED OF PADS, DISKS, DRUMS, FACINGS, LINES, LININGS, ROTORS, CYLINDERS, BRAKE FLUID, BRAKE LINES, VALVES, ROTORS, CALIPERS, AND SPRINGS; BRAKE SEGMENTS FOR VEHICLES; BRAKE LININGS FOR VEHICLES; BRAKE PADS FOR VEHICLES; BRAKE BOOSTER HOUSINGS FOR VEHICLES; BRAKE DISKS FOR VEHICLES; ANTI-THEFT DEVICES FOR VEHICLES; AUTOMOBILE CHASSIS; MINE-CART WHEELS; FOOT BRAKE PEDALS FOR VEHICLES, NAMELY, LIFT TRUCKS, FORK LIFT TRUCKS, AUTOMOBILES, MOTOR CARS, LIFTING CARS, TRUCKS; LUGGAGE CARRIERS FOR VEHICLES; HORNS FOR VEHICLES; HUB CAPS; WHEEL BEARINGS FOR LAND VEHICLES; REAR-VIEW MIRRORS; CLUTCHES FOR LAND VEHICLES; SUSPENSION SHOCK ABSORBERS FOR LAND VEHICLES; VEHICLE SUSPENSION SPRINGS, NAMELY, LEAF SPRINGS AND COIL SPRINGS; VALVES FOR VEHICLE TIRES; STEERING WHEELS FOR VEHICLES (U.S. CLS. 19, 21, 23, 31, 35 AND 44).

CLASS 17—RUBBER GOODS

FOR RAW RUBBER, NATURAL RUBBER AND SYNTHETIC RUBBER, ALL FOR THE MANUFACTURE OF CABLES AND GASKETS; GUTTA PERCHA FOR THE MANUFACTURE OF CABLES; ASBESTOS FOR THE MANUFACTURE OF INSULATING MATERIAL AND CAR TIRES; MICA, MICA SLATE, MICA POWDER, MICA WASHER; PLASTICS IN EXTRUDED FORM FOR USE IN MANUFACTURE; RUBBER BAGS, ENVELOPES, AND POUCHES FOR MERCHANDISE PACKING; ASBESTOS PACKING FOR VALVES AND PISTONS, CAULKING COMPOUNDS, NAMELY, COTTON WOOL, FIBERGLASS INSULATION FOR BUILDINGS, GLASS WOOL FOR BUILDING INSULATION; WATERPROOF PACKINGS FOR ISOLATION OF ELECTRICAL WIRES; WATER-TIGHT RINGS FOR PLUMBING PIPES, NON-METAL WEATHER STRIPS FOR BUILDINGS, PIPE GASKETS, CYLINDER JOINTINGS MATERIAL FOR THE ISOLATION OF COOLING-WATER CANALS AND ENGINE OIL CANALS IN ENGINES AND MOTORS; FLEXIBLE PIPES NOT OF METAL (U.S. CLS. 1, 5, 12, 13, 35 AND 50).

CHRISTOPHER BUONGIORNO, EXAMINING ATTORNEY

SN 79-031,079. NUTKAO S.R.L., ITALY, FILED 3-14-2006.

NUTKAO

OWNER OF INTERNATIONAL REGISTRATION 0819776
DATED 10-23-2003, EXPIRES 10-23-2013.

CLASS 29—MEATS AND PROCESSED FOODS

FOR MEAT, FISH, POULTRY AND GAME; MEAT EXTRACTS; PRESERVED AND DRIED FRUITS AND VEGETABLES; COOKED FRUIT, NAMELY, FRUIT PRESERVES, CANNED FRUIT, FRUIT CHIPS; COOKED VEGETABLES, NAMELY, VEGETABLE CHIPS, VEGETABLE BASED SNACK FOOD, VEGETABLE SPREAD; JELLIES; JAMS; COMPOTES; EGGS; MILK; DAIRY PRODUCTS, NAMELY, DAIRY BASED FOOD BEVERAGE, DAIRY DIPS, MILK ONLY SPREADS AND DAIRY PRODUCTS EXCLUDING ICE CREAM, ICE MILK, AND FROZEN YOGURT; EDIBLE OILS AND FATS; TINNED VEGETABLES (U.S. CL. 46).

CLASS 30—STAPLE FOODS

FOR COFFEE; TEA; COCOA; SUGAR; RICE; TAPIOCA; SAGO; ARTIFICIAL COFFEE; FLOURS; CEREAL PREPARATIONS, NAMELY, READY TO EAT CEREAL DERIVED FOOD BARS, CEREAL BASED SNACK FOOD FEATURING HAZELNUTS, PROCESSED CEREALS; BREAD; PASTRY; CONFECTIONERY, NAMELY, CANDY, CHOCOLATE CANDY, CHOCOLATE BARS, CHOCOLATE SLABS, HAZELNUT CHOCOLATE SPREAD MADE PRIMARILY OF CHOCOLATE, CHOCOLATE SPREAD IN COMBINATION WITH BREAD STICKS; EDIBLE ICE; HONEY; MOLASSES; YEAST; BAKING POWDER; SALT; MUSTARD; VINEGAR; SAUCES AS CONDIMENTS; SPICES; ICE FOR REFRESHMENT, NAMELY, FLAVORED ICE; PASTRY AND CONFECTIONERY PRODUCTS MADE WITH COCOA, NAMELY, COCOA SPREADS, SPREADS CONTAINING CHOCOLATE AND NUTS, AND CHOCOLATE-BASED FILLINGS FOR CAKES AND PIES (U.S. CL. 46).

REBECCA POVARCHUK, EXAMINING ATTORNEY

SN 79-031,224. WIRTH MASCHINEN- UND BOHRGERÄTE-FABRIK GMBH, FED REP GERMANY, FILED 7-5-2005.

WIRTH

THE MARK CONSISTS OF STANDARD CHARACTERS WITHOUT CLAIM TO ANY PARTICULAR FONT, STYLE, SIZE, OR COLOR.

OWNER OF INTERNATIONAL REGISTRATION 0904286 DATED 7-5-2005, EXPIRES 7-5-2015. SEC. 2(F).

CLASS 7—MACHINERY

FOR DRILLING MACHINES AND PARTS THEREFOR, NAMELY, ROTARY TABLE DRILLING RIGS, CORE DRILLING RIGS, WATER WELL, PILE FOUNDATION, SHAFT, LARGE-DIAMETER, BLAST-HOLE, INVESTIGATION, INJECTION AND ANCHOR-HOLE DRILLING UNITS, AIR-LIFT AND JET DRILLING UNITS, AND DRILLING INSTALLATIONS COMPRISING DRILLING RIGS, AND APPARATUS FOR THEIR OPERATION, NAMELY DRAW WORKS AND WINCHES, ROTARY TABLES, ROTARY SWIVELS AND TOP DRIVES, GEAR-BOXES, NAMELY, COMPOUND GEARS, MOTOR DRIVES, MASTER BUSHINGS FOR ROTARY TABLES; DRILLING MACHINES AND PARTS THEREFOR, NAMELY, CORE DRILL RIGS, WATER-WELL DRILL RIGS, PILE-TOP DRILL RIGS, SHAFT BORING RIGS, LARGE-DIAMETER DRILL RIGS, INJECTION DRILL RIGS, ANCHOR-HOLE DRILL RIGS, REVERSE-CIRCULATION DRILL RIGS, JET DRILL RIGS, GEARINGS AND MOTOR DRIVES FOR THE OPERATION OF THESE DRILLING RIGS, ALL FOR USE WITH WATER ECONOMY, CIVIL ENGINEERING, MINING, MARINE TECHNOLOGY AND EXPLORATION DRILLING PURPOSES; UNITS AND APPARATUS FOR PILE FOUNDATION PURPOSES, NAMELY, FOUNDATION WORK MACHINES; ROTARY DRILLING MACHINES AND PARTS THEREFOR, NAMELY, RIGS FOR DRILLING ONSHORE AND OFFSHORE, COMPRISING DERRICKS, DRAW WORKS, TRANSMISSIONS AND MOTOR DRIVES; MECHANICAL EQUIPMENT FOR USE IN DRILLING MACHINES AND PARTS THEREFOR, NAMELY, LATTICE MAST CRANES, TRAVELLING BLOCK BRAKES, LIFTING INSTALLATIONS FOR THE TRANSPORT OF MACHINES, WINCHES, GEARS AND ENCLOSED DRIVES FOR INDUSTRIAL MACHINERY, COMPRESSORS FOR MACHINES, SHUT-OFF ELEMENTS, NAMELY VALVES BEING PARTS OF DRILLING MACHINES, VIBRATORY SCREEN SEPARATORS, DRILL-PIPE ADDING AND HANDLING EQUIPMENT, NAMELY, POWER OPERATED PIPE LAYERS, FORK LIFTS AND LIFTS, DRILL PIPE RACKS, POWER SWIVELS BEING PARTS OF DRILLING MACHINES, CASING MACHINES FOR CASING BORES AND TUNNELS, SWIVELS FOR DRILL PIPES, ROTARY TABLES FOR DRILL PIPES, MACHINE PARTS, NAMELY, KELLY BUSHINGS, PARTS FOR THE AFORESAID UNITS AND MACHINES; DRILL PIPES AND THEIR CORRESPONDING PARTS BEING PARTS OF DRILLING MACHINES, NAMELY, PIPES, JUNCTION PIECES, CONNECTING PIECES, STABILIZERS AND DRILL-COLLARS; MECHANICAL TOOLS FOR THE INSTALLATION AND REMOVAL OF DRILL PIPES, ALL FOR DRILLING TECHNIQUE PURPOSES; MACHINES AND MECHANICAL APPLIANCES FOR DRILLING AND DRIVING OF TUNNELS, SECTIONS, SHAFTS AND CAVITIES, NAMELY, FULL-DIAMETER, ENLARGEMENT, JACKET TUNNEL, SHAFT, AND LARGE-DIAMETER BORING MACHINES, SHAFT SINKERS, TRAILERS AND TRAILER MOUNTED MACHINES, NAMELY BACK-UP SYSTEMS AND ANTI-RETURN STRUCTURES IN INCLINED GALLERIES FOR MACHINERY AND MECHANICAL EQUIPMENT FOR BORING AND DRIVING TUNNELS, SECTIONS, SHAFTS AND CAVITIES; PARTS OF ALL THE AFORESAID MACHINES AND APPLIANCES; MECHANICAL APPLIANCES AND APPARATUS FOR THE INSTALLATION OF LININGS, NAMELY TUNNEL LINING INSTALLA-

TION EQUIPMENT FOR MACHINERY AND MECHANICAL EQUIPMENT FOR BORING AND DRIVING TUNNELS, SECTIONS, SHAFTS AND CAVITIES; TRANSPORTING APPARATUS AND APPLIANCES FOR CONVEYING MUCK AND DEBRIS FOR THE AFORESAID MACHINES AND APPLIANCES, NAMELY, CONVEYORS; MECHANICALLY-OPERATED TOOLS, NAMELY, CUTTER HEADS AND OUTFITS FOR DRILLING UNITS; MACHINES AND APPLIANCES FOR DRILLING AND DRIVING OF TUNNELS, SECTIONS, SHAFTS AND CAVITIES, NAMELY, DRILL BITS FOR ROCK DRILLING, MILLING CUTTERS, LARGE-DIAMETER ROCK DRILLING BITS, ENLARGING BITS FOR ROCK DRILLING, ECCENTRIC BITS FOR ROCK DRILLING, UNDER REAMERS, STEP BITS FOR ROCK DRILLING, FULL-DIAMETER CROWN DRILLS, REAMERS, EARTH AUGERS, SPOON EARTH AUGERS, BUCKETS BEING PARTS OF EARTH AUGERS, CORING UNITS, NAMELY, CORE DRILLING BITS, ELEVATORS; HIGH-PRESSURE HYDROSTATIC, PISTON PUMPS AND PLUNGER PUMPS, WITH MECHANICAL DRIVES AND WITH PRESSURE MEDIUM DRIVES, NAMELY, SLUSH AND MUD PUMPS FOR DRILLING UNITS, DELIVERY PUMPS, PUMPS FOR SOLID CONVEYANCE AND PARTS FOR THE AFORESAID PUMPS; TENSIONING APPARATUS AND APPLIANCES OPERATING ON A PRESSURE MEDIUM BASIS, NAMELY, TIGHTENING MACHINES FOR SCREW AND BOLT CONNECTIONS AND ASSEMBLIES FOR PRE-TENSIONING EXPANSION BOLTS FOR CLOSURES AND FOR THE FIXING OF PARTS TO BE CONNECTED IN REACTORS (U.S. CLS. 13, 19, 21, 23, 31, 34 AND 35).

CLASS 9—ELECTRICAL AND SCIENTIFIC APPARATUS

FOR MEASURING, SURVEILLANCE, CONTROL AND REGULATING APPARATUS AND APPLIANCES, NAMELY ELECTRIC SHUT-OFF SWITCHES FOR DRILLING UNITS AND FOR MACHINING AND APPLIANCES FOR DRILLING AND DRIVING TUNNELS, SECTIONS, SHAFTS AND CAVITIES (U.S. CLS. 21, 23, 26, 36 AND 38).

DAVID HOFFMAN, EXAMINING ATTORNEY

SN 79-031,287. ESKER, FRANCE, FILED 7-21-2006.

FLYDOC

THE MARK CONSISTS OF STANDARD CHARACTERS WITHOUT CLAIM TO ANY PARTICULAR FONT, STYLE, SIZE, OR COLOR.

PRIORITY DATE OF 2-3-2006 IS CLAIMED.

OWNER OF INTERNATIONAL REGISTRATION 0904464 DATED 7-21-2006, EXPIRES 7-21-2016.

CLASS 35—ADVERTISING AND BUSINESS

FOR OFFICE FUNCTIONS; COMPUTER FILE MANAGEMENT FOR THIRD PARTIES; DATA ENTRY; DIRECT MAIL ADVERTISING SERVICES; ENTRY OF ELECTRONIC DATA AND DOCUMENTS IN A DATABASE (U.S. CLS. 100, 101 AND 102).

CLASS 39—TRANSPORTATION AND STORAGE

FOR SHIPPING AND DELIVERY SERVICES, NAMELY, PICKUP, PACKAGING, STORAGE, TRANSPORT, RELAY AND DELIVERY OF PARCELS, MAIL, PACKAGES, WRITTEN ITEMS AND OTHER INFORMATION, IN PARTICULAR LETTERS, POSTCARDS, PRINTED MATTER, ADVERTISING MAILINGS, ADVERTISING MAILINGS WITH OR WITHOUT ADDRESS, CONSIGNMENTS OF BOOKS, UNADDRESSED MAILINGS, NEWSPAPERS, PERIODICALS, BY ALL MEANS OF TRANSPORT, NAMELY, TRANSPORTATION BY AIR, BOAT, RAIL, TRUCK, TRAIN; STORAGE OF DATA AND DOCUMENTS HELD IN ELECTRONIC FORM FOR THE PRODUCTION OF POSTAL ITEMS AND MAILINGS, NAMELY, CIRCULARS, FOR OTHERS; PROVIDING INFORMATION VIA THE INTERNET REGARDING THE TRANSPORT OF GOODS, IN PARTICULAR LETTERS, PARCELS, SMALL PARCELS (U.S. CLS. 100 AND 105).

JEAN IM, EXAMINING ATTORNEY

SN 79-032,994. MIRIANA LTD, UNITED KINGDOM, FILED 3-6-2006.

Miriana

THE MARK CONSISTS OF STANDARD CHARACTERS WITHOUT CLAIM TO ANY PARTICULAR FONT, STYLE, SIZE, OR COLOR.

PRIORITY DATE OF 9-6-2005 IS CLAIMED.

OWNER OF INTERNATIONAL REGISTRATION 0908766 DATED 3-6-2006, EXPIRES 3-6-2016.

THE WORDING "MIRIANA" HAS NO MEANING IN A FOREIGN LANGUAGE.

CLASS 5—PHARMACEUTICALS

FOR MEDICAL PREPARATIONS FROM PLANTS BASED ON THE SO-CALLED BACH FLOWER FOR THE TREATMENT OF MENTAL DISORDERS, DISEASES AND COMPLAINTS, NAMELY, AGAINST FEAR, PANIC, OVER-SENSITIVITY, OVER-CARE FOR THE WELFARE OF OTHERS, UNCERTAINTY, INSUFFICIENT INTEREST IN PRESENT CIRCUMSTANCES INSENSITIVITY, DESPONDENCY, DESPAIR, INDECISION, LACK OF SELF-CONFIDENCE, HOPELESSNESS, LONELINESS, STRESS, DEPRESSION, SADNESS, DISCONTENT, DAYDREAMING, ANGER, HATE, LACK OF ENDURANCE, EXHAUSTION, SELF BLAME, IMAGINING THE WORST, SELF-DENIAL, DESOLATION, OVER-ENTHUSIASM, ARROGANCE, INTOLERANCE, DOMINANCE, INFLEXIBILITY, ALOOF, MENTAL BLOCK, OBSESSION, APATHY, RESIGNATION, RESENTMENT, DIRECTIONLESSNESS, SELF-CONCERN, IMPATIENCE, CALLOUSNESS, GLOOM; MEDICAL PREPARATIONS FOR HUMAN USE FOR THE HOMEOPATHIC TREATMENT OF MENTAL DISORDERS, DISEASES AND COMPLAINTS, NAMELY, AGAINST FEAR, PANIC, OVER-SENSITIVITY, OVER-CARE FOR THE WELFARE OF OTHERS, UNCERTAINTY, INSUFFICIENT INTEREST IN PRESENT CIRCUMSTANCES, INSENSIBILITY, DESPONDENCY, DESPAIR, INDECISION, LACK OF SELF-CONFIDENCE, HOPELESSNESS, LONELINESS, STRESS, DEPRESSION, SADNESS, DISCONTENT, DAYDREAMING, ANGER, HATE, LACK OF ENDURANCE, EXHAUSTION, SELF BLAME, IMAGINING THE WORST, SELF-DENIAL, DESOLATION, OVER-ENTHUSIASM, ARROGANCE, INTOLERANCE, DOMINANCE, INFLEXIBILITY, ALOOF, MENTAL BLOCK, OBSESSION, APATHY, RESIGNATION, RESENTMENT, DIRECTIONLESSNESS, SELF-CONCERN, IMPATIENCE, CALLOUSNESS, GLOOM; MEDICAL PREPARATIONS FOR VETERINARY USE FOR THE HOMEOPATHIC TREATMENT OF MENTAL DISORDERS, DISEASES AND COMPLAINTS, NAMELY, AGAINST FEAR, PANIC, OVER-SENSITIVITY, OVER-CARE FOR THE WELFARE OF OTHERS, UNCERTAINTY, INSUFFICIENT INTEREST IN PRESENT CIRCUMSTANCES, INSENSIBILITY, DESPONDENCY, DESPAIR, INDECISION, LACK OF SELF-CONFIDENCE, HOPELESSNESS, LONELINESS, STRESS, DEPRESSION, SADNESS, DISCONTENT, DAYDREAMING, ANGER, HATE, LACK OF ENDURANCE, EXHAUSTION, SELF BLAME, IMAGINING THE WORST, SELF-DENIAL, DESOLATION, OVER-ENTHUSIASM, ARROGANCE, INTOLERANCE, DOMINANCE, INFLEXIBILITY, ALOOF, MENTAL BLOCK, OBSESSION, APATHY, RESIGNATION, RESENTMENT, DIRECTIONLESSNESS, SELF-CONCERN, IMPATIENCE, CALLOUSNESS, GLOOM; BACH FLOWER ESSENCES FOR HUMAN MEDICAL AND VETERINARY USE FOR THE TREATMENT OF MENTAL DISORDERS, DISEASES AND COMPLAINTS, NAMELY, AGAINST FEAR, PANIC, OVER-SENSITIVITY, OVER-CARE FOR THE WELFARE OF OTHERS, UNCERTAINTY, INSUFFICIENT INTEREST IN PRESENT CIRCUMSTANCES, INSENSIBILITY, DESPONDENCY, DESPAIR, INDECISION, LACK OF SELF-CONFIDENCE, HOPELESSNESS, LONELINESS, STRESS, DEPRESSION, SADNESS, DISCONTENT, DAYDREAMING, ANGER, HATE, LACK OF ENDURANCE, EXHAUSTION, SELF BLAME, IMAGIN-

SN 79-031,602. ESKER, FRANCE, FILED 9-1-2006.

ESKER

THE MARK CONSISTS OF STANDARD CHARACTERS WITHOUT CLAIM TO ANY PARTICULAR FONT, STYLE, SIZE, OR COLOR.

PRIORITY DATE OF 3-28-2006 IS CLAIMED.

OWNER OF INTERNATIONAL REGISTRATION 0905198 DATED 9-1-2006, EXPIRES 9-1-2016.

OWNER OF U.S. REG. NOS. 2,600,175 AND 2,609,660.

CLASS 35—ADVERTISING AND BUSINESS

FOR OFFICE FUNCTIONS; COMPUTER FILE MANAGEMENT FOR THIRD PARTIES; DATA ENTRY; DIRECT MAIL ADVERTISING SERVICES; SERVICES FOR ENTERING DATA AND ELECTRONIC DOCUMENTS IN A DATABASE; MANAGEMENT OF COMPUTER FILES OF ADDRESSES (U.S. CLS. 100, 101 AND 102).

CLASS 39—TRANSPORTATION AND STORAGE

FOR SHIPPING AND DELIVERY SERVICES, NAMELY, PICKUP, PACKAGING, STORAGE, TRANSPORT, RELAY AND DELIVERY OF PARCELS, MAIL, PACKAGES, WRITTEN ITEMS AND OTHER INFORMATION, IN PARTICULAR LETTERS, POSTCARDS, PRINTED MATTER, ADVERTISING MAILINGS, ADVERTISING MAILINGS WITH OR WITHOUT ADDRESS, CONSIGNMENTS OF BOOKS, UNADDRESSED MAILINGS, NEWSPAPERS, PERIODICALS, BY ALL MEANS OF TRANSPORT, NAMELY, TRANSPORTATION BY AIR, BOAT, RAIL, TRUCK, TRAIN; STORAGE OF DATA AND DOCUMENTS HELD IN ELECTRONIC FORM FOR THE PRODUCTION OF POSTAL ITEMS AND MAILINGS, NAMELY, CIRCULARS, FOR OTHERS; PROVIDING INFORMATION VIA THE INTERNET REGARDING THE TRANSPORT OF GOODS, IN PARTICULAR LETTERS, PARCELS, SMALL PARCELS (U.S. CLS. 100 AND 105).

JEAN IM, EXAMINING ATTORNEY

ING THE WORST, SELF-DENIAL, DESOLATION, OVER-ENTHUSIASM, ARROGANCE, INTOLERANCE, DOMINANCE, INFLEXIBILITY, ALOOF, MENTAL BLOCK, OBSESSION, APATHY, RESIGNATION, RESENTMENT, DIRECTIONLESSNESS, SELF-CONCERN, IMPATIENCE, CALLOUSNESS, GLOOM; MEDICAL HUMAN AND VETERINARY VIBRATIONAL REMEDIES DERIVED FROM PLANTS AND ESSENCES IN SPRING WATER FOR THE TREATMENT OF MENTAL DISORDERS, DISEASES AND COMPLAINTS, NAMELY, AGAINST FEAR, PANIC, OVER-SENSITIVITY, OVER-CARE FOR THE WELFARE OF OTHERS, UNCERTAINTY, INSUFFICIENT INTEREST IN PRESENT CIRCUMSTANCES, INSENSIBILITY, DESPONDENCY, DESPAIR, INDECISION, LACK OF SELF-CONFIDENCE, HOPELESSNESS, LONELINESS, STRESS, DEPRESSION, SADNESS, DISCONTENT, DAYDREAMING, ANGER, HATE, LACK OF ENDURANCE, EXHAUSTION, SELF BLAME, IMAGINING THE WORST, SELF-DENIAL, DESOLATION, OVER-ENTHUSIASM, ARROGANCE, INTOLERANCE, DOMINANCE, INFLEXIBILITY, ALOOF, IN MENTAL BLOCK, OBSESSION, APATHY, RESIGNATION, RESENTMENT, DIRECTIONLESSNESS, SELF-CONCERN, IMPATIENCE, CALLOUSNESS, GLOOM; FOOD SUPPLEMENTS FOR HUMAN, MEDICAL AND VETERINARY USE; HOMEOPATHIC PHARMACEUTICALS PREPARATIONS FOR HUMAN MEDICAL AND VETERINARY USE, NAMELY, FOR THE TREATMENT OF MENTAL DISORDERS, DISEASES AND COMPLAINTS, NAMELY, AGAINST FEAR, PANIC, OVER-SENSITIVITY, OVER-CARE FOR THE WELFARE OF OTHERS, UNCERTAINTY, INSUFFICIENT INTEREST IN PRESENT, CIRCUMSTANCES, INSENSIBILITY, DESPONDENCY, DESPAIR, INDECISION, LACK OF SELF-CONFIDENCE, HOPELESSNESS, LONELINESS, STRESS, DEPRESSION, SADNESS, DISCONTENT, DAYDREAMING, ANGER, HATE, LACK OF ENDURANCE, EXHAUSTION, SELF BLAME, IMAGINING THE WORST, SELF-DENIAL, DESOLATION, OVER-ENTHUSIASM, ARROGANCE, INTOLERANCE, DOMINANCE, INFLEXIBILITY, ALOOF, MENTAL BLOCK, OBSESSION, APATHY, RESIGNATION, RESENTMENT, DIRECTIONLESSNESS, SELF-CONCERN, IMPATIENCE, CALLOUSNESS, GLOOM; AND VITAMIN PREPARATIONS FOR HUMAN MEDICAL AND VETERINARY USE (U.S. CLS. 6, 18, 44, 46, 51 AND 52).

CLASS 29—MEATS AND PROCESSED FOODS

FOR FOOD SUPPLEMENTS BASED ON EDIBLE FATS AND FOOD SUPPLEMENTS BASED ON FATTY ACIDS, EACH UNDER ADDITION OF VITAMINS, MINERAL NUTRIENTS, TRACE ELEMENTS, EITHER SEPARATELY OR IN COMBINATION, AS FAR AS INCLUDED IN THIS CLASS (U.S. CL. 46).

DAYNA BROWNE, EXAMINING ATTORNEY

SN 79-033,069. CAPITALIS INTERNATIONAL PTY LTD; C/MCGILLIVRAY PARTNERS, AUSTRALIA, FILED 12-5-2006.

CAPITALIS

THE MARK CONSISTS OF STANDARD CHARACTERS WITHOUT CLAIM TO ANY PARTICULAR FONT, STYLE, SIZE, OR COLOR.

OWNER OF INTERNATIONAL REGISTRATION 0908956 DATED 12-5-2006, EXPIRES 12-5-2016.

CLASS 35—ADVERTISING AND BUSINESS

FOR BUSINESS MANAGEMENT CONSULTANCY; BUSINESS CONSULTANCY AND BUSINESS ADVISORY SERVICES, NAMELY, BUSINESS MANAGEMENT CONSULTING SERVICES RELATING TO SALES STRATEGIES, MARKETING, BRANDING, PUBLIC RELATIONS, FRANCHISING, ADVERTISING AND PROMOTION; BUSINESS CONSULTANCY SERVICES RELATING TO TECHNOLOGY, INNOVATION AND INTELLECTUAL PROPERTY MANAGEMENT (U.S. CLS. 100, 101 AND 102).

CLASS 42—SCIENTIFIC AND COMPUTER SERVICES

FOR LICENSING AND EXPLOITATION OF INTELLECTUAL PROPERTY; INTELLECTUAL PROPERTY LICENSING CONSULTANCY (U.S. CLS. 100 AND 101).

CURTIS FRENCH, EXAMINING ATTORNEY

SN 79-033,321. GENERIC HEALTH PTY LTD; (ACN 110 617 859), AUSTRALIA, FILED 8-18-2006.



PRIORITY DATE OF 2-22-2006 IS CLAIMED.
OWNER OF INTERNATIONAL REGISTRATION 0909507 DATED 8-18-2006, EXPIRES 8-18-2016.

NO CLAIM IS MADE TO THE EXCLUSIVE RIGHT TO USE "GENERIC HEALTH", APART FROM THE MARK AS SHOWN.

CLASS 5—PHARMACEUTICALS

FOR PHARMACEUTICAL PREPARATIONS AND SUBSTANCES, NAMELY, ANTIBIOTICS, ANALGESICS, ANTITUSSIVE-COLD PREPARATIONS, ANTI-ALLERGIC PREPARATIONS, ANTIDEPRESSANTS, APPETITE SUPPRESSANTS, ANTICOAGULANTS; PHARMACEUTICAL PREPARATIONS FOR THE TREATMENT OF ERECTILE DYSFUNCTION, FOR USE IN CHEMOTHERAPY, FOR THE TREATMENT OF GOUT, FOR THE TREATMENT OF HEART RHYTHM DISORDERS, FOR THE TREATMENT OF INFECTIOUS DISEASES, FOR THE TREATMENT OF GASTRO-INTESTINAL DISEASES, FOR INHALATION FOR THE TREATMENT OF PULMONARY HYPERTENSION, FOR OCULAR OR INTRAOCULAR SURGERY, FOR THE TREATMENT OF HORMONAL DISORDERS AND THE PREVENTION OF OSTEOPOROSIS, FOR TREATING ALLERGIC RHINITIS AND ASTHMA, FOR TREATING DIABETES, FOR TREATING SKIN DISORDERS, FOR USE IN DERMATOLOGY, FOR WOUNDS, FOR USE IN UROLOGY, FOR THE TREATMENT OF EYE DISEASES AND CONDITIONS, FOR THE PREVENTION AND TREATMENT OF HEART DISEASE AND DIABETES, FOR OPHTHALMOLOGICAL USE, FOR THE TREATMENT OF BONE DISEASES, FOR THE TREATMENT OF VIRAL AND INFECTIOUS DISEASES, FOR THE TREATMENT OF CANCER, FOR TREATING RESPIRATORY DISEASES AND ASTHMA; PREPARATIONS TO PREVENT AND HYDRATE DRY SKIN CAUSED BY PREGNANCY AND TO PREVENT BLEMISHES AND STRETCH MARKS DURING PREGNANCY; MEDICATED SKIN LOTIONS; VETERINARY PREPARATIONS AND SUBSTANCES, NAMELY, ANIMAL ANTIBIOTICS, MEDICATED ANIMAL SKIN LOTIONS; SANITARY PREPARATIONS FOR MEDICAL PURPOSES; DIETETIC FOODS ADAPTED FOR MEDICAL USE; FOOD FOR BABIES (U.S. CLS. 6, 18, 44, 46, 51 AND 52).

CLASS 35—ADVERTISING AND BUSINESS

FOR ADVERTISING; BUSINESS MANAGEMENT; BUSINESS ADMINISTRATION AND OFFICE WORK; ACCOUNTING; PROVISION OF RETAIL STORE SERVICES IN THE FIELD OF PHARMACEUTICAL PREPARATIONS; ARRANGING EXCHANGES BETWEEN BUYERS AND SELLERS, NAMELY, THE BRINGING TOGETHER, FOR THE BENEFIT OF OTHERS, OF A VARIETY OF GOODS, EXCLUDING THE TRANSPORT THEREOF, ENABLING CUSTOMERS TO CONVENIENTLY VIEW AND PURCHASE THOSE GOODS IN THE FIELD OF PHARMACEUTICALS; EXCHANGE SERVICES, NAMELY, BARTERING OF GOODS FOR OTHERS; FRANCHISING, NAMELY, CONSULTATION AND ASSISTANCE IN BUSINESS MANAGEMENT, OR-

GANIZATION AND PROMOTION; CONDUCTING FREQUENT BUYER INCENTIVE PROGRAMS TO PROMOTE THE SALE OF THE GOODS AND SERVICES OF OTHERS; CONDUCTING INCENTIVE PROGRAMS FOR EMPLOYEES TO PROMOTE PRODUCTIVITY; MARKETING; MARKET RESEARCH; ON-LINE INFORMATION SERVICES RELATED TO ADVERTISING, BUSINESS MANAGEMENT AND ADMINISTRATION, AND OFFICE BUSINESS FUNCTIONS; ONLINE ADVERTISING OVER A DATA COMMUNICATIONS NETWORK; PROVISION OF PAPER DIRECTORIES AND ONLINE DIRECTORIES IN THE FIELD OF PHARMACEUTICALS; BUSINESS INFORMATION SERVICES; BUSINESS AGENT SERVICES, NAMELY, PURCHASING AGENT SERVICES; ADVERTISING SERVICES, NAMELY, PREPARING MAIL ORDER CATALOGUES, SALES PROMOTION, PROMOTIONAL SERVICES, MAIL ORDER PROMOTIONS, SALES PROMOTIONS AT POINT OF PURCHASE, SALES PROMOTIONS BY ISSUING REDEEMABLE COUPONS, SALES PROMOTIONS BY MEANS OF DISCOUNT CARD SERVICES, AND SALES PROMOTIONS THROUGH FREQUENT BUYER INCENTIVE PROGRAMS; DISTRIBUTION OF SAMPLES; OUTDOOR ADVERTISING; ALL OF THE AFOREMENTIONED SERVICES BEING PERFORMED FOR OTHERS (U.S. CLS. 100, 101 AND 102).

TRACY WHITTAKER-BROWN, EXAMINING ATTORNEY

SN 79-033,711. FIBRO GMBH, 74855 HABMERSHEIM, FED REP GERMANY, FILED 10-7-2005.

FIBRO

PRIORITY DATE OF 7-26-2005 IS CLAIMED.
OWNER OF INTERNATIONAL REGISTRATION 0910509
DATED 10-7-2005, EXPIRES 10-7-2015.
OWNER OF U.S. REG. NOS. 1,050,559, 1,050,561 AND 1,295,708.

CLASS 1—CHEMICALS

FOR CYANOACRYLATE INSTANT ADHESIVES, EPOXY RESIN, ACRYLIC RESINS; HARDENERS WITH AN EPOXY RESIN BASE, NAMELY, EPOXY HARDENERS, HARDENERS FOR USE IN THE MANUFACTURE OF POLYURETHANE RUBBERS, FOAMS AND PLASTICS, ADHESIVES FOR GENERAL INDUSTRIAL USE; CHEMICAL SUBSTANCES FOR INDUSTRIAL PURPOSES, NAMELY, LEAK DETECTOR SPRAYS; SOLVENTS FOR INDUSTRIAL AND COMMERCIAL USE; ASSEMBLY ADHESIVES, NAMELY, CONSTRUCTION INDUSTRY ADHESIVES; ASSEMBLY SPRAYS, NAMELY, SPRAYS FOR THE ASSEMBLING OF MACHINES; POLYURETHANE, POLYURETHANE DEFORMATION MATERIAL, NAMELY, POLYURETHANE RESINS; QUICK CLEANERS, NAMELY, CHEMICAL CLEANERS FOR INDUSTRIAL AND COMMERCIAL USE; SEPARATING AGENTS WITH A SILICON OIL BASE, NAMELY, FORM OR MOLD RELEASING AGENTS, PARTING AGENTS FOR INDUSTRIAL AND COMMERCIAL USE; SEPARATING AGENTS WITH A WAX BASE, NAMELY, FORM OR MOLD RELEASING AGENTS, PARTING AGENTS FOR INDUSTRIAL AND COMMERCIAL USE (U.S. CLS. 1, 5, 6, 10, 26 AND 46).

CLASS 7—MACHINERY

FOR MACHINES, NAMELY, FOR AUTOMATION AND ROBOTICS, ROTARY TABLES, ROTARY INDEXING TABLES, BUILT-IN ROTARY INDEXING TABLES, NC ROTARY TABLES, ELECTROMECHANICAL ROTARY INDEXING TABLES; TURRET HEADS, NAMELY, ELECTRIC ROTARY TABLES; STANDARD MACHINES FOR THE CONSTRUCTION OF THE FOLLOWING TOOLS, MACHINE PARTS, AND MACHINE TOOLS, NAMELY, COMPRESSION SPRING TOOLS, COMPRESSION PINS, ADJUSTMENT WASHERS, STRIPPERS, EXTRACTION TOOLS, STOPPING PLATES, BOLT-ON GUIDE; STANDARD SPECIFICATIONS FOR TOOL CONSTRUCTION, NAMELY, PRESSURE SPRINGS, PRESSURE PINS, TUNING DISCS, STRIPPERS, EXTRACTION TOOL, STOPPING PLATES, BOLT-ON GUIDE PILLARS, LOCATING BOLTS FOR ROUND SPRINGS, CONTROL BARS, POT HOUSINGS FOR SPRINGS, POT HOUSINGS FOR CLIPPING PUNCHES, FEEDER PLATES FOR CLIPPING PUNCHES, EJECTOR SLEEVES, EJECTOR PINS, DELIMITING GUIDES FOR CONVEYOR BELTS, DRILL BUSHES WITH AND WITHOUT COLLAR, PIN GUIDES, LINERS, COLLAR BUSHINGS, HEAD POSTS, DATE STAMPS, DAMPING DISCS, RETAINING PLATES, DISTANCE PLATES, SPACER TUBES, SPACER BUSHES AND TUBES FOR BALL CAGES, TRIANGULAR SECTIONS, TRIANGULAR HOLLOW SECTIONS, COMPRESSION SPRINGS, COMPRESSION PLATES, COMPRESSION PINS FOR CLIPPING PUNCHES, THRUST PADS, TAPER SLEEVES, INSERTION TOOLS FOR SPRING-MOUNTED THRUST PADS, DIE SPIGOTS, INJECTION CARTRIDGES, INJECTION PISTOLS, GUIDES WITH PART POSITION CONTROL, PROGRESSION DIE SET UNITS, PANEL CASES, PROTECTIVE BELLOWES, SPRING EJECTORS, SPRING RAMS, COMBINATION SPRING AND SPACER UNITS, SPRINGS, SPRING-MOUNTED THRUST PIECES, SPRING WASHERS, SPRING PLATES, SPRING PLATE ACCESSORIES, FLAT EJECTORS PINS, FLAT SEGMENTS, SINTERED BUSHES, DIE SET UNITS FOR PROGRESSION DIES, CONVEYOR BELTS, CONVEYOR BELT ACCESSORIES, GUIDE PINS, GUIDE BUSHES, GUIDE PLATES, GUIDE STRIPS, GUIDE ELEMENTS, GUIDE BEARINGS, GUIDE PILLARS, GAS PRESSURE SPRINGS, GROUND BOARDS AND STRIPS, SLIDING ELEMENTS, SLIDE PLATES, SLIDING BLOCKS, RUBBER BELLOWES, CAST IRON DIE SETS, LINER BUSHES, LINING BLOCKS, LINING PLATES, LINERS, HARD METAL CLIPPING PUNCHES, HOLLOW ROUND SECTIONS, HOLLOW PILLARS, SLEEVES, CAGE RETAINERS, BOXES FOR TESTING PINS, SLUICE VALVES, SMALL PRESSES, BALL BEARING INSERTS, BALL BEARING GUIDES, BALL BEARING CAGES, BRASS, ELASTOMER SPRINGS, ELASTOMER PADS AND SHEETS, COUPLING SPIGOTS, HOISTING SNAP LINKS, STRIPS, PUNCHING AND STAMPING UNIT, PUNCHES, EXTRACTOR TOOLS, MATRIXES, MEASURING PINS, MEASURING PIN HOLDERS, DEMOUNTABLE PILLARS, SHOULDER SCREWS, DOWEL PINS, DOWEL PIN LININGS, PADS AND SHEETS, PNEUMATIC CONVEYOR BELTS, PNEUMATIC CONVEYORS, EMBOSsing MATERIAL, PRECISION FEELER GAUGES, PRECISION PARTS, FLAT AND SQUARE TOOL STEEL, PRESS CONSOLES, PRISMATIC GUIDES, PROFILED CLIPPING PUNCHES, RECTANGULAR MOUNTING FLANGES, RECTANGULAR PUNCHES, RING BLOCKS, RING BOLTS, ROLLER CAGES, ROLLER SLIDES, ACCESSORIES, WIPERS, PIERCING DIE BUSHES, CLIPPING PUNCHES, CLIPPING PUNCH FEEDER PLATES, QUICK CHANGE CLIPPING PUNCHES, QUICK CHANGE FRAMES, T-HEAD BOLTS, COMPRESSION SPRINGS, SHOULDER SCREWS, COUNTERSUNK SCREWS, SECURING FLANGES, SINTERED GUIDE BUSHES, SPECIAL DIE SETS, CLAMPING ELEMENTS, BOXED CLAMPING TOOL SETS, SHANKS, SPECIAL SPRINGS, SPECIAL SECURING AIDS, STEEL PLATES, STEEL DIE SETS, STANDS FOR CONVEYOR BELTS, GUIDE BUSHES FOR PUNCHES, LIFTER PINS FOR PRESS TOOL STRIPS, PUMMELS, TANK PLATE SYSTEM, WORKPIECE LIFTERS, DISC SPRINGS, LIFTING BOLTS, LIFTER HOOKS, LIFTING BOLTS, LIFTING FLANGES, LIFTER STUDS, CONVEYING AND FASTENING ELEMENTS, OVERRUN CAMS, FORMING SECTIONS, UNIVERSAL SWIVEL HOIST RINGS, URETHANE SPRINGS, URETHANE PADS AND SHEETS, VDI BUSHES, VDI PUNCHES, SCREWED SEALING PLUGS, SQUARE PUNCHES, SQUARE SECTIONS, SQUARE HOLLOW SECTIONS, SQUARE STEEL, FOUR

PILLAR DIE SETS, ROLLER INSERTS, ROLLER RAILS, OILLESS GUIDE ELEMENTS, DEMOUNTABLE GUIDE PILLARS, DIE SET UNITS FOR PROGRESSION CENTERING UNITS, TWO PILLAR DIE SETS, CYLINDER HEAD EJECTORS, CYLINDER HEAD PUNCHES, CHEESE HEAD SCREWS, STRAIGHT PIN BUSHES, STRAIGHT PINS, STRAIGHT PIN EXTRACTORS; MECHANICAL HANDLING APPARATUS FOR GRABBING, RETAINING, DEPOSITING, TRANSLATIONAL AND/OR REVOLVING MOVEMENTS AND/OR CONVEYING OF WORK PIECES, NAMELY, FOR USE IN MANUFACTURING PROCESSES, AND/OR LOADING AND DOWNLOADING OF MACHINE TOOLS; ELEMENTS OF THE AFORESAID HANDLING APPARATUS, NAMELY, GRABS, LINEAR MOVEMENT UNITS, NAMELY, CLAWS, CLUTCHES, HOOKS, NIPPERS, PINCHERS, PICKER ARMS, SINGLE ROTATING HOOKS AND OSCILLATING HOOKS; PORTAL ROBOTS FOR MACHINE TOOLS, PARTS FOR AUTOMATION AND ROBOTICS, NAMELY, SHORT-STROKE UNITS AND SHORT-LIFTING APPARATUS, TRANSLATION UNITS, NAMELY, TRANSLATION MACHINES, LINEAR AXES, ROTATION UNITS, NAMELY, ROTATION MACHINES, ELECTRIC MOTOR MODULES AND GRABS (U.S. CLS. 13, 19, 21, 23, 31, 34 AND 35).

KAREN K. BUSH, EXAMINING ATTORNEY

SN 79-033,781. JOHNSON ELECTRIC INDUSTRIAL; MANUFACTORY LIMITED, CHINA, FILED 12-9-2005.

MOTION

THE MARK CONSISTS OF STANDARD CHARACTERS WITHOUT CLAIM TO ANY PARTICULAR FONT, STYLE, SIZE, OR COLOR.

PRIORITY DATE OF 6-9-2005 IS CLAIMED.

OWNER OF INTERNATIONAL REGISTRATION 0910482 DATED 12-9-2005, EXPIRES 12-9-2015.

CLASS 7—MACHINERY

FOR ELECTRIC MOTORS FOR MACHINES; PIEZOELECTRIC MOTORS FOR MACHINES; PIEZOELECTRIC MOTOR AND GEAR ASSEMBLIES FOR MACHINES; GEAR ASSEMBLIES NOT FOR LAND VEHICLES; GEARS, PINIONS, COGS, WORMS AND WORM WHEELS; GEARBOXES, GEAR TRAINS AND TRANSMISSION SYSTEMS FOR MACHINES AND MOTORS; STARTER MOTORS FOR INTERNAL COMBUSTION ENGINES NOT FOR LAND VEHICLES; BEARINGS AND BEARING BRACKETS, BEING PARTS OF MACHINES; ELECTRIC BRUSHES BEING PARTS OF MOTORS, MACHINES AND DYNAMOS; STATOR ASSEMBLIES; MOUNTING BRACKETS BEING PARTS OF MACHINES; FANS FOR MOTORS OR ENGINES; ELECTRIC MOTOR DRIVEN FANS; IMPELLERS FOR MOTORS OR PUMPS; ELECTRIC MOTOR-DRIVEN PUMPS; DC ELECTRIC MOTOR DRIVEN PUMPS FOR CIRCULATING COOLING WATER FOR INTERNAL COMBUSTION ENGINES FOR LAND VEHICLES; VALVES BEING PARTS OF MACHINES OR ENGINES; DIES AND MOULDS, BEING PARTS OF MACHINES AND MACHINE TOOLS; COOLING FANS AND COOLING MODULES FOR VEHICLE ENGINES; ELECTRIC MOTOR ASSEMBLY APPARATUS, NAMELY, ASSEMBLY JIGS AND ASSEMBLY FIXTURES FOR HOLDING COMPONENTS DURING MACHINING; AUTOMATED ASSEMBLY MACHINES; ARMATURE WINDING MACHINES AND STATOR WINDING MACHINES; WATER COOLING APPLIANCES AND INSTALLATIONS, NAMELY, RADIATORS FOR MOTORS AND ENGINES; ELECTRIC MOTOR ASSEMBLY APPARATUS, NAMELY, AUTOMATED ASSEMBLY MACHINES, ARMATURE WINDING APPARATUS AND STATOR WINDING APPARATUS; COOLING FANS AND COOLING MODULES, BEING PARTS OF VEHICLE ENGINE COOLING SYSTEMS; STARTER MOTORS FOR INTERNAL COMBUSTION ENGINES FOR LAND VEHICLES; ELECTRIC FUEL PUMPS FOR ENGINES OF LAND

VEHICLES; STRUCTURAL PARTS AND FITTINGS FOR ALL THE AFORESAID GOODS; ELECTRIC ROTOR ASSEMBLIES (U.S. CLS. 13, 19, 21, 23, 31, 34 AND 35).

CLASS 9—ELECTRICAL AND SCIENTIFIC APPARATUS

FOR ARMATURE ASSEMBLIES; COMMUTATORS; MAGNETS; TACHOMETERS; ELECTRONIC SPEED SENSORS; TESTING, MONITORING, AND MEASURING APPARATUS FOR ELECTRIC MOTORS, NAMELY, ELECTRIC MOTOR TESTING APPARATUS FOR MEASURING MOTOR TORQUE, FOR MEASURING MOTOR PERFORMANCE, FOR MEASURING MOTOR SPEED, FOR MEASURING MOTOR LIFE/ENDURANCE, AND FOR MEASURING MOTOR END PLAY; ARMATURE BALANCING APPARATUS, ELECTRICAL MONITORING APPARATUS AND NOISE AND VIBRATION MEASUREMENT APPARATUS; ELECTRIC MOTOR ASSEMBLY APPARATUS, NAMELY, ASSEMBLY JIGS AND ASSEMBLY FIXTURES USED FOR MEASURING AND MONITORING PURPOSES; MOTOR ELECTRONICS, NAMELY, BRUSHLESS MOTOR CONTROLLERS, STEPPER MOTOR CONTROLLERS, MOTOR CONTROLLERS, NOISE SUPPRESSION CIRCUITS, MOTOR PROTECTION RELAYS, OVER CURRENT AND OVER VOLTAGE PROTECTION CIRCUITS AND SPEED CONTROLLERS; THERMOSTATS FOR VEHICLES; TEMPERATURE AND PRESSURE INDICATING, MEASURING, SIGNALLING AND CONTROL APPARATUS, NAMELY, TEMPERATURE AND PRESSURE GAUGES AND CONTROLS, AND CENTRAL PROCESSING UNITS THEREFOR; DIGITAL CAMERA LENS MODULES; CAMERA LENSES; STATIONARY AND MOVEABLE LENSES FOR ZOOM AND FOCUS; LENS FRAMES; ELECTRIC MOTOR ASSEMBLY FOR MOVING MOVEABLE LENSES; SENSORS FOR DETECTING MOVEMENT OF MOVEABLE LENSES; CHARGE COUPLED DEVICES (CCD) OR COMPLIMENTARY METAL OXIDE SEMICONDUCTOR (CMOS) DEVICES FOR RECORDING/CAPTURING IMAGES; IRIS METERS AND LENS SHUTTERS; CAMERAS; VIDEO CAMERAS AND CAMCORDERS; VIDEO TELEPHONES; PORTABLE TELEPHONES WITH CAMERA AND/OR VIDEO CAMERA FUNCTION; OPTICAL LENSES; WEBCAMS; COMPUTER PERIPHERAL DEVICES; CONSUMER ELECTRONIC DEVICES NAMELY PERSONAL MEDIA PLAYERS, PERSONAL DIGITAL ASSISTANTS, HANDHELD COMPUTERS AND STEREO EQUIPMENT, NAMELY, STEREO RECEIVERS, AMPLIFIERS, SPEAKERS, TUNERS AND CD PLAYERS, CELLULAR PHONES, MP3 PLAYERS AND RECORDERS, DVD PLAYERS AND RECORDING APPARATUS, PORTABLE DIGITAL AUDIO PLAYERS AND VIDEO DISK PLAYERS, COMBINATION VIDEO PLAYERS AND RECORDERS, PORTABLE AUDIO CASSETTE PLAYERS, PORTABLE VIDEO PLAYERS, VIDEO GAME PLAYERS, OPTICAL DISK PLAYERS, JOYSTICKS USED FOR COMPUTERS OR VIDEO GAMES, MOBILE ELECTRONIC DEVICES, NAMELY, MOBILE RADIOS AND BEEPERS; MOBILE PHONES, SMARTPHONES AND LAPTOPS, ELECTRONIC PROGRAMMABLE CONSUMER DEVICES, NAMELY, COMPUTER CAMERAS; PORTABLE PROGRAMMABLE ELECTRONIC DIARY, PORTABLE AND HANDHELD DIGITAL ELECTRONIC DEVICES FOR RECORDING, ORGANIZING, TRANSMITTING, MANIPULATING, AND REVIEWING TEXT, DATA, AND AUDIO FILES, ELECTRONIC HANDHELD UNITS FOR THE WIRELESS RECEIPT AND/OR TRANSMISSION OF DATA THAT ENABLE THE USER TO KEEP TRACK OF OR MANAGE PERSONAL INFORMATION AND WHICH MAY ALSO HAVE THE CAPACITY TO TRANSMIT AND RECEIVE VOICE COMMUNICATIONS; ELECTRONIC PERSONAL ORGANIZER, AND PAGER; STRUCTURAL PARTS AND FITTINGS FOR ALL THE AFORESAID GOODS (U.S. CLS. 21, 23, 26, 36 AND 38).

CLASS 11—ENVIRONMENTAL CONTROL APPARATUS

FOR WATER COOLING APPLIANCES AND INSTALLATIONS, NAMELY AIR-CONDITIONING UNITS, AIR BLOWERS, BLOWER IMPELLERS, BLOWER DRIVES, AIR FILTERS, CABIN FILTERS, HEAT EXCHANGERS, REFRIGERANT EVAPORATORS AND CONDENSERS; COOLING FANS AND COOLING MODULES, BEING PARTS OF VEHICLE ENGINE COOLING SYSTEMS FOR VEHICLE AIR CONDITIONING SYSTEMS; STRUCTURAL PARTS AND FITTINGS FOR ALL THE AFORESAID GOODS (U.S. CLS. 13, 21, 23, 31 AND 34).

CLASS 12—VEHICLES

FOR ELECTRIC MOTORS FOR VEHICLES; ELECTRIC MOTORS FOR USE IN LAND VEHICLES; PIEZOELECTRIC MOTOR ASSEMBLIES FOR USE IN LAND VEHICLES; ELECTRIC MOTOR ASSEMBLIES FOR POWERING PARTS OF LAND VEHICLES, AND GEAR ASSEMBLIES FOR USE THEREWITH; WINDSCREEN WIPER ASSEMBLIES; STRUCTURAL PARTS AND FITTINGS FOR ALL THE AFORESAID GOODS; BRACKETS FOR MOUNTING ELECTRIC MOTORS IN VEHICLES (U.S. CLS. 19, 21, 23, 31, 35 AND 44).

CLASS 35—ADVERTISING AND BUSINESS

FOR PROCUREMENT SERVICES, NAMELY, PURCHASING MOTORS AND ELECTRICALLY-OPERATED MACHINES AND PARTS THEREOF FOR OTHERS; PROMOTING THE GOODS AND SERVICES OF OTHERS THROUGH THE PLACEMENT OF ADVERTISEMENTS IN PRINTED PUBLICATIONS AND ON SEPARATELY MAINTAINED WEBSITES, THROUGH THE DISTRIBUTION OF PRINTED, ELECTRONIC, VIDEO, AND AUDIO PROMOTIONAL MATERIALS, THROUGH RENDERING SALES PROMOTIONAL ADVICE, AND THROUGH EXHIBITIONS AND TRADE FAIRS (U.S. CLS. 100, 101 AND 102).

CLASS 40—MATERIAL TREATMENT

FOR ASSEMBLY OF ELECTRIC MOTORS, MACHINES AND THEIR PARTS FOR OTHERS (U.S. CLS. 100, 103 AND 106).

CLASS 42—SCIENTIFIC AND COMPUTER SERVICES

FOR TESTING OF MOTORS, ACTUATORS, MACHINES AND THEIR PARTS FOR OTHERS; SCIENTIFIC AND TECHNOLOGICAL SERVICES, NAMELY, TECHNICAL CONSULTATION AND RESEARCH IN THE FIELD OF ENGINES, MOTORS AND ELECTRICALLY-OPERATED MACHINES AND THEIR PARTS; INDUSTRIAL DESIGN SERVICES; INDUSTRIAL ANALYSIS AND RESEARCH SERVICES RELATED TO MOTORS, ELECTRICALLY-OPERATED MACHINES AND THEIR PARTS (U.S. CLS. 100 AND 101).

KAREN K. BUSH, EXAMINING ATTORNEY

CLASS 9—ELECTRICAL AND SCIENTIFIC APPARATUS

FOR COMPUTER SOFTWARE FOR ELECTRONIC MESSAGING SYSTEMS; COMPUTER SOFTWARE FOR ENSURING THE SECURITY OF ELECTRONIC MAIL; INTEGRATED SUITE OF GLOBAL TAX MANAGEMENT SOFTWARE; AND COMPUTERS (U.S. CLS. 21, 23, 26, 36 AND 38).

CLASS 16—PAPER GOODS AND PRINTED MATTER

FOR BLANK PAPER TAPES OR CARDS FOR RECORDING COMPUTER PROGRAMS; INSTRUCTIONAL LEAFLETS FOR TEACHING ABOUT COMPUTER PROGRAMMING; PRINTED BOOKS AND BOOKLETS CONTAINING TECHNICAL AND LINGUISTIC DOCUMENTATION OF TERMINOLOGY TRANSLATIONS; NEWSPAPERS; PRINTED MATTER, NAMELY, BLANK CLAIM CHECK FORMS; PERIODICALS, NAMELY, TRAVEL MAGAZINES; PRINTED PRODUCTS, NAMELY, LISTS FEATURING COMPUTER PRICE COMPARISONS; ACCOUNTING FORMS; PRINTED INFORMATION BULLETINS CONCERNING CONSUMER PRODUCT RECALLS; PRINTED INSTRUCTIONAL AND TEACHING MATERIAL IN THE FIELD OF COMPUTER SCIENCE; MAGAZINES ABOUT SCIENTIFIC DISCOVERIES; BOOKS AND MANUALS IN THE FIELDS OF SCIENCE AND MATH (U.S. CLS. 2, 5, 22, 23, 29, 37, 38 AND 50).

CLASS 35—ADVERTISING AND BUSINESS

FOR SYSTEMIZATION OF INFORMATION INTO COMPUTER DATABASES; COMPUTER FILE MANAGEMENT; COMPILATION OF INFORMATION INTO COMPUTER DATABASES; PROVIDING STATISTICAL INFORMATION; BUSINESS MANAGEMENT ASSISTANCE; DOCUMENT REPRODUCTION (U.S. CLS. 100, 101 AND 102).

CLASS 38—COMMUNICATION

FOR COMMUNICATIONS VIA COMPUTER TERMINALS; ELECTRONIC TRANSMISSION OF MESSAGES, IMAGES, TEXTS, SOUNDS, INFORMATION, DATA BY INTERACTIVE MULTIMEDIA NETWORKS, THESE SERVICES APPLICABLE TO THE INTERNET AND INTRANET NETWORKS, AND GLOBAL COMPUTER INFORMATION NETWORKS; TELECOMMUNICATION ACCESS AND ELECTRONIC MESSAGING SERVICES PROVIDED VIA THE INTERNET; COMPUTER-ASSISTED ELECTRONIC MESSAGE AND IMAGE TRANSMISSION; ELECTRONIC TRANSMISSION OF ORDERS, INFORMATION AND DATA; INFORMATION TRANSMISSION SERVICES VIA ELECTRONIC COMMUNICATIONS; PROVIDING SECURE REAL TIME ELECTRONIC COMMUNICATION OVER A COMPUTER NETWORK FOR EXCHANGES OF INFORMATION AND COMPUTER FILES; PROVISION OF MULTIPLE USER ACCESS TO GLOBAL COMPUTER NETWORKS; RENTAL OF ACCESS TIME TO DATABASE SERVICES ON INTERNET OR INTRANET NETWORKS; TELEPHONE COMMUNICATION SERVICES THROUGH TELEPHONE SWITCHBOARDS (U.S. CLS. 100, 101 AND 104).

CLASS 41—EDUCATION AND ENTERTAINMENT

FOR TRAINING CONCERNING COMPUTING AND IN THE FIELD OF COMPUTING PUBLICATION SERVICES; PUBLISHING OF BOOKS, MAGAZINES, NEWSPAPERS, NEWSLETTERS OR INFORMATION SHEETS AND PUBLICATIONS OTHER THAN THOSE FOR ADVERTISING PURPOSES; WRITTEN TEXT EDITING; TRANSLATION OF DOCUMENTATION AND TERMINOLOGY; TRANSLATION SERVICES FOR PROVIDING LINGUISTIC ADAPTATION OF SOFTWARE INTO FOREIGN LANGUAGES (U.S. CLS. 100, 101 AND 107).

SN 79-033,926. PROMODAG, FRANCE, FILED 3-23-2006.

PROMODAG

OWNER OF INTERNATIONAL REGISTRATION 0911474 DATED 3-23-2006, EXPIRES 3-23-2016.

THE WORDING "PROMODAG" HAS NO MEANING IN A FOREIGN LANGUAGE.

CLASS 42—SCIENTIFIC AND COMPUTER SERVICES

FOR COMPUTER PROGRAMMING; COMPUTER SOFTWARE CONSULTING AND DESIGN SERVICES PROVIDING FOR THE OPERATION, STUDY, ADAPTATION, LEASING, DEVELOPMENT, DESIGN, UPDATING AND MAINTENANCE OF COMPUTER SOFTWARE; DESIGN AND DEVELOPMENT OF MULTIMEDIA PRODUCTS USED IN CONNECTION WITH COMPUTING; DESIGN AND DEVELOPMENT OF COMPUTER SOFTWARE FOR DOCUMENTARY SYSTEMS; COMPUTER ENGINEERING; COMPUTER RENTAL; GEOLOGICAL PROSPECTING; ENGINEERING; DEVELOPMENT OF COMPUTER PROGRAMS FOR ELECTRONIC DOCUMENTATION AND INFORMATION MANAGEMENT SYSTEMS; COMPUTER FAULT DIAGNOSIS AND TECHNICAL SUPPORT EXCLUDING REPAIR, NAMELY, TROUBLESHOOTING OF COMPUTER SOFTWARE PROBLEMS; DESIGN OF WEB SITES, CREATION OF WEB SITES FOR OTHERS; WEB SITE HOSTING SERVICES; COMPUTER CONSULTING; DESIGN OF HOME PAGE SCREENS FOR ACCESS THROUGH THE INTERNET; INSTALLATION OF COMPUTER SOFTWARE FOR DOCUMENTARY SYSTEMS; CONSULTING, NAMELY, COMPUTER TECHNICAL CONSULTING AND CONSULTING VIA TELEPHONE CONCERNING COMPUTER-RELATED FAULT DIAGNOSIS AND SUPPORT; CONSULTING, NAMELY, CONSULTING IN THE FIELD OF COMPUTING (U.S. CLS. 100 AND 101).

VERNA BETH RIRIE, EXAMINING ATTORNEY

CLASS 37—CONSTRUCTION AND REPAIR

FOR VEHICLE REPAIR SERVICES; VEHICLE PAINT SERVICES, VEHICLE ACCESSORY INSTALLATION; VEHICLE CUSTOMIZATION SERVICES, NAMELY, UPGRADING AND ENHANCEMENT OF VEHICLES, AND ADAPTING VEHICLES TO MEET DIFFERENT NATIONAL STANDARDS OR TO CUSTOM FIT; VEHICLE WARRANTY REPAIR AND NON-WARRANTY REPAIR SERVICES (U.S. CLS. 100, 103 AND 106).

CLASS 39—TRANSPORTATION AND STORAGE

FOR TRANSPORT OF GOODS BY SEA AND BY LAND, INCLUDING VEHICLE AND ROLL ON ROLL OFF TRANSPORT SERVICES, TRANSPORT OF AGRICULTURAL AND CONSTRUCTIONAL EQUIPMENT, STATIC CARGO AND CONTAINER CARGO, DELIVERY OF GOODS BY SEA AND BY LAND, INCLUDING OCEAN AND SHORT-SEA SHIPPING DISTRIBUTION SERVICES, NAMELY DELIVERY OF AUTOMOBILES, TRUCKS, HEAVY AND HIGH VEHICLES AND AGRICULTURAL AND CONSTRUCTION EQUIPMENT, STEVEDORING, STORAGE OF GOODS, TRANSPORT BY RAIL; TRUCK HAULING SERVICES; PROVIDING INFORMATION IN THE FIELDS OF TRANSPORT AND STORAGE; RENTAL OF STORAGE CONTAINERS AND RENTAL OF WAREHOUSE SPACE (U.S. CLS. 100 AND 105).

KHANH LE, EXAMINING ATTORNEY

SN 79-033,997. WALLENIS WILHELMSSEN LOGISTICS AS, NORWAY, FILED 2-23-2006.

WALLENIS WILHELMSSEN LOGISTICS

THE MARK CONSISTS OF STANDARD CHARACTERS WITHOUT CLAIM TO ANY PARTICULAR FONT, STYLE, SIZE, OR COLOR.

PRIORITY DATE OF 8-26-2005 IS CLAIMED.

OWNER OF INTERNATIONAL REGISTRATION 0911690 DATED 2-23-2006, EXPIRES 2-23-2016.

OWNER OF U.S. REG. NO. 2,691,868.

NO CLAIM IS MADE TO THE EXCLUSIVE RIGHT TO USE "LOGISTICS", APART FROM THE MARK AS SHOWN.

THE NAME(S), PORTRAIT(S), AND/OR SIGNATURE(S) SHOWN IN THE MARK DOES NOT IDENTIFY A PARTICULAR LIVING INDIVIDUAL.

CLASS 35—ADVERTISING AND BUSINESS

FOR CUSTOMS CLEARANCE; INVENTORY MANAGEMENT AND TRACKING SERVICES FOR AUTOMOBILES AND TRUCKS, HIGH AND HEAVY VEHICLES AND AGRICULTURAL AND CONSTRUCTION EQUIPMENT; LOGISTICS MANAGEMENT RELATING TO TRANSPORT SERVICES OF AUTOMOBILES, TRUCKS, HEAVY AND HIGH VEHICLES AND AGRICULTURAL AND CONSTRUCTION EQUIPMENT; BUSINESS MANAGEMENT SERVICES; BUSINESS CONSULTING SERVICES; BUSINESS ADMINISTRATION SERVICES; BUSINESS MANAGEMENT CONSULTING SERVICES; COMPUTERIZED TRACKING AND TRACING OF GOODS IN TRANSIT; PROVIDING ONLINE AUTOMATED REGISTRATION SERVICES FOR CUSTOMERS TO MANAGE SHIPPING ACCOUNT INFORMATION OVER THE GLOBAL COMPUTER NETWORK; TRANSPORTATION NETWORK MANAGEMENT SOLUTION SERVICES, NAMELY SHIPMENT PROCESSING, PREPARING SHIPPING DOCUMENTS AND INVOICES, TRACKING FREIGHT OVER COMPUTER NETWORKS, INTRANET AND INTERNETS; PROVIDING INFORMATION TO CUSTOMERS FOR TRACKING CARGO SHIPMENTS VIA A GLOBAL COMPUTER NETWORK (U.S. CLS. 100, 101 AND 102).

SN 79-034,640. A.C. MILAN S.P.A., ITALY, FILED 2-16-2007.

ROSSONERI

THE MARK CONSISTS OF STANDARD CHARACTERS WITHOUT CLAIM TO ANY PARTICULAR FONT, STYLE, SIZE, OR COLOR.

OWNER OF INTERNATIONAL REGISTRATION 0905653 DATED 10-11-2006, EXPIRES 10-11-2016.

THE FOREIGN WORDING IN THE MARK TRANSLATES INTO ENGLISH AS "RED-BLACKS".

CLASS 25—CLOTHING

FOR CLOTHING, NAMELY, SHIRTS, T-SHIRTS, JUMPERS, SWEATERS, JACKETS, COATS, TROUSERS, BERMUDA SHORTS, BOXER SHORTS, GYM SHORTS, SWEAT SHORTS, SOCCER SHORTS, SOCKS; FOOTWEAR AND HEAD WEAR (U.S. CLS. 22 AND 39).

CLASS 28—TOYS AND SPORTING GOODS

FOR GAMES AND PLAYTHINGS, NAMELY, ACTION SKILL GAMES AND BOARD GAMES; SOCCER GOALS AND SOCCER GOAL NETS; SOCCER KNEE-PADS AND PROTECTIVE PADDING; SOCCER BALLS (U.S. CLS. 22, 23, 38 AND 50).

CLASS 41—EDUCATION AND ENTERTAINMENT

FOR EDUCATIONAL SERVICES, NAMELY, CONDUCTING WORKSHOPS IN THE FIELD OF SPORTS TRAINING AND CONDITIONING; TRAINING SERVICES IN THE FIELD OF COACHING OF YOUTH SOCCER TEAMS; SOCCER CAMPS; SOCCER INSTRUCTION; ENTERTAINMENT IN THE NATURE OF SOCCER GAMES; AND ORGANIZING COMMUNITY CULTURAL AND SPORTING EVENTS (U.S. CLS. 100, 101 AND 107).

MARILYN IZZI, EXAMINING ATTORNEY

SN 79-034.643. ÇAKARLAR TEKSTİL; SANAYİ VE TİCARET LIMITED SİRKETİ, TURKEY, FILED 2-13-2007.



OWNER OF INTERNATIONAL REGISTRATION 0871685 DATED 11-4-2005, EXPIRES 11-4-2015.

THE NAME(S), PORTRAIT(S), AND/OR SIGNATURE(S) SHOWN IN THE MARK DOES NOT IDENTIFY A PARTICULAR LIVING INDIVIDUAL.

THE COLOR(S) BLUE, WHITE, BROWN, BLACK, YELLOW, RED, AND GREEN IS/ARE CLAIMED AS A FEATURE OF THE MARK.

THE COLOR BLUE APPEARS IN THE WORDING "MC. TINTINI" IN THE LETTER "C" AND THE TWO "N"S AND IN THE DESIGN IN THE TOP PART OF THE CAP, THE TOP PART OF THE VISOR, THE CUFFS, THE TIE, AND THE IRIS OF THE BUNNY'S EYES. THE COLOR YELLOW APPEARS IN THE WORDING "MC. TINTINI" IN THE THIRD "I" AND THE "DOTS" ABOVE THE FIRST AND SECOND "I" AND THE "DOTS" AFTER THE LETTERS "M" AND "C" AND IN THE DESIGN IN THE INSIDES OF THE BUNNY'S EARS, THE FRONT OF THE CAP, THE SEGMENT BETWEEN THE BUNNY'S RIGHT CHEEK AND THE SURROUNDING CIRCLE, THE TWO SEGMENTS BELOW THE BUNNY'S FACE TO THE LEFT AND RIGHT OF THE TIE, AND THE UNDERSIDE OF THE VISOR. THE COLOR BLACK APPEARS IN THE WORDING "MC. TINTINI" AS A SURROUNDING BORDER TO ALL LETTERS AND DOTS AND IN THE DESIGN AS A SURROUNDING BORDER TO ALL DESIGN ELEMENTS, AND IN THE LINES OF THE BUNNY'S MOUTH, TOOTH AND HAND, AND IN THE PUPILS OF THE BUNNY'S EYES. THE COLOR RED APPEARS IN THE WORDING "MC. TINTINI" IN BOTH "T"S AND IN THE DESIGN IN THE BUNNY'S NOSE AND TONGUE, THE LOWER HALF OF THE VISOR, AND IN THE SEGMENTS BETWEEN THE UPPER PART OF THE BUNNY'S RIGHT EAR AND THE SURROUNDING CIRCLE, BETWEEN THE UPPER PART OF THE BUNNY'S RIGHT EAR AND THE RIGHT SIDE OF THE BUNNY'S FACE AND THE BUNNY'S RIGHT HAND AND CUFF, BETWEEN THE BUNNY'S LEFT HAND AND LEFT CHEEK AND CUFF AND THE SURROUNDING CIRCLE, AND ON THE LEFT SIDE OF THE DESIGN BETWEEN THE SURROUNDING CIRCLE AND THE UPPER SEGMENT OF THE BUNNY'S SHIRT AND THE SMALL PART OF THE BUNNY'S RIGHT EAR BELOW THE RIGHT CUFF. THE COLOR GREEN APPEARS IN THE WORDING "MC. TINTINI" IN THE LETTER "M" AND THE FIRST AND SECOND "I" AND IN THE DESIGN IN THE PARTIALLY OBSCURED CIRCLE SURROUNDING THE BUNNY'S FACE. THE COLOR WHITE APPEARS IN THE DESIGN IN THE BUNNY'S HANDS, IN THE LOWER HALF OF THE BUNNY'S FACE INCLUDING THE TOOTH AND INSIDE THE MOUTH, AND THE SCLERA OF THE BUNNY'S EYES. THE COLOR BROWN APPEARS IN THE DESIGN IN THE OUTER BAND OF THE BUNNY'S EARS AND IN THE UPPER HALF OF THE BUNNY'S FACE SURROUNDING THE BUNNY'S EYES.

CLASS 24—FABRICS

FOR WOVEN FABRICS; NON-WOVEN TEXTILE FABRICS; FIBERGLASS FABRICS FOR TEXTILE USE; FIBERGLASS REINFORCEMENT FABRIC FOR USE IN LAND, SEA AND AEROSPACE APPLICATIONS; WATERPROOF FABRIC FOR MANUFACTURING CLOTHING, FURNITURE AND AUTOMOBILE UPHOLSTERY, AND LUGGAGE; FABRIC IMPERVIOUS TO GASES FOR AERONAUTICAL BALLOONS; ALL KINDS OF LININGS OF TEXTILE FOR USE IN CLOTHING; CURTAINS, HOUSEHOLD LINENS, TABLE CLOTHS NOT OF PAPER, OILCLOTH FOR USE AS TABLECLOTH; BED SHEETS, BED LINEN, BED COVERS OF TEXTILE, PILLOW COVERS, UNFITTED FURNITURE COVERS, COFFEE TABLE CLOTHS, HANDKERCHIEFS OF TEXTILE; BED COVERS OF PAPER, QUILTS, BLANKETS, BATH LINEN, TOWELS FOR FACE AND HANDS OF TEXTILE, BATH TOWELS OF TEXTILE (U.S. CLS. 42 AND 50).

CLASS 25—CLOTHING

FOR SWIMWEAR, BEACHWEAR, VESTS, UNDERPANTS, BRASSIERES, UNDERSKIRTS, CORSETS, TIGHTS, DRESSING GOWNS, COATS, OVERCOATS, HOODED JACKETS, TOPCOATS, RAINCOATS, TRENCH COATS, JACKETS, TROUSERS, SKIRTS, DRESSES, WAISTCOATS, SHIRTS, T-SHIRTS, SWEATSHIRTS, PULLOVERS, CARDIGANS, SWEATERS, BLOUSES, SHORTS, BERMUDA SHORTS, PANTS, JEANS, OVERALLS, SCHOOL UNIFORMS; SOCKS; FOOTWEAR, SHOES, BOOTS, SLIPPERS AND PARTS THEREOF; SPORT SHOES AND THEIR IRON FITTINGS SOLD AS A UNIT, SOLES AND HEELS FOR FOOTWEAR, FOOTWEAR UPPERS; HEADGEAR, NAMELY, HEADWEAR, CAPS, HATS, BERETS; CLOTH BABIES DIAPERS OF TEXTILE AND TRIANGLE-SHAPED BABIES' DIAPERS, UNDERSHIRTS FOR BABIES, UNDERPANTS FOR BABIES; SUSPENDERS, COLLARS, BANDANAS, GARTERS, BELTS, TIES, GLOVES, ARMBANDS, SHAWLS, SCARVES, WRISTBANDS, MUFFS (U.S. CLS. 22 AND 39).

CURTIS FRENCH, EXAMINING ATTORNEY

SN 79-035.028. HC INTERNATIONAL S.A., L-1724 LUXEMBOURG, LUXEMBOURG, FILED 9-13-2006.



PRIORITY DATE OF 3-14-2006 IS CLAIMED.
OWNER OF INTERNATIONAL REGISTRATION 0914933 DATED 9-13-2006, EXPIRES 9-13-2016.

CLASS 3—COSMETICS AND CLEANING PREPARATIONS

FOR BLEACHING PREPARATIONS FOR LAUNDRY USE; GENERAL PURPOSE CLEANING, POLISHING, SCOURING AND ABRASIVE PREPARATIONS; SOAPS; PERFUMERY, PERFUMES, ESSENTIAL OILS, COSMETICS, HAIR LOTIONS; DENTIFRICES; ALMOND MILK FOR COSMETIC USE; ALMOND OIL FOR COSMETIC PURPOSES; ALMOND SOAP; PERFUMERY, NAMELY, AMBER; CREAMS AND LOTIONS FOR CELLULITE REDUCTION; SUNSCREEN CREAMS; COSMETIC PREPARATIONS FOR SKIN TANNING; AROMATHERAPY OILS, CREAMS AND LOTIONS; FABRIC SOFTENERS; ASTRINGENTS FOR COSMETIC USE; COSMETIC PREPARATIONS FOR BATHS; BATH SALTS NOT FOR MEDICAL USE; COTTON BUDS FOR COSMETIC USE; BEAUTY MASKS; NON-MEDICATED ORAL CARE PRODUCTS, NAMELY, TOOTHPASTE AND MOUTHWASH; HAIR LOTIONS; HAIR DYES; MASCARA; HAIR AND SKIN COLORANTS, COLORING SKIN CREAMS; MAKE-UP SETS, COMPRISED OF EYELINER, MASCARA, FACE POWDER, LIPSTICK, SKIN CREAM, PENCILS FOR COSMETIC USE, MAKE-UP REMOVING PRODUCTS; COSMETIC CREAMS; LOTIONS FOR COSMETIC USE; PENCILS FOR COSMETIC USE; MAKE-UP REMOVING PRODUCTS; DEPILATORIES; EAU-DE-COLOGNE; LAVENDER WATER; SCENTED WATER; EAUX DE TOILETTE; OILS FOR COSMETIC USE; OILS FOR TOILET PURPOSES; ESSENTIAL OILS; OILS FOR PERFUMES AND SCENTS; CLEANSING MILKS FOR TOILET PURPOSES; LIPSTICK; TISSUES IMPREGNATED WITH COSMETIC LOTIONS; MAKEUP; COSMETICS; SOAPS (U.S. CLS. 1, 4, 6, 50, 51 AND 52).

CLASS 44—MEDICAL, BEAUTY AND AGRICULTURAL SERVICES

FOR MEDICAL SERVICES; BEAUTY SALONS; MEDICAL ASSISTANCE; MEDICAL SERVICES IN THE FIELD OF GERIATRICS; PROVIDING TURKISH BATH FACILITIES; AROMATHERAPY SERVICES; CHIROPRACTICS; PHYSIOTHERAPY; BEAUTY CARE; PLASTIC SURGERY; BEAUTY SALONS; HAIRDRESSING SALONS; CONVALESCENT HOMES; REST HOMES; NURSING HOMES WITH MEDICAL CARE; HOSPICES, NAMELY, ASSISTANCE HOMES; NURSING SERVICES; ESTABLISHMENTS PROVIDING CARE, ESPECIALLY ESTABLISHMENTS PROVIDING BEAUTY CARE AND COSMETIC CARE; HOSPITAL SERVICES; CONSULTING AND INFORMATION RELATING TO GERIATRICS; MANICURIST SERVICES; MASSAGES; HEALTH CARE; CONSULTING AND INFORMATION RELATING TO BEAUTY CARE AND COSMETOLOGY; RENTAL OF SANITATION FACILITIES; CONSULTING AND INFORMATION RELATING TO HEALTH; CONSULTING AND INFORMATION RELATING TO SLIMMING AND WEIGHT LOSS CURES; HEALTH SPA SERVICES, NAMELY, PROVIDING SLIMMING CURES, WEIGHT LOSS CURES, AND BEAUTY CARE CURES TO HEALTH SPA PATRONS (U.S. CLS. 100 AND 101).
PAM WILLIS, EXAMINING ATTORNEY

SN 79-035,098. ZAFFYRE INTERNATIONAL PTY LIMITED, AUSTRALIA, FILED 12-5-2006.



ZAFFYRE
INTERNATIONAL

PRIORITY DATE OF 6-30-2006 IS CLAIMED.
OWNER OF INTERNATIONAL REGISTRATION 0915128
DATED 12-5-2006, EXPIRES 12-5-2016.

NO CLAIM IS MADE TO THE EXCLUSIVE RIGHT TO USE "INTERNATIONAL", APART FROM THE MARK AS SHOWN.

CLASS 35—ADVERTISING AND BUSINESS

FOR ADMINISTRATION OF MANAGEMENT PROGRAMS FOR BUSINESSES IN THE FIELDS OF LEADERSHIP, HUMAN RESOURCES MANAGEMENT, STRATEGIC PLANNING AND DEVELOPMENT; BUSINESS APPRAISALS; BUSINESS MANAGEMENT ASSISTANCE TO INDUSTRIAL OR COMMERCIAL COMPANIES IN THE FIELD OF LEADERSHIP, HUMAN RESOURCES MANAGEMENT, STRATEGIC PLANNING AND DEVELOPMENT; BUSINESS MANAGEMENT CONSULTING IN THE FIELD OF LEADERSHIP, HUMAN RESOURCES MANAGEMENT, STRATEGIC PLANNING AND DEVELOPMENT; BUSINESS RESEARCH; BUSINESS CONSULTING AND ADVISORY SERVICES IN THE FIELDS OF HUMAN RESOURCES MANAGEMENT AND MARKETING STUDIES (U.S. CLS. 100, 101 AND 102).

CLASS 41—EDUCATION AND ENTERTAINMENT

FOR EDUCATIONAL SERVICES, NAMELY, CONDUCTING COLLOQUIUMS, CONFERENCES, CONGRESSES, SEMINARS, SYMPOSIUMS AND WORKSHOPS IN THE FIELD OF LEADERSHIP, HUMAN RESOURCES MANAGEMENT, STRATEGIC PLANNING AND BUSINESS DEVELOPMENT; ARRANGING OF COLLOQUIUMS, CONFERENCES, CONGRESSES, SEMINARS, SYMPOSIUMS AND WORKSHOPS IN THE FIELD OF LEADERSHIP, HUMAN RESOURCES MANAGEMENT, STRATEGIC PLANNING AND BUSINESS DEVELOPMENT; TRAINING SERVICES IN THE FIELD OF LEADERSHIP, HUMAN RESOURCES MANAGEMENT, STRATEGIC PLANNING AND BUSINESS DEVELOPMENT; EDUCATION IN THE FIELD OF LEADERSHIP, HUMAN RESOURCES MANAGEMENT, STRATEGIC PLANNING AND BUSINESS DEVELOPMENT RENDERED THROUGH CORRESPONDENCE COURSES; INFORMATION ABOUT EDUCATION; LENDING LIBRARIES; ORGANIZATION OF EXHIBITIONS FOR CULTURAL AND EDUCATIONAL PURPOSES; PUBLICATION OF BOOKS, NEWSLETTERS AND TEXTS; PUBLISHING OF ONLINE ELECTRONIC PUBLICATIONS; PUBLICATION OF ELECTRONIC BOOKS AND JOURNALS ON-LINE; TEACHING IN THE FIELD OF LEADERSHIP, HUMAN RESOURCES MANAGEMENT, STRATEGIC PLANNING AND BUSINESS DEVELOPMENT; EDUCATIONAL SERVICES, NAMELY, PROVIDING MANAGEMENT COURSES ON THE SUBJECTS OF LEADERSHIP, HUMAN RESOURCES MANAGEMENT, STRATEGIC PLANNING AND BUSINESS DEVELOPMENT; VOCATIONAL GUIDANCE; STANDARDIZED TEST ADMINISTRATION AND SCORING IN THE FIELD OF INDIVIDUAL INTELLIGENCE AND TEST PERFORMANCE (U.S. CLS. 100, 101 AND 107).

CLASS 44—MEDICAL, BEAUTY AND AGRICULTURAL SERVICES

FOR CLINICAL TESTING SERVICES, NAMELY, PSYCHOLOGICAL TESTING SERVICES; CONSULTING SERVICES RELATING TO PSYCHOLOGICAL TESTING (U.S. CLS. 100 AND 101).

ALYSSA PALADINO, EXAMINING ATTORNEY

SN 79-035,397. SORGENTI S.R.L., ITALY, FILED 12-12-2006.

Alice
S A N D I E G O

PRIORITY DATE OF 10-4-2006 IS CLAIMED.
OWNER OF INTERNATIONAL REGISTRATION 0915977
DATED 12-12-2006, EXPIRES 12-12-2016.

CLASS 18—LEATHER GOODS

FOR LEATHER AND IMITATIONS OF LEATHER, AND GOODS MADE OF THESE MATERIALS AND NOT INCLUDED IN OTHER CLASSES, NAMELY LEATHER CASES, HANDBAGS, ANIMAL SKINS, HIDES, TRUNKS AND TRAVELING BAGS, UMBRELLAS, PARASOLS AND WALKING STICKS, WHIPS, HARNESSES AND SADDLERY (U.S. CLS. 1, 2, 3, 22 AND 41).

CLASS 22—CORDAGE AND FIBERS

FOR ROPES, STRING, COMMERCIAL NETS, TENTS, AWNINGS, TARPAULINS NOT FOR SHIPS, SAILS, SACKS OR BAGS FOR THE TRANSPORTATION OR STORAGE OF MATERIALS IN BULK, PADDING AND STUFFING MATERIALS NOT OF RUBBER, PAPER OR PLASTIC, RAW FIBROUS TEXTILE MATERIALS (U.S. CLS. 1, 2, 7, 19, 22, 42 AND 50).

CLASS 23—YARNS AND THREADS

FOR YARNS AND THREADS, FOR TEXTILE USE (U.S. CL. 43).

CLASS 24—FABRICS

FOR VINYL AND CLOTH TEXTILES FOR USE IN THE MANUFACTURE OF ALL KIND OF MEN AND WOMEN CLOTHING AND ACCESSORY AS HATS, BAGS; PAPER BED COVERS AND UNFITTED FABRIC FURNITURE COVERS (U.S. CLS. 42 AND 50).

CLASS 25—CLOTHING

FOR MEN AND WOMEN'S CLOTHING, NAMELY, SUITS, DRESSES, TOPS, SHIRTS, BLOUSES, T-SHIRTS, SWEATERS, FOULARDS, SCARVES, JACKETS, TROUSERS, SKIRTS, HEAVY JACKETS, COATS, BELTS, FOOTWEAR, HEADGEAR, NAMELY, HATS AND CAPS (U.S. CLS. 22 AND 39).

CLASS 26—FANCY GOODS

FOR LACE AND EMBROIDERY, RIBBONS AND BRAIDS, NOVELTY BUTTONS, HOOKS AND EYES, SEWING PINS AND NEEDLES, ARTIFICIAL FLOWERS (U.S. CLS. 37, 39, 40, 42 AND 50).

CLASS 35—ADVERTISING AND BUSINESS

FOR ADVERTISING AND MARKETING; BUSINESS MANAGEMENT; BUSINESS ADMINISTRATION AND MANAGEMENT; PROVIDING OFFICE FUNCTIONS (U.S. CLS. 100, 101 AND 102).

CLASS 38—COMMUNICATION

FOR TELECOMMUNICATIONS ACCESS SERVICES (U.S. CLS. 100, 101 AND 104).

ANNE E. GUSTASON, EXAMINING ATTORNEY

SN 79-035,405. PRINOTH S.P.A., ITALY, FILED 9-25-2006.

Prinoth

PRIORITY DATE OF 6-15-2006 IS CLAIMED.
OWNER OF INTERNATIONAL REGISTRATION 0916004
DATED 9-25-2006, EXPIRES 9-25-2016.

CLASS 7—MACHINERY

FOR MACHINE-OPERATED IMPLEMENTS AND EQUIPMENT FOR AGRICULTURE, HORTICULTURE AND FORESTRY PURPOSES, NAMELY, TRACKS, TILLERS, WINCHES, SHOVELS AND BLADES FOR MAINTAINING SNOW PISTES AND CROSS COUNTRY SKIING TRACKS, AND REPLACEMENT PARTS THEREFOR (U.S. CLS. 13, 19, 21, 23, 31, 34 AND 35).

CLASS 12—VEHICLES

FOR VEHICLES, NAMELY, VEHICLES FOR TRAVELING ON SURFACES COVERED WITH SNOW OR SAND, NAMELY, SNOW AND SAND GROOMING VEHICLES, TRACKED VEHICLES FOR CLEANING BEACHES; TRACKED VEHICLES FOR TRANSPORTING MATERIALS AND PEOPLE, NAMELY, ALL TERRAIN SELF-PROPELLED TRACKED VEHICLES AS WELL AS SPARE PARTS THEREFOR; OFF-ROAD ALL TERRAIN VEHICLES (U.S. CLS. 19, 21, 23, 31, 35 AND 44).

ANNE MADDEN, EXAMINING ATTORNEY

SN 79-035,528. AGA KHAN FUND FOR ECONOMIC DEVELOPMENT S.A., CH-1211 GENEVE, SWITZERLAND, FILED 1-23-2007.

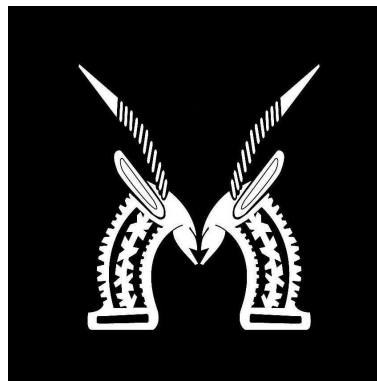

PRIORITY DATE OF 7-25-2006 IS CLAIMED.
OWNER OF INTERNATIONAL REGISTRATION 0916357
DATED 1-23-2007, EXPIRES 1-23-2017.

CLASS 12—VEHICLES

FOR AUTOMOBILES; APPARATUS FOR LOCOMOTION BY LAND, AIR OR WATER, NAMELY, CARS, AIRPLANES AND BOATS (U.S. CLS. 19, 21, 23, 31, 35 AND 44).

CLASS 16—PAPER GOODS AND PRINTED MATTER

FOR PAPER AND PAPER ARTICLES, INCLUDED IN THIS CLASS, NAMELY, PAPER BAGS AND SACKS, PAPER FOR WRAPPING AND PACKAGING, PAPER ILLUSTRATION BOARDS, PAPER LABELS, PAPER MAIL POUCHES, PAPER NAPKINS, PAPER NOTE TABLETS, PAPER RIBBONS, PAPER SHEETS FOR NOTE TAKING, PAPER SHOPPING BAGS, PAPER STATIONERY, PAPER TAGS, PAPER TOWELS, PAPERS FOR HOUSEHOLD AND INDUSTRIAL USE, PAPER PRINTED TICKETS; CARDBOARD AND CARDBOARD ARTICLES, INCLUDED IN THIS CLASS, NAMELY, CARDBOARD PACKAGING, CARDBOARD CARRIERS FOR FOOD AND BEVERAGES; PRINTED MATTER, NAMELY, NEWSPAPERS AND PRINTED PERIODICALS IN THE FIELD OF AIRLINE COMPANIES AND AERONAUTICS, AND BOOKS IN THE FIELD OF AIRLINE COMPANIES AND AERONAUTICS (U.S. CLS. 2, 5, 22, 23, 29, 37, 38 AND 50).

CLASS 21—HOUSEWARES AND GLASS

FOR DECORATIVE OBJECTS, NAMELY, ART OBJECTS, NAMELY, STATUETTES OF PORCELAIN, TERRA-COTTA OR GLASS; DRINKING GLASSES; CUPS NOT OF PRECIOUS METAL; FITTED VANITY CASES, TOOTHBRUSHES, COSMETIC BRUSHES, AND COMBS (U.S. CLS. 2, 13, 23, 29, 30, 33, 40 AND 50).

CLASS 39—TRANSPORTATION AND STORAGE

FOR TRANSPORT OF PASSENGERS AND GOODS; TRAVEL ARRANGEMENT, TRAVEL RESERVATION SERVICES; TRAVEL AGENCY SERVICES, NAMELY, MAKING RESERVATIONS AND BOOKINGS FOR TRANSPORTATION (U.S. CLS. 100 AND 105).

CLASS 43—HOTEL AND RESTAURANT SERVICES

FOR SERVING OF FOOD AND DRINK; ARRANGING TEMPORARY HOUSING ACCOMMODATIONS; MAKING HOTEL RESERVATIONS FOR OTHERS; PROVIDING TEMPORARY ACCOMMODATION (U.S. CLS. 100 AND 101).

ANNE E. GUSTASON, EXAMINING ATTORNEY

SN 79-035,679, BIONORICA AG, FED REP GERMANY, FILED 2-2-2007.

Bionorica Growing solutions for your health

THE MARK CONSISTS OF STANDARD CHARACTERS WITHOUT CLAIM TO ANY PARTICULAR FONT, STYLE, SIZE, OR COLOR.

PRIORITY DATE OF 9-1-2006 IS CLAIMED.
OWNER OF INTERNATIONAL REGISTRATION 0916787 DATED 2-2-2007, EXPIRES 2-2-2017.

OWNER OF U.S. REG. NOS. 1,712,980 AND 2,781,184.

CLASS 3—COSMETICS AND CLEANING PREPARATIONS

FOR ESSENTIAL OILS; PLANT EXTRACTS FOR USE AS COSMETICS, HAIR LOTIONS AND PERFUMERY; COSMETICS (U.S. CLS. 1, 4, 6, 50, 51 AND 52).

CLASS 5—PHARMACEUTICALS

FOR PHARMACEUTICAL, VETERINARY AND SANITARY PREPARATIONS FOR USE IN THE TREATMENT OF INFECTION OF RESPIRATORY TRACT, INFECTION OF URINARY TRACT, URINARY OBSTRUCTION, CHRONICAL VENOUS INSUFFICIENCY, PROSTATE HYPERPLASIA, MUSCLE PAINS, SOFT TISSUE RHEUMATISM, MUSCULOSKELETAL DISEASE, LIVER DISEASE, HEPATITIS, CIRRHOSIS OF THE LIVER; PHARMACEUTICAL PREPARATIONS FOR USE IN THE TREATMENT OF ANGINA, ATHEROSCLEROSIS, BRONCHIAL ASTHMA, CIRCULATORY DISORDERS, CONSTIPATION, DIARRHEA, HEART FAILURE, HEART RHYTHM DISORDERS, HIGH BLOOD PRESSURE, INDIGESTION, INSOMNIA, MIGRAINE, MOTION SICKNESS, NAUSEA, PEPTIC ULCERS, VOMITING AND ALLERGY; PHARMACEUTICAL PREPARATIONS, NAMELY, PLANT EXTRACTS FOR USE AS AN ANTIDEPRESSANT, DIURETIC, HYPNOTIC, SEDATIVE, STIMULANT AND TRANQUILIZER; HEMORRHOIDAL OINTMENT, LAXATIVES, NASAL DECONGESTANT CAPSULES, NASAL SPRAY PREPARATION, NON-NARCOTIC ANALGESIC, THROAT LOZENGES; MEDICAMENTS FOR THE TREATMENT OF GYNECOLOGICAL DISORDERS; MEDICINAL PREPARATIONS IN TABLET FORM, NAMELY, TABLETS FOR REGULATING MENSTRUATION CIRCULATION; DRUGS FOR TREATMENT OF CIRCULATORY ORGAN AILMENTS; HORMONE PREPARATIONS FOR MEDICAL USE; MEDICINAL PREPARATIONS FOR THE TREATMENT OF AILMENTS OF THE URINARY, GENITAL AND ANAL ORGANS; MEDICINAL PREPARATIONS FOR THE TREATMENT OF BLOOD DISEASES AND DISORDERS; ORIENTAL MEDICINE FOR THE TREATMENT OF GYNECOLOGIC DISORDERS; PILLS FOR TREATING DIZZINESS; IMMUNE REGULATORS, NAMELY, MEDICINAL PREPARATIONS FOR THE STRENGTHENING OF THE IMMUNE SYSTEM; PHARMACEUTICAL PREPARATIONS AND MEDICINES FOR THE TREATMENT OF WOMEN'S DISEASES, NAMELY, MIGRAINE AND DEPRESSION; MEDICINES FOR THE TREATMENT OF BREAST PAIN; PHARMACEUTICAL PREPARATIONS AND MEDICINES FOR THE TREATMENT OF GYNECOLOGICAL DISORDERS AFFECTING MENSTRUATION, STERILITY, MENSTRUOUS SYNDROMES, MAMMAE, MASTOPATHY, MASTODYNIA, CLIMACTERIC COMPLAINTS, PREMENSTRUAL SYNDROME, DYSMENORRHEA; DIETETIC SUBSTANCES ADAPTED FOR MEDICAL USE, NAMELY, FOOD FOR MEDICALLY RESTRICTED DIETS, FOOD FOR DIABETICS, VITAMIN AND MINERAL SUPPLEMENTS, HERB TEAS FOR MEDICINAL PURPOSES AND MEDICINAL TEAS; MEDICAL PLASTERS, BANDAGES AND GAUZE FOR DRESSINGS, WOUND DRESSINGS, ALL PURPOSE DISINFECTANTS; PLANT EXTRACTS, TINCTURES AND AROMATIC SUBSTANCES IN LIQUID, SOLID OR GASEOUS FORM, NAMELY, MEDICINAL HERB EXTRACTS; NUTRITIONAL ADDITIVES FOR MEDICAL PURPOSES FOR USE IN FOODS AND DIETARY SUPPLEMENTS FOR HUMAN AND ANIMAL CONSUMPTION; DIETETIC SUPPLEMENTS IN THE FORM OF TABLETS, DROPS, CAPSULES, EXTRACT PREPARATIONS, BALMS AND/OR IN LIQUID FORM, CONTAINING PLANT EXTRACTS FOR THE TREATMENT OF INFECTION OF RESPIRATORY TRACT, INFECTION OF URINARY TRACT, URINARY OBSTRUCTION, CHRONICAL VENOUS INSUFFICIENCY, PROSTATE HYPERPLASIA, MUSCLE PAINS, SOFT TISSUE RHEUMATISM, MUSCULOSKELETAL DISEASE, LIVER DISEASE, HEPATITIS, CIRRHOSIS OF THE LIVER, ANGINA, ATHEROSCLEROSIS, BRONCHIAL ASTHMA, CIRCULATORY DISORDERS, CONSTIPATION, DIARRHEA, HEART FAILURE, HEART RHYTHM DISORDERS, HIGH BLOOD PRESSURE, INDIGESTION, INSOMNIA, MIGRAINE, MOTION SICKNESS, NAUSEA, PEPTIC ULCERS, VOMITING AND ALLERGY, WOMEN'S DISEASES, NAMELY, MIGRAINE AND DEPRESSION, BREAST PAIN, GYNECOLOGICAL DISORDERS AFFECTING MENSTRUATION, STERILITY, MENSTRUOUS SYNDROMES, MAMMAE, MASTOPATHY, MASTODYNIA, CLIMACTERIC COMPLAINTS, PREMENSTRUAL SYNDROME, DYSMENORRHEA; DIETETIC SUPPLEMENTS IN THE FORM OF TABLETS, DROPS, CAPSULES, EXTRACT PREPARATIONS, BALMS AND/OR IN LIQUID FORM, CONTAINING PLANT EXTRACTS FOR USE AS AN ANTIDEPRESSANT, DIURETIC, HYPNOTIC, SEDATIVE, STIMULANT

AND TRANQUILIZER, HEMORRHOIDAL OINTMENT, LAXATIVE, NASAL DECONGESTANT CAPSULES, NASAL SPRAY PREPARATION, NON-NARCOTIC ANALGESIC, THROAT LOZENGES; DIETETIC SUPPLEMENTS IN THE FORM OF TABLETS, DROPS, CAPSULES, EXTRACT PREPARATIONS, BALMS AND/OR IN LIQUID FORM, CONTAINING PLANT EXTRACTS FOR THE TREATMENT OF GYNECOLOGICAL DISORDERS; DIETETIC FOOD SUPPLEMENTS; MINERAL FOOD SUPPLEMENTS, FOOD SUPPLEMENTS BASED ON AMINO ACIDS, MINERALS AND TRACE ELEMENTS (U.S. CLS. 6, 18, 44, 46, 51 AND 52).
STEVEN PEREZ, EXAMINING ATTORNEY

SN 79-036,188. HUISMAN SPECIAL LIFTING EQUIPMENT HOLDING B.V., NETHERLANDS, FILED 12-21-2006.



SN 79-036,187. HUISMAN SPECIAL LIFTING EQUIPMENT HOLDING B.V., NETHERLANDS, FILED 12-21-2006.



PRIORITY DATE OF 6-28-2006 IS CLAIMED.
OWNER OF INTERNATIONAL REGISTRATION 0917988
DATED 12-21-2006, EXPIRES 12-21-2016.
"H" HAS NO MEANING IN A FOREIGN LANGUAGE.

CLASS 7—MACHINERY

FOR CRANES; HOISTING DEVICES, NAMELY, ELECTRIC, HYDRAULIC AND PNEUMATIC HOISTS; GROUND-DRILLING MACHINERY, NAMELY, WELL DRILLING MACHINES; DRILLING RIGS, NAMELY, DRILLS FOR THE MINING, OIL AND GAS INDUSTRY; PIPELAYING INSTALLATIONS IN THE NATURE OF POWER-OPERATED LIFTING AND MOVING EQUIPMENT, NAMELY, PIPE LAYERS; REPLACEMENT PARTS FOR THESE GOODS (U.S. CLS. 13, 19, 21, 23, 31, 34 AND 35).

PRIORITY DATE OF 6-28-2006 IS CLAIMED.
OWNER OF INTERNATIONAL REGISTRATION 0917987
DATED 12-21-2006, EXPIRES 12-21-2016.
"HI" HAS NO MEANING IN A FOREIGN LANGUAGE.

CLASS 37—CONSTRUCTION AND REPAIR

FOR CONSTRUCTION OF PIPELAYING INSTALLATIONS, NAMELY, LAYING AND CONSTRUCTION OF PIPELINES; INSTALLATION OF GROUND DRILLING MACHINERY, NAMELY, DRILLING RIGS; INSTALLATION OF CRANES (U.S. CLS. 100, 103 AND 106).

CLASS 7—MACHINERY

FOR CRANES; HOISTING DEVICES, NAMELY, ELECTRIC, HYDRAULIC AND PNEUMATIC HOISTS; GROUND-DRILLING MACHINERY, NAMELY, WELL DRILLING MACHINES; DRILLING RIGS, NAMELY, DRILLS FOR THE MINING, OIL AND GAS INDUSTRY; PIPELAYING INSTALLATIONS IN THE NATURE OF POWER-OPERATED LIFTING AND MOVING EQUIPMENT, NAMELY, PIPE LAYERS; REPLACEMENT PARTS FOR THESE GOODS (U.S. CLS. 13, 19, 21, 23, 31, 34 AND 35).

CLASS 42—SCIENTIFIC AND COMPUTER SERVICES

FOR DESIGN, DEVELOPMENT, TECHNICAL PLANNING AND TECHNICAL ADVICE OFFERED BY AN ENGINEER, NAMELY, ENGINEERING SERVICES FOR BUILDING AND CONSTRUCTION OF PIPELAYING INSTALLATIONS AND CRANES, HOISTING DEVICES, NAMELY, ELECTRIC AND PNEUMATIC HOISTS, GROUND-DRILLING MACHINERY, NAMELY, WELL DRILLING MACHINES, DRILLING RIGS, NAMELY, DRILLS FOR THE MINING INDUSTRY, PIPELAYING INSTALLATIONS IN THE NATURE OF POWER-OPERATED LIFTING AND MOVING EQUIPMENT, NAMELY, PIPE LAYERS (U.S. CLS. 100 AND 101).

CLASS 37—CONSTRUCTION AND REPAIR

FOR CONSTRUCTION OF PIPELAYING INSTALLATIONS, NAMELY, LAYING AND CONSTRUCTION OF PIPELINES; INSTALLATION OF GROUND DRILLING MACHINERY, NAMELY, DRILLING RIGS; INSTALLATION OF CRANES (U.S. CLS. 100, 103 AND 106).

ROBERT STRUCK, EXAMINING ATTORNEY

CLASS 42—SCIENTIFIC AND COMPUTER SERVICES

FOR DESIGN, DEVELOPMENT, TECHNICAL PLANNING AND TECHNICAL ADVICE OFFERED BY AN ENGINEER, NAMELY, ENGINEERING SERVICES FOR BUILDING AND CONSTRUCTION OF PIPELAYING INSTALLATIONS AND CRANES, HOISTING DEVICES, NAMELY, ELECTRIC AND PNEUMATIC HOISTS, GROUND-DRILLING MACHINERY, NAMELY, WELL DRILLING MACHINES, DRILLING RIGS, NAMELY, DRILLS FOR THE MINING INDUSTRY, PIPELAYING INSTALLATIONS IN THE NATURE OF POWER-OPERATED LIFTING AND MOVING EQUIPMENT, NAMELY, PIPE LAYERS (U.S. CLS. 100 AND 101).

ROBERT STRUCK, EXAMINING ATTORNEY

SN 79-036,292. PHOENIXBIO CO., LTD., HIROSHIMA-KEN 739-0046, JAPAN, FILED 2-8-2007.

PXB-mouse

PRIORITY DATE OF 1-12-2007 IS CLAIMED.
OWNER OF INTERNATIONAL REGISTRATION 0918257
DATED 2-8-2007, EXPIRES 2-8-2017.

CLASS 31—NATURAL AGRICULTURAL PRODUCTS

FOR LIVE LABORATORY ANIMALS (U.S. CLS. 1 AND 46).

CLASS 42—SCIENTIFIC AND COMPUTER SERVICES

FOR MICROORGANISM AND ANIMAL CELL CULTURE TESTING; BIOCHEMICAL SUBSTANCE TESTING; ANIMAL FEEDING TRIALS AND PYROGEN TESTING UNDER RESTRICTIVE CONDITIONS; MEDICINE AND CHEMICAL SUBSTANCE SAFETY TESTING; MEDICINAL AND PHARMACOLOGICAL EFFICACY TESTING; TESTING OF MEDICINE AND PHARMACEUTICAL RESEARCH; PHARMACOKINETICS STUDIES, NAMELY, DRUG METABOLISM STUDIES, PK STUDIES, PD STUDIES, DRUG SAFETY STUDIES; SCIENTIFIC RESEARCH SERVICES; ENTRUSTED RESEARCH AND DEVELOPMENT FOR PHARMACEUTICAL INDUSTRIES; SCIENTIFIC TESTING AND RESEARCH FOR OTHERS (U.S. CLS. 100 AND 101).

FRED CARL, EXAMINING ATTORNEY

CLASS 25—CLOTHING

FOR CLOTHING, NAMELY, T-SHIRTS, SHIRTS, JACKETS, SWEATSHIRTS, SPORT SHIRTS, BASEBALL JERSEYS, HOODED TOPS, PULLOVERS, JUMPERS, SHORTS, BOXER SHORTS, UNDERWEAR, SOCKS, SCARVES, DRESSING GOWNS, CLOTH BIBS, ROMPER SUITS, BABY SLEEP SUITS, DUNGAREES, BRACES IN THE NATURE OF SUSPENDERS, TRACKSUITS, TIES, LINGERIE, HOSIERY, BATHING COSTUMES, BATHING SUITS, BATHING TRUNKS, BATHROBES, BEACHWEAR, BIKINIS, BLOUSES, BRAS, BRIEFS, CAMISOLES, DRESSES, DRESSING GOWNS, EVENING DRESSES, EVENING GOWNS, FROCKS, GOWNS, INFANT WEAR, JEANS, JUMPERS, KILTS, MINISKIRTS, NIGHTWEAR, PAJAMAS, SKIRT SUITS, SKIRTS, SLACKS, VESTS, SLEEPING GARMENTS, SLEEPWEAR, SUITS, SWIM WEAR, SWIMSUITS, TANKINIS, TEDDIES, THONGS, TRACKSUITS, RUNNING AND JOGGING SUITS, TROUSERS, TUXEDOS, WAISTCOATS, WEDDING DRESSES AND WEDDINGS GOWNS, ALL OF THE FOREGOING CLOTHING RELATING TO MUSIC CONCERTS AND MUSIC CONCERT ARTISTS, NOT SOLD THROUGH RETAIL STORES SPECIALIZING IN WEARING APPAREL, BUT RATHER THROUGH RECORD STORES, MUSIC CONCERTS AND OTHER OUTLETS FEATURING PRIMARILY OR SPECIALIZING IN PRODUCTS RELATING TO MUSIC CONCERTS AND MUSIC CONCERT ARTISTS; HEADGEAR, NAMELY, HATS, CAPS, BANDANAS, BERETS AND BASEBALL CAPS; GLOVES; FOOTWEAR; WRISTBANDS; SWEAT BANDS (U.S. CLS. 22 AND 39).

CARRIE GENOVESE, EXAMINING ATTORNEY

SN 79-036,559. E+J S.R.L., ITALY, FILED 1-19-2007.



PRIORITY DATE OF 7-20-2006 IS CLAIMED.
OWNER OF INTERNATIONAL REGISTRATION 0919016
DATED 1-19-2007, EXPIRES 1-19-2017.

THE COLOR(S) PINK AND WHITE IS/ARE CLAIMED AS
A FEATURE OF THE MARK.

THE COLOR PINK APPEARS IN THE BACKGROUND OF
THE RECTANGLE DESIGN AND THE COLOR WHITE
APPEARS IN THE WORDING "E+J".

CLASS 18—LEATHER GOODS

FOR LEATHER AND IMITATIONS OF LEATHER,
AND GOODS MADE OF THESE MATERIALS IN-
CLUDED IN THIS CLASS, NAMELY, TRUNKS, AT-
TACHE CASES AND TRAVELLING BAGS,
RUCKSACKS, SPORTS BAGS AND SWIMMING BAGS
IN THE NATURE OF BEACH BAGS; SADDLERY;
HORSE BLANKETS AND HALTERS; UMBRELLAS
AND PARASOLS; WALKING STICKS; TRAVELLING
SETS OF LEATHER, NAMELY, TRAVEL CASES, TRAVEL
BAGS AND JEWELRY ORGANIZERS FOR TRAVEL;
KEY CASES OF LEATHER (U.S. CLS. 1, 2, 3, 22
AND 41).

SN 79-036,640. I.E.M. INTERNATIONAL EXHIBITION;
MANAGEMENT S.R.L., ITALY, FILED 9-7-2006.



PRIORITY DATE OF 8-11-2006 IS CLAIMED.
OWNER OF INTERNATIONAL REGISTRATION 0919225
DATED 9-7-2006, EXPIRES 9-7-2016.

THE MARK CONSIST OF AND IS CONSTITUTED BY A
GRAPHIC COMPOSITION INCLUDING A FIGURE OF
HEAD OF A LION WITH MANE, PARTIALLY PLACED
UPON A FIGURE OF A GLASS, IN THE FOREGROUND OF
WHICH THERE IS THE WORDING "YOUNG LIONS"
WRITTEN IN SMALL LETTERS.

CLASS 35—ADVERTISING AND BUSINESS

FOR ORGANIZATION OF EXHIBITIONS OR TRADE
FAIRS FOR COMMERCIAL OR ADVERTISING PUR-
POSES; ADVERTISING SERVICES FOR PROMOTING
EXHIBITIONS; BUSINESS MANAGEMENT; BUSINESS
ADMINISTRATION; PROVIDING OFFICE FUNCTIONS
(U.S. CLS. 100, 101 AND 102).

CLASS 41—EDUCATION AND ENTERTAINMENT

FOR ORGANIZATION OF EXHIBITIONS FOR CULTURAL OR EDUCATIONAL PURPOSES, NAMELY, EDUCATION REGARDING WINE, DISTILLED SPIRITS AND LIQUEUR; ARRANGING AND CONDUCTING OF CONFERENCES, CONGRESSES, COLLOQUIUMS, SEMINARS AND SYMPOSIUMS IN THE FIELD OF EDUCATION REGARDING WINES, DISTILLED SPIRITS AND LIQUEUR; EDUCATION SERVICES, NAMELY, PROVIDING GUIDED WINE TASTINGS; TRAINING AND EDUCATIONAL SERVICES, NAMELY, CONFERENCES, CONGRESSES, COLLOQUIUMS, SEMINARS AND SYMPOSIUMS IN WINE TYPOLOGIES AND VARIETALS AND THE MAKING OF WINE, DISTILLED SPIRITS AND LIQUEURS; ENTERTAINMENT SERVICES, NAMELY, ORGANIZATION OF EVENTS INVOLVING TASTING OF WINES, DISTILLED SPIRITS AND LIQUEURS (U.S. CLS. 100, 101 AND 107).

WILLIAM ROSSMAN, EXAMINING ATTORNEY

SN 79-036,743. TIANJIN JINMAO GROUP CO., LTD., CHINA, FILED 4-25-2006.

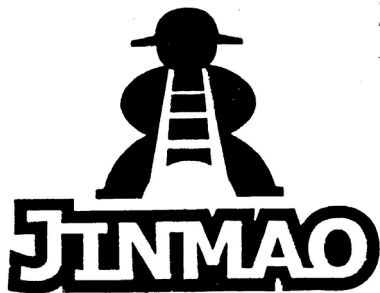

OWNER OF INTERNATIONAL REGISTRATION 0919632 DATED 4-25-2006, EXPIRES 4-25-2016.

THE FOREIGN WORDING IN THE MARK TRANSLATES INTO ENGLISH AS "GOLDEN ANCHOR".

CLASS 6—METAL GOODS

FOR LADDERS OF METAL; METAL STEPLADDERS; EXTENSION POLES OF METAL; EXTENSION POLES PRIMARILY OF METAL FOR USE IN PAINTING AND WINDOW WASHING (U.S. CLS. 2, 12, 13, 14, 23, 25 AND 50).

CLASS 20—FURNITURE AND ARTICLES NOT OTHERWISE CLASSIFIED

FOR NON-METAL LADDERS, NON-METAL STEPLADDERS, NON-METAL EXTENSION LADDERS (U.S. CLS. 2, 13, 22, 25, 32 AND 50).

Laurie Kaufman, Examining Attorney

SN 79-036,829. WELLA AKTIENGESELLSCHAFT, FED REP GERMANY, FILED 2-12-2007.

HDC SYSTEM

THE MARK CONSISTS OF STANDARD CHARACTERS WITHOUT CLAIM TO ANY PARTICULAR FONT, STYLE, SIZE, OR COLOR.

PRIORITY DATE OF 9-1-2006 IS CLAIMED.

OWNER OF INTERNATIONAL REGISTRATION 0919835 DATED 2-12-2007, EXPIRES 2-12-2017.

NO CLAIM IS MADE TO THE EXCLUSIVE RIGHT TO USE "SYSTEM", APART FROM THE MARK AS SHOWN.

CLASS 1—CHEMICALS

FOR CHEMICAL PREPARATIONS USED IN INDUSTRY FOR THE PRODUCTION OF COSMETIC PREPARATIONS, HAIR DYE PREPARATIONS, PERMANENT WAVE PREPARATIONS AND CLEANING PREPARATIONS FOR THE BODY, NAMELY, SKIN CLEANSERS AND SHOWER GEL (U.S. CLS. 1, 5, 6, 10, 26 AND 46).

CLASS 3—COSMETICS AND CLEANING PREPARATIONS

FOR SOAPS, PERFUMERY, ESSENTIAL OILS FOR PERSONAL USE, COSMETICS, NAMELY, SHAMPOOS AND HAIR CONDITIONERS; HAIR COLOR AND DYES, COLOR REMOVAL AND LIGHTENING PREPARATIONS AND HAIR BLEACHES; HAIR STYLING AND FINISHING PRODUCTS, NAMELY, HAIR SPRAYS, SPRAY GELS, GELS, MOUSSES, CREAMS, LOTIONS, POMADES AND HAIRWAXES; HAIR AND SCALP TREATMENTS, NAMELY, RESTRUCTURIZERS AND SCALP CONDITIONERS, HAIR LOTIONS (U.S. CLS. 1, 4, 6, 50, 51 AND 52).

Tina Brown, Examining Attorney

SN 79-036,830. WELLA AKTIENGESELLSCHAFT, FED REP GERMANY, FILED 2-12-2007.

HDC MOLECULES

THE MARK CONSISTS OF STANDARD CHARACTERS WITHOUT CLAIM TO ANY PARTICULAR FONT, STYLE, SIZE, OR COLOR.

PRIORITY DATE OF 9-1-2006 IS CLAIMED.

OWNER OF INTERNATIONAL REGISTRATION 0919836 DATED 2-12-2007, EXPIRES 2-12-2017.

NO CLAIM IS MADE TO THE EXCLUSIVE RIGHT TO USE "MOLECULES", APART FROM THE MARK AS SHOWN.

CLASS 1—CHEMICALS

FOR CHEMICAL PREPARATIONS USED IN INDUSTRY FOR THE PRODUCTION OF COSMETIC PREPARATIONS, HAIR DYE PREPARATIONS, PERMANENT WAVE PREPARATIONS AND CLEANING PREPARATIONS FOR THE BODY, NAMELY, SKIN CLEANSERS AND SHOWER GEL (U.S. CLS. 1, 5, 6, 10, 26 AND 46).

CLASS 3—COSMETICS AND CLEANING PREPARATIONS

FOR SOAPS, PERFUMERY, ESSENTIAL OILS FOR PERSONAL USE, COSMETICS, NAMELY, SHAMPOOS AND HAIR CONDITIONERS; HAIR COLOR AND DYES, COLOR REMOVAL AND LIGHTENING PREPARATIONS AND HAIR BLEACHES; HAIR STYLING AND FINISHING PRODUCTS, NAMELY, HAIR SPRAYS, SPRAY GELS, GELS, MOUSSES, CREAMS, LOTIONS, POMADES AND HAIRWAXES; HAIR AND SCALP TREATMENTS, NAMELY, RESTRUCTURIZERS AND SCALP CONDITIONERS, HAIR LOTIONS (U.S. CLS. 1, 4, 6, 50, 51 AND 52).

Tina Brown, Examining Attorney

SN 79-036,863. SALVADOR ALFONSO MARTÍNEZ, SPAIN,
FILED 12-15-2006.



PRIORITY DATE OF 6-16-2006 IS CLAIMED.
OWNER OF INTERNATIONAL REGISTRATION 0919917
DATED 12-15-2006, EXPIRES 12-15-2016.
NO CLAIM IS MADE TO THE EXCLUSIVE RIGHT TO
USE "RECORDS", APART FROM THE MARK AS SHOWN.
THE COLOR(S) ORANGE AND BLACK IS/ARE CLAIMED
AS A FEATURE OF THE MARK.
THE COLOR BLACK APPEARS IN THE WORDING
"SINCABL". THE COLOR ORANGE APPEARS IN THE
WORDING "RECORDS" AND IN THE LETTER "E" IN
THE WORDING "SINCABLE".

CLASS 9—ELECTRICAL AND SCIENTIFIC APPARATUS

FOR BLANK ACOUSTIC RECORDS; BLANK AUDIO
AND VIDEO CASSETTES; COMPACT DISKS FEATUR-
ING MUSIC; LASER DISKS FEATURING MUSIC;
BLANK CD-ROMS FOR SOUND OR VIDEO RECORD-
ING; COMPUTER PROGRAMS FOR REPRODUCING,
PRODUCING AND RECORDING MUSIC; CINEMATO-
GRAPHIC FILMS; PRERECORDED VIDEO TAPES FEAT-
URING MUSIC; BLANK MAGNETIC MEDIA FOR
RECORDING, TRANSMITTING AND REPRODUCING
SOUND AND IMAGES (U.S. CLS. 21, 23, 26, 36 AND 38).

CLASS 41—EDUCATION AND ENTERTAIN- MENT

FOR MUSIC PRODUCTION SERVICES; AUDIO RE-
CORDING; DISCOTHEQUES; ARRANGING OF SHOWS,
CONCERTS AND MUSICAL CONTESTS; BOOKING OF
SEATS FOR SHOWS; RADIO ENTERTAINMENT SER-
VICES, NAMELY, RADIO PROGRAMS FEATURING
PERFORMANCES BY MUSICIANS AND BANDS; EN-
TERTAINMENT IN THE NATURE OF ON-GOING TEL-
EVISION PROGRAMS IN THE FIELD OF MUSIC AND
VARIETY; PROVIDING CASINO FACILITIES; NIGHT
CLUBS; ARRANGING OF CONFERENCES; ORGANIZA-
TION OF SINGING COMPETITIONS FOR RECREA-
TIONAL PURPOSES; ORGANIZATION OF
EXHIBITIONS FOR MUSICAL EVENTS; ENTERTAIN-
MENT, NAMELY, A CONTINUING VARIETY SHOW
BROADCAST OVER TELEVISION, SATELLITE, AUDIO,
AND VIDEO MEDIA (U.S. CLS. 100, 101 AND 107).

WENDY JUN, EXAMINING ATTORNEY

SN 79-036,869. WELLA AKTIENGESELLSCHAFT, FED REP
GERMANY, FILED 2-12-2007.

HDC ACTIVATOR

THE MARK CONSISTS OF STANDARD CHARACTERS
WITHOUT CLAIM TO ANY PARTICULAR FONT, STYLE,
SIZE, OR COLOR.

PRIORITY DATE OF 9-1-2006 IS CLAIMED.
OWNER OF INTERNATIONAL REGISTRATION 0919931
DATED 2-12-2007, EXPIRES 2-12-2017.
NO CLAIM IS MADE TO THE EXCLUSIVE RIGHT TO
USE "ACTIVATOR", APART FROM THE MARK AS
SHOWN.

CLASS 1—CHEMICALS

FOR CHEMICAL PREPARATIONS USED IN INDUS-
TRY FOR THE PRODUCTION OF COSMETIC PRE-
PARATIONS, HAIR DYE PREPARATIONS,
PERMANENT WAVE PREPARATIONS AND CLEANING
PREPARATIONS FOR THE BODY, NAMELY, SKIN
CLEANSERS AND SHOWER GEL (U.S. CLS. 1, 5, 6, 10,
26 AND 46).

CLASS 3—COSMETICS AND CLEANING PRE- PARATIONS

FOR SOAPS, ESSENTIAL OILS FOR PERSONAL USE,
COSMETICS, NAMELY, SHAMPOOS AND HAIR CON-
DITIONERS; HAIR COLOR AND DYES, COLOR RE-
MOVAL AND LIGHTENING PREPARATIONS AND
HAIR BLEACHES; HAIR STYLING AND FINISHING
PRODUCTS, NAMELY, HAIR SPRAYS, SPRAY GELS,
GELS, MOUSSES, CREAMS, LOTIONS, POMADES AND
HAIRWAXES; HAIR AND SCALP TREATMENTS,
NAMELY, RESTRUCTURIZERS AND SCALP CONDI-
TIONERS, HAIR LOTIONS (U.S. CLS. 1, 4, 6, 50, 51 AND
52).

TINA BROWN, EXAMINING ATTORNEY

SN 79-036,875. MINERALBRUNNEN ÜBERKINGEN-TEI-
NACH AG, FED REP GERMANY, FILED 1-19-2007.



PRIORITY DATE OF 7-21-2006 IS CLAIMED.
OWNER OF INTERNATIONAL REGISTRATION 0919951
DATED 1-19-2007, EXPIRES 1-19-2017.

CLASS 5—PHARMACEUTICALS

FOR DIETETIC FOODS ADAPTED FOR MEDICAL
USE, MINERAL WATER FOR MEDICAL USE (U.S. CLS.
6, 18, 44, 46, 51 AND 52).

CLASS 25—CLOTHING

FOR CLOTHING, NAMELY, SHIRTS, PANTS AND
DRESSES; FOOTWEAR; HEADGEAR, NAMELY, HATS
AND CAPS (U.S. CLS. 22 AND 39).

CLASS 32—LIGHT BEVERAGES

FOR MINERAL WATERS AND AERATED WATERS;
NON-ALCOHOLIC SOFT DRINKS; FRUIT DRINKS AND
FRUIT JUICES; SYRUPS AND OTHER PREPARATIONS
FOR MAKING FRUIT DRINKS (U.S. CLS. 45, 46 AND
48).

VERNA BETH RIRIE, EXAMINING ATTORNEY

SN 79-036,883. ENERDAY GMBH, FED REP GERMANY,
FILED 12-22-2006.

ENERDAY

THE MARK CONSISTS OF STANDARD CHARACTERS WITHOUT CLAIM TO ANY PARTICULAR FONT, STYLE, SIZE, OR COLOR.

PRIORITY DATE OF 6-23-2006 IS CLAIMED.
OWNER OF INTERNATIONAL REGISTRATION 0919970
DATED 12-22-2006, EXPIRES 12-22-2016.

CLASS 7—MACHINERY

FOR EMERGENCY BACKUP GENERATORS, NAMELY, ELECTRIC GENERATORS; EMERGENCY GENERATORS, NAMELY, AUXILIARY POWER UNITS FOR SUPPLYING ELECTRICAL POWER TO HEAT AND POWER GENERATORS; ELECTRIC CURRENT GENERATORS; MECHANICAL CONTROLLING DEVICES FOR CONTROLLING FUEL CELL APPARATUS AND HVACS; HEAT EXCHANGERS BEING PARTS OF MACHINES; TANK REMOVERS FOR REMOVING FUEL FROM A FUEL TANK TO FUEL CELL APPARATUS (U.S. CLS. 13, 19, 21, 23, 31, 34 AND 35).

CLASS 9—ELECTRICAL AND SCIENTIFIC APPARATUS

FOR SOFTWARE FOR CONTROLLING FUEL CELL APPARATUS AND HVACS; REMOTE CONTROLS FOR FUEL CELL APPARATUS AND HVACS; ELECTRIC TRANSMITTERS AND RECEIVERS FOR REMOTE CONTROLS; ELECTRIC SOCKETS; ELECTRICAL FUSES; ELECTRIC SWITCHES; AUTOMATIC PRESSURE CONTROL MACHINES AND INSTRUMENTS; THERMOSTATS; TEMPERATURE LIMITERS FOR LIMITING THE TEMPERATURE IN MACHINES, VEHICLES AND BUILDINGS; ELECTRIC OR ELECTRONIC SENSORS FOR SENSING AMBIENT CONDITIONS, TEMPERATURE AND PRESSURE CONDITIONS IN MACHINES, VEHICLES AND BUILDINGS; ELECTRICAL CURRENT TRANSFORMERS; VOLTAGE REGULATORS; FILTERS FOR RADIO INTERFERENCE SUPPRESSION; EQUIPMENT FOR GENERATING ELECTRIC ENERGY, NAMELY, FUEL CELL APPARATUS; ELECTRIC CONTROLLING DEVICES, NAMELY, ELECTRIC CONTROLLERS; BATTERIES; FUEL CELLS; ELECTRIC BATTERY CHARGERS; EQUIPMENT FOR THE PREPARATION OF THE COMBUSTION MEDIUM TO BE SUPPLIED TO A FUEL CELL REFORMER (U.S. CLS. 21, 23, 26, 36 AND 38).

CLASS 11—ENVIRONMENTAL CONTROL APPARATUS

FOR AIR CONDITIONERS; VENTILATION APPLIANCES, NAMELY, VENTILATING EXHAUST FANS; HEATING APPLIANCES, NAMELY ELECTRIC AND FOSSIL FUEL HEATERS FOR VEHICLES AND HOUSES; CLIMATE CONTROL SYSTEMS FOR VEHICLES, MACHINES AND BUILDINGS, CONSISTING OF HEAT AND COLD PRODUCING APPARATUS; WINDOW DEFROSTING APPARATUS FOR VEHICLES; ELECTRIC WATER HEATERS, NAMELY, HOT WATER HEATERS; ENGINE-INDEPENDENT AIR CONDITIONERS FOR VEHICLES; ELECTRIC HEATERS, NAMELY, ELECTRIC SPACE HEATERS, ELECTRIC RADIANT HEATERS FOR HOUSEHOLD PURPOSES; AUXILIARY HEATERS FOR VEHICLES; ROOF AIR CONDITIONERS, NAMELY, ELECTRIC SPACE COOLING APPARATUS FOR ROOFS; HVAC UNITS; LIGHTS FOR VEHICLES AND HOUSEHOLD PURPOSES; COOLANT RECOVERY SYSTEMS COMPRISING RESERVOIRS, PUMPS, FILTERS, CLEANERS (U.S. CLS. 13, 21, 23, 31 AND 34).

CLASS 12—VEHICLES

FOR VEHICLES AND THEIR PARTS, NAMELY, ROOF PANELS FOR LAND VEHICLES, SUN BLINDS ADAPTED FOR AUTOMOBILES, AND VEHICLE HOOD AND FENDER LOUVERS AND VENTS; VEHICLE WINDOWS, NAMELY, SIDE AND REAR WINDOWS, SKYLIGHT WINDOWS, TILTING WINDOWS; VEHICLE WINDOW LIFTS, NAMELY, VEHICLE WINDOW RAISING MECHANISMS; AUTOMOTIVE INTERIOR TRIM; CAR BODY PANELS; VEHICLE SPOILERS; WIND AND WATER DEFLECTORS, NAMELY, WATER DEFLECTING SKIRTS FOR VEHICLES; SKI AND LUGGAGE RACKS FOR VEHICLES; AUTOMOTIVE WINDSHIELD SHADE SCREEN; DOOR PANELS FOR LAND VEHICLES; SKYLIGHTS FOR VEHICLES, NAMELY, AUTOMOBILE SUNROOFS (U.S. CLS. 19, 21, 23, 31, 35 AND 44).

CLASS 37—CONSTRUCTION AND REPAIR

FOR INSTALLATION AND MAINTENANCE SERVICES FOR ELECTRICAL AND GENERATING MACHINERY, BATTERIES FOR VEHICLES, BUILDINGS AND ELECTRIC GENERATORS, FUEL CELLS, ELECTRIC BATTERY CHARGERS, AIR CONDITIONERS, COOLING UNITS, VENTILATION APPLIANCES, HEATING INSTALLATIONS, LAND VEHICLES, BOATS AND VESSELS AND THEIR PARTS (U.S. CLS. 100, 103 AND 106).

BERNICE MIDDLETON, EXAMINING ATTORNEY

SN 79-036,938. KABUSHIKI KAISHA YASKAWA DENKI,
JAPAN, FILED 12-21-2006.

SEMISTAR

OWNER OF INTERNATIONAL REGISTRATION 0920085
DATED 12-21-2006, EXPIRES 12-21-2016.

CLASS 7—MACHINERY

FOR GAS WELDING MACHINES; OXY-ACETYLENE WELDING AND CUTTING MACHINES; ELECTRIC WELDING MACHINES; LOADING AND UNLOADING MACHINES, NAMELY, HYDRAULIC LIFT TROLLEY TABLES; POSITIONING DEVICES, NAMELY, WELDING POSITIONERS, SERVO MOTORS, LINEAR MOTORS; LOADING-UNLOADING MACHINES AND APPARATUS; CHEMICAL PROCESSING MACHINES AND APPARATUS, NAMELY, GRINDING MILLS; LUMBERING, WOODWORKING, VENEER OR PLYWOOD MAKING MACHINES AND APPARATUS, NAMELY, SAW-TOOTH SETTING MACHINES; PULP MAKING, PAPERMAKING OR PAPER-WORKING MACHINES AND APPARATUS, NAMELY, PAPER REELING MACHINES; PRINTING MACHINES FOR TEXTILE; BOOKBINDING MACHINES AND APPARATUS; PACKAGING OR WRAPPING MACHINES AND APPARATUS; PNEUMATIC OR HYDRAULIC MACHINES AND INSTRUMENTS, NAMELY, PNEUMATIC CONVEYORS; STARTERS FOR MOTORS AND ENGINES; AC AND DC GENERATORS, NOT FOR LAND VEHICLES; AC GENERATORS; DC GENERATORS; MACHINES FOR REPAIRING AND FIXING CDS; DYNAMO BRUSHES; PAINTING MACHINES AND APPARATUS NAMELY, SPRAY GUNS FOR PAINTING; SEMICONDUCTOR MANUFACTURING MACHINES, SUBSTRATE TRANSFER ROBOTS FOR SEMICONDUCTOR MANUFACTURING MACHINES, SUBSTRATE TRANSFER DEVICES FOR SEMICONDUCTOR MANUFACTURING MACHINES; MACHINES FOR THE MANUFACTURE OF INTEGRATED CIRCUITS (U.S. CLS. 13, 19, 21, 23, 31, 34 AND 35).

CLASS 9—ELECTRICAL AND SCIENTIFIC APPARATUS

FOR MEASURING OR TESTING DEVICES AND INSTRUMENTS, NAMELY, AXIS VACUUM ACTUATOR, ELECTRICAL CONTROLLERS; ELECTRICAL POWER DISTRIBUTION UNITS; ELECTRIC CONTROL DEVICES FOR HEATING AND ENERGY MANAGEMENT; ROTARY CONVERTERS; PHASE MODIFIERS; ELECTRIC OR MAGNETIC METERS AND TESTERS, NAMELY, FREQUENCY METERS; TELECOMMUNICATION DEVICES AND APPARATUS, NAMELY, RADIO RECEIVERS; COMPUTERS; ELECTRONIC MACHINES, APPARATUS AND THEIR PARTS, NAMELY, OZONISERS; ELECTROLYSERS; ELECTRIC DOOR OPENERS (U.S. CLS. 21, 23, 26, 36 AND 38).

WENDY JUN, EXAMINING ATTORNEY

SN 79-037,069. BRIGHTSIGHT B.V., NETHERLANDS, FILED 11-22-2006.

BRIGHTSIGHT

THE MARK CONSISTS OF STANDARD CHARACTERS WITHOUT CLAIM TO ANY PARTICULAR FONT, STYLE, SIZE, OR COLOR.

PRIORITY DATE OF 5-22-2006 IS CLAIMED.

OWNER OF INTERNATIONAL REGISTRATION 0920427 DATED 11-22-2006, EXPIRES 11-22-2016.

CLASS 9—ELECTRICAL AND SCIENTIFIC APPARATUS

FOR COMPUTER SOFTWARE FOR USE IN EVALUATING THE SECURITY VALUE OF INTEGRATED CIRCUITS (U.S. CLS. 21, 23, 26, 36 AND 38).

CLASS 41—EDUCATION AND ENTERTAINMENT

FOR EDUCATIONAL SERVICES, NAMELY PROVIDING CLASSES, SEMINARS AND WORKSHOPS IN THE FIELD OF EVALUATING THE SECURITY VALUE OF INTEGRATED CIRCUITS; TRAINING IN THE USE OF COMPUTER SOFTWARE FOR THE PURPOSE OF EVALUATING THE SECURITY VALUE OF INTEGRATED CIRCUITS; ORGANIZATION OF EDUCATIONAL SEMINARS, CONGRESSES AND READINGS IN THE FIELD OF EVALUATING THE SECURITY VALUE OF INTEGRATED CIRCUITS; PUBLISHING OF ELECTRONIC PUBLICATIONS RELATED TO THE EVALUATION OF THE SECURITY VALUE OF INTEGRATED CIRCUITS; PUBLICATION AND PUBLISHING OF EDUCATIONAL BOOKS AND MAGAZINES RELATED TO THE EVALUATION OF THE SECURITY VALUE OF INTEGRATED CIRCUITS (U.S. CLS. 100, 101 AND 107).

CLASS 42—SCIENTIFIC AND COMPUTER SERVICES

FOR PRODUCT RESEARCH AND DEVELOPMENT SERVICES IN THE FIELD OF INFORMATION TECHNOLOGY SECURITY; COMPUTER HARDWARE AND SOFTWARE DEVELOPMENT; MAINTENANCE AND UPDATING OF SOFTWARE; SERVICES OF INFORMATION TECHNOLOGY SPECIALISTS, NAMELY TECHNICAL SUPPORT OF DESIGNERS AND USERS OF INFORMATION TECHNOLOGY PRODUCTS AND SERVICES THAT RELATE TO THE EVALUATION OF THE SECURITY VALUE OF INTEGRATED CIRCUITS (U.S. CLS. 100 AND 101).

BERNICE MIDDLETON, EXAMINING ATTORNEY

SN 79-037,130. OSSERVATORIO ASIA, ITALY, FILED 10-10-2006.

OSSERVATORIO ASIA



OWNER OF INTERNATIONAL REGISTRATION 0920529 DATED 10-10-2006, EXPIRES 10-10-2016.

NO CLAIM IS MADE TO THE EXCLUSIVE RIGHT TO USE "ASIA", APART FROM THE MARK AS SHOWN.

THE COLOR(S) BLACK AND RED IS/ARE CLAIMED AS A FEATURE OF THE MARK.

THE MARK CONSISTS OF THE WORDING "OSSERVATORIO ASIA" WRITTEN IN ORIGINAL CAPITAL LETTERS WHERE "OSSERVATORIO" IS IN BLACK AND "ASIA" IN RED; THE TWO WORDS ARE SEPARATED BY A BLACK THICK VERTICAL LINE NARROWED AT THE END.

THE ENGLISH TRANSLATION OF "OSSERVATORIO" IS OBSERVATORY.

CLASS 35—ADVERTISING AND BUSINESS

FOR SERVICES OF ORGANIZATION AND MANAGEMENT OF MEETINGS, EXHIBITIONS AND SHOWS FOR COMMERCIAL AND ADVERTISING PURPOSES (U.S. CLS. 100, 101 AND 102).

CLASS 41—EDUCATION AND ENTERTAINMENT

FOR SERVICES OF ORGANIZATION AND MANAGEMENT OF SEMINARS (U.S. CLS. 100, 101 AND 107).

PAUL E. FAHRENKOPF, EXAMINING ATTORNEY

SN 79-037,155. HERM. SPRENGER GMBH & CO. KG, FED REP GERMANY, FILED 11-15-2006.

BowBalance

THE MARK CONSISTS OF STANDARD CHARACTERS WITHOUT CLAIM TO ANY PARTICULAR FONT, STYLE, SIZE, OR COLOR.

PRIORITY DATE OF 6-21-2006 IS CLAIMED.

OWNER OF INTERNATIONAL REGISTRATION 0920607 DATED 11-15-2006, EXPIRES 11-15-2016.

CLASS 6—METAL GOODS

FOR SPURS (U.S. CLS. 2, 12, 13, 14, 23, 25 AND 50).

CLASS 9—ELECTRICAL AND SCIENTIFIC APPARATUS

FOR HELMETS FOR HORSE RIDING (U.S. CLS. 21, 23, 26, 36 AND 38).

CLASS 18—LEATHER GOODS

FOR STIRRUPS OF METAL, HARNESS FITTINGS OF IRON, BITS FOR ANIMALS, NAMELY, HORSES, HARNESS FOR ANIMALS, PARTS OF RUBBER FOR STIRRUPS, COLLARS FOR HORSES, COLLARS FOR PETS, DOG COLLARS, CHIN STRAPS OF LEATHER ATTACHED TO HARNESSES FOR HORSES, KNEE PADS FOR HORSE SADDLES, LEASHES FOR ANIMALS, HORSE HALTERS, HORSE COLLARS, RIDING SADDLES, SADDLE TREES, SADDLE CLOTHS FOR HORSES, FASTENINGS FOR SADDLES, SADDLERY, BLINDERS FOR HORSES, STIRRUP LEATHERS, BRIDDOONS, PADS FOR HORSE SADDLES, HARNESS STRAPS, REINS, BRIDLES AND TRACES (U.S. CLS. 1, 2, 3, 22 AND 41).

WOODROW HARTZOG, EXAMINING ATTORNEY

SN 79-037,197. HO CHIN CHAN; TRADING AS BEAMBLES EDUCATION, SINGAPORE, AND DHERRY BRANDON LEE CHUN HOONG; TRADING AS BEAMBLES EDUCATION, SINGAPORE, FILED 10-26-2006.

Beambles

THE MARK CONSISTS OF STANDARD CHARACTERS WITHOUT CLAIM TO ANY PARTICULAR FONT, STYLE, SIZE, OR COLOR.

PRIORITY DATE OF 5-24-2006 IS CLAIMED.

OWNER OF INTERNATIONAL REGISTRATION 0920730 DATED 10-26-2006, EXPIRES 10-26-2016.

CLASS 16—PAPER GOODS AND PRINTED MATTER

FOR A SERIES OF BOOKS, WRITTEN ARTICLES, HANDOUTS AND WORKSHEETS IN THE FIELD OF MATH, SCIENCE, LANGUAGES, NAMELY, THE ENGLISH LANGUAGE AND THE CHINESE LANGUAGE, ART AND CRAFTS; BOOKS IN THE FIELD OF MATH, SCIENCE, LANGUAGES, NAMELY, THE ENGLISH LANGUAGE AND THE CHINESE LANGUAGE, ART AND CRAFTS; CHILDREN'S ACTIVITY BOOKS; CHILDREN'S BOOKS; CHILDREN'S INTERACTIVE EDUCATIONAL BOOKS; CHILDREN'S STORYBOOKS; COLORING BOOKS; COMPOSITION BOOKS; CROSSWORD PUZZLES; EDUCATIONAL BOOKS FEATURING MATH, SCIENCE, LANGUAGES, NAMELY, THE ENGLISH LANGUAGE AND THE CHINESE LANGUAGE, ART AND CRAFTS; EDUCATIONAL PUBLICATIONS, NAMELY, TRAINING MANUALS IN THE FIELD OF MATH, SCIENCE, LANGUAGES, NAMELY, THE ENGLISH LANGUAGE AND THE CHINESE LANGUAGE, ART AND CRAFTS; ENCYCLOPAEDIAS; FLASH CARDS; FLIP BOOKS; NON-FICTION BOOKS ON A VARIETY OF TOPICS IN THE FIELD OF MATH, SCIENCE, LANGUAGES, NAMELY, THE ENGLISH LANGUAGE AND THE CHINESE LANGUAGE, ART AND CRAFTS; PICTURE BOOKS; PRINTED MUSIC BOOKS; PRINTED TEACHING ACTIVITY GUIDES IN THE FIELD OF MATH, SCIENCE, LANGUAGES, NAMELY, THE ENGLISH LANGUAGE AND THE CHINESE LANGUAGE, ART AND CRAFTS; PRINTED TEACHING MATERIALS IN THE FIELD OF MATH, SCIENCE, LANGUAGES, NAMELY, THE ENGLISH LANGUAGE AND THE CHINESE LANGUAGE, ART AND CRAFTS; PUBLICATIONS, NAMELY, BROCHURES, BOOKLETS, AND TEACHING MATERIALS IN THE FIELD OF MATH, SCIENCE, LANGUAGES, NAMELY, THE ENGLISH LANGUAGE AND THE CHINESE LANGUAGE, ART AND CRAFTS; QUICK REFERENCE POCKET GUIDES IN THE FIELD OF MATH, SCIENCE, LANGUAGES, NAMELY, THE ENGLISH LANGUAGE AND THE CHINESE LANGUAGE, ART AND CRAFTS; SERIES OF FICTION AND NON-FICTION BOOKS ON A VARIETY OF TOPICS IN THE FIELD OF MATH, SCIENCE, LANGUAGES, NAMELY, THE ENGLISH LANGUAGE AND THE CHINESE LAN-

GUAGE, ART AND CRAFTS; SERIES OF FICTION BOOKS; SERIES OF NON-FICTION BOOKS IN THE FIELD OF MATH, SCIENCE, LANGUAGES, NAMELY, THE ENGLISH LANGUAGE AND THE CHINESE LANGUAGE, ART AND CRAFTS; SONG BOOKS; STORIES IN ILLUSTRATED FORM; STORY BOOKS; STUDY GUIDES; WORKBOOKS DIRECTED TO MATH, SCIENCE, LANGUAGES, NAMELY, THE ENGLISH LANGUAGE AND THE CHINESE LANGUAGE, ART AND CRAFTS; BOOKS IN THE FIELD OF MATH, SCIENCE, LANGUAGES, NAMELY, THE ENGLISH LANGUAGE AND THE CHINESE LANGUAGE, ART AND CRAFTS; HANDBOOKS IN THE FORM OF MATH, SCIENCE, ENGLISH LANGUAGE, CHINESE LANGUAGE, AND ART AND CRAFTS MANUALS; GENERAL FEATURE MAGAZINES; NEWSLETTERS IN THE FIELD OF MATH, SCIENCE, LANGUAGES, NAMELY, THE ENGLISH LANGUAGE AND THE CHINESE LANGUAGE, ART AND CRAFTS; CARTOON PRINTS; CARTOON STRIPS; COMIC BOOKS; COMIC STRIPS; NOVELS; BOOKMARKS; PHOTOGRAPHS; STATIONERY; ADHESIVES FOR STATIONERY OR HOUSEHOLD PURPOSES; PASTELS; PENCILS; PENS; CANVAS PANELS; ARTS AND CRAFT CLAY KITS; ARTS AND CRAFT PAINT KITS; PAINT BRUSHES; PRINTERS' TYPE; PRINTING BLOCKS; GREETING CARDS; POSTCARDS; WRITING OR DRAWING BOOKS; WRITING PADS; NOTE BOOKS; SCRAPBOOKS; ERASERS; DRAWING INSTRUMENTS; PEN CASES; PENCIL HOLDERS; ELECTRIC OR NON-ELECTRIC PENCIL SHARPENERS; PAPERWEIGHTS; DOCUMENT FILES; FOLDERS; POSTERS; PICTURES; BOOKMARKERS; STICKERS; ALL INCLUDED IN THIS CLASS (U.S. CLS. 2, 5, 22, 23, 29, 37, 38 AND 50).

CLASS 28—TOYS AND SPORTING GOODS

FOR ACTION FIGURE DOLLS; ACTION FIGURES AND ACCESSORIES THEREFOR; ACTION SKILL GAMES; ACTION TARGET GAMES; BALLS FOR GAMES; BATH TOYS; BATHTUB TOYS; BATTERY OPERATED ACTION TOYS; BEAN BAG DOLLS; CARNIVAL MASKS; CAT TOYS; CHILDREN'S MULTIPLE ACTIVITY TOYS; COLLECTABLE TOY FIGURES; COSTUME MASKS; DOG TOYS; FANTASY CHARACTER TOYS; FURNITURE FOR DOLL'S HOUSES; HAND HELD UNIT FOR PLAYING ELECTRONIC GAMES; HAND HELD UNIT FOR PLAYING VIDEO GAMES; PET TOYS; PLAYING CARDS; SQUEEZE TOYS; TALKING TOYS; ACTION FIGURES; TOY BALLOONS; BALLOONS; BOARD GAMES; TOY BUILDING BLOCKS; CARD GAMES; CHRISTMAS TREE DECORATIONS EXCEPT CONFECTIONERY OR ILLUMINATION ARTICLES; DOLLS; DOLLS' FURNITURE; DOLLS' HOUSES; ELECTRONIC EDUCATION GAME MACHINES FOR CHILDREN; ELECTRONIC ACTION TOYS AND ELECTRONIC ACTION TOYS INCORPORATING A TALKING MECHANISM; ELECTRONIC EDUCATIONAL TEACHING GAMES; ELECTRONIC LEARNING TOYS; ELECTRONIC TOY VEHICLES; AUTOMATIC HAND-HELD COMPUTER VIDEO GAMES EXCEPT THOSE ADAPTED FOR USE WITH TELEVISION RECEIVERS; AUTOMATIC HAND-HELD ELECTRONIC GAMES EXCEPT THOSE ADAPTED FOR USE WITH TELEVISION RECEIVERS; HAND PUPPETS; INFLATABLE POOL TOYS; INFLATABLE TOYS; JIGSAW PUZZLES; KITES; PAPER DOLLS; PLASTIC CHARACTER TOYS; PLAY FIGURES; PLAY HOUSES; PLAY TENTS; SLIDES; JUNGLE GYMS; SEE-SAWS; SWING SETS; PLUSH DOLLS; PLUSH TOY FIGURES; PLUSH TOYS; PUPPETS; PUZZLES; RIDE-ON TOY VEHICLES; RIDE-ON TOY MOTORIZED VEHICLES; RIDE-ON TOYS; RUBBER CHARACTER TOYS; SOFT SCULPTURE TOYS; SPINNING TOPS; STUFFED PLUSH DOLLS; STUFFED PLUSH TOYS; STUFFED TOY FIGURINES; STUFFED TOYS; TEDDY BEARS; TOY AUTOMOBILES; TOY FIGURES; TOY FURNITURE; TOY HOUSES; TOY VEHICLES; TOY WEAPONS; TRADING CARD GAMES; WATER SQUIRTING TOYS; WOODEN TOY FIGURES; WOODEN TOY BLOCKS; ALL INCLUDED IN THIS CLASS (U.S. CLS. 22, 23, 38 AND 50).

CLASS 35—ADVERTISING AND BUSINESS

FOR COMPUTERIZED ON-LINE ORDERING FEATURING BOOKS, BEAUTY AND HEALTH PRODUCTS, COMPUTER HARDWARE AND SOFTWARE, ELECTRONICS, FOOD, JEWELLERY, GIFTS, GENERAL MERCHANDISE AND GENERAL CONSUMER GOODS; COMPUTERIZED ON-LINE RETAIL STORE SERVICES IN THE FIELD OF BOOKS, BEAUTY AND HEALTH PRODUCTS, COMPUTER HARDWARE AND SOFTWARE, ELECTRONICS, FOOD, JEWELLERY, GIFTS, GENERAL MERCHANDISE AND GENERAL CONSUMER GOODS; ON-LINE RETAIL STORE SERVICES FEATURING BOOKS, BEAUTY AND HEALTH PRODUCTS, COMPUTER HARDWARE AND SOFTWARE, ELECTRONICS, FOOD, JEWELLERY, GIFTS, GENERAL MERCHANDISE AND GENERAL CONSUMER GOODS; OPERATING AN ON-LINE SHOPPING SITE IN THE FIELD OF BOOKS, BEAUTY AND HEALTH PRODUCTS, COMPUTER HARDWARE AND SOFTWARE, ELECTRONICS, FOOD, JEWELLERY, GIFTS, GENERAL MERCHANDISE AND GENERAL CONSUMER GOODS; OPERATING ON-LINE MARKETPLACES FEATURING BOOKS, BEAUTY AND HEALTH PRODUCTS, COMPUTER HARDWARE AND SOFTWARE, ELECTRONICS, FOOD, JEWELLERY, GIFTS, GENERAL MERCHANDISE AND GENERAL CONSUMER GOODS; DIRECT MAIL ADVERTISING; ADVERTISING SERVICES; ADVERTISING AND ADVERTISEMENT SERVICES; ADVERTISING SERVICES PROVIDED OVER THE INTERNET; RENTAL OF ADVERTISING SPACE; RENTAL OF ADVERTISING SPACE ON THE INTERNET; PROVIDING A WEB SITE WHICH FEATURES ADVERTISEMENTS FOR THE GOODS AND SERVICES OF OTHERS ON A GLOBAL COMPUTER NETWORK; ADVERTISING AND COMMERCIAL INFORMATION SERVICES, VIA THE INTERNET; COLLECTION, PREPARATION, COMPOSITION, PROCESSING, ACQUISITION AND PROVISION OF BUSINESS INFORMATION, DATA, STATISTICS AND INDICES; COMPILATION AND SYSTEMATISATION OF INFORMATION IN DATABANKS; COMPUTERIZED DATABASE MANAGEMENT; COLLECTION OF BUSINESS INFORMATION AND DATA; ACQUISITION AND PROVISION OF BUSINESS INFORMATION AND DATA; PROCESSING OF COMPUTER DATABASES FEATURING BUSINESS INFORMATION, DATA, STATISTICS; BUSINESS SERVICES, NAMELY, PROVIDING COMPUTER DATABASES REGARDING THE PURCHASE AND SALE OF A WIDE VARIETY OF PRODUCTS AND SERVICES OF OTHERS; DATABASE MANAGEMENT; MANAGEMENT AND COMPILATION OF COMPUTERIZED DATABASES; ALL INCLUDED IN THIS CLASS (U.S. CLS. 100, 101 AND 102).

DAVID MURRAY, EXAMINING ATTORNEY

SN 79-037,264. STARA STEFANO ALESSANDRO; E ZUCCON TAMARA, ITALY, FILED 2-23-2007.



OWNER OF INTERNATIONAL REGISTRATION 0920930 DATED 2-23-2007, EXPIRES 2-23-2017.

CLASS 3—COSMETICS AND CLEANING PREPARATIONS

FOR SOAPS; PERFUMERY, ESSENTIAL OILS, COSMETICS, HAIR LOTIONS; DENTIFRICES (U.S. CLS. 1, 4, 6, 50, 51 AND 52).

CLASS 18—LEATHER GOODS

FOR LEATHER AND IMITATIONS OF LEATHER, NAMELY, ALL-PURPOSE MEN'S AND WOMEN'S CARRYING BAGS, BANDOLIERS, PURSES, TRAVELING BAGS, BANDS OF LEATHER, KEY HOLDERS, CREDIT CARDS AND DOCUMENTS CASES, BUSINESS CARD CASES, DIARY CASES, BRIEFCASES, COIN PURSES, WALLETS (U.S. CLS. 1, 2, 3, 22 AND 41).

CLASS 25—CLOTHING

FOR CLOTHING, NAMELY, LEATHER JACKETS, LEATHER SKIRTS, SUITS, TROUSERS, SHIRTS, JEANS, COATS, RAINCOATS, ANORAKS, JACKETS, SKIRTS, T-SHIRTS, SWEATERS, CARDIGANS, MEN'S AND WOMEN'S HOSIERY AND UNDERWEAR, PAJAMAS, NIGHTGOWNS, SPORT APPAREL, FLEECEES, BEACHWEAR, SHAWLS AND SCARVES, TIES, CAPS, HATS, VISORS, GLOVES, BELTS, FOOTWEAR, NAMELY, SHOES, BOOTS AND SANDALS (U.S. CLS. 22 AND 39).

FLORENTINA BLANDU, EXAMINING ATTORNEY

SN 79-037,338. SOLVAY SA, B-1050 BRUXELLES, BELGIUM, FILED 4-12-2007.

EPICEROL

THE MARK CONSISTS OF STANDARD CHARACTERS WITHOUT CLAIM TO ANY PARTICULAR FONT, STYLE, SIZE, OR COLOR.

OWNER OF INTERNATIONAL REGISTRATION 0891154 DATED 7-3-2006, EXPIRES 7-3-2016.

THE WORDING "EPICEROL" HAS NO MEANING IN ENGLISH.

CLASS 1—CHEMICALS

FOR CHEMICALS USED IN INDUSTRY AND SCIENCE; UNPROCESSED ARTIFICIAL AND SYNTHETIC RESINS, UNPROCESSED PLASTICS; ADHESIVES USED IN INDUSTRY (U.S. CLS. 1, 5, 6, 10, 26 AND 46).

CLASS 40—MATERIAL TREATMENT

FOR MATERIAL TREATMENT SERVICES, NAMELY, TREATMENT OF MATERIALS FOR THE MANUFACTURE OF EPICHLOROHYDRIN; WATER AND PAPER TREATMENT SERVICES (U.S. CLS. 100, 103 AND 106).

CLASS 42—SCIENTIFIC AND COMPUTER SERVICES

FOR SCIENTIFIC AND TECHNOLOGICAL SERVICES, NAMELY, NEW PRODUCT DEVELOPMENT FOR OTHERS IN THE FIELD OF CHEMICAL PRODUCTS AND NEW PRODUCT RESEARCH AND DESIGN SERVICES PERFORMED IN CONNECTION THEREWITH; INDUSTRIAL RESEARCH SERVICES IN THE FIELD OF CHEMICAL PRODUCT DEVELOPMENT (U.S. CLS. 100 AND 101).

MAURÉEN DALL, EXAMINING ATTORNEY

SN 79-037,405. SIRE ANALYTICAL SYSTEMS SRL, ITALY,
FILED 3-9-2007.

HB&L

THE MARK CONSISTS OF STANDARD CHARACTERS WITHOUT CLAIM TO ANY PARTICULAR FONT, STYLE, SIZE, OR COLOR.

PRIORITY DATE OF 1-30-2007 IS CLAIMED.
OWNER OF INTERNATIONAL REGISTRATION 0921222
DATED 3-9-2007, EXPIRES 3-9-2017.

CLASS 5—PHARMACEUTICALS

FOR ANTIBACTERIAL PHARMACEUTICALS; ANTI-BIOTICS; DIAGNOSTIC REAGENTS FOR CLINICAL AND MEDICAL LABORATORY USE; CLINICAL AND MEDICAL REAGENTS; MEDICAL DIAGNOSTIC REAGENTS; MEDIA FOR BACTERIOLOGICAL CULTURES (U.S. CLS. 6, 18, 44, 46, 51 AND 52).

CLASS 10—MEDICAL APPARATUS

FOR MEDICAL DIAGNOSTIC APPARATUS FOR BACTERIOLOGICAL TESTS ON HUMAN BIOLOGICAL LIQUIDS (U.S. CLS. 26, 39 AND 44).

TINA KUAN, EXAMINING ATTORNEY

SN 79-037,481. ROYAL COLLECTION INCORPORATED,
JAPAN, FILED 3-26-2007.



PRIORITY DATE OF 2-7-2007 IS CLAIMED.
OWNER OF INTERNATIONAL REGISTRATION 0921442
DATED 3-26-2007, EXPIRES 3-26-2017.

CLASS 18—LEATHER GOODS

FOR BAGS, NAMELY, HANDBAGS, PURSES, ALL-PURPOSE SPORTS BAGS, ALL-PURPOSE ATHLETIC BAGS, AND ALL-PURPOSE CARRYING BAGS; AND UMBRELLAS AND THEIR PARTS (U.S. CLS. 1, 2, 3, 22 AND 41).

CLASS 25—CLOTHING

FOR CLOTHING, NAMELY, JACKETS, SKIRTS, SLACKS, COATS, SWEATERS, SHIRTS, BLOUSES, SOCKS, GLOVES, SCARVES, BANDANAS, MUFFLERS, HATS, CAPS, HEADBANDS, BELTS, AND SUSPENDERS; FOOTWEAR; AND GOLF SHOES (U.S. CLS. 22 AND 39).

CLASS 28—TOYS AND SPORTING GOODS

FOR GOLF IMPLEMENTS, NAMELY, GOLF CLUBS, HEADS FOR GOLF CLUBS, SHAFTS FOR GOLF CLUBS, GRIPS FOR GOLF CLUBS, GOLF BAGS, GOLF BALL MARKERS FOR GREENS, GOLF TEES, GOLF GLOVES, GOLF BALLS, GOLF BALL CLEANERS, AND GOLF DRIVING MATS (U.S. CLS. 22, 23, 38 AND 50).

ELLEN BURNS, EXAMINING ATTORNEY

SN 79-037,484. ELOPAK SYSTEMS AG, CH-8152 GLATTBRUGG, SWITZERLAND, FILED 9-28-2006.



OWNER OF INTERNATIONAL REGISTRATION 0921449
DATED 9-28-2006, EXPIRES 9-28-2016.
OWNER OF U.S. REG. NOS. 2,294,951 AND 3,371,124.

CLASS 7—MACHINERY

FOR MACHINES FOR PRODUCTION AND COATING OF CARDBOARD AND PAPER; MOULDING MACHINES, NAMELY, INJECTION MOULDING MACHINES, EXTRUSION MOULDING MACHINES, BLOW MOULDING MACHINES AND THERMOFORMING MACHINES; MACHINES AND MOULDS FOR MOULDING PACKAGING FITTINGS, CLOSURES OR CAPS; MACHINES FOR APPLYING FITTINGS, CLOSURES OR CAPS TO PACKAGING CONTAINERS; MACHINES FOR PRODUCING, FILLING AND HANDLING CONTAINERS; PACKAGING MACHINES; PACKAGE FILLING MACHINES; CASING MACHINES FOR INDUSTRIAL USE; RINSING MACHINES FOR INDUSTRIAL USE; LABELING MACHINES FOR PACKAGING; PRINTING MACHINES FOR PACKAGING USE; INK JET PRINTING MACHINES FOR PACKAGING USE; CONVEYORS; MACHINES FOR HANDLING AND LOADING ROLL CONTAINERS; WRAPPING MACHINES; MACHINES FOR PRODUCING CARTONS OR OTHER CONTAINERS; MACHINES FOR CASTING FORMED CONTAINERS; MACHINES FOR ATTACHING CONTAINERS TOGETHER (U.S. CLS. 13, 19, 21, 23, 31, 34 AND 35).

CLASS 16—PAPER GOODS AND PRINTED MATTER

FOR WRAPPING AND PACKAGING MATERIAL PARTLY OR WHOLLY OF PAPER, PAPERBOARD OR CARDBOARD; PACKAGING SHEETS OR FILMS PARTLY OR WHOLLY OF PAPER, PAPERBOARD OR CARDBOARD; PACKAGING CONTAINER BLANKS PARTLY OR WHOLLY OF PAPER, PAPERBOARD OR CARDBOARD; PACKAGING CONTAINERS MADE OF PAPER, PAPERBOARD OR CARDBOARD; PACKAGING CONTAINERS PARTLY OR WHOLLY OF PAPER, PAPERBOARD OR CARDBOARD; PACKAGING CARTONS OF PAPER, PAPERBOARD OR CARDBOARD; PACKAGING POUCHES OF PAPER, PAPERBOARD OR CARDBOARD; PACKAGING BLANKS AND CONTAINERS OF PAPER, PAPERBOARD OR CARDBOARD WITH FITTINGS, CLOSURES, OR CAPS; PRINTED INSTRUCTIONAL AND TEACHING MATERIAL IN THE FIELD OF PACKAGING (U.S. CLS. 2, 5, 22, 23, 29, 37, 38 AND 50).

CLASS 20—FURNITURE AND ARTICLES NOT OTHERWISE CLASSIFIED

FOR NON-METAL AND NON-PAPER CONTAINERS AND PACKAGINGS FOR FOODSTUFFS; CONTAINERS, NOT OF METAL FOR COMMERCIAL USE; PLASTICS PACKAGING CONTAINERS; PLASTIC CRATES; NON-METALLIC TRAYS, NAMELY, PLASTICS PACKAGING TRAYS; CONTAINERS WHOLLY OR MAINLY OF PLASTICS MATERIAL FOR COMMERCIAL USE; PACKAGING CONTAINERS NOT OF METAL OR PAPER FOR COMMERCIAL USE; PACKAGING CONTAINERS WHOLLY OR MAINLY OF PLASTICS MATERIAL; NON-METAL, NON-PAPER FITTINGS, CLOSURES, AND CAPS, FOR PACKAGING CONTAINERS (U.S. CLS. 2, 13, 22, 25, 32 AND 50).

PETER B. BROMAGHIM, EXAMINING ATTORNEY

SN 79-037,714. EUGEN WOERNER GMBH & CO KG; ZENTRALSCHMIERANLAGEN, FED REP GERMANY, FILED 8-1-2006.

Woerner

OWNER OF INTERNATIONAL REGISTRATION 0503878 DATED 3-14-1986, EXPIRES 3-14-2016. SEC. 2(F).

CLASS 6—METAL GOODS

FOR FLEXIBLE METAL HOSES, METAL TUBES, METAL TUBE COUPLINGS, AND METAL COLLARS FOR TUBES, AND METAL STORAGE TANKS (U.S. CLS. 2, 12, 13, 14, 23, 25 AND 50).

CLASS 7—MACHINERY

FOR PARTS OF LUBRICATION INSTALLATIONS, NAMELY, ELECTRIC PUMPS AND ELECTRIC DISTRIBUTORS; CENTRALIZED LUBRICATION INSTALLATIONS COMPOSED PRIMARILY OF ELECTRIC PUMPS AND ELECTRIC DISTRIBUTORS; MECHANICAL AND HYDRAULIC LUBRICATION UNITS; LUBRICATION INSTALLATION ACCESSORIES, NAMELY, LUBRICATION CHECK VALVES, LUBRICATION FILTERS, LUBRICATION NOZZLES, LUBRICATION CHOKE VALVES AND PULVERIZERS; OIL PRESSURE LUBRICATION INSTALLATIONS CONSISTING PRIMARILY OF LUBRICATION TANKS, LUBRICATION PUMPS, LUBRICATION FILTERS, LUBRICATION HEAT EXCHANGERS, AND LUBRICATION CHECK VALVES; HYDRAULIC CONTRACTORS; HYDRAULIC DIVERter VALVES FOR PULVERIZER MACHINES (U.S. CLS. 13, 19, 21, 23, 31, 34 AND 35).

CLASS 9—ELECTRICAL AND SCIENTIFIC APPARATUS

FOR ELECTRIC AND ELECTRONIC DIFFERENTIAL PRESSURE SWITCHES, TEST AND CONTROL PANELS, INDICATOR PANELS AND BOARDS, DOSING PARTS, TEMPERATURE INDICATORS, PRESSURE GAUGES AND LEVEL MEASURING INSTRUMENTS; DOSING PARTS FOR LUBRICATION INSTALLATIONS, LEVEL GAUGES, AND CONTRACTORS FOR LUBRICATION INSTALLATIONS (U.S. CLS. 21, 23, 26, 36 AND 38).

CLASS 17—RUBBER GOODS

FOR FLEXIBLE PLASTIC HOSES; TUBE COUPLINGS OF PLASTIC (U.S. CLS. 1, 5, 12, 13, 35 AND 50).

CLASS 20—FURNITURE AND ARTICLES NOT OTHERWISE CLASSIFIED

FOR FIXING COLLARS FOR TUBES OF PLASTIC (U.S. CLS. 2, 13, 22, 25, 32 AND 50). WARREN L. OLANDRIA, EXAMINING ATTORNEY

SN 79-037,641. IID, INC., JAPAN, FILED 2-26-2007.

InterfaceAsia

OWNER OF INTERNATIONAL REGISTRATION 0921861 DATED 2-26-2007, EXPIRES 2-26-2017.

CLASS 38—COMMUNICATION

FOR COMMUNICATION BY ELECTRONIC COMPUTER TERMINALS; COMMUNICATION BY MOBILE TELEPHONE (U.S. CLS. 100, 101 AND 104).

CLASS 42—SCIENTIFIC AND COMPUTER SERVICES

FOR COMPUTER SERVICES, NAMELY, PROVIDING SEARCH ENGINES FOR OBTAINING DATA ON THE INTERNET; COMPUTER SOFTWARE DESIGN; COMPUTER PROGRAMMING; MAINTENANCE OF COMPUTER SOFTWARE (U.S. CLS. 100 AND 101).

DAVID YONTEF, EXAMINING ATTORNEY

SN 79-037,805. SBS SOFTWARE GESELLSCHAFT M.B.H., AUSTRIA, FILED 2-23-2007.

KIXOPERATOR

THE MARK CONSISTS OF STANDARD CHARACTERS WITHOUT CLAIM TO ANY PARTICULAR FONT, STYLE, SIZE, OR COLOR.

PRIORITY DATE OF 11-27-2006 IS CLAIMED.
OWNER OF INTERNATIONAL REGISTRATION 0922284 DATED 2-23-2007, EXPIRES 2-23-2017.

CLASS 9—ELECTRICAL AND SCIENTIFIC APPARATUS

FOR COMPUTER SOFTWARE AND HARDWARE USED TO MONITOR AND CONTROL AUTOMATED CASH DISPENSERS, SELF-SERVICE TERMINALS, NETWORKS OF AUTOMATED CASH DISPENSERS, AND NETWORKS OF SELF-SERVICE TERMINALS (U.S. CLS. 21, 23, 26, 36 AND 38).

CLASS 35—ADVERTISING AND BUSINESS

FOR PROFESSIONAL BUSINESS AND ORGANIZATIONAL MANAGEMENT IN THE FIELD OF ELECTRONIC DATA PROCESSING FOR AUTOMATED CASH DISPENSERS AND SELF-SERVICE TERMINALS, COMPUTER AIDED DATABASE ADMINISTRATION FOR OTHERS (U.S. CLS. 100, 101 AND 102).

CLASS 42—SCIENTIFIC AND COMPUTER SERVICES

FOR CONSULTING SERVICES FOR THE DEVELOPMENT, TECHNICAL SUPPORT, AND OPERATION OF ELECTRONIC DATA PROCESSING IN COMPUTER NETWORKS; TECHNICAL MANAGEMENT OF ELECTRONIC DATA PROCESSING PROJECTS; DEVELOPMENT OF COMPUTER PROGRAMS; INSTALLATION, MAINTENANCE AND REPAIR OF SOFTWARE FOR DATA SYSTEMS TECHNOLOGY INSTALLATIONS (U.S. CLS. 100 AND 101).

FLORENTINA BLANDU, EXAMINING ATTORNEY

SN 79-037,819. QUBA SAILS LIMITED, UNITED KINGDOM, FILED 3-9-2007.

QUBA SAILS

THE MARK CONSISTS OF STANDARD CHARACTERS WITHOUT CLAIM TO ANY PARTICULAR FONT, STYLE, SIZE, OR COLOR.

PRIORITY DATE OF 9-9-2006 IS CLAIMED.
OWNER OF INTERNATIONAL REGISTRATION 0922314 DATED 3-9-2007, EXPIRES 3-9-2017.

CLASS 18—LEATHER GOODS

FOR LUGGAGE; BAGS, NAMELY, CARRY-ALL BAGS, BOOK BAGS, ATHLETIC BAGS, KIT BAGS, OVERNIGHT BAGS, SPORTS BAGS, TRAVEL BAGS, TOTE BAGS; ARTICLES OF LUGGAGE BEING BAGS, NAMELY, CARRY-ALL BAGS, BOOK BAGS, ATHLETIC BAGS, KIT BAGS, OVERNIGHT BAGS, SPORTS BAGS, TRAVEL BAGS, TOTE BAG; RUCKSACKS; TRAVELING BAGS; HOLDALLS; HIPSACKS; SACHELS; BEACH BAGS; DRAW BAGS, NAMELY, DRAWSTRING POUCHES; DUFFLE BAGS; BARREL BAGS; AND SPONGE BAGS, NAMELY, WASH BAGS FOR CARRYING TOILETRIES (U.S. CLS. 1, 2, 3, 22 AND 41).

CLASS 20—FURNITURE AND ARTICLES NOT OTHERWISE CLASSIFIED

FOR FURNITURE; SOFAS, ARMCHAIRS, CHAIRS, TABLES, STOOLS, BEAN BAGS; MIRRORS; AND PICTURE FRAMES (U.S. CLS. 2, 13, 22, 25, 32 AND 50).
BENJAMIN OKEKE, EXAMINING ATTORNEY

SN 79-037,846. BEHN + BATES; MASCHINENFABRIK GMBH & CO. KG, FED REP GERMANY, FILED 2-12-2007.

BEHN + BATES TOPLINE

THE MARK CONSISTS OF STANDARD CHARACTERS WITHOUT CLAIM TO ANY PARTICULAR FONT, STYLE, SIZE, OR COLOR.

PRIORITY DATE OF 8-14-2006 IS CLAIMED.
OWNER OF INTERNATIONAL REGISTRATION 0922411 DATED 2-12-2007, EXPIRES 2-12-2017.

CLASS 7—MACHINERY

FOR PACKING MACHINES IN THE NATURE OF MACHINES FOR FILLING PAPER OR PLASTIC OPEN BAGS OR VALVE BAGS WITH BULK MATERIAL, COMESTIBLE GOODS AND ANIMAL FEED; PACKING MACHINES, NAMELY, FILLING MACHINES WITH ONE OR SEVERAL FILLING SPOUTS, AND STRUCTURAL REPLACEMENT PARTS THEREFORE; PACKING MACHINES, NAMELY, FILLING MACHINES WITH FILLING SPOUTS ARRANGED IN LINE; PACKING MACHINES, NAMELY, ROTATING FILLING MACHINES; PACKING MACHINES, NAMELY, FILLING MACHINES EQUIPPED WITH BULK MATERIAL WEIGHING EQUIPMENT IN THE NATURE OF SCALES BEING A PART OF THE MACHINE; PACKING MACHINES, NAMELY, FILLING MACHINES FOR USE IN DISPENSING LIQUID MATERIALS; PACKING MACHINES, NAMELY, MACHINES FOR FEEDING EMPTY BAGS ONTO BAG-FILLING MACHINES; PACKING MACHINES, NAMELY, EMPTY BAG MAGAZINES FOR BAG FILLING MACHINES; PACKING MACHINES, NAMELY, MACHINES FOR PLACING EMPTY VALVE BAGS ONTO VALVE BAG FILLING MACHINES; PACKING MACHINES, NAMELY, MACHINES AND MECHANICAL PARTS THEREFORE FOR CLOSING OPEN BAGS; PACKING MACHINES, NAMELY, VALVE BAG FILLING MACHINES AND PARTS THEREOF SOLD AS A UNIT THEREWITH; PACKING MACHINES, NAMELY, VALVE BAG FILLING MACHINES AND PARTS THEREFORE IN THE NATURE OF SEALING JAWS, SEALING SYSTEMS, METERING SYSTEMS, COMPRESSION SYSTEMS, FILLING SYSTEMS, AND WEIGHING SYSTEMS; METAL DETECTORS BEING PART OF PACKING MACHINES; MACHINES AND MECHANICAL PARTS THEREFORE FOR CLOSING THE VALVES OF THE VALVE BAGS AFTER FILLING; WEIGHING SYSTEMS, NAMELY, SCALES BEING PART OF PACKING MACHINES FOR WEIGHING NET AND GROSS WEIGHTS; PACKING MACHINES AND MECHANICAL PARTS IN THE NATURE OF METAL DETECTORS SOLD AS A COMPONENT PART OF VALVE BAG FILLING MACHINES; AND CHECK WEIGHING SYSTEMS COMPRISED OF WEIGHING EQUIPMENT IN THE NATURE OF SCALES BEING A PART OF THE MACHINE, ALL SOLD AS A COMPONENT PART OF VALVE BAG FILLING MACHINES AND FOR USE IN CLOSING THE VALVES OF THE VALVE BAGS AFTER FILLING; INDUSTRIAL MACHINE PRESSES FOR PRODUCING OPEN BAGS; AUTOMATED CONVEYORS, BEING PART OF PACKING MACHINES, FOR FEEDING BULK MATERIALS FOR PROCESSING BY THE PACKING MACHINE (U.S. CLS. 13, 19, 21, 23, 31, 34 AND 35).

CLASS 9—ELECTRICAL AND SCIENTIFIC APPARATUS

FOR ELECTRIC AND ELECTRONIC CONTROLLERS FOR FILLING MACHINES AND PACKING MACHINES; ELECTRIC AND ELECTRONIC CONTROL CONTROLLERS FOR ELECTRIC LUMINESCENT DISPLAY PANELS FOR PACKING MACHINES; ELECTRIC AND ELECTRONIC DISPLAYS, NAMELY, ELECTRIC LUMINESCENT DISPLAY PANELS FOR PACKING MACHINES; ELECTRIC AND ELECTRONIC INDICATOR BOARDS FOR PACKING MACHINES; ELECTRIC AND ELECTRONIC CONTROLLERS FOR SPOUTS OF PACKING MACHINES; ELECTRIC AND ELECTRONIC CONTROLLERS FOR FILLING BAGS WITH BULK MATERIALS; ELECTRIC AND ELECTRONIC CONTROLLERS FOR INDUSTRIAL WEIGHING MACHINES; ELECTRIC AND ELECTRONIC CONTROL CONTROLLERS FOR INDUSTRIAL WEIGHING MACHINES; ELECTRIC AND ELECTRONIC WEIGHING SYSTEMS, NAMELY, SCALES AND BALANCES FOR DETERMINING NET AND GROSS WEIGHTS OF PRODUCTS MADE BY PACKING MACHINES (U.S. CLS. 21, 23, 26, 36 AND 38).

CLASS 42—SCIENTIFIC AND COMPUTER SERVICES

FOR TECHNICAL CONSULTANCY IN THE FIELD OF PACKING MACHINES, NAMELY, TECHNICAL SUPPORT SERVICES IN THE NATURE OF TROUBLESHOOTING OF ELECTRICAL AND ELECTRONIC COMPONENTS OF PACKING MACHINES; TECHNICAL PROJECT STUDIES, NAMELY, TECHNICAL RESEARCH IN THE FIELD OF PRODUCT DEVELOPMENT OF PACKING SYSTEMS; SCIENTIFIC RESEARCH AND DEVELOPMENT IN THE NATURE OF DESIGN ENGINEERING STUDIES; CONDUCTING SAFETY-RELATED ENGINEERING SURVEYS (U.S. CLS. 100 AND 101).

ADA HAN, EXAMINING ATTORNEY

CLASS 41—EDUCATION AND ENTERTAINMENT

FOR PUBLICATION OF SOCIETAL, COMMERCIAL, SCIENTIFIC, TECHNICAL AND ECONOMIC ARTICLES, BOOKS AND MAGAZINES ON THE INTERNET, RELATING TO THE COMPOSITION AND DYNAMICS OF THE ATMOSPHERE, POLLUTION, METEOROLOGY, CLIMATOLOGY AND ASTROPHYSICS; ARRANGING OF EDUCATIONAL AND PROFESSIONAL COLLOQUIUMS AND CONFERENCES IN CONNECTION WITH THE COMPOSITION AND DYNAMICS OF THE ATMOSPHERE, POLLUTION, METEOROLOGY, CLIMATOLOGY AND ASTROPHYSICS; PUBLICATION OF PRINTED SCIENTIFIC ARTICLES AND BOOKS (U.S. CLS. 100, 101 AND 107).

CLASS 42—SCIENTIFIC AND COMPUTER SERVICES

FOR DESIGN AND DEVELOPMENT OF SOFTWARE FOR PROCESSING AND ANALYZING DATA OBTAINED BY OBSERVING ATMOSPHERIC PROCESSES, INDOOR AND OUTDOOR AIR COMPONENTS AND POLLUTION; SCIENTIFIC RESEARCH INTO THE PHYSICAL AND CHEMICAL PROPERTIES OF THE ATMOSPHERE, METEOROLOGY, CLIMATOLOGY, ASTROPHYSICS AND SPACE RESEARCH; SCIENTIFIC RESEARCH, STUDIES AND ADVICE IN CONNECTION WITH THE COMPOSITION AND DYNAMICS OF THE ATMOSPHERE, POLLUTION, METEOROLOGY, CLIMATOLOGY AND ASTROPHYSICS (U.S. CLS. 100 AND 101).

PAULA MAHONEY, EXAMINING ATTORNEY

SN 79-038,160, NOKKA-YHTIÖT OY, FI-40951 MUURAME, FINLAND, FILED 2-16-2007.

SN 79-037,986, LEOSPHERE, FRANCE, FILED 2-9-2007.

NOKKA

EZ LIDAR

OWNER OF INTERNATIONAL REGISTRATION 0923205 DATED 2-16-2007, EXPIRES 2-16-2017.

THE ENGLISH TRANSLATION OF "NOKKA" IS "FRONT" OR "NOSE".

PRIORITY DATE OF 8-11-2006 IS CLAIMED.
OWNER OF INTERNATIONAL REGISTRATION 0922763 DATED 2-9-2007, EXPIRES 2-9-2017.

NO CLAIM IS MADE TO THE EXCLUSIVE RIGHT TO USE "LIDAR", APART FROM THE MARK AS SHOWN.

CLASS 9—ELECTRICAL AND SCIENTIFIC APPARATUS

FOR OPTICAL, OPTO-ELECTRONIC, MECHANICAL, ELECTRONIC AND CHEMICAL MEASURING INSTRUMENTS FOR ANALYZING ATMOSPHERIC PROCESSES, INDOOR AND OUTDOOR AIR COMPONENTS, POLLUTION, AS WELL AS FOR RESEARCH INTO THE PHYSICAL AND CHEMICAL PROPERTIES OF THE ATMOSPHERE, METEOROLOGY, CLIMATOLOGY AND ASTROPHYSICS AND FOR SPACE RESEARCH, NAMELY, LIDAR AND LASER RADARS (U.S. CLS. 21, 23, 26, 36 AND 38).

CLASS 7—MACHINERY

FOR AGRICULTURAL AND FOREST INDUSTRY MACHINES, NAMELY, AGRICULTURAL HARVESTERS, TIMBER HARVESTING MACHINERY, WOOD HARVESTING AND PROCESSING MACHINES, LOADERS, CRANES, GRAPPLE LOADERS, TIMBER GRABBERS, FIREWOOD PROCESSORS, WOOD CHIPPERS, SNOWBLOWERS, SNOW PLOUGHS, AND PARTS AND FITTINGS FOR THE AFOREMENTIONED GOODS (U.S. CLS. 13, 19, 21, 23, 31, 34 AND 35).

CLASS 12—VEHICLES

FOR VEHICLES, NAMELY, LAND VEHICLES; APPARATUS FOR LOCOMOTION BY LAND USED IN THE FOREST AND AGRICULTURAL INDUSTRIES, NAMELY, TRAILORS, FOREST TRAILERS, LOADER TRAILERS, TRACTOR TRAILERS, TRACTORS, HARVESTER CARRIERS; AND PARTS AND FITTING FOR THE AFOREMENTIONED GOODS (U.S. CLS. 19, 21, 23, 31, 35 AND 44).

NICHOLAS ALTREE, EXAMINING ATTORNEY

SN 79-038,204. FIPA GMBH, FED REP GERMANY, FILED 9-6-2006.



OWNER OF INTERNATIONAL REGISTRATION 0923376 DATED 9-6-2006, EXPIRES 9-6-2016.

THE COLOR(S) RED AND BLACK IS/ARE CLAIMED AS A FEATURE OF THE MARK.

THE MARK CONSISTS OF THE STYLIZED WORDING FIPA HAVING THE LETTER "F" APPEARING IN RED AND THE LETTERS "IPA" APPEARING IN BLACK.

THE WORDING "FIPA" HAS NO MEANING IN A FOREIGN LANGUAGE.

CLASS 7—MACHINERY

FOR VACUUM PUMPS, SIDE CHANNEL POWER OPERATED BLOWERS, MACHINE PARTS, NAMELY CYLINDERS IN THE NATURE OF SUCTION CUP CARRIER LIFTING CYLINDERS, METAL CLAMPS USED FOR HOLDING PIECE PARTS ON MACHINE TOOL TABLES, VALVES FOR PUMPS, NAMELY, FLOW AND PUSH VALVES; MACHINE PARTS, NAMELY, VACUUM SUCTION CUPS; GRIPPING PLIERS, PLIERS, PNEUMATIC AND ELECTRIC SCISSORS, STRUCTURAL REPLACEMENT PARTS FOR INDUSTRIAL ROBOTS, NAMELY, ROBOTIC ARMS AND HANDS; MACHINE PARTS, NAMELY VACUUM SUCTION CUPS OF GUM, RUBBER, POLYMERS AND ELASTOMERS (U.S. CLS. 13, 19, 21, 23, 31, 34 AND 35).

CLASS 17—RUBBER GOODS

FOR SEMI-FINISHED OR RAW PRODUCTS, NAMELY, RUBBER AND GUM IN THE FORM OF BLOCKS, SLABS, RODS, FILMS, CORDS OR BANDS AND PLASTIC IN EXTRUDED FORM FOR USE IN MANUFACTURE; PACKING MATERIALS FOR FORMING SEALS; AND ELECTRICAL INSULATING MATERIALS; FLEXIBLE PIPES, NOT OF METAL (U.S. CLS. 1, 5, 12, 13, 35 AND 50).

CLASS 37—CONSTRUCTION AND REPAIR

FOR MAINTENANCE AND REPAIR OF MACHINES AND MACHINE PARTS, NAMELY, VACUUM CLEANERS, VACUUM PUMPS, POWER OPERATED BLOWERS, SUCTION CUP CARRIERS, CLAMPING AND GRIPPING DEVICES, INDUSTRIAL ROBOTS AND PARTS OF THE AFOREMENTIONED MACHINES (U.S. CLS. 100, 103 AND 106).

SHARON MEIER, EXAMINING ATTORNEY

SN 79-038,238. EUROPEAN CHANNEL DEVELOPMENT LIMITED, UNITED KINGDOM, FILED 2-9-2007.

JARMIES

THE MARK CONSISTS OF STANDARD CHARACTERS WITHOUT CLAIM TO ANY PARTICULAR FONT, STYLE, SIZE, OR COLOR.

PRIORITY DATE OF 8-9-2006 IS CLAIMED.

OWNER OF INTERNATIONAL REGISTRATION 0923459 DATED 2-9-2007, EXPIRES 2-9-2017.

THE TERM "JARMIES" HAS NO MEANING IN A FOREIGN LANGUAGE.

CLASS 9—ELECTRICAL AND SCIENTIFIC APPARATUS

FOR APPARATUS AND INSTRUMENTS FOR RECORDING AND REPRODUCING SOUND AND VIDEO; AMUSEMENT APPARATUS IN THE NATURE OF VIDEO GAME MACHINES FOR USE WITH TELEVISION RECEIVERS; CHILDREN'S EDUCATIONAL MUSIC DVDS AND LASER DISCS; ELECTRONIC CHILDREN'S BOOKS RECORDED ON COMPUTER MEDIA; AUDIO TAPES FEATURING RECORDED CHILDREN'S BOOKS; HAND-HELD UNITS FOR PLAYING ELECTRONIC GAMES FOR USE WITH EXTERNAL DISPLAY SCREENS OR MONITORS; COMPUTER GAME CARTRIDGES, PROGRAMS AND TAPES; PRE-RECORDED COMPACT DISKS FEATURING MUSIC; BLANK RECORDING DISKS; COMPACT DISCS (CD'S) FEATURING MUSIC; GRAMOPHONE RECORDS FEATURING MUSIC; AUDIO TAPES FEATURING MUSIC; AUDIO TAPE CASSETTES FEATURING MUSIC; VIDEO TAPES FEATURING MUSIC; AUDIO TAPES FEATURING MUSIC; AUDIO TAPE CASSETTES FEATURING MUSIC; VIDEO TAPES FEATURING ANIMATED CARTOONS; SUNGLASSES; CASES FOR SUNGLASSES; CALCULATORS; BICYCLE HELMETS; PROTECTION AND SAFETY FLOATS FOR BATHING AND SWIMMING; LIFE PRESERVING WATER WINGS FOR SAFETY AND PROTECTION; SWIMMING LIFE BELTS (U.S. CLS. 21, 23, 26, 36 AND 38).

CLASS 14—JEWELRY

FOR TEACHING CLOCKS (U.S. CLS. 2, 27, 28 AND 50).

CLASS 16—PAPER GOODS AND PRINTED MATTER

FOR PAPER; CARDBOARD; CHILDREN'S BOOKS; PRINTED ANNUALS ABOUT FICTIONAL CHARACTERS; COMIC BOOKS, SONG BOOKS; MAGAZINES ABOUT FICTIONAL CHARACTERS AND STORIES; PHOTOGRAPH ALBUMS; POSTERS; STATIONERY; DRAWING AND PAINTING MATERIALS, APPARATUS AND INSTRUMENTS, NAMELY, PENCILS, PENS, PAINT BRUSHES, PALETTES, CANVASES AND TABLETS; PRINTED INSTRUCTIONAL AND TEACHING MATERIALS FEATURING FICTIONAL CHARACTERS AND STORIES; BOOK COVERS; BOOK MARKS; PRINTING BLOCKS, FONTS AND TYPES; PHOTOGRAPHS; PICTURES; CALENDARS; GIFT WRAP PAPER, GREETING CARDS, WRAPPING PAPER; STICKERS (U.S. CLS. 2, 5, 22, 23, 29, 37, 38 AND 50).

CLASS 25—CLOTHING

FOR CLOTHING, NAMELY, SHIRTS, PANTS, SHORTS AND JACKETS; FOOTWEAR; HEADGEAR, NAMELY, HATS AND CAPS (U.S. CLS. 22 AND 39).

CLASS 28—TOYS AND SPORTING GOODS

FOR TOYS, GAMES AND PLAYTHINGS, NAMELY, PLUSH TOYS AND BOARD GAMES; DECORATIONS FOR CHRISTMAS TREES; SPORTING BAGS AND CONTAINERS SPECIALLY ADAPTED FOR CARRYING SPORTS ARTICLES; PLAYING CARDS (U.S. CLS. 22, 38 AND 50).

CLASS 41—EDUCATION AND ENTERTAINMENT

FOR ENTERTAINMENT SERVICES IN THE NATURE OF ONGOING TELEVISION PROGRAMS IN THE FIELD OF CHILDREN'S ENTERTAINMENT; PUBLISHING OF BOOKS AND MAGAZINES; PUBLICATION OF BOOKS AND MAGAZINES; ORGANIZATION OF SOCCER COMPETITIONS; PRODUCTION OF RADIO AND TELEVISION PROGRAMS, MOTION PICTURE FILMS AND TELEVISION SHOWS; ENTERTAINMENT SERVICES IN THE NATURE OF ONGOING TELEVISION AND RADIO PROGRAMS IN THE FIELD OF CHILDREN'S ENTERTAINMENT AND ENTERTAINMENT IN THE NATURE OF THEATRE PRODUCTIONS; THEATRE PRODUCTION SERVICES (U.S. CLS. 100, 101 AND 107).

CHARLOTTE CORWIN, EXAMINING ATTORNEY

SN 79-038,271. PALA INVESTMENTS AG, CH-6300 ZUG, SWITZERLAND, FILED 4-16-2007.

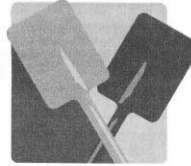

PALA

PRIORITY DATE OF 2-21-2007 IS CLAIMED.
OWNER OF INTERNATIONAL REGISTRATION 0923556
DATED 4-16-2007, EXPIRES 4-16-2017.

THE FOREIGN WORDING IN THE MARK TRANSLATES INTO ENGLISH AS SHOVEL.

CLASS 35—ADVERTISING AND BUSINESS

FOR ADVERTISING SERVICES; BUSINESS MANAGEMENT; BUSINESS ADMINISTRATION AND OFFICE WORK (U.S. CLS. 100, 101 AND 102).

CLASS 36—INSURANCE AND FINANCIAL

FOR FINANCIAL PLANNING AND INVESTMENT ADVISORY SERVICES; INVESTMENT ADVICE; FINANCIAL INVESTMENT IN THE MINING AND NATURAL RESOURCES SECTOR; FINANCIAL AND INVESTMENT SERVICES, NAMELY, MANAGEMENT AND BROKERAGE IN THE FIELDS OF STOCKS, BONDS, OPTIONS, COMMODITIES, FUTURES AND OTHER SECURITIES; PROVIDING INFORMATION AND ADVICE IN THE FIELD OF FINANCE, FINANCIAL INVESTMENTS, AND FINANCIAL VALUATIONS; MANAGEMENT OF PRIVATE EQUITY FUNDS; EQUITY CAPITAL INVESTMENT; FINANCIAL SERVICES, NAMELY, ASSISTING OTHERS WITH THE COMPLETION OF FINANCIAL TRANSACTIONS FOR STOCKS, BONDS, SECURITIES AND EQUITIES; INVESTMENT SERVICES, NAMELY, ASSET ACQUISITION, CONSULTATION, DEVELOPMENT AND MANAGEMENT SERVICES (U.S. CLS. 100, 101 AND 102).

ALICE BENMAMAN, EXAMINING ATTORNEY

SN 79-038,251. KAEFER ISOLIERTECHNIK GMBH & CO. KG, FED REP GERMANY, FILED 9-19-2006.

KAEFER Aerospace

THE MARK CONSISTS OF STANDARD CHARACTERS WITHOUT CLAIM TO ANY PARTICULAR FONT, STYLE, SIZE, OR COLOR.

PRIORITY DATE OF 3-20-2006 IS CLAIMED.

OWNER OF INTERNATIONAL REGISTRATION 0923506
DATED 9-19-2006, EXPIRES 9-19-2016.

NO CLAIM IS MADE TO THE EXCLUSIVE RIGHT TO USE "AEROSPACE", APART FROM THE MARK AS SHOWN.

THE ENGLISH TRANSLATION OF THE WORD "KAEFER" IN THE MARK IS "BEETLE".

CLASS 7—MACHINERY

FOR SOUND ABSORBERS FOR SMOKE INSTALLATIONS, EXHAUST GAS INSTALLATIONS, AIR SUPPLY INSTALLATIONS AND STEAM BLOW-OFF INSTALLATIONS OR COOLING UNITS (U.S. CLS. 13, 19, 21, 23, 31, 34 AND 35).

CLASS 17—RUBBER GOODS

FOR INSULATING MATERIAL AND INSULATING ELEMENTS, IN PARTICULAR SOUND, HEAT, COLD AND HUMIDITY INSULATING MATERIAL IN THE FORM OF BULK MATERIAL, MATS, PANELS, PIPE SLEEVES OR OTHER SHAPED BODIES, INSULATING ELEMENTS FOR WALL DUCTS; PREFABRICATED HEAT, COLD AND SOUND INSULATING WALLS, CEILINGS AND TUNNELS; FIRE PROTECTION INSULATION; SOUND DAMPING MATERIALS; SOUND-PROOFING MATERIALS (U.S. CLS. 1, 5, 12, 13, 35 AND 50).

CLASS 37—CONSTRUCTION AND REPAIR

FOR REPAIR AND MAINTENANCE OF FIRE PROTECTION, HEAT, COLD AND SOUND INSULATION; INSTALLATION SERVICES, IN PARTICULAR INSTALLATION OF FIRE PROTECTION, HEAT, COLD AND SOUND INSULATION (U.S. CLS. 100, 103 AND 106).

RON FAIRBANKS, EXAMINING ATTORNEY

SN 79-038,332. AVIO-DIEPEN HOLDING B.V., NL-2408 AC ALPHEN AAN DEN RIJN, NETHERLANDS, FILED 11-21-2006.



PRIORITY DATE OF 10-19-2006 IS CLAIMED.
OWNER OF INTERNATIONAL REGISTRATION 0923728
DATED 11-21-2006, EXPIRES 11-21-2016.

OWNER OF U.S. REG. NO. 2,511,418.

THE COLOR(S) BLUE, WHITE AND ORANGE IS/ARE CLAIMED AS A FEATURE OF THE MARK.

THE COLOR BLUE APPEARS IN THE WORDS "AVIO-DIEPEN" AND THE CIRCLE DESIGN, THE DESIGN WITHIN THE CIRCLE IS WHITE. THE DESIGN UNDER THE WORDS IS ORANGE.

"AVIO-DIEPEN" HAS NO MEANING IN A FOREIGN LANGUAGE.

CLASS 35—ADVERTISING AND BUSINESS

FOR BUSINESS CONSULTANCY ON IMPORT AND EXPORT OF GOODS PERTAINING TO PARTS, ACCESSORIES AND EQUIPMENT FOR AIRCRAFT; BUSINESS CONSULTANCY ON THE PURCHASE OF PARTS, ACCESSORIES AND EQUIPMENT FOR AIRCRAFTS; ADMINISTRATIVE SERVICES, NAMELY, LOGISTICS MANAGEMENT IN THE FIELD OF AIRCRAFT PARTS AND COMPONENTS; ADMINISTRATIVE PROCESSING OF PURCHASE ORDERS PERTAINING TO PARTS, ACCESSORIES AND EQUIPMENT FOR AIRCRAFT; STOCK MANAGEMENT, NAMELY, INVENTORY MANAGEMENT IN THE FIELD OF AIRCRAFT PARTS AND COMPONENTS; PURCHASE AND SALE CALCULATIONS PERTAINING TO PARTS, ACCESSORIES AND EQUIPMENT FOR AIRCRAFT, NAMELY, COST ACCOUNTING; BUSINESS INTERMEDIARY SERVICES FOR THE ORDERING OF PRODUCTS AND SERVICES BY ELECTRONIC MEANS PERTAINING TO PARTS, ACCESSORIES AND EQUIPMENT FOR AIRCRAFT; ORGANIZATION OF COMMERCIAL EVENTS FOR OTHERS IN THE NATURE OF MARKETING PROMOTIONAL EVENTS; MEDIATION OF BUSINESS CONTACTS FOR THE PURCHASE OF SERVICES; MEDIATION OF BUSINESS CONTACTS FOR THE PURCHASE OF SERVICES BY ELECTRONIC MEANS; INVOICING, ALSO BY ELECTRONIC MEANS (U.S. CLS. 100, 101 AND 102).

CLASS 39—TRANSPORTATION AND STORAGE

FOR DISTRIBUTION IN THE NATURE OF DELIVERY SERVICES PERTAINING TO PARTS, ACCESSORIES AND EQUIPMENT FOR AIRCRAFT; GOODS STORAGE PERTAINING TO PARTS, ACCESSORIES AND EQUIPMENT FOR AIRCRAFT; TRANSPORT OF PARTS, ACCESSORIES AND EQUIPMENT FOR AIRCRAFT; LOGISTICS SERVICES, NAMELY, TRANSPORTATION AND DELIVERY OF AIRCRAFT PARTS, ACCESSORIES AND EQUIPMENT BY AIR, RAIL, TRUCK AND SHIP (U.S. CLS. 100 AND 105).

BRIAN PINO, EXAMINING ATTORNEY

SN 79-038,407. VALERYD INVEST AB, SWEDEN, FILED 3-8-2007.

OWNER OF INTERNATIONAL REGISTRATION 0923922 DATED 3-8-2007, EXPIRES 3-8-2017.

CLASS 12—VEHICLES

FOR VEHICLES FOR LOCOMOTION, APPARATUS FOR LOCOMOTION BY LAND, AIR OR WATER, NAMELY AUTOMOBILES, BOATS AND TROLLEYS; CASTERS FOR TROLLEYS, TRAILERS AND TRUCKS; MOTORS FOR LAND VEHICLES; CLUTCHES, SUSPENSION SYSTEMS AND TRANSMISSION COMPONENTS FOR LAND VEHICLES; AIR CUSHION VEHICLES (U.S. CLS. 19, 21, 23, 31, 35 AND 44).

CLASS 37—CONSTRUCTION AND REPAIR

FOR REPAIR, MAINTENANCE AND INSTALLATION SERVICES FOR AUTOMOBILES AND TROLLEYS (U.S. CLS. 100, 103 AND 106).

ANNE MADDEN, EXAMINING ATTORNEY

SN 79-038,428. RUWEL GMBH, FED REP GERMANY, FILED 3-13-2007.

PRIORITY DATE OF 12-7-2006 IS CLAIMED.
OWNER OF INTERNATIONAL REGISTRATION 0923999 DATED 3-13-2007, EXPIRES 3-13-2017.

OWNER OF U.S. REG. NO. 3,050,966.
THE COLOR(S) GREEN AND GREY IS/ARE CLAIMED AS A FEATURE OF THE MARK.

THE LETTERS "RUWEL" ARE IN GREY AND THE GEOMETRIC SHAPES AND UNDERLINING ARE IN GREEN.

CLASS 9—ELECTRICAL AND SCIENTIFIC APPARATUS

FOR ELECTRICAL AND ELECTRONICAL COMPONENTS, NAMELY, PRINTED CIRCUIT BOARDS (U.S. CLS. 21, 23, 26, 36 AND 38).

CLASS 17—RUBBER GOODS

FOR EXTRUDED PLASTIC BASE MATERIAL FOR PRINTED CIRCUIT BOARDS (U.S. CLS. 1, 5, 12, 13, 35 AND 50).

JOHN E. MICHOS, EXAMINING ATTORNEY

SN 79-038,466. LOSBERGER INTERTENT GMBH, FED REP GERMANY, FILED 2-23-2007.

THE MARK CONSISTS OF STANDARD CHARACTERS WITHOUT CLAIM TO ANY PARTICULAR FONT, STYLE, SIZE, OR COLOR.

OWNER OF INTERNATIONAL REGISTRATION 0924126 DATED 2-23-2007, EXPIRES 2-23-2017.

CLASS 6—METAL GOODS

FOR TRANSPORTABLE BUILDINGS, IN PARTICULAR, LIGHTWEIGHT PREFABRICATED HALLS, AFORESAID OF METAL AND LIGHT METAL; ROOFING OF METAL AND LIGHT METAL AND ROOF COVERINGS OF METAL AND LIGHT METAL, NAMELY, METAL ROOFING TILES; ACCESSORIES AND INTERIOR FITTING ACCESSORIES ALL OF METAL AND LIGHT METAL FOR THE AFORESAID GOODS, NAMELY, METAL FLOORS, PREFABRICATED METAL PODIUM PLATFORMS, GALLERY FIXTURES IN THE NATURE OF METAL FRAMEWORKS, METAL SHELF BRACKETS; TRANSPORTABLE FLOORS OF METAL (U.S. CLS. 2, 12, 13, 14, 23, 25 AND 50).

CLASS 22—CORDAGE AND FIBERS

FOR TENTS FOR EXHIBITIONS AND EVENTS, SUN SHADING AWNINGS, NAMELY, TARPULINS, CANOPIES; RAIN SHELTER AWNINGS, ALL MADE OF TEXTILE (U.S. CLS. 1, 2, 7, 19, 22, 42 AND 50).

CLASS 43—HOTEL AND RESTAURANT SERVICES

FOR RENTAL OF TRANSPORTABLE BUILDINGS, TENTS, MARQUEES, SUN SHADING ROOFS AND RAIN SHELTERS, RENTAL OF PORTABLE MODULAR BUILDINGS IN THE NATURE OF LIGHTWEIGHT PREFABRICATED HALLS (U.S. CLS. 100 AND 101).

MICHAEL TANNER, EXAMINING ATTORNEY

SN 79-038,468. LOSBERGER INTERTENT GMBH, FED REP GERMANY, FILED 2-23-2007.

MAXIFLEX

THE MARK CONSISTS OF STANDARD CHARACTERS WITHOUT CLAIM TO ANY PARTICULAR FONT, STYLE, SIZE, OR COLOR.

OWNER OF INTERNATIONAL REGISTRATION 0924128 DATED 2-23-2007, EXPIRES 2-23-2017.

CLASS 6—METAL GOODS

FOR TRANSPORTABLE BUILDINGS, IN PARTICULAR, LIGHTWEIGHT PREFABRICATED HALLS, AFORESAID OF METAL AND LIGHT METAL; ROOFING OF METAL AND LIGHT METAL AND ROOF COVERINGS OF METAL AND LIGHT METAL, NAMELY, METAL ROOFING TILES; ACCESSORIES AND INTERIOR FITTING ACCESSORIES ALL OF METAL AND LIGHT METAL FOR THE AFORESAID GOODS, NAMELY, METAL FLOORS, PREFABRICATED METAL PODIUM PLATFORMS, GALLERY FIXTURES IN THE NATURE OF METAL FRAMEWORKS, METAL SHELF BRACKETS; TRANSPORTABLE FLOORS OF METAL (U.S. CLS. 2, 12, 13, 14, 23, 25 AND 50).

CLASS 22—CORDAGE AND FIBERS

FOR TENTS FOR EXHIBITIONS AND EVENTS, SUN SHADING AWNINGS, NAMELY, TARPAULINS, CANOPIES; RAIN SHELTER AWNINGS, ALL MADE OF TEXTILE (U.S. CLS. 1, 2, 7, 19, 22, 42 AND 50).

CLASS 43—HOTEL AND RESTAURANT SERVICES

FOR RENTAL OF IT TRANSPORTABLE BUILDINGS, TENTS, MARQUEES, SUN SHADING ROOFS AND RAIN SHELTERS, RENTAL OF PORTABLE MODULAR BUILDINGS IN THE NATURE OF LIGHTWEIGHT PREFABRICATED HALLS (U.S. CLS. 100 AND 101).

MICHAEL TANNER, EXAMINING ATTORNEY

SN 79-038,469. LOSBERGER INTERTENT GMBH, FED REP GERMANY, FILED 2-23-2007.

EASYFLEX

THE MARK CONSISTS OF STANDARD CHARACTERS WITHOUT CLAIM TO ANY PARTICULAR FONT, STYLE, SIZE, OR COLOR.

OWNER OF INTERNATIONAL REGISTRATION 0924129 DATED 2-23-2007, EXPIRES 2-23-2017.

CLASS 6—METAL GOODS

FOR TRANSPORTABLE BUILDINGS, IN PARTICULAR, LIGHTWEIGHT PREFABRICATED HALLS, AFORESAID OF METAL AND LIGHT METAL; ROOFING OF METAL AND LIGHT METAL AND ROOF COVERINGS OF METAL AND LIGHT METAL, NAMELY, METAL ROOFING TILES; ACCESSORIES AND INTERIOR FITTING ACCESSORIES ALL OF METAL AND LIGHT METAL FOR THE AFORESAID GOODS, NAMELY, METAL FLOORS, PREFABRICATED METAL PODIUM PLATFORMS, GALLERY FIXTURES IN THE NATURE OF METAL FRAMEWORKS, METAL SHELF BRACKETS; TRANSPORTABLE FLOORS OF METAL (U.S. CLS. 2, 12, 13, 14, 23, 25 AND 50).

CLASS 22—CORDAGE AND FIBERS

FOR TENTS FOR EXHIBITIONS AND EVENTS, SUN SHADING AWNINGS, NAMELY, TARPAULINS, CANOPIES; RAIN SHELTER AWNINGS, ALL MADE OF TEXTILE (U.S. CLS. 1, 2, 7, 19, 22, 42 AND 50).

CLASS 43—HOTEL AND RESTAURANT SERVICES

FOR RENTAL OF TRANSPORTABLE BUILDINGS, TENTS, MARQUEES, SUN SHADING ROOFS AND RAIN SHELTERS, RENTAL OF PORTABLE MODULAR BUILDINGS IN THE NATURE OF LIGHTWEIGHT PREFABRICATED HALLS (U.S. CLS. 100 AND 101).

MICHAEL TANNER, EXAMINING ATTORNEY

SN 79-038,472. KTM-SPORTMOTORCYCLE AG, AUSTRIA, FILED 4-2-2007.

KTM

THE MARK CONSISTS OF STANDARD CHARACTERS WITHOUT CLAIM TO ANY PARTICULAR FONT, STYLE, SIZE, OR COLOR.

PRIORITY DATE OF 11-22-2006 IS CLAIMED.

OWNER OF INTERNATIONAL REGISTRATION 0924147 DATED 4-2-2007, EXPIRES 4-2-2017.

CLASS 12—VEHICLES

FOR LAND VEHICLES AND STRUCTURAL PARTS THEREFORE (U.S. CLS. 19, 21, 23, 31, 35 AND 44).

CLASS 37—CONSTRUCTION AND REPAIR

FOR REPAIR OF MOTOR VEHICLES AND MOTORS FOR MOTOR VEHICLES; REPAIR OF MOTOR VEHICLE PARTS (U.S. CLS. 100, 103 AND 106).

VERNA BETH RIRIE, EXAMINING ATTORNEY

SN 79-038,524. DELFORT GROUP AG, AUSTRIA, FILED 2-21-2007.

DELFORT

PRIORITY DATE OF 8-22-2006 IS CLAIMED.
OWNER OF INTERNATIONAL REGISTRATION 0924300
DATED 2-21-2007, EXPIRES 2-21-2017.

CLASS 1—CHEMICALS

FOR PAPER PULP; WOOD PULP FOR MANUFACTURING PURPOSES; SPECIAL WOOD AND PAPER PULP FOR USE IN THE PAPER INDUSTRY (U.S. CLS. 1, 5, 6, 10, 26 AND 46).

CLASS 16—PAPER GOODS AND PRINTED MATTER

FOR PAPER, CARDBOARD AND GOODS MADE FROM THESE MATERIALS, NOT INCLUDED IN OTHER CLASSES, NAMELY, PRINTING PAPER, THIN BASE PAPER, RELEASE BASE PAPER, WRITING PAPER, COPY PAPER, OFFICE PAPER, GRAPHICAL PAPER (U.S. CLS. 2, 5, 22, 23, 29, 37, 38 AND 50).

CLASS 22—CORDAGE AND FIBERS

FOR RAW FIBROUS TEXTILE MATERIALS; TEXTILE FIBERS; RAW FLAX FIBERS; HEMP FIBERS; RAW STRAW FIBERS (U.S. CLS. 1, 2, 7, 19, 22, 42 AND 50).

CLASS 34—SMOKERS' ARTICLES

FOR CIGARETTE PAPER, PLUG WRAP PAPER (U.S. CLS. 2, 8, 9 AND 17).

CLASS 35—ADVERTISING AND BUSINESS

FOR WHOLESALE DISTRIBUTORSHIPS AND RETAIL STORE SERVICES FEATURING MANUFACTURED PAPER PRODUCTS (U.S. CLS. 100, 101 AND 102).
MICHAEL TANNER, EXAMINING ATTORNEY

SN 79-038,526. MAGNA POWERTRAIN AG & CO KG, AUSTRIA, FILED 2-26-2007.

DRIVEN BY PASSION

THE MARK CONSISTS OF STANDARD CHARACTERS WITHOUT CLAIM TO ANY PARTICULAR FONT, STYLE, SIZE, OR COLOR.
OWNER OF INTERNATIONAL REGISTRATION 0924310
DATED 2-26-2007, EXPIRES 2-26-2017.

CLASS 12—VEHICLES

FOR VEHICLES, NAMELY, AUTOMOBILES, TRUCKS, TRACTORS, BUSES, MOTORCYCLES, SNOW MOBILES, AND STRUCTURAL PARTS THEREFOR; SPARE PARTS, NAMELY, MOTORS AND ENGINES FOR LAND VEHICLES (U.S. CLS. 19, 21, 23, 31, 35 AND 44).

CLASS 42—SCIENTIFIC AND COMPUTER SERVICES

FOR COMPUTER PROGRAMMING, MAINTENANCE AND RENTAL OF COMPUTER SOFTWARE, IN PARTICULAR IN THE AREAS CAD(COMPUTER AIDED DESIGN)/CAE(COMPUTER AIDED ENGINEERING)/CAM(COMPUTER AIDED MANUFACTURING)/CIM(COMPUTER INTEGRATED MANUFACTURING) AND SIMULATION; CONSULTANCY IN THE FIELD OF COMPUTER PROGRAMMING, MAINTENANCE AND RENTAL OF COMPUTER SOFTWARE, IN PARTICULAR IN THE AREAS CAD(COMPUTER AIDED DESIGN)/CAE(COMPUTER AIDED ENGINEERING)/CAM(COMPUTER AIDED MANUFACTURING)/CIM(COMPUTER INTEGRATED MANUFACTURING) AND SIMULATION AND TROUBLE SHOOTING OF COMPUTER SOFTWARE PROBLEMS; DEVELOPMENT AND ENGINEERING IN THE AREAS OF VEHICLE DESIGN, VEHICLE PLANNING, CHASSIS DESIGN, DRIVE SYSTEMS, ELECTRONIC SYSTEMS, DEVELOPMENT OF TECHNOLOGY AND COMPONENTS FOR AEROSPACE; MECHANICAL, ELECTRIC, ELECTRONIC AND COMPUTER-ASSISTED RESEARCH IN THE NATURE OF CARRYING OUT OF CHECKS AND TESTS OF VEHICLES AND VEHICLE COMPONENTS IN DRIVING TESTS, ON TEST BENCHES AND BY DYNAMIC SIMULATION (U.S. CLS. 100 AND 101).

CHARLOTTE CORWIN, EXAMINING ATTORNEY

SN 79-038,533. SHINKAWA LTD., JAPAN, FILED 3-27-2007.



PRIORITY DATE OF 1-4-2007 IS CLAIMED.
OWNER OF INTERNATIONAL REGISTRATION 0924325
DATED 3-27-2007, EXPIRES 3-27-2017.
THE COLOR(S) LIGHT BLUE IS/ARE CLAIMED AS A FEATURE OF THE MARK.
THE MARK ITSELF IS SOLID LIGHT BLUE.
THE ENGLISH TRANSLATION OF THE FOREIGN WORD(S) IN THE MARK IS RIVER.
THE TRANSLITERATION OF THE NON-LATIN CHARACTERS IN THE MARK IS KAWA.

CLASS 7—MACHINERY

FOR SEMICONDUCTOR MANUFACTURING MACHINES AND SYSTEMS (U.S. CLS. 13, 19, 21, 23, 31, 34 AND 35).

CLASS 37—CONSTRUCTION AND REPAIR

FOR REPAIR OR MAINTENANCE OF INTEGRATED CIRCUITS MANUFACTURING MACHINES AND SYSTEMS, REPAIR OR MAINTENANCE OF SEMICONDUCTOR MANUFACTURING MACHINES AND SYSTEMS (U.S. CLS. 100, 103 AND 106).
TASNEEM HUSSAIN, EXAMINING ATTORNEY

SN 79-038,554. FÉDÉRATION INTERNATIONALE; DES INGENIEURS-CONSEILS; (FIDIC), SWITZERLAND, FILED 4-23-2007.

FIDIC

THE MARK CONSISTS OF STANDARD CHARACTERS WITHOUT CLAIM TO ANY PARTICULAR FONT, STYLE, SIZE, OR COLOR.

PRIORITY DATE OF 10-26-2006 IS CLAIMED.
OWNER OF INTERNATIONAL REGISTRATION 0924378 DATED 4-23-2007, EXPIRES 4-23-2017.

CLASS 35—ADVERTISING AND BUSINESS

FOR BUSINESS ORGANIZATION AND MANAGEMENT CONSULTING SERVICES, BUSINESS ORGANIZATION AND MANAGEMENT CONSULTING SERVICES IN THE FIELD OF BUSINESS ETHICS; BUSINESS CONSULTING AND LOBBYING SERVICES, NAMELY, PROMOTING THE INTERESTS OF CONSULTING ENGINEERS IN THE FIELDS OF LEGISLATION AND REGULATION (U.S. CLS. 100, 101 AND 102).

CLASS 41—EDUCATION AND ENTERTAINMENT

FOR ORGANIZATION OF MEETINGS FOR CULTURAL AND EDUCATIONAL PURPOSES (U.S. CLS. 100, 101 AND 107).

ALICE BENMAMAN, EXAMINING ATTORNEY

SN 79-038,585. BOO FOO WOO CO., LTD., JAPAN, FILED 3-9-2007.

Natural Boo

PRIORITY DATE OF 12-8-2006 IS CLAIMED.
OWNER OF INTERNATIONAL REGISTRATION 0924439 DATED 3-9-2007, EXPIRES 3-9-2017.

OWNER OF U.S. REG. NO. 2,453,601.
NO CLAIM IS MADE TO THE EXCLUSIVE RIGHT TO USE "NATURAL", APART FROM THE MARK AS SHOWN.
THE COLOR(S) BLUE IS/ARE CLAIMED AS A FEATURE OF THE MARK.

THE COLOR BLUE APPEARS IN THE WORDING "NATURAL BOO", AND IN THE DESIGN ELEMENT OF THE ENTIRE MARK.

CLASS 18—LEATHER GOODS

FOR SPORTS BAGS, BAGS FOR SPORTS, ALL PURPOSE SPORT BAGS, BAGS AND HOLDALLS FOR SPORTS CLOTHING, ATHLETIC BAGS, ALL-PURPOSE ATHLETIC BAGS, ALL-PURPOSE CARRYING BAGS, SHOULDER BAGS, BOSTON BAGS, TOTE BAGS, SLING BAGS, WAIST BAGS, BEACH BAGS, BOOK BAGS, BAGS FOR UMBRELLAS, BELT BAGS, DIAPER BAGS, MESSENGER BAGS, CHARM BAGS, COSMETIC BAGS SOLD EMPTY, MAKE-UP BAGS SOLD EMPTY, TRAVEL BAGS, GARMENT BAGS FOR TRAVEL, GARMENTS FOR PETS, GLADSTONE BAGS, GYM BAGS, HANDBAGS, HIKING BAGS, KEY BAGS, KIT BAGS, LEATHER BAGS, LEATHER HANDBAGS, MESH SHOPPING BAGS, HAT BOXES FOR TRAVEL OF LEATHER, ANIMAL CARRIERS, ATTACHÉ CASES, BRIEFCASES, CREDIT CARD CASES, NAME CARD CASES, DOCUMENT CASES, POCKETBOOKS, KEY CASES, LEATHER CASES, LEATHER CASES FOR KEYS, WALLETS, LEATHER SUITCASES AND WALLETS, KEY WALLETS, POCKET WALLETS, PURSES, CHANGE PURSES, COIN PURSES, MULTI-PURPOSE PURSES, PURSES NOT OF PRECIOUS METAL, BANKNOTE HOLDERS, BILLFOLDS, BACKPACKS, BABY BACKPACKS, SCHOOL-CHILDREN'S BACKPACKS, SMALL BACKPACKS, WAIST PACKS, DAYPACKS, RUCKSACKS, SMALL RUCKSACKS, HIKING RUCKSACKS, HIPSACKS, KNAPSACKS, SCHOOL KNAPSACKS, CLOTHING FOR ANIMALS, PET CLOTHING, COLLARS FOR PETS, ANIMAL LEASHES, DOG SHOES, FUR, ANIMAL HIDES, ANIMAL SKINS, PARASOLS, BEACH PARASOLS, UMBRELLAS, BEACH UMBRELLAS, SUN UMBRELLAS (U.S. CLS. 1, 2, 3, 22 AND 41).

CLASS 25—CLOTHING

FOR CLOTHING, NAMELY, COATS, COATS MADE OF COTTON, COATS OF DENIM, RAIN COATS, WIND COATS, JACKETS, DOWN JACKETS, DENIM JACKETS, RAIN JACKETS, WIND-JACKETS, SWEATERS, V-NECK SWEATERS, TURTLENECK SWEATERS, TURTLENECKS, CARDIGANS, PANTS, SWEAT PANTS, JOGGING PANTS, DENIM PANTS, CAPRI PANTS, TROUSERS, INFANTS' TROUSERS, JEANS, DUNGAREES, PANTALOONS, SKIRTS, T-SHIRTS, POLO SHIRTS, SWEAT SHIRTS, WIND SHIRTS, DRESS SHIRTS, UNDERSHIRTS, GYM SUITS, JOGGING SUITS, WARM UP SUITS, RAIN SUITS, LADIES' SUITS, SWEAT SUITS, TANK TOPS, JERSEYS, VESTS, OVERALLS, BIB OVERALLS, PAJAMAS, BABY DOLL PYJAMAS, SHORTS, WALKING SHORTS, SWEAT SHORTS, BERMUDA SHORTS, BOARDSHORTS, GYM SHORTS, FLEECE SHORTS, TRUNKS, BREECHES, CLAM DIGGERS, INFANT WEAR, INFANT AND TODDLER ONE PIECE CLOTHING, UNDERWEAR, WOMEN'S UNDERWEAR, WOVEN OR KNITTED UNDERWEAR, BRAS, BRASIERES, PANTIES, SHORTS AND BRIEFS, UNDERCLOTHES, CAMISOLES, CHEMISES, UNDERGARMENTS, UNDERGARMENTS, TIGHTS, SOCKS, WOOLEN SOCKS, ANKLE SOCKS, ANKLETS, WINDCHEATERS, ANORAKS, PARKAS, PONCHOS, PULLOVERS, FLEECE PULLOVERS, ATHLETIC UNIFORMS, JOGGING OUTFITS, SWIMMING COSTUMES, SWIMMING TRUNKS, SWIMSUITS, TANKINIS, BEACHWEAR, BATHING COSTUMES, BATHING SUITS, BATHING TRUNKS, HEADWEAR, CHILDREN'S HEADWEAR, HATS, WOOLLY HATS, KNITTED CAPS, BASEBALL CAPS, SWIMMING CAPS, BATHING CAPS, CAPS WITH VISORS, VISORS, SUN VISORS, BEANIES, BERTS, TURBANS, BANDANAS, FOOTWEAR, FOOTWEAR FOR MEN AND WOMEN, ATHLETIC FOOTWEAR, BEACH FOOTWEAR, SHOES, BOOTS, WOMEN'S SHOES AND BOOTS, INFANTS' SHOES AND BOOTS, WORK SHOES AND BOOTS, ATHLETIC SHOES, BEACH SHOES, WINTER BOOTS, RAIN BOOTS, LADIES' BOOTS, ANKLE BOOTS, MOCCASINS, GALOSHES, MUKLUKS, SNEAKERS, BASKETBALL SNEAKERS, THONGS FOR FOOTWEAR, THONGS FOR UNDERWEAR, INSOLES, INSOLES FOR SHOES AND BOOTS, CLOTHING BELTS, CLOTHING BELTS MADE OF LEATHER, CLOTHING BELTS OF TEXTILE, CLOTHING SUSPENDERS, APRONS, LAYETTES, CHILDREN'S AND INFANTS' CLOTH BIBS, BABY BIBS NOT OF PAPER, CLOTH BIBS, CRAVATS, DICKIES, INFANT CLOTH DIAPERS, INFANT DIAPER COVERS, INFANT

SLEEPERS, JACKET LINERS, JODHPURS, KERCHIEFS, BABUSHKAS, MUFFLERS, MUFFS, GLOVES, LEG WARMERS, VEILS, WRIST BAND (U.S. CLS. 22 AND 39).
REBECCA GILBERT, EXAMINING ATTORNEY

SN 79-038,601. VITA-LIFE INTERNATIONAL; FRANCHISING & LICENSING AG, FL-9496 BALZERS, LIECHTENSTEIN, FILED 3-20-2007.



PRIORITY DATE OF 10-31-2006 IS CLAIMED.
OWNER OF INTERNATIONAL REGISTRATION 0924508
DATED 3-20-2007, EXPIRES 3-20-2017.

THE COLOR(S) BLACK, WHITE, ORANGE IS/ARE CLAIMED AS A FEATURE OF THE MARK.

THE COLOR BLACK APPEARS IN THE DOLPHIN ON THE LEFT, THE COLOR ORANGE APPEARS ON THE DOLPHIN ON THE RIGHT, AND THE COLOR WHITE APPEARS IN THE BACKGROUND FIELD BEHIND THE DOLPHINS.

CLASS 9—ELECTRICAL AND SCIENTIFIC APPARATUS

FOR MEASURING, SIGNALING AND CHECKING APPARATUS AND INSTRUMENTS, NAMELY, ANALOG AND DIGITAL SIGNAL GENERATING SYSTEMS FOR GENERATING A PULSED ELECTRICAL SIGNAL TO BE TRANSFERRED TO AN APPLICATOR, SUCH APPLICATORS COMPRISED OF HEADSETS, SPEAKERS, LAMPS, LIGHT EMITTING DIODES AND ELECTRICAL CONDUCTORS IN THE FORM OF PADS, MATS AND STICKS; APPARATUS AND INSTRUMENTS FOR CONDUCTING, SWITCHING, TRANSFORMING, ACCUMULATING, REGULATING OR CONTROLLING ELECTRICITY, NAMELY, BATTERIES, CHARGEABLE BATTERIES, BATTERY CHARGERS, CABLES, CONNECTORS AND TRANSFORMERS; COMPUTER PROGRAMMES, NAMELY, OPERATING SOFTWARE, RECORDED ON DATA CARRIERS AND MEANT FOR ELECTRO-STIMULATION APPARATUS, MAGNETIC FIELD THERAPY APPARATUS, SOUND THERAPY APPARATUS, LIGHT THERAPY APPARATUS AND AROMA THERAPY APPARATUS AND COMBINATIONS OF SUCH THERAPY APPARATUS (U.S. CLS. 21, 23, 26, 36 AND 38).

CLASS 10—MEDICAL APPARATUS

FOR ELECTRO-STIMULATION APPARATUS FOR MEDICAL USE FOR GENERATING ELECTRIC CURRENTS TO BE APPLIED TO THE BODY OF A HUMAN OR ANIMAL PATIENT, MAGNETIC FIELD THERAPY APPARATUS, SOUND THERAPY APPARATUS, NAMELY, SOUND GENERATORS FOR MEDICAL USE TO BE APPLIED TO THE BODY OF A HUMAN OR ANIMAL PATIENT, LIGHT THERAPY APPARATUS, NAMELY, LIGHT SIGNAL GENERATORS FOR MEDICAL USE TO BE APPLIED TO THE BODY OF A HUMAN OR ANIMAL PATIENT, AROMA THERAPY APPARATUS AND COMBINATIONS OF SUCH THERAPY APPARATUS IN THE NATURE OF APPARATUS GENERATING TWO OR MORE OF AN ELECTROMAGNETIC FIELD, SOUND, LIGHT AND/OR AROMA; DIAGNOSTIC APPARATUS, NAMELY, PULSE OXIMETER SENSORS FOR PULSE MEASUREMENT AND MEASURING THE OXYGEN CONTENT IN THE BLOOD, ELECTROENCEPHALOGRAPH DEVICES (LEG), ELECTROCARDIOGRAM DEVICES (EGG), AND ANALYZERS AND METERS FOR MEASURING RESPIRATORY GASSES, AND ACCESSORIES THEREFOR, NAMELY, BAGS AND CONTAINERS, PROTECTIVE COVERS, RACKS, STANDS AND MOUNTS, ALL FOR ELECTRO-STIMULATION THERAPY, MAGNETIC FIELD THERAPY, SOUND THERAPY, LIGHT THERAPY, AROMA THERAPY AND COMBINATIONS OF SUCH THERAPIES (U.S. CLS. 26, 39 AND 44).
KRISTINA MORRIS, EXAMINING ATTORNEY

SN 79-038,706. VITA-LIFE INTERNATIONAL; FRANCHISING & LICENSING AG, FL-9496 BALZERS, LIECHTENSTEIN, FILED 3-20-2007.



PRIORITY DATE OF 10-31-2006 IS CLAIMED.
OWNER OF INTERNATIONAL REGISTRATION 0924781
DATED 3-20-2007, EXPIRES 3-20-2017.

OWNER OF U.S. REG. NO. 2,983,917.
THE COLOR(S) BLACK, WHITE, ORANGE IS/ARE CLAIMED AS A FEATURE OF THE MARK.

THE COLOR BLACK APPEARS IN THE DOLPHIN ON THE LEFT, THE COLOR ORANGE APPEARS ON THE DOLPHIN ON THE RIGHT AND THE WORDING "VITA" AND "LIFE", AND THE COLOR WHITE APPEARS IN THE BACKGROUND FIELD BEHIND THE DOLPHINS AND WORDING.

THE ENGLISH TRANSLATION OF THE WORD "VITA" IN THE MARK IS LIFE.

CLASS 9—ELECTRICAL AND SCIENTIFIC APPARATUS

FOR MEASURING SIGNALING END CHECKING APPARATUS AND INSTRUMENTS; NAMELY, ANALOG AND DIGITAL SIGNAL GENERATING SYSTEMS FOR GENERATING A PULSED ELECTRICAL SIGNAL TO BE TRANSFERRED TO AN APPLICATOR, SUCH APPLICATORS COMPRISED OF HEADSETS, SPEAKERS, LAMPS, LIGHT EMITTING DIODES AND ELECTRICAL CONDUCTORS IN THE FORM OF PADS, MATS AND STICKS; APPARATUS AND INSTRUMENTS FOR CONDUCTING, SWITCHING, TRANSFORMING, ACCUMULATING, REGULATING OR CONTROLLING ELECTRICITY, NAMELY, BATTERIES, CHARGEABLE BATTERIES, BATTERY CHARGERS, CABLE CONNECTORS AND TRANSFORMERS; COMPUTER PROGRAMMES, NAMELY, OPERATING SOFTWARE, RECORDED ON DATA CARRIERS AND MEANT FOR ELECTRO-STIMULATION APPARATUS, MAGNETIC FIELD THERAPY APPARATUS SOUND THERAPY APPARATUS, LIGHT THERAPY APPARATUS AND AROMA THERAPY APPARATUS AND COMBINATIONS OF SUCH THERAPY APPARATUS (U.S. CLS. 21, 23, 26, 36 AND 38).

CLASS 10—MEDICAL APPARATUS

FOR ELECTRO-STIMULATION APPARATUS FOR MEDICAL USE FOR GENERATING ELECTRIC CURRENTS TO BE APPLIED TO THE BODY OF A HUMAN OR ANIMAL PATIENT, MAGNETIC FIELD THERAPY APPARATUS, SOUND THERAPY APPARATUS, NAMELY, SOUND GENERATORS FOR MEDICAL USE TO BE APPLIED TO THE BODY OF A HUMAN OR ANIMAL PATIENT, LIGHT THERAPY APPARATUS, NAMELY, LIGHT SIGNAL GENERATORS FOR MEDICAL USE TO BE APPLIED TO THE BODY OF A HUMAN OR ANIMAL PATIENT AROMA THERAPY APPARATUS AND COMBINATIONS OF SUCH THERAPY APPARATUS IN THE NATURE OF APPARATUS GENERATING TWO OR MORE OF AN ELECTROMAGNETIC FIELD, SOUND, LIGHT AND/OR AROMA; DIAGNOSTIC APPARATUS, NAMELY, PULSE OXIMETER SENSORS FOR PULSE MEASUREMENT AND MEASURING THE OXYGEN CONTENT IN THE BLOOD, ELECTROENCEPHALOGRAPH DEVICES (EEG), ELECTROCARDIOGRAM DEVICES (ECG), AND ANALYZERS AND METERS FOR MEASURING RESPIRATORY GASSES, AND ACCESSORIES THEREFOR, NAMELY, BAGS AND CONTAINERS, PROTECTIVE COVERS, RACKS, STANDS AND MOUNTS, ALL FOR ELECTRO-STIMULATION THERAPY, MAGNETIC FIELD THERAPY, SOUND THERAPY, LIGHT THERAPY, AROMA THERAPY AND COMBINATIONS OF SUCH THERAPIES (U.S. CLS. 26, 39 AND 44).

KRISTINA MORRIS, EXAMINING ATTORNEY

CLASS 9—ELECTRICAL AND SCIENTIFIC APPARATUS

FOR PROTECTIVE HELMETS, HELMETS FOR MOTORCYCLISTS; SPECTACLES; SUNGLASSES; EYEGLASSES, SPECTACLE CASES, SPECTACLE CHAINS, SPECTACLE FRAMES, SPECTACLE LENSES, PINCENETZ; SPORTS GLASSES, GOGGLES FOR SPORTS, MOTORCYCLE GOGGLES; VEHICLE BREAKDOWN WARNING TRIANGLES; REFLECTIVE MIRRORS TO PREVENT ACCIDENTS; NAVIGATION APPARATUS FOR VEHICLES IN THE NATURE OF ON-BOARD COMPUTERS; SENSORS FOR THE DETERMINATION OF TEMPERATURES, POSITIONS AND DISTANCES; SHOES FOR PROTECTION AGAINST ACCIDENTS AND FIRE; PROTECTIVE CLOTHING; GLOVES FOR PROTECTION AGAINST ACCIDENTS; PROTECTIVE FACE-SHIELDS FOR PROTECTIVE HELMETS (U.S. CLS. 21, 23, 26, 36 AND 38).

CLASS 12—VEHICLES

FOR MOTORCYCLES; MOTORBIKES; MOTORCYCLE ENGINES; MOTORCYCLE SADDLEBAGS; LUGGAGE CARRIERS FOR VEHICLES; ANTI-THEFT ALARMS FOR VEHICLES; MOTORCYCLE SIDECARS; PNEUMATIC TYRES AND INNER TUBES FOR MOTORCYCLES; PARTS OF MOTORCYCLES, NAMELY, BRAKE CABLES, CLUTCH CABLES, FORK BEARINGS AND RACES, FORK DUST BOOTS, FORK SEALS, HANDLE BARS, HANDLE BAR CONTROL LEVERS, HANDLE BAR DAMPERS, HANDLE BAR GRIPS, BRAKE CALIPERS, BRAKE PEDALS, BRAKE ROTORS, FRONT SPACERS, FRONT DASH PANELS, SHIFT LEVERS, HEADLIGHT MOUNTS, HANDLE BAR THROTTLES (U.S. CLS. 19, 21, 23, 31, 35 AND 44).

SN 79-038,741. MAPAM ITALIA S.R.L., ITALY, FILED 10-3-2006.



PRIORITY DATE OF 4-21-2006 IS CLAIMED.
OWNER OF INTERNATIONAL REGISTRATION 0924860
DATED 10-3-2006, EXPIRES 10-3-2016.

NO CLAIM IS MADE TO THE EXCLUSIVE RIGHT TO USE "ITALY", APART FROM THE MARK AS SHOWN.

THE MARK CONSISTS OF A SIGN DEPICTING A CIRCULAR OUTLINED FIGURE PLACED INSIDE WHICH THERE IS A BAND ALSO CIRCULAR AND OUTLINED INTERRUPTED BY SEMI-CIRCULAR FIGURES, ALL CONTAINING THE WORDING "ACC ITALY" IN FANCY CHARACTERS, THE PORTION "ACC" BEING LARGER IN SIZE AND OUTLINED AND ABOVE THE PORTION "ITALY", THE UPPER STROKE OF THE LETTER "A" FLANKED ON THE LEFT BY A RECTANGLE DIVIDED INTO THREE VERTICAL SPACES OF EQUAL SIZE.

CLASS 18—LEATHER GOODS

FOR RUCKSACKS; PURSES, HANDBAGS, SHOULDER BAGS, LUGGAGE, BEACH BAGS, CLUTCH BAGS, ALL PURPOSE SPORTS BAGS, ATTACHE CASES, SCHOOL BAGS, TOTE BAGS, TRAVELLING BAGS, BACKPACKS, LEATHER CASES, WALLETS FOR CREDIT CARDS, DOCUMENT BRIEFCASES, COSMETIC CASES SOLD EMPTY, KEYCASES, KNAPSACKS, BRIEFCASES, WALLETS, TRAVELLING TRUNKS, SUITCASES, VALISES, UMBRELLAS, PARASOLS, WALKING STICKS (U.S. CLS. 1, 2, 3, 22 AND 41).

CLASS 37—CONSTRUCTION AND REPAIR

FOR CLEANING AND POLISHING OF METAL; MOTORCYCLE CUSTOMIZATION SERVICES; RENTAL OF CLEANING EQUIPMENT; VEHICLE CLEANING; VEHICLE DETAILING; VEHICLE GREASING; VEHICLE LUBRICATION; VEHICLE MAINTENANCE CONSULTATION; VEHICLE PAINTING; VEHICLE POLISHING; VEHICLE REPAIR AND MAINTENANCE; VEHICLE REPAIR CONSULTATION; VEHICLE UNDERCOATING SERVICES; VEHICLE WASHING; TIRE RETREADING; TIRE VULCANIZATION, BALL BEARING REPAIR SERVICES (U.S. CLS. 100, 103 AND 106).

CLASS 40—MATERIAL TREATMENT

FOR LASER AND WATER JET CUTTING OF METALLIC SHEETS; METAL LAMINATING; VULCANIZATION; BURNISHING BY ABRASION; LASER SCRIBING OF METAL SHEETS; METAL TEMPERING; METAL PLATING; METAL CASTING; MACHINE SHOP SERVICES, NAMELY, WORKING METAL IN A LATHE FOR OTHERS (U.S. CLS. 100, 103 AND 106).

GEOFFREY FOSDICK, EXAMINING ATTORNEY

SN 79-038,885. HELU KABEL GMBH, FED REP GERMANY,
FILED 3-12-2007.



OWNER OF INTERNATIONAL REGISTRATION 0751479
DATED 11-6-2000, EXPIRES 11-6-2010.

CLASS 9—ELECTRICAL AND SCIENTIFIC APPARATUS

FOR ELECTRIC CABLES, WIRES, CONDUCTORS AND CONNECTING ARMATURES BELONGING THERETO; THREADED CABLE CONNECTORS OF METAL; THREADED CABLE CONNECTORS OF PLASTIC MATERIAL; CABLE BINDERS OF PLASTIC MATERIAL FOR USE IN CONDUCTING ELECTRICITY; PLASTIC CONDUITS IN THE NATURE OF HELICES OF PLASTIC MATERIAL FOR USE WITH HARNESSSES, WIRES, PLASTIC TUBES AND INDIVIDUAL CABLES ALL USED IN CONDUCTING ELECTRICITY (U.S. CLS. 21, 23, 26, 36 AND 38).

CLASS 17—RUBBER GOODS

FOR PROTECTIVE PLASTIC TUBES FOR USE IN CONDUCTING ELECTRICITY, INSULATING PLASTIC TUBES AND THREADED TUBE CONNECTORS OF PLASTIC MATERIAL AND METAL FOR USE IN CONDUCTING ELECTRICITY (U.S. CLS. 1, 5, 12, 13, 35 AND 50).

RENEE SERVANCE, EXAMINING ATTORNEY

SN 79-038,978. KUMKANG SHOE CO., LTD., REPUBLIC OF KOREA, FILED 12-22-2006.

THE MARK CONSISTS OF STANDARD CHARACTERS WITHOUT CLAIM TO ANY PARTICULAR FONT, STYLE, SIZE, OR COLOR.

OWNER OF INTERNATIONAL REGISTRATION 0925404
DATED 12-22-2006, EXPIRES 12-22-2016.

CLASS 18—LEATHER GOODS

FOR BRIEF CASES, HANDBAGS, RUCK SACKS, PURSES, UMBRELLAS, WALKING STICKS (U.S. CLS. 1, 2, 3, 22 AND 41).

CLASS 25—CLOTHING

FOR LOW-HEELED SHOES; ACCESSORIES FOR SHOE PROTECTION, NAMELY, INSOLES AND SHOE SOLES; BASKETBALL SHOES, MOUNTAINEERING BOOTS, SANDALS, GENTLEMEN'S SUITS, SKIRTS, CARDIGAN JACKETS, GLOVES FOR CLOTHING, HATS, BELTS FOR CLOTHING (U.S. CLS. 22 AND 39).

WENDY JUN, EXAMINING ATTORNEY

SN 79-039,054. ILUNA GROUP S.P.A., ITALY, FILED 4-5-2007.

THE MARK CONSISTS OF STANDARD CHARACTERS WITHOUT CLAIM TO ANY PARTICULAR FONT, STYLE, SIZE, OR COLOR.

PRIORITY DATE OF 12-14-2006 IS CLAIMED.

OWNER OF INTERNATIONAL REGISTRATION 0925594
DATED 4-5-2007, EXPIRES 4-5-2017.

OWNER OF U.S. REG. NO. 3,189,661.

THE WORDING "ILUNA" HAS NO MEANING IN A FOREIGN LANGUAGE.

CLASS 24—FABRICS

FOR CLOTH TEXTILES FOR USE IN THE MANUFACTURE OF CLOTHING, UNDERWEAR, COTTON STOCKINGS, SOCKS, LEOTARDS, TIGHTS, PANTY HOSE, PANTIES, UNDERPANTS, BRIEFS, BRAS, BRASSIERES, CORSETS, SUSPENDERS, SUSPENDER-BELTS, GARTERS, T-SHIRTS, VESTS (U.S. CLS. 42 AND 50).

CLASS 25—CLOTHING

FOR CLOTHING, NAMELY COTTON STOCKINGS, SOCKS, LEOTARDS, TIGHTS, PANTY HOSE, UNDERWEAR, PANTIES, UNDERPANTS, BRIEFS, BRAS, BRASSIERES, CORSETS, SUSPENDERS, SUSPENDER-BELTS, GARTERS, T-SHIRTS, VESTS (U.S. CLS. 22 AND 39).

CLASS 26—FANCY GOODS

FOR LACE AND EMBROIDERY, RIBBONS AND BRAIDS, HOOKS AND UNDERWIRES FOR HABERDASHERY (U.S. CLS. 37, 39, 40, 42 AND 50).

ELI HELLMAN, EXAMINING ATTORNEY

SN 79-039,546. UNION DES ASSOCIATIONS EUROPEENNES; DE FOOTBALL (UEFA), SWITZERLAND,
FILED 10-24-2006.

UEFA CHAMPIONS LEAGUE

THE MARK CONSISTS OF STANDARD CHARACTERS WITHOUT CLAIM TO ANY PARTICULAR FONT, STYLE, SIZE, OR COLOR.

PRIORITY DATE OF 9-12-2006 IS CLAIMED.

OWNER OF INTERNATIONAL REGISTRATION 0926796
DATED 10-24-2006, EXPIRES 10-24-2016.

OWNER OF U.S. REG. NOS. 2,783,449, 2,831,365 AND 3,181,196.

NO CLAIM IS MADE TO THE EXCLUSIVE RIGHT TO USE "LEAGUE", APART FROM THE MARK AS SHOWN.
SEC. 2(F) AS TO "CHAMPIONS".

CLASS 9—ELECTRICAL AND SCIENTIFIC APPARATUS

FOR EXPOSED CAMERA FILMS, PHOTOGRAPHIC SLIDE TRANSPARENCIES, SMALL ELECTRONIC VIDEO GAME MACHINES FOR USE WITH A TELEVISION SET; VIDEO GAMES IN THE NATURE OF INTERACTIVE VIDEO GAME PROGRAMS; VIDEO GAME CONSOLES FOR USE WITH TELEVISION, COIN-OPERATED VIDEO ARCADE GAMES FOR GAME HALLS; VIDEO GAMING DEVICES, IN THE NATURE OF COMPUTERIZED VIDEO TABLE GAMES FOR GAMING PURPOSES; VIDEO GAME TAPE CASSETTES; VIDEO GAME DISCS; ACCESSORIES FOR VIDEO GAMES, NAMELY, JOYSTICKS, MANUALLY OPERATED JOYSTICKS, STEERING WHEELS FOR VIDEO GAMES AND MATS FOR VIDEO GAMES ON WHICH ONE CAN DANCE; SOUND, PICTURES AND DATA RECORDED ON CDS, MP3'S IN THE FIELD OF FOOTBALL AND DOWNLOADABLE SOUND, PICTURES, AND DATA IN THE FIELD OF FOOTBALL; BLANK MAGNETIC, ANALOGUE AND DIGITAL RECORDING MEDIA FOR SOUNDS OR PICTURES; VIDEO TAPES, MAGNETIC TAPES, MAGNETIC DISCS, DVDS, MINIDISKS, DISKETTES, OPTICAL DISCS, COMPACT DISCS, CD-ROMS, VIDEO DISCS, MEMORY CARDS, USB KEYS, ALL UNRECORDED AND ALL PRE-RECORDED WITH MUSIC, SOUND AND PICTURES IN THE FIELD OF FOOTBALL AND CARTOONS; HOLOGRAM APPARATUS; PUBLICATIONS IN ELECTRONIC FORMAT, NAMELY, NEWSLETTERS, MAGAZINES, BOOKS IN THE FIELD OF FOOTBALL STORED ON CD-ROMS AND DOWNLOADABLE FROM COMPUTER DATABASES AND THE INTERNET; SPECTACLES, SUNGLASSES, CASES AND CHAINS FOR SUNGLASSES AND SPECTACLES; BINOCULARS; MAGNETS AND DECORATIVE MAGNETS; DIRECTIONAL COMPASSES; SOUND AND IMAGE RECORDING, TRANSMISSION AND REPRODUCTION APPARATUS; SATELLITE DISHES, SATELLITES; SET TOP BOXES COMPRISED OF SOFTWARE AND EQUIPMENT HARDWARE USED TO CONVERT, SUPPLY AND TRANSMIT AUDIO AND VISUAL DATA; TELEVISION SETS; FLAT PANEL DISPLAY SCREENS, SCREENS WITH LIQUID CRYSTAL DISPLAYS, HIGH-DEFINITION DISPLAY SCREENS AND PLASMA DISPLAY SCREENS; RADIOS; HOME CINEMA SYSTEMS COMPRISED OF LIQUID CRYSTAL DISPLAYS, TELEVISION RECEIVER, AUDIO SPEAKERS; DIGITAL VIDEO RECORDERS; CD PLAYERS; DVD PLAYERS; MP3 PLAYERS; PLAYING DEVICES CONTAINING MUSIC IN DIGITAL FORM STORED ON DISC MEMORIES; LOUD-SPEAKERS; HEADPHONES, EARPHONES; COMPUTERS; KARAOKE SYSTEMS COMPRISED OF KARAOKE PLAYERS; SYSTEMS FOR SOUND EDITING AND SOUND MIXING COMPRISED OF AUDIO MIXERS; SYSTEMS FOR EDITING AND MIXING VIDEO IMAGES COMPRISED OF COMPUTER PROGRAMS FOR EDITING AND MIXING VIDEO IMAGES; COMPUTER DATA PROCESSING APPARATUS, NAMELY, DATA PROCESSORS; COMPUTER KEYBOARDS; COMPUTER SCREENS IN THE NATURE OF MONITORS; MODEMS; COMPUTER ACCESSORIES, NAMELY, PERIPHERALS; COMPUTER MICE, COMPUTER MOUSE PADS; NAVIGATION SYSTEMS COMPRISED OF CAR NAVIGATION COMPUTERS; PERSONAL DATA ASSISTANTS; ELECTRONIC POCKET TRANSLATORS; DICTATING MACHINES; ELECTRONIC AGENDAS; SCANNERS; PRINTERS; PHOTOCOPIERS; FACSIMILE MACHINES; TELEPHONES; AUTOMATIC ANSWERING MACHINES; VIDEOPHONES; CELLULAR TELEPHONES; ACCESSORIES FOR CELLULAR PHONES AND CAMERAS, NAMELY, CASES FOR CELLULAR PHONES, DEVICES FOR USING CELLULAR PHONES HANDS-FREE, EARPHONES AND HEADPHONES FOR CELLULAR PHONES, KEYPADS FOR CELLULAR PHONES, STRAPS FOR CELLULAR PHONES, SPECIAL CASES FOR CARRYING CELLULAR PHONES, ATTACHMENT CORDS FOR CAMERAS AND FOR CELLULAR PHONES; REMOTE CONTROLS FOR TELEVISION SETS AND VIDEO RECORDING AND PLAYING SYSTEMS; TELECONFERENCING SYSTEMS COMPRISED OF TELEPHONES; CALCULATING MACHINES IN THE NATURE OF CALCULATORS; CREDIT CARD READERS; ELECTRONIC CURRENCY CONVERTERS; AUTOMATED TELLER MACHINES; VIDEO CAMERAS, PORTABLE VIDEO CAMERAS WITH BUILT-IN VIDEOCASSETTE RECORDERS; PHOTOGRAPHIC EQUIPMENT, NAMELY, CAMERA TRIPODS, CAMERA FLASHES; PHOTOGRAPHIC APPARATUS,

NAMELY, CAMERA SHUTTERS, CAMERA LENSES; CINEMATOGRAPHIC CAMERAS; MOVIE PROJECTORS; FLASH LAMPS; CAMERA CASES; ELECTRICAL CELLS AND BATTERIES; COMPUTER SCREEN-SAVER PROGRAMS; BLANK MAGNETIC, DIGITAL AND ANALOGUE SOUND AND IMAGE RECORDING MEDIA, NAMELY, CDS, DVDS, PHONOGRAPHIC RECORDS, AND PRE-RECORDED MAGNETIC, DIGITAL AND ANALOGUE SOUND AND IMAGE RECORDING MEDIA, NAMELY, CDS, DVDS, PHONOGRAPHIC RECORDS FEATURING FOOTBALL; MEMORY CARDS; MICRO-PROCESSOR CARDS; MAGNETIC ENCODED AND ELECTRONIC CHIP ENCODED CREDIT CARDS, MAGNETIC ENCODED AND ELECTRONIC CHIP ENCODED TELEPHONE CARDS, MAGNETIC ENCODED AND ELECTRONIC CHIP ENCODED CARDS FOR CASH DISPENSERS, MAGNETIC ENCODED AND ELECTRONIC CHIP ENCODED CARDS FOR AUTOMATED TELLER MACHINES AND CURRENCY CONVERTERS, PREPAID MAGNETIC ENCODED AND ELECTRONIC CHIP ENCODED CARDS FOR CELLULAR PHONES, MAGNETIC ENCODED AND ELECTRONIC CHIP ENCODED CARDS FOR SHOW ADMISSION AND FOR TRAVEL, NAMELY, FOR ADMISSION TO AMENITIES AT HOTELS, MAGNETIC ENCODED AND ELECTRONIC CHIP ENCODED CARDS FOR CHECK GUARANTEE, MAGNETIC ENCODED AND ELECTRONIC CHIP ENCODED DEBIT CARDS; ELECTRIC FLAT IRONS; ALARMS IN THE NATURE OF ANTI-INTRUSION ALARMS, FIRE ALARMS, THEFT ALARMS NOT FOR VEHICLES; ELECTRONIC DISPENSERS FOR ELECTRONIC PARKING LOT TICKET DISPENSERS; PAYMENT SYSTEMS FOR ELECTRONIC COMMERCE COMPRISED OF ELECTRONIC PAYMENT TERMINAL; WIND SOCKS FOR INDICATING WIND DIRECTION; DISTANCE-MEASURING EQUIPMENT, NAMELY, PODEMETERS; SPEED MEASURING AND DISPLAYING EQUIPMENT NAMELY, SPEEDOMETERS (U.S. CLS. 21, 23, 26, 36 AND 38).

CLASS 12—VEHICLES

FOR BICYCLES, MOTORCYCLES, MOTOR CARS, LORRIES BEING TRUCKS, PICKUP TRUCKS, MOTOR BUSES, REFRIGERATED LAND VEHICLES; AIRCRAFT AND BOATS; AIRSHIPS IN THE NATURE OF DIRIGIBLE BALLOONS, AEROSTATS; MOTOR CAR ACCESSORIES, NAMELY SUN VISORS, TIRE COVERS, LUGGAGE RACKS, SKI RACKS, WHEEL RIMS AND TRIMS; PNEUMATIC TIRES, VEHICLE SEAT COVERS, FITTED AND SEMI-FITTED VEHICLE COVERS, CHILDREN'S PUSH CHAIRS IN THE NATURE OF STROLLERS, PUSHCHAIRS IN THE NATURE OF WHEELCHAIRS, MOTOR CAR SEATS FOR BABIES AND CHILDREN; MOTORS FOR LAND VEHICLES (U.S. CLS. 19, 21, 23, 31, 35 AND 44).

CLASS 16—PAPER GOODS AND PRINTED MATTER

FOR BULLDOG CLIPS, COLORING AND DRAWING BOOKS; CHILDREN'S ACTIVITY BOOKS; MAGAZINES FEATURING FOOTBALL; NEWSPAPERS; BOOKS AND MAGAZINES IN THE FIELD OF SPORTSMEN AND SPORTS EVENTS; BOOKMARKS; PRINTED TEACHING MATERIAL IN THE FIELD OF FOOTBALL; SCORE SHEETS; EVENTS PROGRAMS; EVENTS ALBUMS; PHOTOGRAPH ALBUMS; AUTOGRAPH BOOKS, PRINTED TIMETABLES, PAMPHLETS IN THE FIELD OF FOOTBALL; COLLECTOR'S PHOTOGRAPHS OF PLAYERS; BUMPER STICKERS, STICKERS, ALBUMS FOR COINS AND STAMPS, STICKER ALBUMS; POSTERS; PHOTOGRAPHS; PAPER TABLECLOTHS; PAPER NAPKINS; PAPER BAGS; INVITATION CARDS; GREETING CARDS; GIFT WRAPPING PAPER; COASTERS AND TABLE MATS OF PAPER; GARBAGE BAGS OF PAPER AND OF PLASTICS; FOOD WRAPPING PAPER; PAPER COFFEE FILTERS; NON-TEXTILE LABELS OF PAPER; PAPER TOWELS; WET DISPOSABLE WIPES NOT IMPREGNATED WITH CHEMICALS OR COMPOUNDS; TOILET PAPER; BOXES FOR HANDKERCHIEFS OF PAPER AND CARDBOARD; PAPER TISSUES; PAPER DIAPERS; STATIONERY AND PRINTED INSTRUCTIONAL AND TEACHING MATERIAL IN THE FIELD OF FOOTBALL; TYPEWRITER PAPER; COPYING PAPER; ENVELOPES; PADS OF SCRIBBLING PAPER; BLANK JOURNAL WRITING BOOKS; SCRATCH

PADS; PAPER SHEETS FOR NOTE TAKING; PAPER FOR WRITING; BINDER PAPER; FILE FOLDERS; BOOK COVER PAPER; LUMINOUS PAPER; SELF-ADHESIVE PAPER FOR NOTES; PAPERWEIGHTS; CREPE PAPER; CLOTH PAPER; PAPER BADGES AND INSIGNIA; PAPER FLAGS; PAPER PENNANTS; WRITING INSTRUMENTS; FOUNTAIN PENS; PENCILS; BALLPOINT PENS; BALL-POINT PEN AND PENCIL SETS; FELT-TIP PENS; FIBER-TIP PENS AND FELT PENS; MARKER PENS; WRITING INK, INKING PADS, RUBBER STAMPS; ELECTRIC OR NON-ELECTRIC TYPEWRITERS; LITHOGRAPH PRINTS, LITHOGRAPHS BEING WORKS OF ART; FRAMED AND UNFRAMED PAINTINGS; PAINT BOXES IN THE NATURE OF ARTS AND CRAFTS PAINT KITS; COLORED PENCILS; CHALKS; PENCIL ORNAMENTS; BLOCKS FOR PRINTING; ADDRESS BOOKS; AGENDAS; PERSONAL ORGANIZERS OF PAPER; ROAD MAPS; PRINTED TICKETS, ADMISSION TICKETS; BANK CHECKS; COMIC BOOKS; CALENDARS; POSTCARDS; ADVERTISING PANELS AND BANNERS IN THE NATURE OF ADVERTISING SIGNS OF PAPER OR CARDBOARD; IRON-ON, PLASTIC TRANSFERS; ADHESIVE LABELS; OFFICE ARTICLES NOT BEING FURNITURE, NAMELY, STAPLERS, HOLE PUNCHERS, LABELING MACHINES; CORRECTION FLUIDS FOR DOCUMENTS; RUBBER ERASERS; PENCIL SHARPENERS; HOLDERS FOR PENCILS; HOLDERS FOR PENS; DESK STANDS AND HOLDERS FOR A VARIETY OF OFFICE REQUISITES; PAPER CLIPS; ADHESIVE TAPES FOR STATIONERY; HOLDERS FOR THE SAID ADHESIVE TAPES; STAPLES; STENCILS; DOCUMENT FOLDERS; NOTEPAD HOLDERS; BOOK ENDS; RUBBER STAMPS; NON-MAGNETICALLY ENCODED CARDS MADE OF PAPER OR CARDBOARD, NAMELY, CREDIT CARDS, TELEPHONE CARDS, CASH CARDS, DISCOUNT CARDS FOR SHOWS, CHECK GUARANTEE CARDS AND DEBIT CARDS; DISPOSABLE BABIES' DIAPER-PANTS OF PAPER OR CELLULOSE; BAGGAGE TAGS OF PAPER; PASSPORT HOLDERS; TRAVELERS' CHECKS; HOLDERS FOR CHECKBOOKS (U.S. CLS. 2, 5, 22, 23, 29, 37, 38 AND 50).

CLASS 18—LEATHER GOODS

FOR LEATHERS AND IMITATION LEATHERS; UMBRELLAS; PARASOLS; SPORTS BAGS OTHER THAN THOSE ADAPTED FOR THEIR CONTENTS; LEISURE BAGS IN THE NATURE OF OVERNIGHT BAGS; TRAVEL BAGS; RUCKSACKS; CARRY-ALL BAGS; SCHOOL BAGS; BAGS FOR HANGING ON BELTS IN THE NATURE OF WAIST BAGS; HANDBAGS; BALL-SHAPED LEATHER BAGS; BEACH BAGS; GARMENT BAGS FOR TRAVEL; SUITCASES; DOCUMENT CASES; VANITY CASES SOLD EMPTY, TOILETRY BAGS SOLD EMPTY; KEY CASES; WALLETS; CHANGE PURSES; WHIPS (U.S. CLS. 1, 2, 3, 22 AND 41).

CLASS 25—CLOTHING

FOR CLOTHING, NAMELY, SHOES AND FOOTWEAR, HEADWEAR, SHIRTS, SWEATER SHIRTS, POLO SHIRTS, SLEEVELESS BLOUSES, T-SHIRTS, WAISTCOATS, DRESSES, SKIRTS, UNDERCLOTHING, BATHING SUITS, SHORTS, TROUSERS, PULLOVERS, BONNETS, CAPS, HATS, SCARVES, SASHES FOR WEAR, SUN VISORS, TRACKSUITS, SWEAT-SHIRTS, JACKETS, BLAZERS, WATERPROOF CLOTHING IN THE NATURE OF JACKETS, PANTS, SHIRTS, COATS, UNIFORMS, TIES, HEADBANDS AND WRISTBANDS, GLOVES, APRONS, CHILDREN'S AND INFANTS' CLOTH BIBS, SPORTS JACKETS, STADIUM JACKETS, PAJAMAS, ROMPER SUITS, SOCKS AND STOCKINGS, SUSPENDERS, BELTS (U.S. CLS. 22 AND 39).

CLASS 28—TOYS AND SPORTING GOODS

FOR GAMES IN THE NATURE OF ARCADE GAMES, CARD GAMES, TOYS IN THE NATURE OF BATH TOYS; SPORTS BALLS; BOARD GAMES; GAME TABLES FOR TABLE FOOTBALL; STUFFED AND PLUSH CUDDLY TOYS AND DOLLS; TOY VEHICLES; PUZZLES; PLAYGROUND BALLS; INFLATABLE TOYS; SETS OF SMALL DISKS FOR PLAYING A CAPS GAME WHEREIN DISKS ARE FLIPPED AND COLLECTED; GYMNAS TIC AND SPORTING ARTICLES, NAMELY, GYMNAS TIC APPARATUS AND SPRING BOARDS; FOOTBALL EQUIPMENT, NAMELY FOOTBALLS, KNEE, ELBOW AND SHOULDER PADS, SHIN GUARDS, GOALKEEPERS' GLOVES; FOOTBALL GOALS; SPORTS BAGS SPECIFICALLY DESIGNED TO HOLD SPORTS EQUIPMENT; PARTY NOVELTIES, NAMELY, PARTY FAVORS IN THE NATURE OF SMALL TOYS; HAND HELD UNIT FOR PLAYING ELECTRONIC GAMES; NOVELTY FOAM HANDS; PLAYING CARDS; CONFETTI; TOY ROBOTS FOR ENTERTAINMENT (U.S. CLS. 22, 23, 38 AND 50).

CLASS 32—LIGHT BEVERAGES

FOR NON-ALCOHOLIC BEVERAGES, NAMELY, ENERGY DRINKS, CARBONATED BEVERAGES; SYRUPS AND POWDERS FOR PREPARING NON-ALCOHOLIC BEVERAGES; MINERAL AND CARBONATED WATERS; FRUIT AND VEGETABLE BEVERAGES AND FRUIT AND VEGETABLE JUICES; FROZEN FRUIT BEVERAGES; BEERS, STRONG DARK BEERS, LAGERS AND ALES; NON-ALCOHOLIC BEERS (U.S. CLS. 45, 46 AND 48).

CLASS 36—INSURANCE AND FINANCIAL

FOR ISSUANCE AND FINANCIAL MANAGEMENT OF CREDIT CARDS AND TRAVELERS' CHECKS; FINANCIAL SERVICES, NAMELY, LOAN FINANCING; BANKING SERVICES, CREDIT CARD SERVICES, AND FUND INVESTMENT; INSURANCE BROKERAGE; HIRE-PURCHASE FINANCING; FINANCIAL SPONSORSHIP OF SPORTS COMPETITIONS; INFORMATION SERVICES CONCERNING FINANCE AND INSURANCE, PROVIDED FROM A COMPUTER DATABASE OR BY THE INTERNET OR ON ANY WIRELESS ELECTRONIC COMMUNICATION NETWORK; HOME BANKING SERVICES; BANKING SERVICES ON THE INTERNET OR ON ANY WIRELESS ELECTRONIC COMMUNICATION NETWORK; ELECTRONIC PAYMENT, NAMELY, ELECTRONIC PROCESSING AND TRANSMISSION OF BILL PAYMENT DATA FOR PAYMENTS BY MOBILE TELEPHONE; ELECTRONIC PAYMENT, NAMELY, ELECTRONIC PROCESSING AND TRANSMISSION OF BILL PAYMENT DATA FOR PAYMENTS USING ELECTRONIC CASH (U.S. CLS. 100, 101 AND 102).

CLASS 38—COMMUNICATION

FOR TELECOMMUNICATION SERVICES, NAMELY PROVIDING ACCESS TO TELECOMMUNICATION NETWORKS, MOBILE TELEPHONE COMMUNICATIONS; COMMUNICATIONS BY TELEX; COMMUNICATIONS VIA COMPUTER TERMINALS AND COMMUNICATION SERVICES IN THE NATURE OF PROVIDING ACCESS TO DATABASES, TO INTERNET-TYPE TELECOMMUNICATIONS NETWORKS, TO WIRELESS ELECTRONIC TELECOMMUNICATIONS NETWORK; TELEGRAPH SERVICES; COMMUNICATION BY TELEPHONE; FAX TRANSMISSION SERVICES, RADIO COMMUNICATION SERVICES IN THE NATURE OF RADIO CALL SERVICES; TELECONFERENCE SERVICES BY TELEPHONE AND BY VIDEO; TELEVISION BROADCASTING; BROADCASTING CABLE TELEVISION PROGRAMS; RADIO BROADCASTING; SERVICES OF A PRESS NEWS AGENCY, NAMELY, THE TRANSMISSION OF NEWS ITEMS TO NEWS REPORTING ORGANIZATIONS; MESSAGE TRANSMISSION SERVICES IN THE NATURE OF ELECTRONIC MESSAGE TRANSMISSION, WEB MESSAGING; RENTAL OF TELEPHONES, FAX MACHINES AND OTHER COMMUNICATION APPARATUS IN THE NATURE OF HEADSETS FOR TELEPHONES, TELECOPYING EQUIPMENT; INFORMATION TRANSMISSION VIA ELECTRONIC DATA COMMUNICATIONS NETWORKS AND VIA ANY WIRELESS ELECTRONIC COMMUNICATION NETWORK IN THE COMMERCIAL

SECTOR; TELEVISION AND RADIO PROGRAM TRANSMISSION AND BROADCASTING SERVICES PROVIDED VIA THE INTERNET AND VIA ANY WIRELESS ELECTRONIC COMMUNICATIONS NETWORK; SIMULTANEOUS BROADCASTING OF FILM RECORDINGS AND SOUND AND VIDEO RECORDINGS; ELECTRONIC MAIL; PROVISION OF ACCESS TO TELEMATIC SERVERS AND TO ELECTRONIC SITES CONTAINING CONVERSATION GROUPS IN REAL TIME; COMPUTER-ASSISTED MESSAGE AND IMAGE TRANSMISSION; PROVISION OF TELECOMMUNICATIONS ACCESS TO ELECTRONIC SITES CONTAINING HOME PURCHASING AND ORDERING SERVICES VIA COMPUTER AND INTERACTIVE COMMUNICATION TECHNOLOGIES; TRANSMISSION OF INFORMATION VIA DATA COMMUNICATION NETWORKS; TELECOMMUNICATION SERVICES OF PROVIDING MULTIPLE USER DIAL-UP AND DEDICATED ACCESS TO THE INTERNET AND TELECOMMUNICATION ACCESS TO ANY ELECTRONIC WIRELESS TELECOMMUNICATIONS NETWORK; TELECOMMUNICATION ACCESS SERVICES, NAMELY, PROVISION OF ACCESS TO DIGITAL MUSIC SITES ON THE INTERNET AND ON ANY WIRELESS ELECTRONIC COMMUNICATIONS NETWORK; TELECOMMUNICATION ACCESS SERVICES, NAMELY, PROVISION OF ACCESS TO MP3 SITES ON THE INTERNET; PROVIDING TELECOMMUNICATIONS ACCESS SERVICES IN THE NATURE OF LEASING ACCESS TIME TO A DATABASE SERVER CENTRE; PROVIDING TELECOMMUNICATIONS ACCESS SERVICES IN THE NATURE OF LEASING ACCESS TIME TO A COMPUTER DATABASE; TRANSMISSION OF DIGITAL MUSIC BY TELECOMMUNICATIONS; ONLINE TRANSMISSION OF ELECTRONIC PUBLICATIONS; DIGITAL MUSIC TRANSMISSION ON THE INTERNET AND VIA ANY WIRELESS ELECTRONIC COMMUNICATION NETWORK; DIGITAL MUSIC TRANSMISSION VIA MP3 INTERNET SITES; PROVIDING ON-LINE CHAT ROOMS IN REAL TIME AND ELECTRONIC BULLETIN BOARDS FOR TRANSMISSION OF MESSAGES AMONG USERS IN THE FIELD OF GENERAL INTEREST. PROVIDING TELECOMMUNICATIONS ACCESS TO ELECTRONIC BULLETIN BOARDS FOR USE AS ADVERTISEMENT NOTICE BOARDS BY COMPUTER USERS AND PROVIDING CHAT ROOMS IN REAL TIME AND ELECTRONIC BULLETIN BOARDS FOR TRANSMISSION AND DISPLAY OF MESSAGES AMONG USERS IN THE FIELD OF GENERAL INTEREST BY MEANS OF A GLOBAL COMPUTER NETWORK; PROVIDING TELECOMMUNICATIONS ACCESS SERVICES, NAMELY, LEASING OF TELECOMMUNICATIONS ACCESS TIME TO ELECTRONIC BULLETIN DISPLAY AND ADVERTISEMENT NOTICE BOARDS AND TO CHAT ROOMS IN REAL TIME VIA A GLOBAL COMPUTER NETWORK (U.S. CLS. 100, 101 AND 104).

CLASS 41—EDUCATION AND ENTERTAINMENT

FOR EDUCATION SERVICES, NAMELY, PROVIDING CLASSES, SEMINARS, WORKSHOPS IN THE FIELD OF FOOTBALL; TRAINING SERVICES IN THE FIELD OF FOOTBALL; ENTERTAINMENT IN THE NATURE OF FOOTBALL GAMES AND COMPETITIONS; OPERATING LOTTERIES IN THE NATURE OF CONDUCTING LOTTERIES FOR OTHERS, LOTTERY SERVICES AND ARRANGING AND CONDUCTING FOOTBALL COMPETITIONS; BETTING SERVICES IN CONNECTION WITH SPORTS AND GAMING SERVICES IN THE NATURE OF GAMBLING SERVICES IN CONNECTION WITH SPORTS; ENTERTAINMENT SERVICES IN CONNECTION WITH SPORTS EVENTS, IN THE NATURE OF CONDUCTING FOOTBALL GAMES; SPORTING AND CULTURAL ACTIVITIES, NAMELY, ORGANIZING COMMUNITY SPORTING AND CULTURAL EVENTS; ORGANIZATION OF SPORTING AND CULTURAL EVENTS, NAMELY, SWIMMING MEET, SOCCER COMPETITION, ART EXHIBITIONS; ORGANIZATION OF SPORTS COMPETITIONS IN THE NATURE OF FOOTBALL; ORGANIZATION AND PROMOTION OF EVENTS IN THE FIELD OF FOOTBALL; PROVIDING INFORMATION ABOUT ENTRANCE TICKETS TO SPORTS EVENTS AND ENTERTAINMENT, AND SPORTS EVENTS TICKET AND ENTERTAINMENT TICKET AGENCY SERVICES; PROVIDING SPORTS FACILITIES; VIDEO AND AUDIOVISUAL SYSTEMS RENTAL; PRODUCTION AND RENTAL OF FILM RECORDINGS AND

AUDIO AND VIDEO RECORDINGS; PRODUCTION AND DISTRIBUTION OF MOTION PICTURE FILMS; ENTERTAINMENT SERVICES IN THE NATURE OF PLANNING ARRANGEMENT OF SHOWING AUDIO AND VIDEO RECORDINGS AND MOTION PICTURE FILM RECORDINGS; RENTAL OF INTERACTIVE EDUCATIONAL AND ENTERTAINMENT PRODUCTS, NAMELY, ENTERTAINMENT AND EDUCATIONAL INTERACTIVE COMPACT DISCS, CD-ROMS AND COMPUTER GAMES; NEWS REPORTING SERVICES IN THE NATURE OF REPORTING COVERAGE OF RADIO BROADCAST AND TELEvised SPORTS EVENTS; PRODUCTION OF RADIO AND TELEVISION PROGRAMS AND OF VIDEO TAPES; BOOKING OF SEATS FOR SHOWS AND SPORTS EVENTS; TIMING DURING SPORTS EVENTS; ENTERTAINMENT SERVICES, NAMELY, CONDUCTING BEAUTY CONTESTS; BETTING AND GAMBLING SERVICES ONLINE ON THE INTERNET OR ON ANY WIRELESS ELECTRONIC COMMUNICATIONS NETWORK; PROVISION OF SERVICES RELATING TO RAFFLES, NAMELY, CONDUCTING RAFFLES FOR OTHERS; INFORMATION IN THE FIELD OF SPORTS PROVIDED ONLINE FROM A COMPUTER DATABASE OR VIA THE INTERNET OR VIA ANY WIRELESS ELECTRONIC COMMUNICATIONS NETWORK; ENTERTAINMENT SERVICES, NAMELY, PROVIDING ON-LINE COMPUTER GAMES; PUBLICATION OF BOOKS AND NEWSPAPERS; PUBLICATION OF ELECTRONIC BOOKS AND NEWSPAPERS ONLINE; AUDIO AND VIDEO RECORDING SERVICES; PRODUCTION OF ANIMATED CARTOONS FOR THE MOVIES, PRODUCTION OF CARTOONS FOR TELEVISION; RENTAL OF SOUND AND PICTURE RECORDINGS FOR ENTERTAINMENT PURPOSES; INFORMATION CONCERNING EDUCATION, SUPPLIED ONLINE FROM A COMPUTER DATABASE OR BY INTERNET OR ANY WIRELESS ELECTRONIC COMMUNICATION NETWORK; TRANSLATION SERVICES; PHOTOGRAPHIC SERVICES; PROVISION OF ENTERTAINMENT INFRASTRUCTURES, NAMELY, LIGHTING PRODUCTION (U.S. CLS. 100, 101 AND 107).
JEAN IM, EXAMINING ATTORNEY

SN 79-039,558. DELFINGEN S.A. (INCORPORATED COMPANY), FRANCE, FILED 4-10-2007.

DELFINGEN

THE MARK CONSISTS OF STANDARD CHARACTERS WITHOUT CLAIM TO ANY PARTICULAR FONT, STYLE, SIZE, OR COLOR.

PRIORITY DATE OF 10-23-2006 IS CLAIMED.
OWNER OF INTERNATIONAL REGISTRATION 0926824 DATED 4-10-2007, EXPIRES 4-10-2017.

CLASS 9—ELECTRICAL AND SCIENTIFIC APPARATUS

FOR EQUIPMENT FOR ELECTRICITY CONDUITS, NAMELY, ELECTRIC CABLES; PROTECTIVE SHEATHS FOR ELECTRIC CABLES; JUNCTION SLEEVES FOR ELECTRIC CABLES; ELECTRIC WIRING SYSTEMS COMPOSED OF ELECTRIC WIRES, RESISTANCE WIRES, ELECTRICAL CONDUCTORS AND PLUGS; ELECTRICAL CONDUITS; ELECTRICAL CONNECTORS; CONNECTION CABLES FOR ELECTRIC LINES; IDENTIFICATION THREADS FOR ELECTRIC WIRES; ELECTRIC WIRES; IDENTIFICATION SHEATHS FOR ELECTRIC WIRES (U.S. CLS. 21, 23, 26, 36 AND 38).

CLASS 17—RUBBER GOODS

FOR FLEXIBLE PIPES, NOT OF METAL; WATERING HOSES; FIRE HOSE; NON-METALLIC PIPE MUFFS FOR USE WITH METALLIC, PLASTIC OR COMPOSITE PIPES; RUBBER SLEEVES FOR PROTECTING PARTS OF MACHINES; NON-METALLIC PIPE JUNCTIONS FOR USE WITH METALLIC, PLASTIC OR COMPOSITE PIPES; CONNECTING HOSE FOR VEHICLE RADIATORS; AIR, FIRE AND GARDEN HOSES OF TEXTILE MATERIAL; ADHESIVE TAPES FOR INDUSTRIAL AND COMMERCIAL USE; SELF-ADHESIVE TAPES FOR INDUSTRIAL AND COMMERCIAL USE; INSULATORS FOR ELECTRICAL CABLES; INSULATORS FOR ELECTRIC MAINS; DIELECTRIC INSULATORS FOR CARS AND AIRCRAFTS; METAL FOIL FOR INSULATION IN CAR AND AIRCRAFT INDUSTRIES (U.S. CLS. 1, 5, 12, 13, 35 AND 50).

SUE LAWRENCE, EXAMINING ATTORNEY

CLASS 16—PAPER GOODS AND PRINTED MATTER

FOR ADVERTISEMENT BOARDS OF PAPER OR CARDBOARD, GIFT CARDS AND GREETING CARDS, INVITATION CARDS, WRAPPING AND PACKING PAPER, GIFT WRAP PAPER, BAGS MADE OF PAPER OR PLASTIC FOR PACKAGING, BOTTLE ENVELOPES OF CARDBOARD OR PAPER, BOTTLE WRAPPERS OF CARDBOARD OR PAPER, BOXES OF CARDBOARD OR PAPER, PAPER BOWS FOR GIFT WRAPPING, PRINTED MENUS, CALENDARS, GUIDE BOOKS FEATURING JEWELRY, COSTUME JEWELRY AND HOUSEHOLD AND KITCHEN CONTAINERS MADE OF PRECIOUS METAL; BOOKLETS, MAGAZINES, BOOKS, CATALOGUES, ALL IN THE FIELD OF JEWELRY, COSTUME JEWELRY AND HOUSEHOLD AND KITCHEN CONTAINERS; PHOTO ALBUMS, INDEX BOOKS, BOOKMARKS, NOTE PADS, ENVELOPES BEING STATIONERY, PAPER KNIVES BEING STATIONERY, PAPER LABELS, LITHOGRAPHS, GRAPHIC ART REPRODUCTIONS, PHOTOGRAPHS, PICTURES, POSTCARDS, POSTERS, PAPER MATS FOR BEER GLASSES, PEN CASES, FOUNTAIN PENS, PENS, PENCILS, PENCIL SHARPENERS, RUBBER ERASERS, STICKERS BEING STATIONERY, FACE TOWELS OF PAPER, HANDKERCHIEFS OF PAPER, HYGIENIC PAPER, TABLE NAPKINS OF PAPER, TABLE CLOTHS OF PAPER, BOOK ENDS (U.S. CLS. 2, 5, 22, 23, 29, 37, 38 AND 50).

CLASS 18—LEATHER GOODS

FOR LEATHER AND IMITATION OF LEATHER, SPORT BAGS, SCHOOL BAGS, BEACH BAGS, HANDBAGS, SHOULDER BAGS, BRIEFCASES, DUFFLE BAGS, TOTE BAGS, CLUTCH BAGS, ATTACHE-CASES, SUITCASES, GARMENT BAGS FOR TRAVEL, RUCKSACKS, TRUNKS BEING LUGGAGE, TRAVELLING BAGS, WALLETS, PURSES, KEY-CASES OF LEATHER, VANITY CASES SOLD EMPTY, UMBRELLAS (U.S. CLS. 1, 2, 3, 22 AND 41).

JEAN IM, EXAMINING ATTORNEY

SN 79-039,621. C.F.C. S.R.L., ITALY, FILED 10-27-2006.

SN 79-039,779. GIACALONE CHRISTIAN, LUXEMBOURG, FILED 4-10-2007.

MAGRINO

THE MARK CONSISTS OF STANDARD CHARACTERS WITHOUT CLAIM TO ANY PARTICULAR FONT, STYLE, SIZE, OR COLOR.

OWNER OF INTERNATIONAL REGISTRATION 0926965 DATED 10-27-2006, EXPIRES 10-27-2016.

THE ENGLISH TRANSLATION OF "MAGRINO" IN THE MARK IS "TOO THIN".

CINUCCI

THE MARK CONSISTS OF STANDARD CHARACTERS WITHOUT CLAIM TO ANY PARTICULAR FONT, STYLE, SIZE, OR COLOR.

OWNER OF INTERNATIONAL REGISTRATION 0927444 DATED 4-10-2007, EXPIRES 4-10-2017.

CINUCCI HAS NO MEANING IN A FOREIGN LANGUAGE.

CLASS 14—JEWELRY

FOR JEWELRY, COSTUME JEWELRY, SILVER JEWELRY, PRECIOUS STONES, SEMI-PRECIOUS GEMSTONES, PRECIOUS METALS; WATCHES, CLOCKS, WATCH BANDS, WATCH CHAINS, WATCH CASES; NON-ELECTRIC CONTAINERS FOR HOUSEHOLD OR KITCHEN USE, KEY RINGS, ASHTRAYS, CIGARETTE BOXES AND LIGHTERS, CANDY BOXES, JUGS, CUPS, GOBLETS, DISHES AND PLATES, TRAYS, FLASKS, TEA AND COFFEE SERVICES, NAPKIN HOLDERS AND RINGS, SALT AND PEPPER SHAKERS, NUTCRACKERS, PEPPER POTS AND SUGAR BOWLS, EGG CUPS, CANDLESTICKS AND CANDLE RINGS, NON-ELECTRIC CANDELABRAS, DECORATIVE BOXES, JEWELRY BOXES AND CASES, VASES AND BOWLS, ORNAMENTS, STATUETTES, ALL THESE ITEMS MADE IN WHOLE OR IN PART OF PRECIOUS METAL OR COATED THEREWITH (U.S. CLS. 2, 27, 28 AND 50).

CLASS 3—COSMETICS AND CLEANING PREPARATIONS

FOR SOAPS; PERFUMERY, ESSENTIAL OILS, COSMETICS, HAIR LOTIONS (U.S. CLS. 1, 4, 6, 50, 51 AND 52).

CLASS 18—LEATHER GOODS

FOR LEATHER AND IMITATIONS OF LEATHER, AND GOODS MADE OF THESE MATERIALS, NAMELY, BAGS, HANDBAGS, PURSES, POCKET WALLETS, TRAVELLING BAGS, TRUNKS, EMPTY MAKE-UP BAGS AND VANITY CASES, CARRYING CASES FOR DOCUMENTS, DOCUMENT CASES; SUITCASES, UMBRELLAS, PARASOLS AND WALKING STICKS; WHIPS, HARNESS AND SADDLERY (U.S. CLS. 1, 2, 3, 22 AND 41).

CLASS 25—CLOTHING

FOR CLOTHING NAMELY, COATS, SKIRTS, DRESSES, TROUSERS, SHIRTS, JACKETS, OVERCOATS, SWEATERS AND PULLOVERS, HATS, SCARVES, GLOVES INCLUDING THOSE OF LEATHER OR FUR, BELTS, TIES, SHOES, BOOTS, SANDALS, CLOGS, SLIPPERS, TENNIS SHOES, SOCKS, STOCKINGS, NECKTIES, UNDERWEAR, T-SHIRTS, SWEAT-SHIRTS; FOOTWEAR; HEADWEAR (U.S. CLS. 22 AND 39).

ELLEN B. AWRICH, EXAMINING ATTORNEY

SN 79-039,904. NUDE BRANDS LIMITED, LONDON, UNITED KINGDOM, FILED 12-5-2006.



PRIORITY DATE OF 6-26-2006 IS CLAIMED.
OWNER OF INTERNATIONAL REGISTRATION 0927817 DATED 12-5-2006, EXPIRES 12-5-2016.

THE MARK CONSISTS OF FOUR LOWER CASE "N" LETTERS CONFIGURED IN THE SHAPE OF A SQUARE; THE "N" IN THE NORTHEAST CORNER IS FACING NORTH; THE "N" IN THE SOUTHEAST CORNER IS FACING EAST; THE "N" IN THE SOUTHWEST CORNER IS FACING WEST; AND THE "N" IN THE NORTHWEST CORNER IS FACING SOUTH.

SN 79-039,818. KAEL COSMETIC SA, SWITZERLAND, FILED 5-3-2007.

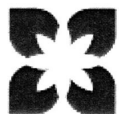

edelbio

PRIORITY DATE OF 3-2-2007 IS CLAIMED.
OWNER OF INTERNATIONAL REGISTRATION 0927548 DATED 5-3-2007, EXPIRES 5-3-2017.

CLASS 3—COSMETICS AND CLEANING PREPARATIONS

FOR COSMETICS; MAKE-UP PREPARATIONS; CREAMS AND LOTIONS FOR BODY, FACE, AND SKIN; HAIR CARE PREPARATIONS (U.S. CLS. 1, 4, 6, 50, 51 AND 52).

CLASS 35—ADVERTISING AND BUSINESS

FOR COMPUTERIZED ON-LINE RETAIL STORE SERVICES IN THE FIELD OF COSMETIC PREPARATIONS, MAKE UP PREPARATIONS, AND BODY, FACE, SKIN AND HAIR CARE PRODUCTS; RETAIL STORE SERVICES IN THE FIELD OF COSMETIC PREPARATIONS, MAKE UP PREPARATIONS, AND BODY, FACE, SKIN AND HAIR CARE PRODUCTS; ADVERTISING (U.S. CLS. 100, 101 AND 102).

CLASS 44—MEDICAL, BEAUTY AND AGRICULTURAL SERVICES

FOR HYGIENE AND BEAUTY CARE FOR HUMAN BEINGS, NAMELY HAIR STYLING AND MASSAGE SERVICES; HEALTH SPA SERVICES FOR HEALTH AND WELLNESS OF THE BODY AND SPIRIT OFFERED AT A HEALTH RESORT; HEALTH SPA SERVICES OFFERED AT A BEAUTY SALON, NAMELY, COSMETIC BODY CARE SERVICES; SAUNA SERVICES; MASSAGE SERVICES; MANICURE SERVICES; PEDICURE SERVICES; SERVICES OF A MAKE-UP ARTIST; BEAUTY SALONS; HAIRDRESSING SALONS; CONSULTING IN HYGIENE AND BEAUTY CARE; PROVIDING INFORMATION ON THE INTERNET WITH RESPECT TO BEAUTY AND BEAUTY CARE PRODUCTS; ADVICE IN THE FIELD OF DIET AND FOOD NUTRITION (U.S. CLS. 100 AND 101).

CIMMERIAN COLEMAN, EXAMINING ATTORNEY

CLASS 3—COSMETICS AND CLEANING PREPARATIONS

FOR SKIN SOAPS; ANTIPERSPIRANTS, DEODORANTS FOR PERSONAL USE; ESSENTIAL OILS, OILS FOR PERFUMES AND SCENTS, PERFUMERY, EAU DE COLOGNE; SACHETS FOR PERFUMING LINEN, POTPOURRI; SCENTED LINEN WATER, TOILET WATER, SCENTED WOOD, NAMELY, INCENSE; HAIR LOTIONS, SHAMPOOS, BLEACHING PREPARATIONS FOR COSMETIC PURPOSES, COSMETIC DYES, NAMELY, BEARD DYES, HAIR DYES, HAIR COLORANTS, HAIR SPRAY, HAIR WAVING LOTIONS, NEUTRALIZERS FOR PERMANENT HAIR WAVING, HYDROGEN PEROXIDE FOR COSMETIC PURPOSES, NAMELY, FOR USE ON HAIR; ADHESIVES FOR AFFIXING FALSE EYELASHES AND FALSE HAIR, MOUSTACHE WAX; DEPILATORIES AND DEPILATORY CREAMS; COSMETICS, COSMETIC PENCILS, EYEBROW PENCILS, FALSE EYELASHES, DECORATIVE TRANSFERS FOR COSMETIC PURPOSES; FALSE NAILS, NAIL CARE PREPARATIONS, NAIL POLISH, NAIL VARNISH FOR COSMETIC PURPOSES, NAIL VARNISH REMOVING PREPARATIONS; ADHESIVES FOR COSMETIC PURPOSES, NON-MEDICATED TOILETRIES, ASTRINGENTS FOR COSMETIC PURPOSES, BATH SALTS NOT FOR MEDICAL PURPOSES, NON-MEDICATED COSMETIC PREPARATIONS FOR BATHS, NON-MEDICATED COSMETIC PREPARATIONS FOR SKIN CARE, COTTON STICKS FOR COSMETIC PURPOSES, COTTON WOOL FOR COSMETIC PURPOSES, COSMETIC CREAMS, SKIN WHITENING CREAMS, GREASES FOR COSMETIC PURPOSES, NAMELY, BATH OIL, LOTIONS FOR COSMETIC PURPOSES, NAMELY, SUNTAN LOTION, OILS FOR COSMETIC PURPOSES AND FOR TOILETRY PURPOSES, PETROLEUM JELLY FOR COSMETIC PURPOSES, POMADES FOR COSMETIC PURPOSES, COTTON SWABS FOR COSMETIC PURPOSES, TALCUM POWDER FOR TOILET USE, PRE-MOISTENED COSMETIC TISSUES IMPREGNATED WITH COSMETIC LOTIONS, MAKE-UP REMOVING PREPARATIONS, CLEANSING MILK FOR TOILET PURPOSES, BEAUTY MASKS, PUMICE STONE FOR PERSONAL USE; DENTIFRICES, NON-MEDICATED MOUTH WASHES NOT FOR MEDICAL PURPOSES, TOOTHPASTE, DENTURE CLEANING PREPARATIONS, NAMELY, POLISHES, BREATH FRESHENING SPRAYS; SHAVING PREPARATIONS, AFTER-SHAVE LOTIONS, PASTES FOR RAZOR STROPS, NAMELY, SHAVING CREAM, SUNSCREEN PREPARATIONS, NAMELY, SUNSCREEN CREAM, COSMETIC SUN-TANNING PREPARATIONS; BLEACHING PREPARATIONS FOR

LAUNDRY USE; GENERAL PURPOSE CLEANING, POLISHING, SCOURING AND ABRASIVE LIQUIDS AND POWDERS (U.S. CLS. 1, 4, 6, 50, 51 AND 52).

CLASS 5—PHARMACEUTICALS

FOR DIETETIC FOOD ADAPTED FOR MEDICAL USE; DIETETIC FOOD PREPARATIONS ADAPTED FOR MEDICAL PURPOSES; FOOD FOR BABIES; MEDICATED CANDY AND MEDICATED CONFECTIONERY; MEDICINAL DRINKS, NAMELY, TEA, MEDICINAL HERB EXTRACTS, MEDICATED BABY OILS; MINERAL FOOD-SUPPLEMENTS; HERBAL MUD PACKS FOR THERAPEUTIC BATH PURPOSES, MINERAL WATER SALTS AND SALTS FOR MINERAL WATER BATHS FOR MEDICAL PURPOSES; SMELLING SALTS; MEDICATED SUNBURN OINTMENTS; EYE WASHES; FIRST AID KITS; MEDICAL PLASTERS, MATERIALS FOR DRESSINGS, NAMELY, BANDAGES; MATERIAL FOR STOPPING TEETH, NAMELY, DENTAL WAX; ADHESIVES FOR DENTURES; ALL-PURPOSE DISINFECTANTS; PREPARATIONS FOR DESTROYING VERMIN; FUNGICIDES, HERBICIDES; AIR FRESHENING PREPARATIONS, AIR PURIFYING PREPARATIONS, NAMELY, AIR DEODORIZER, DEODORANTS OTHER THAN FOR PERSONAL USE, NAMELY, HOUSEHOLD DEODORANTS; THERAPEUTIC PREPARATIONS FOR THE BATH, NAMELY, ALOE VERA GEL, PHARMACEUTICAL PREPARATIONS, NAMELY, ANTICOAGULANTS, DIAGNOSTIC PREPARATIONS FOR VETERINARY USE; SANITARY PREPARATIONS FOR MEDICAL PURPOSES (U.S. CLS. 6, 18, 44, 46, 51 AND 52).

CLASS 35—ADVERTISING AND BUSINESS

FOR ADVERTISING AGENCIES; BUSINESS MANAGEMENT; BUSINESS ADMINISTRATION; PROVIDING OFFICE FUNCTIONS; THE BRINGING TOGETHER, FOR THE BENEFIT OF OTHERS, OF A VARIETY OF GOODS RELATING TO PERSONAL CARE PRODUCTS AND FOOD AND BEVERAGES PRODUCTS, ENABLING CUSTOMERS TO CONVENIENTLY VIEW AND PURCHASE THOSE GOODS IN A RETAIL STORE, THROUGH A TELEVISION SHOPPING CHANNEL, VIA A MAIL ORDER CATALOGUE OR FROM AN INTERNET WEB SITE (U.S. CLS. 100, 101 AND 102).

SHAILA SETTLES, EXAMINING ATTORNEY

CLASS 12—VEHICLES

FOR TWO-WHEELED MOTOR VEHICLES; ON-ROAD MOTORCYCLES; OFF-ROAD MOTORCYCLES; LAND VEHICLES; FOUR-WHEELED MOTOR VEHICLES; THREE-WHEELED MOTOR VEHICLES; PERSONAL JET BOATS AND SNOW MOBILES; PARTS FOR TWO-WHEELED MOTOR VEHICLES, ON-ROAD MOTORCYCLES, OFF-ROAD MOTORCYCLES, LAND VEHICLES, FOUR-WHEELED MOTOR VEHICLES, AND THREE-WHEELED MOTOR VEHICLES, NAMELY, STRUCTURAL PARTS, BRAKE CABLES, CLUTCH CABLES, FORK BEARINGS AND RACES, FORK DUST BOOTS, FORK SEALS, HANDLE BARS, HANDLE BAR CONTROL LEVERS, HANDLE BAR DAMPERS, HANDLE BAR GRIPS, BRAKE CALIPERS, BRAKE PEDALS, BRAKE ROTORS, FRONT SPACERS, FRONT DASH PANELS, SHIFT LEVERS, HEADLIGHT MOUNTS, HANDLE BAR THROTTLES, ENGINES, GAS TANKS, ENGINE CASES, SHOCK ABSORBERS, SHOCK ABSORBING SPRINGS, WHEEL SPROCKETS, WHEELS, BODY PANELS, SEATS, HEAD LIGHT FAIRINGS, OUTRIGGERS BEING STRUCTURAL PARTS OF THE FOREGOING VEHICLES, WING MIRRORS, AND LICENSE PLATE HOLDERS (U.S. CLS. 19, 21, 23, 31, 35 AND 44).

CLASS 16—PAPER GOODS AND PRINTED MATTER

FOR STATIONERY-RELATED ITEMS, NAMELY, PENS, RUBBER ERASERS, PENCILS, POSTERS, LEAFLETS ABOUT MOTORCYCLES, INFORMATIONAL FLYERS ABOUT MOTORCYCLES, BROCHURES ABOUT MOTORCYCLES, EDUCATIONAL PUBLICATIONS, NAMELY, TECHNICAL PRODUCT SHEETS IN THE FIELD OF MOTORCYCLES, OWNERS' MANUALS IN THE FIELD OF MOTORCYCLES, WORKSHOP MANUALS IN THE FIELD OF MOTORCYCLES (U.S. CLS. 2, 5, 22, 23, 29, 37, 38 AND 50).

CLASS 25—CLOTHING

FOR SHIRTS, T-SHIRTS, SWEATERS, JACKETS, WIND RESISTANT JACKETS, RAINCOATS, NECKTIES, GLOVES, SOCKS, HATS, CAPS, SHOES, BOOTS, MOTORCYCLE RIDERS BOOTS, UNDERWEAR (U.S. CLS. 22 AND 39).

SHAILA SETTLES, EXAMINING ATTORNEY

SN 79-039,907, SPORT AND LEISURE; DIRECT.COM LIMITED, LINCOLN, UNITED KINGDOM, FILED 10-27-2006.

SN 79-040,198, F1 HELP LIMITED, UNITED KINGDOM, FILED 4-25-2007.

MEGELLI

WEBTAIL

THE MARK CONSISTS OF STANDARD CHARACTERS WITHOUT CLAIM TO ANY PARTICULAR FONT, STYLE, SIZE, OR COLOR.

PRIORITY DATE OF 7-14-2006 IS CLAIMED.

OWNER OF INTERNATIONAL REGISTRATION 0927829 DATED 10-27-2006, EXPIRES 10-27-2016.

CLASS 9—ELECTRICAL AND SCIENTIFIC APPARATUS

FOR MOTORCYCLE CRASH HELMETS; MOTORCYCLE GOGGLES; SUNGLASSES; MOUSE PADS; AND SPECTACLES (U.S. CLS. 21, 23, 26, 36 AND 38).

THE MARK CONSISTS OF STANDARD CHARACTERS WITHOUT CLAIM TO ANY PARTICULAR FONT, STYLE, SIZE, OR COLOR.

PRIORITY DATE OF 10-27-2006 IS CLAIMED.

OWNER OF INTERNATIONAL REGISTRATION 0928678 DATED 4-25-2007, EXPIRES 4-25-2017.

CLASS 9—ELECTRICAL AND SCIENTIFIC APPARATUS

FOR COMPUTER SOFTWARE FOR SETTING UP WEB-BASED E-COMMERCE; COMPUTER SOFTWARE FOR DEVELOPING AND MAINTAINING WEBSITES (U.S. CLS. 21, 23, 26, 36 AND 38).

CLASS 42—SCIENTIFIC AND COMPUTER SERVICES

FOR DESIGN AND DEVELOPMENT OF COMPUTER SOFTWARE; COMPUTER SOFTWARE DESIGN; RENTAL OF NON-GAME COMPUTER SOFTWARE PROGRAMS; UPDATING OF COMPUTER SOFTWARE AND COMPUTER PROGRAMS FOR OTHERS; INSTALLATION OF COMPUTER SOFTWARE AND COMPUTER PROGRAMS; MAINTENANCE OF COMPUTER SOFTWARE AND COMPUTER PROGRAMS; RECOVERY OF COMPUTER DATA; CONSULTANCY IN THE FIELD OF COMPUTER SOFTWARE; COMPUTER PROGRAMMING; DUPLICATION OF COMPUTER PROGRAMS; COMPUTER RENTAL; HOSTING OF COMPUTER SITES; CREATING AND MAINTAINING WEB-SITES FOR OTHERS (U.S. CLS. 100 AND 101).

TINA KUAN, EXAMINING ATTORNEY

SN 79-040,511. OTKRYTOYE AKTSIONERNOYE OBCHTCH-ESTVO; "SYNERGIYA KAPITAL", RUSSIAN FED., FILED 5-17-2007.

VOGUE

OWNER OF INTERNATIONAL REGISTRATION 0929433 DATED 5-17-2007, EXPIRES 5-17-2017.

CLASS 32—LIGHT BEVERAGES

FOR BEERS AND OTHER NON-ALCOHOLIC DRINKS, NAMELY, MALT COOLERS, HONEY BASED BEVERAGES, AND FRUIT JUICE BEVERAGES (U.S. CLS. 45, 46 AND 48).

CLASS 33—WINES AND SPIRITS

FOR ALCOHOLIC BEVERAGES, NAMELY, BRANDY, WINE, WHISKY, VODKA, GIN, COCKTAILS, LIQUEURS, AND RUM (U.S. CLS. 47 AND 49).

CHRISTINA SOBRAL, EXAMINING ATTORNEY

SN 79-040,481. IMMODAL PHARMAKA GESELLSCHAFT M.B.H., AUSTRIA, FILED 6-26-2007.

PHYTOLOGICAL

SN 79-041,892. STREAMCORE SYSTEM, FRANCE, FILED 5-4-2007.

STREAMCORE SYSTEM

PRIORITY DATE OF 2-14-2007 IS CLAIMED.
OWNER OF INTERNATIONAL REGISTRATION 0929367 DATED 6-26-2007, EXPIRES 6-26-2017.

THE MARK CONSISTS OF STANDARD CHARACTERS WITHOUT CLAIM TO ANY PARTICULAR FONT, STYLE, SIZE, OR COLOR.

PRIORITY DATE OF 11-10-2006 IS CLAIMED.

OWNER OF INTERNATIONAL REGISTRATION 0932735 DATED 5-4-2007, EXPIRES 5-4-2017.

NO CLAIM IS MADE TO THE EXCLUSIVE RIGHT TO USE "SYSTEM", APART FROM THE MARK AS SHOWN.

CLASS 3—COSMETICS AND CLEANING PREPARATIONS

FOR PRODUCTS FOR PERSONAL HYGIENE, NAMELY, BATH SOAP, TOOTHPASTE AND HAIR SHAMPOO; COSMETICS (U.S. CLS. 1, 4, 6, 50, 51 AND 52).

CLASS 5—PHARMACEUTICALS

FOR PHARMACEUTICAL PRODUCTS FOR THE TREATMENT, INCLUDING PROPHYLACTIC TREATMENT, OF: VIRAL AND BACTERIAL INFECTIOUS DISEASES, AUTO IMMUNE AND OTHER IMMUNE RELATED DISEASES, SKIN DISEASES, ALLERGIC DISEASES, COUGHS, COLDS, INFLUENZA, HEADACHE, STOMACH AND DIGESTIVE DISORDERS, MUSCULAR AND/OR RHEUMATIC DISORDERS, CANCER, DISORDERS OF THE CENTRAL NERVOUS SYSTEM, DISORDERS OF THE RESPIRATORY SYSTEM, DISORDERS OF THE CARDIOVASCULAR SYSTEM, DISORDERS OF THE GASTRO-INTESTINAL TRACT; DIETARY AND NUTRITIONALLY FORTIFIED FOOD PRODUCTS ADAPTED FOR MEDICINAL PURPOSES, NAMELY, HERBAL REMEDIES FOR HEALTH MAINTENANCE AND THE RELIEF OF SYMPTOMS ASSOCIATED WITH AGING, MENOPAUSE, POST-MENOPAUSE, FATIGUE, WEAKENED IMMUNE SYSTEM, PHYSICAL AND MENTAL STRESS; DIETETIC SUBSTANCES AND PRODUCTS FOR MEDICAL PURPOSES, NAMELY, NUTRITIONAL, VITAMIN, HERBAL AND MINERAL SUPPLEMENTS AND PREPARATIONS; NUTRITIONAL DRINK MIX FOR USE AS A MEAL REPLACEMENT; NUTRITIONAL SUPPLEMENTS IN SNACK BAR FORM FOR USE AS A MEAL REPLACEMENT (U.S. CLS. 6, 18, 44, 46, 51 AND 52).

CLASS 9—ELECTRICAL AND SCIENTIFIC APPARATUS

FOR APPARATUS FOR SWITCHING AND TRANSMITTING SOUND, IMAGES AND DATA; RECORDED PROGRAMS FOR SWITCHING AND TRANSMITTING SOUND, IMAGES AND/OR DATA (U.S. CLS. 21, 23, 26, 36 AND 38).

CLASS 38—COMMUNICATION

FOR COMMUNICATION BY COMPUTER TERMINALS ON NATIONAL AND INTERNATIONAL NETWORKS; PROVIDING TELECOMMUNICATIONS INFORMATION (U.S. CLS. 100, 101 AND 104).

CLASS 41—EDUCATION AND ENTERTAINMENT

FOR EDUCATION SERVICES, NAMELY PROVIDING SEMINARS IN THE FIELD OF COMPUTING AND TELECOMMUNICATIONS (U.S. CLS. 100, 101 AND 107).

CLASS 30—STAPLE FOODS

FOR TEAS (U.S. CL. 46).
ERNEST SHOSHO, EXAMINING ATTORNEY

CLASS 42—SCIENTIFIC AND COMPUTER SERVICES

FOR PROVIDING TECHNICAL INFORMATION ON INFORMATION TECHNOLOGY (U.S. CLS. 100 AND 101).
REBECCA POVARCHUK, EXAMINING ATTORNEY

SN 79-042,488. BLUEFREEWAY LIMITED; ACN: 122 262 819, AUSTRALIA, FILED 8-2-2007.

blu.

OWNER OF INTERNATIONAL REGISTRATION 0934204 DATED 8-2-2007, EXPIRES 8-2-2017.
THE COLOR(S) GRAY IS/ARE CLAIMED AS A FEATURE OF THE MARK.
THE COLOR GRAY APPEARS IN THE WORDING "BLU".

CLASS 9—ELECTRICAL AND SCIENTIFIC APPARATUS

FOR APPARATUS FOR PROCESSING DATA RELATING TO IMAGES NAMELY DATA PROCESSORS; SOFTWARE, NAMELY, AN APPLICATION THAT ALLOWS THE ADVERTISERS AND MEDIA PUBLISHERS TO CREATE, DELIVER, AND RECEIVE ELECTRONIC, DIGITALLY BASED COMMUNICATION CONTENT FOR ADVERTISING PURPOSES; BLANK MAGNETIC DATA CARRIERS (U.S. CLS. 21, 23, 26, 36 AND 38).

CLASS 35—ADVERTISING AND BUSINESS

FOR ADVERTISING SERVICES; ADVERTISING SERVICES PROVIDED OVER THE INTERNET (U.S. CLS. 100, 101 AND 102).

CLASS 42—SCIENTIFIC AND COMPUTER SERVICES

FOR DESIGN OF MARKETING MATERIAL; WEB SITE DESIGN (U.S. CLS. 100 AND 101).
KATHERINE E. HALMEN, EXAMINING ATTORNEY

SN 79-042,701. CELEMONY SOFTWARE GMBH, 81371 MÜNCHEN, FED REP GERMANY, FILED 8-9-2007.

Celemony

OWNER OF INTERNATIONAL REGISTRATION 0934821 DATED 8-9-2007, EXPIRES 8-9-2017.
THE WORD "CELEMONY" HAS NO MEANING IN ENGLISH.

CLASS 9—ELECTRICAL AND SCIENTIFIC APPARATUS

FOR SOFTWARE USED FOR CREATING AND EDITING MUSIC AND SOUNDS USED IN THE FIELD OF PROFESSIONAL AND NON PROFESSIONAL MUSIC STUDIO APPLICATIONS (U.S. CLS. 21, 23, 26, 36 AND 38).

CLASS 42—SCIENTIFIC AND COMPUTER SERVICES

FOR DESIGN AND DEVELOPMENT OF SOFTWARE FOR CREATING AND EDITING MUSIC AND SOUNDS (U.S. CLS. 100 AND 101).
WENDY GOODMAN, EXAMINING ATTORNEY

SN 79-042,702. CELEMONY SOFTWARE GMBH, 81371 MÜNCHEN, FED REP GERMANY, FILED 8-9-2007.

Melodyne

OWNER OF INTERNATIONAL REGISTRATION 0934822 DATED 8-9-2007, EXPIRES 8-9-2017.
THE WORD "MELODYNE" DOES NOT HAVE ANY MEANING IN A FOREIGN LANGUAGE.

CLASS 9—ELECTRICAL AND SCIENTIFIC APPARATUS

FOR SOFTWARE USED FOR CREATING AND EDITING MUSIC AND SOUNDS USED IN THE FIELD OF PROFESSIONAL AND NON PROFESSIONAL MUSIC STUDIO APPLICATIONS (U.S. CLS. 21, 23, 26, 36 AND 38).

CLASS 42—SCIENTIFIC AND COMPUTER SERVICES

FOR DESIGN AND DEVELOPMENT OF SOFTWARE FOR CREATING AND EDITING MUSIC AND SOUNDS (U.S. CLS. 100 AND 101).
WENDY GOODMAN, EXAMINING ATTORNEY

SN 79-042,769. NINGBO FOTILE KITCHEN; WARE CO., LTD., ZHEJIANG, CHINA, FILED 8-22-2006.

FOTILE

OWNER OF INTERNATIONAL REGISTRATION 0935054 DATED 8-22-2006, EXPIRES 8-22-2016.

OWNER OF U.S. REG. NO. 2,654,619.
THE MARK CONSISTS OF STYLIZED WORD "FOTILE" WHICH IS A COINED WORD WITH NO MEANING IN ANY LANGUAGE OR ANY SIGNIFICANCE IN THE TRADE.

CLASS 11—ENVIRONMENTAL CONTROL APPARATUS

FOR WATER HEATERS; HOT AIR OVENS; BAKERS' OVENS; STOVES; COFFEE ROASTERS; ELECTRIC COOKING UTENSILS; FRUIT ROASTERS; GAS OVENS; GAS STOVES; ELECTRIC STOVES; ELECTRIC OVENS; BREAD TOASTERS; COOKING RANGES FOR KITCHEN; ROASTERS; ELECTRIC COFFEE FILTERS; ELECTRIC COFFEE PERCOLATORS; ELECTRIC COFFEE MACHINES; ELECTRIC KETTLES; MICROWAVE OVENS FOR KITCHEN USE; GAS WATER HEATERS; ELECTRIC WATER HEATERS; REFRIGERATORS; AIR CONDITIONING APPARATUS; AIR PURIFIERS FOR DOMESTIC USE; KITCHEN RANGE HOODS; FAUCETS; FLUSHING TANKS; SOLAR POWER WATER HEATERS; WATER FILTERS; SEA WATER DESALINATION UNITS; DRINKING WATER DISPENSERS; ELECTRIC RADIATORS FOR ROOM HEATING; LIGHTERS FOR IGNITING GAS (U.S. CLS. 13, 21, 23, 31 AND 34).

CLASS 20—FURNITURE AND ARTICLES NOT OTHERWISE CLASSIFIED

FOR CUPBOARDS; BENCHES; SIDEBOARDS; WRITING DESKS; OFFICE FURNITURE; CHAIRS; CHESTS OF DRAWERS; COUNTERS; TABLES; CABINET WORK; DESKS; SHELVES FOR STORAGE; PLATE RACKS; DISPLAY CABINETS; DINNER WAGONS; WASHSTANDS (U.S. CLS. 2, 13, 22, 25, 32 AND 50).
 NAPOLEON SHARMA, EXAMINING ATTORNEY

SN 79-042,899. LIPOTEC, S.A., E-08850 GAVÀ (BARCELONA), SPAIN, FILED 8-24-2007.

DECORINYL

OWNER OF INTERNATIONAL REGISTRATION 0935222 DATED 8-24-2007, EXPIRES 8-24-2017.
 THE WORDING "DECORINYL" HAS NO MEANING IN A FOREIGN LANGUAGE.

CLASS 1—CHEMICALS

FOR CHEMICALS USED IN THE MANUFACTURE OF COSMETICS PRODUCTS AND PHARMACEUTICAL PRODUCTS IN THIS CLASS (U.S. CLS. 1, 5, 6, 10, 26 AND 46).

CLASS 3—COSMETICS AND CLEANING PREPARATIONS

FOR SOAPS, PERFUMERY, ESSENTIAL OILS FOR COSMETIC PURPOSES AND AS COMPONENTS OF MASSAGES AND PERFUMES; COSMETICS, HAIR LOTIONS; DENTIFRICES (U.S. CLS. 1, 4, 6, 50, 51 AND 52).
 SUSAN STIGLITZ, EXAMINING ATTORNEY

SN 79-043,049. INNING 4 S.R.L., ITALY, FILED 7-2-2007.

INNING 4

THE MARK CONSISTS OF STANDARD CHARACTERS WITHOUT CLAIM TO ANY PARTICULAR FONT, STYLE, SIZE, OR COLOR.
 PRIORITY DATE OF 6-11-2007 IS CLAIMED.
 OWNER OF INTERNATIONAL REGISTRATION 0935576 DATED 7-2-2007, EXPIRES 7-2-2017.

CLASS 9—ELECTRICAL AND SCIENTIFIC APPARATUS

FOR COMPUTER SOFTWARE FOR USE IN DATABASE MANAGEMENT FOR THE DESIGN AND THE INTRODUCTION OF NEW PRODUCTS IN THE MARKET; COMPUTER SOFTWARE FOR USE IN DATABASE MANAGEMENT FOR THE SIMULATION OF THE MARKETING PERFORMANCE OF NEW PRODUCTS; COMPUTER SOFTWARE FOR USE IN DATABASE MANAGEMENT FOR THE ESTIMATION OF MARKET POTENTIAL AND EARLY SALES FORECASTS OF NEW PRODUCTS; COMPUTER SOFTWARE FOR USE IN DATABASE MANAGEMENT FOR PRODUCTION MODELS; COMPUTER SOFTWARE FOR USE IN DATABASE MANAGEMENT FOR FINANCIAL MODELS (U.S. CLS. 21, 23, 26, 36 AND 38).

CLASS 42—SCIENTIFIC AND COMPUTER SERVICES

FOR COMPUTER SYSTEMS ANALYSIS; COMPUTER PROGRAMMING; COMPUTER CONSULTATION (U.S. CLS. 100 AND 101).
 SHANNON TWOHIG, EXAMINING ATTORNEY

SN 79-043,095. SYGNIS PHARMA AG, FED REP GERMANY, FILED 7-23-2007.



PRIORITY DATE OF 3-8-2007 IS CLAIMED.
 OWNER OF INTERNATIONAL REGISTRATION 0935693 DATED 7-23-2007, EXPIRES 7-23-2017.
 THE COLOR(S) BLUE, GREEN AND WHITE IS/ARE CLAIMED AS A FEATURE OF THE MARK.
 THE MARK CONSISTS OF THE WORD "SYGNIS" IN BLUE. ABOVE THE LAST "S" IS A CIRCLE IN GREEN WITH A TRIANGLE INSIDE THE CIRCLE IN WHITE.

CLASS 5—PHARMACEUTICALS

FOR PHARMACEUTICAL PREPARATIONS FOR THE TREATMENT OR PREVENTION OF NEUROLOGICAL CONDITIONS (U.S. CLS. 6, 18, 44, 46, 51 AND 52).

CLASS 42—SCIENTIFIC AND COMPUTER SERVICES

FOR CONSULTANCY AND MEDICAL AND SCIENTIFIC RESEARCH AND DEVELOPMENT SERVICES IN THE FIELD OF PHARMACEUTICAL, PHARMACOLOGICAL AND HEALTHCARE PRODUCTS; TECHNICAL ADVICE FOR OTHERS REGARDING RESEARCH AND DEVELOPMENT OF PHARMACEUTICAL PREPARATIONS AS WELL AS RELATING TO PLANNING AND CONSTRUCTING OF PLANTS AND FACTORIES FOR THE PRODUCTION OF PHARMACEUTICAL PREPARATIONS; SCIENTIFIC RESEARCH, NAMELY IN THE PHARMACEUTICAL FIELD (U.S. CLS. 100 AND 101).

CLASS 44—MEDICAL, BEAUTY AND AGRICULTURAL SERVICES

FOR MEDICAL SERVICES; MEDICAL ADVICE REGARDING REHABILITATION, MEDICAL SERVICES IN THE FIELD OF REHABILITATION; HEALTHCARE FOR PEOPLE; MEDICAL CONSULTATION AND MEDICAL SERVICES IN THE PHARMACEUTICAL, PHARMACOLOGICAL AND MEDICAL FIELD AS WELL AS IN THE FIELD OF HEALTHCARE (U.S. CLS. 100 AND 101).
 CARYN GLASSER, EXAMINING ATTORNEY

SN 79-043,579. MINCIONE, ALFONSO, ITALY, FILED 7-20-2007.

U'WA

SPIRIT TRIBE DENIM

PRIORITY DATE OF 2-19-2007 IS CLAIMED.
OWNER OF INTERNATIONAL REGISTRATION 0936783
DATED 7-20-2007, EXPIRES 7-20-2017.
NO CLAIM IS MADE TO THE EXCLUSIVE RIGHT TO
USE "DENIM", APART FROM THE MARK AS SHOWN.
THE WORDING "U'WA" HAS NO MEANING IN A
FOREIGN LANGUAGE.

CLASS 18—LEATHER GOODS

FOR LEATHER AND IMITATIONS OF LEATHER,
AND GOODS MADE OF THESE MATERIALS, NAMELY
BAGS, HANDBAGS, BRIEFCASES, SUITCASES, WAL-
LETS, DOCUMENT CASES, KEY CASES, PURSES,
TRUNKS AND TRAVELING BAGS; ANIMAL SKINS
AND HIDES; UMBRELLAS, PARASOLS AND WALKING
STICKS; WHIPS, HARNESS AND SADDLERY (U.S. CLS.
1, 2, 3, 22 AND 41).

CLASS 25—CLOTHING

FOR CLOTHING, NAMELY JACKETS, HATS, CAPS,
SHIRTS, TIES, TROUSERS, COATS, SWEATERS,
SKIRTS, PULLOVERS, SOCKS, TIGHTS, GLOVES,
SCARVES, JEANS, UNDERWEAR, NIGHTWEAR,
TRACKSUITS AND FOOTWEAR MADE IN WHOLE OR
SUBSTANTIALLY IN PART OF DENIM (U.S. CLS. 22 AND
39).

KATHERINE E. HALMEN, EXAMINING ATTORNEY

SN 79-043,618. MPDV MIKROLAB GMBH, FED REP GER-
MANY, FILED 7-9-2007.

MPDV

OWNER OF INTERNATIONAL REGISTRATION 0936886
DATED 7-9-2007, EXPIRES 7-9-2017.

CLASS 9—ELECTRICAL AND SCIENTIFIC APPARATUS

FOR COMPUTER HARDWARE AND SOFTWARE, IN
PARTICULAR FOR THE CAPTURE AND PROCESSING
OF BUSINESS DATA IN THE FIELDS OF MANUFAC-
TURING, PERSONNEL AND QUALITY CONTROL (U.S.
CLS. 21, 23, 26, 36 AND 38).

CLASS 35—ADVERTISING AND BUSINESS

FOR PROFESSIONAL BUSINESS CONSULTANCY;
BUSINESS ORGANIZATION CONSULTANCY; BUSI-
NESS PERSONNEL MANAGEMENT CONSULTANCY;
BUSINESS MANAGEMENT CONSULTANCY; COMMER-
CIAL EFFICIENCY EXPERT SERVICES; MARKETING
CONSULTATION; MARKET RESEARCH; MARKET OPIN-
ION POLLING STUDIES; PUBLIC RELATION SER-
VICES; PROVIDING STATISTICAL INFORMATION;
EMPLOYMENT AGENCIES, PERSONNEL PLACEMENT
AND RECRUITMENT; COMPILATION AND SYSTEM-
IZATION OF DATA IN DATABASES FOR OTHERS (U.S.
CLS. 100, 101 AND 102).

CLASS 42—SCIENTIFIC AND COMPUTER SERVICES

FOR COMPUTER SOFTWARE DEVELOPMENT, COM-
PUTER SOFTWARE DESIGN FOR OTHERS, AND UP-
DATING OF COMPUTER SOFTWARE, ALL FOR WORD
PROCESSING, DATA PROCESSING AND PROCESS
CONTROL; TECHNICAL AND APPLICATIONS CON-
SULTANCY WITH REGARD TO COMPUTERS AND
COMPUTER PROGRAMS, IN PARTICULAR FOR THE
CAPTURE AND PROCESSING OF BUSINESS DATA IN
THE FIELDS OF MANUFACTURING, PERSONNEL
AND QUALITY CONTROL; COMPUTER PROGRAM-
MING FOR SOLVING SECTOR-SPECIFIC PROBLEMS
ON THE INTERNET; WEBSITE CREATION AND DE-
SIGN FOR OTHERS; COMPUTER PROJECT MANAGE-
MENT SERVICES; ENGINEERING (U.S. CLS. 100 AND
101).

LINDA M. KING, EXAMINING ATTORNEY

SN 79-043,998. JEANNETTE ROWE, FRANKSTON, AUSTRA-
LIA, FILED 5-23-2007.

Dinosauritis

THE MARK CONSISTS OF STANDARD CHARACTERS
WITHOUT CLAIM TO ANY PARTICULAR FONT, STYLE,
SIZE, OR COLOR.

PRIORITY DATE OF 12-6-2006 IS CLAIMED.
OWNER OF INTERNATIONAL REGISTRATION 0938005
DATED 5-23-2007, EXPIRES 5-23-2017.

CLASS 9—ELECTRICAL AND SCIENTIFIC APPARATUS

FOR COMPUTER SOFTWARE CONTAINING CHIL-
DREN'S COMPUTER GAMES, INTERACTIVE ENTERTAIN-
MENT PROGRAMS AND EDUCATIONAL
PROGRAMS AND GAMES FOR ELECTRONIC DE-
VICES; PRE-RECORDED DVD'S, COMPACT PHONO-
GRAPHIC RECORDS AND MAGNETIC DATA
CARRIERS, FEATURING FILMED AND/OR ANI-
MATED CHILDREN'S PROGRAMS; PRE-RECORDED
PHOTOGRAPHIC AND CINEMATOGRAPHIC FILM
FEATURING FILMED AND/OR ANIMATED CHIL-
DREN'S PROGRAMS FOR CINEMA, TV, VIDEO, DVD'S,
ONLINE GAMES AND INTERACTIVE ACTIVITIES FOR
CHILDREN, CHILDREN'S STORIES, MUSIC AND/OR
SONGS; DIGITAL COMPUTER GAMES ON DISK (U.S.
CLS. 21, 23, 26, 36 AND 38).

CLASS 16—PAPER GOODS AND PRINTED MATTER

FOR PRINTED MATTER, PAPER AND CARDBOARD GOODS IN THIS CLASS, NAMELY, CHILDREN'S BOOKS, POSTERS, ENTERTAINMENT EDUCATION MAGAZINES, COLLECTABLE DINOSAUR AND/OR CHARACTER BASED CARDS, COLOURING-IN BOOKS AND CARDBOARD MATS; PHOTOGRAPHS FOR USE IN POSTERS AND PRINTED MATTER; STATIONARY, NAMELY, GIFT CARDS, GREETING CARDS, WRITING PAPER PADS, PAPER STICKERS, PENCILS, PENS, PAPER IMPRESSION AND MARKING STAMPS; TEACHING MATERIALS, NAMELY, FLASH CARDS, NUMBER CARDS, ALPHABET CARDS, INSTRUCTIONAL BOOKLETS FOR CHILDREN IN THE FIELD OF MATHS, SPELLING AND GENERAL INFORMATION BOOKLETS; CHILDREN'S ACTIVITY BOOKS AND COLLECTABLE PAPER GOODS, NAMELY, COMIC BOOKS, MAKE AND DO ACTIVITY BOOKS, PAPER MODEL BOOKS, PAPER MASK MAKING BOOKS, COLLECTABLE DINOSAUR CARDS AND COLLECTABLE ILLUSTRATED POSTERS (U.S. CLS. 2, 5, 22, 23, 29, 37, 38 AND 50).

CLASS 25—CLOTHING

FOR CLOTHING, NAMELY, SLEEPWEAR, SHIRTS, PANTS, DRESSES, SHORTS, SWIMWEAR, SINGLETS, RAINWEAR, JACKETS, COATS, WINDCHEATERS, GLOVES, SCARVES, WEARABLE MASQUERADE PLAY COSTUMES, UNDERWEAR, BEACHWEAR; FOOTWEAR, NAMELY, SOCKS, SHOWS, BOOTS, SANDALS, THONGS BEING FOOTWEAR WITH A BITE SHAPES MARK CUT OUT, SLIPPERS, BEACH SHOES, RUNNING SHOES; AND HEADGEAR, NAMELY, HATS, CAPS, VISORS, BEANIES, NOVELTY HATS, EAR MUFFS (U.S. CLS. 22 AND 39).

CLASS 28—TOYS AND SPORTING GOODS

FOR TOYS, GAMES AND PLAYTHINGS, NAMELY, SOFT STUFFED TOYS, PLASTIC INFLATABLE TOYS, PLASTIC COLLECTABLE TOY DINOSAURS AND MODEL TOY DINOSAURS, PLASTIC PLAY MATS FOR USE WITH TOYS DINOSAURS, WIND-UP TOYS, BATTERY OPERATED ACTION TOYS; DIGITAL TOYS, NAMELY, A BATTERY POWERED COMPUTER GAME WITH LCD SCREEN WHICH FEATURES ANIMATION AND SOUND EFFECTS; CARD GAMES, BOARD GAMES, ACTION SKILL GAMES; PUPPETS, COSTUMES MASKS; BALLOONS; NOVELTIES FOR PARTIES IN THE NATURE OF CRACKER AND NOISE MAKERS, SMALL PARTY FAVOUR TOYS; PLAYGROUND BALLS AND SOFT INDOOR BALLS FOR GAMES; PLASTIC TOY MODEL MAKING CONSTRUCTION KITS, SKITTLES, PLASTIC TOY HOOPS, QUOITS, PLASTIC AND MOULDED NOVELTY DINOSAUR TOYS; SCUBA FLIPPERS (U.S. CLS. 22, 23, 38 AND 50).

CLASS 41—EDUCATION AND ENTERTAINMENT

FOR PRODUCTION OF A SERIES OF FILM, MOTION PICTURES, AND TELEVISION PROGRAMS, FOR TELEVISION TRANSMISSION, VIDEO AND ONLINE WEBSITE AND CHANNEL DISTRIBUTION; PRODUCTION OF A SERIES OF CHILDREN'S TELEVISION PROGRAMS, PRODUCTION OF DIGITAL RECORDINGS OF STORIES AND SONGS; DEVELOPMENT AND DISSEMINATION OF EDUCATIONAL MATERIALS IN THE FIELD OF GENERAL KNOWLEDGE, DINOSAURS, NATURAL HISTORY, MATH, SPELLING AND LITERACY; ENTERTAINMENT, NAMELY, LIVE PERFORMANCE SHOWS BY COSTUMES CHARACTERS, MUSICIANS, DANCERS AND ACTORS (U.S. CLS. 100, 101 AND 107).

ANTHONY RINKER, EXAMINING ATTORNEY

SN 79-044,033. ALPHA TO OMEGA MOTORING LIMITED, UNITED KINGDOM, FILED 7-20-2007.

OWNER OF INTERNATIONAL REGISTRATION 0938101 DATED 7-20-2007, EXPIRES 7-20-2017.

CLASS 9—ELECTRICAL AND SCIENTIFIC APPARATUS

FOR COMPUTER SOFTWARE FOR USE IN RESPECT OF DRIVER TRAINING; PRERECORDED VIDEO TAPES, VIDEO DISCS, VIDEO CASSETTES, CD-ROMS, DIGITAL VIDEO DISCS, ALL RELATING TO INSTRUCTION IN THE FIELD OF DRIVER TRAINING; ELECTRONIC PUBLICATIONS, NAMELY, MANUALS RELATING TO DRIVER TRAINING RECORDED ON COMPUTER MEDIA; PRERECORDED MAGNETIC DATA CARRIERS AND OPTICAL DISCS CONTAINING INFORMATION RELATING TO DRIVER TRAINING; DOWNLOADABLE ELECTRONIC PUBLICATIONS IN THE NATURE OF TEACHING AND INSTRUCTIONAL MATERIALS IN THE FIELD OF DRIVER TRAINING; SIMULATORS FOR TRAINING PERSONS IN THE DRIVING OF VEHICLES (U.S. CLS. 21, 23, 26, 36 AND 38).

CLASS 12—VEHICLES

FOR MOTOR VEHICLES, NAMELY, AUTOMOBILES; MOTORBIKE AND LAND VEHICLES; MOTOR LAND VEHICLES ADAPTED FOR USE IN DRIVER TRAINING AND INSTRUCTION (U.S. CLS. 19, 21, 23, 31, 35 AND 44).

CLASS 16—PAPER GOODS AND PRINTED MATTER

FOR BOOKS RELATING TO DRIVER TRAINING; PRINTED MATTER, NAMELY, LEAFLETS, BROCHURES RELATING TO DRIVER TRAINING, POSTERS, PUBLICATIONS, NAMELY, NEWSLETTERS AND MAGAZINES IN THE FIELD OF DRIVER TRAINING; PHOTOGRAPHS; PRINTED PAPER SIGNS; STATIONERY; PRINTED INSTRUCTIONAL AND TEACHING MATERIALS IN THE FIELD OF DRIVER TRAINING (U.S. CLS. 2, 5, 22, 23, 29, 37, 38 AND 50).

CLASS 35—ADVERTISING AND BUSINESS

FOR COMPILATION AND SYSTEMISATION OF DRIVER AND ROAD SAFETY INFORMATION INTO COMPUTER DATABASES AND DATABANKS; COMPUTERIZED DATABASE MANAGEMENT OF DRIVER AND ROAD SAFETY INFORMATION (U.S. CLS. 100, 101 AND 102).

CLASS 36—INSURANCE AND FINANCIAL

FOR INSURANCE BROKERAGE SERVICES; CREDIT SERVICES, NAMELY, BROKERAGE FOR HIRE PURCHASE, FINANCING, INSTALMENT LOAN FINANCING AND LOAN SERVICES; FINANCIAL SERVICES, NAMELY, MONEY-LENDING; LEASING OF REAL ESTATE FOR USE IN PROVIDING EDUCATION AND TRAINING; PROVIDING INFORMATION, ADVISORY AND CONSULTANCY SERVICES RELATING TO ALL THE AFORESAID SERVICES (U.S. CLS. 100, 101 AND 102).

CLASS 39—TRANSPORTATION AND STORAGE

FOR PROVISION OF DRIVER AND ROAD SAFETY INFORMATION ON PAPER AND BY DATABASE, ON-LINE, ELECTRONIC MAIL AND OTHER ELECTRONIC MEDIA; STORAGE OF DRIVER AND ROAD SAFETY INFORMATION ON PAPER (U.S. CLS. 100 AND 105).

CLASS 41—EDUCATION AND ENTERTAINMENT

FOR VEHICLE DRIVING INSTRUCTION FEATURING DRIVING SIMULATIONS; EDUCATIONAL SERVICES, NAMELY, PROVIDING TRAINING AND INSTRUCTION RELATING TO DRIVING AND ROAD SAFETY; DRIVING SCHOOL SERVICES; PROVIDING INFORMATION ABOUT DRIVING AND ROAD SAFETY TRAINING; CONSULTATION SERVICES ABOUT EDUCATION IN THE FIELD OF DRIVING AND ROAD SAFETY TRAINING; PUBLICATION OF BOOKS AND TEXTS; RENTAL OF EDUCATIONAL AND TRAINING BOOKS AND VIDEOTAPES; PROVIDING ON-LINE PUBLICATIONS FROM A COMPUTER DATABASE IN THE NATURE OF BOOKS AND MANUALS IN THE FIELD OF DRIVER AND ROAD SAFETY (U.S. CLS. 100, 101 AND 107).
DANIEL BRODY, EXAMINING ATTORNEY

SN 79-044,156. SUNRISE & COMPANY (PTE) LTD, SINGAPORE, FILED 7-10-2007.



PRIORITY DATE OF 3-5-2007 IS CLAIMED.
OWNER OF INTERNATIONAL REGISTRATION 0938341 DATED 7-10-2007, EXPIRES 7-10-2017.

NO CLAIM IS MADE TO THE EXCLUSIVE RIGHT TO USE "BADMINTON WORLD", APART FROM THE MARK AS SHOWN.

THE MARK CONSISTS OF FIVE SHUTTLECOCKS ARRANGED TO CREATE A STAR FORMATION.

CLASS 16—PAPER GOODS AND PRINTED MATTER

FOR MAGAZINES, PERIODICALS, BOOKS, NEWSLETTERS, NEWSPAPERS, CATALOGUES, PAMPHLETS, PACKING PAPER, PICTURES, COMIC BOOKS, BOOK COVERS, DIRECTORIES, PRINTED INSTRUCTIONAL AND TEACHING MATERIALS, ALL IN THE FIELD OF BADMINTON AND SPORTS; PAPER, NAMELY, BOND PAPER, COPY PAPER, DIGITAL PRINTING PAPER, OFFSET PAPER; WRITING PADS; NOTE PADS; PHOTOGRAPHS; ENVELOPES AND POUCHES OF PAPER OR PLASTIC FOR MERCHANDISE PACKAGING; CALENDARS; NOTEBOOKS; DIARIES; STICKERS; PENS, PENCILS; STAMPS, NAMELY INK STAMPS; CLIPBOARDS; GREETING CARDS; POSTCARDS; POSTERS; PRINTED MATERIALS, NAMELY, REPORTS FEATURING SPORTS SCORES AND INFORMATION ABOUT SPORTING EVENTS; PRINTED PUBLICATIONS, NAMELY, SPORTS MAGAZINES, SPORTS NEWSPAPERS, SPORTS JOURNALS; GRAPHIC PRINTS, NAMELY, SPORTS PHOTOGRAPHS AND REPRODUCTIONS; HANDBOOKS AND MANUALS FOR INSTRUCTION IN THE FIELD OF SPORTS; STATIONERY; PRINTED TICKETS; PEN AND PENCIL HOLDERS; SCRAPBOOKS; PAPER AND FABRIC GIFT BAGS; ADHESIVES FOR STATIONERY AND HOUSEHOLD USE (U.S. CLS. 2, 5, 22, 23, 29, 37, 38 AND 50).

CLASS 18—LEATHER GOODS

FOR HANDBAGS; SUITCASES; TRAVELING BAGS; BEACH BAGS; BACKPACKS; ATHLETICS BAGS; VALISES; BRIEFCASES; SADDLERY; LEATHER SHOULDER BELT BAGS; CARD CASES, NAMELY, CALLING CARD CASES, BUSINESS CARD CASES; LEATHER AND LEATHER-BOARD CASES; SUITCASE HANDLES; LEATHER KEY CASES; SLING BAGS FOR CARRYING INFANTS; LEATHER TRAVEL BAG SETS; VANITY CASES SOLD EMPTY; UMBRELLAS AND PARASOLS (U.S. CLS. 1, 2, 3, 22 AND 41).

CLASS 25—CLOTHING

FOR SHOES, SPORT SHOES, SANDALS, SLIPPERS; UPPER OUTER CLOTHING, NAMELY, SHIRTS, JACKETS, TRACK SUIT TOPS; UPPER OUTER CLOTHING FOR SPORTS, NAMELY, SPORTS JERSEYS, SPORTS T-SHIRTS, SPORTS TRACKSUITS; PANTS; UNDERPANTS; SPORTS PANTS, NAMELY, JOGGING PANTS, TRACK SUIT BOTTOMS, TENNIS SHORTS, BADMINTON SHORTS; NECKTIES; SOCKS; STOCKINGS; LEGGINGS; UNDERWEAR; HATS, CAPS, VISORS; SPORTSWEAR, NAMELY, POLO SHIRTS, T-SHIRTS, SHORTS, TROUSERS, JACKETS; SWIMMING TRUNKS; SKIRTS; BELTS FOR CLOTHING; SCARVES; SHAWLS; JEANS; T-SHIRTS; SHORTS; SINGLETTS; SHIRTS; OVERCOATS; RAINCOATS; SWEATERS (U.S. CLS. 22 AND 39).

CLASS 28—TOYS AND SPORTING GOODS

FOR BADMINTON RACKETS; TENNIS RACKETS; GOLF CLUBS; GOLF BAGS; SHUTTLECOCKS; STRINGS FOR RACKETS; VOLLEYBALLS; BASKETBALLS; FOOTBALLS; HANDBALLS; NETBALLS; WATER POLO BALLS; IN-LINE SKATES; MANUALLY-OPERATED EXERCISE EQUIPMENT, NAMELY, MANUALLY-OPERATED BODY-BUILDING EQUIPMENT; MANUALLY-OPERATED EXERCISE APPARATUS, NAMELY, ANKLE AND WRIST WEIGHTS, EXERCISE BALLS, CHEST EXPANDERS, SHOULDER STRETCHER USING A CABLE; STATIONARY EXERCISE BICYCLES; ATHLETIC BODY GUARDS, NAMELY, LEG GUARDS, SHOULDER GUARDS, BELLY GUARDS, FEET GUARDS, SHIN GUARDS, KNEE GUARDS, ANKLE GUARDS; ATHLETIC SPORTING GOODS, NAMELY, ATHLETIC WRIST SUPPORT BANDS, PALMS BANDS, ELBOW BANDS, FINGER BANDS, ELBOW BANDS, AND THIGH BANDS FOR SUPPORT AND PROTECTION WHEN PLAYING SPORTS; BAGS ADAPTED TO CONTAIN RACKETS, SPORTS BAGS ADAPTED TO CONTAIN SPORTS RACKETS; SPORTS BAGS SPECIALLY ADAPTED FOR CARRYING SPORTING EQUIPMENT AND RACKETS; TOYS, NAMELY DOLLS; GAMES, NAMELY, BOARD GAMES, HAND-HELD ELECTRONIC GAMES OTHER THAN THOSE ADAPTED FOR USE WITH TELEVISION RECEIVERS; NETS FOR BALL GAMES; PLAYING CARDS (U.S. CLS. 22, 23, 38 AND 50).
WARREN L. OLANDRIA, EXAMINING ATTORNEY

SN 79-044,271. CENTRE VINICOLE CHAMPAGNE; NICOLAS FEUILLATTE.; UNION DE COOPERATIVES AGRICOLES, FRANCE, FILED 8-6-2007.

FEUILLATTE

THE MARK CONSISTS OF STANDARD CHARACTERS WITHOUT CLAIM TO ANY PARTICULAR FONT, STYLE, SIZE, OR COLOR.

PRIORITY DATE OF 2-9-2007 IS CLAIMED.
OWNER OF INTERNATIONAL REGISTRATION 0938632 DATED 8-6-2007, EXPIRES 8-6-2017.

OWNER OF U.S. REG. NO. 1,364,813.
THE WORDING "FEUILLATTE" HAS NO MEANING IN A FOREIGN LANGUAGE

CLASS 33—WINES AND SPIRITS

FOR WINES OF FRENCH ORIGIN, NAMELY, CHAMPAGNE; WINES, SPARKLING WINES, HARD CIDERS, BRANDIES, LIQUEURS (U.S. CLS. 47 AND 49).

CLASS 35—ADVERTISING AND BUSINESS

FOR WHOLESALE AND RETAIL STORE SERVICES FEATURING WINES OF FRENCH ORIGIN, NAMELY, CHAMPAGNE, WINES, SPARKLING WINES, HARD CIDERS, BRANDIES, LIQUEURS (U.S. CLS. 100, 101 AND 102).

WILLIAM ROSSMAN, EXAMINING ATTORNEY

SN 79-044,593. NORRØNA SPORT AS, N-1395 HVALSTAD, NORWAY, FILED 3-15-2007.

NORRØNA

THE MARK CONSISTS OF STANDARD CHARACTERS WITHOUT CLAIM TO ANY PARTICULAR FONT, STYLE, SIZE, OR COLOR.

PRIORITY DATE OF 2-7-2007 IS CLAIMED.

OWNER OF INTERNATIONAL REGISTRATION 0939515 DATED 3-15-2007, EXPIRES 3-15-2017.

OWNER OF U.S. REG. NO. 3,145,655.

THE WORDING "NORRØNA" HAS NO MEANING IN A FOREIGN LANGUAGE.

SN 79-044,434. OVERVLIET SANDRA, NL-2171 DZ SASSENHEIM, NETHERLANDS, FILED 3-27-2007.

SMOOFF

THE MARK CONSISTS OF STANDARD CHARACTERS WITHOUT CLAIM TO ANY PARTICULAR FONT, STYLE, SIZE, OR COLOR.

OWNER OF INTERNATIONAL REGISTRATION 0917340 DATED 2-7-2007, EXPIRES 2-7-2017.

CLASS 20—FURNITURE AND ARTICLES NOT OTHERWISE CLASSIFIED

FOR FURNITURE; OTTOMANS, CHAIRS, BEDS, TABLES, CUSHIONS, ARMCHAIRS, CHAISE LOUNGES, BEDS WHETHER PORTABLE OR NOT FOR DOMESTIC ANIMALS (U.S. CLS. 2, 13, 22, 25, 32 AND 50).

CLASS 24—FABRICS

FOR UPHOLSTERY FABRICS MADE OF TEXTILE OR PLASTIC FOR COVERING OTTOMANS, CHAIRS, BEDS, TABLES, CUSHIONS, HAMMOCKS, ARMCHAIRS, CHAISE LOUNGES AND BEDS WHETHER PORTABLE OR NOT, FOR HUMAN USE AND FOR DOMESTIC ANIMALS (U.S. CLS. 42 AND 50).

CLASS 25—CLOTHING

FOR CLOTHING, NAMELY, COATS, JACKETS, SWEATERS, SHIRTS, T-SHIRTS, POLO SHIRTS, JACKETS, PANTS, TROUSERS, SUITS, SHORTS, SCARVES, TIES, SOCKS, SWIMMING SUITS, DRESSES, SKIRTS, PULLOVERS, BLOUSES, MULES, BATHROBES; SPORTSWEAR, NAMELY, JOGGING SUITS; EVENING WEAR, NAMELY, TUXEDOS; CAPS, GLOVES, SLIPPERS, FLIP-FLOPS, UNDERWEAR; HEADWEAR (U.S. CLS. 22 AND 39).

DAYNA BROWNE, EXAMINING ATTORNEY

CLASS 18—LEATHER GOODS

FOR SUITCASES; TRAVELING BAGS; BAGS FOR SPORTS; BACK FRAMES FOR CARRYING CHILDREN; RUCKSACKS, NAMELY, RUCKSACKS FOR SKIING, SNOW BOARDING, CLIMBING, BICYCLING, HIKING, RUNNING, HUNTING AND FOR MILITARY USE; SATCHELS IN THE NATURE OF CARRYING CASES FOR MAPS; HANDBAGS, CARRYING CASES FOR MAPS (U.S. CLS. 1, 2, 3, 22 AND 41).

CLASS 25—CLOTHING

FOR OUTERWEAR CLOTHING, NAMELY, JACKETS, COATS, WIND RESISTANT JACKETS AND PANTS FOR SNOWBOARDING, SKIING, HUNTING, FISHING, WATER SPORTS, HIKING, RUNNING, CLIMBING AND FOR MILITARY USE; JACKETS, COATS, PANTS, LONG UNDERWEAR, SHORTS, TROUSERS, SHIRTS, PULLOVERS, SWEATERS, SOCKS, SCARVES, UNDERWEAR, VESTS, WIND RESISTANT JACKETS, GLOVES; FOOTWEAR, NAMELY, WINTER BOOTS, BOOTS FOR HIKING AND SNOWBOARDING, SHOES FOR RUNNING, CLIMBING AND WALKING, SANDALS; HEADGEAR, NAMELY, CAPS, HATS (U.S. CLS. 22 AND 39).

CLASS 28—TOYS AND SPORTING GOODS

FOR SPORTING ARTICLES, NAMELY, BAGS DESIGNED ESPECIALLY FOR SKIS AND SURFBOARDS; SKI BINDINGS; FISHING TACKLE, NAMELY, LANDING NETS FOR ANGLERS, FISHING HOOKS, FISHING REELS, FISHING RODS; SNOW SLEDs FOR RECREATIONAL USE, TOBOGGANS; CLIMBING EQUIPMENT, NAMELY, CLIMBING HARNESES; SKIS, WATER SKIS, SNOWBOARDS, WAKEBOARDS; ICE SKATES, ROLLER SKATES; SURFBOARDS; SNOWSHOES; KITES FOR WATER AND SNOW SPORTS; PARAGLIDERS; NETS FOR SPORTS, NAMELY, TENNIS NETS, SOCCER BALL GOAL NETS, VOLLEYBALL NETS, HANDBALL NETS; SKATEBOARDS (U.S. CLS. 22, 23, 38 AND 50).

STEVEN R. FOSTER, EXAMINING ATTORNEY

SN 79-044,916. GLP S.R.L., ITALY, FILED 7-27-2007.

glp

OWNER OF INTERNATIONAL REGISTRATION 0863677 DATED 3-1-2005, EXPIRES 3-1-2015.

OWNER OF U.S. REG. NO. 3,145,677.

CLASS 41—EDUCATION AND ENTERTAINMENT

FOR ARRANGING AND CONDUCTING EDUCATIONAL CONFERENCES; CONDUCTING WORKSHOPS AND SEMINARS IN INDUSTRIAL PROPERTY; TEACHING IN THE FIELD OF INDUSTRIAL PROPERTY (U.S. CLS. 100, 101 AND 107).

CLASS 42—SCIENTIFIC AND COMPUTER SERVICES

FOR PATENT AGENCY, NAMELY, PATENT AGENT SERVICES; INDUSTRIAL PROPERTY CONSULTATION (U.S. CLS. 100 AND 101).
MICHAEL TANNER, EXAMINING ATTORNEY

CLASS 12—VEHICLES

FOR AGRICULTURAL TRACTORS (U.S. CLS. 19, 21, 23, 31, 35 AND 44).
SUSAN LESLIE DUBOIS, EXAMINING ATTORNEY

SN 79-046,164. WOLAGRI S.R.L. CON UNICO SOCIO, ITALY, FILED 10-1-2007.

WOLAGRI

THE MARK CONSISTS OF STANDARD CHARACTERS WITHOUT CLAIM TO ANY PARTICULAR FONT, STYLE, SIZE, OR COLOR.

OWNER OF INTERNATIONAL REGISTRATION 0943378 DATED 10-1-2007, EXPIRES 10-1-2017.

CLASS 7—MACHINERY

FOR AGRICULTURAL MACHINERY AND EQUIPMENT, IN PARTICULAR IRRIGATION EQUIPMENT, BINDING MACHINES, HARVESTER AND BINDING MACHINES, FERTILIZER SPREADING MACHINES, FERTILIZER DISTRIBUTORS, MANURE SPREADERS, HOES, SOWERS, FORAGE BALERS, THRESHERS, ROTARY STALK CRUSHERS; PLOUGHS, BALE LOADERS, ELEVATORS, MOWERS, MILLING MACHINES, BALERS, HAY TEDDERS AND HOEING MACHINES (U.S. CLS. 13, 19, 21, 23, 31, 34 AND 35).

SN 79-047,104. MIGUEL TORRES S.A., SPAIN, FILED 10-19-2007.

LA OSCURIDAD

THE MARK CONSISTS OF STANDARD CHARACTERS WITHOUT CLAIM TO ANY PARTICULAR FONT, STYLE, SIZE, OR COLOR.

OWNER OF INTERNATIONAL REGISTRATION 0945763 DATED 10-19-2007, EXPIRES 10-19-2017.

THE ENGLISH TRANSLATION OF THE WORD "LA OSCURIDAD" IN THE MARK IS "DARKNESS".

CLASS 29—MEATS AND PROCESSED FOODS

FOR PRESERVED, DRIED AND COOKED FRUITS AND VEGETABLES; JAMS, COMPOTES; EDIBLE OILS AND FATS (U.S. CL. 46).

CLASS 30—STAPLE FOODS

FOR VINEGARS (U.S. CL. 46).
RUSS HERMAN, EXAMINING ATTORNEY

* * * * *

SECTION 2.— INTERNATIONAL CLASSIFICATION

The short titles associated below with the international class numbers are terms designed merely for quick identification and are not an official part of the international classification. The full names of international classes are given in section 6.1 of the trademark rules of practice.

The designation "U.S. Cl." appearing in this section refers to the U.S. class in effect prior to Sep. 1, 1973 rather than the international class which applies to applications filed on or after that date. For adoption of international classification see notice in the OFFICIAL GAZETTE of Jun. 26, 1973 (911 O.G. TM 210).

Application in one class

CLASS 1—CHEMICALS

SN 76-362,355. BASF AKTIENGESELLSCHAFT, LUDWIG-SHAFEN AM RHEIN, FED REP GERMANY, FILED 1-24-2002.

STYROSTAR

OWNER OF ERPN CMNTY TM OFC REG. NO. 1723543, DATED 11-20-2001, EXPIRES 6-26-2010.

FOR CHEMICALS IN THE FORM OF POWDERS, GRANULES OR SHAPED PIECES, BEING CATALYSTS FOR USE IN CHEMICAL PROCESSES (U.S. CLS. 1, 5, 6, 10, 26 AND 46).

JEFF DEFORD, EXAMINING ATTORNEY

CLASS 1—(Continued).

SN 76-682,560. KING TECHNOLOGY, INC., HOPKINS, MN. FILED 10-3-2007.

GET DOWN

THE MARK CONSISTS OF STANDARD CHARACTERS WITHOUT CLAIM TO ANY PARTICULAR FONT, STYLE, SIZE, OR COLOR.

FOR WATER PURIFICATION MATERIALS CONTAINED IN DISPENSERS FOR KILLING BACTERIA IN SWIMMING POOLS, HOT TUBS, AND SPAS, NAMELY, WATER PURIFYING MINERAL (U.S. CLS. 1, 5, 6, 10, 26 AND 46).

EMILY CARLSEN, EXAMINING ATTORNEY

SN 76-682,561. KING TECHNOLOGY, INC., HOPKINS, MN. FILED 10-3-2007.

SN 76-682,524. KING TECHNOLOGY, INC., HOPKINS, MN. FILED 10-3-2007.

GET DOWN MINERAL TECHNOLOGY



THE MARK CONSISTS OF STANDARD CHARACTERS WITHOUT CLAIM TO ANY PARTICULAR FONT, STYLE, SIZE, OR COLOR.

NO CLAIM IS MADE TO THE EXCLUSIVE RIGHT TO USE "MINERAL TECHNOLOGY", APART FROM THE MARK AS SHOWN.

FOR WATER PURIFICATION MATERIALS CONTAINED IN DISPENSERS FOR KILLING BACTERIA IN SWIMMING POOLS, HOT TUBS, AND SPAS, NAMELY, WATER PURIFYING MINERAL (U.S. CLS. 1, 5, 6, 10, 26 AND 46).

EMILY CARLSEN, EXAMINING ATTORNEY

NO CLAIM IS MADE TO THE EXCLUSIVE RIGHT TO USE "MINERAL POOL CARE TECHNOLOGY", APART FROM THE MARK AS SHOWN.

FOR WATER PURIFICATION MATERIALS CONTAINED IN DISPENSERS FOR KILLING BACTERIA IN SWIMMING POOLS, HOT TUBS, AND SPAS, NAMELY, WATER PURIFYING MINERAL (U.S. CLS. 1, 5, 6, 10, 26 AND 46).

EMILY CARLSEN, EXAMINING ATTORNEY

CLASS 1—(Continued).

SN 76-682,563. KING TECHNOLOGY, INC., HOPKINS, MN.
FILED 10-3-2007.



NO CLAIM IS MADE TO THE EXCLUSIVE RIGHT TO USE "MINERAL TECHNOLOGY", APART FROM THE MARK AS SHOWN.

FOR WATER PURIFICATION MATERIALS CONTAINED IN DISPENSERS FOR KILLING BACTERIA IN SWIMMING POOLS, HOT TUBS, AND SPAS, NAMELY, WATER PURIFYING MINERAL (U.S. CLS. 1, 5, 6, 10, 26 AND 46).

EMILY CARLSEN, EXAMINING ATTORNEY

SN 76-682,564. KING TECHNOLOGY, INC., HOPKINS, MN.
FILED 10-3-2007.



NO CLAIM IS MADE TO THE EXCLUSIVE RIGHT TO USE "MINERAL SPA CARE TECHNOLOGY", APART FROM THE MARK AS SHOWN.

FOR WATER PURIFICATION MATERIALS CONTAINED IN DISPENSERS FOR KILLING BACTERIA IN SWIMMING POOLS, HOT TUBS, AND SPAS, NAMELY, WATER PURIFYING MINERAL (U.S. CLS. 1, 5, 6, 10, 26 AND 46).

EMILY CARLSEN, EXAMINING ATTORNEY

CLASS 1—(Continued).

SN 77-028,455. CLARK, DENNIS A., LYNNWOOD, WA.
FILED 10-24-2006.



NO CLAIM IS MADE TO THE EXCLUSIVE RIGHT TO USE "PRODUCTS CORPORATION", APART FROM THE MARK AS SHOWN.

FOR CHEMICALS, NAMELY, CHEMICAL CLEANERS FOR INSTITUTIONAL USE IN THE FOOD SERVICE INDUSTRY, NAMELY, CHEMICAL CLEANERS FOR OVENS, GRILLS, GRIDDLES, KETTLES, FOOD FRYERS, REFRIGERATORS, AND POTS AND PANS (U.S. CLS. 1, 5, 6, 10, 26 AND 46).

FIRST USE 8-1-1998; IN COMMERCE 8-1-1998.

KATHERINE CHANG, EXAMINING ATTORNEY

SN 77-034,457. CARGILL, INCORPORATED, WAYZATA, MN. FILED 11-1-2006.

C*FILM

THE MARK CONSISTS OF STANDARD CHARACTERS WITHOUT CLAIM TO ANY PARTICULAR FONT, STYLE, SIZE, OR COLOR.

OWNER OF U.S. REG. NO. 2,635,605.

FOR MODIFIED STARCHES FOR USE IN THE MANUFACTURE OF PAPER IN THE CORRUGATED INDUSTRY (U.S. CLS. 1, 5, 6, 10, 26 AND 46).

FIRST USE 5-1-2006; IN COMMERCE 5-1-2006.

JAMES LOVELACE, EXAMINING ATTORNEY

SN 77-046,796. JACAM CHEMICALS, LLC, STERLING, KS.
FILED 11-17-2006.

SMART FLUID

THE MARK CONSISTS OF STANDARD CHARACTERS WITHOUT CLAIM TO ANY PARTICULAR FONT, STYLE, SIZE, OR COLOR.

NO CLAIM IS MADE TO THE EXCLUSIVE RIGHT TO USE "FLUID", APART FROM THE MARK AS SHOWN.

FOR CHEMICAL PRODUCTS FOR REMOVING AND PREVENTING SCALE ACCUMULATION IN WELLS (U.S. CLS. 1, 5, 6, 10, 26 AND 46).

TRICIA SONNEBORN, EXAMINING ATTORNEY

CLASS 1—(Continued).

SN 77-085,044. LANGE, FRANK WILLIAM, IV, PEWAUKEE, WI. FILED 1-17-2007.

ECO-BOND

THE MARK CONSISTS OF STANDARD CHARACTERS WITHOUT CLAIM TO ANY PARTICULAR FONT, STYLE, SIZE, OR COLOR.

FOR CONSTRUCTION INDUSTRY ADHESIVES (U.S. CLS. 1, 5, 6, 10, 26 AND 46).

FIRST USE 6-1-2006; IN COMMERCE 1-1-2007.
JILL C. ALT, EXAMINING ATTORNEY

CLASS 1—(Continued).

SN 77-120,533. FLORIKAN-E.S.A. CORP., SARASOTA, FL. FILED 3-2-2007.

DYNAMITE

THE MARK CONSISTS OF STANDARD CHARACTERS WITHOUT CLAIM TO ANY PARTICULAR FONT, STYLE, SIZE, OR COLOR.

OWNER OF U.S. REG. NOS. 1,903,310 AND 3,283,154.
FOR SOILS, NAMELY, POTTING SOILS, TREE AND SHRUB PLANTING SOILS, ANNUAL AND PERENNIAL BEDDING SOILS FOR PLANTING (U.S. CLS. 1, 5, 6, 10, 26 AND 46).

KELLY BOULTON, EXAMINING ATTORNEY

SN 77-101,642. SÜD-CHEMIE AG, MUNICH, FED REP GERMANY, FILED 2-7-2007.

BIOSIL

THE MARK CONSISTS OF STANDARD CHARACTERS WITHOUT CLAIM TO ANY PARTICULAR FONT, STYLE, SIZE, OR COLOR.

PRIORITY CLAIMED UNDER SEC. 44(D) ON FED REP GERMANY APPLICATION NO. 30658500.6, FILED 9-21-2006, REG. NO. 30658500. DATED 4-16-2007, EXPIRES 4-16-2017.

FOR CHEMICAL ADSORBENT AGENT FOR PURIFICATION OF BIODIESEL, FUELS, ETHANOL, SOLVENTS, VEGETABLE AND ANIMAL OILS AND FATS, AND BEVERAGES (U.S. CLS. 1, 5, 6, 10, 26 AND 46).

CAROLINE WOOD, EXAMINING ATTORNEY

SN 77-131,015. POLYMERS HOLDING AS, N-3966 STAHELLE, NORWAY, FILED 3-14-2007.

SENTIAL

SN 77-120,521. DNAR, INC., BOSTON, MA. FILED 3-2-2007.

DNAR MARKERS

THE MARK CONSISTS OF STANDARD CHARACTERS WITHOUT CLAIM TO ANY PARTICULAR FONT, STYLE, SIZE, OR COLOR.

NO CLAIM IS MADE TO THE EXCLUSIVE RIGHT TO USE "MARKERS", APART FROM THE MARK AS SHOWN.

FOR MOLECULAR DIAGNOSTIC TESTS COMPRISED OF ANTIBODIES AND OTHER REAGENTS USED FOR MEDICAL AND SCIENTIFIC RESEARCH TO GUIDE CANCER TREATMENT (U.S. CLS. 1, 5, 6, 10, 26 AND 46).

LESLEY LAMOTHE, EXAMINING ATTORNEY

THE MARK CONSISTS OF STANDARD CHARACTERS WITHOUT CLAIM TO ANY PARTICULAR FONT, STYLE, SIZE, OR COLOR.

PRIORITY CLAIMED UNDER SEC. 44(D) ON ERP CMNTY TM OFC APPLICATION NO. 005716097, FILED 2-26-2007, REG. NO. 005716097, DATED 12-14-2007, EXPIRES 2-26-2017.

FOR CARBON BASED CHEMICALS, NAMELY, UNPROCESSED PLASTICS FOR USE IN INDUSTRY, SCIENCE, PHOTOGRAPHY, AGRICULTURE, HORTICULTURE AND FORESTRY; NON-ORGANIC CHEMICALS, NAMELY, CAUSTIC SODA FOR USE IN INDUSTRY, SCIENCE, PHOTOGRAPHY, AGRICULTURE, HORTICULTURE AND FORESTRY (U.S. CLS. 1, 5, 6, 10, 26 AND 46).

ANNE MADDEN, EXAMINING ATTORNEY

CLASS 1—(Continued).

SN 77-141,034. CMS LIFE TECHNOLOGY LIMITED, FO TAN, HONG KONG, FILED 3-27-2007.



FOR CHEMICAL ADDITIVES FOR USE IN THE MANUFACTURE OF PHARMACEUTICALS AND COSMETICS; CHEMICAL PREPARATIONS IN THE NATURE OF FILTERING MATERIALS FOR USE IN AQUARIUMS AND PONDS; WATER TREATMENT CHEMICALS FOR USE IN SWIMMING POOLS AND SPAS; MINERAL SUBSTANCES IN THE NATURE OF FILTERING MATERIALS FOR USE IN THE FILTRATION AND TREATMENT OF WATER; CHEMICAL PRODUCTS FOR THE FRESH-KEEPING AND PRESERVING OF FOOD; CHEMICALS USED IN INDUSTRY AND SCIENCE; CHEMICALS USED IN THE MANUFACTURE OF PAPER; CATALYSTS FOR CHEMICAL AND BIOCHEMICAL PROCESSES; CATALYSTS FOR USE IN THE MANUFACTURE OF RUBBER; PREPARATIONS FOR FORTIFYING PLANTS; SOIL ADDITIVES; CHEMICAL PRODUCTS FOR PREVENTING SCALE; MOULD-RELEASE PREPARATIONS; FLAME RETARDING COMPOSITIONS (U.S. CLS. 1, 5, 6, 10, 26 AND 46).

TANYA AMOS, EXAMINING ATTORNEY

SN 77-141,142. MILLENNIUM SPECIALTY CHEMICALS INC., JACKSONVILLE, FL. FILED 3-27-2007.

SANDALINA

THE MARK CONSISTS OF STANDARD CHARACTERS WITHOUT CLAIM TO ANY PARTICULAR FONT, STYLE, SIZE, OR COLOR.

FOR NON-SYNTHETIC OR SYNTHETIC FRAGRANCE INGREDIENTS USED IN THE MANUFACTURE OF COSMETICS, PERSONAL CARE PRODUCTS, HOUSEHOLD CLEANERS, CANDLES AND HOUSEHOLD PERFUMERY (U.S. CLS. 1, 5, 6, 10, 26 AND 46).

FIRST USE 1-20-2004; IN COMMERCE 1-20-2004.

TEJBIR SINGH, EXAMINING ATTORNEY

CLASS 1—(Continued).

SN 77-141,246. MILLENNIUM SPECIALTY CHEMICALS INC., JACKSONVILLE, FL. FILED 3-27-2007.

NAVACET

THE MARK CONSISTS OF STANDARD CHARACTERS WITHOUT CLAIM TO ANY PARTICULAR FONT, STYLE, SIZE, OR COLOR.

FOR NON-SYNTHETIC OR SYNTHETIC FRAGRANCE INGREDIENTS USED IN THE MANUFACTURE OF COSMETICS, PERSONAL CARE PRODUCTS, HOUSEHOLD CLEANERS, CANDLES AND HOUSEHOLD PERFUMERY (U.S. CLS. 1, 5, 6, 10, 26 AND 46).

TEJBIR SINGH, EXAMINING ATTORNEY

SN 77-147,370. ARCHITECTURAL COMPOSITE TECHNOLOGIES, LLC, ELKHART, IN. FILED 4-3-2007.

ACCENT BOND

THE MARK CONSISTS OF STANDARD CHARACTERS WITHOUT CLAIM TO ANY PARTICULAR FONT, STYLE, SIZE, OR COLOR.

NO CLAIM IS MADE TO THE EXCLUSIVE RIGHT TO USE "BOND", APART FROM THE MARK AS SHOWN.

FOR CONSTRUCTION INDUSTRY ADHESIVES (U.S. CLS. 1, 5, 6, 10, 26 AND 46).

JOHN DWYER, EXAMINING ATTORNEY

SN 77-155,199. H.C. STARCK GMBH, 38642 GOSLAR, FED REP GERMANY, FILED 4-12-2007.

AMPERTRON

THE MARK CONSISTS OF STANDARD CHARACTERS WITHOUT CLAIM TO ANY PARTICULAR FONT, STYLE, SIZE, OR COLOR.

PRIORITY CLAIMED UNDER SEC. 44(D) ON FED REP GERMANY APPLICATION NO. 30663493701, FILED 10-13-2006, REG. NO. 30663493, DATED 11-15-2006, EXPIRES 10-31-2016.

FOR CHEMICALS AND UNPROCESSED PLASTICS, NAMELY, POLYMERS FOR ELECTRONIC MATERIALS (U.S. CLS. 1, 5, 6, 10, 26 AND 46).

ESTHER BELENKER, EXAMINING ATTORNEY

CLASS 1—(Continued).

SN 77-179,307. OMS INVESTMENTS, INC., LOS ANGELES, CA. FILED 5-11-2007.

AGROBLEN

THE MARK CONSISTS OF STANDARD CHARACTERS WITHOUT CLAIM TO ANY PARTICULAR FONT, STYLE, SIZE, OR COLOR.
FOR FERTILIZERS FOR AGRICULTURAL USE (U.S. CLS. 1, 5, 6, 10, 26 AND 46).
JOHN WILKE, EXAMINING ATTORNEY

CLASS 1—(Continued).

SN 77-214,993. WESTERN NUTRIENTS CORPORATION, BAKERSFIELD, CA. FILED 6-25-2007.

LIQUA - JIP

THE MARK CONSISTS OF STANDARD CHARACTERS WITHOUT CLAIM TO ANY PARTICULAR FONT, STYLE, SIZE, OR COLOR.
FOR FERTILIZERS FOR AGRICULTURAL USE; FERTILIZERS FOR DOMESTIC USE (U.S. CLS. 1, 5, 6, 10, 26 AND 46).
FIRST USE 2-1-1998; IN COMMERCE 2-27-1998.
MARLENE BELL, EXAMINING ATTORNEY

SN 77-194,335. SAINT-GOBAIN CERAMICS & PLASTICS, INC., WORCESTER, MA. FILED 5-31-2007.

VIEWMAX

THE MARK CONSISTS OF STANDARD CHARACTERS WITHOUT CLAIM TO ANY PARTICULAR FONT, STYLE, SIZE, OR COLOR.
FOR SCINTILLATION CRYSTALS FOR USE ON CAMERA PLATES (U.S. CLS. 1, 5, 6, 10, 26 AND 46).
SUE LAWRENCE, EXAMINING ATTORNEY

SN 77-229,087. ACL, INC., ELK GROVE VILLAGE, IL. FILED 7-13-2007.

STATICIDE ESD SAFETY SHIELD

THE MARK CONSISTS OF STANDARD CHARACTERS WITHOUT CLAIM TO ANY PARTICULAR FONT, STYLE, SIZE, OR COLOR.
OWNER OF U.S. REG. NOS. 1,171,827 AND 1,295,319.
NO CLAIM IS MADE TO THE EXCLUSIVE RIGHT TO USE "ESD SAFETY", APART FROM THE MARK AS SHOWN.
FOR CHEMICALS FOR USE IN INDUSTRY, NAMELY, ANTI-STATIC CHEMICAL SOLUTIONS FOR ELIMINATING STATIC ELECTRICITY (U.S. CLS. 1, 5, 6, 10, 26 AND 46).
JAY BESCH, EXAMINING ATTORNEY

SN 77-210,336. TOSOH CORPORATION, YAMAGUCHI, JAPAN, FILED 6-20-2007.

TOYOPAK

THE MARK CONSISTS OF STANDARD CHARACTERS WITHOUT CLAIM TO ANY PARTICULAR FONT, STYLE, SIZE, OR COLOR.
OWNER OF JAPAN REG. NO. 2076340, DATED 9-30-1988, EXPIRES 9-30-2008.
OWNER OF U.S. REG. NOS. 1,184,328, 2,752,030 AND 2,982,921.
THE WORDING "TOYOPAK" AND "TOYO" AND "PAK" HAS NO MEANING IN A FOREIGN LANGUAGE.
FOR CHROMATOGRAPHY CHEMICALS, NAMELY, GEL FOR LIQUID CHROMATOGRAPHY (U.S. CLS. 1, 5, 6, 10, 26 AND 46).
COLLEEN DOMBROW, EXAMINING ATTORNEY

SN 77-236,456. ELEMENTIS SPECIALTIES, INC., HIGHTSTOWN, NJ. FILED 7-23-2007.

RHEOLATE CVS

THE MARK CONSISTS OF STANDARD CHARACTERS WITHOUT CLAIM TO ANY PARTICULAR FONT, STYLE, SIZE, OR COLOR.
OWNER OF U.S. REG. NO. 2,135,875.
FOR CHEMICAL RHEOLOGICAL ADDITIVES FOR USE IN THE MANUFACTURE OF COATINGS AND PAINTS (U.S. CLS. 1, 5, 6, 10, 26 AND 46).
CHARISMA HAMPTON, EXAMINING ATTORNEY

CLASS 1—(Continued).

SN 77-261,613. ARR-MAZ PRODUCTS, L.P., MULBERRY, FL. FILED 8-22-2007.

CUSTOFLOC

THE MARK CONSISTS OF STANDARD CHARACTERS WITHOUT CLAIM TO ANY PARTICULAR FONT, STYLE, SIZE, OR COLOR.

OWNER OF U.S. REG. NO. 2,959,236.

FOR WATER SOLUBLE POLYMERS THAT ASSIST IN THE FLOCCULATION OF SMALL PARTICLES, FOR USE IN THE MINING, WATER AND SEWAGE TREATMENT AND PETROLEUM INDUSTRIES (U.S. CLS. 1, 5, 6, 10, 26 AND 46).

ANGELA GAW, EXAMINING ATTORNEY

SN 77-266,587. LOVELAND PRODUCTS, INC., GREELEY, CO. FILED 8-28-2007.

BLACKJACK ZN

THE MARK CONSISTS OF STANDARD CHARACTERS WITHOUT CLAIM TO ANY PARTICULAR FONT, STYLE, SIZE, OR COLOR.

NO CLAIM IS MADE TO THE EXCLUSIVE RIGHT TO USE "ZN", APART FROM THE MARK AS SHOWN.

FOR FERTILIZER CONTAINING ZINC (U.S. CLS. 1, 5, 6, 10, 26 AND 46).

JOHN DWYER, EXAMINING ATTORNEY

SN 77-271,317. ARMOR HOLDINGS FORENSICS, L.L.C., JACKSONVILLE, FL. FILED 9-4-2007.

HARD EVIDENCE

THE MARK CONSISTS OF STANDARD CHARACTERS WITHOUT CLAIM TO ANY PARTICULAR FONT, STYLE, SIZE, OR COLOR.

FOR FINGERPRINT DEVELOPER (U.S. CLS. 1, 5, 6, 10, 26 AND 46).

FIRST USE 0-0-1998; IN COMMERCE 0-0-1998.

CAROLYN GRAY, EXAMINING ATTORNEY

CLASS 1—(Continued).

SN 77-275,026. INNOPHOS, INC., CRANBURY, NJ. FILED 9-9-2007.

CALIPHARM

THE MARK CONSISTS OF STANDARD CHARACTERS WITHOUT CLAIM TO ANY PARTICULAR FONT, STYLE, SIZE, OR COLOR.

FOR CHEMICALS FOR USE IN THE MANUFACTURE OF PHARMACEUTICAL SUBSTANCES; CHEMICALS FOR USE IN THE MANUFACTURE OF PHARMACEUTICAL EXCIPIENTS (U.S. CLS. 1, 5, 6, 10, 26 AND 46).

SHAILA SETTLES, EXAMINING ATTORNEY

SN 77-278,137. WILBUR-ELLIS COMPANY, SAN FRANCISCO, CA. FILED 9-12-2007.



OWNER OF U.S. REG. NO. 2,524,251.

NO CLAIM IS MADE TO THE EXCLUSIVE RIGHT TO USE "TOTAL NUTRITION SYSTEM", APART FROM THE MARK AS SHOWN.

THE MARK CONSISTS OF TWO CONCENTRIC CIRCLES: TOP THIRD (APPROX.) CONTAINS THE WORD "TOTAL" WITH RENDITIONS OF DROPLETS AND GRAIN STALKS; BOTTOM THIRD CONTAINS THE WORD "SYSTEM" WITH RENDITION OF PLANT ROOTS; MIDDLE THIRD INCLUDES HORIZONTAL RECTANGLE WITH ROUNDED CORNERS CONTAINING THE WORD "NUTRITION".

FOR PLANT FOOD; PLANT GROWTH REGULATING PREPARATIONS; PLANT GROWTH REGULATORS FOR AGRICULTURAL USE; PREPARATIONS FOR FORTIFYING PLANTS; SUBSTANCES FOR REGULATING PLANT GROWTH; FERTILIZERS; FERTILIZERS FOR AGRICULTURAL USE (U.S. CLS. 1, 5, 6, 10, 26 AND 46).

FIRST USE 1-1-1998; IN COMMERCE 1-1-1998.

CHRIS WELLS, EXAMINING ATTORNEY

CLASS 1—(Continued).

SN 77-281,999. SPECIALTY COATING SYSTEMS, INC., INDIANAPOLIS, IN. FILED 9-18-2007.

CLASS 1—(Continued).

SN 77-288,116. NOVAZONE, INC., LIVERMORE, CA. FILED 9-25-2007.

ADPRO POLY

SOMBRERO

THE MARK CONSISTS OF STANDARD CHARACTERS WITHOUT CLAIM TO ANY PARTICULAR FONT, STYLE, SIZE, OR COLOR.

NO CLAIM IS MADE TO THE EXCLUSIVE RIGHT TO USE "POLY", APART FROM THE MARK AS SHOWN.

FOR CHEMICAL COMPOUNDS TO PROMOTE ADHESION OF PARYLENE APPLIED TO POLYMERIC SUBSTRATES (U.S. CLS. 1, 5, 6, 10, 26 AND 46).

BENJAMIN OKEKE, EXAMINING ATTORNEY

THE MARK CONSISTS OF STANDARD CHARACTERS WITHOUT CLAIM TO ANY PARTICULAR FONT, STYLE, SIZE, OR COLOR.

FOR CHEMICALS USED IN AGRICULTURE, NAMELY, SUN SCREEN APPLIED TO FRESH FRUITS AND VEGETABLES TO PREVENT DAMAGE DUE TO SUN EXPOSURE (U.S. CLS. 1, 5, 6, 10, 26 AND 46).

ALLISON HOLTZ, EXAMINING ATTORNEY

SN 77-283,508. GE HEALTHCARE UK LIMITED, BUCKINGHAMSHIRE, UNITED KINGDOM, FILED 9-19-2007.

SN 77-291,322. SEASOURCE, INC., SALT LAKE CITY, UT. FILED 9-28-2007.

AURODYE

SOLAR

THE MARK CONSISTS OF STANDARD CHARACTERS WITHOUT CLAIM TO ANY PARTICULAR FONT, STYLE, SIZE, OR COLOR.

FOR LABORATORY CHEMICALS NAMELY, AN ANTIBODY REAGENT USED FOR THE DETECTION OF ANTIGENS IN CELL AND TISSUE ANALYSIS FOR IN VITRO DIAGNOSTIC USE (U.S. CLS. 1, 5, 6, 10, 26 AND 46).

FIRST USE 3-1-1990; IN COMMERCE 3-1-1990.
ANNE FARRELL, EXAMINING ATTORNEY

THE MARK CONSISTS OF STANDARD CHARACTERS WITHOUT CLAIM TO ANY PARTICULAR FONT, STYLE, SIZE, OR COLOR.

FOR FERTILIZER (U.S. CLS. 1, 5, 6, 10, 26 AND 46).
FIRST USE 9-27-2007; IN COMMERCE 9-27-2007.

MIDGE BUTLER, EXAMINING ATTORNEY

SN 77-287,271. CARHILL ENTERPRISES, INC., ST. LOUIS, MO. FILED 9-24-2007.

SN 77-292,797. ARENA, SYLVESTER, PASO ROBLES, CA. FILED 10-1-2007.

V-TECH 5/100

Granola

THE MARK CONSISTS OF STANDARD CHARACTERS WITHOUT CLAIM TO ANY PARTICULAR FONT, STYLE, SIZE, OR COLOR.

FOR CHEMICAL OIL ADDITIVE (U.S. CLS. 1, 5, 6, 10, 26 AND 46).

AISHA CLARKE, EXAMINING ATTORNEY

THE MARK CONSISTS OF STANDARD CHARACTERS WITHOUT CLAIM TO ANY PARTICULAR FONT, STYLE, SIZE, OR COLOR.

FOR FERTILIZERS (U.S. CLS. 1, 5, 6, 10, 26 AND 46).
FIRST USE 1-15-2006; IN COMMERCE 1-15-2006.

JENNY PARK, EXAMINING ATTORNEY

CLASS 1—(Continued).

SN 77-293,111. WILBUR-ELLIS COMPANY, SAN FRANCISCO, CA. FILED 10-1-2007.

SOIL PENETRANT
ADVANTAGE



OWNER OF U.S. REG. NO. 1,917,512.
NO CLAIM IS MADE TO THE EXCLUSIVE RIGHT TO USE "SOIL PENETRANT", APART FROM THE MARK AS SHOWN.

THE MARK CONSISTS OF THE WORDS "SOIL PENETRANT" (BOTH IN SMALLER FONT) ABOVE THE WORD "ADVANTAGE" (BOLD UNDERLINE BISECTED BY INVERTED TRIANGLE).

FOR SURFACTANTS USED TO PROMOTE UNIFORM MOVEMENT OF WATER IN SOIL; CHEMICAL SOIL CONDITIONERS; SOIL CONDITIONING AND IMPROVING PREPARATIONS; SOIL AMENDMENTS AND ADDITIVES (U.S. CLS. 1, 5, 6, 10, 26 AND 46).

CHRIS WELLS, EXAMINING ATTORNEY

SN 77-293,652. GRAYMONT (PA) INC., PLEASANT GAP, PA. FILED 10-2-2007.

BALD EAGLE

THE MARK CONSISTS OF STANDARD CHARACTERS WITHOUT CLAIM TO ANY PARTICULAR FONT, STYLE, SIZE, OR COLOR.

FOR AGRICULTURAL LIMESTONE AND AGRICULTURAL LIMESTONE BYPRODUCTS, NAMELY, PULVERIZED LIMESTONE, LIME, QUICKLIME, HYDRATED LIME, KILN DUST AND CALCIUM HYDROXIDE (U.S. CLS. 1, 5, 6, 10, 26 AND 46).

FIRST USE 12-31-1986; IN COMMERCE 12-31-1986.

KAREN BRACEY, EXAMINING ATTORNEY

SN 77-294,004. THE WILKINSON CORPORATION, MAYVILLE, MI. FILED 10-2-2007.

ExoTherm

THE MARK CONSISTS OF STANDARD CHARACTERS WITHOUT CLAIM TO ANY PARTICULAR FONT, STYLE, SIZE, OR COLOR.

FOR CHEMICAL PREPARATIONS FOR MELTING SNOW AND ICE (U.S. CLS. 1, 5, 6, 10, 26 AND 46).

FIRST USE 10-1-2007; IN COMMERCE 10-1-2007.

JESSICA A. POWERS, EXAMINING ATTORNEY

CLASS 1—(Continued).

SN 77-294,259. MAKHTESHIM AGAN OF NORTH AMERICA, INC., RALEIGH, NC. FILED 10-2-2007.

N-LOCK

THE MARK CONSISTS OF STANDARD CHARACTERS WITHOUT CLAIM TO ANY PARTICULAR FONT, STYLE, SIZE, OR COLOR.

FOR CHEMICAL NITROGEN STABILIZER TO BE USED IN AGRICULTURE (U.S. CLS. 1, 5, 6, 10, 26 AND 46).

HENRY S. ZAK, EXAMINING ATTORNEY

SN 77-295,318. THE DOW CHEMICAL COMPANY, MIDLAND, MI. FILED 10-3-2007.

FORTEGRA

THE MARK CONSISTS OF STANDARD CHARACTERS WITHOUT CLAIM TO ANY PARTICULAR FONT, STYLE, SIZE, OR COLOR.

FOR COPOLYMER CHEMICALS FOR FURTHER MANUFACTURE OF INDUSTRIAL ADHESIVES, ADDITIVES FOR PAINT, COATINGS, COMPOSITES AND ELECTRICAL LAMINATES (U.S. CLS. 1, 5, 6, 10, 26 AND 46).

KIMBERLY FRYE, EXAMINING ATTORNEY

SN 77-296,048. SPECIALTY CONSTRUCTION BRANDS, INC., SAINT PAUL, MN. FILED 10-4-2007.

CHAPCO'S CHAMPION

THE MARK CONSISTS OF STANDARD CHARACTERS WITHOUT CLAIM TO ANY PARTICULAR FONT, STYLE, SIZE, OR COLOR.

OWNER OF U.S. REG. NOS. 871,987 AND 3,300,079.
FOR ADHESIVES FOR WOOD FLOORING (U.S. CLS. 1, 5, 6, 10, 26 AND 46).

JESSICA A. POWERS, EXAMINING ATTORNEY

CLASS 1—(Continued).

SN 77-299,443. HALLIBURTON ENERGY SERVICES, INC., CARROLLTON, TX. FILED 10-9-2007.

CLASS 1—(Continued).

SN 77-311,729. THE DOW CHEMICAL COMPANY, MIDLAND, MI. FILED 10-24-2007.

N-SOLATE

UCAR ENDURANCE

THE MARK CONSISTS OF STANDARD CHARACTERS WITHOUT CLAIM TO ANY PARTICULAR FONT, STYLE, SIZE, OR COLOR.

FOR CHEMICALS USED IN DRILLING FLUIDS FOR OIL AND GAS WELL DRILLING OPERATIONS (U.S. CLS. 1, 5, 6, 10, 26 AND 46).

SHAILA SETTLES, EXAMINING ATTORNEY

THE MARK CONSISTS OF STANDARD CHARACTERS WITHOUT CLAIM TO ANY PARTICULAR FONT, STYLE, SIZE, OR COLOR.

OWNER OF U.S. REG. NOS. 799,363, 1,848,870 AND OTHERS.

FOR AIRCRAFT ANTI-ICING AND DE-ICING CHEMICALS (U.S. CLS. 1, 5, 6, 10, 26 AND 46).

KIMBERLY FRYE, EXAMINING ATTORNEY

SN 77-299,511. HALLIBURTON ENERGY SERVICES, INC., CARROLLTON, TX. FILED 10-9-2007.

SN 77-313,032. PACE INTERNATIONAL, LLC, SEATTLE, WA. FILED 10-25-2007.

FOAM-ZAPPER

EpiShield

THE MARK CONSISTS OF STANDARD CHARACTERS WITHOUT CLAIM TO ANY PARTICULAR FONT, STYLE, SIZE, OR COLOR.

FOR CHEMICALS USED IN DRILLING FLUIDS FOR OIL AND GAS WELL DRILLING OPERATIONS (U.S. CLS. 1, 5, 6, 10, 26 AND 46).

SHAILA SETTLES, EXAMINING ATTORNEY

THE MARK CONSISTS OF STANDARD CHARACTERS WITHOUT CLAIM TO ANY PARTICULAR FONT, STYLE, SIZE, OR COLOR.

FOR AGRICULTURAL PRE-HARVEST CHEMICAL SOLUTION FOR USE IN PRESERVING PRODUCE (U.S. CLS. 1, 5, 6, 10, 26 AND 46).

DANIEL CAPSHAW, EXAMINING ATTORNEY

SN 77-306,312. THE DOW CHEMICAL COMPANY, MIDLAND, MI. FILED 10-17-2007.

SN 77-315,869. SURFATECH CORPORATION, DACULA, GA. FILED 10-29-2007.

ECHELON

COSMOSURF

THE MARK CONSISTS OF STANDARD CHARACTERS WITHOUT CLAIM TO ANY PARTICULAR FONT, STYLE, SIZE, OR COLOR.

FOR POLYURETHANE PREPOLYMER FOR FURTHER MANUFACTURE OF ADHESIVES, BINDERS AND COATINGS (U.S. CLS. 1, 5, 6, 10, 26 AND 46).

KIMBERLY FRYE, EXAMINING ATTORNEY

THE MARK CONSISTS OF STANDARD CHARACTERS WITHOUT CLAIM TO ANY PARTICULAR FONT, STYLE, SIZE, OR COLOR.

FOR CHEMICAL ADDITIVES FOR USE IN THE MANUFACTURE OF COSMETICS USED AS SURFACE ACTIVE AGENTS FOR WHOLESALE USE, NOT FOR SALE AT THE RETAIL LEVEL (U.S. CLS. 1, 5, 6, 10, 26 AND 46).

FIRST USE 9-4-2006; IN COMMERCE 9-4-2006.

ANNE FARRELL, EXAMINING ATTORNEY

CLASS 1—(Continued).

SN 77-317,974. SPECIALTY CONSTRUCTION BRANDS, INC., SAINT PAUL, MN. FILED 10-31-2007.



THE MARK CONSISTS OF THE LETTER "C" IN A STYLIZED FORMAT.
FOR ADHESIVES FOR WOOD FLOORING (U.S. CLS. 1, 5, 6, 10, 26 AND 46).
JESSICA A. POWERS, EXAMINING ATTORNEY

SN 78-525,886. S.A. LHOIST RECHERCHE ET DEVELOPPEMENT EN ABRÉGÉ L.R.D., OTTIGNIES-LOUVAIN-LA-NEUVE, BELGIUM, FILED 12-2-2004.

AKDOLIT

THE MARK CONSISTS OF STANDARD CHARACTERS WITHOUT CLAIM TO ANY PARTICULAR FONT, STYLE, SIZE, OR COLOR.

PRIORITY CLAIMED UNDER SEC. 44(D) ON ERPN CMNTY TM OFC APPLICATION NO. 3859931, FILED 6-2-2004, REG. NO. 003859931, DATED 4-17-2007, EXPIRES 6-2-2014.

FOR CHEMICALS FOR USE IN SCIENCE AND INDUSTRY, CHEMICAL ADDITIVES, NAMELY CALCITIC AND MAGNESIAN PRODUCTS FOR THE TREATMENT OF DRINKING WATERS AND TREATMENT OF INDUSTRIAL PROCESS WATERS (U.S. CLS. 1, 5, 6, 10, 26 AND 46).

LOURDES AYALA, EXAMINING ATTORNEY

CLASS 1—(Continued).

SN 78-876,865. GLOBACHEM NV, SINT TRUIDEN, BELGIUM, FILED 5-4-2006.

PLATINA

THE MARK CONSISTS OF STANDARD CHARACTERS WITHOUT CLAIM TO ANY PARTICULAR FONT, STYLE, SIZE, OR COLOR.

FOR FERTILIZERS AND PLANT GROWTH REGULATORS (U.S. CLS. 1, 5, 6, 10, 26 AND 46).

FIRST USE 6-0-2004; IN COMMERCE 6-0-2004.

WILLIAM VERHOSEK, EXAMINING ATTORNEY

SN 78-902,475. INNOPHOS, INC., CRANBURY, NJ. FILED 6-7-2006.

OSTEOFIT

THE MARK CONSISTS OF STANDARD CHARACTERS WITHOUT CLAIM TO ANY PARTICULAR FONT, STYLE, SIZE, OR COLOR.

FOR CHEMICALS USED IN INDUSTRY, NAMELY, TRICALCIUM PHOSPHATE (U.S. CLS. 1, 5, 6, 10, 26 AND 46).

AMEETA JORDAN, EXAMINING ATTORNEY

SN 78-935,728. MITSUBISHI GAS CHEMICAL COMPANY, INC., TOKYO, JAPAN, FILED 7-24-2006.

H-TMAn

THE MARK CONSISTS OF STYLIZED LETTERS IN THAT THE LETTERS ARE UPPER CASE AND LOWER CASE.

FOR CHEMICALS, NAMELY, ORGANIC ACIDS, ORGANIC ACIDS ANHYDRIDE, FOR INDUSTRIAL USE (U.S. CLS. 1, 5, 6, 10, 26 AND 46).

MARIAM MAHMOUDI, EXAMINING ATTORNEY

CLASS 1—(Continued).

SN 78-962,829. BIOMED IMMUNOTECH, INC., ALACHUA, FL. FILED 8-29-2006.



NO CLAIM IS MADE TO THE EXCLUSIVE RIGHT TO USE "BIOMED IMMUNOTECH", APART FROM THE MARK AS SHOWN.

FOR DIAGNOSTIC REAGENTS FOR SCIENTIFIC USE, NAMELY, PRIMERS, BUFFERS, ENZYMES BEING STABILIZERS AND SUBSTRATES, AND ANTIBODIES USED TO DETERMINE T AND B LYMPHOCYTE RESPONSES AND KITS CONSISTING PRIMARILY OF THE REAGENTS SOLD WITH COMPUTER SOFTWARE USED TO ANALYZE T AND B CELL IMMUNE RESPONSES, PRIMARILY FOR SCIENTIFIC RESEARCH PURPOSES, SCIENTIFIC AND RESEARCH SERVICES, IN THE FIELD OF T CELL SEPARATION, MRNA PURIFICATION AND CDNA SYNTHESIS, PRIMARY AND NESTED POLYMERASE CHAIN REACTION (PCR) AMPLIFICATIONS, CLONALITY DETECTIONS AND CDR3 LENGTH SPECTRATYPING, DATA COLLECTIONS AND ANALYSIS OF RESULTS WITH SOFTWARE, AND MOLECULAR CLONING FOR EACH TCR REPERTOIRE (U.S. CLS. 1, 5, 6, 10, 26 AND 46).

FIRST USE 5-0-2006; IN COMMERCE 5-0-2006.
TRACY WHITTAKER-BROWN, EXAMINING ATTORNEY

CLASS 1—(Continued).

SN 79-037,474. CELULOSA DE LEVANTE, S.A., SPAIN, FILED 2-23-2007.

HEMPCELL

OWNER OF INTERNATIONAL REGISTRATION 0921428 DATED 2-23-2007, EXPIRES 2-23-2017.

FOR CELLULOSE PULP AND SULPHITE PULP FOR USE IN INDUSTRIAL FABRICATION OF PAPER, NAMELY, CIGARETTE PAPER, FILTRATION PAPER, PRINTING AND WRITING PAPER, ARTISTIC AND DECORATIVE PAPER; ACETATE OF CELLULOSE UNPROCESSED FOR AMORPHOUS THERMOPLASTIC MATERIAL USED IN THE INDUSTRIAL FABRICATION OF TRANSPARENT, TRANSLUCENT, AND OPAQUE OBJECTS, NAMELY, KEYS, CALCULATORS, SWITCHES, CAR WHEEL COVERINGS, BLOUSES, DRESSES, LININGS, WEDDING AND PARTY ATTIRE, HOME FURNISHINGS, DRAPERIES, UPHOLSTERY, SLIP COVERS, DIAPERS, FEMININE HYGIENE PRODUCTS, CIGARETTE FILTERS, SURGICAL PRODUCTS, FILTERS; CELLULOSE DERIVATIVES FOR INDUSTRIAL FABRICATION OF PHOTOGRAPHIC FILMS, VARNISHES AND MOLDINGS, NAMELY, CELLULOSE ACETATE BUTYRATE; CELLULOSE ESTERS FOR INDUSTRIAL PURPOSES, NAMELY, ADDITIVE COMPONENTS OF THERMOPLASTIC AND THERMOSETTING SOLVENTS USED AS BINDERS, ADDITIVES, FILM FORMERS OR MODIFIERS IN AUTOMOTIVE, WOOD, PLASTIC, PAPER, PAPER COATINGS, LEATHER COATINGS, CLOTH COATINGS, RADIATION COATINGS, MELTING COATINGS, NAIL CARE COATINGS, PHARMACEUTICAL COATINGS, AND PRINTING INK COATINGS; CELLULOSE ETHERS FOR INDUSTRIAL PURPOSES IN THE AREAS OF FOOD, PAINT, OIL RECOVERY, PAPER, COSMETICS, PHARMACEUTICALS, ADHESIVES, PRINTING, AGRICULTURE, CERAMICS, TEXTILES, DETERGENTS AND BUILDING MATERIALS, NAMELY, ETHERS USED AS ADDITIVES, THICKENERS, WATER RETENTION AGENTS, SUSPENDING AIDS, PROTECTING COLLOIDS, FILM FORMERS, AND THERMOPLASTICS (U.S. CLS. 1, 5, 6, 10, 26 AND 46).

FLORENTINA BLANDU, EXAMINING ATTORNEY

SN 79-030,936. S&B INDUSTRIAL MINERALS GMBH, FED REP GERMANY, FILED 8-23-2006.



OWNER OF INTERNATIONAL REGISTRATION 0903549 DATED 8-23-2006, EXPIRES 8-23-2016.

THE MARK CONSISTS OF THE STYLIZED LETTERS "S" AND "T" AND THE WORDING "STOLLBERG".

FOR CASTING FLUXES; REFINING AGENTS, NAMELY, LIQUID, POWDERED, OR GRANULATED COMPOUNDS FOR TREATING MOLTEN METAL AND METALLURGICAL SLAGS FOR THE METALLURGICAL TREATMENT OF METAL MELTS (U.S. CLS. 1, 5, 6, 10, 26 AND 46).

DANIEL BRODY, EXAMINING ATTORNEY

CLASS 1—(Continued).

SN 79-037,475. CELULOSA DE LEVANTE, S.A., SPAIN,
FILED 2-23-2007.

CLASS 1—(Continued).

SN 79-037,476. CELULOSA DE LEVANTE, S.A., SPAIN,
FILED 2-23-2007.

LINCELL JUTCELL

OWNER OF INTERNATIONAL REGISTRATION 0921429
DATED 2-23-2007, EXPIRES 2-23-2017.

FOR CELLULOSE PULP AND SULPHITE PULP FOR USE IN INDUSTRIAL FABRICATION OF PAPER, NAMELY, CIGARETTE PAPER, BANK NOTE AND SECURITY PAPER, PRINTING AND WRITING PAPER, ARTISTIC AND DECORATIVE PAPER; ACETATE OF CELLULOSE UNPROCESSED FOR AMORPHOUS THERMOPLASTIC MATERIAL USED IN THE INDUSTRIAL FABRICATION OF TRANSPARENT, TRANSLUCENT, AND OPAQUE OBJECTS, NAMELY, KEYS, CALCULATORS, SWITCHES, CAR WHEEL COVERINGS, BLOUSES, DRESSES, LININGS, WEDDING AND PARTY ATTIRE, HOME FURNISHINGS, DRAPERIES, UPHOLSTERY, SLIP COVERS, DIAPERS, FEMININE HYGIENE PRODUCTS, CIGARETTE FILTERS, SURGICAL PRODUCTS, FILTERS; CELLULOSE DERIVATIVES FOR INDUSTRIAL FABRICATION OF PHOTOGRAPHIC FILMS, VARNISHES AND MOLDINGS, NAMELY, CELLULOSE ACETATE BUTYRATE; CELLULOSE ESTERS FOR INDUSTRIAL PURPOSES, NAMELY, ADDITIVE COMPONENTS OF THERMOPLASTIC AND THERMOSETTING SOLVENTS USED AS BINDERS, ADDITIVES, FILM FORMERS OR MODIFIERS IN AUTOMOTIVE, WOOD, PLASTIC, PAPER, PAPER COATINGS, LEATHER COATINGS, CLOTH COATINGS, RADIATION COATINGS, MELTING COATINGS, NAIL CARE COATINGS, PHARMACEUTICAL COATINGS, AND PRINTING INK COATINGS; CELLULOSE ETHERS FOR INDUSTRIAL PURPOSES IN THE AREAS OF FOOD, PAINT, OIL RECOVERY, PAPER, COSMETICS, PHARMACEUTICALS, ADHESIVES, PRINTING, AGRICULTURE, CERAMICS, TEXTILES, DETERGENTS AND BUILDING MATERIALS, NAMELY, ETHERS USED AS ADDITIVES, THICKENERS, WATER RETENTION AGENTS, SUSPENDING AIDS, PROTECTING COLLOIDS, FILM FORMERS, AND THERMOPLASTICS (U.S. CLS. 1, 5, 6, 10, 26 AND 46).

FLORENTINA BLANDU, EXAMINING ATTORNEY

OWNER OF INTERNATIONAL REGISTRATION 0921430
DATED 2-23-2007, EXPIRES 2-23-2017.

FOR CELLULOSE PULP AND SULPHITE PULP FOR USE IN INDUSTRIAL FABRICATION OF PAPER, NAMELY, CIGARETTE PAPER, TEA BAG PAPER, CAPACITOR PAPER, CONDENSER AND ELECTROLYTIC PAPER, LAMINATE BASE PAPER AND NON WOVENS, STENCIL PAPER, PAPER FOR FOOD USE; ACETATE OF CELLULOSE UNPROCESSED FOR INDUSTRIAL FABRICATION OF TRANSPARENT, TRANSLUCENT, AND OPAQUE OBJECTS, NAMELY, CALCULATORS, SWITCHES, CAR WHEEL COVERINGS, BLOUSES, DRESSES, LININGS, WEDDING AND PARTY ATTIRE, HOME FURNISHINGS, DRAPERIES, UPHOLSTERY, SLIP COVERS, DIAPERS, FEMININE HYGIENE PRODUCTS, CIGARETTE FILTERS, SURGICAL PRODUCTS, FILTERS; CELLULOSE DERIVATIVES FOR INDUSTRIAL FABRICATION OF PHOTOGRAPHIC FILMS, VARNISHES AND MOLDINGS, NAMELY, CELLULOSE ACETATE BUTYRATE; CELLULOSE ESTERS FOR INDUSTRIAL PURPOSES, NAMELY, ADDITIVE COMPONENTS OF THERMOPLASTIC AND THERMOSETTING SOLVENTS USED AS BINDERS, ADDITIVES, FILM FORMERS OR MODIFIERS IN AUTOMOTIVE, WOOD, PLASTIC, PAPER, PAPER COATINGS, LEATHER COATINGS, CLOTH COATINGS, RADIATION COATINGS, MELTING COATINGS, NAIL CARE COATINGS, PHARMACEUTICAL COATINGS, AND PRINTING INK COATINGS; CELLULOSE ETHERS FOR INDUSTRIAL PURPOSES IN THE AREAS OF FOOD, PAINT, OIL RECOVERY, PAPER, COSMETICS, PHARMACEUTICALS, ADHESIVES, PRINTING, AGRICULTURE, CERAMICS, TEXTILES, DETERGENTS AND BUILDING MATERIALS, NAMELY, ETHERS USED AS ADDITIVES, THICKENERS, WATER RETENTION AGENTS, SUSPENDING AIDS, PROTECTING COLLOIDS, FILM FORMERS, AND THERMOPLASTICS (U.S. CLS. 1, 5, 6, 10, 26 AND 46).

FLORENTINA BLANDU, EXAMINING ATTORNEY

CLASS 1—(Continued).

SN 79-037,736. CELULOSA DE LEVANTE, S.A., SPAIN,
FILED 2-23-2007.



OWNER OF INTERNATIONAL REGISTRATION 0922090
DATED 2-23-2007, EXPIRES 2-23-2017.

NO CLAIM IS MADE TO THE EXCLUSIVE RIGHT TO
USE "SA", APART FROM THE MARK AS SHOWN.

THE COLOR(S) BROWN AND BLACK IS/ARE CLAIMED
AS A FEATURE OF THE MARK.

BROWN: GRAPHIC ELEMENT AND BLACK: DENOMI-
NATIVE COMBINATION.

GRAPHIC FORMED BY FOUR BROWN HORIZONTAL
LINES ON THEIR RIGHT EXTREME DIVERGE INTO
FOUR CURVED LINES FORMING A "C", ON THE RIGHT
OF WHICH ARE THE DENOMINATIVE ELEMENTS.

THE FOREIGN WORDING IN THE MARK TRANSLATES
INTO ENGLISH AS "CELESA" DOES NOT HAVE AN
ENGLISH MEANING; "CELULOSA" MEANS "CELL"; AND
"LEVANTE" IS A GEOGRAPHIC REFERENCE.

FOR CELLULOSE PULP AND SULPHITE PULP FOR
USE IN INDUSTRIAL FABRICATION OF PAPER,
NAMELY, PLUG WRAP PAPER, TEA BAG PAPER,
VACUUM BAG PAPER, FILTRATION PAPER, BANK
NOTE AND SECURITY PAPER, CAPACITOR PAPER,
CONDENSER PAPER, ELECTROLYTIC PAPER, GRID
PASTING TISSUE, ABSORBENT PAPER, MEAT CASING
PAPER, NON WOVEN PAPER, PRINTING AND WRIT-
ING PAPER, ADHESIVE CARRIER PAPER, ART AND
DECORATIVE PAPER; ACETATE OF CELLULOSE UN-
PROCESSED FOR AMORPHOUS THERMOPLASTIC MA-
TERIAL USED IN THE INDUSTRIAL FABRICATION OF
TRANSPARENT, TRANSLUCENT, AND OPAQUE OB-
JECTS, NAMELY, KEYS, CALCULATORS, SWITCHES,
CAR WHEEL COVERINGS, BLOUSES, DRESSES, LIN-
INGS, WEDDING AND PARTY ATTIRE, HOME FUR-
NISHINGS, DRAPERIES, UPHOLSTERY, SLIP COVERS,
DIAPERS, FEMININE HYGIENE PRODUCTS, CIGAR-
ETTE FILTERS, SURGICAL PRODUCTS, FILTERS; CEL-
LULOSE DERIVATIVES FOR INDUSTRIAL
FABRICATION OF PHOTOGRAPHIC FILMS,
VARNISHES AND MOLDINGS, NAMELY, CELLULOSE
ACETATE BUTYRATE; CELLULOSE ESTERS FOR IN-
DUSTRIAL PURPOSES, NAMELY, ADDITIVE COMPO-
NENTS OF THERMOPLASTIC AND THERMOSETTING
SOLVENTS USED AS BINDERS, ADDITIVES, FILM
FORMERS OR MODIFIERS IN AUTOMOTIVE, WOOD,
PLASTIC, PAPER, PAPER COATINGS, LEATHER COAT-
INGS, CLOTH COATINGS, RADIATION COATINGS,
MELTING COATINGS, NAIL CARE COATINGS, PHAR-
MACEUTICAL COATINGS, AND PRINTING INK COAT-
INGS; CELLULOSE ETHERS FOR INDUSTRIAL
PURPOSES IN THE AREAS OF FOOD, PAINT, OIL
RECOVERY, PAPER, COSMETICS, PHARMACEUTI-
CALS, ADHESIVES, PRINTING, AGRICULTURE, CERA-
MICS, TEXTILES, DETERGENTS AND BUILDING
MATERIALS, NAMELY, ETHERS USED AS ADDITIVES,
THICKENERS, WATER RETENTION AGENTS, SUS-
PENDING AIDS, PROTECTING COLLOIDS, FILM FOR-
MERS, AND THERMOPLASTICS (U.S. CLS. 1, 5, 6, 10, 26
AND 46).

FLORENTINA BLANDU, EXAMINING ATTORNEY

CLASS 1—(Continued).

SN 79-038,720. CELULOSA DE LEVANTE, S.A., SPAIN,
FILED 2-23-2007.

ABACELL

OWNER OF INTERNATIONAL REGISTRATION 0924811
DATED 2-23-2007, EXPIRES 2-23-2017.

FOR CELLULOSE PULP AND SULPHITE PULP FOR
USE IN INDUSTRIAL FABRICATION OF PAPER,
NAMELY, PLUG WRAP PAPER, TEA BAG PAPER,
FILTERS OF COFFEE, VACUUM BAG PAPER, FILTRA-
TION PAPER, BANK NOTE AND SECURITY PAPER,
CAPACITOR PAPER, CONDENSER PAPER, ELECTRO-
LYTIC PAPER, GRID PASTING TISSUE, ABSORBENT
PAPER, MEAT CASING PAPER, PRINTING AND WRIT-
ING PAPER, LAMINATED PAPER, ADHESIVE CAR-
RIER PAPER, NON WOVEN PAPER, CIGARETTE
PAPER, ARTISTIC AND DECORATIVE PAPER; ACET-
ATE OF CELLULOSE UNPROCESSED FOR AMOR-
PHOUS THERMOPLASTIC MATERIAL USED IN THE
INDUSTRIAL FABRICATION OF TRANSPARENT,
TRANSLUCENT, AND OPAQUE OBJECTS, NAMELY,
KEYS, CALCULATORS, SWITCHES, CAR WHEEL COV-
ERINGS, BLOUSES, DRESSES, LININGS, WEDDING
AND PARTY ATTIRE, HOME FURNISHINGS, DRAP-
ERIES, UPHOLSTERY, SLIP COVERS, DIAPERS, FEM-
INE HYGIENE PRODUCTS, CIGARETTE FILTERS,
SURGICAL PRODUCTS, FILTERS; CELLULOSE DERI-
VATIVES FOR INDUSTRIAL FABRICATION OF
PHOTOGRAPHIC FILMS, VARNISHES AND MOLD-
INGS, NAMELY, CELLULOSE ACETATE BUTYRATE;
CELLULOSE ESTERS FOR INDUSTRIAL PURPOSES,
NAMELY, ADDITIVE COMPONENTS OF THERMO
PLASTIC AND THERMOSETTING SOLVENTS USED
AS BINDERS, ADDITIVES, FILM FORMERS OR MODI-
FIERS IN AUTOMOTIVE, WOOD, PLASTIC, PAPER,
PAPER COATINGS, LEATHER COATINGS, CLOTH
COATINGS, RADIATION COATINGS, MELTING COAT-
INGS, NAIL CARE COATINGS, PHARMACEUTICAL
COATINGS, AND PRINTING INK COATINGS; CELLU-
LOSE ETHERS FOR INDUSTRIAL PURPOSES IN THE
AREAS OF FOOD, PAINT, OIL RECOVERY, PAPER,
COSMETICS, PHARMACEUTICALS, ADHESIVES,
PRINTING, AGRICULTURE, CERAMICS, TEXTILES,
DETERGENTS AND BUILDING MATERIALS,
NAMELY, ETHERS USED AS ADDITIVES, THICK-
ENERS, WATER RETENTION AGENTS, SUSPENDING
AIDS, PROTECTING COLLOIDS, FILM FORMERS, AND
THERMOPLASTICS (U.S. CLS. 1, 5, 6, 10, 26 AND 46).

LA TONIA FISHER, EXAMINING ATTORNEY

CLASS 1—(Continued).

SN 79-041,563. ZHEJIANG SANMEI CHEMICAL; INDUSTRY CO., LTD., CHINA, FILED 6-18-2007.



OWNER OF INTERNATIONAL REGISTRATION 0932007 DATED 6-18-2007, EXPIRES 6-18-2017.

THE ENGLISH TRANSLATION OF THE FOREIGN WORD(S) IN THE MARK IS: THE FIRST CHINESE CHARACTER "SAN" MEANS "THREE", THE SECOND CHINESE CHARACTER "MEI" MEANS "BEAUTY"; THE WHOLE OF TWO CHINESE CHARACTERS HAS NO ANY MEANING AND CAN NOT BE TRANSLATED ENGLISH.

THE TRANSLITERATION OF THE NON-LATIN CHARACTERS IN THE MARK IS: SAN MEI.

FOR FLUORSPAR COMPOUNDS; SALTS IN THE NATURE OF CHEMICAL PREPARATIONS FOR INDUSTRIAL USE; AMMONIUM SALTS; INDUSTRIAL CHEMICAL; SIZE FOR FINISHING AND PRIMING FOR METAL AND GLASS; GLASS-FROSTING CHEMICALS; REFRIGERANTS, NAMELY CHEMICALS FOR REFRIGERATION AND COOLING; MORDANTS FOR METAL, USED FOR RUST REMOVAL; FIRE EXTINGUISHING COMPOSITIONS (U.S. CLS. 1, 5, 6, 10, 26 AND 46).

MARK PILARO, EXAMINING ATTORNEY

CLASS 2—PAINTS

SN 77-000,295. MIX MANUFACTURING, INC., ST. PAUL, MN. FILED 9-15-2006.

PRISM PIGMENTS

THE MARK CONSISTS OF STANDARD CHARACTERS WITHOUT CLAIM TO ANY PARTICULAR FONT, STYLE, SIZE, OR COLOR.

NO CLAIM IS MADE TO THE EXCLUSIVE RIGHT TO USE "PIGMENTS", APART FROM THE MARK AS SHOWN. FOR COLOR PIGMENTS (U.S. CLS. 6, 11 AND 16).

FIRST USE 1-1-1992; IN COMMERCE 3-1-1992.

KRISTIN DAHLING, EXAMINING ATTORNEY

CLASS 2—(Continued).

SN 77-018,486. VALSPAR SOURCING, INC., MINNEAPOLIS, MN. FILED 10-11-2006.

FLUROPON PC

THE MARK CONSISTS OF STANDARD CHARACTERS WITHOUT CLAIM TO ANY PARTICULAR FONT, STYLE, SIZE, OR COLOR.

OWNER OF U.S. REG. NO. 810,730.

THE "FLUROPON PC", "FLUROPON" AND "PC" HAS NO MEANING IN A FOREIGN LANGUAGE.

FOR PROTECTIVE AND DECORATIVE CORROSION-RESISTANT COATINGS FOR EXPOSED SURFACES NAMELY, HARDWARE SURFACES, DOMESTIC BUILDING EXPOSED SURFACES, COMMERCIAL BUILDING EXPOSED SURFACES, AND INDUSTRIAL BUILDING EXPOSED SURFACES. (U.S. CLS. 6, 11 AND 16).

SETH A. RAPPAPORT, EXAMINING ATTORNEY

SN 77-031,862. FERRO CORPORATION, CLEVELAND, OH. FILED 10-30-2006.

EVOLUTION

THE MARK CONSISTS OF STANDARD CHARACTERS WITHOUT CLAIM TO ANY PARTICULAR FONT, STYLE, SIZE, OR COLOR.

FOR GLASS-CONTAINING PORCELAIN ENAMEL COATING COMPOSITIONS FOR INDUSTRIAL USE THAT BOND TO METAL SUBSTRATES AT TEMPERATURES ABOVE 1000 F TO PRODUCE VITREOUS GLASS COATINGS HAVING A METALLIC APPEARANCE AND WHICH ARE NOT IN THE NATURE OF PAINT AND WHICH ARE FOR USE IN PRODUCING PROTECTIVE COATINGS ON METAL SUBSTRATES (U.S. CLS. 6, 11 AND 16).

KAELIE KUNG, EXAMINING ATTORNEY

SN 77-134,364. ECOLOGY COATINGS, INC., AKRON, OH. FILED 3-19-2007.



THE COLOR(S) GREEN AND GREY IS/ARE CLAIMED AS A FEATURE OF THE MARK.

THE MARK CONSISTS OF THE RIBBON FOLDED TO FORM A CURVED SHAPED TRIANGLE. THE TILDE DESIGN AND THE WORD "ECOLOGY" APPEAR IN THE COLOR GREEN, THE WORD "COATINGS" APPEARS IN THE COLOR GREY.

FOR PAINTS (U.S. CLS. 6, 11 AND 16).

GEORGIA CARTY, EXAMINING ATTORNEY

CLASS 2—(Continued).

SN 77-144,095. DYNAMIC CONTROL OF NORTH AMERICA, INC., HAMILTON, OH. FILED 3-29-2007.



NO CLAIM IS MADE TO THE EXCLUSIVE RIGHT TO USE "SPRAY", APART FROM THE MARK AS SHOWN.
THE MARK CONSISTS OF STYLIZED WORD "DYNA" STACKED OVER THE STYLIZED WORD "SPRAY" IN A TWO-TONE BOX.
FOR COATING COMPOUND, NAMELY, A LIQUID WATERBORNE, VISCO-ELASTIC POLYMER COATING COMPOUND FOR SOUND, RESONANCE AND VIBRATION CONTROL AND FOR USE AS A SOUND DEADENER, UNDERCOAT, GRAVEL GUARD, RUST PROTECTOR AND THERMAL SHIELD FOR AUTOMOTIVE VEHICLES (U.S. CLS. 6, 11 AND 16).
FIRST USE 11-1-1997; IN COMMERCE 1-14-1998.
RICHARD A. STRASER, EXAMINING ATTORNEY

CLASS 2—(Continued).

SN 77-219,377. SOUTHERN DIVERSIFIED PRODUCTS, LLC, HATTIESBURG, MS. FILED 6-29-2007.

MYTHIC

THE MARK CONSISTS OF STANDARD CHARACTERS WITHOUT CLAIM TO ANY PARTICULAR FONT, STYLE, SIZE, OR COLOR.
FOR PAINTS; INTERIOR PAINT; EXTERIOR PAINT; HOUSE PAINT (U.S. CLS. 6, 11 AND 16).
FIRST USE 6-22-2007; IN COMMERCE 6-22-2007.
VERNA BETH RIRIE, EXAMINING ATTORNEY

SN 77-219,368. SOUTHERN DIVERSIFIED PRODUCTS, LLC, HATTIESBURG, MS. FILED 6-29-2007.

0% TOXIC. 100% SMART.

THE MARK CONSISTS OF STANDARD CHARACTERS WITHOUT CLAIM TO ANY PARTICULAR FONT, STYLE, SIZE, OR COLOR.
FOR PAINTS; INTERIOR PAINT; EXTERIOR PAINT; HOUSE PAINT (U.S. CLS. 6, 11 AND 16).
FIRST USE 6-22-2007; IN COMMERCE 6-22-2007.
VERNA BETH RIRIE, EXAMINING ATTORNEY

SN 77-219,393. SOUTHERN DIVERSIFIED PRODUCTS, LLC, HATTIESBURG, MS. FILED 6-29-2007.



SN 77-219,371. SOUTHERN DIVERSIFIED PRODUCTS, LLC, HATTIESBURG, MS. FILED 6-29-2007.

STRONGER, SAFER, SMARTER
PAINT.

THE MARK CONSISTS OF STANDARD CHARACTERS WITHOUT CLAIM TO ANY PARTICULAR FONT, STYLE, SIZE, OR COLOR.
NO CLAIM IS MADE TO THE EXCLUSIVE RIGHT TO USE "PAINT", APART FROM THE MARK AS SHOWN.
FOR PAINTS; INTERIOR PAINT; EXTERIOR PAINT; HOUSE PAINT (U.S. CLS. 6, 11 AND 16).
FIRST USE 6-22-2007; IN COMMERCE 6-22-2007.
VERNA BETH RIRIE, EXAMINING ATTORNEY

NO CLAIM IS MADE TO THE EXCLUSIVE RIGHT TO USE "NON-TOXIC PAINT", APART FROM THE MARK AS SHOWN.
THE MARK CONSISTS OF THE WORD "MYTHIC" IN STYLIZED FONT ON TOP OF A DESIGN OF A STYLIZED INVERSE TRIANGULAR SHAPE OR "PICK" SHAPED DESIGN. THE WORDS "NON-TOXIC PAINT" APPEAR BELOW THE WORD "MYTHIC" IN BLACK ON A WHITE INVERSE PICK SHAPE GROUND INSIDE OF THE BLACK PICK SHAPE.
FOR PAINTS; INTERIOR PAINT; EXTERIOR PAINT; HOUSE PAINT (U.S. CLS. 6, 11 AND 16).
FIRST USE 6-22-2007; IN COMMERCE 6-22-2007.
VERNA BETH RIRIE, EXAMINING ATTORNEY

CLASS 2—(Continued).

SN 77-244,001. AKZO NOBEL COATINGS INTERNATIONAL B.V., ARNHEM, NETHERLANDS, FILED 8-1-2007.

FLUOROMAX

THE MARK CONSISTS OF STANDARD CHARACTERS WITHOUT CLAIM TO ANY PARTICULAR FONT, STYLE, SIZE, OR COLOR.

OWNER OF BENELUX REG. NO. 0718444, DATED 12-3-2002, EXPIRES 12-3-2012.

FOR INDUSTRIAL PAINTS PARTICULARLY FOR USE ON ARCHITECTURAL ELEMENTS, SUCH AS CLADDING UNITS, DOORS, WINDOWS AND BALCONY RAILS; CLEAR AND PIGMENTED POWDER COATINGS USED IN THE NATURE OF PAINT (U.S. CLS. 6, 11 AND 16).

PAM WILLIS, EXAMINING ATTORNEY

CLASS 2—(Continued).

SN 77-310,085. PERFORMANCE INDICATOR, LLC, LOWELL, MA. FILED 10-22-2007.



OWNER OF U.S. REG. NO. 2,815,176. FOR CAMOUFLAGE PAINTS FOR MILITARY EQUIPMENT; COATING COMPOSITIONS IN THE NATURE OF PAINT FOR INDUSTRIAL APPLICATIONS; FLUORESCENT PAINTS; PAINTS; PAINTS FOR IDENTIFICATION AND AUTHORIZATION; PAVEMENT MARKING PAINT; PAVEMENT STRIPING PAINT (U.S. CLS. 6, 11 AND 16).

FIRST USE 6-14-2002; IN COMMERCE 7-7-2007. LAURA HAMMEL, EXAMINING ATTORNEY

SN 77-266,518. GIGACRETE, INC., SCOTTSDALE, AZ. FILED 8-28-2007.

GIGAFLOOR

THE MARK CONSISTS OF STANDARD CHARACTERS WITHOUT CLAIM TO ANY PARTICULAR FONT, STYLE, SIZE, OR COLOR.

FOR NON-METALLIC, CEMENTITIOUS BUILDING MATERIAL IN THE NATURE OF FLOOR OVERLAYMENT COATINGS FOR FLOORS AND WALLS FOR INTERIOR AND EXTERIOR APPLICATIONS (U.S. CLS. 6, 11 AND 16).

FIRST USE 3-27-2006; IN COMMERCE 3-27-2006. SAMUEL E. SHARPER JR., EXAMINING ATTORNEY

SN 77-310,619. PERFORMANCE INDICATOR, LLC, LOWELL, MA. FILED 10-23-2007.

PERFORMANCE INDICATOR

THE MARK CONSISTS OF STANDARD CHARACTERS WITHOUT CLAIM TO ANY PARTICULAR FONT, STYLE, SIZE, OR COLOR.

OWNER OF U.S. REG. NO. 2,767,033. FOR CAMOUFLAGE PAINTS FOR MILITARY EQUIPMENT; COATING COMPOSITIONS IN THE NATURE OF PAINT FOR INDUSTRIAL APPLICATIONS; FLUORESCENT PAINTS; PAINTS; PAINTS FOR IDENTIFICATION AND AUTHENTICATION; PAVEMENT MARKING PAINT; PAVEMENT STRIPING PAINT (U.S. CLS. 6, 11 AND 16).

FIRST USE 7-7-2007; IN COMMERCE 7-7-2007. LAURA HAMMEL, EXAMINING ATTORNEY

SN 77-294,241. POINTE INTERNATIONAL INC., RIDGEFIELD, NJ. FILED 10-2-2007.

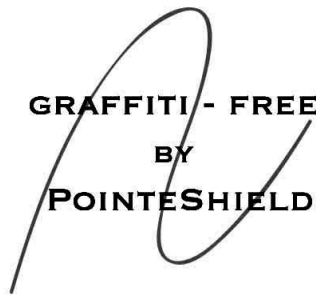

FOR CLEAR PROTECTIVE COATING APPLIED TO THE SURFACE OF IMITATION LEATHER, TEXTILES, AND OTHER SUBSTRATES FOR STAIN RESISTANCE PROPERTIES (U.S. CLS. 6, 11 AND 16).

CAROLINE WOOD, EXAMINING ATTORNEY

CLASS 2—(Continued).

SN 78-920,422. CURTIS-YOUNG CORPORATION, DBA THE TURBON GROUP, CINNAMINSON, NJ. FILED 6-29-2006.

THE TURBON GROUP

THE MARK CONSISTS OF STANDARD CHARACTERS WITHOUT CLAIM TO ANY PARTICULAR FONT, STYLE, SIZE, OR COLOR.

OWNER OF U.S. REG. NOS. 1,285,227 AND 1,978,068.

NO CLAIM IS MADE TO THE EXCLUSIVE RIGHT TO USE "GROUP", APART FROM THE MARK AS SHOWN.

FOR INK JET CARTRIDGES, NAMELY, REPLACEMENT INK JET CARTRIDGES FOR USE WITH INK JET PRINTERS; AND TONER CARTRIDGES, NAMELY, REPLACEMENT TONER CARTRIDGES FOR USE WITH COPIERS AND PRINTERS (U.S. CLS. 6, 11 AND 16).

FIRST USE 8-1-2005; IN COMMERCE 8-1-2005.

LESLEY LAMOTHE, EXAMINING ATTORNEY

CLASS 2—(Continued).

SN 79-038,300. J.C. HEMPEL'S SKIBSFARVE-FABRIK A/S, DENMARK, FILED 9-26-2006.

OCEANIC

THE MARK CONSISTS OF STANDARD CHARACTERS WITHOUT CLAIM TO ANY PARTICULAR FONT, STYLE, SIZE, OR COLOR.

OWNER OF INTERNATIONAL REGISTRATION 0799915 DATED 2-20-2003, EXPIRES 2-20-2013.

OWNER OF U.S. REG. NO. 2,932,735.

FOR PAINTS, NAMELY, PAINT PRIMERS AND PAINT SEALERS, PAINTS WITH ANTI-FOULING PROPERTIES, EMULSION PAINTS, TEXTURED PAINTS, PAINTS WITH SPECIAL EFFECTS, FILLERS, NAMELY PAINT FOR FILLING AND REPAIR, VARNISHES, LACQUERS, ENAMEL PAINTS, RUST PRESERVATIVES IN THE NATURE OF COATINGS, WOOD PRESERVATIVES, PAINT THINNERS FOR LACQUERS AND PAINTS, COLORANTS FOR USE IN THE MANUFACTURE OF PAINT, DYESTUFFS, MORDANT DYES, RAW NATURAL RESINS FOR GENERAL INDUSTRIAL USE, METALS IN FOIL AND POWDER FORM FOR PAINTERS, DECORATORS, PRINTERS AND ARTISTS (U.S. CLS. 6, 11 AND 16).

SHARON MEIER, EXAMINING ATTORNEY

SN 78-920,428. CURTIS-YOUNG CORPORATION, DBA THE TURBON GROUP, CINNAMINSON, NJ. FILED 6-29-2006.

The **Turbon** 
Group

OWNER OF U.S. REG. NOS. 1,285,227 AND 1,978,068.
NO CLAIM IS MADE TO THE EXCLUSIVE RIGHT TO USE "GROUP", APART FROM THE MARK AS SHOWN.

THE MARK CONSISTS OF THE WORDS "THE TURBON GROUP" WITH THE ADDITIONAL STYLIZED LETTERS "TP".

FOR INK JET CARTRIDGES, NAMELY, REPLACEMENT INK JET CARTRIDGES FOR USE WITH INKJET PRINTERS; AND TONER CARTRIDGES, NAMELY, REPLACEMENT TONER CARTRIDGES FOR USE WITH COPIERS AND PRINTERS (U.S. CLS. 6, 11 AND 16).

FIRST USE 8-1-2005; IN COMMERCE 8-1-2005.

LESLEY LAMOTHE, EXAMINING ATTORNEY

CLASS 3—COSMETICS AND CLEANING PREPARATIONS

SN 76-091,511. MARY KAY INC., DALLAS, TX. FILED 7-19-2000.

INDULGE

FOR BODY CREAMS, BODY GELS, TONERS, MOISTURIZERS, NIGHT CREAMS, FACE CREAMS, SKIN CONDITIONERS, MASKS, AND SKIN EMOLLIENTS, SOLD EXCLUSIVELY THROUGH INDEPENDENT SALES CONSULTANTS, DEMONSTRATORS AND OTHER INDIVIDUALS WHO SELL DIRECTLY TO CONSUMERS AWAY FROM A FIXED LOCATION BY MEANS OF PERSONAL HOME AND PRIVATE DEMONSTRATIONS, SALES PARTIES AND LIKE GROUP GATHERINGS OF INDIVIDUAL CONSUMERS, AND RELATED METHODS OF SALES DIRECTLY TO CONSUMERS (U.S. CLS. 1, 4, 6, 50, 51 AND 52).

FIRST USE 12-16-1997; IN COMMERCE 12-16-1997.

MICHAEL ENGEL, EXAMINING ATTORNEY

CLASS 3—(Continued).

SN 76-653,291. SHRINIVAS SUGANDHALAYA, MUMBAI 400072, INDIA, FILED 9-1-2004.

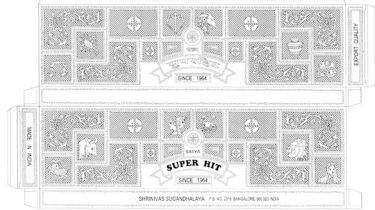

NO CLAIM IS MADE TO THE EXCLUSIVE RIGHT TO USE "SINCE 1964", "MADE IN INDIA", "EXPORT QUALITY", AND "P.B. NO. 2318 BANGALORE-560 023 INDIA", APART FROM THE MARK AS SHOWN.

THE MARK CONSISTS OF A PACKAGE FOR THE GOODS BEING SOLD.

THE ENGLISH TRANSLATION OF "SATYA" IS HONEST OR TRUE.

THE NON-LATIN CHARACTERS IN THE MARK TRANSLITERATE TO "SATYA" AND SUPER HIT.

SEC. 2(F).
FOR INCENSE STICKS (U.S. CLS. 1, 4, 6, 50, 51 AND 52).

FIRST USE 12-31-1996; IN COMMERCE 12-31-1996.
BARBARA GAYNOR, EXAMINING ATTORNEY

CLASS 3—(Continued).

SN 76-673,909. YUVALLA, LLC, WEST HOLLYWOOD, CA. FILED 3-12-2007.

luvalla
CERTIFIED ORGANIC

NO CLAIM IS MADE TO THE EXCLUSIVE RIGHT TO USE "CERTIFIED ORGANIC", APART FROM THE MARK AS SHOWN.

FOR PERSONAL CARE PRODUCTS, NON-MEDICATED SKIN CARE PREPARATIONS, NAMELY, CREAMS, LOTIONS, GELS, TONERS, CLEANERS AND PEELS (U.S. CLS. 1, 4, 6, 50, 51 AND 52).

FIRST USE 3-30-2007; IN COMMERCE 3-30-2007.
PAM WILLIS, EXAMINING ATTORNEY

SN 76-674,251. EUN SUK KIM, LOS ANGELES, CA. FILED 3-19-2007.

AMAZING SHINE

THE MARK CONSISTS OF STANDARD CHARACTERS WITHOUT CLAIM TO ANY PARTICULAR FONT, STYLE, SIZE, OR COLOR.

NO CLAIM IS MADE TO THE EXCLUSIVE RIGHT TO USE "SHINE", APART FROM THE MARK AS SHOWN.

FOR COSMETICS; NAIL CARE PREPARATIONS FOR MANICURES AND PEDICURES (U.S. CLS. 1, 4, 6, 50, 51 AND 52).

ZHALEH DELANEY, EXAMINING ATTORNEY

SN 76-667,963. LOLA COSMETICS, LLC, BEVERLY HILLS, CA. FILED 10-23-2006.

Lola

SN 76-680,576. AUGUSTINE'S ETERNAL GIFTS LLC., CHICAGO, IL. FILED 7-30-2007.

AUGUSTINE'S

OWNER OF U.S. REG. NOS. 1,431,668, 2,667,128 AND 3,032,698.

FOR SKIN AND BODY CARE PREPARATIONS, NAMELY, SKIN CLEANSERS, SKIN MOISTURIZERS, SKIN LOTIONS, SKIN SOAPS, SUN SCREEN PREPARATIONS, COSMETICS, NON-MEDICATED HAIR CARE PREPARATIONS, COLOGNES, PERFUMES, FRAGRANT OILS FOR PERSONAL USE, NON-MEDICATED BATH SALTS, INCENSE AND TOOTH WHITENING PREPARATIONS (U.S. CLS. 1, 4, 6, 50, 51 AND 52).

PAULA MAHONEY, EXAMINING ATTORNEY

THE MARK CONSISTS OF STANDARD CHARACTERS WITHOUT CLAIM TO ANY PARTICULAR FONT, STYLE, SIZE, OR COLOR.

FOR NOVELTY ITEMS HAVING A RELIGIOUS THEME, NAMELY, INCENSE, PERFUME OILS AND SCENTED OILS USED TO PRODUCE AROMAS WHEN HEATED (U.S. CLS. 1, 4, 6, 50, 51 AND 52).

FIRST USE 3-1-2003; IN COMMERCE 3-1-2003.
ERNEST SHOSHO, EXAMINING ATTORNEY

CLASS 3—(Continued).

SN 76-682,968. JEN USA, INC., NORTH BRUNSWICK, NJ. FILED 10-15-2007.

CLASS 3—(Continued).

SN 77-028,861. SELECT WHOLESALERS, INC., SOUTH PLAINFIELD, NJ. FILED 10-25-2006.

EASTSPORT

CLEANSmart

THE MARK CONSISTS OF STANDARD CHARACTERS WITHOUT CLAIM TO ANY PARTICULAR FONT, STYLE, SIZE, OR COLOR.

FOR COLOR COSMETICS, NAMELY, LIPSTICKS, LIP LIPSTICK LINERS, LIP GLOSS, EYELINERS, EYE SHADOWS, BLUSHERS, FACE POWDERS, FOUNDATION, MASCARAS, NAIL POLISHES, EYEBROW PENCILS; NON-MEDICATED SKIN TREATMENT PRODUCTS, NAMELY, CLEANERS, TONERS, MOISTURIZERS, EYE CREAMS, HAND AND BODY LOTIONS, BODY AND SHOWER GELS, AND FACIAL SOAP, NAIL CARE PREPARATIONS AND NAIL POLISH REMOVERS; MEN AND WOMEN'S FRAGRANCE PRODUCTS, NAMELY, COLOGNE, PERFUME, TOILET WATER, SCENTED SOAPS, BODY POWDERS, BATH OILS; SUN SCREEN PREPARATIONS; HAIR CARE PRODUCTS, NAMELY, HAIR COLORING, HAIR BLEACHES, HAIR LIGHTENERS, HIGHLIGHTING PREPARATIONS; SHAMPOOS; CONDITIONERS, HAIR COLOR STAIN REMOVERS; HAIR GELS, MOUSSES, HAIR SPRAYS AND STYLING LOTIONS, AND HAIR CARE PREPARATIONS, NAMELY, HAIR BODY AND ROOT LIFT GELS (U.S. CLS. 1, 4, 6, 50, 51 AND 52).

ANTHONY RINKER, EXAMINING ATTORNEY

THE MARK CONSISTS OF STANDARD CHARACTERS WITHOUT CLAIM TO ANY PARTICULAR FONT, STYLE, SIZE, OR COLOR.

FOR COMMERCIAL GRADE PRODUCTS FOR THE CLEANING INDUSTRY, NAMELY, FLOOR CLEANING PREPARATIONS, FLOOR FINISHING PREPARATIONS, CARPET CLEANERS, CARPET SPOT REMOVERS ALL SOLD SPECIFICALLY TO COMMERCIAL CLEANERS AND COMMERCIAL, INDUSTRIAL AND EDUCATIONAL INSTITUTIONS (U.S. CLS. 1, 4, 6, 50, 51 AND 52).

FIRST USE 6-30-2006; IN COMMERCE 6-30-2006.
JOHN KELLY, EXAMINING ATTORNEY

SN 77-007,051. ULTRADENT PRODUCTS, INC., SOUTH JORDAN, UT. FILED 9-25-2006.

SN 77-057,374. BELVEDERE INTERNATIONAL INC., MISSISSAUGA, ONTARIO, CANADA, FILED 12-5-2006.

PF

URBAN LINES

THE MARK CONSISTS OF STANDARD CHARACTERS WITHOUT CLAIM TO ANY PARTICULAR FONT, STYLE, SIZE, OR COLOR.

PRIORITY CLAIMED UNDER SEC. 44(D) ON CANADA APPLICATION NO. 1272048(1), FILED 11-15-2006.

OWNER OF CANADA REG. NO. TMA672762, DATED 10-24-2007, EXPIRES 10-24-2022.

FOR BODY WASH, SKIN AND BODY MOISTURIZERS, BODY LOTION, BUBBLE BATH, FOAMING BATH, LIQUID HAND SOAP, EAU-DE-TOILETTE (U.S. CLS. 1, 4, 6, 50, 51 AND 52).

PATRICIA EVANKO, EXAMINING ATTORNEY

FOR TOOTH WHITENERS FOR USE BY DENTISTS (U.S. CLS. 1, 4, 6, 50, 51 AND 52).

FIRST USE 2-1-2006; IN COMMERCE 2-1-2006.
ELLEN BURNS, EXAMINING ATTORNEY

CLASS 3—(Continued).

SN 77-070,631. ALCOME OVERSEAS LLC, EDISON, NJ.
FILED 12-22-2006.



NO CLAIM IS MADE TO THE EXCLUSIVE RIGHT TO USE "DESIGNER COLLECTION", APART FROM THE MARK AS SHOWN.

THE MARK CONSISTS OF SHADED POLYGON CONTAINING THE STYLIZED LITERAL ELEMENT, PRINTED IN CONTRASTING COLOR; THE POLYGON IS CENTERED ABOVE A PARTIALLY INSET, SHADED, DIAMOND-SHAPED, QUADRANGLE.

FOR EAU DE PERFUME; FRAGRANCES FOR PERSONAL USE; PERFUME (U.S. CLS. 1, 4, 6, 50, 51 AND 52).
DEZMONA MIZELLE, EXAMINING ATTORNEY

SN 77-090,557. JOSEPH R. ROCHEFORT, EL PASO, TX.
FILED 1-24-2007.

Ofelia's Touch

THE MARK CONSISTS OF STANDARD CHARACTERS WITHOUT CLAIM TO ANY PARTICULAR FONT, STYLE, SIZE, OR COLOR.

THE NAME(S), PORTRAIT(S), AND/OR SIGNATURE(S) SHOWN IN THE MARK IDENTIFIES OFELIA L. ROCHEFORT, WHOSE CONSENT(S) TO REGISTER IS SUBMITTED.

FOR BODY LOTIONS, SHAVING LOTIONS, HAIR LOTIONS (U.S. CLS. 1, 4, 6, 50, 51 AND 52).
JOHN DWYER, EXAMINING ATTORNEY

CLASS 3—(Continued).

SN 77-095,387. ASACHIMICI DI CARUBELLI GIANCARLO E C. SNC, VESCOVATO (CREMONA), ITALY, FILED 1-31-2007.

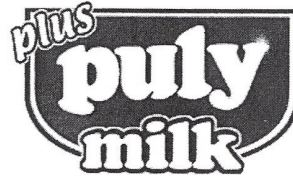

OWNER OF U.S. REG. NO. 2,651,640.

NO CLAIM IS MADE TO THE EXCLUSIVE RIGHT TO USE "MILK", APART FROM THE MARK AS SHOWN.

THE MARK CONSISTS OF THE WORDS "PLUS PULY MILK" AGAINST A BLACK QUADRILATERAL BACKGROUND WHICH IS SURROUNDED BY A BLACK FRAME OF THE SAME SHAPE.

THE WORDING "PULY" HAS NO MEANING IN A FOREIGN LANGUAGE.

FOR SPECIAL DETERGENTS FOR CLEANING CAPPUCCINO MACHINES AND CAPPUCCINO MACHINE FITTINGS; SPECIAL DETERGENTS FOR CAPPUCCINO CUPS AND SAUCERS AND MILK JUGS; FOOD EQUIPMENT CLEANING PREPARATIONS (U.S. CLS. 1, 4, 6, 50, 51 AND 52).

FIRST USE 7-29-1996; IN COMMERCE 7-1-2002.

STEVEN R. FINE, EXAMINING ATTORNEY

SN 77-097,255. L'OREAL, PARIS, FRANCE, FILED 2-1-2007.

AQUALIA THERMAL

THE MARK CONSISTS OF STANDARD CHARACTERS WITHOUT CLAIM TO ANY PARTICULAR FONT, STYLE, SIZE, OR COLOR.

PRIORITY CLAIMED UNDER SEC. 44(D) ON FRANCE APPLICATION NO. 073477139, FILED 1-25-2007.

FOR PERFUME, TOILET WATER; GELS, SALTS FOR THE BATH AND THE SHOWER NOT FOR MEDICAL PURPOSE; TOILET SOAPS, BODY DEODORANTS; COSMETICS, NAMELY, CREAMS, MILKS, LOTIONS, GELS AND POWDERS FOR THE FACE, THE BODY AND THE HANDS; NON-MEDICATED SUN CARE PREPARATIONS; MAKEUP PREPARATIONS; SHAMPOOS; GELS, SPRAYS, MOUSSES AND BALMS FOR THE HAIR STYLING AND HAIR CARE; HAIR LACQUERS; HAIR COLORING AND HAIR DECOLORANT PREPARATIONS; NON-MEDICATED HAIR CARE PREPARATIONS, NAMELY, PERMANENT WAVING AND CURLING PREPARATIONS; ESSENTIAL OILS FOR PERSONAL USE (U.S. CLS. 1, 4, 6, 50, 51 AND 52).

ROSELLE HERRERA, EXAMINING ATTORNEY

CLASS 3—(Continued).

SN 77-101,920. SKINN COSMETICS, TORRANCE, CA. FILED 2-7-2007.

SPOT CHECK

THE MARK CONSISTS OF STANDARD CHARACTERS WITHOUT CLAIM TO ANY PARTICULAR FONT, STYLE, SIZE, OR COLOR.

FOR AGE RETARDANT LOTION; AGE SPOT REDUCING CREAMS; ANTI-AGING CREAM; ANTI-FRECKLE CREAMS; ANTI-WRINKLE CREAM; ANTI-WRINKLE CREAMS; BEAUTY CREAMS; BEAUTY LOTIONS; BEAUTY SERUMS; CLEANSING CREAMS; COLD CREAM; COLD CREAMS; COSMETIC CREAMS; COSMETIC CREAMS FOR SKIN CARE; EYE CREAM; EYE LOTIONS; FACE AND BODY LOTIONS; FACE CREAMS; FACE CREAMS FOR COSMETIC USE; FACIAL CREAM; FACIAL CREAMS; FACIAL LOTION; FAIR COMPLEXION CREAM; LOTIONS FOR FACE AND BODY CARE; SKIN CARE PRODUCTS, NAMELY, NON-MEDICATED SKIN SERUM; SKIN CLEANSING LOTION; SKIN CREAM; SKIN CREAMS; SKIN LOTION; SKIN LOTIONS (U.S. CLS. 1, 4, 6, 50, 51 AND 52).

RENEE SERVANCE, EXAMINING ATTORNEY

SN 77-110,987. RUMI K. LAKHA, D.O., INC., HUNTINGTON PARK, CA. FILED 2-20-2007.

MIA VISAGE

THE MARK CONSISTS OF STANDARD CHARACTERS WITHOUT CLAIM TO ANY PARTICULAR FONT, STYLE, SIZE, OR COLOR.

THE FOREIGN WORDING IN THE MARK TRANSLATES INTO ENGLISH AS MY.

FOR BODY AND BEAUTY CARE COSMETICS; COSMETIC CREAMS FOR SKIN CARE; LOTIONS FOR FACE AND BODY CARE; SKIN AND BODY TOPICAL LOTIONS, CREAMS AND OILS FOR COSMETIC USE; SKIN CONDITIONERS (U.S. CLS. 1, 4, 6, 50, 51 AND 52).

FIRST USE 5-1-2003; IN COMMERCE 5-1-2003.

TASHIA BUNCH, EXAMINING ATTORNEY

CLASS 3—(Continued).

SN 77-115,872. THE PROCTER & GAMBLE COMPANY, CINCINNATI, OH. FILED 2-26-2007.



OWNER OF U.S. REG. NOS. 562,962, 3,220,733 AND OTHERS.

NO CLAIM IS MADE TO THE EXCLUSIVE RIGHT TO USE "BLEACH ALTERNATIVE", APART FROM THE MARK AS SHOWN.

THE STIPPLING IS A FEATURE OF THE MARK.

THE MARK CONSISTS OF THE WORDS "DAWN WITH BLEACH ALTERNATIVE" SUPERIMPOSED OVER A DESIGN OF RAYS REPRESENTING SHAFTS OF LIGHT WITHIN AN OVAL WITH LINES REPRESENTING WAVES IN A SEMI-CIRCLE AROUND THE OUTSIDE OVAL ON THE RIGHT SIDE.

FOR DISH DETERGENT (U.S. CLS. 1, 4, 6, 50, 51 AND 52).

TINA L. SNAPP, EXAMINING ATTORNEY

SN 77-121,390. LEVLAD, LLC, CHATSWORTH, CA. FILED 3-2-2007.

RAINWATER

THE MARK CONSISTS OF STANDARD CHARACTERS WITHOUT CLAIM TO ANY PARTICULAR FONT, STYLE, SIZE, OR COLOR.

FOR HAIR SHAMPOO AND CONDITIONER, BABY SHAMPOO, AND CLARIFYING HAIR SHAMPOO (U.S. CLS. 1, 4, 6, 50, 51 AND 52).

FIRST USE 0-0-1976; IN COMMERCE 0-0-1976.

BARBARA A. GOLD, EXAMINING ATTORNEY

CLASS 3—(Continued).

SN 77-129,253. LANCOME PARFUMS ET BEAUTE & CIE, PARIS, FRANCE, FILED 3-13-2007.

OMBRE ABSOLUE

THE MARK CONSISTS OF STANDARD CHARACTERS WITHOUT CLAIM TO ANY PARTICULAR FONT, STYLE, SIZE, OR COLOR.

PRIORITY CLAIMED UNDER SEC. 44(D) ON FRANCE APPLICATION NO. 073487138, FILED 3-9-2007, REG. NO. 073487138, DATED 3-9-2007, EXPIRES 3-9-2017.

OWNER OF U.S. REG. NOS. 2,592,464, 2,719,719 AND 2,923,993.

THE FOREIGN WORDING IN THE MARK TRANSLATES INTO ENGLISH AS ABSOLUTE SHADE.

FOR COSMETICS, NAMELY, CREAMS, GELS, MILKS, POWDERS AND LOTIONS FOR THE FACE, THE BODY AND THE HANDS; MAKEUP PRODUCTS, NAMELY, MASCARA, EYE LINER, EYE SHADOW, EYEBROW PENCIL, LIPSTICKS, NAIL POLISH, BLUSH, FOUNDATION CREAMS AND POWDER, BODY DEODORANTS; SUN CARE PREPARATIONS, NAMELY, TANNING AND AFTER-SUN MILKS, GELS AND OILS (U.S. CLS. 1, 4, 6, 50, 51 AND 52).

JOHN WILKE, EXAMINING ATTORNEY

CLASS 3—(Continued).

SN 77-130,893. POLA CHEMICAL INDUSTRIES INC., SHI-ZUOKA-KEN, JAPAN, FILED 3-14-2007.

POLA KIREI

THE MARK CONSISTS OF STANDARD CHARACTERS WITHOUT CLAIM TO ANY PARTICULAR FONT, STYLE, SIZE, OR COLOR.

OWNER OF U.S. REG. NOS. 755,665, 1,955,770 AND OTHERS.

THE ENGLISH TRANSLATION OF THE JAPANESE WORD "KIREI" IS "PRETTY", "CLEAN", "FAIR", "BEAUTIFUL", "NICE", "TIDY", "REFINED" OR "POLISHED".

FOR COSMETICS; MAKE-UP POWDER; SKIN LOTIONS; COSMETIC CREAMS; ROUGES; HAIR CARE PREPARATIONS; PERFUMES; SOAPS (U.S. CLS. 1, 4, 6, 50, 51 AND 52).

HANNO RITTNER, EXAMINING ATTORNEY

SN 77-132,284. JAFER LIMITED, HAMILTON, BERMUDA, FILED 3-15-2007.

SN 77-130,696. UNITED STATES SOAP CORPORATION, RESTON, VA. FILED 3-14-2007.

KONA

THE MARK CONSISTS OF STANDARD CHARACTERS WITHOUT CLAIM TO ANY PARTICULAR FONT, STYLE, SIZE, OR COLOR.

OWNER OF U.S. REG. NO. 3,197,063.

FOR SKIN AND SUN CARE PRODUCTS, NAMELY, BODY LOTIONS, BODY OILS, AND BODY CREAMS (U.S. CLS. 1, 4, 6, 50, 51 AND 52).

MELVIN AXILBUND, EXAMINING ATTORNEY

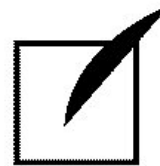
**PERFECT
CONTROL**

FOR MAKE-UP, CONCEALERS, FOUNDATION MAKE-UP, MAKE-UP POWDER, COSMETIC CREAMS, BLUSH, FACIAL MAKE-UP, AND BLUSHER (U.S. CLS. 1, 4, 6, 50, 51 AND 52).

AMY MCMENAMIN, EXAMINING ATTORNEY

CLASS 3—(Continued).

SN 77-135,872. ZIEGLER-LOVE, HEIDI, COLUMBIA, TN. FILED 3-20-2007.

HAIR MAFIA

THE MARK CONSISTS OF STANDARD CHARACTERS WITHOUT CLAIM TO ANY PARTICULAR FONT, STYLE, SIZE, OR COLOR.

NO CLAIM IS MADE TO THE EXCLUSIVE RIGHT TO USE "HAIR", APART FROM THE MARK AS SHOWN. SEC. 2(F).

FOR HAIR CONDITIONER; HAIR CONDITIONERS FOR BABIES; HAIR GEL; HAIR MOUSSE; HAIR POMADES; HAIR SHAMPOO; HAIR SPRAY; HAIR STYLING SPRAY; BABY HAIR CONDITIONER; BABY SHAMPOO (U.S. CLS. 1, 4, 6, 50, 51 AND 52). FIRST USE 8-1-2006; IN COMMERCE 8-1-2006.

THEODORE MCBRIDE, EXAMINING ATTORNEY

CLASS 3—(Continued).

SN 77-146,175. SOUTH SEAS AIRBRUSH TANNING SYSTEMS, LLC, FORT COLLINS, CO. FILED 4-2-2007.



OWNER OF U.S. REG. NO. 2,979,040.

THE MARK CONSISTS OF A STYLIZED PALM TREE WHOSE TRUNK IS FORMED BY A STYLIZED HUMAN FIGURE. THE BASE OF THE TRUNK OF THE TREE IS SITUATED BETWEEN THE WORDS "SOUTH SEAS," BELOW WHICH APPEARS THE WORD "SHADE". A HORIZONTAL LINE APPEARS ABOVE THE WORDS "SOUTH SEAS" WITH THE TRUNK OF THE PALM TREE RUNNING THROUGH IT; A SECOND HORIZONTAL LINE APPEARS BELOW THE WORDS "SOUTH SEAS" AND ABOVE THE WORD "SHADE".

FOR SKIN CARE PRODUCTS, NAMELY, SUNSCREEN PRODUCTS, NAMELY, LOTIONS CONTAINING SUNSCREENS, LIP BALMS CONTAINING SUNSCREENS, MAKE UP PRODUCTS, NAMELY, MINERAL MAKE UP; AND COSMETICS (U.S. CLS. 1, 4, 6, 50, 51 AND 52).

FIRST USE 1-1-2007; IN COMMERCE 1-1-2007.

SETH A. RAPPAPORT, EXAMINING ATTORNEY

SN 77-143,945. AUGENBRAUN & ASSOCIATES, BRIDGEPORT, CT. FILED 3-29-2007.

HEDY'S BEESWAX COMPANY

THE MARK CONSISTS OF STANDARD CHARACTERS WITHOUT CLAIM TO ANY PARTICULAR FONT, STYLE, SIZE, OR COLOR.

NO CLAIM IS MADE TO THE EXCLUSIVE RIGHT TO USE "BEESWAX" AND "COMPANY", APART FROM THE MARK AS SHOWN.

FOR LIP GLOSS, COSMETIC SALVES, BALMS AND LOTIONS FOR THE HANDS, FACE AND BODY (U.S. CLS. 1, 4, 6, 50, 51 AND 52).

KEVIN DINALLO, EXAMINING ATTORNEY

SN 77-146,333. THE TRUSTEE OF THE BYRON NELSON MARITAL TRUST, DALLAS, TX. FILED 4-2-2007.

BYRON NELSON SIGNATURE SERIES

THE MARK CONSISTS OF STANDARD CHARACTERS WITHOUT CLAIM TO ANY PARTICULAR FONT, STYLE, SIZE, OR COLOR.

OWNER OF U.S. REG. NOS. 1,725,794, 2,587,436 AND OTHERS.

NO CLAIM IS MADE TO THE EXCLUSIVE RIGHT TO USE "SIGNATURE SERIES", APART FROM THE MARK AS SHOWN.

THE NAME(S), PORTRAIT(S), AND/OR SIGNATURE(S) SHOWN IN THE MARK DOES NOT IDENTIFY A PARTICULAR LIVING INDIVIDUAL.

FOR COLOGNE (U.S. CLS. 1, 4, 6, 50, 51 AND 52).

BARBARA GAYNOR, EXAMINING ATTORNEY

CLASS 3—(Continued).

SN 77-146,504. L.C. LICENSING, INC., NEW YORK, NY.
FILED 4-2-2007.

PAWTECTION

THE MARK CONSISTS OF STANDARD CHARACTERS
WITHOUT CLAIM TO ANY PARTICULAR FONT, STYLE,
SIZE, OR COLOR.

FOR NON-MEDICATED CREAM FOR PET'S PAWS
(U.S. CLS. 1, 4, 6, 50, 51 AND 52).

DANIEL BRODY, EXAMINING ATTORNEY

SN 77-148,774. L'OREAL USA CREATIVE, INC., NEW YORK,
NY. FILED 4-4-2007.

**SPORTIN' STYLE BY SPORTIN'
WAVES**

THE MARK CONSISTS OF STANDARD CHARACTERS
WITHOUT CLAIM TO ANY PARTICULAR FONT, STYLE,
SIZE, OR COLOR.

OWNER OF U.S. REG. NOS. 1,352,327 AND 1,698,694.
FOR HAIR CARE PREPARATIONS AND HAIR STY-
LING PREPARATIONS (U.S. CLS. 1, 4, 6, 50, 51 AND 52).
ALYSSA PALADINO, EXAMINING ATTORNEY

SN 77-148,777. L'OREAL USA CREATIVE, INC., NEW YORK,
NY. FILED 4-4-2007.

SPORTIN' STYLE

THE MARK CONSISTS OF STANDARD CHARACTERS
WITHOUT CLAIM TO ANY PARTICULAR FONT, STYLE,
SIZE, OR COLOR.

OWNER OF U.S. REG. NOS. 1,352,327 AND 1,698,694.
FOR HAIR CARE PREPARATIONS AND HAIR STY-
LING PREPARATIONS (U.S. CLS. 1, 4, 6, 50, 51 AND 52).
ALYSSA PALADINO, EXAMINING ATTORNEY

CLASS 3—(Continued).

SN 77-149,261. NNENNA PASTOR, HACKETTSTOWN, NJ.
FILED 4-5-2007.

NEKI

THE MARK CONSISTS OF STANDARD CHARACTERS
WITHOUT CLAIM TO ANY PARTICULAR FONT, STYLE,
SIZE, OR COLOR.

FOR BODY AND HAIR OILS; SHEA BUTTER FOR
COSMETIC PURPOSES (U.S. CLS. 1, 4, 6, 50, 51 AND 52).
ERIN FALK, EXAMINING ATTORNEY

SN 77-150,603. PRIMEWEST CAPITAL CORP., CALGARY,
CANADA, FILED 4-6-2007.

MAUI LIFE

THE MARK CONSISTS OF STANDARD CHARACTERS
WITHOUT CLAIM TO ANY PARTICULAR FONT, STYLE,
SIZE, OR COLOR.

NO CLAIM IS MADE TO THE EXCLUSIVE RIGHT TO
USE "MAUI", APART FROM THE MARK AS SHOWN.

FOR AFTERSHAVE CREAMS; AFTERSHAVE EMUL-
SIONS; AFTERSHAVE LOTIONS; BODY AND BEAUTY
CARE COSMETICS; BODY AND BEAUTY CARE PRE-
PARATIONS, NAMELY, CREAMS, GELS, LOTIONS,
SERUMS, BODY LOTIONS AND SKIN TONERS; CO-
LOGNE; DEODORANTS FOR BODY CARE; DEPILA-
TORIES; EYE MAKEUP; EYE SHADOWS; FACE AND
BODY CREAMS; FACE AND BODY LOTIONS; FRA-
GRANCES FOR PERSONAL USE; LIP GLOSS; LIP-
STICKS; MAKE-UP FOR THE FACE AND BODY;
PERFUMES; PERSONAL DEODORANTS; SKIN
CLEANSERS; SKIN CLEANSING CREAM; SKIN
CLEANSING LOTIONS; SKIN LOTIONS; SOAPS FOR
BODY CARE; SOAPS FOR PERSONAL USE; SOAPS FOR
TOILET PURPOSES (U.S. CLS. 1, 4, 6, 50, 51 AND 52).

AMY MCMENAMIN, EXAMINING ATTORNEY

SN 77-163,338. POLA CHEMICAL INDUSTRIES INC., SHI-
ZUOKA-KEN, JAPAN, FILED 4-23-2007.

CREATAGE EXCELLENT

THE MARK CONSISTS OF STANDARD CHARACTERS
WITHOUT CLAIM TO ANY PARTICULAR FONT, STYLE,
SIZE, OR COLOR.

NO CLAIM IS MADE TO THE EXCLUSIVE RIGHT TO
USE "EXCELLENT", APART FROM THE MARK AS
SHOWN.

FOR COSMETICS; MAKE-UP POWDER; SKIN LO-
TIONS; COSMETIC CREAMS; ROUGES; HAIR CARE
PREPARATIONS; PERFUMES; SOAPS (U.S. CLS. 1, 4, 6,
50, 51 AND 52).

HANNO RITTNER, EXAMINING ATTORNEY

CLASS 3—(Continued).

SN 77-164,237. FLATTERY CONCEPTS & DESIGN INC., NEWBURY PARK, CA. FILED 4-24-2007.

Miracle Hydrate

THE MARK CONSISTS OF STANDARD CHARACTERS WITHOUT CLAIM TO ANY PARTICULAR FONT, STYLE, SIZE, OR COLOR.

NO CLAIM IS MADE TO THE EXCLUSIVE RIGHT TO USE "HYDRATE", APART FROM THE MARK AS SHOWN. FOR SKIN LOTIONS; SKIN CREAMS (U.S. CLS. 1, 4, 6, 50, 51 AND 52).
JOHN DWYER, EXAMINING ATTORNEY

SN 77-164,472. SOAPWORKS COMPANY, INC., LOS ANGELES, CA. FILED 4-24-2007.

PEARL OF PURITY

THE MARK CONSISTS OF STANDARD CHARACTERS WITHOUT CLAIM TO ANY PARTICULAR FONT, STYLE, SIZE, OR COLOR.

FOR CLEANING PRODUCTS FOR HOUSEHOLD USE, NAMELY, LIQUID LAUNDRY DETERGENT, POWDERED LAUNDRY DETERGENT, LIQUID FABRIC SOFTENER, FABRIC SOFTENER SHEETS, LIQUID DISHWASHER SOAP, POWDERED DISHWASHER SOAP, LIQUID DISH SOAP, POWDERED OXYGEN BLEACH CLEANSER, LIQUID OXYGEN BLEACH CLEANSER, GLASS CLEANER, ALL PURPOSE CLEANER, SPOT REMOVER, DISPOSABLE WIPES IMPREGNATED WITH CHEMICALS OR COMPOUNDS FOR HOUSEHOLD USE, WOOD CLEANER, LIQUID LAUNDRY DETERGENT FOR USE ON INFANT CLOTHING; BLEACH FOR HOUSEHOLD USE; ALL PURPOSE HOUSEHOLD CLEANER; AUTOMATIC DISHWASHER DETERGENT; WOOD POLISH; PRE-MOISTENED, MULTI-PURPOSE DISPOSABLE CLEANING WIPES IMPREGNATED WITH CHEMICALS OR COMPOUNDS (U.S. CLS. 1, 4, 6, 50, 51 AND 52).
FRANK LATTUCA, EXAMINING ATTORNEY

CLASS 3—(Continued).

SN 77-183,868. KISS NAIL PRODUCTS, INC., PORT WASHINGTON, NY. FILED 5-17-2007.

SALON RESULTS

THE MARK CONSISTS OF STANDARD CHARACTERS WITHOUT CLAIM TO ANY PARTICULAR FONT, STYLE, SIZE, OR COLOR.

NO CLAIM IS MADE TO THE EXCLUSIVE RIGHT TO USE "SALON", APART FROM THE MARK AS SHOWN. FOR ARTIFICIAL FINGERNAILS AND TOENAILS; EYELASHES; NAIL TREATMENTS, NAMELY, NAIL POLISHES, TOP COATS, STRENGTHENERS, SMOOTHERS, HARDENERS, BASE COATS, NAIL BITING DETERRENTS, SEALERS, POLISH DRYING DROPS, CUTICLE REMOVERS, CUTICLE CREAMS AND BALMS (U.S. CLS. 1, 4, 6, 50, 51 AND 52).
CHRIS WELLS, EXAMINING ATTORNEY

SN 77-189,896. BETTYBEAUTY, INC., DARIEN, CT. FILED 5-24-2007.

MALIBU BETTY

THE MARK CONSISTS OF STANDARD CHARACTERS WITHOUT CLAIM TO ANY PARTICULAR FONT, STYLE, SIZE, OR COLOR.

FOR HAIR CARE PREPARATIONS, NAMELY, HAIR SHAMPOOS, HAIR CONDITIONERS, HAIR SPRAYS, HAIR GELS, HAIR MOUSSES, HAIR RELAXERS, HAIR COLORING PREPARATIONS, HAIR COLORANTS, HAIR COLOR, HAIR TINT, HAIR DYE, AND HAIR LIGHTENERS (U.S. CLS. 1, 4, 6, 50, 51 AND 52).
LINDSEY RUBIN, EXAMINING ATTORNEY

SN 77-189,913. BETTYBEAUTY, INC., DARIEN, CT. FILED 5-24-2007.

SHY BETTY

THE MARK CONSISTS OF STANDARD CHARACTERS WITHOUT CLAIM TO ANY PARTICULAR FONT, STYLE, SIZE, OR COLOR.

FOR HAIR CARE PREPARATIONS, NAMELY, HAIR SHAMPOOS, HAIR CONDITIONERS, HAIR SPRAYS, HAIR GELS, HAIR MOUSSES, HAIR RELAXERS, HAIR COLORING PREPARATIONS, HAIR COLORANTS, HAIR COLOR, HAIR TINT, HAIR DYE, AND HAIR LIGHTENERS (U.S. CLS. 1, 4, 6, 50, 51 AND 52).
LINDSEY RUBIN, EXAMINING ATTORNEY

CLASS 3—(Continued).

SN 77-190,824. HENKEL KGAA, DUESSELDORF, FED REP GERMANY, FILED 5-25-2007.

DIADERMINE

THE MARK CONSISTS OF STANDARD CHARACTERS WITHOUT CLAIM TO ANY PARTICULAR FONT, STYLE, SIZE, OR COLOR.

FOR NON-MEDICATED SKIN CARE PREPARATIONS (U.S. CLS. 1, 4, 6, 50, 51 AND 52).

ESTHER A. BORSUK, EXAMINING ATTORNEY

SN 77-193,370. CHANEL, INC., NEW YORK, NY. FILED 5-30-2007.

SOLEIL TAN DE CHANEL

THE MARK CONSISTS OF STANDARD CHARACTERS WITHOUT CLAIM TO ANY PARTICULAR FONT, STYLE, SIZE, OR COLOR.

OWNER OF U.S. REG. NOS. 195,360, 2,795,618 AND OTHERS.

NO CLAIM IS MADE TO THE EXCLUSIVE RIGHT TO USE "TAN", APART FROM THE MARK AS SHOWN.

THE ENGLISH TRANSLATION OF THE WORD "SOLEIL TAN DE CHANEL" IN THE MARK IS SUN AND OF.

FOR COSMETICS, NAMELY, BLUSH (U.S. CLS. 1, 4, 6, 50, 51 AND 52).

INGA ERVIN, EXAMINING ATTORNEY

SN 77-193,740. TOMMASO DI MAIO, DEERFIELD BEACH, FL. FILED 5-30-2007.

HYDRALURE

THE MARK CONSISTS OF STANDARD CHARACTERS WITHOUT CLAIM TO ANY PARTICULAR FONT, STYLE, SIZE, OR COLOR.

FOR SKIN CARE PRODUCTS, NAMELY, NON-MEDICATED SKIN CARE PREPARATIONS; COLOR COSMETICS (U.S. CLS. 1, 4, 6, 50, 51 AND 52).

FIRST USE 7-1-2003; IN COMMERCE 7-1-2003.

LESLEY LAMOTHE, EXAMINING ATTORNEY

CLASS 3—(Continued).

SN 77-193,876. LERNER NEW YORK, INC., NEW YORK, NY. FILED 5-31-2007.

MANHATTAN MOMENT

THE MARK CONSISTS OF STANDARD CHARACTERS WITHOUT CLAIM TO ANY PARTICULAR FONT, STYLE, SIZE, OR COLOR.

NO CLAIM IS MADE TO THE EXCLUSIVE RIGHT TO USE "MANHATTAN", APART FROM THE MARK AS SHOWN.

FOR PERSONAL CARE PRODUCTS, NAMELY, BLUSH, BODY GLITTER, BODY MIST, BODY OIL, BODY SCRUB, BODY WASH, BUBBLE BATH, COLOGNE, CREAM FOR THE BODY, CREAM FOR THE CUTICLES, CREAM FOR THE EYES, CREAM FOR THE FACE, CREAM FOR THE FEET, CREAM FOR THE HANDS (U.S. CLS. 1, 4, 6, 50, 51 AND 52).

MATTHEW MCDOWELL, EXAMINING ATTORNEY

SN 77-210,762. NOXELL CORPORATION, HUNT VALLEY, MD. FILED 6-20-2007.

COLORGENIUS

THE MARK CONSISTS OF STANDARD CHARACTERS WITHOUT CLAIM TO ANY PARTICULAR FONT, STYLE, SIZE, OR COLOR.

FOR COSMETICS (U.S. CLS. 1, 4, 6, 50, 51 AND 52).

SHAUNIA CARLYLE, EXAMINING ATTORNEY

SN 77-231,802. CASTER, 75008 PARIS, FRANCE, FILED 7-17-2007.

**PHYTO[♂]
MEN**

OWNER OF FRANCE REG. NO. 003043578, DATED 7-17-2000, EXPIRES 7-17-2010.

OWNER OF U.S. REG. NO. 2,467,577.

NO CLAIM IS MADE TO THE EXCLUSIVE RIGHT TO USE "MEN", APART FROM THE MARK AS SHOWN.

FOR COSMETICS FOR MEN, NAMELY, SOAPS, PERFUMES, AFTER-SHAVE LOTION, AFTER-SHAVE BALM, SOFTENING SHAVING GEL, INVIGORATING BODY SPLASH, SHOWER GEL, HAIR LOTIONS, SHAMPOOS, ESSENTIAL OILS FOR PERSONAL USE (U.S. CLS. 1, 4, 6, 50, 51 AND 52).

G. MAYERSCHOFF, EXAMINING ATTORNEY

CLASS 3—(Continued).

SN 77-236,848. CEMP USA, INC., DBA EM AMERICA, ALTO, TX. FILED 7-24-2007.

THE NAME "DON IZUMITA" IDENTIFIES A LIVING INDIVIDUAL WHOSE CONSENT IS OF RECORD. THE MARK CONSISTS OF THE WORDS "DR. DON'S" ARE STYLIZED IN SNELL ROUNDHAND FONT. FOR TOOTH POWDER; MOUTHWASH; NON-MEDICATED MOUTHWASH AND GARGLE; TOOTH POLISH (U.S. CLS. 1, 4, 6, 50, 51 AND 52). FIRST USE 4-30-2006; IN COMMERCE 4-30-2006. NICHOLAS ALTREE, EXAMINING ATTORNEY

SN 77-241,893. COMPTOIR NOUVEAU DE LA PARFUMERIE, PARIS, FRANCE, FILED 7-30-2007.

UN JARDIN A CÔME

THE MARK CONSISTS OF STANDARD CHARACTERS WITHOUT CLAIM TO ANY PARTICULAR FONT, STYLE, SIZE, OR COLOR. THE ENGLISH TRANSLATION OF "UN JARDIN A CÔME" IS A GARDEN AT LAKE COMO. FOR PERFUMES, PERFUMERY, EAU DE TOILETTE AND EAU DE PARFUM, ESSENTIAL OILS FOR PERSONAL USE, COSMETICS, HAIR AND BODY LOTIONS, SOAPS, DENTIFRICES, DEODORANTS FOR PERSONAL USE, SHOWER GEL, SHAMPOOS, BEAUTY CREAMS FOR BODY CARE (U.S. CLS. 1, 4, 6, 50, 51 AND 52). TOBY BULLOFF, EXAMINING ATTORNEY

SN 77-249,078. GOLD CANYON CANDLES, L.L.C., CHANDLER, AZ. FILED 8-7-2007.

WHAT WILL THE WORLD SEE WHEN YOU EMERGE?

THE MARK CONSISTS OF STANDARD CHARACTERS WITHOUT CLAIM TO ANY PARTICULAR FONT, STYLE, SIZE, OR COLOR. FOR PERSONAL CARE PRODUCTS, NAMELY, SHOWER GELS, HAND, BODY, AND FOOT LOTIONS AND EXFOLIATORS, HAND SOAP, AND BATH ADDITIVES, NAMELY, LIQUID BATH SOAPS, BATH OILS, BATH LOTIONS, BATH GELS, AND AFTER BATH SPRAYS (U.S. CLS. 1, 4, 6, 50, 51 AND 52). FIRST USE 8-1-2007; IN COMMERCE 8-1-2007. KEVIN DINALLO, EXAMINING ATTORNEY

CLASS 3—(Continued).

SN 77-249,785. T2 SKINCARE, LLC, WYNNEWOOD, PA. FILED 8-8-2007.

BRIGHT AND HEALTHY

THE MARK CONSISTS OF STANDARD CHARACTERS WITHOUT CLAIM TO ANY PARTICULAR FONT, STYLE, SIZE, OR COLOR. FOR NON-MEDICATED SKIN CARE PREPARATIONS (U.S. CLS. 1, 4, 6, 50, 51 AND 52). FIRST USE 8-31-2006; IN COMMERCE 8-31-2006. KIMBERLY PERRY, EXAMINING ATTORNEY

SN 77-249,792. T2 SKINCARE, LLC, WYNNEWOOD, PA. FILED 8-8-2007.

BRIGHT AND RADIANT

THE MARK CONSISTS OF STANDARD CHARACTERS WITHOUT CLAIM TO ANY PARTICULAR FONT, STYLE, SIZE, OR COLOR. FOR NON-MEDICATED SKIN CARE PREPARATIONS (U.S. CLS. 1, 4, 6, 50, 51 AND 52). KIMBERLY PERRY, EXAMINING ATTORNEY

SN 77-249,794. T2 SKINCARE, LLC, WYNNEWOOD, PA. FILED 8-8-2007.

BRIGHT AND FLAWLESS

THE MARK CONSISTS OF STANDARD CHARACTERS WITHOUT CLAIM TO ANY PARTICULAR FONT, STYLE, SIZE, OR COLOR. FOR NON-MEDICATED SKIN CARE PREPARATIONS (U.S. CLS. 1, 4, 6, 50, 51 AND 52). KIMBERLY PERRY, EXAMINING ATTORNEY

CLASS 3—(Continued).

SN 77-251,915. FARANAK BRAUN, LAWRENCE, KS. FILED 8-10-2007.

Cooprika

THE MARK CONSISTS OF STANDARD CHARACTERS WITHOUT CLAIM TO ANY PARTICULAR FONT, STYLE, SIZE, OR COLOR.

FOR BAR SOAP (U.S. CLS. 1, 4, 6, 50, 51 AND 52).
FIRST USE 8-1-2007; IN COMMERCE 8-9-2007.
CHRISTINA SOBRAL, EXAMINING ATTORNEY

SN 77-254,802. T2 SKINCARE, LLC, WYNNEWOOD, PA. FILED 8-14-2007.

NATURALLY FLAWLESS

THE MARK CONSISTS OF STANDARD CHARACTERS WITHOUT CLAIM TO ANY PARTICULAR FONT, STYLE, SIZE, OR COLOR.

FOR NON-MEDICATED SKIN CARE PREPARATIONS (U.S. CLS. 1, 4, 6, 50, 51 AND 52).
FIRST USE 7-14-2007; IN COMMERCE 7-14-2007.
KIMBERLY PERRY, EXAMINING ATTORNEY

SN 77-257,006. LAUREN HUTTON'S GOOD STUFF LLC, NEW YORK, NY. FILED 8-16-2007.

CLEANTHERAPY

THE MARK CONSISTS OF STANDARD CHARACTERS WITHOUT CLAIM TO ANY PARTICULAR FONT, STYLE, SIZE, OR COLOR.

FOR CLEANING PREPARATIONS FOR HOUSEHOLD PURPOSES; PERSONAL CARE PRODUCTS, NAMELY, HAND SOAP, FACIAL SOAP, FACIAL CLEANSER, BATH SOAP, BUBBLE BATH; LAUNDRY DETERGENT FOR HOUSEHOLD PURPOSES (U.S. CLS. 1, 4, 6, 50, 51 AND 52).
SARA THOMAS, EXAMINING ATTORNEY

CLASS 3—(Continued).

SN 77-272,428. GARTH REDWOOD, VENICE, CA. FILED 9-5-2007.

RAW (Redwood Athletic Wipes)

THE MARK CONSISTS OF STANDARD CHARACTERS WITHOUT CLAIM TO ANY PARTICULAR FONT, STYLE, SIZE, OR COLOR.

NO CLAIM IS MADE TO THE EXCLUSIVE RIGHT TO USE WIPES, APART FROM THE MARK AS SHOWN.

FOR PRE-MOISTENED COSMETIC WIPES (U.S. CLS. 1, 4, 6, 50, 51 AND 52).
ALICE BENMAMAN, EXAMINING ATTORNEY

SN 77-272,547. ARBONNE INTERNATIONAL, LLC, IRVINE, CA. FILED 9-5-2007.

ABC ARBONNE BABY CARE

THE MARK CONSISTS OF STANDARD CHARACTERS WITHOUT CLAIM TO ANY PARTICULAR FONT, STYLE, SIZE, OR COLOR.

OWNER OF U.S. REG. NOS. 1,770,981, 3,159,813 AND OTHERS.

NO CLAIM IS MADE TO THE EXCLUSIVE RIGHT TO USE "BABY CARE", APART FROM THE MARK AS SHOWN.

FOR NON-MEDICATED SKIN CARE PREPARATIONS; HAIR CARE PREPARATIONS; SUN SCREEN; FACE AND BODY LOTIONS; BODY OIL; SKIN CREAMS; NON-MEDICATED DIAPER RASH CREAMS (U.S. CLS. 1, 4, 6, 50, 51 AND 52).
FIRST USE 2-11-2000; IN COMMERCE 2-11-2000.

KIMBERLY FRYE, EXAMINING ATTORNEY

SN 77-272,555. ARBONNE INTERNATIONAL, LLC, IRVINE, CA. FILED 9-5-2007.

ARBONNE BABY CARE

OWNER OF U.S. REG. NOS. 1,770,981, 3,159,813 AND OTHERS.

NO CLAIM IS MADE TO THE EXCLUSIVE RIGHT TO USE "BABY CARE", APART FROM THE MARK AS SHOWN.

FOR NON-MEDICATED SKIN CARE PREPARATIONS; HAIR CARE PREPARATIONS; SUN SCREEN; FACE AND BODY LOTIONS; BODY OIL; SKIN CREAMS; NON-MEDICATED DIAPER RASH CREAMS (U.S. CLS. 1, 4, 6, 50, 51 AND 52).
FIRST USE 2-11-2000; IN COMMERCE 2-11-2000.

KIMBERLY FRYE, EXAMINING ATTORNEY

CLASS 3—(Continued).

SN 77-272,583. ARBONNE INTERNATIONAL, LLC, IRVINE, CA. FILED 9-5-2007.



OWNER OF U.S. REG. NOS. 2,982,066 AND 3,216,351. FOR NON-MEDICATED SKIN CARE PREPARATIONS AND ANTI-AGING FORMULATIONS (U.S. CLS. 1, 4, 6, 50, 51 AND 52). FIRST USE 4-26-2005; IN COMMERCE 4-26-2005. KIMBERLY FRYE, EXAMINING ATTORNEY

SN 77-276,568. LABORATOIRE DELON (1990) INC., DOLLARD-DES-ORMEAUX, CANADA, FILED 9-11-2007.

BODY AMERICA

THE MARK CONSISTS OF STANDARD CHARACTERS WITHOUT CLAIM TO ANY PARTICULAR FONT, STYLE, SIZE, OR COLOR. FOR BODY AND BEAUTY CARE COSMETICS; BODY CREAM; BODY CREAM SOAP; BODY LOTION; BODY SCRUB; BODY SPRAYS; LIP BALM; LIP CREAM; SOAPS FOR BODY CARE (U.S. CLS. 1, 4, 6, 50, 51 AND 52). BILL DAWE, EXAMINING ATTORNEY

SN 77-276,876. NAERHEIM, TOR-ERIK, BEND, OR. FILED 9-11-2007.

Elements Baby

THE MARK CONSISTS OF STANDARD CHARACTERS WITHOUT CLAIM TO ANY PARTICULAR FONT, STYLE, SIZE, OR COLOR. NO CLAIM IS MADE TO THE EXCLUSIVE RIGHT TO USE "BABY", APART FROM THE MARK AS SHOWN. FOR BABY WIPES (U.S. CLS. 1, 4, 6, 50, 51 AND 52). MYRIAH HABEEB, EXAMINING ATTORNEY

CLASS 3—(Continued).

SN 77-277,896. KISS NAIL PRODUCTS, INC., PORT WASHINGTON, NY. FILED 9-12-2007.

FLAWLESS CRYSTAL

THE MARK CONSISTS OF STANDARD CHARACTERS WITHOUT CLAIM TO ANY PARTICULAR FONT, STYLE, SIZE, OR COLOR. FOR NAIL CARE PRODUCTS, NAMELY, ARTIFICIAL FINGERNAILS, ARTIFICIAL FINGERNAIL ADHESIVE, FINGERNAIL ADHESIVE REMOVER, FINGERNAIL STRENGTHENER, FINGERNAIL SEALER, FINGERNAIL PROTECTOR, NAIL POLISH KITS, ACRYLIC FINGERNAIL SCULPTURING KITS COMPRISING ARTIFICIAL NAILS, NAIL GLUE AND NAIL FILES; NAIL ART KITS COMPRISING NAIL DECALS, NAIL GLITTER, NAIL CHARMS, NAIL DANGLES, AND ANY PRINTED MATTER THAT CAN BE ADHERED TO THE NAIL WHICH BEAUTIFIES AND DECORATES THE NAIL; EMERY BOARDS (U.S. CLS. 1, 4, 6, 50, 51 AND 52). KEVON CHISOLM, EXAMINING ATTORNEY

SN 77-277,910. KISS NAIL PRODUCTS, INC., PORT WASHINGTON, NY. FILED 9-12-2007.

FRENCH FLIP

THE MARK CONSISTS OF STANDARD CHARACTERS WITHOUT CLAIM TO ANY PARTICULAR FONT, STYLE, SIZE, OR COLOR. FOR NAIL CARE PRODUCTS, NAMELY, ARTIFICIAL FINGERNAILS, ARTIFICIAL FINGERNAIL ADHESIVE, FINGERNAIL ADHESIVE REMOVER, FINGERNAIL STRENGTHENER, FINGERNAIL SEALER, FINGERNAIL PROTECTOR, NAIL POLISH KITS, ACRYLIC FINGERNAIL SCULPTURING KITS COMPRISING ARTIFICIAL NAILS, NAIL GLUE AND NAIL FILES; NAIL ART KITS COMPRISING NAIL DECALS, NAIL GLITTER, NAIL CHARMS, NAIL DANGLES, AND ANY PRINTED MATTER THAT CAN BE ADHERED TO THE NAIL WHICH BEAUTIFIES AND DECORATES THE NAIL; EMERY BOARDS (U.S. CLS. 1, 4, 6, 50, 51 AND 52). KEVON CHISOLM, EXAMINING ATTORNEY

CLASS 3—(Continued).

SN 77-280,403. ARBONNE INTERNATIONAL, LLC, IRVINE, CA. FILED 9-14-2007.

SEASOURCE DETOX SPA

THE MARK CONSISTS OF STANDARD CHARACTERS WITHOUT CLAIM TO ANY PARTICULAR FONT, STYLE, SIZE, OR COLOR.

NO CLAIM IS MADE TO THE EXCLUSIVE RIGHT TO USE "DETOX SPA", APART FROM THE MARK AS SHOWN.

FOR COSMETICS; NON-MEDICATED SKIN CARE PREPARATIONS; HAIR CARE PREPARATIONS (U.S. CLS. 1, 4, 6, 50, 51 AND 52).

KIMBERLY FRYE, EXAMINING ATTORNEY

SN 77-281,074. ALUTA, INC., CINCINNATI, OH. FILED 9-17-2007.

EZ SKIN CARE

NO CLAIM IS MADE TO THE EXCLUSIVE RIGHT TO USE "CARE", APART FROM THE MARK AS SHOWN.

FOR SKIN SOAP (U.S. CLS. 1, 4, 6, 50, 51 AND 52).

KEVON CHISOLM, EXAMINING ATTORNEY

SN 77-281,943. CASTER, 75008 PARIS, FRANCE, FILED 9-18-2007.

PHYTOCEDRAT

THE MARK CONSISTS OF STANDARD CHARACTERS WITHOUT CLAIM TO ANY PARTICULAR FONT, STYLE, SIZE, OR COLOR.

FOR NON-MEDICATED HAIR CARE PREPARATIONS, NAMELY, SHAMPOOS (U.S. CLS. 1, 4, 6, 50, 51 AND 52).

G. MAYERSCHOFF, EXAMINING ATTORNEY

CLASS 3—(Continued).

SN 77-282,121. S & S SOAP COMPANY, INC., BRONX, NY. FILED 9-18-2007.

KING-PINK

FOR DISHWASHER DETERGENTS; DISHWASHING DETERGENTS (U.S. CLS. 1, 4, 6, 50, 51 AND 52).

FIRST USE 11-2-1982; IN COMMERCE 11-2-1982.

AHSEN KHAN, EXAMINING ATTORNEY

SN 77-284,317. MARY KAY INC., ADDISON, TX. FILED 9-20-2007.

GLISTENING WINTERBERRY

THE MARK CONSISTS OF STANDARD CHARACTERS WITHOUT CLAIM TO ANY PARTICULAR FONT, STYLE, SIZE, OR COLOR.

NO CLAIM IS MADE TO THE EXCLUSIVE RIGHT TO USE "WINTERBERRY", APART FROM THE MARK AS SHOWN.

FOR BODY CARE PRODUCTS, NAMELY, LOTIONS, CREAMS, MOISTURIZERS, CLEANSERS, BODY WASH, BODY SPRITZER (U.S. CLS. 1, 4, 6, 50, 51 AND 52).

DORITT L. CARROLL, EXAMINING ATTORNEY

SN 77-286,772. PHILOSOPHY, INC., PHOENIX, AZ. FILED 9-24-2007.

CANNED HEAT

THE MARK CONSISTS OF STANDARD CHARACTERS WITHOUT CLAIM TO ANY PARTICULAR FONT, STYLE, SIZE, OR COLOR.

FOR (BASED ON INTENT TO USE) BABY LOTION; BABY POWDER; BABY SHAMPOO; BAR SOAP; BODY POWDER; BODY SCRUB; COSMETIC FACIAL BLOT- TING PAPERS; COSMETIC PADS; COSMETIC PENCILS; COSMETIC PREPARATIONS FOR THE CARE OF MOUTH AND TEETH; COSMETICS; DEPILATORIES; FACIAL SCRUBS; FRAGRANCES FOR PERSONAL USE; HAIR CARE PREPARATIONS; NAIL CARE PREPARATIONS; NON-MEDICATED BATH PREPARATIONS; NON-MEDICATED LIP CARE PREPARATIONS; NON-MEDICATED SKIN CARE PREPARATIONS; NON-MEDICATED SUN CARE PREPARATIONS; NON-MEDI- CATED TOILETRIES; PERSONAL DEODORANTS; SCENTED ROOM SPRAYS; SHAVING PREPARATIONS; SHOWER AND BATH GEL (U.S. CLS. 1, 4, 6, 50, 51 AND 52).

KATHERINE STOIDES, EXAMINING ATTORNEY

CLASS 3—(Continued).

SN 77-286,777. PHILOSOPHY, INC., PHOENIX, AZ. FILED 9-24-2007.

THE COFFEE CAN

THE MARK CONSISTS OF STANDARD CHARACTERS WITHOUT CLAIM TO ANY PARTICULAR FONT, STYLE, SIZE, OR COLOR.

FOR BABY LOTION; BABY POWDER; BABY SHAM-POO; BAR SOAP; BODY POWDER; BODY SCRUB; COSMETIC FACIAL BLOTting PAPERS; COSMETIC PADS; COSMETIC PENCILS; COSMETIC PREPARATIONS FOR THE CARE OF MOUTH AND TEETH; COSMETICS; DEPILATORIES; FACIAL SCRUBS; FRAGRANCES FOR PERSONAL USE; HAIR CARE PREPARATIONS; NAIL CARE PREPARATIONS; NON-MEDICATED BATH PREPARATIONS; NON-MEDICATED LIP CARE PREPARATIONS; NON-MEDICATED SKIN CARE PREPARATIONS; NON-MEDICATED SUN CARE PREPARATIONS; NON-MEDICATED TOILETRIES; PERSONAL DEODORANTS; SCENTED ROOM SPRAYS; SHAVING PREPARATIONS; SHOWER AND BATH GEL (U.S. CLS. 1, 4, 6, 50, 51 AND 52).

KATHERINE STOIDES, EXAMINING ATTORNEY

CLASS 3—(Continued).

SN 77-286,792. PHILOSOPHY, INC., PHOENIX, AZ. FILED 9-24-2007.

CANNED GOODS

THE MARK CONSISTS OF STANDARD CHARACTERS WITHOUT CLAIM TO ANY PARTICULAR FONT, STYLE, SIZE, OR COLOR.

FOR BABY LOTION; BABY POWDER; BABY SHAM-POO; BAR SOAP; BODY POWDER; BODY SCRUB; COSMETIC FACIAL BLOTting PAPERS; COSMETIC PADS; COSMETIC PENCILS; COSMETIC PREPARATIONS FOR THE CARE OF MOUTH AND TEETH; COSMETICS; DEPILATORIES; FACIAL SCRUBS; FRAGRANCES FOR PERSONAL USE; HAIR CARE PREPARATIONS; NAIL CARE PREPARATIONS; NON-MEDICATED BATH PREPARATIONS; NON-MEDICATED LIP CARE PREPARATIONS; NON-MEDICATED SKIN CARE PREPARATIONS; NON-MEDICATED SUN CARE PREPARATIONS; NON-MEDICATED TOILETRIES; PERSONAL DEODORANTS; SCENTED ROOM SPRAYS; SHAVING PREPARATIONS; SHOWER AND BATH GEL (U.S. CLS. 1, 4, 6, 50, 51 AND 52).

KATHERINE STOIDES, EXAMINING ATTORNEY

SN 77-286,785. PHILOSOPHY, INC., PHOENIX, AZ. FILED 9-24-2007.

THE CAN, CAN

THE MARK CONSISTS OF STANDARD CHARACTERS WITHOUT CLAIM TO ANY PARTICULAR FONT, STYLE, SIZE, OR COLOR.

FOR BABY LOTION; BABY POWDER; BABY SHAM-POO; BAR SOAP; BODY POWDER; BODY SCRUB; COSMETIC FACIAL BLOTting PAPERS; COSMETIC PADS; COSMETIC PENCILS; COSMETIC PREPARATIONS FOR THE CARE OF MOUTH AND TEETH; COSMETICS; DEPILATORIES; FACIAL SCRUBS; FRAGRANCES FOR PERSONAL USE; HAIR CARE PREPARATIONS; NAIL CARE PREPARATIONS; NON-MEDICATED BATH PREPARATIONS; NON-MEDICATED LIP CARE PREPARATIONS; NON-MEDICATED SKIN CARE PREPARATIONS; NON-MEDICATED SUN CARE PREPARATIONS; NON-MEDICATED TOILETRIES; PERSONAL DEODORANTS; SCENTED ROOM SPRAYS; SHAVING PREPARATIONS; SHOWER AND BATH GEL (U.S. CLS. 1, 4, 6, 50, 51 AND 52).

KATHERINE STOIDES, EXAMINING ATTORNEY

SN 77-286,794. PHILOSOPHY, INC., PHOENIX, AZ. FILED 9-24-2007.

THE FAMILY TREE

THE MARK CONSISTS OF STANDARD CHARACTERS WITHOUT CLAIM TO ANY PARTICULAR FONT, STYLE, SIZE, OR COLOR.

FOR BABY LOTION; BABY POWDER; BABY SHAM-POO; BAR SOAP; BODY POWDER; BODY SCRUB; COSMETIC FACIAL BLOTting PAPERS; COSMETIC PADS; COSMETIC PENCILS; COSMETIC PREPARATIONS FOR THE CARE OF MOUTH AND TEETH; COSMETICS; DEPILATORIES; FACIAL SCRUBS; FRAGRANCES FOR PERSONAL USE; HAIR CARE PREPARATIONS; NAIL CARE PREPARATIONS; NON-MEDICATED BATH PREPARATIONS; NON-MEDICATED LIP CARE PREPARATIONS; NON-MEDICATED SKIN CARE PREPARATIONS; NON-MEDICATED SUN CARE PREPARATIONS; NON-MEDICATED TOILETRIES; PERSONAL DEODORANTS; SCENTED ROOM SPRAYS; SHAVING PREPARATIONS; SHOWER AND BATH GEL (U.S. CLS. 1, 4, 6, 50, 51 AND 52).

KATHERINE STOIDES, EXAMINING ATTORNEY

CLASS 3—(Continued).

SN 77-286,800. PHILOSOPHY, INC., PHOENIX, AZ. FILED 9-24-2007.

BREAD PUDDING

THE MARK CONSISTS OF STANDARD CHARACTERS WITHOUT CLAIM TO ANY PARTICULAR FONT, STYLE, SIZE, OR COLOR.

FOR BABY LOTION; BABY POWDER; BABY SHAM-POO; BAR SOAP; BODY POWDER; BODY SCRUB; COSMETIC FACIAL BLOTting PAPERS; COSMETIC PADS; COSMETIC PENCILS; COSMETIC PREPARATIONS FOR THE CARE OF MOUTH AND TEETH; COSMETICS; DEPILATORIES; FACIAL SCRUBS; FRAGRANCES FOR PERSONAL USE; HAIR CARE PREPARATIONS; NAIL CARE PREPARATIONS; NON-MEDICATED BATH PREPARATIONS; NON-MEDICATED LIP CARE PREPARATIONS; NON-MEDICATED SKIN CARE PREPARATIONS; NON-MEDICATED SUN CARE PREPARATIONS; NON-MEDICATED TOILETRIES; PERSONAL DEODORANTS; SCENTED ROOM SPRAYS; SHAVING PREPARATIONS; SHOWER AND BATH GEL (U.S. CLS. 1, 4, 6, 50, 51 AND 52).
KATHERINE STOIDES, EXAMINING ATTORNEY

CLASS 3—(Continued).

SN 77-286,825. PHILOSOPHY, INC., PHOENIX, AZ. FILED 9-24-2007.

FIRST STAR

THE MARK CONSISTS OF STANDARD CHARACTERS WITHOUT CLAIM TO ANY PARTICULAR FONT, STYLE, SIZE, OR COLOR.

FOR BABY LOTION; BABY POWDER; BABY SHAM-POO; BAR SOAP; BODY POWDER; BODY SCRUB; COSMETIC FACIAL BLOTting PAPERS; COSMETIC PADS; COSMETIC PENCILS; COSMETIC PREPARATIONS FOR THE CARE OF MOUTH AND TEETH; COSMETICS; DEPILATORIES; FACIAL SCRUBS; FRAGRANCES FOR PERSONAL USE; HAIR CARE PREPARATIONS; NAIL CARE PREPARATIONS; NON-MEDICATED BATH PREPARATIONS; NON-MEDICATED LIP CARE PREPARATIONS; NON-MEDICATED SKIN CARE PREPARATIONS; NON-MEDICATED SUN CARE PREPARATIONS; NON-MEDICATED TOILETRIES; PERSONAL DEODORANTS; SCENTED ROOM SPRAYS; SHAVING PREPARATIONS; SHOWER AND BATH GEL (U.S. CLS. 1, 4, 6, 50, 51 AND 52).
DAWN HAN, EXAMINING ATTORNEY

SN 77-286,810. PHILOSOPHY, INC., PHOENIX, AZ. FILED 9-24-2007.

THE GIFT

THE MARK CONSISTS OF STANDARD CHARACTERS WITHOUT CLAIM TO ANY PARTICULAR FONT, STYLE, SIZE, OR COLOR.

FOR BABY LOTION; BABY POWDER; BABY SHAM-POO; BAR SOAP; BODY POWDER; BODY SCRUB; COSMETIC FACIAL BLOTting PAPERS; COSMETIC PADS; COSMETIC PENCILS; COSMETIC PREPARATIONS FOR THE CARE OF MOUTH AND TEETH; COSMETICS; DEPILATORIES; FACIAL SCRUBS; FRAGRANCES FOR PERSONAL USE; HAIR CARE PREPARATIONS; NAIL CARE PREPARATIONS; NON-MEDICATED BATH PREPARATIONS; NON-MEDICATED LIP CARE PREPARATIONS; NON-MEDICATED SKIN CARE PREPARATIONS; NON-MEDICATED SUN CARE PREPARATIONS; NON-MEDICATED TOILETRIES; PERSONAL DEODORANTS; SCENTED ROOM SPRAYS; SHAVING PREPARATIONS; SHOWER AND BATH GEL (U.S. CLS. 1, 4, 6, 50, 51 AND 52).
KATHERINE STOIDES, EXAMINING ATTORNEY

SN 77-286,836. PHILOSOPHY, INC., PHOENIX, AZ. FILED 9-24-2007.

NORTH STAR

THE MARK CONSISTS OF STANDARD CHARACTERS WITHOUT CLAIM TO ANY PARTICULAR FONT, STYLE, SIZE, OR COLOR.

FOR BABY LOTION; BABY POWDER; BABY SHAM-POO; BAR SOAP; BODY POWDER; BODY SCRUB; COSMETIC FACIAL BLOTting PAPERS; COSMETIC PADS; COSMETIC PENCILS; COSMETIC PREPARATIONS FOR THE CARE OF MOUTH AND TEETH; COSMETICS; DEPILATORIES; FACIAL SCRUBS; FRAGRANCES FOR PERSONAL USE; HAIR CARE PREPARATIONS; NAIL CARE PREPARATIONS; NON-MEDICATED BATH PREPARATIONS; NON-MEDICATED LIP CARE PREPARATIONS; NON-MEDICATED SKIN CARE PREPARATIONS; NON-MEDICATED SUN CARE PREPARATIONS; NON-MEDICATED TOILETRIES; PERSONAL DEODORANTS; SCENTED ROOM SPRAYS; SHAVING PREPARATIONS; SHOWER AND BATH GEL (U.S. CLS. 1, 4, 6, 50, 51 AND 52).
DAWN HAN, EXAMINING ATTORNEY

CLASS 3—(Continued).

SN 77-286,844. PHILOSOPHY, INC., PHOENIX, AZ. FILED 9-24-2007.

SNOWFLAKE

THE MARK CONSISTS OF STANDARD CHARACTERS WITHOUT CLAIM TO ANY PARTICULAR FONT, STYLE, SIZE, OR COLOR.

FOR BABY LOTION; BABY POWDER; BABY SHAMPOO; BAR SOAP; BODY POWDER; BODY SCRUB; COSMETIC FACIAL BLOTting PAPERS; COSMETIC PADS; COSMETIC PENCILS; COSMETIC PREPARATIONS FOR THE CARE OF MOUTH AND TEETH; COSMETICS; DEPILATORIES; FACIAL SCRUBS; FRAGRANCES FOR PERSONAL USE; HAIR CARE PREPARATIONS; NAIL CARE PREPARATIONS; NON-MEDICATED BATH PREPARATIONS; NON-MEDICATED LIP CARE PREPARATIONS; NON-MEDICATED SKIN CARE PREPARATIONS; NON-MEDICATED SUN CARE PREPARATIONS; NON-MEDICATED TOILETRIES; PERSONAL DEODORANTS; SCENTED ROOM SPRAYS; SHAVING PREPARATIONS; SHOWER AND BATH GEL (U.S. CLS. 1, 4, 6, 50, 51 AND 52).

DAWN HAN, EXAMINING ATTORNEY

CLASS 3—(Continued).

SN 77-286,901. PHILOSOPHY, INC., PHOENIX, AZ. FILED 9-24-2007.

WARM, SOFT KISSES

THE MARK CONSISTS OF STANDARD CHARACTERS WITHOUT CLAIM TO ANY PARTICULAR FONT, STYLE, SIZE, OR COLOR.

FOR BABY LOTION; BABY POWDER; BABY SHAMPOO; BAR SOAP; BODY POWDER; BODY SCRUB; COSMETIC FACIAL BLOTting PAPERS; COSMETIC PADS; COSMETIC PENCILS; COSMETIC PREPARATIONS FOR THE CARE OF MOUTH AND TEETH; COSMETICS; DEPILATORIES; FACIAL SCRUBS; FRAGRANCES FOR PERSONAL USE; HAIR CARE PREPARATIONS; NAIL CARE PREPARATIONS; NON-MEDICATED BATH PREPARATIONS; NON-MEDICATED LIP CARE PREPARATIONS; NON-MEDICATED SKIN CARE PREPARATIONS; NON-MEDICATED SUN CARE PREPARATIONS; NON-MEDICATED TOILETRIES; PERSONAL DEODORANTS; SCENTED ROOM SPRAYS; SHAVING PREPARATIONS; SHOWER AND BATH GEL (U.S. CLS. 1, 4, 6, 50, 51 AND 52).

DAWN HAN, EXAMINING ATTORNEY

SN 77-288,430. ZOTOS INTERNATIONAL, INC., DARIEN, CT. FILED 9-25-2007.

HAIR SPECIFICS

THE MARK CONSISTS OF STANDARD CHARACTERS WITHOUT CLAIM TO ANY PARTICULAR FONT, STYLE, SIZE, OR COLOR.

OWNER OF U.S. REG. NO. 1,457,895.
NO CLAIM IS MADE TO THE EXCLUSIVE RIGHT TO USE "HAIR", APART FROM THE MARK AS SHOWN.

FOR HAIR CARE PREPARATIONS (U.S. CLS. 1, 4, 6, 50, 51 AND 52).

KYLE PEETE, EXAMINING ATTORNEY

SN 77-286,863. PHILOSOPHY, INC., PHOENIX, AZ. FILED 9-24-2007.

FIRST SNOW

THE MARK CONSISTS OF STANDARD CHARACTERS WITHOUT CLAIM TO ANY PARTICULAR FONT, STYLE, SIZE, OR COLOR.

FOR BABY LOTION; BABY POWDER; BABY SHAMPOO; BAR SOAP; BODY POWDER; BODY SCRUB; COSMETIC FACIAL BLOTting PAPERS; COSMETIC PADS; COSMETIC PENCILS; COSMETIC PREPARATIONS FOR THE CARE OF MOUTH AND TEETH; COSMETICS; DEPILATORIES; FACIAL SCRUBS; FRAGRANCES FOR PERSONAL USE; HAIR CARE PREPARATIONS; NAIL CARE PREPARATIONS; NON-MEDICATED BATH PREPARATIONS; NON-MEDICATED LIP CARE PREPARATIONS; NON-MEDICATED SKIN CARE PREPARATIONS; NON-MEDICATED SUN CARE PREPARATIONS; NON-MEDICATED TOILETRIES; PERSONAL DEODORANTS; SCENTED ROOM SPRAYS; SHAVING PREPARATIONS; SHOWER AND BATH GEL (U.S. CLS. 1, 4, 6, 50, 51 AND 52).

DAWN HAN, EXAMINING ATTORNEY

SN 77-290,378. THE PROCTER & GAMBLE COMPANY, CINCINNATI, OH. FILED 9-27-2007.

THE COLOR THAT CHANGES EVERYTHING

THE MARK CONSISTS OF STANDARD CHARACTERS WITHOUT CLAIM TO ANY PARTICULAR FONT, STYLE, SIZE, OR COLOR.

FOR HAIR COLOR (U.S. CLS. 1, 4, 6, 50, 51 AND 52).

BARBARA RUTLAND, EXAMINING ATTORNEY

CLASS 3—(Continued).

SN 77-290,669. THE CLOROX COMPANY, OAKLAND, CA.
FILED 9-27-2007.

COOL MINT

THE MARK CONSISTS OF STANDARD CHARACTERS WITHOUT CLAIM TO ANY PARTICULAR FONT, STYLE, SIZE, OR COLOR.

NO CLAIM IS MADE TO THE EXCLUSIVE RIGHT TO USE "MINT", APART FROM THE MARK AS SHOWN.

FOR BLEACHING PREPARATIONS FOR HOUSEHOLD USE; LAUNDRY BLEACH (U.S. CLS. 1, 4, 6, 50, 51 AND 52).

MICHAEL TANNER, EXAMINING ATTORNEY

SN 77-290,965. MIRACLE HYDRATE, LLC, SANDY, UT.
FILED 9-27-2007.

INNOVENOM

THE MARK CONSISTS OF STANDARD CHARACTERS WITHOUT CLAIM TO ANY PARTICULAR FONT, STYLE, SIZE, OR COLOR.

FOR SKIN LOTIONS; COSMETIC CREAMS FOR SKIN CARE (U.S. CLS. 1, 4, 6, 50, 51 AND 52).

SARA THOMAS, EXAMINING ATTORNEY

SN 77-291,102. LUTZ & PATMOS, INC., NEW YORK, NY.
FILED 9-28-2007.

LUTZ & PATMOS

THE MARK CONSISTS OF STANDARD CHARACTERS WITHOUT CLAIM TO ANY PARTICULAR FONT, STYLE, SIZE, OR COLOR.

OWNER OF U.S. REG. NO. 2,598,134.

FOR DETERGENT SOAPS, FABRIC SOFTENERS, SOAPS, SACHETS, PERFUMES, PERFUME OILS, SCENTED OILS USED TO PRODUCE AROMAS WHEN HEATED, FRAGRANCE FOR PERSONAL USE, BATH SALTS, BATH OILS, FOAM BATH, LAVENDER OIL, PEPPERMINT OIL, POTPOURRI, ROOM FRAGRANCES, BODY SPRAY, SCENTED LINEN SPRAY, SCENTED LINEN WATER, SCENTED ROOM SPRAYS, ESSENTIAL OILS (U.S. CLS. 1, 4, 6, 50, 51 AND 52).

MATTHEW MCDOWELL, EXAMINING ATTORNEY

CLASS 3—(Continued).

SN 77-291,531. HOCKER, ALICE J., DBA DULCIBELLA,
FLOWER MOUND, TX. FILED 9-28-2007.

Butt-U-Tiful

THE MARK CONSISTS OF STANDARD CHARACTERS WITHOUT CLAIM TO ANY PARTICULAR FONT, STYLE, SIZE, OR COLOR.

FOR SOAPS FOR BODY CARE (U.S. CLS. 1, 4, 6, 50, 51 AND 52).

FIRST USE 9-1-2007; IN COMMERCE 9-1-2007.

JUDITH HELFMAN, EXAMINING ATTORNEY

SN 77-291,637. HOCKER, ALICE J., DBA DULCIBELLA,
FLOWER MOUND, TX. FILED 9-28-2007.

Dulcibella

THE MARK CONSISTS OF STANDARD CHARACTERS WITHOUT CLAIM TO ANY PARTICULAR FONT, STYLE, SIZE, OR COLOR.

THE NAME "DULCIBELLA" IDENTIFIES A LIVING INDIVIDUAL WHOSE CONSENT IS OF RECORD.

FOR SOAPS FOR BODY CARE (U.S. CLS. 1, 4, 6, 50, 51 AND 52).

FIRST USE 9-1-2007; IN COMMERCE 9-1-2007.

JUDITH HELFMAN, EXAMINING ATTORNEY

SN 77-291,712. THIERRY BELLET, ETRETAT, FRANCE,
FILED 9-28-2007.

TREASURE ISLAND

THE MARK CONSISTS OF STANDARD CHARACTERS WITHOUT CLAIM TO ANY PARTICULAR FONT, STYLE, SIZE, OR COLOR.

FOR WOMEN'S FRAGRANCES, NAMELY, PERFUMERY, TOILET WATERS, EAU DE PERFUME, PERFUME, BODY LOTION, BODY SOAP, SHOWER GEL AND PERSONAL DEODORANT SPRAY; MEN'S FRAGRANCES, NAMELY, MEN'S COLOGNE AND FRAGRANCE FOR PERSONAL USE, AFTER SHAVE LOTION, BODY SOAP, SHOWER GEL AND PERSONAL DEODORANT SPRAY (U.S. CLS. 1, 4, 6, 50, 51 AND 52).

FIRST USE 2-14-2007; IN COMMERCE 2-14-2007.

REBECCA EISINGER, EXAMINING ATTORNEY

CLASS 3—(Continued).

SN 77-292,161. TULIP BOUTIQUE, INC., CALABASAS, CA. FILED 9-28-2007.

MALE2MALE

THE MARK CONSISTS OF STANDARD CHARACTERS WITHOUT CLAIM TO ANY PARTICULAR FONT, STYLE, SIZE, OR COLOR.

FOR BODY LOTIONS; COLOGNE; CLEANER FOR USE ON SEXUAL AIDS (U.S. CLS. 1, 4, 6, 50, 51 AND 52). FIRST USE 6-30-2006; IN COMMERCE 6-30-2006. ANGELA GAW, EXAMINING ATTORNEY



SN 77-292,368. HABERMEHL, ELAINE J., SILVER SPRING, MD. FILED 9-30-2007.

Kaleidosoap

THE MARK CONSISTS OF STANDARD CHARACTERS WITHOUT CLAIM TO ANY PARTICULAR FONT, STYLE, SIZE, OR COLOR.

FOR (BASED ON INTENT TO USE) BATH SOAPS (U.S. CLS. 1, 4, 6, 50, 51 AND 52). SHANNON TWOHIG, EXAMINING ATTORNEY



SN 77-292,528. SHINY MAM ENTERPRISES, LLC, NEW YORK, NY. FILED 10-1-2007.

NATURE IN COUTURE

THE MARK CONSISTS OF STANDARD CHARACTERS WITHOUT CLAIM TO ANY PARTICULAR FONT, STYLE, SIZE, OR COLOR.

FOR COSMETICS FOR PERSONAL USE; FRAGRANCES FOR PERSONAL USE; FACE CREAMS; BODY LOTIONS; BATH OILS; SOAPS; LIP BALMS; LIPSTICKS, HAIR CARE PREPARATIONS; FACE POWDERS; PERFUMES; DEODORANTS FOR BODY CARE; FACIAL MASKS; MASSAGE CREAMS AND LOTIONS; FACIAL CLEANSERS; BRUSH AND PAD COSMETIC APPLICATIONS IN THE NATURE OF POWDER COMPACTS, SKIN BLUSH AND SKIN BRONZER; BODY SPRAYS (U.S. CLS. 1, 4, 6, 50, 51 AND 52). TINA BROWN, EXAMINING ATTORNEY

CLASS 3—(Continued).

SN 77-292,689. LA MER TECHNOLOGY, INC., NEW YORK, NY. FILED 10-1-2007.

POUDRE DE LA MER

THE MARK CONSISTS OF STANDARD CHARACTERS WITHOUT CLAIM TO ANY PARTICULAR FONT, STYLE, SIZE, OR COLOR.

OWNER OF U.S. REG. NOS. 1,245,722, 2,527,231 AND OTHERS.

NO CLAIM IS MADE TO THE EXCLUSIVE RIGHT TO USE "POUDRE", APART FROM THE MARK AS SHOWN.

THE FOREIGN WORDING IN THE MARK TRANSLATES INTO ENGLISH AS POWDER OF THE SEA.

FOR COSMETICS; NON-MEDICATED SKIN CARE PREPARATIONS; BODY AND BEAUTY CARE COSMETICS (U.S. CLS. 1, 4, 6, 50, 51 AND 52).

LINDA ORNDORFF, EXAMINING ATTORNEY



SN 77-292,758. LA MER TECHNOLOGY, INC., NEW YORK, NY. FILED 10-1-2007.

THE RADIANT INFUSION

THE MARK CONSISTS OF STANDARD CHARACTERS WITHOUT CLAIM TO ANY PARTICULAR FONT, STYLE, SIZE, OR COLOR.

FOR NON-MEDICATED SKIN CARE PREPARATIONS (U.S. CLS. 1, 4, 6, 50, 51 AND 52).

FIRST USE 3-31-2007; IN COMMERCE 3-31-2007.

LINDA ORNDORFF, EXAMINING ATTORNEY



SN 77-292,787. WAY OUT WAX, INC., MORRISVILLE, VT. FILED 10-1-2007.

CLEAN AIR

THE MARK CONSISTS OF STANDARD CHARACTERS WITHOUT CLAIM TO ANY PARTICULAR FONT, STYLE, SIZE, OR COLOR.

FOR HOUSEHOLD CLEANING PREPARATIONS, NAMELY, COUNTERTOP CLEANERS AND SPRAYS, LAUNDRY DETERGENTS, CARPET SHAMPOOS AND UPHOLSTERY CLEANERS; AND, COSMETIC PREPARATIONS FOR BODY CARE, NAMELY, SHAMPOO, SOAP, MOISTURIZING LOTIONS AND BALMS (U.S. CLS. 1, 4, 6, 50, 51 AND 52).

JANICE L. MCMORROW, EXAMINING ATTORNEY

CLASS 3—(Continued).

SN 77-292,931. FARAH, MICHEL, MIAMI, FL. FILED 10-1-2007.

OMIC

THE MARK CONSISTS OF STANDARD CHARACTERS WITHOUT CLAIM TO ANY PARTICULAR FONT, STYLE, SIZE, OR COLOR.

FOR BODY CREAM; SKIN AND BODY TOPICAL LOTIONS, CREAMS AND OILS FOR COSMETIC USE; SKIN CREAM; BODY OIL; SKIN MOISTURIZER; SKIN LIGHTENERS; SKIN SOAP; SKIN TONERS; LIQUID SOAPS FOR HANDS, FACE AND BODY; BODY LOTION; SKIN LOTION; SOAPS FOR BODY CARE; HAND SOAPS (U.S. CLS. 1, 4, 6, 50, 51 AND 52).

FIRST USE 11-0-1990; IN COMMERCE 11-0-1990.
KIMBERLY PERRY, EXAMINING ATTORNEY

CLASS 3—(Continued).

SN 77-293,429. PASQUALE, FRANCO, SAN FRANCISCO, CA. FILED 10-2-2007.

S-MAN

THE MARK CONSISTS OF STANDARD CHARACTERS WITHOUT CLAIM TO ANY PARTICULAR FONT, STYLE, SIZE, OR COLOR.

FOR COSMETIC AND GROOMING SUPPLIES, NAMELY, SHAVING OIL, SHAVING GEL, SHAVING CREAM, SHAVING BALM, SHAVING LOTION, AFTER-SHAVE BALM, AFTERSHAVE LOTION, AFTERSHAVE LIQUID, FACIAL AND BODY SCRUB, FACIAL AND BODY EXFOLIANT, FACIAL AND BODY CLEANSER, FACIAL AND BODY CREAM, FACIAL AND BODY SOAP, FACIAL AND BODY OIL, BODY POWDER, DEODORANTS AND ANTIPERSPIRANTS FOR PERSONAL USE, ESSENTIAL OILS FOR PERSONAL USE, AROMATHERAPY OILS, FACE AND BODY CREAM, FACIAL AND BODY LOTION, SKIN MOISTURIZER, HAIR STYLING PREPARATIONS, HAIR SHAMPOO, HAIR CONDITIONER, ESSENTIAL OILS, SUN BLOCK PREPARATIONS, SUN SCREEN PREPARATIONS; FRAGRANCES, NAMELY, COLOGNE AND PERFUME (U.S. CLS. 1, 4, 6, 50, 51 AND 52).

JORDAN BAKER, EXAMINING ATTORNEY

SN 77-293,029. UNILEVER SUPPLY CHAIN, INC., CLINTON, CT. FILED 10-1-2007.



OWNER OF U.S. REG. NOS. 1,574,203, 2,744,693 AND OTHERS.

THE MARK CONSISTS OF "DEGREE GIRL" WITH ORNAMENTAL DESIGNS.

FOR DEODORANTS AND ANTIPERSPIRANTS (U.S. CLS. 1, 4, 6, 50, 51 AND 52).

C. DIONNE CLYBURN, EXAMINING ATTORNEY

SN 77-293,441. DARLING, JACQUELYN, PEEKSKILL, NY. FILED 10-2-2007.

Skin Care for Back There

THE MARK CONSISTS OF STANDARD CHARACTERS WITHOUT CLAIM TO ANY PARTICULAR FONT, STYLE, SIZE, OR COLOR.

NO CLAIM IS MADE TO THE EXCLUSIVE RIGHT TO USE "SKIN CARE", APART FROM THE MARK AS SHOWN.

FOR SKIN AND BODY TOPICAL LOTIONS, CREAMS AND OILS FOR COSMETIC USE; LOTIONS FOR BODY; NON-MEDICATED SKIN CARE PREPARATIONS, NAMELY, CREAMS, LOTIONS, GELS, TONERS, CLEANSERS AND PEELS (U.S. CLS. 1, 4, 6, 50, 51 AND 52).

RONALD MCMORROW, EXAMINING ATTORNEY

CLASS 3—(Continued).

SN 77-293,579. UNILEVER SUPPLY CHAIN, INC., CLINTON, CT. FILED 10-2-2007.



OWNER OF U.S. REG. NOS. 1,574,203, 2,744,693 AND OTHERS.
 THE MARK CONSISTS OF "DEGREE GIRL CANDY REVOLUTION" AND ORNAMENTAL DESIGN.
 FOR DEODORANTS AND ANTIPERSPIRANTS (U.S. CLS. 1, 4, 6, 50, 51 AND 52).
 C. DIONNE CLYBURN, EXAMINING ATTORNEY

SN 77-293,606. HUNTER GROUP LTD. PART., HUAYK-WANG, BANGKOK, THAILAND, FILED 10-2-2007.



FOR NON-MEDICATED PET SOAPS AND SHAMPOOS (U.S. CLS. 1, 4, 6, 50, 51 AND 52).
 STEVEN PEREZ, EXAMINING ATTORNEY

SN 77-293,745. DAVIS, SEANETTE, LOS ANGELES, CA. FILED 10-2-2007.

nettiescrub

THE MARK CONSISTS OF STANDARD CHARACTERS WITHOUT CLAIM TO ANY PARTICULAR FONT, STYLE, SIZE, OR COLOR.
 FOR BODY AND BEAUTY CARE COSMETICS, NATURAL SKIN CARE EMULSIONS (U.S. CLS. 1, 4, 6, 50, 51 AND 52).
 FIRST USE 6-2-2007; IN COMMERCE 6-2-2007.
 CORY BOONE, EXAMINING ATTORNEY

CLASS 3—(Continued).

SN 77-293,855. UNILEVER SUPPLY CHAIN, INC., CLINTON, CT. FILED 10-2-2007.



OWNER OF U.S. REG. NOS. 1,574,203, 2,744,693 AND OTHERS.
 THE MARK CONSISTS OF "DEGREE GIRL CRAZY VIOLET" AND ORNAMENTAL DESIGN.
 FOR DEODORANTS AND ANTIPERSPIRANTS (U.S. CLS. 1, 4, 6, 50, 51 AND 52).
 C. DIONNE CLYBURN, EXAMINING ATTORNEY

SN 77-293,901. GERONDALE, GRANT, OCONOMOWOC, WI. AND CAROL L. GERONDALE, OCONOMOWOC, WI. FILED 10-2-2007.

BUGSLIDE

THE MARK CONSISTS OF STANDARD CHARACTERS WITHOUT CLAIM TO ANY PARTICULAR FONT, STYLE, SIZE, OR COLOR.
 FOR PREPARATIONS FOR CLEANING, PROTECTING AND PRESERVING VEHICLE SURFACES (U.S. CLS. 1, 4, 6, 50, 51 AND 52).
 FIRST USE 8-31-2004; IN COMMERCE 8-31-2004.
 JAMES A. RAUEN, EXAMINING ATTORNEY

CLASS 3—(Continued).

SN 77-293,907. CAL TAN, LLC, LOS ANGELES, CA. FILED 10-2-2007.

SWEET SUTRA

THE MARK CONSISTS OF STANDARD CHARACTERS WITHOUT CLAIM TO ANY PARTICULAR FONT, STYLE, SIZE, OR COLOR.

FOR AFTER SUN CREAMS; AFTER-SUN GELS; AFTER-SUN LOTIONS; SUN CARE LOTIONS; SUN CREAMS; SUN TAN GEL; SUN TAN LOTION; SUN TAN OIL; COSMETIC SUNTAN LOTIONS; SUNTANNING PREPARATIONS; COSMETIC SUN-TANNING PREPARATIONS; SKIN LOTIONS; BODY LOTIONS (U.S. CLS. 1, 4, 6, 50, 51 AND 52).

FIRST USE 10-31-2006; IN COMMERCE 10-31-2006.
BRENDAN REGAN, EXAMINING ATTORNEY

CLASS 3—(Continued).

SN 77-294,071. UNILEVER SUPPLY CHAIN, INC., CLINTON, CT. FILED 10-2-2007.



OWNER OF U.S. REG. NOS. 1,574,203, 2,744,693 AND OTHERS.

THE MARK CONSISTS OF "DEGREE GIRL TROPICAL POWER" WITH ORNAMENTAL DESIGN.

FOR DEODORANTS AND ANTIPERSPIRANTS (U.S. CLS. 1, 4, 6, 50, 51 AND 52).

C. DIONNE CLYBURN, EXAMINING ATTORNEY

SN 77-294,149. SIGNORELLI, DANIEL D, UPPER MONCLAIR NJ, NJ. FILED 10-2-2007.

NATASANA

THE MARK CONSISTS OF STANDARD CHARACTERS WITHOUT CLAIM TO ANY PARTICULAR FONT, STYLE, SIZE, OR COLOR.

THE FOREIGN WORDING IN THE MARK TRANSLATES INTO ENGLISH AS BORN HEALTHY.

FOR BODY AND BEAUTY CARE COSMETICS; COSMETIC CREAMS FOR SKIN CARE; MOISTURIZING CREAMS (U.S. CLS. 1, 4, 6, 50, 51 AND 52).

REBECCA GILBERT, EXAMINING ATTORNEY

SN 77-293,915. CAL TAN, LLC, LOS ANGELES, CA. FILED 10-2-2007.

SULTRY SUTRA

THE MARK CONSISTS OF STANDARD CHARACTERS WITHOUT CLAIM TO ANY PARTICULAR FONT, STYLE, SIZE, OR COLOR.

FOR AFTER SUN CREAMS; AFTER-SUN GELS; AFTER-SUN LOTIONS; SUN CARE LOTIONS; SUN CREAMS; SUN TAN GEL; SUN TAN LOTION; SUN TAN OIL; COSMETIC SUNTAN LOTIONS; SUNTANNING PREPARATIONS; COSMETIC SUN-TANNING PREPARATIONS; SKIN LOTIONS; BODY LOTIONS (U.S. CLS. 1, 4, 6, 50, 51 AND 52).

FIRST USE 10-31-2006; IN COMMERCE 10-31-2006.
BRENDAN REGAN, EXAMINING ATTORNEY

SN 77-294,496. CHAE ORGANICS, INC., LA VETA, CO. FILED 10-2-2007.

SAFE4U

THE MARK CONSISTS OF STANDARD CHARACTERS WITHOUT CLAIM TO ANY PARTICULAR FONT, STYLE, SIZE, OR COLOR.

FOR COSMETIC SUN CARE PRODUCTS FOR USE IN SUN SCREENING, SUN PROTECTION AND SUN TANNING, NAMELY, SUNSCREEN PREPARATIONS, CREAMS AND LOTIONS, SUNBLOCK PREPARATIONS, CREAMS AND LOTIONS, AND SUNTAN PREPARATIONS, CREAMS AND LOTIONS (U.S. CLS. 1, 4, 6, 50, 51 AND 52).

TIMOTHY FINNEGAN, EXAMINING ATTORNEY

CLASS 3—(Continued).

SN 77-294,580. MARIANA CHICET KETCHIAN AND JACK KETCHIAN PARTNERSHIP, DBA NATURAL EUROPEAN SKIN CARE PRODUCTS, LOS ANGELES, CA. FILED 10-2-2007.

ESCORT

THE MARK CONSISTS OF STANDARD CHARACTERS WITHOUT CLAIM TO ANY PARTICULAR FONT, STYLE, SIZE, OR COLOR.

FOR SKIN MOISTURIZER; FACE AND BODY LOTIONS; FACE AND BODY CREAMS; FACIAL MASKS; FACIAL SCRUBS; SUNSCREEN CREAMS; LIQUID FOUNDATION (MIZU-OSHIROI); FACE POWDER; LIPSTICKS; CONCEALERS; SHAMPOOS; CONDITIONERS; SOAPS (U.S. CLS. 1, 4, 6, 50, 51 AND 52).

FIRST USE 4-28-1999; IN COMMERCE 4-28-1999.
EDWARD NELSON, EXAMINING ATTORNEY

SN 77-294,584. THE MARIANA CHICET KETCHIAN AND JACK KETCHIAN PARTNERSHIP, DBA NATURAL EUROPEAN SKIN CARE PRODUCTS, LOS ANGELES, CA. FILED 10-2-2007.

CHICET

THE MARK CONSISTS OF STANDARD CHARACTERS WITHOUT CLAIM TO ANY PARTICULAR FONT, STYLE, SIZE, OR COLOR.

SEC. 2(F).
FOR FACIAL MASKS; SHAMPOOS; BODY MASK POWDER (U.S. CLS. 1, 4, 6, 50, 51 AND 52).
FIRST USE 2-1-1993; IN COMMERCE 2-1-1993.
KATHY DE JONGE, EXAMINING ATTORNEY

SN 77-294,969. THE CUTEX COMPANY, IRVINGTON, NY. FILED 10-3-2007.

TWISTER

THE MARK CONSISTS OF STANDARD CHARACTERS WITHOUT CLAIM TO ANY PARTICULAR FONT, STYLE, SIZE, OR COLOR.

OWNER OF U.S. REG. NO. 3,024,577.
FOR NAIL POLISH REMOVER (U.S. CLS. 1, 4, 6, 50, 51 AND 52).
FIRST USE 5-20-2004; IN COMMERCE 5-20-2004.
PAUL F. GAST, EXAMINING ATTORNEY

CLASS 3—(Continued).

SN 77-295,494. LYNN SUZANNE TRESS, BOCA RATON, FL. FILED 10-3-2007.



NO CLAIM IS MADE TO THE EXCLUSIVE RIGHT TO USE "PANTY", APART FROM THE MARK AS SHOWN.

THE COLOR(S) PINK, BLACK AND WHITE IS/ARE CLAIMED AS A FEATURE OF THE MARK.

THE MARK CONSISTS OF THE WORDING PANTI BRITE IMPOSED OVER A PINK BACKGROUND; THE WORDING PANTI BRITE IS IN WHITE LETTERS WITH A BLACK DROP SHADOW; THE LETTERS "I" ARE DOTTED WITH A WHITE DAISY DESIGN WITH A BLACK SHADOW.

FOR SPOT REMOVER; STAIN REMOVERS (U.S. CLS. 1, 4, 6, 50, 51 AND 52).
DOMINIC FATHY, EXAMINING ATTORNEY

SN 77-295,669. SIGNORELLI, DANIEL D, UPPER MONTCCLAIR NJ, NJ. FILED 10-3-2007.

VIVESANA

THE MARK CONSISTS OF STANDARD CHARACTERS WITHOUT CLAIM TO ANY PARTICULAR FONT, STYLE, SIZE, OR COLOR.

THE FOREIGN WORDING IN THE MARK TRANSLATES INTO ENGLISH AS LIVE HEALTHY.

FOR SUNSCREEN CREAM; LIP BALM; NON-MEDICATED SUN CARE PREPARATIONS; SKIN MOISTURIZER; SUN CARE LOTIONS; SUN CREAMS (U.S. CLS. 1, 4, 6, 50, 51 AND 52).

REBECCA GILBERT, EXAMINING ATTORNEY

SN 77-295,710. MOBILE TECHNOLOGY 2, LLC, OAKLAND, CA. FILED 10-3-2007.

FOLARA

THE MARK CONSISTS OF STANDARD CHARACTERS WITHOUT CLAIM TO ANY PARTICULAR FONT, STYLE, SIZE, OR COLOR.

FOR HAIR CARE LOTIONS; HAIR CARE PREPARATIONS; HAIR CONDITIONER; HAIR EMOLLIENTS; HAIR RELAXING PREPARATIONS; HAIR STRAIGHTENING PREPARATIONS; EXFOLIANT CREAMS; NON-MEDICATED SKIN CARE PREPARATIONS, NAMELY, CREAMS, LOTIONS, GELS, TONERS, CLEANERS AND PEELS; SKIN MOISTURIZER (U.S. CLS. 1, 4, 6, 50, 51 AND 52).

ANNE E. GUSTASON, EXAMINING ATTORNEY

CLASS 3—(Continued).

SN 77-295,966. CONNIE ELDER INTERNATIONAL, LLC, NASHVILLE, TN. FILED 10-4-2007.

UNDEROLOGY

THE MARK CONSISTS OF STANDARD CHARACTERS WITHOUT CLAIM TO ANY PARTICULAR FONT, STYLE, SIZE, OR COLOR.

FOR COSMETIC CREAMS FOR SKIN CARE (U.S. CLS. 1, 4, 6, 50, 51 AND 52).

RENEE MCCRAY, EXAMINING ATTORNEY

SN 77-296,314. TESLAR INSIDE CORPORATION, MIAMI, FL. FILED 10-4-2007.

7to9

THE MARK CONSISTS OF STANDARD CHARACTERS WITHOUT CLAIM TO ANY PARTICULAR FONT, STYLE, SIZE, OR COLOR.

FOR PERFUMES (U.S. CLS. 1, 4, 6, 50, 51 AND 52).

LYDIA BELZER, EXAMINING ATTORNEY

SN 77-296,345. SIGNORELLI, DANIEL D, UPPER MON-TCLAIR NJ, NJ. FILED 10-4-2007.

Solar to Polar

THE MARK CONSISTS OF STANDARD CHARACTERS WITHOUT CLAIM TO ANY PARTICULAR FONT, STYLE, SIZE, OR COLOR.

FOR AFTER SUN CREAMS; AFTER-SUN LOTIONS; COSMETIC SUN-PROTECTING PREPARATIONS; NON-MEDICATED SUN CARE PREPARATIONS; SUN BLOCK; SUN CARE LOTIONS; SUN CREAMS; SUN SCREEN; SUN SCREEN PREPARATIONS; LIP BALM; NON-MEDICATED LIP CARE PREPARATIONS; NON-MEDICATED LIP PROTECTOR; MOISTURIZING CREAMS; SKIN MOISTURIZER (U.S. CLS. 1, 4, 6, 50, 51 AND 52).

REBECCA GILBERT, EXAMINING ATTORNEY

CLASS 3—(Continued).

SN 77-296,490. SIGNORELLI, DANIEL D, UPPER MON-TCLAIR NJ, NJ. FILED 10-4-2007.

Nature versus Nature

THE MARK CONSISTS OF STANDARD CHARACTERS WITHOUT CLAIM TO ANY PARTICULAR FONT, STYLE, SIZE, OR COLOR.

FOR AFTER SUN CREAMS; COSMETIC SUN-PROTECTING PREPARATIONS; SUN BLOCK; SUN BLOCK PREPARATIONS; SUN CARE LOTIONS; SUN CREAMS; SUN SCREEN; SUN SCREEN PREPARATIONS; LIP BALM; NON-MEDICATED LIP CARE PREPARATIONS; NON-MEDICATED LIP PROTECTOR; MOISTURIZING CREAMS; SKIN MOISTURIZER (U.S. CLS. 1, 4, 6, 50, 51 AND 52).

REBECCA GILBERT, EXAMINING ATTORNEY

SN 77-296,625. CORAL HEAD, INC., GARDENA, CA. FILED 10-4-2007.



OWNER OF U.S. REG. NOS. 2,468,942 AND 3,129,325.
THE MARK CONSISTS OF THE HAWAIIAN SUN, A VOLCANIC ERUPTION, THE HAWAIIAN ISLAND AND THE SURF.

FOR SUNCARE PRODUCTS, NAMELY, SUNSCREEN AND SUN BLOCK PREPARATIONS; TANNING LOTIONS, CREAMS, OILS, SPRAYS, AND STICKS; AFTER-SUN CREAMS AND LOTIONS; SKIN MOISTURIZERS AND LIP BALM; PATCHES CONTAINING SUNSCREEN AND SUN BLOCK FOR USE ON THE SKIN (U.S. CLS. 1, 4, 6, 50, 51 AND 52).

FIRST USE 5-0-2007; IN COMMERCE 5-0-2007.

CURTIS FRENCH, EXAMINING ATTORNEY

CLASS 3—(Continued).

SN 77-297,237. ABERCROMBIE & FITCH TRADING CO.,
NEW ALBANY, OH. FILED 10-5-2007.

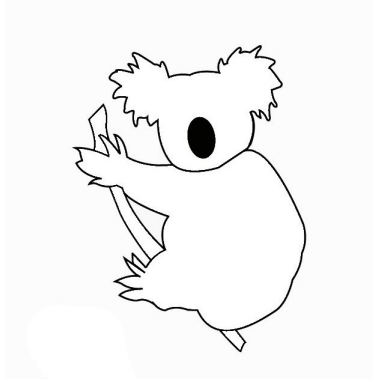

THE MARK CONSISTS OF A MISCELLANEOUS DESIGN FOR COLOGNE; FRAGRANCES FOR PERSONAL USE; PERFUME; BEAUTY CREAMS; BEAUTY CREAMS FOR BODY CARE; BEAUTY LOTIONS; BODY AND BEAUTY CARE COSMETICS; BODY LOTIONS; HAND LOTIONS; MAKE-UP; LIP BALM; LIP GLOSS (U.S. CLS. 1, 4, 6, 50, 51 AND 52).

FLORENTINA BLANDU, EXAMINING ATTORNEY

SN 77-297,259. THE PROCTER & GAMBLE COMPANY,
CINCINNATI, OH. FILED 10-5-2007.

AUSSOME VOLUME

THE MARK CONSISTS OF STANDARD CHARACTERS WITHOUT CLAIM TO ANY PARTICULAR FONT, STYLE, SIZE, OR COLOR.

NO CLAIM IS MADE TO THE EXCLUSIVE RIGHT TO USE "VOLUME", APART FROM THE MARK AS SHOWN.

FOR HAIR CARE PREPARATIONS (U.S. CLS. 1, 4, 6, 50, 51 AND 52).

FIRST USE 1-23-2006; IN COMMERCE 1-23-2006.
BARBARA RUTLAND, EXAMINING ATTORNEY

CLASS 3—(Continued).

SN 77-298,362. PHILOSOPHY, INC., PHOENIX, AZ. FILED
10-8-2007.

GOOSE PIMPLES

THE MARK CONSISTS OF STANDARD CHARACTERS WITHOUT CLAIM TO ANY PARTICULAR FONT, STYLE, SIZE, OR COLOR.

FOR BABY LOTION; BABY POWDER; BABY SHAM-POO; BAR SOAP; BODY POWDER; BODY SCRUB; COSMETIC FACIAL BLOTTING PAPERS; COSMETIC PADS; COSMETIC PENCILS; COSMETIC PREPARATIONS FOR THE CARE OF MOUTH AND TEETH; COSMETICS; DEPILATORIES; FACIAL SCRUBS; FRAGRANCES FOR PERSONAL USE; HAIR CARE PREPARATIONS; NAIL CARE PREPARATIONS; NON-MEDICATED BATH PREPARATIONS; NON-MEDICATED LIP CARE PREPARATIONS; NON-MEDICATED SKIN CARE PREPARATIONS; NON-MEDICATED SUN CARE PREPARATIONS; NON-MEDICATED TOILETRIES; PERSONAL DEODORANTS; SCENTED ROOM SPRAYS; SHAVING PREPARATIONS; SHOWER AND BATH GEL (U.S. CLS. 1, 4, 6, 50, 51 AND 52).

KATHERINE STOIDES, EXAMINING ATTORNEY

SN 77-298,460. THE MARIANA CHICET KETCHIAN AND JACK KETCHIAN PARTNERSHIP, DBA NATURAL EUROPEAN SKIN CARE PRODUCTS, LOS ANGELES, CA. FILED 10-8-2007.

BONMER

THE MARK CONSISTS OF STANDARD CHARACTERS WITHOUT CLAIM TO ANY PARTICULAR FONT, STYLE, SIZE, OR COLOR.

FOR SKIN MOISTURIZER; FACE AND BODY LOTIONS; FACE AND BODY CREAMS; FACIAL MASKS; FACIAL SCRUBS; SUNSCREEN CREAMS; LIQUID FOUNDATION (MIZU-OSHIROI); FACE POWDER; LIPSTICKS; CONCEALERS; SHAMPOOS; CONDITIONERS; SOAPS (U.S. CLS. 1, 4, 6, 50, 51 AND 52).

FIRST USE 6-27-1998; IN COMMERCE 6-27-1998.

KATHY DE JONGE, EXAMINING ATTORNEY

SN 77-298,506. UNILEVER SUPPLY CHAIN, INC., CLINTON, CT. FILED 10-8-2007.

VASELINE WARMCARE

THE MARK CONSISTS OF STANDARD CHARACTERS WITHOUT CLAIM TO ANY PARTICULAR FONT, STYLE, SIZE, OR COLOR.

OWNER OF U.S. REG. NOS. 140,345, 3,295,224 AND OTHERS.

FOR BODY LOTION (U.S. CLS. 1, 4, 6, 50, 51 AND 52).
C. DIONNE CLYBURN, EXAMINING ATTORNEY

CLASS 3—(Continued).

SN 77-298,619. CHURCH & DWIGHT CO., INC., PRINCETON, NJ. FILED 10-8-2007.

LAVENDER & LINEN

THE MARK CONSISTS OF STANDARD CHARACTERS WITHOUT CLAIM TO ANY PARTICULAR FONT, STYLE, SIZE, OR COLOR.

NO CLAIM IS MADE TO THE EXCLUSIVE RIGHT TO USE "LAVENDER", APART FROM THE MARK AS SHOWN. FOR (BASED ON INTENT TO USE) FABRIC SOFTENERS (U.S. CLS. 1, 4, 6, 50, 51 AND 52).

JULIE GUTTADAURO, EXAMINING ATTORNEY

SN 77-301,901. THE CARTOON NETWORK, INC., ATLANTA, GA. FILED 10-11-2007.

BEN 10 ALIEN FORCE

THE MARK CONSISTS OF STANDARD CHARACTERS WITHOUT CLAIM TO ANY PARTICULAR FONT, STYLE, SIZE, OR COLOR.

OWNER OF U.S. REG. NOS. 3,080,336, 3,206,776 AND OTHERS.

FOR BUBBLE BATH, COLOGNE, EAU DE PARFUM, EAU DE TOILETTE, NAIL POLISH, NAIL GLITTER, HAIR SHAMPOO, SKIN CREAM, LIP BALM, BREATH FRESHENING CONFECTIONERIES, NAMELY, BREATH MINTS, TOOTHPASTE, MOUTHWASH, SKIN LOTIONS, SUNSCREEN CREAM, COSMETIC SUNTAN LOTIONS, SOAPS, COSMETICS (U.S. CLS. 1, 4, 6, 50, 51 AND 52).

MICHAEL WEBSTER, EXAMINING ATTORNEY

SN 77-302,055. T2 SKINCARE, LLC, WYNNEWOOD, PA. FILED 10-11-2007.

VIRTUAL PEEL

THE MARK CONSISTS OF STANDARD CHARACTERS WITHOUT CLAIM TO ANY PARTICULAR FONT, STYLE, SIZE, OR COLOR.

NO CLAIM IS MADE TO THE EXCLUSIVE RIGHT TO USE "PEEL", APART FROM THE MARK AS SHOWN.

FOR SKIN EXFOLIATION MASKS (U.S. CLS. 1, 4, 6, 50, 51 AND 52).

KIMBERLY PERRY, EXAMINING ATTORNEY

CLASS 3—(Continued).

SN 77-302,224. BODY CONFECTIONS, LLC, LOS ANGELES, CA. FILED 10-11-2007.

Pedi Pebbles

THE MARK CONSISTS OF STANDARD CHARACTERS WITHOUT CLAIM TO ANY PARTICULAR FONT, STYLE, SIZE, OR COLOR.

NO CLAIM IS MADE TO THE EXCLUSIVE RIGHT TO USE "PEDI", APART FROM THE MARK AS SHOWN.

FOR BATH BEADS; BATH CRYSTALS; BATH FOAM; BATH GEL; BATH LOTION; BATH MILKS; BATH OIL; BATH OILS FOR COSMETIC PURPOSES; BATH PEARLS; BATH POWDER; BATH SOAPS IN LIQUID, SOLID OR GEL FORM; BATHING LOTIONS; BEAUTY CREAMS FOR BODY CARE; BODY AND BEAUTY CARE COSMETICS; BODY ART PENS; BODY CRAYONS; BODY CREAM; BODY CREAM SOAP; BODY DEODORANT IN PILL FORM; BODY EMULSIONS; BODY MASK CREAM; BODY MASK LOTION; BODY MASK POWDER; BODY MASKS; BODY OIL; BODY POWDER; BODY SCRUB; BODY SPRAY USED AS A PERSONAL DEODORANT AND AS A FRAGRANCE; BODY SPRAYS; BODY SPRAYS, NAMELY, WATER IN ATOMIZED CONTAINERS USED TO PRODUCE A COOLING EFFECT; BODY WASHES; BUBBLE BATH; COSMETIC PREPARATIONS FOR BODY CARE; DEODORANTS FOR BODY CARE; FACE AND BODY CREAMS; FACE AND BODY GLITTER; FACE AND BODY LOTIONS; FACE AND BODY MILK; FOAM BATH; FOOT DEODORANT SPRAY; FOOT POWDER; LIQUID BATH SOAPS; LIQUID SOAP USED IN FOOT BATH; LIQUID SOAPS FOR HANDS, FACE AND BODY; LOTIONS FOR FEET; MAKE-UP FOR THE FACE AND BODY; NON-MEDICATED BATH PREPARATIONS; NON-MEDICATED BODY SOAKS; NON-MEDICATED FOOT CREAM; OIL BATHS FOR HAIR CARE; SCENTED BODY LOTIONS AND CREAMS; SCENTED BODY SPRAY; SHOWER AND BATH FOAM; SHOWER AND BATH GEL; SKIN AND BODY TOPICAL LOTIONS, CREAMS AND OILS FOR COSMETIC USE; SKIN CARE PREPARATIONS, NAMELY, BODY POLISH; SOAPS FOR BODY CARE; TONING LOTION FOR THE FACE, BODY AND HANDS; WAX FOR REMOVING BODY HAIR; WAX STRIPS FOR REMOVING BODY HAIR (U.S. CLS. 1, 4, 6, 50, 51 AND 52).

DOMINIC FATHY, EXAMINING ATTORNEY

SN 77-302,790. UNILEVER SUPPLY CHAIN, INC., CLINTON, CT. FILED 10-12-2007.



OWNER OF U.S. REG. NOS. 1,574,203, 2,744,693 AND OTHERS.

THE MARK CONSISTS OF "DEGREE GIRL OMG!" AND ORNAMENTAL DESIGN.

FOR DEODORANTS AND ANTIPERSPIRANTS (U.S. CLS. 1, 4, 6, 50, 51 AND 52).

C. DIONNE CLYBURN, EXAMINING ATTORNEY

CLASS 3—(Continued).

SN 77-304,363. CAL TAN, LLC, LOS ANGELES, CA. FILED 10-15-2007.

BEACHES & CREAM

THE MARK CONSISTS OF STANDARD CHARACTERS WITHOUT CLAIM TO ANY PARTICULAR FONT, STYLE, SIZE, OR COLOR.

FOR COSMETIC SUNTAN LOTIONS; SUNTAN CREAMS; SUNTANNING PREPARATIONS; BODY CREAM; BODY LOTIONS (U.S. CLS. 1, 4, 6, 50, 51 AND 52).

BRENDAN REGAN, EXAMINING ATTORNEY

SN 77-306,038. PHILOSOPHY, INC., PHOENIX, AZ. FILED 10-17-2007.

FIASCO

THE MARK CONSISTS OF STANDARD CHARACTERS WITHOUT CLAIM TO ANY PARTICULAR FONT, STYLE, SIZE, OR COLOR.

FOR BABY LOTION; BABY POWDER; BABY SHAMPOO; BAR SOAP; BODY POWDER; BODY SCRUB; COSMETIC FACIAL BLOTting PAPERS; COSMETIC PADS; COSMETIC PENCILS; COSMETIC PREPARATIONS FOR THE CARE OF MOUTH AND TEETH; COSMETICS; DEPILATORIES; FACIAL SCRUBS; FRAGRANCES FOR PERSONAL USE; HAIR CARE PREPARATIONS; NAIL CARE PREPARATIONS; NON-MEDICATED BATH PREPARATIONS; NON-MEDICATED LIP CARE PREPARATIONS; NON-MEDICATED SKIN CARE PREPARATIONS; NON-MEDICATED SUN CARE PREPARATIONS; NON-MEDICATED TOILETRIES; PERSONAL DEODORANTS; SCENTED ROOM SPRAYS; SHAVING PREPARATIONS; SHOWER AND BATH GEL (U.S. CLS. 1, 4, 6, 50, 51 AND 52).

KATHERINE STOIDES, EXAMINING ATTORNEY

CLASS 3—(Continued).

SN 77-307,308. TRIMPER, DANIEL, MONTVALE, NJ. FILED 10-18-2007.

NATURAL HAIR

THE MARK CONSISTS OF STANDARD CHARACTERS WITHOUT CLAIM TO ANY PARTICULAR FONT, STYLE, SIZE, OR COLOR.

NO CLAIM IS MADE TO THE EXCLUSIVE RIGHT TO USE "HAIR", APART FROM THE MARK AS SHOWN. SEC. 2(F).

FOR HAIR CARE PREPARATIONS, NAMELY, HAIR SHAMPOO, HAIR CLEANSER, HAIR REVITALIZING LOTION, HAIR SCALP CLEANSER, HAIR CONDITIONER, HAIR PURIFYING SHAMPOO, HAIR CLARIFYING SHAMPOO, HAIR MOISTURIZING CONDITIONER, HAIR SPRAY, HAIR THICKENERS, HAIR STYLING GEL, NON-MEDICATED HAIR GROWTH PROMOTERS AND HAIR NURISHING GEL (U.S. CLS. 1, 4, 6, 50, 51 AND 52).

FIRST USE 6-15-1997; IN COMMERCE 6-15-1997. DAVID C. REIHNER, EXAMINING ATTORNEY

SN 77-314,242. UNILEVER SUPPLY CHAIN, INC., CLINTON, CT. FILED 10-26-2007.

LIFE CAN'T WAIT

THE MARK CONSISTS OF STANDARD CHARACTERS WITHOUT CLAIM TO ANY PARTICULAR FONT, STYLE, SIZE, OR COLOR.

FOR HAIR CREAMS; HAIR GEL; HAIR MOUSSE; HAIR POMADES; HAIR SPRAY; HAIR STYLING PREPARATIONS; SHAMPOO-CONDITIONERS (U.S. CLS. 1, 4, 6, 50, 51 AND 52).

C. DIONNE CLYBURN, EXAMINING ATTORNEY

SN 77-314,562. CAL TAN, LLC, FORMERLY CALIFORNIA TAN, INC., LOS ANGELES, CA. FILED 10-26-2007.

WHIPPED BUTTER

THE MARK CONSISTS OF STANDARD CHARACTERS WITHOUT CLAIM TO ANY PARTICULAR FONT, STYLE, SIZE, OR COLOR.

FOR SUNTANNING PREPARATIONS; NON-MEDICATED SKIN CARE PREPARATIONS; AFTER SUN CREAMS; AFTER-SUN GELS; AFTER-SUN LOTIONS; COSMETIC SUN-TANNING PREPARATIONS; SUN CARE LOTIONS; SUN TAN GEL; SUN TAN LOTION; SUN CREAMS; SKIN MOISTURIZER (U.S. CLS. 1, 4, 6, 50, 51 AND 52).

FIRST USE 11-26-2007; IN COMMERCE 11-26-2007. BRENDAN REGAN, EXAMINING ATTORNEY

CLASS 3—(Continued).

SN 77-314,564. CAL TAN, LLC, FORMERLY CALIFORNIA TAN, INC., LOS ANGELES, CA. FILED 10-26-2007.

DARK BUTTER

THE MARK CONSISTS OF STANDARD CHARACTERS WITHOUT CLAIM TO ANY PARTICULAR FONT, STYLE, SIZE, OR COLOR.

FOR SUNTANNING PREPARATIONS; NON-MEDICATED SKIN CARE PREPARATIONS; AFTER SUN CREAMS; AFTER-SUN GELS; AFTER-SUN LOTIONS; COSMETIC SUN-TANNING PREPARATIONS; SUN CARE LOTIONS; SUN TAN GEL; SUN TAN LOTION; SUN CREAMS; SKIN MOISTURIZER (U.S. CLS. 1, 4, 6, 50, 51 AND 52).

FIRST USE 11-26-2007; IN COMMERCE 11-26-2007.
BRENDAN REGAN, EXAMINING ATTORNEY

SN 77-314,694. S. C. JOHNSON & SON, INC., RACINE, WI. FILED 10-26-2007.

FLIRTY MANGO

THE MARK CONSISTS OF STANDARD CHARACTERS WITHOUT CLAIM TO ANY PARTICULAR FONT, STYLE, SIZE, OR COLOR.

NO CLAIM IS MADE TO THE EXCLUSIVE RIGHT TO USE "MANGO", APART FROM THE MARK AS SHOWN.

FOR SHAVE GEL, SHAVE FOAM, SHAVE CREAM (U.S. CLS. 1, 4, 6, 50, 51 AND 52).

JOHN DWYER, EXAMINING ATTORNEY

SN 77-316,185. LA MER TECHNOLOGY, INC., NEW YORK, NY. FILED 10-29-2007.



OWNER OF U.S. REG. NOS. 1,245,722, 2,276,149 AND OTHERS.

THE FOREIGN WORDING IN THE MARK TRANSLATES INTO ENGLISH AS THE SEA.

FOR COSMETICS; NON-MEDICATED SKIN CARE PREPARATIONS (U.S. CLS. 1, 4, 6, 50, 51 AND 52).

FIRST USE 12-31-1984; IN COMMERCE 12-31-1984.
LINDA ORNDORFF, EXAMINING ATTORNEY

CLASS 3—(Continued).

SN 77-316,389. AVON PRODUCTS, INC., NEW YORK, NY. FILED 10-29-2007.

50'S GLAM

THE MARK CONSISTS OF STANDARD CHARACTERS WITHOUT CLAIM TO ANY PARTICULAR FONT, STYLE, SIZE, OR COLOR.

OWNER OF U.S. REG. NO. 3,146,624.
FOR EAU DE TOILETTE, FRAGRANCED BODY SPRAY, PERSONAL DEODORANT, AND BODY LOTION (U.S. CLS. 1, 4, 6, 50, 51 AND 52).

NATALIE POLZER, EXAMINING ATTORNEY

SN 77-316,590. GUERLAIN S.A., PARIS, FRANCE, FILED 10-30-2007.

BRUME D'AUTOMNE

THE MARK CONSISTS OF STANDARD CHARACTERS WITHOUT CLAIM TO ANY PARTICULAR FONT, STYLE, SIZE, OR COLOR.

PRIORITY CLAIMED UNDER SEC. 44(D) ON FRANCE APPLICATION NO. 073498756, FILED 5-4-2007, REG. NO. 073498756, DATED 5-4-2007, EXPIRES 5-4-2017.

THE FOREIGN WORDING IN THE MARK TRANSLATES INTO ENGLISH AS "FOG OF AUTUMN, HAZE OF AUTUMN" OR "MIST OF AUTUMN".

FOR PERFUME, PERFUMERY, EAU DE COLOGNE, TOILET WATERS (U.S. CLS. 1, 4, 6, 50, 51 AND 52).

LEIGH CAROLINE CASE, EXAMINING ATTORNEY

SN 77-316,674. PARFUMS GIVENCHY S.A., LEVALLOIS, FRANCE, FILED 10-30-2007.

GLOSS INTERDIT

THE MARK CONSISTS OF STANDARD CHARACTERS WITHOUT CLAIM TO ANY PARTICULAR FONT, STYLE, SIZE, OR COLOR.

PRIORITY CLAIMED UNDER SEC. 44(D) ON FRANCE APPLICATION NO. 073503604, FILED 5-31-2007, REG. NO. 000865675, DATED 8-12-1999, EXPIRES 8-12-2009.

OWNER OF U.S. REG. NO. 3,317,918.

NO CLAIM IS MADE TO THE EXCLUSIVE RIGHT TO USE "GLOSS", APART FROM THE MARK AS SHOWN.

THE FOREIGN WORDING IN THE MARK TRANSLATES INTO ENGLISH AS FORBIDDEN.

FOR MAKE UP PRODUCTS, NAMELY, LIP GLOSS (U.S. CLS. 1, 4, 6, 50, 51 AND 52).

JAMES STEIN, EXAMINING ATTORNEY

CLASS 3—(Continued).

SN 77-316,680. PHILOSOPHY, INC., PHOENIX, AZ. FILED 10-30-2007.

BEGIN AGAIN

THE MARK CONSISTS OF STANDARD CHARACTERS WITHOUT CLAIM TO ANY PARTICULAR FONT, STYLE, SIZE, OR COLOR.

FOR BABY LOTION; BABY POWDER; BABY SHAMPOO; BAR SOAP; BODY POWDER; BODY SCRUB; COSMETIC FACIAL BLOTting PAPERS; COSMETIC PADS; COSMETIC PENCILS; COSMETIC PREPARATIONS FOR THE CARE OF MOUTH AND TEETH; COSMETICS; DEPILATORIES; FACIAL SCRUBS; FRAGRANCES FOR PERSONAL USE; HAIR CARE PREPARATIONS; NAIL CARE PREPARATIONS; NON-MEDICATED BATH PREPARATIONS; NON-MEDICATED LIP CARE PREPARATIONS; NON-MEDICATED SKIN CARE PREPARATIONS; NON-MEDICATED SUN CARE PREPARATIONS; NON-MEDICATED TOILETRIES; PERSONAL DEODORANTS; SCENTED ROOM SPRAYS; SHAVING PREPARATIONS; SHOWER AND BATH GEL (U.S. CLS. 1, 4, 6, 50, 51 AND 52).

KATHERINE STOIDES, EXAMINING ATTORNEY

SN 77-316,769. PHILOSOPHY, INC., PHOENIX, AZ. FILED 10-30-2007.

YOU ARE MY SUNSHINE

THE MARK CONSISTS OF STANDARD CHARACTERS WITHOUT CLAIM TO ANY PARTICULAR FONT, STYLE, SIZE, OR COLOR.

OWNER OF U.S. REG. NO. 3,171,973.

FOR BABY LOTION; BABY POWDER; BABY SHAMPOO; BAR SOAP; BODY POWDER; BODY SCRUB; COSMETIC FACIAL BLOTting PAPERS; COSMETIC PADS; COSMETIC PENCILS; COSMETIC PREPARATIONS FOR THE CARE OF MOUTH AND TEETH; COSMETICS; DEPILATORIES; FACIAL SCRUBS; FRAGRANCES FOR PERSONAL USE; HAIR CARE PREPARATIONS; NAIL CARE PREPARATIONS; NON-MEDICATED BATH PREPARATIONS; NON-MEDICATED LIP CARE PREPARATIONS; NON-MEDICATED SKIN CARE PREPARATIONS; NON-MEDICATED SUN CARE PREPARATIONS; NON-MEDICATED TOILETRIES; PERSONAL DEODORANTS; SCENTED ROOM SPRAYS; SHAVING PREPARATIONS; SHOWER AND BATH GEL (U.S. CLS. 1, 4, 6, 50, 51 AND 52).

KATHERINE STOIDES, EXAMINING ATTORNEY

CLASS 3—(Continued).

SN 77-316,859. THE CLOROX COMPANY, OAKLAND, CA. FILED 10-30-2007.

GREEN WORKS

THE MARK CONSISTS OF STANDARD CHARACTERS WITHOUT CLAIM TO ANY PARTICULAR FONT, STYLE, SIZE, OR COLOR.

NO CLAIM IS MADE TO THE EXCLUSIVE RIGHT TO USE "GREEN", APART FROM THE MARK AS SHOWN.

FOR AUTOMOBILE POLISHES; LEATHER POLISHES; AUTOMOBILE WAX; TREATMENT PREPARATIONS FOR USE ON VEHICLE WHEELS AND WHEEL COVERS; AUTOMOBILE CLEANERS; CLEANING PREPARATIONS FOR AUTOMOBILES; DETERGENTS FOR AUTOMOBILES (U.S. CLS. 1, 4, 6, 50, 51 AND 52).

MICHAEL TANNER, EXAMINING ATTORNEY

SN 77-317,219. L'OREAL USA CREATIVE, INC., NEW YORK, NY. FILED 10-30-2007.

COLOR BLAST

THE MARK CONSISTS OF STANDARD CHARACTERS WITHOUT CLAIM TO ANY PARTICULAR FONT, STYLE, SIZE, OR COLOR.

NO CLAIM IS MADE TO THE EXCLUSIVE RIGHT TO USE "COLOR", APART FROM THE MARK AS SHOWN.

FOR HAIR COLOR (U.S. CLS. 1, 4, 6, 50, 51 AND 52).

SHARON MEIER, EXAMINING ATTORNEY

SN 77-317,741. PHILOSOPHY, INC., PHOENIX, AZ. FILED 10-31-2007.

FILL OUT

THE MARK CONSISTS OF STANDARD CHARACTERS WITHOUT CLAIM TO ANY PARTICULAR FONT, STYLE, SIZE, OR COLOR.

FOR BABY LOTION; BABY POWDER; BABY SHAMPOO; BAR SOAP; BODY POWDER; BODY SCRUB; COSMETIC FACIAL BLOTting PAPERS; COSMETIC PADS; COSMETIC PENCILS; COSMETIC PREPARATIONS FOR THE CARE OF MOUTH AND TEETH; COSMETICS; DEPILATORIES; FACIAL SCRUBS; FRAGRANCES FOR PERSONAL USE; HAIR CARE PREPARATIONS; NAIL CARE PREPARATIONS; NON-MEDICATED BATH PREPARATIONS; NON-MEDICATED LIP CARE PREPARATIONS; NON-MEDICATED SKIN CARE PREPARATIONS; NON-MEDICATED SUN CARE PREPARATIONS; NON-MEDICATED TOILETRIES; PERSONAL DEODORANTS; SCENTED ROOM SPRAYS; SHAVING PREPARATIONS; SHOWER AND BATH GEL (U.S. CLS. 1, 4, 6, 50, 51 AND 52).

KATHERINE STOIDES, EXAMINING ATTORNEY

CLASS 3—(Continued).

SN 77-318,759. RUE21, INC., WARRENDALE, PA. FILED 11-1-2007.

REVERT ECO

THE MARK CONSISTS OF STANDARD CHARACTERS WITHOUT CLAIM TO ANY PARTICULAR FONT, STYLE, SIZE, OR COLOR.

FOR FRAGRANCE FOR PERSONAL USE; PERFUME; COLOGNE; BODY AND BATH PRODUCTS, NAMELY, SOAPS, LOTIONS, BODY SPRAY, BODY SPLASH, BUBBLE BATH; AND GIFT SETS COMPRISED OF COMBINATIONS OF THE ABOVE, SOLD AS A UNIT (U.S. CLS. 1, 4, 6, 50, 51 AND 52).

GIANCARLO CASTRO, EXAMINING ATTORNEY

SN 77-319,152. SERGEANT'S PET CARE PRODUCTS, INC., OMAHA, NE. FILED 11-1-2007.

SPLISH SPLASH

THE MARK CONSISTS OF STANDARD CHARACTERS WITHOUT CLAIM TO ANY PARTICULAR FONT, STYLE, SIZE, OR COLOR.

OWNER OF U.S. REG. NO. 3,277,675.
FOR GROOMING PRODUCTS FOR ANIMALS, NAMELY, PET CONDITIONERS AND FRAGRANCE SPRAYS FOR PETS (U.S. CLS. 1, 4, 6, 50, 51 AND 52).
FIRST USE 2-0-2006; IN COMMERCE 2-0-2006.
BENJAMIN OKEKE, EXAMINING ATTORNEY

SN 77-319,278. MAKE-UP ART COSMETICS INC., NEW YORK, NY. FILED 11-1-2007.

VIVA GLAMOUROUS

THE MARK CONSISTS OF STANDARD CHARACTERS WITHOUT CLAIM TO ANY PARTICULAR FONT, STYLE, SIZE, OR COLOR.

OWNER OF U.S. REG. NO. 2,369,642.
FOR COSMETICS (U.S. CLS. 1, 4, 6, 50, 51 AND 52).
FIRST USE 10-25-2007; IN COMMERCE 10-25-2007.
TINA L. SNAPP, EXAMINING ATTORNEY

CLASS 3—(Continued).

SN 77-319,962. UNILEVER SUPPLY CHAIN, INC., CLINTON, CT. FILED 11-2-2007.

**VASELINE INTENSIVE RESCUE
CLINICAL THERAPY**

THE MARK CONSISTS OF STANDARD CHARACTERS WITHOUT CLAIM TO ANY PARTICULAR FONT, STYLE, SIZE, OR COLOR.

OWNER OF U.S. REG. NOS. 140,345, 2,532,124 AND 3,295,224.

FOR BODY LOTION (U.S. CLS. 1, 4, 6, 50, 51 AND 52).
C. DIONNE CLYBURN, EXAMINING ATTORNEY

SN 77-320,105. CAL TAN, LLC, DBA CALIFORNIA TAN, INC., LOS ANGELES, CA. FILED 11-2-2007.

CYPHER

THE MARK CONSISTS OF STANDARD CHARACTERS WITHOUT CLAIM TO ANY PARTICULAR FONT, STYLE, SIZE, OR COLOR.

FOR SUNTANNING PREPARATIONS; NON-MEDICATED SKIN CARE PREPARATIONS; AFTER SUN CREAMS; AFTER-SUN GELS; AFTER-SUN LOTIONS; SUN CARE LOTIONS; COSMETIC SUN-TANNING PREPARATIONS; SUN TAN LOTION; SUN TAN OIL; SUN TAN GEL; SKIN MOISTURIZER; SUN CREAMS (U.S. CLS. 1, 4, 6, 50, 51 AND 52).

BRENDAN REGAN, EXAMINING ATTORNEY

SN 77-321,166. PHILOSOPHY, INC., PHOENIX, AZ. FILED 11-5-2007.

**WHEN YOU NEED, WHERE YOU
NEED IT**

THE MARK CONSISTS OF STANDARD CHARACTERS WITHOUT CLAIM TO ANY PARTICULAR FONT, STYLE, SIZE, OR COLOR.

FOR BABY LOTION; BABY POWDER; BABY SHAMPOO; BAR SOAP; BODY POWDER; BODY SCRUB; COSMETIC FACIAL BLOTTER PAPER; COSMETIC PADS; COSMETIC PENCILS; COSMETIC PREPARATIONS FOR THE CARE OF MOUTH AND TEETH; COSMETICS; DEPILATORIES; FACIAL SCRUBS; FRAGRANCES FOR PERSONAL USE; HAIR CARE PREPARATIONS; NAIL CARE PREPARATIONS; NON-MEDICATED BATH PREPARATIONS; NON-MEDICATED LIP CARE PREPARATIONS; NON-MEDICATED SKIN CARE PREPARATIONS; NON-MEDICATED SUN CARE PREPARATIONS; NON-MEDICATED TOILETRIES; PERSONAL DEODORANTS; SCENTED ROOM SPRAYS; SHAVING PREPARATIONS; SHOWER AND BATH GEL (U.S. CLS. 1, 4, 6, 50, 51 AND 52).

KATHERINE STOIDES, EXAMINING ATTORNEY

CLASS 3—(Continued).

SN 77-321,351. CAL TAN, LLC, DBA CALIFORNIA TAN, INC., LOS ANGELES, CA. FILED 11-5-2007.

PotenC

THE MARK CONSISTS OF STANDARD CHARACTERS WITHOUT CLAIM TO ANY PARTICULAR FONT, STYLE, SIZE, OR COLOR.

FOR SUNTANNING PREPARATIONS; NON-MEDICATED SKIN CARE PREPARATIONS; AFTER SUN CREAMS; AFTER-SUN GELS; AFTER-SUN LOTIONS; COSMETIC SUN-TANNING PREPARATIONS; SUN CARE LOTIONS; SUN TAN GEL; SUN TAN LOTION; SUN CREAMS; SKIN MOISTURIZER (U.S. CLS. 1, 4, 6, 50, 51 AND 52).

BRENDAN REGAN, EXAMINING ATTORNEY

SN 77-321,361. CAL TAN, LLC, DBA CALIFORNIA TAN, INC., LOS ANGELES, CA. FILED 11-5-2007.

DEFINITELY DARK

THE MARK CONSISTS OF STANDARD CHARACTERS WITHOUT CLAIM TO ANY PARTICULAR FONT, STYLE, SIZE, OR COLOR.

FOR SUNTANNING PREPARATIONS; NON-MEDICATED SKIN CARE PREPARATIONS; AFTER SUN CREAMS; AFTER-SUN GELS; AFTER-SUN LOTIONS; COSMETIC SUN-TANNING PREPARATIONS; SUN CARE LOTIONS; SUN TAN GEL; SUN TAN LOTION; SUN CREAMS; SKIN MOISTURIZER (U.S. CLS. 1, 4, 6, 50, 51 AND 52).

BRENDAN REGAN, EXAMINING ATTORNEY

SN 77-322,270. UNILEVER SUPPLY CHAIN, INC., CLINTON, CT. FILED 11-6-2007.

DOVE CLINICAL PROTECTION

THE MARK CONSISTS OF STANDARD CHARACTERS WITHOUT CLAIM TO ANY PARTICULAR FONT, STYLE, SIZE, OR COLOR.

OWNER OF U.S. REG. NOS. 786,043, 1,699,679 AND OTHERS.

NO CLAIM IS MADE TO THE EXCLUSIVE RIGHT TO USE "CLINICAL PROTECTION", APART FROM THE MARK AS SHOWN.

FOR DEODORANTS AND ANTIPERSPIRANTS (U.S. CLS. 1, 4, 6, 50, 51 AND 52).

C. DIONNE CLYBURN, EXAMINING ATTORNEY

CLASS 3—(Continued).

SN 77-322,489. COTY US LLC, NEW YORK, NY. FILED 11-6-2007.

RENEGADE

THE MARK CONSISTS OF STANDARD CHARACTERS WITHOUT CLAIM TO ANY PARTICULAR FONT, STYLE, SIZE, OR COLOR.

FOR COSMETICS; PERFUMERY, NAMELY, PERFUME, COLOGNE, SCENTED SOAPS, EAU DE TOILETTE; BEAUTY CARE PREPARATIONS, NAMELY, SKIN AND BODY CREAMS, SKIN, FACIAL AND BODY LOTIONS, SKIN, FACIAL AND BODY CLEANSERS, SKIN, FACIAL AND BODY TONERS AND SKIN, FACIAL AND BODY MOISTURIZERS; BODY WASH, SHOWER GEL AND BUBBLE BATH (U.S. CLS. 1, 4, 6, 50, 51 AND 52).

DAVID MURRAY, EXAMINING ATTORNEY

SN 77-325,936. PHILOSOPHY, INC., PHOENIX, AZ. FILED 11-9-2007.

SOUL TWINS

THE MARK CONSISTS OF STANDARD CHARACTERS WITHOUT CLAIM TO ANY PARTICULAR FONT, STYLE, SIZE, OR COLOR.

FOR BABY LOTION; BABY POWDER; BABY SHAMPOO; BAR SOAP; BODY POWDER; BODY SCRUB; COSMETIC FACIAL BLOTTER PAPERS; COSMETIC PADS; COSMETIC PENCILS; COSMETIC PREPARATIONS FOR THE CARE OF MOUTH AND TEETH; COSMETICS; DEPILATORIES; FACIAL SCRUBS; FRAGRANCES FOR PERSONAL USE; HAIR CARE PREPARATIONS; NAIL CARE PREPARATIONS; NON-MEDICATED BATH PREPARATIONS; NON-MEDICATED LIP CARE PREPARATIONS; NON-MEDICATED SKIN CARE PREPARATIONS; NON-MEDICATED SUN CARE PREPARATIONS; NON-MEDICATED TOILETRIES; PERSONAL DEODORANTS; SCENTED ROOM SPRAYS; SHAVING PREPARATIONS; SHOWER AND BATH GEL (U.S. CLS. 1, 4, 6, 50, 51 AND 52).

KATHERINE STOIDES, EXAMINING ATTORNEY

SN 77-326,988. CHURCH & DWIGHT CO., INC., PRINCETON, NJ. FILED 11-12-2007.

ERASER STICK

THE MARK CONSISTS OF STANDARD CHARACTERS WITHOUT CLAIM TO ANY PARTICULAR FONT, STYLE, SIZE, OR COLOR.

NO CLAIM IS MADE TO THE EXCLUSIVE RIGHT TO USE "STICK", APART FROM THE MARK AS SHOWN.

FOR DEPILATORIES (U.S. CLS. 1, 4, 6, 50, 51 AND 52).

JULIE GUTTADAURO, EXAMINING ATTORNEY

CLASS 3—(Continued).

SN 77-327,781. LA MER TECHNOLOGY, INC., NEW YORK, NY. FILED 11-13-2007.

IDEAL BEGINNINGS

THE MARK CONSISTS OF STANDARD CHARACTERS WITHOUT CLAIM TO ANY PARTICULAR FONT, STYLE, SIZE, OR COLOR.

FOR NON-MEDICATED SKIN CARE PREPARATIONS; SKIN CLEANSERS (U.S. CLS. 1, 4, 6, 50, 51 AND 52).
LINDA ORNDORFF, EXAMINING ATTORNEY

SN 77-330,071. PHILOSOPHY, INC., PHOENIX, AZ. FILED 11-15-2007.

THE CORNER OFFICE

THE MARK CONSISTS OF STANDARD CHARACTERS WITHOUT CLAIM TO ANY PARTICULAR FONT, STYLE, SIZE, OR COLOR.

FOR BABY LOTION; BABY POWDER; BABY SHAMPOO; BAR SOAP; BODY POWDER; BODY SCRUB; COSMETIC FACIAL BLOTTERING PAPERS; COSMETIC PADS; COSMETIC PENCILS; COSMETIC PREPARATIONS FOR THE CARE OF MOUTH AND TEETH; COSMETICS; DEPILATORIES; FACIAL SCRUBS; FRAGRANCES FOR PERSONAL USE; HAIR CARE PREPARATIONS; NAIL CARE PREPARATIONS; NON-MEDICATED BATH PREPARATIONS; NON-MEDICATED LIP CARE PREPARATIONS; NON-MEDICATED SKIN CARE PREPARATIONS; NON-MEDICATED SUN CARE PREPARATIONS; NON-MEDICATED TOILETRIES; PERSONAL DEODORANTS; SCENTED ROOM SPRAYS; SHAVING PREPARATIONS; SHOWER AND BATH GEL (U.S. CLS. 1, 4, 6, 50, 51 AND 52).
KATHERINE STOIDES, EXAMINING ATTORNEY

CLASS 3—(Continued).

SN 77-331,511. CHURCH & DWIGHT CO., INC., PRINCETON, NJ. FILED 11-16-2007.



OWNER OF U.S. REG. NOS. 2,430,077, 3,028,707 AND 3,081,633.

NO CLAIM IS MADE TO THE EXCLUSIVE RIGHT TO USE "CLEAN", APART FROM THE MARK AS SHOWN.

FOR ALL PURPOSE CLEANING PREPARATIONS, TOILET BOWL CLEANING PREPARATIONS, LAUNDRY DETERGENT, LAUNDRY PRE-TREATMENT FOR STAINS ON FABRICS, CLOTHING, UPHOLSTERY, CARPETS AND LINEN, STAIN REMOVAL COMPOUNDS SOLD IN AN APPLICATION DEVICE, NAMELY, AN ATOMIZER CONTAINING LAUNDRY STAIN PRE-TREATMENT FORMULATIONS AND STAIN REMOVERS FOR DIRECT APPLICATION TO STAINS FOR USE ON FABRICS, CLOTHING, UPHOLSTERY AND LINEN, CLEANING PREPARATIONS FOR USE ON FABRICS, CLOTHING, UPHOLSTERY AND LINEN; STAIN REMOVERS, SPOT REMOVERS (U.S. CLS. 1, 4, 6, 50, 51 AND 52).

FIRST USE 8-1-1999; IN COMMERCE 8-1-1999.
JULIE GUTTADAURO, EXAMINING ATTORNEY

SN 77-333,564. VERTICAL BRANDING, INC., ENCINO, CA. FILED 11-19-2007.

Lash Enchantment

THE MARK CONSISTS OF STANDARD CHARACTERS WITHOUT CLAIM TO ANY PARTICULAR FONT, STYLE, SIZE, OR COLOR.

NO CLAIM IS MADE TO THE EXCLUSIVE RIGHT TO USE "LASH", APART FROM THE MARK AS SHOWN.

FOR COSMETIC PREPARATIONS FOR EYE LASHES (U.S. CLS. 1, 4, 6, 50, 51 AND 52).

CHRIS WELLS, EXAMINING ATTORNEY

CLASS 3—(Continued).

SN 77-333,852. MARY KAY INC., ADDISON, TX. FILED 11-20-2007.

MK MEN

THE MARK CONSISTS OF STANDARD CHARACTERS WITHOUT CLAIM TO ANY PARTICULAR FONT, STYLE, SIZE, OR COLOR.

OWNER OF U.S. REG. NOS. 2,559,020, 3,277,528 AND OTHERS.

NO CLAIM IS MADE TO THE EXCLUSIVE RIGHT TO USE "MEN", APART FROM THE MARK AS SHOWN.

FOR NON-MEDICATED TOILETRIES (U.S. CLS. 1, 4, 6, 50, 51 AND 52).

FIRST USE 5-26-2007; IN COMMERCE 5-26-2007.
DORITT L. CARROLL, EXAMINING ATTORNEY

SN 77-333,903. MARY KAY INC., ADDISON, TX. FILED 11-20-2007.

TIMWISE

THE MARK CONSISTS OF STANDARD CHARACTERS WITHOUT CLAIM TO ANY PARTICULAR FONT, STYLE, SIZE, OR COLOR.

OWNER OF U.S. REG. NOS. 2,414,631 AND 3,304,771. FOR COSMETICS; NON-MEDICATED SKIN CARE PREPARATIONS (U.S. CLS. 1, 4, 6, 50, 51 AND 52).

FIRST USE 12-16-2000; IN COMMERCE 12-16-2000.
DORITT L. CARROLL, EXAMINING ATTORNEY

SN 77-339,218. S. C. JOHNSON & SON, INC., RACINE, WI. FILED 11-28-2007.

FLIRTY MANGO

THE MARK CONSISTS OF STANDARD CHARACTERS WITHOUT CLAIM TO ANY PARTICULAR FONT, STYLE, SIZE, OR COLOR.

NO CLAIM IS MADE TO THE EXCLUSIVE RIGHT TO USE "MANGO", APART FROM THE MARK AS SHOWN.

FOR HAND LOTION, BODY LOTION, BODY WASH, BODY SCRUBS, BODY SPRAYS, DEPILATORIES, DEODORANTS AND ANTIPERSPIRANTS (U.S. CLS. 1, 4, 6, 50, 51 AND 52).

JOHN DWYER, EXAMINING ATTORNEY

CLASS 3—(Continued).

SN 77-351,426. PHILOSOPHY, INC., PHOENIX, AZ. FILED 12-13-2007.

MUSCLE MAN

THE MARK CONSISTS OF STANDARD CHARACTERS WITHOUT CLAIM TO ANY PARTICULAR FONT, STYLE, SIZE, OR COLOR.

FOR BABY LOTION; BABY POWDER; BABY SHAMPOO; BAR SOAP; BODY POWDER; BODY SCRUB; COSMETIC FACIAL BLOTTING PAPERS; COSMETIC PADS; COSMETIC PENCILS; COSMETIC PREPARATIONS FOR THE CARE OF MOUTH AND TEETH; COSMETICS; DEPILATORIES; FACIAL SCRUBS; FRAGRANCES FOR PERSONAL USE; HAIR CARE PREPARATIONS; NAIL CARE PREPARATIONS; NON-MEDICATED BATH PREPARATIONS; NON-MEDICATED LIP CARE PREPARATIONS; NON-MEDICATED SKIN CARE PREPARATIONS; NON-MEDICATED SUN CARE PREPARATIONS; NON-MEDICATED TOILETRIES; PERSONAL DEODORANTS; SCENTED ROOM SPRAYS; SHAVING PREPARATIONS; SHOWER AND BATH GEL (U.S. CLS. 1, 4, 6, 50, 51 AND 52).

KATHERINE STOIDES, EXAMINING ATTORNEY

SN 77-352,529. PHILOSOPHY, INC., PHOENIX, AZ. FILED 12-14-2007.

SNOW CONE

THE MARK CONSISTS OF STANDARD CHARACTERS WITHOUT CLAIM TO ANY PARTICULAR FONT, STYLE, SIZE, OR COLOR.

FOR BABY LOTION; BABY POWDER; BABY SHAMPOO; BAR SOAP; BODY POWDER; BODY SCRUB; COSMETIC FACIAL BLOTTING PAPERS; COSMETIC PADS; COSMETIC PENCILS; COSMETIC PREPARATIONS FOR THE CARE OF MOUTH AND TEETH; COSMETICS; DEPILATORIES; FACIAL SCRUBS; FRAGRANCES FOR PERSONAL USE; HAIR CARE PREPARATIONS; NAIL CARE PREPARATIONS; NON-MEDICATED BATH PREPARATIONS; NON-MEDICATED LIP CARE PREPARATIONS; NON-MEDICATED SKIN CARE PREPARATIONS; NON-MEDICATED SUN CARE PREPARATIONS; NON-MEDICATED TOILETRIES; PERSONAL DEODORANTS; SCENTED ROOM SPRAYS; SHAVING PREPARATIONS; SHOWER AND BATH GEL (U.S. CLS. 1, 4, 6, 50, 51 AND 52).

KATHERINE STOIDES, EXAMINING ATTORNEY

CLASS 3—(Continued).

SN 77-352,541. PHILOSOPHY, INC., PHOENIX, AZ. FILED 12-14-2007.

HANDYMAN

THE MARK CONSISTS OF STANDARD CHARACTERS WITHOUT CLAIM TO ANY PARTICULAR FONT, STYLE, SIZE, OR COLOR.

FOR HOUSEHOLD CLEANING PREPARATIONS (U.S. CLS. 1, 4, 6, 50, 51 AND 52).
KATHERINE STOIDES, EXAMINING ATTORNEY

CLASS 3—(Continued).

SN 78-795,905. IDEAL PRODUCTS, LLC, LOS ANGELES, CA. FILED 1-20-2006.

IDEAL

THE MARK CONSISTS OF STANDARD CHARACTERS WITHOUT CLAIM TO ANY PARTICULAR FONT, STYLE, SIZE, OR COLOR.

FOR AFTER-SHAVE GEL; ALL-PURPOSE CLEANERS; AROMATHERAPY OILS; AROMATHERAPY PILLOWS COMPRISING POTPOURRI IN FABRIC CONTAINERS; AUTOMOTIVE CLEANING PREPARATIONS; CARPET CLEANING PREPARATIONS; DENTAL BLEACHING GEL; DEPILATORIES; HAIR CARE PREPARATIONS; SHAVING CREAMS (U.S. CLS. 1, 4, 6, 50, 51 AND 52).
BARBARA GAYNOR, EXAMINING ATTORNEY

SN 78-228,029. ZOTOS INTERNATIONAL, INC., DARIEN, CT. FILED 3-20-2003.

SPIKER BLAST

OWNER OF U.S. REG. NO. 2,667,123.
FOR HAIR CARE PREPARATIONS. (U.S. CLS. 1, 4, 6, 50, 51 AND 52).
FIRST USE 8-1-2001; IN COMMERCE 8-1-2001.
JASON BLAIR, EXAMINING ATTORNEY

SN 78-731,779. CHANEL, INC., NEW YORK, NY. FILED 10-12-2005.

31 RUE CAMBON

THE MARK CONSISTS OF STANDARD CHARACTERS WITHOUT CLAIM TO ANY PARTICULAR FONT, STYLE, SIZE, OR COLOR.

OWNER OF U.S. REG. NO. 2,964,843.
SEC. 2(F).
FOR FRAGRANCES FOR PERSONAL USE (U.S. CLS. 1, 4, 6, 50, 51 AND 52).
FIRST USE 3-30-2007; IN COMMERCE 3-30-2007.
LAURA KOVALSKY, EXAMINING ATTORNEY

SN 78-925,970. KAO KABUSHIKI KAISHA, AKA KAO CORPORATION, CHUO-KU, TOKYO, JAPAN, FILED 7-10-2006.

TARGETED THERAPY

THE MARK CONSISTS OF STANDARD CHARACTERS WITHOUT CLAIM TO ANY PARTICULAR FONT, STYLE, SIZE, OR COLOR.

NO CLAIM IS MADE TO THE EXCLUSIVE RIGHT TO USE "THERAPY", APART FROM THE MARK AS SHOWN.
SEC. 2(F).
FOR NON-MEDICATED SKIN CARE PREPARATIONS (U.S. CLS. 1, 4, 6, 50, 51 AND 52).
FIRST USE 1-7-2007; IN COMMERCE 1-7-2007.
ELLEN PERKINS, EXAMINING ATTORNEY

SN 78-948,442. THE PROCTER & GAMBLE COMPANY, CINCINNATI, OH. FILED 8-9-2006.

RENEWAL

THE MARK CONSISTS OF STANDARD CHARACTERS WITHOUT CLAIM TO ANY PARTICULAR FONT, STYLE, SIZE, OR COLOR.

FOR COSMETIC TOOTH WHITENER (U.S. CLS. 1, 4, 6, 50, 51 AND 52).
FIRST USE 1-22-2006; IN COMMERCE 1-22-2006.
CURTIS FRENCH, EXAMINING ATTORNEY

CLASS 3—(Continued).

SN 78-966,165. ROLITE COMPANY, INC., HARTLAND, WI.
FILED 9-1-2006.

WELLNESS FOR THE FEET

THE MARK CONSISTS OF STANDARD CHARACTERS WITHOUT CLAIM TO ANY PARTICULAR FONT, STYLE, SIZE, OR COLOR.

FOR FOOT CARE PRODUCTS, NAMELY, FOOT BALM, NON-MEDICATED FOOT CREAM, NON-MEDICATED FOOT SPRAY, FOOT DEODORANT, FOOT SOAK AND FOOT BATH SALTS AND TABLETS (U.S. CLS. 1, 4, 6, 50, 51 AND 52).

DEIRDRE ROBERTSON, EXAMINING ATTORNEY

CLASS 3—(Continued).

THE LEFT PORTION WITH THE WORDING "AUTOSOL", THE RIGHT PORTION WITH THE WORDING "METAL POLISH", "MADE IN GERMANY" AND "SEVERAL TIMES AWARDED WITH GOLD MEDALS ON AN INTERNATIONAL LEVEL", AND THREE CIRCLES CONSISTING OF MEDALS CONTAINING THE WORDING "MONDE SELECTION BRUXELLES SELECTION MONDIALE DE LA QUALITE AND 3LE SELECTION MONDIALE DES PRODUITS D'ENTRETIEN PAINTURES ET VERNIS -MEDAILLE D'OR BRUXELLES -18. SEPTEMBRE 1971".

THE ENGLISH TRANSLATION OF "MONDE SELECTION BRUXELLES SELECTION MONDIALE DE LA QUALITE" AND "3LE SELECTION MONDIALE DES PRODUITS D'ENTRETIEN PAINTURES ET VERNIS-MEDAILLE D'OR BRUXELLES 18. SEPTEMBRE 1971" IS: "WORLD SELECTION BRUSSELS WORLD SELECTION OF QUALITY" AND "31ST WORLD SELECTION OF PRODUCTS IN THE FIELD OF PAINTS AND VARNISHES-GOLD MEDAL BRUSSELS". "SEPTEMBER 18, 1971".

FOR FURBISHING PREPARATIONS, NAMELY, SHAMPOOS AND SCENTED SHAMPOOS FOR AUTOMOBILE CARPETS AND UPHOLSTERY, UPHOLSTERY CLEANERS, ALL-PURPOSE CLEANERS AND AUTOMOBILE CLEANERS; POLISHING PREPARATIONS, NAMELY, POLISHING POWDER, AUTOMOBILE POLISHING PASTE AND AUTOMOBILE LIQUID POLISH; CLEANING PREPARATIONS FOR AUTOMOBILES (U.S. CLS. 1, 4, 6, 50, 51 AND 52).

LEIGH LOWRY, EXAMINING ATTORNEY

SN 79-005,123. DURSOL-FABRIK OTTO DURST GMBH & CO. KG, FED REP GERMANY, FILED 7-9-2004.

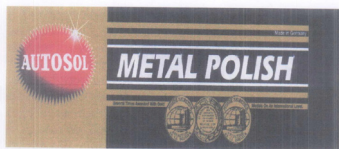

PRIORITY DATE OF 3-31-2004 IS CLAIMED.
OWNER OF INTERNATIONAL REGISTRATION 0832639 DATED 7-9-2004, EXPIRES 7-9-2014.

NO CLAIM IS MADE TO THE EXCLUSIVE RIGHT TO USE "MADE IN GERMANY" OR "METAL POLISH" OR "SEVERAL TIMES AWARDED WITH GOLD MEDALS ON AN INTERNATIONAL LEVEL" OR "MONDE SELECTION BRUXELLES SELECTION MONDIALE DE LA QUALITE" OR "3LE SELECTION MONDIALE DES PRODUITS D'ENTRETIEN PAINTURES ET VERNIS - MEDAILLE D'OR BRUXELLES - 18. SEPTEMBRE 1971", APART FROM THE MARK AS SHOWN.

THE COLOR(S) RED, GOLD, BLACK AND WHITE IS/ARE CLAIMED AS A FEATURE OF THE MARK.

THE COLOR RED APPEARS IN THE TOOTHED-EDGE MEDAL; THE COLOR WHITE APPEARS IN THE WORDING AUTOSOL METAL POLISH AND MADE IN GERMANY THE LINES, THE OUTLINE OF THE MEDAL'S DECORATIVE TOOTH BORDER AND THE HIGHLIGHT STAR; THE COLOR GOLD APPEARS IN THE BANDS AND THE BACKGROUND OF THE MARK; THE COLOR BLACK APPEARS IN THE WORDING SEVERAL TIMES AWARDED WITH GOLD MEDALS ON AN INTERNATIONAL LEVEL, MONDE SELECTION BRUXELLES SELECTION MONDIALE DE LA QUALITE AND 3LE SELECTION MONDIALE DES PRODUITS D'ENTRETIEN PAINTURES ET VERNIS - MEDAILLE D'OR BRUXELLES -18. SEPTEMBRE 1971, THE DESIGNS WITHIN THE THREE CONNECTED OVALS, THE HIGHLIGHTING ON THE TOOTHED-EDGE MEDAL AND THE BACKGROUND OF THE MARK.

THE MARK CONSISTS OF A DIVIDED RECTANGLE,

SN 79-017,596. AUTUMNPAPER LIMITED, HAYWARDS HEATH, WEST SUSSEX, UNITED KINGDOM, FILED 9-30-2005.

MY QUEEN

PRIORITY DATE OF 3-31-2005 IS CLAIMED.
OWNER OF INTERNATIONAL REGISTRATION 0868078A DATED 9-30-2005, EXPIRES 9-30-2015.

FOR PERFUMES, EAUX DE TOILETTE, PERSONAL DEODORANTS; ESSENTIAL OILS; OILS FOR COSMETIC PURPOSES; SOAPS; CLEANSING MILKS; COSMETICS; MAKE-UP, NAMELY, MAKE-UP FOUNDATION, PRESSED FACE POWDERS, LIP GLOSS, MASCARA, EYE SHADOW, EYEBROW PENCILS, LIP LINERS, EYE DEFINING PENCILS, AND LOOSE FACE POWDERS; MAKE-UP REMOVING PRODUCTS, NAMELY, LOTION, MAKE-UP REMOVER MILK, SKIN CLEANSING MASKS, NAIL POLISH REMOVERS; COSMETIC PRODUCTS FOR SKIN CARE ELIMINATING CELLULITIS, FOR THE BATH AND FOR TANNING, NAMELY, DAY CREAMS, NIGHT CREAMS, MOISTURIZING EYE CREAMS, ANTI-WRINKLE CREAMS, TONING EMULSIONS, CLEANSING GELS FOR THE FACE, BATH AND SHOWER GELS, COSMETIC PREPARATIONS AGAINST SUNBURN; BEAUTY MASKS; COSMETIC PENCILS; BLUSHES; NAIL VARNISH; LIPSTICK; EYELINER; SHAVING PREPARATIONS, SHAVING SOAPS; SHAVING GELS; AFTER-SHAVE LOTIONS (U.S. CLS. 1, 4, 6, 50, 51 AND 52).

LEIGH LOWRY, EXAMINING ATTORNEY

CLASS 3—(Continued).

SN 79-021,094. ESCADA AG, FED REP GERMANY, FILED 11-10-2005.

CEREMONIA

THE MARK CONSISTS OF STANDARD CHARACTERS WITHOUT CLAIM TO ANY PARTICULAR FONT, STYLE, SIZE, OR COLOR.

PRIORITY DATE OF 8-26-2005 IS CLAIMED.

OWNER OF INTERNATIONAL REGISTRATION 0877393 DATED 11-10-2005, EXPIRES 11-10-2015.

THE TRANSLATION OF THE MARK "CEREMONIA" IS CEREMONY.

FOR PERFUMERIES, COSMETICS AND BODY CARE PRODUCTS, NAMELY, ESSENTIAL OILS FOR PERSONAL USE, BODY LOTION, BODY CREAM, BATH AND SHOWER GEL, DEODORANTS FOR PERSONAL USE, SKIN CREAM, MOISTURIZING MILKS, LOTIONS, CREAMS AND GELS FOR THE BODY, PERFUMED BODY POWDERS (U.S. CLS. 1, 4, 6, 50, 51 AND 52).

WILLIAM VERHOSEK, EXAMINING ATTORNEY

SN 79-029,623. COSMETIQUE ET PARFUM; INTERNATIONAL - C P I, FRANCE, FILED 9-5-2006.

MAGICAL MOON

THE MARK CONSISTS OF STANDARD CHARACTERS WITHOUT CLAIM TO ANY PARTICULAR FONT, STYLE, SIZE, OR COLOR.

PRIORITY DATE OF 3-6-2006 IS CLAIMED.

OWNER OF INTERNATIONAL REGISTRATION 0900178 DATED 9-5-2006, EXPIRES 9-5-2016.

FOR PERFUMES, EAUX DE TOILETTE, DEODORANTS FOR PERSONAL USE; PERFUMERY; ESSENTIAL OILS; OILS FOR COSMETIC USE; SOAPS; COSMETIC MILK; COSMETICS; CREAMS, LOTIONS AND COSMETIC PREPARATIONS FOR SKIN CARE; BEAUTY MASKS; CREAMS AND LOTIONS FOR FACE AND BODY CARE; BLUSHER, MAKE-UP POWDERS; SHAVING PREPARATIONS; AFTER-SHAVE LOTIONS; MOISTURIZING AFTER-SHAVE CREAMS; SHAVING SOAPS (U.S. CLS. 1, 4, 6, 50, 51 AND 52).

KIMBERLY PERRY, EXAMINING ATTORNEY

CLASS 3—(Continued).

SN 79-035,294. VAGHEGGI S.P.A., ITALY, FILED 8-28-2006.

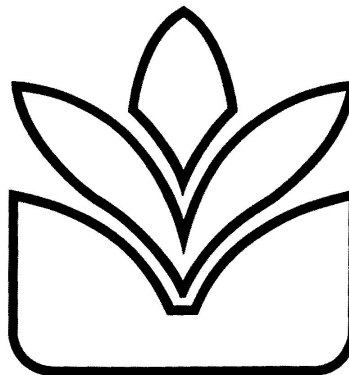

PRIORITY DATE OF 4-4-2006 IS CLAIMED.

OWNER OF INTERNATIONAL REGISTRATION 0915645 DATED 8-28-2006, EXPIRES 8-28-2016.

THE MARK CONSISTS OF A SIGN DEPICTING A PORTION OF A STYLIZED QUADRILATERAL HAVING ROUNDED LOWER CORNERS AND CLOSED, IN THE UPPER PART, BY TWO CONCAVE SPECULAR AND STYLIZED ARCS PROJECTING FROM THE POINT OF CONTACT OF WHICH, UPWARDS, THERE IS A FIGURE EVOCATIVE OF TWO STYLIZED SPACED APART LEAVES PROJECTING FROM THE INTERSECTION OF WHICH IN TURN THERE IS A STYLIZED QUADRILATERAL LEAF-SHAPED FIGURE.

FOR FACIAL, BODY AND FOOT SCRUBS IN THE FORM OF GEL, CREAM, FLUID AND SALT; EYE MAKE-UP REMOVER; SKIN CLEANSING CREAMS; SKIN CLEANSING LOTIONS; SKIN CLEANSING GEL; SKIN CLEANSING MILK; SKIN CLEANSING EMULSIONS; WHITENING CLEANSING MILK; FACE AND BODY LOTIONS, BEAUTY SERUMS AND SKIN CREAMS IN LIQUID; FACE AND BODY TONIC LOTIONS; SKIN WHITENING PREPARATIONS AS TONIC, CREAMS AND FLUID; FACE CREAMS AND EMULSIONS; BODY CREAMS AND EMULSIONS; TONING CREAMS FOR THE FACE, BODY AND HANDS; NON-MEDICATED FOOT AND LEG CREAMS, GELS AND LOTIONS; HAND CREAMS AND LOTIONS, AND HAND CLEANING PREPARATIONS AS FLUIDS AND EMULSIONS; EYE AND LIP CONTOUR CREAMS, GELS AND LOTIONS; BEAUTY MASKS; SKIN LIFTING EFFECT MASKS; WHITENING CREAM FACE MASKS; NON-MEDICATED DEODORIZING FOOT LOTIONS AND CREAMS; ESSENTIAL OILS FOR PERSONAL USE; ESSENTIAL OILS, GELS, CREAMS, AND LOTIONS, FOR MASSAGE; NON-MEDICATED BODY WRAPS AND STRIPS FOR SKIN TREATMENTS; PERFUMES; TOILET WATER; DEODORANTS FOR PERSONAL USE; SHOWER GEL; BUBBLE BATH; NON-MEDICATED BATH AND SHOWER OILS AND SALTS; BATH PEARLS; BATH AND SHOWER CLEANSING MILK; SKIN AND TOILET SOAPS; FOOT BATH CREAMS, GELS AND LOTIONS; SHAVING BALMS; SHAVING CREAM; AFTER SHAVE LOTIONS, CREAMS, EMULSIONS AND GELS; CONCEALER FOR MAKE-UP; COSMETIC PENCILS AND BRUSHES; FOUNDATION MAKE-UP; FACE POWDERS; EYE SHADOW; TALCUM POWDER; ROUGES; LIPSTICKS; MASCARAS; EYE LINERS; SUN SCREEN PREPARATIONS; SUN TANNING PREPARATIONS; NAIL POLISH; NAIL POLISH REMOVERS; HAIR SHAMPOOS; HAIR SPRAYS; HAIR LOTIONS; HAIR BALMS AND CREAMS; HAIR SERUM; NON-MEDICATED PROTECTIVE HAIR OILS; HAIR GELS; HAIR MASKS; HAIR CONDITIONERS; HAIR LACQUER; HAIR MOUSSE; DEPILATORY CREAMS; DEPILATORY WAX; DEPILATORY PREPARATIONS; DEPILATORY STRIPS; DEPILATORY ROLL-STRIPS AND STICKS; MOUSTACHE WAX; DENTIFRICES; NON-MEDICATED EYE COMPRESSES FOR COSMETIC TREATMENTS (U.S. CLS. 1, 4, 6, 50, 51 AND 52).

LINDA M. KING, EXAMINING ATTORNEY

CLASS 3—(Continued).

SN 79-037,428. ALTRO LIMITED, HERTFORDSHIRE, UNITED KINGDOM, FILED 4-14-2007.



U L T R A
D E E P
S H I N E

OWNER OF INTERNATIONAL REGISTRATION 0921290 DATED 4-14-2007, EXPIRES 4-14-2017.

OWNER OF U.S. REG. NO. 1,529,179.

NO CLAIM IS MADE TO THE EXCLUSIVE RIGHT TO USE "AUTO" AND "ULTRA DEEP SHINE", APART FROM THE MARK AS SHOWN.

FOR AUTOMOTIVE SHAMPOOS AND CONDITIONERS; AUTOMOTIVE CLEANING, POLISHING, RUST-INHIBITING, RUST-REMOVING AND SCOURING PREPARATIONS (U.S. CLS. 1, 4, 6, 50, 51 AND 52).

STEVEN JACKSON, EXAMINING ATTORNEY

SN 79-037,562. OYSTER COSMETICS S.P.A., ITALY, FILED 3-27-2007.

PIEGAVIVA

THE MARK CONSISTS OF STANDARD CHARACTERS WITHOUT CLAIM TO ANY PARTICULAR FONT, STYLE, SIZE, OR COLOR.

PRIORITY DATE OF 11-20-2006 IS CLAIMED.

OWNER OF INTERNATIONAL REGISTRATION 0921629 DATED 3-27-2007, EXPIRES 3-27-2017.

THE WORDING "PIEGAVIVA" HAS NO MEANING IN A FOREIGN LANGUAGE.

FOR BLEACHING PREPARATIONS AND DETERGENT FOR LAUNDRY USE; GENERAL PURPOSE CLEANING, POLISHING, SCOURING AND ABRASIVE LIQUIDS AND POWDERS; SOAPS; PERFUMERY, ESSENTIAL OILS, COSMETICS, HAIR LOTIONS; DENTIFRICES (U.S. CLS. 1, 4, 6, 50, 51 AND 52).

ELISSA GARBER KON, EXAMINING ATTORNEY

CLASS 3—(Continued).

SN 79-040,823. ALFRED DUNHILL LIMITED, UNITED KINGDOM, FILED 6-4-2007.



OWNER OF INTERNATIONAL REGISTRATION 0930219 DATED 6-4-2007, EXPIRES 6-4-2017.

OWNER OF U.S. REG. NOS. 859,052, 2,766,129 AND 3,085,590.

SEC. 2(F).

FOR PERFUMES, EAU DE TOILETTE, EAU DE PARFUM, COLOGNE; ESSENTIAL OILS; COSMETICS; NON-MEDICATED BATH AND SHOWER PREPARATIONS; TOILETTE SOAPS; BODY DEODORANT; CREAMS AND GELS FOR THE FACE, THE BODY AND THE HANDS; NON-MEDICATED TOILET PREPARATIONS, NAMELY, BODY MOISTURIZERS, BODY CLEANSERS, BODY EXFOLIATORS, SKIN MOISTURIZERS AND SKIN CLEANSERS; NON-MEDICATED SUN CARE PREPARATIONS; HAIR CARE PREPARATIONS; SHAMPOOS; GELS, SPRAYS, MOUSSES AND BALMS FOR HAIR STYLING AND HAIR CARE; DENTIFRICES; ANTIPERSPIRANTS; DEODORANTS FOR PERSONAL USE; SHAVING PREPARATIONS; AFTER SHAVE PREPARATIONS (U.S. CLS. 1, 4, 6, 50, 51 AND 52).

FLORENTINA BLANDU, EXAMINING ATTORNEY

SN 79-043,139. THIERRY MUGLER PARFUMS S.A.S., FRANCE, FILED 8-7-2007.

HYPER TENSION

THE MARK CONSISTS OF STANDARD CHARACTERS WITHOUT CLAIM TO ANY PARTICULAR FONT, STYLE, SIZE, OR COLOR.

PRIORITY DATE OF 2-9-2007 IS CLAIMED.

OWNER OF INTERNATIONAL REGISTRATION 0935865 DATED 8-7-2007, EXPIRES 8-7-2017.

FOR PERFUMERY; COSMETIC PRODUCTS, NAMELY, COSMETICS (U.S. CLS. 1, 4, 6, 50, 51 AND 52).

CARYN GLASSER, EXAMINING ATTORNEY

CLASS 3—(Continued).

SN 79-044,725. BIOTA BITKISEL KOZMETIK; LABORATUURLARI TICARET LIMITED SIRKETI, TURKEY, FILED 7-10-2007.

DERACINE

THE MARK CONSISTS OF STANDARD CHARACTERS WITHOUT CLAIM TO ANY PARTICULAR FONT, STYLE, SIZE, OR COLOR.

OWNER OF INTERNATIONAL REGISTRATION 0939823 DATED 7-10-2007, EXPIRES 7-10-2017.

FOR AUTOMATIC DISHWASHING DETERGENTS; DISH DETERGENTS; DISHWASHER DETERGENTS; GERMICIDAL DETERGENTS; LAUNDRY DETERGENTS; TOILET BOWL DETERGENTS; DETERGENT SOAP; DETERGENTS FOR AUTOMOBILES; DETERGENTS FOR MACHINE DISHWASHING; BLEACHING PREPARATIONS FOR COSMETIC PURPOSES; BLEACHING PREPARATIONS FOR HOUSEHOLD USE; BLUEING FOR LAUNDRY; LIMESTONE REMOVING PREPARATION FOR USE ON HOUSEHOLD APPARATUS; GLASS CLEANERS; GLASS CLEANING PREPARATIONS; PERFUMERY; PERFUMES, ESSENTIAL OILS FOR PERSONAL USE, COLOGNE, LOTIONS FOR SKIN, HAIR, FACE, BODY, DEODORANTS FOR PERSONAL USE, AFTER-SHAVE LOTIONS, DEODORANTS AND ANTIPERSPIRANTS; NAIL POLISH; LIPSTICKS; MAS-CARAS; SKIN CREAMS IN LIQUID AND IN SOLID FORM; HAIR DYE; HAIR CLEANING PREPARATIONS; SHAMPOOS; HAIR CARE PREPARATIONS; HAIR CONDITIONER, HAIR CREAMS, HAIR GELS, HAIR LOTIONS, HAIR OILS, HAIR CARE CREAMS, HAIR CARE LOTIONS; EYE LINER; FACE POWDER; NAIL POLISH REMOVER; AFTER-SHAVE CREAMS; BATH GELS; DEPILATORIES; DEPILATORY CREAMS; HENNA FOR COSMETIC PURPOSES; TISSUES IMPREGNATED WITH COSMETIC LOTIONS; COTTON STICKS FOR COSMETIC PURPOSES; SOAPS; SOAPS FOR BODY CARE, SOAPS FOR HOUSEHOLD USE, SOAPS FOR PERSONAL USE, SOAPS FOR TOILET PURPOSES; DENTIFRICES; TOOTH PASTE; TOOTH GEL; TEETH CLEANING LOTIONS; TOOTH POLISH; TOOTH POWDER; SKIN ABRASIVE PREPARATIONS; GENERAL PURPOSE CLEANING, POLISHING, AND ABRASIVE LIQUIDS AND POWDERS; FLEXIBLE ABRASIVES; ABRASIVE PAPER; ABRASIVE PASTE; ABRASIVE ROLLS; ABRASIVE SHEETS; ABRASIVE STRIPS; ABRASIVE CLOTH; ABRASIVE PAPER IN THE NATURE OF SANDPAPER; PUMICE STONES FOR PERSONAL USE; POLISH FOR MUSICAL INSTRUMENTS; POLISHING POWDERS; POLISHING PREPARATIONS (U.S. CLS. 1, 4, 6, 50, 51 AND 52).

BARBARA GAYNOR, EXAMINING ATTORNEY

SN 79-045,415. COTY PRESTIGE LANCASTER GROUP GMBH, FED REP GERMANY, FILED 9-24-2007.

EXPERT INSTITUTE AT HOME

THE MARK CONSISTS OF STANDARD CHARACTERS WITHOUT CLAIM TO ANY PARTICULAR FONT, STYLE, SIZE, OR COLOR.

PRIORITY DATE OF 7-19-2007 IS CLAIMED.

OWNER OF INTERNATIONAL REGISTRATION 0941554 DATED 9-24-2007, EXPIRES 9-24-2017.

FOR SOAPS, PERFUMERY; ESSENTIAL OILS; COSMETIC LOTIONS FOR THE EYES, FACE, BODY AND LIPS; COSMETICS; COSMETIC HAIR LOTIONS (U.S. CLS. 1, 4, 6, 50, 51 AND 52).

MARK PILARO, EXAMINING ATTORNEY

CLASS 4—LUBRICANTS AND FUELS

SN 77-111,480. CANDLE LAMP COMPANY, LLC, RIVERSIDE, CA. FILED 2-20-2007.

SNUFF-IT

THE MARK CONSISTS OF STANDARD CHARACTERS WITHOUT CLAIM TO ANY PARTICULAR FONT, STYLE, SIZE, OR COLOR.

FOR LAMP AND CANDLE WICKS THAT EXTINGUISH THEMSELVES IF THE LIGHT SOURCE FALLS OVER (U.S. CLS. 1, 6 AND 15).

FIRST USE 1-0-1999; IN COMMERCE 1-0-1999.
STEPHEN AQUILA, EXAMINING ATTORNEY

SN 77-264,143. BRIGHT OF AMERICA, LLC, SUMMERSVILLE, WV. FILED 8-24-2007.



NO CLAIM IS MADE TO THE EXCLUSIVE RIGHT TO USE "NATURAL", APART FROM THE MARK AS SHOWN.

THE MARK CONSISTS OF OUTER OVAL WITH RUFFLED EDGES CONTAINING INTERNAL OVAL WITH INCOMPLETE SHADED LINE THROUGH CENTER AND SHADED CURVED LINES ON EITHER SIDE IN OUTER OVAL; CURVED WORD "NATURAL" AT TOP OF OUTER OVAL AND CURVED WORD "PERFECTION" AT BOTTOM OF OUTER OVAL AND WORDS "MORE SCENT" ABOVE THE SHADED LINE IN INNER OVAL AND "LESS SOOT" BELOW SHADED LINE IN INNER OVAL.

FOR SOY BASED CANDLES AND CANDLES CONTAINING SOY DERIVATIVES (U.S. CLS. 1, 6 AND 15).

CIMMERIAN COLEMAN, EXAMINING ATTORNEY

CLASS 4—(Continued).

SN 77-271,959. ADDINOL LUBE OIL GMBH, LEUNA, FED REP GERMANY, FILED 9-5-2007.

ADDINOL

THE MARK CONSISTS OF STANDARD CHARACTERS WITHOUT CLAIM TO ANY PARTICULAR FONT, STYLE, SIZE, OR COLOR.

OWNER OF FED REP GERMANY REG. NO. 39639447, DATED 12-4-1996, RENEWED AS REG. NO. 39639447, DATED 8-1-2006, EXPIRES 9-30-2016.

THE WORDING "ADDINOL" HAS NO MEANING IN ENGLISH.

FOR OILS AND LUBRICANTS FOR INDUSTRIAL USE; OILS FOR ENGINES AND GEARS OF MOTOR VEHICLES (U.S. CLS. 1, 6 AND 15).

JASON LOTT, EXAMINING ATTORNEY

SN 77-280,404. ARBONNE INTERNATIONAL, LLC, IRVINE, CA. FILED 9-14-2007.

SEASOURCE DETOX SPA

THE MARK CONSISTS OF STANDARD CHARACTERS WITHOUT CLAIM TO ANY PARTICULAR FONT, STYLE, SIZE, OR COLOR.

NO CLAIM IS MADE TO THE EXCLUSIVE RIGHT TO USE "DETOX SPA", APART FROM THE MARK AS SHOWN. FOR CANDLES (U.S. CLS. 1, 6 AND 15).

KIMBERLY FRYE, EXAMINING ATTORNEY

SN 77-288,045. STRINGER, KEITH, ATHENS, TX. FILED 9-25-2007.

SUZZETTE'S CABIN CANDLES

THE MARK CONSISTS OF STANDARD CHARACTERS WITHOUT CLAIM TO ANY PARTICULAR FONT, STYLE, SIZE, OR COLOR.

NO CLAIM IS MADE TO THE EXCLUSIVE RIGHT TO USE "CANDLES", APART FROM THE MARK AS SHOWN. FOR SCENTED CANDLES AND VOTIVE CANDLES (U.S. CLS. 1, 6 AND 15).

FIRST USE 1-0-1996; IN COMMERCE 1-0-1996.

AISHA CLARKE, EXAMINING ATTORNEY

CLASS 4—(Continued).

SN 77-292,051. MY PRODUCTION, GIF SUR YVETTE, FRANCE, FILED 9-28-2007.

GREEN HEARTS

THE MARK CONSISTS OF STANDARD CHARACTERS WITHOUT CLAIM TO ANY PARTICULAR FONT, STYLE, SIZE, OR COLOR.

FOR COMBUSTIBLES BRIQUETTES AND CHARCOAL BRIQUETTES FOR BARBECUES (U.S. CLS. 1, 6 AND 15).

ANNE MADDEN, EXAMINING ATTORNEY

SN 77-292,150. KAYLA PRODUCTIONS, INC., ENCINO, CA. FILED 9-28-2007.

"...LIKE A PRESCRIPTION FOR YOUR SOUL"

THE MARK CONSISTS OF STANDARD CHARACTERS WITHOUT CLAIM TO ANY PARTICULAR FONT, STYLE, SIZE, OR COLOR.

FOR CANDLES (U.S. CLS. 1, 6 AND 15).

FIRST USE 2-0-2002; IN COMMERCE 2-0-2002.

MICHAEL GAAFAR, EXAMINING ATTORNEY

SN 77-293,600. RBF HOLDINGS LLC, HOUSTON, TX. FILED 10-2-2007.



NO CLAIM IS MADE TO THE EXCLUSIVE RIGHT TO USE "RENEWABLE BIO-FUELS", APART FROM THE MARK AS SHOWN.

THE COLOR(S) BLACK, GREEN AND ORANGE IS/ARE CLAIMED AS A FEATURE OF THE MARK.

THE MARK CONSISTS OF THE COLOR BLACK APPEARING IN THE LETTERS RBF AND WORDS RENEWABLE BIO FUELS WITH COLORS GREEN AND ORANGE APPEARING IN CIRCULAR ARROW DESIGN.

FOR BIODEGRADABLE FUEL IN THE NATURE OF A METHYL ESTER OR BIODIESEL USABLE AS A SUPPLEMENT OR SUBSTITUTE FOR FOSSIL-BASED DIESEL FUEL (U.S. CLS. 1, 6 AND 15).

NAKWAMA ANKRAH, EXAMINING ATTORNEY

CLASS 4—(Continued).

SN 77-296,768. REEVES, ROBERT S., DBA BOB REEVES
BRASS MOUTHPIECES, VALENCIA, CA. FILED 10-4-2007.

H2OIL

THE MARK CONSISTS OF STANDARD CHARACTERS
WITHOUT CLAIM TO ANY PARTICULAR FONT, STYLE,
SIZE, OR COLOR.

FOR LIGHT OILS (U.S. CLS. 1, 6 AND 15).
FIRST USE 12-30-1993; IN COMMERCE 12-30-1993.
ANTHONY RINKER, EXAMINING ATTORNEY

SN 77-309,942. SOY BASICS, LLC, NEW HAMPTON, IA.
FILED 10-22-2007.

BURN A BEAN

THE MARK CONSISTS OF STANDARD CHARACTERS
WITHOUT CLAIM TO ANY PARTICULAR FONT, STYLE,
SIZE, OR COLOR.

FOR CANDLES (U.S. CLS. 1, 6 AND 15).
FIRST USE 1-1-2007; IN COMMERCE 1-1-2007.
JULIE WATSON, EXAMINING ATTORNEY

SN 77-323,932. BELLISIO FOODS, INC., DBA MICHELINA'S,
INC., DULUTH, MN. FILED 11-7-2007.

THE FAMILY TABLE

THE MARK CONSISTS OF STANDARD CHARACTERS
WITHOUT CLAIM TO ANY PARTICULAR FONT, STYLE,
SIZE, OR COLOR.

FOR CANDLES; DECORATIVE CANDLES (U.S. CLS. 1,
6 AND 15).
JESSICA FATHY, EXAMINING ATTORNEY

CLASS 4—(Continued).

SN 77-351,431. PHILOSOPHY, INC., PHOENIX, AZ. FILED
12-13-2007.

OPEN HOUSE

THE MARK CONSISTS OF STANDARD CHARACTERS
WITHOUT CLAIM TO ANY PARTICULAR FONT, STYLE,
SIZE, OR COLOR.

FOR CANDLES (U.S. CLS. 1, 6 AND 15).
KATHERINE STOIDES, EXAMINING ATTORNEY

SN 79-039,332. GATE GLOBAL ALTERNATIVE ENERGY;
GERMANY GMBH, FED REP GERMANY, FILED 6-4-
2007.

POWERED BY NATURE

THE MARK CONSISTS OF STANDARD CHARACTERS
WITHOUT CLAIM TO ANY PARTICULAR FONT, STYLE,
SIZE, OR COLOR.

PRIORITY DATE OF 2-27-2007 IS CLAIMED.
OWNER OF INTERNATIONAL REGISTRATION 0926243
DATED 6-4-2007, EXPIRES 6-4-2017.

FOR INDUSTRIAL OILS AND GREASES; LUBRI-
CANTS; FUELS; MOTOR SPIRITS (U.S. CLS. 1, 6 AND
15).

ANDREA HACK, EXAMINING ATTORNEY

CLASS 5—PHARMACEUTICALS

SN 76-539,608. GRO-PRO LLC, INVERNESS, FL. FILED 8-21-
2003.



NO CLAIM IS MADE TO THE EXCLUSIVE RIGHT TO
USE "LLC", APART FROM THE MARK AS SHOWN.

FOR CROP PROTECTANTS IN THE NATURE OF
HERBICIDES AND PESTICIDES FOR DOMESTIC USE
(U.S. CLS. 6, 18, 44, 46, 51 AND 52).

ANGELA M. MICHELI, EXAMINING ATTORNEY

CLASS 5—(Continued).

SN 76-667,740. 1-800-HEALTHY.COM, INC., RIDGELAND, MS. FILED 10-19-2006.

OPTICHOL

THE MARK CONSISTS OF STANDARD CHARACTERS WITHOUT CLAIM TO ANY PARTICULAR FONT, STYLE, SIZE, OR COLOR.

FOR DIETARY SUPPLEMENTS (U.S. CLS. 6, 18, 44, 46, 51 AND 52).

FIRST USE 10-27-2004; IN COMMERCE 10-27-2004.
ADA HAN, EXAMINING ATTORNEY

SN 76-668,965. JOHNSON & JOHNSON, NEW BRUNSWICK, NJ. FILED 11-13-2006.



OWNER OF U.S. REG. NOS. 533,626, 677,465 AND OTHERS.

SEC. 2(F).
FOR NURSING PADS (U.S. CLS. 6, 18, 44, 46, 51 AND 52).

FIRST USE 0-0-2003; IN COMMERCE 0-0-2003.
KEVIN DINALLO, EXAMINING ATTORNEY

SN 76-677,125. MEDIGENE AG, 82152 PLANEGG/MARTINSRIED, FED REP GERMANY, FILED 5-27-2005.

EndoTAG

THE MARK CONSISTS OF STANDARD CHARACTERS WITHOUT CLAIM TO ANY PARTICULAR FONT, STYLE, SIZE, OR COLOR.

FOR MEDICINES FOR HUMANS AND ANIMALS IN THE FORM OF SERUMS AND DIAGNOSTIC PREPARATIONS FOR MEDICAL PURPOSES AND THERAPEUTIC USE, NAMELY, MEDICINES FOR TREATING TUMOROUS DISEASES SUCH AS GLIOMAS, CARCINOMAS OF THE COLON, OVARIAN CARCINOMAS, CERVICAL CARCINOMAS, CARCINOMAS OF THE PROSTATE, MELANOMAS, BASAL CELL CARCINOMAS, ACTINIC KERATOSIS, BREAST CANCERS, BONE CANCERS, BRAIN CANCERS, COLON CANCERS, ENDOCRINE SYSTEM CANCERS, GASTROINTESTINAL CANCERS, GYNAECOLOGICAL CANCERS, HEAD AND NECK CANCERS, LEUKEMIAS, LUNG CANCERS, LYMPHOMAS, METASTASES, MYELOMAS, PEDIATRIC CANCERS, PENILE CANCERS, SARCOMAS, SKIN CANCERS, TESTICULAR CANCERS, THYROID CANCERS, URINARY TRACT CANCERS, PLEURAL CANCERS, NEURONAL CANCERS, MESOTHELIOMAS, ASTROCYTOMAS, OLIGODENDROGLIOMAS, MENINGIOMAS, NEUROFIBROMAS, GLIOBLASTOMAS, EPENDYMOMAS, SCHWANNOMAS, NEUROFIBROSARCOMAS, NEUROBLASTOMAS, PITUITARY GLAND

CLASS 5—(Continued).

CANCERS, CANCERS OF THE HYPOPHYSIS, MEDULLOBLASTOMAS, RENAL CELL CARCINOMAS, PANCREATIC CANCERS, GASTRIC CANCERS, BLADDER CANCERS, LIVER CANCERS, PROSTATE CANCER, FIBROSARCOMAS, SQUAMOUS CELL CARCINOMAS, NEUROECTODERMAL CANCERS, HODGKIN'S LYMPHOMAS, NON-HODGKIN'S LYMPHOMAS, HEPATOMAS, EPIDERMAL CARCINOMAS, OR MEDICINES FOR TREATING CHRONIC INFLAMMATORY DISEASES SUCH AS RHEUMATOID ARTHRITIS, AUTOIMMUNE DISEASES, ALLERGIES, MULTIPLE SCLEROSIS; MEDICINES FOR STIMULATING WOUND HEALING; MEDICINES FOR TREATING EYE DISEASES AND ARTERIOSCLEROSIS; MEDICINES FOR TREATING CARDIOVASCULAR ILLNESSES, NAMELY, HYPERLIPIDAEMIA, CORONARY HEART DISEASES AND CARDIAC INSUFFICIENCY; MEDICINES FOR TREATING SKIN DISEASES, NAMELY, WARTS, GENITAL WARTS AND HERPES; EXCLUDING MEDICINES FOR ENEMAS AND FOR THE PREPARATION OF A COLOSCOPY (U.S. CLS. 6, 18, 44, 46, 51 AND 52).
WILLIAM VERHOSEK, EXAMINING ATTORNEY

SN 76-679,324. HERAEUS KULZER GMBH, D-63450 HANAU, FED REP GERMANY, FILED 7-10-2007.



PRIORITY CLAIMED UNDER SEC. 44(D) ON FED REP GERMANY APPLICATION NO. 30706715.7, FILED 1-30-2007, REG. NO. 30706715, DATED 6-21-2007, EXPIRES 1-31-2017.

OWNER OF U.S. REG. NO. 2,569,385.
FOR IMPRESSION MATERIALS, PARTICULARLY FROM SYNTHETIC MATERIAL, FOR DENTAL PURPOSES (U.S. CLS. 6, 18, 44, 46, 51 AND 52).
ZACHARY BELLO, EXAMINING ATTORNEY

SN 77-015,144. OPTIMUM NUTRITION, INC., AURORA, IL. FILED 10-5-2006.

OPTI-MEN

THE MARK CONSISTS OF STANDARD CHARACTERS WITHOUT CLAIM TO ANY PARTICULAR FONT, STYLE, SIZE, OR COLOR.

FOR DIETARY AND NUTRITIONAL SUPPLEMENTS (U.S. CLS. 6, 18, 44, 46, 51 AND 52).

FIRST USE 11-1-1999; IN COMMERCE 11-1-1999.
JULIE WATSON, EXAMINING ATTORNEY

CLASS 5—(Continued).

SN 77-024,825. KRAMER LABORATORIES, INC., MIAMI, FL. FILED 10-19-2006.

PECHITOS

THE MARK CONSISTS OF STANDARD CHARACTERS WITHOUT CLAIM TO ANY PARTICULAR FONT, STYLE, SIZE, OR COLOR.

FOR MULTIPURPOSE MEDICATED BALM OR SALVE FOR THE RELIEF OF COLD SYMPTOMS FOR INFANTS AND CHILDREN (U.S. CLS. 6, 18, 44, 46, 51 AND 52).

BERYL GARDNER, EXAMINING ATTORNEY

SN 77-062,578. GLAXO GROUP LIMITED, GREENFORD, MIDDLESEX, ENGLAND, FILED 12-12-2006.

EZUNA

THE MARK CONSISTS OF STANDARD CHARACTERS WITHOUT CLAIM TO ANY PARTICULAR FONT, STYLE, SIZE, OR COLOR.

FOR PHARMACEUTICAL PREPARATIONS AND SUBSTANCES FOR THE TREATMENT OF INFECTIOUS DISEASES, BLOOD DISORDERS, PAIN, INFLAMMATION, SEPSIS, ALOPECIA AND OBESITY, AND FOR THE TREATMENT OF VIRAL, METABOLIC, ENDOCRINE, MUSCULOSKELETAL, CARDIOVASCULAR, CARDIOPULMONARY, GENITOURINARY, SEXUAL DYSFUNCTION, ONCOLOGICAL, HEPATOLOGICAL, OPHTHALMOLOGICAL, RESPIRATORY, NEUROLOGICAL, GASTROINTESTINAL, HORMONAL, DERMATOLOGICAL AND PSYCHIATRIC RELATED DISEASES AND DISORDERS, AND FOR THE TREATMENT OF DAMAGED SKIN AND TISSUE; AND FOR VACCINES (U.S. CLS. 6, 18, 44, 46, 51 AND 52).

MARK PILARO, EXAMINING ATTORNEY

SN 77-114,796. SOLVAY PHARMACEUTICALS B.V., WEESP, NETHERLANDS, FILED 2-23-2007.

EZEQUA

THE MARK CONSISTS OF STANDARD CHARACTERS WITHOUT CLAIM TO ANY PARTICULAR FONT, STYLE, SIZE, OR COLOR.

FOR PHARMACEUTICAL PREPARATIONS AND SUBSTANCES FOR THE TREATMENT OF DISEASES OF THE CENTRAL NERVOUS SYSTEM, GASTRO-INTESTINAL DISEASES, GYNECOLOGICAL DISEASES AND CARDIOVASCULAR DISEASES (U.S. CLS. 6, 18, 44, 46, 51 AND 52).

DAVID TAYLOR, EXAMINING ATTORNEY

CLASS 5—(Continued).

SN 77-118,089. BEVERAGE INNOVATIONS (INTERNATIONAL) LTD., NASSAU, NEW PROVIDENCE, BAHAMAS, FILED 2-28-2007.

VENGA VENGA

THE MARK CONSISTS OF STANDARD CHARACTERS WITHOUT CLAIM TO ANY PARTICULAR FONT, STYLE, SIZE, OR COLOR.

THE TERM "VENGA VENGA" TRANSLATES FROM SPANISH TO ENGLISH AS COME COME.

FOR VITAMIN FORTIFIED BEVERAGES (U.S. CLS. 6, 18, 44, 46, 51 AND 52).

JAMES A. RAUEN, EXAMINING ATTORNEY

SN 77-119,730. RECKITT BENCKISER INC., PARSIPPANY, NJ. FILED 3-1-2007.

APPLE CINNAMON MEDLEY

THE MARK CONSISTS OF STANDARD CHARACTERS WITHOUT CLAIM TO ANY PARTICULAR FONT, STYLE, SIZE, OR COLOR.

NO CLAIM IS MADE TO THE EXCLUSIVE RIGHT TO USE "APPLE CINNAMON", APART FROM THE MARK AS SHOWN.

FOR AIR FRESHENING PREPARATIONS; AIR PURIFYING PREPARATIONS; ROOM AIR FRESHENERS; AIR FRESHENERS IN THE NATURE OF PREPARATIONS FOR PERFUMING OR FRAGRANCING THE AIR; HOUSEHOLD DEODORANTS; PREPARATIONS FOR NEUTRALIZING ODORS IN CARPETS, TEXTILES AND IN THE AIR (U.S. CLS. 6, 18, 44, 46, 51 AND 52).

JENNY PARK, EXAMINING ATTORNEY

SN 77-121,020. FIDIA FARMACEUTICI S.P.A., I-35031 ABANO TERME, ITALY, FILED 3-2-2007.

HYALO GYN

THE MARK CONSISTS OF STANDARD CHARACTERS WITHOUT CLAIM TO ANY PARTICULAR FONT, STYLE, SIZE, OR COLOR.

NO CLAIM IS MADE TO THE EXCLUSIVE RIGHT TO USE "GYN", APART FROM THE MARK AS SHOWN.

FOR PHARMACEUTICAL PREPARATIONS FOR DERMATOLOGICAL AND GYNECOLOGICAL USE; PARAPHARMACEUTICAL PRODUCTS FOR USE IN DERMATOLOGY AND GYNECOLOGY; EXTERNAL ITCH CREAMS, GELS AND SPRAYS; LUBRICANTS FOR CONDOMS; VAGINAL MOISTURIZERS (U.S. CLS. 6, 18, 44, 46, 51 AND 52).

ANNE MADDEN, EXAMINING ATTORNEY

CLASS 5—(Continued).

SN 77-121,059. FIDIA FARMACEUTICI S.P.A., I-35031 ABA-NO TERME, ITALY, FILED 3-2-2007.

HYALOFEMME

THE MARK CONSISTS OF STANDARD CHARACTERS WITHOUT CLAIM TO ANY PARTICULAR FONT, STYLE, SIZE, OR COLOR.

THE WORD "HYALOFEMME" HAS NO MEANING IN A FOREIGN LANGUAGE.

FOR PHARMACEUTICAL PREPARATIONS FOR DERMATOLOGICAL AND GYNECOLOGICAL USE; PARAPHARMACEUTICAL PRODUCTS FOR USE IN DERMATOLOGY AND GYNECOLOGY; EXTERNAL ITCH CREAMS, GELS AND SPRAYS; LUBRICANTS FOR CONDOMS; VAGINAL MOISTURIZERS (U.S. CLS. 6, 18, 44, 46, 51 AND 52).
ANNE MADDEN, EXAMINING ATTORNEY

CLASS 5—(Continued).

SN 77-125,462. APEX MERCHANDISE GROUP, LLC, SCOTTSDALE, AZ. FILED 3-8-2007.

PH ION

THE MARK CONSISTS OF STANDARD CHARACTERS WITHOUT CLAIM TO ANY PARTICULAR FONT, STYLE, SIZE, OR COLOR.

NO CLAIM IS MADE TO THE EXCLUSIVE RIGHT TO USE "PH", APART FROM THE MARK AS SHOWN.

FOR NUTRITIONAL SUPPLEMENTS; DIETARY SUPPLEMENTS; FOOD SUPPLEMENTS; NUTRITIONAL DRINK MIX FOR USE AS A MEAL REPLACEMENT; MEAL REPLACEMENT AND DIETARY SUPPLEMENT DRINK MIXES; HERBAL SUPPLEMENTS; MINERAL SUPPLEMENTS; VITAMIN SUPPLEMENTS; VITAMIN ENRICHED WATER; VITAMIN FORTIFIED BEVERAGES; HERBAL TEAS FOR MEDICINAL PURPOSES; DIETARY FIBER AS AN ADDITIVE FOR FOOD PRODUCTS (U.S. CLS. 6, 18, 44, 46, 51 AND 52).
FIRST USE 1-0-2003; IN COMMERCE 1-0-2003.

DAVID ELTON, EXAMINING ATTORNEY

SN 77-128,859. CRIST, CHARLES L., SPRINGFIELD, MO. FILED 3-12-2007.

JIROFFA

THE MARK CONSISTS OF STANDARD CHARACTERS WITHOUT CLAIM TO ANY PARTICULAR FONT, STYLE, SIZE, OR COLOR.

FOR DIETARY AND NUTRITIONAL SUPPLEMENTS; NUTRITIONAL HEALTH SUPPLEMENTS AND VITAMIN SUPPLEMENTS (U.S. CLS. 6, 18, 44, 46, 51 AND 52).
FIRST USE 8-13-2004; IN COMMERCE 8-13-2004.

FRANK LATTUCA, EXAMINING ATTORNEY

SN 77-122,594. FRUTA VIDA INTERNATIONAL, INC., AUSTIN, TX. FILED 3-5-2007.

Fruta Vida

THE MARK CONSISTS OF STANDARD CHARACTERS WITHOUT CLAIM TO ANY PARTICULAR FONT, STYLE, SIZE, OR COLOR.

THE FOREIGN WORDING IN THE MARK TRANSLATES INTO ENGLISH AS THE WORD FRUIT AND THE WORD LIFE.

FOR FRUIT-BASED NUTRITIONAL DIETARY SUPPLEMENT (U.S. CLS. 6, 18, 44, 46, 51 AND 52).
FIRST USE 11-30-2004; IN COMMERCE 11-30-2004.

HOWARD B. LEVINE, EXAMINING ATTORNEY

SN 77-129,671. VALKO, JAMES J., CLEARWATER, FL. FILED 3-13-2007.

NULEAN

THE MARK CONSISTS OF STANDARD CHARACTERS WITHOUT CLAIM TO ANY PARTICULAR FONT, STYLE, SIZE, OR COLOR.

FOR DIETARY AND NUTRITIONAL SUPPLEMENTS (U.S. CLS. 6, 18, 44, 46, 51 AND 52).

FIRST USE 7-1-2006; IN COMMERCE 7-1-2006.

JOHN DWYER, EXAMINING ATTORNEY

CLASS 5—(Continued).

SN 77-130,133. ONCONOME, INC., SEATTLE, WA. FILED 3-13-2007.

COLOMARK

THE MARK CONSISTS OF STANDARD CHARACTERS WITHOUT CLAIM TO ANY PARTICULAR FONT, STYLE, SIZE, OR COLOR.

FOR REAGENTS FOR MEDICAL USE IN DIAGNOSIS, EVALUATION, IMAGING, AND THERAPEUTIC APPLICATIONS, AND KITS COMPRISING REAGENTS FOR MEDICAL USE IN DIAGNOSIS, EVALUATION, IMAGING, AND THERAPEUTIC APPLICATIONS (U.S. CLS. 6, 18, 44, 46, 51 AND 52).

ALICIA COLLINS, EXAMINING ATTORNEY

SN 77-132,411. CHAIRMAN SERVICES, LTD., ROAD TOWN, BR. VIRGIN ISLANDS, FILED 3-15-2007.

ENZYBAR

THE MARK CONSISTS OF STANDARD CHARACTERS WITHOUT CLAIM TO ANY PARTICULAR FONT, STYLE, SIZE, OR COLOR.

FOR NUTRITIONAL SUPPLEMENT, NAMELY, A NUTRITIONAL BAR WITH PANCREATIC ENZYMES (U.S. CLS. 6, 18, 44, 46, 51 AND 52).

LINDA ESTRADA, EXAMINING ATTORNEY

SN 77-136,178. DERMWORX, INC., HOLLYWOOD, FL. FILED 3-21-2007.

ACNEWORX

THE MARK CONSISTS OF STANDARD CHARACTERS WITHOUT CLAIM TO ANY PARTICULAR FONT, STYLE, SIZE, OR COLOR.

FOR TOPICAL COMPOUNDS AND PREPARATIONS, NAMELY, MEDICATED CREAMS AND LOTIONS FOR THE TREATMENT OF ACNE; ACNE MEDICATIONS (U.S. CLS. 6, 18, 44, 46, 51 AND 52).

AMY MCMENAMIN, EXAMINING ATTORNEY

CLASS 5—(Continued).

SN 77-136,186. DERMWORX, INC., HOLLYWOOD, FL. FILED 3-21-2007.

CERUMWORX

THE MARK CONSISTS OF STANDARD CHARACTERS WITHOUT CLAIM TO ANY PARTICULAR FONT, STYLE, SIZE, OR COLOR.

FOR TOPICAL SERUMS AND PREPARATIONS FOR MEDICAL USE, NAMELY, MEDICATED ANTIOXIDANT SERUMS, CREAMS AND LOTIONS FOR SKIN AND FACE; VITAMIN C SERUM PREPARATIONS (U.S. CLS. 6, 18, 44, 46, 51 AND 52).

AMY MCMENAMIN, EXAMINING ATTORNEY

SN 77-136,191. DERMWORX, INC., HOLLYWOOD, FL. FILED 3-21-2007.

LIDOWORX

THE MARK CONSISTS OF STANDARD CHARACTERS WITHOUT CLAIM TO ANY PARTICULAR FONT, STYLE, SIZE, OR COLOR.

FOR TOPICAL COMPOUNDS AND PREPARATIONS FOR ANESTHETIC AND MEDICAL USE, NAMELY, MEDICATED ANESTHETIC CREAMS, LOTIONS, GELS AND OINTMENTS; LOCAL ANESTHETICS (U.S. CLS. 6, 18, 44, 46, 51 AND 52).

AMY MCMENAMIN, EXAMINING ATTORNEY

SN 77-136,195. DERMWORX, INC., HOLLYWOOD, FL. FILED 3-21-2007.

SMSS

THE MARK CONSISTS OF STANDARD CHARACTERS WITHOUT CLAIM TO ANY PARTICULAR FONT, STYLE, SIZE, OR COLOR.

FOR TOPICAL COMPOUNDS AND DERMATOLOGICAL PREPARATIONS FOR MEDICAL USE, NAMELY, MEDICATED LOTIONS, CREAMS, AND OINTMENTS FOR SKIN AND FACE FOR TREATMENT OF DERMATOLOGICAL CONDITIONS (U.S. CLS. 6, 18, 44, 46, 51 AND 52).

AMY MCMENAMIN, EXAMINING ATTORNEY

CLASS 5—(Continued).

SN 77-136,200. DERMWORX, INC., HOLLYWOOD, FL.
FILED 3-21-2007.

CLASS 5—(Continued).

SN 77-139,962. BASILEA PHARMACEUTICA AG, BASEL,
SWITZERLAND, FILED 3-26-2007.

SMALL MOLECULE SOLUBILIZATION SYSTEM

THE MARK CONSISTS OF STANDARD CHARACTERS WITHOUT CLAIM TO ANY PARTICULAR FONT, STYLE, SIZE, OR COLOR.

NO CLAIM IS MADE TO THE EXCLUSIVE RIGHT TO USE "SYSTEM", APART FROM THE MARK AS SHOWN.

FOR TOPICAL COMPOUNDS AND DERMATOLOGICAL PREPARATIONS FOR MEDICAL USE, NAMELY, MEDICATED LOTIONS, CREAMS, AND OINTMENTS FOR SKIN AND FACE FOR TREATMENT OF DERMATOLOGICAL CONDITIONS (U.S. CLS. 6, 18, 44, 46, 51 AND 52).

AMY MCMENAMIN, EXAMINING ATTORNEY

BASILEA LABS

THE MARK CONSISTS OF STANDARD CHARACTERS WITHOUT CLAIM TO ANY PARTICULAR FONT, STYLE, SIZE, OR COLOR.

NO CLAIM IS MADE TO THE EXCLUSIVE RIGHT TO USE LABS, APART FROM THE MARK AS SHOWN.

FOR PHARMACEUTICAL AND VETERINARY PRODUCTS AND PREPARATIONS FOR THE TREATMENT OR PREVENTION OF DERMATOLOGICAL CONDITIONS, NAMELY, ECZEMA, INFLAMMATION, INFECTION, WARTS, PSORIASIS, AGING OF THE SKIN, ULTRA VIOLET RADIATION AND CANCER; FOR THE TREATMENT OF INFECTIONS CAUSED BY BACTERIA, FUNGI, VIRUSES, AND RHEUMATOID ARTHRITIS; FOR THE TREATMENT OF DISEASES, DISORDERS AND CONDITIONS IN THE AREA OF ONCOLOGY; AS WELL AS DIAGNOSTIC PREPARATIONS AND REAGENTS FOR CLINICAL OR MEDICAL LABORATORY USE (U.S. CLS. 6, 18, 44, 46, 51 AND 52).

CURTIS FRENCH, EXAMINING ATTORNEY

SN 77-137,312. GLAXO GROUP LIMITED, GREENFORD,
MIDDLESEX, UNITED KINGDOM, FILED 3-22-2007.

SN 77-141,160. ALBRITTON, FORD IV, DALLAS, TX. FILED
3-27-2007.

REVTRAN

THE MARK CONSISTS OF STANDARD CHARACTERS WITHOUT CLAIM TO ANY PARTICULAR FONT, STYLE, SIZE, OR COLOR.

OWNER OF UNITED KINGDOM REG. NO. 1500465,
DATED 5-13-1992, EXPIRES 5-13-2009.

FOR ANTIVIRAL AND ANTI-INFECTIVE PHARMACEUTICAL PREPARATIONS FOR THE TREATMENT OF HIV; ANTIBACTERIALS AND ANTIBIOTICS EXCLUDING THOSE USED FOR THE TREATMENT OF HEPATITIS (U.S. CLS. 6, 18, 44, 46, 51 AND 52).

THEODORE MCBRIDE, EXAMINING ATTORNEY

SUSTAIN BIOLOGICS

THE MARK CONSISTS OF STANDARD CHARACTERS WITHOUT CLAIM TO ANY PARTICULAR FONT, STYLE, SIZE, OR COLOR.

NO CLAIM IS MADE TO THE EXCLUSIVE RIGHT TO USE "BIOLOGICS", APART FROM THE MARK AS SHOWN.

FOR VITAMINS AND NUTRITIONAL AND DIETARY HEALTH SUPPLEMENTS (U.S. CLS. 6, 18, 44, 46, 51 AND 52).

JENNIFER MARTIN, EXAMINING ATTORNEY

CLASS 5—(Continued).

SN 77-141,293. BASILEA PHARMACEUTICA AG, BASEL, SWITZERLAND, FILED 3-27-2007.

BASILEA LABORATORIES

THE MARK CONSISTS OF STANDARD CHARACTERS WITHOUT CLAIM TO ANY PARTICULAR FONT, STYLE, SIZE, OR COLOR.

NO CLAIM IS MADE TO THE EXCLUSIVE RIGHT TO USE LABORATORIES, APART FROM THE MARK AS SHOWN.

FOR PHARMACEUTICAL AND VETERINARY PRODUCTS AND PREPARATIONS FOR THE TREATMENT OR PREVENTION OF DERMATOLOGICAL CONDITIONS, NAMELY, ECZEMA, INFLAMMATION, INFECTION, WARTS, PSORIASIS, AGING OF THE SKIN, ULTRA VIOLET RADIATION AND CANCER; FOR THE TREATMENT OF INFECTIONS CAUSED BY BACTERIA, FUNGI, VIRUSES, AND RHEUMATOID ARTHRITIS; FOR THE TREATMENT OF DISEASES, DISORDERS AND CONDITIONS IN THE AREA OF ONCOLOGY; AS WELL AS DIAGNOSTIC PREPARATIONS AND REAGENTS FOR CLINICAL OR MEDICAL LABORATORY USE (U.S. CLS. 6, 18, 44, 46, 51 AND 52).

CURTIS FRENCH, EXAMINING ATTORNEY

CLASS 5—(Continued).

SN 77-141,483. MANNKIND CORPORATION, VALENCIA, CA. FILED 3-27-2007.

WINZELA

SN 77-141,480. MANNKIND CORPORATION, VALENCIA, CA. FILED 3-27-2007.

VISPRESE

THE MARK CONSISTS OF STANDARD CHARACTERS WITHOUT CLAIM TO ANY PARTICULAR FONT, STYLE, SIZE, OR COLOR.

FOR PHARMACEUTICAL PREPARATIONS, NAMELY, PHARMACEUTICAL PREPARATIONS FOR THE TREATMENT OF ALLERGY, ALZHEIMER'S DISEASE, ASTHMA, AUTOIMMUNE DISEASES AND DISORDERS, CANCER, CARDIOVASCULAR DISEASES AND DISORDERS, CENTRAL NERVOUS SYSTEM AND NEUROLOGICAL DISEASES AND DISORDERS, DIABETES, ENDOCRINE DISEASES AND DISORDERS, ERECTILE AND SEXUAL DYSFUNCTION AND DISORDERS, GASTROINTESTINAL DISEASES AND DISORDERS, GYNECOLOGICAL AND FERTILITY DISEASES AND DISORDERS, HEMOLYTIC DISEASES AND DISORDERS, HORMONAL DISEASES AND DISORDERS, HYPERTENSION, INFECTIOUS DISEASES, IMMUNOLOGICAL, BACTERIAL, VIRAL AND FUNGAL DISEASES AND DISORDERS, INFLAMMATION AND INFLAMMATORY DISEASES AND DISORDERS, METABOLIC DISEASES AND DISORDERS, MIGRAINES, MUSCULOSKELETAL DISEASES AND DISORDERS, NEOPLASTIC DISEASES AND DISORDERS, OBESITY, OPHTHALMIC AND EYE DISEASES AND DISORDERS, OSTEOPOROSIS, PAIN, PARKINSON'S DISEASE, PSYCHIATRIC DISEASES AND DISORDERS, RESPIRATORY DISEASES AND DISORDERS, SMOKING AND SUBSTANCE ADDICTIONS AND RELATED DISEASES AND DISORDERS, STROKE, UROLOGICAL DISORDERS, WEIGHT AND APPETITE CONTROL (U.S. CLS. 6, 18, 44, 46, 51 AND 52).

STEVEN R. FOSTER, EXAMINING ATTORNEY

THE MARK CONSISTS OF STANDARD CHARACTERS WITHOUT CLAIM TO ANY PARTICULAR FONT, STYLE, SIZE, OR COLOR.

FOR PHARMACEUTICAL PREPARATIONS, NAMELY, PHARMACEUTICAL PREPARATIONS FOR THE TREATMENT OF ALLERGY, ALZHEIMER'S DISEASE, ASTHMA, AUTOIMMUNE DISEASES AND DISORDERS, CANCER, CARDIOVASCULAR DISEASES AND DISORDERS, CENTRAL NERVOUS SYSTEM AND NEUROLOGICAL DISEASES AND DISORDERS, DIABETES, ENDOCRINE DISEASES AND DISORDERS, ERECTILE AND SEXUAL DYSFUNCTION AND DISORDERS, GASTROINTESTINAL DISEASES AND DISORDERS, GYNECOLOGICAL AND FERTILITY DISEASES AND DISORDERS, HEMOLYTIC DISEASES AND DISORDERS, HORMONAL DISEASES AND DISORDERS, HYPERTENSION, INFECTIOUS DISEASES, IMMUNOLOGICAL, BACTERIAL, VIRAL AND FUNGAL DISEASES AND DISORDERS, INFLAMMATION AND INFLAMMATORY DISEASES AND DISORDERS, METABOLIC DISEASES AND DISORDERS, MIGRAINES, MUSCULOSKELETAL DISEASES AND DISORDERS, NEOPLASTIC DISEASES AND DISORDERS, OBESITY, OPHTHALMIC AND EYE DISEASES AND DISORDERS, OSTEOPOROSIS, PAIN, PARKINSON'S DISEASE, PSYCHIATRIC DISEASES AND DISORDERS, RESPIRATORY DISEASES AND DISORDERS, SMOKING AND SUBSTANCE ADDICTIONS AND RELATED DISEASES AND DISORDERS, STROKE, UROLOGICAL DISORDERS, WEIGHT AND APPETITE CONTROL (U.S. CLS. 6, 18, 44, 46, 51 AND 52).

STEVEN R. FOSTER, EXAMINING ATTORNEY

CLASS 5—(Continued).

SN 77-141,484. MANNKIND CORPORATION, VALENCIA, CA. FILED 3-27-2007.

CLASS 5—(Continued).

SN 77-141,485. MANNKIND CORPORATION, VALENCIA, CA. FILED 3-27-2007.

WYSIMBRA

ELSIMRA

THE MARK CONSISTS OF STANDARD CHARACTERS WITHOUT CLAIM TO ANY PARTICULAR FONT, STYLE, SIZE, OR COLOR.

FOR PHARMACEUTICAL PREPARATIONS, NAMELY, PHARMACEUTICAL PREPARATIONS FOR THE TREATMENT OF ALLERGY, ALZHEIMER'S DISEASE, ASTHMA, AUTOIMMUNE DISEASES AND DISORDERS, CANCER, CARDIOVASCULAR DISEASES AND DISORDERS, CENTRAL NERVOUS SYSTEM AND NEUROLOGICAL DISEASES AND DISORDERS, DIABETES, ENDOCRINE DISEASES AND DISORDERS, ERECTILE AND SEXUAL DYSFUNCTION AND DISORDERS, GASTROINTESTINAL DISEASES AND DISORDERS, GYNECOLOGICAL AND FERTILITY DISEASES AND DISORDERS, HEMOLYTIC DISEASES AND DISORDERS, HORMONAL DISEASES AND DISORDERS, HYPERTENSION, INFECTIOUS DISEASES, IMMUNOLOGICAL, BACTERIAL, VIRAL AND FUNGAL DISEASES AND DISORDERS, INFLAMMATION AND INFLAMMATORY DISEASES AND DISORDERS, METABOLIC DISEASES AND DISORDERS, MIGRAINES, MUSCULOSKELETAL DISEASES AND DISORDERS, NEOPLASTIC DISEASES AND DISORDERS, OBESITY, OPHTHALMIC AND EYE DISEASES AND DISORDERS, OSTEOPOROSIS, PAIN, PARKINSON'S DISEASE, PSYCHIATRIC DISEASES AND DISORDERS, RESPIRATORY DISEASES AND DISORDERS, SMOKING AND SUBSTANCE ADDICTIONS AND RELATED DISEASES AND DISORDERS, STROKE, UROLOGICAL DISORDERS, WEIGHT AND APPETITE CONTROL (U.S. CLS. 6, 18, 44, 46, 51 AND 52).

STEVEN R. FOSTER, EXAMINING ATTORNEY

THE MARK CONSISTS OF STANDARD CHARACTERS WITHOUT CLAIM TO ANY PARTICULAR FONT, STYLE, SIZE, OR COLOR.

FOR PHARMACEUTICAL PREPARATIONS, NAMELY, PHARMACEUTICAL PREPARATIONS FOR THE TREATMENT OF ALLERGY, ALZHEIMER'S DISEASE, ASTHMA, AUTOIMMUNE DISEASES AND DISORDERS, CANCER, CARDIOVASCULAR DISEASES AND DISORDERS, CENTRAL NERVOUS SYSTEM AND NEUROLOGICAL DISEASES AND DISORDERS, DIABETES, ENDOCRINE DISEASES AND DISORDERS, ERECTILE AND SEXUAL DYSFUNCTION AND DISORDERS, GASTROINTESTINAL DISEASES AND DISORDERS, GYNECOLOGICAL AND FERTILITY DISEASES AND DISORDERS, HEMOLYTIC DISEASES AND DISORDERS, HORMONAL DISEASES AND DISORDERS, HYPERTENSION, INFECTIOUS DISEASES, IMMUNOLOGICAL, BACTERIAL, VIRAL AND FUNGAL DISEASES AND DISORDERS, INFLAMMATION AND INFLAMMATORY DISEASES AND DISORDERS, METABOLIC DISEASES AND DISORDERS, MIGRAINES, MUSCULOSKELETAL DISEASES AND DISORDERS, NEOPLASTIC DISEASES AND DISORDERS, OBESITY, OPHTHALMIC AND EYE DISEASES AND DISORDERS, OSTEOPOROSIS, PAIN, PARKINSON'S DISEASE, PSYCHIATRIC DISEASES AND DISORDERS, RESPIRATORY DISEASES AND DISORDERS, SMOKING AND SUBSTANCE ADDICTIONS AND RELATED DISEASES AND DISORDERS, STROKE, UROLOGICAL DISORDERS, WEIGHT AND APPETITE CONTROL (U.S. CLS. 6, 18, 44, 46, 51 AND 52).

STEVEN R. FOSTER, EXAMINING ATTORNEY

CLASS 5—(Continued).

SN 77-141,491. MANNKIND CORPORATION, VALENCIA, CA. FILED 3-27-2007.

WINIVRIA

THE MARK CONSISTS OF STANDARD CHARACTERS WITHOUT CLAIM TO ANY PARTICULAR FONT, STYLE, SIZE, OR COLOR.

FOR PHARMACEUTICAL PREPARATIONS, NAMELY, PHARMACEUTICAL PREPARATIONS FOR THE TREATMENT OF ALLERGY, ALZHEIMER'S DISEASE, ASTHMA, AUTOIMMUNE DISEASES AND DISORDERS, CANCER, CARDIOVASCULAR DISEASES AND DISORDERS, CENTRAL NERVOUS SYSTEM AND NEUROLOGICAL DISEASES AND DISORDERS, DIABETES, ENDOCRINE DISEASES AND DISORDERS, ERECTILE AND SEXUAL DYSFUNCTION AND DISORDERS, GASTROINTESTINAL DISEASES AND DISORDERS, GYNECOLOGICAL AND FERTILITY DISEASES AND DISORDERS, HEMOLYTIC DISEASES AND DISORDERS, HORMONAL DISEASES AND DISORDERS, HYPERTENSION, INFECTIOUS DISEASES, IMMUNOLOGICAL, BACTERIAL, VIRAL AND FUNGAL DISEASES AND DISORDERS, INFLAMMATION AND INFLAMMATORY DISEASES AND DISORDERS, METABOLIC DISEASES AND DISORDERS, MIGRAINES, MUSCULOSKELETAL DISEASES AND DISORDERS, NEOPLASTIC DISEASES AND DISORDERS, OBESITY, OPHTHALMIC AND EYE DISEASES AND DISORDERS, OSTEOPOROSIS, PAIN, PARKINSON'S DISEASE, PSYCHIATRIC DISEASES AND DISORDERS, RESPIRATORY DISEASES AND DISORDERS, SMOKING AND SUBSTANCE ADDICTIONS AND RELATED DISEASES AND DISORDERS, STROKE, UROLOGICAL DISORDERS, WEIGHT AND APPETITE CONTROL (U.S. CLS. 6, 18, 44, 46, 51 AND 52).

STEVEN R. FOSTER, EXAMINING ATTORNEY

SN 77-141,589. NEXGEN PHARMA, INC., IRVINE, CA. FILED 3-27-2007.

MAXIMUM ORGANICS

THE MARK CONSISTS OF STANDARD CHARACTERS WITHOUT CLAIM TO ANY PARTICULAR FONT, STYLE, SIZE, OR COLOR.

NO CLAIM IS MADE TO THE EXCLUSIVE RIGHT TO USE "ORGANICS", APART FROM THE MARK AS SHOWN. FOR DIETARY AND NUTRITIONAL SUPPLEMENTS (U.S. CLS. 6, 18, 44, 46, 51 AND 52).

C. DIONNE CLYBURN, EXAMINING ATTORNEY

CLASS 5—(Continued).

SN 77-145,962. WEISER GROUP LLC, EVANS CITY, PA. FILED 4-2-2007.

NATURE'S DEFENSE

THE MARK CONSISTS OF STANDARD CHARACTERS WITHOUT CLAIM TO ANY PARTICULAR FONT, STYLE, SIZE, OR COLOR.

FOR ANIMAL REPELLANTS, NAMELY, REPELLANTS FOR DETERRING DEER AND SIMILAR WOODLAND ANIMALS FROM DAMAGING LANDSCAPING AND GARDENS, NOT INCLUDING INSECT REPELLANTS OR INSECTICIDES (U.S. CLS. 6, 18, 44, 46, 51 AND 52).

LAURA HAMMEL, EXAMINING ATTORNEY

SN 77-149,355. XANODYNE PHARMACEUTICALS, INC., NEWPORT, KY. FILED 4-5-2007.

DUETDHA EC

THE MARK CONSISTS OF STANDARD CHARACTERS WITHOUT CLAIM TO ANY PARTICULAR FONT, STYLE, SIZE, OR COLOR.

OWNER OF U.S. REG. NO. 2,754,166. NO CLAIM IS MADE TO THE EXCLUSIVE RIGHT TO USE "EC", APART FROM THE MARK AS SHOWN. FOR VITAMINS, MINERALS AND NUTRITIONAL SUPPLEMENTS (U.S. CLS. 6, 18, 44, 46, 51 AND 52). FIRST USE 10-22-2006; IN COMMERCE 10-22-2006. BRIAN PINO, EXAMINING ATTORNEY

SN 77-149,616. PROFESSIONAL DISPOSABLES INTERNATIONAL, INC., ORANGEBURG, NY. FILED 4-5-2007.

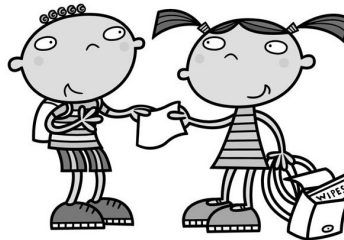

NO CLAIM IS MADE TO THE EXCLUSIVE RIGHT TO USE "WIPES", APART FROM THE MARK AS SHOWN.

THE MARK CONSISTS OF A BOY AND GIRL. FOR ANTISEPTIC PRE-MOISTENED TOWELETTES (U.S. CLS. 6, 18, 44, 46, 51 AND 52). FIRST USE 1-1-2007; IN COMMERCE 1-1-2007. YAT SYE, LEE, EXAMINING ATTORNEY

CLASS 5—(Continued).

SN 77-149,722. CAPSULINE, INC., POMPANO BEACH, FL. FILED 4-5-2007.



NO CLAIM IS MADE TO THE EXCLUSIVE RIGHT TO USE "PETVITAMINS.COM" AND "PET COMPANY", APART FROM THE MARK AS SHOWN.

THE COLOR(S) LIGHT BLUE AND DARK BLUE, YELLOW AND TAN, RED, WHITE AND BLACK AND GRAY IS/ARE CLAIMED AS A FEATURE OF THE MARK.

THE MARK CONSISTS OF THE COLOR LIGHT BLUE APPEARS IN THE DESIGN OF THE CAT, THE COLOR DARK BLUE APPEARS ON THE LEFT SIDE OF THE CAT, THE COLOR YELLOW APPEARS ON THE DESIGN OF THE DOG, THE COLOR TAN APPEARS ON THE LEFT SIDE AND THE CIRCLE AROUND THE EYE OF THE DOG, THE COLOR RED APPEARS IN THE LABEL, THE COLOR WHITE APPEARS IN THE WORDING "PETVITAMINS.COM THE HAPPY HEALTHY PET COMPANY", THE COLOR BLACK APPEARS IN THE OUTLINES AROUND THE DESIGNS AND THE LABEL, AND THE COLOR GRAY APPEARS IN THE CIRCLE AROUND THE EYE OF THE CAT.

FOR VITAMIN AND MINERAL SUPPLEMENTS; FEED SUPPLEMENTS FOR PETS; UNIT DOSE CAPSULES SOLD EMPTY FOR PHARMACEUTICAL USE (U.S. CLS. 6, 18, 44, 46, 51 AND 52).

TASNEEM HUSSAIN, EXAMINING ATTORNEY

SN 77-150,970. BLUE CALIFORNIA, RANCHO SANTA MARGARITA, CA. FILED 4-6-2007.



NO CLAIM IS MADE TO THE EXCLUSIVE RIGHT TO USE "PANAX PROCYMIDONE FREE", APART FROM THE MARK AS SHOWN.

THE COLOR(S) ORANGE, WHITE, AND GREEN IS/ARE CLAIMED AS A FEATURE OF THE MARK.

THE WORD "PANAX" IS IN ORANGE, WHILE THE WORD "BLUE" IS PLACED ON A GREEN LEAF AND IN WHITE LETTERING. THE WORDS "PROCYMIDONE FREE" ARE IN GREEN.

FOR NUTRITIONAL SUPPLEMENTS (U.S. CLS. 6, 18, 44, 46, 51 AND 52).

KAPIL BHANOT, EXAMINING ATTORNEY

CLASS 5—(Continued).

SN 77-155,938. AVICENA GROUP, INC., PALO ALTO, CA. FILED 4-13-2007.

AVICENA

THE MARK CONSISTS OF STANDARD CHARACTERS WITHOUT CLAIM TO ANY PARTICULAR FONT, STYLE, SIZE, OR COLOR.

OWNER OF U.S. REG. NO. 2,856,215.
FOR PHARMACEUTICAL PREPARATIONS FOR THE TREATMENT OF NEUROLOGICAL AND NEUROMUSCULAR DISORDERS (U.S. CLS. 6, 18, 44, 46, 51 AND 52).
LOURDES AYALA, EXAMINING ATTORNEY

SN 77-155,966. AVICENA GROUP, INC., PALO ALTO, CA. FILED 4-13-2007.



OWNER OF U.S. REG. NO. 2,856,215.
THE COLOR(S) GOLD AND LIGHT BLUE IS/ARE CLAIMED AS A FEATURE OF THE MARK.

THE MARK CONSISTS OF THE WORD "AVICENA" IN A STYLIZED SCRIPT, WITH A GOLD CAPITAL LETTER "A", SUCH A CONTAINING A GOLD CURVED LINE THAT THINS FROM LEFT TO RIGHT, SUCH GOLD CURVE CONTINUING OVER THE LOWER CASE LIGHT BLUE LETTERS "VICENA".

FOR PHARMACEUTICAL PREPARATIONS FOR THE TREATMENT OF NEUROLOGICAL AND NEUROMUSCULAR DISORDERS (U.S. CLS. 6, 18, 44, 46, 51 AND 52).
LOURDES AYALA, EXAMINING ATTORNEY

SN 77-159,330. FORTRESS SYSTEMS LLC, OMAHA, NE. FILED 4-18-2007.

WHEY 100

THE MARK CONSISTS OF STANDARD CHARACTERS WITHOUT CLAIM TO ANY PARTICULAR FONT, STYLE, SIZE, OR COLOR.

NO CLAIM IS MADE TO THE EXCLUSIVE RIGHT TO USE "WHEY", APART FROM THE MARK AS SHOWN.

FOR DIETARY SUPPLEMENT, NAMELY, POWDERED PROTEIN MADE IN PART OF WHEY PROTEIN FOR USE AS A NUTRITIONAL INGREDIENT IN VARIOUS POWDERED AND READY-TO-DRINK BEVERAGES (U.S. CLS. 6, 18, 44, 46, 51 AND 52).

FIRST USE 11-1-2006; IN COMMERCE 11-1-2006.
TOBY BULLOFF, EXAMINING ATTORNEY

CLASS 5—(Continued).

SN 77-162,929. TOTAL NUTRACEUTICAL TECHNOLOGIES INC., LAS VEGAS, NV. FILED 4-23-2007.

Arthrogenex

THE MARK CONSISTS OF STANDARD CHARACTERS WITHOUT CLAIM TO ANY PARTICULAR FONT, STYLE, SIZE, OR COLOR.

FOR DIETARY AND NUTRITIONAL SUPPLEMENTS (U.S. CLS. 6, 18, 44, 46, 51 AND 52).
ELLEN B. AWRICH, EXAMINING ATTORNEY

SN 77-164,521. ELAN CORPORATION, PLC., DUBLIN 2, IRELAND, FILED 4-24-2007.

PHARMAZOME

THE MARK CONSISTS OF STANDARD CHARACTERS WITHOUT CLAIM TO ANY PARTICULAR FONT, STYLE, SIZE, OR COLOR.

FOR DRUG DELIVERY AGENTS CONSISTING OF CONTROLLED RELEASE MICROPARTICLES IN POWDERED FORM FOR THE CONTINUOUS CONTROLLED RELEASE OF THERAPEUTIC AGENTS USED AS AN INGREDIENT OF PHARMACEUTICAL AND VETERINARY PREPARATIONS (U.S. CLS. 6, 18, 44, 46, 51 AND 52).
DAVID MURRAY, EXAMINING ATTORNEY

SN 77-165,660. BLUE CALIFORNIA, RANCHO SANTA MARGARITA, CA. FILED 4-25-2007.

VitaDHA

THE MARK CONSISTS OF STANDARD CHARACTERS WITHOUT CLAIM TO ANY PARTICULAR FONT, STYLE, SIZE, OR COLOR.

FOR NUTRITIONAL SUPPLEMENTS (U.S. CLS. 6, 18, 44, 46, 51 AND 52).
KAPIL BHANOT, EXAMINING ATTORNEY

CLASS 5—(Continued).

SN 77-166,613. NATUROPATHIC ALTERNATIVES LLC, CHANDLER, AZ. FILED 4-26-2007.

Naturopathic Alternatives

THE MARK CONSISTS OF STANDARD CHARACTERS WITHOUT CLAIM TO ANY PARTICULAR FONT, STYLE, SIZE, OR COLOR.

NO CLAIM IS MADE TO THE EXCLUSIVE RIGHT TO USE "NATUROPATHIC", APART FROM THE MARK AS SHOWN.

FOR HOMEOPATHIC PHARMACEUTICALS FOR USE IN THE TREATMENT OF A WIDE VARIETY OF EVERYDAY AILMENTS, NAMELY, COLIC, COUGH, COLDS, DIARRHEA CONSTIPATION, GAS, ASTHMA, ECZEMA, EARACHE, TEETHING, TOENAIL FUNGUS, ANXIETY, ATTENTION DEFICIT DISORDER, DEPRESSION, WEIGHT LOSS, MENOPAUSE, STRESS, INSOMNIA, CONJUNCTIVITIS, ALLERGIES, PAIN, ARTHRITIS, BACKACHE, FEVER, FATIGUE, HEADACHE, MIGRAINE, INDIGESTION, PREMENSTRUAL SYNDROME, RESTLESSNESS, SINUSITIS, SORE THROAT AND WATER RETENTION, IN INFANTS, CHILDREN AND ADULTS; HOMEOPATHIC SUPPLEMENTS (U.S. CLS. 6, 18, 44, 46, 51 AND 52).
BRIAN CALLAGHAN, EXAMINING ATTORNEY

SN 77-174,994. STEIN, DANIEL S., TAMPA, FL. FILED 5-7-2007.

LIBIDINOL

THE MARK CONSISTS OF STANDARD CHARACTERS WITHOUT CLAIM TO ANY PARTICULAR FONT, STYLE, SIZE, OR COLOR.

FOR NUTRITIONAL SUPPLEMENTS FOR FEMALE SEXUAL ENHANCEMENT (U.S. CLS. 6, 18, 44, 46, 51 AND 52).
AISHA SALEM, EXAMINING ATTORNEY

SN 77-177,697. PROLAB NUTRITION, INC., CHATSWORTH, CA. FILED 5-10-2007.

BETA ALANINE EXTREME

THE MARK CONSISTS OF STANDARD CHARACTERS WITHOUT CLAIM TO ANY PARTICULAR FONT, STYLE, SIZE, OR COLOR.

NO CLAIM IS MADE TO THE EXCLUSIVE RIGHT TO USE "BETA ALANINE", APART FROM THE MARK AS SHOWN.

FOR DIETARY SUPPLEMENTS (U.S. CLS. 6, 18, 44, 46, 51 AND 52).
TEJBIR SINGH, EXAMINING ATTORNEY

CLASS 5—(Continued).

SN 77-179,422. SICAP INDUSTRIES, LLC, GUILDERLAND, NY. FILED 5-11-2007.

Sinus Genie

THE MARK CONSISTS OF STANDARD CHARACTERS WITHOUT CLAIM TO ANY PARTICULAR FONT, STYLE, SIZE, OR COLOR.
OWNER OF U.S. REG. NOS. 2,934,888 AND 3,194,160.
NO CLAIM IS MADE TO THE EXCLUSIVE RIGHT TO USE "SINUS", APART FROM THE MARK AS SHOWN.
FOR NASAL SPRAY PREPARATIONS (U.S. CLS. 6, 18, 44, 46, 51 AND 52).
TASNEEM HUSSAIN, EXAMINING ATTORNEY

SN 77-180,762. COMPOUND SOLUTIONS, INC., ESCONDI-DO, CA. FILED 5-14-2007.

Relax & Restore

THE MARK CONSISTS OF STANDARD CHARACTERS WITHOUT CLAIM TO ANY PARTICULAR FONT, STYLE, SIZE, OR COLOR.
NO CLAIM IS MADE TO THE EXCLUSIVE RIGHT TO USE "RELAX", APART FROM THE MARK AS SHOWN.
FOR FUNCTIONAL BEVERAGE, NAMELY, A READY TO DRINK NUTRITIONAL SUPPLEMENT AND A POWDERED NUTRITIONAL SUPPLEMENT DRINK MIX, TO PROMOTE FEELINGS OF WELL BEING (U.S. CLS. 6, 18, 44, 46, 51 AND 52).
JULIE WATSON, EXAMINING ATTORNEY

SN 77-195,153. NOVARTIS AG, BASEL, SWITZERLAND, FILED 6-1-2007.

COOLING BEADS

THE MARK CONSISTS OF STANDARD CHARACTERS WITHOUT CLAIM TO ANY PARTICULAR FONT, STYLE, SIZE, OR COLOR.
FOR COUGH TREATMENT PREPARATIONS; PREPARATIONS FOR TREATING COLDS; ALLERGY RELIEF MEDICATION (U.S. CLS. 6, 18, 44, 46, 51 AND 52).
JANICE KIM, EXAMINING ATTORNEY

CLASS 5—(Continued).

SN 77-195,164. NOVARTIS AG, BASEL, SWITZERLAND, FILED 6-1-2007.

THERAFLU COOLING BEADS

THE MARK CONSISTS OF STANDARD CHARACTERS WITHOUT CLAIM TO ANY PARTICULAR FONT, STYLE, SIZE, OR COLOR.
FOR COUGH TREATMENT PREPARATIONS; PREPARATIONS FOR TREATING COLDS; ALLERGY RELIEF MEDICATION (U.S. CLS. 6, 18, 44, 46, 51 AND 52).
JANICE KIM, EXAMINING ATTORNEY

SN 77-200,954. SUPPLEMENT INNOVATIONS, LLC, FARGO, ND. FILED 6-7-2007.

Catalyte

THE MARK CONSISTS OF STANDARD CHARACTERS WITHOUT CLAIM TO ANY PARTICULAR FONT, STYLE, SIZE, OR COLOR.
FOR DIETARY SUPPLEMENTS FOR HUMAN CONSUMPTION; MEAL REPLACEMENT AND DIETARY SUPPLEMENT DRINK MIXES; NUTRACEUTICALS FOR USE AS A DIETARY SUPPLEMENT; SOY PROTEIN FOR USE AS A NUTRITIONAL INGREDIENT IN VARIOUS POWDERED AND READY-TO-DRINK BEVERAGES (U.S. CLS. 6, 18, 44, 46, 51 AND 52).
JERI J. FICKES, EXAMINING ATTORNEY

SN 77-204,792. AMATO, TERI, FLORAL PARK, NY. FILED 6-13-2007.

LOVRUB

THE MARK CONSISTS OF STANDARD CHARACTERS WITHOUT CLAIM TO ANY PARTICULAR FONT, STYLE, SIZE, OR COLOR.
FOR NATURAL TOPICAL FORMULATION FOR SEXUAL ENHANCEMENT, NAMELY, WATER-BASED PERSONAL LUBRICANT (U.S. CLS. 6, 18, 44, 46, 51 AND 52).
JENNIFER MARTIN, EXAMINING ATTORNEY

CLASS 5—(Continued).

SN 77-215,065. ALAVEN PHARMACEUTICAL LLC, MARIETTA, GA. FILED 6-25-2007.



THE MARK CONSISTS OF THE LITERAL ELEMENT "PREFERAOB", IN WHICH THE LETTER "O", OF THE "OB" LETTER PORTION OF THE MARK, ENCIRCLES THE LETTER "A" OF THE MARK.

FOR PHARMACEUTICALS, NAMELY, PRE-NATAL VITAMINS WITH IRON (U.S. CLS. 6, 18, 44, 46, 51 AND 52).

FIRST USE 3-20-2007; IN COMMERCE 5-6-2007.
KATHERINE M. DUBRAY, EXAMINING ATTORNEY

SN 77-217,950. IROKO PHARMACEUTICALS, LLC, PHILADELPHIA, PA. FILED 6-28-2007.



NO CLAIM IS MADE TO THE EXCLUSIVE RIGHT TO USE "PHARMACEUTICALS LLC", APART FROM THE MARK AS SHOWN.

THE MARK CONSISTS OF A STYLIZED CIRCULAR DESIGN AND THE WORDS IROKO PHARMACEUTICALS LLC.

FOR A FULL LINE OF PHARMACEUTICAL PREPARATIONS (U.S. CLS. 6, 18, 44, 46, 51 AND 52).
RAMONA ORTIGA, EXAMINING ATTORNEY

SN 77-218,879. NUTRITION & FITNESS, INC., FAYETTEVILLE, NC. FILED 6-29-2007.

ALLER-G-FREE

THE MARK CONSISTS OF STANDARD CHARACTERS WITHOUT CLAIM TO ANY PARTICULAR FONT, STYLE, SIZE, OR COLOR.

FOR NATURAL DIETARY SUPPLEMENT FOR ALLERGY RELIEF (U.S. CLS. 6, 18, 44, 46, 51 AND 52).
DARRYL SPRUILL, EXAMINING ATTORNEY

CLASS 5—(Continued).

SN 77-221,081. TED'S TINCTURES, INC., MOUNTAIN VIEW, CA. FILED 7-3-2007.



THE COLOR(S) BLUE AND ORANGE IS/ARE CLAIMED AS A FEATURE OF THE MARK.

THE MARK CONSISTS OF THE COLOR BLUE IN THE WORDS "FLY" AND "RIGHT" AND THE COLOR ORANGE IN THE AIRPLANE. THE "F" IN THE WORD "FLY" ALSO CONTAINS THE CONDENSATION TRAIL OF THE ORANGE AIRPLANE.

FOR MEDICINAL HERB EXTRACTS (U.S. CLS. 6, 18, 44, 46, 51 AND 52).

FIRST USE 6-5-2007; IN COMMERCE 6-5-2007.
RICHARD A. STRASER, EXAMINING ATTORNEY

SN 77-221,617. ASKLEPION PHARMACEUTICALS, LLC, BRENTWOOD, TN. FILED 7-3-2007.

XEBAM

THE MARK CONSISTS OF STANDARD CHARACTERS WITHOUT CLAIM TO ANY PARTICULAR FONT, STYLE, SIZE, OR COLOR.

FOR CHOLIC ACID FOR THE TREATMENT OF CHILDREN WITH INBORN DEFECTS IN BILE ACID SYNTHESIS (U.S. CLS. 6, 18, 44, 46, 51 AND 52).

MICHAEL LITZAU, EXAMINING ATTORNEY

SN 77-226,706. PAMLAB, L.L.C., COVINGTON, LA. FILED 7-11-2007.

ZERLOR

THE MARK CONSISTS OF STANDARD CHARACTERS WITHOUT CLAIM TO ANY PARTICULAR FONT, STYLE, SIZE, OR COLOR.

"ZERLOR" HAS NO SIGNIFICANCE IN THE RELEVANT TRADE OR INDUSTRY OR AS APPLIED TO THE GOODS, OR ANY MEANING IN A FOREIGN LANGUAGE.

FOR ANALGESIC USED FOR MILD TO MODERATE PAIN (U.S. CLS. 6, 18, 44, 46, 51 AND 52).

FIRST USE 5-31-2006; IN COMMERCE 5-31-2006.
LINDA E. BLOHM, EXAMINING ATTORNEY

CLASS 5—(Continued).

SN 77-227,189. SHANKER, RANDALL P., OKEMOS, MI.
FILED 7-11-2007.

IV ENERGY

THE MARK CONSISTS OF STANDARD CHARACTERS WITHOUT CLAIM TO ANY PARTICULAR FONT, STYLE, SIZE, OR COLOR.

FOR NON-ALCOHOLIC BEVERAGES IN THE NATURE OF VITAMIN AND MINERAL FORTIFIED WATERS (U.S. CLS. 6, 18, 44, 46, 51 AND 52).
ERIN FALK, EXAMINING ATTORNEY

CLASS 5—(Continued).

SN 77-242,886. SNOASIS MEDICAL, INC., DENVER, CO.
FILED 7-31-2007.

RENU

THE MARK CONSISTS OF STANDARD CHARACTERS WITHOUT CLAIM TO ANY PARTICULAR FONT, STYLE, SIZE, OR COLOR.

FOR BIOLOGICAL TISSUE FOR MEDICAL USE, NAMELY, TISSUES AND CELLS FOUND IN UMBILICAL CORD, PLACENTA, AMNIOTIC SAC AND AMNIOTIC FLUID, FOR DENTAL AND ORAL MAXILLOFACIAL APPLICATIONS, BONE GRAFTING, GUIDED TISSUE REGENERATION AND RELATED TISSUE REGENERATION PROCEDURES (U.S. CLS. 6, 18, 44, 46, 51 AND 52).
G. MAYERSCHOFF, EXAMINING ATTORNEY

SN 77-252,334. ARIZONA PHARMACEUTICALS, LLC,
PHOENIX, AZ. FILED 8-10-2007.

SN 77-233,396. RUNA ESSENTIALS, LLC, HOLMDEL, NJ.
FILED 7-19-2007.



NO CLAIM IS MADE TO THE EXCLUSIVE RIGHT TO USE "ESSENTIALS", APART FROM THE MARK AS SHOWN.

THE MARK CONSISTS OF A DESIGN OF A BUTTERFLY WITH A WOMAN AS THE BUTTERFLY'S BODY, SURROUNDED BY A SPIRAL. THE WORDS "RUNA ESSENTIALS" ARE BELOW THE DESIGN.

THE ENGLISH TRANSLATION OF THE WORD "RUNA" IN THE MARK IS "RUNE".

FOR HEALTH AND BEAUTY POST-COSMETIC SURGERY RECOVERY PRODUCTS, NAMELY, ADHESIVE BANDAGES, GAUZE, AND MEDICAL ADHESIVE TAPE (U.S. CLS. 6, 18, 44, 46, 51 AND 52).

FIRST USE 6-21-2007; IN COMMERCE 6-21-2007.
JAMES GRIFFIN, EXAMINING ATTORNEY

DONORMYL

THE MARK CONSISTS OF STANDARD CHARACTERS WITHOUT CLAIM TO ANY PARTICULAR FONT, STYLE, SIZE, OR COLOR.

FOR SLEEPING PILLS/TABLETS (U.S. CLS. 6, 18, 44, 46, 51 AND 52).

FIRST USE 6-1-2007; IN COMMERCE 6-1-2007.

MARY CRAWFORD, EXAMINING ATTORNEY

SN 77-258,145. GLOBAL BIOTECHNOLOGIES, INC., PORTLAND, ME. FILED 8-17-2007.

FRESH N' CLEAN

THE MARK CONSISTS OF STANDARD CHARACTERS WITHOUT CLAIM TO ANY PARTICULAR FONT, STYLE, SIZE, OR COLOR.

FOR WASH AID FOR THE REMOVAL OF CONTAMINANTS FROM FRUITS, VEGETABLES, MEATS, POULTRY AND FISH DURING COMMERCIAL AND HOME FOOD PROCESSING, NAMELY, DISINFECTANTS FOR HYGIENIC PURPOSES (U.S. CLS. 6, 18, 44, 46, 51 AND 52).

FIRST USE 3-15-1997; IN COMMERCE 3-15-1997.

AHSEN KHAN, EXAMINING ATTORNEY

CLASS 5—(Continued).

SN 77-260,080. ROSARIO ARREDONDO-KIDD, DBA FREEDOM FORMULAS LLC, SCOTTSDALE, AZ. AND R. PAUL KIDD, DBA FREEDOM FORMULAS LLC, SCOTTSDALE, AZ. FILED S.R. 8-20-2007; AM. P.R. 2-11-2008.



THE COLOR(S) CHROME, MAROON AND BLACK IS/ARE CLAIMED AS A FEATURE OF THE MARK.

THE MARK CONSISTS OF A CHROME SHIELD DESIGN, THE SHIELD IS OUTLINED IN BLACK AND HAS TWO 'F'S IN MAROON, WITH ONE 'F' MIRRORING THE OTHER 'F'.

FOR DIET CAPSULES; DIET PILLS; DIETARY AND NUTRITIONAL SUPPLEMENTS; DIETARY FOOD SUPPLEMENTS; DIETARY SUPPLEMENTAL DRINKS; DIETARY SUPPLEMENTS; DIETARY SUPPLEMENTS FOR HUMAN CONSUMPTION; GROUND FLAX SEED FIBER FOR USE AS A DIETARY SUPPLEMENT; HERBAL SUPPLEMENTS; MEAL REPLACEMENT AND DIETARY SUPPLEMENT DRINK MIXES; MINERAL NUTRITIONAL SUPPLEMENTS; MINERAL SUPPLEMENTS; NUTRACEUTICALS FOR USE AS A DIETARY SUPPLEMENT; NUTRITIONAL SUPPLEMENTS; POWDERED FRUIT-FLAVORED DIETARY SUPPLEMENT DRINK MIX; POWDERED NUTRITIONAL SUPPLEMENT DRINK MIX; VITAMIN AND MINERAL SUPPLEMENTS; VITAMIN SUPPLEMENT IN TABLET FORM FOR USE IN MAKING AN EFFERVESCENT BEVERAGE WHEN ADDED TO WATER; VITAMIN SUPPLEMENTS (U.S. CLS. 6, 18, 44, 46, 51 AND 52).

FIRST USE 10-12-2006; IN COMMERCE 10-12-2006.
DANIEL CAPSHAW, EXAMINING ATTORNEY

CLASS 5—(Continued).

SN 77-270,104. ECLIPSE PHARMACEUTICALS INC., FAR HILLS, NJ. FILED 9-1-2007.

VIZTAC

THE MARK CONSISTS OF STANDARD CHARACTERS WITHOUT CLAIM TO ANY PARTICULAR FONT, STYLE, SIZE, OR COLOR.

THE TERM "VIZTAC" HAS NO MEANING IN A FOREIGN LANGUAGE.

FOR DRUG DELIVERY AGENTS CONSISTING OF COMPOUNDS THAT FACILITATE DELIVERY OF A WIDE RANGE OF PHARMACEUTICALS; PHARMACEUTICAL PREPARATIONS FOR THE PREVENTION AND TREATMENT OF DISORDERS OF THE NERVOUS SYSTEM, THE IMMUNE SYSTEM, THE CARDIO-VASCULAR SYSTEM, THE METABOLIC SYSTEM, THE RESPIRATORY SYSTEM, THE MUSCULO-SKELETAL SYSTEM, THE GENITOURINARY SYSTEM; FOR THE TREATMENT OF INFLAMMATORY DISORDERS; FOR USE IN DERMATOLOGY, ONCOLOGY, HEMATOLOGY AND IN TISSUE AND ORGAN TRANSPLANTATION, IN OPHTHALMOLOGY AND FOR GASTROENTEROLOGICAL DISORDERS; MIXED VITAMIN PREPARATIONS; VITAMIN B PREPARATIONS; VITAMIN C PREPARATIONS; VITAMIN AND MINERAL PREPARATIONS FOR MEDICAL USE; VITAMIN AND MINERAL PREPARATIONS FOR USE AS INGREDIENTS IN THE FOOD AND PHARMACEUTICAL INDUSTRY; VITAMIN PREPARATIONS; VITAMINS (U.S. CLS. 6, 18, 44, 46, 51 AND 52).

ROBERT C. CLARK JR., EXAMINING ATTORNEY

SN 77-271,180. TEVA SPECIALTY PHARMACEUTICALS LLC, HORSHAM, PA. FILED 9-4-2007.

PROUD TO BE CFC FREE.

THE MARK CONSISTS OF STANDARD CHARACTERS WITHOUT CLAIM TO ANY PARTICULAR FONT, STYLE, SIZE, OR COLOR.

NO CLAIM IS MADE TO THE EXCLUSIVE RIGHT TO USE "CFC", APART FROM THE MARK AS SHOWN.

FOR INHALERS FILLED WITH PHARMACEUTICAL PREPARATIONS FOR THE TREATMENT OF RESPIRATORY DISEASE (U.S. CLS. 6, 18, 44, 46, 51 AND 52).

ANDREW RHIM, EXAMINING ATTORNEY

SN 77-271,190. TEVA SPECIALTY PHARMACEUTICALS LLC, HORSHAM, PA. FILED 9-4-2007.

PROUD TO BE FREE.

THE MARK CONSISTS OF STANDARD CHARACTERS WITHOUT CLAIM TO ANY PARTICULAR FONT, STYLE, SIZE, OR COLOR.

FOR INHALERS FILLED WITH PHARMACEUTICAL PREPARATIONS FOR THE TREATMENT OF RESPIRATORY DISEASE (U.S. CLS. 6, 18, 44, 46, 51 AND 52).

ANDREW RHIM, EXAMINING ATTORNEY

CLASS 5—(Continued).

SN 77-271,191. TEVA SPECIALTY PHARMACEUTICALS LLC, HORSHAM, PA. FILED 9-4-2007.

WE'RE THERE EVERY BREATH OF THE WAY.

THE MARK CONSISTS OF STANDARD CHARACTERS WITHOUT CLAIM TO ANY PARTICULAR FONT, STYLE, SIZE, OR COLOR.

FOR INHALERS FILLED WITH PHARMACEUTICAL PREPARATIONS FOR THE TREATMENT OF RESPIRATORY DISEASE (U.S. CLS. 6, 18, 44, 46, 51 AND 52).

ANDREW RHIM, EXAMINING ATTORNEY



SN 77-271,196. TEVA SPECIALTY PHARMACEUTICALS LLC, HORSHAM, PA. FILED 9-4-2007.

GO THE DISTANCE

THE MARK CONSISTS OF STANDARD CHARACTERS WITHOUT CLAIM TO ANY PARTICULAR FONT, STYLE, SIZE, OR COLOR.

FOR INHALERS FILLED WITH PHARMACEUTICAL PREPARATIONS FOR THE TREATMENT OF RESPIRATORY DISEASE (U.S. CLS. 6, 18, 44, 46, 51 AND 52).

ANDREW RHIM, EXAMINING ATTORNEY



SN 77-271,201. TEVA SPECIALTY PHARMACEUTICALS LLC, HORSHAM, PA. FILED 9-4-2007.

RELIEF YOU CAN TRUST

THE MARK CONSISTS OF STANDARD CHARACTERS WITHOUT CLAIM TO ANY PARTICULAR FONT, STYLE, SIZE, OR COLOR.

FOR INHALERS FILLED WITH PHARMACEUTICAL PREPARATIONS FOR THE TREATMENT OF RESPIRATORY DISEASE (U.S. CLS. 6, 18, 44, 46, 51 AND 52).

ANDREW RHIM, EXAMINING ATTORNEY



SN 77-271,206. TEVA SPECIALTY PHARMACEUTICALS LLC, HORSHAM, PA. FILED 9-4-2007.

WHEN LIFE TAKES YOUR BREATH AWAY

THE MARK CONSISTS OF STANDARD CHARACTERS WITHOUT CLAIM TO ANY PARTICULAR FONT, STYLE, SIZE, OR COLOR.

FOR INHALERS FILLED WITH PHARMACEUTICAL PREPARATIONS FOR THE TREATMENT OF RESPIRATORY DISEASE (U.S. CLS. 6, 18, 44, 46, 51 AND 52).

ANDREW RHIM, EXAMINING ATTORNEY

CLASS 5—(Continued).

SN 77-272,121. HEALTHY DIRECTIONS, LLC, POTOMAC, MD. FILED 9-5-2007.

Q10 ANSWER

THE MARK CONSISTS OF STANDARD CHARACTERS WITHOUT CLAIM TO ANY PARTICULAR FONT, STYLE, SIZE, OR COLOR.

NO CLAIM IS MADE TO THE EXCLUSIVE RIGHT TO USE "Q10". APART FROM THE MARK AS SHOWN.

FOR VITAMINS AND NUTRITIONAL SUPPLEMENTS (U.S. CLS. 6, 18, 44, 46, 51 AND 52).

ELI HELLMAN, EXAMINING ATTORNEY



SN 77-272,214. UNIVERSAL PROTEIN SUPPLEMENTS CORPORATION DBA UNIVERSAL NUTRITION, INC., NEW BRUNSWICK, NJ. FILED 9-5-2007.

ANIMAL

THE MARK CONSISTS OF STANDARD CHARACTERS WITHOUT CLAIM TO ANY PARTICULAR FONT, STYLE, SIZE, OR COLOR.

OWNER OF U.S. REG. NOS. 2,437,306, 2,784,232 AND OTHERS.

FOR NUTRITIONAL SUPPLEMENTS FOR HUMAN CONSUMPTION (U.S. CLS. 6, 18, 44, 46, 51 AND 52).

FIRST USE 0-0-1983; IN COMMERCE 0-0-1983.

EMILY CARLSEN, EXAMINING ATTORNEY



SN 77-273,076. OLSON, MARK, VISTA, CA. FILED 9-6-2007.

MRM

THE MARK CONSISTS OF STANDARD CHARACTERS WITHOUT CLAIM TO ANY PARTICULAR FONT, STYLE, SIZE, OR COLOR.

FOR DIETARY FOOD SUPPLEMENTS; NUTRITIONAL SUPPLEMENTS (U.S. CLS. 6, 18, 44, 46, 51 AND 52).

FIRST USE 4-1-1996; IN COMMERCE 4-1-1996.

JAY FLOWERS, EXAMINING ATTORNEY

CLASS 5—(Continued).

SN 77-273,538. LONGEVITY & HEALTH, INC., ROAD TOWN, TORTOLA, BR.VIRGIN ISLANDS, FILED 9-6-2007.

HEALTH BREAKTHROUGHS

THE MARK CONSISTS OF STANDARD CHARACTERS WITHOUT CLAIM TO ANY PARTICULAR FONT, STYLE, SIZE, OR COLOR.

NO CLAIM IS MADE TO THE EXCLUSIVE RIGHT TO USE "HEALTH", APART FROM THE MARK AS SHOWN.

FOR DIETARY SUPPLEMENTS, FOOD SUPPLEMENTS, HERBAL SUPPLEMENTS, MINERAL SUPPLEMENTS, NUTRITIONAL SUPPLEMENTS, VITAMIN SUPPLEMENTS, NUTRITIONAL FOOD BARS FOR USE AS MEAL REPLACEMENTS (U.S. CLS. 6, 18, 44, 46, 51 AND 52).

YAT SYE, LEE, EXAMINING ATTORNEY

SN 77-276,116. NUTRU, INC., CHICAGO, IL. FILED 9-11-2007.

SA-TO-RI⁷

THE MARK CONSISTS OF THE TERM "SA-TO-RI⁷" WITH THE NUMBER "7" APPEARING IN SUPERSCRIPIT. THE FOREIGN WORDING IN THE MARK TRANSLATES INTO ENGLISH AS "ENLIGHTENMENT".

FOR DIETARY SUPPLEMENTS (U.S. CLS. 6, 18, 44, 46, 51 AND 52).

MATTHEW MCDOWELL, EXAMINING ATTORNEY

SN 77-276,480. COOK BIOTECH INCORPORATED, WEST LAFAYETTE, IN. FILED 9-11-2007.

VET BIOSIST

THE MARK CONSISTS OF STANDARD CHARACTERS WITHOUT CLAIM TO ANY PARTICULAR FONT, STYLE, SIZE, OR COLOR.

NO CLAIM IS MADE TO THE EXCLUSIVE RIGHT TO USE "VET", APART FROM THE MARK AS SHOWN.

FOR BIOLOGICAL MATERIALS, NAMELY, SMALL INTESTINAL SUBMUCOSA AND OTHER ECM (EXTRA CELLULAR MATRIX) MATERIAL USED FOR SURGICAL REPAIR AND REINFORCEMENT OF TISSUE (U.S. CLS. 6, 18, 44, 46, 51 AND 52).

JILL PRATER, EXAMINING ATTORNEY

CLASS 5—(Continued).

SN 77-277,011. BLUEBONNET NUTRITION CORP., SUGAR LAND, TX. FILED 9-11-2007.

LICORICE ACTIVE

THE MARK CONSISTS OF STANDARD CHARACTERS WITHOUT CLAIM TO ANY PARTICULAR FONT, STYLE, SIZE, OR COLOR.

NO CLAIM IS MADE TO THE EXCLUSIVE RIGHT TO USE "LICORICE", APART FROM THE MARK AS SHOWN.

FOR NUTRITIONAL SUPPLEMENTS CONTAINING LICORICE EXTRACT (U.S. CLS. 6, 18, 44, 46, 51 AND 52).

MICHAEL ENGEL, EXAMINING ATTORNEY

SN 77-277,468. RECKITT BENCKISER INC., PARSIPPANY, NJ. FILED 9-12-2007.

D-CON PROFESSIONAL

THE MARK CONSISTS OF STANDARD CHARACTERS WITHOUT CLAIM TO ANY PARTICULAR FONT, STYLE, SIZE, OR COLOR.

OWNER OF U.S. REG. NOS. 576,305, 1,945,137 AND 2,289,011.

NO CLAIM IS MADE TO THE EXCLUSIVE RIGHT TO USE "PROFESSIONAL", APART FROM THE MARK AS SHOWN.

FOR RODENTICIDES; INSECTICIDES; PESTICIDES; MITICIDES; PREPARATIONS FOR DESTROYING VERMIN (U.S. CLS. 6, 18, 44, 46, 51 AND 52).

JAMES LOVELACE, EXAMINING ATTORNEY

SN 77-278,640. C.B. FLEET COMPANY, INCORPORATED, LYNCHBURG, VA. FILED 9-13-2007.

RELIEF BY FLEET

THE MARK CONSISTS OF STANDARD CHARACTERS WITHOUT CLAIM TO ANY PARTICULAR FONT, STYLE, SIZE, OR COLOR.

OWNER OF U.S. REG. NO. 2,931,489.

NO CLAIM IS MADE TO THE EXCLUSIVE RIGHT TO USE "RELIEF", APART FROM THE MARK AS SHOWN.

FOR PRE-MOISTENED MEDICATED RECTAL WIPES FOR TEMPORARY RELIEF FROM ITCHING AND DISCOMFORT ASSOCIATED WITH HEMORRHOIDS AND OTHER ANORECTAL DISORDERS; PHARMACEUTICAL PREPARATIONS FOR TEMPORARY RELIEF FROM ITCHING AND DISCOMFORT ASSOCIATED WITH HEMORRHOIDS AND OTHER ANORECTAL DISORDERS; ORAL LAXATIVES (U.S. CLS. 6, 18, 44, 46, 51 AND 52).

KAPIL BHANOT, EXAMINING ATTORNEY

CLASS 5—(Continued).

SN 77-280,407. ARBONNE INTERNATIONAL, LLC, IRVINE, CA. FILED 9-14-2007.

SEASOURCE DETOX SPA

THE MARK CONSISTS OF STANDARD CHARACTERS WITHOUT CLAIM TO ANY PARTICULAR FONT, STYLE, SIZE, OR COLOR.

NO CLAIM IS MADE TO THE EXCLUSIVE RIGHT TO USE "DETOX SPA", APART FROM THE MARK AS SHOWN. FOR HERBAL TEA FOR NUTRITIONAL AND DIETETIC PURPOSES; NUTRITIONAL SUPPLEMENTS; AIR FRESHENERS (U.S. CLS. 6, 18, 44, 46, 51 AND 52).
KIMBERLY FRYE, EXAMINING ATTORNEY

SN 77-282,109. NUTRI-VET LLC, BOISE, ID. FILED 9-18-2007.

ALLERG-EZE

THE MARK CONSISTS OF STANDARD CHARACTERS WITHOUT CLAIM TO ANY PARTICULAR FONT, STYLE, SIZE, OR COLOR.

FOR ANIMAL FEED SUPPLEMENT (U.S. CLS. 6, 18, 44, 46, 51 AND 52).
APRIL ROACH, EXAMINING ATTORNEY

SN 77-283,286. HOLLIS-EDEN PHARMACEUTICALS, INC., SAN DIEGO, CA. FILED 9-19-2007.

Apoptone

THE MARK CONSISTS OF STANDARD CHARACTERS WITHOUT CLAIM TO ANY PARTICULAR FONT, STYLE, SIZE, OR COLOR.

FOR (BASED ON INTENT TO USE) PHARMACEUTICAL PREPARATIONS FOR USE IN CHEMOTHERAPY; PHARMACEUTICAL PRODUCTS FOR THE TREATMENT OF VIRAL AND INFECTIOUS DISEASES, FOR THE TREATMENT OF CANCER (U.S. CLS. 6, 18, 44, 46, 51 AND 52).
ANNE FARRELL, EXAMINING ATTORNEY

CLASS 5—(Continued).

SN 77-286,492. URBAN HEALTH SYSTEMS LLC, DACULA, GA. FILED 9-22-2007.

GLUCO LIFE

THE MARK CONSISTS OF STANDARD CHARACTERS WITHOUT CLAIM TO ANY PARTICULAR FONT, STYLE, SIZE, OR COLOR.

NO CLAIM IS MADE TO THE EXCLUSIVE RIGHT TO USE "GLUCO", APART FROM THE MARK AS SHOWN. FOR DIETARY AND NUTRITIONAL SUPPLEMENTS (U.S. CLS. 6, 18, 44, 46, 51 AND 52).
WILLIAM ROSSMAN, EXAMINING ATTORNEY

SN 77-287,021. ARES TRADING S.A., AUBONNE, SWITZERLAND, FILED 9-24-2007.

OPTOVO

THE MARK CONSISTS OF STANDARD CHARACTERS WITHOUT CLAIM TO ANY PARTICULAR FONT, STYLE, SIZE, OR COLOR.

OWNER OF SWITZERLAND REG. NO. 467618, DATED 12-13-1999, EXPIRES 12-13-2009.
OWNER OF U.S. REG. NO. 2,629,797.
FOR PHARMACEUTICAL PREPARATIONS FOR USE IN THE TREATMENT OF HORMONAL AND REPRODUCTIVE DISEASES, CONDITIONS AND DISORDERS, CANCERS AND INFLAMMATORY DISEASES (U.S. CLS. 6, 18, 44, 46, 51 AND 52).
TEJBIR SINGH, EXAMINING ATTORNEY

SN 77-287,172. CYTONICS CORPORATION, JUPITER, FL. FILED 9-24-2007.

ArthroSure

THE MARK CONSISTS OF STANDARD CHARACTERS WITHOUT CLAIM TO ANY PARTICULAR FONT, STYLE, SIZE, OR COLOR.

FOR ASSAYS FOR MEDICAL DIAGNOSTIC PURPOSES (U.S. CLS. 6, 18, 44, 46, 51 AND 52).
CURTIS FRENCH, EXAMINING ATTORNEY

CLASS 5—(Continued).

SN 77-287,573. KROEGER HERB PRODUCTS CO., INC., BOULDER, CO. FILED 9-24-2007.

Complete Concentrates

THE MARK CONSISTS OF STANDARD CHARACTERS WITHOUT CLAIM TO ANY PARTICULAR FONT, STYLE, SIZE, OR COLOR.

NO CLAIM IS MADE TO THE EXCLUSIVE RIGHT TO USE "CONCENTRATES", APART FROM THE MARK AS SHOWN.

SEC. 2(F).

FOR NATURAL DIETARY SUPPLEMENTS (U.S. CLS. 6, 18, 44, 46, 51 AND 52).

FIRST USE 6-1-1999; IN COMMERCE 6-1-1999.

AHSEN KHAN, EXAMINING ATTORNEY

SN 77-289,273. WESTERN HOLDINGS, LLC, CHEYENNE, WY. FILED 9-26-2007.

FAT CELL KILLER

THE MARK CONSISTS OF STANDARD CHARACTERS WITHOUT CLAIM TO ANY PARTICULAR FONT, STYLE, SIZE, OR COLOR.

NO CLAIM IS MADE TO THE EXCLUSIVE RIGHT TO USE "FAT CELL", APART FROM THE MARK AS SHOWN. FOR DIETARY SUPPLEMENTS (U.S. CLS. 6, 18, 44, 46, 51 AND 52).

HEATHER SAPP, EXAMINING ATTORNEY

SN 77-289,562. BALCHEM CORPORATION, NEW HAMPTON, NY. FILED 9-26-2007.

EQUISHURE

THE MARK CONSISTS OF STANDARD CHARACTERS WITHOUT CLAIM TO ANY PARTICULAR FONT, STYLE, SIZE, OR COLOR.

OWNER OF U.S. REG. NOS. 2,441,606 AND 2,533,588. FOR ENCAPSULATED FEED SUPPLEMENTS FOR HORSES (U.S. CLS. 6, 18, 44, 46, 51 AND 52).

MARY ROSSMAN, EXAMINING ATTORNEY

CLASS 5—(Continued).

SN 77-290,194. PURDUE PRODUCTS L.P., STAMFORD, CT. FILED 9-27-2007.

X-PREP

THE MARK CONSISTS OF STANDARD CHARACTERS WITHOUT CLAIM TO ANY PARTICULAR FONT, STYLE, SIZE, OR COLOR.

FOR BOWEL EVACUANT PREPARATIONS (U.S. CLS. 6, 18, 44, 46, 51 AND 52).

TANYA AMOS, EXAMINING ATTORNEY

SN 77-290,377. LABRADA BODYBUILDING NUTRITION, INC., HOUSTON, TX. FILED 9-27-2007.

Lee Labrada's Designer Carbs

THE MARK CONSISTS OF STANDARD CHARACTERS WITHOUT CLAIM TO ANY PARTICULAR FONT, STYLE, SIZE, OR COLOR.

OWNER OF U.S. REG. NOS. 2,334,903, 2,509,455 AND 2,512,277.

NO CLAIM IS MADE TO THE EXCLUSIVE RIGHT TO USE "DESIGNER CARBS", APART FROM THE MARK AS SHOWN.

THE NAME "LEE LABRADA" IDENTIFIES A LIVING INDIVIDUAL WHOSE CONSENT IS OF RECORD.

FOR NUTRITIONAL SUPPLEMENTS (U.S. CLS. 6, 18, 44, 46, 51 AND 52).

ANDREA HACK, EXAMINING ATTORNEY

SN 77-290,804. CGS ENTERPRISES, WESTLAKE, OH. FILED 9-27-2007.



THE MARK CONSISTS OF THE STYLIZED WORD "VESTALCARE". THE WORD "VESTALCARE" IS POSITIONED OVER THE TOP EDGE OF A SUN WITH RAYS PROJECTING UP.

FOR DIETARY SUPPLEMENTS; HOMEOPATHIC SUPPLEMENTS (U.S. CLS. 6, 18, 44, 46, 51 AND 52).

FIRST USE 10-0-2004; IN COMMERCE 11-0-2004.

ANDREA K. NADELMAN, EXAMINING ATTORNEY

CLASS 5—(Continued).

SN 77-291,105. NYMOX CORPORATION, HASBROUCK HEIGHTS, NJ. FILED 9-28-2007.

ALZHEIMALERT

THE MARK CONSISTS OF STANDARD CHARACTERS WITHOUT CLAIM TO ANY PARTICULAR FONT, STYLE, SIZE, OR COLOR.

OWNER OF U.S. REG. NO. 3,261,367.

FOR DIAGNOSTIC TEST KITS CONTAINING REAGENTS TO DETERMINE WHETHER A SAMPLE HAS ELEVATED LEVELS OF NEURAL THREAD PROTEIN, TO BE USED AS AN AID TO A PHYSICIAN IN THE DIAGNOSIS OF ALZHEIMER'S DISEASE AND OTHER NEURODEGENERATIVE DISORDERS (U.S. CLS. 6, 18, 44, 46, 51 AND 52).

AMY GEARIN, EXAMINING ATTORNEY

SN 77-291,145. FREE SPEECH TRUST, ABBEVILLE, GA. FILED 9-28-2007.

TUMOR_x

THE MARK CONSISTS OF A STYLIZED LETTER X AT THE END OF TUMORX WHICH IS ARTISTICALLY JOINED TO THE LETTER R.

FOR VITAMINS, MINERAL SUPPLEMENTS, HERBAL SUPPLEMENTS, ENZYME PREPARATIONS FOR USE AS A DIETARY SUPPLEMENT; NEUTRACEUTICAL PREPARATIONS FOR USE AS A DIETARY SUPPLEMENT FOR THE MAINTENANCE OF HEALTH; NEUTRACEUTICAL PREPARATIONS FOR: BLOOD/HEMIC DISEASES & DISORDERS, CARDIOLOGICAL/HEART DISEASES & DISORDERS, CARDIOVASCULAR/CIRCULATORY DISEASES & DISORDERS, CONGENITAL/GENETIC DISEASES & DISORDERS, DIGESTIVE DISEASES & DISORDERS, ENDOCRINE DISEASES & DISORDERS, IMMUNE DISEASES & DISORDERS, INFECTIOUS DISEASES & DISORDERS, LYMPHATIC DISEASES & DISORDERS, METABOLIC DISEASES & DISORDERS, MUSCULOSKELETAL/SKELETON & MUSCLE DISEASES, NEOPLASTIC/CANCEROUS DISEASES & DISORDERS, NEUROLOGIC/NERVE DISEASES & DISORDERS, NUTRITIONAL DISEASES & DISORDERS, OPTIC/EYE DISEASES & DISORDERS, REPRODUCTIVE DISEASE & DISORDERS, RESPIRATORY DISEASES & DISORDERS, SKIN DISEASES & DISORDERS, URINARY DISEASES & DISORDERS, VIRAL DISEASES & DISORDERS (U.S. CLS. 6, 18, 44, 46, 51 AND 52).

FIRST USE 8-14-2002; IN COMMERCE 8-14-2002.

DOMINICK J. SALEMI, EXAMINING ATTORNEY

CLASS 5—(Continued).

SN 77-291,173. SERGEANT'S PET CARE PRODUCTS, INC., OMAHA, NE. FILED 9-28-2007.

PURRSCRIPTIONS

THE MARK CONSISTS OF STANDARD CHARACTERS WITHOUT CLAIM TO ANY PARTICULAR FONT, STYLE, SIZE, OR COLOR.

OWNER OF U.S. REG. NO. 3,001,884.

FOR FLEA AND TICK CONTROL PRODUCTS, NAMELY, ANTIPARASITIC COLLARS FOR PETS (U.S. CLS. 6, 18, 44, 46, 51 AND 52).

FIRST USE 3-0-2006; IN COMMERCE 3-0-2006.

BENJAMIN OKEKE, EXAMINING ATTORNEY

SN 77-291,183. FORM-A-FEED, INC., STEWART, MN. FILED 9-28-2007.

FORM-A-LEAN

THE MARK CONSISTS OF STANDARD CHARACTERS WITHOUT CLAIM TO ANY PARTICULAR FONT, STYLE, SIZE, OR COLOR.

FOR NON-MEDICATED ADDITIVES FOR ANIMAL FEED FOR USE AS NUTRITIONAL SUPPLEMENTS; NUTRITIONAL ADDITIVES FOR LIVESTOCK FEED FOR MEDICAL PURPOSES (U.S. CLS. 6, 18, 44, 46, 51 AND 52).

FIRST USE 5-28-1985; IN COMMERCE 5-28-1985.

SHAILA SETTLES, EXAMINING ATTORNEY

SN 77-291,521. VAJDA, PAUL, ST. MICHAEL, MN. FILED 9-28-2007.

VITAMETABOLIC DESIGNS

THE MARK CONSISTS OF STANDARD CHARACTERS WITHOUT CLAIM TO ANY PARTICULAR FONT, STYLE, SIZE, OR COLOR.

FOR DIETARY SUPPLEMENTS FOR HUMAN CONSUMPTION (U.S. CLS. 6, 18, 44, 46, 51 AND 52).

TOBY BULLOFF, EXAMINING ATTORNEY

CLASS 5—(Continued).

SN 77-291,558. CASTLE ROCK INNOVATIONS, LLC, CASTLE ROCK, CO. FILED 9-28-2007.

FREE!

THE MARK CONSISTS OF STANDARD CHARACTERS WITHOUT CLAIM TO ANY PARTICULAR FONT, STYLE, SIZE, OR COLOR.

FOR ODOR COUNTERACTANTS, DEODORIZERS AND AIR FRESHENING PREPARATIONS FOR PERSONAL, RESIDENTIAL, COMMERCIAL AND INSTITUTIONAL USE (U.S. CLS. 6, 18, 44, 46, 51 AND 52).
LINDA MICKLEBURGH, EXAMINING ATTORNEY

CLASS 5—(Continued).

SN 77-291,935. ARBOR PHARMACEUTICALS, INC., RALEIGH, NC. FILED 9-28-2007.

DEXYLITOL

THE MARK CONSISTS OF STANDARD CHARACTERS WITHOUT CLAIM TO ANY PARTICULAR FONT, STYLE, SIZE, OR COLOR.

FOR PHARMACEUTICAL OR MEDICAL FOOD AGENTS FOR THE TREATMENT OF RESPIRATORY CONDITIONS AND INFECTIONS (U.S. CLS. 6, 18, 44, 46, 51 AND 52).
BENJAMIN ALLEN, EXAMINING ATTORNEY

SN 77-291,667. VITAQUEST INTERNATIONAL LLC, WEST CALDWELL, NJ. FILED 9-28-2007.

AcaiBlast

THE MARK CONSISTS OF STANDARD CHARACTERS WITHOUT CLAIM TO ANY PARTICULAR FONT, STYLE, SIZE, OR COLOR.

FOR DIETARY SUPPLEMENTS (U.S. CLS. 6, 18, 44, 46, 51 AND 52).
SHANNON TWOHIG, EXAMINING ATTORNEY

SN 77-291,966. HUMCO HOLDING GROUP, INC., TEXARKANA, TX. FILED 9-28-2007.

MIRANEL

THE MARK CONSISTS OF STANDARD CHARACTERS WITHOUT CLAIM TO ANY PARTICULAR FONT, STYLE, SIZE, OR COLOR.

FOR PHARMACEUTICAL PRODUCT, NAMELY, ANTIFUNGAL FOR TOPICAL USE (U.S. CLS. 6, 18, 44, 46, 51 AND 52).
JUDITH HELFMAN, EXAMINING ATTORNEY

SN 77-291,924. ARBOR PHARMACEUTICALS, INC., RALEIGH, NC. FILED 9-28-2007.

AXYLITOL

THE MARK CONSISTS OF STANDARD CHARACTERS WITHOUT CLAIM TO ANY PARTICULAR FONT, STYLE, SIZE, OR COLOR.

FOR PHARMACEUTICAL OR MEDICAL FOOD AGENTS FOR THE TREATMENT OF RESPIRATORY CONDITIONS AND INFECTIONS (U.S. CLS. 6, 18, 44, 46, 51 AND 52).
BENJAMIN ALLEN, EXAMINING ATTORNEY

SN 77-292,370. THETA BIOMED. CONSULT. DEVELOP. CO., INC, BROOKLINE, MA. FILED 9-30-2007.

NRG-Q

THE MARK CONSISTS OF STANDARD CHARACTERS WITHOUT CLAIM TO ANY PARTICULAR FONT, STYLE, SIZE, OR COLOR.

FOR DIETARY NUTRICEUTICAL FOR ADMINISTRATION TO HUMANS (U.S. CLS. 6, 18, 44, 46, 51 AND 52).
KAREN K. BUSH, EXAMINING ATTORNEY

CLASS 5—(Continued).

SN 77-292,377. DESIGNER SUPPLEMENTS, INC., NEW HYDE PARK, NY. FILED 9-30-2007.

SUPERBOL

THE MARK CONSISTS OF STANDARD CHARACTERS WITHOUT CLAIM TO ANY PARTICULAR FONT, STYLE, SIZE, OR COLOR.
FOR DIETARY SUPPLEMENTS FOR HUMAN CONSUMPTION (U.S. CLS. 6, 18, 44, 46, 51 AND 52).
KAREN K. BUSH, EXAMINING ATTORNEY

SN 77-292,452. MEDICAL NANOTECHNOLOGIES, INC., DBA MEDICAL NANOTECHNOLOGIES, INC., RICHARDSON, TX. FILED 9-30-2007.

MedNanoTech

THE MARK CONSISTS OF STANDARD CHARACTERS WITHOUT CLAIM TO ANY PARTICULAR FONT, STYLE, SIZE, OR COLOR.
FOR REAGENTS FOR MEDICAL USE (U.S. CLS. 6, 18, 44, 46, 51 AND 52).
JESSICA A. POWERS, EXAMINING ATTORNEY

SN 77-292,529. WOODS, RANDALL, SUN LAKES, AZ. FILED 10-1-2007.

TCR-VAX

THE MARK CONSISTS OF STANDARD CHARACTERS WITHOUT CLAIM TO ANY PARTICULAR FONT, STYLE, SIZE, OR COLOR.
FOR VETERINARY VACCINES FOR CANINE (U.S. CLS. 6, 18, 44, 46, 51 AND 52).
TINA BROWN, EXAMINING ATTORNEY

CLASS 5—(Continued).

SN 77-292,603. OSTEOTECH, INC., EATONTOWN, NJ. FILED 10-1-2007.



THE MARK CONSISTS OF THREE CURVING LINES PARTIALLY INSIDE A CIRCLE LOCATED BETWEEN THE A AND T IN THE WORD DURATECH.
FOR HUMAN COLLAGEN BASED MATERIAL FOR USE IN DURAL REPAIR AND NEUROSURGICAL AND ORTHOPEDIC SURGICAL PROCEDURES (U.S. CLS. 6, 18, 44, 46, 51 AND 52).
CHRISTINA SOBRAL, EXAMINING ATTORNEY

SN 77-292,955. APPLE A DAY, LLC, MONTPELIER, VT. FILED 10-1-2007.

FOCUS ON DEMAND

THE MARK CONSISTS OF STANDARD CHARACTERS WITHOUT CLAIM TO ANY PARTICULAR FONT, STYLE, SIZE, OR COLOR.
FOR DIETARY SUPPLEMENTS; NUTRACEUTICALS FOR USE AS A DIETARY SUPPLEMENT; NUTRITIONAL SUPPLEMENTS (U.S. CLS. 6, 18, 44, 46, 51 AND 52).
DAVID MURRAY, EXAMINING ATTORNEY

SN 77-293,216. IA NUTRITION, INC., HARTFORD, CT. FILED 10-1-2007.

CARDIO FIRE

THE MARK CONSISTS OF STANDARD CHARACTERS WITHOUT CLAIM TO ANY PARTICULAR FONT, STYLE, SIZE, OR COLOR.
NO CLAIM IS MADE TO THE EXCLUSIVE RIGHT TO USE "CARDIO", APART FROM THE MARK AS SHOWN.
FOR DIETARY AND NUTRITIONAL SUPPLEMENTS (U.S. CLS. 6, 18, 44, 46, 51 AND 52).
DAVID HOFFMAN, EXAMINING ATTORNEY

CLASS 5—(Continued).

SN 77-293,361. GOWAN COMPANY, L.L.C., YUMA, AZ. FILED 10-1-2007.

TNT Broadleaf

THE MARK CONSISTS OF STANDARD CHARACTERS WITHOUT CLAIM TO ANY PARTICULAR FONT, STYLE, SIZE, OR COLOR.

NO CLAIM IS MADE TO THE EXCLUSIVE RIGHT TO USE "BROADLEAF", APART FROM THE MARK AS SHOWN.

FOR AGRICULTURAL PESTICIDES (U.S. CLS. 6, 18, 44, 46, 51 AND 52).

FRANK LATTUCA, EXAMINING ATTORNEY

SN 77-293,549. RESVERATROL PARTNERS, LLC, SAN DIMAS, CA. FILED 10-2-2007.

SECOND CENTURY

THE MARK CONSISTS OF STANDARD CHARACTERS WITHOUT CLAIM TO ANY PARTICULAR FONT, STYLE, SIZE, OR COLOR.

FOR DIETARY SUPPLEMENTS (U.S. CLS. 6, 18, 44, 46, 51 AND 52).

AMY GEARIN, EXAMINING ATTORNEY

SN 77-293,557. RESVERATROL PARTNERS, LLC, SAN DIMAS, CA. FILED 10-2-2007.

II CENTURY

THE MARK CONSISTS OF STANDARD CHARACTERS WITHOUT CLAIM TO ANY PARTICULAR FONT, STYLE, SIZE, OR COLOR.

FOR DIETARY SUPPLEMENTS (U.S. CLS. 6, 18, 44, 46, 51 AND 52).

AMY GEARIN, EXAMINING ATTORNEY

CLASS 5—(Continued).

SN 77-293,630. VITALSURGE, L.L.C., JOPLIN, MO. FILED 10-2-2007.

ZELO

THE MARK CONSISTS OF STANDARD CHARACTERS WITHOUT CLAIM TO ANY PARTICULAR FONT, STYLE, SIZE, OR COLOR.

THE ENGLISH TRANSLATION OF "ZELO" IN THE MARK IS "ZEAL."

FOR NUTRITIONALLY ENHANCED WATER (U.S. CLS. 6, 18, 44, 46, 51 AND 52).

ROSELLE HERRERA, EXAMINING ATTORNEY

SN 77-293,686. HEARTLAND PRODUCTS, INC., VALLEY CITY, ND. FILED 10-2-2007.

Omega Greens

THE MARK CONSISTS OF STANDARD CHARACTERS WITHOUT CLAIM TO ANY PARTICULAR FONT, STYLE, SIZE, OR COLOR.

FOR DIETARY FOOD SUPPLEMENTS (U.S. CLS. 6, 18, 44, 46, 51 AND 52).

RICHARD WHITE, EXAMINING ATTORNEY

SN 77-293,772. TRIOLITE, INC., BRIGHAM CITY, UT. FILED 10-2-2007.

ANTIMONY

THE MARK CONSISTS OF STANDARD CHARACTERS WITHOUT CLAIM TO ANY PARTICULAR FONT, STYLE, SIZE, OR COLOR.

FOR HOMEOPATHIC PHARMACEUTICALS FOR USE IN THE TREATMENT OF BRAIN FUNCTION, MUSCLE HOMEOSTASIS, IMMUNE SYSTEM, DIGESTIVE SYSTEM, LIVER, KIDNEYS, CIRCULATORY SYSTEM, GLANDULAR SYSTEM, SKIN, AND LUNGS (U.S. CLS. 6, 18, 44, 46, 51 AND 52).

RICHARD A. STRASER, EXAMINING ATTORNEY

CLASS 5—(Continued).

SN 77-294,061. 4-H OF HOPE MINISTRIES, INC., ROCKWELL, NC. FILED 10-2-2007.

ALCODINE

THE MARK CONSISTS OF STANDARD CHARACTERS WITHOUT CLAIM TO ANY PARTICULAR FONT, STYLE, SIZE, OR COLOR.
FOR TOPICAL ANTISEPTIC MICROBIAL SOLUTION (U.S. CLS. 6, 18, 44, 46, 51 AND 52).
TARAH HARDY, EXAMINING ATTORNEY

SN 77-294,113. NATURAL SYNERGIES, LLC, BOCA RATON, FL. FILED 10-2-2007.

HEALTHY PLANET SYNERGIES

THE MARK CONSISTS OF STANDARD CHARACTERS WITHOUT CLAIM TO ANY PARTICULAR FONT, STYLE, SIZE, OR COLOR.
FOR DIETARY AND NUTRITIONAL SUPPLEMENTS; VITAMINS AND MINERAL SUPPLEMENTS (U.S. CLS. 6, 18, 44, 46, 51 AND 52).
STEVEN R. FOSTER, EXAMINING ATTORNEY

SN 77-294,123. CORN PRODUCTS INTERNATIONAL, INC., WESTCHESTER, IL. FILED 10-2-2007.

VIDAGAVE

THE MARK CONSISTS OF STANDARD CHARACTERS WITHOUT CLAIM TO ANY PARTICULAR FONT, STYLE, SIZE, OR COLOR.
FOR DIETARY FIBER AS AN ADDITIVE FOR FOOD PRODUCTS OR DIETARY OR NUTRITIONAL SUPPLEMENTS (U.S. CLS. 6, 18, 44, 46, 51 AND 52).
ELLEN PERKINS, EXAMINING ATTORNEY

CLASS 5—(Continued).

SN 77-294,247. MAKHTESHIM AGAN OF NORTH AMERICA INC., RALEIGH, NC. FILED 10-2-2007.

PYRIMAX

THE MARK CONSISTS OF STANDARD CHARACTERS WITHOUT CLAIM TO ANY PARTICULAR FONT, STYLE, SIZE, OR COLOR.
FOR HERBICIDES FOR AGRICULTURAL USE (U.S. CLS. 6, 18, 44, 46, 51 AND 52).
SHANNON TWOHIG, EXAMINING ATTORNEY

SN 77-294,459. MILLER, TIMOTHY C, RALEIGH, NC. FILED 10-2-2007.

eyepothecary

THE MARK CONSISTS OF STANDARD CHARACTERS WITHOUT CLAIM TO ANY PARTICULAR FONT, STYLE, SIZE, OR COLOR.
FOR BEE POLLEN FOR USE AS A DIETARY FOOD SUPPLEMENT; CALCIUM SUPPLEMENTS; DIETARY AND NUTRITIONAL SUPPLEMENTS; DIETARY FOOD SUPPLEMENTS; DIETARY SUPPLEMENTAL DRINKS; DIETARY SUPPLEMENTS; DIETARY SUPPLEMENTS FOR HUMAN CONSUMPTION; FOOD SUPPLEMENTS; FOOD SUPPLEMENTS, NAMELY, ANTI-OXIDANTS; GROUND FLAXSEED FIBER FOR USE AS A DIETARY SUPPLEMENT; HERB TEAS FOR MEDICINAL PURPOSES; HERBAL PRODUCTS, NAMELY, AROMATHERAPY PACKS CONTAINING HERBS USED FOR RELIEF FROM HEADACHES, INSOMNIA AND SINUS DISCOMFORT; HERBAL SUPPLEMENTS; HOMEOPATHIC SUPPLEMENTS; MEDICINAL HERB EXTRACTS; MEDICINAL HERBS IN DRIED OR PRESERVED FORM; MINERAL NUTRITIONAL SUPPLEMENTS; MINERAL SUPPLEMENTS; MIXED VITAMIN PREPARATIONS; MULTI-VITAMIN PREPARATIONS; NUTRACEUTICALS FOR USE AS A DIETARY SUPPLEMENT; NUTRITIONAL ADDITIVES FOR MEDICAL PURPOSES FOR USE IN FOODS AND DIETARY SUPPLEMENTS FOR HUMAN CONSUMPTION; NUTRITIONAL SUPPLEMENTS; NUTRITIONAL SUPPLEMENTS IN LOTION FORM SOLD AS A COMPONENT OF NUTRITIONAL SKIN CARE PRODUCTS; POWDERED FRUIT-FLAVORED DIETARY SUPPLEMENT DRINK MIX; POWDERED NUTRITIONAL SUPPLEMENT DRINK MIX; VITAMIN B PREPARATIONS; VITAMIN C PREPARATIONS; VITAMIN D PREPARATIONS; VITAMIN AND MINERAL FORMED AND PACKAGED AS BARS; VITAMIN AND MINERAL PREPARATIONS FOR MEDICAL USE; VITAMIN AND MINERAL PREPARATIONS FOR USE AS INGREDIENTS IN THE FOOD AND PHARMACEUTICAL INDUSTRY; VITAMIN AND MINERAL SUPPLEMENTS; VITAMIN DROPS; VITAMIN ENRICHED WATER; VITAMIN FORTIFIED BEVERAGES; VITAMIN PREPARATIONS; VITAMIN SUPPLEMENT IN TABLET FORM FOR USE IN MAKING AN EFFERVESCENT BEVERAGE WHEN ADDED TO WATER; VITAMIN SUPPLEMENTS; VITAMIN TABLETS; VITAMINS; WHEAT FOR USE AS A DIETARY SUPPLEMENT (U.S. CLS. 6, 18, 44, 46, 51 AND 52).
ELLEN BURNS, EXAMINING ATTORNEY

CLASS 5—(Continued).

SN 77-294,609. ALVA INTERNATIONAL LLC, NILES, IL.
FILED 10-2-2007.

ACNEVIR

THE MARK CONSISTS OF STANDARD CHARACTERS
WITHOUT CLAIM TO ANY PARTICULAR FONT, STYLE,
SIZE, OR COLOR.

FOR ACNE TREATMENT PREPARATIONS (U.S. CLS.
6, 18, 44, 46, 51 AND 52).
MARY MUNSON, EXAMINING ATTORNEY

CLASS 5—(Continued).

SN 77-295,016. NEW YORK GOLDEN NUTRITION CENTER
INC., JAMAICA, NY. FILED 10-3-2007.

New Slim-30

THE MARK CONSISTS OF STANDARD CHARACTERS
WITHOUT CLAIM TO ANY PARTICULAR FONT, STYLE,
SIZE, OR COLOR.

FOR DIETARY AND NUTRITIONAL SUPPLEMENTS;
DIETARY SUPPLEMENTS; DIETARY SUPPLEMENTS
FOR HUMAN CONSUMPTION (U.S. CLS. 6, 18, 44, 46,
51 AND 52).

NAAKWAMA ANKRAH, EXAMINING ATTORNEY

SN 77-294,709. W.F. YOUNG, INCORPORATED, EAST
LONGMEADOW, MA. FILED 10-3-2007.

FIBERFLEX

THE MARK CONSISTS OF STANDARD CHARACTERS
WITHOUT CLAIM TO ANY PARTICULAR FONT, STYLE,
SIZE, OR COLOR.

FOR NUTRITIONAL SUPPLEMENTS (U.S. CLS. 6, 18,
44, 46, 51 AND 52).
MARIA-VICTORIA SUAREZ, EXAMINING ATTORNEY

SN 77-295,118. OMEGA NATURAL SCIENCE, INC., WAL-
THAM, MA. FILED 10-3-2007.

NOT ALL OMEGA-3S ARE THE SAME EITHER.

THE MARK CONSISTS OF STANDARD CHARACTERS
WITHOUT CLAIM TO ANY PARTICULAR FONT, STYLE,
SIZE, OR COLOR.

FOR DIETARY SUPPLEMENTS (U.S. CLS. 6, 18, 44, 46,
51 AND 52).
FIRST USE 5-0-2005; IN COMMERCE 5-0-2005.
PATRICIA EVANKO, EXAMINING ATTORNEY

SN 77-294,871. RBC LIFE SCIENCES, INC., IRVING, TX.
FILED 10-3-2007.

OliViva

THE MARK CONSISTS OF STANDARD CHARACTERS
WITHOUT CLAIM TO ANY PARTICULAR FONT, STYLE,
SIZE, OR COLOR.

FOR DIETARY SUPPLEMENTAL DRINKS (U.S. CLS.
6, 18, 44, 46, 51 AND 52).
SAMUEL E. SHARPER JR., EXAMINING ATTORNEY

SN 77-295,247. CANOPUS BIOPHARMA, STUDIO CITY, CA.
FILED 10-3-2007.

OLTIPRAZ

THE MARK CONSISTS OF STANDARD CHARACTERS
WITHOUT CLAIM TO ANY PARTICULAR FONT, STYLE,
SIZE, OR COLOR.

FOR PHARMACEUTICAL PREPARATIONS FOR THE
TREATMENT OF ALZHEIMERS AND MUCOSITIS (U.S.
CLS. 6, 18, 44, 46, 51 AND 52).

ERNEST SHOSHO, EXAMINING ATTORNEY

CLASS 5—(Continued).

SN 77-295,287. CHELSEA THERAPEUTICS, INC., CHARLOTTE, NC. FILED 10-3-2007.

VASCOTRENE

THE MARK CONSISTS OF STANDARD CHARACTERS WITHOUT CLAIM TO ANY PARTICULAR FONT, STYLE, SIZE, OR COLOR.

FOR PHARMACEUTICAL PREPARATIONS, NAMELY, A PHARMACEUTICAL PREPARATION FOR THE TREATMENT OF VARIOUS DISORDERS CHARACTERIZED BY A DEFICIENCY OF NOREPINEPHRINE (U.S. CLS. 6, 18, 44, 46, 51 AND 52).

KIMBERLY FRYE, EXAMINING ATTORNEY

SN 77-295,310. CHELSEA THERAPEUTICS, INC., CHARLOTTE, NC. FILED 10-3-2007.

NORTHERA

THE MARK CONSISTS OF STANDARD CHARACTERS WITHOUT CLAIM TO ANY PARTICULAR FONT, STYLE, SIZE, OR COLOR.

FOR PHARMACEUTICAL PREPARATIONS, NAMELY, A PHARMACEUTICAL PREPARATION FOR THE TREATMENT OF VARIOUS DISORDERS CHARACTERIZED BY A DEFICIENCY OF NOREPINEPHRINE (U.S. CLS. 6, 18, 44, 46, 51 AND 52).

KIMBERLY FRYE, EXAMINING ATTORNEY

SN 77-295,338. SERGEANT'S PET CARE PRODUCTS, INC., OMAHA, NE. FILED 10-3-2007.

SENTRY

THE MARK CONSISTS OF STANDARD CHARACTERS WITHOUT CLAIM TO ANY PARTICULAR FONT, STYLE, SIZE, OR COLOR.

OWNER OF U.S. REG. NOS. 798,686, 2,981,960 AND 3,002,748.

FOR FLEA AND TICK CONTROL PRODUCTS, NAMELY, SPRAYS, SHAMPOOS, MEDICATED POWDERS, AND TOPICAL OINTMENTS FOR PETS; FLEA AND TICK CONTROL SPRAYS, POWDERS AND AEROSOL FOGGERS FOR PREMISE APPLICATIONS; CARPET INSECTICIDES AND FRESHENERS; AND INSECT REPELLENT AND INSECTICIDE FOR USE ON ANIMALS (U.S. CLS. 6, 18, 44, 46, 51 AND 52).

FIRST USE 4-0-2004; IN COMMERCE 4-0-2004.
BENJAMIN OKEKE, EXAMINING ATTORNEY

CLASS 5—(Continued).

SN 77-295,452. LIFETREE BIOTECH USA, INC., ENGLEWOOD CLIFFS, NJ. FILED 10-3-2007.

GenO2

THE MARK CONSISTS OF STANDARD CHARACTERS WITHOUT CLAIM TO ANY PARTICULAR FONT, STYLE, SIZE, OR COLOR.

FOR NUTRITIONAL ADDITIVES FOR MEDICAL PURPOSES FOR USE IN FOODS AND DIETARY SUPPLEMENTS FOR HUMAN CONSUMPTION; DIETARY AND NUTRITIONAL SUPPLEMENTS; DIETARY FOOD SUPPLEMENTS; DIETARY SUPPLEMENTAL DRINKS; DIETARY SUPPLEMENTS; DIETARY SUPPLEMENTS FOR HUMAN CONSUMPTION; HERBAL SUPPLEMENTS; HOMEOPATHIC SUPPLEMENTS; MINERAL NUTRITIONAL SUPPLEMENTS; MINERAL SUPPLEMENTS; VITAMIN AND MINERAL SUPPLEMENTS; VITAMIN SUPPLEMENT IN TABLET FORM FOR USE IN MAKING AN EFFERVESCENT BEVERAGE WHEN ADDED TO WATER; VITAMIN SUPPLEMENTS (U.S. CLS. 6, 18, 44, 46, 51 AND 52).

HANNO RITTNER, EXAMINING ATTORNEY

SN 77-295,580. MILLENNIUM MEDICAL SPA LLC, NEWPORT BEACH, CA. FILED 10-3-2007.

RELEANA

THE MARK CONSISTS OF STANDARD CHARACTERS WITHOUT CLAIM TO ANY PARTICULAR FONT, STYLE, SIZE, OR COLOR.

FOR HORMONES FOR MEDICAL PURPOSES, NAMELY, LIQUID SUBLINGUAL FORM OF HUMAN CHORIONIC GONATROPIN FOR WEIGHT LOSS (U.S. CLS. 6, 18, 44, 46, 51 AND 52).

FIRST USE 1-1-2006; IN COMMERCE 1-1-2006.
IRA J. GOODSAY, EXAMINING ATTORNEY

SN 77-295,714. HALYO LLC, CHERRY HILL, NJ. FILED 10-3-2007.

Halyo

THE MARK CONSISTS OF STANDARD CHARACTERS WITHOUT CLAIM TO ANY PARTICULAR FONT, STYLE, SIZE, OR COLOR.

FOR DIETARY AND NUTRITIONAL SUPPLEMENTS (U.S. CLS. 6, 18, 44, 46, 51 AND 52).

GINA HAYES, EXAMINING ATTORNEY

CLASS 5—(Continued).

SN 77-295,947. NATURAL HEALTH CORPORATION, MIAMI, FL. FILED 10-4-2007.

LIVERCHOL

THE MARK CONSISTS OF STANDARD CHARACTERS WITHOUT CLAIM TO ANY PARTICULAR FONT, STYLE, SIZE, OR COLOR.

FOR DIETARY SUPPLEMENTS (U.S. CLS. 6, 18, 44, 46, 51 AND 52).

ANDREA HACK, EXAMINING ATTORNEY

CLASS 5—(Continued).

SN 77-296,809. BIOLOGIX HEALTH SCIENCES, LLC, DBA NASORX, PHOENIX, AZ. FILED 10-4-2007.

NasoRx

THE MARK CONSISTS OF STANDARD CHARACTERS WITHOUT CLAIM TO ANY PARTICULAR FONT, STYLE, SIZE, OR COLOR.

FOR ANTIBACTERIAL SPRAY (U.S. CLS. 6, 18, 44, 46, 51 AND 52).

BRIAN CALLAGHAN, EXAMINING ATTORNEY

SN 77-296,135. PASCUAL LABORATORIES, INC., QUEZON CITY, PHILIPPINES, FILED 10-4-2007.

CRx C-Lium

THE MARK CONSISTS OF STANDARD CHARACTERS WITHOUT CLAIM TO ANY PARTICULAR FONT, STYLE, SIZE, OR COLOR.

FOR FOOD SUPPLEMENT (U.S. CLS. 6, 18, 44, 46, 51 AND 52).

GIANCARLO CASTRO, EXAMINING ATTORNEY

SN 77-297,879. SIGLER, BRIAN G., IRVINE, CA. AND MILLER, JR., WILLIAM G., CLOVIS, CA. AND BRANNON, JEFFREY L., CORONA, CA. AND BRIZENDINE, RYAN S., MISSION VIEJO, CA. FILED 10-5-2007.

SLUMPBUSTER

THE MARK CONSISTS OF STANDARD CHARACTERS WITHOUT CLAIM TO ANY PARTICULAR FONT, STYLE, SIZE, OR COLOR.

FOR NUTRITIONAL ENERGY BARS FOR USE AS A MEAL SUBSTITUTE (U.S. CLS. 6, 18, 44, 46, 51 AND 52).

KAPIL BHANOT, EXAMINING ATTORNEY

SN 77-296,233. NATURAL HEALTH CORPORATION, MIAMI, FL. FILED 10-4-2007.

URINOEASY

THE MARK CONSISTS OF STANDARD CHARACTERS WITHOUT CLAIM TO ANY PARTICULAR FONT, STYLE, SIZE, OR COLOR.

FOR DIETARY SUPPLEMENTS FOR HUMAN USE (U.S. CLS. 6, 18, 44, 46, 51 AND 52).

ANDREA HACK, EXAMINING ATTORNEY

SN 77-298,142. TANG, VIVIAN, SAN JOSE, CA. FILED 10-7-2007.

LifeCream

THE MARK CONSISTS OF STANDARD CHARACTERS WITHOUT CLAIM TO ANY PARTICULAR FONT, STYLE, SIZE, OR COLOR.

FOR MEDICINAL HERBAL EXTRACTS FOR MEDICAL PURPOSES (U.S. CLS. 6, 18, 44, 46, 51 AND 52).

HANNO RITTNER, EXAMINING ATTORNEY

CLASS 5—(Continued).

SN 77-298,203. NOVARTIS AG, BASEL, SWITZERLAND, FILED 10-8-2007.

GENTLE WARMING

THE MARK CONSISTS OF STANDARD CHARACTERS WITHOUT CLAIM TO ANY PARTICULAR FONT, STYLE, SIZE, OR COLOR.

NO CLAIM IS MADE TO THE EXCLUSIVE RIGHT TO USE "WARMING", APART FROM THE MARK AS SHOWN.

FOR PHARMACEUTICAL PREPARATIONS FOR THE TREATMENT OF COUGH, COLD, ALLERGY AND FLU SYMPTOMS (U.S. CLS. 6, 18, 44, 46, 51 AND 52).

KELLY MCCOY, EXAMINING ATTORNEY

SN 77-298,206. NOVARTIS AG, BASEL, SWITZERLAND, FILED 10-8-2007.

TRIAMINIC GENTLE WARMING

THE MARK CONSISTS OF STANDARD CHARACTERS WITHOUT CLAIM TO ANY PARTICULAR FONT, STYLE, SIZE, OR COLOR.

NO CLAIM IS MADE TO THE EXCLUSIVE RIGHT TO USE "WARMING", APART FROM THE MARK AS SHOWN.

FOR PHARMACEUTICAL PREPARATIONS FOR THE TREATMENT OF COUGH, COLD, ALLERGY AND FLU SYMPTOMS (U.S. CLS. 6, 18, 44, 46, 51 AND 52).

KELLY MCCOY, EXAMINING ATTORNEY

SN 77-298,920. AVANIR PHARMACEUTICALS, ALISO VIEJO, CA. FILED 10-8-2007.

ZENVIA

THE MARK CONSISTS OF STANDARD CHARACTERS WITHOUT CLAIM TO ANY PARTICULAR FONT, STYLE, SIZE, OR COLOR.

FOR PHARMACEUTICAL PREPARATIONS FOR THE TREATMENT OF PAIN AND FOR THE TREATMENT AND REHABILITATION OF NEUROLOGICAL DISORDERS (U.S. CLS. 6, 18, 44, 46, 51 AND 52).

GIANCARLO CASTRO, EXAMINING ATTORNEY

CLASS 5—(Continued).

SN 77-301,273. NEXT LEVEL NUTRITION, INC., ANAHEIM, CA. FILED 10-11-2007.



NO CLAIM IS MADE TO THE EXCLUSIVE RIGHT TO USE "NITRO", APART FROM THE MARK AS SHOWN.

THE COLOR(S) SILVER, WHITE, ORANGE, YELLOW AND RED IS/ARE CLAIMED AS A FEATURE OF THE MARK.

THE MARK CONSISTS OF THE WORD "NITRO" IN SILVER AND OUTLINED IN WHITE ABOVE THE WORD "ACTIVE" IN WHITE AND OUTLINED IN SILVER. BETWEEN THE TWO WORDS IS A HORIZONTAL SILVER LINE, OUTLINED IN WHITE. A SHADOW OUTLINE OF THE WORD "NITRO" APPEARS IN RED. ALL OF THIS APPEARS ON A RED, ORANGE AND YELLOW PATTERNED BACKGROUND.

FOR DIETARY SUPPLEMENTS (U.S. CLS. 6, 18, 44, 46, 51 AND 52).

FIRST USE 6-1-2007; IN COMMERCE 6-1-2007.

KATHERINE CHANG, EXAMINING ATTORNEY

SN 77-302,476. CARGILL, INCORPORATED, WAYZATA, MN. FILED 10-12-2007.



OWNER OF U.S. REG. NOS. 798,187, 808,227 AND OTHERS.

THE COLOR(S) RED, WHITE, BLACK IS/ARE CLAIMED AS A FEATURE OF THE MARK.

THE MARK CONSISTS OF RED OUTLINED CIRCULAR PATTERN COMING TO A POINT AT THE TOP AND BOTTOM WITH A WHITE COLOR INSIDE THE CIRCULAR PATTERN AND AGWAY WRITTEN IN BLACK IN THE MIDDLE OF THE CIRCULAR PATTERN.

FOR MEDICATED ANIMAL FEED (U.S. CLS. 6, 18, 44, 46, 51 AND 52).

FIRST USE 3-5-1964; IN COMMERCE 3-5-1964.

BRENDAN REGAN, EXAMINING ATTORNEY

SN 77-304,483. NUTRI-VET LLC, BOISE, ID. FILED 10-15-2007.

NASTY HABIT

THE MARK CONSISTS OF STANDARD CHARACTERS WITHOUT CLAIM TO ANY PARTICULAR FONT, STYLE, SIZE, OR COLOR.

FOR NUTRITIONAL SUPPLEMENTS FOR ANIMALS (U.S. CLS. 6, 18, 44, 46, 51 AND 52).

APRIL ROACH, EXAMINING ATTORNEY

CLASS 5—(Continued).

SN 77-305,598. HOLLIS-EDEN PHARMACEUTICALS, INC., SAN DIEGO, CA. FILED 10-16-2007.

Triolex

THE MARK CONSISTS OF STANDARD CHARACTERS WITHOUT CLAIM TO ANY PARTICULAR FONT, STYLE, SIZE, OR COLOR.

FOR PHARMACEUTICAL ANTI-ALLERGIC PREPARATIONS AND SUBSTANCES; PHARMACEUTICAL PREPARATIONS AND SUBSTANCES FOR THE TREATMENT OF GASTRO-INTESTINAL DISEASES; PHARMACEUTICAL PREPARATIONS FOR THE PREVENTION AND TREATMENT OF DISORDERS OF THE NERVOUS SYSTEM, THE IMMUNE SYSTEM, THE CARDIO-VASCULAR SYSTEM, THE METABOLIC SYSTEM, THE RESPIRATORY SYSTEM, THE MUSCULO-SKELETAL SYSTEM, THE GENITOURINARY SYSTEM; FOR THE TREATMENT OF INFLAMMATORY DISORDERS; FOR USE IN DERMATOLOGY, ONCOLOGY, HEMATOLOGY AND IN TISSUE AND ORGAN TRANSPLANTATION, IN OPHTHALMOLOGY AND FOR GASTROENTEROLOGICAL DISORDERS; PHARMACEUTICAL PREPARATIONS FOR TREATING DIABETES; PHARMACEUTICALS, NAMELY, LIPID LOWERING AGENTS (U.S. CLS. 6, 18, 44, 46, 51 AND 52).

ANNE FARRELL, EXAMINING ATTORNEY

SN 77-306,393. ERNST MÜHLBAUER GMBH & CO KG, NORDERFRIEDRICHSKOOG, FED REP GERMANY, FILED 10-17-2007.

Luxatemp Cubic

THE MARK CONSISTS OF STANDARD CHARACTERS WITHOUT CLAIM TO ANY PARTICULAR FONT, STYLE, SIZE, OR COLOR.

OWNER OF U.S. REG. NO. 1,911,030.
NO CLAIM IS MADE TO THE EXCLUSIVE RIGHT TO USE "CUBIC", APART FROM THE MARK AS SHOWN.

FOR MATERIAL FOR TOOTH CROWNS FOR DENTAL PURPOSES (U.S. CLS. 6, 18, 44, 46, 51 AND 52).

KATHRYN COWARD, EXAMINING ATTORNEY

SN 77-306,413. VITAQUEST INTERNATIONAL LLC, WEST CALDWELL, NJ. FILED 10-17-2007.

AmalakiSplash

THE MARK CONSISTS OF STANDARD CHARACTERS WITHOUT CLAIM TO ANY PARTICULAR FONT, STYLE, SIZE, OR COLOR.

FOR DIETARY SUPPLEMENTAL DRINKS; DIETARY SUPPLEMENTS (U.S. CLS. 6, 18, 44, 46, 51 AND 52).

SHANNON TWOHIG, EXAMINING ATTORNEY

CLASS 5—(Continued).

SN 77-307,263. BOX ELDER B-GONE, SAINT PAUL, MN. FILED 10-18-2007.

BOX ELDER B-GONE

THE MARK CONSISTS OF STANDARD CHARACTERS WITHOUT CLAIM TO ANY PARTICULAR FONT, STYLE, SIZE, OR COLOR.

NO CLAIM IS MADE TO THE EXCLUSIVE RIGHT TO USE "BOX ELDER", APART FROM THE MARK AS SHOWN.

FOR INSECTICIDES (U.S. CLS. 6, 18, 44, 46, 51 AND 52).

CAROLYN CATALDO, EXAMINING ATTORNEY

SN 77-308,126. GLAXOSMITHKLINE BIOLOGICALS, S.A., RIXENSART, BELGIUM, FILED 10-19-2007.

ZILBRIX

THE MARK CONSISTS OF STANDARD CHARACTERS WITHOUT CLAIM TO ANY PARTICULAR FONT, STYLE, SIZE, OR COLOR.

OWNER OF ERP N CMNTY TM OFC REG. NO. 001992023, DATED 11-20-2001, EXPIRES 12-10-2010.

FOR VACCINES FOR HUMAN USE (U.S. CLS. 6, 18, 44, 46, 51 AND 52).

CURTIS FRENCH, EXAMINING ATTORNEY

SN 77-308,127. FL FOOD LION, INC., SALISBURY, NC. FILED 10-19-2007.



OWNER OF U.S. REG. NO. 3,050,769.
NO CLAIM IS MADE TO THE EXCLUSIVE RIGHT TO USE "BALANCED NUTRITIONAL SUPPLEMENT", APART FROM THE MARK AS SHOWN.

FOR DIETARY SUPPLEMENTAL DRINKS (U.S. CLS. 6, 18, 44, 46, 51 AND 52).

WANDA KAY PRICE, EXAMINING ATTORNEY

CLASS 5—(Continued).

SN 77-308,133. FL FOOD LION, INC., SALISBURY, NC. FILED 10-19-2007.



OWNER OF U.S. REG. NO. 3,050,769.
 NO CLAIM IS MADE TO THE EXCLUSIVE RIGHT TO USE "BALANCED NUTRITIONAL SUPPLEMENT", APART FROM THE MARK AS SHOWN.
 FOR DIETARY SUPPLEMENT DRINKS (U.S. CLS. 6, 18, 44, 46, 51 AND 52).
 WANDA KAY PRICE, EXAMINING ATTORNEY

SN 77-310,033. ARBOR PHARMACEUTICALS, INC., RALEIGH, NC. FILED 10-22-2007.

NEOTIC

THE MARK CONSISTS OF STANDARD CHARACTERS WITHOUT CLAIM TO ANY PARTICULAR FONT, STYLE, SIZE, OR COLOR.
 FOR EAR DROPS (U.S. CLS. 6, 18, 44, 46, 51 AND 52).
 BENJAMIN ALLEN, EXAMINING ATTORNEY

SN 77-312,189. RANDOB LABS LTD., CORNWALL, NY. FILED 10-24-2007.

STING-KILL

THE MARK CONSISTS OF STANDARD CHARACTERS WITHOUT CLAIM TO ANY PARTICULAR FONT, STYLE, SIZE, OR COLOR.
 SEC. 2(F).
 FOR TOPICAL ANESTHETICS (U.S. CLS. 6, 18, 44, 46, 51 AND 52).
 FIRST USE 4-25-1962; IN COMMERCE 5-3-1962.
 RONALD MCMORROW, EXAMINING ATTORNEY

CLASS 5—(Continued).

SN 77-313,443. BIOLOGIX HEALTH SCIENCES, LLC, DBA NOVAIRE, PHOENIX, AZ. FILED 10-25-2007.

Novaire

THE MARK CONSISTS OF STANDARD CHARACTERS WITHOUT CLAIM TO ANY PARTICULAR FONT, STYLE, SIZE, OR COLOR.
 FOR ANTIBACTERIAL SPRAY; DECONGESTANT NASAL SPRAYS; NASAL SPRAY PREPARATIONS (U.S. CLS. 6, 18, 44, 46, 51 AND 52).
 BRIAN CALLAGHAN, EXAMINING ATTORNEY

SN 77-313,743. CHOKE NUTRITION, HENDERSON, NV. FILED 10-25-2007.

Choke Nutrition

THE MARK CONSISTS OF STANDARD CHARACTERS WITHOUT CLAIM TO ANY PARTICULAR FONT, STYLE, SIZE, OR COLOR.
 NO CLAIM IS MADE TO THE EXCLUSIVE RIGHT TO USE "NUTRITION", APART FROM THE MARK AS SHOWN.

FOR MIXED VITAMIN PREPARATIONS; MULTI-VITAMIN PREPARATIONS; VITAMIN B PREPARATIONS; VITAMIN C PREPARATIONS; VITAMIN D PREPARATIONS; VITAMIN AND MINERAL FORMED AND PACKAGED AS BARS; VITAMIN AND MINERAL SUPPLEMENTS; VITAMIN DROPS; VITAMIN ENRICHED WATER; VITAMIN FORTIFIED BEVERAGES; VITAMIN PREPARATIONS; VITAMIN SUPPLEMENT IN TABLET FORM FOR USE IN MAKING AN EFFERVESCENT BEVERAGE WHEN ADDED TO WATER; VITAMIN SUPPLEMENTS; VITAMIN TABLETS; VITAMINS; BEE POLLEN FOR USE AS A DIETARY FOOD SUPPLEMENT; CALCIUM SUPPLEMENTS; DIETARY AND NUTRITIONAL SUPPLEMENTS; DIETARY FOOD SUPPLEMENTS; DIETARY SUPPLEMENTAL DRINKS; DIETARY SUPPLEMENTS; DIETARY SUPPLEMENTS FOR HUMAN CONSUMPTION; FOOD SUPPLEMENTS; FOOD SUPPLEMENTS, NAMELY, ANTI-OXIDANTS; GROUND FLAXSEED FIBER FOR USE AS A DIETARY SUPPLEMENT; HERBAL SUPPLEMENTS; HOMEOPATHIC SUPPLEMENTS; LECITHIN FOR USE AS A DIETARY SUPPLEMENT; MEAL REPLACEMENT AND DIETARY SUPPLEMENT DRINK MIXES; MINERAL NUTRITIONAL SUPPLEMENTS; MINERAL SUPPLEMENTS; NUTRACEUTICALS FOR USE AS A DIETARY SUPPLEMENT; NUTRITIONAL SUPPLEMENTS; NUTRITIONAL SUPPLEMENTS IN LOTION FORM SOLD AS A COMPONENT OF NUTRITIONAL SKIN CARE PRODUCTS; POWDERED FRUIT-FLAVORED DIETARY SUPPLEMENT DRINK MIX; POWDERED NUTRITIONAL SUPPLEMENT DRINK MIX; WHEAT FOR USE AS A DIETARY SUPPLEMENT (U.S. CLS. 6, 18, 44, 46, 51 AND 52).
 TRACY WHITTAKER-BROWN, EXAMINING ATTORNEY

CLASS 5—(Continued).

SN 77-316,081. VITAQUEST INTERNATIONAL LLC, WEST CALDWELL, NJ. FILED 10-29-2007.

AmlaSplash

THE MARK CONSISTS OF STANDARD CHARACTERS WITHOUT CLAIM TO ANY PARTICULAR FONT, STYLE, SIZE, OR COLOR.

FOR DIETARY SUPPLEMENTAL DRINKS; DIETARY SUPPLEMENTS (U.S. CLS. 6, 18, 44, 46, 51 AND 52).
SHANNON TWOHIG, EXAMINING ATTORNEY

SN 77-317,296. JARROW FORMULAS, INC., LOS ANGELES, CA. FILED 10-30-2007.

JARRO-DOPHILUS EPS

THE MARK CONSISTS OF STANDARD CHARACTERS WITHOUT CLAIM TO ANY PARTICULAR FONT, STYLE, SIZE, OR COLOR.

OWNER OF U.S. REG. NOS. 2,681,488, 3,339,174 AND OTHERS.

FOR DIETARY AND NUTRITIONAL SUPPLEMENTS (U.S. CLS. 6, 18, 44, 46, 51 AND 52).

FIRST USE 6-11-2001; IN COMMERCE 6-11-2001.
JAMES STEIN, EXAMINING ATTORNEY

SN 77-317,628. SARAMAR LLC, CHICAGO, IL. FILED 10-31-2007.

AMBI PUR

THE MARK CONSISTS OF STANDARD CHARACTERS WITHOUT CLAIM TO ANY PARTICULAR FONT, STYLE, SIZE, OR COLOR.

OWNER OF U.S. REG. NOS. 3,159,679, 3,234,112 AND OTHERS.

FOR AIR FRESHENING, AIR DEODORIZING AND ODOR NEUTRALIZING PREPARATIONS FOR THE AIR (U.S. CLS. 6, 18, 44, 46, 51 AND 52).

CAROL SPILS, EXAMINING ATTORNEY

CLASS 5—(Continued).

SN 77-318,913. NOVARTIS AG, BASEL, SWITZERLAND, FILED 11-1-2007.

BENEFIBER PLUS HEART HEALTH

THE MARK CONSISTS OF STANDARD CHARACTERS WITHOUT CLAIM TO ANY PARTICULAR FONT, STYLE, SIZE, OR COLOR.

OWNER OF U.S. REG. NOS. 1,792,114, 2,961,168 AND OTHERS.

NO CLAIM IS MADE TO THE EXCLUSIVE RIGHT TO USE "HEART HEALTH", APART FROM THE MARK AS SHOWN.

FOR DIETARY FIBER SUPPLEMENT AND LAXATIVE (U.S. CLS. 6, 18, 44, 46, 51 AND 52).

ELI HELLMAN, EXAMINING ATTORNEY

SN 77-326,160. CHAIN DRUG MARKETING ASSOCIATION, INC., NOVI, MI. FILED 11-9-2007.

QUALITY CHOICE

THE MARK CONSISTS OF STANDARD CHARACTERS WITHOUT CLAIM TO ANY PARTICULAR FONT, STYLE, SIZE, OR COLOR.

OWNER OF U.S. REG. NOS. 2,144,847 AND 2,964,690.

FOR ANTI-DIABETIC PHARMACEUTICALS, EAR WAX REMOVAL DROPS, ENEMA PREPARATIONS (U.S. CLS. 6, 18, 44, 46, 51 AND 52).

FIRST USE 1-1-1998; IN COMMERCE 1-1-1998.

MARY BOAGNI, EXAMINING ATTORNEY

SN 77-329,510. SERGEANT'S PET CARE PRODUCTS, INC., OMAHA, NE. FILED 11-14-2007.

SKIP-FLEA

THE MARK CONSISTS OF STANDARD CHARACTERS WITHOUT CLAIM TO ANY PARTICULAR FONT, STYLE, SIZE, OR COLOR.

OWNER OF U.S. REG. NO. 218,757.

FOR FLEA AND TICK SHAMPOO FOR PETS (U.S. CLS. 6, 18, 44, 46, 51 AND 52).

FIRST USE 6-0-1919; IN COMMERCE 6-0-1919.

BENJAMIN OKEKE, EXAMINING ATTORNEY

CLASS 5—(Continued).

SN 77-331,614. COASTSIDE BIO RESOURCES, STONINGTON, ME. FILED 11-16-2007.

OmegaHigh

THE MARK CONSISTS OF STANDARD CHARACTERS WITHOUT CLAIM TO ANY PARTICULAR FONT, STYLE, SIZE, OR COLOR.
FOR DIETARY SUPPLEMENTS FOR HUMAN CONSUMPTION (U.S. CLS. 6, 18, 44, 46, 51 AND 52).
FIRST USE 8-1-2007; IN COMMERCE 8-1-2007.
TASNEEM HUSSAIN, EXAMINING ATTORNEY

CLASS 5—(Continued).

SN 77-334,121. CANOPUS BIOPHARMA, STUDIO CITY, CA. FILED 11-20-2007.

Total CALM

THE MARK CONSISTS OF STANDARD CHARACTERS WITHOUT CLAIM TO ANY PARTICULAR FONT, STYLE, SIZE, OR COLOR.
FOR NUTRACEUTICALS FOR USE AS A DIETARY SUPPLEMENT (U.S. CLS. 6, 18, 44, 46, 51 AND 52).
ERNEST SHOSHO, EXAMINING ATTORNEY

SN 77-331,654. ESSENTIAL DENTAL SYSTEMS, INC., SOUTH HACKENSACK, NJ. FILED 11-16-2007.

ENDO-CHX

THE MARK CONSISTS OF STANDARD CHARACTERS WITHOUT CLAIM TO ANY PARTICULAR FONT, STYLE, SIZE, OR COLOR.
FOR DENTAL PRODUCT, NAMELY, ROOT CANAL CLEANSER (U.S. CLS. 6, 18, 44, 46, 51 AND 52).
FIRST USE 11-12-2007; IN COMMERCE 11-12-2007.
JUDITH HELFMAN, EXAMINING ATTORNEY

SN 77-334,249. CVS PHARMACY, INC., WOONSOCKET, RI. FILED 11-20-2007.

SIMPLY EARTH

THE MARK CONSISTS OF STANDARD CHARACTERS WITHOUT CLAIM TO ANY PARTICULAR FONT, STYLE, SIZE, OR COLOR.
FOR VITAMINS (U.S. CLS. 6, 18, 44, 46, 51 AND 52).
ZACHARY BELLO, EXAMINING ATTORNEY

SN 77-333,035. INTERVET INC., MILLSBORO, DE. FILED 11-19-2007.

ONSET

THE MARK CONSISTS OF STANDARD CHARACTERS WITHOUT CLAIM TO ANY PARTICULAR FONT, STYLE, SIZE, OR COLOR.
FOR CATTLE VACCINES (U.S. CLS. 6, 18, 44, 46, 51 AND 52).
BARBARA GAYNOR, EXAMINING ATTORNEY

SN 77-334,930. W.F. YOUNG, INCORPORATED, EAST LONGMEADOW, MA. FILED 11-21-2007.

SHOER'S FRIEND

THE MARK CONSISTS OF STANDARD CHARACTERS WITHOUT CLAIM TO ANY PARTICULAR FONT, STYLE, SIZE, OR COLOR.
FOR ANIMAL FEED ADDITIVE FOR USE AS A NUTRITIONAL SUPPLEMENT (U.S. CLS. 6, 18, 44, 46, 51 AND 52).
FIRST USE 12-0-2000; IN COMMERCE 12-0-2000.
MARIA-VICTORIA SUAREZ, EXAMINING ATTORNEY

CLASS 5—(Continued).

SN 77-334,962. W.F. YOUNG, INCORPORATED, EAST LONGMEADOW, MA. FILED 11-21-2007.

MORE MUSCLE

THE MARK CONSISTS OF STANDARD CHARACTERS WITHOUT CLAIM TO ANY PARTICULAR FONT, STYLE, SIZE, OR COLOR.

FOR ANIMAL FEED ADDITIVE FOR USE AS A NUTRITIONAL SUPPLEMENT (U.S. CLS. 6, 18, 44, 46, 51 AND 52).

FIRST USE 1-0-2001; IN COMMERCE 1-0-2001.

MARIA-VICTORIA SUAREZ, EXAMINING ATTORNEY

SN 77-335,143. TEVA SPECIALTY PHARMACEUTICALS LLC, HORSHAM, PA. FILED 11-21-2007.

REACH FOR RELIEF

THE MARK CONSISTS OF STANDARD CHARACTERS WITHOUT CLAIM TO ANY PARTICULAR FONT, STYLE, SIZE, OR COLOR.

FOR INHALERS FILLED WITH PHARMACEUTICAL PREPARATIONS FOR THE TREATMENT OF RESPIRATORY DISEASE (U.S. CLS. 6, 18, 44, 46, 51 AND 52).

ANDREW RHIM, EXAMINING ATTORNEY

SN 77-336,559. PORTELA & CA., S.A., 4745-457 SAO MA-MEDE, PORTUGAL, FILED 11-26-2007.

EXALIEF

THE MARK CONSISTS OF STANDARD CHARACTERS WITHOUT CLAIM TO ANY PARTICULAR FONT, STYLE, SIZE, OR COLOR.

OWNER OF PORTUGAL REG. NO. 391954, DATED 4-9-2006, EXPIRES 4-9-2016.

FOR PHARMACEUTICAL PREPARATIONS FOR THE TREATMENT OF DISEASES AND DISORDERS OF THE CENTRAL AND PERIPHERAL NERVOUS SYSTEM; PHARMACEUTICAL PREPARATIONS FOR THE TREATMENT OF PARKINSON'S DISEASE; PHARMACEUTICAL PREPARATIONS FOR THE TREATMENT OF CARDIOVASCULAR DISEASES (U.S. CLS. 6, 18, 44, 46, 51 AND 52).

ALYSSA PALADINO, EXAMINING ATTORNEY

CLASS 5—(Continued).

SN 77-342,259. MAKHTESHIM AGAN OF NORTH AMERICA, INC., RALEIGH, NC. FILED 12-3-2007.

LEGION

THE MARK CONSISTS OF STANDARD CHARACTERS WITHOUT CLAIM TO ANY PARTICULAR FONT, STYLE, SIZE, OR COLOR.

FOR PESTICIDES, FUNGICIDES, HERBICIDES AND INSECTICIDES FOR AGRICULTURAL USE (U.S. CLS. 6, 18, 44, 46, 51 AND 52).

HENRY S. ZAK, EXAMINING ATTORNEY

SN 77-344,765. CANOPUS BIOPHARMA, STUDIO CITY, CA. FILED 12-5-2007.

SpirH

THE MARK CONSISTS OF STANDARD CHARACTERS WITHOUT CLAIM TO ANY PARTICULAR FONT, STYLE, SIZE, OR COLOR.

FOR PHARMACEUTICAL PREPARATIONS FOR THE PREVENTION AND TREATMENT OF OCULAR DISORDERS OR DISEASES, FOR THE TREATMENT OF BACTERIA-BASED DISEASES, AND FOR THE TREATMENT OF DIABETES AND ANTI-INFECTIVE PREPARATIONS, ANTIVIRAL PREPARATIONS, ANTIBIOTICS, ANTIFUNGAL PREPARATIONS AND VACCINES (U.S. CLS. 6, 18, 44, 46, 51 AND 52).

ERNEST SHOSHO, EXAMINING ATTORNEY

SN 78-226,483. ASTRAZENECA AB, SODERTALJE, SWEDEN, FILED 3-17-2003.

VAROMBIS

OWNER OF ERPN CMNTY TM OFC REG. NO. 004884581, DATED 3-5-2007, EXPIRES 2-2-2016.

FOR PHARMACEUTICAL PREPARATIONS FOR THE TREATMENT OF CARDIO-VASCULAR DISEASES (U.S. CLS. 6, 18, 44, 46, 51 AND 52).

JOHN GARTNER, EXAMINING ATTORNEY

CLASS 5—(Continued).

SN 78-817,064. VANG, TONG, GRAND RAPIDS, MI. FILED 2-16-2006.

Glyco-8

THE MARK CONSISTS OF STANDARD CHARACTERS WITHOUT CLAIM TO ANY PARTICULAR FONT, STYLE, SIZE, OR COLOR.

FOR DIETARY SUPPLEMENT IN THE NATURE OF A GLYCOGEN COMPLEX CONTAINING EIGHT ESSENTIAL SUGARS (U.S. CLS. 6, 18, 44, 46, 51 AND 52).

FIRST USE 1-1-2006; IN COMMERCE 2-7-2006.
COLLEEN KEARNEY, EXAMINING ATTORNEY

SN 78-817,065. VANG, TONG, GRAND RAPIDS, MI. FILED 2-16-2006.

Techmedica Health

THE MARK CONSISTS OF STANDARD CHARACTERS WITHOUT CLAIM TO ANY PARTICULAR FONT, STYLE, SIZE, OR COLOR.

NO CLAIM IS MADE TO THE EXCLUSIVE RIGHT TO USE "HEALTH", APART FROM THE MARK AS SHOWN.

FOR DIETARY SUPPLEMENTS (U.S. CLS. 6, 18, 44, 46, 51 AND 52).
FIRST USE 6-1-2004; IN COMMERCE 1-1-2005.
COLLEEN KEARNEY, EXAMINING ATTORNEY

SN 78-823,355. GUNA INC., ALBUQUERQUE, NM. FILED 2-25-2006.

MYCOX

THE MARK CONSISTS OF THE WORD "MYCOX" IS WRITTEN IN BETWEEN TO LINES ABOVE AND BELOW. FOR HOMEOPATHIC MEDICINE FOR THE TREATMENT OF YEAST INFECTION (U.S. CLS. 6, 18, 44, 46, 51 AND 52).

FIRST USE 0-0-1995; IN COMMERCE 2-21-2006.
SAMUEL E. SHARPER JR., EXAMINING ATTORNEY

CLASS 5—(Continued).

SN 78-902,232. GUNA INC., ALBUQUERQUE, NM. FILED 6-6-2006.

ANTI AGE SKIN

NO CLAIM IS MADE TO THE EXCLUSIVE RIGHT TO USE "ANTI AGE SKIN", APART FROM THE MARK AS SHOWN.

FOR HOMEOPATHIC PHARMACEUTICALS FOR USE IN THE TREATMENT OF SKIN DISORDERS (U.S. CLS. 6, 18, 44, 46, 51 AND 52).

FIRST USE 9-10-2005; IN COMMERCE 3-15-2006.
WENDY GOODMAN, EXAMINING ATTORNEY

SN 78-936,596. VET BRANDS INTERNATIONAL, INC., MIRAMAR, FL. FILED 7-25-2006.

V.E.T. Pharmaceuticals

NO CLAIM IS MADE TO THE EXCLUSIVE RIGHT TO USE "VET" AND "PHARMACEUTICALS", APART FROM THE MARK AS SHOWN.

THE COLOR(S) BLACK, WHITE AND RED IS/ARE CLAIMED AS A FEATURE OF THE MARK.

THE MARK CONSISTS OF A BLACK RECTANGULAR BACKGROUND, WITH RED ILLUSTRATED ANIMAL PAW PRINTS APPEARING IN THE UPPER RIGHT HAND CORNER AND THE LETTERS "V.E.T." IN WHITE LETTERS ON TOP OF THE WORD "PHARMACEUTICALS" ALSO IN WHITE LETTERS BENEATH.

FOR ANIMAL FEED SUPPLEMENTS; DIETARY SUPPLEMENTS FOR ANIMALS; FEED SUPPLEMENTS FOR DOGS, CATS AND LIVESTOCK; MEDICATED ANIMAL FEED; NUTRITIONAL ADDITIVES TO FOODSTUFFS FOR ANIMALS, FOR MEDICAL PURPOSES; PHARMACEUTICAL PREPARATIONS FOR ANIMAL SKINCARE; PHARMACEUTICAL PRODUCTS FOR SKIN CARE FOR ANIMALS; PREPARATIONS TO PREVENT CHEWING OR BITING BY ANIMALS; VETERINARY PREPARATIONS FOR THE TREATMENT OF URINARY INFECTIONS AND CONDITIONS IN CATS AND DOGS; PREPARATIONS FOR CATS AND DOGS WITH DEFICIENT DIGESTIVE CONDITIONS; PREPARATIONS FOR DOGS AND CATS IN NEED OF ENZYME REPLACEMENT THERAPY OR SUPPLEMENTS; PREPARATIONS FOR DOGS SUFFERING FROM HYPOTHYROIDISM (U.S. CLS. 6, 18, 44, 46, 51 AND 52).

FIRST USE 7-1-2003; IN COMMERCE 7-1-2003.
KENNETH E. SHARPERSON, EXAMINING ATTORNEY

CLASS 5—(Continued).

SN 78-939,377. STI LABS, INC., TARZANA, CA. FILED 7-27-2006.

twinkle

THE MARK CONSISTS OF STANDARD CHARACTERS WITHOUT CLAIM TO ANY PARTICULAR FONT, STYLE, SIZE, OR COLOR.

FOR OVER THE COUNTER EYE DROPS FOR BEAUTY (U.S. CLS. 6, 18, 44, 46, 51 AND 52).

FIRST USE 5-15-2006; IN COMMERCE 7-17-2006.
JAMES GRIFFIN, EXAMINING ATTORNEY

SN 78-941,598. ADNEXUS, A BRISTOL-MYERS SQUIBB R&D COMPANY, WALTHAM, MA. FILED 7-31-2006.

ADNEXUS THERAPEUTICS

THE MARK CONSISTS OF STANDARD CHARACTERS WITHOUT CLAIM TO ANY PARTICULAR FONT, STYLE, SIZE, OR COLOR.

NO CLAIM IS MADE TO THE EXCLUSIVE RIGHT TO USE "THERAPEUTICS", APART FROM THE MARK AS SHOWN.

FOR BIOTECHNOLOGY AND PHARMACEUTICAL PRODUCTS, NAMELY, THERAPEUTIC PROTEINS FOR HUMAN USE FOR THE TREATMENT AND PREVENTION OF OBESITY, DIABETES, INCONTINENCE, CARDIOVASCULAR DISEASES, CENTRAL NERVOUS SYSTEM DISEASES AND DISORDERS, METABOLIC DISORDERS, STROKE, CANCER, INFLAMMATION AND INFLAMMATORY DISEASES, RESPIRATORY AND INFECTIOUS DISEASES, AUTO-IMMUNE DISEASES, SOLID ORGAN TRANSPLANT REJECTION; PHARMACEUTICAL PREPARATIONS FOR HUMAN USE, NAMELY, ANTIBIOTICS, ANTI-FUNGALS, ANTI-VIRALS, IMMUNOSUPPRESSANTS AND PHARMACEUTICAL ANTIBODIES (U.S. CLS. 6, 18, 44, 46, 51 AND 52).
BARBARA BROWN, EXAMINING ATTORNEY

SN 78-948,582. GOOD HEALTH NATURALLY, INC., LAS VEGAS, NV. FILED 8-9-2006.

SERRAPLUS+

THE MARK CONSISTS OF STANDARD CHARACTERS WITHOUT CLAIM TO ANY PARTICULAR FONT, STYLE, SIZE, OR COLOR.

FOR DIETARY AND NUTRITIONAL SUPPLEMENTS; DIETARY SUPPLEMENTS; MINERAL SUPPLEMENTS; VITAMINS (U.S. CLS. 6, 18, 44, 46, 51 AND 52).

FIRST USE 4-27-2005; IN COMMERCE 4-27-2005.
BENJAMIN ALLEN, EXAMINING ATTORNEY

CLASS 5—(Continued).

SN 78-948,733. SOLVAY PHARMACEUTICALS B.V., WEESP, NETHERLANDS, FILED 8-9-2006.

FLUSHIELD

THE MARK CONSISTS OF STANDARD CHARACTERS WITHOUT CLAIM TO ANY PARTICULAR FONT, STYLE, SIZE, OR COLOR.

OWNER OF NETHERLANDS REG. NO. 005248224, DATED 10-18-2007, EXPIRES 10-18-2017.

FOR INFLUENZA VIRUS VACCINES; VACCINES AND ADJUVANTS FOR VACCINES ALL FOR HUMAN USE (U.S. CLS. 6, 18, 44, 46, 51 AND 52).

HOWARD SMIGA, EXAMINING ATTORNEY

SN 78-950,560. COHEN, JEFFREY A., MARINA DEL REY, CA. FILED 8-11-2006.

HEART ON

THE MARK CONSISTS OF STANDARD CHARACTERS WITHOUT CLAIM TO ANY PARTICULAR FONT, STYLE, SIZE, OR COLOR.

NO CLAIM IS MADE TO THE EXCLUSIVE RIGHT TO USE "HEART", APART FROM THE MARK AS SHOWN.

FOR NUTRITIONAL, VITAMIN, MINERAL, HERBAL AND DIETARY SUPPLEMENTS TO ENHANCE AND PROMOTE HEART HEALTH AND FUNCTION, CARDIO-VASCULAR HEALTH AND FUNCTION, CIRCULATORY AND RESPIRATORY HEALTH AND FUNCTION, SEX DRIVE AND SEXUAL PERFORMANCE AND SEXUAL FUNCTION AND HEALTH, METABOLIC HEALTH AND FUNCTION, AND OVERALL HEALTH AND WELL BEING; BOTANICAL NUTRITIONAL SUPPLEMENTS; HOMEOPATHIC SUPPLEMENTS; NUTRACEUTICAL DIETARY SUPPLEMENTS; NON-PRESCRIPTION HEALTH SUPPLEMENTS AND PREPARATIONS FOR THE TREATMENT OF HEART AND CIRCULATORY AILMENTS AND SEXUAL PERFORMANCE AND DYSFUNCTION; FOOD SUPPLEMENTS; NUTRITIONAL ADDITIVES FOR MEDICAL PURPOSES FOR USE IN DIETARY SUPPLEMENTS FOR HUMAN CONSUMPTION; MEDICATED CHEWING GUM; MEDICATED MINTS (U.S. CLS. 6, 18, 44, 46, 51 AND 52).

FIRST USE 3-19-1996; IN COMMERCE 3-19-1996.

KAPIL BHANOT, EXAMINING ATTORNEY

CLASS 5—(Continued).

SN 79-030,175. IMF ALLIANCE CORPORATION S.A., SOCIÉTÉ ANONYME, LUXEMBOURG, FILED 3-7-2006.



PRIORITY DATE OF 9-9-2005 IS CLAIMED.

OWNER OF INTERNATIONAL REGISTRATION 0901756 DATED 3-7-2006, EXPIRES 3-7-2016.

FOR FOOD SUPPLEMENTS, NAMELY, WHOLE NATURAL FOOD SUPPLEMENTS ADAPTED FOR MEDICAL USE; FOOD SUPPLEMENTS FOR MEDICAL OR THERAPEUTIC USE AND HEALTH FOOD SUPPLEMENTS CONSISTING PRINCIPALLY OF VITAMINS AND/OR MINERALS; DIETARY SUPPLEMENTS, NAMELY, ENZYMES AND DIETARY SUPPLEMENTS FOR MEDICAL OR THERAPEUTIC USE; VITAMIN ENRICHED FOOD FOR MEDICAL AND THERAPEUTIC USE; VITAMIN AND MINERAL PREPARATIONS FOR MEDICAL OR THERAPEUTIC USE, NAMELY, DIETETIC FOOD AND FOOD SUPPLEMENTS; VITAMIN AND MINERAL PREPARATIONS FOR MEDICAL USE, NAMELY, NUTRIENTS FOR USE AS DIETARY SUPPLEMENTS, NUTRITIONAL SUPPLEMENTS AND MULTI-VITAMIN PREPARATIONS; NAMELY, NUTRIENTS FOR USE AS DIETARY SUPPLEMENTS AND NUTRITIONAL SUPPLEMENTS FOR ESTHETIC PURPOSES, MULTI-VITAMIN PREPARATIONS AND NUTRIENTS FOR USE AS DIETARY SUPPLEMENTS PROVIDING SELECTIVE ABSORPTION OF THEIR PROPERTIES IN THE BODY FOR MEDICAL OR THERAPEUTIC USE; NUTRITIONAL SUPPLEMENTS FOR MEDICAL USE, NAMELY, NUTRITIONAL SUPPLEMENTS CONTAINING EXTRACTS OF PLANTS AND HERBS; HEALTH CARE PRODUCTS FOR MEDICAL USE, NAMELY, MULTI-VITAMIN PREPARATIONS, MINERAL NUTRITIONAL SUPPLEMENTS; DIETARY AND NUTRITIONAL SUPPLEMENTS FOR MEDICAL USE, NAMELY, SUPPLEMENTS TO PROMOTE AND AID THE INTAKE AND EFFECTIVENESS OF OTHER SUPPLEMENTS AND NUTRIENTS; VITAMINS FOR MEDICAL USE AND MINERAL SUPPLEMENTS FOR MEDICAL USE; TRACE MINERAL SUPPLEMENTS FOR MEDICAL USE; NUTRITIONAL SUPPLEMENTS, NAMELY, ENZYMES AND CO-ENZYMES FOR MEDICAL USE; FOOD SUPPLEMENTS ADAPTED FOR MEDICAL USE, NAMELY, ANTIOXIDANTS; AMINO ACIDS FOR MEDICAL PURPOSES; NUTRITIONAL OILS NOT FOR FOOD OR COSMETIC PURPOSES, NAMELY, NUTRITIONAL OILS FOR MEDICAL, HEALTH AND THERAPEUTIC PURPOSES; DIETARY AND NUTRITIONAL SUPPLEMENTS ADAPTED FOR MEDICAL USE CONSISTING OF ENZYMATICALLY ACTIVE, INTERRELATED, INTERWOVEN AND INTERDEPENDENT NUTRIENTS; NUTRITIONAL SUPPLEMENTS IN CAPSULE FORM ADAPTED FOR MEDICAL USE; NUTRACEUTICALS AS A DIETARY SUPPLEMENT; NUTRITIONALLY FORTIFIED BEVERAGES, NAMELY, NUTRITIONAL TONICS AND TONICS FOR MEDICINAL PURPOSES; NUTRITIONALLY FORTIFIED BEVERAGES, MEDICINAL HERBS AND ROOTS IN DRIED OR PRESERVED FORM, NAMELY, HERBS AND ROOTS FOR MEDICINAL AND THERAPEUTIC USE; HERB TEAS FOR MEDICINAL PURPOSES (U.S. CLS. 6, 18, 44, 46, 51 AND 52).

TINA BROWN, EXAMINING ATTORNEY

CLASS 5—(Continued).

SN 79-031,385. PRO NATURA GESELLSCHAFT, FÜR GESUNDE ERNÄHRUNG MBH, FED REP GERMANY, FILED 5-29-2006.

Fructaid

THE MARK CONSISTS OF STANDARD CHARACTERS WITHOUT CLAIM TO ANY PARTICULAR FONT, STYLE, SIZE, OR COLOR.

PRIORITY DATE OF 12-1-2005 IS CLAIMED.

OWNER OF INTERNATIONAL REGISTRATION 0904712 DATED 5-29-2006, EXPIRES 5-29-2016.

FOR PHARMACEUTICAL AND VETERINARY PREPARATIONS AS WELL AS PREPARATIONS FOR HEALTHCARE, NAMELY, PHARMACEUTICAL AND HEALTHCARE PREPARATIONS, INCLUDING DIETARY SUPPLEMENTS, FOR THE TREATMENT OF FRUCTOSE INTOLERANCE, INCLUDING HEREDITARY FRUCTOSE INTOLERANCE AND INTESTINAL FRUCTOSE INTOLERANCE, LACK OF FRUCTOSE 1,6-DIPHOSPHATASE, DIABETES, INCLUDING DIABETES MELLITUS TYPE I AND DIABETES MELLITUS TYPE II, CARDIOVASCULAR DISEASE, INCLUDING HYPERTENSION AND CORONARY HEART DISEASE, METABOLIC SYNDROME, ADIPOSITY AND OBESITY AND VETERINARY PREPARATIONS FOR THE TREATMENT OF FRUCTOSE INTOLERANCE AND OBESITY IN DOGS AND CATS; DIETETIC FOODS AND DRINKS AND FOOD SUPPLEMENTS AND DIETARY SUPPLEMENTS FOR MEDICAL USE; FOOD SUPPLEMENTS AND DIETARY SUPPLEMENTS FOR NONMEDICAL USE, NAMELY, ENZYMES FOR DIGESTIVE PURPOSES; FOOD FOR BABIES (U.S. CLS. 6, 18, 44, 46, 51 AND 52).

DEBRA LEE, EXAMINING ATTORNEY

SN 79-035,407. MEDESTEA; RESEARCH & PRODUCTION S.P.A., ITALY, FILED 1-10-2007.



PRIORITY DATE OF 12-15-2006 IS CLAIMED.

OWNER OF INTERNATIONAL REGISTRATION 0916012 DATED 1-10-2007, EXPIRES 1-10-2017.

FOR WOUND DRESSINGS, MEDICAL AND SURGICAL BANDAGES AND DRESSINGS, MEDICATED TOPICAL SKIN GELS, CREAMS, CLEANSERS AND LOTIONS USED IN CONNECTION WITH WOUND CARE (U.S. CLS. 6, 18, 44, 46, 51 AND 52).

FLORENTINA BLANDU, EXAMINING ATTORNEY

CLASS 5—(Continued).

SN 79-036,756. PAUL WHYTE, AUSTRALIA, FILED 4-2-2007.

Satin Gel

THE MARK CONSISTS OF STANDARD CHARACTERS WITHOUT CLAIM TO ANY PARTICULAR FONT, STYLE, SIZE, OR COLOR.

OWNER OF INTERNATIONAL REGISTRATION 0919682 DATED 4-2-2007, EXPIRES 4-2-2017.

NO CLAIM IS MADE TO THE EXCLUSIVE RIGHT TO USE "GEL", APART FROM THE MARK AS SHOWN.

FOR PERSONAL LUBRICANT AND MEDICAL LUBRICANTS, NAMELY, ORAL, ANAL, VAGINAL LUBRICANTS (U.S. CLS. 6, 18, 44, 46, 51 AND 52).

CURTIS FRENCH, EXAMINING ATTORNEY

CLASS 5—(Continued).

SN 79-039,867. BÖRNER GMBH, FED REP GERMANY, FILED 1-31-2007.

SANHELIOS

OWNER OF INTERNATIONAL REGISTRATION 0506140 DATED 9-12-1986, EXPIRES 9-12-2016.

OWNER OF U.S. REG. NOS. 619,806 AND 2,563,323.

THE WORDING "SANHELIOS" HAS NO ENGLISH LANGUAGE TRANSLATION.

FOR DIETARY FOOD SUPPLEMENTS (U.S. CLS. 6, 18, 44, 46, 51 AND 52).

SHANNON TWOHIG, EXAMINING ATTORNEY

SN 79-037,866. MERCK KGAA, FED REP GERMANY, FILED 3-24-2007.

NEUBION

THE MARK CONSISTS OF STANDARD CHARACTERS WITHOUT CLAIM TO ANY PARTICULAR FONT, STYLE, SIZE, OR COLOR.

PRIORITY DATE OF 2-23-2007 IS CLAIMED.

OWNER OF INTERNATIONAL REGISTRATION 0922456 DATED 3-24-2007, EXPIRES 3-24-2017.

FOR PHARMACEUTICAL AND VETERINARY PREPARATIONS FOR TREATING PAIN, VITAMIN DEFICIENCIES, DIABETES AND RELATED CONDITIONS IN THE NATURE OF NEUROPATHY, RETINOPATHY, NEPHROPATHY AND VASCULAR DYSFUNCTION; SANITARY PREPARATIONS FOR MEDICAL PURPOSES; DIETETIC SUBSTANCES ADAPTED FOR MEDICAL USE (U.S. CLS. 6, 18, 44, 46, 51 AND 52).

NAAKWAMA ANKRAH, EXAMINING ATTORNEY

SN 79-043,336. NOVARTIS AG, SWITZERLAND, FILED 9-3-2007.

BYPAZIO

THE MARK CONSISTS OF STANDARD CHARACTERS WITHOUT CLAIM TO ANY PARTICULAR FONT, STYLE, SIZE, OR COLOR.

PRIORITY DATE OF 5-31-2007 IS CLAIMED.

OWNER OF INTERNATIONAL REGISTRATION 0936260 DATED 9-3-2007, EXPIRES 9-3-2017.

FOR PHARMACEUTICAL PREPARATIONS FOR THE PREVENTION AND TREATMENT OF DISEASES AND DISORDERS OF THE NERVOUS SYSTEM, THE IMMUNE SYSTEM, THE CARDIO-VASCULAR SYSTEM, THE METABOLIC SYSTEM, THE RESPIRATORY SYSTEM, THE GENITOURINARY SYSTEM, FOR MUSCULO-SKELETAL AND INFLAMMATORY DISORDERS, AND FOR USE IN DERMATOLOGY, ONCOLOGY, HEMATOLOGY, OPHTHALMOLOGY, AND IN TISSUE AND ORGAN TRANSPLANTATION, AND FOR THE TREATMENT OF DIABETES; PHARMACEUTICAL PREPARATIONS FOR THE PREVENTION AND TREATMENT OF GASTROENTEROLOGICAL DISORDERS, AND FOR THE PREVENTION AND TREATMENT OF OCULAR DISORDERS; PHARMACEUTICAL PRODUCTS, NAMELY, ANTI-INFECTIVE PREPARATIONS, ANTIBIOTICS, ANTIBACTERIAL SUBSTANCES FOR MEDICAL PURPOSES, ANTIVIRAL PREPARATIONS, ANTIFUNGAL PREPARATIONS, AND VACCINES (U.S. CLS. 6, 18, 44, 46, 51 AND 52).

SHAILA SETTLES, EXAMINING ATTORNEY

SN 79-038,092. GIACONDA LIMITED, SYDNEY, AUSTRALIA, FILED 2-26-2007.

PICOCONDA

THE MARK CONSISTS OF STANDARD CHARACTERS WITHOUT CLAIM TO ANY PARTICULAR FONT, STYLE, SIZE, OR COLOR.

PRIORITY DATE OF 11-9-2006 IS CLAIMED.

OWNER OF INTERNATIONAL REGISTRATION 0923036 DATED 2-26-2007, EXPIRES 2-26-2017.

FOR PHARMACEUTICALS FOR THE TREATMENT OF DISEASES OF THE STOMACH, INTESTINES AND BOWEL; PHARMACEUTICALS FOR PURGING OF THE SMALL AND LARGE INTESTINES; PHARMACEUTICALS FOR TREATMENT OF GASTROENTERITIS AND CONSTIPATION (U.S. CLS. 6, 18, 44, 46, 51 AND 52).

GINA FINK, EXAMINING ATTORNEY

CLASS 5—(Continued).

SN 79-043,337. NOVARTIS AG, SWITZERLAND, FILED 9-3-2007.

OVERGIC

THE MARK CONSISTS OF STANDARD CHARACTERS WITHOUT CLAIM TO ANY PARTICULAR FONT, STYLE, SIZE, OR COLOR.

PRIORITY DATE OF 5-31-2007 IS CLAIMED.
OWNER OF INTERNATIONAL REGISTRATION 0936261 DATED 9-3-2007, EXPIRES 9-3-2017.

FOR PHARMACEUTICAL PREPARATIONS FOR THE PREVENTION AND TREATMENT OF DISEASES AND DISORDERS OF THE NERVOUS SYSTEM, THE IMMUNE SYSTEM, THE CARDIO-VASCULAR SYSTEM, THE METABOLIC SYSTEM, THE RESPIRATORY SYSTEM, THE GENITOURINARY SYSTEM, FOR MUSCULO-SKELETAL AND INFLAMMATORY DISORDERS, AND FOR USE IN DERMATOLOGY, ONCOLOGY, HEMATOLOGY, OPHTHALMOLOGY, AND IN TISSUE AND ORGAN TRANSPLANTATION, AND FOR THE TREATMENT OF DIABETES; PHARMACEUTICAL PREPARATIONS FOR THE PREVENTION AND TREATMENT OF GASTROENTEROLOGICAL DISORDERS, AND FOR THE PREVENTION AND TREATMENT OF OCULAR DISORDERS; PHARMACEUTICAL PRODUCTS, NAMELY, ANTI-INFECTIVE PREPARATIONS, ANTIBIOTICS, ANTIBACTERIAL SUBSTANCES FOR MEDICAL PURPOSES, ANTIVIRAL PREPARATIONS, ANTIFUNGAL PREPARATIONS, AND VACCINES (U.S. CLS. 6, 18, 44, 46, 51 AND 52).

SHAILA SETTLES, EXAMINING ATTORNEY

CLASS 5—(Continued).

SN 79-043,339. NOVARTIS AG, SWITZERLAND, FILED 8-31-2007.

JAKAVI

THE MARK CONSISTS OF STANDARD CHARACTERS WITHOUT CLAIM TO ANY PARTICULAR FONT, STYLE, SIZE, OR COLOR.

PRIORITY DATE OF 5-31-2007 IS CLAIMED.
OWNER OF INTERNATIONAL REGISTRATION 0936263 DATED 8-31-2007, EXPIRES 8-31-2017.

FOR PHARMACEUTICAL PREPARATIONS FOR THE PREVENTION AND TREATMENT OF DISEASES AND DISORDERS OF THE NERVOUS SYSTEM, THE IMMUNE SYSTEM, THE CARDIO-VASCULAR SYSTEM, THE METABOLIC SYSTEM, THE RESPIRATORY SYSTEM, THE GENITOURINARY SYSTEM, FOR MUSCULO-SKELETAL AND INFLAMMATORY DISORDERS, AND FOR USE IN DERMATOLOGY, ONCOLOGY, HEMATOLOGY, OPHTHALMOLOGY, AND IN TISSUE AND ORGAN TRANSPLANTATION, AND FOR THE TREATMENT OF DIABETES; PHARMACEUTICAL PREPARATIONS FOR THE PREVENTION AND TREATMENT OF GASTROENTEROLOGICAL DISORDERS, AND FOR THE PREVENTION AND TREATMENT OF OCULAR DISORDERS; PHARMACEUTICAL PRODUCTS, NAMELY, ANTI-INFECTIVE PREPARATIONS, ANTIBIOTICS, ANTIBACTERIAL SUBSTANCES FOR MEDICAL PURPOSES, ANTIVIRAL PREPARATIONS, ANTIFUNGAL PREPARATIONS, AND VACCINES (U.S. CLS. 6, 18, 44, 46, 51 AND 52).

SHAILA SETTLES, EXAMINING ATTORNEY

SN 79-043,338. NOVARTIS AG, SWITZERLAND, FILED 8-31-2007.

MAYZENT

THE MARK CONSISTS OF STANDARD CHARACTERS WITHOUT CLAIM TO ANY PARTICULAR FONT, STYLE, SIZE, OR COLOR.

PRIORITY DATE OF 5-31-2007 IS CLAIMED.
OWNER OF INTERNATIONAL REGISTRATION 0936262 DATED 8-31-2007, EXPIRES 8-31-2017.

FOR PHARMACEUTICAL PREPARATIONS FOR THE PREVENTION AND TREATMENT OF DISEASES AND DISORDERS OF THE NERVOUS SYSTEM, THE IMMUNE SYSTEM, THE CARDIO-VASCULAR SYSTEM, THE METABOLIC SYSTEM, THE RESPIRATORY SYSTEM, THE GENITOURINARY SYSTEM, FOR MUSCULO-SKELETAL AND INFLAMMATORY DISORDERS, AND FOR USE IN DERMATOLOGY, ONCOLOGY, HEMATOLOGY, OPHTHALMOLOGY, AND IN TISSUE AND ORGAN TRANSPLANTATION, AND FOR THE TREATMENT OF DIABETES; PHARMACEUTICAL PREPARATIONS FOR THE PREVENTION AND TREATMENT OF GASTROENTEROLOGICAL DISORDERS, AND FOR THE PREVENTION AND TREATMENT OF OCULAR DISORDERS; PHARMACEUTICAL PRODUCTS, NAMELY, ANTI-INFECTIVE PREPARATIONS, ANTIBIOTICS, ANTIBACTERIAL SUBSTANCES FOR MEDICAL PURPOSES, ANTIVIRAL PREPARATIONS, ANTIFUNGAL PREPARATIONS, AND VACCINES (U.S. CLS. 6, 18, 44, 46, 51 AND 52).

SHAILA SETTLES, EXAMINING ATTORNEY

SN 79-043,340. NOVARTIS AG, SWITZERLAND, FILED 9-12-2007.

JAKAZO

THE MARK CONSISTS OF STANDARD CHARACTERS WITHOUT CLAIM TO ANY PARTICULAR FONT, STYLE, SIZE, OR COLOR.

PRIORITY DATE OF 5-31-2007 IS CLAIMED.
OWNER OF INTERNATIONAL REGISTRATION 0936264 DATED 9-12-2007, EXPIRES 9-12-2017.

FOR PHARMACEUTICAL PREPARATIONS FOR THE PREVENTION AND TREATMENT OF DISEASES AND DISORDERS OF THE NERVOUS SYSTEM, THE IMMUNE SYSTEM, THE CARDIO-VASCULAR SYSTEM, THE METABOLIC SYSTEM, THE RESPIRATORY SYSTEM, THE GENITOURINARY SYSTEM, FOR MUSCULO-SKELETAL AND INFLAMMATORY DISORDERS, AND FOR USE IN DERMATOLOGY, ONCOLOGY, HEMATOLOGY, OPHTHALMOLOGY, AND IN TISSUE AND ORGAN TRANSPLANTATION, AND FOR THE TREATMENT OF DIABETES; PHARMACEUTICAL PREPARATIONS FOR THE PREVENTION AND TREATMENT OF GASTROENTEROLOGICAL DISORDERS, AND FOR THE PREVENTION AND TREATMENT OF OCULAR DISORDERS; PHARMACEUTICAL PRODUCTS, NAMELY, ANTI-INFECTIVE PREPARATIONS, ANTIBIOTICS, ANTIBACTERIAL SUBSTANCES FOR MEDICAL PURPOSES, ANTIVIRAL PREPARATIONS, ANTIFUNGAL PREPARATIONS, AND VACCINES (U.S. CLS. 6, 18, 44, 46, 51 AND 52).

SHAILA SETTLES, EXAMINING ATTORNEY

CLASS 5—(Continued).

SN 79-043,585. NOVARTIS AG, SWITZERLAND, FILED 8-31-2007.

RYDAPT

THE MARK CONSISTS OF STANDARD CHARACTERS WITHOUT CLAIM TO ANY PARTICULAR FONT, STYLE, SIZE, OR COLOR.

PRIORITY DATE OF 5-31-2007 IS CLAIMED.

OWNER OF INTERNATIONAL REGISTRATION 0936793 DATED 8-31-2007, EXPIRES 8-31-2017.

FOR PHARMACEUTICAL PREPARATIONS FOR THE PREVENTION AND TREATMENT OF DISEASES AND DISORDERS OF THE NERVOUS SYSTEM, THE IMMUNE SYSTEM, THE CARDIO-VASCULAR SYSTEM, THE METABOLIC SYSTEM, THE RESPIRATORY SYSTEM, THE GENITOURINARY SYSTEM, FOR MUSCULO-SKELETAL AND INFLAMMATORY DISORDERS, AND FOR USE IN DERMATOLOGY, ONCOLOGY, HEMATOLOGY, OPHTHALMOLOGY, AND IN TISSUE AND ORGAN TRANSPLANTATION, AND FOR THE TREATMENT OF DIABETES; PHARMACEUTICAL PREPARATIONS FOR THE PREVENTION AND TREATMENT OF GASTROENTEROLOGICAL DISORDERS, AND FOR THE PREVENTION AND TREATMENT OF OCULAR DISORDERS; PHARMACEUTICAL PRODUCTS, NAMELY, ANTI-INFECTIVE PREPARATIONS, ANTIBIOTICS, ANTIBACTERIAL SUBSTANCES FOR MEDICAL PURPOSES, ANTIVIRAL PREPARATIONS, ANTIFUNGAL PREPARATIONS, AND VACCINES (U.S. CLS. 6, 18, 44, 46, 51 AND 52).

SHAILA SETTLES, EXAMINING ATTORNEY

CLASS 5—(Continued).

SN 79-044,064. BOEHRINGER INGELHEIM INTERNATIONAL GMBH, FED REP GERMANY, FILED 8-28-2007.

TAQALU

THE MARK CONSISTS OF STANDARD CHARACTERS WITHOUT CLAIM TO ANY PARTICULAR FONT, STYLE, SIZE, OR COLOR.

PRIORITY DATE OF 2-28-2007 IS CLAIMED.

OWNER OF INTERNATIONAL REGISTRATION 0938203 DATED 8-28-2007, EXPIRES 8-28-2017.

FOR PHARMACEUTICAL PREPARATIONS AND SUBSTANCES FOR THE TREATMENT OF DISEASES AND DISORDERS OF THE ALIMENTARY TRACT AND METABOLISM, BLOOD AND BLOOD FORMING ORGANS, THE CARDIOVASCULAR SYSTEM, THE MUSCULOSKELETAL SYSTEM, THE CENTRAL NERVOUS SYSTEM, THE PERIPHERAL NERVOUS SYSTEM, THE GENITOURINARY SYSTEM, THE RESPIRATORY SYSTEM, AND DERMATOLOGICAL DISORDERS, HORMONES FOR MEDICAL PURPOSES, ANTI-INFECTIVE PREPARATIONS, ANTI-VIRAL PREPARATIONS AND CYTOSTATIC PREPARATIONS FOR USE IN THE TREATMENT OF CANCER (U.S. CLS. 6, 18, 44, 46, 51 AND 52).

MICHAEL TANNER, EXAMINING ATTORNEY

SN 79-043,586. NOVARTIS AG, SWITZERLAND, FILED 8-31-2007.

PURTRIO

THE MARK CONSISTS OF STANDARD CHARACTERS WITHOUT CLAIM TO ANY PARTICULAR FONT, STYLE, SIZE, OR COLOR.

PRIORITY DATE OF 5-31-2007 IS CLAIMED.

OWNER OF INTERNATIONAL REGISTRATION 0936794 DATED 8-31-2007, EXPIRES 8-31-2017.

FOR PHARMACEUTICAL PREPARATIONS FOR THE PREVENTION OF AND TREATMENT OF DISORDERS OF THE NERVOUS SYSTEM, THE IMMUNE SYSTEM, THE CARDIO-VASCULAR SYSTEM INCLUDING DIABETES AND METABOLIC DISEASES, THE RESPIRATORY SYSTEM, THE MUSCULOSKELETAL SYSTEM, THE GENITOURINARY SYSTEM; FOR THE TREATMENT OF INFLAMMATORY DISORDERS; FOR USE IN DERMATOLOGY, IN ONCOLOGY, IN HEMATOLOGY, IN TRANSPLANTATION, IN OPHTHALMOLOGY, AND IN THE GASTROENTEROLOGICAL AREA; FOR THE PREVENTION AND TREATMENT OF OCULAR DISORDERS OR DISEASES; PHARMACEUTICAL PREPARATIONS FOR THE TREATMENT OF BACTERIA-BASED DISEASES; ANTI-INFECTIVES, ANTIVIRALS, ANTIBIOTICS, ANTIFUNGALS, VACCINES, AND DIAGNOSTIC PREPARATIONS FOR MEDICAL USE (U.S. CLS. 6, 18, 44, 46, 51 AND 52).

ELI HELLMAN, EXAMINING ATTORNEY

SN 79-044,065. BOEHRINGER INGELHEIM INTERNATIONAL GMBH, FED REP GERMANY, FILED 8-28-2007.

YADRANAY

THE MARK CONSISTS OF STANDARD CHARACTERS WITHOUT CLAIM TO ANY PARTICULAR FONT, STYLE, SIZE, OR COLOR.

PRIORITY DATE OF 5-4-2007 IS CLAIMED.

OWNER OF INTERNATIONAL REGISTRATION 0938204 DATED 8-28-2007, EXPIRES 8-28-2017.

FOR PHARMACEUTICAL PREPARATIONS AND SUBSTANCES FOR THE TREATMENT OF DISEASES AND DISORDERS OF THE ALIMENTARY TRACT AND METABOLISM, BLOOD AND BLOOD FORMING ORGANS, THE CARDIOVASCULAR SYSTEM, THE MUSCULOSKELETAL SYSTEM, THE CENTRAL NERVOUS SYSTEM, THE PERIPHERAL NERVOUS SYSTEM, THE GENITOURINARY SYSTEM, THE RESPIRATORY SYSTEM, AND DERMATOLOGICAL DISORDERS, HORMONES FOR MEDICAL PURPOSES, ANTI-INFECTIVE PREPARATIONS, ANTI-VIRAL PREPARATIONS AND CYTOSTATIC PREPARATIONS FOR USE IN THE TREATMENT OF CANCER (U.S. CLS. 6, 18, 44, 46, 51 AND 52).

MICHAEL TANNER, EXAMINING ATTORNEY

CLASS 5—(Continued).

SN 79-046,112. SANOFI-AVENTIS, FRANCE, FILED 9-28-2007.

KIJIFIP

THE MARK CONSISTS OF STANDARD CHARACTERS WITHOUT CLAIM TO ANY PARTICULAR FONT, STYLE, SIZE, OR COLOR.

PRIORITY DATE OF 4-19-2007 IS CLAIMED.
OWNER OF INTERNATIONAL REGISTRATION 0943229 DATED 9-28-2007, EXPIRES 9-28-2017.

FOR PHARMACEUTICAL PRODUCTS, NAMELY, PREPARATIONS FOR THE PREVENTION AND/OR TREATMENT OF CARDIOVASCULAR DISEASES; PHARMACEUTICAL PRODUCTS, NAMELY, PREPARATIONS FOR THE PREVENTION AND TREATMENT OF CANCER; PHARMACEUTICAL PRODUCTS, NAMELY, PREPARATIONS FOR THE PREVENTION AND TREATMENT OF THROMBOSIS; PHARMACEUTICAL PRODUCTS, NAMELY, PREPARATIONS FOR THE PREVENTION AND TREATMENT OF DISEASES IN THE FIELD OF INTERNAL MEDICINE; PHARMACEUTICAL PRODUCTS, NAMELY, PREPARATIONS FOR THE PREVENTION AND TREATMENT OF DISEASES OF THE CENTRAL NERVOUS SYSTEM; PHARMACEUTICAL PRODUCTS, NAMELY, PREPARATIONS FOR THE PREVENTION AND TREATMENT OF RESPIRATORY DISEASES (U.S. CLS. 6, 18, 44, 46, 51 AND 52).
SUSAN STIGLITZ, EXAMINING ATTORNEY

CLASS 6—(Continued).

SN 77-098,224. C. HAGER & SONS HINGE MANUFACTURING COMPANY, ST. LOUIS, MO. FILED 2-2-2007.

HAGER

THE MARK CONSISTS OF STANDARD CHARACTERS WITHOUT CLAIM TO ANY PARTICULAR FONT, STYLE, SIZE, OR COLOR.

OWNER OF U.S. REG. NOS. 836,571, 1,419,741 AND OTHERS.

SEC. 2(F).
FOR METAL HINGES, NAMELY, DOOR HINGES, CABINET HINGES, STRAP HINGES AND CONTINUOUS HINGES; METAL DOOR PULLS; METAL CABINET KNOBS; MISCELLANEOUS METAL HARDWARE ITEMS FOR DOORS, NAMELY, WALL STOPS AND HOLDERS, FLOOR STOPS AND HOLDERS, PUSH, PULL AND ARMOR PLATES, FILLER PLATES, DOOR EDGINGS AND CORNER GUARDS, PROTECTION PLATES, DOOR LATCHES AND PLATES, SURFACE BOLTS, FLUSH BOLTS, AND COORDINATORS, NON-LUMINOUS AND NON-MECHANICAL METAL SIGNS, SADDLE THRESHOLDS, THERMAL BARRIER THRESHOLDS, HALF SADDLE THRESHOLDS, FLOOR PLATE ASSEMBLIES, PANIC THRESHOLDS, DOOR COVER PLATES FOR LOCK SETS, INTERLOCKING RESIDENTIAL THRESHOLDS, DOOR BOTTOMS AND AUTOMATIC DOOR BOTTOMS, DOOR BOTTOM SWEEPS, METAL WEATHERSTRIPPING FOR USE WITH DOORS, ASTRAGALS, MEETING STILES, AND OVERHEAD DRIP GUARDS; METAL SLIDING DOOR HARDWARE, NAMELY, GUIDES, ALIGNERS, CARPET RISERS, HANGERS, MOUNT PLATES, PIVOTS, STOPS, TRACKS, TRACK FASCIA, TRACK MOUNT BRACKETS, AND TRACK SPACERS; METAL LOCKS FOR DOORS; METAL NON-ELECTRIC DOOR CLOSERS; PANIC EXIT DEVICES, NAMELY, METAL MANUAL TOUCHBARS FOR DOORS (U.S. CLS. 2, 12, 13, 14, 23, 25 AND 50).

FIRST USE 0-0-1849; IN COMMERCE 0-0-1849.
SCOTT BIBB, EXAMINING ATTORNEY

CLASS 6—METAL GOODS

SN 76-495,302. FOLDING GUARD COMPANY, CHICAGO, IL. FILED 3-6-2003.

QWIK-FENCE

THE MARK CONSISTS OF STANDARD CHARACTERS WITHOUT CLAIM TO ANY PARTICULAR FONT, STYLE, SIZE, OR COLOR.

FOR METAL RAILINGS, FENCES AND ENCLOSURE WALLS FOR GUARDING AND CONTROLLING ACCESS TO ROBOTS AND OTHER MACHINERY (U.S. CLS. 2, 12, 13, 14, 23, 25 AND 50).

FIRST USE 6-30-1996; IN COMMERCE 6-30-1996.
RAUL CORDOVA, EXAMINING ATTORNEY

SN 77-101,840. GATEWAY MANUFACTURING, INC., MT. STERLING, KY. FILED 2-7-2007.

Pet Shield

NO CLAIM IS MADE TO THE EXCLUSIVE RIGHT TO USE "PET", APART FROM THE MARK AS SHOWN.

FOR METAL REMOVABLE GUARD BARRIERS FOR USE IN A VEHICLE FOR PETS (U.S. CLS. 2, 12, 13, 14, 23, 25 AND 50).

SIMON TENG, EXAMINING ATTORNEY

CLASS 6—(Continued).

SN 77-110,578. WRIGHT, KEVIN W., MEMPHIS, TN. FILED 2-19-2007.



NO CLAIM IS MADE TO THE EXCLUSIVE RIGHT TO USE "HAND FORGED METAL DOORS", APART FROM THE MARK AS SHOWN.

FOR METAL DOOR UNITS; METAL DOORS (U.S. CLS. 2, 12, 13, 14, 23, 25 AND 50).

GEORGIA CARTY, EXAMINING ATTORNEY

SN 77-135,837. XUZHOU GUANGHUAN STEEL TUBE CO., LTD., JIANGSU, CHINA, FILED 3-20-2007.



OWNER OF CHINA REG. NO. 181473, DATED 7-5-1983, RENEWED AS REG. NO. 181473, DATED 7-5-2003, EXPIRES 7-4-2013.

NO CLAIM IS MADE TO THE EXCLUSIVE RIGHT TO USE "BRAND", APART FROM THE MARK AS SHOWN.

"GH" HAS NO MEANING IN A FOREIGN LANGUAGE. THE NON-LATIN CHARACTER(S) IN THE MARK TRANSLITERATES INTO "GUANG HUAN PAI", AND THIS MEANS "HALO" BRAND IN ENGLISH.

FOR WELDED TUBE, NAMELY, ELECTRIC RESISTANCE WELDING STEEL TUBE AND GALVANIZED WELDING STEEL TUBE (U.S. CLS. 2, 12, 13, 14, 23, 25 AND 50).

VIVIAN MICZNIK FIRST, EXAMINING ATTORNEY

SN 77-146,779. GOTO MFG. CO., LTD., TOKYO, JAPAN, FILED 4-2-2007.

FUKI

THE MARK CONSISTS OF STANDARD CHARACTERS WITHOUT CLAIM TO ANY PARTICULAR FONT, STYLE, SIZE, OR COLOR.

THE WORD "FUKI" HAS NO MEANING IN A FOREIGN LANGUAGE.

FOR METAL LOCKS AND KEYS THEREFOR (U.S. CLS. 2, 12, 13, 14, 23, 25 AND 50).

DEIRDRE ROBERTSON, EXAMINING ATTORNEY

CLASS 6—(Continued).

SN 77-147,421. DAVIS, SHAWN, MCKEES ROCKS, PA. FILED 4-3-2007.

CURVCO STEEL STRUCTURES

THE MARK CONSISTS OF STANDARD CHARACTERS WITHOUT CLAIM TO ANY PARTICULAR FONT, STYLE, SIZE, OR COLOR.

NO CLAIM IS MADE TO THE EXCLUSIVE RIGHT TO USE "STEEL STRUCTURES", APART FROM THE MARK AS SHOWN.

FOR PRE-FABRICATED STEEL BUILDINGS (U.S. CLS. 2, 12, 13, 14, 23, 25 AND 50).

JORDAN BAKER, EXAMINING ATTORNEY

SN 77-166,373. DOORDAM, LLC, WASSAIC, NY. FILED 4-26-2007.

THE FLOOD STOPS HERE

THE MARK CONSISTS OF STANDARD CHARACTERS WITHOUT CLAIM TO ANY PARTICULAR FONT, STYLE, SIZE, OR COLOR.

FOR PORTABLE FLOOD BARRIERS, NAMELY, PORTABLE METAL BARRIERS FOR RESTRAINING FLOOD WATERS (U.S. CLS. 2, 12, 13, 14, 23, 25 AND 50).

MAUREEN DALL, EXAMINING ATTORNEY

SN 77-183,994. TUBE FORGINGS OF AMERICA, INC., PORTLAND, OR. FILED 5-17-2007.



OWNER OF U.S. REG. NO. 864,835.

THE MARK CONSISTS OF THE LETTERS "TFA" SURROUNDED BY A CIRCULAR DESIGN.

FOR METAL PIPE FITTINGS AND METAL FLANGES (U.S. CLS. 2, 12, 13, 14, 23, 25 AND 50).

FIRST USE 7-31-2007; IN COMMERCE 7-31-2007.

HEATHER THOMPSON, EXAMINING ATTORNEY

CLASS 6—(Continued).

SN 77-192,724. MENARD, INC., EAU CLAIRE, WI. FILED 5-30-2007.

MASTERCRAFT

THE MARK CONSISTS OF STANDARD CHARACTERS WITHOUT CLAIM TO ANY PARTICULAR FONT, STYLE, SIZE, OR COLOR.

OWNER OF U.S. REG. NOS. 2,634,108 AND 2,694,523.
 FOR DOORS, DOOR PANELS, DOOR FRAMES, DOOR CASING, AND DOOR UNITS, MADE OF METAL (U.S. CLS. 2, 12, 13, 14, 23, 25 AND 50).
 FIRST USE 3-0-1989; IN COMMERCE 3-0-1989.
 KATHERINE CONNOLLY, EXAMINING ATTORNEY

SN 77-197,977. EOK SEALING TECHNOLOGIES CO., LTD., TAICHUNG CITY, TAIWAN, FILED 6-5-2007.

YJK

THE MARK CONSISTS OF STANDARD CHARACTERS WITHOUT CLAIM TO ANY PARTICULAR FONT, STYLE, SIZE, OR COLOR.

FOR METAL OIL SEALS, PORT OIL SEALS MADE OF METAL, PORT OIL SEALS MADE OF METAL FOR VEHICLES, AND PORT OIL SEALS MADE OF METAL FOR MOTORCYCLES (U.S. CLS. 2, 12, 13, 14, 23, 25 AND 50).
 CAROLYN GRAY, EXAMINING ATTORNEY

SN 77-218,862. SORIA, JORGE PIMENTEL, RIVERSIDE, CA. FILED 6-29-2007.



NO CLAIM IS MADE TO THE EXCLUSIVE RIGHT TO USE "ANCHOR", APART FROM THE MARK AS SHOWN. THE COLOR(S) RED, BLACK. IS/ARE CLAIMED AS A FEATURE OF THE MARK.

THE MARK CONSISTS OF THE TERMS, "ANCHOR POINT" IN RED, WITH THE DESIGN OF A BLACK "X" SEPARATING THE WORDS, UNDERLINED BY THE DESIGN OF A CHAIN CONNECTED TO THE "X," WITH THE DESIGN OF AN ANCHOR AND A CLAMP ATTACHED TO THE ENDS OF THE CHAIN, IN BLACK.
 FOR ANCHORS (U.S. CLS. 2, 12, 13, 14, 23, 25 AND 50).
 BARBARA A. GOLD, EXAMINING ATTORNEY

CLASS 6—(Continued).

SN 77-250,872. MARKIN TUBING, LP, WYOMING, NY. FILED 8-9-2007.



THE MARK CONSISTS OF THREE DIAGNAL LINES FORMING THE LETTER M.
 FOR STEEL AND METAL TUBING (U.S. CLS. 2, 12, 13, 14, 23, 25 AND 50).
 KAPIL BHANOT, EXAMINING ATTORNEY

SN 77-251,294. NEW POLE POWER SYSTEM CO., LTD., SHANGHAI, CHINA, FILED 8-9-2007.

1W

THE MARK CONSISTS OF STANDARD CHARACTERS WITHOUT CLAIM TO ANY PARTICULAR FONT, STYLE, SIZE, OR COLOR.

FOR METAL FASTENERS, NAMELY, BOLTS, CLAMPS, CLAMP SETS COMPRISED OF METAL CLAMPS, HINGES, NUTS, COTTER PINS AND BALL LOCK PINS, PLATES, RIVETS, SCREWS, STUDS, WASHERS, AND FENCING FASTENERS, NAMELY, STAYS (U.S. CLS. 2, 12, 13, 14, 23, 25 AND 50).
 FIRST USE 5-22-2007; IN COMMERCE 5-22-2007.
 JIM RINGLE, EXAMINING ATTORNEY

SN 77-263,625. TOPCOR, LAGUNA BEACH, CA. FILED 8-24-2007.



THE MARK CONSISTS OF THE WORD "BAGGLE" IN A STYLIZED TEXT WITH THE DESIGN OF A BRACELET.
 FOR METAL BRACELET-TYPE PURSE HANGERS, NAMELY, RING-SHAPED HANGERS USED TO HANG HANDBAGS FROM VARIOUS SURFACES (U.S. CLS. 2, 12, 13, 14, 23, 25 AND 50).
 ELIZABETH HUGHITT, EXAMINING ATTORNEY

CLASS 6—(Continued).

SN 77-265,012. GREAT TRANGO HOLDINGS, INC., LOUISVILLE, CO. FILED 8-27-2007.

TRANGO

THE MARK CONSISTS OF STANDARD CHARACTERS WITHOUT CLAIM TO ANY PARTICULAR FONT, STYLE, SIZE, OR COLOR.

OWNER OF U.S. REG. NOS. 1,948,645 AND 2,773,727.

FOR METAL GOODS, NAMELY, CARABINERS; METAL CLIMBING EQUIPMENT, NAMELY, CRAMPONS, BOLT HANGERS, NUTS AND CHOCKS (U.S. CLS. 2, 12, 13, 14, 23, 25 AND 50).

FIRST USE 7-1-1992; IN COMMERCE 7-1-1992.

MARK PILARO, EXAMINING ATTORNEY

SN 77-265,016. MAKUR VALVES ENTERPRISE LIMITED, APIA, SAMOA, FILED 8-27-2007.

MAKÜR

FOR METAL PIPE JOINTS; METAL PIPES AND FITTINGS THEREFOR; METAL VALVES FOR PIPES; MANUALLY OPERATED METAL VALVES; METAL BALL VALVES NOT BEING PARTS OF MACHINES (U.S. CLS. 2, 12, 13, 14, 23, 25 AND 50).

VIVIAN MICZNIK FIRST, EXAMINING ATTORNEY

SN 77-290,007. KEY CRAZE INC., DBA KEY CRAZE, SACRAMENTO, CA. FILED 9-27-2007.



NO CLAIM IS MADE TO THE EXCLUSIVE RIGHT TO USE INC. APART FROM THE MARK AS SHOWN.

THE COLOR(S) ORANGE, BLACK, RED, WHITE, GREEN, BLUE, LIGHT BLUE, TURQUOISE, AND TEAL IS/ARE CLAIMED AS A FEATURE OF THE MARK.

THE COLOR ORANGE APPEARS IN THE WORDING "KEY" AND IN THE DESIGN OF TWO OF THE HEXA-

CLASS 6—(Continued).

GONS. THE COLOR BLACK APPEARS IN THE WORDING "CRAZE". THE COLOR WHITE APPEARS IN THE WORDING "INC" AND AS THE OUTLINE IN THE WORDS "KEYCRAZE". THE COLORS BLUE AND LIGHT BLUE APPEAR IN THE DESIGN OF THE HEXAGONS. THE COLORS TURQUOISE AND GREEN APPEAR IN THE DESIGN OF THE KEYS AND THE COLOR TEAL APPEARS IN THE DESIGN OF THE RECTANGULAR BACKGROUND. THE MARK APPEARS OVER A TRANSPARENT BACKGROUND.

FOR METAL KEY BLANKS (U.S. CLS. 2, 12, 13, 14, 23, 25 AND 50).

AHSEN KHAN, EXAMINING ATTORNEY

SN 77-293,675. CHICAGO CLAMP COMPANY, LLC, BROADVIEW, IL. FILED S.R. 10-2-2007; AM. P.R. 10-2-2007.



NO CLAIM IS MADE TO THE EXCLUSIVE RIGHT TO USE "CHICAGO CLAMP", APART FROM THE MARK AS SHOWN.

THE MARK CONSISTS OF THE WORDS "CHICAGO CLAMP" TOGETHER WITH A LOGO LOCATED EITHER ABOVE OR NEXT TO THE WORDS CONSISTING OF TWO STRAIGHT LINES WITH A WAVEY LINE IN BETWEEN THE TWO STRAIGHT LINES.

FOR METAL CLAMPS (U.S. CLS. 2, 12, 13, 14, 23, 25 AND 50).

FIRST USE 6-1-2007; IN COMMERCE 6-1-2007.

ATTIYA MALIK, EXAMINING ATTORNEY

SN 77-295,199. DAVIS, SHAWN, BOCA RATON, FL. FILED 10-3-2007.

STRIDE

THE MARK CONSISTS OF STANDARD CHARACTERS WITHOUT CLAIM TO ANY PARTICULAR FONT, STYLE, SIZE, OR COLOR.

FOR PRE-ENGINEERED STEEL BUILDINGS AND HOMES (U.S. CLS. 2, 12, 13, 14, 23, 25 AND 50).

MARCIE MILONE, EXAMINING ATTORNEY

CLASS 6—(Continued).

SN 77-296,253. STINSON, MARGARET M, CANTON, MI. FILED 10-4-2007.

KEY LEAF

THE MARK CONSISTS OF STANDARD CHARACTERS WITHOUT CLAIM TO ANY PARTICULAR FONT, STYLE, SIZE, OR COLOR.

NO CLAIM IS MADE TO THE EXCLUSIVE RIGHT TO USE "KEY", APART FROM THE MARK AS SHOWN.

FOR METAL KEY CHAINS (U.S. CLS. 2, 12, 13, 14, 23, 25 AND 50).

SAMUEL E. SHARPER JR., EXAMINING ATTORNEY

CLASS 6—(Continued).

SN 77-310,258. NUCOR CORPORATION, CHARLOTTE, NC. FILED 10-22-2007.

NU PHASE

THE MARK CONSISTS OF STANDARD CHARACTERS WITHOUT CLAIM TO ANY PARTICULAR FONT, STYLE, SIZE, OR COLOR.

FOR COMMON METALS AND THEIR ALLOYS; STEEL (U.S. CLS. 2, 12, 13, 14, 23, 25 AND 50).

KEVIN DINALLO, EXAMINING ATTORNEY

SN 77-312,799. D-GENERATION, INC., DAYTONA BEACH, FL. FILED 10-24-2007.

SN 77-296,521. BECAUSE OF HIM UNLIMITED, INCORPORATED, SOUTHFIELD, MI. FILED 10-4-2007.

LIVE LAUGH LOVE



THE MARK CONSISTS OF STANDARD CHARACTERS WITHOUT CLAIM TO ANY PARTICULAR FONT, STYLE, SIZE, OR COLOR.

FOR METAL BOXES; METAL KEY CHAINS; METAL KEY FOBs; METAL KEY RINGS; METAL KNOBS (U.S. CLS. 2, 12, 13, 14, 23, 25 AND 50).

FIRST USE 9-26-2001; IN COMMERCE 9-26-2001.

CARYN GLASSER, EXAMINING ATTORNEY

SN 77-313,370. NUCOR CORPORATION, CHARLOTTE, NC. FILED 10-25-2007.

NU-PHASE

THE MARK CONSISTS OF STANDARD CHARACTERS WITHOUT CLAIM TO ANY PARTICULAR FONT, STYLE, SIZE, OR COLOR.

FOR COMMON METALS AND THEIR ALLOYS; STEEL (U.S. CLS. 2, 12, 13, 14, 23, 25 AND 50).

KEVIN DINALLO, EXAMINING ATTORNEY

NO CLAIM IS MADE TO THE EXCLUSIVE RIGHT TO USE "PWC", OR "PRAY" OR "WITHOUT OR CEASING", APART FROM THE MARK AS SHOWN.

THE STIPPLING IS FOR SHADING PURPOSES ONLY.

THE MARK CONSISTS OF A CIRCLE OPEN AT THE TOP AND BOTTOM WITH THE WORDS "PRAY WITHOUT CEASING" CURVING FROM LEFT TO RIGHT ALONG THE TOP OF THE CIRCLE. WITHIN THE CIRCLE ARE TWO HANDS CLASPED IN AN ATTITUDE OF PRAYER, OVERLAID WITH THE LETTERS IN CAPITALS "PWC", WITH THE "W" LARGER THAN THE LETTERS "P" AND "C". BELOW THE CIRCLE, THE HANDS AND THE LETTERS "PWC" REST UPON AN OPEN BOOK.

FOR METAL DOG TAGS; METAL KEY CHAINS (U.S. CLS. 2, 12, 13, 14, 23, 25 AND 50).

RICHARD WHITE, EXAMINING ATTORNEY

CLASS 6—(Continued).

SN 77-313,383. NUCOR CORPORATION, CHARLOTTE, NC.
FILED 10-25-2007.

NUPHASE

THE MARK CONSISTS OF STANDARD CHARACTERS
WITHOUT CLAIM TO ANY PARTICULAR FONT, STYLE,
SIZE, OR COLOR.

FOR COMMON METALS AND THEIR ALLOYS;
STEEL (U.S. CLS. 2, 12, 13, 14, 23, 25 AND 50).
KEVIN DINALLO, EXAMINING ATTORNEY

SN 77-323,776. BELLISIO FOODS, INC., DBA MICHELINA'S,
INC., DULUTH, MN. FILED 11-7-2007.

THE FAMILY TABLE

THE MARK CONSISTS OF STANDARD CHARACTERS
WITHOUT CLAIM TO ANY PARTICULAR FONT, STYLE,
SIZE, OR COLOR.

FOR METAL HOLIDAY ORNAMENTS AND DECORA-
TIONS, EXCLUDING TREE ORNAMENTS (U.S. CLS. 2,
12, 13, 14, 23, 25 AND 50).
JESSICA FATHY, EXAMINING ATTORNEY

SN 78-316,603. UNBREAKABLE COMPANY, KENNETT
SQUARE, PA. FILED 10-21-2003.

ALL LOCKS SHOULD BE UNBREAKABLE

OWNER OF U.S. REG. NO. 2,625,892.
FOR SECURITY DEVICES, NAMELY, METAL ANTI-
THEFT LOCKS (U.S. CLS. 2, 12, 13, 14, 23, 25 AND 50).
LINDA E. BLOHM, EXAMINING ATTORNEY

CLASS 6—(Continued).

SN 78-750,073. KIM TIN CORPORATION, HO CHI MINH
CITY, VIETNAM, FILED 11-9-2005.



PRIORITY CLAIMED UNDER SEC. 44(D) ON VIETNAM
APPLICATION NO. 4-2005-14377. FILED 10-27-2005, REG.
NO. 81501, DATED 4-25-2007, EXPIRES 10-27-2015.

THE ENGLISH TRANSLATION OF THE WORDS "KIM
TIN" IS "NEEDLE" AND "BELIEF" IN THE VIETNAMESE
LANGUAGE.

FOR METAL RODS FOR WELDING, METAL WELD-
ING RODS, WIRES OF METAL FOR WELDING, AND
BARS OF METAL FOR WELDING (U.S. CLS. 2, 12, 13, 14,
23, 25 AND 50).

WILLIAM VERHOSEK, EXAMINING ATTORNEY

SN 79-037,778. THYSSENKRUPP TITANIUM GMBH, FED
REP GERMANY, FILED 3-15-2007.

DTG

THE MARK CONSISTS OF STANDARD CHARACTERS
WITHOUT CLAIM TO ANY PARTICULAR FONT, STYLE,
SIZE, OR COLOR.

PRIORITY DATE OF 1-15-2007 IS CLAIMED.

OWNER OF INTERNATIONAL REGISTRATION 0922204
DATED 3-15-2007, EXPIRES 3-15-2017.

THE WORDING "DTG" HAS NO MEANING IN A
FOREIGN LANGUAGE.

FOR COMMON METALS, UNWROUGHT AND SEMI-
WORKED, FOR FURTHER MANUFACTURE; ALUMI-
NUM, TITAN, MAGNESIUM, ZINC, TIN, NICKEL AND
THEIR ALLOYS; SLABS AND BLOCKS MADE OF
COMMON METALS AND THEIR ALLOYS; ROLLED
STEEL FINISHED PRODUCTS, MADE OF THE AFORE-
SAID METALS AND THEIR ALLOYS, IN PARTICULAR
HOT AND COLD ROLLED STRIPS AND SHEETS;
PROFILES AND TUBES MADE OF COMMON METALS
AND THEIR ALLOYS; FORGINGS MADE OF COMMON
METALS AND THEIR ALLOYS (U.S. CLS. 2, 12, 13, 14,
23, 25 AND 50).

SUSAN STIGLITZ, EXAMINING ATTORNEY

CLASS 7—MACHINERY

SN 76-665,317. UNION SPECIAL CORPORATION, HUNTLEY, IL. FILED 8-29-2006.

UNION SPECIAL

THE MARK CONSISTS OF STANDARD CHARACTERS WITHOUT CLAIM TO ANY PARTICULAR FONT, STYLE, SIZE, OR COLOR.

OWNER OF U.S. REG. NOS. 825,274 AND 1,138,686. FOR SEWING MACHINES AND REPLACEMENT PARTS THEREFORE (U.S. CLS. 13, 19, 21, 23, 31, 34 AND 35).

FIRST USE 11-13-1885; IN COMMERCE 11-13-1885. DOMINIC FATHY, EXAMINING ATTORNEY

CLASS 7—(Continued).

SN 76-676,145. BOURNE ENERGY, MALIBU, CA. FILED 4-27-2007.

TIDALSTAR

THE MARK CONSISTS OF STANDARD CHARACTERS WITHOUT CLAIM TO ANY PARTICULAR FONT, STYLE, SIZE, OR COLOR.

FOR RENEWABLE ENERGY SYSTEMS, NAMELY ELECTRICITY GENERATORS (U.S. CLS. 13, 19, 21, 23, 31, 34 AND 35).

FIRST USE 4-19-2006; IN COMMERCE 6-20-2006. JULIE GUTTADAURO, EXAMINING ATTORNEY

SN 76-673,202. MORRILL MOTORS, INC., ERWIN, TN. FILED 2-26-2007.

SSC²

OWNER OF U.S. REG. NO. 2,010,641. FOR SOLID STATE CONTROLLED ELECTRIC MOTORS FOR MACHINES (U.S. CLS. 13, 19, 21, 23, 31, 34 AND 35).

FIRST USE 4-0-2006; IN COMMERCE 4-0-2006. ASMAT KHAN, EXAMINING ATTORNEY

SN 76-676,146. BOURNE ENERGY, MALIBU, CA. FILED 4-27-2007.

BOURNE ENERGY

THE MARK CONSISTS OF STANDARD CHARACTERS WITHOUT CLAIM TO ANY PARTICULAR FONT, STYLE, SIZE, OR COLOR.

NO CLAIM IS MADE TO THE EXCLUSIVE RIGHT TO USE "ENERGY", APART FROM THE MARK AS SHOWN.

FOR RENEWABLE ENERGY SYSTEMS, NAMELY ELECTRICITY GENERATORS (U.S. CLS. 13, 19, 21, 23, 31, 34 AND 35).

JULIE GUTTADAURO, EXAMINING ATTORNEY

SN 76-673,724. APOLLO SPRAYERS INTERNATIONAL, INC., VISTA, CA. FILED 3-7-2007.



NO CLAIM IS MADE TO THE EXCLUSIVE RIGHT TO USE "ATOMIZER" AND "SPRAYERS INTERNATIONAL, INC.", APART FROM THE MARK AS SHOWN.

THE STIPPLING IS A FEATURE OF THE MARK. FOR POWER-OPERATED SPRAY GUNS (U.S. CLS. 13, 19, 21, 23, 31, 34 AND 35).

FIRST USE 8-28-2006; IN COMMERCE 8-28-2006. WANDA KAY PRICE, EXAMINING ATTORNEY

SN 76-679,092. CARTER PRODUCTS CO., INC., GRAND RAPIDS, MI. FILED 7-5-2007.

ACCURIGHT

THE MARK CONSISTS OF STANDARD CHARACTERS WITHOUT CLAIM TO ANY PARTICULAR FONT, STYLE, SIZE, OR COLOR.

FOR BAND SAW ACCESSORIES, NAMELY, BAND SAW MICRO-ADJUSTABLE GUIDES, BAND SAW BLADES, BAND SAW PULLEYS AND BAND SAW TABLE INSERTS (U.S. CLS. 13, 19, 21, 23, 31, 34 AND 35).

FIRST USE 6-1-2005; IN COMMERCE 6-30-2005. JULIE GUTTADAURO, EXAMINING ATTORNEY

CLASS 7—(Continued).

SN 76-680,887. TWO LAZY, LLC, MILLBURY, MA. FILED 8-20-2007.

LAZY SPRAYER

THE MARK CONSISTS OF STANDARD CHARACTERS WITHOUT CLAIM TO ANY PARTICULAR FONT, STYLE, SIZE, OR COLOR.

NO CLAIM IS MADE TO THE EXCLUSIVE RIGHT TO USE "SPRAYER", APART FROM THE MARK AS SHOWN.

FOR ELECTRIC SPRAY PUMP HEAD FOR USE ON INTERCHANGEABLE LIQUID CONTAINERS (U.S. CLS. 13, 19, 21, 23, 31, 34 AND 35).

DAWN FELDMAN, EXAMINING ATTORNEY

CLASS 7—(Continued).

SN 77-065,568. ROPER PUMP COMPANY, COMMERCE, GA. FILED 12-15-2006.

DURAFLOW

THE MARK CONSISTS OF STANDARD CHARACTERS WITHOUT CLAIM TO ANY PARTICULAR FONT, STYLE, SIZE, OR COLOR.

FOR PUMPS THAT ACT AS FLOW DIVIDERS DISTRIBUTING FUEL EVENLY TO TURBINES THAT GENERATE ELECTRICITY (U.S. CLS. 13, 19, 21, 23, 31, 34 AND 35).

FIRST USE 8-29-2005; IN COMMERCE 8-29-2005.
MARY BOAGNI, EXAMINING ATTORNEY

SN 76-682,514. MORGAN, MORRIS, RIVERTON, UT. FILED 10-2-2007.

POWERLINE

THE MARK CONSISTS OF STANDARD CHARACTERS WITHOUT CLAIM TO ANY PARTICULAR FONT, STYLE, SIZE, OR COLOR.

FOR PRESSURE WASHERS AND ACCESSORIES THEREFOR (U.S. CLS. 13, 19, 21, 23, 31, 34 AND 35).

FIRST USE 9-1-1990; IN COMMERCE 9-1-1990.
GINA HAYES, EXAMINING ATTORNEY

SN 77-119,209. DRESSER-RAND COMPANY, OLEAN, NY. FILED 3-1-2007.

VECTRA

THE MARK CONSISTS OF STANDARD CHARACTERS WITHOUT CLAIM TO ANY PARTICULAR FONT, STYLE, SIZE, OR COLOR.

THE WORDING "VECTRA" HAS NO MEANING IN A FOREIGN LANGUAGE.

FOR POWER TURBINES FOR ENERGY RECOVERY AND CONVERSION OR FOR GENERATION OF ELECTRICITY IN INDUSTRIAL APPLICATIONS (U.S. CLS. 13, 19, 21, 23, 31, 34 AND 35).

FIRST USE 0-0-1996; IN COMMERCE 0-0-1996.
INGA ERVIN, EXAMINING ATTORNEY

SN 77-043,909. TNT'S DISTRIBUTING, COTTONWOOD, AZ. FILED 11-14-2006.

CRYO PERFORMANCE

THE MARK CONSISTS OF STANDARD CHARACTERS WITHOUT CLAIM TO ANY PARTICULAR FONT, STYLE, SIZE, OR COLOR.

NO CLAIM IS MADE TO THE EXCLUSIVE RIGHT TO USE "PERFORMANCE", APART FROM THE MARK AS SHOWN.

"PERFORMANCE" APPEARING IN THE MARK HAS NO SIGNIFICANCE IN THE RELEVANT TRADE OR INDUSTRY OR AS APPLIED TO THE GOODS/SERVICES LISTED IN THE APPLICATION, NO GEOGRAPHICAL SIGNIFICANCE, NOR ANY MEANING IN A FOREIGN LANGUAGE.

FOR SPARK PLUGS (U.S. CLS. 13, 19, 21, 23, 31, 34 AND 35).

FIRST USE 12-1-1998; IN COMMERCE 12-1-1998.
MARK SPARACINO, EXAMINING ATTORNEY

SN 77-126,098. TECO-WESTINGHOUSE MOTOR COMPANY, ROUND ROCK, TX. FILED 3-8-2007.

ETHANOL DUTY

THE MARK CONSISTS OF STANDARD CHARACTERS WITHOUT CLAIM TO ANY PARTICULAR FONT, STYLE, SIZE, OR COLOR.

NO CLAIM IS MADE TO THE EXCLUSIVE RIGHT TO USE "ETHANOL", APART FROM THE MARK AS SHOWN.

FOR ELECTRIC MOTORS FOR MACHINES (U.S. CLS. 13, 19, 21, 23, 31, 34 AND 35).

DAVID MURRAY, EXAMINING ATTORNEY

CLASS 7—(Continued).

SN 77-126,311. ADASTRA TECHNOLOGIES, INC., TORRANCE, CA. FILED 3-8-2007.

Min-eLux

THE MARK CONSISTS OF STANDARD CHARACTERS WITHOUT CLAIM TO ANY PARTICULAR FONT, STYLE, SIZE, OR COLOR.

FOR MACHINES FOR CURING ULTRAVIOLET-CURABLE COATINGS ONTO CONCRETE, MARBLE, STONE, TILE, GRAPHITE, METAL, PLASTIC AND WOOD FOR FLOORS, CABINETS, COUNTERTOPS, BATHTUBS, WALLS, GOLF CLUBS AND PLASTIC TUBING BY THE USE OF ULTRAVIOLET LIGHT (U.S. CLS. 13, 19, 21, 23, 31, 34 AND 35).

FIRST USE 8-11-2006; IN COMMERCE 8-11-2006.
KEVIN CORWIN, EXAMINING ATTORNEY

SN 77-127,604. TAJA SEVILLE, SOUTHFIELD, MI. FILED 3-9-2007.

Butterking

THE MARK CONSISTS OF STANDARD CHARACTERS WITHOUT CLAIM TO ANY PARTICULAR FONT, STYLE, SIZE, OR COLOR.

FOR ELECTRIC BUTTER MAKERS FOR HOUSEHOLD PURPOSES, NAMELY, SMALL ELECTRIC KITCHEN APPLIANCES WHICH MAKE FRESH BUTTER FROM CREAM IN SEVERAL MINUTES (U.S. CLS. 13, 19, 21, 23, 31, 34 AND 35).

ANDREA BUTLER, EXAMINING ATTORNEY

SN 77-129,462. GENERAL KINEMATICS CORPORATION, CRYSTAL LAKE, IL. FILED 3-13-2007.

VIBRA-CLEAN

THE MARK CONSISTS OF STANDARD CHARACTERS WITHOUT CLAIM TO ANY PARTICULAR FONT, STYLE, SIZE, OR COLOR.

OWNER OF U.S. REG. NOS. 1,040,447, 1,295,756 AND 1,796,239.

FOR MACHINES, NAMELY, VIBRATING DRUMS FOR CLEANING CASTINGS AND PROCESSING METAL CASTING MATERIALS (U.S. CLS. 13, 19, 21, 23, 31, 34 AND 35).

TINA L. SNAPP, EXAMINING ATTORNEY

CLASS 7—(Continued).

SN 77-129,491. GENERAL KINEMATICS CORPORATION, CRYSTAL LAKE, IL. FILED 3-13-2007.

VARIO-DRIVE

THE MARK CONSISTS OF STANDARD CHARACTERS WITHOUT CLAIM TO ANY PARTICULAR FONT, STYLE, SIZE, OR COLOR.

FOR VIBRATING EQUIPMENT FOR THE FOUNDRY INDUSTRY, NAMELY, VIBRATING MACHINES FOR REMOVING SAND FROM CASTINGS (U.S. CLS. 13, 19, 21, 23, 31, 34 AND 35).

TINA L. SNAPP, EXAMINING ATTORNEY

SN 77-129,722. SATEC GMBH, 53619 RHEINBREITBACH, FED REP GERMANY, FILED 3-13-2007.

SATEC

THE MARK CONSISTS OF STANDARD CHARACTERS WITHOUT CLAIM TO ANY PARTICULAR FONT, STYLE, SIZE, OR COLOR.

OWNER OF FED REP GERMANY REG. NO. 2009370, DATED 3-31-1992, RENEWED AS REG. NO. 2009370, DATED 10-29-2001, EXPIRES 10-28-2011.

FOR DRYCLEANING MACHINES (U.S. CLS. 13, 19, 21, 23, 31, 34 AND 35).

FIRST USE 0-0-1959; IN COMMERCE 1-26-1999.

ALEXANDER L. POWERS, EXAMINING ATTORNEY

SN 77-130,948. OTTO ENGINEERING, INC., CARPENTERSVILLE, IL. FILED 3-14-2007.

OTTO EXPECT EXCELLENCE

THE MARK CONSISTS OF STANDARD CHARACTERS WITHOUT CLAIM TO ANY PARTICULAR FONT, STYLE, SIZE, OR COLOR.

OWNER OF U.S. REG. NOS. 935,243, 2,932,497 AND OTHERS.

FOR MACHINED PARTS, NAMELY, PNEUMATIC VALVES; MACHINE PARTS, NAMELY, PRECISION TURNED AND MILLED VALVE ELEMENTS, THREADED AND UNTHREADED SHAFTS, TUBES, PINS, CONNECTORS AND ASSEMBLIES THEREOF FOR USE IN HYDRAULIC VALVES, MISSILES, ROCKETS, ARMORED VEHICLES, BOMBS, GUNS, AIRPLANES AND AIRCRAFT, PUMPS, NAMELY, POSITIVE DISPLACEMENT, SUMP, SUCTION, ROTARY, AND VACUUM, DISPENSING MACHINES, AND MECHANICAL MIXING MACHINES (U.S. CLS. 13, 19, 21, 23, 31, 34 AND 35).

ROBERT STRUCK, EXAMINING ATTORNEY

CLASS 7—(Continued).

SN 77-133,275. J-I-T DISTRIBUTING, INC., SOUTH BEND, IN. FILED 3-16-2007.



NO CLAIM IS MADE TO THE EXCLUSIVE RIGHT TO USE "CUSTOM MACHINE MANUFACTURING PRODUCT OF" AND "DISTRIBUTING, INC. SINCE 1987", APART FROM THE MARK AS SHOWN.

THE MARK CONSISTS OF THE WORDS "CUSTOM MACHINE MANUFACTURING" ARCHED OVER THE LETTERS "CMM" AND THE WORDS "PRODUCT OF J-I-T DISTRIBUTING, INC. SINCE 1987" INSCRIBED IN AN OVAL BENEATH THE "CMM".

FOR INDUSTRIAL MACHINERY FOR USE IN MANUFACTURING AND FABRICATING VINYL FENCING (U.S. CLS. 13, 19, 21, 23, 31, 34 AND 35).

FIRST USE 2-15-2005; IN COMMERCE 2-15-2005.
MARCIE MILONE, EXAMINING ATTORNEY

SN 77-137,055. LUDWIG SCHWERDTEL GMBH, 85757 KARLSFELD, FED REP GERMANY, FILED 3-21-2007.

SCHWERDTEL

THE MARK CONSISTS OF STANDARD CHARACTERS WITHOUT CLAIM TO ANY PARTICULAR FONT, STYLE, SIZE, OR COLOR.

SEC. 2(F).

FOR CONVEYORS FOR HIGHLY VISCOUS LIQUIDS, COMPRISING CONTAINERS WHICH TAKE UP THE LIQUID, AND PISTON PUMPS OR PRESSURE PISTONS; FILLING MACHINES FOR FILLING HIGHLY VISCOUS LIQUIDS INTO CARTOUCHES OR CANS, COMPRISING DOSAGE DISPENSERS OF VOLUMETRIC OR GRAVIMETRIC OPERATION, POSSIBLY TOPPED BY CONTROLLABLE LIQUID-DISCHARGE NOZZLES; ADVANCES, NAMELY, CONVEYORS FOR CANS, BOXES AND CARTOUCHES, COMPRISING RECEIVING TABLES FOR CANS, BOXES AND CARTOUCHES AND ADVANCE MECHANISMS FOR THE CANS, BOXES AND CARTOUCHES; SEALING MACHINES FOR CANS, BOXES AND CARTOUCHES, NAMELY, MACHINES FOR PLACING AND FIXING LIDS, LEDGES, LOCKS OR CLOSURES ON CANS, BOXES, OR CARTOUCHES (U.S. CLS. 13, 19, 21, 23, 31, 34 AND 35).

FIRST USE 9-1-1979; IN COMMERCE 9-1-1979.
ROSELLE HERRERA, EXAMINING ATTORNEY

CLASS 7—(Continued).

SN 77-148,250. ROYAL APPLIANCE MFG. CO., GLENWILLOW, OH. FILED 4-4-2007.



THE MARK CONSISTS OF A DRAWING OF A CAMEL WITH THE WORD "NOMAD" BETWEEN TWO LINES AND THE WORDS "H2O ON THE GO" ENCLOSED WITHIN AN OVAL.

FOR POWER-OPERATED SPRAYERS (U.S. CLS. 13, 19, 21, 23, 31, 34 AND 35).

MARGERY A. TIERNEY, EXAMINING ATTORNEY

SN 77-149,834. DEERE & COMPANY, MOLINE, IL. FILED 4-5-2007.

QUAD-COOL

THE MARK CONSISTS OF STANDARD CHARACTERS WITHOUT CLAIM TO ANY PARTICULAR FONT, STYLE, SIZE, OR COLOR.

FOR RADIATOR COOLER SYSTEM, NAMELY, RADIATOR, HYDRAULIC OIL COOLER, CONDENSING UNIT, TRANSMISSION COOLER AND ENGINE OIL COOLER, SOLD AS AN INTEGRAL COMPONENT OF EARTH MOVING MACHINES, NAMELY, LOADERS (U.S. CLS. 13, 19, 21, 23, 31, 34 AND 35).

FIRST USE 5-31-2005; IN COMMERCE 5-31-2005.
MATTHEW PAPPAS, EXAMINING ATTORNEY

SN 77-152,096. ASIA MOTOR COMPANY, KARACHI, PAKISTAN, FILED 4-9-2007.

SAKURA

THE MARK CONSISTS OF STANDARD CHARACTERS WITHOUT CLAIM TO ANY PARTICULAR FONT, STYLE, SIZE, OR COLOR.

THE FOREIGN WORDING IN THE MARK TRANSLATES INTO ENGLISH AS CHERRY BLOSSOM.

FOR OIL FILTERS; AIR FILTERS FOR MOTORS AND ENGINES; FUEL FILTERS; AND RADIATORS FOR COOLING ENGINES (U.S. CLS. 13, 19, 21, 23, 31, 34 AND 35).

REBECCA GILBERT, EXAMINING ATTORNEY

CLASS 7—(Continued).

SN 77-155,364. DANIEL E. DAVIS, HARLINGEN, TX. FILED 4-12-2007.

DPL

THE MARK CONSISTS OF STANDARD CHARACTERS WITHOUT CLAIM TO ANY PARTICULAR FONT, STYLE, SIZE, OR COLOR.

FOR PIPE LAYER MACHINES (U.S. CLS. 13, 19, 21, 23, 31, 34 AND 35).

FIRST USE 3-0-2003; IN COMMERCE 3-0-2003.
ODESSA BIBBINS, EXAMINING ATTORNEY

SN 77-161,681. JOSEPH VOEGELE AG, MANNHEIM, FED REP GERMANY, FILED 4-20-2007.

VISION

THE MARK CONSISTS OF STANDARD CHARACTERS WITHOUT CLAIM TO ANY PARTICULAR FONT, STYLE, SIZE, OR COLOR.

FOR ROAD CONSTRUCTION MACHINERY, NAMELY, MACHINERY FOR PREPARING, LAYING AND COMPACTING ROAD PAVEMENTS AND PARTS THEREFOR (U.S. CLS. 13, 19, 21, 23, 31, 34 AND 35).
BERNICE MIDDLETON, EXAMINING ATTORNEY

SN 77-166,364. GENMAX POWER INDUSTRIAL INC, CORAL SPRINGS, FL. FILED 4-26-2007.



THE COLOR(S) BLACK, YELLOW AND WHITE IS/ARE CLAIMED AS A FEATURE OF THE MARK.

THE MARK CONSISTS OF A WHITE BACKGROUND WITH A BLACK CAPITAL LETTER "M". THERE IS ALSO THE CAPITAL LETTER "A" IN FRONT OF THE "M" IN YELLOW. THE CAPITAL LETTER "A" IN YELLOW DOES NOT HAVE A LINE THROUGH IT, SO IT LOOKS LIKE THE LETTER "V" UPSIDE DOWN. BELOW THE LOGO IS THE WORD "AMICO" IN BLACK AND CAPITAL LETTERS.

FOR ELECTRIC GENERATORS (U.S. CLS. 13, 19, 21, 23, 31, 34 AND 35).

FIRST USE 11-28-2005; IN COMMERCE 11-28-2005.
RUSS HERMAN, EXAMINING ATTORNEY

CLASS 7—(Continued).

SN 77-183,218. BOART LONGYEAR INTERNATIONAL HOLDINGS, INC., SALT LAKE CITY, UT. FILED 5-17-2007.

V-WALL

THE MARK CONSISTS OF STANDARD CHARACTERS WITHOUT CLAIM TO ANY PARTICULAR FONT, STYLE, SIZE, OR COLOR.

FOR DRILLING MACHINES AND PARTS THEREOF, NAMELY, DRILLING RODS; EARTH DRILLING EQUIPMENT, NAMELY, DRILL RODS, WIRELINE CORE BARRELS FOR EARTH DRILLING AND OVERSHOT ASSEMBLIES FOR EARTH DRILLING AND PARTS FOR WIRELINE CORE BARRELS FOR EARTH DRILLING AND OVERSHOT ASSEMBLIES FOR EARTH DRILLING, NAMELY, HEAD ASSEMBLIES, INNER TUBES, OVERSHOT DOGS, JAWS AND LATCHES (U.S. CLS. 13, 19, 21, 23, 31, 34 AND 35).

KIM SAITO, EXAMINING ATTORNEY

SN 77-205,546. HABASIT AG, REINACH-BASEL, SWITZERLAND, FILED 6-13-2007.

RAM

THE MARK CONSISTS OF STANDARD CHARACTERS WITHOUT CLAIM TO ANY PARTICULAR FONT, STYLE, SIZE, OR COLOR.

OWNER OF U.S. REG. NO. 2,045,076.
FOR CONVEYOR COMPONENTS, NAMELY, PLASTIC CHAIN AND PLASTIC BELTING FOR FOOD AND BEVERAGE PROCESSING AND PACKAGING CONVEYORS (U.S. CLS. 13, 19, 21, 23, 31, 34 AND 35).

FIRST USE 3-1-1996; IN COMMERCE 3-1-1996.
BILL DAWE, EXAMINING ATTORNEY

SN 77-210,981. ITT CORPORATION, WHITE PLAINS, NY. FILED 6-20-2007.

HOME DEFENDER

THE MARK CONSISTS OF STANDARD CHARACTERS WITHOUT CLAIM TO ANY PARTICULAR FONT, STYLE, SIZE, OR COLOR.

NO CLAIM IS MADE TO THE EXCLUSIVE RIGHT TO USE "HOME", APART FROM THE MARK AS SHOWN.

FOR FIRE PUMPS (U.S. CLS. 13, 19, 21, 23, 31, 34 AND 35).

DAVID MURRAY, EXAMINING ATTORNEY

CLASS 7—(Continued).

SN 77-225,336. APPLIED MATERIALS, INC., SANTA CLARA, CA. FILED 7-9-2007.

PRODUCER ACE

THE MARK CONSISTS OF STANDARD CHARACTERS WITHOUT CLAIM TO ANY PARTICULAR FONT, STYLE, SIZE, OR COLOR.

OWNER OF U.S. REG. NO. 2,304,624.

NO CLAIM IS MADE TO THE EXCLUSIVE RIGHT TO USE "PRODUCER", APART FROM THE MARK AS SHOWN, FOR MACHINES FOR THE PROCESSING, PRODUCTION, POLISHING, AND CLEANING OF SEMICONDUCTOR SUBSTRATES, THIN SEMICONDUCTOR FILMS, SILICON DISCS AND SILICON WAFERS (U.S. CLS. 13, 19, 21, 23, 31, 34 AND 35).

STEVEN R. FOSTER, EXAMINING ATTORNEY

SN 77-226,903. MITCHCO INCORPORATED, TORRANCE, CA. FILED 7-11-2007.

PERFECTPARK

THE MARK CONSISTS OF STANDARD CHARACTERS WITHOUT CLAIM TO ANY PARTICULAR FONT, STYLE, SIZE, OR COLOR.

FOR VEHICLE DISPLAY, MOVING, PARKING AND STORAGE SYSTEM COMPRISED OF COMPUTER CONTROLLED MACHINERY, NAMELY, AUTOMATED VEHICLE PARKING UNITS; ROBOTIC MACHINERY, NAMELY, INDUSTRIAL ROBOTS FOR USE IN AN AUTOMATED VEHICLE DISPLAY, MOVING, PARKING AND STORAGE SYSTEM; AND POWER-OPERATED LIFTS FOR DISPLAYING, MOVING, PARKING AND STORING VEHICLES (U.S. CLS. 13, 19, 21, 23, 31, 34 AND 35).

STEVEN JACKSON, EXAMINING ATTORNEY

SN 77-258,427. BRUNETTE INDUSTRIES LTD., NEW WESTMINSTER, CANADA, FILED 8-17-2007.

LOG SINGULATOR

THE MARK CONSISTS OF STANDARD CHARACTERS WITHOUT CLAIM TO ANY PARTICULAR FONT, STYLE, SIZE, OR COLOR.

OWNER OF CANADA REG. NO. TMA281,833, DATED 7-29-1983, EXPIRES 7-29-2013.

NO CLAIM IS MADE TO THE EXCLUSIVE RIGHT TO USE "LOG", APART FROM THE MARK AS SHOWN.

FOR SAWMILL MACHINERY USED FOR DISPENSING LOGS INTO PRODUCTION PROCESS (U.S. CLS. 13, 19, 21, 23, 31, 34 AND 35).

JORDAN BAKER, EXAMINING ATTORNEY

CLASS 7—(Continued).

SN 77-263,325. THE GLEASON WORKS, ROCHESTER, NY. FILED 8-24-2007.

OPTI-CUT

THE MARK CONSISTS OF STANDARD CHARACTERS WITHOUT CLAIM TO ANY PARTICULAR FONT, STYLE, SIZE, OR COLOR.

OWNER OF U.S. REG. NO. 2,529,739.

FOR POWER-OPERATED CUTTING TOOLS, NAMELY, GASHING, SHAPING AND HOBBIING TOOLS HAVING REPLACEABLE CUTTING INSERTS, FOR THE MANUFACTURE OF GEARS AND OTHER TOOTHED ARTICLES; CUTTING INSERTS AND REPLACEMENT PARTS FOR SUCH TOOLS (U.S. CLS. 13, 19, 21, 23, 31, 34 AND 35).

MICHELLE DUBOIS, EXAMINING ATTORNEY

SN 77-276,524. GLENDO CORPORATION, EMPORIA, KS. FILED 9-11-2007.

GraverSmith

THE MARK CONSISTS OF STANDARD CHARACTERS WITHOUT CLAIM TO ANY PARTICULAR FONT, STYLE, SIZE, OR COLOR.

OWNER OF U.S. REG. NOS. 1,468,824, 3,120,802 AND OTHERS.

FOR ENGRAVING MACHINES; ELECTRIC AND PNEUMATIC ENGRAVING TOOLS AND COMPONENT PARTS THEREOF (U.S. CLS. 13, 19, 21, 23, 31, 34 AND 35).

ROBERT LAVACHE, EXAMINING ATTORNEY

SN 77-278,600. CREATIVE CULINARY MARKETING SOLUTIONS, LLC, ATLANTA, GA. FILED 9-13-2007.

**CULINARYPREP**

NO CLAIM IS MADE TO THE EXCLUSIVE RIGHT TO USE "CULINARY PREP", APART FROM THE MARK AS SHOWN.

THE COLOR(S) GREEN AND GREY IS/ARE CLAIMED AS A FEATURE OF THE MARK.

THE MARK CONSISTS OF A LOGO CONSISTING OF A STYLIZED "CP" SYMBOL MADE UP OF THREE GREEN VERTICALLY ORIENTED STACKED SEMI-CIRCLES ORIENTED TO FORM A LETTER "C", WITH THE TOP OF THE "C" ALIGNED WITH, AND NEXT TO BUT NOT TOUCHING, A NARROW GREY VERTICAL LINE, WITH ANOTHER SET OF THREE GREY VERTICALLY ORIENTED STACKED SEMI-CIRCLES ON THE OPPOSITE SIDE OF

CLASS 7—(Continued).

THE NARROW GREY VERTICAL LINE AND AND IN REFLECTION OF THE GREEN SEMI-CIRCLES, FORMING A LETTER "P", WITH THE NARROW GREY VERTICAL LINE FORMING THE STEM OF THE LETTER "P". ALL TOGETHER WITH THE WORD COMBINATION "CULINARYPREP" UNDERNEATH THE STYLIZED "CP" SYMBOL. THE "CULINARY" PORTION OF THE WORD COMBINATION IS FEATURED IN GREEN, WHILE THE "PREP" PORTION OF THE WORD COMBINATION IS FEATURED IN GREY.

FOR ELECTRIC FOOD PREPARATION APPARATUS, NAMELY, TUMBLERS FOR MARINATING FOOD (U.S. CLS. 13, 19, 21, 23, 31, 34 AND 35).

FIRST USE 5-1-2007; IN COMMERCE 5-1-2007.
H. M. FISHER, EXAMINING ATTORNEY

CLASS 7—(Continued).

SN 77-291,241. ELLIS WILLIAMS ENGINEERING COMPANY, MAGNOLIA, TX. FILED 9-28-2007.



FOR OIL-WELL PUMPING MACHINES; SLUDGE PUMPS (U.S. CLS. 13, 19, 21, 23, 31, 34 AND 35).
FIRST USE 10-1-2003; IN COMMERCE 10-2-2003.
CYNTHIA SLOAN, EXAMINING ATTORNEY

SN 77-284,339. HYDROPRESS HUBER AB, LINDOME, SWEDEN, FILED 9-20-2007.

SN 77-291,250. DILLMAN, JEFFREY D., AMES, IA. FILED 9-28-2007.

STEP SCREEN

Tru Count Air Clutch

THE MARK CONSISTS OF STANDARD CHARACTERS WITHOUT CLAIM TO ANY PARTICULAR FONT, STYLE, SIZE, OR COLOR.

SEC. 2(F).
FOR MACHINES TO SEPARATE SOLID PARTICLES FROM A LIQUID (U.S. CLS. 13, 19, 21, 23, 31, 34 AND 35).
FIRST USE 9-10-1989; IN COMMERCE 9-10-1989.
SHAUNIA CARLYLE, EXAMINING ATTORNEY

THE MARK CONSISTS OF STANDARD CHARACTERS WITHOUT CLAIM TO ANY PARTICULAR FONT, STYLE, SIZE, OR COLOR.

NO CLAIM IS MADE TO THE EXCLUSIVE RIGHT TO USE "AIR CLUTCH", APART FROM THE MARK AS SHOWN.

FOR CLUTCHES FOR FARM MACHINES (U.S. CLS. 13, 19, 21, 23, 31, 34 AND 35).
FIRST USE 9-25-2007; IN COMMERCE 9-25-2007.
KATHERINE E. HALMEN, EXAMINING ATTORNEY

SN 77-286,555. DELEO THEODORE, FORT COLLINS, CO. FILED 9-23-2007.

SN 77-291,639. LOUGHBERRY MFG. CORP., SARATOGA SPRINGS, NY. FILED 9-28-2007.

QUIET~RIOT

we follow nature

THE MARK CONSISTS OF STANDARD CHARACTERS WITHOUT CLAIM TO ANY PARTICULAR FONT, STYLE, SIZE, OR COLOR.

FOR EXHAUST SILENCERS FOR ENGINES; SILENCERS AS PART OF VEHICLE EXHAUST SYSTEMS (U.S. CLS. 13, 19, 21, 23, 31, 34 AND 35).

JAMES A. RAUEN, EXAMINING ATTORNEY

THE MARK CONSISTS OF STANDARD CHARACTERS WITHOUT CLAIM TO ANY PARTICULAR FONT, STYLE, SIZE, OR COLOR.

FOR MECHANICAL SPREADERS; VACUUM CLEANERS FOR INDUSTRIAL PURPOSES (U.S. CLS. 13, 19, 21, 23, 31, 34 AND 35).

LEE-ANNE BERNS, EXAMINING ATTORNEY

CLASS 7—(Continued).

SN 77-292,218. KOODEN, WAYNE, E., DBA DIAMOND BLADE WORLD, CHATSWORTH, CA. FILED 9-29-2007.

Diamond Blade World

THE MARK CONSISTS OF STANDARD CHARACTERS WITHOUT CLAIM TO ANY PARTICULAR FONT, STYLE, SIZE, OR COLOR.

NO CLAIM IS MADE TO THE EXCLUSIVE RIGHT TO USE "DIAMOND BLADE", APART FROM THE MARK AS SHOWN.

FOR (BASED ON USE IN COMMERCE) BLADES FOR POWER SAWS (U.S. CLS. 13, 19, 21, 23, 31, 34 AND 35).

FIRST USE 6-1-2007; IN COMMERCE 7-1-2007.
LINDA M. KING, EXAMINING ATTORNEY

SN 77-292,552. JACKSON, GERALD M, LAKE CITY, MI. FILED 10-1-2007.

STRIKE HOPPER

THE MARK CONSISTS OF STANDARD CHARACTERS WITHOUT CLAIM TO ANY PARTICULAR FONT, STYLE, SIZE, OR COLOR.

FOR CONCRETE CONSTRUCTION MACHINES; CONCRETE FINISHING MACHINES; CONCRETE LEVELING MACHINES (U.S. CLS. 13, 19, 21, 23, 31, 34 AND 35).

FIRST USE 6-1-2007; IN COMMERCE 6-1-2007.
JAY BESCH, EXAMINING ATTORNEY

SN 77-293,142. B27 RESOURCES, INC., PLANO, TX. FILED 10-1-2007.

PUMPWORKS 610

THE MARK CONSISTS OF STANDARD CHARACTERS WITHOUT CLAIM TO ANY PARTICULAR FONT, STYLE, SIZE, OR COLOR.

OWNER OF U.S. REG. NO. 3,104,217.

FOR INDUSTRIAL FLUID PUMPS, NAMELY, CENTRIFUGAL, SUCTION, ROTARY AND POSITIVE DISPLACEMENT PUMPS FOR USE IN THE INDUSTRIES OF OIL AND GAS REFINING, OIL AND GAS PRODUCTION, RUBBER MANUFACTURING, PULP AND PAPER MANUFACTURING AND CHEMICAL PROCESSING; INDUSTRIAL FLUID PUMPING SYSTEMS CONSISTING OF PUMPS, ELECTRIC MOTORS FOR MACHINES, COUPLINGS FOR MACHINES, VALVES BEING PART OF ROTARY PUMPS, METAL PIPING, INSTRUMENTATION AND ELECTRONIC CONTROLS THEREFOR, ALL SOLD AS A UNIT AND FOR USE IN THE INDUSTRIES OF OIL AND GAS REFINING, OIL AND GAS PRODUCTION, RUBBER MANUFACTURING, PULP AND PAPER MANUFACTURING AND CHEMICAL PROCESSING (U.S. CLS. 13, 19, 21, 23, 31, 34 AND 35).

ZACHARY BELLO, EXAMINING ATTORNEY

CLASS 7—(Continued).

SN 77-293,146. B27 RESOURCES, INC., PLANO, TX. FILED 10-1-2007.

PUMPWORKS REMAN

THE MARK CONSISTS OF STANDARD CHARACTERS WITHOUT CLAIM TO ANY PARTICULAR FONT, STYLE, SIZE, OR COLOR.

OWNER OF U.S. REG. NO. 3,104,217.

FOR INDUSTRIAL FLUID PUMPS, NAMELY, CENTRIFUGAL, SUCTION, ROTARY AND POSITIVE DISPLACEMENT PUMPS FOR USE IN THE INDUSTRIES OF OIL AND GAS REFINING, OIL AND GAS PRODUCTION, RUBBER MANUFACTURING, PULP AND PAPER MANUFACTURING AND CHEMICAL PROCESSING; INDUSTRIAL FLUID PUMPING SYSTEMS CONSISTING OF PUMPS, ELECTRIC MOTORS FOR MACHINES, COUPLINGS FOR MACHINES, VALVES BEING PART OF ROTARY PUMPS, METAL PIPING, INSTRUMENTATION AND ELECTRONIC CONTROLS THEREFOR, ALL SOLD AS A UNIT AND FOR USE IN THE INDUSTRIES OF OIL AND GAS REFINING, OIL AND GAS PRODUCTION, RUBBER MANUFACTURING, PULP AND PAPER MANUFACTURING AND CHEMICAL PROCESSING (U.S. CLS. 13, 19, 21, 23, 31, 34 AND 35).

ZACHARY BELLO, EXAMINING ATTORNEY

SN 77-294,372. VISDYNAMICS RESEARCH SDN BHD, 75250 MELAKA, MALAYSIA, FILED 10-2-2007.

UGP

THE MARK CONSISTS OF STANDARD CHARACTERS WITHOUT CLAIM TO ANY PARTICULAR FONT, STYLE, SIZE, OR COLOR.

FOR MACHINES FOR MANUFACTURING, ASSEMBLING, PACKING AND HANDLING SEMICONDUCTORS (U.S. CLS. 13, 19, 21, 23, 31, 34 AND 35).

GIANCARLO CASTRO, EXAMINING ATTORNEY

SN 77-294,461. CALIFORNIA ENERGY & POWER, POMONA, CA. FILED 10-2-2007.

**CHANGING THE WORLD...ONE
REVOLUTION AT A TIME**

THE MARK CONSISTS OF STANDARD CHARACTERS WITHOUT CLAIM TO ANY PARTICULAR FONT, STYLE, SIZE, OR COLOR.

FOR VERTICAL AXIS WIND TURBINE (U.S. CLS. 13, 19, 21, 23, 31, 34 AND 35).

MARIAM MAHMOUDI, EXAMINING ATTORNEY

CLASS 7—(Continued).

SN 77-301,862. JACKSON, GERALD M, LAKE CITY, MI. FILED 10-11-2007.



THE COLOR(S) GREEN, YELLOW, RED, BLACK, AND BLUE-GRAY IS/ARE CLAIMED AS A FEATURE OF THE MARK.

THE MARK CONSISTS OF THE DESIGN OF A STYLIZED CARICATURE OF A GRASS HOPPER WITH WHEELS ATTACHED TO ITS HIND LEGS AND A SCREED ATTACHED TO ITS CENTER PAIR OF LEGS. THE COLORS GREEN AND YELLOW APPEAR IN THE BODY OF THE GRASS HOPPER. THE COLOR GREEN APPEARS IN THE LEGS OF THE GRASS HOPPER. THE COLORS YELLOW AND RED APPEAR IN THE ANTENNA OF THE GRASS HOPPER. THE COLOR BLACK APPEARS IN THE EYE OF THE GRASS HOPPER. THE COLORS BLACK AND RED APPEAR IN THE WHEELS. THE COLOR BLUE-GRAY APPEARS IN THE SCREED.

FOR CONCRETE CONSTRUCTION MACHINES; CONCRETE FINISHING MACHINES; CONCRETE LEVELING MACHINES (U.S. CLS. 13, 19, 21, 23, 31, 34 AND 35).
FIRST USE 6-1-2007; IN COMMERCE 6-1-2007.
JAY BESCH, EXAMINING ATTORNEY

SN 77-316,116. APARICIO, PEDRO LUIS, GUADALAJARA, MEXICO, FILED 10-29-2007.



THE COLOR(S) BLACK, GRAY AND RED IS/ARE CLAIMED AS A FEATURE OF THE MARK.

THE MARK CONSISTS OF THE WORDS "EMERY" IN BLACK AND "MARK" IN GRAY. BELOW THE WORD APPEARS A RED LINE.

FOR MIXERS; JUICE MACHINES; KITCHEN MACHINES, NAMELY, ELECTRIC STANDING MIXERS; MECHANICAL MIXING MACHINES (U.S. CLS. 13, 19, 21, 23, 31, 34 AND 35).
CAROLYN CATALDO, EXAMINING ATTORNEY

CLASS 7—(Continued).

SN 77-316,545. SUPERABRASIVE INC., BUFORD, GA. FILED 10-30-2007.



THE COLOR(S) LEMON YELLOW IS/ARE CLAIMED AS A FEATURE OF THE MARK.

THE MARK CONSISTS OF THE WORD "LAVINA" AND THE NUMBER "32" BOTH IN LEMON YELLOW COLOR. THE FOREIGN WORDING IN THE MARK TRANSLATES INTO ENGLISH AS AVALANCHE.

FOR FLOOR POLISHING MACHINES (U.S. CLS. 13, 19, 21, 23, 31, 34 AND 35).
GEORGE LORENZO, EXAMINING ATTORNEY

SN 77-321,157. CHURCH & DWIGHT CO., INC., PRINCETON, NJ. FILED 11-5-2007.



THE MARK CONSISTS OF STANDARD CHARACTERS WITHOUT CLAIM TO ANY PARTICULAR FONT, STYLE, SIZE, OR COLOR.

OWNER OF U.S. REG. NOS. 2,430,077, 3,028,707 AND 3,166,656.

NO CLAIM IS MADE TO THE EXCLUSIVE RIGHT TO USE "CLEAN", APART FROM THE MARK AS SHOWN.

FOR HAND HELD BATTERY POWERED DEVICE FOR CLEANING AND REMOVING SPOTS AND STAINS FROM CARPETS AND UPHOLSTERY (U.S. CLS. 13, 19, 21, 23, 31, 34 AND 35).

JULIE GUTTADAURO, EXAMINING ATTORNEY

SN 77-321,173. CHURCH & DWIGHT CO., INC., PRINCETON, NJ. FILED 11-5-2007.



OWNER OF U.S. REG. NOS. 2,430,077, 3,028,707 AND 3,166,656.

NO CLAIM IS MADE TO THE EXCLUSIVE RIGHT TO USE "CLEAN", APART FROM THE MARK AS SHOWN.

FOR HAND HELD BATTERY POWERED DEVICE FOR CLEANING AND REMOVING SPOTS AND STAINS FROM CARPETS AND UPHOLSTERY (U.S. CLS. 13, 19, 21, 23, 31, 34 AND 35).

JULIE GUTTADAURO, EXAMINING ATTORNEY

CLASS 7—(Continued).

SN 77-328,906. WEEMS INDUSTRIES, INC., MARION, IA.
FILED 11-14-2007.

CYCLONE

THE MARK CONSISTS OF STANDARD CHARACTERS
WITHOUT CLAIM TO ANY PARTICULAR FONT, STYLE,
SIZE, OR COLOR.

FOR COMPRESSED AIR BLOW GUN (U.S. CLS. 13, 19,
21, 23, 31, 34 AND 35).
WARREN L. OLANDRIA, EXAMINING ATTORNEY

SN 78-796,148. MILLER INDUSTRIES TOWING EQUIP-
MENT, INC., OOLTEWAH, TN. FILED 1-20-2006.

METRO

THE MARK CONSISTS OF STANDARD CHARACTERS
WITHOUT CLAIM TO ANY PARTICULAR FONT, STYLE,
SIZE, OR COLOR.

FOR HOISTS, BOOMS, LIFTS AND WINCHES ALL OF
WHICH ARE MOUNTED ON TRUCKS AND USED IN
THE RECOVERY AND TOWING OF DISABLED LAND
VEHICLES (U.S. CLS. 13, 19, 21, 23, 31, 34 AND 35).
FIRST USE 1-0-2004; IN COMMERCE 1-0-2004.
LAURA HAMMEL, EXAMINING ATTORNEY

SN 78-797,089. THE CARLYLE JOHNSON MACHINE COM-
PANY, LLC, BOLTON, CT. FILED 1-23-2006.

TORQ-LOK

THE MARK CONSISTS OF STANDARD CHARACTERS
WITHOUT CLAIM TO ANY PARTICULAR FONT, STYLE,
SIZE, OR COLOR.

FOR CLUTCHES FOR MACHINES (U.S. CLS. 13, 19, 21,
23, 31, 34 AND 35).
JENNIFER VASQUEZ, EXAMINING ATTORNEY

CLASS 7—(Continued).

SN 78-859,629. DEUTZ POWER SYSTEMS GMBH & CO. KG,
MANNHEIM, FED REP GERMANY, FILED 4-12-2006.

 The logo for GENTAINER features the word "GENTAINER" in a bold, sans-serif font. The letters are contained within a rectangular border that has a slightly irregular, hand-drawn appearance. The border is composed of thick black lines.

OWNER OF FED REP GERMANY REG. NO. 30088276,
DATED 3-31-2003, EXPIRES 12-10-2010.

OWNER OF U.S. REG. NO. 2,790,187.
FOR STATIONARY AND MOBILE COMBUSTION
ENGINES, NAMELY, DIESEL AND GAS ENGINES AS
NEW ENGINES, SHORT BLOCK, EXCHANGE GAS AND
DIESEL COMBUSTION ENGINES, REBUILT AND RE-
PAIRED GAS AND DIESEL COMBUSTION ENGINES
NOT FOR LAND VEHICLES AS WELL AS GENERAT-
ING SETS COMPRISED OF COMBUSTION ENGINES
AND MACHINES, POWER GENERATING SETS COM-
PRISED OF COMBUSTION ENGINES AND MACHINES
AS WELL AS NEW, EXCHANGE, REBUILT AND RE-
PAIRED PARTS OF SUCH COMBUSTION ENGINES
AND MACHINES; CONTAINER WITH SUCH COMBUS-
TION ENGINES AND MACHINES, IN PARTICULAR
COGENERATION PLANTS AND POWER GENERATING
SETS COMPRISED OF COMBUSTION ENGINES AND
MACHINES. (U.S. CLS. 13, 19, 21, 23, 31, 34 AND 35).
DAVID COLLIER, EXAMINING ATTORNEY

SN 78-920,276. LYDDON, JOHN, WOODSIDE, CA. FILED 6-
29-2006.

GRAB YOUR WORLD

THE MARK CONSISTS OF STANDARD CHARACTERS
WITHOUT CLAIM TO ANY PARTICULAR FONT, STYLE,
SIZE, OR COLOR.

FOR HYDRAULICALLY ACTUATED GRABBING
JAWS (U.S. CLS. 13, 19, 21, 23, 31, 34 AND 35).
JENNIFER MARTIN, EXAMINING ATTORNEY

CLASS 7—(Continued).

SN 79-025,609. M.J. MEIJER AERATION B.V.; H.O.D.N. TANIS FOOD TEC, NETHERLANDS, FILED 2-2-2006.



PRIORITY DATE OF 12-9-2005 IS CLAIMED.
 OWNER OF INTERNATIONAL REGISTRATION 0889637 DATED 2-2-2006, EXPIRES 2-2-2016.
 NO CLAIM IS MADE TO THE EXCLUSIVE RIGHT TO USE "FOOD" AND "TEC", APART FROM THE MARK AS SHOWN.
 THE COLOR(S) ROSE, BLACK, WHITE IS/ARE CLAIMED AS A FEATURE OF THE MARK.
 THE COLOR ROSE APPEARS IN THE LETTERS "TFT" ABOVE THE LITERAL ELEMENT "TANIS FOOD TEC" IN WHITE AND INSIDE A BLACK RECTANGLE.
 FOR ELECTRIC FOOD PROCESSORS FOR THE PREPARATION, AERATION, WHIPPING AND FILLING OF FOODSTUFFS; COLOR, FLAVOR AND ACID INJECTING MACHINE FOR CENTER-FILLED FOOD PRODUCTS; MACHINES FOR CLEANING SURFACES USING HIGH PRESSURE WATER (U.S. CLS. 13, 19, 21, 23, 31, 34 AND 35).
 DAVID HOFFMAN, EXAMINING ATTORNEY

SN 79-038,222. BOSUN TOOLS GROUP CO., LTD, CHINA, FILED 2-14-2007.

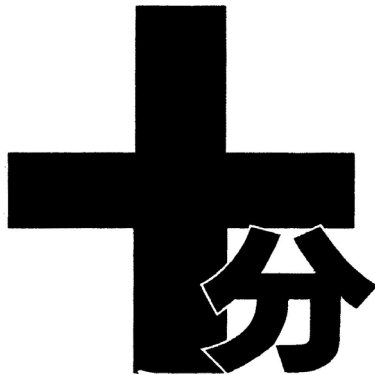

OWNER OF INTERNATIONAL REGISTRATION 0923431 DATED 2-14-2007, EXPIRES 2-14-2017.
 THE FIRST CHINESE CHARACTER WHOSE TRANSLITERATION IS "SHI" MEANS "TEN", THE SECOND CHINESE CHARACTER WHOSE TRANSLITERATION IS "FEN" MEANS "POINTS"; THE COMBINATION OF THE TWO CHINESE CHARACTER HAS NO MEANING IN A FOREIGN LANGUAGE.
 THE TRANSLITERATION OF THE NON-LATIN CHARACTERS IN THE MARK IS SHI FEN.
 FOR ELECTRIC POLISHERS, POWER DRILLING BITS, CUTTING MACHINES, CIRCULAR POWER SAW BLADES, PUNCHING PRESSES, MACHINE PARTS, NAMELY, BLADES, MACHINE TOOLS FOR CUTTING AND FORMING MATERIALS, ELECTRIC KNIVES BEING PARTS OF MACHINES, ELECTRIC HAND-HELD DRILLS, CUTTING MACHINES (U.S. CLS. 13, 19, 21, 23, 31, 34 AND 35).
 CHARLOTTE CORWIN, EXAMINING ATTORNEY

CLASS 7—(Continued).

SN 79-038,223. BOSUN TOOLS GROUP CO., LTD, CHINA, FILED 2-14-2007.



OWNER OF INTERNATIONAL REGISTRATION 0923432 DATED 2-14-2007, EXPIRES 2-14-2017.
 OWNER OF U.S. REG. NO. 2,669,218.
 THE ENGLISH TRANSLATION OF BO SHEN IS LARGE DEEP.
 THE TRANSLITERATION OF THE NON-LATIN CHARACTERS IN THE MARK IS: BO SHEN.
 FOR ELECTRIC POLISHERS, POWER DRILLING BITS, CUTTING MACHINES, CIRCULAR POWER SAW BLADES, PUNCHING PRESSES, MACHINE PARTS, NAMELY, BLADES, MACHINE TOOLS FOR CUTTING AND FORMING MATERIALS, ELECTRIC KNIVES BEING PARTS OF MACHINES, ELECTRIC HAND-HELD DRILLS, CUTTING MACHINES (U.S. CLS. 13, 19, 21, 23, 31, 34 AND 35).
 CHARLOTTE CORWIN, EXAMINING ATTORNEY

SN 79-038,343. SMAGARD LTD., GIBRALTAR, UNITED KINGDOM, FILED 4-10-2007.



OWNER OF INTERNATIONAL REGISTRATION 0923751 DATED 4-10-2007, EXPIRES 4-10-2017.
 THE ENGLISH TRANSLATION OF THE FOREIGN WORD IN THE MARK IS IONENERGY.
 FOR MACHINES FOR THE ELECTROCHEMICAL TREATMENT OF LIQUIDS (U.S. CLS. 13, 19, 21, 23, 31, 34 AND 35).
 ALICE BENMAMAN, EXAMINING ATTORNEY

SN 79-038,411. YAMATOMO KOSAN KABUSHIKI KAISHA, JAPAN, FILED 3-28-2007.



THE MARK CONSISTS OF STANDARD CHARACTERS WITHOUT CLAIM TO ANY PARTICULAR FONT, STYLE, SIZE, OR COLOR.
 OWNER OF INTERNATIONAL REGISTRATION 0923928 DATED 3-28-2007, EXPIRES 3-28-2017.
 FOR METALWORKING MACHINES, NAMELY, MACHINING CENTERS, DRILLING MACHINES, CUTTING MACHINES, LATHES, BORING MACHINES, THREADING MACHINES, MILLING MACHINES, BENDING MACHINES; PLASTIC PROCESSING MACHINES, NAMELY, COMPRESSION MOLDING MACHINES, INJECTION MOLDING MACHINES AND EXTRUSION MOLDING MACHINES; WOODWORKING MACHINES, NAMELY, CIRCULAR SAWS, ELECTRIC PLANERS, WOOD LATHES AND ELECTRICAL WOOD DRILLS (U.S. CLS. 13, 19, 21, 23, 31, 34 AND 35).
 STEVEN JACKSON, EXAMINING ATTORNEY

CLASS 7—(Continued).

SN 79-040,097. RUSSELL MINERAL EQUIPMENT PTY LIMITED, AUSTRALIA, FILED 5-24-2007.

MILLMAST

THE MARK CONSISTS OF STANDARD CHARACTERS WITHOUT CLAIM TO ANY PARTICULAR FONT, STYLE, SIZE, OR COLOR.

PRIORITY DATE OF 11-24-2006 IS CLAIMED.

OWNER OF INTERNATIONAL REGISTRATION 0928407 DATED 5-24-2007, EXPIRES 5-24-2017.

FOR MILL MACHINERY FOR HANDLING APPARATUS FOR LINING, LIFTING AND HANDLING MILL MACHINERY, NAMELY, ROLLING MILLS, LADLES, LADLE FEEDERS, FURNACE AND LADLE LINING MACHINES, GRAPPLES, BUCKETS, SCOOPS, AND HOOKS FOR MATERIAL HANDLING APPARATUS, TRAVELERS, CARRIAGES, TRAVELING PLATFORMS AND ANCILLARY EQUIPMENT, PARTS AND ACCESSORIES, QUARRY AND MINING MACHINES, NAMELY, ROOF BOLTERS, DRILLS, COAL CUTTERS, SCALERS AND POWER LOADERS AND MACHINE TOOLS, NAMELY, METAL BITS, FITTINGS, AND ATTACHMENTS IN THE NATURE OF PICKS AND MILLING TEETH, MINERAL PROCESSING MACHINERY AND ANCILLARY EQUIPMENT, PARTS AND ACCESSORIES FOR USE IN SIZE REDUCTION OF ASPHALT, STEEL-REINFORCED CONCRETE, STONE AND CONSTRUCTION AND DEMOLITION DEBRIS, NAMELY, CRUSHERS, PULVERIZERS, IMPACT BREAKERS, HAMMERMILLS, DISINTEGRATING MILLS, VIBRATING AND REVOLVING SCREENS AND CONVEYORS (U.S. CLS. 13, 19, 21, 23, 31, 34 AND 35).

KELLY MCCOY, EXAMINING ATTORNEY

SN 79-040,856. HEBEI PINGLE FLOUR MACHINERY; GROUP CO., LTD., CHINA, FILED 7-13-2007.



OWNER OF INTERNATIONAL REGISTRATION 0930301 DATED 7-13-2007, EXPIRES 7-13-2017.

THE ENGLISH TRANSLATION OF THE FOREIGN WORD(S) IN THE MARK IS "APPLE HAPPY"

THE TRANSLITERATION OF THE NON-LATIN CHARACTERS IN THE MARK IS "PINGLE"

FOR FLOUR MILL MACHINES AND MACHINES FOR USE IN THE FOOD INDUSTRY, NAMELY, MACHINES FOR MILLING FLOUR AND PARTS AND FITTING THEREFOR (U.S. CLS. 13, 19, 21, 23, 31, 34 AND 35).

CHARLES L. JENKINS, EXAMINING ATTORNEY

CLASS 7—(Continued).

SN 79-042,660. ATHLETE FA CORPORATION, JAPAN, FILED 8-1-2007.

Athlete

OWNER OF INTERNATIONAL REGISTRATION 0934666 DATED 8-1-2007, EXPIRES 8-1-2017.

OWNER OF U.S. REG. NO. 2,494,015.

FOR SEMICONDUCTOR MANUFACTURING MACHINES; SEMICONDUCTOR MOUNTING MACHINES; SEMICONDUCTOR PACKAGING MACHINES; ELECTRONIC PARTS ASSEMBLING MACHINES (U.S. CLS. 13, 19, 21, 23, 31, 34 AND 35).

DAVID HOFFMAN, EXAMINING ATTORNEY

CLASS 8—HAND TOOLS

SN 76-527,959. AUTOZONE, INC., MEMPHIS, TN, FILED 7-7-2003.

DURALAST

OWNER OF U.S. REG. NOS. 1,467,999 AND 1,607,305.

FOR HAND TOOLS, NAMELY, WRENCHES, RATCHET WRENCHES AND ATTACHMENTS THEREFOR, SOCKET WRENCHES, SOCKET SETS, PLIERS, SCREWDRIVERS, VICES AND HAMMERS, EXCEPT FOR THOSE SPECIFICALLY DESIGNED AND INTENDED FOR USE IN ROOFING APPLICATIONS (U.S. CLS. 23, 28 AND 44).

ANDREA BUTLER, EXAMINING ATTORNEY

SN 76-680,634. SILVER SLIDER, INC., JACKSONVILLE, FL, FILED 8-13-2007.

THE SILVER SLIDER

THE MARK CONSISTS OF STANDARD CHARACTERS WITHOUT CLAIM TO ANY PARTICULAR FONT, STYLE, SIZE, OR COLOR.

FOR HAND TOOLS, NAMELY, A LEVER WITH HOOKS TO ENGAGE AND REMOVE MANHOLE COVERS AND GRATES (U.S. CLS. 23, 28 AND 44).

FIRST USE 7-10-2006; IN COMMERCE 3-21-2007.

CHERYL CLAYTON, EXAMINING ATTORNEY

CLASS 8—(Continued).

SN 76-682,508. WAGIC, INC., LOS GATOS, CA. FILED 10-2-2007.

SURE-SLOT

FOR HAND TOOLS, NAMELY, A COMBINATION SCREWDRIVER HAVING A NUMBER OF BITS (U.S. CLS. 23, 28 AND 44).
GINA HAYES, EXAMINING ATTORNEY

SN 77-106,086. BLACKHAWK INDUSTRIES PRODUCT GROUP UNLIMITED LLC, NORFOLK, VA. FILED 2-13-2007.

DYNAMIC ENTRY

THE MARK CONSISTS OF STANDARD CHARACTERS WITHOUT CLAIM TO ANY PARTICULAR FONT, STYLE, SIZE, OR COLOR.
OWNER OF U.S. REG. NO. 2,770,466.
SEC. 2(F).
FOR HAND TOOLS, NAMELY, PICKS, RAKES, BOLT CUTTER, HAMMERS, SLEDGEHAMMERS, RAMS, SHOVELS, HALLAGAN TOOLS, WEDGES, MATTOCKS, SCRAPERS, AND SPADES (U.S. CLS. 23, 28 AND 44).
FIRST USE 11-1-1998; IN COMMERCE 11-1-1998.
KATHERINE E. HALMEN, EXAMINING ATTORNEY

SN 77-135,993. PANAVISE PRODUCTS, INC., RENO, NV. FILED 3-20-2007.

WISE BUDDY

THE MARK CONSISTS OF STANDARD CHARACTERS WITHOUT CLAIM TO ANY PARTICULAR FONT, STYLE, SIZE, OR COLOR.
NO CLAIM IS MADE TO THE EXCLUSIVE RIGHT TO USE "WISE", APART FROM THE MARK AS SHOWN.
FOR HAND TOOLS, NAMELY, VISES (U.S. CLS. 23, 28 AND 44).
SHAUNIA CARLYLE, EXAMINING ATTORNEY

CLASS 8—(Continued).

SN 77-159,850. ROBY, FLOYD K., WEST HAZLETON, PA. FILED 4-18-2007.

Roby "Bug-Master"

THE MARK CONSISTS OF STANDARD CHARACTERS WITHOUT CLAIM TO ANY PARTICULAR FONT, STYLE, SIZE, OR COLOR.
FOR METAL FLY TYING VISES FOR HOLDING FISH HOOKS WHILE TYING VARIOUS IMITATION INSECT PATTERNS FOR USE IN SPORT OR FLY-FISHING (U.S. CLS. 23, 28 AND 44).
FIRST USE 1-13-1989; IN COMMERCE 4-9-2007.
JIM RINGLE, EXAMINING ATTORNEY

SN 77-185,390. STILETTO TOOLS, INC., WINTON, CA. FILED 5-19-2007.

MINI 14

THE MARK CONSISTS OF STANDARD CHARACTERS WITHOUT CLAIM TO ANY PARTICULAR FONT, STYLE, SIZE, OR COLOR.
NO CLAIM IS MADE TO THE EXCLUSIVE RIGHT TO USE "14", APART FROM THE MARK AS SHOWN.
FOR HAND TOOLS, NAMELY, HAMMERS (U.S. CLS. 23, 28 AND 44).
FIRST USE 7-1-2004; IN COMMERCE 7-1-2004.
THEODORE MCBRIDE, EXAMINING ATTORNEY

SN 77-188,102. GIL HIBBEN, LAGRANGE, KY. FILED 5-23-2007.



THE MARK CONSISTS OF THE OVERALL DESIGN AND SHAPE OF A KNIFE. THE SHADING IN THE DRAWING IS NOT CLAIMED AS A FEATURE OF THE MARK. THE STIPPLING IS USED TO INDICATE 3-DIMENSIONAL TOPOGRAPHY AND IS NOT PART OF THE MARK.
SEC. 2(F).
FOR KNIVES (U.S. CLS. 23, 28 AND 44).
FIRST USE 11-27-1987; IN COMMERCE 11-27-1987.
JORDAN BAKER, EXAMINING ATTORNEY

CLASS 8—(Continued).

SN 77-222,171. AMES TRUE TEMPER PROPERTIES, INC., WILMINGTON, DE. FILED 7-5-2007.

UNIONTOOLS

THE MARK CONSISTS OF STANDARD CHARACTERS WITHOUT CLAIM TO ANY PARTICULAR FONT, STYLE, SIZE, OR COLOR.

OWNER OF U.S. REG. NOS. 1,617,346, 1,619,472 AND 3,012,013.

FOR MANUALLY OPERATED HAND TOOLS, NAMELY, SOD LIFTERS, TRANSPLANTERS, WEED CUTTERS, THATCHING RAKES, NUT GATHERERS, BEAN HOOKS, GRASS WHIPS, SOIL SCOOPS, DITCH BANK BLADES, GRASS HOOKS, CORN KNIVES, FRUIT PICKERS AND GRASS TRIMMERS (U.S. CLS. 23, 28 AND 44).

MICHELE SWAIN, EXAMINING ATTORNEY

SN 77-222,172. AMES TRUE TEMPER PROPERTIES, INC., WILMINGTON, DE. FILED 7-5-2007.

RAZORBACK

THE MARK CONSISTS OF STANDARD CHARACTERS WITHOUT CLAIM TO ANY PARTICULAR FONT, STYLE, SIZE, OR COLOR.

OWNER OF U.S. REG. NOS. 1,909,748, 1,968,748 AND 2,210,122.

FOR MANUALLY OPERATED HAND TOOLS, NAMELY, WEED CUTTERS, THATCHING RAKES, NUT GATHERERS, BEAN HOOKS, SOD LIFTERS, SOIL SCOOPS, FRUIT PICKERS AND GRASS TRIMMERS (U.S. CLS. 23, 28 AND 44).

MICHELE SWAIN, EXAMINING ATTORNEY

SN 77-222,459. AMES TRUE TEMPER PROPERTIES, INC., WILMINGTON, DE. FILED 7-5-2007.



OWNER OF U.S. REG. NOS. 1,617,346, 1,619,472 AND 3,012,013.

FOR MANUALLY OPERATED HAND TOOLS, NAMELY, SOD LIFTERS, TRANSPLANTERS, WEED CUTTERS, THATCHING RAKES, NUT GATHERERS, BEAN HOOKS, GRASS WHIPS, SOIL SCOOPS, DITCH BANK BLADES, GRASS HOOKS, CORN KNIVES, FRUIT PICKERS AND GRASS TRIMMERS (U.S. CLS. 23, 28 AND 44).

MICHELE SWAIN, EXAMINING ATTORNEY

CLASS 8—(Continued).

SN 77-246,400. ANDIS COMPANY, STURTEVANT, WI. FILED 8-3-2007.

PHAT MASTER

THE MARK CONSISTS OF STANDARD CHARACTERS WITHOUT CLAIM TO ANY PARTICULAR FONT, STYLE, SIZE, OR COLOR.

OWNER OF U.S. REG. NOS. 2,121,349, 2,488,678 AND OTHERS.

FOR ELECTRIC HAIR CLIPPERS AND BLADES FOR ELECTRIC HAIR CLIPPERS (U.S. CLS. 23, 28 AND 44).

BRIAN CALLAGHAN, EXAMINING ATTORNEY

SN 77-254,727. FISKARS BRANDS, INC., MADISON, WI. FILED 8-14-2007.

POWER-PIVOT

THE MARK CONSISTS OF STANDARD CHARACTERS WITHOUT CLAIM TO ANY PARTICULAR FONT, STYLE, SIZE, OR COLOR.

FOR HAND-HELD LAWN AND GARDEN TOOLS, NAMELY, PRUNERS, SHEARS, GRASS SHEARS, AND HAND-HELD MULTI-PURPOSE TOOLS COMPRISING A COMBINATION OF THE FOLLOWING KNIFE BLADES, SCISSORS, SNIPS, SAWS, WIRE CUTTERS AND PLIERS (U.S. CLS. 23, 28 AND 44).

RICHARD A. STRASER, EXAMINING ATTORNEY

SN 77-265,037. GREAT TRANGO HOLDINGS, INC., LOUISVILLE, CO. FILED 8-27-2007.



THE MARK CONSISTS OF STANDARD CHARACTERS WITHOUT CLAIM TO ANY PARTICULAR FONT, STYLE, SIZE, OR COLOR.

OWNER OF U.S. REG. NOS. 1,948,645 AND 2,773,727. FOR HAND TOOLS, NAMELY, NUT TOOLS, KNIVES, STICK CLIPS, ICE AXES, HAMMERS, HAMMERHEADS AND PICKS (U.S. CLS. 23, 28 AND 44).

FIRST USE 7-1-1992; IN COMMERCE 7-1-1992.

MARK PILARO, EXAMINING ATTORNEY

CLASS 8—(Continued).

SN 77-276,297. FIBER INSTRUMENT SALES, INC., ORIS-KANY, NY. FILED 9-11-2007.

Lynx

THE MARK CONSISTS OF STANDARD CHARACTERS WITHOUT CLAIM TO ANY PARTICULAR FONT, STYLE, SIZE, OR COLOR.

FOR OPTICAL FIBER CUTTING TOOLS, NAMELY, CLEAVERS FOR CUTTING GLASS OPTICAL FIBERS (U.S. CLS. 23, 28 AND 44).

FIRST USE 9-2-2005; IN COMMERCE 8-6-2007.
PAUL CROWLEY, EXAMINING ATTORNEY

SN 77-278,874. AMERICAN SAFETY RAZOR COMPANY, CEDAR KNOLLS, NJ. FILED 9-13-2007.

SPEED 4

THE MARK CONSISTS OF STANDARD CHARACTERS WITHOUT CLAIM TO ANY PARTICULAR FONT, STYLE, SIZE, OR COLOR.

OWNER OF U.S. REG. NO. 2,801,500.

NO CLAIM IS MADE TO THE EXCLUSIVE RIGHT TO USE "4", APART FROM THE MARK AS SHOWN.

FOR RAZORS AND RAZOR BLADES (U.S. CLS. 23, 28 AND 44).

FRANK LATTUCA, EXAMINING ATTORNEY

SN 77-290,362. ORTIZ, ALVARO, MIAMI, FL. FILED 9-27-2007.

SCRAPE IT

THE MARK CONSISTS OF STANDARD CHARACTERS WITHOUT CLAIM TO ANY PARTICULAR FONT, STYLE, SIZE, OR COLOR.

SEC. 2(F).

FOR CALLUS REMOVER IN THE NATURE OF A SCRAPER (U.S. CLS. 23, 28 AND 44).

FIRST USE 1-1-2001; IN COMMERCE 7-1-2002.
KEVIN DINALLO, EXAMINING ATTORNEY

CLASS 8—(Continued).

SN 77-295,470. YAN CAN COOK, INC., DBA YAN CAN COOK, FOSTER CITY, CA. FILED 10-3-2007.



OWNER OF U.S. REG. NOS. 2,311,369, 2,792,428 AND OTHERS.

THE NAME SHOWN IN THE MARK IDENTIFIES "MARTIN YAN" WHOSE CONSENT IS OF RECORD.

THE MARK CONSISTS OF A SQUARE WITH A DESIGN ELEMENT LOCATED WITHIN WHICH TRANSLATES AS "MARTIN YAN" WITH THE WORDS "MARTIN YAN" IN STYLIZED SCRIPT BELOW.

THE NON-LATIN CHARACTERS IN THE MARK TRANSLITERATE TO MARTIN YAN AND THIS MEANS MARTIN YAN IN ENGLISH.

FOR CHEF'S KNIVES (U.S. CLS. 23, 28 AND 44).

FIRST USE 9-18-1985; IN COMMERCE 9-18-1985.
MICHAEL WEBSTER, EXAMINING ATTORNEY

SN 77-297,454. YUGENKAISHA NENOHI, ISEHARA-SHI, JAPAN, FILED 10-5-2007.

sushius

THE MARK CONSISTS OF STANDARD CHARACTERS WITHOUT CLAIM TO ANY PARTICULAR FONT, STYLE, SIZE, OR COLOR.

FOR BUTCHER KNIVES; CHEF KNIVES; FISH SLICING KITCHEN KNIVES; HOUSEHOLD KNIVES; JAPANESE CHOPPING KITCHEN KNIVES; VEGETABLE KNIVES (U.S. CLS. 23, 28 AND 44).

FIRST USE 7-1-2007; IN COMMERCE 7-1-2007.
ALLISON HOLTZ, EXAMINING ATTORNEY

SN 77-302,046. AMERICAN SAFETY RAZOR COMPANY, CEDAR KNOLLS, NJ. FILED 10-11-2007.

SUNSOFT

THE MARK CONSISTS OF STANDARD CHARACTERS WITHOUT CLAIM TO ANY PARTICULAR FONT, STYLE, SIZE, OR COLOR.

FOR RAZORS AND RAZOR BLADES (U.S. CLS. 23, 28 AND 44).

FRANK LATTUCA, EXAMINING ATTORNEY

CLASS 8—(Continued).

SN 77-313,446. AMERICAN GREASE STICK COMPANY,
DBA AGS, MUSKEGON, MI. FILED 10-25-2007.

RATCHET MAN

THE MARK CONSISTS OF STANDARD CHARACTERS
WITHOUT CLAIM TO ANY PARTICULAR FONT, STYLE,
SIZE, OR COLOR.

NO CLAIM IS MADE TO THE EXCLUSIVE RIGHT TO
USE "RATCHET", APART FROM THE MARK AS SHOWN.
FOR HAND TOOLS, NAMELY, RATCHET
WRENCHES DESIGNED TO ENGAGE OR GRIP AN
OBJECT (U.S. CLS. 23, 28 AND 44).

EDWARD NELSON, EXAMINING ATTORNEY

SN 77-315,381. D-GENERATION, INC., DAYTONA BEACH,
FL. FILED 10-28-2007.

LIVE LAUGH LOVE

THE MARK CONSISTS OF STANDARD CHARACTERS
WITHOUT CLAIM TO ANY PARTICULAR FONT, STYLE,
SIZE, OR COLOR.

FOR CUTLERY, NAMELY, FORKS, SPOONS AND
KNIVES; FLATWARE, NAMELY, FORKS, KNIVES,
AND SPOONS; TABLEWARE NAMELY, KNIVES,
FORKS AND SPOONS (U.S. CLS. 23, 28 AND 44).

FIRST USE 9-4-2002; IN COMMERCE 9-4-2002.
CARYN GLASSER, EXAMINING ATTORNEY

SN 77-316,796. AMERICAN SAFETY RAZOR COMPANY,
CEDAR KNOLLS, NJ. FILED 10-30-2007.

MAGNUM

THE MARK CONSISTS OF STANDARD CHARACTERS
WITHOUT CLAIM TO ANY PARTICULAR FONT, STYLE,
SIZE, OR COLOR.

FOR RAZOR BLADES; RAZORS (U.S. CLS. 23, 28 AND
44).

FRANK LATTUCA, EXAMINING ATTORNEY

CLASS 8—(Continued).

SN 77-323,780. BELLISIO FOODS, INC., DBA MICHELINA'S,
INC., DULUTH, MN. FILED 11-7-2007.

THE FAMILY TABLE

THE MARK CONSISTS OF STANDARD CHARACTERS
WITHOUT CLAIM TO ANY PARTICULAR FONT, STYLE,
SIZE, OR COLOR.

FOR KITCHEN CUTLERY, NAMELY, KNIVES,
FORKS, AND SPOONS (U.S. CLS. 23, 28 AND 44).

JESSICA FATHY, EXAMINING ATTORNEY

SN 77-330,109. SERGEANT'S PET CARE PRODUCTS, INC.,
OMAHA, NE. FILED 11-15-2007.

POOCHI

THE MARK CONSISTS OF STANDARD CHARACTERS
WITHOUT CLAIM TO ANY PARTICULAR FONT, STYLE,
SIZE, OR COLOR.

OWNER OF U.S. REG. NOS. 1,493,123, 2,817,121 AND
3,271,667.

FOR NAIL CLIPPERS FOR PETS (U.S. CLS. 23, 28 AND
44).

FIRST USE 6-0-2007; IN COMMERCE 6-0-2007.
BENJAMIN OKEKE, EXAMINING ATTORNEY

SN 78-826,787. GLASWELD SYSTEMS, INC., BEND, OR.
FILED 3-1-2006.

G Fusion

THE MARK CONSISTS OF THE CHARACTERS "G
FUSION".

FOR AUTO GLASS REPAIR KIT CONSISTING OF
HAND TOOLS, NAMELY, AN INJECTOR FOR INSERT-
ING WINDSHIELD REPAIR RESINS, AND PARTS,
NAMELY, UV CURING LAMP AND WINDSHIELD
REPAIR RESINS (U.S. CLS. 23, 28 AND 44).

FIRST USE 10-15-2005; IN COMMERCE 2-1-2006.
MICHELLE DUBOIS, EXAMINING ATTORNEY

CLASS 8—(Continued).

SN 78-921,440. PROFESSIONAL TOOL MANUFACTURING LLC, ASHLAND, OR. FILED 6-30-2006.

WORK SHARP

THE MARK CONSISTS OF STANDARD CHARACTERS WITHOUT CLAIM TO ANY PARTICULAR FONT, STYLE, SIZE, OR COLOR.

NO CLAIM IS MADE TO THE EXCLUSIVE RIGHT TO USE "SHARP", APART FROM THE MARK AS SHOWN.

FOR HAND TOOLS, NAMELY, HAND OPERATED KNIFE SHARPENERS, HAND OPERATED TOOL SHARPENERS AND HAND OPERATED SANDERS (U.S. CLS. 23, 28 AND 44).

ANDREA BUTLER, EXAMINING ATTORNEY

CLASS 9—(Continued).

SN 76-521,942. KABUSHIKI KAISHA SONY COMPUTER ENTERTAINMENT, TA SONY COMPUTER ENTERTAINMENT INC., TOKYO 107-0052, JAPAN, FILED 6-11-2003.

COLOR IS NOT CLAIMED AS A FEATURE OF THE MARK.

FOR INSTANT CAMERAS WITH FILMS; ELECTRONIC MACHINES AND INSTRUMENTS FOR AMUSEMENT PARKS, NAMELY, COIN-OPERATED VIDEO GAMES WITH TELEVISION; SLOT MACHINES; DIGITAL VERSATILE DISC RECORDERS; DIGITAL VERSATILE DISC VIDEO RECORDERS; DIGITAL VERSATILE DISC ROM PLAYERS; DIGITAL VERSATILE DISC PLAYERS; HARD DISC DRIVE VIDEO RECORDERS; HARD DISC DRIVE RECORDERS; OPTICAL DISCS ENCODED WITH ASSEMBLERS, COMPILERS, AND COMPUTER PROGRAMS FOR SOFTWARE DEVELOPMENT AND COMPUTER PROGRAMMING IN THE NATURE OF VIDEO GAME AND VIDEO GAME SOFTWARE; OPTICAL DISCS ENCODED WITH VIDEO GAME PROGRAMS FOR PERSONAL OR BUSINESS USE; MAGNETIC OPTICAL DISCS ENCODED WITH VIDEO GAME PROGRAMS FOR PERSONAL OR BUSINESS USE; CD-ROMS ENCODED WITH VIDEO GAME PROGRAMS FOR PERSONAL USE; DIGITAL VERSATILE DISC ROMS ENCODED WITH VIDEO GAME PROGRAMS FOR PERSONAL USE; CONTROLLERS, JOYSTICKS, MEMORY CARDS, VOLUME CONTROLLERS, AND MOUSE FOR VIDEO GAMES FOR USE WITH TELEVISION GAME SYSTEMS FOR PERSONAL USE; PHOTOGRAPHIC APPARATUS AND INSTRUMENTS, NAMELY, CAMERAS; AUDIO CASSETTE RECORDERS; AUDIO TAPE RECORDERS AND/OR DIGITAL AUDIO TAPE RECORDERS; AUDIO OPTICAL DISC RECORDERS; VIDEO-CAMERAS, VIDEODISC PLAYERS, VIDEOTAPE RECORDERS; PHOTO-SENSITIVE TUBES; VACUUM TUBES; RECTIFIER TUBES; ELECTRON TUBES; VIDEO GAME MACHINE FOR USE WITH TELEVISION FOR PERSONAL USE (U.S. CLS. 21, 23, 26, 36 AND 38).

IRA J. GOODSAD, EXAMINING ATTORNEY

CLASS 9—ELECTRICAL AND SCIENTIFIC APPARATUS

SN 76-424,366. OSRAM GMBH, MÜNCHEN, FED REP GERMANY, FILED 6-24-2002.

FIREFLY

OWNER OF FED REP GERMANY REG. NO. 30132228.711, DATED 6-25-2001, EXPIRES 5-31-2011.

FOR SOLID-STATE ELECTRONIC CIRCUITS, NAMELY, LIGHT EMITTING DIODES AND PARTS THEREFOR (U.S. CLS. 21, 23, 26, 36 AND 38).

FIRST USE 4-26-2002; IN COMMERCE 4-26-2002.

KATHLEEN M. VANSTON, EXAMINING ATTORNEY

SN 76-674,126. EPCSOLUTIONS, INC., GREAT FALLS, VA. FILED 3-15-2007.

INTERNET OF THINGS FOR BUSINESS

THE MARK CONSISTS OF STANDARD CHARACTERS WITHOUT CLAIM TO ANY PARTICULAR FONT, STYLE, SIZE, OR COLOR.

FOR COMPUTER SYSTEM COMPRISED OF COMPUTER HARDWARE AND SOFTWARE THAT ALLOWS ANY SECOND GENERATION ULTRA HIGH FREQUENCY TAGGED ASSET TO BE CREATED OR ENCODED AND LATER READ AND VALIDATED BY RADIO FREQUENCY IDENTIFICATION (RFID) PRINTERS, RFID READERS AND RFID HANDHELD READERS (U.S. CLS. 21, 23, 26, 36 AND 38).

KATHLEEN M. VANSTON, EXAMINING ATTORNEY

CLASS 9—(Continued).

SN 76-674,298. ANYCOM TECHNOLOGIES AG, MONCHEN-GLADBACH, FED REP GERMANY, FILED 3-20-2007.

FIPO

PRIORITY CLAIMED UNDER SEC. 44(D) ON FED REP GERMANY APPLICATION NO. 30700740.5/0, FILED 1-2-2007.

OWNER OF FED REP GERMANY REG. NO. 30700470, DATED 1-31-2007, EXPIRES 1-31-2017.

FOR COMPUTER HARDWARE; WIRELESS COMPUTER PERIPHERALS; APPARATUS FOR RECORDING, TRANSMISSION OR REPRODUCTION OF SOUND AND IMAGES FOR WIRED AND WIRELESS COMMUNICATION HARDWARE (U.S. CLS. 21, 23, 26, 36 AND 38).

JAY FLOWERS, EXAMINING ATTORNEY

SN 76-674,444. ROAD SAFETY INTERNATIONAL, INC., THOUSAND OAKS, CA. FILED 3-22-2007.

DYNAMIC OVER-SPEED

THE MARK CONSISTS OF STANDARD CHARACTERS WITHOUT CLAIM TO ANY PARTICULAR FONT, STYLE, SIZE, OR COLOR.

FOR COMPUTER SOFTWARE AND COMPUTER HARDWARE FOR USE IN MONITORING, TRACKING AND CONTROLLING THE SPEED OF VEHICLES AND PROVIDING DATABASE REPORTS IN CONNECTION WITH DRIVER PERFORMANCE (U.S. CLS. 21, 23, 26, 36 AND 38).

JOHN DALIER, EXAMINING ATTORNEY

SN 76-676,872. A & A OPTICAL COMPANY, CARROLLTON, TX. FILED 5-15-2007.



THE STIPPLING IN THE DRAWING IS FOR SHADING PURPOSES ONLY.

FOR EYEWEAR FRAMES (U.S. CLS. 21, 23, 26, 36 AND 38).

FIRST USE 8-0-2005; IN COMMERCE 4-0-2006.
TRACY WHITTAKER-BROWN, EXAMINING ATTORNEY

CLASS 9—(Continued).

SN 76-679,910. BAWEK, BRADLEY, WINONA, MN. FILED 7-26-2007.



NO CLAIM IS MADE TO THE EXCLUSIVE RIGHT TO USE "HUNTER'S WINDSTRING", APART FROM THE MARK AS SHOWN.

BLACK, GOLDEN YELLOW, WHITE, OLIVE GREEN AND DARK OLIVE GREEN

THE LITERAL ELEMENT OF THE MARK CONSISTS OF HUNTER'S WINDSTRING. THE MARK CONSISTS OF HUNTER'S WINDSTRING IN STYLIZED LETTERING. THE WORD "HUNTER'S" IS ABOUT HALF THE SIZE OF THE WORD "WINDSTRING" AND IS PLACED ON TOP OF THAT WORD AFTER THE W. THE H IS CAPITALIZED AND THE REST OF THE LETTERS ARE SMALL CASE. IT IS OF A CAMOUFLAGED GOLDEN YELLOW COLOR. THE WORD "WINDSTRING" IS ALSO CAPITALIZED WITH THE FIRST LETTER ONLY, AND IS OF A CAMOUFLAGED OLIVE GREEN COLOR. THE SECOND "I" IN THE WORD WINDSTRING IS A DARKER OLIVE COLOR. THE MARK IS ON A BLACK BACKGROUND WHICH HAS A WHITE SCOPE SIGHT IN THE UPPER LEFT HAND SIDE AND IS CONNECTED TO THE SECOND "I" IN "WINDSTRING" BY TWO WHITE LINES COMING OUT THE BOTTOM OF THE "I" TO THE CENTER OF THE SCOPE. THE COLOR BLACK APPEARS IN THE BACKGROUND OF THE LOGO; THE COLOR GOLDEN YELLOW APPEARS IN THE WORD HUNTER'S; THE COLOR OLIVE GREEN APPEARS IN THE WORD WINDSTRING WHERE THE LETTER SECOND "I" IS A DARKER OLIVE GREEN THAN THE REST OF THE LETTERS; THE COLOR WHITE APPEARS IN A SCOPE IN THE UPPER LEFT HAND SIDE OF THE IMAGE AND IN TWO WHITE LINES COMING OUT THE BOTTOM OF THE I TO THE CENTER OF THE SCOPE.

FOR SPORTING GOODS, NAMELY A WIND DETECTION DEVICE FOR HUNTING (U.S. CLS. 21, 23, 26, 36 AND 38).

FIRST USE 2-13-2007; IN COMMERCE 1-14-2008.
DAVID MURRAY, EXAMINING ATTORNEY

CLASS 9—(Continued).

SN 76-682,997. YAMAHA CORPORATION, HAMAMATSU-SHI, SHIZUOKA, JAPAN, FILED 10-16-2007.

CLASS 9—(Continued).

SN 77-006,323. SARTORIUS STEDIM BIOTECH GMBH, GOTTINGEN, FED REP GERMANY, FILED 9-25-2006.

REALISTRICK

THE MARK CONSISTS OF STANDARD CHARACTERS WITHOUT CLAIM TO ANY PARTICULAR FONT, STYLE, SIZE, OR COLOR.

FOR APPARATUS AND INSTRUMENTS FOR PROCESSING, REPRODUCING, TRANSMITTING AND RECORDING SOUND OR IMAGES, NAMELY, TELEVISION SETS; RADIO-BROADCASTING RECEIVERS; MICROPHONES; LOUDSPEAKERS; WOOFERS; SUB-WOOFERS; HEADPHONES; EARPHONES; MINI AUDIO SYSTEMS COMPRISING AMPLIFIERS, LOUDSPEAKERS; AUDIO/VIDEO AMPLIFIERS; RECORDERS/PLAYERS OF OPTICAL DISCS; HARD DISC RECORDERS; AUDIO MIXERS; AUDIO SIGNAL PROCESSORS; AUDIO/VIDEO RECEIVERS; ELECTRONIC SOUND EFFECTORS; COMPUTER SOFTWARE FOR CONTROLLING AUDIO APPARATUS (U.S. CLS. 21, 23, 26, 36 AND 38).

ESTHER BELENKER, EXAMINING ATTORNEY

BIOPAT

THE MARK CONSISTS OF STANDARD CHARACTERS WITHOUT CLAIM TO ANY PARTICULAR FONT, STYLE, SIZE, OR COLOR.

FOR GAS ANALYZERS; SPECTROMETERS INCLUDING FLUORESCENCE SPECTROMETERS; TURBIDITY MEASURING AMPLIFIERS; DATA PROCESSING EQUIPMENT, NAMELY, COMPUTERS FOR RECORDING, STORING, REPRODUCING AND/OR CONTROLLING DATA SUCH AS PROCESSES FOR CONVERSION OF MATERIALS; AND SOFTWARE FOR CONTROLLING PROCESSES FOR THE CONVERSION OF MATERIALS (U.S. CLS. 21, 23, 26, 36 AND 38).

ALICIA COLLINS, EXAMINING ATTORNEY

SN 76-978,651. PEARCE, CAMERON P., SAN JUAN CAPISTRANO, CA. FILED 6-1-2004.

SN 77-007,290. ARUZE CORP., TOKYO, JAPAN, FILED 9-26-2006.

PRIMO

THE MARK CONSISTS OF STANDARD CHARACTERS WITHOUT CLAIM TO ANY PARTICULAR FONT, STYLE, SIZE, OR COLOR.

OWNER OF U.S. REG. NO. 2,760,561.

FOR SUNGLASSES, EYEGLASSES, EYEGLASS CASES, EYEGLASS CHAINS, EYEGLASS FRAMES, AND REPLACEMENT LENSES AND REPLACEMENT PARTS FOR EYEGLASSES (U.S. CLS. 21, 23, 26, 36 AND 38).

FIRST USE 12-1-1967; IN COMMERCE 12-1-1967.

BONNIE LUKEN, EXAMINING ATTORNEY

G-WAVE

PRIORITY CLAIMED UNDER SEC. 44(D) ON JAPAN APPLICATION NO. 2006-68403, FILED 7-21-2006, REG. NO. 5054549, DATED 6-15-2007, EXPIRES 6-15-2017.

THE MARK CONSISTS OF A STYLIZED FORM OF THE LETTERS "GWAVE".

FOR SLOT MACHINES; CABINETS FOR SLOT MACHINES SOLD AS AN INTEGRAL COMPONENT THEREOF; VIDEO SLOT MACHINES; GAMING MACHINES; VIDEO GAMING MACHINES; MEDIA STORAGE COMPUTER SOFTWARE, NAMELY, COMPUTER SOFTWARE FOR CONTROLLING SLOT MACHINES AND GAMING MACHINES (U.S. CLS. 21, 23, 26, 36 AND 38).

JAMES MACFARLANE, EXAMINING ATTORNEY

CLASS 9—(Continued).

SN 77-007,307. ARUZE CORP., TOKYO, JAPAN, FILED 9-26-2006.



PRIORITY CLAIMED UNDER SEC. 44(D) ON JAPAN APPLICATION NO. 2006-68404, FILED 7-21-2006, REG. NO. 5028407, DATED 2-23-2007, EXPIRES 2-23-2017.

THE MARK CONSISTS OF A STYLIZED LETTER "G".
FOR SLOT MACHINES; CABINETS FOR SLOT MACHINES SOLD AS AN INTEGRAL COMPONENT THEREOF; VIDEO SLOT MACHINES; GAMING MACHINES; VIDEO GAMING MACHINES; MEDIA STORAGE COMPUTER SOFTWARE, NAMELY, COMPUTER SOFTWARE FOR CONTROLLING SLOT MACHINES AND GAMING MACHINES (U.S. CLS. 21, 23, 26, 36 AND 38).

JAMES MACFARLANE, EXAMINING ATTORNEY

SN 77-008,660. SOUNDSPECTRUM, INC., NEW YORK, NY, FILED 9-27-2006.

SOUNDSPECTRUM

THE MARK CONSISTS OF STANDARD CHARACTERS WITHOUT CLAIM TO ANY PARTICULAR FONT, STYLE, SIZE, OR COLOR.

OWNER OF U.S. REG. NO. 3,226,767.
SEC. 2(F).

FOR DOWNLOADABLE COMPUTER SOFTWARE IN THE FIELD OF AUDIO VISUALIZATION THAT CREATES VISUAL EFFECTS FOR VIEWING WHILE USERS LISTEN TO MUSIC (U.S. CLS. 21, 23, 26, 36 AND 38).

FIRST USE 8-0-2004; IN COMMERCE 8-0-2004.
JANICE KIM, EXAMINING ATTORNEY

CLASS 9—(Continued).

SN 77-016,254. INFOWEAPONS INCORPORATED, DULUTH, GA. FILED 10-6-2006.

INFOWEAPONS

THE MARK CONSISTS OF STANDARD CHARACTERS WITHOUT CLAIM TO ANY PARTICULAR FONT, STYLE, SIZE, OR COLOR.

FOR COMPUTER HARDWARE AND SOFTWARE, NAMELY, NETWORK APPLIANCES, SERVERS, AND INTERNET COMMUNICATION EQUIPMENT AND RELATED SOFTWARE FOR MANAGING AND CONTROLLING SUCH HARDWARE (U.S. CLS. 21, 23, 26, 36 AND 38).

PAULA MAHONEY, EXAMINING ATTORNEY

SN 77-020,123. KANAWHA SCALES & SYSTEMS, INC., POCA, WV. FILED 10-12-2006.

ASHSCAN

THE MARK CONSISTS OF STANDARD CHARACTERS WITHOUT CLAIM TO ANY PARTICULAR FONT, STYLE, SIZE, OR COLOR.

FOR EQUIPMENT FOR IN-LINE ANALYZING AND MEASURING OF ASH CONTENT IN COAL (U.S. CLS. 21, 23, 26, 36 AND 38).

FIRST USE 10-3-2005; IN COMMERCE 10-3-2005.
ROBIN CHOSID, EXAMINING ATTORNEY

SN 77-022,433. FORD MOTOR COMPANY, DEARBORN, MI, FILED 10-17-2006.

SYNC

THE MARK CONSISTS OF STANDARD CHARACTERS WITHOUT CLAIM TO ANY PARTICULAR FONT, STYLE, SIZE, OR COLOR.

SEC. 2(F).

FOR ELECTRONIC INTERFACE MODULES FOR WIRED AND WIRELESS INTERFACE OF MOBILE PHONES AND ELECTRONIC MEDIA PLAYERS WITH AN AUTOMOTIVE ELECTRICAL SYSTEM (U.S. CLS. 21, 23, 26, 36 AND 38).

FIRST USE 1-7-2007; IN COMMERCE 1-7-2007.
HOWARD SMIGA, EXAMINING ATTORNEY

CLASS 9—(Continued).

SN 77-023,686. INNOVATION FUND LLC, NEW YORK, NY. FILED 10-18-2006.

BOOK POD

THE MARK CONSISTS OF STANDARD CHARACTERS WITHOUT CLAIM TO ANY PARTICULAR FONT, STYLE, SIZE, OR COLOR.

NO CLAIM IS MADE TO THE EXCLUSIVE RIGHT TO USE "BOOK", APART FROM THE MARK AS SHOWN.

FOR FLASH DRIVES, FLASH MEMORY CARDS, MICROCHIPS, AND MICROCHIP CARDS CONTAINING DIGITAL SIGNAL PROCESSORS, MICRO-PROCESSORS, AUDIO PROCESSORS, AND VIDEO PROCESSORS, SOLD ALONE BUT FOR LATER PLACEMENT IN PRINTED PUBLICATIONS WHICH THEN COMMUNICATE WIRELESSLY OR THROUGH USB COMPUTER HARDWARE TO COMPUTERS, MOBILE PHONES, AND PERSONAL DATA ASSISTANTS ADDITIONAL INFORMATION RELATED TO THE SUBJECT MATTER OF THE PUBLICATIONS (U.S. CLS. 21, 23, 26, 36 AND 38).
TANYA AMOS, EXAMINING ATTORNEY

SN 77-023,796. INNOVATION FUND LLC, NEW YORK, NY. FILED 10-18-2006.

BOOK POD YOUR PRINT TO MEDIA CONNECTION

THE MARK CONSISTS OF STANDARD CHARACTERS WITHOUT CLAIM TO ANY PARTICULAR FONT, STYLE, SIZE, OR COLOR.

FOR FLASH DRIVES, FLASH MEMORY CARDS, MICROCHIPS, AND MICROCHIP CARDS CONTAINING DIGITAL SIGNAL PROCESSORS, MICRO-PROCESSORS, AUDIO PROCESSORS, AND VIDEO PROCESSORS, SOLD ALONE BUT FOR LATER PLACEMENT IN PRINTED PUBLICATIONS WHICH THEN COMMUNICATE WIRELESSLY OR THROUGH USB COMPUTER HARDWARE TO COMPUTERS, MOBILE PHONES, AND PERSONAL DATA ASSISTANTS ADDITIONAL INFORMATION RELATED TO THE SUBJECT MATTER OF THE PUBLICATIONS (U.S. CLS. 21, 23, 26, 36 AND 38).
TANYA AMOS, EXAMINING ATTORNEY

CLASS 9—(Continued).

SN 77-033,843. VIDEO GAMING TECHNOLOGIES, INC., SMYRNA, TN. FILED 11-1-2006.

BLACK BURT

THE MARK CONSISTS OF STANDARD CHARACTERS WITHOUT CLAIM TO ANY PARTICULAR FONT, STYLE, SIZE, OR COLOR.

FOR COMPUTER SOFTWARE AND FIRMWARE FOR GAMES OF CHANCE ON ANY COMPUTERIZED PLATFORM, INCLUDING DEDICATED GAMING CONSOLES, VIDEO BASED SLOT MACHINES, REEL BASED SLOT MACHINES, AND VIDEO LOTTERY TERMINALS; GAMING DEVICES, NAMELY, GAMING MACHINES, SLOT MACHINES, BINGO MACHINES, WITH OR WITHOUT VIDEO OUTPUT (U.S. CLS. 21, 23, 26, 36 AND 38).
DOMINIC FATHY, EXAMINING ATTORNEY

SN 77-035,607. TENNAPLEX, 83022 ROSENHEIM, FED REP GERMANY, FILED 11-2-2006.

TENNAPLEX

THE MARK CONSISTS OF STANDARD CHARACTERS WITHOUT CLAIM TO ANY PARTICULAR FONT, STYLE, SIZE, OR COLOR.

PRIORITY CLAIMED UNDER SEC. 44(D) ON FED REP GERMANY APPLICATION NO. DE3064953, FILED 8-10-2006, REG. NO. 30649532, DATED 10-16-2006, EXPIRES 8-31-2016.

FOR ANTENNAS, TRANSMITTING AND RECEPTION ANTENNAS FOR RADIO AND TELEVISION TRANSMITTING STATIONS, ANTENNAS FOR MOBILE COMMUNICATION NETWORKS, COMBINERS AND AMPLIFIERS FOR MOBILE COMMUNICATION BASE STATIONS, SATELLITE AND TERRESTRIAL ANTENNAS ANALOG AND DIGITAL, BROADBAND NETS AND HEADENDS, MOBILE RADIO ANTENNAS AND RECEIVERS, CAR ANTENNAS, CORDLESS PHONES INDOOR ANTENNAS, CABLES AND CONNECTORS FOR ANTENNAS, SIGNAL METERS, FEEDERS FOR SATELLITE ANTENNAS, MOBILE HOME ANTENNAS; TRANSMISSION TECHNOLOGY AND ELECTRONICS, NAMELY, BANDPASS AND DUPLEX FILTERS, TRANSMISSION COUPLERS, MULTI-RANGE COMBINER FILTERS, 3-DB COUPLERS, RING CIRCUITS, SPLITTERS, CIRCULATORS, TERMINATORS, MULTI-COUPLERS AND RECEIVING AMPLIFIERS, AUTO-TUNE TRANSMITTER COMBINERS, REPEATERS; STANDARD TELEPHONES, DIGITAL ANSWER-PHONES, CORDLESS PHONES, RADIO AND CELL-PHONE ANTENNA COUPLERS, CELL-PHONE INSTALLATION TESTERS; BROADBAND MODULAR OPTICAL COMPACT RECEPTION NODE UNITS WITH BROADBAND RETURN PATH AND STATUS MONITORING, VARIABLE DISTRIBUTION AMPLIFIER PLATFORMS WITH INTERCHANGEABLE RETURN PATH AMPLIFIERS AND STATUS MONITORING, IN-HOUSE DISTRIBUTION AMPLIFIERS WITH INTERCHANGEABLE RETURN PATH COMPONENTS, HOUSE CONNECTION INTERFACES FOR CABLE TV SYSTEMS; MODEMS; SATELLITE DISHES AND PROCESSORS (U.S. CLS. 21, 23, 26, 36 AND 38).
EDWARD NELSON, EXAMINING ATTORNEY

CLASS 9—(Continued).

SN 77-049,733. SMARTFUNDIT.COM LIMITED, BASINGSTOKE, HAMPSHIRE, UNITED KINGDOM, FILED 11-22-2006.

SMARTFUNDIT.COM

THE MARK CONSISTS OF STANDARD CHARACTERS WITHOUT CLAIM TO ANY PARTICULAR FONT, STYLE, SIZE, OR COLOR.

FOR COMPUTER SOFTWARE FOR FINANCIAL SERVICES, NAMELY, SOFTWARE THAT ASSISTS WITH THE PROCUREMENT OF FINANCING IN THE FIELD OF COMPUTER SOFTWARE AND COMPUTER HARDWARE (U.S. CLS. 21, 23, 26, 36 AND 38).

SANI KHOURI, EXAMINING ATTORNEY

SN 77-059,781. DRÄGER SAFETY AG & CO. KGAA, LÜBECK, FED REP GERMANY, FILED 12-8-2006.

FPS

THE MARK CONSISTS OF STANDARD CHARACTERS WITHOUT CLAIM TO ANY PARTICULAR FONT, STYLE, SIZE, OR COLOR.

PRIORITY CLAIMED UNDER SEC. 44(D) ON ERPN CMNTY TM OFC APPLICATION NO. 005532007, FILED 12-7-2006, REG. NO. 005532007, DATED 11-15-2007, EXPIRES 12-7-2016.

FOR BREATHING PROTECTION MASKS AND BREATHING PROTECTION FILTERS FOR PROTECTION MASKS (U.S. CLS. 21, 23, 26, 36 AND 38).

SIMON TENG, EXAMINING ATTORNEY

CLASS 9—(Continued).

SN 77-062,656. GALAXY AUDIO, INC., WICHITA, KS. FILED 12-12-2006.

CHAMELEON
MICRO SPOT

THE COLOR(S) RED AND BLACK IS/ARE CLAIMED AS A FEATURE OF THE MARK.

THE COLOR BLACK APPEARS IN THE WORDING CHAMELEON MICRO SPOT AND THE COLOR RED APPEARS IN THE DESIGN OF THE CIRCLES.

FOR LOUDSPEAKERS (U.S. CLS. 21, 23, 26, 36 AND 38).

FIRST USE 3-1-2007; IN COMMERCE 3-1-2007.

ANNE E. GUSTASON, EXAMINING ATTORNEY

SN 77-063,378. EMUSE MEDIA LIMITED, DUBLIN 2, IRELAND, FILED 12-13-2006.

EMUSE ABSOLUTELY

THE MARK CONSISTS OF STANDARD CHARACTERS WITHOUT CLAIM TO ANY PARTICULAR FONT, STYLE, SIZE, OR COLOR.

PRIORITY CLAIMED UNDER SEC. 44(D) ON ERPN CMNTY TM OFC APPLICATION NO. 5175344, FILED 7-3-2006, REG. NO. 005175344, DATED 7-27-2007, EXPIRES 7-3-2016.

FOR COMPUTER HARDWARE; COMPUTER SOFTWARE AND FIRMWARE FOR DEVELOPING, INTEGRATING AND DEPLOYING INTERACTIVE AUDIO-VISUAL AND TELEVISION APPLICATIONS; COMPUTER SOFTWARE FOR INTERACTIVE TELEVISION APPLICATIONS (U.S. CLS. 21, 23, 26, 36 AND 38).

RONALD MCMORROW, EXAMINING ATTORNEY

CLASS 9—(Continued).

SN 77-076,919. CROREY, DAVID J., CLINTON TOWNSHIP, MI. FILED 1-5-2007.

CENTER MARK

THE MARK CONSISTS OF STANDARD CHARACTERS WITHOUT CLAIM TO ANY PARTICULAR FONT, STYLE, SIZE, OR COLOR.

NO CLAIM IS MADE TO THE EXCLUSIVE RIGHT TO USE "MARK", APART FROM THE MARK AS SHOWN.

FOR MAGNETIC HAND TOOLS, NAMELY, AN ELECTRICAL BOX LOCATOR FOR FINDING AN ELECTRICAL BOX BEHIND A SHEET OF DRYWALL, PANELING, OR PLYWOOD (U.S. CLS. 21, 23, 26, 36 AND 38).

JENNIFER HETU, EXAMINING ATTORNEY

SN 77-077,441. DIGITENNA LLC, OOSTBURG, WI. FILED 1-5-2007.

DUV

THE MARK CONSISTS OF STANDARD CHARACTERS WITHOUT CLAIM TO ANY PARTICULAR FONT, STYLE, SIZE, OR COLOR.

FOR ANTENNAS; AND ACCESSORIES AND PARTS THEREOF, NAMELY, VHF, UHF, AND FM ANTENNAS, PREAMPLIFIERS, AMPLIFIERS, AND COMMUNICATION CABLES (U.S. CLS. 21, 23, 26, 36 AND 38).

ELLEN PERKINS, EXAMINING ATTORNEY

SN 77-088,917. SIBLINGS INVESTMENT, INC. DBA VANTEC THERMAL TECHNOLOGIES, FREMONT, CA. FILED 1-23-2007.

EZ SWAP

THE MARK CONSISTS OF STANDARD CHARACTERS WITHOUT CLAIM TO ANY PARTICULAR FONT, STYLE, SIZE, OR COLOR.

SEC. 2(F).

FOR COMPUTERS AND COMPUTER HARDWARE (U.S. CLS. 21, 23, 26, 36 AND 38).

FIRST USE 1-3-2003; IN COMMERCE 1-3-2003.

BARBARA GAYNOR, EXAMINING ATTORNEY

CLASS 9—(Continued).

SN 77-093,551. SASSON CAPITAL, TAIPEI 115, TAIWAN, FILED 1-29-2007.

ORINDA NETWORKS

THE MARK CONSISTS OF STANDARD CHARACTERS WITHOUT CLAIM TO ANY PARTICULAR FONT, STYLE, SIZE, OR COLOR.

NO CLAIM IS MADE TO THE EXCLUSIVE RIGHT TO USE "NETWORKS", APART FROM THE MARK AS SHOWN.

FOR COMPUTER NETWORKING HARDWARE, NAMELY, CARRIER GRADE WIRELESS INDOOR AND OUTDOOR WIDE-AREA NETWORKING (WLAN) EQUIPMENT, NAMELY, (802.11 LA/B/G/N, WIMAX) WIRELESS ACCESS POINT DEVICES, WIRELESS SUBSCRIBER BASE STATIONS, LONG-RANGE NETWORK BRIDGES; CONNECTIVITY MANAGEMENT SOFTWARE TO IMPROVE SECURITY WITH HIGH-SPEED DELIVERY OF DATA, VIDEO AND VOICE; RFID (RADIO FREQUENCY IDENTIFICATION) READERS AND ANTENNAS COMPLIANT WITH INTERNATIONAL STANDARDS AND ENVIRONMENTAL REQUIREMENTS FOR SYSTEMS INTEGRATION FOR USE WITH SOFTWARE APPLICATIONS FOR THIRD-PARTY ASSET TRACKING, INVENTORY VERIFICATION, AND WORKFLOW PROCESS MANAGEMENT SOFTWARE APPLICATIONS (U.S. CLS. 21, 23, 26, 36 AND 38).

FIRST USE 1-25-2007; IN COMMERCE 1-25-2007.

DAVID I, EXAMINING ATTORNEY

SN 77-095,784. INTERNETSAFETY.COM, INC., ACWORTH, GA. FILED 1-31-2007.

SAFE EYES

THE MARK CONSISTS OF STANDARD CHARACTERS WITHOUT CLAIM TO ANY PARTICULAR FONT, STYLE, SIZE, OR COLOR.

NO CLAIM IS MADE TO THE EXCLUSIVE RIGHT TO USE "SAFE", APART FROM THE MARK AS SHOWN.

FOR SOFTWARE FOR FACILITATING INTERNET PARENTAL CONTROL, NAMELY, SOFTWARE THAT PROVIDES AN INTERNET CONTENT FILTER (U.S. CLS. 21, 23, 26, 36 AND 38).

FIRST USE 1-21-2003; IN COMMERCE 1-21-2003.

GEORGIA CARTY, EXAMINING ATTORNEY

CLASS 9—(Continued).

SN 77-099,785. TREK 2000 INTERNATIONAL LTD., LOYANG INDUSTRIAL EST., SINGAPORE, FILED 2-5-2007.

THUMBDRIVE

THE MARK CONSISTS OF STANDARD CHARACTERS WITHOUT CLAIM TO ANY PARTICULAR FONT, STYLE, SIZE, OR COLOR.

OWNER OF U.S. REG. NO. 3,175,651.
SEC. 2(F).

FOR PORTABLE DIGITAL ELECTRONIC DEVICES FOR RECORDING, ORGANIZING, TRANSFERRING, STORING, AND REVIEWING TEXT, DATA, IMAGE, AUDIO AND VIDEO FILES; COMPUTER SOFTWARE FOR USE IN RECORDING, ORGANIZING, TRANSFERRING, STORING, AND REVIEWING TEXT, DATA, IMAGE, AUDIO AND VIDEO FILES ON PORTABLE DIGITAL ELECTRONIC DEVICES (U.S. CLS. 21, 23, 26, 36 AND 38).

FIRST USE 0-0-1999; IN COMMERCE 0-0-2000.
KAREN SEVERSON, EXAMINING ATTORNEY

SN 77-101,026. LIFEGATE, INC., SAN FRANCISCO, CA. FILED 2-6-2007.

Lifegate

THE MARK CONSISTS OF STANDARD CHARACTERS WITHOUT CLAIM TO ANY PARTICULAR FONT, STYLE, SIZE, OR COLOR.

FOR COMPUTER SOFTWARE FOR USE WITH MEDICAL MONITORING EQUIPMENT AND SENSORS, FOR RECEIVING, PROCESSING, TRANSMITTING AND DISPLAYING DATA FOR REMOTE MONITORING OF INDIVIDUAL SUBSCRIBERS' AND PATIENTS' VITAL SIGNS; COMPUTER SOFTWARE AND FIRMWARE UTILIZED FOR TRACKING AND LOCATING INDIVIDUAL SUBSCRIBERS AND PATIENTS WHO MAY BE EXPERIENCING CRISIS EPISODES OR EMERGENCY EVENTS AND SUBSEQUENTLY SENDING ALERTS AND MESSAGES TO PERSONALIZED CONTACTS AND MEDICAL AND EMERGENCY PERSONNEL RESPONDERS TO INITIATE AND FACILITATE INTERVENTION; COMPUTER SOFTWARE USED FOR RELAYING ELECTRONIC AND WIRELESS MESSAGES, ALERTS, AND DATA CONCERNING INDIVIDUAL SUBSCRIBERS' AND PATIENTS' VITAL SIGNS VIA THE GLOBAL COMMUNICATION NETWORKS AND ELECTRONIC AND WIRELESS DEVICES, NAMELY, VIA MOBILE PHONES, COMMUNICATION DEVICES, PERSONAL DIGITAL ASSISTANTS AND COMPUTERS (U.S. CLS. 21, 23, 26, 36 AND 38).

FIRST USE 11-5-2007; IN COMMERCE 11-5-2007.
KATHERINE M. DUBRAY, EXAMINING ATTORNEY

CLASS 9—(Continued).

SN 77-104,505. MASTROMATTEI, PIETRO, MIDDLETON, MA. AND MASTROMATTEI, MARCO, MIDDLETON, MA. FILED 2-11-2007.

**TRITON
MUSIC**

NO CLAIM IS MADE TO THE EXCLUSIVE RIGHT TO USE "MUSIC", APART FROM THE MARK AS SHOWN.

FOR AUDIO RECORDINGS FEATURING MUSIC BY DIFFERENT ARTISTS; DOWNLOADABLE MP3 FILES, MP3 RECORDINGS, ONLINE DISCUSSION BOARDS, WEB CASTS, POD CASTS FEATURING MUSIC, AUDIO BOOKS AND NEWS BROADCASTS; DOWNLOADABLE MUSICAL SOUND RECORDINGS; DOWNLOADABLE RING TONES, GRAPHICS AND MUSIC VIA A GLOBAL COMPUTER NETWORK AND WIRELESS DEVICES; DOWNLOADABLE VIDEO RECORDINGS FEATURING MUSIC BY DIFFERENT ARTISTS; MUSICAL SOUND RECORDINGS; SOUND RECORDINGS FEATURING MUSIC BY DIFFERENT ARTISTS; VIDEO RECORDINGS FEATURING MUSIC BY DIFFERENT ARTISTS; VISUAL RECORDINGS AND AUDIO VISUAL RECORDINGS FEATURING MUSIC AND ANIMATION (U.S. CLS. 21, 23, 26, 36 AND 38).

FIRST USE 1-7-2003; IN COMMERCE 1-7-2003.
PATRICIA EVANKO, EXAMINING ATTORNEY

SN 77-104,814. ARACHNOID BIOMETRICS IDENTIFICATION GROUP CORP., TAIPEI CITY, TAIWAN, FILED 2-12-2007.

vitaARCH

THE ENGLISH TRANSLATION OF "VITA" IS LIFE AS A TOAST.

FOR COMPUTER HARDWARE; COMPUTER SOFTWARE, NAMELY, COMPUTER GRAPHICS SOFTWARE, COMPUTER SEARCH ENGINE SOFTWARE, COMPUTER SOFTWARE FOR CREATING SEARCHABLE DATABASES OF INFORMATION AND DATA, COMPUTER SOFTWARE FOR ADMINISTRATION OF COMPUTER LOCAL AREA NETWORKS; FINGERPRINT DEVICE, NAMELY, BIOMETRIC FINGERPRINT DOOR LOCK, COMPUTERIZED TIME CLOCK WITH FINGERPRINT RECOGNITION; INTERNET EQUIPMENT, NAMELY, MODEMS; PUBLIC INFORMATION STATION, NAMELY, COMPUTER NETWORK HUBS, SWITCHES AND ROUTERS; COMPUTER HARD DISCS; DATA STORAGE DEVICE, NAMELY, PORTABLE BLANK HARD DRIVE FOR COMPUTER; PERSONAL COMPUTERS; RECORDABLE MAGNETIC DISK, NAMELY, BLANK RECORDABLE DVDS, BLANK RECORDABLE OPTICAL DISC; LAPTOP COMPUTERS; COMPUTER MEMORY STORAGE DEVICE, NAMELY, FLASH MEMORY DISC, WIRELESS LOCAL AREA NETWORK CARD FOR PORTABLE COMPUTER; COMPUTER PROGRAM, NAMELY, COMPUTER OPERATING PROGRAMS, COMPUTER PROGRAMS USED FOR ELECTRONIC CASH REGISTER SYSTEMS; COMPUTER TERMINALS; MAGNETICALLY ENCODED KEY CARD USED FOR SOFTWARE PROTECTION; PROGRAMMABLE DATA ACCESS PROCESSOR, NAMELY, DATA ACCESS PORT FOR USE WITH ELECTRICAL CONTROL PANELS FOR CONNECTING MULTIPLE DATA AND ELECTRICAL DEVICES; COMPUTER FIRMWARE FOR USE IN DATABASE MANAGEMENT, USE AS A SPREADSHEET, WORD PROCESSING; COMPUTER WORKSTATION, COMPRISING OF A HIGH-END DESKTOP MICROCOMPUTER DESIGNED FOR TECHNICAL APPLICATIONS,

CLASS 9—(Continued).

NAMELY, UNIPLEXED INFORMATION AND COMPUTING OPERATING SYSTEMS, REDUCED INSTRUCTION SET COMPUTER PROCESSORS, AND ENGINEERING APPLICATIONS; REMOVABLE HARD DISK DRIVES; CREDIT CARD TRANSACTION MACHINE, NAMELY, ELECTRONIC MACHINES FOR READING CREDIT CARDS AND RECORDING FINANCIAL OPERATIONS; PERSONAL DIGITAL ASSISTANTS (PDA); ELECTRONIC DATA CAPTURE (EDC) SOFTWARE DESIGNED FOR THE COLLECTION OF CLINICAL DATA IN ELECTRONIC FORMAT FOR USE MAINLY IN HUMAN CLINICAL TRIALS; COMPUTER MOUSE; COMPUTER MOUSE WITH FINGERPRINT AUTHENTICATION CAPABILITIES; BIOMETRIC TERMINALS IN THE NATURE OF ELECTRONIC MODULES HAVING A FINGERPRINT SENSOR AND PROVIDING AN ELECTRONIC REPRESENTATION THAT ENABLES IDENTIFICATION OR CLASSIFICATION OF A PERSON BY THE PERSON'S FINGERPRINTS; A BIOMETRIC SCANNER USED FOR ACCESS CONTROL PURPOSES THAT VALIDATES A USER'S IDENTITY BY VERIFYING A USER'S FINGERPRINTS PRIOR TO PROVIDING ACCESS TO A DATA PROCESSING SYSTEM; PORTABLE USB FLASH DRIVE WITH FINGERPRINT AUTHENTICATION CAPABILITIES (U.S. CLS. 21, 23, 26, 36 AND 38).

TINA KUAN, EXAMINING ATTORNEY

SN 77-105,010. ADOBE SYSTEMS INCORPORATED, SAN JOSE, CA. FILED 2-12-2007.

ARNO

THE MARK CONSISTS OF STANDARD CHARACTERS WITHOUT CLAIM TO ANY PARTICULAR FONT, STYLE, SIZE, OR COLOR.

FOR DOWNLOADABLE PRINTING FONTS; PRINTING FONTS THAT CAN BE DOWNLOADED PROVIDED BY MEANS OF ELECTRONIC TRANSMISSION (U.S. CLS. 21, 23, 26, 36 AND 38).

FIRST USE 4-16-2007; IN COMMERCE 4-16-2007.

TRACY WHITTAKER-BROWN, EXAMINING ATTORNEY

SN 77-105,139. CRF INC., WALTHAM, MA. FILED 2-12-2007.

TrialCollector

THE MARK CONSISTS OF STANDARD CHARACTERS WITHOUT CLAIM TO ANY PARTICULAR FONT, STYLE, SIZE, OR COLOR.

FOR COMPUTER SOFTWARE FOR THE COLLECTION, EDITING, ORGANIZING, MODIFYING, BOOK MARKING, TRANSMISSION, STORAGE AND SHARING OF DATA AND INFORMATION (U.S. CLS. 21, 23, 26, 36 AND 38).

FIRST USE 1-1-2006; IN COMMERCE 1-1-2006.

JEFF DEFORD, EXAMINING ATTORNEY

CLASS 9—(Continued).

SN 77-105,155. CRF INC., WALTHAM, MA. FILED 2-12-2007.

TrialIntegrator

THE MARK CONSISTS OF STANDARD CHARACTERS WITHOUT CLAIM TO ANY PARTICULAR FONT, STYLE, SIZE, OR COLOR.

FOR COMPUTER SOFTWARE FOR THE COLLECTION, EDITING, ORGANIZING, MODIFYING, BOOK MARKING, TRANSMISSION, STORAGE AND SHARING OF DATA AND INFORMATION (U.S. CLS. 21, 23, 26, 36 AND 38).

FIRST USE 1-1-2006; IN COMMERCE 1-1-2006.

JEFF DEFORD, EXAMINING ATTORNEY

SN 77-106,152. ETCO INCORPORATED, WARWICK, RI. FILED 2-13-2007.

FLAT SNAP

THE MARK CONSISTS OF STANDARD CHARACTERS WITHOUT CLAIM TO ANY PARTICULAR FONT, STYLE, SIZE, OR COLOR.

FOR ELECTRICAL WIRE TO WIRE CONNECTORS (U.S. CLS. 21, 23, 26, 36 AND 38).

AMY MCMENAMIN, EXAMINING ATTORNEY

SN 77-108,391. HYPER IMAGE INC, GLENDALE, CA. FILED 2-15-2007.



THE COLOR(S) RED, ORANGE, YELLOW AND GREEN IS/ARE CLAIMED AS A FEATURE OF THE MARK.

THE MARK CONSISTS OF THE WORD "RACE" IN A STYLIZED FONT WITH A RED TO ORANGE TO YELLOW TO GREEN DIAGONAL COLOR GRADATION ON ALL LETTERS AND A SUPERIMPOSED CHECKERED FLAG.

FOR ANIMATED MOTION PICTURE FILMS ABOUT SCIENCE FICTION CAR RACES AND THE TEAMS' ADVENTURES OFF THE TRACK (U.S. CLS. 21, 23, 26, 36 AND 38).

FIRST USE 6-12-2006; IN COMMERCE 11-15-2006.

ARETHA SOMERVILLE, EXAMINING ATTORNEY

CLASS 9—(Continued).

SN 77-108,441. INFINITE Z, INC., CAMPBELL, CA. FILED 2-15-2007.

Infinite Z

THE MARK CONSISTS OF STANDARD CHARACTERS WITHOUT CLAIM TO ANY PARTICULAR FONT, STYLE, SIZE, OR COLOR.

FOR COMPUTER TECHNOLOGY, NAMELY, SOFTWARE AND HARDWARE FOR ENABLING TWO-DIMENSIONAL AND THREE-DIMENSIONAL PROJECTED IMAGES; AS WELL AS CORRESPONDING TWO-DIMENSIONAL AND THREE-DIMENSIONAL PROJECTED AUDIO ASSOCIATED WITH THOSE IMAGES; TWO-DIMENSIONAL AND THREE-DIMENSIONAL GRAPHICAL USER INTERFACE SOFTWARE AND HARDWARE; INTERACTIVE MULTIMEDIA COMPUTER PROGRAM FOR ENABLING DIRECT HANDS-ON INTERACTION WITH TWO-DIMENSIONAL AND THREE-DIMENSIONAL PROJECTED IMAGES AND AUDIO; BIOFEEDBACK SYSTEMS, NAMELY, HARDWARE AND SOFTWARE FOR MONITORING AND READING BIOLOGICAL FUNCTIONS THROUGH ELECTRODES, ANTENNAS AND OTHER SENSORS ATTACHED OR NOT ATTACHED TO THE BODY (U.S. CLS. 21, 23, 26, 36 AND 38).

LYDIA BELZER, EXAMINING ATTORNEY

SN 77-108,526. DIGITAL AGE COMMUNICATIONS, INC., WESTFIELD, NJ. FILED 2-15-2007.

DIGITAL AGE PRODUCTS

THE MARK CONSISTS OF STANDARD CHARACTERS WITHOUT CLAIM TO ANY PARTICULAR FONT, STYLE, SIZE, OR COLOR.

NO CLAIM IS MADE TO THE EXCLUSIVE RIGHT TO USE "PRODUCTS", APART FROM THE MARK AS SHOWN.

FOR PORTABLE AUDIO SPEAKERS, WIRELESS COMPUTER PERIPHERALS, DEVICES FOR WIRELESS RADIO TRANSMISSION, APPARATUS FOR WIRELESS TRANSMISSION OF ACOUSTIC AND VIDEO INFORMATION, BATTERIES, BATTERY CHARGING DEVICES, ADAPTERS FOR ELECTRICALLY OPERATED DEVICES, MEMORY CARDS FOR ELECTRONIC ITEMS, DIGITAL DISK DRIVES, WIRED AND WIRELESS HEADPHONES, AND WIRED AND WIRELESS EARPHONES (U.S. CLS. 21, 23, 26, 36 AND 38).

FIRST USE 7-23-2004; IN COMMERCE 7-23-2004.
BENJAMIN OKEKE, EXAMINING ATTORNEY

CLASS 9—(Continued).

SN 77-108,650. MIGUEL CABALLERO LTDA., BOGOTA, COLOMBIA, FILED 2-15-2007.



Miguel Caballero

OWNER OF COLOMBIA REG. NO. 316136, DATED 4-18-2006, EXPIRES 4-18-2016.

THE NAME(S), PORTRAIT(S), AND/OR SIGNATURE(S) SHOWN IN THE MARK IDENTIFIES "MIGUEL CABALLERO", WHOSE CONSENT(S) TO REGISTER IS MADE OF RECORD.

THE MARK CONSISTS OF A SHIELD BEARING A FLEUR DE LIS AND A STYLIZED LION ABOVE TWO CROSSED SWORDS WITH THE WORDS "MIGUEL CABALLERO" BELOW THE SHIELD.

FOR BULLET-PROOF VESTS AND CLOTHING; PROTECTIVE EYEGLASSES; PROTECTIVE INDUSTRIAL BOOTS FOR PROTECTION FROM ANTI-PERSONAL MINES; PROTECTIVE HELMETS; PROTECTIVE MASKS; FACE-PROTECTION SHIELDS; HAND-HELD PROTECTIVE SHIELDS FOR USE BY POLICE, MILITARY, CORRECTIONAL FACILITIES, AND THE LIKE; HARD PLATE PERSONAL BODY ARMOR (U.S. CLS. 21, 23, 26, 36 AND 38).

FIRST USE 8-31-2003; IN COMMERCE 8-31-2003.
MORGAN WYNNE, EXAMINING ATTORNEY

SN 77-108,887. BOUNCE REFLEX LLC, SAN ANSELMO, CA. FILED 2-15-2007.

BOUNCE REFLEX

THE MARK CONSISTS OF STANDARD CHARACTERS WITHOUT CLAIM TO ANY PARTICULAR FONT, STYLE, SIZE, OR COLOR.

FOR DOWNLOADABLE MP3 FILES, MP3 RECORDINGS, ONLINE DISCUSSION BOARDS, WEB CASTS, POD CASTS FEATURING MUSIC, AUDIO BOOKS AND NEWS BROADCASTS; DOWNLOADABLE MUSICAL SOUND RECORDINGS; DOWNLOADABLE RING TONES, GRAPHICS AND MUSIC VIA A GLOBAL COMPUTER NETWORK AND WIRELESS DEVICES; DOWNLOADABLE VIDEO RECORDINGS FEATURING MUSIC; DOWNLOADABLE MUSIC VIA THE INTERNET AND WIRELESS DEVICES; MUSICAL SOUND RECORDINGS; MUSICAL VIDEO RECORDINGS; SOUND RECORDINGS FEATURING MUSIC; VIDEO RECORDINGS FEATURING MUSIC; VISUAL RECORDINGS AND AUDIO VISUAL RECORDINGS FEATURING MUSIC AND ANIMATION (U.S. CLS. 21, 23, 26, 36 AND 38).

ANDREA K. NADELMAN, EXAMINING ATTORNEY

CLASS 9—(Continued).

SN 77-109,966. INFINITE Z, INC., CAMPBELL, CA. FILED 2-16-2007.



THE MARK CONSISTS OF A 3-DIMENSIONAL INFINITY SYMBOL, A 3-DIMENSIONAL "Z," AND "INFINITE Z."

FOR COMPUTER TECHNOLOGY, NAMELY, SOFTWARE AND HARDWARE FOR ENABLING TWO-DIMENSIONAL AND THREE-DIMENSIONAL PROJECTED IMAGES; AS WELL AS CORRESPONDING TWO-DIMENSIONAL AND THREE-DIMENSIONAL PROJECTED AUDIO ASSOCIATED WITH THOSE IMAGES; TWO-DIMENSIONAL AND THREE-DIMENSIONAL GRAPHICAL USER INTERFACE SOFTWARE AND HARDWARE; INTERACTIVE MULTIMEDIA COMPUTER PROGRAM FOR ENABLING DIRECT HANDS-ON INTERACTION WITH TWO-DIMENSIONAL AND THREE-DIMENSIONAL PROJECTED IMAGES AND AUDIO; BIOFEEDBACK SYSTEMS, NAMELY HARDWARE AND SOFTWARE FOR MONITORING AND READING BIOLOGICAL FUNCTIONS THROUGH ELECTRODES, ANTENNAS AND OTHER SENSORS ATTACHED OR NOT ATTACHED TO THE BODY (U.S. CLS. 21, 23, 26, 36 AND 38).

LYDIA BELZER, EXAMINING ATTORNEY

SN 77-114,978. HARRIS STRATEX NETWORKS OPERATING CORPORATION, MORRISVILLE, NC. FILED 2-23-2007.

NETBOSS XE

THE MARK CONSISTS OF STANDARD CHARACTERS WITHOUT CLAIM TO ANY PARTICULAR FONT, STYLE, SIZE, OR COLOR.

OWNER OF U.S. REG. NOS. 2,790,141 AND 3,344,982.

FOR COMPUTER SOFTWARE AND MANUALS AND DOCUMENTATION DISTRIBUTED THEREWITH, NAMELY, OPERATIONAL SUPPORT SYSTEMS SOFTWARE FOR MANAGEMENT OF COMPUTER AND TELECOMMUNICATIONS NETWORKS, NAMELY, MODULAR SOFTWARE APPLICATIONS THAT PROVIDE TELECOMMUNICATIONS SERVICE ASSURANCE FUNCTIONALITY, NAMELY, TELECOMMUNICATIONS NETWORK FAULT MANAGEMENT AND TELECOMMUNICATIONS NETWORK PERFORMANCE MANAGEMENT, THE FOREGOING ALL BEING FOR USE AND SALE IN FIELDS OUTSIDE OF, AND EXCLUDING, THE FIELD OF RETAIL (U.S. CLS. 21, 23, 26, 36 AND 38).

FIRST USE 10-2-2006; IN COMMERCE 10-2-2006.
AMEETA JORDAN, EXAMINING ATTORNEY

CLASS 9—(Continued).

SN 77-116,052. PREMIER RETICLES, LTD., WINCHESTER, VA. FILED 2-26-2007.

SPIDERWEB

THE MARK CONSISTS OF STANDARD CHARACTERS WITHOUT CLAIM TO ANY PARTICULAR FONT, STYLE, SIZE, OR COLOR.

FOR RETICLES FOR RIFLE SCOPES; RIFLE SCOPES; SPOTTING SCOPES; AND RIFLE SCOPES HAVING CUSTOM DESIGNED RETICLES THEREIN (U.S. CLS. 21, 23, 26, 36 AND 38).

STEVEN JACKSON, EXAMINING ATTORNEY

SN 77-116,917. SELA PRODUCTS, LLC, EDMOND, OK. FILED 2-27-2007.



THE COLOR(S) RED, BLACK, AND WHITE IS/ARE CLAIMED AS A FEATURE OF THE MARK.

THE MARK CONSISTS OF THE LETTERS "USI" IN RED WITH THE WORDS "ULTIMATE SOURCE INTERNATIONAL" AT THE TOP IN BLACK WITH A RED AND WHITE GLOBE ABOVE THE LETTER "I" AND A BLACK SWOOSH ENCOMPASSING THE LETTERS "USI".

FOR CONNECTING ELECTRICAL CABLES; ELECTRIC CONNECTORS; ELECTRIC CORDS; ELECTRIC WIRES AND CABLES; ELECTRICAL CONNECTORS; ELECTRICAL POWER CONNECTORS; ROUND PLUG CONNECTORS; THREADED CABLE CONNECTORS OF METAL (U.S. CLS. 21, 23, 26, 36 AND 38).

TEJBIR SINGH, EXAMINING ATTORNEY

SN 77-118,424. CODESTREET, LLC, NEW YORK, NY. FILED 2-28-2007.

TEAMWORK

THE MARK CONSISTS OF STANDARD CHARACTERS WITHOUT CLAIM TO ANY PARTICULAR FONT, STYLE, SIZE, OR COLOR.

FOR COMPUTER SOFTWARE PROGRAM FOR FACILITATING TRADING OF FIXED INCOME SECURITIES BY AUTOMATICALLY NOTIFYING USERS OF POTENTIAL TRADING OPPORTUNITIES DERIVED FROM PROCESSING A COMBINATION OF MARKET DATA AND USER DATA (U.S. CLS. 21, 23, 26, 36 AND 38).

FIRST USE 10-1-2003; IN COMMERCE 1-1-2004.
NICHOLAS ALTREE, EXAMINING ATTORNEY

CLASS 9—(Continued).

SN 77-119,273. MEADWESTVACO CORPORATION, GLEN ALLEN, VA. FILED 3-1-2007.



FOR PROTECTIVE CARRYING CASES FOR ITEMS, NAMELY, PORTABLE MUSIC PLAYERS; ELECTRONIC MULTIMEDIA EQUIPMENT, NAMELY, LAPTOP COMPUTERS AND HANDHELD PERSONAL GAMING UNITS; AUDIO SPEAKERS; CELL PHONES; AND CALCULATORS (U.S. CLS. 21, 23, 26, 36 AND 38).
TINA BROWN, EXAMINING ATTORNEY

SN 77-123,055. ROBBINS RESEARCH INTERNATIONAL, INC., SAN DIEGO, CA. FILED 3-6-2007.

ANTHONY ROBBINS PERSONAL
COACHING COLLECTION

THE MARK CONSISTS OF STANDARD CHARACTERS WITHOUT CLAIM TO ANY PARTICULAR FONT, STYLE, SIZE, OR COLOR.

OWNER OF U.S. REG. NOS. 1,863,573 AND 2,551,974. THE NAME "ANTHONY ROBBINS" IDENTIFIES A LIVING INDIVIDUAL WHOSE CONSENT IS OF RECORD. FOR AUDIO AND VIDEO RECORDINGS IN THE FIELD OF PERSONAL IMPROVEMENT (U.S. CLS. 21, 23, 26, 36 AND 38).

FIRST USE 7-30-2006; IN COMMERCE 10-3-2006.
BENJAMIN OKEKE, EXAMINING ATTORNEY

SN 77-123,136. MEMEO INC., ALISO VIEJO, CA. FILED 3-6-2007.

LifeAgent

THE MARK CONSISTS OF STANDARD CHARACTERS WITHOUT CLAIM TO ANY PARTICULAR FONT, STYLE, SIZE, OR COLOR.

FOR COMPUTER SOFTWARE FOR ORGANIZING, SYNCHING, SHARING AND PROTECTING DIGITAL CONTENTS TO ANY DESTINATION AUTOMATICALLY (U.S. CLS. 21, 23, 26, 36 AND 38).

FIRST USE 2-1-2007; IN COMMERCE 2-1-2007.
LESLEY LAMOTHE, EXAMINING ATTORNEY

CLASS 9—(Continued).

SN 77-123,900. NORTHROP GRUMMAN CORPORATION, LOS ANGELES, CA. FILED 3-6-2007.



NO CLAIM IS MADE TO THE EXCLUSIVE RIGHT TO USE "NAV" AND "DDS", APART FROM THE MARK AS SHOWN.

THE MARK CONSISTS OF THE MARK CONSISTS OF A CROSS-STYLE DESIGN IN THE CENTER OF THE LETTERS "NAVDDS."

FOR COMPUTER HARDWARE AND COMPUTER SOFTWARE FOR PROCESSING INFORMATION RECEIVED FROM SENSORS TO GENERATE POSITION, VELOCITY, ATTITUDE AND TIME INFORMATION FOR SHIP NAVIGATION (U.S. CLS. 21, 23, 26, 36 AND 38).

FIRST USE 6-1-2006; IN COMMERCE 6-1-2006.
JANICE KIM, EXAMINING ATTORNEY

SN 77-124,343. LEAD DATA INTERNATIONAL, INC., CERRITOS, CA. FILED 3-7-2007.

BELLATEK

THE MARK CONSISTS OF STANDARD CHARACTERS WITHOUT CLAIM TO ANY PARTICULAR FONT, STYLE, SIZE, OR COLOR.

FOR BLANK RECORDABLE CDS AND DVDS; COMPUTER HARDWARE, NAMELY, MODULAR HARD DRIVE BAYS; OPTICAL DISK DRIVES; CD/DVD DUPLICATORS; FLASH MEMORY CARDS; MP3 PLAYERS; DIGITAL PHOTO FRAMES FOR DISPLAYING DIGITAL PICTURES; WIRELESS TELECOMMUNICATIONS PROTOCOL HEADSETS FOR USE WITH COMPUTER HARDWARE AND CELL PHONES (U.S. CLS. 21, 23, 26, 36 AND 38).

MICHAEL LITZAU, EXAMINING ATTORNEY

CLASS 9—(Continued).

SN 77-124,512. LUCIANI, JOHN C, WAKEFIELD, MA. FILED 3-7-2007.

wiblock

THE MARK CONSISTS OF STANDARD CHARACTERS WITHOUT CLAIM TO ANY PARTICULAR FONT, STYLE, SIZE, OR COLOR.

FOR FULL LINE OF ELECTRONIC AND MECHANICAL PARTS AND FITTINGS FOR PORTABLE AND HANDHELD DIGITAL ELECTRONIC DEVICES ORGANIZING, TRANSMITTING, MANIPULATING, AND REVIEWING TEXT, DATA, AUDIO AND VIDEO FILES NAMELY DIGITAL VIDEO RECORDERS, DIGITAL AUDIO RECORDERS, RADIO TRANSMITTERS, VIDEO TRANSMITTERS, CELL PHONES, AUDIO PROCESSORS, SOUND BOARDS, VIDEO DISPLAY CARDS, AUDIO ANALYZERS, RADIO RECEIVERS, SOUND AMPLIFIERS, VIDEO RECEIVERS, VIDEO MONITORS, AUDIO SPEAKERS, ELECTRONIC PERSONAL ORGANIZER, WIRELESS COMPUTER PERIPHERALS, SYSTEM BOARDS (MOTHER CARDS) AND PROCESSORS, WIRED OR WIRELESS POS (POINT OF SERVICE) DEVICES, LAN (LOCAL AREA NETWORK) HARDWARE; ELECTRONIC DOCKING STATIONS; STANDS SPECIALLY DESIGNED FOR DIGITAL VIDEO RECORDERS, DIGITAL AUDIO RECORDERS, RADIO TRANSMITTERS, VIDEO TRANSMITTERS, CELL PHONES, AUDIO PROCESSORS, SOUND BOARDS, VIDEO DISPLAY CARDS, AUDIO ANALYZERS, RADIO RECEIVERS, SOUND AMPLIFIERS, VIDEO RECEIVERS, VIDEO MONITORS, AUDIO SPEAKERS, ELECTRONIC PERSONAL ORGANIZER, WIRELESS COMPUTER PERIPHERALS, SYSTEM BOARDS (MOTHER CARDS) AND PROCESSORS, WIRED OR WIRELESS POS (POINT OF SERVICE) DEVICES, LAN (LOCAL AREA NETWORK) HARDWARE; BATTERY CHARGERS; BATTERY PACKS; ELECTRICAL CONNECTORS, WIRES, CABLES, AND ADAPTORS; WIRED AND WIRELESS REMOTE CONTROLS FOR DIGITAL VIDEO RECORDERS, DIGITAL AUDIO RECORDERS, RADIO TRANSMITTERS, VIDEO TRANSMITTERS, CELL PHONES, AUDIO PROCESSORS, SOUND BOARDS, VIDEO DISPLAY CARDS, AUDIO ANALYZERS, RADIO RECEIVERS, SOUND AMPLIFIERS, VIDEO RECEIVERS, VIDEO MONITORS, AUDIO SPEAKERS, ELECTRONIC PERSONAL ORGANIZER, WIRELESS COMPUTER PERIPHERALS, SYSTEM BOARDS (MOTHER CARDS) AND PROCESSORS, WIRED OR WIRELESS POS (POINT OF SERVICE) DEVICES, LAN (LOCAL AREA NETWORK) HARDWARE; HEADPHONES AND EARPHONES; STEREO AMPLIFIER; AUDIO SPEAKER MOUNTS; AUTOMOBILE STEREO ADAPTERS; SOUND RECORDING APPARATUS; DIGITAL AUDIO RECORDERS; RADIO RECEIVERS; RADIO TRANSMITTERS; IMAGE SCANNERS; VIDEO VIEWERS, NAMELY, VIDEO MONITORS FOR DIGITAL VIDEO RECORDERS, DIGITAL AUDIO RECORDERS, RADIO TRANSMITTERS, VIDEO TRANSMITTERS, CELL PHONES, VIDEO DISPLAY CARDS, AUDIO ANALYZERS, RADIO RECEIVERS, VIDEO RECEIVERS, VIDEO MONITORS, ELECTRONIC PERSONAL ORGANIZER, WIRELESS COMPUTER PERIPHERALS, SYSTEM BOARDS (MOTHER CARDS) AND PROCESSORS, WIRED OR WIRELESS POS (POINT OF SERVICE) DEVICES, LAN (LOCAL AREA NETWORK) HARDWARE; ELECTRONIC MEMORY CARD READERS; A FULL LINE OF COMPUTER SOFTWARE FOR DIGITAL VIDEO RECORDERS, DIGITAL AUDIO RECORDERS, RADIO TRANSMITTERS, VIDEO TRANSMITTERS, CELL PHONES, AUDIO PROCESSORS, SOUND BOARDS, VIDEO DISPLAY CARDS, AUDIO ANALYZERS, RADIO RECEIVERS, SOUND AMPLIFIERS, VIDEO RECEIVERS, VIDEO MONITORS, AUDIO SPEAKERS, ELECTRONIC PERSONAL ORGANIZER, WIRELESS COMPUTER PERIPHERALS, SYSTEM BOARDS (MOTHER CARDS) AND PROCESSORS, WIRED OR WIRELESS POS (POINT OF SERVICE) DEVICES, LAN (LOCAL AREA NETWORK) HARDWARE; COMPUTER APPLICATION SOFTWARE FOR

CLASS 9—(Continued).

RECORDING AND ORGANIZING CALENDARS; AND SCHEDULES, TO-DO LISTS, AND CONTACT INFORMATION; COMPUTER GAME SOFTWARE; COMPUTER SOFTWARE FOR CLOCK AND ALARM CLOCK FUNCTIONALITY; CARRYING CASES, SACKS, AND BAGS, ALL FOR USE WITH DIGITAL VIDEO RECORDERS, DIGITAL AUDIO RECORDERS, RADIO TRANSMITTERS, VIDEO TRANSMITTERS, CELL PHONES, AUDIO PROCESSORS, SOUND BOARDS, VIDEO DISPLAY CARDS, AUDIO ANALYZERS, RADIO RECEIVERS, SOUND AMPLIFIERS, VIDEO RECEIVERS, VIDEO MONITORS, AUDIO SPEAKERS, ELECTRONIC PERSONAL ORGANIZER, WIRELESS COMPUTER PERIPHERALS, SYSTEM BOARDS (MOTHER CARDS) AND PROCESSORS, WIRED OR WIRELESS POS (POINT OF SERVICE) DEVICES, LAN (LOCAL AREA NETWORK) HARDWARE; WIRELESS SENSORS, ELECTRONIC SENSORS, SENSOR CARDS AND SOFTWARE FOR MEASURING TEMPERATURE, MOISTURE, GAS PRESSURE, GAS WEIGHT, GAS DENSITY, GAS VELOCITY, RADON, POLLUTANT, GAS CONCENTRATION, ATMOSPHERIC PRESSURE, PRESSURE, WEIGHT, TORQUE, MOTION, PROXIMITY, LIQUID LEVELS, LIQUID VISCOSITY, SALINITY, POSITION, ALTITUDE, DISTANCE, VELOCITY, ACCELERATION, NOISE, SOUND LEVEL, LIGHT INTENSITY, ULTRASONIC VIBRATION, ELECTRICAL RESISTANCE, ELECTRICAL VOLTAGE, ELECTRICAL CURRENT, MAGNETIC FIELDS, TIME, HEAT, RADIATION, SEISMIC IMPULSES, VIBRATION, BIOMETRICS; WIRELESS SENSOR NETWORKS; WIRELESS MICRO ELECTROMECHANICAL SENSOR NETWORKS; INTER OPERABLE WIRELESS SENSOR NETWORKS; WIRELESS SENSOR NETWORK HARDWARE PLATFORM; WIRELESS SENSOR NETWORK SOFTWARE PLATFORM; SYSTEM BOARDS AND PROCESSORS, NAMELY, PROCESSOR RADIO BOARDS; GATEWAY AND INTERFACE BOARDS; ELECTRIC ACTUATORS; COMPUTER SOFTWARE FOR THE OPERATION OF WIRELESS SENSORS, ELECTRONIC SENSORS, AND ELECTRONIC ACTUATORS, AND MANUALS (U.S. CLS. 21, 23, 26, 36 AND 38).

H. M. FISHER, EXAMINING ATTORNEY

SN 77-125,469. APEX MERCHANDISE GROUP, LLC, SCOTTSDALE, AZ. FILED 3-8-2007.

PH ION

THE MARK CONSISTS OF STANDARD CHARACTERS WITHOUT CLAIM TO ANY PARTICULAR FONT, STYLE, SIZE, OR COLOR.

NO CLAIM IS MADE TO THE EXCLUSIVE RIGHT TO USE "PH", APART FROM THE MARK AS SHOWN.

FOR DVDS FEATURING EDUCATIONAL MATERIAL IN THE FIELD OF NUTRITION; PRE-RECORDED DVD'S FEATURING EDUCATIONAL MATERIAL IN THE FIELD OF NUTRITION (U.S. CLS. 21, 23, 26, 36 AND 38).

DAVID ELTON, EXAMINING ATTORNEY

CLASS 9—(Continued).

SN 77-125,523. GAME ONE SAS, PARIS, FRANCE, FILED 3-8-2007.

GAME ONE

OWNER OF U.S. REG. NOS. 2,682,102 AND 2,863,917.
NO CLAIM IS MADE TO THE EXCLUSIVE RIGHT TO USE "GAME", APART FROM THE MARK AS SHOWN.

FOR VIDEO RECORDERS; COMPUTER MEMORIES; PRINTED CIRCUITS; COMPUTERS; COMPUTER PERIPHERALS, NAMELY, COMPUTER MONITORS, COMPUTER GLARE SCREENS, KEYBOARDS, MICE, CONTROL CONSOLES AND JOYSTICKS, DISKETTE DRIVES, DIGITIZERS, PRINTERS AND MODEMS; TELECOMMUNICATIONS EQUIPMENT, NAMELY, TELEPHONES AND FACSIMILE MACHINES; PRERECORDED AUDIO TAPES AND VIDEO TAPES, COMPUTER PROGRAMS AND ELECTRONIC DATABASES RECORDED ON COMPUTER MEDIA, ALL IN THE FIELDS OF GAMES, VIDEO GAMES AND TOYS; COMPUTER GAME SOFTWARE; VIDEO GAME CONSOLES, NAMELY, VIDEO GAME INTERACTIVE REMOTE CONTROL UNITS; VIDEO GAME MACHINES FOR USE WITH TELEVISIONS; ELECTRONIC GAMES FOR USE WITH A TELEVISION RECEIVER (U.S. CLS. 21, 23, 26, 36 AND 38).

REBECCA POVARCHUK, EXAMINING ATTORNEY

SN 77-125,762. PET FOOD EXPRESS, LTD., SAN LEANDRO, CA. FILED 3-8-2007.

BARKTONZ

THE MARK CONSISTS OF STANDARD CHARACTERS WITHOUT CLAIM TO ANY PARTICULAR FONT, STYLE, SIZE, OR COLOR.

FOR DOWNLOADABLE RINGTONES AND OTHER AUDIO AND VISUAL MATERIALS, NAMELY, AUDIO AND VIDEO FILES FEATURING RING TONES, GRAPHICS AND PHOTOGRAPHS VIA A GLOBAL COMPUTER NETWORK AND WIRELESS DEVICES (U.S. CLS. 21, 23, 26, 36 AND 38).

PAUL CROWLEY, EXAMINING ATTORNEY

SN 77-126,882. THE GILLETTE COMPANY, BOSTON, MA. FILED 3-9-2007.

RECHARGEABLES REINVENTED

THE MARK CONSISTS OF STANDARD CHARACTERS WITHOUT CLAIM TO ANY PARTICULAR FONT, STYLE, SIZE, OR COLOR.

NO CLAIM IS MADE TO THE EXCLUSIVE RIGHT TO USE "RECHARGEABLES", APART FROM THE MARK AS SHOWN.

FOR BATTERIES (U.S. CLS. 21, 23, 26, 36 AND 38).
WOODROW HARTZOG, EXAMINING ATTORNEY

CLASS 9—(Continued).

SN 77-127,086. TRADICOM LLC, CINCINNATI, OH. FILED 3-9-2007.



THE MARK CONSISTS OF PICTURE OF A CHEF WITH THE WORD MARK "CHEF 24/7".

FOR VENDING MACHINES (U.S. CLS. 21, 23, 26, 36 AND 38).

WARREN L. OLANDRIA, EXAMINING ATTORNEY

SN 77-128,238. TEETERS, DIANA L. SHREVEPORT, LA. FILED 3-12-2007.

Wedding Essentials

NO CLAIM IS MADE TO THE EXCLUSIVE RIGHT TO USE "WEDDING", APART FROM THE MARK AS SHOWN.

FOR DIGITAL MEDIA, NAMELY, A SERIES OF DVDS FEATURING 3D ANIMATIONS AND MOVING BACKGROUND IMAGES FOR WEDDING VIDEO EDITING AND PRODUCTION (U.S. CLS. 21, 23, 26, 36 AND 38).

FIRST USE 5-5-2001; IN COMMERCE 9-5-2001.
SIMON TENG, EXAMINING ATTORNEY

CLASS 9—(Continued).

SN 77-128,817. ARUZE CORPORATION, TOKYO, JAPAN, FILED 3-12-2007.



PRIORITY CLAIMED UNDER SEC. 44(D) ON JAPAN APPLICATION NO. 2007-12802, FILED 2-16-2007, REG. NO. 5075515, DATED 9-17-2007, EXPIRES 9-7-2017.

NO CLAIM IS MADE TO THE EXCLUSIVE RIGHT TO USE "PAY", APART FROM THE MARK AS SHOWN.

FOR SLOT MACHINES AND REPLACEMENT PARTS THEREFOR; VIDEO SLOT MACHINES AND REPLACEMENT PARTS THEREFOR; GAMING MACHINES AND REPLACEMENT PARTS THEREFOR; GAMING MACHINES WITH A LIQUID CRYSTAL DISPLAY AND REPLACEMENT PARTS THEREFOR; MECHANICAL REEL TYPE SLOT MACHINES WITH A LIQUID CRYSTAL DISPLAY AND REPLACEMENT PARTS THEREFOR; MEDIA STORAGE COMPUTER SOFTWARE, AND COMPUTER SOFTWARE FOR CONTROLLING SLOT MACHINES AND GAME MACHINES, AND COMPUTER GAME SOFTWARE FOR GAME MACHINES OR SLOT MACHINES (U.S. CLS. 21, 23, 26, 36 AND 38).

HENRY S. ZAK, EXAMINING ATTORNEY

CLASS 9—(Continued).

SN 77-129,038. UNIVERSAL AUDIO, INC., SCOTTS VALLEY, CA. FILED 3-12-2007.

545

THE MARK CONSISTS OF STANDARD CHARACTERS WITHOUT CLAIM TO ANY PARTICULAR FONT, STYLE, SIZE, OR COLOR.

FOR AUDIO EQUALIZERS; AUDIO PROCESSING EQUIPMENT, NAMELY, FILTER SETS; COMPUTER HARDWARE; COMPUTER SOFTWARE EMULATING AUDIO EQUALIZERS AND AUDIO FILTER SETS; COMPUTER SOFTWARE FOR MANIPULATING DIGITAL AUDIO INFORMATION FOR USE IN AUDIO MEDIA APPLICATIONS; USER MANUALS SUPPLIED AS A UNIT WITH COMPUTER HARDWARE AND SOFTWARE (U.S. CLS. 21, 23, 26, 36 AND 38).

BRIAN PINO, EXAMINING ATTORNEY

SN 77-128,866. SONA MOBILE HOLDINGS CORP., NEW YORK, NY. FILED 3-12-2007.

SN 77-130,920. PRONK TECHNOLOGIES, INC., PASADENA, CA. FILED 3-14-2007.

DEAL ME IN

PRONK TECHNOLOGIES

THE MARK CONSISTS OF STANDARD CHARACTERS WITHOUT CLAIM TO ANY PARTICULAR FONT, STYLE, SIZE, OR COLOR.

FOR ELECTRONIC WIRELESS GAMING SYSTEMS, NAMELY, A SERVER BASED VIDEO, BOARD, AND ELECTRONIC GAMBLING GAMING SYSTEM COMPRISED OF ELECTRONIC KIOSKS AND PERSONAL COMPUTERS; WIRELESS HANDHELD VIDEO, BOARD, AND ELECTRONIC GAMBLING GAMING DEVICES, NAMELY, PERSONAL DIGITAL ASSISTANTS AND CELLULAR PHONES FOR USE IN SELECTING AND PLAYING VIDEO GAMES; COMPUTER SOFTWARE AND HARDWARE FOR DETERMINING WHAT TO WAGER ON, HOW MUCH TO WAGER, HOW TO WAGER ON AND PLACING WAGERS ON GAMES OF CHANCE AND SPORTS ON ANY COMPUTERIZED PLATFORM; ELECTRONIC GAME SOFTWARE FOR WIRELESS AND WIRED DEVICES; AND INSTRUCTION MANUALS FOR USE THEREWITH (U.S. CLS. 21, 23, 26, 36 AND 38).

FRANK LATTUCA, EXAMINING ATTORNEY

THE MARK CONSISTS OF STANDARD CHARACTERS WITHOUT CLAIM TO ANY PARTICULAR FONT, STYLE, SIZE, OR COLOR.

NO CLAIM IS MADE TO THE EXCLUSIVE RIGHT TO USE "TECHNOLOGIES", APART FROM THE MARK AS SHOWN.

FOR ELECTRONIC APPARATUS FOR GENERATING SIMULATED HUMAN VITAL SIGN MEASUREMENTS IN MEDICAL APPARATUS FOR TESTING THE ACCURACY OF MEDICAL DIAGNOSTIC APPARATUS AND FOR TRAINING MEDICAL PERSONNEL (U.S. CLS. 21, 23, 26, 36 AND 38).

FIRST USE 8-1-2002; IN COMMERCE 11-1-2003.
STEVEN R. FOSTER, EXAMINING ATTORNEY

CLASS 9—(Continued).

SN 77-131,086. OREGON RESEARCH INSTITUTE, EUGENE, OR. FILED 3-14-2007.



THE COLOR(S) BLUE, GREEN, YELLOW, RED, WHITE AND BLACK IS/ARE CLAIMED AS A FEATURE OF THE MARK.

THE MARK CONSISTS OF THE COLOR BLUE APPEARS IN THE TERM "CITY", IN THE MIDDLE BUILDING AND AS THE BACKGROUND COLOR OF THE CIRCLE WHICH CONTAINS THE BUILDINGS; THE COLOR GREEN APPEARS IN THE LEFT BUILDING; THE COLOR YELLOW APPEARS IN THE RIGHT BUILDING; THE COLOR RED APPEARS IN THE TERM "CLICK"; THE COLOR WHITE APPEARS AS THE BACKGROUND COLOR OF THE POLYGON CONTAINING THE WORDS "CLICK CITY" AND THE COLOR BLACK OUTLINES THE BUILDINGS AND THE POLYGON WHICH CONTAINS THE TERMS "CLICK CITY".

FOR COMPUTER SOFTWARE FOR SCHOOL BASED INTRANET FOR CREATING EDUCATIONAL INFORMATION FOR 5TH AND 6TH GRADE SCHOOL CHILDREN IN THE FIELD OF PREVENTING THEM FROM STARTING TO SMOKE CIGARETTES OR CHEW TOBACCO AND ALLOW THEM TO SEE WHAT OTHER STUDENTS THINK ABOUT TOBACCO (U.S. CLS. 21, 23, 26, 36 AND 38).

FIRST USE 2-26-2007; IN COMMERCE 2-26-2007.
BILL DAWE, EXAMINING ATTORNEY

SN 77-131,272. PRONK TECHNOLOGIES, INC., PASADENA, CA. FILED 3-14-2007.

PRONK

THE MARK CONSISTS OF STANDARD CHARACTERS WITHOUT CLAIM TO ANY PARTICULAR FONT, STYLE, SIZE, OR COLOR.

FOR ELECTRONIC APPARATUS FOR GENERATING SIMULATED HUMAN VITAL SIGN MEASUREMENTS IN MEDICAL APPARATUS FOR TESTING THE ACCURACY OF MEDICAL DIAGNOSTIC APPARATUS AND FOR TRAINING MEDICAL PERSONNEL (U.S. CLS. 21, 23, 26, 36 AND 38).

STEVEN R. FOSTER, EXAMINING ATTORNEY

CLASS 9—(Continued).

SN 77-131,801. GRANDE, PHILIP J., SARASOTA, FL. FILED 3-15-2007.

Phil's X1

THE MARK CONSISTS OF STANDARD CHARACTERS WITHOUT CLAIM TO ANY PARTICULAR FONT, STYLE, SIZE, OR COLOR.

FOR STOCK RESEARCH SOFTWARE, NAMELY, COMPUTER SOFTWARE FOR USE AS A RESEARCH PLATFORM ALLOWING USER ANALYSIS OF TRENDS IN THE PRICE OF INDIVIDUAL STOCKS (U.S. CLS. 21, 23, 26, 36 AND 38).

FIRST USE 8-6-2006; IN COMMERCE 8-6-2006.
KAPIL BHANOT, EXAMINING ATTORNEY

SN 77-131,893. THOMAS G. FARIA CORPORATION, UN-CASVILLE, CT. FILED 3-15-2007.

MAESTRO

THE MARK CONSISTS OF STANDARD CHARACTERS WITHOUT CLAIM TO ANY PARTICULAR FONT, STYLE, SIZE, OR COLOR.

FOR NAVIGATION AND COMMAND CENTER USING GPS, NAMELY, A GLOBAL POSITION SYSTEM (GPS) AND CONSISTING OF A COMPUTER, COMPUTER SOFTWARE, TRANSMITTERS, RECEIVERS, AND NETWORK INTERFACE DEVICES (U.S. CLS. 21, 23, 26, 36 AND 38).

STEVEN PEREZ, EXAMINING ATTORNEY

SN 77-131,933. HARRELL'S, INC., LAKELAND, FL. FILED 3-15-2007.

CUSTOMIX

THE MARK CONSISTS OF STANDARD CHARACTERS WITHOUT CLAIM TO ANY PARTICULAR FONT, STYLE, SIZE, OR COLOR.

FOR COMPUTER SOFTWARE FOR MANAGING A FERTILIZER BLENDING AND CHEMICAL BUSINESS, NAMELY, SALES TRACKING, PRODUCTION TRACKING, INVENTORY TRACKING AND ORDERING, CUSTOM FORMULATION, REGULATORY COMPLIANCE, DISPATCH AND DELIVERY, INVOICING, RECEIVING, SALES TERRITORY MANAGEMENT AND INSTRUCTIONAL MANUALS SOLD AS A UNIT FOR THE FERTILIZER INDUSTRY (U.S. CLS. 21, 23, 26, 36 AND 38).

FIRST USE 8-28-1990; IN COMMERCE 8-28-1990.
LOURDES AYALA, EXAMINING ATTORNEY

CLASS 9—(Continued).

SN 77-132,109. THE FRATELLIS, LONDON, UNITED KINGDOM, FILED 3-15-2007.

CLASS 9—(Continued).

SN 77-132,819. LAETUS GMBH, ALSBACH-HÄHNLEIN, FED REP GERMANY, FILED 3-16-2007.

THE FRATELLIS

POLYCHECK wt

THE MARK CONSISTS OF STANDARD CHARACTERS WITHOUT CLAIM TO ANY PARTICULAR FONT, STYLE, SIZE, OR COLOR.

PRIORITY CLAIMED UNDER SEC. 44(D) ON ERPN CMNTY TM OFC APPLICATION NO. 5326251, FILED 9-20-2006, REG. NO. 005326251, DATED 10-31-2007, EXPIRES 9-20-2016.

THE ENGLISH TRANSLATION OF THE WORD "FRATELLIS" IN THE MARK IS "BROTHERS".

FOR SOUND AND VISUAL RECORDINGS FEATURING MUSIC; SOUND AND VISUAL RECORDINGS FEATURING MUSIC PROVIDED BY DOWNLOADING AND STREAMING VIA COMMUNICATIONS NETWORKS (U.S. CLS. 21, 23, 26, 36 AND 38).

LEIGH CAROLINE CASE, EXAMINING ATTORNEY

THE MARK CONSISTS OF STANDARD CHARACTERS WITHOUT CLAIM TO ANY PARTICULAR FONT, STYLE, SIZE, OR COLOR.

OWNER OF ERPN CMNTY TM OFC REG. NO. 005701065, DATED 11-26-2007, EXPIRES 11-26-2017.

FOR OPTICAL, ELECTRIC AND ELECTRONIC MONITORING EQUIPMENT, IN PARTICULAR FOR PHARMACEUTICAL PRODUCTS, NAMELY, VIDEO MONITORS, OPTICAL CHARACTER RECOGNITION APPARATUS (OCR), OPTICAL INSPECTION APPARATUS FOR INDUSTRIAL USE, RADIO FREQUENCY IDENTIFICATION (RFID) TAG READERS; SOFTWARE FOR MONITORING, CONTROL AND/OR DOCUMENTATION OF PACKAGING PROCESSES; WRITING AND READING APPARATUS FOR BAR AND MATRIX CODES, NAMELY, BAR CODE READERS, BAR CODE SCANNERS, MATRIX CODE READERS, BAR CODE PRINTERS, MATRIX CODE PRINTERS; CAMERA AND IMAGE PROCESSING SYSTEMS, NAMELY, CAMERAS, INCLUDING SOFTWARE THEREFOR (U.S. CLS. 21, 23, 26, 36 AND 38).

PAM WILLIS, EXAMINING ATTORNEY

SN 77-132,669. TAR HEELS TRADING COMPANY, LLC, PHILADELPHIA, PA. FILED 3-16-2007.

SN 77-133,011. INSIGHT STRATEGIC CONCEPTS INC., ELKHART, IN. FILED 3-16-2007.

CRO COSTPRO

BLOOM

THE MARK CONSISTS OF STANDARD CHARACTERS WITHOUT CLAIM TO ANY PARTICULAR FONT, STYLE, SIZE, OR COLOR.

NO CLAIM IS MADE TO THE EXCLUSIVE RIGHT TO USE "CRO", APART FROM THE MARK AS SHOWN.

FOR COMPUTER PROGRAMS DESIGNED TO ALLOW PHARMACEUTICAL COMPANIES TO PLAN, BUDGET AND NEGOTIATE OUTSOURCING PROJECTS; DOWNLOADABLE DATA BASE WHICH PHARMACEUTICAL COMPANIES MAY UTILIZE TO BUILD ESTIMATES ON COSTS TO OUTSOURCE PROJECTS (U.S. CLS. 21, 23, 26, 36 AND 38).

MAUREEN DALL, EXAMINING ATTORNEY

THE MARK CONSISTS OF STANDARD CHARACTERS WITHOUT CLAIM TO ANY PARTICULAR FONT, STYLE, SIZE, OR COLOR.

FOR BUSINESS PERFORMANCE OPTIMIZATION SOFTWARE FOR EMPLOYEE TASK ASSIGNMENT, JOB PERFORMANCE, DEVELOPMENT OF STRATEGIC GOALS AND TASKS, TRACKING PROGRESS, SPECIFYING TRAINING, AND MEASURING PERFORMANCE DIRECTED TO CORPORATE AND INSTITUTIONAL USERS (U.S. CLS. 21, 23, 26, 36 AND 38).

PETER B. BROMAGHIM, EXAMINING ATTORNEY

CLASS 9—(Continued).

SN 77-133,314. AGILENT TECHNOLOGIES, INC., SANTA CLARA, CA. FILED 3-16-2007.

OPENLAB

THE MARK CONSISTS OF STANDARD CHARACTERS WITHOUT CLAIM TO ANY PARTICULAR FONT, STYLE, SIZE, OR COLOR.

FOR CHEMICAL AND BIOLOGICAL ANALYTICAL EQUIPMENT, NAMELY, A LABORATORY OPERATING SYSTEM COMPRISED OF COMPUTER HARDWARE AND COMPUTER SOFTWARE TO FACILITATE THE INTERACTION AND MANAGEMENT OF INSTRUMENTS, SCIENTIFIC DATA AND BUSINESS PROCESS ELECTRONIC DATA (U.S. CLS. 21, 23, 26, 36 AND 38).

FRANK LATTUCA, EXAMINING ATTORNEY

SN 77-133,327. SIBEAM, INC., SUNNYVALE, CA. FILED 3-16-2007.

OMNILINK

THE MARK CONSISTS OF STANDARD CHARACTERS WITHOUT CLAIM TO ANY PARTICULAR FONT, STYLE, SIZE, OR COLOR.

FOR SEMICONDUCTORS, INTEGRATED CIRCUITS, SEMICONDUCTOR DEVICES, COMPUTER MEMORIES; OPERATING SOFTWARE FOR SEMICONDUCTORS, INTEGRATED CIRCUITS AND SEMICONDUCTOR DEVICES; ANTENNAS; COMPUTER CHIPSET SYSTEMS, CONSISTING PRIMARILY OF COMPUTER CHIPSETS, COMPUTER HARDWARE, AND SOFTWARE FOR USE IN TELEVISIONS AND OTHER CONSUMER ELECTRONIC DEVICES FOR TRANSMISSION AND DELIVERY OF AUDIO, VIDEO AND MULTIMEDIA CONTENT; COMPUTER NETWORKING HARDWARE; COMPUTER SOFTWARE FOR SETTING UP AND CONFIGURING LOCAL AREA NETWORKS AND WIDE AREA NETWORKS; COMPUTER SOFTWARE FOR ADMINISTRATION OF COMPUTER NETWORKS; COMPUTER NETWORKING SOFTWARE FOR THE COLLECTION, MODIFYING, TRANSMISSION, STORAGE AND SHARING OF DATA AND INFORMATION (U.S. CLS. 21, 23, 26, 36 AND 38).

JACQUELINE A. LAVINE, EXAMINING ATTORNEY

CLASS 9—(Continued).

SN 77-133,342. SIBEAM, INC., SUNNYVALE, CA. FILED 3-16-2007.

MICROARRAY

THE MARK CONSISTS OF STANDARD CHARACTERS WITHOUT CLAIM TO ANY PARTICULAR FONT, STYLE, SIZE, OR COLOR.

FOR SEMICONDUCTORS, INTEGRATED CIRCUITS, SEMICONDUCTOR DEVICES, COMPUTER MEMORIES; OPERATING SOFTWARE FOR SEMICONDUCTORS, INTEGRATED CIRCUITS AND SEMICONDUCTOR DEVICES; ANTENNAS; COMPUTER CHIPSET SYSTEMS, CONSISTING PRIMARILY OF COMPUTER CHIPSETS, COMPUTER HARDWARE, AND SOFTWARE FOR USE IN TELEVISIONS AND OTHER CONSUMER ELECTRONIC DEVICES FOR TRANSMISSION AND DELIVERY OF AUDIO, VIDEO AND MULTIMEDIA CONTENT; COMPUTER NETWORKING HARDWARE; COMPUTER SOFTWARE FOR SETTING UP AND CONFIGURING LOCAL AREA NETWORKS AND WIDE AREA NETWORKS; COMPUTER SOFTWARE FOR ADMINISTRATION OF COMPUTER NETWORKS; COMPUTER NETWORKING SOFTWARE FOR THE COLLECTION, MODIFYING, TRANSMISSION, STORAGE AND SHARING OF DATA AND INFORMATION (U.S. CLS. 21, 23, 26, 36 AND 38).

JACQUELINE A. LAVINE, EXAMINING ATTORNEY

SN 77-133,686. DIGITAL SIGNATURE, INC., SANTA ANA, CA. FILED 3-17-2007.

Mint

THE MARK CONSISTS OF STANDARD CHARACTERS WITHOUT CLAIM TO ANY PARTICULAR FONT, STYLE, SIZE, OR COLOR.

FOR DIGITAL AUDIO PLAYBACK DEVICE CONSISTING PRIMARILY OF AN AMPLIFIER, SPEAKERS, A REMOTE CONTROLLER, AND WIRED AND WIRELESS CONNECTIONS FOR AMPLIFYING AND GENERATING AUDIO SIGNALS RECEIVED FROM THE WIRED AND WIRELESS CONNECTIONS; A VIDEO PLAYBACK DEVICE CONSISTING PRIMARILY OF A VIDEO DECODER, VIDEO SCALER, GRAPHIC PROCESSOR, AND WIRED AND WIRELESS CONNECTIONS FOR DECODING AND MAPPING VIDEO RECEIVED FROM THE WIRED AND WIRELESS CONNECTIONS TO A TARGET SCREEN (U.S. CLS. 21, 23, 26, 36 AND 38).

LA TONIA FISHER, EXAMINING ATTORNEY

CLASS 9—(Continued).

SN 77-133,790. DILLER, RICHARD L., CHAMBERSBURG, PA. FILED 3-17-2007.

StediWatt

THE MARK CONSISTS OF STANDARD CHARACTERS WITHOUT CLAIM TO ANY PARTICULAR FONT, STYLE, SIZE, OR COLOR.

FOR VOLTAGE SURGE PROTECTORS; VOLTAGE SURGE SUPPRESSORS (U.S. CLS. 21, 23, 26, 36 AND 38). FIRST USE 6-1-1974; IN COMMERCE 6-1-1974.

BILL DAWE, EXAMINING ATTORNEY

SN 77-133,960. ICUITI CORPORATION, ROCHESTER, NY. FILED 3-19-2007.

VUSION

THE MARK CONSISTS OF STANDARD CHARACTERS WITHOUT CLAIM TO ANY PARTICULAR FONT, STYLE, SIZE, OR COLOR.

FOR VIDEO EYEWEAR; VIRTUAL REALITY GAME HEADSETS; SOFTWARE AND FIRMWARE FOR DISPLAYING VIDEO GAMES AND ELECTRONIC MEDIA ON DISPLAY SCREEN DEVICES, PERSONAL VIDEO DISPLAY SCREENS AND PERSONAL VIDEO DISPLAY DEVICES, HOME THEATER DISPLAYS, NAMELY, VIDEO DISPLAY SCREENS AND FLAT PANEL DISPLAY SCREENS; COMPUTER HARDWARE, AND VIDEO DISPLAY SOFTWARE (U.S. CLS. 21, 23, 26, 36 AND 38).

KATHY DE JONGE, EXAMINING ATTORNEY

SN 77-134,119. SOFTEON, INC., VIENNA, VA. FILED 3-19-2007.

SCFLEX

THE MARK CONSISTS OF STANDARD CHARACTERS WITHOUT CLAIM TO ANY PARTICULAR FONT, STYLE, SIZE, OR COLOR.

THE WORDING "SC," "FLEX," AND "SCFLEX" HAS NO MEANING IN A FOREIGN LANGUAGE.

FOR COMPUTER SOFTWARE FOR RETAIL SALES CHANNEL MANAGEMENT, ORDER FULFILLMENT MANAGEMENT, CUSTOMER RELATIONSHIP MANAGEMENT, MARKETING ANALYTICS, ACCOUNTING AND MANAGEMENT OF INVENTORY AND SUPPLY CHAIN OF GOODS AND SERVICES AND MANUALS SOLD IN CONJUNCTION THEREWITH (U.S. CLS. 21, 23, 26, 36 AND 38).

FIRST USE 3-1-2007; IN COMMERCE 3-1-2007.

KATHERINE CONNOLLY, EXAMINING ATTORNEY

CLASS 9—(Continued).

SN 77-134,133. SOFTEON, INC., VIENNA, VA. FILED 3-19-2007.



THE MARK CONSISTS OF SCFLEX IN A STYLIZED FONT.

THE WORDING "SC," "FLEX," AND "SCFLEX" HAS NO MEANING IN A FOREIGN LANGUAGE.

FOR COMPUTER SOFTWARE FOR RETAIL SALES CHANNEL MANAGEMENT, ORDER FULFILLMENT MANAGEMENT, CUSTOMER RELATIONSHIP MANAGEMENT, MARKETING ANALYTICS, ACCOUNTING AND MANAGEMENT OF INVENTORY AND SUPPLY CHAIN OF GOODS AND SERVICES AND MANUALS SOLD IN CONJUNCTION THEREWITH (U.S. CLS. 21, 23, 26, 36 AND 38).

FIRST USE 3-1-2007; IN COMMERCE 3-1-2007.

KATHERINE CONNOLLY, EXAMINING ATTORNEY

SN 77-135,400. D-LINK SYSTEMS, INC., FOUNTAIN VALLEY, CA. FILED 3-20-2007.

MediaBridge

THE MARK CONSISTS OF STANDARD CHARACTERS WITHOUT CLAIM TO ANY PARTICULAR FONT, STYLE, SIZE, OR COLOR.

FOR COMPUTER HARDWARE FOR INTERCONNECTING AND MANAGING A WIRELESS NETWORK, NAMELY, COMPUTER NETWORK ADAPTERS; COMPUTER HARDWARE FOR WIRELESS NETWORKS, NAMELY, ADAPTERS, WIRELESS ACCESS POINT (WAP) DEVICES, DIGITAL MEDIA ADAPTERS, DIGITAL MEDIA PLAYERS, AND PRESENTATION GATEWAY ROUTERS IN THE NATURE OF COMPUTER CONTROL HARDWARE, AND ROUTERS (U.S. CLS. 21, 23, 26, 36 AND 38).

DORITT L. CARROLL, EXAMINING ATTORNEY

CLASS 9—(Continued).

SN 77-135,446. ELECTRONICA INTEGRAL DE SONIDO, S.A., ZARAGOZA, SPAIN, FILED 3-20-2007.



THE MARK CONSISTS OF WORDING AND A DESIGN. THE DESIGN CONSISTS OF TWO STACKED RECTANGLES THAT ARE SHADED. THE BOTTOM RECTANGLE IS LARGER AND CONTAINS A STYLIZED LETTER "Q". THE WORD "OQULTO" APPEARS TO THE RIGHT OF THE DESIGN".

FOR ELECTROACOUSTIC TRANSDUCERS, NAMELY, LOUDSPEAKERS, AMPLIFIERS, SOUND REGULATORS FOR VOLUME AND CHANNEL SELECTION, BAFFLE BOXES, MICROPHONES, AND ACCESSORIES FOR THESE DEVICES, NAMELY, POWER SUPPLY UNITS, CONSOLE FOR A MICROPHONE, PLASTIC HOUSINGS AND TRIM RINGS FOR LOUDSPEAKERS AND REGULATORS AND LIDS AND CABLES ALL FOR AUDIO CONTROL AND DISTRIBUTION (U.S. CLS. 21, 23, 26, 36 AND 38).

CORY BOONE, EXAMINING ATTORNEY

SN 77-135,501. ROPER SCIENTIFIC, INC., TUCSON, AZ. FILED 3-20-2007.

PAR

THE MARK CONSISTS OF STANDARD CHARACTERS WITHOUT CLAIM TO ANY PARTICULAR FONT, STYLE, SIZE, OR COLOR.

FOR VOLTAGE CONTROLLERS FOR SCIENTIFIC DIGITAL CAMERAS (U.S. CLS. 21, 23, 26, 36 AND 38).

HANNO RITTNER, EXAMINING ATTORNEY

SN 77-135,615. AUERSOFT LLC, MESA, AZ. FILED 3-20-2007.

V-FAX

THE MARK CONSISTS OF STANDARD CHARACTERS WITHOUT CLAIM TO ANY PARTICULAR FONT, STYLE, SIZE, OR COLOR.

FOR COMPUTER SOFTWARE FOR CONVERSION OF FACSIMILES TO DATABASE DOCUMENTS (U.S. CLS. 21, 23, 26, 36 AND 38).

FIRST USE 0-0-2006; IN COMMERCE 0-0-2006.

KAREN SEVERSON, EXAMINING ATTORNEY

CLASS 9—(Continued).

SN 77-135,839. FLUENT, INC., DEERFIELD BEACH, FL. FILED 3-20-2007.

IADVERTISE

THE MARK CONSISTS OF STANDARD CHARACTERS WITHOUT CLAIM TO ANY PARTICULAR FONT, STYLE, SIZE, OR COLOR.

FOR COMPUTER SOFTWARE FOR MANAGING ONLINE ADVERTISING THAT MAY BE DOWNLOADED FROM A GLOBAL COMPUTER NETWORK (U.S. CLS. 21, 23, 26, 36 AND 38).

FIRST USE 3-7-2007; IN COMMERCE 3-7-2007.

LA TONIA FISHER, EXAMINING ATTORNEY

SN 77-136,694. SEED STUDIO INCORPORATION, TAIPEI CITY, TAIWAN, FILED 3-21-2007.

SEEDSTUDIO

THE MARK CONSISTS OF STANDARD CHARACTERS WITHOUT CLAIM TO ANY PARTICULAR FONT, STYLE, SIZE, OR COLOR.

FOR COMPUTER HARDWARE; COMPUTER GAME SOFTWARE; VIDEO GAME SOFTWARE; GAME CONSOLES, NAMELY, VIDEO GAME MACHINES FOR USE WITH EXTERNAL DISPLAY SCREEN OR MONITOR; PRE-RECORDED COMPACT DISCS FEATURING COMPUTER GAMES; AUDIO AND VIDEO COMPACT DISCS FEATURING COMPUTER GAMES (U.S. CLS. 21, 23, 26, 36 AND 38).

KAREN K. BUSH, EXAMINING ATTORNEY

SN 77-137,106. GENESEE SCIENTIFIC CORPORATION, SAN DIEGO, CA. FILED 3-21-2007.

NEXT-GEN

THE MARK CONSISTS OF STANDARD CHARACTERS WITHOUT CLAIM TO ANY PARTICULAR FONT, STYLE, SIZE, OR COLOR.

FOR DISPOSABLE LATEX AND NITRILE GLOVES FOR LABORATORY USE (U.S. CLS. 21, 23, 26, 36 AND 38).

FIRST USE 10-2-2006; IN COMMERCE 10-2-2006.

KATHY DE JONGE, EXAMINING ATTORNEY

CLASS 9—(Continued).

SN 77-139,319. LAMAR TECHNOLOGIES LLC, MARYSVILLE, WA. FILED 3-23-2007.



NO CLAIM IS MADE TO THE EXCLUSIVE RIGHT TO USE "SUPER SWITCH", APART FROM THE MARK AS SHOWN.

THE MARK CONSISTS OF A WINGED LIGHTNING-BOLT LOGO INCLUDING A CENTRAL SHIELD CONTAINING A STYLIZED LETTER ABBREVIATION "LT".

FOR AIRCRAFT POWER SWITCHES, NAMELY, SOLID STATE AIRCRAFT POWER SWITCHES USED IN AN AIRCRAFT POWER SYSTEM (U.S. CLS. 21, 23, 26, 36 AND 38).

DOMINIC FATHY, EXAMINING ATTORNEY

CLASS 9—(Continued).

SN 77-140,414. LARSEN, JOANNE, CHICAGO, IL. FILED 3-26-2007.

ASK THE DIETITIAN

THE MARK CONSISTS OF STANDARD CHARACTERS WITHOUT CLAIM TO ANY PARTICULAR FONT, STYLE, SIZE, OR COLOR.

FOR DOWNLOADABLE PODCASTS IN THE FIELDS OF HEALTH, NUTRITION AND FITNESS (U.S. CLS. 21, 23, 26, 36 AND 38).

DAWN FELDMAN, EXAMINING ATTORNEY

SN 77-140,997. SER SOLUTIONS, INC., DULLES, VA. FILED 3-27-2007.

POWERED BY SER SOLUTIONS

THE MARK CONSISTS OF STANDARD CHARACTERS WITHOUT CLAIM TO ANY PARTICULAR FONT, STYLE, SIZE, OR COLOR.

NO CLAIM IS MADE TO THE EXCLUSIVE RIGHT TO USE "SOLUTIONS", APART FROM THE MARK AS SHOWN.

FOR SOFTWARE FOR CALL CONTACT CENTERS, CUSTOMER RELATIONSHIP MANAGEMENT AND ENTERPRISE APPLICATIONS, NAMELY, SOFTWARE USED IN MONITORING AND ANALYZING INTERACTIONS WITH CUSTOMERS ACROSS MULTIPLE CALL CONTACT CENTER COMMUNICATION CHANNELS; SOFTWARE FOR CALL CONTACT CENTERS, CUSTOMER RELATIONSHIP MANAGEMENT AND ENTERPRISE APPLICATIONS, NAMELY, SPEECH ANALYTICS AND SPEECH RECOGNITION SOFTWARE FOR MONITORING, ANALYZING AND/OR REPORTING COMMUNICATION BETWEEN AGENT AND CUSTOMER; COMPUTER HARDWARE AND SOFTWARE FOR MANAGING AND CONTROLLING CALL CONTACT CENTER OPERATIONS; COMPUTER HARDWARE AND SOFTWARE FOR CUSTOMER RELATIONSHIP MANAGEMENT AT CALL CONTACT CENTERS OPERATIONS, NAMELY, MANAGING, MONITORING AND TRACKING COMMUNICATIONS AND TRANSACTIONS, ASSESSING THE SKILLS OF EMPLOYEES AND MANAGEMENT OF THE ALLOCATION OF THOSE EMPLOYEES WITHIN THE BUSINESS, STATISTICS REPORTING, PROVIDING MARKETING RESEARCH, CONTACT MANAGEMENT, LIABILITY MANAGEMENT AND RISK MANAGEMENT (U.S. CLS. 21, 23, 26, 36 AND 38).

CAROLYN GRAY, EXAMINING ATTORNEY

SN 77-139,455. DEPALMA'S ACTION KARATE, LLC, MESA, AZ. FILED 3-23-2007.



THE MARK CONSISTS OF THE WORDING "DEPALMA'S" AND THE DESIGN OF A KICKER WITH A BALL BEHIND HIM.

FOR PRE-RECORDED VIDEO AND AUDIO CASSETTES, VIDEO AND AUDIO TAPES, VIDEO AND AUDIO DISCS, CDS, DVDS, FEATURING MARTIAL ARTS (U.S. CLS. 21, 23, 26, 36 AND 38).

FIRST USE 2-1-1997; IN COMMERCE 2-1-1997.
KAREN K. BUSH, EXAMINING ATTORNEY

CLASS 9—(Continued).

SN 77-141,310. O2ASIS, INC., VENICE, FL. FILED 3-27-2007.

BREATHE AND BELIEVE

THE MARK CONSISTS OF STANDARD CHARACTERS WITHOUT CLAIM TO ANY PARTICULAR FONT, STYLE, SIZE, OR COLOR.

NO CLAIM IS MADE TO THE EXCLUSIVE RIGHT TO USE "BREATHE", APART FROM THE MARK AS SHOWN.

FOR RECREATIONAL OXYGEN AND AROMA DELIVERY SYSTEMS COMPRISED OF OXYGEN BREATHING UNITS AND STANDS THEREFORE, OXYGEN GENERATORS, NASAL CANNULAS AND ELECTRONIC CONNECTORS, NOT FOR MEDICAL USE (U.S. CLS. 21, 23, 26, 36 AND 38).

ELIZABETH HUGHITT, EXAMINING ATTORNEY

SN 77-141,366. NEXPAK CORPORATION, DULUTH, GA. FILED 3-27-2007.

SLIMPAK

THE MARK CONSISTS OF STANDARD CHARACTERS WITHOUT CLAIM TO ANY PARTICULAR FONT, STYLE, SIZE, OR COLOR.

OWNER OF U.S. REG. NO. 2,458,628.

FOR STORAGE CONTAINERS FOR RECORDED MEDIA, NAMELY, PLASTIC STORAGE CONTAINERS FOR HOLDING A SINGLE OPTICAL MEDIA DISC (U.S. CLS. 21, 23, 26, 36 AND 38).

FIRST USE 6-30-2000; IN COMMERCE 6-30-2000.

BERYL GARDNER, EXAMINING ATTORNEY

SN 77-141,387. SWIFT, TAYLOR, HENDERSONVILLE, TN. FILED 3-27-2007.

TAYLOR SWIFT

THE MARK CONSISTS OF STANDARD CHARACTERS WITHOUT CLAIM TO ANY PARTICULAR FONT, STYLE, SIZE, OR COLOR.

THE NAME "TAYLOR SWIFT" IDENTIFIES A LIVING INDIVIDUAL WHOSE CONSENT IS OF RECORD.

FOR SERIES OF MUSICAL SOUND RECORDINGS; PRE-RECORDED AUDIO CASSETTES, COMPACT DISCS, DVD'S AND VIDEO TAPES FEATURING PERFORMANCES BY AN INDIVIDUAL; MOUSE PADS (U.S. CLS. 21, 23, 26, 36 AND 38).

FIRST USE 10-0-2000; IN COMMERCE 10-0-2000.

MICHAEL KEATING, EXAMINING ATTORNEY

CLASS 9—(Continued).

SN 77-141,710. SONY ONLINE ENTERTAINMENT LLC, CULVER CITY, CA. FILED 3-27-2007.



THE MARK CONSISTS OF THE WORD VANGUARD ABOVE A LINE POINTED AT BOTH ENDS AND THE WORDS SAGA OF HEROES BELOW THE LINE.

FOR SOFTWARE AND ELECTRONIC GAMES, NAMELY, SOFTWARE GAMES RECORDED ON CD-ROMS AND DVDS FOR COMPUTERS; SOFTWARE GAMES THAT ARE DOWNLOADABLE FROM A REMOTE COMPUTER SITE; VIRTUAL REALITY GAME SOFTWARE, NAMELY, INTERACTIVE VIDEO GAMES OF VIRTUAL REALITY COMPRISED OF COMPUTER SOFTWARE; USER DOCUMENTATION SOLD AS A UNIT THEREWITH (U.S. CLS. 21, 23, 26, 36 AND 38).

FIRST USE 12-10-2006; IN COMMERCE 12-10-2006.

CHRISTINA SOBRAL, EXAMINING ATTORNEY

SN 77-141,711. QUALCOMM INCORPORATED, SAN DIEGO, CA. FILED 3-27-2007.

UNLEASH THE POWER OF TV

THE MARK CONSISTS OF STANDARD CHARACTERS WITHOUT CLAIM TO ANY PARTICULAR FONT, STYLE, SIZE, OR COLOR.

NO CLAIM IS MADE TO THE EXCLUSIVE RIGHT TO USE "TV", APART FROM THE MARK AS SHOWN.

FOR AUDIO, VISUAL, AND DATA PROCESSING APPARATUS, NAMELY, NETWORK, MANAGEMENT, TRANSMISSION AND RECEIVER SYSTEMS COMPRISING HARDWARE AND SOFTWARE FOR ENABLING THE DISTRIBUTION AND/OR PLAYBACK OF AUDIO, VISUAL, AND DATA INFORMATION VIA SATELLITE AND TERRESTRIAL COMMUNICATIONS SYSTEMS, VIA NETWORK SYSTEMS, AND VIA WIRELESS COMMUNICATIONS SYSTEMS (U.S. CLS. 21, 23, 26, 36 AND 38).

MICHELE SWAIN, EXAMINING ATTORNEY

SN 77-141,810. DISKEEPER CORPORATION, BURBANK, CA. FILED 3-27-2007.

**INNOVATORS IN PERFORMANCE
AND RELIABILITY
TECHNOLOGIES**

THE MARK CONSISTS OF STANDARD CHARACTERS WITHOUT CLAIM TO ANY PARTICULAR FONT, STYLE, SIZE, OR COLOR.

NO CLAIM IS MADE TO THE EXCLUSIVE RIGHT TO USE "PERFORMANCE AND RELIABILITY TECHNOLOGIES", APART FROM THE MARK AS SHOWN.

FOR COMPUTER SOFTWARE FOR USE IN COMPUTER SYSTEMS MANAGEMENT (U.S. CLS. 21, 23, 26, 36 AND 38).

LINDA M. KING, EXAMINING ATTORNEY

CLASS 9—(Continued).

SN 77-142,566. UNITED PARCEL SERVICE OF AMERICA, INC., ATLANTA, GA. FILED 3-28-2007.

UPS FTZ FACILITATOR

THE MARK CONSISTS OF STANDARD CHARACTERS WITHOUT CLAIM TO ANY PARTICULAR FONT, STYLE, SIZE, OR COLOR.

OWNER OF U.S. REG. NOS. 2,485,673, 2,973,108 AND 3,159,309.

NO CLAIM IS MADE TO THE EXCLUSIVE RIGHT TO USE "FTZ FACILITATOR", APART FROM THE MARK AS SHOWN.

FOR COMPUTER PROGRAMS FOR USE IN THE TRANSPORTATION AND DELIVERY FIELD, NAMELY, FOR PREPARING AND PRINTING SHIPPING DOCUMENTS AND INVOICES, TRACKING OF SHIPPED PACKAGES AND FREIGHT, PACKAGE SHIPPING RATE CALCULATORS, CURRENT SHIPPING STATUS INFORMATION, SHIPPING SERVICE OPTIONS AND COSTS, PACKAGE ARRIVAL DATES AND DELIVERY NOTIFICATION, DATA MANAGEMENT FOR TRANSPORTATION AND DELIVERY SERVICES, SHIPPING RECORD KEEPING, E-MAIL STATUS UPDATES, INTERNET BILLING ACCESS, LOGISTICS PLANNING AND SUPPLY CHAIN MANAGEMENT SOLUTIONS, AND IMPORT AND EXPORT TRANSACTION MANAGEMENT SERVICES; COMPUTER SOFTWARE FOR APPLICATION AND DATABASE INTEGRATION (U.S. CLS. 21, 23, 26, 36 AND 38).

LINDA E. BLOHM, EXAMINING ATTORNEY

SN 77-143,108. PRIMA ROYAL ENTERPRISES, LTD., IRWINDALE, CA. FILED 3-28-2007.

BOBBI BLU

THE MARK CONSISTS OF STANDARD CHARACTERS WITHOUT CLAIM TO ANY PARTICULAR FONT, STYLE, SIZE, OR COLOR.

THE NAME(S), PORTRAIT(S), AND/OR SIGNATURE(S) SHOWN IN THE MARK DOES NOT IDENTIFY A PARTICULAR LIVING INDIVIDUAL.

FOR EYEGLASS FRAMES FOR PRESCRIPTION AND NON-PRESCRIPTION LENSES; SUNGLASSES; EYEGLASS AND SUNGLASS CASES; CORDS AND CHAINS FOR EYEWEAR; ELECTRIC HAIR CURLERS; HAIR CURLING AND STRAIGHTENING IRONS (U.S. CLS. 21, 23, 26, 36 AND 38).

LINDA M. KING, EXAMINING ATTORNEY

CLASS 9—(Continued).

SN 77-144,361. COMPUTERS AND STRUCTURES, INC., BERKELEY, CA. FILED 3-29-2007.

BrIM

THE MARK CONSISTS OF STANDARD CHARACTERS WITHOUT CLAIM TO ANY PARTICULAR FONT, STYLE, SIZE, OR COLOR.

FOR COMPUTER PROGRAMS FOR STRUCTURAL AND ENGINEERING APPLICATIONS, NAMELY, BRIDGE DESIGN, BRIDGE CONSTRUCTION MODELING, AND BRIDGE DESIGN AND CONSTRUCTION ANALYSIS AND INSTRUCTIONAL MANUALS SOLD AS A UNIT (U.S. CLS. 21, 23, 26, 36 AND 38).

FIRST USE 2-28-2007; IN COMMERCE 2-28-2007.

BILL DAWE, EXAMINING ATTORNEY

SN 77-144,651. TRANSPARENT LOGIC TECHNOLOGIES, INC., CHESAPEAKE, VA. FILED 3-30-2007.

LogicBase: Exchange

THE MARK CONSISTS OF STANDARD CHARACTERS WITHOUT CLAIM TO ANY PARTICULAR FONT, STYLE, SIZE, OR COLOR.

NO CLAIM IS MADE TO THE EXCLUSIVE RIGHT TO USE EXCHANGE, APART FROM THE MARK AS SHOWN.

FOR COMPUTER SOFTWARE FOR USE IN AUTOMATED PROCESSING OF BUSINESS DECISIONS, RULES AND WORKFLOW THAT MAY BE DOWNLOADED FROM A GLOBAL COMPUTER NETWORK (U.S. CLS. 21, 23, 26, 36 AND 38).

SANI KHOURI, EXAMINING ATTORNEY

SN 77-144,868. TRANSPARENT LOGIC TECHNOLOGIES, INC., CHESAPEAKE, VA. FILED 3-30-2007.

LogicBase: Opus

THE MARK CONSISTS OF STANDARD CHARACTERS WITHOUT CLAIM TO ANY PARTICULAR FONT, STYLE, SIZE, OR COLOR.

FOR COMPUTER SOFTWARE FOR USE IN AUTOMATED PROCESSING OF BUSINESS DECISIONS, RULES AND WORKFLOW THAT MAY BE DOWNLOADED FROM A GLOBAL COMPUTER NETWORK (U.S. CLS. 21, 23, 26, 36 AND 38).

SANI KHOURI, EXAMINING ATTORNEY

CLASS 9—(Continued).

SN 77-144,879. TRANSPARENT LOGIC TECHNOLOGIES, INC., CHESAPEAKE, VA. FILED 3-30-2007.

LogicBase: Virtuoso

THE MARK CONSISTS OF STANDARD CHARACTERS WITHOUT CLAIM TO ANY PARTICULAR FONT, STYLE, SIZE, OR COLOR.

FOR COMPUTER SOFTWARE FOR USE IN AUTOMATED PROCESSING OF BUSINESS DECISIONS, RULES AND WORKFLOW THAT MAY BE DOWNLOADED FROM A GLOBAL COMPUTER NETWORK (U.S. CLS. 21, 23, 26, 36 AND 38).

SANI KHOURI, EXAMINING ATTORNEY

SN 77-145,467. Z.A.O. "SEKYURIT", MOSCOW, RUSSIAN FED., FILED 3-31-2007.

ZECURION

THE MARK CONSISTS OF STANDARD CHARACTERS WITHOUT CLAIM TO ANY PARTICULAR FONT, STYLE, SIZE, OR COLOR.

FOR COMPUTER SOFTWARE, COMPUTER PROGRAMS, AND DOWNLOADABLE COMPUTER SOFTWARE FOR USE IN ENCRYPTION AND DECRYPTION OF DIGITAL FILES, FOR THE PROTECTION OF DATA FROM UNAUTHORIZED USE AND ACCESS, FOR USE IN USER ACCESS CONTROL AND USER ACTIVITY MONITORING, FOR USE IN LEXICAL, CONTENT, AND SEMANTIC ANALYSIS, AND FOR USE IN DIGITAL RIGHTS MANAGEMENT AND CONFIGURATION MANAGEMENT (U.S. CLS. 21, 23, 26, 36 AND 38).

ELLEN BURNS, EXAMINING ATTORNEY

SN 77-146,378. DAIHAN SCIENTIFIC CO., LTD., SEOUL 136-120, REPUBLIC OF KOREA, FILED 4-2-2007.

WiseBath

THE MARK CONSISTS OF STANDARD CHARACTERS WITHOUT CLAIM TO ANY PARTICULAR FONT, STYLE, SIZE, OR COLOR.

FOR LABORATORY EQUIPMENT AND SUPPLIES, NAMELY, CONSTANT TEMPERATURE WATER BATH, GENERAL PURPOSE WATER BATH, SHAKING WATER BATH, MULTI-CHAMBER WATER BATH, PRECISE VISCOSITY WATER BATH, HIGH TEMPERATURE OIL BATH (U.S. CLS. 21, 23, 26, 36 AND 38).

ALEXANDER L. POWERS, EXAMINING ATTORNEY

CLASS 9—(Continued).

SN 77-146,390. DAIHAN SCIENTIFIC CO., LTD., SEOUL 136-120, REPUBLIC OF KOREA, FILED 4-2-2007.

WiseCircu

THE MARK CONSISTS OF STANDARD CHARACTERS WITHOUT CLAIM TO ANY PARTICULAR FONT, STYLE, SIZE, OR COLOR.

FOR LABORATORY EQUIPMENT AND SUPPLIES, NAMELY, CONSTANT TEMPERATURE WATER CIRCULATION TANKS, HIGH TEMPERATURE CIRCULATORS, CIRCULATING WATER BATHS, CONSTANT LOW TEMPERATURE WATER CIRCULATION TANKS, REFRIGERATING CIRCULATORS, COLD TRAP BATHS (U.S. CLS. 21, 23, 26, 36 AND 38).

IRA J. GOODSAY, EXAMINING ATTORNEY

SN 77-147,171. MATTEL, INC., EL SEGUNDO, CA. FILED 4-3-2007.

B-VIEW

THE MARK CONSISTS OF STANDARD CHARACTERS WITHOUT CLAIM TO ANY PARTICULAR FONT, STYLE, SIZE, OR COLOR.

FOR ELECTRONICS, NAMELY, DIGITAL PHOTO FRAMES (U.S. CLS. 21, 23, 26, 36 AND 38).

FIRST USE 12-19-2007; IN COMMERCE 12-19-2007.

JAMES A. RAUEN, EXAMINING ATTORNEY

CLASS 9—(Continued).

SN 77-147,201. SCHOLASTIC INC., NEW YORK, NY. FILED 4-3-2007.

GOOSEBUMPS

THE MARK CONSISTS OF STANDARD CHARACTERS WITHOUT CLAIM TO ANY PARTICULAR FONT, STYLE, SIZE, OR COLOR.

OWNER OF U.S. REG. NOS. 1,871,292 AND 2,019,991.
 FOR PRERECORDED AUDIO AND VIDEO TAPES AND CASSETTES, COMPACT AND LASER DISCS, AUDIO BOOKS, CD ROM'S FEATURING HORROR/SUSPENSE ENTERTAINMENT FOR CHILDREN AND ADOLESCENTS; COMPUTER GAME SOFTWARE, COMPRISING, AUDIO/VIDEO GAME CARTRIDGES, CASSETTES; COMPUTER GAME DISCS; COMPUTER GAME EQUIPMENT CONTAINING MEMORY DEVICES, NAMELY, DISCS; COMPUTER GAME PROGRAMS; COMPUTER GAME JOY STICKS AND MOUSE PADS; INTERACTIVE VIDEO GAMES OF VIRTUAL REALITY COMPRISED OF HARDWARE AND SOFTWARE; SCREEN SAVER COMPUTER PROGRAMS; CALCULATORS; AUDIO AND TAPE CASSETTE RECORDERS, NAMELY, DIGITAL ANSWERING AND RECORDING DEVICES; AUDIO AND VIDEO CASSETTE TAPE PLAYERS; RADIOS; HEADPHONES; LIFE JACKETS; WALKIE-TALKIES; CAMERAS; BICYCLE HELMETS; MAGNETS; DIRECTIONAL COMPASS; AND SUNGLASSES (U.S. CLS. 21, 23, 26, 36 AND 38).
 KATHLEEN M. VANSTON, EXAMINING ATTORNEY

SN 77-147,915. NICHOLAS HIND, CLEARLAKE PARK, CA. FILED 4-3-2007.



THE COLOR(S) GREEN, BLUE, TURQUOISE, GREY, BLACK, AND WHITE IS/ARE CLAIMED AS A FEATURE OF THE MARK.
 THE MARK CONSISTS OF A GREEN OVAL, WITH A BLUE QUADRILATERAL STYLIZED SHAPE LAYERED ON TOP, DEPICTING A SEASCAPE AND HORIZON, WITH A WHITE AND GREY MOON RISING IN THE BACKGROUND TO THE LEFT, AND WITH TWO WHITE SEAGULLS FLYING BENEATH IT, AND SAILBOAT WITH A HUMAN EAR FOR A SAIL IN THE FOREGROUND TO

CLASS 9—(Continued).

THE RIGHT. THE SAILBOAT AND EAR ARE IN VARIOUS SHADES OF WHITE, GRAY, TURQUOISE AND BLUE AND IS OUTLINED IN BLACK. THE POLE FOR THE SAIL IS IN BLACK. THE "HORIZON" LINE CONSISTS OF A WHITE GRADIENT. "LISTEN TO THE WIND" IS IN BLACK ALONG THE BOTTOM EDGE OF THE GREEN OVAL, AND IS CONTOURED TO THE SHAPE OF THE OVAL. THE WORDS "TO THE" ARE SET VERTICALLY, WITH "TO" LAID OUT ON TOP OF "THE". THE MERIDIANS AND PARALLEL LINES ARE IN BLACK.
 FOR MUSICAL SOUND RECORDINGS (U.S. CLS. 21, 23, 26, 36 AND 38).
 FIRST USE 7-5-2006; IN COMMERCE 1-15-2007.
 JENNIFER MARTIN, EXAMINING ATTORNEY

SN 77-148,381. IOPTRON CORPORATION, WOBURN, MA. FILED 4-4-2007.

ASTROBOY

THE MARK CONSISTS OF STANDARD CHARACTERS WITHOUT CLAIM TO ANY PARTICULAR FONT, STYLE, SIZE, OR COLOR.
 FOR TELESCOPES WITH COMPUTERIZED HAND CONTROLLERS; TRIPODS WITH COMPUTERIZED HAND CONTROLLERS; BODY-TUBES FOR TELESCOPES; CENTRAL PROCESSING UNITS FOR PROCESSING INFORMATION, DATA, SOUND OR IMAGES, NAMELY, COMPUTERIZED CONTROLLERS AND RELATED SOFTWARE USED TO CONTROL THE MOVEMENT OF THE TELESCOPES, COMPUTER SOFTWARE FOR PROVIDING A DETAILED STAR CHART, TAKING AND MANIPULATING THE IMAGES OF THE OBSERVING OBJECTS, RECORDING AND MANIPULATING THE SOUNDS OF THE OBSERVING OBJECTS (U.S. CLS. 21, 23, 26, 36 AND 38).
 FIRST USE 3-27-2007; IN COMMERCE 3-27-2007.
 SCOTT BIBB, EXAMINING ATTORNEY

CLASS 9—(Continued).

SN 77-149,012. PANAVISION INTERNATIONAL, L.P.,
WOODLAND HILLS, CA. FILED 4-4-2007.



OWNER OF U.S. REG. NOS. 627,362, 1,972,238 AND
3,128,333.

FOR TELEVISIONS; HOME THEATER SYSTEMS
COMPOSED OF TELEVISION AND AUDIOVISUAL RE-
CEIVERS, AMPLIFIERS, SPEAKERS, DVD PLAYERS,
CD PLAYERS AND RECEIVERS, PROJECTION
SCREENS, AND THEATRE PROJECTION EQUIPMENT,
NAMELY, FILM PROJECTORS AND DIGITAL PROJEC-
TORS; AUDIOVISUAL RECEIVERS; STEREO SPEAK-
ERS; DVD PLAYERS AND RECORDERS; CD PLAYERS
AND RECORDERS; PROJECTION SCREENS; AND PRO-
JECTION EQUIPMENT, NAMELY, FILM PROJECTORS
AND DIGITAL PROJECTORS; PORTABLE LISTENING
DEVICES, NAMELY, MP3 AND DIGITAL AUDIO
PLAYERS, PORTABLE VIDEO DEVICES, NAMELY,
VIDEO PLAYERS, DVD PLAYERS AND DIGITAL VI-
DEO MEDIA PLAYERS; PORTABLE TELEPHONES;
DIGITAL CAMERAS AND ACCESSORIES, NAMELY,
LENSES, LIGHTS, FILTERS, CASES, ADAPTERS, BAT-
TERIES, CABLES; DIGITAL CAMCORDERS AND AC-
CESSORIES, NAMELY, LENSES, LIGHTS, FILTERS,
CASES, ADAPTERS, BATTERIES, CABLES; PERSONAL
VIDEO RECORDERS; VCR PLAYERS AND RECORDERS
(U.S. CLS. 21, 23, 26, 36 AND 38).
NATALIE POLZER, EXAMINING ATTORNEY

SN 77-149,206. RIDEMAKERZ, LLC, FALLS CHURCH, VA.
FILED 4-5-2007.

RIDEMONEY

THE MARK CONSISTS OF STANDARD CHARACTERS
WITHOUT CLAIM TO ANY PARTICULAR FONT, STYLE,
SIZE, OR COLOR.

FOR PREPAID GIFT CARDS, MAGANETICALLY EN-
CODED (U.S. CLS. 21, 23, 26, 36 AND 38).
BILL DAWE, EXAMINING ATTORNEY

CLASS 9—(Continued).

SN 77-152,982. CRESCENDO SYSTEMS CORPORATION,
LAVAL, CANADA, FILED 4-10-2007.

Concerto Maestro

THE MARK CONSISTS OF STANDARD CHARACTERS
WITHOUT CLAIM TO ANY PARTICULAR FONT, STYLE,
SIZE, OR COLOR.

FOR COMPUTER PROGRAMS FOR MANAGING DIC-
TATION, TRANSCRIPTION AND SPEECH PROCESSING
SYSTEMS (U.S. CLS. 21, 23, 26, 36 AND 38).
TEJBIR SINGH, EXAMINING ATTORNEY

SN 77-155,186. ORTRONICS, INC., NEW LONDON, CT.
FILED 4-12-2007.

SWING-AWAY

THE MARK CONSISTS OF STANDARD CHARACTERS
WITHOUT CLAIM TO ANY PARTICULAR FONT, STYLE,
SIZE, OR COLOR.

FOR EQUIPMENT FOR VOICE AND DATA COMMU-
NICATIONS SYSTEMS, NAMELY, FACE PLATES USED
FOR SURROUNDING AND PROTECTING A WORK-
STATION APERTURE, WORKSTATION OUTLETS AND
BOXES FOR ELECTRICAL AND FIBER OPTIC CON-
NECTIONS AND TERMINATIONS, ACCESS POINTS
FOR WIRELESS NETWORKS, AND ASSOCIATED
MOUNTING HARDWARE AND SPACERS (U.S. CLS.
21, 23, 26, 36 AND 38).

FIRST USE 2-2-2006; IN COMMERCE 2-2-2006.
FRANK LATTUCA, EXAMINING ATTORNEY

CLASS 9—(Continued).

SN 77-155,645. PROGRAMMABLE DIVISION OF XANTREX TECHNOLOGY INC., SAN DIEGO, CA. FILED 4-12-2007.

ReFlex Power

THE MARK CONSISTS OF STANDARD CHARACTERS WITHOUT CLAIM TO ANY PARTICULAR FONT, STYLE, SIZE, OR COLOR.

NO CLAIM IS MADE TO THE EXCLUSIVE RIGHT TO USE POWER, APART FROM THE MARK AS SHOWN.

FOR MODULAR, PRECISION PROGRAMMABLE DC AND AC ELECTRICAL POWER SUPPLIES; PROGRAMMABLE ELECTRONIC LOADS, NAMELY, A DEVICE THAT SIMULATES LOADING ON AN ELECTRONIC CIRCUIT TO TEST POWER SUPPLIES, BATTERIES AND FUEL CELLS; SOPHISTICATED DIGITAL CONTROLLERS FOR PRECISION CONTROL; AND RACK MOUNTABLE MAINFRAMES, NAMELY, BUT NOT LIMITED TO, A 4U HIGH CHASSIS THAT MOUNTS IN STANDARD 19 INCH WIDE EQUIPMENT RACKS WHICH CAN BE FLEXIBLY CONFIGURED AND RECONFIGURED BY ENGINEERS AND OTHER USERS INTO UNIQUE POWER SYSTEMS AND MAY BE USED IN AUTOMATED TEST, PROCESS CONTROL AND POWER BUS SIMULATION APPLICATIONS ACROSS A MULTITUDE OF INDUSTRIES (U.S. CLS. 21, 23, 26, 36 AND 38).

FIRST USE 9-10-2004; IN COMMERCE 9-20-2004.
GIANCARLO CASTRO, EXAMINING ATTORNEY

SN 77-156,189. ZEND TECHNOLOGIES LTD., RAMAT GAN, ISRAEL, FILED 4-13-2007.

ZEND FRAMEWORK

THE MARK CONSISTS OF STANDARD CHARACTERS WITHOUT CLAIM TO ANY PARTICULAR FONT, STYLE, SIZE, OR COLOR.

OWNER OF U.S. REG. NOS. 2,638,052, 2,651,494 AND 2,791,730.

NO CLAIM IS MADE TO THE EXCLUSIVE RIGHT TO USE "FRAMEWORK", APART FROM THE MARK AS SHOWN.

FOR COMPUTER SOFTWARE DEVELOPMENT TOOLS (U.S. CLS. 21, 23, 26, 36 AND 38).

FIRST USE 10-0-2005; IN COMMERCE 10-0-2005.
DANIEL CAPSHAW, EXAMINING ATTORNEY

CLASS 9—(Continued).

SN 77-158,425. THE MCGEE GROUP, MARIETTA, GA. FILED 4-17-2007.



NO CLAIM IS MADE TO THE EXCLUSIVE RIGHT TO USE "GROUP", APART FROM THE MARK AS SHOWN.

THE MARK CONSISTS OF THE WORDS "THE MCGEE GROUP" BENEATH A STYLIZED DESIGN OF PARTIAL EYEGLASS FRAMES.

FOR EYEGLASS CASES; EYEGLASS FRAMES (U.S. CLS. 21, 23, 26, 36 AND 38).

KIMBERLY PERRY, EXAMINING ATTORNEY

SN 77-159,876. DISKEEPER CORPORATION, BURBANK, CA. FILED 4-18-2007.

FASTER THAN NEW

THE MARK CONSISTS OF STANDARD CHARACTERS WITHOUT CLAIM TO ANY PARTICULAR FONT, STYLE, SIZE, OR COLOR.

FOR COMPUTER PROGRAMS FOR COMPUTER SYSTEMS MANAGEMENT (U.S. CLS. 21, 23, 26, 36 AND 38).

LINDA M. KING, EXAMINING ATTORNEY

SN 77-162,282. ATMEL CORPORATION, SAN JOSE, CA. FILED 4-20-2007.

PICOPOWER

THE MARK CONSISTS OF STANDARD CHARACTERS WITHOUT CLAIM TO ANY PARTICULAR FONT, STYLE, SIZE, OR COLOR.

FOR SEMICONDUCTOR INTEGRATED CIRCUITS, NAMELY, MICROCONTROLLER CHIPS; CIRCUIT BOARDS HAVING AT LEAST ONE MICROCONTROLLER CHIP; APPLICATION SPECIFIC INTEGRATED CIRCUITS (ASICS); TOOLS, NAMELY, KITS FOR DEMONSTRATING, EVALUATING, AND SIMULATING MICROCONTROLLERS COMPRISING SOFTWARE FOR DEMONSTRATING, EVALUATING AND SIMULATING MICROCONTROLLERS, CIRCUIT BOARDS WITH OR WITHOUT AT LEAST ONE CHIP INCORPORATED OR EMBEDDED THEREIN, AND COMPUTER PROGRAMS FOR DEMONSTRATING, EVALUATING, AND SIMULATING MICROCONTROLLERS (U.S. CLS. 21, 23, 26, 36 AND 38).

LEE-ANNE BERNS, EXAMINING ATTORNEY

CLASS 9—(Continued).

SN 77-166,541. COLLEGE PARK INDUSTRIES, INC., FRASER, MI. FILED 4-26-2007.

IPECS

THE MARK CONSISTS OF STANDARD CHARACTERS WITHOUT CLAIM TO ANY PARTICULAR FONT, STYLE, SIZE, OR COLOR.

FOR ELECTRONIC APPARATUS FOR COLLECTING, PROCESSING AND STORING DATA RELATING TO THE MOVEMENT OF A PROSTHETIC OR NATURAL LIMB (U.S. CLS. 21, 23, 26, 36 AND 38).

JENNIFER VASQUEZ, EXAMINING ATTORNEY

SN 77-167,411. MERCURY COMPUTER SYSTEMS, INC., CHELMSFORD, MA. FILED 4-27-2007.

Waveform-Ready

THE MARK CONSISTS OF STANDARD CHARACTERS WITHOUT CLAIM TO ANY PARTICULAR FONT, STYLE, SIZE, OR COLOR.

FOR DIGITAL DATA PROCESSING PLATFORMS FOR WIDEBAND DATALINK AND SATELLITE COMMUNICATIONS PROCESSING, NAMELY, DIGITAL DATA PROCESSORS, EMBEDDED PROCESSING BOARDS, COMPUTER NODES, CO-PROCESSING BOARDS, WIDEBAND REMOTE FIBER TRANSCIEVERS, AND OPERATING SYSTEM SOFTWARE ATTENDANT THERETO, ALL FOR WIDEBAND DATALINK AND SATELLITE COMMUNICATIONS (U.S. CLS. 21, 23, 26, 36 AND 38).

REBECCA GILBERT, EXAMINING ATTORNEY

SN 77-168,655. COMFYWARE LTD., TEL AVIV, ISRAEL, FILED 4-30-2007.

3C DEVELOPMENTAL CYCLE

THE MARK CONSISTS OF STANDARD CHARACTERS WITHOUT CLAIM TO ANY PARTICULAR FONT, STYLE, SIZE, OR COLOR.

THE WORDING "3C DEVELOPMENTAL CYCLE" HAS NO MEANING IN A FOREIGN LANGUAGE.

FOR MULTIPLE ACTIVITY INTERACTIVE MULTIMEDIA COMPUTER GAME PROGRAM FOR TEACHING AND ENTERTAINING CHILDREN; MULTIMEDIA GAME SOFTWARE; MULTIMEDIA CHILDREN'S EDUCATIONAL SOFTWARE; COMPUTER KEYBOARD (U.S. CLS. 21, 23, 26, 36 AND 38).

FIRST USE 4-1-2006; IN COMMERCE 4-1-2006.
BARBARA BROWN, EXAMINING ATTORNEY

CLASS 9—(Continued).

SN 77-168,673. COMFYWARE LTD., TEL AVIV, ISRAEL, FILED 4-30-2007.



THE MARK CONSISTS OF THREE LETTER "C"S IN AN INTERIOR AREA, THE INTERIOR AREA IS SURROUNDED BY A PERIMETER AREA HAVING THE WORDS "CURIOSITY, CHALLENGE, AND CONFIDENCE".

FOR MULTIPLE ACTIVITY INTERACTIVE MULTIMEDIA COMPUTER GAME PROGRAM FOR TEACHING AND ENTERTAINING CHILDREN; MULTIMEDIA GAME SOFTWARE; MULTIMEDIA CHILDREN'S EDUCATIONAL SOFTWARE; COMPUTER KEYBOARD (U.S. CLS. 21, 23, 26, 36 AND 38).

FIRST USE 4-1-2006; IN COMMERCE 4-1-2006.
BARBARA BROWN, EXAMINING ATTORNEY

SN 77-168,853. CHILLY AUTUMN SOFTWARE, INC., NEW MARKET, MD. FILED 4-30-2007.

REAL ADVANTAGE PRO

THE MARK CONSISTS OF STANDARD CHARACTERS WITHOUT CLAIM TO ANY PARTICULAR FONT, STYLE, SIZE, OR COLOR.

FOR COMPUTER SOFTWARE, NAMELY, REAL ESTATE MARKETING AND PRODUCTIVITY SOFTWARE DESIGNED FOR REAL ESTATE AGENTS TO CREATE AND GENERATE REAL ESTATE FLYERS, POST CARDS AND BROCHURES FOR REAL ESTATE AGENTS TO PROMOTE THEMSELVES AND THE PROPERTIES THAT THEY HAVE LISTED FOR SALE (U.S. CLS. 21, 23, 26, 36 AND 38).

LESLIE RICHARDS, EXAMINING ATTORNEY

SN 77-169,054. TUBEDEPOT, LLC, MEMPHIS, TN. FILED 4-30-2007.

BLACK SABLE

THE MARK CONSISTS OF STANDARD CHARACTERS WITHOUT CLAIM TO ANY PARTICULAR FONT, STYLE, SIZE, OR COLOR.

FOR ELECTRON TUBES (U.S. CLS. 21, 23, 26, 36 AND 38).

FIRST USE 12-26-2006; IN COMMERCE 4-30-2007.
MARLENE BELL, EXAMINING ATTORNEY

CLASS 9—(Continued).

SN 77-176,134. POWERTECH INDUSTRIAL CO., LTD.,
TAIPEI HSIEN, TAIWAN, FILED 5-9-2007.

HYBRID GREEN UPS

THE MARK CONSISTS OF STANDARD CHARACTERS WITHOUT CLAIM TO ANY PARTICULAR FONT, STYLE, SIZE, OR COLOR.

NO CLAIM IS MADE TO THE EXCLUSIVE RIGHT TO USE "UPS", APART FROM THE MARK AS SHOWN.

FOR POWER SUPPLIES; MOBILE PHONE BATTERY CHARGERS; MOBILE PHONE BATTERY CHARGER STATIONS; BATTERY CHARGERS; UNIVERSAL POWER SUPPLIES; POWER SAVING ADAPTERS; ELECTRIC STORAGE BATTERIES; UNINTERRUPTIBLE POWER SUPPLIES; AC/DC CONVERTERS; POWER SOURCE STABLE ADAPTERS (U.S. CLS. 21, 23, 26, 36 AND 38).

GEOFFREY FOSDICK, EXAMINING ATTORNEY

SN 77-176,149. POWERTECH INDUSTRIAL CO., LTD.,
TAIPEI HSIEN, TAIWAN, FILED 5-9-2007.

HYBRID GREEN POWER

THE MARK CONSISTS OF STANDARD CHARACTERS WITHOUT CLAIM TO ANY PARTICULAR FONT, STYLE, SIZE, OR COLOR.

NO CLAIM IS MADE TO THE EXCLUSIVE RIGHT TO USE "POWER", APART FROM THE MARK AS SHOWN.

FOR POWER SUPPLIES; MOBILE PHONE BATTERY CHARGERS; MOBILE PHONE BATTERY CHARGER STATIONS; BATTERY CHARGERS; UNIVERSAL POWER SUPPLIES; POWER SAVING ADAPTERS; ELECTRIC STORAGE BATTERIES; UNINTERRUPTIBLE POWER SUPPLIES; AC/DC CONVERTERS; POWER SOURCE STABLE ADAPTERS (U.S. CLS. 21, 23, 26, 36 AND 38).

GEOFFREY FOSDICK, EXAMINING ATTORNEY

SN 77-177,239. RESERVOIR LABS, INC., NEW YORK, NY.
FILED 5-10-2007.

R-Scope

THE MARK CONSISTS OF STANDARD CHARACTERS WITHOUT CLAIM TO ANY PARTICULAR FONT, STYLE, SIZE, OR COLOR.

FOR PATTERN RECOGNITION SYSTEMS COMPOSED OF COMPUTER CHIPS, COMPUTER HARDWARE AND SOFTWARE (U.S. CLS. 21, 23, 26, 36 AND 38).

DAWN FELDMAN, EXAMINING ATTORNEY

CLASS 9—(Continued).

SN 77-179,892. MORTON, ROBERT PECK, ATLANTA, GA.
FILED 5-14-2007.

CrystaPath

THE MARK CONSISTS OF STANDARD CHARACTERS WITHOUT CLAIM TO ANY PARTICULAR FONT, STYLE, SIZE, OR COLOR.

FOR COVERSIP TAPE USED TO COVER TISSUE SPECIMENS ON A MICROSCOPE SLIDE, WHICH IS USED IN LIEU OF A GLASS COVERSIP AND IS APPLIED OVER A TISSUE SPECIMEN IN ORDER TO SECURE THE SPECIMEN TO THE MICROSCOPE SLIDE (U.S. CLS. 21, 23, 26, 36 AND 38).

MARK SPARACINO, EXAMINING ATTORNEY

SN 77-180,545. NETALOG, INC., CHARLESTON, SC. FILED
5-14-2007.

HIPCASE

THE MARK CONSISTS OF STANDARD CHARACTERS WITHOUT CLAIM TO ANY PARTICULAR FONT, STYLE, SIZE, OR COLOR.

FOR CASES FOR PORTABLE DIGITAL DEVICES, NAMELY, PORTABLE DIGITAL MEDIA PLAYERS, PERSONAL DIGITAL ASSISTANTS, PORTABLE PHONES, AND PORTABLE COMPUTERS (U.S. CLS. 21, 23, 26, 36 AND 38).

JAY BESCH, EXAMINING ATTORNEY

SN 77-180,632. MACKARL ENTERPRISES, INC., CITY OF
INDUSTRY, CA. FILED 5-14-2007.



THE MARK CONSISTS OF THE LETTERS "RF" WITH A SUPERSCRIP NUMERAL "3" AND AN ELLIPSE.

FOR CELLULAR TELEPHONES AND PAGERS; TELEPHONE, CELLULAR TELEPHONE AND RADIO RECEIVER HEADSETS; CELLULAR TELEPHONE MICROPHONES; CELLULAR TELEPHONE ACCESSORIES, NAMELY, BATTERIES, BATTERY CHARGERS, CIGARETTE LIGHTER ADAPTERS, BELT CLIPS, HANDS FREE KITS FOR CELLULAR PHONES COMPRISED OF CAR DASHBOARD AND WALL MOUNTS; AND REPLACEMENT PARTS AND CASES THEREFOR (U.S. CLS. 21, 23, 26, 36 AND 38).

FIRST USE 1-30-2001; IN COMMERCE 1-30-2001.

NELSON SNYDER, EXAMINING ATTORNEY

CLASS 9—(Continued).

SN 77-180,670. SIERRA COMPUTER, LTD DBA HIGHLY RELIABLE SYSTEMS, RENO, NV. FILED 5-14-2007.

RAIDFrame

THE MARK CONSISTS OF STANDARD CHARACTERS WITHOUT CLAIM TO ANY PARTICULAR FONT, STYLE, SIZE, OR COLOR.

FOR COMPUTER BACKUP AND STORAGE SYSTEMS WITH MULTIPLE REMOVABLE RAID CARTRIDGES (U.S. CLS. 21, 23, 26, 36 AND 38).

ASMAT KHAN, EXAMINING ATTORNEY

CLASS 9—(Continued).

CING SOFTWARE, NAMELY, SOFTWARE USING AN INDUCTIVE INFERENCE ENGINE FOR USE IN KNOWLEDGE PROCESSING FOR USE IN ACCOUNTING, APPAREL, AUDIO, AUTOS, BOOKS, BLOGS, CAFES, CALENDARING, CAMERAS, CARS, CELLULAR, CHARTS, CLOTHES, COFFEE, COLLEGES, COMPANIES, COMPUTERS, CONTACTS, CORPORATIONS, DATING, DENTISTS, DESKTOPS, DIAGRAMS, DOCS, DOCTORS, DRINKS, EDUCATION, ELECTRONICS, EMPLOYMENT, FILMS, FOOD, FINANCE, FURNISHINGS, FURNITURE, GARDEN, GIFTS, GRAPHS, HEALTH, HOME, IMAGES, JOBS, KITCHEN, LAPTOPS, MAGAZINES, MAIL, MEDICAL, MESSAGES, MORTGAGE, MOVIES, MUSIC, MAPS, NEWS, NOTEBOOKS, PERSONALS, PHONES, PHOTOS, PODCASTS, PRESENTS, PRESENTATIONS, PRINTERS, RESTAURANTS, SCHOOLS, SHOWS, SINGLES, SOFTWARE, SONGS, SPORTS, SPREADSHEET, SUPPLEMENTS, TALK, TRAINING, TRAVEL, TOYS, TV, VIDEOS, VIEWS, WINES, WORK, WIRELESS, UNIVERSITIES, AND WEB SITES (U.S. CLS. 21, 23, 26, 36 AND 38).

KELLY BOULTON, EXAMINING ATTORNEY

SN 77-181,586. ULTRA CONCURRENT, INC., APTOS, CA. FILED 5-15-2007.

ONTOLEFT

THE MARK CONSISTS OF STANDARD CHARACTERS WITHOUT CLAIM TO ANY PARTICULAR FONT, STYLE, SIZE, OR COLOR.

FOR COMPUTER SOFTWARE FOR SEARCHING, COMPILING, INDEXING, QUERYING, AND ORGANIZING INFORMATION ON COMPUTER NETWORKS; COMPUTER HARDWARE AND COMPUTER SOFTWARE FOR SEARCHING, COMPILING, INDEXING, QUERYING, AND ORGANIZING INFORMATION WITHIN HANDHELDS, INDIVIDUAL WORKSTATIONS AND PERSONAL COMPUTERS AND NETWORKED COMPUTERS; COMPUTER SOFTWARE FOR CREATING INDEXES AND SEARCHING, AND QUERYING IN THE FIELDS OF ACCOUNTING, APPAREL, AUDIO, AUTOS, BOOKS, BLOGS, CAFES, CALENDARING, CAMERAS, CARS, CELLULAR, CHARTS, CLOTHES, COFFEE, COLLEGES, COMPANIES, COMPUTERS, CONTACTS, CORPORATIONS, DATING, DENTISTS, DESKTOPS, DIAGRAMS, DOCS, DOCTORS, DRINKS, EDUCATION, ELECTRONICS, EMPLOYMENT, FILMS, FOOD, FINANCE, FURNISHINGS, FURNITURE, GARDEN, GIFTS, GRAPHS, HEALTH, HOME, IMAGES, JOBS, KITCHEN, LAPTOPS, MAGAZINES, MAIL, MEDICAL, MESSAGES, MORTGAGE, MOVIES, MUSIC, MAPS, NEWS, NOTEBOOKS, PERSONALS, PHONES, PHOTOS, PODCASTS, PRESENTS, PRESENTATIONS, PRINTERS, RESTAURANTS, SCHOOLS, SHOWS, SINGLES, SOFTWARE, SONGS, SPORTS, SPREADSHEET, SUPPLEMENTS, TALK, TRAINING, TRAVEL, TOYS, TV, VIDEOS, VIEWS, WINES, WORK, WIRELESS, UNIVERSITIES, AND WEB SITES; COMPUTER INFEREN-

SN 77-181,592. ULTRA CONCURRENT, INC., APTOS, CA. FILED 5-15-2007.

ONTORIGHT

THE MARK CONSISTS OF STANDARD CHARACTERS WITHOUT CLAIM TO ANY PARTICULAR FONT, STYLE, SIZE, OR COLOR.

FOR COMPUTER SOFTWARE FOR SEARCHING, COMPILING, INDEXING, QUERYING, AND ORGANIZING INFORMATION ON COMPUTER NETWORKS; COMPUTER HARDWARE AND COMPUTER SOFTWARE FOR SEARCHING, COMPILING, INDEXING, QUERYING, AND ORGANIZING INFORMATION WITHIN HANDHELDS, INDIVIDUAL WORKSTATIONS AND PERSONAL COMPUTERS AND NETWORKED COMPUTERS; COMPUTER SOFTWARE FOR CREATING INDEXES AND SEARCHING, AND QUERYING IN THE FIELDS OF ACCOUNTING, APPAREL, AUDIO, AUTOS, BOOKS, BLOGS, CAFES, CALENDARING, CAMERAS, CARS, CELLULAR, CHARTS, CLOTHES, COFFEE, COLLEGES, COMPANIES, COMPUTERS, CONTACTS, CORPORATIONS, DATING, DENTISTS, DESKTOPS, DIAGRAMS, DOCS, DOCTORS, DRINKS, EDUCATION, ELECTRONICS, EMPLOYMENT, FILMS, FOOD, FINANCE, FURNISHINGS, FURNITURE, GARDEN, GIFTS, GRAPHS, HEALTH, HOME, IMAGES, JOBS, KITCHEN, LAPTOPS, MAGAZINES, MAIL, MEDICAL, MESSAGES, MORTGAGE, MOVIES, MUSIC, MAPS, NEWS, NOTEBOOKS, PERSONALS, PHONES, PHOTOS, PODCASTS, PRESENTS, PRESENTATIONS, PRINTERS, RESTAURANTS, SCHOOLS, SHOWS, SINGLES, SOFTWARE, SONGS, SPORTS, SPREADSHEET, SUPPLEMENTS, TALK, TRAINING, TRAVEL, TOYS, TV, VIDEOS, VIEWS, WINES, WORK, WIRELESS, UNIVERSITIES, AND WEB SITES; COMPUTER INFEREN-

CLASS 9—(Continued).

CING SOFTWARE, NAMELY, SOFTWARE USING AN INDUCTIVE INFERENCE ENGINE FOR USE IN KNOWLEDGE PROCESSING FOR USE IN ACCOUNTING, APPAREL, AUDIO, AUTOS, BOOKS, BLOGS, CAFES, CALENDARING, CAMERAS, CARS, CELLULAR, CHARTS, CLOTHES, COFFEE, COLLEGES, COMPANIES, COMPUTERS, CONTACTS, CORPORATIONS, DATING, DENTISTS, DESKTOPS, DIAGRAMS, DOCS, DOCTORS, DRINKS, EDUCATION, ELECTRONICS, EMPLOYMENT, FILMS, FOOD, FINANCE, FURNISHINGS, FURNITURE, GARDEN, GIFTS, GRAPHS, HEALTH, HOME, IMAGES, JOBS, KITCHEN, LAPTOPS, MAGAZINES, MAIL, MEDICAL, MESSAGES, MORTGAGE, MOVIES, MUSIC, MAPS, NEWS, NOTEBOOKS, PERSONALS, PHONES, PHOTOS, PODCASTS, PRESENTS, PRESENTATIONS, PRINTERS, RESTAURANTS, SCHOOLS, SHOWS, SINGLES, SOFTWARE, SONGS, SPORTS, SPREADSHEET, SUPPLEMENTS, TALK, TRAINING, TRAVEL, TOYS, TV, VIDEOS, VIEWS, WINES, WORK, WIRELESS, UNIVERSITIES, AND WEB SITES (U.S. CLS. 21, 23, 26, 36 AND 38).

KELLY BOULTON, EXAMINING ATTORNEY

CLASS 9—(Continued).

CING SOFTWARE, NAMELY, SOFTWARE USING AN INDUCTIVE INFERENCE ENGINE FOR USE IN KNOWLEDGE PROCESSING FOR USE IN ACCOUNTING, APPAREL, AUDIO, AUTOS, BOOKS, BLOGS, CAFES, CALENDARING, CAMERAS, CARS, CELLULAR, CHARTS, CLOTHES, COFFEE, COLLEGES, COMPANIES, COMPUTERS, CONTACTS, CORPORATIONS, DATING, DENTISTS, DESKTOPS, DIAGRAMS, DOCS, DOCTORS, DRINKS, EDUCATION, ELECTRONICS, EMPLOYMENT, FILMS, FOOD, FINANCE, FURNISHINGS, FURNITURE, GARDEN, GIFTS, GRAPHS, HEALTH, HOME, IMAGES, JOBS, KITCHEN, LAPTOPS, MAGAZINES, MAIL, MEDICAL, MESSAGES, MORTGAGE, MOVIES, MUSIC, MAPS, NEWS, NOTEBOOKS, PERSONALS, PHONES, PHOTOS, PODCASTS, PRESENTS, PRESENTATIONS, PRINTERS, RESTAURANTS, SCHOOLS, SHOWS, SINGLES, SOFTWARE, SONGS, SPORTS, SPREADSHEET, SUPPLEMENTS, TALK, TRAINING, TRAVEL, TOYS, TV, VIDEOS, VIEWS, WINES, WORK, WIRELESS, UNIVERSITIES, AND WEB SITES (U.S. CLS. 21, 23, 26, 36 AND 38).

KELLY BOULTON, EXAMINING ATTORNEY

SN 77-181,637. ULTRACONCURRENT, INC., APTOS, CA. FILED 5-15-2007.

SN 77-181,641. ULTRACONCURRENT, INC., APTOS, CA. FILED 5-15-2007.

ONTOFINDER

ONTOHELP

THE MARK CONSISTS OF STANDARD CHARACTERS WITHOUT CLAIM TO ANY PARTICULAR FONT, STYLE, SIZE, OR COLOR.

FOR COMPUTER SOFTWARE FOR SEARCHING, COMPILING, INDEXING, QUERYING, AND ORGANIZING INFORMATION ON COMPUTER NETWORKS; COMPUTER HARDWARE AND COMPUTER SOFTWARE FOR SEARCHING, COMPILING, INDEXING, QUERYING, AND ORGANIZING INFORMATION WITHIN HANDHELDS, INDIVIDUAL WORKSTATIONS AND PERSONAL COMPUTERS AND NETWORKED COMPUTERS; COMPUTER SOFTWARE FOR CREATING INDEXES AND SEARCHING, AND QUERYING IN THE FIELDS OF ACCOUNTING, APPAREL, AUDIO, AUTOS, BOOKS, BLOGS, CAFES, CALENDARING, CAMERAS, CARS, CELLULAR, CHARTS, CLOTHES, COFFEE, COLLEGES, COMPANIES, COMPUTERS, CONTACTS, CORPORATIONS, DATING, DENTISTS, DESKTOPS, DIAGRAMS, DOCS, DOCTORS, DRINKS, EDUCATION, ELECTRONICS, EMPLOYMENT, FILMS, FOOD, FINANCE, FURNISHINGS, FURNITURE, GARDEN, GIFTS, GRAPHS, HEALTH, HOME, IMAGES, JOBS, KITCHEN, LAPTOPS, MAGAZINES, MAIL, MEDICAL, MESSAGES, MORTGAGE, APPAREL, AUDIO, AUTOS, BOOKS, BLOGS, CAFES, CALENDARING, CAMERAS, CARS, CELLULAR, CHARTS, CLOTHES, COFFEE, COLLEGES, COMPANIES, COMPUTERS, CONTACTS, CORPORATIONS, DATING, DENTISTS, DESKTOPS, DIAGRAMS, DOCS, DOCTORS, DRINKS, EDUCATION, ELECTRONICS, EMPLOYMENT, FILMS, FOOD, FINANCE, FURNISHINGS, FURNITURE, GARDEN, GIFTS, GRAPHS, HEALTH, HOME, IMAGES, JOBS, KITCHEN, LAPTOPS, MAGAZINES, MAIL, MEDICAL, MESSAGES, MORTGAGE, MOVIES, MUSIC, MAPS, NEWS, NOTEBOOKS, PERSONALS, PHONES, PHOTOS, PODCASTS, PRESENTS, PRESENTATIONS, PRINTERS, RESTAURANTS, SCHOOLS, SHOWS, SINGLES, SOFTWARE, SONGS, SPORTS, SPREADSHEET, SUPPLEMENTS, TALK, TRAINING, TRAVEL, TOYS, TV, VIDEOS, VIEWS, WINES, WORK, WIRELESS, UNIVERSITIES, AND WEB SITES; COMPUTER INFEREN-

THE MARK CONSISTS OF STANDARD CHARACTERS WITHOUT CLAIM TO ANY PARTICULAR FONT, STYLE, SIZE, OR COLOR.

FOR COMPUTER SOFTWARE FOR SEARCHING, COMPILING, INDEXING, QUERYING, AND ORGANIZING INFORMATION ON COMPUTER NETWORKS; COMPUTER HARDWARE AND COMPUTER SOFTWARE FOR SEARCHING, COMPILING, INDEXING, QUERYING, AND ORGANIZING INFORMATION WITHIN HANDHELDS, INDIVIDUAL WORKSTATIONS AND PERSONAL COMPUTERS AND NETWORKED COMPUTERS; COMPUTER SOFTWARE FOR CREATING INDEXES AND SEARCHING, AND QUERYING IN THE FIELDS OF ACCOUNTING, APPAREL, AUDIO, AUTOS, BOOKS, BLOGS, CAFES, CALENDARING, CAMERAS, CARS, CELLULAR, CHARTS, CLOTHES, COFFEE, COLLEGES, COMPANIES, COMPUTERS, CONTACTS, CORPORATIONS, DATING, DENTISTS, DESKTOPS, DIAGRAMS, DOCS, DOCTORS, DRINKS, EDUCATION, ELECTRONICS, EMPLOYMENT, FILMS, FOOD, FINANCE, FURNISHINGS, FURNITURE, GARDEN, GIFTS, GRAPHS, HEALTH, HOME, IMAGES, JOBS, KITCHEN, LAPTOPS, MAGAZINES, MAIL, MEDICAL, MESSAGES, MORTGAGE, APPAREL, AUDIO, AUTOS, BOOKS, BLOGS, CAFES, CALENDARING, CAMERAS, CARS, CELLULAR, CHARTS, CLOTHES, COFFEE, COLLEGES, COMPANIES, COMPUTERS, CONTACTS, CORPORATIONS, DATING, DENTISTS, DESKTOPS, DIAGRAMS, DOCS, DOCTORS, DRINKS, EDUCATION, ELECTRONICS, EMPLOYMENT, FILMS, FOOD, FINANCE, FURNISHINGS, FURNITURE, GARDEN, GIFTS, GRAPHS, HEALTH, HOME, IMAGES, JOBS, KITCHEN, LAPTOPS, MAGAZINES, MAIL, MEDICAL, MESSAGES, MORTGAGE, MOVIES, MUSIC, MAPS, NEWS, NOTEBOOKS, PERSONALS, PHONES, PHOTOS, PODCASTS, PRESENTS, PRESENTATIONS, PRINTERS, RESTAURANTS, SCHOOLS, SHOWS, SINGLES, SOFTWARE, SONGS, SPORTS, SPREADSHEET, SUPPLEMENTS, TALK, TRAINING, TRAVEL, TOYS, TV, VIDEOS, VIEWS, WINES, WORK, WIRELESS, UNIVERSITIES, AND WEB SITES; COMPUTER INFEREN-

CLASS 9—(Continued).

CING SOFTWARE, NAMELY, SOFTWARE USING AN INDUCTIVE INFERENCE ENGINE FOR USE IN KNOWLEDGE PROCESSING FOR USE IN ACCOUNTING, APPAREL, AUDIO, AUTOS, BOOKS, BLOGS, CAFES, CALENDARING, CAMERAS, CARS, CELLULAR, CHARTS, CLOTHES, COFFEE, COLLEGES, COMPANIES, COMPUTERS, CONTACTS, CORPORATIONS, DATING, DENTISTS, DESKTOPS, DIAGRAMS, DOCS, DOCTORS, DRINKS, EDUCATION, ELECTRONICS, EMPLOYMENT, FILMS, FOOD, FINANCE, FURNISHINGS, FURNITURE, GARDEN, GIFTS, GRAPHS, HEALTH, HOME, IMAGES, JOBS, KITCHEN, LAPTOPS, MAGAZINES, MAIL, MEDICAL, MESSAGES, MORTGAGE, MOVIES, MUSIC, MAPS, NEWS, NOTEBOOKS, PERSONALS, PHONES, PHOTOS, PODCASTS, PRESENTS, PRESENTATIONS, PRINTERS, RESTAURANTS, SCHOOLS, SHOWS, SINGLES, SOFTWARE, SONGS, SPORTS, SPREADSHEET, SUPPLEMENTS, TALK, TRAINING, TRAVEL, TOYS, TV, VIDEOS, VIEWS, WINES, WORK, WIRELESS, UNIVERSITIES, AND WEB SITES (U.S. CLS. 21, 23, 26, 36 AND 38).

KELLY BOULTON, EXAMINING ATTORNEY

CLASS 9—(Continued).

CING SOFTWARE, NAMELY, SOFTWARE USING AN INDUCTIVE INFERENCE ENGINE FOR USE IN KNOWLEDGE PROCESSING FOR USE IN ACCOUNTING, APPAREL, AUDIO, AUTOS, BOOKS, BLOGS, CAFES, CALENDARING, CAMERAS, CARS, CELLULAR, CHARTS, CLOTHES, COFFEE, COLLEGES, COMPANIES, COMPUTERS, CONTACTS, CORPORATIONS, DATING, DENTISTS, DESKTOPS, DIAGRAMS, DOCS, DOCTORS, DRINKS, EDUCATION, ELECTRONICS, EMPLOYMENT, FILMS, FOOD, FINANCE, FURNISHINGS, FURNITURE, GARDEN, GIFTS, GRAPHS, HEALTH, HOME, IMAGES, JOBS, KITCHEN, LAPTOPS, MAGAZINES, MAIL, MEDICAL, MESSAGES, MORTGAGE, MOVIES, MUSIC, MAPS, NEWS, NOTEBOOKS, PERSONALS, PHONES, PHOTOS, PODCASTS, PRESENTS, PRESENTATIONS, PRINTERS, RESTAURANTS, SCHOOLS, SHOWS, SINGLES, SOFTWARE, SONGS, SPORTS, SPREADSHEET, SUPPLEMENTS, TALK, TRAINING, TRAVEL, TOYS, TV, VIDEOS, VIEWS, WINES, WORK, WIRELESS, UNIVERSITIES, AND WEB SITES (U.S. CLS. 21, 23, 26, 36 AND 38).

KELLY BOULTON, EXAMINING ATTORNEY

SN 77-181,647. ULTRACONCURRENT, INC., APTOS, CA. FILED 5-15-2007.

ONTOSUPPORT

THE MARK CONSISTS OF STANDARD CHARACTERS WITHOUT CLAIM TO ANY PARTICULAR FONT, STYLE, SIZE, OR COLOR.

FOR COMPUTER SOFTWARE FOR SEARCHING, COMPILING, INDEXING, QUERYING, AND ORGANIZING INFORMATION ON COMPUTER NETWORKS; COMPUTER HARDWARE AND COMPUTER SOFTWARE FOR SEARCHING, COMPILING, INDEXING, QUERYING, AND ORGANIZING INFORMATION WITHIN HANDHELD, INDIVIDUAL WORKSTATIONS AND PERSONAL COMPUTERS AND NETWORKED COMPUTERS; COMPUTER SOFTWARE FOR CREATING INDEXES AND SEARCHING, AND QUERYING IN THE FIELDS OF ACCOUNTING, APPAREL, AUDIO, AUTOS, BOOKS, BLOGS, CAFES, CALENDARING, CAMERAS, CARS, CELLULAR, CHARTS, CLOTHES, COFFEE, COLLEGES, COMPANIES, COMPUTERS, CONTACTS, CORPORATIONS, DATING, DENTISTS, DESKTOPS, DIAGRAMS, DOCS, DOCTORS, DRINKS, EDUCATION, ELECTRONICS, EMPLOYMENT, FILMS, FOOD, FINANCE, FURNISHINGS, FURNITURE, GARDEN, GIFTS, GRAPHS, HEALTH, HOME, IMAGES, JOBS, KITCHEN, LAPTOPS, MAGAZINES, MAIL, MEDICAL, MESSAGES, MORTGAGE, MOVIES, MUSIC, MAPS, NEWS, NOTEBOOKS, PERSONALS, PHONES, PHOTOS, PODCASTS, PRESENTS, PRESENTATIONS, PRINTERS, RESTAURANTS, SCHOOLS, SHOWS, SINGLES, SOFTWARE, SONGS, SPORTS, SPREADSHEET, SUPPLEMENTS, TALK, TRAINING, TRAVEL, TOYS, TV, VIDEOS, VIEWS, WINES, WORK, WIRELESS, UNIVERSITIES, AND WEB SITES; COMPUTER INFERENCE

SN 77-181,852. 4D TECHNOLOGY CORPORATION, TUCSON, AZ. FILED 5-15-2007.

Dynamic Interferometry

THE MARK CONSISTS OF STANDARD CHARACTERS WITHOUT CLAIM TO ANY PARTICULAR FONT, STYLE, SIZE, OR COLOR.

NO CLAIM IS MADE TO THE EXCLUSIVE RIGHT TO USE "INTERFEROMETRY", APART FROM THE MARK AS SHOWN.

FOR INTERFEROMETERS (U.S. CLS. 21, 23, 26, 36 AND 38).

KATHERINE M. DUBRAY, EXAMINING ATTORNEY

SN 77-183,073. VERTICAL CIRCUITS, INC., SCOTTS VALLEY, CA. FILED 5-16-2007.

Vertical Digital Dispense

NO CLAIM IS MADE TO THE EXCLUSIVE RIGHT TO USE "VERTICAL", APART FROM THE MARK AS SHOWN. THE COLOR(S) RED IS/ARE CLAIMED AS A FEATURE OF THE MARK.

THE MARK CONSISTS OF THE PHRASE "VERTICAL DIGITAL DISPENSE" IN RED ITALIC ARIAL BOLD TYPE FONT.

FOR SEMICONDUCTOR DEVICES (U.S. CLS. 21, 23, 26, 36 AND 38).

JAMES LOVELACE, EXAMINING ATTORNEY

CLASS 9—(Continued).

SN 77-185,106. DILITHIUM NETWORKS, INC., PETALUMA, CA. FILED 5-18-2007.

VT-RING

THE MARK CONSISTS OF STANDARD CHARACTERS WITHOUT CLAIM TO ANY PARTICULAR FONT, STYLE, SIZE, OR COLOR.

FOR COMPUTER SOFTWARE FOR PROVIDING VIDEO AND AUDIO CONTENT IN THE FORM OF RINGBACKS OR RING TONES; TELECOMMUNICATIONS SOFTWARE, NAMELY, SOFTWARE FOR CALL ESTABLISHMENT AND MEDIA DELIVERY (U.S. CLS. 21, 23, 26, 36 AND 38).

RICHARD A. STRASER, EXAMINING ATTORNEY

SN 77-187,106. INFIMATIC, LLC, HEBRON, KY. FILED 5-22-2007.

FREEDOM ELOG

THE MARK CONSISTS OF STANDARD CHARACTERS WITHOUT CLAIM TO ANY PARTICULAR FONT, STYLE, SIZE, OR COLOR.

FOR COMPUTER SOFTWARE FOR MONITORING THE OPERATION OF MACHINE TOOLS AND OTHER EQUIPMENT USED IN A MANUFACTURING ENVIRONMENT (U.S. CLS. 21, 23, 26, 36 AND 38).

FIRST USE 11-1-2001; IN COMMERCE 11-1-2001.

AISHA CLARKE, EXAMINING ATTORNEY

SN 77-187,152. ULTRA CONCURRENT, INC., APTOS, CA. FILED 5-22-2007.

ONTOFORWARD

THE MARK CONSISTS OF STANDARD CHARACTERS WITHOUT CLAIM TO ANY PARTICULAR FONT, STYLE, SIZE, OR COLOR.

FOR COMPUTER SOFTWARE FOR SEARCHING, COMPILING, INDEXING, QUERYING, AND ORGANIZING INFORMATION ON COMPUTER NETWORKS; COMPUTER HARDWARE AND COMPUTER SOFTWARE FOR SEARCHING, COMPILING, INDEXING, QUERYING, AND ORGANIZING INFORMATION WITHIN HANDHELDS, INDIVIDUAL WORKSTATIONS AND PERSONAL COMPUTERS AND NETWORKED COMPUTERS; COMPUTER SOFTWARE FOR CREATING INDEXES AND SEARCHING, AND QUERYING IN THE FIELDS OF ACCOUNTING, APPAREL, AUDIO, AUTOS, BOOKS, BLOGS, CAFES, CALENDARING, CAMERAS, CARS, CELLULAR, CHARTS, CLOTHES, COFFEE, COLLEGES, COMPANIES, COMPUTERS, CONTACTS, CORPORATIONS, DATING, DENTISTS, DESKTOPS, DIAGRAMS, DOCS, DOCTORS, DRINKS, EDUCATION, ELECTRONICS, EMPLOYMENT, FILMS,

CLASS 9—(Continued).

FOOD, FINANCE, FURNISHINGS, FURNITURE, GARDEN, GIFTS, GRAPHS, HEALTH, HOME, IMAGES, JOBS, KITCHEN, LAPTOPS, MAGAZINES, MAIL, MEDICAL, MESSAGES, MORTGAGE, MOVIES, MUSIC, MAPS, NEWS, NOTEBOOKS, PERSONALS, PHONES, PHOTOS, PODCASTS, PRESENTS, PRESENTATIONS, PRINTERS, RESTAURANTS, SCHOOLS, SHOWS, SINGLES, SOFTWARE, SONGS, SPORTS, SPREADSHEET, SUPPLEMENTS, TALK, TRAINING, TRAVEL, TOYS, TV, VIDEOS, VIEWS, WINES, WORK, WIRELESS, UNIVERSITIES, AND WEB SITES; COMPUTER INFERENCE ENGINE SOFTWARE, NAMELY, SOFTWARE USING AN INDUCTIVE INFERENCE ENGINE FOR USE IN KNOWLEDGE PROCESSING FOR USE IN ACCOUNTING, APPAREL, AUDIO, AUTOS, BOOKS, BLOGS, CAFES, CALENDARING, CAMERAS, CARS, CELLULAR, CHARTS, CLOTHES, COFFEE, COLLEGES, COMPANIES, COMPUTERS, CONTACTS, CORPORATIONS, DATING, DENTISTS, DESKTOPS, DIAGRAMS, DOCS, DOCTORS, DRINKS, EDUCATION, ELECTRONICS, EMPLOYMENT, FILMS, FOOD, FINANCE, FURNISHINGS, FURNITURE, GARDEN, GIFTS, GRAPHS, HEALTH, HOME, IMAGES, JOBS, KITCHEN, LAPTOPS, MAGAZINES, MAIL, MEDICAL, MESSAGES, MORTGAGE, MOVIES, MUSIC, MAPS, NEWS, NOTEBOOKS, PERSONALS, PHONES, PHOTOS, PODCASTS, PRESENTS, PRESENTATIONS, PRINTERS, RESTAURANTS, SCHOOLS, SHOWS, SINGLES, SOFTWARE, SONGS, SPORTS, SPREADSHEET, SUPPLEMENTS, TALK, TRAINING, TRAVEL, TOYS, TV, VIDEOS, VIEWS, WINES, WORK, WIRELESS, UNIVERSITIES, AND WEB SITES (U.S. CLS. 21, 23, 26, 36 AND 38).

KELLY BOULTON, EXAMINING ATTORNEY

SN 77-187,156. ULTRA CONCURRENT, INC., APTOS, CA. FILED 5-22-2007.

ONTOBACK

THE MARK CONSISTS OF STANDARD CHARACTERS WITHOUT CLAIM TO ANY PARTICULAR FONT, STYLE, SIZE, OR COLOR.

FOR COMPUTER SOFTWARE FOR SEARCHING, COMPILING, INDEXING, QUERYING, AND ORGANIZING INFORMATION ON COMPUTER NETWORKS; COMPUTER HARDWARE AND COMPUTER SOFTWARE FOR SEARCHING, COMPILING, INDEXING, QUERYING, AND ORGANIZING INFORMATION WITHIN HANDHELDS, INDIVIDUAL WORKSTATIONS AND PERSONAL COMPUTERS AND NETWORKED COMPUTERS; COMPUTER SOFTWARE FOR CREATING INDEXES AND SEARCHING, AND QUERYING IN THE FIELDS OF ACCOUNTING, APPAREL, AUDIO, AUTOS, BOOKS, BLOGS, CAFES, CALENDARING, CAMERAS, CARS, CELLULAR, CHARTS, CLOTHES, COFFEE, COLLEGES, COMPANIES, COMPUTERS, CONTACTS, CORPORATIONS, DATING, DENTISTS, DESKTOPS, DIAGRAMS, DOCS, DOCTORS, DRINKS, EDUCATION, ELECTRONICS, EMPLOYMENT, FILMS, FOOD, FINANCE, FURNISHINGS, FURNITURE, GARDEN, GIFTS, GRAPHS, HEALTH, HOME, IMAGES, JOBS, KITCHEN, LAPTOPS, MAGAZINES, MAIL, MEDICAL, MESSAGES, MORTGAGE, MOVIES, MUSIC, MAPS, NEWS, NOTEBOOKS, PERSONALS, PHONES, PHOTOS, PODCASTS, PRESENTS, PRESENTATIONS, PRINTERS, RESTAURANTS, SCHOOLS, SHOWS, SINGLES, SOFTWARE, SONGS, SPORTS, SPREADSHEET, SUPPLEMENTS, TALK, TRAINING, TRAVEL, TOYS, TV, VIDEOS, VIEWS, WINES, WORK, WIRELESS, UNIVERSITIES, AND WEB SITES; COMPUTER INFERENCE

CLASS 9—(Continued).

CING SOFTWARE, NAMELY, SOFTWARE USING AN INDUCTIVE INFERENCE ENGINE FOR USE IN KNOWLEDGE PROCESSING FOR USE IN ACCOUNTING, APPAREL, AUDIO, AUTOS, BOOKS, BLOGS, CAFES, CALENDARING, CAMERAS, CARS, CELLULAR, CHARTS, CLOTHES, COFFEE, COLLEGES, COMPANIES, COMPUTERS, CONTACTS, CORPORATIONS, DATING, DENTISTS, DESKTOPS, DIAGRAMS, DOCS, DOCTORS, DRINKS, EDUCATION, ELECTRONICS, EMPLOYMENT, FILMS, FOOD, FINANCE, FURNISHINGS, FURNITURE, GARDEN, GIFTS, GRAPHS, HEALTH, HOME, IMAGES, JOBS, KITCHEN, LAPTOPS, MAGAZINES, MAIL, MEDICAL, MESSAGES, MORTGAGE, MOVIES, MUSIC, MAPS, NEWS, NOTEBOOKS, PERSONALS, PHONES, PHOTOS, PODCASTS, PRESENTS, PRESENTATIONS, PRINTERS, RESTAURANTS, SCHOOLS, SHOWS, SINGLES, SOFTWARE, SONGS, SPORTS, SPREADSHEET, SUPPLEMENTS, TALK, TRAINING, TRAVEL, TOYS, TV, VIDEOS, VIEWS, WINES, WORK, WIRELESS, UNIVERSITIES, AND WEB SITES (U.S. CLS. 21, 23, 26, 36 AND 38).

KELLY BOULTON, EXAMINING ATTORNEY

CLASS 9—(Continued).

CING SOFTWARE, NAMELY, SOFTWARE USING AN INDUCTIVE INFERENCE ENGINE FOR USE IN KNOWLEDGE PROCESSING FOR USE IN ACCOUNTING, APPAREL, AUDIO, AUTOS, BOOKS, BLOGS, CAFES, CALENDARING, CAMERAS, CARS, CELLULAR, CHARTS, CLOTHES, COFFEE, COLLEGES, COMPANIES, COMPUTERS, CONTACTS, CORPORATIONS, DATING, DENTISTS, DESKTOPS, DIAGRAMS, DOCS, DOCTORS, DRINKS, EDUCATION, ELECTRONICS, EMPLOYMENT, FILMS, FOOD, FINANCE, FURNISHINGS, FURNITURE, GARDEN, GIFTS, GRAPHS, HEALTH, HOME, IMAGES, JOBS, KITCHEN, LAPTOPS, MAGAZINES, MAIL, MEDICAL, MESSAGES, MORTGAGE, MOVIES, MUSIC, MAPS, NEWS, NOTEBOOKS, PERSONALS, PHONES, PHOTOS, PODCASTS, PRESENTS, PRESENTATIONS, PRINTERS, RESTAURANTS, SCHOOLS, SHOWS, SINGLES, SOFTWARE, SONGS, SPORTS, SPREADSHEET, SUPPLEMENTS, TALK, TRAINING, TRAVEL, TOYS, TV, VIDEOS, VIEWS, WINES, WORK, WIRELESS, UNIVERSITIES, AND WEB SITES (U.S. CLS. 21, 23, 26, 36 AND 38).

KELLY BOULTON, EXAMINING ATTORNEY

SN 77-187,215. COMMVault SYSTEMS, INC., OCEANPORT, NJ. FILED 5-22-2007.

SN 77-187,159. ULTRACONCURRENT, INC., APTOS, CA. FILED 5-22-2007.

RECOVERY DIRECTOR**ONTOCATEGORY**

THE MARK CONSISTS OF STANDARD CHARACTERS WITHOUT CLAIM TO ANY PARTICULAR FONT, STYLE, SIZE, OR COLOR.

FOR COMPUTER SOFTWARE FOR SEARCHING, COMPILING, INDEXING, QUERYING, AND ORGANIZING INFORMATION ON COMPUTER NETWORKS; COMPUTER HARDWARE AND COMPUTER SOFTWARE FOR SEARCHING, COMPILING, INDEXING, QUERYING, AND ORGANIZING INFORMATION WITHIN HANDHELDS, INDIVIDUAL WORKSTATIONS AND PERSONAL COMPUTERS AND NETWORKED COMPUTERS; COMPUTER SOFTWARE FOR CREATING INDEXES AND SEARCHING, AND QUERYING IN THE FIELDS OF ACCOUNTING, APPAREL, AUDIO, AUTOS, BOOKS, BLOGS, CAFES, CALENDARING, CAMERAS, CARS, CELLULAR, CHARTS, CLOTHES, COFFEE, COLLEGES, COMPANIES, COMPUTERS, CONTACTS, CORPORATIONS, DATING, DENTISTS, DESKTOPS, DIAGRAMS, DOCS, DOCTORS, DRINKS, EDUCATION, ELECTRONICS, EMPLOYMENT, FILMS, FOOD, FINANCE, FURNISHINGS, FURNITURE, GARDEN, GIFTS, GRAPHS, HEALTH, HOME, IMAGES, JOBS, KITCHEN, LAPTOPS, MAGAZINES, MAIL, MEDICAL, MESSAGES, MORTGAGE, MOVIES, MUSIC, MAPS, NEWS, NOTEBOOKS, PERSONALS, PHONES, PHOTOS, PODCASTS, PRESENTS, PRESENTATIONS, PRINTERS, RESTAURANTS, SCHOOLS, SHOWS, SINGLES, SOFTWARE, SONGS, SPORTS, SPREADSHEET, SUPPLEMENTS, TALK, TRAINING, TRAVEL, TOYS, TV, VIDEOS, VIEWS, WINES, WORK, WIRELESS, UNIVERSITIES, AND WEB SITES; COMPUTER INFEREN-

THE MARK CONSISTS OF STANDARD CHARACTERS WITHOUT CLAIM TO ANY PARTICULAR FONT, STYLE, SIZE, OR COLOR.

NO CLAIM IS MADE TO THE EXCLUSIVE RIGHT TO USE "RECOVERY", APART FROM THE MARK AS SHOWN.

FOR COMPUTER SOFTWARE FOR USE IN SYSTEMS MANAGEMENT; COMPUTER SOFTWARE FOR USE IN DATA STORAGE MANAGEMENT AND STORAGE AREA NETWORKS; COMPUTER SOFTWARE AND HARDWARE FOR USE IN DATA COMMUNICATIONS; COMPUTER SOFTWARE FOR BACKING UP AND RESTORING COMPUTER DATA; COMPUTER SOFTWARE FOR USE IN DISASTER RECOVERY; COMPUTER SOFTWARE FOR USE IN REMOVABLE STORAGE MEDIA MANAGEMENT; COMPUTER SOFTWARE FOR USE IN THE FIELD OF ENTERPRISE INFORMATION MANAGEMENT; COMPUTER SOFTWARE FOR GENERATING REPORTS FROM DATABASES; COMPUTER SOFTWARE FOR USE IN THE CENTRAL MANAGEMENT OF COMPUTERS ATTACHED TO A COMPUTER NETWORK; COMPUTER SOFTWARE FOR REPLICATING AND ARCHIVING FILES FROM ONE DATA STORE TO ANOTHER; COMPUTER SOFTWARE FOR USE IN DEVELOPING DATA ANALYSIS APPLICATIONS AND OTHER COMPUTER SOFTWARE; COMPUTER SOFTWARE FOR MONITORING, ANALYZING, REPORTING AND SOLVING PERFORMANCE AND DATA AVAILABILITY ISSUES OF APPLICATION SOFTWARE, DATABASES, NETWORK, STORAGE, AND OTHER COMPUTER COMPONENTS AND PROGRAMS; INSTRUCTION MANUALS SUPPLIED AS A UNIT WITH THE FOREGOING; PUBLICATIONS IN ELECTRONIC FORM, ON MAGNETIC AND OPTICAL COMPUTER-READABLE MEDIA OR DOWNLOADABLE VIA COMPUTER AND COMMUNICATION NETWORKS, INCLUDING THE INTERNET, NAMELY, WORK BOOKS, QUICK REFERENCE GUIDES, TECHNICAL REFERENCE MANUALS, USER MANUALS, AND EVALUATION GUIDES IN THE FIELD OF COMPUTERS, COMPUTER SOFTWARE, COMPUTER PERIPHERALS, AND COMPUTER NETWORKS (U.S. CLS. 21, 23, 26, 36 AND 38).

JILL C. ALT, EXAMINING ATTORNEY

CLASS 9—(Continued).

SN 77-187,524. WALTON ADVANCED ENGINEERING, INC., KAOHSIUNG, TAIWAN, FILED 5-22-2007.

Bits 'n Bytes

THE MARK CONSISTS OF STANDARD CHARACTERS WITHOUT CLAIM TO ANY PARTICULAR FONT, STYLE, SIZE, OR COLOR.

NO CLAIM IS MADE TO THE EXCLUSIVE RIGHT TO USE "BYTES", APART FROM THE MARK AS SHOWN.

FOR INTEGRATED CIRCUITS, SEMICONDUCTOR CHIP, COMPUTER CHIPS, COMPUTER MEMORY CARDS, FLASH MEMORY CARDS, MEMORY EXPANSION MODULES AND COMPUTER MEMORY EXPANSION MODULES (U.S. CLS. 21, 23, 26, 36 AND 38).

RICHARD A. STRASER, EXAMINING ATTORNEY

CLASS 9—(Continued).

SN 77-193,703. INSTITUTE FOR SYSTEMS BIOLOGY, SEATTLE, WA. FILED 5-30-2007.

ISB

THE MARK CONSISTS OF STANDARD CHARACTERS WITHOUT CLAIM TO ANY PARTICULAR FONT, STYLE, SIZE, OR COLOR.

FOR COMPUTER SOFTWARE FOR DATA GENERATION AND DATA ANALYSIS FOR USE IN SCIENTIFIC RESEARCH (U.S. CLS. 21, 23, 26, 36 AND 38).

PAULA MAYS, EXAMINING ATTORNEY

SN 77-188,463. DISKEEPER CORPORATION, BURBANK, CA. FILED 5-23-2007.



OWNER OF U.S. REG. NO. 1,531,764.
NO CLAIM IS MADE TO THE EXCLUSIVE RIGHT TO USE "CORPORATION", APART FROM THE MARK AS SHOWN.

THE MARK CONSISTS OF THE WORDS "DISKEEPER CORPORATION" TO THE RIGHT OF A STYLIZED IMAGE OF A DISK.

FOR COMPUTER PROGRAMS FOR USE IN COMPUTER SYSTEMS MANAGEMENT (U.S. CLS. 21, 23, 26, 36 AND 38).

FIRST USE 8-30-2005; IN COMMERCE 8-30-2005.
LINDA M. KING, EXAMINING ATTORNEY

SN 77-195,841. ADVANCED ENERGY INDUSTRIES, INC., FORT COLLINS, CO. FILED 6-1-2007.

Solaron

THE MARK CONSISTS OF STANDARD CHARACTERS WITHOUT CLAIM TO ANY PARTICULAR FONT, STYLE, SIZE, OR COLOR.

FOR POWER CONTROLLERS; POWER SUPPLIES; INVERTERS (U.S. CLS. 21, 23, 26, 36 AND 38).

FIRST USE 5-25-2007; IN COMMERCE 5-25-2007.

HOWARD B. LEVINE, EXAMINING ATTORNEY

SN 77-190,946. ACTIVIDENTITY CORPORATION, FREMONT, CA. FILED 5-25-2007.

IDAssure

THE MARK CONSISTS OF STANDARD CHARACTERS WITHOUT CLAIM TO ANY PARTICULAR FONT, STYLE, SIZE, OR COLOR.

FOR COMPUTER HARDWARE AND SOFTWARE FOR USER AUTHENTICATION IN THE FIELD OF CONTROLLING NETWORK FUNCTIONS AND ACCESS FOR NETWORK SECURITY AND SERVER SECURITY (U.S. CLS. 21, 23, 26, 36 AND 38).

DAWN HAN, EXAMINING ATTORNEY

SN 77-196,891. BLUE MARBLE GROUP, INC., GARDINER, ME. FILED 6-4-2007.

GEOCORE

THE MARK CONSISTS OF STANDARD CHARACTERS WITHOUT CLAIM TO ANY PARTICULAR FONT, STYLE, SIZE, OR COLOR.

FOR COMPUTER SOFTWARE, NAMELY, A COMBINATION SOFTWARE LIBRARY FOR A VARIETY OF STANDARD GIS APPLICATIONS FOR GIS DATA TRANSLATION AND MANIPULATION WHICH ALLOWS THE USER TO DESCRIBE AND MANIPULATE GEODETIC DATA (U.S. CLS. 21, 23, 26, 36 AND 38).

FIRST USE 3-26-2007; IN COMMERCE 3-26-2007.

PAUL E. FAHRENKOPF, EXAMINING ATTORNEY

CLASS 9—(Continued).

SN 77-199,650. CSSN, INC, DBA CARD SCANNING SOLUTIONS, LOS ANGELES, CA. FILED 6-6-2007.

ClubScan

THE MARK CONSISTS OF STANDARD CHARACTERS WITHOUT CLAIM TO ANY PARTICULAR FONT, STYLE, SIZE, OR COLOR.

FOR COMPUTER DATABASE SOFTWARE FOR THE PURPOSE OF COLLECTING DATA FROM SCANS OF IDENTIFICATION DOCUMENTS SUCH AS DRIVING LICENSES, FROM VISITORS TO NIGHTCLUBS AND THEN CATEGORIZING THE INFORMATION AS A VISITOR LOG FOR MARKETING ACTIVITIES (U.S. CLS. 21, 23, 26, 36 AND 38).

FIRST USE 10-7-2003; IN COMMERCE 10-7-2003.
JESSICA A. POWERS, EXAMINING ATTORNEY

CLASS 9—(Continued).

SN 77-204,962. FULL ARMOR CORPORATION, BOSTON, MA. FILED 6-13-2007.

FULL ARMOR WORKFLOW STUDIO

THE MARK CONSISTS OF STANDARD CHARACTERS WITHOUT CLAIM TO ANY PARTICULAR FONT, STYLE, SIZE, OR COLOR.

OWNER OF U.S. REG. NOS. 2,558,892 AND 2,879,064.

NO CLAIM IS MADE TO THE EXCLUSIVE RIGHT TO USE "WORKFLOW STUDIO", APART FROM THE MARK AS SHOWN.

FOR COMPUTER SOFTWARE, NAMELY, A SOFTWARE TOOL FOR CREATING, MANAGING AND IMPLEMENTING COMPUTER PROCESS AUTOMATION PROCEDURES (U.S. CLS. 21, 23, 26, 36 AND 38).

WARREN L. OLANDRIA, EXAMINING ATTORNEY

SN 77-206,419. BUSINESS TO BUSINESS MARKETING, SAN DIEGO, CA. FILED 6-14-2007.

Maintenance Connect Pro

THE MARK CONSISTS OF STANDARD CHARACTERS WITHOUT CLAIM TO ANY PARTICULAR FONT, STYLE, SIZE, OR COLOR.

NO CLAIM IS MADE TO THE EXCLUSIVE RIGHT TO USE "MAINTENANCE", APART FROM THE MARK AS SHOWN.

FOR COMPUTER SOFTWARE FOR FACILITIES MAINTENANCE MANAGEMENT (U.S. CLS. 21, 23, 26, 36 AND 38).

FIRST USE 1-1-2007; IN COMMERCE 4-1-2007.

SUSAN LESLIE DUBOIS, EXAMINING ATTORNEY

SN 77-200,779. CLEAROUNDS COMMUNICATIONS, INC., BURR RIDGE, IL. FILED 6-7-2007.

Hear how good life can be

THE MARK CONSISTS OF STANDARD CHARACTERS WITHOUT CLAIM TO ANY PARTICULAR FONT, STYLE, SIZE, OR COLOR.

FOR TELEPHONES; CORDED AND CORDLESS TELEPHONE SETS; TELEPHONE APPARATUS AND EQUIPMENT, NAMELY, TRANSMITTERS, RECEIVERS, AMPLIFIERS, CALLER IDENTIFICATION BOXES, PHONE ANSWERING APPARATUS AND SPEAKER-PHONES; TELEPHONE ASSISTIVE EQUIPMENT FOR THOSE WITH LIMITED OR IMPAIRED HEARING, NAMELY, TELEPHONES WITH RING SIGNALING FEATURES THAT NOTIFY USERS THAT THE TELEPHONE IS RINGING USING VISUAL SIGNALS, VIBRATION, OR SHAKING; SOUND ENHANCERS, OR AMPLIFIERS NOT FOR MEDICAL PURPOSES; BATTERIES FOR TELEPHONES AND TELEPHONE EQUIPMENT (U.S. CLS. 21, 23, 26, 36 AND 38).

FIRST USE 6-15-2006; IN COMMERCE 6-15-2006.

KATHERINE M. DUBRAY, EXAMINING ATTORNEY

SN 77-206,575. BUSINESS TO BUSINESS MARKETING, SAN DIEGO, CA. FILED 6-14-2007.

Print Shop Connect

THE MARK CONSISTS OF STANDARD CHARACTERS WITHOUT CLAIM TO ANY PARTICULAR FONT, STYLE, SIZE, OR COLOR.

OWNER OF U.S. REG. NO. 2,869,393.

NO CLAIM IS MADE TO THE EXCLUSIVE RIGHT TO USE "PRINT SHOP", APART FROM THE MARK AS SHOWN.

FOR COMPUTER SOFTWARE FOR COMMERCIAL PRINT SHOP ORDER MANAGEMENT (U.S. CLS. 21, 23, 26, 36 AND 38).

FIRST USE 9-2-2006; IN COMMERCE 10-1-2006.

SUSAN LESLIE DUBOIS, EXAMINING ATTORNEY

CLASS 9—(Continued).

SN 77-207,460. NEW YORK BLOOD CENTER, INC., NEW YORK, NY. FILED 6-15-2007.



NO CLAIM IS MADE TO THE EXCLUSIVE RIGHT TO USE "BLOOD OPERATIONS SUPPORT SOFTWARE", APART FROM THE MARK AS SHOWN.

FOR CD-ROMS AND DOWNLOADABLE COMPUTER SOFTWARE FOR USE IN THE MANAGEMENT OF BLOOD BANK DATABASES THAT MANAGE INFORMATION CONCERNING, COLLECTION, PROCESSING, STORAGE AND DISTRIBUTION OF BLOOD (U.S. CLS. 21, 23, 26, 36 AND 38).

FIRST USE 8-1-2005; IN COMMERCE 8-1-2005.
RUSS HERMAN, EXAMINING ATTORNEY

CLASS 9—(Continued).

SN 77-209,113. KODY & COMPANY, LLC, DANVILLE, CA. FILED 6-18-2007.



NO CLAIM IS MADE TO THE EXCLUSIVE RIGHT TO USE "LEARNING", APART FROM THE MARK AS SHOWN.

THE COLOR(S) PURPLE, ORANGE, BLUE, GREEN, RED AND YELLOW IS/ARE CLAIMED AS A FEATURE OF THE MARK.

THE MARK CONSISTS OF "MY LEARNING" IS IN KID FRIENDLY FONT AND BOLD BRIGHT COLORS WITH ALL LETTERS CAPITALIZED. THE "M" IS IN PURPLE, THE "Y" IN ORANGE, THE "L" IN BLUE, THE "E" IN GREEN, "A" IS IN PURPLE, THE "R" IN RED, THE "N" IN GREEN, THE "I" IN YELLOW, THE "N" IN BLUE, THE "G" IN RED. "STEPS" IS IN ALL CAPITAL BLOCKED LETTERS WITH BOLD COLORS. THE "S" IS BLUE, THE "T" IS RED, THE "E" IS ORANGE, THE "P" IS GREEN, THE "S" IS RED. THE "E" IN "STEPS" IS DESIGNED LIKE SET OF 3 STEPS.

FOR CHILDREN'S EDUCATIONAL MUSIC CDS AND DVDS (U.S. CLS. 21, 23, 26, 36 AND 38).
DOMINIC J. FERRAIUOLO, EXAMINING ATTORNEY

SN 77-207,709. FRA SYSTEMS, LLC, TULSA, OK. FILED 6-15-2007.

CREDIT POINT SOFTWARE

THE MARK CONSISTS OF STANDARD CHARACTERS WITHOUT CLAIM TO ANY PARTICULAR FONT, STYLE, SIZE, OR COLOR.

NO CLAIM IS MADE TO THE EXCLUSIVE RIGHT TO USE "CREDIT" AND "SOFTWARE", APART FROM THE MARK AS SHOWN.

FOR BROWSER-BASED COMPUTER SOFTWARE FOR CREDIT AND COLLECTIONS PROFESSIONALS TO ASSIST IN MAKING BUSINESS TO BUSINESS CREDIT DECISIONS UTILIZING DATABASE MANAGEMENT (U.S. CLS. 21, 23, 26, 36 AND 38).

SHANNON TWOHIG, EXAMINING ATTORNEY

SN 77-214,005. TREKSTOR GMBH & CO. KG, LORSCH, FED REP GERMANY, FILED 6-24-2007.

MovieStation

THE MARK CONSISTS OF STANDARD CHARACTERS WITHOUT CLAIM TO ANY PARTICULAR FONT, STYLE, SIZE, OR COLOR.

PRIORITY CLAIMED UNDER SEC. 44(D) ON ERP CMNTY TM OFC APPLICATION NO. 005743257, FILED 3-8-2007, REG. NO. 005743257, DATED 12-4-2007, EXPIRES 3-8-2017.

FOR EXTERNAL COMPUTER HARD DRIVE DIRECTLY CONNECTABLE TO A TELEVISION SET FOR THE REPRODUCTION OF CINEMATOGRAPHIC, PHOTOGRAPHIC OR MUSIC FILES, WITH OR WITHOUT CONNECTION TO A COMPUTER (U.S. CLS. 21, 23, 26, 36 AND 38).

NORA BUCHANAN WILL, EXAMINING ATTORNEY

CLASS 9—(Continued).

SN 77-215,023. DLJJ & ASSOCIATES, LLC, BEVERLY HILLS, CA. FILED 6-25-2007.



FOR VIDEO GAME CARTRIDGES, DISCS, PROGRAMS AND SOFTWARE, COMPUTER GAME CARTRIDGES, DISCS, PROGRAMS AND SOFTWARE, MOTION PICTURE FILMS IN THE FIELD OF COUNTER-TERRORISM AND HOMELAND SAFETY AND SECURITY, MOTION PICTURE FILMS, CINEMATOGRAPHIC FILMS, PRERECORDED CDS, CD-ROMS, DVDS, AUDIO AND VIDEO TAPES AND CASSETTES ALL FEATURING DOCUMENTARIES IN THE FIELD OF COUNTER-TERRORISM AND HOMELAND SAFETY AND SECURITY; MUSICAL SOUND RECORDINGS; AUDIO AND VIDEO RECORDINGS IN THE FIELD OF COUNTER-TERRORISM AND HOMELAND SAFETY AND SECURITY, PRERECORDED CDS, CD-ROMS, AUDIO AND VIDEO TAPES AND CASSETTES IN THE FIELD OF COUNTER-TERRORISM AND HOMELAND SAFETY AND SECURITY, COMPUTER SOFTWARE FOR USE IN DATABASE MANAGEMENT AND PROVIDING ASSESSMENTS AND THREAT ANALYSIS IN THE FIELD OF COUNTER TERRORISM AND HOMELAND SAFETY AND SECURITY; ELECTRONIC PUBLICATIONS RECORDED ON COMPUTER MEDIA AND DOWNLOADABLE ELECTRONIC PUBLICATIONS IN THE NATURE OF NEWSLETTERS, MAGAZINES, BOOKS, JOURNALS AND BROCHURES, ALL IN THE FIELD OF COUNTER TERRORISM AND HOMELAND SAFETY AND SECURITY; DOWNLOADABLE MP3 FILES, DOWNLOADABLE MP3 RECORDINGS, ONLINE DISCUSSION BOARDS, WEB CASTS, POD CASTS FEATURING MUSIC, AUDIO BOOKS AND NEWS BROADCASTS; DOWNLOADABLE RING TONES, GRAPHICS AND MUSIC VIA A GLOBAL COMPUTER NETWORK AND WIRELESS DEVICES (U.S. CLS. 21, 23, 26, 36 AND 38).

MICHAEL WEBSTER, EXAMINING ATTORNEY

SN 77-217,128. ROYAL BANK OF CANADA, MONTREAL, CANADA, FILED 6-27-2007.

RBC QUANTS

THE MARK CONSISTS OF STANDARD CHARACTERS WITHOUT CLAIM TO ANY PARTICULAR FONT, STYLE, SIZE, OR COLOR.

OWNER OF U.S. REG. NOS. 2,463,205, 2,797,520 AND OTHERS.

NO CLAIM IS MADE TO THE EXCLUSIVE RIGHT TO USE "QUANTS", APART FROM THE MARK AS SHOWN.

FOR SOFTWARE INCORPORATING ALGORITHMIC STRATEGY FOR USE IN CONNECTION WITH ELECTRONIC TRADING (U.S. CLS. 21, 23, 26, 36 AND 38).

ERIN FALK, EXAMINING ATTORNEY

CLASS 9—(Continued).

SN 77-217,154. BUSINESS TO BUSINESS MARKETING, SAN DIEGO, CA. FILED 6-27-2007.

Print Shop Pro Webdesk

THE MARK CONSISTS OF STANDARD CHARACTERS WITHOUT CLAIM TO ANY PARTICULAR FONT, STYLE, SIZE, OR COLOR.

OWNER OF U.S. REG. NO. 2,869,393.

NO CLAIM IS MADE TO THE EXCLUSIVE RIGHT TO USE "PRINT SHOP", APART FROM THE MARK AS SHOWN.

FOR COMPUTER SOFTWARE FOR RECEIVING ONLINE PRINTING ORDERS (U.S. CLS. 21, 23, 26, 36 AND 38).

FIRST USE 4-1-2002; IN COMMERCE 6-1-2002.

SUSAN LESLIE DUBOIS, EXAMINING ATTORNEY

SN 77-219,013. PREMIER MANUFACTURING GROUP, INC., SHELTON, CT. FILED 6-29-2007.

TOPDOCK

THE MARK CONSISTS OF STANDARD CHARACTERS WITHOUT CLAIM TO ANY PARTICULAR FONT, STYLE, SIZE, OR COLOR.

FOR POWER, DATA AND TELEPHONE SERVICE DISTRIBUTION MODULE, NAMELY, MULTIPLE ELECTRICAL POWER, DATA, AUDIO AND VIDEO FILE STORAGE DEVICES AND TELEPHONE SERVICE OUTLETS CONFIGURED AS A SINGLE UNIT AND MOUNTABLE TO A TABLE, WORK BENCH OR OTHER WORK SURFACE (U.S. CLS. 21, 23, 26, 36 AND 38).

MARY I. SPARROW, EXAMINING ATTORNEY

SN 77-220,450. AGX TECHNOLOGIES, INC., MONROVIA, CA. FILED 7-2-2007.

AGx Technologies

THE MARK CONSISTS OF STANDARD CHARACTERS WITHOUT CLAIM TO ANY PARTICULAR FONT, STYLE, SIZE, OR COLOR.

NO CLAIM IS MADE TO THE EXCLUSIVE RIGHT TO USE "TECHNOLOGIES", APART FROM THE MARK AS SHOWN.

FOR LASERS NOT FOR MEDICAL USE (U.S. CLS. 21, 23, 26, 36 AND 38).

FIRST USE 2-20-2006; IN COMMERCE 2-20-2006.

TEJBIR SINGH, EXAMINING ATTORNEY

CLASS 9—(Continued).

SN 77-220,458. AGX TECHNOLOGIES, INC., MONROVIA, CA. FILED 7-2-2007.

CLASS 9—(Continued).

SN 77-225,368. NAV-TV CORP., BOCA RATON, FL. FILED 7-9-2007.



BLUEGIG

NO CLAIM IS MADE TO THE EXCLUSIVE RIGHT TO USE "TECHNOLOGIES", APART FROM THE MARK AS SHOWN.

THE MARK CONSISTS OF THE LETTERS "AGX" IN A LARGE CIRCLE WITH THE LETTER "X" IN A SMALL CIRCLE WITHIN THE LARGE CIRCLE AND THE WORD "TECHNOLOGIES" TO THE RIGHT OF THE LARGE CIRCLE.

FOR LASERS NOT FOR MEDICAL USE (U.S. CLS. 21, 23, 26, 36 AND 38).

FIRST USE 2-20-2006; IN COMMERCE 2-20-2006.
TEJBIR SINGH, EXAMINING ATTORNEY

THE MARK CONSISTS OF STANDARD CHARACTERS WITHOUT CLAIM TO ANY PARTICULAR FONT, STYLE, SIZE, OR COLOR.

THE WORDING "BLUEGIG" HAS NO MEANING IN FOREIGN LANGUAGE.

FOR ELECTRONIC INTERFACES IN THE NATURE OF HANDS FREE MOBILE TELEPHONE WIRELESS DEVICE FOR LAND VEHICLES, AV INPUT-OUTPUT IN THE NATURE OF AN ELECTRONIC MODULE FOR LAND VEHICLES, ELECTRONIC AUDIO AND VIDEO MODULES FOR LAND VEHICLES, AND PERSONAL ENTERTAINMENT ELECTRONICS, NAMELY, PORTABLE MEDIA PLAYER DEVICE (U.S. CLS. 21, 23, 26, 36 AND 38).

FIRST USE 4-25-2007; IN COMMERCE 4-25-2007.
BRIAN CALLAGHAN, EXAMINING ATTORNEY

SN 77-224,698. NAV-TV CORP., BOCA RATON, FL. FILED 7-9-2007.

SN 77-228,780. CAPCOM CO., LTD., OSAKA, JAPAN, FILED 7-13-2007.

FREEGIG

GHOST'N GOBLINS

THE MARK CONSISTS OF STANDARD CHARACTERS WITHOUT CLAIM TO ANY PARTICULAR FONT, STYLE, SIZE, OR COLOR.

THE WORDING "FREEGIG" HAS NO MEANING IN A FOREIGN LANGUAGE.

FOR ELECTRONIC INTERFACES IN THE NATURE OF HANDS FREE MOBILE TELEPHONE WIRELESS DEVICE FOR LAND VEHICLES, AV INPUT-OUTPUT IN THE NATURE OF AN ELECTRONIC MODULE FOR LAND VEHICLES, ELECTRONIC AUDIO AND VIDEO MODULES FOR LAND VEHICLES, AND PERSONAL ENTERTAINMENT ELECTRONICS, NAMELY, PORTABLE MEDIA PLAYER DEVICE (U.S. CLS. 21, 23, 26, 36 AND 38).

FIRST USE 4-25-2007; IN COMMERCE 4-25-2007.
BRIAN CALLAGHAN, EXAMINING ATTORNEY

THE MARK CONSISTS OF STANDARD CHARACTERS WITHOUT CLAIM TO ANY PARTICULAR FONT, STYLE, SIZE, OR COLOR.

FOR DOWNLOADABLE GAME SOFTWARE; DOWNLOADABLE COMPUTER GAMES; DOWNLOADABLE GAME SOFTWARE FOR PLAYING ON MOBILE PHONES; SCREEN SAVER SOFTWARE AND WALLPAPER SOFTWARE; DOWNLOADABLE SCREEN SAVER SOFTWARE AND WALLPAPER SOFTWARE FOR MOBILE PHONES; DOWNLOADABLE FILES CONTAINING IMAGES, MOVING IMAGES AND MUSIC FOR MOBILE PHONES (U.S. CLS. 21, 23, 26, 36 AND 38).

LINDA MICKLEBURGH, EXAMINING ATTORNEY

CLASS 9—(Continued).

SN 77-228,983. EIDOS INTERACTIVE LIMITED, WIMBLEDON, LONDON, UNITED KINGDOM, FILED 7-13-2007.

SPY Q

THE MARK CONSISTS OF STANDARD CHARACTERS WITHOUT CLAIM TO ANY PARTICULAR FONT, STYLE, SIZE, OR COLOR.

PRIORITY CLAIMED UNDER SEC. 44(D) ON UNITED KINGDOM APPLICATION NO. 2451111, FILED 3-29-2007, REG. NO. 2451111, DATED 9-28-2007, EXPIRES 3-29-2017.

FOR COMPUTER GAME SOFTWARE; VIDEO GAME SOFTWARE; COMPUTER GAMES AND VIDEO GAMES DOWNLOADABLE FROM A REMOTE COMPUTER LOCATION OR RECORDED ON CD-ROMS, COMPACT DISCS, AND GAME CARTRIDGES; DOWNLOADABLE ELECTRONIC PUBLICATIONS IN THE NATURE OF NEWSLETTERS AND MAGAZINES FEATURING ACTION AND ADVENTURE GAMES (U.S. CLS. 21, 23, 26, 36 AND 38).

BARNEY CHARLON, EXAMINING ATTORNEY

SN 77-229,133. BURGER KING BRANDS, INC., MIAMI, FL. FILED 7-13-2007.

THE KING OF ALL GIFTS

THE MARK CONSISTS OF STANDARD CHARACTERS WITHOUT CLAIM TO ANY PARTICULAR FONT, STYLE, SIZE, OR COLOR.

FOR MAGNETICALLY ENCODED ELECTRONIC DEBIT AND STORED-VALUE CARDS (U.S. CLS. 21, 23, 26, 36 AND 38).

FIRST USE 5-1-2007; IN COMMERCE 5-1-2007.
ERIN FALK, EXAMINING ATTORNEY

SN 77-231,107. QFORMA, INC., SANTA FE, NM. FILED 7-17-2007.

KNOWLEDGEFLOWS

THE MARK CONSISTS OF STANDARD CHARACTERS WITHOUT CLAIM TO ANY PARTICULAR FONT, STYLE, SIZE, OR COLOR.

FOR TRAINING SOFTWARE FOR THE HEALTH CARE INDUSTRY THAT SIMULATES THE BUSINESS ENVIRONMENT AND DAY-TO-DAY OPERATIONS OF A CLIENT COMPANY'S CUSTOMER IN ORDER TO INCREASE THE CLIENT COMPANY'S KNOWLEDGE OF CUSTOMER NEEDS (U.S. CLS. 21, 23, 26, 36 AND 38).

ANDREA K. NADELMAN, EXAMINING ATTORNEY

CLASS 9—(Continued).

SN 77-231,490. STM GROUP, INC., IRVINE, CA. FILED 7-17-2007.



THE MARK CONSISTS OF THE STYLIZED LETTERS "S", "T", AND "M".

FOR ANTENNAE, VOICE DATA AND VIDEO TRANSMITTERS, VOICE, DATA AND VIDEO RECEIVERS, COMPUTER MODEMS, DIGITAL SIGNAL PROCESSORS, PACKET ASSEMBLERS AND DISASSEMBLERS, VERY SMALL APERTURE TERMINALS AND TELEPHONE HANDSETS SOLD INDIVIDUALLY AND TOGETHER IN A WIRELESS COMMUNICATIONS NETWORK THAT ENABLES VOICE, DATA AND VIDEO TRANSMISSION; AND COMPUTER SOFTWARE TO MANAGE A WIRELESS COMMUNICATIONS NETWORK COMPRISING ANTENNAE, TRANSMITTERS, RECEIVERS, MODEMS, PROCESSORS, ASSEMBLERS, DISASSEMBLERS, VERY SMALL APERTURE TERMINALS AND HANDSETS (U.S. CLS. 21, 23, 26, 36 AND 38).

FIRST USE 1-0-1985; IN COMMERCE 1-0-1985.
MICHAEL KEATING, EXAMINING ATTORNEY

SN 77-231,606. CAPCOM CO., LTD., OSAKA, JAPAN, FILED 7-17-2007.

GHOULS'N GHOSTS

THE MARK CONSISTS OF STANDARD CHARACTERS WITHOUT CLAIM TO ANY PARTICULAR FONT, STYLE, SIZE, OR COLOR.

FOR DOWNLOADABLE GAME SOFTWARE; DOWNLOADABLE COMPUTER GAMES; DOWNLOADABLE GAME SOFTWARE FOR PLAYING ON MOBILE PHONES; SCREEN SAVER SOFTWARE AND WALLPAPER SOFTWARE; DOWNLOADABLE SCREEN SAVER SOFTWARE AND WALLPAPER SOFTWARE FOR MOBILE PHONES; DOWNLOADABLE FILES CONTAINING IMAGES, MOVING IMAGES AND MUSIC FOR MOBILE PHONES (U.S. CLS. 21, 23, 26, 36 AND 38).

LINDA MICKLEBURGH, EXAMINING ATTORNEY

CLASS 9—(Continued).

SN 77-231,647. CAPCOM CO., LTD., OSAKA, JAPAN, FILED 7-17-2007.

GHOULS'N GHOSTS

THE MARK CONSISTS OF STANDARD CHARACTERS WITHOUT CLAIM TO ANY PARTICULAR FONT, STYLE, SIZE, OR COLOR.

FOR COMPUTER GAME SOFTWARE; COMPUTER GAME IN THE FORM OF CARTRIDGES, CASSETTES, DISCS OR TAPES; VIDEO GAME CARTRIDGES; VIDEO GAME MACHINES FOR USE WITH TELEVISION RECEIVERS (U.S. CLS. 21, 23, 26, 36 AND 38).

FIRST USE 0-0-1988; IN COMMERCE 0-0-1988.
LINDA MICKLEBURGH, EXAMINING ATTORNEY

CLASS 9—(Continued).

SN 77-232,799. NT-WARE SYSTEMPROGRAMMIERUNGS GMBH, BAD IBURG, FED REP GERMANY, FILED 7-18-2007.

UNIFLOW OM MIND

THE MARK CONSISTS OF STANDARD CHARACTERS WITHOUT CLAIM TO ANY PARTICULAR FONT, STYLE, SIZE, OR COLOR.

FOR OPTICAL, MEASURING, SIGNALING AND CHECKING APPARATUS AND INSTRUMENTS, NAMELY, ELECTRONIC DEVICES IN THE NATURE OF RADIO FREQUENCY IDENTIFICATION (RFID) TAGS, CHIPCARD READERS, MAGNETIC CODED CARD READERS, SMART CARD READERS, ELECTRONIC CARD AND BADGE READERS AND ELECTRONIC DIGITAL FINGERPRINT READERS FOR USE IN IDENTIFYING AND RECOGNIZING USERS OF PRINTING OR COPYING DEVICES; DATA PROCESSING EQUIPMENT, NAMELY, COMPUTER HARDWARE IN A BOX THAT CAN BE CONNECTED, DIRECTLY OR VIA A NETWORK, TO A PRINTING OR COPYING DEVICE OR A USER IDENTIFICATION DEVICE, FOR IMPORT AND PROCESSING OF USER-SPECIFIC PRINT DATA, COPY DATA AND CHARGES; COMPUTER SOFTWARE FOR PRINTER AND COPIER MANAGEMENT, NAMELY, FOR COMPILING AND ACCOUNTING PRINT AND COPY CHARGES AND FOR AUTOMATING AND OPTIMIZING PRINT WORKFLOW (U.S. CLS. 21, 23, 26, 36 AND 38).

JAY BESCH, EXAMINING ATTORNEY

SN 77-232,569. NOTION MUSIC, INC., GREENSBORO, NC. FILED 7-18-2007.

NTEMPO

THE MARK CONSISTS OF STANDARD CHARACTERS WITHOUT CLAIM TO ANY PARTICULAR FONT, STYLE, SIZE, OR COLOR.

FOR A FEATURE OF INTERACTIVE EDUCATIONAL SOFTWARE FOR TEACHING AND LEARNING MUSICAL COMPOSITION, FEATURING MUSIC NOTATION AND MUSICAL COMPOSITION GENERATION TECHNOLOGY (U.S. CLS. 21, 23, 26, 36 AND 38).

FIRST USE 4-30-2005; IN COMMERCE 4-30-2005.
SCOTT BIBB, EXAMINING ATTORNEY

SN 77-232,920. CAPCOM CO., LTD., OSAKA, JAPAN, FILED 7-18-2007.

GHOST'N GOBLINS

THE MARK CONSISTS OF STANDARD CHARACTERS WITHOUT CLAIM TO ANY PARTICULAR FONT, STYLE, SIZE, OR COLOR.

FOR COMPUTER GAME SOFTWARE; COMPUTER GAME IN THE FORM OF CARTRIDGES, CASSETTES, DISCS OR TAPES; VIDEO GAME CARTRIDGES; VIDEO GAME MACHINES FOR USE WITH TELEVISION RECEIVERS (U.S. CLS. 21, 23, 26, 36 AND 38).

FIRST USE 9-19-1985; IN COMMERCE 9-19-1985.
LINDA MICKLEBURGH, EXAMINING ATTORNEY

CLASS 9—(Continued).

SN 77-233,017. NISTICA, INC., BRIDGEWATER, NJ. FILED 7-18-2007.

FLEDGE

THE MARK CONSISTS OF STANDARD CHARACTERS WITHOUT CLAIM TO ANY PARTICULAR FONT, STYLE, SIZE, OR COLOR.

FOR REMOTELY OPERABLE ADD/DROP MULTIPLEXERS (ROADM) FOR TELECOMMUNICATIONS NETWORKS (U.S. CLS. 21, 23, 26, 36 AND 38).

FIRST USE 5-0-2006; IN COMMERCE 5-0-2006.
TARAH HARDY, EXAMINING ATTORNEY

SN 77-233,293. RADIOSPIRE NETWORKS, INC., CONCORD, MA. FILED 7-19-2007.

WOLOBI

THE MARK CONSISTS OF STANDARD CHARACTERS WITHOUT CLAIM TO ANY PARTICULAR FONT, STYLE, SIZE, OR COLOR.

THE WORD "WOLOBI" HAS NO MEANING IN A FOREIGN LANGUAGE.

FOR CONSUMER ELECTRONICS FOR USE IN THE DELIVERY OF AUDIO AND VIDEO CONTENT IN HOME ENTERTAINMENT SYSTEMS, NAMELY, WIRELESS SPEAKERS, AUDIO/VIDEO CABLE REPLACEMENT HUBS, WIRELESS HOME THEATER HUBS, WIRELESS GAMING HUBS, AND REPLACEMENT PARTS THEREFOR (U.S. CLS. 21, 23, 26, 36 AND 38).

ELIZABETH HUGHITT, EXAMINING ATTORNEY

SN 77-233,633. CHARMANT INC., FUKUI-KEN, JAPAN, FILED 7-19-2007.

CONCEPT FLEX

THE MARK CONSISTS OF STANDARD CHARACTERS WITHOUT CLAIM TO ANY PARTICULAR FONT, STYLE, SIZE, OR COLOR.

NO CLAIM IS MADE TO THE EXCLUSIVE RIGHT TO USE "FLEX", APART FROM THE MARK AS SHOWN.

FOR EYEGLASSES, EYEGLASS FRAMES AND EYEGLASS CASES (U.S. CLS. 21, 23, 26, 36 AND 38).

DAYNA BROWNE, EXAMINING ATTORNEY

CLASS 9—(Continued).

SN 77-235,291. NISTICA, INC., BRIDGEWATER, NJ. FILED 7-20-2007.



THE MARK CONSISTS OF THE COMPANY NAME NISTICA WITH A CIRCULAR LOGO OVER THE "A" AND A BRISTLECONE PINE TREE.

THE WORDING "NISTICA" HAS NO MEANING IN ANY FOREIGN LANGUAGE.

FOR EQUIPMENT FOR TEST AND MEASUREMENT AND TELECOMMUNICATIONS NETWORKS SPECIALIZING IN REMOTELY OPERABLE ADD/DROP MULTIPLEXER (ROADM) TECHNOLOGY, NAMELY, TELECOMMUNICATIONS AND DATA NETWORKING HARDWARE, NAMELY, DEVICES FOR TRANSPORTING AND AGGREGATING VOICE, DATA, AND VIDEO COMMUNICATIONS ACROSS MULTIPLE NETWORK INFRASTRUCTURES AND COMMUNICATIONS PROTOCOLS (U.S. CLS. 21, 23, 26, 36 AND 38).

FIRST USE 1-0-2005; IN COMMERCE 1-0-2005.
TARAH HARDY, EXAMINING ATTORNEY

SN 77-235,811. JAY TRENDS MERCHANDISING INC., NEW YORK, NY. FILED 7-23-2007.

Morph-FX

THE MARK CONSISTS OF STANDARD CHARACTERS WITHOUT CLAIM TO ANY PARTICULAR FONT, STYLE, SIZE, OR COLOR.

THE WORDING "FX" HAS NO MEANING IN A FOREIGN LANGUAGE.

FOR HOME ELECTRONICS, NAMELY, MP3 AUDIO SPEAKERS, MP3 PLAYERS, PORTABLE AUDIO SPEAKERS, FM RADIO TRANSMITTERS AND MINI AUDIO SPEAKERS (U.S. CLS. 21, 23, 26, 36 AND 38).

ELIZABETH KAJUBI, EXAMINING ATTORNEY

CLASS 9—(Continued).

SN 77-238,250. ALWAYS RECORDS INC., BROOKLYN, NY. FILED 7-25-2007.

ALWAYSRECORDS.COM

THE MARK CONSISTS OF STANDARD CHARACTERS WITHOUT CLAIM TO ANY PARTICULAR FONT, STYLE, SIZE, OR COLOR.

FOR MUSICAL SOUND RECORDINGS; MUSICAL VIDEO RECORDINGS; PRE-RECORDED DISCS, CDS, DVDS FEATURING MUSIC AND ENTERTAINMENT; DOWNLOADABLE RINGTONES, MUSIC, GRAPHICS, IMAGES, MUSICAL MP3 SOUND RECORDINGS AND MUSICAL VIDEOS DOWNLOADED FROM A REMOTE COMPUTER NETWORK (U.S. CLS. 21, 23, 26, 36 AND 38).

WON TEAK OH, EXAMINING ATTORNEY

CLASS 9—(Continued).

SN 77-238,959. ZILOG, INC., SAN JOSE, CA. FILED 7-25-2007.

Avni

THE MARK CONSISTS OF STANDARD CHARACTERS WITHOUT CLAIM TO ANY PARTICULAR FONT, STYLE, SIZE, OR COLOR.

THE WORDING "AVNI" HAS NO MEANING IN A FOREIGN LANGUAGE.

FOR INTEGRATED CIRCUITS; MICROCONTROLLERS; COMPUTER SOFTWARE, FIRMWARE AND HARDWARE FOR ENHANCING THE PERFORMANCE OF INTEGRATED CIRCUITS; COMPUTER SOFTWARE, FIRMWARE AND HARDWARE FOR ENHANCING THE PERFORMANCE OF MICROCONTROLLERS; SUPPORT AND DEVELOPMENT TOOLS FOR INTEGRATED CIRCUITS, NAMELY, EVALUATION CIRCUIT BOARDS, CIRCUIT BOARD INTERFACES, ASSEMBLER SOFTWARE, COMPILER SOFTWARE, SOFTWARE FOR DEBUGGING COMPUTER PROGRAMS, COMPUTER SOFTWARE FOR LINKING INTEGRATED CIRCUITS TO PORTS ON CIRCUIT BOARDS, AND SOFTWARE SIMULATORS OF CIRCUIT DESIGNS; AND SUPPORT AND DEVELOPMENT TOOLS FOR MICROCONTROLLERS, NAMELY, EVALUATION CIRCUIT BOARDS, CIRCUIT BOARD INTERFACES, ASSEMBLER SOFTWARE, COMPILER SOFTWARE, SOFTWARE FOR DEBUGGING COMPUTER PROGRAMS, COMPUTER SOFTWARE FOR LINKING MICROCONTROLLERS TO PORTS ON CIRCUIT BOARDS, AND SOFTWARE SIMULATORS OF CIRCUIT DESIGNS (U.S. CLS. 21, 23, 26, 36 AND 38).

RENEE SERVANCE, EXAMINING ATTORNEY

SN 77-238,964. ZILOG, INC., SAN JOSE, CA. FILED 7-26-2007.

Zatara

THE MARK CONSISTS OF STANDARD CHARACTERS WITHOUT CLAIM TO ANY PARTICULAR FONT, STYLE, SIZE, OR COLOR.

THE WORDING "ZATARA" HAS NO MEANING IN A FOREIGN LANGUAGE.

FOR INTEGRATED CIRCUITS; MICROCONTROLLERS; COMPUTER SOFTWARE, FIRMWARE AND HARDWARE FOR ENHANCING THE PERFORMANCE OF INTEGRATED CIRCUITS; COMPUTER SOFTWARE, FIRMWARE AND HARDWARE FOR ENHANCING THE PERFORMANCE OF MICROCONTROLLERS; SUPPORT AND DEVELOPMENT TOOLS FOR INTEGRATED CIRCUITS, NAMELY, EVALUATION CIRCUIT BOARDS, CIRCUIT BOARD INTERFACES, ASSEMBLER SOFTWARE, COMPILER SOFTWARE, SOFTWARE FOR DEBUGGING COMPUTER PROGRAMS, COMPUTER SOFTWARE FOR LINKING INTEGRATED CIRCUITS TO PORTS ON CIRCUIT BOARDS, AND SOFTWARE SIMULATORS OF CIRCUIT DESIGNS; AND SUPPORT AND DEVELOPMENT TOOLS FOR MICROCONTROLLERS, NAMELY, EVALUATION CIRCUIT BOARDS, CIRCUIT BOARD INTERFACES, ASSEMBLER SOFTWARE, COMPILER SOFTWARE, SOFTWARE FOR DEBUGGING COMPUTER PROGRAMS, COMPUTER SOFTWARE FOR LINKING MICROCONTROLLERS TO PORTS ON CIRCUIT BOARDS, AND SOFTWARE SIMULATORS OF CIRCUIT DESIGNS (U.S. CLS. 21, 23, 26, 36 AND 38).

RENEE SERVANCE, EXAMINING ATTORNEY

SN 77-238,825. THUMP RECORDS, INC., BREA, CA. FILED 7-25-2007.

THUMP

THE MARK CONSISTS OF STANDARD CHARACTERS WITHOUT CLAIM TO ANY PARTICULAR FONT, STYLE, SIZE, OR COLOR.

OWNER OF U.S. REG. NOS. 1,768,516, 2,206,183 AND OTHERS.

FOR MP3 PLAYERS AND DIGITAL AUDIO PLAYERS SOLD AS AN INTEGRAL COMPONENT OF SUNGLASSES AND EYEWEAR (U.S. CLS. 21, 23, 26, 36 AND 38).

FIRST USE 11-14-2004; IN COMMERCE 11-14-2004. AMY HELLA, EXAMINING ATTORNEY

CLASS 9—(Continued).

SN 77-242,009. LIGHTHOUSE SOLAR, INC., BOULDER, CO. FILED 7-30-2007.

LUMOS

THE MARK CONSISTS OF STANDARD CHARACTERS WITHOUT CLAIM TO ANY PARTICULAR FONT, STYLE, SIZE, OR COLOR.

FOR APPARATUS FOR CONVERTING ELECTRONIC RADIATION TO ELECTRICAL ENERGY, NAMELY, PHOTOVOLTAIC SOLAR MODULES, PHOTOVOLTAIC SOLAR HYBRID MODULES, SOLAR CELLS, AND ELECTRONIC SENSORS FOR MEASURING SOLAR RADIATION (U.S. CLS. 21, 23, 26, 36 AND 38).

ALICE SUE CARRUTHERS, EXAMINING ATTORNEY

CLASS 9—(Continued).

SN 77-244,250. KNOWLES, BEYONCE', BEVERLY HILLS, CA. FILED 8-1-2007.

B'PHONE

SN 77-243,429. ZILOG, INC., SAN JOSE, CA. FILED 7-31-2007.

Acclaim16

THE MARK CONSISTS OF STANDARD CHARACTERS WITHOUT CLAIM TO ANY PARTICULAR FONT, STYLE, SIZE, OR COLOR.

OWNER OF U.S. REG. NO. 2,944,911.

FOR INTEGRATED CIRCUITS; MICROCONTROLLERS; COMPUTER SOFTWARE, FIRMWARE AND HARDWARE FOR ENHANCING THE PERFORMANCE OF INTEGRATED CIRCUITS; COMPUTER SOFTWARE, FIRMWARE AND HARDWARE FOR ENHANCING THE PERFORMANCE OF MICROCONTROLLERS; SUPPORT AND DEVELOPMENT TOOLS FOR INTEGRATED CIRCUITS, NAMELY, EVALUATION CIRCUIT BOARDS, CIRCUIT BOARD INTERFACES, ASSEMBLER SOFTWARE, COMPILER SOFTWARE, SOFTWARE FOR DEBUGGING COMPUTER PROGRAMS, COMPUTER SOFTWARE FOR LINKING INTEGRATED CIRCUITS TO PORTS ON CIRCUIT BOARDS, AND SOFTWARE SIMULATORS OF CIRCUIT DESIGNS; AND SUPPORT AND DEVELOPMENT TOOLS FOR MICROCONTROLLERS, NAMELY, EVALUATION CIRCUIT BOARDS, CIRCUIT BOARD INTERFACES, ASSEMBLER SOFTWARE, COMPILER SOFTWARE, SOFTWARE FOR DEBUGGING COMPUTER PROGRAMS, COMPUTER SOFTWARE FOR LINKING MICROCONTROLLERS TO PORTS ON CIRCUIT BOARDS, AND SOFTWARE SIMULATORS OF CIRCUIT DESIGNS (U.S. CLS. 21, 23, 26, 36 AND 38).

RENEE SERVANCE, EXAMINING ATTORNEY

THE MARK CONSISTS OF STANDARD CHARACTERS WITHOUT CLAIM TO ANY PARTICULAR FONT, STYLE, SIZE, OR COLOR.

FOR HANDHELD AND MOBILE DIGITAL ELECTRONIC DEVICES FOR THE SENDING AND RECEIVING OF TELEPHONE CALLS, FAXES, ELECTRONIC MAIL AND OTHER DIGITAL DATA, NAMELY, HANDHELD COMPUTERS, PERSONAL DIGITAL ASSISTANTS, ELECTRONIC PERSONAL ORGANIZERS, ELECTRONIC NOTEPADS; BLANK MAGNETIC DATA CARRIERS; TELEPHONES, MOBILE PHONES, COMPUTER GAMING MACHINES, VIDEOPHONES, CAMERAS; PRE-RECORDED COMPUTER PROGRAMS FOR PERSONAL INFORMATION MANAGEMENT, DATABASE MANAGEMENT SOFTWARE, ELECTRONIC MAIL AND MESSAGING SOFTWARE, PAGING SOFTWARE, DATABASE SYNCHRONIZATION SOFTWARE, COMPUTER PROGRAMS FOR ACCESSING, BROWSING AND SEARCHING ONLINE DATABASES, COMPUTER SOFTWARE AND FIRMWARE, NAMELY, OPERATING SYSTEM PROGRAMS, DATA SYNCHRONIZATION PROGRAMS, AND APPLICATION DEVELOPMENT TOOL PROGRAMS FOR PERSONAL AND HANDHELD COMPUTERS; ELECTRONIC HANDHELD UNITS FOR THE WIRELESS RECEIPT AND/OR TRANSMISSION OF DATA THAT ENABLE THE USER TO KEEP TRACK OF OR MANAGE PERSONAL INFORMATION; SOFTWARE FOR THE REDIRECTION OF MESSAGES, INTERNET E-MAIL AND/OR OTHER DATA TO ONE OR MORE ELECTRONIC HANDHELD DEVICES FROM A DATA STORE ON OR ASSOCIATED WITH A PERSONAL COMPUTER OR A SERVER; AND SOFTWARE FOR THE SYNCHRONIZATION OF DATA BETWEEN A REMOTE STATION OR DEVICE AND A FIXED OR REMOTE STATION OR DEVICE; COMPUTER HARDWARE AND SOFTWARE FOR PROVIDING INTEGRATED TELEPHONE COMMUNICATION WITH COMPUTERIZED GLOBAL INFORMATION NETWORKS; MP3 AND OTHER DIGITAL FORMAT AUDIO PLAYERS (U.S. CLS. 21, 23, 26, 36 AND 38).

REBECCA SMITH, EXAMINING ATTORNEY

CLASS 9—(Continued).

SN 77-244,823. DURR, SCOTT, WOODSTOCK, GA. FILED 8-1-2007.

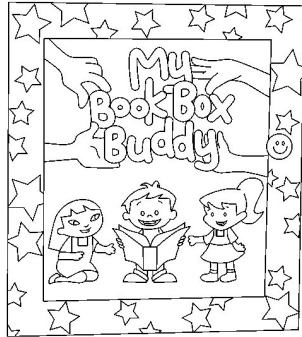

THE MARK CONSISTS OF THE WORDS "MY BOOK BOX BUDDY" IN BUBBLE-TYPE LETTERS WITH HANDS, CHILDREN, SMILEY FACE DOOR KNOB AND BORDERED WITH STARS.

FOR AUDIO PLAYER, NAMELY, AN INTERACTIVE, TALKING BOX THAT PLAYS PRE-RECORDED SKITS AND IS USED TO CONCEAL THE IDENTITY OF A BOOK JUST PRIOR TO STORY TIME (U.S. CLS. 21, 23, 26, 36 AND 38).

TERESA M. RUPP, EXAMINING ATTORNEY

SN 77-248,301. NETGEAR, INC., SANTA CLARA, CA. FILED 8-6-2007.

READYNAS

THE MARK CONSISTS OF STANDARD CHARACTERS WITHOUT CLAIM TO ANY PARTICULAR FONT, STYLE, SIZE, OR COLOR.

FOR COMPUTER HARDWARE; COMPUTER BACK-UP AND STORAGE HARDWARE; AND COMPUTER BACK-UP AND STORAGE SOFTWARE (U.S. CLS. 21, 23, 26, 36 AND 38).

FIRST USE 4-0-2005; IN COMMERCE 4-0-2005.
LA TONIA FISHER, EXAMINING ATTORNEY

CLASS 9—(Continued).

SN 77-251,881. NINJAI GANG, LLC, KAILUA, HI. FILED 8-9-2007.



OWNER OF U.S. REG. NO. 3,329,847.
THE MARK CONSISTS OF THE LETTERS "KK" BACK TO BACK.

FOR VIDEO GAME CARTRIDGES; PRERECORDED AUDIOVISUAL RECORDINGS ABOUT ACTION ADVENTURE; PRERECORDED AUDIO RECORDINGS FEATURING MUSIC AND STORIES; MOUSE PADS; COMPUTER SOFTWARE FOR USE AS A SCREEN SAVER; SUNGLASSES; SUNGLASS CASES; COMPUTER GAME SOFTWARE; COMPUTER GAME EQUIPMENT, NAMELY, JOYSTICKS; COMPUTER MICE; DECORATIVE MAGNETS; GRADUATED RULERS; INTERACTIVE CHILDREN'S EDUCATIONAL SOFTWARE, CATCHER'S HELMETS; FOOTBALL HELMETS; PROTECTIVE HELMETS; AND SAFETY HELMETS (U.S. CLS. 21, 23, 26, 36 AND 38).

TASNEEM HUSSAIN, EXAMINING ATTORNEY

SN 77-253,290. CELLGUIDE LTD., REHOVOT, ISRAEL, FILED 8-13-2007.

ACLYS

THE MARK CONSISTS OF STANDARD CHARACTERS WITHOUT CLAIM TO ANY PARTICULAR FONT, STYLE, SIZE, OR COLOR.

FOR INTEGRATED CIRCUITS, COMPUTER CHIPS, NAMELY, ANALOG, DIGITAL, AND MIXED SIGNAL INTEGRATED CIRCUITS, DIGITAL SIGNAL PROCESSORS, MICROCONTROLLERS, MICROCOMPUTERS, AND MICROPROCESSORS AND SOFTWARE EMBEDDED THEREIN; TELECOMMUNICATION EQUIPMENT, NAMELY, TELEPHONES, CELLULAR TELEPHONES, MOBILE TELEPHONES; COMPUTER SOFTWARE FOR USE IN GLOBAL POSITIONING AND WIRELESS NAVIGATION AND SATELLITE COMMUNICATIONS, GLOBAL POSITIONING SYSTEM (GPS) CONSISTING OF COMPUTERS, COMPUTER SOFTWARE, TRANSMITTERS, RECEIVERS, AND NETWORK INTERFACE DEVICES; SOFTWARE FOR USE IN GLOBAL POSITIONING AND WIRELESS NAVIGATION AND SATELLITE COMMUNICATIONS AND PERIPHERAL EQUIPMENT, NAMELY, COMPUTER PERIPHERALS FOR CELLULAR AND LINEAR NETWORKS; COMPUTER HARDWARE AND PERIPHERAL EQUIPMENT FOR CELLULAR AND LINEAR NETWORKS (U.S. CLS. 21, 23, 26, 36 AND 38).

JAMES GRIFFIN, EXAMINING ATTORNEY

CLASS 9—(Continued).

SN 77-253,874. LUMINENT, INC., CHATSWORTH, CA. AND FIBERXON, INC., SANTA CLARA, CA. FILED 8-13-2007.

SOURCE PHOTONICS

THE MARK CONSISTS OF STANDARD CHARACTERS WITHOUT CLAIM TO ANY PARTICULAR FONT, STYLE, SIZE, OR COLOR.

NO CLAIM IS MADE TO THE EXCLUSIVE RIGHT TO USE "PHOTONICS", APART FROM THE MARK AS SHOWN.

FOR OPTICAL COMPONENTS FOR COMMUNICATIONS NETWORKS, NAMELY, TRANSCEIVERS (U.S. CLS. 21, 23, 26, 36 AND 38).

KELLEY WELLS, EXAMINING ATTORNEY

SN 77-254,485. VONAGE MARKETING INC., HOLMDEL, NJ. FILED 8-14-2007.

V-PORTAL

THE MARK CONSISTS OF STANDARD CHARACTERS WITHOUT CLAIM TO ANY PARTICULAR FONT, STYLE, SIZE, OR COLOR.

FOR COMPUTER AND TELECOMMUNICATIONS NETWORK HUBS, SWITCHES AND ROUTERS; COMPUTER HARDWARE AND SOFTWARE FOR USE IN CONNECTING TELECOMMUNICATIONS EQUIPMENT, TELEPHONES, COMPUTERS, WIRED AND WIRELESS NETWORKS; COMPUTER SOFTWARE AND HARDWARE FOR PROVIDING TRANSMISSION AND EXCHANGE OF VOICE, VIDEO, DATA, IMAGES AND GRAPHICS IN THE FIELD OF TELECOMMUNICATIONS; COMPUTER HARDWARE FOR TELECOMMUNICATIONS FOR CONNECTING DEVICES VIA IN-HOME PHONE AND ELECTRICAL WIRING; DEVICES FOR PROVIDING VOICE OVER INTERNET PROTOCOL (VOIP) COMMUNICATIONS, NAMELY, NETWORK HUBS, SWITCHES AND ROUTERS; DEVICES FOR COMBINING LANDLINE WITH VOIP SERVICES, NAMELY, NETWORK HUBS, SWITCHES AND ROUTERS (U.S. CLS. 21, 23, 26, 36 AND 38).

SETH A. RAPPAPORT, EXAMINING ATTORNEY

CLASS 9—(Continued).

SN 77-254,712. RADIOSPIRE NETWORKS, INC., CONCORD, MA. FILED 8-14-2007.

AIRHOOK

THE MARK CONSISTS OF STANDARD CHARACTERS WITHOUT CLAIM TO ANY PARTICULAR FONT, STYLE, SIZE, OR COLOR.

"AIRHOOK" APPEARING IN THE MARK HAS NO SIGNIFICANCE IN THE RELEVANT TRADE OR INDUSTRY OR AS APPLIED TO THE GOODS/SERVICES LISTED IN THE APPLICATION, NO GEOGRAPHICAL SIGNIFICANCE, NOR ANY MEANING IN A FOREIGN LANGUAGE.

FOR INTEGRATED CIRCUIT CHIPS FOR USE IN THE DELIVERY OF AUDIO AND VIDEO CONTENT IN HOME ENTERTAINMENT SYSTEMS AND REPLACEMENT PARTS THEREFOR (U.S. CLS. 21, 23, 26, 36 AND 38).

ELIZABETH HUGHITT, EXAMINING ATTORNEY

SN 77-255,126. BENCOMP COMMUNICATIONS, INC., VICTOR, NY. FILED 8-14-2007.

RECRUITERSEGE

THE MARK CONSISTS OF STANDARD CHARACTERS WITHOUT CLAIM TO ANY PARTICULAR FONT, STYLE, SIZE, OR COLOR.

FOR SOFTWARE FOR USE IN HUMAN RESOURCES OPERATIONS AND FUNCTIONS, NAMELY, TO CREATE EMPLOYEE BENEFIT STATEMENTS (U.S. CLS. 21, 23, 26, 36 AND 38).

FIRST USE 11-6-2006; IN COMMERCE 11-6-2006.
WILLIAM ROSSMAN, EXAMINING ATTORNEY

SN 77-255,745. CALIPER LIFE SCIENCES, INC., MOUNTAIN VIEW, CA. FILED 8-15-2007.

EZREADER

THE MARK CONSISTS OF STANDARD CHARACTERS WITHOUT CLAIM TO ANY PARTICULAR FONT, STYLE, SIZE, OR COLOR.

FOR SCIENTIFIC INSTRUMENTS AND DEVICES FOR THE DEVELOPMENT, TESTING, SCREENING AND ANALYSIS OF PHARMACEUTICALS, FOR CHEMICAL SCREENING AND ANALYSIS, FOR THE TESTING, SCREENING AND ANALYSIS OF BIOLOGICAL SUBSTANCES AND FOR NUCLEIC ACID CHARACTERIZATION (U.S. CLS. 21, 23, 26, 36 AND 38).

JOHN HWANG, EXAMINING ATTORNEY

CLASS 9—(Continued).

SN 77-255,960. OCEAN OPTICS, INC., DUNEDIN, FL. FILED 8-15-2007.

LAMPS

THE MARK CONSISTS OF STANDARD CHARACTERS WITHOUT CLAIM TO ANY PARTICULAR FONT, STYLE, SIZE, OR COLOR.

FOR LASER ASSISTED MICROWAVE PLASMA EQUIPMENT IN THE NATURE OF A SPECTROSCOPY APPARATUS USED FOR TESTING THE ELEMENTAL EMISSIONS OF THE PLASMA LIGHT EMITTED FROM A SAMPLE MATERIAL WHEN ABLATED BY A LASER, THE EQUIPMENT BEING COMPRISED OF SAMPLE CHAMBERS FOR HOLDING A SAMPLE MATERIAL TO BE TESTED, LASERS FOR ABLATING THE SAMPLE MATERIAL, MICROWAVE CAVITIES FOR LENGTHENING THE PLASMA DURATION AND INCREASING PLASMA AMPLITUDE, AND OPTICAL FIBERS AND LENSES TO IMAGE THE PLASMA LIGHT INTO A SPECTROMETER FOR EMISSION CHARACTERIZATION AND ANALYSIS OF THE ELEMENTAL COMPOSITION OF THE SAMPLE MATERIAL (U.S. CLS. 21, 23, 26, 36 AND 38).

PAUL CROWLEY, EXAMINING ATTORNEY

CLASS 9—(Continued).

SN 77-258,074. LUMINENT, INC., CHATSWORTH, CA. AND FIBERXON, INC., SANTA CLARA, CA. FILED 8-17-2007.



source PHOTONICS

NO CLAIM IS MADE TO THE EXCLUSIVE RIGHT TO USE "PHOTONICS", APART FROM THE MARK AS SHOWN.

THE MARK CONSISTS OF LETTER "S" IN BLOCK FORMAT ABOVE WORDS "SOURCE PHOTONICS".

FOR OPTICAL COMPONENTS FOR COMMUNICATIONS NETWORKS, NAMELY, TRANSCEIVERS (U.S. CLS. 21, 23, 26, 36 AND 38).

KELLEY WELLS, EXAMINING ATTORNEY

SN 77-259,128. BRITT, SANFORD L., FAIRPORT, NY. FILED 8-20-2007.

Snap Sampler

THE MARK CONSISTS OF STANDARD CHARACTERS WITHOUT CLAIM TO ANY PARTICULAR FONT, STYLE, SIZE, OR COLOR.

NO CLAIM IS MADE TO THE EXCLUSIVE RIGHT TO USE "SAMPLER", APART FROM THE MARK AS SHOWN.

FOR WATER SAMPLING EQUIPMENT, NAMELY, WATER COLLECTION INSTRUMENTATION FOR MONITORING AND DETECTING CHEMICAL AND PHYSICAL PROPERTIES OF THE WATER; DOWNHOLE WATER SAMPLING EQUIPMENT, NAMELY, WATER COLLECTION INSTRUMENTATION FOR MONITORING AND DETECTING CHEMICAL AND PHYSICAL PROPERTIES OF THE WATER; FLUID CAPTURE EQUIPMENT FOR REMOTE SAMPLE COLLECTION, NAMELY, WATER INSTRUMENTATION FOR MONITORING AND DETECTING CHEMICAL AND PHYSICAL PROPERTIES OF THE WATER; SAMPLE BOTTLES FOR SAID WATER COLLECTING, MONITORING AND DETECTING EQUIPMENT (U.S. CLS. 21, 23, 26, 36 AND 38).

FIRST USE 6-1-2002; IN COMMERCE 4-20-2004.

BRENDAN MCCAULEY, EXAMINING ATTORNEY

SN 77-257,986. SIMON & SCHUSTER, INC., NEW YORK, NY. FILED 8-17-2007.

THE HARDY BOYS

THE MARK CONSISTS OF STANDARD CHARACTERS WITHOUT CLAIM TO ANY PARTICULAR FONT, STYLE, SIZE, OR COLOR.

OWNER OF U.S. REG. NO. 3,199,498.

THE NAME(S), PORTRAIT(S), AND/OR SIGNATURE(S) SHOWN IN THE MARK DOES NOT IDENTIFY A PARTICULAR LIVING INDIVIDUAL.

FOR INTERACTIVE MULTIMEDIA COMPUTER GAME PROGRAMS, NONE RELATING TO WRESTLING PERSONALITIES (U.S. CLS. 21, 23, 26, 36 AND 38).

C. DIONNE CLYBURN, EXAMINING ATTORNEY

CLASS 9—(Continued).

SN 77-259,165. OMNIPLATFORM SOFTWARE CORPORATION, RIVERSIDE, CA. FILED 8-20-2007.



FOR COMPUTER SOFTWARE FOR COLLECTION, ORGANIZING AND SHARING OF DATA AND INFORMATION, NAMELY, TAKING COMPANY ASSETS, COMBINING THEM INTO A TEMPLATE FORM WHICH CAN THEN BE CUSTOMIZED AND VIEWED BY CUSTOMERS OVER THE INTERNET OR EMAILED AND PRINTED AT THEIR DISCRETION (U.S. CLS. 21, 23, 26, 36 AND 38).

LINDA ORNDORFF, EXAMINING ATTORNEY

CLASS 9—(Continued).

SN 77-265,526. JCM AMERICAN CORPORATION, LAS VEGAS, NV. FILED 8-27-2007.



THE MARK CONSISTS OF STANDARD CHARACTERS WITHOUT CLAIM TO ANY PARTICULAR FONT, STYLE, SIZE, OR COLOR.

FOR HANDHELD ELECTRONIC COMMUNICATION COMPUTER FOR FIELD SERVICE OF PAYMENT SYSTEM COMPONENTS (U.S. CLS. 21, 23, 26, 36 AND 38).
DEIRDRE ROBERTSON, EXAMINING ATTORNEY

SN 77-262,028. DTN, INC., OMAHA, NE. FILED 8-22-2007.



THE MARK CONSISTS OF STANDARD CHARACTERS WITHOUT CLAIM TO ANY PARTICULAR FONT, STYLE, SIZE, OR COLOR.

NO CLAIM IS MADE TO THE EXCLUSIVE RIGHT TO USE "SECURE", APART FROM THE MARK AS SHOWN.

FOR ELECTRONIC CARD READING TERMINAL DESIGNED FOR USE WITH BULK TERMINAL OR WEIGH SCALE AUTOMATION SYSTEMS (U.S. CLS. 21, 23, 26, 36 AND 38).

JENNY PARK, EXAMINING ATTORNEY

SN 77-265,639. OLUKAI, INC., ALISO VIEJO, CA. FILED 8-28-2007.



OWNER OF U.S. REG. NO. 3,163,969.

THE MARK CONSISTS OF A HOOK.

FOR BINOCULARS; CAMERA CASES; CELLPHONE CASES; CASES FOR MOBILE LAPTOP COMPUTERS; PERSONAL DATA ASSISTANT CASES; PORTABLE MUSIC PLAYER CASES; COMPACT DISK STORAGE WALLETS; COMPUTER CARRYING BAGS; COMPUTER CARRYING CASES; DIRECTIONAL COMPASSES; DUST COVERS FOR COMPUTERS; MAGNETS; LUMINOUS SIGNS; MOUSEPADS; NEON SIGNS; PRERECORDED COMPACT DISCS FEATURING MUSIC; PRERECORDED VIDEO DISCS FEATURING INFORMATION ON FASHION, LIFESTYLE, MUSIC, SPORTS AND TRAVEL; PROTECTIVE GEAR, NAMELY, PROTECTIVE CLOTHING; SIGNAL WHISTLES; SUNGLASSES; DIVING AND SWIMMING GOGGLES, GOGGLES FOR SPORTS; SPECTACLE FRAMES, PROTECTIVE CASES FOR SPECTACLES; THERMOMETERS (U.S. CLS. 21, 23, 26, 36 AND 38).

ANDREW RHIM, EXAMINING ATTORNEY

SN 77-264,316. SCOTT W. CLIFTON, TYLER, TX. AND BLAKE L. CLIFTON, TYLER, TX. AND MARK A. CLIFTON, TYLER, TX. AND GAYLON CLIFTON, TYLER, TX. AND EDITH W. CLIFTON, TYLER, TX. FILED 8-25-2007.



THE MARK CONSISTS OF STANDARD CHARACTERS WITHOUT CLAIM TO ANY PARTICULAR FONT, STYLE, SIZE, OR COLOR.

FOR AUDIO RECORDINGS FEATURING MUSIC; DOWNLOADABLE MUSICAL SOUND RECORDINGS; MUSICAL SOUND RECORDINGS; MUSICAL VIDEO RECORDINGS (U.S. CLS. 21, 23, 26, 36 AND 38).

FIRST USE 6-1-2005; IN COMMERCE 4-1-2006.

TRICIA SONNEBORN, EXAMINING ATTORNEY

CLASS 9—(Continued).

SN 77-267,098. SNI/SI NETWORKS LLC, NEW YORK, NY. FILED 8-29-2007.

HIDDEN ARMOR, FOUND TREASURES

THE MARK CONSISTS OF STANDARD CHARACTERS WITHOUT CLAIM TO ANY PARTICULAR FONT, STYLE, SIZE, OR COLOR.

FOR DVDS FEATURING PRE-RECORDED ENTERTAINMENT IN THE NATURE OF A TELEVISION SERIES IN THE FIELD OF EVALUATING AND APPRAISING WEAPONRY (U.S. CLS. 21, 23, 26, 36 AND 38).
FRANK LATTUCA, EXAMINING ATTORNEY

SN 77-267,479. DUBUQUE MICROCOMPUTER CONSULTANTS, LTD., DUBUQUE, IA. FILED 8-29-2007.

WORKING PRODUCT

THE MARK CONSISTS OF STANDARD CHARACTERS WITHOUT CLAIM TO ANY PARTICULAR FONT, STYLE, SIZE, OR COLOR.

FOR DIGITAL MATERIALS, NAMELY, CDS AND DOWNLOADABLE COMPUTER SOFTWARE PROVIDING DATABASES AND APPLICATION PROGRAMS CONTAINING INFORMATION, INTERPRETATION AND ORGANIZATION OF MANUFACTURER'S MATERIAL SAFETY DATA SHEETS THAT RELATE TO HAZARDOUS MATERIALS USED IN THE WORKPLACE (U.S. CLS. 21, 23, 26, 36 AND 38).

SUSAN STIGLITZ, EXAMINING ATTORNEY

SN 77-268,064. PRIMA PRINCESSA PRODUCTIONS, LLC, MONTCLAIR, NJ. FILED 8-30-2007.

PRIMA PRINCESSA

THE MARK CONSISTS OF STANDARD CHARACTERS WITHOUT CLAIM TO ANY PARTICULAR FONT, STYLE, SIZE, OR COLOR.

THE WORDING "PRIMA PRINCESSA" HAS NO MEANING IN A FOREIGN LANGUAGE.

FOR PRERECORDED DIGITAL VIDEO DISKS FEATURING EDUCATIONAL ENTERTAINMENT ABOUT BALLET (U.S. CLS. 21, 23, 26, 36 AND 38).

CHARLOTTE CORWIN, EXAMINING ATTORNEY

CLASS 9—(Continued).

SN 77-269,024. ISOCLEAR, INC., CHICAGO, IL. FILED 8-31-2007.

NO CLAIM IS MADE TO THE EXCLUSIVE RIGHT TO USE "CASE", APART FROM THE MARK AS SHOWN.

THE COLOR(S) BLUE AND BLACK IS/ARE CLAIMED AS A FEATURE OF THE MARK.

THE MARK CONSISTS OF BLUE SHADED LETTER O'S. THE COLOR BLACK APPEARS IN THE LANGUAGE "COMFORT CASE" AND IN THE OUTLINE AND THE CENTER OF THE LETTER O'S.

FOR CONTACT LENS CLEANING APPARATUS, NAMELY, LIMITED USE DISPOSABLE CONTACT CASES DESIGNED TO REMOVE CONTAMINANTS FROM THE CONTACT LENSES (U.S. CLS. 21, 23, 26, 36 AND 38).

LAURIE MAYES, EXAMINING ATTORNEY

SN 77-270,403. LIN, FANG CHUN, DBA ANDREA LIN, IRVINE, CA. FILED 9-3-2007.

Dance A GoGo

THE MARK CONSISTS OF STANDARD CHARACTERS WITHOUT CLAIM TO ANY PARTICULAR FONT, STYLE, SIZE, OR COLOR.

NO CLAIM IS MADE TO THE EXCLUSIVE RIGHT TO USE "DANCE" AND "GOGO", APART FROM THE MARK AS SHOWN.

FOR DVDS FEATURING DANCE FITNESS INSTRUCTIONAL VIDEOS (U.S. CLS. 21, 23, 26, 36 AND 38).

NAKWAMA ANKRAH, EXAMINING ATTORNEY

SN 77-271,886. ZERO TECHNOLOGIES, LLC, BENSALEM, PA. FILED 9-5-2007.

Z-TESTER

THE MARK CONSISTS OF STANDARD CHARACTERS WITHOUT CLAIM TO ANY PARTICULAR FONT, STYLE, SIZE, OR COLOR.

FOR ELECTRONIC WATER TESTER FOR MONITORING AND DETECTING CONTAMINATION (U.S. CLS. 21, 23, 26, 36 AND 38).

DOMINIC FATHY, EXAMINING ATTORNEY

CLASS 9—(Continued).

SN 77-272,125. QED, INC., LEXINGTON, KY. FILED 9-5-2007.



THE COLOR(S) BLACK, WHITE, BLUE, TAN, AND RED IS/ARE CLAIMED AS A FEATURE OF THE MARK.

THE MARK CONSISTS OF A BLACK BACKGROUND WITH AN OVAL OUTLINED IN WHITE FOLLOWED BY TWO SMALLER BLACK OVAL LINES. THE SMALLEST OVAL IS BLUE. THE INSIDE OF THE LAST OVAL IS TAN WITH BLUE VERTICAL AND HORIZONTAL BLACK LINES WITHIN. THE NAME "BURRISS" IS WRITTEN IN SCRIPT IN RED OUTLINED IN BLACK. THE NAME APPEARS ACROSS THE OVALS.

FOR ELECTRONIC EFFECT PEDALS FOR USE WITH SOUND AMPLIFIERS; GUITAR AMPLIFIERS (U.S. CLS. 21, 23, 26, 36 AND 38).

FIRST USE 9-22-2002; IN COMMERCE 9-22-2002.
GINA HAYES, EXAMINING ATTORNEY

SN 77-273,210. LMS MEDICAL SYSTEMS, MONTREAL, CANADA, FILED 9-6-2007.

Clinical Situational Awareness

THE MARK CONSISTS OF STANDARD CHARACTERS WITHOUT CLAIM TO ANY PARTICULAR FONT, STYLE, SIZE, OR COLOR.

FOR COMPUTER SOFTWARE FOR DATA COLLECTION FROM A FETAL OR MATERNAL MONITOR AND ENTERED BY A CAREGIVER TO COMPARE THE RATE OF PROGRESS OF A LABORING MOTHER TO A GROUP OF SIMILAR WOMAN WHO DELIVERED VAGINALLY; COMPUTER SOFTWARE FOR IDENTIFYING AND MARKING PATTERNS IN THE FETAL HEART TRACING FOR REVIEW BY A CLINICIAN; COMPUTER SOFTWARE FOR USING BASIC DATA ABOUT PREGNANT WOMAN AND HER FETUS TO CALCULATE THE RISK OF EXPERIENCING SHOULDER DYSTOCIA, A LABOR COMPLICATION THAT CAN CAUSE PERMANENT DAMAGE TO THE FETUS (U.S. CLS. 21, 23, 26, 36 AND 38).

FIRST USE 2-25-2007; IN COMMERCE 3-13-2007.
DAVID C. REIHNER, EXAMINING ATTORNEY

CLASS 9—(Continued).

SN 77-273,572. JCM AMERICAN CORPORATION, LAS VEGAS, NV. FILED 9-6-2007.



THE COLOR(S) BLUE, WHITE, AND BLACK IS/ARE CLAIMED AS A FEATURE OF THE MARK.

THE MARK CONSISTS OF A THREE SIDED BLUE SHIELD CONTAINING A WHITE STYLIZED SUN RISING OVER A WHITE REPRESENTATION OF OCEAN WAVES WITH BLACK SHADING AT ONE OR MORE EDGES OF THE SHIELD.

FOR CASH REGISTERS; ELECTRONIC VALIDATORS FOR DISCRIMINATING TRUE MONEY FROM COUNTERFEIT MONEY AND FOR DISCRIMINATING BETWEEN VARIOUS DENOMINATIONS OF MONEY; ELECTRONIC COIN COUNTERS (U.S. CLS. 21, 23, 26, 36 AND 38).

DEIRDRE ROBERTSON, EXAMINING ATTORNEY

SN 77-275,693. STF SERVICES CORPORATION, EAST SYRACUSE, NY. FILED 9-10-2007.

SUPERFORM

THE MARK CONSISTS OF STANDARD CHARACTERS WITHOUT CLAIM TO ANY PARTICULAR FONT, STYLE, SIZE, OR COLOR.

OWNER OF U.S. REG. NO. 2,603,637.

FOR COMPUTER SOFTWARE PROVIDING ELECTRONIC FORMS FOR USE IN THE FIELDS OF LAW, PUBLIC ADMINISTRATION, BUSINESS, ACCOUNTING, TAX, HEALTH, ENVIRONMENTAL, FINANCING, REAL ESTATE, HUMAN RESOURCES, LABOR, EMPLOYEE BENEFITS, PAYROLL, COMMUNICATIONS, SAFETY, ESTATES AND IMPORT/EXPORT (U.S. CLS. 21, 23, 26, 36 AND 38).

FIRST USE 10-0-1993; IN COMMERCE 10-0-1993.
JENNIFER VASQUEZ, EXAMINING ATTORNEY

CLASS 9—(Continued).

SN 77-277,607. MIDWEST SALES & SERVICE, INC., SOUTH BEND, IN. FILED 9-12-2007.

PUMMELL DRIVE

THE MARK CONSISTS OF STANDARD CHARACTERS WITHOUT CLAIM TO ANY PARTICULAR FONT, STYLE, SIZE, OR COLOR.

NO CLAIM IS MADE TO THE EXCLUSIVE RIGHT TO USE "DRIVE", APART FROM THE MARK AS SHOWN.

FOR HOME AUDIO AND VIDEO PRODUCTS, NAMELY, STEREO TUNERS, AMPLIFIERS, PREAMPLIFIERS, AUDIO-VISUAL RECEIVERS, GRAPHIC EQUALIZERS, MICROPHONES, ANALOG AND DIGITAL AUDIO CASSETTE DECKS, TURNTABLES, COMPACT DISC PLAYERS, COMPACT DISC CHANGERS, DIGITAL VIDEO RECORDERS AND VIDEO DISK PLAYERS, LOUDSPEAKERS, TELEVISIONS, VIDEO MONITORS AND RECEIVERS, VIDEO CASSETTE RECORDERS AND VIDEO CASSETTE PLAYERS, REMOTE CONTROL UNITS FOR STEREO TUNERS, AUDIO-VISUAL RECEIVERS, TELEVISIONS, COMPACT DISC PLAYERS, COMPACT DISC CHANGERS, DIGITAL VIDEO RECORDERS AND VIDEO DISK PLAYERS, VIDEO CASSETTE RECORDERS AND VIDEO CASSETTE PLAYERS; CAR AUDIO PRODUCTS, NAMELY, STEREO TUNERS, AMPLIFIERS, AUDIO-VISUAL RECEIVERS; AND PORTABLE AUDIO AND VIDEO PRODUCTS, NAMELY, MICROPHONES, CASSETTE DECKS, AND VIDEO CAMCORDERS (U.S. CLS. 21, 23, 26, 36 AND 38).
TASNEEM HUSSAIN, EXAMINING ATTORNEY

SN 77-278,235. FORGENT NETWORKS, INC., AUSTIN, TX. FILED 9-12-2007.

ASURE SOFTWARE

THE MARK CONSISTS OF STANDARD CHARACTERS WITHOUT CLAIM TO ANY PARTICULAR FONT, STYLE, SIZE, OR COLOR.

NO CLAIM IS MADE TO THE EXCLUSIVE RIGHT TO USE SOFTWARE, APART FROM THE MARK AS SHOWN.

FOR SOFTWARE, NAMELY, SOFTWARE USED FOR MANAGING AND SCHEDULING MEETINGS AND SOFTWARE USED FOR THE MANAGEMENT AND TRACKING OF INFORMATION TECHNOLOGY AND FIXED ASSETS (U.S. CLS. 21, 23, 26, 36 AND 38).
RENEE MCCRAY, EXAMINING ATTORNEY

CLASS 9—(Continued).

SN 77-278,975. BEA SYSTEMS, INC., SAN JOSE, CA. FILED 9-13-2007.

BEA WEBLOGIC EVENT SERVER

THE MARK CONSISTS OF STANDARD CHARACTERS WITHOUT CLAIM TO ANY PARTICULAR FONT, STYLE, SIZE, OR COLOR.

OWNER OF U.S. REG. NOS. 2,119,055, 2,241,600 AND OTHERS.

NO CLAIM IS MADE TO THE EXCLUSIVE RIGHT TO USE "EVENT SERVER", APART FROM THE MARK AS SHOWN.

FOR HIGH PERFORMANCE COMPUTER SOFTWARE USED TO DISCERN PATTERNS, TRENDS AND CORRELATIONS BETWEEN APPLICATION INPUTS (U.S. CLS. 21, 23, 26, 36 AND 38).

FIRST USE 5-31-2007; IN COMMERCE 5-31-2007.
JEFFERY COWARD, EXAMINING ATTORNEY

SN 77-278,986. BEA SYSTEMS, INC., SAN JOSE, CA. FILED 9-13-2007.

BEA WEBLOGIC REAL TIME

THE MARK CONSISTS OF STANDARD CHARACTERS WITHOUT CLAIM TO ANY PARTICULAR FONT, STYLE, SIZE, OR COLOR.

OWNER OF U.S. REG. NOS. 2,119,055, 2,241,600 AND OTHERS.

NO CLAIM IS MADE TO THE EXCLUSIVE RIGHT TO USE "REAL TIME", APART FROM THE MARK AS SHOWN.

FOR COMPUTER SOFTWARE USED TO OPTIMIZE PERFORMANCE OF APPLICATIONS BY PROVIDING PREDICTABLE RESPONSE TIMES (U.S. CLS. 21, 23, 26, 36 AND 38).

FIRST USE 1-31-2006; IN COMMERCE 1-31-2006.
JEFFERY COWARD, EXAMINING ATTORNEY

SN 77-279,328. HEISEI ELECTRONICS CO., LTD., JUNGHE CITY, TAIWAN, FILED 9-13-2007.

HEISEI

THE MARK CONSISTS OF STANDARD CHARACTERS WITHOUT CLAIM TO ANY PARTICULAR FONT, STYLE, SIZE, OR COLOR.

FOR COMPUTERS; CASH REGISTERS; AUTOMATED BILLING MACHINES FOR PROCESSING ACCOUNTING INFORMATION; INTERACTIVE COMPUTER KIOSKS COMPRISING COMPUTERS, COMPUTER HARDWARE, COMPUTER PERIPHERALS, AND COMPUTER OPERATING SOFTWARE, FOR USE IN SELLING TICKETS (U.S. CLS. 21, 23, 26, 36 AND 38).

FIRST USE 9-3-2007; IN COMMERCE 9-3-2007.
AMEETA JORDAN, EXAMINING ATTORNEY

CLASS 9—(Continued).

SN 77-279,644. SPECTRA LOGIC CORPORATION, BOULDER, CO. FILED 9-14-2007.

TRANSCALE

THE MARK CONSISTS OF STANDARD CHARACTERS WITHOUT CLAIM TO ANY PARTICULAR FONT, STYLE, SIZE, OR COLOR.

FOR COMPUTER STORAGE DEVICES, NAMELY, HIGH-SPEED STORAGE SUBSYSTEMS FOR STORAGE AND BACKUP OF ELECTRONIC DATA EITHER LOCALLY OR VIA A TELECOMMUNICATIONS NETWORK AND THE COMPUTER HARDWARE AND SOFTWARE FOR INTEGRATING SUCH DEVICES INTO A COMPUTER SYSTEM (U.S. CLS. 21, 23, 26, 36 AND 38).

TIMOTHY FINNEGAN, EXAMINING ATTORNEY

SN 77-280,251. TOP CREATION (ASIA) LTD., WANCHAI, HONG KONG, FILED 9-14-2007.

YUBZ

THE MARK CONSISTS OF STYLIZED TEXT OF "YUBZ". FOR CELLULAR TELEPHONES; CELL PHONE BATTERY CHARGES; COMPUTER TERMINALS; TELEPHONES; TELEPHONE APPARATUS; TELEPHONE CONNECTORS; TELEPHONE SETS; COMPUTER HARDWARE AND PERIPHERALS, NAMELY, INTERFACE DEVICES FOR ACCESSING GLOBAL COMPUTER NETWORKS; RECONFIGURABLE PROCESSORS FOR USE IN WIRELESS COMMUNICATION HANDSETS AND NETWORK EQUIPMENT IN THE FIELD OF WIDEBAND COMMUNICATIONS; MOBILE TELEPHONE APPARATUS WITH BUILT-IN FACSIMILE SYSTEMS; SOFTWARE FOR ENSURING THE SECURITY OF ELECTRONIC MAIL; COMPUTER FAX MODEM CARDS; TELECOMMUNICATIONS AND DATA NETWORKING HARDWARE, NAMELY, DEVICES FOR TRANSPORTING AND AGGREGATING VOICE, DATA, AND VIDEO COMMUNICATIONS ACROSS MULTIPLE NETWORK INFRASTRUCTURES AND COMMUNICATIONS PROTOCOLS; PAGING EQUIPMENT; RADIO TELEPHONES; DEVICES FOR WIRELESS RADIO TRANSMISSION (U.S. CLS. 21, 23, 26, 36 AND 38).

FIRST USE 7-6-2006; IN COMMERCE 7-6-2006.

YAT SYE, LEE, EXAMINING ATTORNEY

CLASS 9—(Continued).

SN 77-280,986. ASSOCIATED PHARMACIES, INC., SCOTTSBORO, AZ. FILED 9-17-2007.

SCAN & TOSS

THE MARK CONSISTS OF STANDARD CHARACTERS WITHOUT CLAIM TO ANY PARTICULAR FONT, STYLE, SIZE, OR COLOR.

FOR COMPUTER SOFTWARE FOR ORDERING PRESCRIPTION DRUGS (U.S. CLS. 21, 23, 26, 36 AND 38).

FIRST USE 8-1-2006; IN COMMERCE 2-1-2007.

KATINA MISTER, EXAMINING ATTORNEY

SN 77-282,687. ELK PRODUCTS, INC., HILDEBRAN, NC. FILED 9-18-2007.

ELKGUARD

THE MARK CONSISTS OF STANDARD CHARACTERS WITHOUT CLAIM TO ANY PARTICULAR FONT, STYLE, SIZE, OR COLOR.

FOR SELF-CONTAINED, WIRELESS INTRUDER ALARM SYSTEM INCORPORATING BUILT IN SIREN, PASSIVE INFRA-RED DETECTORS; EXPANDABLE BATTERY AND CHARGER VIA ADD-ON PERIPHERALS (U.S. CLS. 21, 23, 26, 36 AND 38).

FIRST USE 9-1-2007; IN COMMERCE 9-1-2007.

KELLY MCCOY, EXAMINING ATTORNEY

SN 77-283,693. DAVID CLARK COMPANY INCORPORATED, WORCESTER, MA. FILED 9-19-2007.

X11

THE MARK CONSISTS OF STANDARD CHARACTERS WITHOUT CLAIM TO ANY PARTICULAR FONT, STYLE, SIZE, OR COLOR.

OWNER OF U.S. REG. NOS. 3,363,639 AND 3,363,640. FOR AVIATION COMMUNICATION AND RELATED EQUIPMENT, NAMELY, HEADSETS (U.S. CLS. 21, 23, 26, 36 AND 38).

FIRST USE 7-31-2006; IN COMMERCE 7-31-2006.

YAT SYE, LEE, EXAMINING ATTORNEY

CLASS 9—(Continued).

SN 77-284,213. SYNAPTICS INCORPORATED, SANTA CLARA, CA. FILED 9-20-2007.

CLASS 9—(Continued).

SN 77-285,275. BEHAVIORIAL RECOGNITION SYSTEMS, INC., HOUSTON, TX. FILED 9-21-2007.

ClearSense

HYPOCEPT

THE MARK CONSISTS OF STANDARD CHARACTERS WITHOUT CLAIM TO ANY PARTICULAR FONT, STYLE, SIZE, OR COLOR.

FOR ELECTRONIC CIRCUITRY; INTEGRATED CIRCUITS AND CIRCUIT BOARDS; INPUT DEVICES, NAMELY, TOUCH-SENSITIVE INPUT DEVICES FOR CONSUMER ELECTRONIC PRODUCTS THAT ALLOW THE USER TO INTERFACE WITH OR CONTROL THE PRODUCTS, AND SOFTWARE THEREFORE; AND COMPUTER SOFTWARE DESIGN TOOLS FOR DESIGNING INPUT DEVICES FOR CONSUMER ELECTRONIC PRODUCTS THAT ALLOW THE USER TO INTERFACE WITH OR CONTROL THE PRODUCTS (U.S. CLS. 21, 23, 26, 36 AND 38).

ANGELA M. MICHELI, EXAMINING ATTORNEY

THE MARK CONSISTS OF STANDARD CHARACTERS WITHOUT CLAIM TO ANY PARTICULAR FONT, STYLE, SIZE, OR COLOR.

FOR COMPUTER SOFTWARE COMPONENT FOR DESCRIBING OBSERVED BEHAVIOR PATTERNS IN A SCENE UNDER SURVEILLANCE (U.S. CLS. 21, 23, 26, 36 AND 38).

ANTHONY RINKER, EXAMINING ATTORNEY

SN 77-285,977. DLOO, INC., ALAMEDA, CA. FILED 9-21-2007.

SN 77-284,707. BANOM, INC., WAYNE, PA. FILED 9-20-2007.

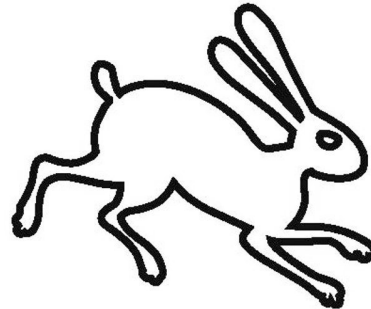

OWNER OF U.S. REG. NO. 2,606,079.
THE MARK CONSISTS OF THREE TRIANGLES IN A SEMI-CIRCLE AND IS APPLIED TO THE FINGERTIPS OF THE GLOVES. THE DOTTED LINES IN THE DRAWING SHOW PLACEMENT OF THE MARK ON THE GLOVES.

SEC. 2(F).
FOR PROTECTIVE GLOVES FOR INDUSTRIAL USE (U.S. CLS. 21, 23, 26, 36 AND 38).
FIRST USE 8-18-2000; IN COMMERCE 8-18-2000.
ROBIN CHOSID, EXAMINING ATTORNEY

THE MARK CONSISTS OF STYLIZED IMAGE OF A RABBIT.

FOR COMPUTER SOFTWARE FOR USE IN COMPUTER OPERATING SYSTEMS, SOFTWARE DEVELOPMENT, SYSTEMS ADMINISTRATION, DATABASE MANAGEMENT, MULTIMEDIA CREATION, WORD PROCESSING, DESKTOP PUBLISHING, USER TRAINING AND INSTRUCTION MANUALS SOLD AS A UNIT (U.S. CLS. 21, 23, 26, 36 AND 38).

FIRST USE 10-2-2006; IN COMMERCE 7-17-2007.
MARGERY A. TIERNEY, EXAMINING ATTORNEY

CLASS 9—(Continued).

SN 77-286,141. ALLSTARCADE LLC, DBA GFU INDUSTRIES, SAN LUIS OBISPO, CA. FILED 9-21-2007.

Arkeg

THE MARK CONSISTS OF STANDARD CHARACTERS WITHOUT CLAIM TO ANY PARTICULAR FONT, STYLE, SIZE, OR COLOR.

FOR AMUSEMENT APPARATUS ADAPTED FOR USE WITH AN EXTERNAL DISPLAY SCREEN OR MONITOR; VIDEO GAME MACHINES FOR USE WITH EXTERNAL DISPLAY SCREEN OR MONITOR; VIDEO OUTPUT GAME MACHINES FOR USE WITH EXTERNAL DISPLAY SCREEN OR MONITOR (U.S. CLS. 21, 23, 26, 36 AND 38).

FIRST USE 8-1-2001; IN COMMERCE 2-10-2007.
ERNEST SHOSHO, EXAMINING ATTORNEY

SN 77-286,207. ARBOGAST PROPERTY MANAGEMENT, LLC, GENOA, NV. FILED 9-21-2007.



THE COLOR(S) BLACK, RED AND WHITE IS/ARE CLAIMED AS A FEATURE OF THE MARK.

THE MARK CONSISTS OF AN EXPRESSIVE CARTOON CHARACTER BLACK AND WHITE SHARK WITH WHITE GILLS, A SMILING EXPRESSION EXPOSING WHITE SHARP TEETH IN A BLACK MOUTH, WITH SINISTER BLACK AND WHITE EYES, WEARING A BLACK BUSINESS SUIT JACKET WITH A FLAPPING BLACK NECKTIE, AND CARRYING A BLACK BRIEFCASE; THE SHARK IS PARTLY OBSCURED BY A RED UNIVERSAL PROHIBITION SYMBOL, AND APPEARS TO BE SWIMMING BEHIND THE DIAGONAL SLASH OF THE SYMBOL, AND IN FRONT OF THE PERIMETER CIRCLE OF THE SYMBOL. THE INTERIOR OF THE PROHIBITION SYMBOL IS TRANSPARENT.

FOR AUDIO AND VIDEO RECORDINGS FEATURING EDUCATIONAL INFORMATION ABOUT LAW, PERSONAL FINANCE, LEGAL SELF-HELP, ASSET PROTECTION (U.S. CLS. 21, 23, 26, 36 AND 38).

FIRST USE 9-14-2007; IN COMMERCE 9-14-2007.
TOBY BULLOFF, EXAMINING ATTORNEY

CLASS 9—(Continued).

SN 77-286,479. DIGITAL 1 MEDIA, INC., CLEARWATER, FL. FILED 9-22-2007.

REFLEX

THE MARK CONSISTS OF STANDARD CHARACTERS WITHOUT CLAIM TO ANY PARTICULAR FONT, STYLE, SIZE, OR COLOR.

FOR COMPUTER SOFTWARE FOR MUSIC EDITING, CONTROLS, PLAYBACK, RECORDING, LOOPING, SAMPLING, MANAGEMENT, AND FOR MANAGEMENT OF DIGITAL AUDIO FILES (U.S. CLS. 21, 23, 26, 36 AND 38).

FIRST USE 12-15-2006; IN COMMERCE 8-24-2007.
LINDA M. KING, EXAMINING ATTORNEY

SN 77-286,818. INCHARGE TECHNOLOGIES LLC, SAN LEANDRO, CA. FILED 9-24-2007.

JUICEBAR

THE MARK CONSISTS OF STANDARD CHARACTERS WITHOUT CLAIM TO ANY PARTICULAR FONT, STYLE, SIZE, OR COLOR.

FOR BATTERY CHARGER FOR CONSUMER ELECTRONICS (U.S. CLS. 21, 23, 26, 36 AND 38).

SAMUEL E. SHARPER JR., EXAMINING ATTORNEY

SN 77-286,997. CHEYENNE MOUNTAIN ENTERTAINMENT, INC., MESA, AZ. FILED 9-24-2007.

SOCIAL NETWORKS AT PLAY

THE MARK CONSISTS OF STANDARD CHARACTERS WITHOUT CLAIM TO ANY PARTICULAR FONT, STYLE, SIZE, OR COLOR.

NO CLAIM IS MADE TO THE EXCLUSIVE RIGHT TO USE "NETWORKS", APART FROM THE MARK AS SHOWN.

FOR SOFTWARE AND ELECTRONIC GAMES, NAMELY, SOFTWARE GAMES RECORDED ON CD-ROM AND DIGITAL VIDEO DISCS FOR COMPUTERS; SOFTWARE GAMES RECORDED ON CD-ROM, DIGITAL VIDEO DISCS, AND CARTRIDGES FOR CONSOLE AND INDIVIDUAL PORTABLE GAMING SYSTEMS; SOFTWARE GAMES THAT ARE DOWNLOADABLE FROM A REMOTE COMPUTER SITE; AND SOFTWARE GAMES FOR MOBILE PHONES, PERSONAL DIGITAL ASSISTANTS AND HANDHELD COMPUTERS (U.S. CLS. 21, 23, 26, 36 AND 38).

KATHERINE STOIDES, EXAMINING ATTORNEY

CLASS 9—(Continued).

SN 77-287,048. F5 NETWORKS, INC., SEATTLE, WA. FILED 9-24-2007.

IQUERY

THE MARK CONSISTS OF STANDARD CHARACTERS WITHOUT CLAIM TO ANY PARTICULAR FONT, STYLE, SIZE, OR COLOR.

FOR COMPUTER HARDWARE; SOFTWARE UTILIZING INTERACTION PROTOCOLS FOR USE IN ENHANCING, OPTIMIZING, MONITORING, AND MANAGING COMPUTER NETWORK TRAFFIC, APPLICATIONS COMMUNICATING ACROSS NETWORKS, AND DEVICES CONNECTED TO SUCH NETWORK (U.S. CLS. 21, 23, 26, 36 AND 38).

ROSELLE HERRERA, EXAMINING ATTORNEY

CLASS 9—(Continued).

SN 77-287,082. PATIENT CARE TECHNOLOGY SYSTEMS, LLC., MISSION VIEJO, CA. FILED 9-24-2007.

Amelior ED

THE MARK CONSISTS OF STANDARD CHARACTERS WITHOUT CLAIM TO ANY PARTICULAR FONT, STYLE, SIZE, OR COLOR.

OWNER OF U.S. REG. NOS. 2,656,679, 3,300,062 AND OTHERS.

NO CLAIM IS MADE TO THE EXCLUSIVE RIGHT TO USE "ED", APART FROM THE MARK AS SHOWN.

FOR COMPUTER SOFTWARE FOR USE BY EMERGENCY AND URGENT CARE PROVIDERS FOR THE PURPOSES OF TRACKING THE LOCATION AND CARE PROGRESSION OF PATIENTS WITHIN AN EMERGENCY OR URGENT CARE FACILITY; LOCATING STAFF AND ASSETS; COMPLETING ELECTRONIC CLINICAL CHARTS FOR PATIENT CARE DOCUMENTATION; SENDING AND RECEIVING TREATMENT ORDERS; PRESCRIBING MEDICATIONS; COMMUNICATING, CODING AND STORING ALL PATIENT CARE INFORMATION BETWEEN CAREGIVERS AND MANAGING THE DISPOSITION OF PATIENTS (U.S. CLS. 21, 23, 26, 36 AND 38).

FIRST USE 7-29-2001; IN COMMERCE 10-0-2001.
ESTHER BELENKER, EXAMINING ATTORNEY

SN 77-287,060. BEST VENDORS MANAGEMENT, INC., MINNEAPOLIS, MN. FILED 9-24-2007.



SN 77-287,335. ENERGY FOCUS, INC., SOLON, OH. FILED 9-24-2007.

FREEDOM SWITCH

THE MARK CONSISTS OF A HORIZONTAL RECTANGLE WITH THE LEFT HALF CONSISTING OF THE STYLIZED LETTERS "BV" WITH AN OPEN PARENTHESIS TO THE LEFT AND TWO CLOSE PARENTHESSES TO THE RIGHT, AND THE RIGHT HALF CONSISTING OF THE WORD "FUSION" WITHIN THE RECTANGLE.

FOR COMPUTER SOFTWARE FOR USE IN THE VENDING INDUSTRY FOR THE COLLECTION, SYNCHRONIZATION, ORGANIZING, MODIFYING, TRANSFERRING, STORING AND SHARING OF DATA AND INFORMATION RELATING TO SALES, CASH ACCOUNTING, INVENTORY AND VENDOR METRICS (U.S. CLS. 21, 23, 26, 36 AND 38).

KELLY BOULTON, EXAMINING ATTORNEY

THE MARK CONSISTS OF STANDARD CHARACTERS WITHOUT CLAIM TO ANY PARTICULAR FONT, STYLE, SIZE, OR COLOR.

NO CLAIM IS MADE TO THE EXCLUSIVE RIGHT TO USE "SWITCH", APART FROM THE MARK AS SHOWN.

FOR JUNCTION BOXES AND WIRELESS TRANSMITTERS FOR USE IN CONTROLLING SWIMMING POOL LIGHTS; SWIMMING POOL LIGHTING CONTROLLERS (U.S. CLS. 21, 23, 26, 36 AND 38).

JOHN DWYER, EXAMINING ATTORNEY

CLASS 9—(Continued).

SN 77-287,711. ASCEND SOFTWARE INCORPORATED, BREA, CA. FILED 9-24-2007.

ITEMGURU

THE MARK CONSISTS OF STANDARD CHARACTERS WITHOUT CLAIM TO ANY PARTICULAR FONT, STYLE, SIZE, OR COLOR.

FOR (BASED ON USE IN COMMERCE) COMPUTER SOFTWARE FOR MANAGEMENT OF PURCHASING DECISIONS AND PURCHASE ORDER ACCURACY (U.S. CLS. 21, 23, 26, 36 AND 38).

FIRST USE 3-31-2006; IN COMMERCE 5-31-2006.

CIMMERIAN COLEMAN, EXAMINING ATTORNEY

SN 77-287,793. ASTHEBURGERTURNS HOLDINGS, LLC, BIRMINGHAM, AL. FILED 9-25-2007.

ASTHEBURGERTURNS

THE MARK CONSISTS OF STANDARD CHARACTERS WITHOUT CLAIM TO ANY PARTICULAR FONT, STYLE, SIZE, OR COLOR.

FOR DVDS FEATURING TRAINING MATERIALS FOR RESTAURANT MANAGERS, EMPLOYEES AND POTENTIAL EMPLOYEES IN THE FIELD OF RESTAURANT SERVICES; DOWNLOADABLE PODCASTS FOR RESTAURANT MANAGERS, EMPLOYEES AND POTENTIAL EMPLOYEES IN THE FIELD OF RESTAURANT SERVICES (U.S. CLS. 21, 23, 26, 36 AND 38).

TASHIA BUNCH, EXAMINING ATTORNEY

SN 77-288,159. COMSCI, LLC, EDISON, NJ. FILED 9-25-2007.

WIRELESSVISIBILITY

THE MARK CONSISTS OF STANDARD CHARACTERS WITHOUT CLAIM TO ANY PARTICULAR FONT, STYLE, SIZE, OR COLOR.

FOR COMPUTER SOFTWARE, NAMELY, AN EXPENSE MANAGEMENT TOOL FOR REPORTING, ANALYZING AND OPTIMIZING WIRELESS COMMUNICATION RATE PLANS, MANAGING CELLULAR TELEPHONE USE AND TRACKING EXPENSES ACROSS MULTIPLE WIRELESS CARRIERS AND CARRIER MARKETS (U.S. CLS. 21, 23, 26, 36 AND 38).

MARY ROSSMAN, EXAMINING ATTORNEY

CLASS 9—(Continued).

SN 77-288,608. ALI NOURBAKHS, MISSION VIEJO, CA. FILED 9-25-2007.

ILLHUMANNATION

THE MARK CONSISTS OF STANDARD CHARACTERS WITHOUT CLAIM TO ANY PARTICULAR FONT, STYLE, SIZE, OR COLOR.

FOR MUSICAL SOUND RECORDINGS; MUSICAL VIDEO RECORDINGS; PRE-RECORDED CDS, VIDEO TAPES, LASER DISKS AND DVDS FEATURING MUSIC, SONGS, LYRICS; BLANK CD-ROMS FOR SOUND OR VIDEO RECORDING; CD CASES; DOWNLOADABLE MUSICAL SOUND RECORDINGS; DOWNLOADABLE RING TONES, GRAPHICS AND MUSIC VIA A GLOBAL COMPUTER NETWORK AND WIRELESS DEVICES (U.S. CLS. 21, 23, 26, 36 AND 38).

SIMON TENG, EXAMINING ATTORNEY

SN 77-288,699. ARK'S MIND, LLC, BELLMORE, NY. FILED 9-25-2007.

Charge-Large

THE MARK CONSISTS OF STANDARD CHARACTERS WITHOUT CLAIM TO ANY PARTICULAR FONT, STYLE, SIZE, OR COLOR.

FOR INTERACTIVE VIDEO GAMES COMPRISED OF COMPUTER HARDWARE AND SOFTWARE (U.S. CLS. 21, 23, 26, 36 AND 38).

ANNE MADDEN, EXAMINING ATTORNEY

SN 77-289,279. ABC COIN, INC., FRISCO, TX. FILED 9-26-2007.

COIN EXCHANGE

THE MARK CONSISTS OF STANDARD CHARACTERS WITHOUT CLAIM TO ANY PARTICULAR FONT, STYLE, SIZE, OR COLOR.

OWNER OF U.S. REG. NO. 2,629,519.

NO CLAIM IS MADE TO THE EXCLUSIVE RIGHT TO USE "COIN", APART FROM THE MARK AS SHOWN.

SEC. 2(F).

FOR COIN COUNTING MACHINE THAT GIVES A DETAILED RECEIPT OF THE AMOUNT AND TYPE OF COINS COUNTED AND ISSUES A CERTIFICATE REDEEMABLE FOR COINS OR PAPER CURRENCY (U.S. CLS. 21, 23, 26, 36 AND 38).

FIRST USE 1-1-2002; IN COMMERCE 1-1-2002.

PATRICIA EVANKO, EXAMINING ATTORNEY

CLASS 9—(Continued).

SN 77-290,021. SHENZHEN DONJIN COMMUNICATION TECH CO., LTD., FUTIAN, SHENZHEN, CHINA, FILED 9-27-2007.

keygoe

THE MARK CONSISTS OF THE WORD "KEYGOE".
 FOR COMMUNICATION HUBS; COMPUTER KEYBOARDS; COMPUTER CENTRAL PROCESSING UNITS; CENTRAL PROCESSING UNITS FOR PROCESSING INFORMATION, DATA, SOUND OR IMAGES; AUTOMATIC SWITCHING APPARATUS; ELECTRONIC AND OPTICAL COMMUNICATIONS INSTRUMENTS AND COMPONENTS, NAMELY, OPTICAL TRANSMITTERS; COMPUTER SOFTWARE TO MONITOR AND CONTROL FACTORY MANUFACTURING PROCESSES; MODEMS; COMPUTER MONITORS; SOUND RECORDING APPARATUS (U.S. CLS. 21, 23, 26, 36 AND 38).
 FIRST USE 10-10-2006; IN COMMERCE 5-5-2007.
 CURTIS FRENCH, EXAMINING ATTORNEY

SN 77-290,022. SHENZHEN DONJIN COMMUNICATION TECH CO., LTD., FUTIAN, SHENZHEN, CHINA, FILED 9-27-2007.

eoogoe

THE MARK CONSISTS OF THE WORD "EOOGOE".
 FOR COMMUNICATION HUBS; COMPUTER KEYBOARDS; COMPUTER CENTRAL PROCESSING UNITS; CENTRAL PROCESSING UNITS FOR PROCESSING INFORMATION, DATA, SOUND OR IMAGES; AUTOMATIC SWITCHING APPARATUS; ELECTRONIC AND OPTICAL COMMUNICATIONS INSTRUMENTS AND COMPONENTS, NAMELY, OPTICAL TRANSMITTERS; COMPUTER SOFTWARE TO MONITOR AND CONTROL FACTORY MANUFACTURING PROCESSES; MODEMS; COMPUTER MONITORS; SOUND RECORDING APPARATUS (U.S. CLS. 21, 23, 26, 36 AND 38).
 FIRST USE 10-10-2006; IN COMMERCE 5-5-2007.
 CURTIS FRENCH, EXAMINING ATTORNEY

CLASS 9—(Continued).

SN 77-290,075. HALL, SHELLIE L., CHICAGO, IL. FILED 9-27-2007.

get creative 

FOR (BASED ON INTENT TO USE) AUDIO AND VIDEO RECORDINGS FEATURING CREATIVE MEDIA PUBLISHING; DOWNLOADABLE MP3 FILES, MP3 RECORDINGS, ONLINE DISCUSSION BOARDS, WEBCASTS AND PODCASTS FEATURING MUSIC, AUDIO BOOKS AND NEWS BROADCASTS; DOWNLOADABLE MULTIMEDIA FILE CONTAINING ARTWORK, TEXT, AUDIO, VIDEO, GAMES, AND INTERNET WEB LINKS RELATING TO CREATIVE MEDIA PUBLISHING; DOWNLOADABLE PODCASTS IN THE FIELD OF CREATIVE MEDIA PUBLISHING; DOWNLOADABLE VIDEO RECORDINGS FEATURING CREATIVE MEDIA PUBLISHING (U.S. CLS. 21, 23, 26, 36 AND 38).
 SHANNON TWOHIG, EXAMINING ATTORNEY

SN 77-290,317. FROGWARE, LLC, CYPRESS, TX. FILED 9-27-2007.

FrogWare

THE MARK CONSISTS OF STANDARD CHARACTERS WITHOUT CLAIM TO ANY PARTICULAR FONT, STYLE, SIZE, OR COLOR.
 FOR COMPUTER SOFTWARE FOR PERSONAL ORGANIZATION, CONTACT MANAGEMENT, EVENT PLANNING, AND WEDDING PLANNING (U.S. CLS. 21, 23, 26, 36 AND 38).
 FIRST USE 6-1-1996; IN COMMERCE 1-1-1997.
 NAPOLEON SHARMA, EXAMINING ATTORNEY

SN 77-290,428. SUBTERRACOM WIRELESS SOLUTIONS, LLC, EAST BRUNSWICK, NJ. FILED 9-27-2007.

SUBTERRA-VOIP

THE MARK CONSISTS OF STANDARD CHARACTERS WITHOUT CLAIM TO ANY PARTICULAR FONT, STYLE, SIZE, OR COLOR.
 FOR WIRELESS MOBILE TELEPHONE APPARATUS FOR VOICE COMMUNICATIONS WITHIN AND TO AND FROM UNDERGROUND MINES (U.S. CLS. 21, 23, 26, 36 AND 38).
 JEAN IM, EXAMINING ATTORNEY

CLASS 9—(Continued).

SN 77-290,446. RUSSOUND/FMP INC., NEWMARKET, NH. FILED 9-27-2007.

AVENUE

THE MARK CONSISTS OF STANDARD CHARACTERS WITHOUT CLAIM TO ANY PARTICULAR FONT, STYLE, SIZE, OR COLOR.

FOR ELECTRONIC EQUIPMENT FOR DISTRIBUTION OF AUDIO AND CONTROL SIGNALS OVER RESIDENTIAL WIRING (U.S. CLS. 21, 23, 26, 36 AND 38).

FIRST USE 9-6-2007; IN COMMERCE 9-6-2007.

TRACY CROSS, EXAMINING ATTORNEY

CLASS 9—(Continued).

SN 77-291,260. LEISURELOGIX, LLC, OLDSMAR, FL. FILED 9-28-2007.

LEISURELOGIX

THE MARK CONSISTS OF STANDARD CHARACTERS WITHOUT CLAIM TO ANY PARTICULAR FONT, STYLE, SIZE, OR COLOR.

FOR COMPUTER SOFTWARE FOR ROAD TRIP PLANNING, MAPPING AND TRAVEL RESERVATIONS (U.S. CLS. 21, 23, 26, 36 AND 38).

ANDREW RHIM, EXAMINING ATTORNEY

SN 77-290,578. DAVID ALLEN & CO., OJAI, CA. FILED 9-27-2007.

**THE SHORTEST DISTANCE
BETWEEN YOU AND SUCCESS**

THE MARK CONSISTS OF STANDARD CHARACTERS WITHOUT CLAIM TO ANY PARTICULAR FONT, STYLE, SIZE, OR COLOR.

FOR DVDS, CDS, AND SOFTWARE FEATURING INFORMATION AND INSTRUCTION ON THE DEVELOPMENT OF MANAGEMENT AND BUSINESS SKILLS, EFFICIENT WORK HABITS, PLANNING AND ORGANIZATIONAL TECHNIQUES, AND PERSONAL PRODUCTIVITY GROWTH; AND PRERECORDED VIDEO AND AUDIO CASSETTE TAPES FEATURING INFORMATION AND INSTRUCTION ON THE DEVELOPMENT OF MANAGEMENT AND BUSINESS SKILLS, EFFICIENT WORK HABITS, PLANNING AND ORGANIZATIONAL TECHNIQUES, AND PERSONAL PRODUCTIVITY AND GROWTH (U.S. CLS. 21, 23, 26, 36 AND 38).

FIRST USE 5-15-2006; IN COMMERCE 5-15-2006.

KATHRYN COWARD, EXAMINING ATTORNEY

SN 77-291,280. SAHU, BHIM P, LEANDER, TX. FILED 9-28-2007.

On Duty Manager

THE MARK CONSISTS OF STANDARD CHARACTERS WITHOUT CLAIM TO ANY PARTICULAR FONT, STYLE, SIZE, OR COLOR.

FOR COMPUTER E-COMMERCE SOFTWARE TO ALLOW USERS TO PERFORM ELECTRONIC BUSINESS TRANSACTIONS VIA A GLOBAL COMPUTER NETWORK (U.S. CLS. 21, 23, 26, 36 AND 38).

CHRISTOPHER BUONGIORNO, EXAMINING ATTORNEY

SN 77-290,686. JAMES A. WIRKUS, PEWAUKEE, WI. FILED 9-27-2007.

CALCUGRAM

THE MARK CONSISTS OF STANDARD CHARACTERS WITHOUT CLAIM TO ANY PARTICULAR FONT, STYLE, SIZE, OR COLOR.

FOR CALCULATORS (U.S. CLS. 21, 23, 26, 36 AND 38).

MICHAEL KAZAZIAN, EXAMINING ATTORNEY

SN 77-291,285. RHEOSENSE, INC., SAN RAMON, CA. FILED 9-28-2007.

VROC

THE MARK CONSISTS OF STANDARD CHARACTERS WITHOUT CLAIM TO ANY PARTICULAR FONT, STYLE, SIZE, OR COLOR.

FOR RHEOMETERS AND VISCOMETERS FOR MEASURING THE VISCOSITY, VISCOELASTICITY, TEMPERATURE, AND PRESSURE OF FLUIDS (U.S. CLS. 21, 23, 26, 36 AND 38).

FIRST USE 7-12-2007; IN COMMERCE 7-12-2007.

BRIAN PINO, EXAMINING ATTORNEY

CLASS 9—(Continued).

SN 77-291,368. CONEXXUS, LOUISVILLE, KY. FILED 9-28-2007.



THE MARK CONSISTS OF A STYLIZED SUN INSIDE A BOX WITH THE STYLIZED WORD "CONEXXUS" NEXT TO THE BOX WITH THE SUN.

FOR COMPUTER SOFTWARE FOR ACCOUNTING AND AUDITING (U.S. CLS. 21, 23, 26, 36 AND 38).
FIRST USE 2-5-2007; IN COMMERCE 6-1-2007.
MATTHEW MCDOWELL, EXAMINING ATTORNEY

SN 77-291,396. BDSRCO, INC., WILMINGTON, DE. FILED 9-28-2007.

WURL

THE MARK CONSISTS OF STANDARD CHARACTERS WITHOUT CLAIM TO ANY PARTICULAR FONT, STYLE, SIZE, OR COLOR.

FOR SUNGLASSES (U.S. CLS. 21, 23, 26, 36 AND 38).
MIDGE BUTLER, EXAMINING ATTORNEY

SN 77-291,398. INTRICON CORPORATION, ARDEN HILLS, MN. FILED 9-28-2007.

ETHOS

THE MARK CONSISTS OF STANDARD CHARACTERS WITHOUT CLAIM TO ANY PARTICULAR FONT, STYLE, SIZE, OR COLOR.

FOR DIGITAL SIGNAL PROCESSOR AMPLIFIER FOR HEARING AIDS (U.S. CLS. 21, 23, 26, 36 AND 38).
TINA KUAN, EXAMINING ATTORNEY

CLASS 9—(Continued).

SN 77-291,446. ENVIRONMENTAL SUPPORT SOLUTIONS, INC., TEMPE, AZ. FILED 9-28-2007.

TOTAL EMISSIONS MANAGEMENT SOLUTION

THE MARK CONSISTS OF STANDARD CHARACTERS WITHOUT CLAIM TO ANY PARTICULAR FONT, STYLE, SIZE, OR COLOR.

NO CLAIM IS MADE TO THE EXCLUSIVE RIGHT TO USE "EMISSIONS MANAGEMENT", APART FROM THE MARK AS SHOWN.

FOR COMPUTER SOFTWARE USED TO MANAGE MULTI-MEDIA EMISSIONS INFORMATION FOR REGULATORY COMPLIANCE AND RISK MANAGEMENT (U.S. CLS. 21, 23, 26, 36 AND 38).

MIDGE BUTLER, EXAMINING ATTORNEY

SN 77-291,464. B-NOW ENTERPRISES, INC., SANTA FE, NM. FILED 9-28-2007.

TEMPO IN MOTION

THE MARK CONSISTS OF STANDARD CHARACTERS WITHOUT CLAIM TO ANY PARTICULAR FONT, STYLE, SIZE, OR COLOR.

FOR DIGITAL MEDIA, NAMELY, DOWNLOADABLE AUDIO AND VIDEO FILES, CDS AND DVDS FEATURING SPORTS TRAINING AIDS (U.S. CLS. 21, 23, 26, 36 AND 38).

BILL DAWE, EXAMINING ATTORNEY

SN 77-291,476. SWANSON, LIANNE STERLING, AGUA DULCE, CA. FILED 9-28-2007.

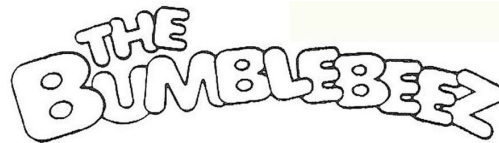

THE MARK CONSISTS OF STYLIZED LETTERING OF THE WORDS "THE BUMBLEBEEZ".

FOR AUDIO RECORDINGS FEATURING MUSIC AND LYRICS; CHILDREN'S EDUCATIONAL MUSIC CDS AND DVDS; DOWNLOADABLE MUSICAL SOUND RECORDINGS; DOWNLOADABLE RING TONES, GRAPHICS AND MUSIC VIA A GLOBAL COMPUTER NETWORK AND WIRELESS DEVICES; DOWNLOADABLE VIDEO RECORDINGS FEATURING MUSIC AND LYRICS; DOWNLOADABLE MUSICAL PERFORMANCES, RINGTONES VIA THE INTERNET AND WIRELESS DEVICES; SOUND RECORDINGS FEATURING MUSIC AND LYRICS; VIDEO RECORDINGS FEATURING MUSIC AND LYRICS; VISUAL RECORDINGS AND AUDIO VISUAL RECORDINGS FEATURING MUSIC AND ANIMATION (U.S. CLS. 21, 23, 26, 36 AND 38).

FIRST USE 3-1-1990; IN COMMERCE 3-1-1990.
ALLISON SCHRODY, EXAMINING ATTORNEY

CLASS 9—(Continued).

SN 77-291,478. ENVIRONMENTAL SUPPORT SOLUTIONS, INC., TEMPE, AZ. FILED 9-28-2007.

TEMS

THE MARK CONSISTS OF STANDARD CHARACTERS WITHOUT CLAIM TO ANY PARTICULAR FONT, STYLE, SIZE, OR COLOR.

FOR COMPUTER SOFTWARE USED TO MANAGE MULTI-MEDIA EMISSIONS INFORMATION FOR REGULATORY COMPLIANCE AND MANAGEMENT (U.S. CLS. 21, 23, 26, 36 AND 38).

MIDGE BUTLER, EXAMINING ATTORNEY

SN 77-291,492. WIRELESS INPUT INC., GRAYSLAKE, IL. FILED 9-28-2007.

iPWR

THE MARK CONSISTS OF STANDARD CHARACTERS WITHOUT CLAIM TO ANY PARTICULAR FONT, STYLE, SIZE, OR COLOR.

FOR BATTERY CHARGE DEVICES; BATTERY CHARGERS; PORTABLE MEDIA PLAYERS; CELL PHONE BATTERY CHARGERS; CELLULAR PHONES; DIGITAL CELLULAR PHONES; INTERNET PHONES; KEYBOARDS FOR MOBILE PHONES; GAMING MACHINES; HEADSETS FOR TELEPHONES; CARRYING CASES SPECIALLY ADAPTED FOR POCKET CALCULATORS AND CELLPHONES; COMMUNICATIONS HEADSETS FOR USE WITH COMMUNICATION RADIOS, INTERCOM SYSTEMS, OR OTHER COMMUNICATIONS NETWORK TRANSCIVERS; TELEPHONE HEADSETS; LAPTOP COMPUTERS; BACKUP DRIVES FOR COMPUTERS; BATTERIES; BATTERY CASES; BATTERY PACKS; BATTERY TERMINAL CONNECTOR CLAMPS; CELL PHONE BATTERY CHARGERS FOR USE IN VEHICLES; ELECTRIC STORAGE BATTERIES; ELECTRICAL CELLS AND BATTERIES; ELECTRICAL STORAGE BATTERIES; EMERGENCY AUTO KITS COMPRISED OF A HAND HELD SPOTLIGHT AND BATTERY CHARGER; INTEGRATED BATTERY BACKUP SYSTEMS COMPRISING A BATTERY, AN ELECTRONIC MEASUREMENT APPARATUS FOR USE IN THE MEASUREMENT OF BATTERY HEALTH AND PERFORMANCE, AND A REMOTE COMPUTER SOFTWARE PROGRAM THAT USES THE FOREGOING DATA TO TREND, PREDICT, AND STORE DATA RELATED TO THE HEALTH OF THE BATTERY; MOBILE TELEPHONE BATTERIES; RECHARGEABLE ELECTRIC BATTERIES; REMOVABLE HARD DRIVE BASED COMPUTER BACKUP SYSTEMS; RENEWABLE BATTERY SYSTEM TO PROVIDE BACKUP POWER; SOLAR RECHARGING BATTERY PACK FOR DIGITAL CAMERAS (U.S. CLS. 21, 23, 26, 36 AND 38).

MICHAEL SOUDERS, EXAMINING ATTORNEY

CLASS 9—(Continued).

SN 77-291,546. LEX PRODUCTS CORP., STAMFORD, CT. FILED 9-28-2007.

E-STRING

THE MARK CONSISTS OF STANDARD CHARACTERS WITHOUT CLAIM TO ANY PARTICULAR FONT, STYLE, SIZE, OR COLOR.

FOR ELECTRICAL POWER EXTENSION CORDS (U.S. CLS. 21, 23, 26, 36 AND 38).

LINDA ORNDORFF, EXAMINING ATTORNEY

SN 77-291,653. TIFFEN ACQUISITION, L.L.C., HAUPAUGE, NY. FILED 9-28-2007.

RED SLED

THE MARK CONSISTS OF STANDARD CHARACTERS WITHOUT CLAIM TO ANY PARTICULAR FONT, STYLE, SIZE, OR COLOR.

NO CLAIM IS MADE TO THE EXCLUSIVE RIGHT TO USE "SLED", APART FROM THE MARK AS SHOWN.

FOR FILM AND VIDEO CAMERA MOUNTING APPARATUS, NAMELY, A PLATFORM WHICH HOLDS THE CAMERA, BATTERY AND MONITOR AND AN ARM FOR ADJUSTABLY MOVING THE PLATFORM; OPERATOR-SUPPORTED FILM AND VIDEO CAMERA STABILIZERS AND COMPONENTS THEREOF, NAMELY, VEST, MONITOR, POWER SUPPLY, ARTICULATED ARM, BOOM, POST, LIFT, GIMBAL, SPEAKER, INFRARED REMOTE, CONNECTOR AND CASE ALL SOLD AS A UNIT (U.S. CLS. 21, 23, 26, 36 AND 38).

TARAH HARDY, EXAMINING ATTORNEY

SN 77-291,678. LEX PRODUCTS CORP., STAMFORD, CT. FILED 9-28-2007.

DATASNAKE

THE MARK CONSISTS OF STANDARD CHARACTERS WITHOUT CLAIM TO ANY PARTICULAR FONT, STYLE, SIZE, OR COLOR.

FOR ELECTRIC WIRES AND CABLES; ELECTRICAL CABLES AND CORDSETS (U.S. CLS. 21, 23, 26, 36 AND 38).

FIRST USE 10-31-2004; IN COMMERCE 10-31-2004.

LINDA ORNDORFF, EXAMINING ATTORNEY

CLASS 9—(Continued).

SN 77-291,918. PANAVISION IMAGING, LLC, HOMER, NY. FILED 9-28-2007.

DYNAMAX

THE MARK CONSISTS OF STANDARD CHARACTERS WITHOUT CLAIM TO ANY PARTICULAR FONT, STYLE, SIZE, OR COLOR.

FOR INTEGRATED CIRCUITS FOR USE IN DIGITAL IMAGING SENSORS AND DIGITAL IMAGING EQUIPMENT (U.S. CLS. 21, 23, 26, 36 AND 38).
ELLEN BURNS, EXAMINING ATTORNEY

SN 77-292,030. FRED WAGENHALS, SCOTTSDALE, AZ. FILED 9-28-2007.

FAN HUB

THE MARK CONSISTS OF STANDARD CHARACTERS WITHOUT CLAIM TO ANY PARTICULAR FONT, STYLE, SIZE, OR COLOR.

NO CLAIM IS MADE TO THE EXCLUSIVE RIGHT TO USE "HUB", APART FROM THE MARK AS SHOWN.

FOR INTERACTIVE COMPUTER KIOSKS COMPRISING COMPUTERS, COMPUTER HARDWARE, COMPUTER PERIPHERALS, AND COMPUTER OPERATING SOFTWARE, FOR USE IN ONLINE SALES OF GIFTS, NAMELY, APPAREL, NOVELTY ITEMS, ELECTRONIC POSTCARDS, AND AUDIO/VISUAL GREETING MESSAGES (U.S. CLS. 21, 23, 26, 36 AND 38).
MARILYN IZZI, EXAMINING ATTORNEY

SN 77-292,045. DYNAMIC DETAILS, INC., ANAHEIM, CA. FILED 9-28-2007.

FLAT-WRAP

THE MARK CONSISTS OF STANDARD CHARACTERS WITHOUT CLAIM TO ANY PARTICULAR FONT, STYLE, SIZE, OR COLOR.

FOR PRINTED CIRCUIT BOARDS (U.S. CLS. 21, 23, 26, 36 AND 38).
RAUL CORDOVA, EXAMINING ATTORNEY

CLASS 9—(Continued).

SN 77-292,048. KAYAKO, INC., BOISE, ID. FILED 9-28-2007.

KAYAKO

THE MARK CONSISTS OF STANDARD CHARACTERS WITHOUT CLAIM TO ANY PARTICULAR FONT, STYLE, SIZE, OR COLOR.

FOR COMPUTER SOFTWARE FOR USE IN CUSTOMER RELATIONSHIP MANAGEMENT (CRM) (U.S. CLS. 21, 23, 26, 36 AND 38).
FIRST USE 11-30-2001; IN COMMERCE 11-30-2001.
RAUL CORDOVA, EXAMINING ATTORNEY

SN 77-292,055. FRED WAGENHALS, SCOTTSDALE, AZ. FILED 9-28-2007.



NO CLAIM IS MADE TO THE EXCLUSIVE RIGHT TO USE HUB, APART FROM THE MARK AS SHOWN.

THE MARK CONSISTS OF THE WORDS "FAN" AND "HUB" INSIDE A RECTANGLE WITH THE WORDS VERTICALLY OFFSET FROM EACH OTHER WITH THE UPPER RIGHT PORTION OF THE LETTER "N" HAVING AN ELONGATED LINE POSITIONED OVER THE WORD "HUB", WHILE THE LOWER LEFT PORTION OF THE LETTER "H" HAVING AN ELONGATED LINE POSITIONED UNDER THE WORD "FAN". A FIVE POINT STAR IS EMBEDDED WITHIN THE LETTERS "A" AND "U" RESPECTIVELY.

FOR INTERACTIVE COMPUTER KIOSKS COMPRISING COMPUTERS, COMPUTER HARDWARE, COMPUTER PERIPHERALS, AND COMPUTER OPERATING SOFTWARE, FOR USE IN ONLINE SALES OF GIFTS, NAMELY APPAREL, NOVELTY ITEMS, ELECTRONIC POSTCARDS, AND AUDIO/VISUAL GREETING MESSAGES (U.S. CLS. 21, 23, 26, 36 AND 38).
MARILYN IZZI, EXAMINING ATTORNEY

CLASS 9—(Continued).

SN 77-292,057. TEKTRONIX, INC., BEAVERTON, OR. FILED 9-28-2007.

DPX

THE MARK CONSISTS OF STANDARD CHARACTERS WITHOUT CLAIM TO ANY PARTICULAR FONT, STYLE, SIZE, OR COLOR.

OWNER OF U.S. REG. NOS. 2,616,016 AND 3,259,496.

FOR COMPONENT FEATURE OF AN ELECTRONIC TEST AND MEASUREMENT INSTRUMENT, NAMELY, AN OSCILLOSCOPE OR SPECTRUM ANALYZER, FOR PROCESSING ELECTRICAL WAVEFORM SIGNALS FOR DISPLAY BY THE INSTRUMENT (U.S. CLS. 21, 23, 26, 36 AND 38).

FIRST USE 6-14-2002; IN COMMERCE 6-14-2002.

MARILYN IZZI, EXAMINING ATTORNEY

CLASS 9—(Continued).

SN 77-292,311. MED-VANTAGE, INC., SAN FRANCISCO, CA. FILED 9-29-2007.

QSDirectory

THE MARK CONSISTS OF STANDARD CHARACTERS WITHOUT CLAIM TO ANY PARTICULAR FONT, STYLE, SIZE, OR COLOR.

FOR COMPUTER SOFTWARE IN THE NATURE OF A DATABASE AND BUSINESS RULES SYSTEM FOR USE IN CREATING PERFORMANCE MEASURES ON HEALTH CARE DATA (U.S. CLS. 21, 23, 26, 36 AND 38).

FIRST USE 7-23-2007; IN COMMERCE 7-23-2007.

JENNY PARK, EXAMINING ATTORNEY

SN 77-292,125. FANDEEN PUBLISHING COMPANY, OVERLAND PARK, KS. FILED 9-28-2007.



The logo for ASR Records features the letters 'ASR' in a large, stylized, bold font. The letter 'A' is particularly prominent, with a horizontal line extending from its base. Below 'ASR', the word 'Records' is written in a smaller, simpler font, underlined.

NO CLAIM IS MADE TO THE EXCLUSIVE RIGHT TO USE "RECORDS", APART FROM THE MARK AS SHOWN.

THE MARK CONSISTS OF THE STYLIZED CAPITAL LETTERS "ASR" IN WITH 3 LINES COMING OUT FROM THE "A" GOING HORIZONTALLY UNDER THE WORD. THE STYLIZED WORD "RECORDS" IS UNDERNEATH.

THE FOREIGN WORDING IN THE MARK TRANSLATES INTO ENGLISH AS "TIME THROUGH THE AGES".

FOR DIGITAL MATERIALS, NAMELY, CDS AND DVDS FEATURING JAZZ MUSIC PERFORMANCES AND CLINICS (U.S. CLS. 21, 23, 26, 36 AND 38).

FIRST USE 1-0-1995; IN COMMERCE 5-0-1995.

AMY HELLA, EXAMINING ATTORNEY

SN 77-292,324. PIRIA, INC., LOUISVILLE, CO. FILED 9-29-2007.

Rambla

THE MARK CONSISTS OF STANDARD CHARACTERS WITHOUT CLAIM TO ANY PARTICULAR FONT, STYLE, SIZE, OR COLOR.

FOR WEB SITE DEVELOPMENT SOFTWARE; COMPUTER SOFTWARE, NAMELY, SOFTWARE DEVELOPMENT TOOLS FOR THE CREATION OF MOBILE INTERNET APPLICATIONS AND CLIENT INTERFACES (U.S. CLS. 21, 23, 26, 36 AND 38).

DEIRDRE ROBERTSON, EXAMINING ATTORNEY

SN 77-292,306. MED-VANTAGE, INC, SAN FRANCISCO, CA. FILED 9-29-2007.

EPDirectory

THE MARK CONSISTS OF STANDARD CHARACTERS WITHOUT CLAIM TO ANY PARTICULAR FONT, STYLE, SIZE, OR COLOR.

FOR COMPUTER SOFTWARE IN THE NATURE OF A DATABASE AND BUSINESS RULES SYSTEM FOR USE IN CREATING PERFORMANCE MEASURES ON HEALTH CARE DATA (U.S. CLS. 21, 23, 26, 36 AND 38).

FIRST USE 7-23-2007; IN COMMERCE 7-23-2007.

ESTHER A. BORSUK, EXAMINING ATTORNEY

SN 77-292,376. MYOSOTIC LLC, WOODINVILLE, WA. FILED 9-30-2007.

Myosotic SignaPoint

THE MARK CONSISTS OF STANDARD CHARACTERS WITHOUT CLAIM TO ANY PARTICULAR FONT, STYLE, SIZE, OR COLOR.

FOR MEDICAL SOFTWARE FOR ANALYSIS OF BIOMEDICAL SIGNALS (U.S. CLS. 21, 23, 26, 36 AND 38).

FIRST USE 10-31-2005; IN COMMERCE 10-31-2005.

KAREN K. BUSH, EXAMINING ATTORNEY

CLASS 9—(Continued).

SN 77-292,420. D-GENERATION, INC., DAYTONA BEACH, FL. FILED 9-30-2007.

LIVE LAUGH LOVE

THE MARK CONSISTS OF STANDARD CHARACTERS WITHOUT CLAIM TO ANY PARTICULAR FONT, STYLE, SIZE, OR COLOR.

FOR DECORATIVE MAGNETS; DECORATIVE REFRIGERATOR MAGNETS (U.S. CLS. 21, 23, 26, 36 AND 38).

FIRST USE 6-8-1999; IN COMMERCE 6-8-1999.
CARYN GLASSER, EXAMINING ATTORNEY

SN 77-292,501. SANGREAL MUSIC, INC., NORTH HOLLYWOOD, CA. FILED 10-1-2007.

DIVINE HERESY

THE MARK CONSISTS OF STANDARD CHARACTERS WITHOUT CLAIM TO ANY PARTICULAR FONT, STYLE, SIZE, OR COLOR.

FOR SERIES OF MUSICAL SOUND RECORDINGS (U.S. CLS. 21, 23, 26, 36 AND 38).

MICHAEL ENGEL, EXAMINING ATTORNEY

SN 77-292,523. INTEGRITY NEWS MEDIA, INC., LA JOLLA, CA. FILED 10-1-2007.

Fashion Fantasy Fortune

THE MARK CONSISTS OF STANDARD CHARACTERS WITHOUT CLAIM TO ANY PARTICULAR FONT, STYLE, SIZE, OR COLOR.

NO CLAIM IS MADE TO THE EXCLUSIVE RIGHT TO USE "FASHION", APART FROM THE MARK AS SHOWN, FOR INTERACTIVE MULTIMEDIA COMPUTER GAME PROGRAM (U.S. CLS. 21, 23, 26, 36 AND 38).

FIRST USE 10-1-2007; IN COMMERCE 10-1-2007.
REBECCA GILBERT, EXAMINING ATTORNEY

CLASS 9—(Continued).

SN 77-292,539. THE FONT BUREAU, INC., BOSTON, MA. FILED 10-1-2007.

MODERNO FB

THE MARK CONSISTS OF STANDARD CHARACTERS WITHOUT CLAIM TO ANY PARTICULAR FONT, STYLE, SIZE, OR COLOR.

NO CLAIM IS MADE TO THE EXCLUSIVE RIGHT TO USE "MODERNO", APART FROM THE MARK AS SHOWN. THE ENGLISH TRANSLATION OF THE WORD "MODERNO" IN THE MARK IS "MODERN".

FOR PRINTING FONTS THAT CAN BE DOWNLOADED PROVIDED BY MEANS OF ELECTRONIC TRANSMISSION; TYPEFACE FONTS RECORDED ON MAGNETIC MEDIA (U.S. CLS. 21, 23, 26, 36 AND 38).

FIRST USE 9-12-2007; IN COMMERCE 9-12-2007.
SUSAN LESLIE DUBOIS, EXAMINING ATTORNEY

SN 77-292,671. INFOVISA, INC., CORNELIUS, NC. FILED 10-1-2007.

MAUI

THE MARK CONSISTS OF STANDARD CHARACTERS WITHOUT CLAIM TO ANY PARTICULAR FONT, STYLE, SIZE, OR COLOR.

FOR COMPUTER SOFTWARE FOR USE IN TRUST ACCOUNTING (U.S. CLS. 21, 23, 26, 36 AND 38).

FIRST USE 1-2-1997; IN COMMERCE 1-2-1997.
PAUL F. GAST, EXAMINING ATTORNEY

SN 77-292,678. INFOVISA, INC., CORNELIUS, NC. FILED 10-1-2007.

TRUST MESSENGER

THE MARK CONSISTS OF STANDARD CHARACTERS WITHOUT CLAIM TO ANY PARTICULAR FONT, STYLE, SIZE, OR COLOR.

NO CLAIM IS MADE TO THE EXCLUSIVE RIGHT TO USE "TRUST", APART FROM THE MARK AS SHOWN.

FOR COMPUTER SOFTWARE FOR USE IN TRUST ACCOUNTING (U.S. CLS. 21, 23, 26, 36 AND 38).

PAUL F. GAST, EXAMINING ATTORNEY

CLASS 9—(Continued).

SN 77-292,707. AGILIS INTERNATIONAL, INC., ROCKVILLE, MD. FILED 10-1-2007.

CLASS 9—(Continued).

SN 77-292,753. IMOTIONS - EMOTION TECHNOLOGY A/S, COPENHAGEN, DENMARK, FILED 10-1-2007.

Accelerate Your Gain

IMOTIONS EMOTION TOOL

THE MARK CONSISTS OF STANDARD CHARACTERS WITHOUT CLAIM TO ANY PARTICULAR FONT, STYLE, SIZE, OR COLOR.

FOR COMPUTER SOFTWARE FOR PROVIDING AN ON-LINE DATABASE IN THE FIELD OF TRANSACTION PROCESSING TO UPLOAD TRANSACTIONAL DATA, PROVIDE STATISTICAL ANALYSIS, AND PRODUCE NOTIFICATIONS AND REPORTS; COMPUTER SOFTWARE FOR THE FIELD OF WAREHOUSING AND DISTRIBUTION, TO MANAGE TRANSACTIONAL DATA, PROVIDE STATISTICAL ANALYSIS, AND PRODUCE NOTIFICATIONS AND REPORTS (U.S. CLS. 21, 23, 26, 36 AND 38).

STEVEN R. FINE, EXAMINING ATTORNEY

THE MARK CONSISTS OF STANDARD CHARACTERS WITHOUT CLAIM TO ANY PARTICULAR FONT, STYLE, SIZE, OR COLOR.

OWNER OF U.S. REG. NOS. 3,245,073 AND 3,354,582. NO CLAIM IS MADE TO THE EXCLUSIVE RIGHT TO USE "EMOTION TOOL", APART FROM THE MARK AS SHOWN.

FOR COMPUTER SOFTWARE FOR USE IN TRACKING AND COLLECTING INFORMATION ABOUT THE EYE PROPERTIES AND PSYCHO-PHYSIOLOGICAL CHANGES OF HUMANS AND MEASURING, ANALYZING, MODELING AND REPRODUCING THE COGNITIVE, AND EMOTIONAL PROCESSES IN HUMAN BEINGS (U.S. CLS. 21, 23, 26, 36 AND 38).

ADA HAN, EXAMINING ATTORNEY

SN 77-292,742. AGILIS INTERNATIONAL, INC., ROCKVILLE, MD. FILED 10-1-2007.

SN 77-292,908. KOEI CO., LTD., YOKOHAMA, JAPAN, FILED 10-1-2007.

TrafficMind

OPOONA

THE MARK CONSISTS OF STANDARD CHARACTERS WITHOUT CLAIM TO ANY PARTICULAR FONT, STYLE, SIZE, OR COLOR.

FOR COMPUTER SOFTWARE THAT PROVIDES REAL-TIME, INTEGRATED BUSINESS MANAGEMENT INTELLIGENCE BY COMBINING INFORMATION FROM VARIOUS DATABASES AND PRESENTING IT IN AN EASY-TO-UNDERSTAND USER INTERFACE; COMPUTER SOFTWARE FOR PROVIDING AN ON-LINE DATABASE IN THE FIELD OF TRANSACTION PROCESSING TO UPLOAD TRANSACTIONAL DATA, PROVIDE STATISTICAL ANALYSIS, AND PRODUCE NOTIFICATIONS AND REPORTS (U.S. CLS. 21, 23, 26, 36 AND 38).

STEVEN R. FINE, EXAMINING ATTORNEY

THE MARK CONSISTS OF STANDARD CHARACTERS WITHOUT CLAIM TO ANY PARTICULAR FONT, STYLE, SIZE, OR COLOR.

FOR COMPUTER GAME DISCS, COMPUTER GAME PROGRAMS, COMPUTER GAME SOFTWARE; VIDEO GAME DISCS, VIDEO GAME PROGRAMS, VIDEO GAME SOFTWARE; DOWNLOADABLE COMPUTER GAME SOFTWARE, DOWNLOADABLE VIDEO GAME SOFTWARE; USER MANUALS PROVIDED TOGETHER THEREWITH AS A UNIT (U.S. CLS. 21, 23, 26, 36 AND 38).

KIMBERLY PERRY, EXAMINING ATTORNEY

CLASS 9—(Continued).

SN 77-292,939. BRINK, WILL, NATICK, MA. FILED 10-1-2007.

**BRINK'S BODY BUILDING
REVEALED**

THE MARK CONSISTS OF STANDARD CHARACTERS WITHOUT CLAIM TO ANY PARTICULAR FONT, STYLE, SIZE, OR COLOR.

NO CLAIM IS MADE TO THE EXCLUSIVE RIGHT TO USE "BODY BUILDING", APART FROM THE MARK AS SHOWN.

FOR DOWNLOADABLE ELECTRONIC PUBLICATIONS IN THE NATURE OF BOOKS IN THE FIELD OF HEALTH, WELLNESS, FITNESS, BODY BUILDING, WEIGHT LOSS, NUTRITION, AND NUTRITIONAL SUPPLEMENTS (U.S. CLS. 21, 23, 26, 36 AND 38).

FIRST USE 0-0-2006; IN COMMERCE 0-0-2006.
BARBARA A. GOLD, EXAMINING ATTORNEY

SN 77-292,941. I.D. SYSTEMS, INC., HACKENSACK, NJ. FILED 10-1-2007.



THE MARK CONSISTS OF THE LITERAL ELEMENT "AVRAMP" WITH A STYLIZED INITIAL LETTER "A" DEPICTING AN AIRPLANE IN FLIGHT.

FOR WIRELESS TRANSMITTERS AND RECEIVERS FOR USE WITH AIRCRAFT GROUND SUPPORT EQUIPMENT AND OPERATORS OF AIRCRAFT GROUND SUPPORT EQUIPMENT; COMPUTER HARDWARE AND SOFTWARE FOR WIRELESSLY MANAGING, MONITORING, ANALYZING, AND TRACKING AIRCRAFT GROUND SUPPORT EQUIPMENT AND OPERATORS OF AIRCRAFT GROUND SUPPORT EQUIPMENT (U.S. CLS. 21, 23, 26, 36 AND 38).

BARBARA A. GOLD, EXAMINING ATTORNEY

SN 77-292,942. AVA SOLAR, INC., FT. COLLINS, CO. FILED 10-1-2007.

AVA SOLAR

THE MARK CONSISTS OF STANDARD CHARACTERS WITHOUT CLAIM TO ANY PARTICULAR FONT, STYLE, SIZE, OR COLOR.

NO CLAIM IS MADE TO THE EXCLUSIVE RIGHT TO USE "SOLAR", APART FROM THE MARK AS SHOWN.

FOR PHOTOVOLTAIC MODULES FOR RESIDENTIAL, COMMERCIAL AND UTILITY USE (U.S. CLS. 21, 23, 26, 36 AND 38).

JASON BLAIR, EXAMINING ATTORNEY

CLASS 9—(Continued).

SN 77-292,948. I.D. SYSTEMS, INC., HACKENSACK, NJ. FILED 10-1-2007.



THE MARK CONSISTS OF THE LITERAL ELEMENTS "WIFREE" WITH THREE PARTIAL, CIRCULAR SHAPES POSITIONED ABOVE THE LETTER "I".

FOR RADIO FREQUENCY TRANSMITTERS AND RECEIVERS FOR USE WITH VEHICLES, POWERED AND NON-POWERED ASSETS, NAMELY, FORKLIFTS, LIFT TRUCKS, TOW TRUCKS, CRANES, AIRCRAFT GROUND SUPPORT EQUIPMENT, LETTERS, RAIL CARS, PACKAGES, LUGGAGE, PALLETS, AND CONTAINERS; COMPUTER HARDWARE AND SOFTWARE FOR MANAGING, MONITORING, ANALYZING, AND TRACKING ENTERPRISE ASSETS, NAMELY, MOBILE POWER EQUIPMENT, VEHICLES, FORKLIFTS, LIFT TRUCKS, TOW TRACTORS, CRANES, AIRCRAFT GROUND SUPPORT EQUIPMENT, LETTERS, RAIL CARS, PACKAGES, LUGGAGE, PALLETS, CONTAINERS, AND DRIVERS (U.S. CLS. 21, 23, 26, 36 AND 38).

BARBARA A. GOLD, EXAMINING ATTORNEY

SN 77-292,965. AVA SOLAR, INC., FT. COLLINS, CO. FILED 10-1-2007.



NO CLAIM IS MADE TO THE EXCLUSIVE RIGHT TO USE "SOLAR", APART FROM THE MARK AS SHOWN. THE COLOR(S) GREEN AND ORANGE IS/ARE CLAIMED AS A FEATURE OF THE MARK.

THE MARK CONSISTS OF THE WORD "AVA" IN GREEN AND "SOLAR" IN ORANGE WITH THE LETTER "O" SOLID IN THE CENTER AND OUTLINED IN ORANGE.

FOR PHOTOVOLTAIC MODULES FOR RESIDENTIAL, COMMERCIAL AND UTILITY USE (U.S. CLS. 21, 23, 26, 36 AND 38).

JASON BLAIR, EXAMINING ATTORNEY

SN 77-293,332. TAYMAC CORPORATION, GILBERT, AZ. FILED 10-1-2007.

ZERO PROFILE

THE MARK CONSISTS OF STANDARD CHARACTERS WITHOUT CLAIM TO ANY PARTICULAR FONT, STYLE, SIZE, OR COLOR.

FOR ELECTRIC OUTLET COVERS (U.S. CLS. 21, 23, 26, 36 AND 38).

ANDREA K. NADELMAN, EXAMINING ATTORNEY

CLASS 9—(Continued).

SN 77-293,341. TAYMAC CORPORATION, TEMPE, AZ.
FILED 10-1-2007.

WALL PLATES RE-INVENTED

THE MARK CONSISTS OF STANDARD CHARACTERS WITHOUT CLAIM TO ANY PARTICULAR FONT, STYLE, SIZE, OR COLOR.

NO CLAIM IS MADE TO THE EXCLUSIVE RIGHT TO USE "WALL PLATES", APART FROM THE MARK AS SHOWN.

FOR ELECTRIC OUTLET COVERS; ELECTRIC SWITCH PLATES (U.S. CLS. 21, 23, 26, 36 AND 38).

ANDREA K. NADELMAN, EXAMINING ATTORNEY

SN 77-293,383. INFRARED FIBER SYSTEMS, INC., SILVER SPRING, MD. FILED 10-1-2007.

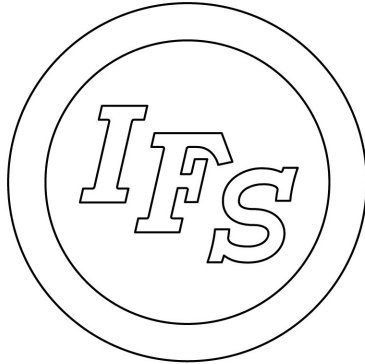

FOR OPTICAL FIBER FOR HIGH-POWER INFRARED MEDICAL AND DENTAL LASERS; SCIENTIFIC APPARATUS AND INSTRUMENTS, NAMELY, SPECTROMETERS (U.S. CLS. 21, 23, 26, 36 AND 38).

FIRST USE 3-3-1995; IN COMMERCE 7-31-1995.
MATTHEW PAPPAS, EXAMINING ATTORNEY

SN 77-293,479. LEXMAN, NANDAN, NAPERVILLE, IL.
FILED 10-2-2007.

I AM LOOKING FOR

THE MARK CONSISTS OF STANDARD CHARACTERS WITHOUT CLAIM TO ANY PARTICULAR FONT, STYLE, SIZE, OR COLOR.

FOR COMPUTER PROGRAMS FOR SEARCHING THE CONTENTS OF COMPUTERS AND COMPUTER NETWORKS BY REMOTE CONTROL (U.S. CLS. 21, 23, 26, 36 AND 38).

VIVIAN MICZNIK FIRST, EXAMINING ATTORNEY

CLASS 9—(Continued).

SN 77-293,517. SAFILO SOCIETÀ AZIONARIA FABBRICA ITALIANA LAVORAZIONE OCCHIALI SPA, PADOVA, ITALY, FILED 10-2-2007.

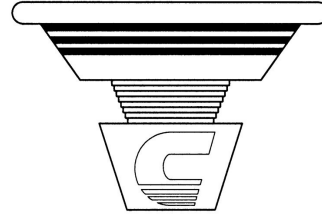

OWNER OF U.S. REG. NOS. 1,232,592 AND 2,493,798.
THE MARK CONSISTS OF PLUG DESIGN WITH CAPITAL LETTER "C" AT BOTTOM.

FOR EYEGLASSES AND SUNGLASSES; EYEGLASS FRAMES, CASES, HINGES, TEMPLES AND LENSES FOR SPECTACLES AND SUNGLASSES; PARTS AND ACCESSORIES THEREOF (U.S. CLS. 21, 23, 26, 36 AND 38).

LESLIE RICHARDS, EXAMINING ATTORNEY

SN 77-293,532. SEMISOUTH LABORATORIES, INC., STARKVILLE, MS. FILED 10-2-2007.

OFFET

THE MARK CONSISTS OF STANDARD CHARACTERS WITHOUT CLAIM TO ANY PARTICULAR FONT, STYLE, SIZE, OR COLOR.

OWNER OF U.S. REG. NOS. 3,254,617 AND 3,352,220.
FOR SEMICONDUCTOR CHIPS; SEMICONDUCTOR DEVICES; TRANSISTORS; POWER SWITCHES (U.S. CLS. 21, 23, 26, 36 AND 38).

MARCIE MILONE, EXAMINING ATTORNEY

SN 77-293,664. PANETTA, JOSEPH, PHILADELPHIA, PA.
FILED 10-2-2007.

MATHBALL USA

THE MARK CONSISTS OF STANDARD CHARACTERS WITHOUT CLAIM TO ANY PARTICULAR FONT, STYLE, SIZE, OR COLOR.

NO CLAIM IS MADE TO THE EXCLUSIVE RIGHT TO USE "USA", APART FROM THE MARK AS SHOWN.

FOR EDUCATIONAL COMPUTER GAME SOFTWARE (U.S. CLS. 21, 23, 26, 36 AND 38).

CORY BOONE, EXAMINING ATTORNEY

CLASS 9—(Continued).

SN 77-293,682. PIVOT POINT INTERNATIONAL, INC., EVANSTON, IL. FILED 10-2-2007.

A DESIGNER'S APPROACH

THE MARK CONSISTS OF STANDARD CHARACTERS WITHOUT CLAIM TO ANY PARTICULAR FONT, STYLE, SIZE, OR COLOR.

NO CLAIM IS MADE TO THE EXCLUSIVE RIGHT TO USE "DESIGNER'S", APART FROM THE MARK AS SHOWN.

FOR PRE-RECORDED DVDS CONTAINING A SERIES OF EDUCATIONAL MATERIALS RELATING TO HAIR SCULPTURE, HAIR DESIGN, HAIR COLORING, PERMANENTS AND TEXTURIZING OF HAIR, AND HAIR-STYLING FOR LONG HAIR (U.S. CLS. 21, 23, 26, 36 AND 38).
JOHN WILKE, EXAMINING ATTORNEY

CLASS 9—(Continued).

SN 77-293,698. ONANON, INC., MILPITAS, CA. FILED 10-2-2007.



THE COLOR(S) DARK GREEN AND LIGHT GREEN IS/ ARE CLAIMED AS A FEATURE OF THE MARK.

THE MARK CONSISTS OF THE DARK GREEN LETTERS "ON" APPEARING INSIDE THE LIGHT GREEN CIRCLE, THE WORDING "ANON" APPEARING IN DARK GREEN, AND THE WORDING "THE CAN DO COMPANY" APPEARING IN LIGHT GREEN.

FOR APPARATUS FOR CONVERTING ELECTRONIC RADIATION TO ELECTRICAL ENERGY, NAMELY, PHOTOVOLTAIC CLADDING PANELS; BATTERY TERMINAL CONNECTOR CLAMPS; CABLE CONNECTORS; CONNECTORS FOR ELECTRONIC CIRCUITS; ELECTRIC CONNECTORS; ELECTRICAL CONNECTORS; ELECTRICAL POWER CONNECTORS; INSULATED ELECTRICAL CONNECTORS; MOTOR VEHICLE TO TRAILER ELECTRICAL CONNECTORS; PLUG CONNECTORS; PLUG-IN CONNECTORS; POWER SUPPLY CONNECTORS AND ADAPTORS FOR USE WITH PORTABLE ELECTRONIC DEVICES; ROUND PLUG CONNECTORS; TELEPHONE CONNECTORS (U.S. CLS. 21, 23, 26, 36 AND 38).
JENNY PARK, EXAMINING ATTORNEY

SN 77-293,737. QUICKOFFICE, PLANO, TX. FILED 10-2-2007.

Quickoffice Quickview

THE MARK CONSISTS OF STANDARD CHARACTERS WITHOUT CLAIM TO ANY PARTICULAR FONT, STYLE, SIZE, OR COLOR.

FOR COMPUTER APPLICATION SOFTWARE FOR MOBILE PHONES (U.S. CLS. 21, 23, 26, 36 AND 38).
CORY BOONE, EXAMINING ATTORNEY

SN 77-294,005. SWIM FREE, LLC, PACIFIC PALISADES, CA. FILED 10-2-2007.

SWIM FREE

THE MARK CONSISTS OF STANDARD CHARACTERS WITHOUT CLAIM TO ANY PARTICULAR FONT, STYLE, SIZE, OR COLOR.

OWNER OF U.S. REG. NO. 2,548,249.
NO CLAIM IS MADE TO THE EXCLUSIVE RIGHT TO USE "SWIM", APART FROM THE MARK AS SHOWN.

FOR SWIM GOGGLES AND SWIM MASKS; SUNGLASSES; FLOATATION SWIM VESTS; INFLATABLE FLOTATION DEVICES FOR SAFETY (U.S. CLS. 21, 23, 26, 36 AND 38).
HENRY S. ZAK, EXAMINING ATTORNEY

SN 77-293,688. ATALASOFT, INC., EASTHAMPTON, MA. FILED 10-2-2007.

ATALASOFT

THE MARK CONSISTS OF STANDARD CHARACTERS WITHOUT CLAIM TO ANY PARTICULAR FONT, STYLE, SIZE, OR COLOR.

FOR COMPUTER IMAGING SOFTWARE FOR USE IN THE DEVELOPMENT OF SOFTWARE APPLICATIONS (U.S. CLS. 21, 23, 26, 36 AND 38).
FIRST USE 8-15-2000; IN COMMERCE 8-15-2000.
JESSICA A. POWERS, EXAMINING ATTORNEY

CLASS 9—(Continued).

SN 77-294,036. NEXPERIENCE LTD., PETACH-TIKVA, ISRAEL, FILED 10-2-2007.

 The logo for NEXPERIENCE features the word "nexperience" in a lowercase, sans-serif font. A stylized human figure with arms raised is integrated into the letter 'i'.

FOR TESTING EQUIPMENT FOR THE ACTIVATION, ANALYSIS, DIAGNOSTICS, MONITORING AND CERTIFICATION OF APPLICATIONS RUNNING ON MOBILE PHONES AND OTHER PORTABLE DEVICES (U.S. CLS. 21, 23, 26, 36 AND 38).
HENRY S. ZAK, EXAMINING ATTORNEY

SN 77-294,159. WMS GAMING INC., WAUKEGAN, IL. FILED 10-2-2007.

SILVERBACK

THE MARK CONSISTS OF STANDARD CHARACTERS WITHOUT CLAIM TO ANY PARTICULAR FONT, STYLE, SIZE, OR COLOR.

FOR GAMING MACHINES THAT GENERATE OR DISPLAY WAGER OUTCOMES; GAMING SOFTWARE THAT GENERATES OR DISPLAYS WAGER OUTCOMES OF GAMING MACHINES (U.S. CLS. 21, 23, 26, 36 AND 38).

GEORGE LORENZO, EXAMINING ATTORNEY

SN 77-294,190. ELITE CINEMA, L.L.C., SAMMAMISH, WA. FILED 10-2-2007.

ELITE CINEMA

THE MARK CONSISTS OF STANDARD CHARACTERS WITHOUT CLAIM TO ANY PARTICULAR FONT, STYLE, SIZE, OR COLOR.

OWNER OF U.S. REG. NOS. 3,341,588, 3,353,864 AND OTHERS.

NO CLAIM IS MADE TO THE EXCLUSIVE RIGHT TO USE "CINEMA", APART FROM THE MARK AS SHOWN.

FOR MOTION PICTURE FILMS ABOUT SUBJECTS CONSISTING OF HORROR, COMEDY, SCIENCE FICTION, THRILLER, ACTION/ADVENTURE (U.S. CLS. 21, 23, 26, 36 AND 38).

DAWN FELDMAN, EXAMINING ATTORNEY

CLASS 9—(Continued).

SN 77-294,217. OHANAE, INC., LOS GATOS, CA. FILED 10-2-2007.

OHANAE

THE MARK CONSISTS OF STANDARD CHARACTERS WITHOUT CLAIM TO ANY PARTICULAR FONT, STYLE, SIZE, OR COLOR.

FOR COMPUTER PROGRAMS FOR DATA MANAGEMENT ON PORTABLE STORAGE DEVICES (U.S. CLS. 21, 23, 26, 36 AND 38).

FIRST USE 4-30-2007; IN COMMERCE 4-30-2007.

G. MAYERSCHOFF, EXAMINING ATTORNEY

SN 77-294,302. HEARING ENHANCEMENT GROUP, LLC, THOUSAND OAKS, CA. FILED 10-2-2007.



FOR HEADPHONES (U.S. CLS. 21, 23, 26, 36 AND 38).
SHANNON TWOHIG, EXAMINING ATTORNEY

SN 77-294,545. BSA OPTICS INC., FT. LAUDERDALE, FL. FILED 10-2-2007.

AIMBRITE

THE MARK CONSISTS OF STANDARD CHARACTERS WITHOUT CLAIM TO ANY PARTICULAR FONT, STYLE, SIZE, OR COLOR.

FOR LASER POINTING DEVICE FOR USE WITH FIREARMS (U.S. CLS. 21, 23, 26, 36 AND 38).

MELISSA VALLILLO, EXAMINING ATTORNEY

CLASS 9—(Continued).

SN 77-294,552. BSA OPTICS INC., FT. LAUDERDALE, FL. FILED 10-2-2007.

TACMASTER

THE MARK CONSISTS OF STANDARD CHARACTERS WITHOUT CLAIM TO ANY PARTICULAR FONT, STYLE, SIZE, OR COLOR.
FOR BINOCULARS; HUNTING BINOCULARS (U.S. CLS. 21, 23, 26, 36 AND 38).
MELISSA VALLILLO, EXAMINING ATTORNEY

SN 77-294,557. BSA OPTICS INC., FT. LAUDERDALE, FL. FILED 10-2-2007.

SPECTRE

THE MARK CONSISTS OF STANDARD CHARACTERS WITHOUT CLAIM TO ANY PARTICULAR FONT, STYLE, SIZE, OR COLOR.
FOR SPOTTING SCOPES (U.S. CLS. 21, 23, 26, 36 AND 38).
MELISSA VALLILLO, EXAMINING ATTORNEY

SN 77-294,579. RESCUE TECHNOLOGIES CORPORATION, AIEA, HI. FILED 10-2-2007.

NIGHTSTREAMER

THE MARK CONSISTS OF STANDARD CHARACTERS WITHOUT CLAIM TO ANY PARTICULAR FONT, STYLE, SIZE, OR COLOR.
FOR SIGNAL MARKERS, NAMELY, MARKERS USED TO ENHANCE VISIBILITY OF PERSONS IN DISTRESS (U.S. CLS. 21, 23, 26, 36 AND 38).
MICHAEL KEATING, EXAMINING ATTORNEY

CLASS 9—(Continued).

SN 77-294,585. RESCUE TECHNOLOGIES CORPORATION, AIEA, HI. FILED 10-2-2007.

OPENS UP THE NIGHT

THE MARK CONSISTS OF STANDARD CHARACTERS WITHOUT CLAIM TO ANY PARTICULAR FONT, STYLE, SIZE, OR COLOR.
FOR SIGNAL MARKERS, NAMELY, MARKERS USED TO ENHANCE VISIBILITY OF PERSONS IN DISTRESS (U.S. CLS. 21, 23, 26, 36 AND 38).
MICHAEL KEATING, EXAMINING ATTORNEY

SN 77-294,883. DRESSER, INC., ADDISON, TX. FILED 10-3-2007.

FUSION

THE MARK CONSISTS OF STANDARD CHARACTERS WITHOUT CLAIM TO ANY PARTICULAR FONT, STYLE, SIZE, OR COLOR.
FOR AUTOMATION CONTROL SYSTEMS FOR RETAIL FUELING STATIONS CAPABLE OF TRANSMITTING INFORMATION VIA WORLDWIDE WEB, NAMELY, COMPUTER HARDWARE AND SOFTWARE THAT CONTROLS AND MONITORS FUEL DISPENSERS, POINT OF SALE SYSTEMS TO MANAGE FUEL AND MERCHANDISE SALES, CREDIT, DEBIT AND SMART CARD PROCESSING, ELECTRONIC CASH REGISTERS, PAYMENT TERMINALS, UNDERGROUND STORAGE TANKS, PRICE SIGNAGE, CAR WASH MACHINERY AND VIDEO SECURITY SYSTEMS (U.S. CLS. 21, 23, 26, 36 AND 38).
DANIEL BRODY, EXAMINING ATTORNEY

SN 77-295,046. COPPERHEAD INDUSTRIES, LLC, MONTICELLO, MN. FILED 10-3-2007.

SNAKEPIT

THE MARK CONSISTS OF STANDARD CHARACTERS WITHOUT CLAIM TO ANY PARTICULAR FONT, STYLE, SIZE, OR COLOR.
FOR TRACER BOXES, NAMELY, BOXES BURIED BELOW GROUND LEVEL AND HAVING CONNECTORS FOR TRACER WIRES ON SUBTERRANEAN PIPELINES, WATER, SEWER, GAS, ELECTRICAL, AND COMMUNICATION LINES, AND OTHER UTILITY LINES AND CONDUITS (U.S. CLS. 21, 23, 26, 36 AND 38).
JILL C. ALT, EXAMINING ATTORNEY

CLASS 9—(Continued).

SN 77-295,137. L-3 COMMUNICATIONS SECURITY AND DETECTION SYSTEMS, INC., WOBURN, MA. FILED 10-3-2007.

MVT-HR

THE MARK CONSISTS OF STANDARD CHARACTERS WITHOUT CLAIM TO ANY PARTICULAR FONT, STYLE, SIZE, OR COLOR.

OWNER OF U.S. REG. NO. 2,383,762.
FOR EXPLOSIVE DETECTION SYSTEMS COMPOSED PRIMARILY OF ELECTRONIC DETECTORS, CHEMICAL SENSORS, COMPUTERIZED ANALYSIS EQUIPMENT, DATA ACQUISITION UNITS AND COMPUTER SOFTWARE (U.S. CLS. 21, 23, 26, 36 AND 38).
FIRST USE 5-1-2005; IN COMMERCE 5-1-2005.
AHSEN KHAN, EXAMINING ATTORNEY

SN 77-295,257. DOMINEY DESIGN INC., DECATUR, GA. FILED 10-3-2007.

SLIDESHOWPRO

THE MARK CONSISTS OF STANDARD CHARACTERS WITHOUT CLAIM TO ANY PARTICULAR FONT, STYLE, SIZE, OR COLOR.

FOR COMPUTER SOFTWARE FOR CREATING PRESENTATIONS OF PHOTOS, VIDEO, AUDIO, AND TEXT; AND FOR CONTENT MANAGEMENT OF PHOTOS, VIDEO, AUDIO, AND TEXT FOR USE IN CREATING PRESENTATIONS THAT MAY BE DOWNLOADED FROM A GLOBAL COMPUTER NETWORK; COMPUTER SOFTWARE TO ENHANCE THE AUDIO-VISUAL CAPABILITIES OF MULTIMEDIA APPLICATIONS, NAMELY, FOR THE INTEGRATION OF TEXT, AUDIO, GRAPHICS, STILL IMAGES AND MOVING PICTURES (U.S. CLS. 21, 23, 26, 36 AND 38).
FIRST USE 4-18-2005; IN COMMERCE 4-18-2005.
DAVID H. STINE, EXAMINING ATTORNEY

SN 77-295,424. TAQUA, INC., RICHARDSON, TX. FILED 10-3-2007.

TAQUA

THE MARK CONSISTS OF STANDARD CHARACTERS WITHOUT CLAIM TO ANY PARTICULAR FONT, STYLE, SIZE, OR COLOR.

FOR TELECOMMUNICATIONS LOCAL EXCHANGE SWITCH AND SOFTSWITCH, WHICH ENABLES SERVICE PROVIDERS TO DELIVER TELEPHONE SERVICES TO RESIDENTIAL AND BUSINESS CUSTOMERS (U.S. CLS. 21, 23, 26, 36 AND 38).
FIRST USE 3-11-1998; IN COMMERCE 3-11-1998.
GEOFFREY FOSDICK, EXAMINING ATTORNEY

CLASS 9—(Continued).

SN 77-295,462. INFINITE POWER SOLUTIONS, INC., LITTLETON, CO. FILED 10-3-2007.

LiTE★STAR

THE MARK CONSISTS OF THE WORDS "LITE" AND "STAR" SEPERATED BY A STAR SYMBOL IN BETWEEN THEM.

FOR BATTERIES (U.S. CLS. 21, 23, 26, 36 AND 38).
FIRST USE 2-28-2001; IN COMMERCE 4-5-2001.
DAVID C. REIHNER, EXAMINING ATTORNEY

SN 77-295,474. ZELCO INDUSTRIES, INC., MT. VERNON, NY. FILED 10-3-2007.

OUTI

THE MARK CONSISTS OF STANDARD CHARACTERS WITHOUT CLAIM TO ANY PARTICULAR FONT, STYLE, SIZE, OR COLOR.

FOR HEADPHONES (U.S. CLS. 21, 23, 26, 36 AND 38).
MARIA-VICTORIA SUAREZ, EXAMINING ATTORNEY

SN 77-295,538. MOBILISA, INC., PORT TOWNSEND, WA. FILED 10-3-2007.

BOLO TRACKER

THE MARK CONSISTS OF STANDARD CHARACTERS WITHOUT CLAIM TO ANY PARTICULAR FONT, STYLE, SIZE, OR COLOR.

NO CLAIM IS MADE TO THE EXCLUSIVE RIGHT TO USE "TRACKER", APART FROM THE MARK AS SHOWN.
FOR COMPUTER HARDWARE AND SOFTWARE THAT COLLECTS PERSONAL INFORMATION FOR IDENTIFICATION PURPOSES (U.S. CLS. 21, 23, 26, 36 AND 38).

FIRST USE 9-14-2007; IN COMMERCE 9-14-2007.
ALEX KEAM, EXAMINING ATTORNEY

CLASS 9—(Continued).

SN 77-295,601. PUNCH ENTERTAINMENT, INC., MOUNTAIN VIEW, CA. FILED 10-3-2007.

MOBILE BATTLES

THE MARK CONSISTS OF STANDARD CHARACTERS WITHOUT CLAIM TO ANY PARTICULAR FONT, STYLE, SIZE, OR COLOR.

FOR DOWNLOADABLE ELECTRONIC GAME SOFTWARE FOR USE ON COMPUTERIZED PLATFORMS, NAMELY, MOBILE PHONES, HAND HELD COMPUTERS, PERSONAL DIGITAL ASSISTANTS, PORTABLE MEDIA PLAYERS, LAPTOP COMPUTERS AND DESKTOP COMPUTERS (U.S. CLS. 21, 23, 26, 36 AND 38).

FIRST USE 4-30-2007; IN COMMERCE 4-30-2007.
CHRIS WELLS, EXAMINING ATTORNEY

SN 77-295,618. PUNCH ENTERTAINMENT, INC., MOUNTAIN VIEW, CA. FILED 10-3-2007.

MOBILE BATTLES

THE COLOR(S) GREY AND BLACK IS/ARE CLAIMED AS A FEATURE OF THE MARK.

THE MARK CONSISTS OF THE WORDS "MOBILE BATTLES" IN BLOCK TYPE WITH BLACK OUTLINE. INSIDE THE OUTLINE IS GREY SHADING AND RIVET IMAGES SO THE TEXT LOOKS TO BE MADE OF TYPE OF GREY COLORED METAL.

FOR DOWNLOADABLE ELECTRONIC GAME SOFTWARE FOR USE ON COMPUTERIZED PLATFORMS, NAMELY MOBILE PHONES, HAND HELD COMPUTERS, PERSONAL DIGITAL ASSISTANTS, PORTABLE MEDIA PLAYERS, LAPTOP COMPUTERS AND DESKTOP COMPUTERS (U.S. CLS. 21, 23, 26, 36 AND 38).

FIRST USE 4-30-2007; IN COMMERCE 4-30-2007.
CHRIS WELLS, EXAMINING ATTORNEY

SN 77-295,621. VERTICAL BRANDING, INC., ENCINO, CA. FILED 10-3-2007.

Steam Buddy

THE MARK CONSISTS OF STANDARD CHARACTERS WITHOUT CLAIM TO ANY PARTICULAR FONT, STYLE, SIZE, OR COLOR.

NO CLAIM IS MADE TO THE EXCLUSIVE RIGHT TO USE STEAM, APART FROM THE MARK AS SHOWN.

FOR ELECTRIC FLAT IRONS; FABRIC STEAMERS; GARMENT STEAMERS (U.S. CLS. 21, 23, 26, 36 AND 38).
CHRIS WELLS, EXAMINING ATTORNEY

CLASS 9—(Continued).

SN 77-295,720. RESCUE TECHNOLOGIES CORPORATION, AIEA, HI. FILED 10-4-2007.

LIGHTS UP THE NIGHT

THE MARK CONSISTS OF STANDARD CHARACTERS WITHOUT CLAIM TO ANY PARTICULAR FONT, STYLE, SIZE, OR COLOR.

FOR SIGNAL MARKERS, NAMELY, MARKERS USED TO ENHANCE VISIBILITY OF PERSONS IN DISTRESS (U.S. CLS. 21, 23, 26, 36 AND 38).

MICHAEL KEATING, EXAMINING ATTORNEY

SN 77-295,776. NIPPON DENKI KABUSHIKI KAISHA D/B/A NEC CORPORATION, TOKYO, JAPAN, FILED 10-4-2007.

SIGMABLADE

THE MARK CONSISTS OF STANDARD CHARACTERS WITHOUT CLAIM TO ANY PARTICULAR FONT, STYLE, SIZE, OR COLOR.

FOR COMPUTER SOFTWARE, NAMELY, COMPUTER SOFTWARE FOR NETWORK MANAGEMENT; COMPUTER HARDWARE AND COMPUTER SOFTWARE PLATFORM FOR INTEGRATING COMPUTER SERVERS, DATA STORAGE HARDWARE AND SOFTWARE, COMPUTER NETWORKING HARDWARE AND COMPUTER NETWORKING SOFTWARE; COMPUTER SOFTWARE FOR CONTROLLING, ADMINISTRATING AND MANAGING NETWORKS; NETWORK MANAGEMENT SOFTWARE FOR LOCAL AND GLOBAL COMPUTER NETWORKS AND FOR COMPUTER COMMUNICATION INFORMATION NETWORKS; NETWORK ACCESS SERVER OPERATING SOFTWARE; COMPUTER HARDWARE; COMPUTERS; COMPUTER SERVERS; NETWORK ACCESS SERVER HARDWARE; COMPUTER NETWORKING HARDWARE (U.S. CLS. 21, 23, 26, 36 AND 38).

HEATHER THOMPSON, EXAMINING ATTORNEY

SN 77-295,934. EAR PHONE CONNECTION, INC., CANYON COUNTRY, CA. FILED 10-4-2007.

FOX

THE MARK CONSISTS OF STANDARD CHARACTERS WITHOUT CLAIM TO ANY PARTICULAR FONT, STYLE, SIZE, OR COLOR.

FOR SURVEILLANCE EARPHONE (U.S. CLS. 21, 23, 26, 36 AND 38).

FIRST USE 1-1-2004; IN COMMERCE 1-1-2004.
JOHN WILKE, EXAMINING ATTORNEY

CLASS 9—(Continued).

SN 77-295,965. INFINITE POWER SOLUTIONS, INC., LITTLETON, CO. FILED 10-4-2007.



THE MARK CONSISTS OF AN INFINITY IMAGE IN SOLID AND STRIPED BLACK LINES.
FOR BATTERIES (U.S. CLS. 21, 23, 26, 36 AND 38).
FIRST USE 2-28-2001; IN COMMERCE 2-28-2001.
DAVID C. REIHNER, EXAMINING ATTORNEY

SN 77-295,980. FORD CONSULTING GROUP, INC., MINNEAPOLIS, MN. FILED 10-4-2007.

KNOWTIME

THE MARK CONSISTS OF STANDARD CHARACTERS WITHOUT CLAIM TO ANY PARTICULAR FONT, STYLE, SIZE, OR COLOR.

FOR COMPUTER SOFTWARE FOR LOGGING, ORGANIZING AND REVIEWING PROJECTS IN TIME MANAGEMENT SOFTWARE AND CREATING STATUS REPORTS AND SUMMARIES OF PROJECTS (U.S. CLS. 21, 23, 26, 36 AND 38).

FIRST USE 10-3-2007; IN COMMERCE 10-3-2007.
DORITT L. CARROLL, EXAMINING ATTORNEY

SN 77-295,981. PRESSMAN, COREY SCOTT, PORTLAND, OR. FILED 10-4-2007.

mediaPedia

THE MARK CONSISTS OF STANDARD CHARACTERS WITHOUT CLAIM TO ANY PARTICULAR FONT, STYLE, SIZE, OR COLOR.

FOR COMPUTER SOFTWARE TO ENHANCE THE AUDIO-VISUAL CAPABILITIES OF MULTIMEDIA APPLICATIONS, NAMELY, FOR THE INTEGRATION OF TEXT, AUDIO, GRAPHICS, STILL IMAGES AND MOVING PICTURES; INTERACTIVE MULTIMEDIA COMPUTER PROGRAM FOR DELIVERING ORGANIZED MULTIMEDIA CONTENT (U.S. CLS. 21, 23, 26, 36 AND 38).

FIRST USE 9-25-2007; IN COMMERCE 9-25-2007.
DORITT L. CARROLL, EXAMINING ATTORNEY

CLASS 9—(Continued).

SN 77-296,088. FASHION ELECTRONICS, INC., ROCKVILLE, MD. FILED 10-4-2007.

BLUEACTION

THE MARK CONSISTS OF STANDARD CHARACTERS WITHOUT CLAIM TO ANY PARTICULAR FONT, STYLE, SIZE, OR COLOR.

FOR APPARATUS FOR WIRELESS TRANSMISSION OF ACOUSTIC INFORMATION; WIRELESS TELEPHONES; WIRELESS TELEPHONY APPARATUS; WIRELESS TELEVISION SET FOR PROVIDING VIDEO CONFERENCING AND TELEPHONE SERVICE OVER THE INTERNET; CELLULAR PHONES; CELLULAR TELEPHONE APPARATUSES; DEVICES FOR HANDS-FREE USE OF MOBILE PHONES; DIGITAL CELLULAR PHONES; EAR PHONES; HANDS FREE KITS FOR PHONES; INTERNET PHONES; MOBILE PHONES; TELEMATICS APPARATUS, NAMELY, WIRELESS INTERNET DEVICES WHICH PROVIDE TELEMATIC SERVICES AND HAVE A CELLULAR PHONE FUNCTION; VIDEO PHONES; MP4 PLAYERS; PORTABLE LISTENING DEVICES, NAMELY, MP3 PLAYERS; DEVICES FOR WIRELESS RADIO TRANSMISSION; RECORDING AND PLAYING DEVICES FOR SOUND AND IMAGE CARRIERS; PERSONAL DIGITAL ASSISTANTS (PDA); PORTABLE MEDIA PLAYERS; PORTABLE TELECOMMUNICATION INSTANT MESSAGING DEVICES; PORTABLE TELEPHONES; COMMUNICATIONS HEADSETS FOR USE WITH COMMUNICATION RADIOS, INTERCOM SYSTEMS, OR OTHER COMMUNICATIONS NETWORK TRANSCEIVERS; HEADSETS FOR TELEPHONES; HEADSETS FOR USE WITH COMPUTERS; TELEPHONE HEADSETS; AUDIO SPEAKERS; LOUD SPEAKER SYSTEMS; BATTERY CHARGE DEVICES; CHARGE-COUPLED DEVICES (CCD); CHARGED COUPLING DEVICES; AMPLIFIER FOR WIRELESS COMMUNICATIONS; AUDIO AMPLIFIERS; STEREO AMPLIFIERS; DIGITAL AUDIO PLAYERS; ELECTRIC AUDIO PLAYBACK UNITS; PERSONAL STEREOS; STEREO RECEIVERS (U.S. CLS. 21, 23, 26, 36 AND 38).

FIRST USE 1-31-2007; IN COMMERCE 1-31-2007.
LINDA E. BLOHM, EXAMINING ATTORNEY

SN 77-296,136. LIVE NATION WORLDWIDE, INC., BEVERLY HILLS, CA. FILED 10-4-2007.

VENUE NATION

THE MARK CONSISTS OF STANDARD CHARACTERS WITHOUT CLAIM TO ANY PARTICULAR FONT, STYLE, SIZE, OR COLOR.

FOR PRE-RECORDED CDS, AUDIO CASSETTES, VIDEO CASSETTES, DVDS, SOUND FILES, AND DIGITAL STORAGE DEVICES, NAMELY, MP3 PLAYERS AND FLASH DRIVES, ALL FEATURING MUSICAL PERFORMANCES (U.S. CLS. 21, 23, 26, 36 AND 38).

ERNEST SHOSHO, EXAMINING ATTORNEY

CLASS 9—(Continued).

SN 77-296,236. GECCO LLC LTD LIAB CO DELAWARE, WAVERLY, PA. FILED 10-4-2007.

ADVS

THE MARK CONSISTS OF STANDARD CHARACTERS WITHOUT CLAIM TO ANY PARTICULAR FONT, STYLE, SIZE, OR COLOR.

FOR FIRE SPRINKLER SYSTEM UTILIZING VACUUM PRESSURE AND REPLACEMENT PARTS AND FITTINGS THEREFOR, NAMELY, FILTERS, HOSES, PUMPS, ELECTRIC MOTORS, GAS MOTORS, RELIEF VALVES, AND FIRE SPRINKLER PIPING, SOLD TOGETHER AS A UNIT (U.S. CLS. 21, 23, 26, 36 AND 38).
ANDREA HACK, EXAMINING ATTORNEY

SN 77-296,308. THE OHIO ART COMPANY, BRYAN, OH. FILED 10-4-2007.

ETCH A SKETCH

THE MARK CONSISTS OF STANDARD CHARACTERS WITHOUT CLAIM TO ANY PARTICULAR FONT, STYLE, SIZE, OR COLOR.

OWNER OF U.S. REG. NOS. 725,595, 2,344,863 AND OTHERS.
FOR VIDEO GAME SOFTWARE (U.S. CLS. 21, 23, 26, 36 AND 38).
AMOS T. MATTHEWS, JR., EXAMINING ATTORNEY

SN 77-296,329. TESLAR INSIDE CORPORATION, MIAMI, FL. FILED 10-4-2007.

7to9

THE MARK CONSISTS OF STANDARD CHARACTERS WITHOUT CLAIM TO ANY PARTICULAR FONT, STYLE, SIZE, OR COLOR.

FOR SUNGLASSES; CASES FOR SUNGLASSES (U.S. CLS. 21, 23, 26, 36 AND 38).
LYDIA BELZER, EXAMINING ATTORNEY

CLASS 9—(Continued).

SN 77-297,213. PRIME THERAPEUTICS LLC, EAGAN, MN. FILED 10-5-2007.

PRIMESECURE

THE MARK CONSISTS OF STANDARD CHARACTERS WITHOUT CLAIM TO ANY PARTICULAR FONT, STYLE, SIZE, OR COLOR.

FOR COMPUTER PROGRAMS FOR MANAGING USER INFORMATION, PASSWORD MAINTENANCE, AND ACCESS REQUESTS TO MULTIPLE COMPUTER SYSTEMS (U.S. CLS. 21, 23, 26, 36 AND 38).
KIMBERLY FRYE, EXAMINING ATTORNEY

SN 77-297,300. GEONAMIC SYSTEMS, INC., DULUTH, GA. FILED 10-5-2007.

PipelineOffice

THE MARK CONSISTS OF STANDARD CHARACTERS WITHOUT CLAIM TO ANY PARTICULAR FONT, STYLE, SIZE, OR COLOR.

FOR COMPUTER SOFTWARE FOR APPLICATION AND DATABASE INTEGRATION (U.S. CLS. 21, 23, 26, 36 AND 38).
KELLY MCCOY, EXAMINING ATTORNEY

SN 77-297,381. INNOVATION TAP LLC, DRESHER, PA. FILED 10-5-2007.

REALDEAL

THE MARK CONSISTS OF STANDARD CHARACTERS WITHOUT CLAIM TO ANY PARTICULAR FONT, STYLE, SIZE, OR COLOR.

FOR COMPUTER SOFTWARE USED TO PROVIDE REAL-TIME DATA, INFORMATION AND ANALYSES THAT FACILITATE DECISION MAKING PROCESSES ON TRANSACTIONS IN THE POWER AND ENERGY TRADING BUSINESS, FOR USE BY FINANCIAL INSTITUTIONS, ENERGY COMPANIES, UTILITIES AND POWER MARKETING ORGANIZATIONS (U.S. CLS. 21, 23, 26, 36 AND 38).
TRICIA SONNEBORN, EXAMINING ATTORNEY

CLASS 9—(Continued).

SN 77-297,556. AIROHA TECHNOLOGY CORP., HSINCHU, TAIWAN, FILED 10-5-2007.



The logo for AIROHA features the word "AIROHA" in a bold, sans-serif font. The letter "H" is unique, with a horizontal crossbar that extends to the left and right, crossing the vertical stems of the letters "A" and "O" respectively.

THE MARK CONSISTS OF THE WORDING "AIROHA" WHERE THE CROSSBAR FOR THE LETTER "H" CONTINUES AND FUNCTIONS ALSO AS THE CROSSBAR FOR THE LETTER "A".

FOR SEMICONDUCTOR CHIPS; SILICON CHIPS; COMPUTER CHIPS; CHIP CARRIERS, NAMELY, SEMICONDUCTOR CHIP HOUSINGS; SEMICONDUCTOR DEVICES, NAMELY, INTEGRATED CIRCUITS; SEMICONDUCTORS; SEMICONDUCTOR POWER ELEMENTS; TRANSISTORS; CIRCUIT BOARDS; CARDS WITH INTEGRATED CIRCUITS; BLANK INTEGRATED CIRCUIT CARDS FOR RECORDING, TRANSMITTING, AND REPRODUCING SOUND AND IMAGES IN MOBILE TELEPHONE SERVICES; ELECTRIC AND ELECTRONIC CIRCUITS; ELECTRONIC INTEGRATED CIRCUITS; INTEGRATED CIRCUITS; ELECTRONIC CIRCUIT BOARD; ELECTRONIC CHIPS FOR THE MANUFACTURER OF INTEGRATED CIRCUITS; SEMICONDUCTOR MEMORIES; ELECTRONIC MEMORIES; AUDIO MIXERS; TRANSCIEVERS; RADIO TRANSMITTERS; RADIO RECEIVERS; POWER AMPLIFIERS; MICRO-COMPUTERS; MOTHERBOARDS; COMPUTER INTERFACE BOARDS; GLOBAL POSITIONING SYSTEM (GPS) CONSISTING OF COMPUTERS, COMPUTER SOFTWARE, TRANSMITTERS, RECEIVERS, AND NETWORK INTERFACE DEVICES; COMMUNICATIONS HEADSETS FOR USE WITH COMMUNICATION RADIOS, INTERCOM SYSTEMS, OR OTHER COMMUNICATIONS NETWORK TRANSCIEVERS; COMPUTER HARDWARE AND SOFTWARE FOR SETTING UP AND CONFIGURING WIDE AREA NETWORKS; MOBILE COMPUTING AND OPERATING PLATFORMS CONSISTING OF DATA TRANSCIEVERS, WIRELESS NETWORKS AND GATEWAYS FOR COLLECTION AND MANAGEMENT OF DATA; RADIO FREQUENCY IDENTIFICATION (RFID) CREDENTIALS, NAMELY, CARDS AND TAGS, AND READERS FOR RADIO FREQUENCY IDENTIFICATION CREDENTIALS; AERIALS; ANTENNAS (U.S. CLS. 21, 23, 26, 36 AND 38).

FIRST USE 8-31-2001; IN COMMERCE 9-30-2004.
KYLE PEETE, EXAMINING ATTORNEY

CLASS 9—(Continued).

SN 77-297,612. XP MICRO, INC, WALNUT, CA. FILED 10-5-2007.

Maxstor

THE MARK CONSISTS OF STANDARD CHARACTERS WITHOUT CLAIM TO ANY PARTICULAR FONT, STYLE, SIZE, OR COLOR.

FOR COMPUTER HARD DISCS (U.S. CLS. 21, 23, 26, 36 AND 38).

MATTHEW MCDOWELL, EXAMINING ATTORNEY

SN 77-297,618. OK, GO, INC., PALISADES, NY. FILED 10-5-2007.

OK GO

THE MARK CONSISTS OF STANDARD CHARACTERS WITHOUT CLAIM TO ANY PARTICULAR FONT, STYLE, SIZE, OR COLOR.

FOR MUSICAL SOUND RECORDINGS (U.S. CLS. 21, 23, 26, 36 AND 38).

FIRST USE 9-0-2000; IN COMMERCE 9-0-2000.
FRANK LATTUCA, EXAMINING ATTORNEY

SN 77-297,629. FOODCUBE TECHNOLOGIES, INC., CINCINNATI, OH. FILED 10-5-2007.

FoodCube

THE MARK CONSISTS OF STANDARD CHARACTERS WITHOUT CLAIM TO ANY PARTICULAR FONT, STYLE, SIZE, OR COLOR.

FOR INTERACTIVE COMPUTER KIOSKS COMPRISING COMPUTERS, COMPUTER HARDWARE, COMPUTER PERIPHERALS, AND COMPUTER OPERATING SOFTWARE, FOR USE IN OPERATING SELF-SERVICE ELECTRONIC KIOSKS FOR CUSTOMER ORDERING OF FOOD CONCESSIONS AND MERCHANDISE AT ATHLETIC AND ENTERTAINMENT FACILITIES AND OTHER RETAIL ESTABLISHMENTS (U.S. CLS. 21, 23, 26, 36 AND 38).

PAUL E. FAHRENKOPF, EXAMINING ATTORNEY

CLASS 9—(Continued).

SN 77-298,000. NELSON KENDALL R, RALEIGH, NC. FILED 10-6-2007.

Big Bang Astronomy Shop

THE MARK CONSISTS OF STANDARD CHARACTERS WITHOUT CLAIM TO ANY PARTICULAR FONT, STYLE, SIZE, OR COLOR.

NO CLAIM IS MADE TO THE EXCLUSIVE RIGHT TO USE "ASTRONOMY SHOP", APART FROM THE MARK AS SHOWN.

FOR BODY-TUBES FOR TELESCOPES; OPTICAL OR TELESCOPIC LENS SIGHTS; REFLECTORS FOR TELESCOPES; TRIPODS FOR TELESCOPES; ZENITH TELESCOPES (U.S. CLS. 21, 23, 26, 36 AND 38).
ROBERT C. CLARK JR., EXAMINING ATTORNEY

CLASS 9—(Continued).

SN 77-298,371. SPEEDHUT, INC., LINDON, UT. FILED 10-8-2007.

SPEEDHUT

THE MARK CONSISTS OF STANDARD CHARACTERS WITHOUT CLAIM TO ANY PARTICULAR FONT, STYLE, SIZE, OR COLOR.

FOR AUTOMOTIVE, MARINE, AND MOTORCYCLE MEASURING INSTRUMENTS, NAMELY, WATER TEMPERATURE GAUGES, AIR FUEL/RATIO GAUGES, BOOST GAUGES, VACUUM GAUGES, EXHAUST GAS TEMPERATURE GAUGES, SPEEDOMETERS, AND TACHOMETERS (U.S. CLS. 21, 23, 26, 36 AND 38).

FIRST USE 4-1-2001; IN COMMERCE 4-1-2001.
LINDA E. BLOHM, EXAMINING ATTORNEY

SN 77-298,671. ULTRACONCURRENT, INC., APTOS, CA. FILED 10-8-2007.

ONTOORG

THE MARK CONSISTS OF STANDARD CHARACTERS WITHOUT CLAIM TO ANY PARTICULAR FONT, STYLE, SIZE, OR COLOR.

FOR COMPUTER SOFTWARE FOR CREATING SEARCHABLE DATABASES OF INFORMATION AND DATA, NAMELY, COMPUTER SOFTWARE FOR SEARCHING, COMPILING, INDEXING, QUERYING, INFERENCE AND ORGANIZING INFORMATION ON COMPUTER NETWORKS; COMPUTER HARDWARE AND SOFTWARE FOR CREATING SEARCHABLE DATABASES OF INFORMATION AND DATA, NAMELY, COMPUTER HARDWARE AND COMPUTER SOFTWARE FOR SEARCHING, COMPILING, INDEXING, QUERYING, INFERENCE AND ORGANIZING INFORMATION WITHIN HANDHELDS, INDIVIDUAL WORKSTATIONS AND PERSONAL COMPUTERS AND NETWORKED COMPUTERS; COMPUTER SOFTWARE FOR CREATING SEARCHABLE DATABASES OF INFORMATION AND DATA, NAMELY, COMPUTER SOFTWARE FOR CREATING INDEXES AND SEARCHING, QUERYING AND INFERENCE THEORIES OF INFORMATION IN THE FOLLOWING AREAS: ACCOUNTING, APPAREL, AUDIO, AUTOS, BOOKS, BLOGS, CAFES, CALENDARING, CAMERAS, CARS, CELLULAR, CHARTS, CLOTHES, COFFEE, COLLEGES, COMPANIES, COMPUTERS, CONTACTS, CORPORATIONS, DATING, DENTISTS, DESKTOPS, DIAGRAMS, DOCS, DOCTORS, DRINKS, EDUCATION, ELECTRONICS, EMPLOYMENT, FILMS, FOOD, FINANCE, FURNISHINGS, FURNITURE, GARDEN, GIFTS, GRAPHS, HEALTH, HOME, IMAGES, JOBS, KITCHEN, LAPTOPS, MAGAZINES, MAIL, MEDICAL, MESSAGES, MORTGAGE, MOVIES, MUSIC, MAPS, NEWS, NOTEBOOKS, PERSONALS, PHONES, PHOTOS, PODCASTS, PRESENTS, PRESENTATIONS, PRINTERS, RESTAURANTS, SCHOOLS, SHOWS, SINGLES, SOFTWARE, SONGS, SPORTS, SPREADSHEET, SUPPLEMENTS, TALK, TRAINING, TRAVEL, TOYS, TV, VIDEOS, VIEWS, WINES, WORK, WIRELESS, UNIVERSITIES, AND WEB SITES (U.S. CLS. 21, 23, 26, 36 AND 38).

THEODORE MCBRIDE, EXAMINING ATTORNEY

SN 77-298,001. INDUSTRIAL AMPS, INC., YORK, PA. FILED 10-6-2007.

IA

THE MARK CONSISTS OF STANDARD CHARACTERS WITHOUT CLAIM TO ANY PARTICULAR FONT, STYLE, SIZE, OR COLOR.

FOR AMPLIFIERS; ELECTRONIC EFFECT PEDALS FOR USE WITH SOUND AMPLIFIERS; ELECTRONIC SOUND PICKUP FOR GUITARS AND BASSES; GUITAR AMPLIFIERS; GUITAR CABLES; GUITAR EFFECTS PROCESSORS; GUITAR PEDALS; LOUDSPEAKERS WITH BUILT IN AMPLIFIERS; MUSICAL INSTRUMENT AMPLIFIERS; POWER AMPLIFIERS; PRE-AMPLIFIERS; RACKS FOR AMPLIFIERS; SOUND AMPLIFIERS; SOUND MIXERS WITH INTEGRATED AMPLIFIERS; STEREO AMPLIFIERS (U.S. CLS. 21, 23, 26, 36 AND 38).

JILL C. ALT, EXAMINING ATTORNEY

CLASS 9—(Continued).

SN 77-299,372. ULTRACONCURRENT, INC., APTOS, CA.
FILED 10-9-2007.

ONTOVISUAL

THE MARK CONSISTS OF STANDARD CHARACTERS WITHOUT CLAIM TO ANY PARTICULAR FONT, STYLE, SIZE, OR COLOR.

FOR COMPUTER SOFTWARE FOR CREATING SEARCHABLE DATABASES OF INFORMATION AND DATA, NAMELY, COMPUTER SOFTWARE FOR SEARCHING, COMPILING, INDEXING, QUERYING, INFERRING AND ORGANIZING INFORMATION ON COMPUTER NETWORKS; COMPUTER HARDWARE AND SOFTWARE FOR CREATING SEARCHABLE DATABASES OF INFORMATION AND DATA, NAMELY, COMPUTER HARDWARE AND COMPUTER SOFTWARE FOR SEARCHING, COMPILING, INDEXING, QUERYING, INFERRING AND ORGANIZING INFORMATION WITHIN HANDHELDS, INDIVIDUAL WORKSTATIONS AND PERSONAL COMPUTERS AND NETWORKED COMPUTERS; COMPUTER SOFTWARE FOR CREATING SEARCHABLE DATABASES OF INFORMATION AND DATA, NAMELY, COMPUTER SOFTWARE FOR CREATING INDEXES AND SEARCHING, QUERYING AND INFERRING THEORIES OF INFORMATION IN THE FOLLOWING AREAS: ACCOUNTING, APPAREL, AUDIO, AUTOS, BOOKS, BLOGS, CAFES, CALENDARING, CAMERAS, CARS, CELLULAR, CHARTS, CLOTHES, COFFEE, COLLEGES, COMPANIES, COMPUTERS, CONTACTS, CORPORATIONS, DATING, DENTISTS, DESKTOPS, DIAGRAMS, DOCS, DOCTORS, DRINKS, EDUCATION, ELECTRONICS, EMPLOYMENT, FILMS, FOOD, FINANCE, FURNISHINGS, FURNITURE, GARDEN, GIFTS, GRAPHS, HEALTH, HOME, IMAGES, JOBS, KITCHEN, LAPTOPS, MAGAZINES, MAIL, MEDICAL, MESSAGES, MORTGAGE, MOVIES, MUSIC, MAPS, NEWS, NOTEBOOKS, PERSONALS, PHONES, PHOTOS, PODCASTS, PRESENTS, PRESENTATIONS, PRINTERS, RESTAURANTS, SCHOOLS, SHOWS, SINGLES, SOFTWARE, SONGS, SPORTS, SPREADSHEET, SUPPLEMENTS, TALK, TRAINING, TRAVEL, TOYS, TV, VIDEOS, VIEWS, WINES, WORK, WIRELESS, UNIVERSITIES, AND WEB SITES (U.S. CLS. 21, 23, 26, 36 AND 38).

THEODORE MCBRIDE, EXAMINING ATTORNEY

SN 77-300,315. WMS GAMING INC., WAUKEGAN, IL.
FILED 10-10-2007.

JACKPOT CANYON

THE MARK CONSISTS OF STANDARD CHARACTERS WITHOUT CLAIM TO ANY PARTICULAR FONT, STYLE, SIZE, OR COLOR.

NO CLAIM IS MADE TO THE EXCLUSIVE RIGHT TO USE "JACKPOT", APART FROM THE MARK AS SHOWN.

FOR GAMING MACHINES THAT GENERATE OR DISPLAY WAGER OUTCOMES; GAMING SOFTWARE THAT GENERATES OR DISPLAYS WAGER OUTCOMES OF GAMING MACHINES (U.S. CLS. 21, 23, 26, 36 AND 38).

GEORGE LORENZO, EXAMINING ATTORNEY

CLASS 9—(Continued).

SN 77-300,983. RELIASOFT CORPORATION, TUCSON, AZ.
FILED 10-10-2007.

RCM++

THE MARK CONSISTS OF STANDARD CHARACTERS WITHOUT CLAIM TO ANY PARTICULAR FONT, STYLE, SIZE, OR COLOR.

FOR COMPUTER SOFTWARE FOR RELIABILITY CENTERED MAINTENANCE ANALYSIS, NAMELY, FOR USE IN PERFORMING RELIABILITY ANALYSIS AS IT PERTAINS TO IDENTIFYING AND ESTABLISHING THE OPERATIONAL, MAINTENANCE, AND CAPITAL IMPROVEMENT POLICIES THAT WILL MANAGE THE RISKS OF EQUIPMENT FAILURE MOST EFFECTIVELY WITH THE USE OF INDUSTRY STANDARDS, CONSISTING OF, BUT NOT LIMITED TO ATA MSG-3, SAE JA1012 AND NAIVAIR 00-25-403 AND OTHERS (U.S. CLS. 21, 23, 26, 36 AND 38).

FIRST USE 10-0-2003; IN COMMERCE 2-0-2005.

SALLY SHIH, EXAMINING ATTORNEY

SN 77-301,583. ARUZE CORPORATION, TOKOYO, JAPAN,
FILED 10-11-2007.



THE MARK CONSISTS OF A STYLIZED PICTURE OF CLOUDS ON TOP OF WHICH ARE CHINESE CHARACTERS WHICH MEAN "FANTASTIC MONKEY" IN ENGLISH AND THE ENGLISH WORDS "FANTASTIC MONKEY".

THE NON-LATIN CHARACTER(S) IN THE MARK TRANSLITERATES INTO "HOUWANG XUNBAO", AND THIS MEANS "MONKEY, KING, SEEK (OR SEARCH), TREASURE" IN ENGLISH.

FOR SLOT MACHINES AND REPLACEMENT PARTS THEREFOR; VIDEO SLOT MACHINES AND REPLACEMENT PARTS THEREFOR; GAMING MACHINES AND REPLACEMENT PARTS THEREFOR; GAMING MACHINES WITH A LIQUID CRYSTAL DISPLAY AND REPLACEMENT PARTS THEREFOR; MECHANICAL REEL TYPE SLOT MACHINES WITH A LIQUID CRYSTAL DISPLAY AND REPLACEMENT PARTS THEREFOR; MEDIA STORAGE COMPUTER SOFTWARE FOR ELECTRONIC CIRCUITS, OPTICAL DISKS, MAGNETIC TAPES, MAGNETIC DISKS, MAGNETIC CARDS, OPTICAL-MAGNETIC DISKS, CD-ROMS, ROM-CARTRIDGES AND DVDS, NAMELY, COMPUTER SOFTWARE FOR CONTROLLING SLOT MACHINES AND GAME MACHINES; COMPUTER GAME SOFTWARE FOR GAME MACHINES AND SLOT MACHINES (U.S. CLS. 21, 23, 26, 36 AND 38).

JIM RINGLE, EXAMINING ATTORNEY

CLASS 9—(Continued).

SN 77-301,594. ARUZE CORPORATION, TOKOYO, JAPAN, FILED 10-11-2007.



THE MARK CONSISTS OF A STYLIZED PICTURE OF CLOUDS ON TOP OF WHICH ARE CHINESE CHARACTERS WHICH MEAN "FORTUNE JOURNEY" IN ENGLISH AND THE ENGLISH WORDS "FORTUNE JOURNEY".

THE NON-LATIN CHARACTER(S) IN THE MARK TRANSLITERATES INTO "XING YUN LU CHENG", AND THIS MEANS "FORTUNE JOURNEY" IN ENGLISH.

FOR SLOT MACHINES AND REPLACEMENT PARTS THEREFOR; VIDEO SLOT MACHINES AND REPLACEMENT PARTS THEREFOR; GAMING MACHINES AND REPLACEMENT PARTS THEREFOR; GAMING MACHINES WITH A LIQUID CRYSTAL DISPLAY AND REPLACEMENT PARTS THEREFOR; MECHANICAL REEL TYPE SLOT MACHINES WITH A LIQUID CRYSTAL DISPLAY AND REPLACEMENT PARTS THEREFOR; MEDIA STORAGE COMPUTER SOFTWARE FOR ELECTRONIC CIRCUITS, OPTICAL DISKS, MAGNETIC TAPES, MAGNETIC DISKS, MAGNETIC CARDS, OPTICAL-MAGNETIC DISKS, CD-ROMS, ROM-CARTRIDGES AND DVDS, NAMELY, COMPUTER SOFTWARE FOR CONTROLLING SLOT MACHINES AND GAME MACHINES; COMPUTER GAME SOFTWARE FOR GAME MACHINES AND SLOT MACHINES (U.S. CLS. 21, 23, 26, 36 AND 38).

JIM RINGLE, EXAMINING ATTORNEY

SN 77-301,610. ARUZE CORPORATION, TOKOYO, JAPAN, FILED 10-11-2007.



THE MARK CONSISTS OF CHINESE CHARACTERS WHICH MEAN "THE KING OF MONGOLIA" IN ENGLISH ABOVE THE ENGLISH WORDS "THE KING OF MONGOLIA".

THE NON-LATIN CHARACTER(S) IN THE MARK TRANSLITERATES INTO "MENG GU ZHI WANG", AND THIS MEANS "KING OF MONGOLIA" IN ENGLISH.

FOR SLOT MACHINES AND REPLACEMENT PARTS THEREFOR; VIDEO SLOT MACHINES AND REPLACEMENT PARTS THEREFOR; GAMING MACHINES AND REPLACEMENT PARTS THEREFOR; GAMING MACHINES WITH A LIQUID CRYSTAL DISPLAY AND REPLACEMENT PARTS THEREFOR; MECHANICAL REEL TYPE SLOT MACHINES WITH A LIQUID CRYSTAL DISPLAY AND REPLACEMENT PARTS THEREFOR; MEDIA STORAGE COMPUTER SOFTWARE FOR ELECTRONIC CIRCUITS, OPTICAL DISKS, MAGNETIC TAPES, MAGNETIC DISKS, MAGNETIC CARDS, OPTICAL-MAGNETIC DISKS, CD-ROMS, ROM-CARTRIDGES AND DVDS, NAMELY, COMPUTER SOFTWARE FOR CONTROLLING SLOT MACHINES AND GAME MACHINES; COMPUTER GAME SOFTWARE FOR GAME MACHINES AND SLOT MACHINES (U.S. CLS. 21, 23, 26, 36 AND 38).

JIM RINGLE, EXAMINING ATTORNEY

CLASS 9—(Continued).

SN 77-301,622. ARUZE CORPORATION, TOKOYO, JAPAN, FILED 10-11-2007.



THE MARK CONSISTS OF CHINESE CHARACTERS WHICH MEAN "THE GREAT EMPEROR" IN ENGLISH ABOVE THE ENGLISH WORDS "THE GREAT KHAN".

THE NON-LATIN CHARACTER(S) IN THE MARK TRANSLITERATES INTO "WEI DI", AND THIS MEANS "GREAT EMPEROR" IN ENGLISH.

FOR SLOT MACHINES AND REPLACEMENT PARTS THEREFOR; VIDEO SLOT MACHINES AND REPLACEMENT PARTS THEREFOR; GAMING MACHINES AND REPLACEMENT PARTS THEREFOR; GAMING MACHINES WITH A LIQUID CRYSTAL DISPLAY AND REPLACEMENT PARTS THEREFOR; MECHANICAL REEL TYPE SLOT MACHINES WITH A LIQUID CRYSTAL DISPLAY AND REPLACEMENT PARTS THEREFOR; MEDIA STORAGE COMPUTER SOFTWARE FOR ELECTRONIC CIRCUITS, OPTICAL DISKS, MAGNETIC TAPES, MAGNETIC DISKS, MAGNETIC CARDS, OPTICAL-MAGNETIC DISKS, CD-ROMS, ROM-CARTRIDGES AND DVDS, NAMELY, COMPUTER SOFTWARE FOR CONTROLLING SLOT MACHINES AND GAME MACHINES; COMPUTER GAME SOFTWARE FOR GAME MACHINES AND SLOT MACHINES (U.S. CLS. 21, 23, 26, 36 AND 38).

JIM RINGLE, EXAMINING ATTORNEY

SN 77-301,633. ARUZE CORPORATION, TOKOYO, JAPAN, FILED 10-11-2007.



THE MARK CONSISTS OF A STYLIZED PICTURE OF A DRAGON ON TOP OF WHICH ARE CHINESE CHARACTERS WHICH MEAN "KUNG FU DRAGON" IN ENGLISH AND THE ENGLISH WORDS "KUNG FU DRAGON".

THE NON-LATIN CHARACTER(S) IN THE MARK TRANSLITERATES INTO LONG DE CHUAN REN, AND THIS MEANS DRAGON OF LEGENDARY PERSON/DRAGON OF BIOGRAPHY (OR CHRONICLE) HUMAN (OR PERSON) IN ENGLISH.

FOR SLOT MACHINES AND REPLACEMENT PARTS THEREFOR; VIDEO SLOT MACHINES AND REPLACEMENT PARTS THEREFOR; GAMING MACHINES AND REPLACEMENT PARTS THEREFOR; GAMING MACHINES WITH A LIQUID CRYSTAL DISPLAY AND REPLACEMENT PARTS THEREFOR; MECHANICAL REEL TYPE SLOT MACHINES WITH A LIQUID CRYSTAL DISPLAY AND REPLACEMENT PARTS THEREFOR; MEDIA STORAGE COMPUTER SOFTWARE FOR ELECTRONIC CIRCUITS, OPTICAL DISKS, MAGNETIC TAPES, MAGNETIC DISKS, MAGNETIC CARDS, OPTICAL-MAGNETIC DISKS, CD-ROMS, ROM-CARTRIDGES AND DVDS, NAMELY, COMPUTER SOFTWARE FOR CONTROLLING SLOT MACHINES AND GAME MACHINES; COMPUTER GAME SOFTWARE FOR GAME MACHINES AND SLOT MACHINES (U.S. CLS. 21, 23, 26, 36 AND 38).

JIM RINGLE, EXAMINING ATTORNEY

CLASS 9—(Continued).

SN 77-301,643. ARUZE CORPORATION, TOKYO, JAPAN,
FILED 10-11-2007.



THE MARK CONSISTS OF A STYLIZED PICTURE OF A DRAGON ON TOP OF WHICH ARE CHINESE CHARACTERS WHICH MEAN "DRAGON FIST" IN ENGLISH AND THE ENGLISH WORDS "DRAGON FIST".

THE NON-LATIN CHARACTER(S) IN THE MARK TRANSLITERATES INTO LONG QUAN, AND THIS MEANS "DRAGON FIST" IN ENGLISH.

FOR SLOT MACHINES AND REPLACEMENT PARTS THEREFOR; VIDEO SLOT MACHINES AND REPLACEMENT PARTS THEREFOR; GAMING MACHINES AND REPLACEMENT PARTS THEREFOR; GAMING MACHINES WITH A LIQUID CRYSTAL DISPLAY AND REPLACEMENT PARTS THEREFOR; MECHANICAL REEL TYPE SLOT MACHINES WITH A LIQUID CRYSTAL DISPLAY AND REPLACEMENT PARTS THEREFOR; MEDIA STORAGE COMPUTER SOFTWARE FOR ELECTRONIC CIRCUITS, OPTICAL DISKS, MAGNETIC TAPES, MAGNETIC DISKS, MAGNETIC CARDS, OPTICAL-MAGNETIC DISKS, CD-ROMS, ROM-CARTRIDGES AND DVDS, NAMELY, COMPUTER SOFTWARE FOR CONTROLLING SLOT MACHINES AND GAME MACHINES; COMPUTER GAME SOFTWARE FOR GAME MACHINES AND SLOT MACHINES (U.S. CLS. 21, 23, 26, 36 AND 38).

JIM RINGLE, EXAMINING ATTORNEY

CLASS 9—(Continued).

SN 77-301,756. ULTRACONCURRENT, INC., APTOS, CA.
FILED 10-11-2007.

ONTOSCHEDULE

THE MARK CONSISTS OF STANDARD CHARACTERS WITHOUT CLAIM TO ANY PARTICULAR FONT, STYLE, SIZE, OR COLOR.

FOR COMPUTER SOFTWARE FOR CREATING SEARCHABLE DATABASES OF INFORMATION AND DATA, NAMELY, COMPUTER SOFTWARE FOR SEARCHING, COMPILING, INDEXING, QUERYING, INFERENCE AND ORGANIZING INFORMATION ON COMPUTER NETWORKS; COMPUTER HARDWARE AND SOFTWARE FOR CREATING SEARCHABLE DATABASES OF INFORMATION AND DATA, NAMELY, COMPUTER HARDWARE AND COMPUTER SOFTWARE FOR SEARCHING, COMPILING, INDEXING, QUERYING, INFERENCE AND ORGANIZING INFORMATION WITHIN HANDHELDS, INDIVIDUAL WORKSTATIONS AND PERSONAL COMPUTERS AND NETWORKED COMPUTERS; COMPUTER SOFTWARE FOR CREATING SEARCHABLE DATABASES OF INFORMATION AND DATA, NAMELY, COMPUTER SOFTWARE FOR CREATING INDEXES AND SEARCHING, QUERYING AND INFERENCE THEORIES OF INFORMATION IN THE FOLLOWING AREAS: ACCOUNTING, APPAREL, AUDIO, AUTOS, BOOKS, BLOGS, CAFES, CALENDARING, CAMERAS, CARS, CELLULAR, CHARTS, CLOTHES, COFFEE, COLLEGES, COMPANIES, COMPUTERS, CONTACTS, CORPORATIONS, DATING, DENTISTS, DESKTOPS, DIAGRAMS, DOCS, DOCTORS, DRINKS, EDUCATION, ELECTRONICS, EMPLOYMENT, FILMS, FOOD, FINANCE, FURNISHINGS, FURNITURE, GARDEN, GIFTS, GRAPHS, HEALTH, HOME, IMAGES, JOBS, KITCHEN, LAPTOPS, MAGAZINES, MAIL, MEDICAL, MESSAGES, MORTGAGE, MOVIES, MUSIC, MAPS, NEWS, NOTEBOOKS, PERSONALS, PHONES, PHOTOS, PODCASTS, PRESENTS, PRESENTATIONS, PRINTERS, RESTAURANTS, SCHOOLS, SHOWS, SINGLES, SOFTWARE, SONGS, SPORTS, SPREADSHEET, SUPPLEMENTS, TALK, TRAINING, TRAVEL, TOYS, TV, VIDEOS, VIEWS, WINES, WORK, WIRELESS, UNIVERSITIES, AND WEB SITES (U.S. CLS. 21, 23, 26, 36 AND 38).

THEODORE MCBRIDE, EXAMINING ATTORNEY

SN 77-301,657. HEARST COMMUNICATIONS, INC., NEW YORK, NY. FILED 10-11-2007.

CLUB COSMO

THE MARK CONSISTS OF STANDARD CHARACTERS WITHOUT CLAIM TO ANY PARTICULAR FONT, STYLE, SIZE, OR COLOR.

FOR COMPACT DISCS FEATURING MUSIC (U.S. CLS. 21, 23, 26, 36 AND 38).

FIRST USE 1-1-1999; IN COMMERCE 1-1-1999.

JOHN DALIER, EXAMINING ATTORNEY

CLASS 9—(Continued).

SN 77-301,762. ULTRACONCURRENT, INC., APTOS, CA. FILED 10-11-2007.

ONTOTASKS

THE MARK CONSISTS OF STANDARD CHARACTERS WITHOUT CLAIM TO ANY PARTICULAR FONT, STYLE, SIZE, OR COLOR.

FOR COMPUTER SOFTWARE FOR CREATING SEARCHABLE DATABASES OF INFORMATION AND DATA, NAMELY, COMPUTER SOFTWARE FOR SEARCHING, COMPILING, INDEXING, QUERYING, INFERRING AND ORGANIZING INFORMATION ON COMPUTER NETWORKS; COMPUTER HARDWARE AND SOFTWARE FOR CREATING SEARCHABLE DATABASES OF INFORMATION AND DATA, NAMELY, COMPUTER HARDWARE AND COMPUTER SOFTWARE FOR SEARCHING, COMPILING, INDEXING, QUERYING, INFERRING AND ORGANIZING INFORMATION WITHIN HANDHELDS, INDIVIDUAL WORKSTATIONS AND PERSONAL COMPUTERS AND NETWORKED COMPUTERS; COMPUTER SOFTWARE FOR CREATING SEARCHABLE DATABASES OF INFORMATION AND DATA, NAMELY, COMPUTER SOFTWARE FOR CREATING INDEXES AND SEARCHING, QUERYING AND INFERRING THEORIES OF INFORMATION IN THE FOLLOWING AREAS: ACCOUNTING, APPAREL, AUDIO, AUTOS, BOOKS, BLOGS, CAFES, CALENDARING, CAMERAS, CARS, CELLULAR, CHARTS, CLOTHES, COFFEE, COLLEGES, COMPANIES, COMPUTERS, CONTACTS, CORPORATIONS, DATING, DENTISTS, DESKTOPS, DIAGRAMS, DOCS, DOCTORS, DRINKS, EDUCATION, ELECTRONICS, EMPLOYMENT, FILMS, FOOD, FINANCE, FURNISHINGS, FURNITURE, GARDEN, GIFTS, GRAPHS, HEALTH, HOME, IMAGES, JOBS, KITCHEN, LAPTOPS, MAGAZINES, MAIL, MEDICAL, MESSAGES, MORTGAGE, MOVIES, MUSIC, MAPS, NEWS, NOTEBOOKS, PERSONALS, PHONES, PHOTOS, PODCASTS, PRESENTS, PRESENTATIONS, PRINTERS, RESTAURANTS, SCHOOLS, SHOWS, SINGLES, SOFTWARE, SONGS, SPORTS, SPREADSHEET, SUPPLEMENTS, TALK, TRAINING, TRAVEL, TOYS, TV, VIDEOS, VIEWS, WINES, WORK, WIRELESS, UNIVERSITIES, AND WEB SITES (U.S. CLS. 21, 23, 26, 36 AND 38).

THEODORE MCBRIDE, EXAMINING ATTORNEY

SN 77-302,673. DESTINEER PUBLISHING CORP., PLYMOUTH, MN. FILED 10-12-2007.

PIZZA MANIA

THE MARK CONSISTS OF STANDARD CHARACTERS WITHOUT CLAIM TO ANY PARTICULAR FONT, STYLE, SIZE, OR COLOR.

FOR COMPUTER GAME SOFTWARE FOR USE WITH PERSONAL COMPUTERS AND VIDEO GAME CONSOLES; DOWNLOADABLE COMPUTER GAME SOFTWARE FOR USE WITH CABLE AND SATELLITE ACCESSIBLE VIDEO CONTROLLERS AND PORTABLE VIDEO DISPLAYS (U.S. CLS. 21, 23, 26, 36 AND 38).

FRED CARL, EXAMINING ATTORNEY

CLASS 9—(Continued).

SN 77-303,806. MOCON, INC., MINNEAPOLIS, MN. FILED 10-15-2007.

BASELINE

THE MARK CONSISTS OF STANDARD CHARACTERS WITHOUT CLAIM TO ANY PARTICULAR FONT, STYLE, SIZE, OR COLOR.

FOR TOTAL HYDROCARBON ANALYZERS; TOTAL VOLATILE ORGANIC CARBON ANALYZERS; METHANE AND NONMETHANE ANALYZERS; TOTAL CARBON ANALYZERS; GAS CHROMATOGRAPHY APPARATUS; PHOTOIONIZATION SENSORS FOR MEASURING TRACE LEVELS OF VOLATILE ORGANIC COMPOUNDS; GAS CHROMATOGRAPH PERMEATION CALIBRATORS; AND MULTIPOINT SAMPLERS FOR GAS CHROMATOGRAPHS AND GAS ANALYZERS (U.S. CLS. 21, 23, 26, 36 AND 38).

FIRST USE 12-31-1969; IN COMMERCE 12-31-1969.

PAUL E. FAHRENKOPF, EXAMINING ATTORNEY

SN 77-304,081. SUNBEAM PRODUCTS, INC., BOCA RATON, FL. FILED 10-15-2007.

SUNBEAM

THE MARK CONSISTS OF STANDARD CHARACTERS WITHOUT CLAIM TO ANY PARTICULAR FONT, STYLE, SIZE, OR COLOR.

OWNER OF U.S. REG. NOS. 145,335, 280,756 AND OTHERS.

FOR ELECTRICAL PRODUCTS, NAMELY, EXTENSION CORDS, POWER STRIPS AND BATTERIES (U.S. CLS. 21, 23, 26, 36 AND 38).

FIRST USE 11-1-2004; IN COMMERCE 11-1-2004.

BRENDAN REGAN, EXAMINING ATTORNEY

SN 77-304,255. SANFORD, L.P., OAK BROOK, IL. FILED 10-15-2007.

DYMO FILE

THE MARK CONSISTS OF STANDARD CHARACTERS WITHOUT CLAIM TO ANY PARTICULAR FONT, STYLE, SIZE, OR COLOR.

OWNER OF U.S. REG. NOS. 702,685, 1,310,765 AND OTHERS.

NO CLAIM IS MADE TO THE EXCLUSIVE RIGHT TO USE "FILE", APART FROM THE MARK AS SHOWN.

FOR COMPUTER SOFTWARE AND COMPUTER HARDWARE FOR USE IN THE FIELD OF DOCUMENT MANAGEMENT FOR INDEXING, SCANNING, IMAGING, MANAGING, STORING, ARCHIVING AND RETRIEVING DOCUMENTS (U.S. CLS. 21, 23, 26, 36 AND 38).

JUDITH HELFMAN, EXAMINING ATTORNEY

CLASS 9—(Continued).

SN 77-304,294. C&D TECHNOLOGIES, INC., BLUE BELL, PA.
FILED 10-15-2007.

VELOCITY

THE MARK CONSISTS OF STANDARD CHARACTERS WITHOUT CLAIM TO ANY PARTICULAR FONT, STYLE, SIZE, OR COLOR.

FOR INDUSTRIAL BATTERY AND BATTERY CHARGER MODULE FOR USE IN THE MATERIAL HANDLING INDUSTRY (U.S. CLS. 21, 23, 26, 36 AND 38).

FIRST USE 1-2-2007; IN COMMERCE 1-2-2007.
HANNO RITTNER, EXAMINING ATTORNEY

SN 77-305,729. WMS GAMING INC., WAUKEGAN, IL.
FILED 10-17-2007.

SPANISH PARADISE

THE MARK CONSISTS OF STANDARD CHARACTERS WITHOUT CLAIM TO ANY PARTICULAR FONT, STYLE, SIZE, OR COLOR.

FOR GAMING MACHINES THAT GENERATE OR DISPLAY WAGER OUTCOMES; GAMING SOFTWARE THAT GENERATES OR DISPLAYS WAGER OUTCOMES OF GAMING MACHINES (U.S. CLS. 21, 23, 26, 36 AND 38).

GEORGE LORENZO, EXAMINING ATTORNEY

SN 77-306,610. I.D. SYSTEMS, INC., HACKENSACK, NJ.
FILED 10-17-2007.

OPTI-KAN

THE MARK CONSISTS OF STANDARD CHARACTERS WITHOUT CLAIM TO ANY PARTICULAR FONT, STYLE, SIZE, OR COLOR.

FOR PARTS REPLENISHMENT SYSTEM COMPRISED OF WIRELESS TRANSMITTERS, WIRELESS RECEIVERS, COMPUTER HARDWARE AND SOFTWARE FOR AUTOMATING AND OPTIMIZING MATERIAL HANDLING TASKS FOR MANUFACTURING AND INDUSTRIAL PRODUCTION LINES (U.S. CLS. 21, 23, 26, 36 AND 38).

BARBARA A. GOLD, EXAMINING ATTORNEY

CLASS 9—(Continued).

SN 77-307,579. DRESSER, INC., ADDISON, TX. FILED 10-18-2007.

GLOBAL VISION

THE MARK CONSISTS OF STANDARD CHARACTERS WITHOUT CLAIM TO ANY PARTICULAR FONT, STYLE, SIZE, OR COLOR.

FOR FUEL DISPENSERS FOR SERVICE STATIONS AND COMMERCIAL FUEL DISPENSING STATIONS (U.S. CLS. 21, 23, 26, 36 AND 38).

DANIEL BRODY, EXAMINING ATTORNEY

SN 77-307,617. HALLIBURTON ENERGY SERVICES, INC., CARROLLTON, TX. FILED 10-18-2007.

RIG TOOLS

THE MARK CONSISTS OF STANDARD CHARACTERS WITHOUT CLAIM TO ANY PARTICULAR FONT, STYLE, SIZE, OR COLOR.

OWNER OF U.S. REG. NO. 2,593,259.

SEC. 2(F).

FOR COMPUTER SOFTWARE PROGRAMS AND ELECTRONIC DATABASES STORED ON COMPUTER MEDIA FOR USE IN DETERMINING DRILL BIT HYDRAULICS, CASING SIZES, API CLEARANCES, AND DRILL BIT NOMENCLATURE REFERENCES (U.S. CLS. 21, 23, 26, 36 AND 38).

FIRST USE 1-2-2002; IN COMMERCE 1-2-2002.

SHAILA SETTLES, EXAMINING ATTORNEY

SN 77-307,695. CODONICS, INC., MIDDLEBURG HTS., OH.
FILED 10-18-2007.

CLARITY

THE MARK CONSISTS OF STANDARD CHARACTERS WITHOUT CLAIM TO ANY PARTICULAR FONT, STYLE, SIZE, OR COLOR.

FOR COMPUTER HARDWARE AND SOFTWARE FOR ORGANIZING AND VIEWING DIGITAL IMAGES, PHOTOGRAPHS, DOCUMENTS, AND MULTIMEDIA CONTENT INCLUDING VIDEO, MOTION PICTURES, TEXT, AND GRAPHICS (U.S. CLS. 21, 23, 26, 36 AND 38).

RICHARD A. STRASER, EXAMINING ATTORNEY

CLASS 9—(Continued).

SN 77-308,179. ASTHEBURGERTURNS HOLDINGS, LLC, BIRMINGHAM, AL. FILED 10-19-2007.

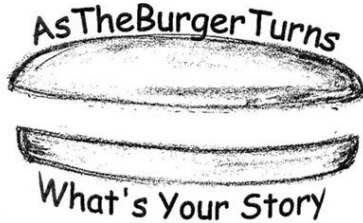

THE MARK CONSISTS OF DRAWN IMAGE OF TOP HALF AND BOTTOM HALF OF HAMBURGER BUN SEPARATED WITH THE WORDS, "AS THE BURGER TURNS", ABOVE THE TOP HALF OF THE BUN AND THE WORDS, "WHAT'S YOUR STORY", BELOW THE BOTTOM HALF OF THE BUN.

FOR DVDS FEATURING TRAINING MATERIALS FOR RESTAURANT MANAGERS, EMPLOYEES AND POTENTIAL EMPLOYEES IN THE FIELD OF RESTAURANT SERVICES; DOWNLOADABLE PODCASTS FOR RESTAURANT MANAGERS, EMPLOYEES AND POTENTIAL EMPLOYEES IN THE FIELD OF RESTAURANT SERVICES (U.S. CLS. 21, 23, 26, 36 AND 38).
TASHIA BUNCH, EXAMINING ATTORNEY

CLASS 9—(Continued).

SN 77-310,275. ICONOPSYCH CARE LLC, COLUMBIA, MO. FILED 10-22-2007.

Iconic Health

THE MARK CONSISTS OF STANDARD CHARACTERS WITHOUT CLAIM TO ANY PARTICULAR FONT, STYLE, SIZE, OR COLOR.

NO CLAIM IS MADE TO THE EXCLUSIVE RIGHT TO USE "HEALTH", APART FROM THE MARK AS SHOWN.

FOR COMPUTER SOFTWARE FOR PATIENT/DOCTOR INTERACTION MANAGEMENT, BILLING, SCHEDULING, MANAGEMENT OF RECORDS (U.S. CLS. 21, 23, 26, 36 AND 38).

ROBIN CHOSID, EXAMINING ATTORNEY

SN 77-308,203. HALLIBURTON ENERGY SERVICES, INC., CARROLLTON, TX. FILED 10-19-2007.

WAVESONIC

THE MARK CONSISTS OF STANDARD CHARACTERS WITHOUT CLAIM TO ANY PARTICULAR FONT, STYLE, SIZE, OR COLOR.

OWNER OF U.S. REG. NOS. 2,593,200 AND 2,636,678. SEC. 2(F).

FOR OPEN HOLE WIRELINE ACOUSTIC LOGGING TOOL USED TO GATHER DATA THAT MEASURES POROSITY, AMPLITUDE VARIATION, ROCK PROPERTIES AND BOREHOLE STRESS DATA, ANISOTROPY, THROUGH CASING DATA, AND FRACTURE DETECTION (U.S. CLS. 21, 23, 26, 36 AND 38).

FIRST USE 9-30-2000; IN COMMERCE 9-30-2000.
SHAILA SETTLES, EXAMINING ATTORNEY

SN 77-310,386. IGT, RENO, NV. FILED 10-22-2007.

MAGNOLIA

THE MARK CONSISTS OF STANDARD CHARACTERS WITHOUT CLAIM TO ANY PARTICULAR FONT, STYLE, SIZE, OR COLOR.

FOR GAMING MACHINES, NAMELY, DEVICES WHICH ACCEPT A WAGER AND COMPONENTS THEREFOR, NAMELY, CONTROLLERS, DISPLAYS, BUTTON PANELS, BOLSTERS, ELECTRICAL WIRING, AND COMPUTER HARDWARE AND SOFTWARE ASSOCIATED THEREWITH (U.S. CLS. 21, 23, 26, 36 AND 38).

JENNIFER DIXON, EXAMINING ATTORNEY

SN 77-308,264. SPIELO MANUFACTURING ULC, MONCTON, NEW BRUNSWICK, CANADA, FILED 10-19-2007.

ADVENTURES IN BONUSLAND

THE MARK CONSISTS OF STANDARD CHARACTERS WITHOUT CLAIM TO ANY PARTICULAR FONT, STYLE, SIZE, OR COLOR.

FOR RECONFIGURABLE CASINO AND LOTTERY GAMING EQUIPMENT, NAMELY, SLOT MACHINES AND VIDEO LOTTERY TERMINALS AND OPERATIONAL COMPUTER GAME SOFTWARE THEREFOR (U.S. CLS. 21, 23, 26, 36 AND 38).

TASHIA BUNCH, EXAMINING ATTORNEY

SN 77-310,442. BIG FISH GAMES, INC., SEATTLE, WA. FILED 10-22-2007.

MYSTERY CASE FILES: MADAME FATE

THE MARK CONSISTS OF STANDARD CHARACTERS WITHOUT CLAIM TO ANY PARTICULAR FONT, STYLE, SIZE, OR COLOR.

FOR ELECTRONIC GAME PROGRAMS (U.S. CLS. 21, 23, 26, 36 AND 38).

CHERYL CLAYTON, EXAMINING ATTORNEY

CLASS 9—(Continued).

SN 77-310,680. RISE & SHINE VENTURES, LLC, AMELIA ISLAND, FL. FILED 10-23-2007.

W.I.S.E. TECHNOLOGIES

THE MARK CONSISTS OF STANDARD CHARACTERS WITHOUT CLAIM TO ANY PARTICULAR FONT, STYLE, SIZE, OR COLOR.

NO CLAIM IS MADE TO THE EXCLUSIVE RIGHT TO USE "TECHNOLOGIES", APART FROM THE MARK AS SHOWN.

FOR WIRELESS ILLUMINATION CONTROLLERS; LIGHT EMITTING DIODE DISPLAYS; LIGHTING CONTROL PANELS (U.S. CLS. 21, 23, 26, 36 AND 38).

JULIE WATSON, EXAMINING ATTORNEY

CLASS 9—(Continued).

SN 77-313,010. BSA OPTICS INC., FT. LAUDERDALE, FL. FILED 10-25-2007.

VARMINT BRITE

THE MARK CONSISTS OF STANDARD CHARACTERS WITHOUT CLAIM TO ANY PARTICULAR FONT, STYLE, SIZE, OR COLOR.

FOR GUN SCOPES; RIFLE SCOPES (U.S. CLS. 21, 23, 26, 36 AND 38).

MELISSA VALLILLO, EXAMINING ATTORNEY

SN 77-311,785. WMS GAMING INC., WAUKEGAN, IL. FILED 10-24-2007.

SERGEANT WINBIG

THE MARK CONSISTS OF STANDARD CHARACTERS WITHOUT CLAIM TO ANY PARTICULAR FONT, STYLE, SIZE, OR COLOR.

FOR GAMING MACHINES THAT GENERATE OR DISPLAY WAGER OUTCOMES; GAMING SOFTWARE THAT GENERATES OR DISPLAYS WAGER OUTCOMES OF GAMING MACHINES (U.S. CLS. 21, 23, 26, 36 AND 38).

GEORGE LORENZO, EXAMINING ATTORNEY

SN 77-313,880. INFINITE POWER SOLUTIONS, INC., LITTLETON, CO. FILED 10-25-2007.

MEC

THE MARK CONSISTS OF STANDARD CHARACTERS WITHOUT CLAIM TO ANY PARTICULAR FONT, STYLE, SIZE, OR COLOR.

FOR BATTERIES (U.S. CLS. 21, 23, 26, 36 AND 38).

DAVID C. REIHNER, EXAMINING ATTORNEY

SN 77-312,363. GLOBAL RAINMAKERS, INC., SAN JUAN, PUERTO RICO, FILED 10-24-2007.

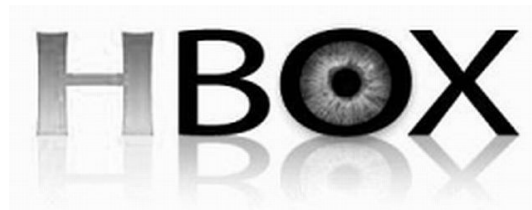

THE MARK CONSISTS OF THE CAPITAL LETTERS HBOX WITH AN EYE LOCATED IN THE CENTER OF THE LETTER "O".

FOR BIOMETRIC DEVICE, NAMELY, DEVICE PROVIDING IDENTIFICATION VIA IRIS AND FACIAL RECOGNITION TO AUTOMATICALLY IDENTIFY PERSONS (U.S. CLS. 21, 23, 26, 36 AND 38).

TARAH HARDY, EXAMINING ATTORNEY

SN 77-313,886. INFINITE POWER SOLUTIONS, INC., LITTLETON, CO. FILED 10-25-2007.

TFMEC

THE MARK CONSISTS OF STANDARD CHARACTERS WITHOUT CLAIM TO ANY PARTICULAR FONT, STYLE, SIZE, OR COLOR.

FOR BATTERIES (U.S. CLS. 21, 23, 26, 36 AND 38).

DAVID C. REIHNER, EXAMINING ATTORNEY

CLASS 9—(Continued).

SN 77-314,436. TELCOR INC, LINCOLN, NE. FILED 10-26-2007.

OIS

THE MARK CONSISTS OF STANDARD CHARACTERS WITHOUT CLAIM TO ANY PARTICULAR FONT, STYLE, SIZE, OR COLOR.

FOR COMPUTER SOFTWARE THAT PROVIDES A CLINICAL, PATHOLOGY OR CYTOLOGY LABORATORY WITH A MODULAR SET OF SYSTEM TOOLS TO SUCCESSFULLY OPERATE AN OUTREACH BUSINESS WHILE ACCESSING THE INFORMATION FROM A PERSONAL COMPUTER THROUGH AN INTERNET BROWSER (U.S. CLS. 21, 23, 26, 36 AND 38).

FIRST USE 10-1-2002; IN COMMERCE 10-1-2002.
MATTHEW PAPPAS, EXAMINING ATTORNEY

CLASS 9—(Continued).

SN 77-316,246. ENOETIC, LLC, TEMPE, AZ. FILED 10-29-2007.

Photology

THE MARK CONSISTS OF STANDARD CHARACTERS WITHOUT CLAIM TO ANY PARTICULAR FONT, STYLE, SIZE, OR COLOR.

FOR DIGITAL IMAGING SOFTWARE; COMPUTER SOFTWARE FOR SEARCHING, INDEXING, ORGANIZING, PROCESSING, VIEWING, SHARING AND PRINTING DIGITAL PHOTOGRAPHS AND IMAGES ON PERSONAL COMPUTERS THAT MAY BE DOWNLOADED FROM A GLOBAL COMPUTER NETWORK (U.S. CLS. 21, 23, 26, 36 AND 38).

FIRST USE 10-29-2007; IN COMMERCE 10-29-2007.
ZACHARY BELLO, EXAMINING ATTORNEY

SN 77-315,644. WMS GAMING INC., WAUKEGAN, IL. FILED 10-29-2007.

EXTRA EXTRA LUCK

THE MARK CONSISTS OF STANDARD CHARACTERS WITHOUT CLAIM TO ANY PARTICULAR FONT, STYLE, SIZE, OR COLOR.

FOR GAMING MACHINES THAT GENERATE OR DISPLAY WAGER OUTCOMES; GAMING SOFTWARE THAT GENERATES OR DISPLAYS WAGER OUTCOMES OF GAMING MACHINES (U.S. CLS. 21, 23, 26, 36 AND 38).

GEORGE LORENZO, EXAMINING ATTORNEY

SN 77-315,725. WMS GAMING INC., WAUKEGAN, IL. FILED 10-29-2007.

LIVE LOBSTERS DANCE PARTY

THE MARK CONSISTS OF STANDARD CHARACTERS WITHOUT CLAIM TO ANY PARTICULAR FONT, STYLE, SIZE, OR COLOR.

OWNER OF U.S. REG. NO. 3,252,324.

FOR GAMING MACHINES THAT GENERATE OR DISPLAY WAGER OUTCOMES; GAMING SOFTWARE THAT GENERATES OR DISPLAYS WAGER OUTCOMES OF GAMING MACHINES (U.S. CLS. 21, 23, 26, 36 AND 38).

GEORGE LORENZO, EXAMINING ATTORNEY

SN 77-316,704. PUBLISHING GROUP OF AMERICA, INC., FRANKLIN, TN. FILED 10-30-2007.

AMERICAN PROFILE PRESENTS

THE MARK CONSISTS OF STANDARD CHARACTERS WITHOUT CLAIM TO ANY PARTICULAR FONT, STYLE, SIZE, OR COLOR.

OWNER OF U.S. REG. NO. 3,028,089.

NO CLAIM IS MADE TO THE EXCLUSIVE RIGHT TO USE "AMERICAN", APART FROM THE MARK AS SHOWN. FOR SERIES OF PRE-RECORDED CD'S, DVD'S, VIDEOTAPES, AND LASER DISCS, ALL FEATURING MUSIC AND ENTERTAINMENT (U.S. CLS. 21, 23, 26, 36 AND 38).

FRED MANDIR, EXAMINING ATTORNEY

SN 77-317,240. NEUTRON DYNAMIC SYSTEMS INC., CRESTON, BRITISH COLUMBIA, CANADA, FILED 10-30-2007.

MISCHIEVIOUS

THE MARK CONSISTS OF STANDARD CHARACTERS WITHOUT CLAIM TO ANY PARTICULAR FONT, STYLE, SIZE, OR COLOR.

FOR PRERECORDED DIGITAL VIDEO DISCS (DVD'S) CONTAINING ADULT CONTENT AND PRERECORDED VIDEO TAPES CONTAINING ADULT CONTENT (U.S. CLS. 21, 23, 26, 36 AND 38).

CYNTHIA SLOAN, EXAMINING ATTORNEY

CLASS 9—(Continued).

SN 77-317,575. WMS GAMING INC., WAUKEGAN, IL.
FILED 10-31-2007.

JACKPOT EXPLOSION

THE MARK CONSISTS OF STANDARD CHARACTERS WITHOUT CLAIM TO ANY PARTICULAR FONT, STYLE, SIZE, OR COLOR.

NO CLAIM IS MADE TO THE EXCLUSIVE RIGHT TO USE "JACKPOT", APART FROM THE MARK AS SHOWN.

FOR GAMING MACHINES THAT GENERATE OR DISPLAY WAGER OUTCOMES; GAMING SOFTWARE THAT GENERATES OR DISPLAYS WAGER OUTCOMES OF GAMING MACHINES (U.S. CLS. 21, 23, 26, 36 AND 38).

GEORGE LORENZO, EXAMINING ATTORNEY

SN 77-318,813. AOL LLC, DULLES, VA. FILED 11-1-2007.

PLATFORM-A

THE MARK CONSISTS OF STANDARD CHARACTERS WITHOUT CLAIM TO ANY PARTICULAR FONT, STYLE, SIZE, OR COLOR.

FOR COMPUTER SOFTWARE, DATABASES, AND HARDWARE FOR PLACEMENT, DISSEMINATION, TRACKING, MEASURING AND TARGETING OF ADVERTISING AND INTEGRATED MULTIMEDIA CONTENT (U.S. CLS. 21, 23, 26, 36 AND 38).

ANNE MADDEN, EXAMINING ATTORNEY

SN 77-319,748. WMS GAMING INC., WAUKEGAN, IL.
FILED 11-2-2007.

PHARAOH'S PYRAMID

THE MARK CONSISTS OF STANDARD CHARACTERS WITHOUT CLAIM TO ANY PARTICULAR FONT, STYLE, SIZE, OR COLOR.

FOR GAMING MACHINES THAT GENERATE OR DISPLAY WAGER OUTCOMES; GAMING SOFTWARE THAT GENERATES OR DISPLAYS WAGER OUTCOMES OF GAMING MACHINES (U.S. CLS. 21, 23, 26, 36 AND 38).

GEORGE LORENZO, EXAMINING ATTORNEY

CLASS 9—(Continued).

SN 77-319,752. WMS GAMING INC., WAUKEGAN, IL.
FILED 11-2-2007.

CAPTAIN'S COVE

THE MARK CONSISTS OF STANDARD CHARACTERS WITHOUT CLAIM TO ANY PARTICULAR FONT, STYLE, SIZE, OR COLOR.

FOR GAMING MACHINES THAT GENERATE OR DISPLAY WAGER OUTCOMES; GAMING SOFTWARE THAT GENERATES OR DISPLAYS WAGER OUTCOMES OF GAMING MACHINES (U.S. CLS. 21, 23, 26, 36 AND 38).

GEORGE LORENZO, EXAMINING ATTORNEY

SN 77-321,080. EAR PHONE CONNECTION, INC., CANYON COUNTRY, CA. FILED 11-5-2007.

Chameleon

THE MARK CONSISTS OF STANDARD CHARACTERS WITHOUT CLAIM TO ANY PARTICULAR FONT, STYLE, SIZE, OR COLOR.

FOR LAPEL MICROPHONE FOR PORTABLE TWO-WAY RADIO (U.S. CLS. 21, 23, 26, 36 AND 38).

FIRST USE 1-1-2004; IN COMMERCE 1-1-2004.

JOHN WILKE, EXAMINING ATTORNEY

SN 77-322,928. ULTRA CONCURRENT, INC., APTOS, CA.
FILED 11-6-2007.

ONTOSUBSUME

THE MARK CONSISTS OF STANDARD CHARACTERS WITHOUT CLAIM TO ANY PARTICULAR FONT, STYLE, SIZE, OR COLOR.

FOR COMPUTER SOFTWARE FOR CREATING SEARCHABLE DATABASES OF INFORMATION AND DATA, NAMELY, COMPUTER SOFTWARE FOR SEARCHING, COMPILING, INDEXING, QUERYING, INFERENCEING AND ORGANIZING INFORMATION ON COMPUTER NETWORKS; COMPUTER HARDWARE AND SOFTWARE FOR CREATING SEARCHABLE DATABASES OF INFORMATION AND DATA, NAMELY, COMPUTER HARDWARE AND COMPUTER SOFTWARE FOR SEARCHING, COMPILING, INDEXING, QUERYING, INFERENCEING AND ORGANIZING INFORMATION WITHIN HANDHELDS, INDIVIDUAL WORKSTATIONS AND PERSONAL COMPUTERS AND NETWORKED COMPUTERS; COMPUTER SOFTWARE FOR CREATING SEARCHABLE DATABASES OF INFORMATION AND DATA, NAMELY, COMPUTER

CLASS 9—(Continued).

SOFTWARE FOR CREATING INDEXES AND SEARCHING, QUERYING AND INFERENCING THEORIES OF INFORMATION IN THE FOLLOWING AREAS: ACCOUNTING, APPAREL, AUDIO, AUTOS, BOOKS, BLOGS, CAFES, CALENDARING, CAMERAS, CARS, CELLULAR, CHARTS, CLOTHES, COFFEE, COLLEGES, COMPANIES, COMPUTERS, CONTACTS, CORPORATIONS, DATING, DENTISTS, DESKTOPS, DIAGRAMS, DOCS, DOCTORS, DRINKS, EDUCATION, ELECTRONICS, EMPLOYMENT, FILMS, FOOD, FINANCE, FURNISHINGS, FURNITURE, GARDEN, GIFTS, GRAPHS, HEALTH, HOME, IMAGES, JOBS, KITCHEN, LAPTOPS, MAGAZINES, MAIL, MEDICAL, MESSAGES, MORTGAGE, MOVIES, MUSIC, MAPS, NEWS, NOTEBOOKS, PERSONALS, PHONES, PHOTOS, PODCASTS, PRESENTS, PRESENTATIONS, PRINTERS, RESTAURANTS, SCHOOLS, SHOWS, SINGLES, SOFTWARE, SONGS, SPORTS, SPREADSHEET, SUPPLEMENTS, TALK, TRAINING, TRAVEL, TOYS, TV, VIDEOS, VIEWS, WINES, WORK, WIRELESS, UNIVERSITIES, AND WEB SITES (U.S. CLS. 21, 23, 26, 36 AND 38).

THEODORE MCBRIDE, EXAMINING ATTORNEY

CLASS 9—(Continued).

SN 77-324,569. SAMSUNG ELECTRONICS CO., LTD., SUWON-SI, GYEONGGI-DO, REPUBLIC OF KOREA, FILED 11-8-2007.

INSTINCT

THE MARK CONSISTS OF STANDARD CHARACTERS WITHOUT CLAIM TO ANY PARTICULAR FONT, STYLE, SIZE, OR COLOR.

FOR MOBILE PHONES; SMARTPHONES (U.S. CLS. 21, 23, 26, 36 AND 38).
 NAPOLEON SHARMA, EXAMINING ATTORNEY

SN 77-323,972. WMS GAMING INC., WAUKEGAN, IL. FILED 11-7-2007.

HOG WILD

THE MARK CONSISTS OF STANDARD CHARACTERS WITHOUT CLAIM TO ANY PARTICULAR FONT, STYLE, SIZE, OR COLOR.

FOR GAMING MACHINES THAT GENERATE OR DISPLAY WAGER OUTCOMES; GAMING SOFTWARE THAT GENERATES OR DISPLAYS WAGER OUTCOMES OF GAMING MACHINES (U.S. CLS. 21, 23, 26, 36 AND 38).

GEORGE LORENZO, EXAMINING ATTORNEY

SN 77-324,877. ULTRACONCURRENT, INC., APTOS, CA. FILED 11-8-2007.

ONTOPROVENANCE

THE MARK CONSISTS OF STANDARD CHARACTERS WITHOUT CLAIM TO ANY PARTICULAR FONT, STYLE, SIZE, OR COLOR.

FOR COMPUTER SOFTWARE FOR CREATING SEARCHABLE DATABASES OF INFORMATION AND DATA, NAMELY, COMPUTER SOFTWARE FOR SEARCHING, COMPILING, INDEXING, QUERYING, INFERENCING AND ORGANIZING INFORMATION ON COMPUTER NETWORKS; COMPUTER HARDWARE AND SOFTWARE FOR CREATING SEARCHABLE DATABASES OF INFORMATION AND DATA, NAMELY, COMPUTER HARDWARE AND COMPUTER SOFTWARE FOR SEARCHING, COMPILING, INDEXING, QUERYING, INFERENCING AND ORGANIZING INFORMATION WITHIN HANDHELDS, INDIVIDUAL WORKSTATIONS AND PERSONAL COMPUTERS AND NETWORKED COMPUTERS; COMPUTER SOFTWARE FOR CREATING SEARCHABLE DATABASES OF INFORMATION AND DATA, NAMELY, COMPUTER SOFTWARE FOR CREATING INDEXES AND SEARCHING, QUERYING AND INFERENCING THEORIES OF INFORMATION IN THE FOLLOWING AREAS: ACCOUNTING, APPAREL, AUDIO, AUTOS, BOOKS, BLOGS, CAFES, CALENDARING, CAMERAS, CARS, CELLULAR, CHARTS, CLOTHES, COFFEE, COLLEGES, COMPANIES, COMPUTERS, CONTACTS, CORPORATIONS, DATING, DENTISTS, DESKTOPS, DIAGRAMS, DOCS, DOCTORS, DRINKS, EDUCATION, ELECTRONICS, EMPLOYMENT, FILMS, FOOD, FINANCE, FURNISHINGS, FURNITURE, GARDEN, GIFTS, GRAPHS, HEALTH, HOME, IMAGES, JOBS, KITCHEN, LAPTOPS, MAGAZINES, MAIL, MEDICAL, MESSAGES, MORTGAGE, MOVIES, MUSIC, MAPS, NEWS, NOTEBOOKS, PERSONALS, PHONES, PHOTOS, PODCASTS, PRESENTS, PRESENTATIONS, PRINTERS, RESTAURANTS, SCHOOLS, SHOWS, SINGLES, SOFTWARE, SONGS, SPORTS, SPREADSHEET, SUPPLEMENTS, TALK, TRAINING, TRAVEL, TOYS, TV, VIDEOS, VIEWS, WINES, WORK, WIRELESS, UNIVERSITIES, AND WEB SITES (U.S. CLS. 21, 23, 26, 36 AND 38).

THEODORE MCBRIDE, EXAMINING ATTORNEY

SN 77-324,305. EH EUROPE GMBH, ZURICH, SWITZERLAND. FILED 11-8-2007.

HAWKERPAK

THE MARK CONSISTS OF STANDARD CHARACTERS WITHOUT CLAIM TO ANY PARTICULAR FONT, STYLE, SIZE, OR COLOR.

OWNER OF U.S. REG. NO. 2,253,338.
 FOR BATTERIES (U.S. CLS. 21, 23, 26, 36 AND 38).
 JUDITH HELFMAN, EXAMINING ATTORNEY

CLASS 9—(Continued).

SN 77-325,189. RED.COM, INC., EASTSOUND, WA. FILED 11-8-2007.

RED QUICK

THE MARK CONSISTS OF STANDARD CHARACTERS WITHOUT CLAIM TO ANY PARTICULAR FONT, STYLE, SIZE, OR COLOR.

FOR DIGITAL CINEMA CAMERA SYSTEMS AND ACCESSORIES, SOLD INDIVIDUALLY OR AS A UNIT, COMPRISED OF, CAMERAS, CAMERA LENSES, FLASH MEMORY CARDS, ELECTRONIC MEMORIES, HARD DRIVES FOR VIDEO RECORDERS, VIDEO MONITORS AND FLAT PANEL DISPLAY SCREENS, ALL FOR USE IN THE CREATION, STORAGE, DELIVERY, MANIPULATION, RECORDING, PLAYBACK OR VIEWING OF VIDEO, MUSIC, GRAPHICS, PHOTOS, AUDIO, TEXT, AND MULTIMEDIA DATA; CINEMATOGRAPHIC PROJECTORS; PHOTOGRAPHIC PROJECTORS; SLIDE PROJECTORS; COMPUTER PROGRAMS FOR DIGITAL CINEMA CAMERAS, AUDIO AND VISUAL EDUCATIONAL AND TEACHING APPARATUS AND INSTRUMENTS, NAMELY, COMPUTER HARDWARE AND COMPUTER SOFTWARE PROGRAMS FOR THE INTEGRATION OF TEXT, AUDIO, GRAPHICS, STILL IMAGE AND MOVING PICTURES INTO AN INTERACTIVE DELIVERY FOR MULTIMEDIA APPLICATIONS, COMPUTER WHITE BOARDS, VIDEO PROJECTORS AND VIDEO DISPLAY MONITORS (U.S. CLS. 21, 23, 26, 36 AND 38).

EVELYN BRADLEY, EXAMINING ATTORNEY

SN 77-329,196. SYNAPTICS INCORPORATED, SANTA CLARA, CA. FILED 11-14-2007.

ClearArray

THE MARK CONSISTS OF STANDARD CHARACTERS WITHOUT CLAIM TO ANY PARTICULAR FONT, STYLE, SIZE, OR COLOR.

FOR ELECTRONIC CIRCUITRY; INTEGRATED CIRCUITS AND CIRCUIT BOARDS; INPUT DEVICES, NAMELY, TOUCH-SENSITIVE INPUT DEVICES FOR CONSUMER ELECTRONIC PRODUCTS THAT ALLOW THE USER TO INTERFACE WITH OR CONTROL THE PRODUCTS, AND SOFTWARE THEREFORE; AND COMPUTER SOFTWARE DESIGN TOOLS FOR DESIGNING INPUT DEVICES FOR CONSUMER ELECTRONIC PRODUCTS THAT ALLOW THE USER TO INTERFACE WITH OR CONTROL THE PRODUCTS (U.S. CLS. 21, 23, 26, 36 AND 38).

ALEXANDER L. POWERS, EXAMINING ATTORNEY

CLASS 9—(Continued).

SN 77-330,713. ATALASOFT, INC., EASTHAMPTON, MA. FILED 11-15-2007.

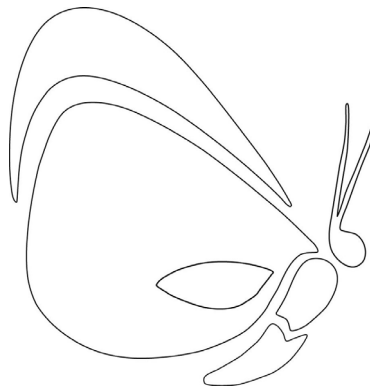

THE MARK CONSISTS OF A BUTTERFLY. FOR COMPUTER IMAGING SOFTWARE FOR USE IN THE DEVELOPMENT OF SOFTWARE APPLICATIONS (U.S. CLS. 21, 23, 26, 36 AND 38).

FIRST USE 8-15-2000; IN COMMERCE 8-15-2000.
JESSICA A. POWERS, EXAMINING ATTORNEY

SN 77-333,958. DENIAU, FLAVIEN A.A, MAZANGÉ, FRANCE, FILED 11-20-2007.

Piratrax

THE MARK CONSISTS OF STANDARD CHARACTERS WITHOUT CLAIM TO ANY PARTICULAR FONT, STYLE, SIZE, OR COLOR.

FOR COMPUTER SOFTWARE FOR DELETION AND REMOVAL OF DATA, INFORMATION, INTERNET TRACES FROM COMPUTER HARD DRIVES AND ELECTRONIC DEVICES. COMPUTER SOFTWARE FOR ENCRYPTION; DOWNLOADABLE COMPUTER SOFTWARE FOR DELETION AND REMOVAL OF DATA, INFORMATION, INTERNET TRACES FROM COMPUTER HARD DRIVES AND ELECTRONIC DEVICES; DOWNLOADABLE COMPUTER SOFTWARE FOR ENCRYPTION (U.S. CLS. 21, 23, 26, 36 AND 38).

FIRST USE 11-1-2007; IN COMMERCE 11-1-2007.
RONALD AIKENS, EXAMINING ATTORNEY

CLASS 9—(Continued).

SN 77-334,385. ULTRACONCURRENT, INC., APTOS, CA.
FILED 11-20-2007.

CLASS 9—(Continued).

SN 77-334,388. ULTRACONCURRENT, INC., APTOS, CA.
FILED 11-20-2007.

ONTOCLASS

ONTOSET

THE MARK CONSISTS OF STANDARD CHARACTERS WITHOUT CLAIM TO ANY PARTICULAR FONT, STYLE, SIZE, OR COLOR.

FOR COMPUTER SOFTWARE FOR CREATING SEARCHABLE DATABASES OF INFORMATION AND DATA, NAMELY, COMPUTER SOFTWARE FOR SEARCHING, COMPILING, INDEXING, QUERYING, INFERENCE AND ORGANIZING INFORMATION ON COMPUTER NETWORKS; COMPUTER HARDWARE AND SOFTWARE FOR CREATING SEARCHABLE DATABASES OF INFORMATION AND DATA, NAMELY, COMPUTER HARDWARE AND COMPUTER SOFTWARE FOR SEARCHING, COMPILING, INDEXING, QUERYING, INFERENCE AND ORGANIZING INFORMATION WITHIN HANDHELDS, INDIVIDUAL WORKSTATIONS AND PERSONAL COMPUTERS AND NETWORKED COMPUTERS; COMPUTER SOFTWARE FOR CREATING SEARCHABLE DATABASES OF INFORMATION AND DATA, NAMELY, COMPUTER SOFTWARE FOR CREATING INDEXES AND SEARCHING, QUERYING AND INFERENCE THEORIES OF INFORMATION IN THE FOLLOWING AREAS - ACCOUNTING, APPAREL, AUDIO, AUTOS, BOOKS, BLOGS, CAFES, CALENDARING, CAMERAS, CARS, CELLULAR, CHARTS, CLOTHES, COFFEE, COLLEGES, COMPANIES, COMPUTERS, CONTACTS, CORPORATIONS, DATING, DENTISTS, DESKTOPS, DIAGRAMS, DOCS, DOCTORS, DRINKS, EDUCATION, ELECTRONICS, EMPLOYMENT, FILMS, FOOD, FINANCE, FURNISHINGS, FURNITURE, GARDEN, GIFTS, GRAPHS, HEALTH, HOME, IMAGES, JOBS, KITCHEN, LAPTOPS, MAGAZINES, MAIL, MEDICAL, MESSAGES, MORTGAGE, MOVIES, MUSIC, MAPS, NEWS, NOTEBOOKS, PERSONALS, PHONES, PHOTOS, PODCASTS, PRESENTS, PRESENTATIONS, PRINTERS, RESTAURANTS, SCHOOLS, SHOWS, SINGLES, SOFTWARE, SONGS, SPORTS, SPREADSHEET, SUPPLEMENTS, TALK, TRAINING, TRAVEL, TOYS, TV, VIDEOS, VIEWS, WINES, WORK, WIRELESS, UNIVERSITIES, AND WEB SITES (U.S. CLS. 21, 23, 26, 36 AND 38).

THEODORE MCBRIDE, EXAMINING ATTORNEY

THE MARK CONSISTS OF STANDARD CHARACTERS WITHOUT CLAIM TO ANY PARTICULAR FONT, STYLE, SIZE, OR COLOR.

FOR COMPUTER SOFTWARE FOR CREATING SEARCHABLE DATABASES OF INFORMATION AND DATA, NAMELY, COMPUTER SOFTWARE FOR SEARCHING, COMPILING, INDEXING, QUERYING, INFERENCE AND ORGANIZING INFORMATION ON COMPUTER NETWORKS; COMPUTER HARDWARE AND SOFTWARE FOR CREATING SEARCHABLE DATABASES OF INFORMATION AND DATA, NAMELY, COMPUTER HARDWARE AND COMPUTER SOFTWARE FOR SEARCHING, COMPILING, INDEXING, QUERYING, INFERENCE AND ORGANIZING INFORMATION WITHIN HANDHELDS, INDIVIDUAL WORKSTATIONS AND PERSONAL COMPUTERS AND NETWORKED COMPUTERS; COMPUTER SOFTWARE FOR CREATING SEARCHABLE DATABASES OF INFORMATION AND DATA, NAMELY, COMPUTER SOFTWARE FOR CREATING INDEXES AND SEARCHING, QUERYING AND INFERENCE THEORIES OF INFORMATION IN THE FOLLOWING AREAS - ACCOUNTING, APPAREL, AUDIO, AUTOS, BOOKS, BLOGS, CAFES, CALENDARING, CAMERAS, CARS, CELLULAR, CHARTS, CLOTHES, COFFEE, COLLEGES, COMPANIES, COMPUTERS, CONTACTS, CORPORATIONS, DATING, DENTISTS, DESKTOPS, DIAGRAMS, DOCS, DOCTORS, DRINKS, EDUCATION, ELECTRONICS, EMPLOYMENT, FILMS, FOOD, FINANCE, FURNISHINGS, FURNITURE, GARDEN, GIFTS, GRAPHS, HEALTH, HOME, IMAGES, JOBS, KITCHEN, LAPTOPS, MAGAZINES, MAIL, MEDICAL, MESSAGES, MORTGAGE, MOVIES, MUSIC, MAPS, NEWS, NOTEBOOKS, PERSONALS, PHONES, PHOTOS, PODCASTS, PRESENTS, PRESENTATIONS, PRINTERS, RESTAURANTS, SCHOOLS, SHOWS, SINGLES, SOFTWARE, SONGS, SPORTS, SPREADSHEET, SUPPLEMENTS, TALK, TRAINING, TRAVEL, TOYS, TV, VIDEOS, VIEWS, WINES, WORK, WIRELESS, UNIVERSITIES, AND WEB SITES (U.S. CLS. 21, 23, 26, 36 AND 38).

THEODORE MCBRIDE, EXAMINING ATTORNEY

CLASS 9—(Continued).

SN 77-334,391. ULTRACONCURRENT, INC., APTOS, CA.
FILED 11-20-2007.

ONTOREFLECT

CLASS 9—(Continued).

SN 77-335,415. BSA OPTICS INC., FT. LAUDERDALE, FL.
FILED 11-21-2007.

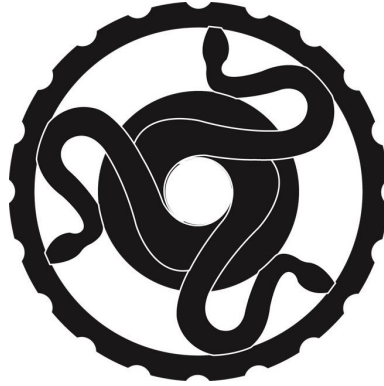

THE MARK CONSISTS OF INTERTWINED SNAKES ON A WHEEL.
FOR GUN SCOPES; RIFLE SCOPES (U.S. CLS. 21, 23, 26, 36 AND 38).
MELISSA VALLILLO, EXAMINING ATTORNEY

THE MARK CONSISTS OF STANDARD CHARACTERS WITHOUT CLAIM TO ANY PARTICULAR FONT, STYLE, SIZE, OR COLOR.

FOR COMPUTER SOFTWARE FOR CREATING SEARCHABLE DATABASES OF INFORMATION AND DATA, NAMELY, COMPUTER SOFTWARE FOR SEARCHING, COMPILING, INDEXING, QUERYING, INFERENCE AND ORGANIZING INFORMATION ON COMPUTER NETWORKS; COMPUTER HARDWARE AND SOFTWARE FOR CREATING SEARCHABLE DATABASES OF INFORMATION AND DATA, NAMELY, COMPUTER HARDWARE AND COMPUTER SOFTWARE FOR SEARCHING, COMPILING, INDEXING, QUERYING, INFERENCE AND ORGANIZING INFORMATION WITHIN HANDHELDS, INDIVIDUAL WORKSTATIONS AND PERSONAL COMPUTERS AND NETWORKED COMPUTERS; COMPUTER SOFTWARE FOR CREATING SEARCHABLE DATABASES OF INFORMATION AND DATA, NAMELY, COMPUTER SOFTWARE FOR CREATING INDEXES AND SEARCHING, QUERYING AND INFERENCE THEORIES OF INFORMATION IN THE FOLLOWING AREAS - ACCOUNTING, APPAREL, AUDIO, AUTOS, BOOKS, BLOGS, CAFES, CALENDARING, CAMERAS, CARS, CELLULAR, CHARTS, CLOTHES, COFFEE, COLLEGES, COMPANIES, COMPUTERS, CONTACTS, CORPORATIONS, DATING, DENTISTS, DESKTOPS, DIAGRAMS, DOCS, DOCTORS, DRINKS, EDUCATION, ELECTRONICS, EMPLOYMENT, FILMS, FOOD, FINANCE, FURNISHINGS, FURNITURE, GARDEN, GIFTS, GRAPHS, HEALTH, HOME, IMAGES, JOBS, KITCHEN, LAPTOPS, MAGAZINES, MAIL, MEDICAL, MESSAGES, MORTGAGE, MOVIES, MUSIC, MAPS, NEWS, NOTEBOOKS, PERSONALS, PHONES, PHOTOS, PODCASTS, PRESENTS, PRESENTATIONS, PRINTERS, RESTAURANTS, SCHOOLS, SHOWS, SINGLES, SOFTWARE, SONGS, SPORTS, SPREADSHEET, SUPPLEMENTS, TALK, TRAINING, TRAVEL, TOYS, TV, VIDEOS, VIEWS, WINES, WORK, WIRELESS, UNIVERSITIES, AND WEB SITES (U.S. CLS. 21, 23, 26, 36 AND 38).
THEODORE MCBRIDE, EXAMINING ATTORNEY

SN 77-335,435. BSA OPTICS INC., FT. LAUDERDALE, FL.
FILED 11-21-2007.



THE MARK CONSISTS OF A SNAKE HEAD DESIGN IN A CIRCLE.
FOR GUN SCOPES; RIFLE SCOPES (U.S. CLS. 21, 23, 26, 36 AND 38).
MELISSA VALLILLO, EXAMINING ATTORNEY

CLASS 9—(Continued).

SN 77-335,616. TIFFEN ACQUISITION, L.L.C., HAUPAUGE, NY. FILED 11-21-2007.

TIFFEN DFX

THE MARK CONSISTS OF STANDARD CHARACTERS WITHOUT CLAIM TO ANY PARTICULAR FONT, STYLE, SIZE, OR COLOR.

OWNER OF U.S. REG. NOS. 824,851, 2,137,809 AND OTHERS.

FOR COMPUTER SOFTWARE USED TO CREATE SPECIAL IMAGING EFFECTS FOR PHOTOGRAPHY AND FILM MAKING (U.S. CLS. 21, 23, 26, 36 AND 38).

FIRST USE 2-1-2007; IN COMMERCE 2-1-2007.
TARAH HARDY, EXAMINING ATTORNEY

CLASS 9—(Continued).

SOFTWARE FOR CREATING INDEXES AND SEARCHING, QUERYING AND INFERENCING THEORIES OF INFORMATION IN THE FOLLOWING AREAS - ACCOUNTING, APPAREL, AUDIO, AUTOS, BOOKS, BLOGS, CAFES, CALENDARING, CAMERAS, CARS, CELLULAR, CHARTS, CLOTHES, COFFEE, COLLEGES, COMPANIES, COMPUTERS, CONTACTS, CORPORATIONS, DATING, DENTISTS, DESKTOPS, DIAGRAMS, DOCS, DOCTORS, DRINKS, EDUCATION, ELECTRONICS, EMPLOYMENT, FILMS, FOOD, FINANCE, FURNISHINGS, FURNITURE, GARDEN, GIFTS, GRAPHS, HEALTH, HOME, IMAGES, JOBS, KITCHEN, LAPTOPS, MAGAZINES, MAIL, MEDICAL, MESSAGES, MORTGAGE, MOVIES, MUSIC, MAPS, NEWS, NOTEBOOKS, PERSONALS, PHONES, PHOTOS, PODCASTS, PRESENTS, PRESENTATIONS, PRINTERS, RESTAURANTS, SCHOOLS, SHOWS, SINGLES, SOFTWARE, SONGS, SPORTS, SPREADSHEET, SUPPLEMENTS, TALK, TRAINING, TRAVEL, TOYS, TV, VIDEOS, VIEWS, WINES, WORK, WIRELESS, UNIVERSITIES, AND WEB SITES (U.S. CLS. 21, 23, 26, 36 AND 38).

THEODORE MCBRIDE, EXAMINING ATTORNEY

SN 77-336,187. EPISTAR CORPORATION, HSINCHU, TAIWAN, FILED 11-24-2007.

VENUS

THE MARK CONSISTS OF STANDARD CHARACTERS WITHOUT CLAIM TO ANY PARTICULAR FONT, STYLE, SIZE, OR COLOR.

FOR LIGHT DIODES, LIGHT EMITTING DIODE (LED) DISPLAYS AND LIGHT EMITTING DIODES (U.S. CLS. 21, 23, 26, 36 AND 38).

JESSICA A. POWERS, EXAMINING ATTORNEY

SN 77-337,054. ULTRACONCURRENT, INC., APTOS, CA. FILED 11-26-2007.

ONTORATING

THE MARK CONSISTS OF STANDARD CHARACTERS WITHOUT CLAIM TO ANY PARTICULAR FONT, STYLE, SIZE, OR COLOR.

FOR COMPUTER SOFTWARE FOR CREATING SEARCHABLE DATABASES OF INFORMATION AND DATA, NAMELY, COMPUTER SOFTWARE FOR SEARCHING, COMPILING, INDEXING, QUERYING, INFERENCING AND ORGANIZING INFORMATION ON COMPUTER NETWORKS; COMPUTER HARDWARE AND SOFTWARE FOR CREATING SEARCHABLE DATABASES OF INFORMATION AND DATA, NAMELY, COMPUTER HARDWARE AND COMPUTER SOFTWARE FOR SEARCHING, COMPILING, INDEXING, QUERYING, INFERENCING AND ORGANIZING INFORMATION WITHIN HANDHELDS, INDIVIDUAL WORKSTATIONS AND PERSONAL COMPUTERS AND NETWORKED COMPUTERS; COMPUTER SOFTWARE FOR CREATING SEARCHABLE DATABASES OF INFORMATION AND DATA, NAMELY, COMPUTER SOFTWARE FOR CREATING INDEXES AND SEARCHING, QUERYING AND INFERENCING THEORIES OF INFORMATION IN THE FOLLOWING AREAS - ACCOUNTING, APPAREL, AUDIO, AUTOS, BOOKS, BLOGS, CAFES, CALENDARING, CAMERAS, CARS, CELLULAR, CHARTS, CLOTHES, COFFEE, COLLEGES, COMPANIES, COMPUTERS, CONTACTS, CORPORATIONS, DATING, DENTISTS, DESKTOPS, DIAGRAMS, DOCS, DOCTORS, DRINKS, EDUCATION, ELECTRONICS, EMPLOYMENT, FILMS, FOOD, FINANCE, FURNISHINGS, FURNITURE, GARDEN, GIFTS, GRAPHS, HEALTH, HOME, IMAGES, JOBS, KITCHEN, LAPTOPS, MAGAZINES, MAIL, MEDICAL, MESSAGES, MORTGAGE, MOVIES, MUSIC, MAPS, NEWS, NOTEBOOKS, PERSONALS, PHONES, PHOTOS, PODCASTS, PRESENTS, PRESENTATIONS, PRINTERS, RESTAURANTS, SCHOOLS, SHOWS, SINGLES, SOFTWARE, SONGS, SPORTS, SPREADSHEET, SUPPLEMENTS, TALK, TRAINING, TRAVEL, TOYS, TV, VIDEOS, VIEWS, WINES, WORK, WIRELESS, UNIVERSITIES, AND WEB SITES (U.S. CLS. 21, 23, 26, 36 AND 38).

THEODORE MCBRIDE, EXAMINING ATTORNEY

SN 77-337,050. ULTRACONCURRENT, INC., APTOS, CA. FILED 11-26-2007.

ONTORANK

THE MARK CONSISTS OF STANDARD CHARACTERS WITHOUT CLAIM TO ANY PARTICULAR FONT, STYLE, SIZE, OR COLOR.

FOR COMPUTER SOFTWARE FOR CREATING SEARCHABLE DATABASES OF INFORMATION AND DATA, NAMELY, COMPUTER SOFTWARE FOR SEARCHING, COMPILING, INDEXING, QUERYING, INFERENCING AND ORGANIZING INFORMATION ON COMPUTER NETWORKS; COMPUTER HARDWARE AND SOFTWARE FOR CREATING SEARCHABLE DATABASES OF INFORMATION AND DATA, NAMELY, COMPUTER HARDWARE AND COMPUTER SOFTWARE FOR SEARCHING, COMPILING, INDEXING, QUERYING, INFERENCING AND ORGANIZING INFORMATION WITHIN HANDHELDS, INDIVIDUAL WORKSTATIONS AND PERSONAL COMPUTERS AND NETWORKED COMPUTERS; COMPUTER SOFTWARE FOR CREATING SEARCHABLE DATABASES OF INFORMATION AND DATA, NAMELY, COMPUTER

CLASS 9—(Continued).

SN 77-337,055. ULTRACONCURRENT, INC., APTOS, CA. FILED 11-26-2007.

ONTOMETA

THE MARK CONSISTS OF STANDARD CHARACTERS WITHOUT CLAIM TO ANY PARTICULAR FONT, STYLE, SIZE, OR COLOR.

FOR COMPUTER SOFTWARE FOR CREATING SEARCHABLE DATABASES OF INFORMATION AND DATA, NAMELY, COMPUTER SOFTWARE FOR SEARCHING, COMPILING, INDEXING, QUERYING, INFERRING AND ORGANIZING INFORMATION ON COMPUTER NETWORKS; COMPUTER HARDWARE AND SOFTWARE FOR CREATING SEARCHABLE DATABASES OF INFORMATION AND DATA, NAMELY, COMPUTER HARDWARE AND COMPUTER SOFTWARE FOR SEARCHING, COMPILING, INDEXING, QUERYING, INFERRING AND ORGANIZING INFORMATION WITHIN HANDHELDS, INDIVIDUAL WORKSTATIONS AND PERSONAL COMPUTERS AND NETWORKED COMPUTERS; COMPUTER SOFTWARE FOR CREATING SEARCHABLE DATABASES OF INFORMATION AND DATA, NAMELY, COMPUTER SOFTWARE FOR CREATING INDEXES AND SEARCHING, QUERYING AND INFERRING THEORIES OF INFORMATION IN THE FOLLOWING AREAS - ACCOUNTING, APPAREL, AUDIO, AUTOS, BOOKS, BLOGS, CAFES, CALENDARING, CAMERAS, CARS, CELLULAR, CHARTS, CLOTHES, COFFEE, COLLEGES, COMPANIES, COMPUTERS, CONTACTS, CORPORATIONS, DATING, DENTISTS, DESKTOPS, DIAGRAMS, DOCS, DOCTORS, DRINKS, EDUCATION, ELECTRONICS, EMPLOYMENT, FILMS, FOOD, FINANCE, FURNISHINGS, FURNITURE, GARDEN, GIFTS, GRAPHS, HEALTH, HOME, IMAGES, JOBS, KITCHEN, LAPTOPS, MAGAZINES, MAIL, MEDICAL, MESSAGES, MORTGAGE, MOVIES, MUSIC, MAPS, NEWS, NOTEBOOKS, PERSONALS, PHONES, PHOTOS, PODCASTS, PRESENTS, PRESENTATIONS, PRINTERS, RESTAURANTS, SCHOOLS, SHOWS, SINGLES, SOFTWARE, SONGS, SPORTS, SPREADSHEET, SUPPLEMENTS, TALK, TRAINING, TRAVEL, TOYS, TV, VIDEOS, VIEWS, WINES, WORK, WIRELESS, UNIVERSITIES, AND WEB SITES (U.S. CLS. 21, 23, 26, 36 AND 38).

THEODORE MCBRIDE, EXAMINING ATTORNEY

SN 77-337,168. BIG FISH GAMES, INC., SEATTLE, WA. FILED 11-26-2007.

MYSTERY IN LONDON

THE MARK CONSISTS OF STANDARD CHARACTERS WITHOUT CLAIM TO ANY PARTICULAR FONT, STYLE, SIZE, OR COLOR.

FOR ELECTRONIC GAME PROGRAMS (U.S. CLS. 21, 23, 26, 36 AND 38).

CHERYL CLAYTON, EXAMINING ATTORNEY

CLASS 9—(Continued).

SN 77-338,633. MATERIALS PROCESSING CORPORATION, EAGAN, MN. FILED 11-28-2007.



THE COLOR(S) GREEN IS/ARE CLAIMED AS A FEATURE OF THE MARK.

THE MARK CONSISTS OF THE WORD "GREENEYE" WITH AN EYE DESIGN, ALL IN TONES OF THE COLOR GREEN.

FOR PERSONAL COMPUTERS; LAPTOP COMPUTERS; NOTEBOOK COMPUTERS; TELEVISIONS (U.S. CLS. 21, 23, 26, 36 AND 38).

FIRST USE 11-21-2007; IN COMMERCE 11-21-2007.

CORY BOONE, EXAMINING ATTORNEY

SN 77-340,308. SYNAPTICS INCORPORATED, SANTA CLARA, CA. FILED 11-29-2007.

ClearPad

THE MARK CONSISTS OF STANDARD CHARACTERS WITHOUT CLAIM TO ANY PARTICULAR FONT, STYLE, SIZE, OR COLOR.

FOR ELECTRONIC CIRCUITRY; INTEGRATED CIRCUITS AND CIRCUIT BOARDS; INPUT DEVICES, NAMELY, TOUCH-SENSITIVE INPUT DEVICES FOR CONSUMER ELECTRONIC PRODUCTS THAT ALLOW THE USER TO INTERFACE WITH OR CONTROL THE PRODUCTS, AND SOFTWARE THEREFORE; AND COMPUTER SOFTWARE DESIGN TOOLS FOR DESIGNING INPUT DEVICES FOR CONSUMER ELECTRONIC PRODUCTS THAT ALLOW THE USER TO INTERFACE WITH OR CONTROL THE PRODUCTS (U.S. CLS. 21, 23, 26, 36 AND 38).

FIRST USE 3-0-2001; IN COMMERCE 3-0-2001.

ANGELA M. MICHELI, EXAMINING ATTORNEY

SN 77-345,158. C2 GAMING, LLC, DBA C2 GAMING, LLC, LAS VEGAS, NV. FILED 12-5-2007.

Nest Egg

THE MARK CONSISTS OF STANDARD CHARACTERS WITHOUT CLAIM TO ANY PARTICULAR FONT, STYLE, SIZE, OR COLOR.

FOR GAMING MACHINES, NAMELY, ELECTRONIC SLOT AND BINGO MACHINES (U.S. CLS. 21, 23, 26, 36 AND 38).

FIRST USE 1-24-2005; IN COMMERCE 1-24-2005.

STEVEN PEREZ, EXAMINING ATTORNEY

CLASS 9—(Continued).

SN 77-345,201. C2 GAMING, LLC, DBA C2 GAMING, LLC, LAS VEGAS, NV. FILED 12-5-2007.

The Big Slice

THE MARK CONSISTS OF STANDARD CHARACTERS WITHOUT CLAIM TO ANY PARTICULAR FONT, STYLE, SIZE, OR COLOR.

FOR GAMING MACHINES, NAMELY, ELECTRONIC SLOT AND BINGO MACHINES (U.S. CLS. 21, 23, 26, 36 AND 38).

STEVEN PEREZ, EXAMINING ATTORNEY

SN 77-345,430. POLAROID CORPORATION, WALTHAM, MA. FILED 12-6-2007.



THE MARK CONSISTS OF A CIRCLE FILLED WITH CURVED AMORPHOUS SHAPES, BARS AND LINES.

FOR DVD-PLAYERS; PORTABLE DVD-PLAYERS; PERSONAL DVD-PLAYERS; HOME THEATER PRODUCTS, NAMELY, LCD PANELS, AMPLIFIERS, RADIOS AND AUDIO SPEAKERS; DIGITAL VIDEO RECORDERS; MP3 PLAYERS; DIGITAL PICTURE FRAMES FOR DISPLAYING DIGITAL PICTURES, VIDEO CLIPS AND MUSIC; DIGITAL AUDIO PLAYERS; COMPACT DISC, CDR AND CDRW PLAYERS, COMPACT DISC PLAYERS; VIDEO CASSETTE RECORDERS; TELEVISION SETS; TELEVISION MONITORS; REMOTE CONTROLS FOR TELEVISIONS; HEADPHONES; CONVERTERS; SATELLITE RECEIVERS; SATELLITE DISHES; PROGRAMMABLE DIGITAL TELEVISION RECORDERS; PRINTERS; DIGITAL CAMERAS; TELEPHONES; VIDEOPHONES; GLOBAL POSITIONING SYSTEM (GPS) CONSISTING OF COMPUTERS, COMPUTER SOFTWARE, TRANSMITTERS, RECEIVERS, AND NETWORK INTERFACE DEVICES; PLAYER-OPERATED ELECTRONIC CONTROLLERS FOR ELECTRONIC VIDEO GAME MACHINES; PROTECTIVE CARRYING CASES FOR PORTABLE DVD PLAYERS, MP-3 PLAYERS AND CAMERAS; PAGERS; COMPUTERS; LAPTOP COMPUTERS; CD-ROM DRIVES; COMPUTER DOCKING STATIONS; COMPUTER HARDWARE; HANDHELD COMPUTERS (U.S. CLS. 21, 23, 26, 36 AND 38).

AMY HELLA, EXAMINING ATTORNEY

CLASS 9—(Continued).

SN 77-346,180. MONSTER CABLE PRODUCTS, INC., BRISBANE, CA. FILED 12-6-2007.



OWNER OF U.S. REG. NOS. 2,220,851, 2,728,729 AND OTHERS.

NO CLAIM IS MADE TO THE EXCLUSIVE RIGHT TO USE "ULTIMATE HIGH SPEED" AND "14.9 GBPS", APART FROM THE MARK AS SHOWN.

THE MARK CONSISTS OF THE LITERAL ELEMENT ON A STYLIZED DESIGN.

FOR ELECTRICAL AND ELECTROMAGNETIC SIGNAL TRANSMITTING, AMPLIFYING, RECEIVING, AND CONVERTING DEVICES, NAMELY, CABLES, WIRES, AND CONNECTORS FOR USE WITH ELECTRICAL, ELECTRONIC, AND COMPUTER DEVICES (U.S. CLS. 21, 23, 26, 36 AND 38).

JOHN WILKE, EXAMINING ATTORNEY

SN 77-346,186. MONSTER CABLE PRODUCTS, INC., BRISBANE, CA. FILED 12-6-2007.



OWNER OF U.S. REG. NOS. 2,220,851, 2,728,729 AND OTHERS.

NO CLAIM IS MADE TO THE EXCLUSIVE RIGHT TO USE "STANDARD SPEED" AND "2.23 GBPS", APART FROM THE MARK AS SHOWN.

THE MARK CONSISTS OF THE LITERAL ELEMENT ON A STYLIZED DESIGN.

FOR ELECTRICAL AND ELECTROMAGNETIC SIGNAL TRANSMITTING, AMPLIFYING, RECEIVING, AND CONVERTING DEVICES, NAMELY, CABLES, WIRES, AND CONNECTORS FOR USE WITH ELECTRICAL, ELECTRONIC, AND COMPUTER DEVICES (U.S. CLS. 21, 23, 26, 36 AND 38).

JOHN WILKE, EXAMINING ATTORNEY

CLASS 9—(Continued).

SN 77-346,199. MONSTER CABLE PRODUCTS, INC., BRISBANE, CA. FILED 12-6-2007.



OWNER OF U.S. REG. NOS. 2,220,851, 2,728,729 AND OTHERS.

NO CLAIM IS MADE TO THE EXCLUSIVE RIGHT TO USE "ULTRA-HIGH SPEED" AND "10.2 GBPS", APART FROM THE MARK AS SHOWN.

THE MARK CONSISTS OF THE LITERAL ELEMENT ON A STYLIZED DESIGN.

FOR ELECTRICAL AND ELECTROMAGNETIC SIGNAL TRANSMITTING, AMPLIFYING, RECEIVING, AND CONVERTING DEVICES, NAMELY, CABLES, WIRES, AND CONNECTORS FOR USE WITH ELECTRICAL, ELECTRONIC, AND COMPUTER DEVICES (U.S. CLS. 21, 23, 26, 36 AND 38).

JOHN WILKE, EXAMINING ATTORNEY

CLASS 9—(Continued).

SN 77-346,218. MONSTER CABLE PRODUCTS, INC., BRISBANE, CA. FILED 12-6-2007.



OWNER OF U.S. REG. NOS. 2,220,851, 2,728,729 AND OTHERS.

NO CLAIM IS MADE TO THE EXCLUSIVE RIGHT TO USE "CABLE" AND "PERFORMANCE GUARANTEED", APART FROM THE MARK AS SHOWN.

THE MARK CONSISTS OF THE LITERAL ELEMENT ON A STYLIZED DESIGN.

FOR ELECTRICAL AND ELECTROMAGNETIC SIGNAL TRANSMITTING, AMPLIFYING, RECEIVING, AND CONVERTING DEVICES, NAMELY, CABLES, WIRES, AND CONNECTORS FOR USE WITH ELECTRICAL, ELECTRONIC, AND COMPUTER DEVICES (U.S. CLS. 21, 23, 26, 36 AND 38).

JOHN WILKE, EXAMINING ATTORNEY

SN 77-346,206. MONSTER CABLE PRODUCTS, INC., BRISBANE, CA. FILED 12-6-2007.



NO CLAIM IS MADE TO THE EXCLUSIVE RIGHT TO USE "ADVANCED HIGH SPEED" AND "6.68 GBPS", APART FROM THE MARK AS SHOWN.

THE MARK CONSISTS OF THE LITERAL ELEMENT ON A STYLIZED DESIGN.

FOR ELECTRICAL AND ELECTROMAGNETIC SIGNAL TRANSMITTING, AMPLIFYING, RECEIVING, AND CONVERTING DEVICES, NAMELY, CABLES, WIRES, AND CONNECTORS FOR USE WITH ELECTRICAL, ELECTRONIC, AND COMPUTER DEVICES (U.S. CLS. 21, 23, 26, 36 AND 38).

JOHN WILKE, EXAMINING ATTORNEY

SN 77-346,224. MONSTER CABLE PRODUCTS, INC., BRISBANE, CA. FILED 12-6-2007.



OWNER OF U.S. REG. NOS. 2,220,851, 2,728,729 AND OTHERS.

NO CLAIM IS MADE TO THE EXCLUSIVE RIGHT TO USE "FULL LIFETIME WARRANTY", APART FROM THE MARK AS SHOWN.

THE MARK CONSISTS OF THE LITERAL ELEMENT ON A STYLIZED DESIGN.

FOR ELECTRICAL AND ELECTROMAGNETIC SIGNAL TRANSMITTING, AMPLIFYING, RECEIVING, AND CONVERTING DEVICES, NAMELY, CABLES, WIRES, AND CONNECTORS FOR USE WITH ELECTRICAL, ELECTRONIC, AND COMPUTER DEVICES (U.S. CLS. 21, 23, 26, 36 AND 38).

JOHN WILKE, EXAMINING ATTORNEY

CLASS 9—(Continued).

SN 77-346,241. MONSTER CABLE PRODUCTS, INC., BRISBANE, CA. FILED 12-6-2007.



OWNER OF U.S. REG. NOS. 2,220,851, 2,728,729 AND OTHERS.

NO CLAIM IS MADE TO THE EXCLUSIVE RIGHT TO USE "HIGH SPEED" AND "4.95 GBPS", APART FROM THE MARK AS SHOWN.

THE MARK CONSISTS OF THE LITERAL ELEMENT ON A STYLIZED DESIGN.

FOR ELECTRICAL AND ELECTROMAGNETIC SIGNAL TRANSMITTING, AMPLIFYING, RECEIVING, AND CONVERTING DEVICES, NAMELY, CABLES, WIRES, AND CONNECTORS FOR USE WITH ELECTRICAL, ELECTRONIC, AND COMPUTER DEVICES (U.S. CLS. 21, 23, 26, 36 AND 38).

JOHN WILKE, EXAMINING ATTORNEY

CLASS 9—(Continued).

SN 77-349,123. CHEYENNE MOUNTAIN ENTERTAINMENT, INC., MESA, AZ. FILED 12-11-2007.

CLIQPLA.NET

THE MARK CONSISTS OF STANDARD CHARACTERS WITHOUT CLAIM TO ANY PARTICULAR FONT, STYLE, SIZE, OR COLOR.

FOR SOFTWARE AND ELECTRONIC GAMES, NAMELY, SOFTWARE GAMES RECORDED ON CD-ROM AND DIGITAL VIDEO DISCS FOR COMPUTERS, SOFTWARE GAMES RECORDED ON CD-ROMS, DIGITAL VIDEO DISCS, AND CARTRIDGES FOR CONSOLE AND INDIVIDUAL PORTABLE GAMING SYSTEMS, SOFTWARE GAMES THAT ARE DOWNLOADABLE FROM A REMOTE COMPUTER SITE, AND SOFTWARE GAMES FOR MOBILE PHONES, PERSONAL DIGITAL ASSISTANTS, AND HANDHELD COMPUTERS; DOWNLOADABLE RING TONES VIA THE INTERNET AND WIRELESS DEVICES; DOWNLOADABLE VOICE RING TONES VIA THE INTERNET AND WIRELESS DEVICES; DOWNLOADABLE WALL PAPERS, NAMELY STILL IMAGES FOR BACKGROUNDS ON PHONE SCREENS VIA THE INTERNET AND WIRELESS DEVICES; DOWNLOADABLE SCREEN SAVERS VIA THE INTERNET AND WIRELESS DEVICES; DOWNLOADABLE ANIMATED IMAGES FOR USE ON PHONE SCREENS VIA THE INTERNET AND WIRELESS DEVICES; AND COMPUTER SOFTWARE FOR DOWNLOADING IMAGES FOR MOBILE TELECOMMUNICATION DEVICES, NAMELY, MOBILE AND CELLULAR TELEPHONES, HANDHELD COMPUTERS, PERSONAL COMPUTERS AND PERSONAL DIGITAL ASSISTANTS VIA THE GLOBAL COMPUTER NETWORK AND WIRELESS DEVICES (U.S. CLS. 21, 23, 26, 36 AND 38).

KATHERINE STOIDES, EXAMINING ATTORNEY

SN 77-346,686. SAMSUNG ELECTRONICS CO., LTD., SUWON-SI, GYEONGGI-DO, REPUBLIC OF KOREA, FILED 12-7-2007.

SN 77-349,490. CHEYENNE MOUNTAIN ENTERTAINMENT, INC., MESA, AZ. FILED 12-11-2007.

VEER

THE MARK CONSISTS OF STANDARD CHARACTERS WITHOUT CLAIM TO ANY PARTICULAR FONT, STYLE, SIZE, OR COLOR.

FOR MOBILE PHONES (U.S. CLS. 21, 23, 26, 36 AND 38).

NAPOLEON SHARMA, EXAMINING ATTORNEY

PROVOQ

THE MARK CONSISTS OF STANDARD CHARACTERS WITHOUT CLAIM TO ANY PARTICULAR FONT, STYLE, SIZE, OR COLOR.

FOR SOFTWARE AND ELECTRONIC GAMES, NAMELY, SOFTWARE GAMES RECORDED ON CD-ROM AND DIGITAL VIDEO DISCS FOR COMPUTERS; SOFTWARE GAMES RECORDED ON CD-ROMS, DIGITAL VIDEO DISCS, AND CARTRIDGES FOR CONSOLE AND INDIVIDUAL PORTABLE GAMING SYSTEMS; SOFTWARE GAMES THAT ARE DOWNLOADABLE FROM A REMOTE COMPUTER SITE; AND SOFTWARE GAMES FOR MOBILE PHONES, PERSONAL DIGITAL ASSISTANTS, AND HANDHELD COMPUTERS (U.S. CLS. 21, 23, 26, 36 AND 38).

KATHERINE STOIDES, EXAMINING ATTORNEY

CLASS 9—(Continued).

SN 77-352,904. ELOQUA CORPORATION, TORONTO, ONTARIO, CANADA, FILED 12-14-2007.

ELOQUA LEAD SCORING

THE MARK CONSISTS OF STANDARD CHARACTERS WITHOUT CLAIM TO ANY PARTICULAR FONT, STYLE, SIZE, OR COLOR.

OWNER OF U.S. REG. NO. 2,753,650.
NO CLAIM IS MADE TO THE EXCLUSIVE RIGHT TO USE "LEAD SCORING", APART FROM THE MARK AS SHOWN.

THE WORDING "ELOQUA" HAS NO MEANING IN A FOREIGN LANGUAGE.

FOR ADAPTIVE COMPUTER SOFTWARE DESIGNED TO FACILITATE FOR OTHERS THE AUTOMATED MEASUREMENT AND RANKING OF LEADS ACCORDING TO THEIR BUYING INTEREST AND TO SYSTEMATICALLY MEASURE THE CHANGING VALUE OF A LEAD, INCLUDING PASSING HIGHER-RANKED LEADS TO SALES PERSONNEL AND PLACING LOWER-RANKED LEADS INTO AN AUTOMATED NURTURING PROGRAM DESIGNED TO MONITOR THE LEVEL OF THE LEAD'S ACTIVITY AND IDENTIFY WHEN ITS STATUS HAS CHANGED TO A HIGHER RANK, WHICH SOFTWARE EVOLVES IN RESPONSE TO THE LEAD INFORMATION COLLECTED AND FACILITATES CONVERSION OF A LEAD TO A CUSTOMER, ALL FOR MARKETING AND SALES PURPOSES (U.S. CLS. 21, 26, 36 AND 38).

DANIEL CAPSHAW, EXAMINING ATTORNEY

CLASS 9—(Continued).

SN 77-352,961. ELOQUA CORPORATION, TORONTO, ONTARIO, CANADA, FILED 12-14-2007.

ELOQUA LEAD NURTURING

THE MARK CONSISTS OF STANDARD CHARACTERS WITHOUT CLAIM TO ANY PARTICULAR FONT, STYLE, SIZE, OR COLOR.

OWNER OF U.S. REG. NO. 2,573,650.
NO CLAIM IS MADE TO THE EXCLUSIVE RIGHT TO USE "LEAD NURTURING", APART FROM THE MARK AS SHOWN.

THE WORDING "ELOQUA" HAS NO MEANING IN A FOREIGN LANGUAGE.

FOR ADAPTIVE COMPUTER SOFTWARE DESIGNED TO FACILITATE FOR OTHERS AUTOMATED CONTINUED CONTACT WITH PROSPECTIVE AND ACTUAL CUSTOMERS BY TRANSMITTING EMAIL, PUBLICATIONS, AND EVENT INVITATIONS, BASED ON THE INFORMATION RECEIVED BY THE OTHERS FROM THE PROSPECTIVE AND ACTUAL CUSTOMERS, ALL FOR MARKETING AND SALES PURPOSES (U.S. CLS. 21, 23, 26, 36 AND 38).

DANIEL CAPSHAW, EXAMINING ATTORNEY

SN 77-352,938. ELOQUA CORPORATION, TORONTO, ONTARIO, CANADA, FILED 12-14-2007.

ELOQUA EVENT MANAGEMENT

THE MARK CONSISTS OF STANDARD CHARACTERS WITHOUT CLAIM TO ANY PARTICULAR FONT, STYLE, SIZE, OR COLOR.

OWNER OF U.S. REG. NO. 2,753,650.
NO CLAIM IS MADE TO THE EXCLUSIVE RIGHT TO USE "EVENT MANAGEMENT", APART FROM THE MARK AS SHOWN.

THE WORDING "ELOQUA" HAS NO MEANING IN A FOREIGN LANGUAGE.

FOR ADAPTIVE COMPUTER SOFTWARE DESIGNED TO FACILITATE FOR OTHERS THE AUTOMATION OF MANAGING SINGLE EVENTS OR GROUPS OF EVENTS, NAMELY, TRANSMITTAL OF INVITATIONS, TRACKING OF RESPONSES, REGISTRATION, AND FOLLOW UP, AND MANAGEMENT OF WAITING LISTS, ALL FOR MARKETING AND SALES PURPOSES (U.S. CLS. 21, 23, 26, 36 AND 38).

DANIEL CAPSHAW, EXAMINING ATTORNEY

SN 77-357,283. MONSTER CABLE PRODUCTS, INC., BRISBANE, CA. FILED 12-20-2007.



OWNER OF U.S. REG. NOS. 2,220,851, 2,728,729 AND OTHERS.

NO CLAIM IS MADE TO THE EXCLUSIVE RIGHT TO USE "HDMI" AND "STANDARD SPEED" AND "HIGH SPEED" AND "ADVANCED HIGH SPEED" AND "ULTRA-HIGH SPEED" AND "SPEED RATED", APART FROM THE MARK AS SHOWN.

THE MARK CONSISTS OF THE LITERAL ELEMENT ON A STYLIZED DESIGN.

FOR ELECTRICAL AND ELECTROMAGNETIC SIGNAL TRANSMITTING, AMPLIFYING, RECEIVING, AND CONVERTING DEVICES, NAMELY, CABLES, WIRES, AND CONNECTORS FOR USE WITH ELECTRICAL, ELECTRONIC, AND COMPUTER DEVICES (U.S. CLS. 21, 23, 26, 36 AND 38).

JOHN WILKE, EXAMINING ATTORNEY

CLASS 9—(Continued).

SN 77-358,505. MONSTER CABLE PRODUCTS, INC., BRISBANE, CA. FILED 12-21-2007.



OWNER OF U.S. REG. NOS. 2,220,851, 2,728,729 AND OTHERS.

NO CLAIM IS MADE TO THE EXCLUSIVE RIGHT TO USE "POWER", APART FROM THE MARK AS SHOWN.

THE MARK CONSISTS OF THE STYLIZED LITERAL ELEMENT AND DESIGN.

FOR ELECTRICAL AND ELECTRONIC CONTROL DEVICES, NAMELY, ELECTRICAL AND ELECTROMAGNETIC SIGNAL TRANSMITTING, AMPLIFYING, RECEIVING, AND CONVERTING DEVICES, NAMELY, CABLES, WIRES, CONNECTORS, AND CONTROL DEVICES FOR USE WITH ELECTRICAL, ELECTRONIC, AND COMPUTER DEVICES, NAMELY, ELECTRICAL AND ELECTRONIC SIGNAL SWITCHES, ELECTRICAL AND ELECTRONIC SIGNAL SPLITTERS, ELECTRICAL AND ELECTRONIC SIGNAL MULTIPLEXERS, ELECTRICAL AND ELECTRONIC SIGNAL WIRELESS REMOTE CONTROLLERS AND ELECTRICAL AND ELECTRONIC SIGNAL CONTROLLERS; COMPUTER COMPONENTS AND ACCESSORIES, NAMELY, COMPUTER PERIPHERALS; AUDIO EQUIPMENT AND ACCESSORIES, NAMELY, POWER AMPLIFIERS, AUDIO SIGNAL EQUALIZERS; ELECTRICAL CONTROL COMPONENTS AND ACCESSORIES, NAMELY, POWER CONDITIONERS, POWER CELL RE-CHARGERS, POWER AMPLIFIERS, VOLTAGE STABILIZERS, CURRENT STABILIZERS, POWERSTRIPS, ELECTRICAL SURGE PROTECTORS, CIRCUIT CHARGERS AND CIRCUIT BREAKERS; UNINTERRUPTIBLE POWER SUPPLY DEVICES (U.S. CLS. 21, 23, 26, 36 AND 38).

FIRST USE 5-27-1998; IN COMMERCE 5-27-1998.
JOHN WILKE, EXAMINING ATTORNEY

SN 77-360,117. ULTRAONCURRENT, INC., APTOS, CA. FILED 12-27-2007.

ONTOOR

THE MARK CONSISTS OF STANDARD CHARACTERS WITHOUT CLAIM TO ANY PARTICULAR FONT, STYLE, SIZE, OR COLOR.

FOR COMPUTER SOFTWARE FOR CREATING SEARCHABLE DATABASES OF INFORMATION AND DATA, NAMELY, COMPUTER SOFTWARE FOR SEARCHING, COMPILING, INDEXING, QUERYING, INFERRING AND ORGANIZING INFORMATION ON COMPUTER NETWORKS; COMPUTER HARDWARE AND SOFTWARE FOR CREATING SEARCHABLE DATABASES OF INFORMATION AND DATA, NAMELY, COMPUTER HARDWARE AND COMPUTER SOFTWARE FOR SEARCHING, COMPILING, INDEXING, QUERYING, INFERRING AND ORGANIZING INFORMATION WITHIN HANDHELDS, INDIVIDUAL WORKSTATIONS AND PERSONAL COMPUTERS AND NETWORKED COMPUTERS; COMPUTER SOFTWARE FOR CREATING SEARCHABLE DATABASES OF INFORMATION AND DATA, NAMELY, COMPUTER

CLASS 9—(Continued).

SOFTWARE FOR CREATING INDEXES AND SEARCHING, QUERYING AND INFERRING THEORIES OF INFORMATION IN THE FOLLOWING AREAS - ACCOUNTING, APPAREL, AUDIO, AUTOS, BOOKS, BLOGS, CAFES, CALENDARING, CAMERAS, CARS, CELLULAR, CHARTS, CLOTHES, COFFEE, COLLEGES, COMPANIES, COMPUTERS, CONTACTS, CORPORATIONS, DATING, DENTISTS, DESKTOPS, DIAGRAMS, DOCS, DOCTORS, DRINKS, EDUCATION, ELECTRONICS, EMPLOYMENT, FILMS, FOOD, FINANCE, FURNISHINGS, FURNITURE, GARDEN, GIFTS, GRAPHS, HEALTH, HOME, IMAGES, JOBS, KITCHEN, LAPTOPS, MAGAZINES, MAIL, MEDICAL, MESSAGES, MORTGAGE, MOVIES, MUSIC, MAPS, NEWS, NOTEBOOKS, PERSONALS, PHONES, PHOTOS, PODCASTS, PRESENTS, PRESENTATIONS, PRINTERS, RESTAURANTS, SCHOOLS, SHOWS, SINGLES, SOFTWARE, SONGS, SPORTS, SPREADSHEET, SUPPLEMENTS, TALK, TRAINING, TRAVEL, TOYS, TV, VIDEOS, VIEWS, WINES, WORK, WIRELESS, UNIVERSITIES, AND WEB SITES (U.S. CLS. 21, 23, 26, 36 AND 38).

THEODORE MCBRIDE, EXAMINING ATTORNEY

SN 77-360,119. ULTRAONCURRENT, INC., APTOS, CA. FILED 12-27-2007.

ONTONOT

THE MARK CONSISTS OF STANDARD CHARACTERS WITHOUT CLAIM TO ANY PARTICULAR FONT, STYLE, SIZE, OR COLOR.

FOR COMPUTER SOFTWARE FOR CREATING SEARCHABLE DATABASES OF INFORMATION AND DATA, NAMELY, COMPUTER SOFTWARE FOR SEARCHING, COMPILING, INDEXING, QUERYING, INFERRING AND ORGANIZING INFORMATION ON COMPUTER NETWORKS; COMPUTER HARDWARE AND SOFTWARE FOR CREATING SEARCHABLE DATABASES OF INFORMATION AND DATA, NAMELY, COMPUTER HARDWARE AND COMPUTER SOFTWARE FOR SEARCHING, COMPILING, INDEXING, QUERYING, INFERRING AND ORGANIZING INFORMATION WITHIN HANDHELDS, INDIVIDUAL WORKSTATIONS AND PERSONAL COMPUTERS AND NETWORKED COMPUTERS; COMPUTER SOFTWARE FOR CREATING SEARCHABLE DATABASES OF INFORMATION AND DATA, NAMELY, COMPUTER SOFTWARE FOR CREATING INDEXES AND SEARCHING, QUERYING AND INFERRING THEORIES OF INFORMATION IN THE FOLLOWING AREAS - ACCOUNTING, APPAREL, AUDIO, AUTOS, BOOKS, BLOGS, CAFES, CALENDARING, CAMERAS, CARS, CELLULAR, CHARTS, CLOTHES, COFFEE, COLLEGES, COMPANIES, COMPUTERS, CONTACTS, CORPORATIONS, DATING, DENTISTS, DESKTOPS, DIAGRAMS, DOCS, DOCTORS, DRINKS, EDUCATION, ELECTRONICS, EMPLOYMENT, FILMS, FOOD, FINANCE, FURNISHINGS, FURNITURE, GARDEN, GIFTS, GRAPHS, HEALTH, HOME, IMAGES, JOBS, KITCHEN, LAPTOPS, MAGAZINES, MAIL, MEDICAL, MESSAGES, MORTGAGE, MOVIES, MUSIC, MAPS, NEWS, NOTEBOOKS, PERSONALS, PHONES, PHOTOS, PODCASTS, PRESENTS, PRESENTATIONS, PRINTERS, RESTAURANTS, SCHOOLS, SHOWS, SINGLES, SOFTWARE, SONGS, SPORTS, SPREADSHEET, SUPPLEMENTS, TALK, TRAINING, TRAVEL, TOYS, TV, VIDEOS, VIEWS, WINES, WORK, WIRELESS, UNIVERSITIES, AND WEB SITES (U.S. CLS. 21, 23, 26, 36 AND 38).

THEODORE MCBRIDE, EXAMINING ATTORNEY

CLASS 9—(Continued).

SN 77-360,122. ULTRACONCURRENT, INC., APTOS, CA.
FILED 12-27-2007.

CLASS 9—(Continued).

SN 78-399,230. SYMANTEC CORPORATION, CUPERTINO,
CA. FILED 4-9-2004.

ONTOAND

THE MARK CONSISTS OF STANDARD CHARACTERS WITHOUT CLAIM TO ANY PARTICULAR FONT, STYLE, SIZE, OR COLOR.

FOR COMPUTER SOFTWARE FOR CREATING SEARCHABLE DATABASES OF INFORMATION AND DATA, NAMELY, COMPUTER SOFTWARE FOR SEARCHING, COMPILING, INDEXING, QUERYING, INFERRING AND ORGANIZING INFORMATION ON COMPUTER NETWORKS; COMPUTER HARDWARE AND SOFTWARE FOR CREATING SEARCHABLE DATABASES OF INFORMATION AND DATA, NAMELY, COMPUTER HARDWARE AND COMPUTER SOFTWARE FOR SEARCHING, COMPILING, INDEXING, QUERYING, INFERRING AND ORGANIZING INFORMATION WITHIN HANDHELDS, INDIVIDUAL WORKSTATIONS AND PERSONAL COMPUTERS AND NETWORKED COMPUTERS; COMPUTER SOFTWARE FOR CREATING SEARCHABLE DATABASES OF INFORMATION AND DATA, NAMELY, COMPUTER SOFTWARE FOR CREATING INDEXES AND SEARCHING, QUERYING AND INFERRING THEORIES OF INFORMATION IN THE FOLLOWING AREAS - ACCOUNTING, APPAREL, AUDIO, AUTOS, BOOKS, BLOGS, CAFES, CALENDARING, CAMERAS, CARS, CELLULAR, CHARTS, CLOTHES, COFFEE, COLLEGES, COMPANIES, COMPUTERS, CONTACTS, CORPORATIONS, DATING, DENTISTS, DESKTOPS, DIAGRAMS, DOCS, DOCTORS, DRINKS, EDUCATION, ELECTRONICS, EMPLOYMENT, FILMS, FOOD, FINANCE, FURNISHINGS, FURNITURE, GARDEN, GIFTS, GRAPHS, HEALTH, HOME, IMAGES, JOBS, KITCHEN, LAPTOPS, MAGAZINES, MAIL, MEDICAL, MESSAGES, MORTGAGE, MOVIES, MUSIC, MAPS, NEWS, NOTEBOOKS, PERSONALS, PHONES, PHOTOS, PODCASTS, PRESENTS, PRESENTATIONS, PRINTERS, RESTAURANTS, SCHOOLS, SHOWS, SINGLES, SOFTWARE, SONGS, SPORTS, SPREADSHEET, SUPPLEMENTS, TALK, TRAINING, TRAVEL, TOYS, TV, VIDEOS, VIEWS, WINES, WORK, WIRELESS, UNIVERSITIES, AND WEB SITES (U.S. CLS. 21, 23, 26, 36 AND 38).

THEODORE MCBRIDE, EXAMINING ATTORNEY

ICOMMAND

THE MARK CONSISTS OF STANDARD CHARACTERS WITHOUT CLAIM TO ANY PARTICULAR FONT, STYLE, SIZE, OR COLOR.

FOR COMPUTER ANTI VIRUS SOFTWARE; INTERNET SECURITY SOFTWARE; ENTERPRISE SECURITY SOFTWARE; INTRUSION DETECTION SOFTWARE; FIRE WALL SOFTWARE; PRIVACY CONTROL SOFTWARE; CONTENT FILTERING SOFTWARE; CLONING SOFTWARE, NAMELY, SOFTWARE FOR CLONING COMPUTER HARD DRIVES, SOFTWARE FOR CLONING COMPUTER OPERATING SYSTEMS, SOFTWARE FOR CLONING DATA FILES, SOFTWARE RECONFIGURING PERSONAL COMPUTERS; COMPUTER SOFTWARE FOR THE CREATION OF VIRTUAL PRIVATE NETWORK; COMPUTER SOFTWARE AND DOWNLOADABLE COMPUTE SOFTWARE, NAMELY, UTILITY SOFTWARE; COMPUTER UTILITY SOFTWARE FOR REMOVAL OF COMPUTER APPLICATIONS AND SOFTWARE; UTILITY SOFTWARE FOR FACILITATING COMPUTER USE AT REMOTE LOCATIONS AND FOR FACILITATING COMMUNICATIONS AMONG MOBILE USERS OVER NETWORKS; COMPUTER SOFTWARE, NAMELY, MIDDLEWARE FOR INTERFACING CLIENT APPLICATIONS AND NETWORKED OR HOST BASED DATABASES; COMPUTER SOFTWARE AND DOWNLOADABLE COMPUTER SOFTWARE FOR USE IN UPDATING OTHER COMPUTER SOFTWARE; COMPUTER SOFTWARE FOR USE IN NETWORKING APPLICATIONS, NAMELY, COMMUNICATIONS SOFTWARE FOR CONNECTING COMPUTER NETWORK USERS; COMPUTER SOFTWARE FOR SENDING AND RECEIVING FACSIMILE TRANSMISSIONS FROM COMPUTERS AND NOTEBOOK COMPUTERS; COMPUTER SOFTWARE FOR CONNECTING AND MANAGING REMOTE COMPUTERS, FOR SYNCHRONIZATION OF FILES THROUGH E-MAIL, FOR PROVIDING SECURITY TO REMOTE COMPUTER USERS, FOR IMPLEMENTING COMPUTER, SOFTWARE AND NETWORK SECURITY MEASURES FOR REMOTE COMPUTER USERS; COMPUTER SOFTWARE FOR FILE MANAGEMENT AND TRANSFER; COMPUTER SOFTWARE FOR TELECOMMUTING, NAMELY, FOR CONNECTING TO AND USE OF A REMOTE COMPUTER NETWORK, A REMOTE COMPUTER AND MOBILE DEVICES; COMPUTER SOFTWARE FOR FACSIMILE TRANSMISSION; COMPUTER SOFTWARE FOR USE WITH A HOME OR REMOTE OFFICE, NAMELY, FOR REMOTELY ACCESSING OTHER COMPUTER NETWORKS; COMPUTER SOFTWARE AND ELECTRONIC DATABASES RECORDED ON COMPUTER MEDIA FOR USE IN DIAGNOSIS, REPAIR AND CONFIGURATION OF COMPUTERS, COMPUTER SOFTWARE AND COMPUTER PERIPHERALS; USER MANUALS SUPPLIED WITH ALL OF THE FOREGOING; COMPUTER HARDWARE; COMPUTER HARDWARE APPLIANCES THAT PROVIDE FIRE WALL, CONTENT FILTERING, INTRUSION ALERT, VIRUS PROTECTION, VIRTUAL PRIVATE NETWORKING AND OTHER SECURITY FUNCTIONS (U.S. CLS. 21, 23, 26, 36 AND 38).

JEFFERY COWARD, EXAMINING ATTORNEY

CLASS 9—(Continued).

SN 78-550,248. LEVITON MANUFACTURING CO., INC.,
LITTLE NECK, NY. FILED 1-19-2005.

CLASS 9—(Continued).

SN 78-564,041. NEURAL TECHNOLOGIES LIMITED, HAMP-
SHIRE, UNITED KINGDOM, FILED 2-9-2005.

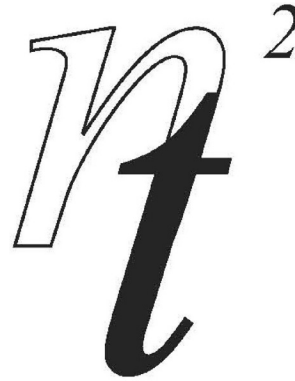

TOUCHPOINT

PRIORITY CLAIMED UNDER SEC. 44(D) ON UNITED KINGDOM APPLICATION NO. 2372465, FILED 8-9-2004, REG. NO. 23722465B, DATED 7-29-2005, EXPIRES 8-9-2014.

FOR COMPUTER SOFTWARE FOR ANALYZING AND PROCESSING FINANCIAL INFORMATION; DATA MANAGEMENT SOFTWARE FOR COLLECTING AND STORING FINANCIAL DATA; COMPUTER SOFTWARE FOR ASSESSING CREDIT RISK; COMPUTER SOFTWARE FOR ANALYZING CUSTOMER ATTRITION; COMPUTER SOFTWARE FOR ENCRYPTING DATA FOR FRAUD PREVENTION; COMPUTER SOFTWARE FOR TRANSMITTING DATA AND IMAGES VIA COMPUTER NETWORKS FOR USE IN THE FIELD OF COLLECTIONS; COMPUTER SOFTWARE RELATING TO REVENUE ASSISTANCE, NAMELY, SOFTWARE FOR TRANSMITTING DATA AND IMAGES VIA COMPUTER NETWORKS; COMPUTER SOFTWARE RELATING TO TELECOMMUNICATIONS, NAMELY, SOFTWARE FOR TRANSMITTING DATA AND IMAGES VIA COMPUTER NETWORKS; COMPUTER SOFTWARE RELATING TO MARKETING, NAMELY, SOFTWARE FOR TRANSMITTING DATA AND IMAGES VIA COMPUTER NETWORKS; COMPUTER SOFTWARE RELATING TO LITIGATION, NAMELY, SOFTWARE FOR TRANSMITTING DATA AND IMAGES VIA COMPUTER NETWORKS; SOFTWARE FOR THE MANAGEMENT OF ACCOUNTS, NAMELY, SOFTWARE FOR TRANSMITTING DATA AND IMAGES VIA COMPUTER NETWORKS; APPARATUS FOR RECORDING, TRANSMISSION OR REPRODUCTION OF SOUND OR IMAGES; PRE-RECORDED MAGNETIC DATA CARRIERS FEATURING FINANCIAL INFORMATION; PRE-RECORDED RECORDING DISCS FEATURING FINANCIAL INFORMATION; CALCULATING MACHINES; COMPUTERS (U.S. CLS. 21, 23, 26, 36 AND 38).
SOPHIA S. KIM, EXAMINING ATTORNEY

THE MARK CONSISTS OF STANDARD CHARACTERS WITHOUT CLAIM TO ANY PARTICULAR FONT, STYLE, SIZE, OR COLOR.

FOR ELECTRIC LIGHT CONTROLS (U.S. CLS. 21, 23, 26, 36 AND 38).

FIRST USE 10-16-1998; IN COMMERCE 1-2-1999.

KELLY BOULTON, EXAMINING ATTORNEY

CLASS 9—(Continued).

SN 78-599,740. KONAMI GAMING, INC., LAS VEGAS, NV.
FILED 3-31-2005.

FATE OR FORTUNE

THE MARK CONSISTS OF STANDARD CHARACTERS WITHOUT CLAIM TO ANY PARTICULAR FONT, STYLE, SIZE, OR COLOR.

FOR GAMING EQUIPMENT, NAMELY, SLOT MACHINES, GAMING MACHINES, AND GAME SOFTWARE USED THEREWITH (U.S. CLS. 21, 23, 26, 36 AND 38).

SKYE YOUNG, EXAMINING ATTORNEY

SN 78-629,917. SDI TECHNOLOGIES INC., RAHWAY, NJ.
FILED 5-13-2005.

RESON8

THE MARK CONSISTS OF STANDARD CHARACTERS WITHOUT CLAIM TO ANY PARTICULAR FONT, STYLE, SIZE, OR COLOR.

FOR (BASED ON USE IN COMMERCE) RADIOS INCORPORATING CLOCKS AND THEIR COMPONENT PARTS, NAMELY, AUDIO AMPLIFIERS; (BASED ON INTENT TO USE) HEADPHONES; AUDIO SPEAKERS (U.S. CLS. 21, 23, 26, 36 AND 38).

FIRST USE 6-30-2005; IN COMMERCE 6-30-2005.

DAWN HAN, EXAMINING ATTORNEY

SN 78-670,362. BALLY GAMING INTERNATIONAL, INC.,
LAS VEGAS, NV. FILED 7-14-2005.

Blazing 7s Grand

THE MARK CONSISTS OF STANDARD CHARACTERS WITHOUT CLAIM TO ANY PARTICULAR FONT, STYLE, SIZE, OR COLOR.

OWNER OF U.S. REG. NO. 1,894,972.

NO CLAIM IS MADE TO THE EXCLUSIVE RIGHT TO USE "7S", APART FROM THE MARK AS SHOWN.

FOR GAMING DEVICES, NAMELY, SLOT MACHINES, WITH OR WITHOUT VIDEO OUTPUT (U.S. CLS. 21, 23, 26, 36 AND 38).

MONIQUE MILLER, EXAMINING ATTORNEY

CLASS 9—(Continued).

SN 78-684,939. FUJITSU LIMITED, KAWASAKI-SHI, KANAGAWA, JAPAN, FILED 8-3-2005.

Web Accessibility Inspector

THE MARK CONSISTS OF STANDARD CHARACTERS WITHOUT CLAIM TO ANY PARTICULAR FONT, STYLE, SIZE, OR COLOR.

PRIORITY CLAIMED UNDER SEC. 44(D) ON JAPAN APPLICATION NO. 2005-040840, FILED 5-11-2005, REG. NO. 4915580, DATED 12-16-2005, EXPIRES 12-16-2015.

NO CLAIM IS MADE TO THE EXCLUSIVE RIGHT TO USE "WEB ACCESSIBILITY", APART FROM THE MARK AS SHOWN.

FOR COMPUTER SOFTWARE FOR CHECKING THE ACCESSIBILITY OF WEBSITES FOR PEOPLE WITH VISUAL IMPAIRMENTS (U.S. CLS. 21, 23, 26, 36 AND 38).

DAVID MURRAY, EXAMINING ATTORNEY

SN 78-719,623. NBA PROPERTIES, INC., NEW YORK, NY.
FILED 9-23-2005.



OWNER OF U.S. REG. NOS. 1,901,528, 2,425,573 AND OTHERS.

FOR AUDIO RECORDINGS AND VIDEO RECORDINGS IN THE FIELD OF BASKETBALL; AUDIO, VIDEO, COMPUTER AND LASER DISCS, PRE-RECORDED AUDIO AND VIDEO CASSETTES, PRE-RECORDED AUDIO AND VIDEO TAPES, PRE-RECORDED COMPACT DISCS, PRE-RECORDED COMPUTER DISCS, ALL RELATED TO BASKETBALL; COMPUTER ACCESSORIES, NAMELY, MOUSE PADS, MICE, DISC CASES, COMPUTER CARRY-ON CASES, KEYBOARD WRIST PADS, COMPUTER MONITOR CARDBOARD FRAMES, ALL RELATED TO BASKETBALL; COMPUTER PROGRAMS FOR VIEWING INFORMATION, STATISTICS OR TRIVIA ABOUT BASKETBALL; COMPUTER SOFTWARE, NAMELY, SCREEN SAVERS FEATURING BASKETBALL THEMES, COMPUTER SOFTWARE TO ACCESS AND VIEW COMPUTER WALLPAPER, COMPUTER BROWSERS, COMPUTER SKINS AND COMPUTER CURSORS; COMPUTER GAME SOFTWARE; VIDEO GAME SOFTWARE, VIDEO GAME CARTRIDGES AND VIDEO GAME MACHINES FOR USE WITH TELEVISIONS; WIRELESS TELEPHONES; RADIOS, TELEPHONES, AND CELL PHONE ACCESSORIES, NAMELY, FACE PLATES AND CELL PHONE COVERS; VIDEO MONITORS, COMPUTER MONITORS, BINOCULARS; SUNGLASSES; EYEGLASS FRAMES; EYEWEAR STRAPS AND CHAINS; EYEGLASS AND SUNGLASS CASES; MAGNETS; DISPOSABLE CAMERAS; CREDIT CARDS AND PRE-PAID TELEPHONE CALLING CARDS MAGNETICALLY ENCODED, DOWNLOADABLE VI-

CLASS 9—(Continued).

DEO RECORDINGS, VIDEO STREAM RECORDINGS, AND AUDIO RECORDINGS IN THE FIELD OF BASKETBALL PROVIDED OVER THE INTERNET; DOWNLOADABLE COMPUTER SOFTWARE FOR VIEWING DATABASES OF INFORMATION, STATISTICAL INFORMATION, TRIVIA, POLLING INFORMATION, AND INTERACTIVE POLLING IN THE FIELD OF BASKETBALL PROVIDED OVER THE INTERNET; DOWNLOADABLE COMPUTER GAME SOFTWARE, VIDEO GAME PROGRAMS, INTERACTIVE VIDEO GAMES AND TRIVIA GAME SOFTWARE PROVIDED OVER THE INTERNET; DOWNLOADABLE COMPUTER SOFTWARE FOR USE AS SCREENSAVERS, WALLPAPER, BROWSERS, SKINS, AVATARS AND CURSORS OVER THE INTERNET; DOWNLOADABLE ELECTRONIC PUBLICATIONS IN THE NATURE OF MAGAZINES, NEWSLETTERS, COLORING BOOKS, GAME SCHEDULES ALL IN THE FIELD OF BASKETBALL PROVIDED OVER THE INTERNET; DOWNLOADABLE CATALOGS PROVIDED OVER THE INTERNET FEATURING AN ARRAY OF BASKETBALL-THEMED PRODUCTS; DOWNLOADABLE GREETING CARDS PROVIDED OVER THE INTERNET (U.S. CLS. 21, 23, 26, 36 AND 38).

COLLEEN KEARNEY, EXAMINING ATTORNEY

CLASS 9—(Continued).

SN 78-779,227. VISIBLE ASSETS, INC., MISSISSAUGA, CANADA, FILED 12-22-2005.

.tag

SN 78-743,948. PHILLIPS, YUSUF S./"DJ SHARIF SIZA" (PSEUD.), MARIETTA, GA. FILED 10-31-2005.

DJ Sharif Siza

THE MARK CONSISTS OF STANDARD CHARACTERS WITHOUT CLAIM TO ANY PARTICULAR FONT, STYLE, SIZE, OR COLOR.

FOR RADIO RECEIVERS; RADIO TRANSMITTERS (U.S. CLS. 21, 23, 26, 36 AND 38).

JUSTINE D. PARKER, EXAMINING ATTORNEY

THE MARK CONSISTS OF STANDARD CHARACTERS WITHOUT CLAIM TO ANY PARTICULAR FONT, STYLE, SIZE, OR COLOR.

NO CLAIM IS MADE TO THE EXCLUSIVE RIGHT TO USE "DJ", APART FROM THE MARK AS SHOWN.

THE NAME "DJ SHARIF SIZA" IDENTIFIES A LIVING INDIVIDUAL WHOSE CONSENT IS OF RECORD.

FOR A CONTINUING SERIES OF PRE-RECORDED COMPACT DISCS, PHONOGRAPH RECORDS, AUDIO CASSETTES, LASER DISCS, DIGITAL VIDEO DISCS AND PRE-RECORDED VIDEOTAPES ALL FEATURING MUSICAL RECORDINGS AND MUSICAL PERFORMANCES AND PRESENTATIONS (U.S. CLS. 21, 23, 26, 36 AND 38).

FIRST USE 1-1-2002; IN COMMERCE 1-1-2002.
EDWARD NELSON, EXAMINING ATTORNEY

SN 78-787,193. GUARDIAN APPLICATIONS, INC, MINNEAPOLIS, MN. FILED 1-8-2006.

Privacy Matters

SN 78-766,833. DSCI, FREEHOLD, NJ. FILED 12-5-2005.

MIRAGE-ANALYSIM

THE MARK CONSISTS OF STANDARD CHARACTERS WITHOUT CLAIM TO ANY PARTICULAR FONT, STYLE, SIZE, OR COLOR.

FOR COMPUTER SOFTWARE, NAMELY, DATABASE MANAGEMENT SOFTWARE, FOR USE IN DATA ANALYSIS FOR PURPOSES OF MODEL SIMULATION (U.S. CLS. 21, 23, 26, 36 AND 38).

TRACY WHITTAKER-BROWN, EXAMINING ATTORNEY

THE MARK CONSISTS OF STANDARD CHARACTERS WITHOUT CLAIM TO ANY PARTICULAR FONT, STYLE, SIZE, OR COLOR.

NO CLAIM IS MADE TO THE EXCLUSIVE RIGHT TO USE "PRIVACY", APART FROM THE MARK AS SHOWN.

FOR COMPUTER SOFTWARE FOR ENCRYPTION OF DATA CONTAINED IN DATABASES (U.S. CLS. 21, 23, 26, 36 AND 38).

STEVEN PEREZ, EXAMINING ATTORNEY

CLASS 9—(Continued).

SN 78-809,374. ABLE PLANET, INCORPORATED, WHEAT RIDGE, CO. FILED 2-7-2006.

Turn it Down!

THE MARK CONSISTS OF STANDARD CHARACTERS WITHOUT CLAIM TO ANY PARTICULAR FONT, STYLE, SIZE, OR COLOR.

FOR AMPLIFIER FOR WIRELESS COMMUNICATIONS; AMPLIFIERS; AUDIO AMPLIFIERS; AUDIO CASSETTE DECKS FOR AUTOMOBILES; AUDIO CASSETTE RECORDERS; AUDIO EQUIPMENT FOR VEHICLES, NAMELY, STEREOs, SPEAKERS, AMPLIFIERS, EQUALIZERS, CROSSOVERS AND SPEAKER HOUSINGS; AUDIO MIXERS; AUDIO PROCESSING EQUIPMENT, NAMELY, LIMITERS AND COMPRESSORS; AUDIO SPEAKERS; AUDIO TAPE RECORDERS; AUDIO-VIDEO RECEIVERS; CELLULAR TELEPHONES; CORDLESS TELEPHONES; DIGITAL AUDIO PLAYERS; DIGITAL AUDIO TAPE PLAYERS; DIGITAL AUDIO TAPE RECORDERS; ELECTRIC AUDIO PLAYBACK UNITS WITH LIGHTS AND SPEAKERS; ELECTRONIC EFFECT PEDALS FOR USE WITH SOUND AMPLIFIERS; GUITAR AMPLIFIERS; HEADPHONES; HEADSETS FOR TELEPHONES; HEADSETS FOR USE WITH COMPUTERS; LOUD SPEAKER SYSTEMS; LOUDSPEAKERS WITH BUILT IN AMPLIFIERS; MUSICAL INSTRUMENT AMPLIFIERS; OPTICAL SEMICONDUCTOR AMPLIFIERS; PERSONAL HEADPHONES FOR USE WITH SOUND TRANSMITTING SYSTEMS; PERSONAL STEREOs; POWER AMPLIFIERS; PRE-AMPLIFIERS; RADAR RECEIVERS WITH AMPLIFIERS; SOUND AMPLIFIERS; SOUND MIXERS WITH INTEGRATED AMPLIFIERS; STEREO AMPLIFIERS; TELEPHONE HEADSETS (U.S. CLS. 21, 23, 26, 36 AND 38).
MYRIAH HABEEB, EXAMINING ATTORNEY

SN 78-824,946. FRASER ADVANCED INFORMATION SYSTEMS, WEST READING, PA. FILED 2-28-2006.

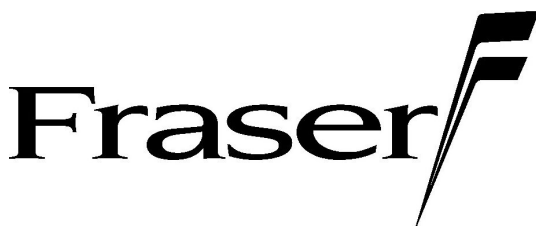

OWNER OF U.S. REG. NO. 2,756,042.
THE MARK CONSISTS OF THE TERM "FRASER" AND A STYLIZED FLAG.

FOR COMPUTER SOFTWARE FOR DOCUMENT MANAGEMENT, INTEGRATION OF BUSINESS INFORMATION, AND CREATION OF BUSINESS FORMS (U.S. CLS. 21, 23, 26, 36 AND 38).

FIRST USE 1-2-2002; IN COMMERCE 1-2-2002.
YONG KIM, EXAMINING ATTORNEY

CLASS 9—(Continued).

SN 78-828,149. QUANTEL LIMITED, NEWBURY BERKSHIRE, ENGLAND, FILED 3-3-2006.

PABLO

THE MARK CONSISTS OF STANDARD CHARACTERS WITHOUT CLAIM TO ANY PARTICULAR FONT, STYLE, SIZE, OR COLOR.

PRIORITY CLAIMED UNDER SEC. 44(D) ON ERP CMNTY TM OFC APPLICATION NO. 4923868, FILED 2-24-2006, REG. NO. 4923868, DATED 10-8-2007, EXPIRES 2-24-2016.

FOR INTEGRATED PROPRIETARY COMPUTER HARDWARE AND SOFTWARE FOR CONVERTING, EDITING, COMPOSITING, COLOR CORRECTING, PROCESSING, MIXING AND MANIPULATING IMAGES OR IMAGE SIGNALS WITH OR WITHOUT AUDIO SIGNALS, FOR USE IN THE TELEVISION, CINEMATOGRAPHIC, ENTERTAINMENT AND GRAPHIC ARTS INDUSTRIES; EDUCATIONAL OR TRAINING HARDWARE AND SOFTWARE FEATURING INSTRUCTION IN CONVERTING, EDITING, COMPOSITING, COLOR CORRECTING, PROCESSING, MIXING AND MANIPULATING IMAGES OR IMAGE SIGNALS WITH OR WITHOUT AUDIO SIGNALS (U.S. CLS. 21, 23, 26, 36 AND 38).

ALYSSA PALADINO, EXAMINING ATTORNEY

SN 78-867,718. GRIFFIN INTERNATIONAL COMPANIES, INC., MINNEAPOLIS, MN. FILED 4-24-2006.

REACT

THE MARK CONSISTS OF STANDARD CHARACTERS WITHOUT CLAIM TO ANY PARTICULAR FONT, STYLE, SIZE, OR COLOR.

FOR PLAYER-OPERATED ELECTRONIC CONTROLLERS FOR ELECTRONIC VIDEO GAME DEVICES, NAMELY, WIRELESS CONTROLLERS FOR USE WITH VIDEO GAMES, WIRELESS CONTROLLERS FOR USE WITH VIDEO GAMES AND VIDEO GAME INTERACTIVE CONTROL FLOOR PADS OR MATS; PROTECTIVE CARRYING CASES SPECIALLY ADAPTED FOR VIDEO GAME ACCESSORIES, AND ACCESSORIES FOR VIDEO GAME DEVICES, NAMELY, SPEAKERS AND ELECTRICAL CABLES (U.S. CLS. 21, 23, 26, 36 AND 38).

TIMOTHY FINNEGAN, EXAMINING ATTORNEY

CLASS 9—(Continued).

SN 78-872,734. BAUMANN II, PAUL, PORTLAND, OR.
FILED 4-28-2006.

CLASS 9—(Continued).

SN 78-875,116. EDMUND OPTICS, INC., BARRINGTON, NJ.
FILED 5-3-2006.



FOR AUXILIARY POWER UNITS FOR SUPPLYING ELECTRICAL POWER TO HEAT AND POWER GENERATORS IN THE TRUCKING INDUSTRY (U.S. CLS. 21, 23, 26, 36 AND 38).
SUZANNE BLANE, EXAMINING ATTORNEY



SN 78-874,513. ELBIT SYSTEMS LTD., HAIFA, ISRAEL,
FILED 5-2-2006.



VIPER

THE MARK CONSISTS OF STANDARD CHARACTERS WITHOUT CLAIM TO ANY PARTICULAR FONT, STYLE, SIZE, OR COLOR.

PRIORITY CLAIMED UNDER SEC. 44(D) ON ISRAEL APPLICATION NO. 185081, FILED 11-6-2005, REG. NO. 185081, DATED 8-7-2007, EXPIRES 11-6-2015.

PRIORITY CLAIMED UNDER SEC. 44(D) ON ISRAEL APPLICATION NO. 185080, FILED 11-6-2005, REG. NO. 185080, DATED 8-7-2007, EXPIRES 11-6-2015.

FOR STATIONARY AND PORTABLE TACTICAL ROBOTS FOR USE IN THE FIELDS OF LAW ENFORCEMENT, SECURITY AND NATIONAL DEFENSE, ALL FOR LOCATING, CONTROLLING, MONITORING, MEASURING, PHOTOGRAPHING, IDENTIFYING, DISMANTLING, DISPLACING, EXPLODING, DESTROYING, HANDLING AND MANAGING, FROM A DISTANCE AND CLOSE RANGE, OBJECTS, WEAPONS, DETONATORS, EXPLOSIVES AND DANGEROUS MATERIALS; COMMUNICATIONS COMPUTERS; APPARATUS FOR THE TRANSMISSION AND DISPLAY OF IMAGES AND TEXT; AND COMPUTER SOFTWARE FOR CONTROLLING STATIONARY AND PORTABLE TACTICAL ROBOTS FOR USE IN THE FIELDS OF LAW ENFORCEMENT, SECURITY AND NATIONAL DEFENSE (U.S. CLS. 21, 23, 26, 36 AND 38).
MICHAEL WEBSTER, EXAMINING ATTORNEY

THE COLOR(S) CHAMPAGNE AND BURGUNDY IS/ARE CLAIMED AS A FEATURE OF THE MARK.

THE MARK CONSISTS OF TWO BANDS OF COLORS, CHAMPAGNE AND BURGUNDY, APPLIED TO THE GOODS. THE COLOR BURGUNDY APPEARS ON THE TOP BAND AND THE COLOR CHAMPAGNE APPEARS ON THE BOTTOM BAND. THE DOTTED LINES IN THE DRAWING DEPICT THE GOODS. THE MATTER SHOWN BY THE DOTTED LINES IS NOT A PART OF THE MARK AND ONLY SERVES TO SHOW THE POSITION OF THE MARK.

SEC. 2(F).
FOR LENS ASSEMBLIES FOR INDUSTRIAL APPLICATIONS (U.S. CLS. 21, 23, 26, 36 AND 38).
FIRST USE 1-0-2001; IN COMMERCE 1-0-2001.
TERESA M. RUPP, EXAMINING ATTORNEY

CLASS 9—(Continued).

SN 78-885,212. SONY KABUSHIKI KAISHA, TA SONY CORPORATION, TOKYO, JAPAN, FILED 5-16-2006.

Duara

THE MARK CONSISTS OF STANDARD CHARACTERS WITHOUT CLAIM TO ANY PARTICULAR FONT, STYLE, SIZE, OR COLOR.

PRIORITY CLAIMED UNDER SEC. 44(D) ON JAPAN APPLICATION NO. 2005108247, FILED 11-17-2005, REG. NO. 4967351, DATED 7-7-2006, EXPIRES 7-7-2016.

"DUARA" APPEARING IN THE MARK HAS NO SIGNIFICANCE IN THE RELEVANT TRADE OR INDUSTRY OR AS APPLIED TO THE GOODS/SERVICES LISTED IN THE APPLICATION, NO GEOGRAPHICAL SIGNIFICANCE, NOR ANY MEANING IN A FOREIGN LANGUAGE.

FOR VIDEO CAMERAS; DIGITAL CAMERAS; VIDEO-TAPE RECORDERS; VIDEOTAPE PLAYERS; VIDEO-DISC RECORDERS; VIDEODISC PLAYERS; VIDEO CAMERAS WITH VIDEOTAPE PLAYBACK AND/OR RECORDING UNITS; VIDEO CAMERAS WITH VIDEO-DISC PLAYBACK AND/OR RECORDING UNITS; BLANK VIDEOTAPES AND VIDEODISCS; RECHARGEABLE BATTERY UNITS AND BATTERY PACKS; ALTERNATING CURRENT ADAPTERS; CABLES FOR PHOTOGRAPHIC CAMERAS; STEREO AUDIO-VIDEO PHOTO CABLES; ACCESSORIES FOR VIDEO AND DIGITAL CAMERAS, NAMELY, HOUSINGS FOR DRY CELLS AND RECHARGEABLE BATTERY PACKS; WIRELESS REMOTE CONTROLLERS; BLANK MAGNET-OPTICAL DISCS AND IC CHIPS TO RECORD IMAGES; PRINTERS AND SCANNERS; VIDEO CAMERAS FOR BROADCASTING (U.S. CLS. 21, 23, 26, 36 AND 38).

PAM WILLIS, EXAMINING ATTORNEY

SN 78-897,897. VOLCANO CORPORATION, RANCHO CORDOVA, CA. FILED 6-1-2006.

AIM

THE MARK CONSISTS OF STANDARD CHARACTERS WITHOUT CLAIM TO ANY PARTICULAR FONT, STYLE, SIZE, OR COLOR.

FOR COMPUTER HARDWARE FOR ANGIO INTRAVASCULAR ULTRASOUND MAPPING; COMPUTER SOFTWARE FOR ANGIO INTRAVASCULAR ULTRASOUND MAPPING (U.S. CLS. 21, 23, 26, 36 AND 38).

GILBERT SWIFT, EXAMINING ATTORNEY

CLASS 9—(Continued).

SN 78-900,231. BENNETT GROUP FINANCIAL SERVICES LLC, WASHINGTON, DC. FILED 6-5-2006.

CULTURAL FINANCIAL REVOLUTION

THE MARK CONSISTS OF STANDARD CHARACTERS WITHOUT CLAIM TO ANY PARTICULAR FONT, STYLE, SIZE, OR COLOR.

NO CLAIM IS MADE TO THE EXCLUSIVE RIGHT TO USE "FINANCIAL", APART FROM THE MARK AS SHOWN.

FOR PRE-RECORDED VIDEO AND AUDIO TAPES AND DISCS FEATURING ADVICE AND COMMENTARY ON FINANCIAL MATTERS, AND DISCUSSION AND EDUCATION ON BUSINESS AND FINANCE; COMPUTER SOFTWARE FOR PERFORMING AND ENABLING FINANCIAL ANALYSIS AND FOR USE AS A SPREADSHEET IN THE FIELD OF FINANCES (U.S. CLS. 21, 23, 26, 36 AND 38).

LYDIA BELZER, EXAMINING ATTORNEY

SN 78-904,970. PRINCETON TECHNOLOGY, INC., IRVINE, CA. FILED 6-9-2006.

ZEESHAN

THE MARK CONSISTS OF STANDARD CHARACTERS WITHOUT CLAIM TO ANY PARTICULAR FONT, STYLE, SIZE, OR COLOR.

FOR COMPUTER HARDWARE; MICROPROCESSORS; INTEGRATED CIRCUITS FOR COMPUTERS AND PERIPHERALS; INTEGRATED CIRCUIT CHIPS FOR COMPUTERS AND PERIPHERALS; CIRCUIT CHIPS FOR COMPUTERS AND PERIPHERALS; MICROCOMPUTERS; COMPUTER CHIP SETS; COMPUTER MOTHERBOARDS AND DAUGHTER BOARDS; PRINTED CIRCUIT BOARDS; ELECTRONIC CIRCUIT BOARDS; COMPUTER GRAPHICS BOARDS; COMPUTER NETWORKING HARDWARE; COMPUTER NETWORK ADAPTORS, SWITCHES, ROUTERS AND HUBS; ELECTRONIC APPARATUS FOR USE WITH COMPUTERS, NAMELY, MUSIC PLAYERS IN THE NATURE OF MP3 AND MP4 PLAYERS; COMPUTER PERIPHERALS; SEMICONDUCTOR PROCESSORS; SEMICONDUCTOR PROCESSOR CHIPS; COMPUTER MEMORIES; SEMICONDUCTOR MEMORIES; VIDEO CIRCUIT BOARDS; AUDIO CIRCUIT BOARDS; AUDIO-VIDEO CIRCUIT BOARDS; VIDEO GRAPHIC ACCELERATORS; MULTIMEDIA ACCELERATOR BOARDS; VIDEO PROCESSORS; FAX MODEMS; COMPUTER HARDWARE AND SOFTWARE FOR TRANSMISSION AND RECEIPT OF FACSIMILES; COMPUTER HARDWARE AND SOFTWARE FOR THE DEVELOPMENT, MAINTENANCE, AND USE OF LOCAL AND WIDE AREA COMPUTER NETWORKS; COMPUTER HARDWARE AND SOFTWARE FOR THE DEVELOPMENT, MAINTENANCE, AND USE OF INTERACTIVE AUDIO-VIDEO COMPUTER CONFERENCE SYSTEMS; COMPUTER HARDWARE AND SOFTWARE FOR THE RECEIPT, DISPLAY AND USE OF BROADCAST VIDEO, AUDIO, AND DIGITAL DATA SIGNALS (U.S. CLS. 21, 23, 26, 36 AND 38).

KAREN K. BUSH, EXAMINING ATTORNEY

CLASS 9—(Continued).

SN 78-906,350. THAT CORPORATION, MILFORD, MA.
FILED 6-12-2006.

ANALOG ENGINE

THE MARK CONSISTS OF STANDARD CHARACTERS WITHOUT CLAIM TO ANY PARTICULAR FONT, STYLE, SIZE, OR COLOR.

OWNER OF U.S. REG. NO. 2,021,507.
NO CLAIM IS MADE TO THE EXCLUSIVE RIGHT TO USE "ANALOG", APART FROM THE MARK AS SHOWN.
SEC. 2(F).

FOR INTEGRATED CIRCUITS; AND INTEGRATED CIRCUIT SIGNAL DYNAMICS PROCESSORS (U.S. CLS. 21, 23, 26, 36 AND 38).

FIRST USE 7-15-1993; IN COMMERCE 7-15-1993.
JEFF DEFORD, EXAMINING ATTORNEY

SN 78-907,739. E INK CORPORATION, CAMBRIDGE, MA.
FILED 6-14-2006.

RADIOPAPER

THE MARK CONSISTS OF STANDARD CHARACTERS WITHOUT CLAIM TO ANY PARTICULAR FONT, STYLE, SIZE, OR COLOR.

FOR ELECTRONIC VISUAL DISPLAY PANELS CAPABLE OF BEING UPDATED REMOTELY WITHOUT PHYSICAL CONNECTIONS, AND CONTAINING ELECTRO-OPTIC MATERIAL WHICH CHANGES COLOR OR OPTICAL CHARACTERISTICS, FOR USE ON OR IN CONNECTION WITH HAND-HELD DEVICES, ELECTRONIC APPARATUS, INCLUDING BUT NOT LIMITED TO CELLULAR TELEPHONES, MACHINERY, SIGNS, CREDIT CARDS, TEXTILES, PAPER PRODUCTS, RUBBER GOODS, AND LEATHER GOODS (U.S. CLS. 21, 23, 26, 36 AND 38).

HEATHER BIDDULPH, EXAMINING ATTORNEY

SN 78-914,424. TRISSENTIAL, LLC, MINNETONKA, MN.
FILED 6-23-2006.

PROJECY

THE MARK CONSISTS OF STANDARD CHARACTERS WITHOUT CLAIM TO ANY PARTICULAR FONT, STYLE, SIZE, OR COLOR.

FOR COMPUTER SOFTWARE USED TO CREATE CUSTOMIZABLE ELECTRONIC FORMS FOR USE IN THE FIELD OF BUSINESS PROJECT MANAGEMENT (U.S. CLS. 21, 23, 26, 36 AND 38).

FIRST USE 10-10-2003; IN COMMERCE 6-14-2004.
WENDY GOODMAN, EXAMINING ATTORNEY

CLASS 9—(Continued).

SN 78-919,942. TIME DOMAIN CORPORATION, HUNTSVILLE, AL. FILED 6-29-2006.

PulsON Powered

THE MARK CONSISTS OF STANDARD CHARACTERS WITHOUT CLAIM TO ANY PARTICULAR FONT, STYLE, SIZE, OR COLOR.

OWNER OF U.S. REG. NOS. 2,373,081, 2,730,049 AND OTHERS.

FOR WIRELESS COMMUNICATIONS HARDWARE USED FOR ULTRA WIDEBAND RADIO COMMUNICATIONS, POSITIONING AND RADAR, NAMELY, ULTRA WIDEBAND RADIO TRANSMITTERS, TRANSCEIVERS, RECEIVERS AND ANTENNAS; WIRELESS COMMUNICATIONS COMPUTER SOFTWARE USED TO ALLOW WIRELESS RADIO COMMUNICATION, POSITIONING AND RADAR BETWEEN ULTRA WIDEBAND RADIO TRANSMITTERS, TRANSCEIVERS, AND RECEIVERS; ENCODED TAGS AND ELECTRONIC CARD READERS AND CHIP CARD READERS FOR COOPERATIVE ASSET, OBJECT, PERSON, AND ANIMAL TRACKING SYSTEMS; MONOSTATIC, BISTATIC, AND MULTI-STATIC RADARS FOR NONCOOPERATIVE TARGET DETECTION AND TRACKING; WIRELESS LOCAL AREA NETWORKS FOR WIRELESS DATA AND VOICE COMMUNICATION; INVISIBLE ELECTRIC SECURITY FENCES, FIELDS AND DOMES; WIRELESS DIGITAL PRINTERS; WIRELESS AUDIO SPEAKER AND MICROPHONE SYSTEMS COMPRISED OF ULTRA WIDE BAND TRANSMITTERS, RECEIVERS, ANTENNAS AND INTEGRATED CIRCUITS USED TO TRANSMIT DIGITIZED SOUND INFORMATION WIRELESSLY USING ULTRA WIDEBAND TECHNOLOGY; PRISONER MONITORING SYSTEMS COMPRISING ULTRA WIDE BAND TRANSMITTERS, RECEIVERS, ANTENNAS AND INTEGRATED CIRCUITS USED TO MONITOR AND TRACK THE LOCATION OF PRISONERS WITHIN A PRISON ENVIRONMENT USING ULTRA WIDE BAND TECHNOLOGY; HOME ARREST TRACKING SYSTEMS COMPRISED OF ULTRA WIDE BAND TRANSMITTERS, RECEIVERS, ANTENNAS AND INTEGRATED CIRCUITS USED TO MONITOR AND TRACK INDIVIDUALS UNDER HOUSE ARREST USING ULTRA WIDEBAND TECHNOLOGY; MOTION SENSORS THAT DETECT SENSOR THROUGH WALLS; ELECTRIC COLLISION AVOIDANCE SENSORS USED TO DETECT THE IMMINENCE OF A COLLISION USING ULTRA WIDE BAND TECHNOLOGY; DANGER PROXIMITY WARNING SYSTEMS, NAMELY, TRANSMITTERS, RECEIVERS, SENSORS, DETECTORS, ALARMS, AND COMPUTER HARDWARE AND COMPUTER SOFTWARE FOR THE FOREGOING; AUTOMATION CONTROL SYSTEMS, NAMELY, TRANSMITTERS, RECEIVERS, SENSORS, DETECTORS, ACTUATORS, AND COMPUTER HARDWARE AND COMPUTER SOFTWARE FOR THE FOREGOING; ENVIRONMENTAL CONTROL SYSTEMS COMPRISED OF TRANSMITTERS, RECEIVERS, COMPUTER HARDWARE AND SOFTWARE FOR THE FOREGOING AND ELECTRONIC SENSORS AND DETECTORS; ROBOTIC CONTROL SYSTEMS, NAMELY, TRANSMITTERS, RECEIVERS, SENSORS, DETECTORS, ACTUATORS, AND COMPUTER HARDWARE AND COMPUTER SOFTWARE FOR THE FOREGOING; OBJECT DELIVERY SYSTEMS, NAMELY, TRANSMITTERS, RECEIVERS, SENSORS, DETECTORS, ACTUATORS, AND COMPUTER HARDWARE AND COMPUTER SOFTWARE FOR THE FOREGOING; CONTAINER MONITORING SYSTEMS, NAMELY, CAMERAS, TRANSMITTERS, RECEIVERS, SENSORS, DETECTORS, ACTUATORS, AND COMPUTER HARDWARE AND COMPUTER SOFTWARE FOR THE FOREGOING; SENSOR MONITORING SYSTEMS, TRANSMITTERS, RECEIVERS, SENSORS, DETECTORS, ACTUATORS, AND COMPUTER HARDWARE AND COMPUTER SOFTWARE FOR THE FOREGOING; SMART HOMES, NAMELY, COMPUTER HARDWARE AND SOFTWARE USED TO AUTOMATE, CONTROL, INTEGRATE AND MONITOR VARIOUS HOME ELEC-

CLASS 9—(Continued).

TRONICS SYSTEMS, NAMELY, AUDIO, VIDEO, HOME THEATER, LIGHTING, SECURITY, HEATING, VENTILATION AND AIR CONDITIONING (HVAC) AND HOME APPLIANCES; SMART FARMS, NAMELY, COMPUTER HARDWARE AND SOFTWARE FOR FARM MANAGEMENT AND FOR FARM SECURITY, INTRUSION AND FIRE DETECTION; AND POSITION AWARE CONTROL SYSTEMS, NAMELY, ULTRA WIDE BAND TRANSMITTERS, RECEIVERS, ANTENNAS, COMPUTER HARDWARE AND SOFTWARE AND INTEGRATED CIRCUITS USED TO FACILITATE POSITION DETERMINATION (U.S. CLS. 21, 23, 26, 36 AND 38).

NAKIA HENRY, EXAMINING ATTORNEY

SN 78-921,297. ARTSCETERA GROUP, LLC, BROOKLYN, NY. FILED 6-30-2006.

ARFIE

THE MARK CONSISTS OF STANDARD CHARACTERS WITHOUT CLAIM TO ANY PARTICULAR FONT, STYLE, SIZE, OR COLOR.

FOR AUDIO RECORDINGS, CD'S AND DVD'S FEATURING PRE-RECORDED MUSIC FOR CHILDREN AND FAMILIES AND ACCOMPANYING WRITTEN AND INSTRUCTIONAL MATERIALS, SOLD TOGETHER AS A UNIT; COMPUTER GAME SOFTWARE AND VIDEO GAME SOFTWARE FOR CHILDREN AND FAMILIES; PRECORDED VIDEO TAPES, CD ROMS AND DVDS FEATURING CHILDREN'S MUSIC AND MOVIES (U.S. CLS. 21, 23, 26, 36 AND 38).

MARK SPARACINO, EXAMINING ATTORNEY

SN 78-922,756. ARTSCETERA GROUP, LLC, BROOKLYN, NY. FILED 7-5-2006.

PAWLA

THE MARK CONSISTS OF STANDARD CHARACTERS WITHOUT CLAIM TO ANY PARTICULAR FONT, STYLE, SIZE, OR COLOR.

FOR AUDIO RECORDINGS, CD'S AND DVD'S FEATURING PRE-RECORDED MUSIC FOR CHILDREN AND FAMILIES AND ACCOMPANYING WRITTEN AND INSTRUCTIONAL MATERIALS, SOLD TOGETHER AS A UNIT; COMPUTER GAME SOFTWARE AND VIDEO GAME SOFTWARE FOR CHILDREN AND FAMILIES; PRECORDED VIDEO TAPES, CD ROM AND DVDS ALL FEATURING CHILDREN'S MUSIC AND MOVIES (U.S. CLS. 21, 23, 26, 36 AND 38).

MARK SPARACINO, EXAMINING ATTORNEY

CLASS 9—(Continued).

SN 78-924,579. U.S. FOAM TECHNOLOGIES, INC., LONGVIEW, TX. FILED 7-7-2006.

ACCU-BID

THE MARK CONSISTS OF STANDARD CHARACTERS WITHOUT CLAIM TO ANY PARTICULAR FONT, STYLE, SIZE, OR COLOR.

FOR COMPUTER SOFTWARE FOR WAREHOUSING AND SEARCHING DATA, NAMELY, COMPUTER SOFTWARE TO AUTOMATE DATA WAREHOUSING, AND FOR CREATING SEARCHABLE DATABASES OF INFORMATION AND DATA, ALL FOR USE IN THE FIELD OF FIREFIGHTING (U.S. CLS. 21, 23, 26, 36 AND 38).

LYDIA BELZER, EXAMINING ATTORNEY

SN 78-925,790. SILICONSYSTEMS, INC., ALISO VIEJO, CA. FILED 7-10-2006.

SILICONDRIVE SECURE

THE MARK CONSISTS OF STANDARD CHARACTERS WITHOUT CLAIM TO ANY PARTICULAR FONT, STYLE, SIZE, OR COLOR.

NO CLAIM IS MADE TO THE EXCLUSIVE RIGHT TO USE "SILICON DRIVE", APART FROM THE MARK AS SHOWN.

FOR FLASH BASED SOLID STATE DIGITAL STORAGE MEDIA (U.S. CLS. 21, 23, 26, 36 AND 38).

DANIEL CAPSHAW, EXAMINING ATTORNEY

SN 78-929,628. 4307861 CANADA INC., VILLE ST-LAURENT, CANADA, FILED 7-14-2006.

NOONSKI

THE MARK CONSISTS OF STANDARD CHARACTERS WITHOUT CLAIM TO ANY PARTICULAR FONT, STYLE, SIZE, OR COLOR.

PRIORITY CLAIMED UNDER SEC. 44(D) ON CANADA APPLICATION NO. 1301716, FILED 5-5-2006, REG. NO. TMA692949, DATED 7-30-2007, EXPIRES 7-30-2022.

FOR COMPUTER AND/OR VIDEO GAME SOFTWARE AND COMPUTER, VIDEO GAME AND ELECTRONIC EQUIPMENT AND ACCESSORIES, NAMELY, REMOTE CONTROL UNITS FOR COMPUTERS, HAND HELD JOY STOCK AND STEERING WHEEL UNITS FOR PLAYING COMPUTER AND VIDEO GAMES; CABLES TO CONNECT VIDEO GAME SYSTEMS TO TELEVISIONS, DVD PLAYERS, VCR PLAYERS, AND MULTIPLE VIDEO GAME SYSTEMS; ADAPTERS TO CONNECT MULTIPLE VIDEO GAME PLAYERS TO THE SAME VIDEO GAME SYSTEM ALLOWING FOR SIMULTANEOUS PLAY; VIDEO GAME BATTERY PACKS, AUTOMOBILE ELECTRICAL POWER ADAPTORS FOR VIDEO GAME SYSTEMS; HEAD CLEANING TAPES AND COMPACT

CLASS 9—(Continued).

DISCS FOR VIDEO GAMES; VIDEO GAME ADAPTER SWITCHES, NAMELY, A SYSTEM TO ALLOW SWITCHING BETWEEN GAME SYSTEMS, TELEVISION, DVDS AND VCERS WITHOUT HAVING TO DISCONNECT SUCH ITEMS; EXTENSION CABLES FOR EXTENDING VIDEO GAME SYSTEMS AND PERIPHERALS TO TELEVISIONS OVER LONG DISTANCES; COMPUTER AND VIDEO GAME MEMORY CARDS, PLASTIC, METAL AND RUBBER DECORATIVE PROTECTIVE COVERS FOR HAND HELD VIDEO GAME SYSTEMS; COMPUTER AND VIDEO GAME STANDS SPECIFICALLY DESIGNED FOR HOLDING A COMPUTER AND VIDEO GAME SYSTEMS; PLASTIC CARRYING CASES FOR VIDEO GAME SYSTEMS, ACCESSORIES AND GAMES; COMPUTER MOUSE, COMPUTER MOUSE PADS, AND WRIST PADS; HEADPHONES; EAR PHONES FOR VIDEO GAME SYSTEMS, TELEVISIONS, VCERS, DVD PLAYERS AND RADIOS; MICROPHONES, TELEPHONES, COMPUTER SOFTWARE FOR ACCESSING AND SEARCHING THE INTERNET; HIGH-SPEED MEMORY CARDS FOR USE WITH VIDEO GAME SYSTEMS; SHIELDED COMPUTER SPEAKERS; HEADSETS FOR VIDEO GAME SYSTEMS, TELEVISIONS, DVD PLAYERS, CD PLAYERS, MP3 PLAYERS AND RADIOS; PORTABLE STEREO, RADIOS, AUDIO SPEAKERS, WIRELESS SPEAKERS, WOOFERS; PORTABLE THEATER PRODUCTS, NAMELY, LCDS, NAMELY, LIQUID CRYSTAL DISPLAYS; AMPLIFIERS; BLANK COMPUTER DISKETTES; KEYBOARDS NOT SOLD AS AN INTEGRATED PART OF PERSONAL COMPUTERS, ADAPTERS TO CONNECT KEYBOARDS TO COMPUTER SYSTEMS, DESK DRAWERS SPECIFICALLY MADE TO HOLD COMPUTER KEYBOARDS; SPEAKER WIRE, SWITCHES USED TO CONTROL THE AUDIO LEVEL, COMPUTER CABLES, MONITOR CABLES, MODEM CABLES AND VIDEO GAME CABLES; VIDEO GAME CARTRIDGES FOR USE WITH TELEVISIONS, VIDEO UNITS, AUDIO UNITS AND VIDEO GAME SYSTEMS; COMPUTER CARTRIDGES, CASSETTES AND DISCS FEATURING GAMES, MOVIES AND MUSIC; VIDEO CASSETTES FEATURING GAMES, MOVIES AND MUSIC; PROTECTIVE CASES; AUDIO CABLES AND OPTICAL CABLES FOR VIDEO CAMERAS AND STEREO SYSTEMS; HOUSEHOLD AND PERSONAL CONSUMER ELECTRONIC PRODUCTS AND RELATED ACCESSORIES, NAMELY, COMPACT DISC PLAYERS, DVD PLAYERS, DVD RECORDERS, MP3 PLAYERS, RADIOS, TELEPHONES, SPEAKERPHONES, REMOTE CONTROLS, TELEVISION MONITORS, TELEVISION RECEIVERS, LCD PANELS, TUBE TELEVISIONS, CAMERAS, DIGITAL CAMERAS, FLASH PLAYERS, PERSONAL DIGITAL ASSISTANTS, MICROPHONES, CABLES, STEREO CABLES, ADAPTERS, CONVERTERS FOR ELECTRIC PLUGS, VIDEO TAPE RECORDERS, CASSETTE PLAYERS, HEADPHONES, EARPHONES, WALKIE-TALKIES, DEVICES FOR HANDS-FREE USE OF MOBILE PHONES, PORTABLE AUDIO PLAYERS, CALLER IDENTIFICATION, MAGNETIC HEAD CLEANERS; ANTENNAS FOR WIRELESS COMMUNICATION APPARATUS; BATTERIES; BATTERY CHARGERS; CARRYING CASES SPECIALLY ADAPTED FOR POCKET CALCULATORS AND CELL PHONES; HEADSETS FOR TELEPHONES, MICROPHONES; SPECIALTY HOLSTER FOR CARRYING CELLULAR PHONES, PAGERS AND PERSONAL DIGITAL ASSISTANTS (U.S. CLS. 21, 23, 26, 36 AND 38).

KEVON CHISOLM, EXAMINING ATTORNEY

CLASS 9—(Continued).

SN 78-939,338. VIDEOJET TECHNOLOGIES INC., WOOD DALE, IL. FILED 7-27-2006.

IMPRINTS

THE MARK CONSISTS OF STANDARD CHARACTERS WITHOUT CLAIM TO ANY PARTICULAR FONT, STYLE, SIZE, OR COLOR.

FOR COMPUTER SOFTWARE FOR GENERATING UNIQUE PRODUCT IDENTIFIERS THAT CAN BE EMBEDDED IN A RFID CHIP, BE SCANNED AS A LINEAR OR 2D BAR CODE, OR BE HUMAN READABLE IN ORDER TO TRACE ITEMS FROM THEIR SOURCE THROUGHOUT THE SUPPLY CHAIN (U.S. CLS. 21, 23, 26, 36 AND 38).

JASON LOTT, EXAMINING ATTORNEY

SN 78-941,697. CRANIUM, INC., SEATTLE, WA. FILED 7-31-2006.

CRANIUM

THE MARK CONSISTS OF STANDARD CHARACTERS WITHOUT CLAIM TO ANY PARTICULAR FONT, STYLE, SIZE, OR COLOR.

OWNER OF U.S. REG. NOS. 2,652,364, 2,856,670 AND OTHERS.

FOR INTERACTIVE DVD GAMES, NAMELY, GAMES PRIMARILY CONSISTING OF PRERECORDED DVD'S FEATURING GAMES THAT PARTICIPANTS PLAY ALONG WITH; (BASED ON INTENT TO USE) VIDEO GAMES, NAMELY, VIDEO GAME CARTRIDGES; COMPUTER GAMES, NAMELY, COMPUTER GAME PROGRAMS; COMPUTER GAME SOFTWARE (U.S. CLS. 21, 23, 26, 36 AND 38).

FIRST USE 12-7-2005; IN COMMERCE 12-7-2005.

MAUREEN DALL, EXAMINING ATTORNEY

CLASS 9—(Continued).

SN 78-945,572. INFOGIX, INC., NAPERVILLE, IL. FILED 8-4-2006.

CLASS 9—(Continued).

SN 78-946,844. MICROSOFT CORPORATION, REDMOND, WA. FILED 8-7-2006.

ACR/DETAIL

THE MARK CONSISTS OF STANDARD CHARACTERS WITHOUT CLAIM TO ANY PARTICULAR FONT, STYLE, SIZE, OR COLOR.

OWNER OF U.S. REG. NOS. 1,423,672, 1,884,679 AND OTHERS.

FOR COMPUTER ENTERPRISE SOFTWARE TO MONITOR INFORMATION PROCESSES AND DETECT INACCURATE, INCONSISTENT OR INCOMPLETE DATA IN ORDER TO ENSURE THE ACCURACY, CONSISTENCY AND RELIABILITY OF INFORMATION, AND MANUALS DISTRIBUTED THEREWITH AS A UNIT (U.S. CLS. 21, 23, 26, 36 AND 38).

FIRST USE 11-30-1991; IN COMMERCE 11-30-1991.
JORDAN BAKER, EXAMINING ATTORNEY



SN 78-946,234. INFOGIX, INC., NAPERVILLE, IL. FILED 8-7-2006.

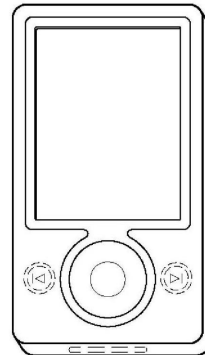

ACR/SUMMARY

THE MARK CONSISTS OF STANDARD CHARACTERS WITHOUT CLAIM TO ANY PARTICULAR FONT, STYLE, SIZE, OR COLOR.

OWNER OF U.S. REG. NOS. 1,423,672, 1,883,384 AND OTHERS.

FOR COMPUTER ENTERPRISE SOFTWARE TO MONITOR INFORMATION PROCESSES AND DETECT INACCURATE, INCONSISTENT OR INCOMPLETE DATA IN ORDER TO ENSURE THE ACCURACY, CONSISTENCY AND RELIABILITY OF INFORMATION, AND MANUALS DISTRIBUTED THEREWITH AS A UNIT (U.S. CLS. 21, 23, 26, 36 AND 38).

FIRST USE 11-30-1991; IN COMMERCE 11-30-1991.
JORDAN BAKER, EXAMINING ATTORNEY

THE MARK CONSISTS OF A CONFIGURATION FOR A MULTIMEDIA PLAYER, ENTERTAINMENT AND COMMUNICATION DEVICE. DOTTED LINES ARE NOT CLAIMED AS PART OF THE MARK.

FOR MULTIMEDIA PLAYER AND ENTERTAINMENT DEVICES, NAMELY, PORTABLE VIDEO AND MP3 PLAYERS (U.S. CLS. 21, 23, 26, 36 AND 38).

FIRST USE 11-14-2006; IN COMMERCE 11-14-2006.
CAROLYN CATALDO, EXAMINING ATTORNEY

CLASS 9—(Continued).

SN 78-952,569. VFS TECHNOLOGIES LIMITED, NASSAU, BAHAMAS, FILED 8-15-2006.

ADPRO

THE MARK CONSISTS OF STANDARD CHARACTERS WITHOUT CLAIM TO ANY PARTICULAR FONT, STYLE, SIZE, OR COLOR.

OWNER OF AUSTRALIA REG. NO. 403445, DATED 2-8-1984, EXPIRES 2-8-2015.

FOR ALARM INSTALLATIONS AND ALARMS, ANTI-INTRUSION ALARMS, APPARATUS FOR TRANSMITTING SOUND OR IMAGES FROM A REMOTE LOCATION TO A CENTRAL OFFICE; DIGITAL VIDEO AND AUDIO RECORDERS FOR SECURITY SYSTEMS; APPARATUS FOR TRANSMITTING AUDIO AND VIDEO DATA FROM A REMOTE LOCATION TO A CENTRAL OFFICE; SOFTWARE FOR VIDEO ALARM AND EVENT VERIFICATION OF REMOTE SITE ALARMS, BUILDING SECURITY SYSTEMS COMPRISING SOFTWARE AND HARDWARE FOR CONTROLLING APPARATUS AND PROVIDING PICTURE, VIDEO, AUDIO, ALARM STATUS, BUILDING PLANS, AND OTHER INFORMATION TO AND FROM A REMOTE STATION; COMPUTER HARDWARE AND SOFTWARE SYSTEM FOR REMOTELY MONITORING AND CONTROLLING DEVICES WITHIN A BUILDING, FACILITY, GROUNDS, OR DESIGNATED SPATIAL AREA; FACILITIES MANAGEMENT SOFTWARE, NAMELY, SOFTWARE TO CONTROL SECURITY SYSTEMS; SYSTEMS FOR INTELLIGENT PROCESSING OF VIDEO AND STILL IMAGES FOR SECURITY AND SURVEILLANCE, NAMELY, COMPUTER HARDWARE AND SOFTWARE ADAPTED FOR VIDEO PROCESSING, VIDEO MOTION DETECTION, ANALYZING IMAGES TO GENERATE AN ALARM AND SECURITY ZONE ISOLATION TECHNOLOGY; DETECTION DEVICES FOR SECURITY SYSTEMS, NAMELY, MOTION DETECTORS, PASSIVE INFRA-RED DETECTORS, VIDEO CAMERAS AND VIDEO MONITORS; PARTS AND FITTINGS FOR ALL THE AFORESAID GOODS (U.S. CLS. 21, 23, 26, 36 AND 38).

ROBERT C. CLARK JR., EXAMINING ATTORNEY

SN 78-959,191. BASF CORPORATION, FLORHAM PARK, NJ. FILED 8-24-2006.

SMARTSCAN

THE MARK CONSISTS OF STANDARD CHARACTERS WITHOUT CLAIM TO ANY PARTICULAR FONT, STYLE, SIZE, OR COLOR.

SEC. 2(F).
FOR SPECTROPHOTOMETER FOR USE WITH AUTOMOTIVE REFINISH COLORS (U.S. CLS. 21, 23, 26, 36 AND 38).

FIRST USE 8-1-1996; IN COMMERCE 8-1-1996.
DOMINIC FATHY, EXAMINING ATTORNEY

CLASS 9—(Continued).

SN 78-961,029. SCOSCHE INDUSTRIES, INC., OXNARD, CA. FILED 8-25-2006.

ICE'D

THE MARK CONSISTS OF STANDARD CHARACTERS WITHOUT CLAIM TO ANY PARTICULAR FONT, STYLE, SIZE, OR COLOR.

FOR AUDIO EQUIPMENT FOR VEHICLES, NAMELY, STEREOS, AMPLIFIERS, TUNERS, SPEAKERS, WIRING KITS CONSISTING ESSENTIALLY OF WIRES AND CONNECTORS FOR INSTALLING AUDIO EQUIPMENT IN AUTOMOBILES (U.S. CLS. 21, 23, 26, 36 AND 38).

JOHN E. MICHOS, EXAMINING ATTORNEY

SN 78-961,033. SCOSCHE INDUSTRIES, INC., OXNARD, CA. FILED 8-25-2006.

ICE'D AUDIO

THE MARK CONSISTS OF STANDARD CHARACTERS WITHOUT CLAIM TO ANY PARTICULAR FONT, STYLE, SIZE, OR COLOR.

NO CLAIM IS MADE TO THE EXCLUSIVE RIGHT TO USE "AUDIO", APART FROM THE MARK AS SHOWN.

FOR AUDIO EQUIPMENT FOR VEHICLES, NAMELY, STEREOS, AMPLIFIERS, TUNERS, SPEAKERS, WIRING KITS CONSISTING ESSENTIALLY OF WIRES AND CONNECTORS FOR INSTALLING AUDIO EQUIPMENT IN AUTOMOBILES (U.S. CLS. 21, 23, 26, 36 AND 38).

JOHN E. MICHOS, EXAMINING ATTORNEY

SN 78-962,198. SHAMIE, RITA, BEVERLY HILLS, CA. FILED 8-28-2006.

FEEL THE LOVE

THE MARK CONSISTS OF STANDARD CHARACTERS WITHOUT CLAIM TO ANY PARTICULAR FONT, STYLE, SIZE, OR COLOR.

FOR SOUND RECORDINGS FEATURING MUSICAL PERFORMANCE (U.S. CLS. 21, 23, 26, 36 AND 38).

FIRST USE 3-1-2004; IN COMMERCE 3-1-2004.
ELLEN PERKINS, EXAMINING ATTORNEY

CLASS 9—(Continued).

SN 78-965,383. INTEC INC., MIAMI, FL. FILED 8-31-2006.

CLASS 9—(Continued).

SN 78-965,386. INTEC INC., MIAMI, FL. FILED 8-31-2006.

Hey mommy love. This is
the one!

Welcome. This is Maximum
Gaming.

THE MARK CONSISTS OF STANDARD CHARACTERS WITHOUT CLAIM TO ANY PARTICULAR FONT, STYLE, SIZE, OR COLOR.

FOR ELECTRONIC VIDEO GAMES ACCESSORIES, NAMELY, VIDEO GAME CONTROLLERS, HAND HELD CONTROLLERS, DANCE MAT VIDEO GAME CONTROLLERS, VIDEO GAME INTERACTIVE REMOTE CONTROL UNITS, AUDIO AND VIDEO CABLES, AUDIO AND VIDEO CONNECTORS, DIGITAL VIDEO DEVICE PROTECTORS, NAMELY, DVD CASES, CARRYING CASES FOR VIDEO DISC PLAYERS, CARRYING CASES FOR PORTABLE VIDEO GAME PLAYERS, ELECTRICAL CABLES, MULTIPLAYER LINK CABLES FOR VIDEO GAME UNITS, STANDS FOR SUPPORTING VIDEO GAME CONSOLES AND STANDS FOR SUPPORTING VIDEO GAMES, PROTECTIVE CASES FOR VIDEO GAME UNITS, PROTECTIVE CASES FOR VIDEO GAMING COMPACT DISCS AND DIGITAL VIDEO DEVICES, AUDIO VIDEO SWITCH SELECTORS, SOUND SYSTEMS COMPRISED OF AUDIO AMPLIFIERS, AUDIO TUNERS AND AUDIO SPEAKERS, AUDIO SPEAKERS AND AUDIO SPEAKER ENCLOSURES, AMPLIFIERS, EARPHONES, EAR BUDS, PERSONAL HEADPHONES, HEADSETS FOR VIDEO GAME PLAYER, AUDIO VIDEO SCREEN EQUIPMENT FOR VIDEO GAMES, NAMELY, FLAT PANEL DISPLAY SCREENS AND LIQUID CRYSTAL DISPLAYS FOR VIDEO GAMES, ELECTRONIC VIDEO GAME SCREEN DISPLAYS COMPRISED OF LIQUID CRYSTAL DISPLAYS FOR USE WITH VIDEO GAME UNITS, MEMORY CARDS FOR VIDEO GAME UNITS, AUDIO AND VIDEO SPLITTERS, VIDEO ADAPTERS, AUDIO VIDEO EXTENSION CABLES, LIGHTS, NAMELY, LIGHT-EMITTING DIODES (LEDS) FOR ILLUMINATING VIDEO GAME DISPLAYS, MAGNIFIER FOR MAGNIFYING VIDEO GAME DISPLAY, PROTECTIVE SHIELDS FOR PROTECTING VIDEO GAME DISPLAYS, POWER SUPPLIES FOR VIDEO GAME DEVICES NAMELY AC/DC ADAPTERS, AUTOMOBILE ADAPTERS, BATTERIES, RECHARGEABLE BATTERIES, CHARGING UNITS FOR RECHARGING BATTERIES, AC/DC CONVERTERS, CLEANING KITS COMPRISED OF CD/DVD ROTATING MECHANICAL CLEANERS, CD/DVD LENS CLEANING DISCS, AND CD/DVD CLEANING FLUID FOR CLEANING COMPACT DISCS AND VIDEO GAME UNITS (U.S. CLS. 21, 23, 26, 36 AND 38).

KATHY DE JONGE, EXAMINING ATTORNEY

THE MARK CONSISTS OF STANDARD CHARACTERS WITHOUT CLAIM TO ANY PARTICULAR FONT, STYLE, SIZE, OR COLOR.

FOR ELECTRONIC VIDEO GAMES ACCESSORIES, NAMELY, VIDEO GAME CONTROLLERS, HAND HELD CONTROLLERS, DANCE MAT VIDEO GAME CONTROLLERS, VIDEO GAME INTERACTIVE REMOTE CONTROL UNITS, AUDIO AND VIDEO CABLES, AUDIO AND VIDEO CONNECTORS, DIGITAL VIDEO DEVICE PROTECTORS, NAMELY, DVD CASES, CARRYING CASES FOR VIDEO DISC PLAYERS, CARRYING CASES FOR PORTABLE VIDEO GAME PLAYERS, ELECTRICAL CABLES, MULTIPLAYER LINK CABLES FOR VIDEO GAME UNITS, STANDS FOR SUPPORTING VIDEO GAME CONSOLES AND STANDS FOR SUPPORTING VIDEO GAMES, PROTECTIVE CASES FOR VIDEO GAME UNITS, PROTECTIVE CASES FOR VIDEO GAMING COMPACT DISCS AND DIGITAL VIDEO DEVICES, AUDIO VIDEO SWITCH SELECTORS, SOUND SYSTEMS COMPRISED OF AUDIO AMPLIFIERS, AUDIO TUNERS AND AUDIO SPEAKERS, AUDIO SPEAKERS AND AUDIO SPEAKER ENCLOSURES, AMPLIFIERS, EARPHONES, EAR BUDS, PERSONAL HEADPHONES, HEADSETS FOR VIDEO GAME PLAYER, AUDIO VIDEO SCREEN EQUIPMENT FOR VIDEO GAMES, NAMELY, FLAT PANEL DISPLAY SCREENS AND LIQUID CRYSTAL DISPLAYS FOR VIDEO GAMES, ELECTRONIC VIDEO GAME SCREEN DISPLAYS COMPRISED OF LIQUID CRYSTAL DISPLAYS FOR USE WITH VIDEO GAME UNITS, MEMORY CARDS FOR VIDEO GAME UNITS, AUDIO AND VIDEO SPLITTERS, VIDEO ADAPTERS, AUDIO VIDEO EXTENSION CABLES, LIGHTS, NAMELY, LIGHT-EMITTING DIODES (LEDS) FOR ILLUMINATING VIDEO GAME DISPLAYS, MAGNIFIER FOR MAGNIFYING VIDEO GAME DISPLAY, PROTECTIVE SHIELDS FOR PROTECTING VIDEO GAME DISPLAYS, POWER SUPPLIES FOR VIDEO GAME DEVICES, NAMELY, AC/DC ADAPTERS, AUTOMOBILE ADAPTERS, BATTERIES, RECHARGEABLE BATTERIES, CHARGING UNITS FOR RECHARGING BATTERIES, AC/DC CONVERTERS, CLEANING KITS COMPRISED OF CD/DVD ROTATING MECHANICAL CLEANERS, CD/DVD LENS CLEANING DISCS, AND CD/DVD CLEANING FLUID FOR CLEANING COMPACT DISCS AND VIDEO GAME UNITS (U.S. CLS. 21, 23, 26, 36 AND 38).

KATHY DE JONGE, EXAMINING ATTORNEY

CLASS 9—(Continued).

SN 78-978,834. GOLDSTEIN, ROBERT N, DALLAS, TX. FILED 7-7-2006.

CHEATERS DETECTIVE AGENCY

THE MARK CONSISTS OF STANDARD CHARACTERS WITHOUT CLAIM TO ANY PARTICULAR FONT, STYLE, SIZE, OR COLOR.

OWNER OF U.S. REG. NOS. 2,640,153, 2,716,167 AND 2,885,756.

NO CLAIM IS MADE TO THE EXCLUSIVE RIGHT TO USE "DETECTIVE AGENCY", APART FROM THE MARK AS SHOWN.

FOR INVESTIGATIVE SUPPLIES AND EQUIPMENT FOR DETECTIVE AGENCY, NAMELY, SURVEILLANCE CAMERAS, ELECTRONIC BUG DETECTION DEVICES, AND AUDIO AND VIDEO RECORDERS (U.S. CLS. 21, 23, 26, 36 AND 38).

JENNIFER VASQUEZ, EXAMINING ATTORNEY

SN 79-028,939. DURAN GROUP GMBH, FED REP GERMANY, FILED 7-14-2006.

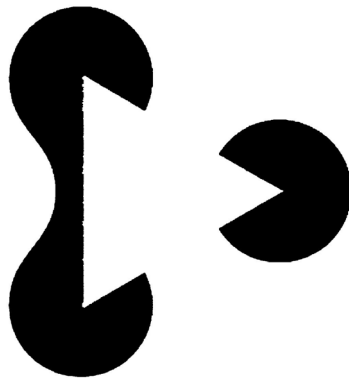

PRIORITY DATE OF 1-25-2006 IS CLAIMED. OWNER OF INTERNATIONAL REGISTRATION 0898617 DATED 7-14-2006, EXPIRES 7-14-2016.

FOR LABORATORY APPARATUS AND INSTRUMENTS, NAMELY, VOLUMETRIC APPARATUS, NAMELY, BEAKERS, FLASKS, LABORATORY GLASSWARE; LABORATORY APPARATUS AND INSTRUMENTS, NAMELY, FILTRATION APPARATUS, NAMELY, LABORATORY FILTERS, AND FILTRATION SYSTEMS COMPRISING VACUUM FILTER FLASKS AND SILICONE BOTTLE STOPPERS (U.S. CLS. 21, 23, 26, 36 AND 38).

ADA HAN, EXAMINING ATTORNEY

CLASS 9—(Continued).

SN 79-032,633. NAIM AUDIO LIMITED, UNITED KINGDOM, FILED 2-23-2006.

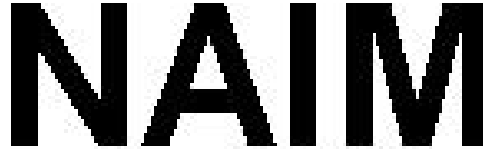

PRIORITY DATE OF 9-13-2005 IS CLAIMED. OWNER OF INTERNATIONAL REGISTRATION 0907868 DATED 2-23-2006, EXPIRES 2-23-2016.

OWNER OF U.S. REG. NOS. 1,625,792 AND 1,715,208.

FOR ELECTRICAL AND ELECTRONIC AUDIO APPARATUS AND INSTRUMENTS, NAMELY, HOME CINEMA PROCESSORS, AMPLIFIERS, LOUDSPEAKERS, DVD PLAYERS, COMBINATION DVD AND CD PLAYERS, COMPACT DISC PLAYERS, HIFI SYSTEMS COMPRISED OF EQUALIZERS AND AMPLIFIERS, PRE-AMPLIFIERS, POWER AMPLIFIERS, POWER SUPPLIES FOR HIFI SYSTEMS, POWER SUPPLIES FOR HOME CINEMA SYSTEMS, CROSSOVER SYSTEMS COMPRISED OF MODULES FOR STEREO LOUDSPEAKERS, STEREO TUNERS, COMPUTER HARDWARE AND SOFTWARE FOR NETWORKING THE AFOREMENTIONED; TAPE RECORDERS AND PLAYBACK MACHINES, OPTICAL DISC RECORDERS AND PLAYBACK MACHINES, PHONOGRAPHIC AND RECORD PLAYING MACHINES; RECORD PLAYERS, TONE ARMS IN THE NATURE OF ANALOGUE UNIPIVOT TONE ARMS; STYLI, NAMELY, THE NEEDLE ON A TONE ARM FOR USE ON A VINYL RECORD PLAYER, RADIO SIGNAL TUNERS, RECEIVERS AND TRANSMITTERS; REMOTE CONTROL APPARATUS AND INSTRUMENTS FOR USE WITH HOME CINEMA SYSTEMS, HIFI SYSTEMS, DVD PLAYERS; CD PLAYERS; PRE-RECORDED CDS FEATURING MUSIC; RE-RECORDED VINYL RECORDS FEATURING MUSIC; PRE-RECORDED DVDS FEATURING MUSICAL PERFORMANCES (U.S. CLS. 21, 23, 26, 36 AND 38).

DEBRA LEE, EXAMINING ATTORNEY

SN 79-037,364. IPEK SPEZIAL-TV GESMBH & CO. KG, AUSTRIA, FILED 3-26-2007.



OWNER OF INTERNATIONAL REGISTRATION 0921136 DATED 3-26-2007, EXPIRES 3-26-2017.

NO CLAIM IS MADE TO THE EXCLUSIVE RIGHT TO USE "SPEZIAL-TV", APART FROM THE MARK AS SHOWN.

THE COLOR(S) RED, DARK GREY, LIGHT GREY IS/ARE CLAIMED AS A FEATURE OF THE MARK.

THE MARK CONSISTS OF A THICK RED SOLID-LINE OVAL CONTAINING TWO GRAY BANDS WHICH EXTEND THROUGH THE CIRCLE TO FORM THE DOT OVER THE LETTER "I" IN THE WORD "IPEK" ALL IN GRAY. THE WORDING "SPEZIAL-TV" APPEARS IN A LIGHTER SHADE OF GRAY UNDERNEATH THE WORD "IPEK".

THE FOREIGN WORDING IN THE MARK TRANSLATES INTO ENGLISH AS SPECIAL-TV.

FOR CAMERAS FOR THE INSPECTION OF TUBE SYSTEMS AND CONTROLLING DEVICES THEREFORE (U.S. CLS. 21, 23, 26, 36 AND 38).

ELLEN BURNS, EXAMINING ATTORNEY

CLASS 9—(Continued).

SN 79-038,008. LAP GMBH LASER APPLIKATIONEN, FED REP GERMANY, FILED 2-1-2007.

Calix

THE MARK CONSISTS OF STANDARD CHARACTERS WITHOUT CLAIM TO ANY PARTICULAR FONT, STYLE, SIZE, OR COLOR.

PRIORITY DATE OF 8-10-2006 IS CLAIMED. OWNER OF INTERNATIONAL REGISTRATION 0922813 DATED 2-1-2007, EXPIRES 2-1-2017.

THE WORDING "CALIX" HAS NO MEANING IN A FOREIGN LANGUAGE.

FOR LASER, NOT FOR MEDIAL PURPOSES, FOR ALIGNING, POSITIONING AND FOR MEASURING, LASER MEASURING DEVICES NOT FOR MEDICAL PURPOSES, NAMELY TRIANGULATION MEASURING DEVICES, LINE-LASER FOR ALIGNMENT AND POSITIONING OF ITEMS, PERSONS OR MACHINES, LASER PROJECTORS FOR DISPLAYING OUTLINES, TEMPLATES, PATTERNS OR OTHER SHAPES OF ALL KINDS OF SURFACES, LASER DOPPLER, LASER SCANNER FOR MEASURING DIMENSIONS, SCANNING OBJECTS, PROFILES AND SURFACES OF OBJECTS (U.S. CLS. 21, 23, 26, 36 AND 38).

CHRISTOPHER BUONGIORNO, EXAMINING ATTORNEY

CLASS 9—(Continued).

SN 79-038,028. OPTO ENGINEERING S.R.L., ITALY, FILED 2-23-2007.



PRIORITY DATE OF 11-22-2006 IS CLAIMED. OWNER OF INTERNATIONAL REGISTRATION 0922857 DATED 2-23-2007, EXPIRES 2-23-2017.

NO CLAIM IS MADE TO THE EXCLUSIVE RIGHT TO USE "ENGINEERING" AND "COMPANY", APART FROM THE MARK AS SHOWN.

THE MARK CONSISTS OF THE WORDING "OPTO ENGINEERING THE TELECENTRIC COMPANY" ON THE BOTTOM PORTION OF THE MARK AND MULTIPLE TRIANGLES ALL CONNECTED TO A SINGLE POINT IN THE UPPER LEFT HAND CORNER OF THE MARK, TWO CIRCLE QUARTER WEDGE DESIGN BEHIND THE STYLIZED LETTERS "OE" IN THE UPPER CENTER PORTION OF THE MARK, AND THREE DIFFERENT SIZED BANDS AND BARS IN THE UPPER RIGHT HAND CORNER OF THE MARK.

FOR OPTICAL LENSES; OPTICAL LENSES AND OBJECTIVES FOR INDUSTRIAL PURPOSES; OPTICAL LENSES FOR DETECTORS, OPTICAL LENSES FOR CAMERAS, OPTICAL LENSES FOR INDUSTRIAL CAMERAS, OPTICAL LENSES FOR MICROSCOPES, OPTICAL LENSES FOR LASERS, OPTICAL LENSES FOR TELECAMERAS, OPTICAL LENSES FOR SPECTROSCOPES; OBJECTIVE CAMERA LENSES; OBJECTIVE CAMERA LENSES FOR INDUSTRIAL USE; OBJECTIVE CAMERA LENSES FOR TELECAMERAS, CAMERAS, LASERS; OPTICAL LENSES FOR DIMENSIONAL MEASUREMENTS, OPTICAL LENSES FOR ELECTRONIC COMPONENTS, OPTICAL LENSES FOR WEB AND TISSUE INSPECTION, OPTICAL LENSES FOR THE PRINTING INDUSTRY, OPTICAL LENSES FOR PHOTOGRAPHY; PROJECTION APPARATUS; LENSES AND OPTICAL APPARATUS FOR INFRARED VIEW, LENSES AND OPTICAL APPARATUS FOR ZOOMING (U.S. CLS. 21, 23, 26, 36 AND 38).

WARREN L. OLANDRIA, EXAMINING ATTORNEY

SN 79-038,058. MUGEN HADOU GIJUTSU; KABUSHIKI KAISYA, JAPAN, FILED 3-2-2007.

Q — W a v e

THE MARK CONSISTS OF STANDARD CHARACTERS WITHOUT CLAIM TO ANY PARTICULAR FONT, STYLE, SIZE, OR COLOR.

PRIORITY DATE OF 11-7-2006 IS CLAIMED. OWNER OF INTERNATIONAL REGISTRATION 0922919 DATED 3-2-2007, EXPIRES 3-2-2017.

FOR RECORDED VIDEO DISCS FEATURING HEALING ENERGY (U.S. CLS. 21, 23, 26, 36 AND 38).

MARLENE BELL, EXAMINING ATTORNEY

CLASS 9—(Continued).

SN 79-038,181. GEBRÜDER FREI GMBH & CO, FED REP GERMANY, FILED 4-11-2007.

Tomo

THE MARK CONSISTS OF STANDARD CHARACTERS WITHOUT CLAIM TO ANY PARTICULAR FONT, STYLE, SIZE, OR COLOR.

PRIORITY DATE OF 11-9-2006 IS CLAIMED.

OWNER OF INTERNATIONAL REGISTRATION 0923259 DATED 4-11-2007, EXPIRES 4-11-2017.

THE ENGLISH TRANSLATION OF "TOMO" IS FRIENDLY OR INTELLIGENT.

FOR APPARATUS FOR RECORDING, TRANSMISSION AND REPRODUCTION OF SOUND AND IMAGES, NAMELY PROFESSIONAL AUDIO APPARATUS FOR RECORDING STUDIOS AND PRIVATE USE (U.S. CLS. 21, 23, 26, 36 AND 38).

BERNICE MIDDLETON, EXAMINING ATTORNEY

CLASS 9—(Continued).

SN 79-039,768. DIGISLIDE HOLDINGS PTY LTD, NORTH ADELAIDE SA 5006, AUSTRALIA, FILED 5-25-2007.

Manta Ray

THE MARK CONSISTS OF STANDARD CHARACTERS WITHOUT CLAIM TO ANY PARTICULAR FONT, STYLE, SIZE, OR COLOR.

OWNER OF INTERNATIONAL REGISTRATION 0927401 DATED 5-25-2007, EXPIRES 5-25-2017.

FOR APPARATUS FOR RECORDING, TRANSMISSION AND REPRODUCTION OF IMAGES, AND RECORDING AND REPRODUCTION OF SOUND; VIDEO PROJECTORS; AND VIDEO PROJECTORS HAVING TELEVISION RECEPTION EQUIPMENT (U.S. CLS. 21, 23, 26, 36 AND 38).

WARREN L. OLANDRIA, EXAMINING ATTORNEY

SN 79-038,835. PLAXIS B.V., NL-2628 XJ DELFT, NETHERLANDS, FILED 3-14-2007.

PLAXIS

THE MARK CONSISTS OF STANDARD CHARACTERS WITHOUT CLAIM TO ANY PARTICULAR FONT, STYLE, SIZE, OR COLOR.

PRIORITY DATE OF 11-3-2006 IS CLAIMED.

OWNER OF INTERNATIONAL REGISTRATION 0925082 DATED 3-14-2007, EXPIRES 3-14-2017.

THE WORDING "PLAXIS" HAS NO MEANING IN A FOREIGN LANGUAGE.

FOR COMPUTER SOFTWARE FOR GEOTECHNICAL APPLICATIONS, NAMELY, ENGINEERING ANALYSIS OF SOIL AND ROCK; DOWNLOADABLE ELECTRONIC PUBLICATIONS, NAMELY, MANUALS IN THE FIELD OF GEOTECHNICAL ENGINEERING; AND SCIENTIFIC, SURVEYING AND GEOTECHNICAL APPARATUS AND INSTRUMENTS, NAMELY, SURVEYING MACHINES AND INSTRUMENTS (U.S. CLS. 21, 23, 26, 36 AND 38).

PATRICIA EVANKO, EXAMINING ATTORNEY

SN 79-041,255. DALIC, SOCIÉTÉ ANONYME, FRANCE, FILED 2-28-2007.

DALISTICK

OWNER OF INTERNATIONAL REGISTRATION 0622868 DATED 7-12-1994, EXPIRES 7-12-2014.

OWNER OF U.S. REG. NO. 2,058,556.

FOR TOOLS AND APPARATUS FOR ELECTROLYTIC METALLIZATION AND ELECTROPLATING, NAMELY, ELECTROPLATING MACHINES AND ELECTROLYSERS (U.S. CLS. 21, 23, 26, 36 AND 38).

DAVID HOFFMAN, EXAMINING ATTORNEY

SN 79-038,837. MATSUSHITA ELECTRIC; INDUSTRIAL CO., LTD., JAPAN, FILED 2-27-2007.

GLOBALRANGE

OWNER OF INTERNATIONAL REGISTRATION 0925085 DATED 2-27-2007, EXPIRES 2-27-2017.

FOR TELEPHONES; IP (INTERNET PROTOCOL) PHONES; VOIP (VOICE-OVER INTERNET PROTOCOL) PHONES; VOIP (VOICE-OVER INTERNET PROTOCOL) VIDEO PHONES; MOBILE PHONES; ELECTRONIC MACHINES, APPARATUS AND THEIR PARTS, NAMELY TERMINAL ADAPTORS, GATEWAY SERVERS, PERSONAL COMPUTERS, ROUTERS, RECORDING MEDIA STORING COMPUTER OPERATING PROGRAMS IN THE NATURE OF OPTICAL DISCS AND MEMORY CARDS, AND COMPUTER MONITORS (U.S. CLS. 21, 23, 26, 36 AND 38).

DARRYL SPRUILL, EXAMINING ATTORNEY

SN 79-042,956. KOSTAL INDUSTRIE ELEKTRIK GMBH, FED REP GERMANY, FILED 6-14-2007.

PIKO

THE MARK CONSISTS OF STANDARD CHARACTERS WITHOUT CLAIM TO ANY PARTICULAR FONT, STYLE, SIZE, OR COLOR.

PRIORITY DATE OF 1-20-2007 IS CLAIMED.

OWNER OF INTERNATIONAL REGISTRATION 0935330 DATED 6-14-2007, EXPIRES 6-14-2017.

THE WORDING "PIKO" HAS NO MEANING IN A FOREIGN LANGUAGE.

FOR INVERTERS FOR SOLAR MODULES (U.S. CLS. 21, 23, 26, 36 AND 38).

ROSELLE HERRERA, EXAMINING ATTORNEY

CLASS 9—(Continued).

SN 79-043,200. HARTING ELECTRO-OPTICS; GMBH & CO. KG, 32339 ESPELKAMP, FED REP GERMANY, FILED 7-27-2007.

Micromid

THE MARK CONSISTS OF STANDARD CHARACTERS WITHOUT CLAIM TO ANY PARTICULAR FONT, STYLE, SIZE, OR COLOR.

OWNER OF INTERNATIONAL REGISTRATION 0935999 DATED 7-27-2007, EXPIRES 7-27-2017.

FOR ELECTRICAL, ELECTRONIC, OPTICAL AND ELECTRO-OPTICAL COMPONENTS, NAMELY, BASE PLATES PROVIDED WITH ELECTRONIC CONDUCTOR TRACKS AND COMPONENTS IN THE NATURE OF OPTICAL WAVE GUIDES, OPTICAL TRANSMITTERS, OPTICAL TRANSCEIVERS, AND ELECTRIC, ELECTRONIC AND ELECTRO-OPTICAL PLUGS AND CONNECTORS; CIRCUIT BOARDS PROVIDED WITH ELECTRICAL, ELECTRONIC, OPTICAL OR ELECTRO-OPTICAL COMPONENT PARTS IN THE NATURE OF OPTICAL WAVE GUIDES, OPTICAL TRANSMITTERS, OPTICAL TRANSCEIVERS, AND ELECTRIC, ELECTRONIC AND ELECTRO-OPTICAL PLUGS AND CONNECTORS; ELECTRICAL PLUGS, OPTICAL PLUGS AND ELECTRO-OPTICAL PLUGS (U.S. CLS. 21, 23, 26, 36 AND 38).

WILLIAM ROSSMAN, EXAMINING ATTORNEY

CLASS 9—(Continued).

SN 79-043,748. LAVISION GMBH, FED REP GERMANY, FILED 7-30-2007.

TOMO PIV

THE MARK CONSISTS OF STANDARD CHARACTERS WITHOUT CLAIM TO ANY PARTICULAR FONT, STYLE, SIZE, OR COLOR.

PRIORITY DATE OF 3-7-2007 IS CLAIMED.

OWNER OF INTERNATIONAL REGISTRATION 0937241 DATED 7-30-2007, EXPIRES 7-30-2017.

NO CLAIM IS MADE TO THE EXCLUSIVE RIGHT TO USE "PIV", APART FROM THE MARK AS SHOWN.

FOR LIGHT SENSORS, PHOTOMULTIPLIER, PHOTO-DIODES, CAMERAS, OPTICAL LENSES, MICROSCOPES, LASER NOT FOR MEDICAL USE, COMBINATIONS OF THE FOREMENTIONED GOODS FOR THE PRODUCTION OF OPTICAL MEASURING SYSTEMS (U.S. CLS. 21, 23, 26, 36 AND 38).

JULIE WATSON, EXAMINING ATTORNEY

SN 79-043,639. PROSTAGE GMBH, SWITZERLAND, FILED 7-31-2007.

StageWire

THE MARK CONSISTS OF STANDARD CHARACTERS WITHOUT CLAIM TO ANY PARTICULAR FONT, STYLE, SIZE, OR COLOR.

PRIORITY DATE OF 3-5-2007 IS CLAIMED.

OWNER OF INTERNATIONAL REGISTRATION 0936938 DATED 7-31-2007, EXPIRES 7-31-2017.

FOR HARDWARE, SOFTWARE, COMPUTER PERIPHERAL DEVICES AND AUDIO PERIPHERAL DEVICES FOR A TECHNOLOGY TO PROVIDE COMMUNICATION BETWEEN MULTIPLE UNITS, NAMELY, COMPUTER PERIPHERAL DEVICES, AUDIO PERIPHERAL DEVICES, ADAPTERS, COMPUTER CARD ADAPTERS AND PARTS THEREFOR; NETWORK INTERCONNECTING INTERFACES, NAMELY, MIDI INTERFACES AND MIDI ADAPTERS; REMOTE CONTROLLERS AND CONTROLLER SYSTEMS COMPRISED OF HARDWARE AND SOFTWARE TO SWITCH, ROUTE AND CONTROL AUDIO AND VIDEO SIGNALS, AUDIO MIXING DESKS, AUDIO EFFECT UNITS, MUSICAL INSTRUMENT AMPLIFIERS AND PROFESSIONAL AND CONSUMER AUDIO EQUIPMENT (U.S. CLS. 21, 23, 26, 36 AND 38).

KELLY MCCOY, EXAMINING ATTORNEY

SN 79-043,750. CODIXX AG, FED REP GERMANY, FILED 7-25-2007.

colorPol

THE MARK CONSISTS OF STANDARD CHARACTERS WITHOUT CLAIM TO ANY PARTICULAR FONT, STYLE, SIZE, OR COLOR.

OWNER OF INTERNATIONAL REGISTRATION 0937250 DATED 7-25-2007, EXPIRES 7-25-2017.

FOR POLARIZING FILTERS AND COMPONENTS CONTAINING POLARIZING FILTERS, NAMELY, LIQUID CRYSTAL DISPLAYS; POLARIZING FOILS; MICROSCOPES; PROJECTORS; CAMERAS AND OPTICAL FILTERS; LIQUID CRYSTAL SHUTTERS; VIDEO AND IMAGE PROJECTORS; POLARIZING OPTIC LASERS; ELECTRO-OPTICAL DEVICES, NAMELY KERR CELLS, FARADAY ISOLATORS AND FARADAY ROTATORS; OPTICAL ATTENUATORS; POLARIMETERS; ELLIPSO-METERS; POLARIZING GLASSES; POLARIZING SENSITIVE SENSORS AND POLARIZING WINDOWS (U.S. CLS. 21, 23, 26, 36 AND 38).

JOHN HWANG, EXAMINING ATTORNEY

CLASS 10—MEDICAL APPARATUS

SN 76-423,402. UNIVERSITY OF ROCHESTER, OFFICE OF TECHNOLOGY TRANSFER, ROCHESTER, NY. FILED 6-20-2002.

SMRT BANDAGE

NO CLAIM IS MADE TO THE EXCLUSIVE RIGHT TO USE "BANDAGE", APART FROM THE MARK AS SHOWN.

FOR TRANSDERMAL BIOSENSOR DEVICE FOR THE DIAGNOSIS AND IDENTIFICATION OF INFECTIOUS DISEASES; TRANSDERMAL BIOSENSOR DEVICE WHICH IDENTIFIES THE PRESENCE OF A DISEASE OR INFECTION AND ADMINISTERS A THERAPEUTIC MEDICINE, SOLD WITHOUT MEDICATION (U.S. CLS. 26, 39 AND 44).

AISHA CLARKE, EXAMINING ATTORNEY

SN 76-430,837. UNIVERSITY OF ROCHESTER, OFFICE OF TECHNOLOGY TRANSFER, ROCHESTER, NY. FILED 7-15-2002.

SMARTBANDAGE

FOR TRANSDERMAL BIOSENSOR DEVICE FOR THE DIAGNOSIS AND IDENTIFICATION OF INFECTIOUS DISEASES, TRANSDERMAL BIOSENSOR DEVICE WHICH IDENTIFIES THE PRESENCE OF A DISEASE OR INFECTION AND ADMINISTERS A THERAPEUTIC MEDICINE, SOLD WITHOUT MEDICATION (U.S. CLS. 26, 39 AND 44).

AISHA CLARKE, EXAMINING ATTORNEY

SN 76-676,420. GENERAL HOME PHARMACY INC, WESTLAKE VILLAGE, CA. FILED 5-4-2007.



NO CLAIM IS MADE TO THE EXCLUSIVE RIGHT TO USE "SINUS", APART FROM THE MARK AS SHOWN.

THE COLOR(S) GREEN, BLUE AND YELLOW IS/ARE CLAIMED AS A FEATURE OF THE MARK.

THE COLOR GREEN APPEARS THROUGHOUT THE LETTERING OF THE LITERAL TERMS "SINUS AERO". THE COLOR BLUE APPEARS IN THE CIRCLE DESIGN TO THE LEFT OF THE LITERAL ELEMENTS IN THE MARK, AND IN THE WAVY OR CURVED LINES REPRESENTING VAPORS RISING FROM THE CIRCLE DESIGN. THE COLOR YELLOW APPEARS IN THE CENTER OF THE CIRCLE DESIGN.

FOR MEDICAL EQUIPMENT, NAMELY, NEBULIZERS, SOLD EMPTY, FOR USE IN THE AEROSOL DELIVERY OF PHARMACEUTICAL PREPARATIONS FOR TREATING SINUSITIS (U.S. CLS. 26, 39 AND 44).

HEATHER BIDDULPH, EXAMINING ATTORNEY

CLASS 10—(Continued).

SN 77-080,051. MAQUET CARDIOPULMONARY AG, HIRRLINGEN, FED REP GERMANY, FILED 1-10-2007.

QUADROX i

PRIORITY CLAIMED UNDER SEC. 44(D) ON ERPN CMNTY TM OFC APPLICATION NO. 005545561, FILED 12-1-2006, REG. NO. 005545561, DATED 10-26-2007, EXPIRES 12-1-2016.

OWNER OF U.S. REG. NOS. 2,471,761 AND 2,705,943. THE MARK CONSISTS OF THE WORD "QUADROX I." FOR OXYGENATORS FOR MEDICAL USE (U.S. CLS. 26, 39 AND 44).

GEORGE LORENZO, EXAMINING ATTORNEY

SN 77-087,684. PETERS SURGICAL, BOBIGNY, FRANCE, FILED 1-22-2007.

UNIRING

THE MARK CONSISTS OF STANDARD CHARACTERS WITHOUT CLAIM TO ANY PARTICULAR FONT, STYLE, SIZE, OR COLOR.

OWNER OF ERPN CMNTY TM OFC REG. NO. 005591301, DATED 10-30-2007, EXPIRES 12-29-2016.

FOR CARDIAC RINGS FOR VALVULAR ANNULOPLASTY (U.S. CLS. 26, 39 AND 44).

DANIEL CAPSHAW, EXAMINING ATTORNEY

SN 77-105,805. A.R. MEDICOM INC., LACHINE, CANADA, FILED 2-13-2007.

DISTECH

THE MARK CONSISTS OF STANDARD CHARACTERS WITHOUT CLAIM TO ANY PARTICULAR FONT, STYLE, SIZE, OR COLOR.

OWNER OF U.S. REG. NO. 2,905,273.

THE WORDING "DISTECH" HAS NO MEANING IN A FOREIGN LANGUAGE.

FOR DISPOSABLE MEDICAL AND DENTAL STERILIZATION POUCHES; DISPOSABLE HEADREST COVERS FOR MEDICAL AND DENTAL EXAMINATION CHAIRS (U.S. CLS. 26, 39 AND 44).

FIRST USE 4-27-2006; IN COMMERCE 4-27-2006.

MORGAN WYNNE, EXAMINING ATTORNEY

CLASS 10—(Continued).

SN 77-106,239. SURGIMARK, INC., YAKIMA, WA. FILED 2-13-2007.

ULTRASUMP

THE MARK CONSISTS OF STANDARD CHARACTERS WITHOUT CLAIM TO ANY PARTICULAR FONT, STYLE, SIZE, OR COLOR.

FOR MEDICAL APPARATUS; NAMELY, A NASOGASTRIC TUBE AND AN APPLIANCE USED FOR INTERCONNECTING THE TUBE WITH ANOTHER TUBE/DRAIN AND/OR A SUCTION SOURCE FOR REMOVING BODY FLUIDS DURING AND/OR AFTER DIAGNOSTIC OR OPERATIVE PROCEDURES (U.S. CLS. 26, 39 AND 44).

VIVIAN MICZNIK FIRST, EXAMINING ATTORNEY



SN 77-112,285. ARBEL MEDICAL LTD., YOKNEAM, ISRAEL, FILED 2-21-2007.

ARBEL

THE MARK CONSISTS OF STANDARD CHARACTERS WITHOUT CLAIM TO ANY PARTICULAR FONT, STYLE, SIZE, OR COLOR.

FOR MEDICAL DEVICES FOR PERFORMING CRYOSURGERY, NAMELY, PROBES, NEEDLES, CATHETERS, APPLICATORS, SPRAYERS, BALLOONS, AND AEROSOLIZING DEVICES (U.S. CLS. 26, 39 AND 44).

JOHN DWYER, EXAMINING ATTORNEY



SN 77-116,339. ARBEL MEDICAL LTD., YOKNEAM, ISRAEL, FILED 2-26-2007.

ARBEL

THE MARK CONSISTS OF STANDARD CHARACTERS WITHOUT CLAIM TO ANY PARTICULAR FONT, STYLE, SIZE, OR COLOR.

FOR MEDICAL DEVICES FOR PERFORMING CRYOTHERAPY AND ESTHETIC TREATMENT, NAMELY, PROBES, NEEDLES, CATHETERS, APPLICATORS, SPRAYERS, BALLOONS, AND AEROSOLIZING DEVICES (U.S. CLS. 26, 39 AND 44).

JOHN DWYER, EXAMINING ATTORNEY

CLASS 10—(Continued).

SN 77-118,775. DXTECH, LLC, MELBOURNE, FL. FILED 2-28-2007.

P3 TECHNOLOGY

THE MARK CONSISTS OF STANDARD CHARACTERS WITHOUT CLAIM TO ANY PARTICULAR FONT, STYLE, SIZE, OR COLOR.

NO CLAIM IS MADE TO THE EXCLUSIVE RIGHT TO USE "TECHNOLOGY", APART FROM THE MARK AS SHOWN.

FOR ELECTROCHEMICAL MEDICAL DETECTION ASSAYS FOR CLINICAL DIAGNOSIS OF BODILY FLUIDS (U.S. CLS. 26, 39 AND 44).

REBECCA POVARCHUK, EXAMINING ATTORNEY



SN 77-120,021. AVALIGN TECHNOLOGIES, INC., LAKE FOREST, IL. FILED 3-1-2007.

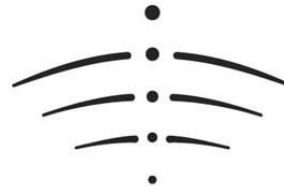

FOR SURGICAL INSTRUMENTS FOR USE IN A VARIETY OF SURGICAL FIELDS INCLUDING BUT NOT LIMITED TO CARDIOVASCULAR, THORACIC, ENT, ORTHOPAEDIC, OPHTHALMIC, ENDOSCOPIC, NEURO, SPINE, DENTAL, UROLOGICAL AND PLASTIC SURGERY AND SUBASSEMBLIES AND COMPONENTS THEREFOR; ACCESSORIES FOR SURGICAL INSTRUMENTS, NAMELY, BRACKETS, CLAMPS, HANDLERS, EXTRACTORS AND RETRACTORS; SURGICAL IMPLANTS COMPRISING OF ARTIFICIAL MATERIAL AND COMPONENTS THEREFOR; SURGICAL NEEDLES AND SHARPS; SURGICAL PRECISION-GROUND GUIDE WIRES AND TUBING IN THE NATURE OF SURGICAL TUBING FOR VASCULAR ACCESS AND DRUG DELIVERY; STERILIZATION CONTAINERS AND TRAYS (U.S. CLS. 26, 39 AND 44).

MARIAM MAHMOUDI, EXAMINING ATTORNEY

CLASS 10—(Continued).

SN 77-124,853. MASIMO CORPORATION, IRVINE, CA. FILED 3-7-2007.

RED

THE MARK CONSISTS OF STANDARD CHARACTERS WITHOUT CLAIM TO ANY PARTICULAR FONT, STYLE, SIZE, OR COLOR.

FOR MEDICAL DEVICES, NAMELY, PATIENT MONITORING SENSORS AND CABLES (U.S. CLS. 26, 39 AND 44).

JEFF DEFORD, EXAMINING ATTORNEY

CLASS 10—(Continued).

SN 77-136,007. MENTOR CORPORATION, SANTA BARBARA, CA. FILED 3-20-2007.

PINK PASSION

THE MARK CONSISTS OF STANDARD CHARACTERS WITHOUT CLAIM TO ANY PARTICULAR FONT, STYLE, SIZE, OR COLOR.

NO CLAIM IS MADE TO THE EXCLUSIVE RIGHT TO USE "PINK", APART FROM THE MARK AS SHOWN.

FOR COMPRESSION GARMENTS, NAMELY, POST-OPERATIVE GIRDLES, BINDERS, BRAS, BODY SUITS, VESTS AND SLEEVES (U.S. CLS. 26, 39 AND 44).

JENNIFER VASQUEZ, EXAMINING ATTORNEY

SN 77-127,215. MICROTEK MEDICAL EUROPE LIMITED, STAFFORDSHIRE, ENGLAND, FILED 3-9-2007.

MICROCLIP

THE MARK CONSISTS OF STANDARD CHARACTERS WITHOUT CLAIM TO ANY PARTICULAR FONT, STYLE, SIZE, OR COLOR.

FOR MEDICAL APPARATUS FOR SURGICAL USE, NAMELY, LAPAROSCOPIC LIGATION CLIP APPLICATOR (U.S. CLS. 26, 39 AND 44).

ALICE SUE CARRUTHERS, EXAMINING ATTORNEY

SN 77-140,424. ENTEROMEDICS, INC., ST. PAUL, MN. FILED 3-26-2007.

EMPOWER

THE MARK CONSISTS OF STANDARD CHARACTERS WITHOUT CLAIM TO ANY PARTICULAR FONT, STYLE, SIZE, OR COLOR.

FOR MEDICAL APPARATUS FOR THE TREATMENT OF OBESITY, NAMELY, NEURAL TISSUE REGULATORS; PORTABLE AND NON-PORTABLE PROGRAMMERS FOR NEURAL TISSUE REGULATORS AND NEUROMODULATION SYSTEMS CONSISTING OF IMPLANTED NEURAL TISSUE REGULATOR AND LAPAROSCOPICALLY IMPLANTED LEADS (U.S. CLS. 26, 39 AND 44).

DAWN FELDMAN, EXAMINING ATTORNEY

SN 77-134,534. MASIMO CORPORATION, IRVINE, CA. FILED 3-19-2007.

PVI

THE MARK CONSISTS OF STANDARD CHARACTERS WITHOUT CLAIM TO ANY PARTICULAR FONT, STYLE, SIZE, OR COLOR.

FOR MEDICAL DEVICES, NAMELY, PATIENT MONITORS AND PATIENT SENSORS (U.S. CLS. 26, 39 AND 44).

KHANH LE, EXAMINING ATTORNEY

SN 77-143,286. DAVID MYUNG, SANTA CLARA, CA. AND DENNIS CARTER, STANFORD, CA. AND STUART B. GOODMAN, LOS ALTOS, CA. AND CURTIS W. FRANK, CUPERTINO, CA. FILED 3-29-2007.

BIOMIMEDICA

THE MARK CONSISTS OF STANDARD CHARACTERS WITHOUT CLAIM TO ANY PARTICULAR FONT, STYLE, SIZE, OR COLOR.

FOR SURGICAL IMPLANTS COMPRISING ARTIFICIAL MATERIAL (U.S. CLS. 26, 39 AND 44).

CORY BOONE, EXAMINING ATTORNEY

CLASS 10—(Continued).

SN 77-145,212. CARL ZEISS VISION GMBH, 73430 AALEN, FED REP GERMANY, FILED 3-30-2007.

i.Polatest

THE MARK CONSISTS OF STANDARD CHARACTERS WITHOUT CLAIM TO ANY PARTICULAR FONT, STYLE, SIZE, OR COLOR.

PRIORITY CLAIMED UNDER SEC. 44(D) ON FED REP GERMANY APPLICATION NO. 30704325.8/1, FILED 1-26-2007, REG. NO. 30704325, DATED 5-4-2007, EXPIRES 1-31-2017.

FOR ELECTRONIC APPARATUS FOR TESTING AND EXAMINING THE EYES (U.S. CLS. 26, 39 AND 44).
ROSELLE HERRERA, EXAMINING ATTORNEY

SN 77-145,930. LAMAR, FRANK R., ROCHESTER, NY. AND LAMAR, JAMES R., ROCHESTER, NY. FILED 4-2-2007.

HYBRIDGE

THE MARK CONSISTS OF STANDARD CHARACTERS WITHOUT CLAIM TO ANY PARTICULAR FONT, STYLE, SIZE, OR COLOR.

FOR DENTAL BRIDGES PERMANENTLY SUPPORTED ON DENTAL IMPLANTS (U.S. CLS. 26, 39 AND 44).

FIRST USE 4-2-2007; IN COMMERCE 4-2-2007.
AMOS T. MATTHEWS, JR., EXAMINING ATTORNEY

SN 77-159,618. VERTOS MEDICAL, INC., SAN JOSE, CA. FILED 4-18-2007.

VERTOS MEDICAL

THE MARK CONSISTS OF STANDARD CHARACTERS WITHOUT CLAIM TO ANY PARTICULAR FONT, STYLE, SIZE, OR COLOR.

NO CLAIM IS MADE TO THE EXCLUSIVE RIGHT TO USE "MEDICAL", APART FROM THE MARK AS SHOWN.

FOR SURGICAL AND MEDICAL APPARATUS AND INSTRUMENTS FOR USE IN SPINAL SURGICAL PROCEDURES; SURGICAL AND MEDICAL APPARATUS AND INSTRUMENTS FOR USE IN THE DIAGNOSIS OF SPINAL DISEASES AND DISORDERS (U.S. CLS. 26, 39 AND 44).

REBECCA POVARCHUK, EXAMINING ATTORNEY

CLASS 10—(Continued).

SN 77-165,191. MOLNLYCKE HEALTH CARE AB, GOTE-BORG, SWEDEN, FILED 4-25-2007.

Latex SMART

NO CLAIM IS MADE TO THE EXCLUSIVE RIGHT TO USE "LATEX", APART FROM THE MARK AS SHOWN. FOR SURGICAL GLOVES (U.S. CLS. 26, 39 AND 44).
COLLEEN KEARNEY, EXAMINING ATTORNEY

SN 77-166,906. DONALD J. SHIELDS, JR., ARCADIA, CA. FILED 4-26-2007.

STATISON

THE MARK CONSISTS OF STANDARD CHARACTERS WITHOUT CLAIM TO ANY PARTICULAR FONT, STYLE, SIZE, OR COLOR.

FOR ULTRASOUND APPARATUS FOR VETERINARY PURPOSES (U.S. CLS. 26, 39 AND 44).

HANNO RITTNER, EXAMINING ATTORNEY

SN 77-166,910. DONALD J. SHIELDS, JR., ARCADIA, CA. FILED 4-26-2007.



NO CLAIM IS MADE TO THE EXCLUSIVE RIGHT TO USE "MEDICAL", APART FROM THE MARK AS SHOWN.

THE MARK CONSISTS OF THE WORD "STATISON" POSITIONED ABOVE THE WORD "MEDICAL"; THE "O" HAVING BEEN REPLACED BY A STYLIZED SPHERICAL DESIGN POSITIONED OVER AN ELLIPSE.

FOR ULTRASOUND APPARATUS FOR VETERINARY PURPOSES (U.S. CLS. 26, 39 AND 44).

HANNO RITTNER, EXAMINING ATTORNEY

CLASS 10—(Continued).

SN 77-170,372. LRC PRODUCTS LIMITED, LONDON, UNITED KINGDOM, FILED 5-1-2007.

CHOCOLATE PASSION

THE MARK CONSISTS OF STANDARD CHARACTERS WITHOUT CLAIM TO ANY PARTICULAR FONT, STYLE, SIZE, OR COLOR.

NO CLAIM IS MADE TO THE EXCLUSIVE RIGHT TO USE "CHOCOLATE", APART FROM THE MARK AS SHOWN.

FOR CONDOMS (U.S. CLS. 26, 39 AND 44).
TANYA AMOS, EXAMINING ATTORNEY

SN 77-170,960. SMITH & NEPHEW, INC., MEMPHIS, TN. FILED 5-2-2007.

HEWSON

THE MARK CONSISTS OF STANDARD CHARACTERS WITHOUT CLAIM TO ANY PARTICULAR FONT, STYLE, SIZE, OR COLOR.

SEC. 2(F).
FOR MEDICAL DEVICES, NAMELY, LIGAMENT FIXATION AND SUTURE RETRIEVER (U.S. CLS. 26, 39 AND 44).

FIRST USE 6-17-1987; IN COMMERCE 6-17-1987.
TINA BROWN, EXAMINING ATTORNEY

SN 77-171,921. CALIFORNIA EXOTIC NOVELTIES LLC, CHINO, CA. FILED 5-3-2007.

CRYSTAL FLEX

THE MARK CONSISTS OF STANDARD CHARACTERS WITHOUT CLAIM TO ANY PARTICULAR FONT, STYLE, SIZE, OR COLOR.

FOR ADULT SEXUAL AIDS, NAMELY, VIBRATORS (U.S. CLS. 26, 39 AND 44).

FIRST USE 3-1-2007; IN COMMERCE 3-1-2007.
ALLISON HOLTZ, EXAMINING ATTORNEY

CLASS 10—(Continued).

SN 77-179,627. BIOLASE TECHNOLOGY, INC., IRVINE, CA. FILED 5-13-2007.

MDFLOW

THE MARK CONSISTS OF STANDARD CHARACTERS WITHOUT CLAIM TO ANY PARTICULAR FONT, STYLE, SIZE, OR COLOR.

FOR ELECTROMAGNETIC ENERGY EMITTING DEVICES FOR MEDICAL USE, NAMELY, LASERS FOR MEDICAL USE, AND PARTS AND COMPONENTS THEREFOR (U.S. CLS. 26, 39 AND 44).

MARK PILARO, EXAMINING ATTORNEY

SN 77-185,280. BIOLASE TECHNOLOGY, INC., IRVINE, CA. FILED 5-18-2007.

WATERLASE MD

THE MARK CONSISTS OF STANDARD CHARACTERS WITHOUT CLAIM TO ANY PARTICULAR FONT, STYLE, SIZE, OR COLOR.

OWNER OF U.S. REG. NO. 2,660,361.
NO CLAIM IS MADE TO THE EXCLUSIVE RIGHT TO USE "MD", APART FROM THE MARK AS SHOWN.

FOR ELECTROMAGNETIC ENERGY EMITTING DEVICES FOR MEDICAL USE, NAMELY, LASERS FOR MEDICAL USE, AND PARTS AND COMPONENTS THEREFOR (U.S. CLS. 26, 39 AND 44).

MARK PILARO, EXAMINING ATTORNEY

SN 77-185,281. BIOLASE TECHNOLOGY, INC., IRVINE, CA. FILED 5-18-2007.

MD GOLD

THE MARK CONSISTS OF STANDARD CHARACTERS WITHOUT CLAIM TO ANY PARTICULAR FONT, STYLE, SIZE, OR COLOR.

NO CLAIM IS MADE TO THE EXCLUSIVE RIGHT TO USE "MD", APART FROM THE MARK AS SHOWN.

FOR ELECTROMAGNETIC ENERGY EMITTING DEVICES FOR MEDICAL USE, NAMELY, LASERS FOR MEDICAL USE; ELECTROMAGNETIC ENERGY EMITTING MEDICAL HANDPIECES, NAMELY, LASER EMITTING HANDPIECES; AND PARTS AND COMPONENTS THEREFOR (U.S. CLS. 26, 39 AND 44).

MARK PILARO, EXAMINING ATTORNEY

CLASS 10—(Continued).

SN 77-188,556. STRYKER CORPORATION, KALAMAZOO, MI. FILED 5-23-2007.

CROSSFIRE

THE MARK CONSISTS OF STANDARD CHARACTERS WITHOUT CLAIM TO ANY PARTICULAR FONT, STYLE, SIZE, OR COLOR.

FOR RADIO-FREQUENCY AND SHAVER SURGICAL SYSTEMS, NAMELY, CONSOLES, FOOTSWITCHES, HANDPIECES, RADIO-FREQUENCY PROBES, SURGICAL CUTTING INSTRUMENTS AND CUTTING BLADES (U.S. CLS. 26, 39 AND 44).

DAVID C. REIHNER, EXAMINING ATTORNEY

SN 77-189,486. CRITICAL CARE INNOVATIONS, INC., CHANTILLY, VA. FILED 5-24-2007.

CRYOFLEX

THE MARK CONSISTS OF STANDARD CHARACTERS WITHOUT CLAIM TO ANY PARTICULAR FONT, STYLE, SIZE, OR COLOR.

FOR FULL LINE OF SURGICAL APPARATUS, INSTRUMENTS AND EQUIPMENT FOR USE IN CRYO-SURGERY (U.S. CLS. 26, 39 AND 44).

MARLENE BELL, EXAMINING ATTORNEY

SN 77-193,496. THE DENTAL ICE COMPANY, PENSACOLA, FL. FILED 5-30-2007.



NO CLAIM IS MADE TO THE EXCLUSIVE RIGHT TO USE "DENTAL ICE", APART FROM THE MARK AS SHOWN.

THE MARK CONSISTS OF THE WORDS "DENTAL ICE" AND A SOLID CIRCLE WITH TWO CURVED CUT OUTS.

FOR MEDICAL ICE PACKS (U.S. CLS. 26, 39 AND 44). SOPHIA S. KIM, EXAMINING ATTORNEY

CLASS 10—(Continued).

SN 77-203,692. SHARON GRYBINAS, ST. LOUIS, MO. FILED 6-12-2007.

C-CURE MEDBOX

THE MARK CONSISTS OF STANDARD CHARACTERS WITHOUT CLAIM TO ANY PARTICULAR FONT, STYLE, SIZE, OR COLOR.

NO CLAIM IS MADE TO THE EXCLUSIVE RIGHT TO USE "MEDBOX", APART FROM THE MARK AS SHOWN.

FOR MEDICAL PRODUCTS IN THE NATURE OF NON-DISPOSABLE MEDICAL DEVICES, NAMELY, PORTABLE PHARMACEUTICAL STORAGE BOXES, CASES AND CABINETS SPECIALLY FITTED WITH COMPARTMENTS ADAPTED FOR HOLDING AND ORGANIZING PHARMACEUTICAL PILL BOTTLES AND MEDICATION DESCRIPTIVE MATERIAL FOR INDIVIDUALS (U.S. CLS. 26, 39 AND 44).

TINA BROWN, EXAMINING ATTORNEY

SN 77-207,763. TELEFLEX MEDICAL INCORPORATED, TEMECULA, CA. FILED 6-15-2007.



OWNER OF U.S. REG. NO. 3,077,624.

THE MARK CONSISTS OF THE WORDS "OPTI-NEB PRO" WITH SIX CIRCLES INCREASING IN SIZE.

FOR MEDICAL DEVICES, NAMELY, COMPRESSORS FOR NEBULIZERS AND NEBULIZERS FOR RESPIRATION THERAPY (U.S. CLS. 26, 39 AND 44).

RONALD MCMORROW, EXAMINING ATTORNEY

SN 77-211,203. ABIOMED, INC., DANVERS, MA. FILED 6-20-2007.



OWNER OF U.S. REG. NOS. 1,332,596, 1,650,057 AND OTHERS.

FOR AUTOMATED EQUIPMENT FOR PROVIDING CARDIAC SUPPORT FOR EITHER OR BOTH CHAMBERS OF THE HEART (U.S. CLS. 26, 39 AND 44).

FIRST USE 12-15-2006; IN COMMERCE 12-15-2006. ALICIA COLLINS, EXAMINING ATTORNEY

CLASS 10—(Continued).

SN 77-218,188. SUROS SURGICAL SYSTEMS, INC., INDIANAPOLIS, IN. FILED 6-28-2007.

CELERO PETITE

THE MARK CONSISTS OF STANDARD CHARACTERS WITHOUT CLAIM TO ANY PARTICULAR FONT, STYLE, SIZE, OR COLOR.

NO CLAIM IS MADE TO THE EXCLUSIVE RIGHT TO USE "PETITE", APART FROM THE MARK AS SHOWN.

FOR MEDICAL AND SURGICAL INSTRUMENTS FOR PERFORMING BIOPSIES (U.S. CLS. 26, 39 AND 44).

CAROLYN GRAY, EXAMINING ATTORNEY

SN 77-229,208. HOCHHAUSER, JULIE, EASTON, PA. FILED 7-13-2007.



NO CLAIM IS MADE TO THE EXCLUSIVE RIGHT TO USE "DENTAL" AND "INCORPORATED", APART FROM THE MARK AS SHOWN.

THE COLOR(S) ORANGE AND BLUE IS/ARE CLAIMED AS A FEATURE OF THE MARK.

THE MARK CONSISTS OF LOWER CASE "JAZI" IN ORANGE; LOWER CASE "DENTAL" IN BLUE. LOWER-CASE "INCORPORATED" IN BLUE. JAZI APPEARS ON TOP, DENTAL IS UNDERNEATH; INCORPORATED ON THE BOTTOM.

FOR ORTHODONTIC MACHINES AND INSTRUMENTS (U.S. CLS. 26, 39 AND 44).

FIRST USE 6-20-2006; IN COMMERCE 6-30-2006.

TASHIA BUNCH, EXAMINING ATTORNEY

CLASS 10—(Continued).

SN 77-240,272. APLUS MEDICAL SUPPLIES CORPORATION, TAIPEI, TAIWAN, FILED 7-27-2007.



FOR ANESTHETIC MASKS, ANESTHETIC DELIVERY APPARATUS, APPARATUS FOR ARTIFICIAL RESPIRATION, AEROSOL DISPENSERS FOR MEDICAL USE, CANNULAE, CATHETERS, CATHETERS AND PARTS AND FITTINGS THEREFOR, CPR (CARDIOPULMONARY RESUSCITATION) MASKS, HYPERBARIC OXYGEN CHAMBERS FOR MEDICAL PURPOSES, INHALERS FOR THERAPEUTIC USE, SOLD EMPTY, INHALERS FOR MEDICAL PURPOSES, SOLD EMPTY, LARYNGOSCOPES, MASKS FOR USE BY MEDICAL PERSONNEL, MEDICAL APPARATUS, NAMELY, ELECTRIC HEATING DEVICES FOR CURATIVE TREATMENT, MEDICAL DEVICE, NAMELY, CARBON DIOXIDE INDICATORS, NEBULIZERS FOR RESPIRATION THERAPY, OXYGEN MASKS FOR MEDICAL USE, OXYGEN CONCENTRATORS FOR MEDICAL APPLICATIONS, RESUSCITATORS, RESUSCITATION APPARATUS, RESPIRATORS FOR ARTIFICIAL RESPIRATION, RESPIRATORY MASKS FOR MEDICAL PURPOSES, SURGICAL CUTLERY, SPIROMETER MOUTH PIECES AND TUBING, SUCTION CUPS FOR MEDICAL PURPOSES, SURGICAL INSTRUMENTS, NAMELY, ESU PENCIL, TONGUE DEPRESSORS, THREAD FOR MEDICAL USE, VENTILATORS AND ANESTHESIA MACHINES FOR USE IN PATIENT CARE (U.S. CLS. 26, 39 AND 44).

FIRST USE 6-11-2007; IN COMMERCE 6-11-2007.

FLORENTINA BLANDU, EXAMINING ATTORNEY

SN 77-244,446. SIEBER, LORI L., VAIL, AZ. FILED 8-1-2007.

PASS

THE MARK CONSISTS OF STANDARD CHARACTERS WITHOUT CLAIM TO ANY PARTICULAR FONT, STYLE, SIZE, OR COLOR.

FOR MEDICAL APPARATUS, NAMELY, A SLING THAT IS COUPLED WITH AND PREVENTS A CONTINUOUS PASSIVE MOTION MACHINE FROM MOVING OUT OF ALIGNMENT THROUGH THE WEIGHT OF A USER (U.S. CLS. 26, 39 AND 44).

NAKWAMA ANKRAH, EXAMINING ATTORNEY

CLASS 10—(Continued).

SN 77-257,790. CHURCH, JUDITH ANN, DBA CHURCH PRODUCTS COMPANY, ALISO VIEJO, CA. FILED 8-17-2007.

comfortpan 

FOR BED PANS (U.S. CLS. 26, 39 AND 44).
FIRST USE 9-24-1993; IN COMMERCE 9-24-1993.
COLLEEN DOMBROW, EXAMINING ATTORNEY

SN 77-274,576. TRIREME MEDICAL, INC., PLEASANTON, CA. FILED 9-7-2007.

ANTARES

THE MARK CONSISTS OF STANDARD CHARACTERS WITHOUT CLAIM TO ANY PARTICULAR FONT, STYLE, SIZE, OR COLOR.

FOR STENTS AND ENDOVASCULAR DEVICES, NAMELY, STENT DELIVERY SYSTEMS (U.S. CLS. 26, 39 AND 44).

JEFFERY COWARD, EXAMINING ATTORNEY

SN 77-277,298. BLUE SKY SCRUBS, LLC, AUSTIN, TX. FILED 9-12-2007.

SKINNY SCRUBS

THE MARK CONSISTS OF STANDARD CHARACTERS WITHOUT CLAIM TO ANY PARTICULAR FONT, STYLE, SIZE, OR COLOR.

NO CLAIM IS MADE TO THE EXCLUSIVE RIGHT TO USE "SCRUBS", APART FROM THE MARK AS SHOWN.

FOR SURGICAL SCRUB SUITS (U.S. CLS. 26, 39 AND 44).

ALLISON HOLTZ, EXAMINING ATTORNEY

CLASS 10—(Continued).

SN 77-282,637. PIONEER SURGICAL TECHNOLOGY, INC., MARQUETTE, MI. FILED 9-18-2007.

SLIMFUSE

THE MARK CONSISTS OF STANDARD CHARACTERS WITHOUT CLAIM TO ANY PARTICULAR FONT, STYLE, SIZE, OR COLOR.

FOR SPINAL IMPLANTS COMPOSED OF ARTIFICIAL MATERIAL; SPINAL FIXATION DEVICES; SURGICAL INSTRUMENTS FOR USE IN ORTHOPEDIC AND SPINAL SURGERY (U.S. CLS. 26, 39 AND 44).

NAKIA HENRY, EXAMINING ATTORNEY

SN 77-283,875. SYNERON MEDICAL LTD, YOKNEAM ILLIT, ISRAEL, FILED 9-19-2007.

LITEDUO

THE MARK CONSISTS OF STANDARD CHARACTERS WITHOUT CLAIM TO ANY PARTICULAR FONT, STYLE, SIZE, OR COLOR.

FOR LASERS FOR DENTAL USE (U.S. CLS. 26, 39 AND 44).

MYRIAH HABEEB, EXAMINING ATTORNEY

SN 77-286,745. FLYNN, RORY, LOS ANGELES, CA. FILED 9-24-2007.

In Like Flynn

THE MARK CONSISTS OF STANDARD CHARACTERS WITHOUT CLAIM TO ANY PARTICULAR FONT, STYLE, SIZE, OR COLOR.

FOR CONDOMS (U.S. CLS. 26, 39 AND 44).

WOODROW HARTZOG, EXAMINING ATTORNEY

CLASS 10—(Continued).

SN 77-287,117. MENG, MU, MUSKEGON, MI. FILED 9-24-2007.

Sononir

THE MARK CONSISTS OF STANDARD CHARACTERS WITHOUT CLAIM TO ANY PARTICULAR FONT, STYLE, SIZE, OR COLOR.
FOR MEDICAL ULTRASOUND APPARATUS (U.S. CLS. 26, 39 AND 44).
GIANCARLO CASTRO, EXAMINING ATTORNEY

SN 77-287,590. QUADRA PRO ALOFT LLC, SCOTTSDALE, AZ. FILED 9-24-2007.

QUADRA PRO ALOFT

THE MARK CONSISTS OF STANDARD CHARACTERS WITHOUT CLAIM TO ANY PARTICULAR FONT, STYLE, SIZE, OR COLOR.
NO CLAIM IS MADE TO THE EXCLUSIVE RIGHT TO USE "PRO", APART FROM THE MARK AS SHOWN.
FOR BOXED KIT COMPRISED OF SURGICAL MASK, ANTISEPTIC HAND WIPES, NASAL SALINE SPRAY, AND VITAMINS AND MINERAL SUPPLEMENTS, WHICH IS USED TO REDUCE TRANSMISSION OF THE COMMON COLD (U.S. CLS. 26, 39 AND 44).
STEVEN R. FOSTER, EXAMINING ATTORNEY

SN 77-288,225. WOUND SYSTEMS, LLC, ATLANTA, GA. FILED 9-25-2007.

Dolphin Pressure Redistribution System

THE MARK CONSISTS OF STANDARD CHARACTERS WITHOUT CLAIM TO ANY PARTICULAR FONT, STYLE, SIZE, OR COLOR.
NO CLAIM IS MADE TO THE EXCLUSIVE RIGHT TO USE "PRESSURE REDISTRIBUTION SYSTEM", APART FROM THE MARK AS SHOWN.
FOR AIR MATTRESSES FOR MEDICAL PURPOSES (U.S. CLS. 26, 39 AND 44).
EDWARD FENNESSY, EXAMINING ATTORNEY

CLASS 10—(Continued).

SN 77-288,260. WOUND SYSTEMS, LLC, ATLANTA, GA. FILED 9-25-2007.

Dolphin Pad

THE MARK CONSISTS OF STANDARD CHARACTERS WITHOUT CLAIM TO ANY PARTICULAR FONT, STYLE, SIZE, OR COLOR.
NO CLAIM IS MADE TO THE EXCLUSIVE RIGHT TO USE "PAD", APART FROM THE MARK AS SHOWN.
FOR AIR MATTRESSES FOR MEDICAL PURPOSES (U.S. CLS. 26, 39 AND 44).
EDWARD FENNESSY, EXAMINING ATTORNEY

SN 77-288,358. WOUND SYSTEMS, LLC, ATLANTA, GA. FILED 9-25-2007.

Dolphin Mattress

THE MARK CONSISTS OF STANDARD CHARACTERS WITHOUT CLAIM TO ANY PARTICULAR FONT, STYLE, SIZE, OR COLOR.
NO CLAIM IS MADE TO THE EXCLUSIVE RIGHT TO USE "MATTRESS", APART FROM THE MARK AS SHOWN.
FOR AIR MATTRESSES FOR MEDICAL PURPOSES (U.S. CLS. 26, 39 AND 44).
EDWARD FENNESSY, EXAMINING ATTORNEY

SN 77-288,367. WOUND SYSTEMS, LLC, ATLANTA, GA. FILED 9-25-2007.

Dolphin Bed

THE MARK CONSISTS OF STANDARD CHARACTERS WITHOUT CLAIM TO ANY PARTICULAR FONT, STYLE, SIZE, OR COLOR.
NO CLAIM IS MADE TO THE EXCLUSIVE RIGHT TO USE "BED", APART FROM THE MARK AS SHOWN.
FOR AIR MATTRESSES FOR MEDICAL PURPOSES (U.S. CLS. 26, 39 AND 44).
EDWARD FENNESSY, EXAMINING ATTORNEY

CLASS 10—(Continued).

SN 77-290,353. TRAN HOLDINGS, LLC, ORLANDO, FL.
FILED 9-27-2007.

TRANSCATHETER EXTRACTOR

THE MARK CONSISTS OF STANDARD CHARACTERS WITHOUT CLAIM TO ANY PARTICULAR FONT, STYLE, SIZE, OR COLOR.

NO CLAIM IS MADE TO THE EXCLUSIVE RIGHT TO USE "EXTRACTOR", APART FROM THE MARK AS SHOWN.

FOR SURGICAL APPARATUS, NAMELY, CATHETER EXTRACTORS (U.S. CLS. 26, 39 AND 44).

FIRST USE 1-0-2007; IN COMMERCE 1-0-2007.

WON TEAK OH, EXAMINING ATTORNEY

CLASS 10—(Continued).

SN 77-291,485. TALLEY GROUP, LTD., ROMSEY, HANTS,
UNITED KINGDOM, FILED 9-28-2007.

VENTURI

THE MARK CONSISTS OF STANDARD CHARACTERS WITHOUT CLAIM TO ANY PARTICULAR FONT, STYLE, SIZE, OR COLOR.

FOR VACUUM PUMPS FOR APPLYING NEGATIVE PRESSURE TO PATIENTS; DRAINAGE CANISTERS FOR USE WITH THE VACUUM PUMPS TO COLLECT EXUDATES, AND CONNECTION TUBING (U.S. CLS. 26, 39 AND 44).

LINDA MICKLEBURGH, EXAMINING ATTORNEY

SN 77-291,146. ELECTRO-OPTICAL SCIENCES, INC., NEW YORK, NY. FILED 9-28-2007.

BEFORE YOU ABLATE, YOU
MUST DIFFERENTIATE

THE MARK CONSISTS OF STANDARD CHARACTERS WITHOUT CLAIM TO ANY PARTICULAR FONT, STYLE, SIZE, OR COLOR.

FOR INSTRUMENTATION COMPRISING COMPUTER-ASSISTED OPTICAL IMAGERS AND IMAGE ANALYZERS FOR USE IN THE DETECTION OF DENTAL CARIES, CUTANEOUS MELANOMA AND OTHER PATHOLOGIES OF THE TEETH, SKIN AND OTHER TISSUES (U.S. CLS. 26, 39 AND 44).

DOMINICK J. SALEMI, EXAMINING ATTORNEY

SN 77-291,590. HERBIG AND STRAUSS COMPANY, SALEM, OR. FILED 9-28-2007.

Chuck-it

THE MARK CONSISTS OF STANDARD CHARACTERS WITHOUT CLAIM TO ANY PARTICULAR FONT, STYLE, SIZE, OR COLOR.

FOR BAGS FOR THE COLLECTION AND DISPOSAL OF EMESIS WASTE (U.S. CLS. 26, 39 AND 44).

CURTIS FRENCH, EXAMINING ATTORNEY

SN 77-291,343. ESSORANT, INCORPORATED, MINNETONKA, MN. FILED 9-28-2007.

mykase

THE MARK CONSISTS OF STANDARD CHARACTERS WITHOUT CLAIM TO ANY PARTICULAR FONT, STYLE, SIZE, OR COLOR.

FOR CASES FITTED FOR MEDICAL INSTRUMENTS AND/OR FOR USE BY DOCTORS (U.S. CLS. 26, 39 AND 44).

BRENDAN MCCAULEY, EXAMINING ATTORNEY

SN 77-291,923. THOMAS A. LINDHEIMER, LEWISVILLE, NC. FILED 9-28-2007.

Peri-jett
perineal
rinse aid

THE MARK CONSISTS OF STANDARD CHARACTERS WITHOUT CLAIM TO ANY PARTICULAR FONT, STYLE, SIZE, OR COLOR.

NO CLAIM IS MADE TO THE EXCLUSIVE RIGHT TO USE "PERINEAL RINSE AID", APART FROM THE MARK AS SHOWN.

FOR IRRIGATORS FOR MEDICAL USE (U.S. CLS. 26, 39 AND 44).

ELLEN BURNS, EXAMINING ATTORNEY

CLASS 10—(Continued).

SN 77-292,219. CENTUM RESEARCH LLC, BAKERSFIELD, CA. FILED 9-29-2007.

ENDO Q

THE MARK CONSISTS OF STANDARD CHARACTERS WITHOUT CLAIM TO ANY PARTICULAR FONT, STYLE, SIZE, OR COLOR.

FOR GYNECOLOGICAL MEDICAL INSTRUMENTS FOR EXAMINING WOMEN' S REPRODUCTIVE ORGANS (U.S. CLS. 26, 39 AND 44).
FIRST USE 7-30-2007; IN COMMERCE 7-30-2007.
LINDA M. KING, EXAMINING ATTORNEY

CLASS 10—(Continued).

SN 77-293,701. KATHLEEN E. EDINGER, BELFORD, NJ. FILED 10-2-2007.

ORTHOMATE

THE MARK CONSISTS OF STANDARD CHARACTERS WITHOUT CLAIM TO ANY PARTICULAR FONT, STYLE, SIZE, OR COLOR.

FOR SUPPORTS FOR GENERAL MEDICAL USE (U.S. CLS. 26, 39 AND 44).
JOHN WILKE, EXAMINING ATTORNEY

SN 77-292,918. OPTICAL SENSORS INCORPORATED, EDEN PRAIRIE, MN. FILED 10-1-2007.

CARDIOVASCULOGAM

THE MARK CONSISTS OF STANDARD CHARACTERS WITHOUT CLAIM TO ANY PARTICULAR FONT, STYLE, SIZE, OR COLOR.

FOR NON-INVASIVE HEMODYNAMIC MONITORING SYSTEM FOR VASCULAR AND CARDIOVASCULAR DIAGNOSTICS AND THERAPY MANAGEMENT, COMPRISED OF MONITORING AND DIAGNOSTIC DEVICES THAT DISPLAY A DEPICTION OF MECHANICAL AND HEMODYNAMIC FUNCTION USED TO AID IN CARDIOVASCULAR DIAGNOSES AND THERAPY MANAGEMENT (U.S. CLS. 26, 39 AND 44).
KIMBERLY PERRY, EXAMINING ATTORNEY

SN 77-293,886. BALDWIN, CHARLES C., COLUMBIA, MO. FILED 10-2-2007.

CB AWAKE JT AIRWAY

THE MARK CONSISTS OF STANDARD CHARACTERS WITHOUT CLAIM TO ANY PARTICULAR FONT, STYLE, SIZE, OR COLOR.

FOR MEDICAL APPARATUS FOR DIAGNOSING OR TREATING RESPIRATORY CONDITIONS; MOUTH GUARDS FOR MEDICAL PURPOSES (U.S. CLS. 26, 39 AND 44).
GEOFFREY FOSDICK, EXAMINING ATTORNEY

SN 77-293,495. CHARRON, ALAIN, MEUDON, FRANCE, FILED 10-2-2007.

SpectraOne

THE MARK CONSISTS OF STANDARD CHARACTERS WITHOUT CLAIM TO ANY PARTICULAR FONT, STYLE, SIZE, OR COLOR.

FOR PULSED LIGHT APPARATUS FOR THE COSMETIC TREATMENT OF THE FACE AND SKIN. PULSED LIGHT APPARATUS FOR SURGICAL AND MEDICAL USE (U.S. CLS. 26, 39 AND 44).
ALEXANDER L. POWERS, EXAMINING ATTORNEY

SN 77-293,984. ACTIVE IMPLANTS CORPORATION, MEMPHIS, TN. FILED 10-2-2007.

NUsurface

THE MARK CONSISTS OF STANDARD CHARACTERS WITHOUT CLAIM TO ANY PARTICULAR FONT, STYLE, SIZE, OR COLOR.

FOR ORTHOPEDIC JOINT IMPLANTS (U.S. CLS. 26, 39 AND 44).
AMY GEARIN, EXAMINING ATTORNEY

CLASS 10—(Continued).

SN 77-294,328. HEARING ENHANCEMENT GROUP, LLC, THOUSAND OAKS, CA. FILED 10-2-2007.



FOR HEARING AIDS (U.S. CLS. 26, 39 AND 44).
SHANNON TWOHIG, EXAMINING ATTORNEY

SN 77-294,417. ORALFLO TECHNOLOGIES, LLC, RARITAN, NJ. FILED 10-2-2007.

ORALFLO

THE MARK CONSISTS OF STANDARD CHARACTERS WITHOUT CLAIM TO ANY PARTICULAR FONT, STYLE, SIZE, OR COLOR.

FOR CUPS FOR DISPENSING MEDICINE (U.S. CLS. 26, 39 AND 44).
FIRST USE 4-11-2003; IN COMMERCE 4-11-2003.
LESLIE RICHARDS, EXAMINING ATTORNEY

SN 77-295,559. ENHANCED VISION SYSTEMS, HUNTINGTON BEACH, CA. FILED 10-3-2007.

MOJO

THE MARK CONSISTS OF STANDARD CHARACTERS WITHOUT CLAIM TO ANY PARTICULAR FONT, STYLE, SIZE, OR COLOR.

FOR MEDICAL APPARATUS IN THE FORM OF VIDEO HEADSETS FOR PROVIDING VISUAL ASSISTANCE TO PERSONS WITH SYMPTOMS ASSOCIATED WITH LOW VISION (U.S. CLS. 26, 39 AND 44).
ALEX KEAM, EXAMINING ATTORNEY

CLASS 10—(Continued).

SN 77-295,578. ELIXIR MEDICAL CORPORATION, SUNNYVALE, CA. FILED 10-3-2007.

INNOVATION FOR LIFE

THE MARK CONSISTS OF STANDARD CHARACTERS WITHOUT CLAIM TO ANY PARTICULAR FONT, STYLE, SIZE, OR COLOR.

FOR MEDICAL DEVICES FOR USE IN VASCULAR AND INTRAVASCULAR PROCEDURES, NAMELY, STENTS, STENT DELIVERY SYSTEMS, AND CATHETERS (U.S. CLS. 26, 39 AND 44).
DOMINIC FATHY, EXAMINING ATTORNEY

SN 77-295,742. NELLCOR PURITAN BENNETT LLC, BOULDER, CO. FILED 10-4-2007.

SANDMAN INFO

THE MARK CONSISTS OF STANDARD CHARACTERS WITHOUT CLAIM TO ANY PARTICULAR FONT, STYLE, SIZE, OR COLOR.

OWNER OF U.S. REG. NOS. 2,293,035, 2,635,968 AND 2,635,969.
FOR MEDICAL APPARATUS FOR DIAGNOSING AND TREATING RESPIRATORY-RELATED SLEEP DISORDERS, NAMELY, CONTINUOUS POSITIVE AIRWAY PRESSURE DEVICES AND PARTS AND FITTINGS THEREFOR (U.S. CLS. 26, 39 AND 44).
MARCIE MILONE, EXAMINING ATTORNEY

SN 77-296,388. ST. JUDE MEDICAL, CARDIOLOGY DIVISION, INC., DBA ST. JUDE MEDICAL, CARDIOVASCULAR DIVISION, MINNETONKA, MN. FILED 10-4-2007.

MAXIMUM

THE MARK CONSISTS OF STANDARD CHARACTERS WITHOUT CLAIM TO ANY PARTICULAR FONT, STYLE, SIZE, OR COLOR.

FOR MEDICAL DEVICES, NAMELY, INTRODUCERS (U.S. CLS. 26, 39 AND 44).
FIRST USE 2-6-1997; IN COMMERCE 2-6-1997.
NAAKWAMA ANKRAH, EXAMINING ATTORNEY

CLASS 10—(Continued).

SN 77-297,727. MOMENTUM MANAGEMENT LLC, BEVERLY HILLS, CA. FILED 10-5-2007.

THE SENSUAL O

THE MARK CONSISTS OF STANDARD CHARACTERS WITHOUT CLAIM TO ANY PARTICULAR FONT, STYLE, SIZE, OR COLOR.

FOR ADULT SEXUAL AIDS, NAMELY, VIBRATING RUBBER RINGS FOR THE PENIS (U.S. CLS. 26, 39 AND 44).

FIRST USE 9-17-2006; IN COMMERCE 9-17-2006.
TRACY WHITTAKER-BROWN, EXAMINING ATTORNEY

SN 77-304,681. ELIXIR MEDICAL CORPORATION, SUNNYVALE, CA. FILED 10-15-2007.

TAKING INNOVATION TO HEART

THE MARK CONSISTS OF STANDARD CHARACTERS WITHOUT CLAIM TO ANY PARTICULAR FONT, STYLE, SIZE, OR COLOR.

FOR MEDICAL DEVICES FOR USE IN VASCULAR AND INTRAVASCULAR PROCEDURES, NAMELY, STENTS, STENT DELIVERY SYSTEMS, AND CATHETERS (U.S. CLS. 26, 39 AND 44).

DOMINIC FATHY, EXAMINING ATTORNEY

SN 77-306,015. NELLCOR PURITAN BENNETT LLC, BOULDER, CO. FILED 10-17-2007.

SANDMAN DUO

THE MARK CONSISTS OF STANDARD CHARACTERS WITHOUT CLAIM TO ANY PARTICULAR FONT, STYLE, SIZE, OR COLOR.

OWNER OF U.S. REG. NOS. 2,293,035, 2,635,968 AND 2,635,969.

FOR MEDICAL APPARATUS FOR DIAGNOSING AND TREATING RESPIRATORY-RELATED SLEEP DISORDERS, NAMELY, BI-LEVEL POSITIVE PRESSURE DEVICES AND PARTS AND FITTINGS THEREFOR (U.S. CLS. 26, 39 AND 44).

MARCIE MILONE, EXAMINING ATTORNEY

CLASS 10—(Continued).

SN 77-307,570. TRAN HOLDINGS, LLC, ORLANDO, FL. FILED 10-18-2007.



NO CLAIM IS MADE TO THE EXCLUSIVE RIGHT TO USE "EXTRACTOR", APART FROM THE MARK AS SHOWN.

THE MARK CONSISTS OF THE WORDS "TRANSCATHETER EXTRACTOR" IN COMBINATION WITH A GEOMETRIC DESIGN.

FOR SURGICAL APPARATUS, NAMELY, CATHETER EXTRACTORS (U.S. CLS. 26, 39 AND 44).
WON TEAK OH, EXAMINING ATTORNEY

SN 77-309,082. ACTIVE IMPLANTS CORPORATION, MEMPHIS, TN. FILED 10-19-2007.

HYDROSPHERING

THE MARK CONSISTS OF STANDARD CHARACTERS WITHOUT CLAIM TO ANY PARTICULAR FONT, STYLE, SIZE, OR COLOR.

FOR ORTHOPEDIC JOINT IMPLANTS (U.S. CLS. 26, 39 AND 44).

AMY GEARIN, EXAMINING ATTORNEY

SN 77-309,089. ACTIVE IMPLANTS CORPORATION, MEMPHIS, TN. FILED 10-19-2007.

BUFFER

THE MARK CONSISTS OF STANDARD CHARACTERS WITHOUT CLAIM TO ANY PARTICULAR FONT, STYLE, SIZE, OR COLOR.

FOR ORTHOPEDIC JOINT IMPLANTS (U.S. CLS. 26, 39 AND 44).

AMY GEARIN, EXAMINING ATTORNEY

CLASS 10—(Continued).

SN 77-310,340. SURGICAL INNOVATIONS LIMITED, LEEDS, UNITED KINGDOM, FILED 10-22-2007.

SURGICAL INNOVATIONS

THE MARK CONSISTS OF STANDARD CHARACTERS WITHOUT CLAIM TO ANY PARTICULAR FONT, STYLE, SIZE, OR COLOR.

PRIORITY CLAIMED UNDER SEC. 44(D) ON CANADA APPLICATION NO. 005983457, FILED 6-8-2007.

NO CLAIM IS MADE TO THE EXCLUSIVE RIGHT TO USE "SURGICAL", APART FROM THE MARK AS SHOWN.

FOR SURGICAL APPARATUS AND INSTRUMENTS FOR USE IN GENERAL SURGERY AND LAPAROSCOPIC SURGERY; MEDICAL APPARATUS AND INSTRUMENTS NAMELY, PORT ACCESS SYSTEMS COMPRISING CANNULAE, TROCARS, VALVES, SEALS, LUER CAPS AND FACIA ADAPTERS; PARTS AND FITTINGS FOR SURGICAL AND MEDICAL APPARATUS AND INSTRUMENTS NAMELY, CANNULAE, TROCARS, VALVES, SEALS, LUER CAPS, AND FACIA ADAPTERS (U.S. CLS. 26, 39 AND 44).

FIRST USE 4-16-1995; IN COMMERCE 12-31-1998.

MARGERY A. TIERNEY, EXAMINING ATTORNEY

SN 77-312,535. MOMENTUM MANAGEMENT LLC, BEVERLY HILLS, CA. FILED 10-24-2007.

THE SENSUAL CENTER

THE MARK CONSISTS OF STANDARD CHARACTERS WITHOUT CLAIM TO ANY PARTICULAR FONT, STYLE, SIZE, OR COLOR.

FOR ADULT SEXUAL AIDS, NAMELY, VIBRATING RUBBER RINGS FOR THE PENIS; CONDOMS (U.S. CLS. 26, 39 AND 44).

FIRST USE 10-9-2006; IN COMMERCE 10-9-2006.

TRACY WHITTAKER-BROWN, EXAMINING ATTORNEY

SN 77-335,058. ABBOTT CARDIOVASCULAR SYSTEMS INC., SANTA CLARA, CA. FILED 11-21-2007.

OMNILINK ELITE

THE MARK CONSISTS OF STANDARD CHARACTERS WITHOUT CLAIM TO ANY PARTICULAR FONT, STYLE, SIZE, OR COLOR.

OWNER OF U.S. REG. NO. 2,711,790.

FOR MEDICAL AND SURGICAL DEVICE, NAMELY, A BALLOON EXPANDABLE STENT, CATHETER AND GUIDEWIRE (U.S. CLS. 26, 39 AND 44).

CHERYL CLAYTON, EXAMINING ATTORNEY

CLASS 10—(Continued).

SN 78-708,919. SADRA MEDICAL, INC., CAMPBELL, CA. FILED 9-8-2005.

Lotus

THE MARK CONSISTS OF STANDARD CHARACTERS WITHOUT CLAIM TO ANY PARTICULAR FONT, STYLE, SIZE, OR COLOR.

FOR MEDICAL DEVICES AND INSTRUMENTS FOR USE IN THE TREATMENT OF CARDIAC, CARDIOVASCULAR, AND HEART VALVE DISEASE AND DISORDERS, NAMELY, IMPLANTABLE HEART VALVES, AND IMPLANTABLE HEART VALVE DELIVERY SYSTEMS FOR USE IN HEART VALVE REPLACEMENTS (U.S. CLS. 26, 39 AND 44).

PETER B. BROMAGHIM, EXAMINING ATTORNEY

SN 78-803,497. PTW-NEW YORK CORPORATION, HICKSVILLE, NY. FILED 1-31-2006.

UNIDOS

THE MARK CONSISTS OF STANDARD CHARACTERS WITHOUT CLAIM TO ANY PARTICULAR FONT, STYLE, SIZE, OR COLOR.

THE ENGLISH TRANSLATION OF THE SPANISH WORD "UNIDOS" IN THE MARK IS "UNITED".

FOR MEDICAL ELECTROMETER USED TO CALIBRATE MEDICAL DIAGNOSTIC X-RAY MACHINES AND RADIATION THERAPY TREATMENT MACHINES (U.S. CLS. 26, 39 AND 44).

FIRST USE 7-13-1994; IN COMMERCE 10-7-1995.

WON TEAK OH, EXAMINING ATTORNEY

SN 78-803,522. PTW-NEW YORK CORPORATION, HICKSVILLE, NY. FILED 1-31-2006.

MULTIDOS

THE MARK CONSISTS OF STANDARD CHARACTERS WITHOUT CLAIM TO ANY PARTICULAR FONT, STYLE, SIZE, OR COLOR.

FOR MULTIPLE CHANNEL MEDICAL DOSIMETER THAT MEASURES THE RADIATION OUTPUT PRODUCED BY RADIATION THERAPY TREATMENT MACHINES (U.S. CLS. 26, 39 AND 44).

FIRST USE 6-10-1994; IN COMMERCE 12-5-1995.

WON TEAK OH, EXAMINING ATTORNEY

CLASS 10—(Continued).

SN 78-803,543. PTW-NEW YORK CORPORATION, HICKSVILLE, NY. FILED 1-31-2006.

DIAMENTOR

THE MARK CONSISTS OF STANDARD CHARACTERS WITHOUT CLAIM TO ANY PARTICULAR FONT, STYLE, SIZE, OR COLOR.

FOR MEDICAL DOSE METER THAT MEASURES THE TOTAL RADIATION DOSE RECEIVED BY A PATIENT DURING A DIAGNOSTIC PROCEDURE (U.S. CLS. 26, 39 AND 44).

FIRST USE 1-12-1959; IN COMMERCE 12-19-1960.
WON TEAK OH, EXAMINING ATTORNEY

SN 79-035,686. MÖLLER MEDICAL GMBH & CO. KG, FED REP GERMANY, FILED 2-24-2007.

LiquoGuard

THE MARK CONSISTS OF STANDARD CHARACTERS WITHOUT CLAIM TO ANY PARTICULAR FONT, STYLE, SIZE, OR COLOR.

OWNER OF INTERNATIONAL REGISTRATION 0916802 DATED 2-24-2007, EXPIRES 2-24-2017.

FOR SURGICAL, MEDICAL AND DENTAL APPARATUS AND INSTRUMENTS FOR USE IN THE DRAINAGE OF INTERNAL BODILY FLUIDS, NAMELY, DRAINAGE APPLIANCES FOR SURGICAL PURPOSES; APPARATUS AND INSTRUMENTS FOR VETERINARY SURGERY, NAMELY, SURGICAL AND MEDICAL APPARATUS AND INSTRUMENTS FOR USE IN GENERAL SURGERY (U.S. CLS. 26, 39 AND 44).

DAYNA BROWNE, EXAMINING ATTORNEY

SN 79-037,117. ERGODYNAMICS HOLDING B.V., NETHERLANDS, FILED 11-15-2006.

FLOW

THE MARK CONSISTS OF STANDARD CHARACTERS WITHOUT CLAIM TO ANY PARTICULAR FONT, STYLE, SIZE, OR COLOR.

PRIORITY DATE OF 5-16-2006 IS CLAIMED.

OWNER OF INTERNATIONAL REGISTRATION 0920500 DATED 11-15-2006, EXPIRES 11-15-2016.

FOR MEDICAL ERGONOMIC APPARATUS AND INSTRUMENTS, NAMELY CERVICAL PILLOWS, AIR PILLOWS, AND ELECTRIC HEATED PILLOWS TO PREVENT AND TO CURE SUCH CONDITIONS AS REPETITIVE STRAIN INJURY, DECUBITUS, BACKACHE, THROMBOSIS (U.S. CLS. 26, 39 AND 44).

WOODROW HARTZOG, EXAMINING ATTORNEY

CLASS 10—(Continued).

SN 79-037,869. CSÓKAY, ANDRÁS, HUNGARY, FILED 1-26-2007.

BETHLEHEM

OWNER OF INTERNATIONAL REGISTRATION 0922460 DATED 1-26-2007, EXPIRES 1-26-2017.

FOR SURGICAL APPARATUS AND INSTRUMENTS; FINGER GUARDS FOR MEDICAL PURPOSES; ELASTIC BANDAGES (U.S. CLS. 26, 39 AND 44).

TASHIA BUNCH, EXAMINING ATTORNEY

SN 79-045,674. ING. GIULIANO ROGGERO E C. S.A.S., ITALY, FILED 9-13-2007.

Diafuser

OWNER OF INTERNATIONAL REGISTRATION 0942144 DATED 9-13-2007, EXPIRES 9-13-2017.

THE COLOR(S) BLUE IS/ARE CLAIMED AS A FEATURE OF THE MARK.

THE COLOR BLUE APPEARS IN THE WORDING "DIAFUSER"

FOR MEDICAL APPARATUS, NAMELY, INFUSION AND INJECTION DEVICES FOR ADMINISTERING DRUGS (U.S. CLS. 26, 39 AND 44).

JUSTINE D. PARKER, EXAMINING ATTORNEY

CLASS 11—ENVIRONMENTAL CONTROL APPARATUS

SN 76-679,720. WINDSOR SMITH HOMES, INC., BRENTWOOD, CA. FILED 7-20-2007.

WINDSOR SMITH HOME

THE MARK CONSISTS OF STANDARD CHARACTERS WITHOUT CLAIM TO ANY PARTICULAR FONT, STYLE, SIZE, OR COLOR.

NO CLAIM IS MADE TO THE EXCLUSIVE RIGHT TO USE "HOME", APART FROM THE MARK AS SHOWN.

THE NAME SHOWN IN THE MARK IDENTIFIES WINDSOR SMITH WHOSE CONSENT IS OF RECORD.

FOR INDOOR AND OUTDOOR ELECTRICAL LIGHTING FIXTURES AND LAMPS; PLUMBING FIXTURES, NAMELY, SINK TRAPS, SINK SPRAYERS, SHOWER SPRAYERS, SHOWER MIXERS (U.S. CLS. 13, 21, 23, 31 AND 34).

MIDGE BUTLER, EXAMINING ATTORNEY

CLASS 11—(Continued).

SN 76-682,613. KRAFT ENERGY SYSTEMS, INC., FORT WORTH, TX. FILED 10-5-2007.



THE COLOR(S) RED, BLACK AND WHITE IS/ARE CLAIMED AS A FEATURE OF THE MARK.

THE MARK CONSISTS OF A STYLIZED "KE", CONSISTING OF A CHEVRON AND THREE BARS IN A RED FONT TO THE LEFT OF THE WORDS "KRAFTENERGY". THE COLOR BLACK APPEARS IN THE WORD "KRAFT" AND THE COLOR WHITE WITH BLACK OUTLINING APPEARS IN THE WORD "ENERGY".

FOR CURING APPARATUS FOR MANUFACTURING CONCRETE PRODUCTS AND HEATING APPARATUS FOR AGGREGATE SILOS (U.S. CLS. 13, 21, 23, 31 AND 34).

FIRST USE 3-18-1999; IN COMMERCE 3-18-1999.
CYNTHIA SLOAN, EXAMINING ATTORNEY

SN 76-682,615. SATCO PRODUCTS, INC., BRENTWOOD, NY. FILED 10-4-2007.

GREEN MATTERS

THE MARK CONSISTS OF STANDARD CHARACTERS WITHOUT CLAIM TO ANY PARTICULAR FONT, STYLE, SIZE, OR COLOR.

FOR ELECTRICAL LIGHT BULBS, LIGHTING FIXTURES AND PARTS THEREOF (U.S. CLS. 13, 21, 23, 31 AND 34).

NICHOLAS ALTREE, EXAMINING ATTORNEY

SN 76-682,676. SHARP KABUSHIKI KAISHA, TA SHARP CORPORATION, OSAKA 545-8522, JAPAN, FILED 10-4-2007.

TWINTOUCH

THE MARK CONSISTS OF STANDARD CHARACTERS WITHOUT CLAIM TO ANY PARTICULAR FONT, STYLE, SIZE, OR COLOR.

FOR MICROWAVE OVENS FOR COMMERCIAL USE (U.S. CLS. 13, 21, 23, 31 AND 34).

DANIEL BRODY, EXAMINING ATTORNEY

CLASS 11—(Continued).

SN 76-978,561. EMERSON ELECTRIC CO., ST. LOUIS, MO. FILED 10-13-2000.



OWNER OF U.S. REG. NOS. 111,931, 1,820,423 AND OTHERS.

THE STIPPLING IS A FEATURE OF THE MARK.

FOR PLUMBING EQUIPMENT, NAMELY, SINK STRAINERS, BIBBS, COCKS, VALVES, TRAPS, VALVE BULBS, CONES, HOT WATER HEATERS; PORTABLE ELECTRIC HEATERS; OVEN GAS IGNITERS; THERMOSTATIC VALVES; ELECTRIC LIGHTING FIXTURES FOR COMMERCIAL USE; HOT WATER AND STEAM BOILERS; PLUMBING FITTINGS, NAMELY, VALVES FOR FLUID CONTROL; COMMERCIAL AND INDUSTRIAL AIR AND GAS HEATING ELEMENTS, NAMELY, CONTROLS, SENSORS, BANDS, NOZZLES, BLOWERS, HOT WATER BOILERS, STEAM BOILERS, STRIP HEATERS, TUBULAR COOLING ELEMENTS, RANGE SURFACE ELEMENTS AND HOT PLATES AND REPLACEMENT PARTS THEREFOR; HOT WATER HEATERS AND DISPENSERS; IRRIGATION EQUIPMENT, NAMELY, AGRICULTURAL IRRIGATION UNITS AND REPLACEMENT PARTS THEREFOR, HOSES, NOZZLES, SPRINKLERS, HOSE END SPRAYERS, COUPLINGS, HANGERS, REELS, HOSE CONNECTORS, PISTOL GRIPS AND COUPLERS; PORTABLE ELECTRIC HEATERS AND REPLACEMENT PARTS THEREFOR; ELECTRIC RADIANT HEATERS FOR HOUSEHOLD USE AND REPLACEMENT PARTS THEREFOR; WATER FOUNTAINS AND REPLACEMENT PARTS THEREFOR; WATER FOUNTAIN COMPONENTS, NAMELY, TEMPERATURE CONTROL VALVES, THERMOSTATS, HEATERS AND FAUCETS (U.S. CLS. 13, 21, 23, 31 AND 34).

PAULA MAHONEY, EXAMINING ATTORNEY

SN 77-114,358. HOFFMAN, DAVID N., GOLDEN, CO. FILED 2-23-2007.

NORLITE

FOR FLASHLIGHTS (U.S. CLS. 13, 21, 23, 31 AND 34). FIRST USE 6-1-2006; IN COMMERCE 6-1-2006.

MICHAEL GAFFAR, EXAMINING ATTORNEY

CLASS 11—(Continued).

SN 77-117,344. SEARS BRANDS, LLC, HOFFMAN ESTATES, IL. FILED 2-27-2007.

SENSACOOK

THE MARK CONSISTS OF STANDARD CHARACTERS WITHOUT CLAIM TO ANY PARTICULAR FONT, STYLE, SIZE, OR COLOR.

FOR COMPONENT FEATURE OF STOVES, RANGES, COOKTOPS, AND OVENS, NAMELY, A SMART BURNER THAT USES RADIO WAVES GENERATED BY AN ANTENNA PLACED BENEATH THE BURNER TO SENSE THE PRESENCE OF A POT AND/OR PAN, AUTOMATICALLY HEATS THE COMBINATION OF BURNERS THAT BEST FITS THE POT OR PAN, DETERMINES IF A POT/PAN HAS BEEN REMOVED AND AUTOMATICALLY SHUTS OFF ACCORDINGLY, AND DETERMINES WHETHER OR NOT THE OBJECTS ARE LIGHT WEIGHT, METAL OR NON-METAL ITEMS THAT SHOULD OR SHOULD NOT BE HEATED (U.S. CLS. 13, 21, 23, 31 AND 34).

TINA L. SNAPP, EXAMINING ATTORNEY

SN 77-119,768. PENTAIR FILTRATION, INC., SHEBOYGAN, WI. FILED 3-1-2007.

TWISTER

THE MARK CONSISTS OF STANDARD CHARACTERS WITHOUT CLAIM TO ANY PARTICULAR FONT, STYLE, SIZE, OR COLOR.

FOR DRINKING WATER TREATMENT SYSTEMS FOR HOUSEHOLD USE USING REPLACEABLE CARTRIDGES CONSISTING PRIMARILY OF REPLACEABLE CARTRIDGE FILTRATION UNITS AND MOUNTING BRACKETS TO ATTACH AND FACILITATE REPLACEMENT OF THE CARTRIDGE FILTRATION UNITS (U.S. CLS. 13, 21, 23, 31 AND 34).

Laurie Mayes, Examining Attorney

SN 77-120,868. THE REALLY COOL LIGHTBOX CO., INC., TUCSON, AZ. FILED 3-2-2007.

THE REALLY COOL NIGHT LIGHT!

THE MARK CONSISTS OF STANDARD CHARACTERS WITHOUT CLAIM TO ANY PARTICULAR FONT, STYLE, SIZE, OR COLOR.

NO CLAIM IS MADE TO THE EXCLUSIVE RIGHT TO USE "NIGHT LIGHT", APART FROM THE MARK AS SHOWN.

FOR ELECTRIC NIGHT LIGHT KITS CONSISTING PRIMARILY OF ELECTRIC NIGHT LIGHTS (U.S. CLS. 13, 21, 23, 31 AND 34).

FIRST USE 2-23-2007; IN COMMERCE 2-23-2007.
ZHALEH DELANEY, EXAMINING ATTORNEY

CLASS 11—(Continued).

SN 77-130,557. GARY WILLIAMS, WADSWORTH, OH. FILED 3-14-2007.

LEAK READY!

NO CLAIM IS MADE TO THE EXCLUSIVE RIGHT TO USE "LEAK", APART FROM THE MARK AS SHOWN.

FOR ROOF WATER DIVERSION KIT FOR FUNNELING LEAKS INTO A RECEPTACLE COMPRISED OF A FIVE-FOOT BY FIVE-FOOT TARPAULIN, 50-FOOT, FOUR-PLY GARDEN HOSE, SIX-GALLON BUCKET, SHUT-OFF CLAMP, SIX GALVANIZED WIRES AND EIGHT NON-METAL TIE DOWNS (U.S. CLS. 13, 21, 23, 31 AND 34).

FIRST USE 2-19-2007; IN COMMERCE 2-19-2007.
IRA J. GOODSaid, EXAMINING ATTORNEY

SN 77-135,169. TAISEI GIKEN, ADACHI-KU, TOKYO, JAPAN, FILED 3-20-2007.

TAISEI GIKEN

THE MARK CONSISTS OF STANDARD CHARACTERS WITHOUT CLAIM TO ANY PARTICULAR FONT, STYLE, SIZE, OR COLOR.

NO CLAIM IS MADE TO THE EXCLUSIVE RIGHT TO USE "GIKEN", APART FROM THE MARK AS SHOWN.

THE FOREIGN WORDING IN THE MARK TRANSLATES INTO ENGLISH AS "TAISEI" WHICH MEANS "BE PERFECTED," "ATTAIN GREATNESS" OR "ACHIEVE GREAT SUCCESS." "GIKEN" MEANS "ENGINEERING" OR "TECHNOLOGY RESEARCH".

FOR GAS CLEANING AND PURIFYING APPARATUS, NAMELY, APPARATUS TO REMOVE PARTICLES IN THE EXHAUST GAS FROM SEMICONDUCTOR MANUFACTURING MACHINES AND/OR LCD MANUFACTURING MACHINES; OIL PURIFYING INSTALLATIONS (U.S. CLS. 13, 21, 23, 31 AND 34).

FIRST USE 4-0-2001; IN COMMERCE 4-0-2001.
KAREN K. BUSH, EXAMINING ATTORNEY

CLASS 11—(Continued).

SN 77-135,248. TAISEI GIKEN KABUSHIKI KAISHA, TA TAISEI GIKEN CO., LTD., ADACHI-KU, TOKYO, JAPAN, FILED 3-20-2007.

SUN OIL CLEANER

THE MARK CONSISTS OF STANDARD CHARACTERS WITHOUT CLAIM TO ANY PARTICULAR FONT, STYLE, SIZE, OR COLOR.

NO CLAIM IS MADE TO THE EXCLUSIVE RIGHT TO USE "OIL CLEANER", APART FROM THE MARK AS SHOWN.

FOR OIL CLEANING AND PURIFYING APPARATUS, NAMELY, VACUUM OR COIL-BASED APPARATUS FOR REMOVAL OF CONTAMINANTS SUCH AS ACIDS, GASES, WATER AND PARTICLES (U.S. CLS. 13, 21, 23, 31 AND 34).

FIRST USE 4-0-2001; IN COMMERCE 4-0-2001.
SIMON TENG, EXAMINING ATTORNEY

SN 77-138,859. ESTECH, LLC, COLUMBUS, OH. FILED 3-23-2007.

WATERCYCLE

THE MARK CONSISTS OF STANDARD CHARACTERS WITHOUT CLAIM TO ANY PARTICULAR FONT, STYLE, SIZE, OR COLOR.

THE WORDLING "WATERCYCLE" HAS NO MEANING IN A FOREIGN LANGUAGE.

FOR WATER TREATMENT EQUIPMENT, NAMELY, WATER EVAPORATION UNITS USED IN CONJUNCTION WITH SOLID WASTE TREATMENT EQUIPMENT (U.S. CLS. 13, 21, 23, 31 AND 34).

TEJBIR SINGH, EXAMINING ATTORNEY

SN 77-139,252. ESTECH, LLC, COLUMBUS, OH. FILED 3-23-2007.

FIBRECYCLE

THE MARK CONSISTS OF STANDARD CHARACTERS WITHOUT CLAIM TO ANY PARTICULAR FONT, STYLE, SIZE, OR COLOR.

OWNER OF U.S. REG. NOS. 2,992,915 AND 3,169,113.

FOR SOLID WASTE TREATMENT EQUIPMENT, NAMELY, AUTOCLAVES FOR SOLID WASTE REDUCTION AND PROCESSING (U.S. CLS. 13, 21, 23, 31 AND 34).

TEJBIR SINGH, EXAMINING ATTORNEY

CLASS 11—(Continued).

SN 77-142,633. FRYMASTER LLC, SHREVEPORT, LA. FILED 3-28-2007.

OIL ATTENDANT

THE MARK CONSISTS OF STANDARD CHARACTERS WITHOUT CLAIM TO ANY PARTICULAR FONT, STYLE, SIZE, OR COLOR.

NO CLAIM IS MADE TO THE EXCLUSIVE RIGHT TO USE "OIL", APART FROM THE MARK AS SHOWN.

FOR GAS AND ELECTRIC COMMERCIAL FRYERS, COMPONENTS FOR GAS AND ELECTRIC COMMERCIAL FRYERS, NAMELY, FILTER MODULES, SENSORS AND DEVICES FOR MONITORING OIL (U.S. CLS. 13, 21, 23, 31 AND 34).

JAMES A. RAUEN, EXAMINING ATTORNEY

SN 77-153,970. ESTECH, LLC, COLUMBUS, OH. FILED 4-11-2007.

POWERCYCLE

THE MARK CONSISTS OF STANDARD CHARACTERS WITHOUT CLAIM TO ANY PARTICULAR FONT, STYLE, SIZE, OR COLOR.

FOR SOLID WASTE TREATMENT EQUIPMENT, NAMELY, AUTOCLAVES FOR SOLID WASTE REDUCTION AND PROCESSING (U.S. CLS. 13, 21, 23, 31 AND 34).

TEJBIR SINGH, EXAMINING ATTORNEY

SN 77-183,563. TOTO LTD., KITAKYUSHU-SHI, JAPAN, FILED 5-17-2007.

RENESSE

THE MARK CONSISTS OF STANDARD CHARACTERS WITHOUT CLAIM TO ANY PARTICULAR FONT, STYLE, SIZE, OR COLOR.

FOR SHOWER SETS, NAMELY, VALVES AND SPOUTS FOR SHOWERS; SHOWER HEADS; HAND-HELD SHOWER SPRAYS; SHOWER BARS IN THE NATURE OF SHOWER FIXTURES COMPRISING SHOWER HEADS AND HAND-HELD SHOWER SPRAYERS; PLUMBING FIXTURES AND ACCESSORIES, NAMELY, FAUCETS; BALANCE PRESSURE UNITS; THERMOSTAT VALVES; TUB SETS, NAMELY, VALVES AND SPOUTS FOR TUBS; WATER VALVES FOR BATH DECKS (U.S. CLS. 13, 21, 23, 31 AND 34).

BARBARA BROWN, EXAMINING ATTORNEY

CLASS 11—(Continued).

SN 77-189,439. W.B.B.M. CORP., GLENVIEW, IL. FILED 5-24-2007.

Dr. Sanitizer

THE MARK CONSISTS OF STANDARD CHARACTERS WITHOUT CLAIM TO ANY PARTICULAR FONT, STYLE, SIZE, OR COLOR.

NO CLAIM IS MADE TO THE EXCLUSIVE RIGHT TO USE "SANITIZER", APART FROM THE MARK AS SHOWN.

FOR SANITIZING MACHINES USED TO CLEAN THE AIR, KILL GERMS AND BACTERIA, AND REMOVE ODOR FROM CLOTHES AND SHOES (U.S. CLS. 13, 21, 23, 31 AND 34).

KELLEY WELLS, EXAMINING ATTORNEY

SN 77-205,920. BEGHELLI NORTH AMERICA, MIRAMAR, FL. FILED 6-14-2007.

ILLUMINA

THE MARK CONSISTS OF STANDARD CHARACTERS WITHOUT CLAIM TO ANY PARTICULAR FONT, STYLE, SIZE, OR COLOR.

FOR ELECTRIC LUMINAIRES, LIGHT POST LUMINAIRES, LUMINAIRE REFRACTORS, FLUORESCENT LAMP SOURCES, NAMELY, FLORESCENT LAMPS AND FLUORESCENT LAMP TUBES; HIGH PERFORMANCE, HIGH EFFICIENCY LINEAR LUMINAIRES FOR INDOOR AND OUTDOOR INDUSTRIAL USE ENCASED IN A POLYCARBONATE CASING (U.S. CLS. 13, 21, 23, 31 AND 34).

FIRST USE 2-1-2001; IN COMMERCE 5-1-2002.
LA TONIA FISHER, EXAMINING ATTORNEY

SN 77-206,582. HANSA AGENCIES PTY LTD, NORTH MELBOURNE, AUSTRALIA, FILED 6-14-2007.

NITE STALKER

THE MARK CONSISTS OF STANDARD CHARACTERS WITHOUT CLAIM TO ANY PARTICULAR FONT, STYLE, SIZE, OR COLOR.

OWNER OF AUSTRALIA REG. NO. 807835, DATED 9-21-1999, EXPIRES 9-21-2009.

FOR LIGHTING INSTALLATIONS AND APPARATUS FOR AUTOMOBILES AND VEHICLES, NAMELY, HEADLIGHTS, DRIVING LIGHTS, AND SPOTLIGHTS; LIGHT BULBS; LAMP REFLECTORS AND REFLECTOR LIGHTS, INCLUDING VEHICLE REFLECTORS (U.S. CLS. 13, 21, 23, 31 AND 34).

MARK SPARACINO, EXAMINING ATTORNEY

CLASS 11—(Continued).

SN 77-221,390. RINNAI AMERICA CORP., PEACHTREE CITY, GA. FILED 7-3-2007.

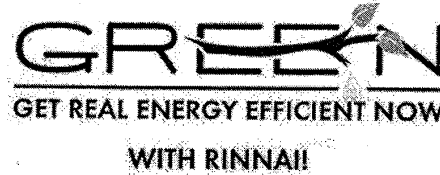

NO CLAIM IS MADE TO THE EXCLUSIVE RIGHT TO USE "GREEN", APART FROM THE MARK AS SHOWN.

THE MARK CONSISTS OF A STYLIZED VERSION OF THE WORD "GREEN" INCLUDING A TREE BRANCH WITH LEAVES CROSSING OVER THE LETTERS "EE" AND THE WORDING "GET REAL ENERGY EFFICIENT NOW WITH RINNAI!"

FOR FIREPLACES, HOT WATER HEATERS, CONVECTION HEATERS, FURNACES, AND GAS SPACE HEATERS; APPLIANCES FOR DOMESTIC USE, NAMELY, GAS STOVES AND COOK TOPS, GAS RICE COOKERS (U.S. CLS. 13, 21, 23, 31 AND 34).

DAVID MURRAY, EXAMINING ATTORNEY

SN 77-251,453. SONG BATH LLC, NEW CANAAN, CT. FILED 8-9-2007.

SONG

**Bath & Kitchen Masterpieces
The Leader in Style and Price**

NO CLAIM IS MADE TO THE EXCLUSIVE RIGHT TO USE "BATH & KITCHEN" AND "THE LEADER IN STYLE AND PRICE", APART FROM THE MARK AS SHOWN.

THE COLOR(S) RED IS/ARE CLAIMED AS A FEATURE OF THE MARK.

THE MARK CONSISTS OF THE WORD "SONG" IN CAPITAL RED LETTERS, ABOVE THE PHRASES "BATH & KITCHEN MASTERPIECES" AND "THE LEADER IN STYLE AND PRICE" IN BLACK LETTERS.

FOR BATHTUBS, SINKS, BATHTUB LEGS, AND BATHTUB DRAIN ASSEMBLIES (U.S. CLS. 13, 21, 23, 31 AND 34).

ALLISON HOLTZ, EXAMINING ATTORNEY

SN 77-251,469. SONG BATH LLC, NEW CANAAN, CT. FILED 8-9-2007.

Bath & Kitchen Masterpieces

THE MARK CONSISTS OF STANDARD CHARACTERS WITHOUT CLAIM TO ANY PARTICULAR FONT, STYLE, SIZE, OR COLOR.

NO CLAIM IS MADE TO THE EXCLUSIVE RIGHT TO USE "BATH & KITCHEN", APART FROM THE MARK AS SHOWN.

FOR BATHTUBS, SINKS, BATHTUB LEGS, AND BATHTUB DRAIN ASSEMBLIES (U.S. CLS. 13, 21, 23, 31 AND 34).

ALLISON HOLTZ, EXAMINING ATTORNEY

CLASS 11—(Continued).

SN 77-253,988. TRUE MANUFACTURING CO., INC., O'FAL-
LON, MO. FILED 8-13-2007.

THE ART OF COOL

THE MARK CONSISTS OF STANDARD CHARACTERS
WITHOUT CLAIM TO ANY PARTICULAR FONT, STYLE,
SIZE, OR COLOR.

FOR REFRIGERATORS AND REFRIGERATED COOL-
ERS (U.S. CLS. 13, 21, 23, 31 AND 34).

DAVID H. STINE, EXAMINING ATTORNEY

SN 77-254,056. TRUE MANUFACTURING CO., INC., O'FAL-
LON, MO. FILED 8-13-2007.

THE INNOVATION OF COLD

THE MARK CONSISTS OF STANDARD CHARACTERS
WITHOUT CLAIM TO ANY PARTICULAR FONT, STYLE,
SIZE, OR COLOR.

FOR REFRIGERATORS AND REFRIGERATED COOL-
ERS (U.S. CLS. 13, 21, 23, 31 AND 34).

DAVID H. STINE, EXAMINING ATTORNEY

SN 77-262,007. HENNING INNOVATIONS L.L.C., ROBERTS-
DALE, AL. FILED 8-22-2007.

AQUA-CHI

THE MARK CONSISTS OF STANDARD CHARACTERS
WITHOUT CLAIM TO ANY PARTICULAR FONT, STYLE,
SIZE, OR COLOR.

FOR APPARATUS FOR USE IN HYDROTHERAPY
SPAS AND FOOTBATHS, NAMELY, WATER CONDI-
TIONING UNITS (U.S. CLS. 13, 21, 23, 31 AND 34).

FIRST USE 8-0-2000; IN COMMERCE 8-0-2000.

JENNIFER VASQUEZ, EXAMINING ATTORNEY

CLASS 11—(Continued).

SN 77-267,120. AIRCODE USA, INC., DOVER, FL. FILED 8-
29-2007.

Aircode

THE MARK CONSISTS OF STANDARD CHARACTERS
WITHOUT CLAIM TO ANY PARTICULAR FONT, STYLE,
SIZE, OR COLOR.

FOR AIR PURIFICATION UNITS; AIR PURIFIERS;
AIR PURIFYING UNITS FOR COMMERCIAL AND
INDUSTRIAL USE (U.S. CLS. 13, 21, 23, 31 AND 34).

FIRST USE 12-1-2004; IN COMMERCE 12-1-2004.

EVELYN BRADLEY, EXAMINING ATTORNEY

SN 77-269,127. ERIVATIONS, INC., CALEDONIA, MI. FILED
8-31-2007.

HOTPOD

THE MARK CONSISTS OF STANDARD CHARACTERS
WITHOUT CLAIM TO ANY PARTICULAR FONT, STYLE,
SIZE, OR COLOR.

FOR HEATING AND COOLING APPARATUS,
NAMELY, ELECTRIC SUPPLEMENTAL HEATING
AND COOLING DEVICES FOR USE IN CONTROLLING
ROOM TEMPERATURE (U.S. CLS. 13, 21, 23, 31 AND 34).

BRIAN CALLAGHAN, EXAMINING ATTORNEY

SN 77-274,058. PACIFIC CORNETTA, INC., TUALATIN, OR.
FILED 9-7-2007.

POWER HUNT

THE MARK CONSISTS OF STANDARD CHARACTERS
WITHOUT CLAIM TO ANY PARTICULAR FONT, STYLE,
SIZE, OR COLOR.

NO CLAIM IS MADE TO THE EXCLUSIVE RIGHT TO
USE "POWER", APART FROM THE MARK AS SHOWN.

FOR ELECTRICAL DEVICES FOR PERSONAL USE
OR FOOD AND BEVERAGE PREPARATION THAT ARE
POWERED BY DC POWER FROM A BATTERY,
NAMELY, HAIR DRIERS, COFFEE MAKERS, SAND-
WICH MAKERS, CONTACT GRILLS, AND SPACE HEAT-
ERS, THAT ARE CONFIGURED TO FUNCTION WITH
A DC POWER SOURCE (U.S. CLS. 13, 21, 23, 31 AND 34).

LINDA MICKLEBURGH, EXAMINING ATTORNEY

CLASS 11—(Continued).

SN 77-276,779. MAURA DANIEL, INC., CULVER CITY, CA. FILED 9-11-2007.

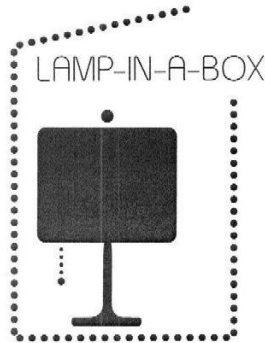

NO CLAIM IS MADE TO THE EXCLUSIVE RIGHT TO USE "LAMP-IN-A-BOX", APART FROM THE MARK AS SHOWN.

THE MARK CONSISTS OF A SILHOUETTE OF A TABLE LAMP FRAMED BY A DOTTED RECTANGLE WITH THE TOP BORDER ANGLED SLIGHTLY UPWARD TO SUGGEST THE OPEN LID OF A BOX, AND THE WORDING "LAMP-IN-A-BOX" APPEARING ABOVE THE LAMP AND BELOW THE TOP BORDER OF THE BOX.

FOR TABLE LAMPS (U.S. CLS. 13, 21, 23, 31 AND 34).
MICHAEL GAFFAR, EXAMINING ATTORNEY

SN 77-281,418. PEARLESSENCE, LTD., CLEVELAND, OH. FILED 9-17-2007.

Sniff Scent

THE MARK CONSISTS OF STANDARD CHARACTERS WITHOUT CLAIM TO ANY PARTICULAR FONT, STYLE, SIZE, OR COLOR.

NO CLAIM IS MADE TO THE EXCLUSIVE RIGHT TO USE "SCENT", APART FROM THE MARK AS SHOWN.

FOR DIFFUSERS FOR ROOM FRESHENING PURPOSES, NAMELY, NON-POWERED REED DIFFUSERS; FRAGRANCE DISPENSING UNITS (U.S. CLS. 13, 21, 23, 31 AND 34).

FIRST USE 5-0-2007; IN COMMERCE 7-0-2007.
LINDSEY RUBIN, EXAMINING ATTORNEY

CLASS 11—(Continued).

SN 77-287,503. FLEETWOOD GAMING, INC., BILLINGS, MT. FILED 9-24-2007.

BRILLIANT CONCEPTS

THE MARK CONSISTS OF STANDARD CHARACTERS WITHOUT CLAIM TO ANY PARTICULAR FONT, STYLE, SIZE, OR COLOR.

FOR LIGHTING FIXTURES (U.S. CLS. 13, 21, 23, 31 AND 34).

CURTIS FRENCH, EXAMINING ATTORNEY

SN 77-288,456. XALOY INCORPORATED, NEW CASTLE, PA. FILED 9-25-2007.

nXheat

THE MARK CONSISTS OF STANDARD CHARACTERS WITHOUT CLAIM TO ANY PARTICULAR FONT, STYLE, SIZE, OR COLOR.

FOR INDUCTION HEATERS FOR INDUSTRIAL USE IN THE MOLDING OF PLASTICS (U.S. CLS. 13, 21, 23, 31 AND 34).

CHARISMA HAMPTON, EXAMINING ATTORNEY

SN 77-289,085. GROTE INDUSTRIES, INC., MADISON, IN. FILED 9-26-2007.

SUPERNOVA

THE MARK CONSISTS OF STANDARD CHARACTERS WITHOUT CLAIM TO ANY PARTICULAR FONT, STYLE, SIZE, OR COLOR.

OWNER OF U.S. REG. NO. 2,177,188.
FOR VEHICLE LAMPS, NAMELY, MARKER, STOP AND TAIL LAMPS (U.S. CLS. 13, 21, 23, 31 AND 34).

FIRST USE 4-6-1998; IN COMMERCE 4-15-1998.
NAPOLEON SHARMA, EXAMINING ATTORNEY

CLASS 11—(Continued).

SN 77-290,074. SUNBEAM PRODUCTS, INC., BOCA RATON, FL. FILED 9-27-2007.

LITTLE DIPPER

THE MARK CONSISTS OF STANDARD CHARACTERS WITHOUT CLAIM TO ANY PARTICULAR FONT, STYLE, SIZE, OR COLOR.

FOR ELECTRIC FOOD WARMER (U.S. CLS. 13, 21, 23, 31 AND 34).

FIRST USE 9-1-1997; IN COMMERCE 9-1-1997.
BRENDAN REGAN, EXAMINING ATTORNEY

SN 77-290,324. HANS GROHE AG, SCHILTACH, FED REP GERMANY, FILED 9-27-2007.

WHO DO YOU SHOWER WITH

THE MARK CONSISTS OF STANDARD CHARACTERS WITHOUT CLAIM TO ANY PARTICULAR FONT, STYLE, SIZE, OR COLOR.

FOR SHOWER SYSTEMS CONSISTING PRIMARILY OF SHOWERS, SHOWERHEADS, HANDSHOWERS AND SLIDE BARS THEREFOR; SHOWERPANELS; BODY SPRAYS; PIPES BEING PARTS OF SANITARY FACILITIES, NAMELY, SANITARY FLEXIBLE TUBES, SPRAY NOZZLES, BEING PARTS FOR MULTIFUNCTION SHOWERS (U.S. CLS. 13, 21, 23, 31 AND 34).

JERI J. FICKES, EXAMINING ATTORNEY

SN 77-291,114. TEKQUEST INDUSTRIES CORPORATION, SANFORD, FL. FILED 9-28-2007.

Coffee Flavor Guard

THE MARK CONSISTS OF STANDARD CHARACTERS WITHOUT CLAIM TO ANY PARTICULAR FONT, STYLE, SIZE, OR COLOR.

FOR WATER FILTERS (U.S. CLS. 13, 21, 23, 31 AND 34).

DOMINICK J. SALEMI, EXAMINING ATTORNEY

CLASS 11—(Continued).

SN 77-291,420. BEMIS MANUFACTURING COMPANY, SHEBOYGAN FALLS, WI. FILED 9-28-2007.

NEXTSTEP

THE MARK CONSISTS OF STANDARD CHARACTERS WITHOUT CLAIM TO ANY PARTICULAR FONT, STYLE, SIZE, OR COLOR.

FOR TOILET SEATS (U.S. CLS. 13, 21, 23, 31 AND 34).
KATHLEEN LORENZO, EXAMINING ATTORNEY

SN 77-291,571. STERIL-AIRE, INC., BURBANK, CA. FILED 9-28-2007.

PURE AIR. REAL SCIENCE.

THE MARK CONSISTS OF STANDARD CHARACTERS WITHOUT CLAIM TO ANY PARTICULAR FONT, STYLE, SIZE, OR COLOR.

NO CLAIM IS MADE TO THE EXCLUSIVE RIGHT TO USE "AIR", APART FROM THE MARK AS SHOWN.

FOR AIR CLEANING UNITS; AIR FILTERS FOR DOMESTIC USE; AIR PURIFICATION UNITS; AIR PURIFIERS; HOUSEHOLD AIR CLEANERS; ULTRAVIOLET LAMPS NOT FOR MEDICAL PURPOSES (U.S. CLS. 13, 21, 23, 31 AND 34).

MICHAEL KEATING, EXAMINING ATTORNEY

SN 77-291,578. STERIL-AIRE, INC., BURBANK, CA. FILED 9-28-2007.

STERIL-ZONE

THE MARK CONSISTS OF STANDARD CHARACTERS WITHOUT CLAIM TO ANY PARTICULAR FONT, STYLE, SIZE, OR COLOR.

FOR AIR CLEANING UNITS; AIR FILTERS FOR DOMESTIC USE; AIR PURIFICATION UNITS; AIR PURIFIERS; HOUSEHOLD AIR CLEANERS; ULTRAVIOLET LAMPS NOT FOR MEDICAL PURPOSES (U.S. CLS. 13, 21, 23, 31 AND 34).

MICHAEL KEATING, EXAMINING ATTORNEY

CLASS 11—(Continued).

SN 77-292,940. TOTO, U.S.A., INC., MORROW, GA. FILED 10-1-2007.

GWYNETH

THE MARK CONSISTS OF STANDARD CHARACTERS WITHOUT CLAIM TO ANY PARTICULAR FONT, STYLE, SIZE, OR COLOR.
FOR TOILETS (U.S. CLS. 13, 21, 23, 31 AND 34).
BARBARA A. GOLD, EXAMINING ATTORNEY

SN 77-293,272. CHARLESS GRILLING SYSTEMS, LLC, WOLCOTT, CO. FILED 10-1-2007.

CHARLESS

THE MARK CONSISTS OF STANDARD CHARACTERS WITHOUT CLAIM TO ANY PARTICULAR FONT, STYLE, SIZE, OR COLOR.
FOR BARBECUE GRILLS; CHARCOAL GRILLS; ELECTRIC GRILLS; ELECTRIC OUTDOOR GRILLS; GAS GRILLS (U.S. CLS. 13, 21, 23, 31 AND 34).
KATINA MISTER, EXAMINING ATTORNEY

SN 77-293,502. ESTECH, LLC, COLUMBUS, OH. FILED 10-2-2007.

ESTECH

THE MARK CONSISTS OF STANDARD CHARACTERS WITHOUT CLAIM TO ANY PARTICULAR FONT, STYLE, SIZE, OR COLOR.
FOR WATER TREATMENT EQUIPMENT, NAMELY, SEPARATORS, EVAPORATORS AND SPRAY DRYERS USED IN CONJUNCTION WITH SOLID WASTE TREATMENT EQUIPMENT (U.S. CLS. 13, 21, 23, 31 AND 34).
RUSS HERMAN, EXAMINING ATTORNEY

CLASS 11—(Continued).

SN 77-293,528. NEONLITE ELECTRONIC & LIGHTING (H.K.) LIMITED, TSIM SHA TSUI, KOWLOON, HONG KONG, FILED 10-2-2007.

DIMMERABLE

THE MARK CONSISTS OF STANDARD CHARACTERS WITHOUT CLAIM TO ANY PARTICULAR FONT, STYLE, SIZE, OR COLOR.
FOR ELECTRIC LANTERNS; ELECTRIC LIGHT BULBS; ELECTRIC LAMPS; LAMPS; SAFETY LAMPS FOR UNDERGROUND USE; ELECTRIC LIGHTING APPARATUS, NAMELY, TRACK LIGHTING UNITS; LIGHTING TUBES, NAMELY, LUMINOUS TUBES FOR LIGHTING; ELECTRIC TORCHES FOR LIGHTING; LIGHTING TUBES, NAMELY, DISCHARGE TUBES FOR LIGHTING; SOCKETS FOR ELECTRIC LIGHTS; STREET LIGHTS, NAMELY, STREET LIGHTING FIXTURES, LIGHT BULBS (U.S. CLS. 13, 21, 23, 31 AND 34).
AMY GEARIN, EXAMINING ATTORNEY

SN 77-293,709. CECILWARE CORPORATION, LONG ISLAND CITY, NY. FILED 10-2-2007.



THE MARK CONSISTS OF THREE ROLLERS WITHIN THE STYLIZED LETTER "C" AND THE STYLIZED WORDS "ROLLERWARE".
FOR ELECTRIC GRILLS (U.S. CLS. 13, 21, 23, 31 AND 34).
DAVID MILLER, EXAMINING ATTORNEY

SN 77-294,048. LAERA, VITO, FORT LAUDERDALE, FL. FILED 10-2-2007.

BEONI

THE MARK CONSISTS OF STANDARD CHARACTERS WITHOUT CLAIM TO ANY PARTICULAR FONT, STYLE, SIZE, OR COLOR.
FOR SINKS; FAUCETS (U.S. CLS. 13, 21, 23, 31 AND 34).
BENJAMIN ALLEN, EXAMINING ATTORNEY

CLASS 11—(Continued).

SN 77-294,066. LAERA, VITO, FORT LAUDERDALE, FL. FILED 10-2-2007.

VLANCO

THE MARK CONSISTS OF STANDARD CHARACTERS WITHOUT CLAIM TO ANY PARTICULAR FONT, STYLE, SIZE, OR COLOR.
FOR FAUCETS; SINKS (U.S. CLS. 13, 21, 23, 31 AND 34).
BENJAMIN ALLEN, EXAMINING ATTORNEY

SN 77-294,236. LTG, LTD., FARGO, ND. FILED 10-2-2007.

EARTH-TWIST

THE MARK CONSISTS OF STANDARD CHARACTERS WITHOUT CLAIM TO ANY PARTICULAR FONT, STYLE, SIZE, OR COLOR.
FOR FLUORESCENT LAMPS (U.S. CLS. 13, 21, 23, 31 AND 34).
CAROLINE WOOD, EXAMINING ATTORNEY

SN 77-295,711. ASHBROOK SIMON-HARTLEY OPERATIONS, LP, HOUSTON, TX. FILED 10-3-2007.

EKG +

THE MARK CONSISTS OF STANDARD CHARACTERS WITHOUT CLAIM TO ANY PARTICULAR FONT, STYLE, SIZE, OR COLOR.
NO CLAIM IS MADE TO THE EXCLUSIVE RIGHT TO USE "EKG", APART FROM THE MARK AS SHOWN.
FOR THICKENING AND DEWATERING MACHINES FOR USE IN TREATMENT OF LIQUIDS INCLUDING WATER, INDUSTRIAL EFFLUENT AND SEWAGE (U.S. CLS. 13, 21, 23, 31 AND 34).
JAMES LOVELACE, EXAMINING ATTORNEY

CLASS 11—(Continued).

SN 77-296,399. STAR MANUFACTURING INTERNATIONAL INC., ST. LOUIS, MO. FILED 10-4-2007.

CLAMSHELL

THE MARK CONSISTS OF STANDARD CHARACTERS WITHOUT CLAIM TO ANY PARTICULAR FONT, STYLE, SIZE, OR COLOR.
OWNER OF U.S. REG. NO. 1,658,144.
FOR COMMERCIAL COOKING GRIDDLE WITH HOOD ATTACHED (U.S. CLS. 13, 21, 23, 31 AND 34).
FIRST USE 10-5-1989; IN COMMERCE 10-5-1989.
WILLIAM VERHOSEK, EXAMINING ATTORNEY

SN 77-296,453. WOOD, ROBERT, JACKSONVILLE, FL. FILED 10-4-2007.

GERTIE'S JEWELS

THE MARK CONSISTS OF STANDARD CHARACTERS WITHOUT CLAIM TO ANY PARTICULAR FONT, STYLE, SIZE, OR COLOR.
THE NAME(S), PORTRAIT(S), AND/OR SIGNATURE(S) SHOWN IN THE MARK DOES NOT IDENTIFY A PARTICULAR LIVING INDIVIDUAL.
FOR AROMATHERAPY AND FRAGRANCE DISPENSING UNITS, AND REFILLS THEREFOR, SOLD AS A UNIT; REFILLS FOR AROMATHERAPY AND FRAGRANCE DISPENSING UNITS (U.S. CLS. 13, 21, 23, 31 AND 34).
WILLIAM VERHOSEK, EXAMINING ATTORNEY

SN 77-296,460. WOOD, ROBERT, JACKSONVILLE, FL. FILED 10-4-2007.

Powered by RaceScentz

THE MARK CONSISTS OF STANDARD CHARACTERS WITHOUT CLAIM TO ANY PARTICULAR FONT, STYLE, SIZE, OR COLOR.
FOR AROMATHERAPY AND FRAGRANCE DISPENSING UNITS, AND REFILLS THEREFOR, SOLD AS A UNIT; REFILLS FOR AROMATHERAPY AND FRAGRANCE DISPENSING UNITS (U.S. CLS. 13, 21, 23, 31 AND 34).
WILLIAM VERHOSEK, EXAMINING ATTORNEY

CLASS 11—(Continued).

SN 77-296,472. SCHULD, DANIEL E., HAMPSHIRE, IL. FILED 10-4-2007.

HumidiGreen

THE MARK CONSISTS OF STANDARD CHARACTERS WITHOUT CLAIM TO ANY PARTICULAR FONT, STYLE, SIZE, OR COLOR.
FOR HUMIDIFIERS (U.S. CLS. 13, 21, 23, 31 AND 34).
ODESSA BIBBINS, EXAMINING ATTORNEY

SN 77-296,487. ALEN CORPORATION, AUSTIN, TX. FILED 10-4-2007.

THE COLOR(S) GREEN IS/ARE CLAIMED AS A FEATURE OF THE MARK.
THE MARK CONSISTS OF STYLIZED LETTERS OF "ALEN" IN GREEN WITH A LOOPING L.
FOR AIR PURIFICATION UNITS (U.S. CLS. 13, 21, 23, 31 AND 34).
FIRST USE 4-10-2005; IN COMMERCE 5-1-2005.
LAURIE MAYES, EXAMINING ATTORNEY

SN 77-297,534. BRIGGS PLUMBING PRODUCTS, INC., GOOSE CREEK, SC. FILED 10-5-2007.

SPOLETO

THE MARK CONSISTS OF STANDARD CHARACTERS WITHOUT CLAIM TO ANY PARTICULAR FONT, STYLE, SIZE, OR COLOR.
FOR SINKS AND TOILETS (U.S. CLS. 13, 21, 23, 31 AND 34).
JOHN GARTNER, EXAMINING ATTORNEY

CLASS 11—(Continued).

SN 77-304,142. SUNBEAM PRODUCTS, INC., BOCA RATON, FL. FILED 10-15-2007.

SUNBEAM

THE MARK CONSISTS OF STANDARD CHARACTERS WITHOUT CLAIM TO ANY PARTICULAR FONT, STYLE, SIZE, OR COLOR.
OWNER OF U.S. REG. NOS. 145,335, 280,756 AND OTHERS.
FOR WATER FILTER SYSTEMS, NAMELY, WATER FILTERS BEING PART OF PITCHERS AND JUGS (U.S. CLS. 13, 21, 23, 31 AND 34).
FIRST USE 10-9-2002; IN COMMERCE 10-9-2002.
BRENDAN REGAN, EXAMINING ATTORNEY

SN 77-304,949. SUNBEAM PRODUCTS, INC., BOCA RATON, FL. FILED 10-16-2007.

SUNBEAM

THE MARK CONSISTS OF STANDARD CHARACTERS WITHOUT CLAIM TO ANY PARTICULAR FONT, STYLE, SIZE, OR COLOR.
OWNER OF U.S. REG. NOS. 145,335, 280,756 AND OTHERS.
FOR ELECTRIC LIGHTING PRODUCTS, NAMELY, LIGHT BULBS, NIGHT LIGHTS, FLICKERING LIGHTS, ROPE LIGHTS, NIGHTLIGHT SHADES, LAMPS, AND DECORATIVE BASES FOR LIGHT BULBS (U.S. CLS. 13, 21, 23, 31 AND 34).
FIRST USE 11-15-2002; IN COMMERCE 11-15-2002.
BRENDAN REGAN, EXAMINING ATTORNEY

SN 77-305,226. SUNBEAM PRODUCTS, INC., BOCA RATON, FL. FILED 10-16-2007.

SUNBEAM

THE MARK CONSISTS OF STANDARD CHARACTERS WITHOUT CLAIM TO ANY PARTICULAR FONT, STYLE, SIZE, OR COLOR.
OWNER OF U.S. REG. NOS. 145,335, 280,756 AND OTHERS.
FOR REFRIGERATION PRODUCTS, NAMELY, AIR CONDITIONERS, DEHUMIDIFIERS, ICE MAKERS, AND WATER AND BEVERAGE COOLERS (U.S. CLS. 13, 21, 23, 31 AND 34).
FIRST USE 4-2-2003; IN COMMERCE 4-2-2003.
BRENDAN REGAN, EXAMINING ATTORNEY

CLASS 11—(Continued).

SN 77-316,683. ARTISAN MANUFACTURING CORPORATION, NEW YORK, NY. FILED 10-30-2007.

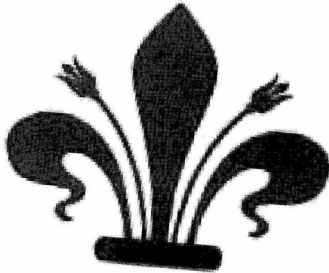

FOR SINKS (U.S. CLS. 13, 21, 23, 31 AND 34).
FIRST USE 8-21-2003; IN COMMERCE 8-21-2003.
NAKIA HENRY, EXAMINING ATTORNEY

SN 77-325,515. CHUCK HENKEL, ARLINGTON, VA. FILED 11-9-2007.



THE COLOR(S) BLUE AND RED IS/ARE CLAIMED AS A FEATURE OF THE MARK.

THE MARK CONSISTS OF THE WORD "ECO" IN BLUE AND THE WORD HEATER IN RED WITH A BLUE CURVED LINE UNDER THE WORD "ECO" AND A RED CURVED LINE ABOVE THE WORD HEATER.

FOR ELECTRIC WALL-MOUNTED HEATERS AND ELECTRIC PANEL HEATERS (U.S. CLS. 13, 21, 23, 31 AND 34).

JOHN SCHUYLER YARD, EXAMINING ATTORNEY

SN 77-346,803. NEONLITE ELECTRONIC & LIGHTING (H.K.) LIMITED, KOWLOON, HONG KONG, FILED 12-7-2007.



OWNER OF U.S. REG. NOS. 2,835,810 AND 3,319,016.
FOR HOT WATER BOILERS, HOT WATER HEATERS, AIR CONDITIONERS, REFRIGERATORS, ELECTROMAGNETIC COOKERS, AIR CONDITIONERS FOR AUTOMOBILES (U.S. CLS. 13, 21, 23, 31 AND 34).
AMY GEARIN, EXAMINING ATTORNEY

CLASS 11—(Continued).

SN 78-235,518. EMERSON ELECTRIC CO., ST. LOUIS, MO. FILED 4-9-2003.

COMFORT PLUS

FOR HUMIDIFIERS AND INDOOR AIR CLEANERS (U.S. CLS. 13, 21, 23, 31 AND 34).
JEFFERY COWARD, EXAMINING ATTORNEY

SN 78-470,608. SOUTHERN CALIFORNIA CANDLE COMPANY, INC., DBA CELESTIAL SCIENCE, LOS ANGELES, CA. FILED 8-19-2004.

MONSTER MATCH

THE MARK CONSISTS OF STANDARD CHARACTERS WITHOUT CLAIM TO ANY PARTICULAR FONT, STYLE, SIZE, OR COLOR.

NO CLAIM IS MADE TO THE EXCLUSIVE RIGHT TO USE "MATCH", APART FROM THE MARK AS SHOWN.

FOR LIGHTERS PRIMARILY FOR LIGHTING FIREPLACES AND CANDLES (U.S. CLS. 13, 21, 23, 31 AND 34).

FIRST USE 3-31-2003; IN COMMERCE 6-30-2003.
JERI J. FICKES, EXAMINING ATTORNEY

SN 78-826,008. POLLARO CUSTOM FURNITURE, INC., EAST ORANGE, NJ. FILED 3-1-2006.

RUHLMANN

THE MARK CONSISTS OF STANDARD CHARACTERS WITHOUT CLAIM TO ANY PARTICULAR FONT, STYLE, SIZE, OR COLOR.

SEC. 2(F).

FOR ELECTRIC LAMPS, ELECTRIC CHANDELIERS, ELECTRIC LIGHTING FIXTURES, ELECTRIC SCNCE LIGHTING FIXTURES (U.S. CLS. 13, 21, 23, 31 AND 34).

GEOFFREY FOSDICK, EXAMINING ATTORNEY

CLASS 11—(Continued).

SN 78-919,809. CHEVRON IP INC., SAN RAMON, CA. FILED 6-29-2006.

XSORBX

THE MARK CONSISTS OF STANDARD CHARACTERS WITHOUT CLAIM TO ANY PARTICULAR FONT, STYLE, SIZE, OR COLOR.

FOR PORTABLE WATER FILTRATION DEVICES (U.S. CLS. 13, 21, 23, 31 AND 34).

MARGARET POWER, EXAMINING ATTORNEY

SN 78-934,217. RELIANCE WORLDWIDE CORPORATION, THROUGH ITS DIVISION CASH ACME, CULLMAN, AL. FILED 7-20-2006.

CASH-FLO

THE MARK CONSISTS OF STANDARD CHARACTERS WITHOUT CLAIM TO ANY PARTICULAR FONT, STYLE, SIZE, OR COLOR.

FOR PLUMBING FITTINGS, NAMELY, BACKFLOW PREVENTION VALVES AND VALVE ASSEMBLY (U.S. CLS. 13, 21, 23, 31 AND 34).

ANTHONY RINKER, EXAMINING ATTORNEY

SN 79-039,596. KATZ, ALAIN, FRANCE, FILED 5-23-2007.

IRIAN

PRIORITY DATE OF 12-11-2006 IS CLAIMED.
OWNER OF INTERNATIONAL REGISTRATION 0926905 DATED 5-23-2007, EXPIRES 5-23-2017.

FOR AIR CONDITIONING AND HEATING APPARATUS, NAMELY, AIR CONDITIONERS AND ELECTRIC SPACE HEATERS; AIR CONDITIONING UNITS; DAMPERS, NAMELY CONTROL DEVICES USED IN LABORATORY AIR DUCTS TO REGULATE THE FLOW OF AIR; LABORATORY VENTILATION HOODS; APPARATUS AND MACHINES FOR AIR PURIFICATION AND DIFFUSION OF FLUXES, NAMELY, AIR PURIFICATION UNITS; APPARATUS FOR FILTERING AIR, FOR STERILIZING AIR, NAMELY, AIR CLEANING UNITS CONTAINING AN AIRFLOW CONTROL, AN AIR FILTER, ULTRAVIOLET LIGHTS AND A PHOTOCATALYTIC FILTER (U.S. CLS. 13, 21, 23, 31 AND 34).

DAWN HAN, EXAMINING ATTORNEY

CLASS 11—(Continued).

SN 79-043,435. WERNER & PFLEIDERER; LEBENSMITTEL-TECHNIK GMBH, FED REP GERMANY, FILED 8-8-2007.

Baky

THE MARK CONSISTS OF STANDARD CHARACTERS WITHOUT CLAIM TO ANY PARTICULAR FONT, STYLE, SIZE, OR COLOR.

OWNER OF INTERNATIONAL REGISTRATION 0936492 DATED 8-8-2007, EXPIRES 8-8-2017.

FOR BAKING OVENS FOR COMMERCIAL USE (U.S. CLS. 13, 21, 23, 31 AND 34).

ELLEN B. AWRICH, EXAMINING ATTORNEY

SN 79-043,983. TIANTAI HONGSHI SECURITY GLASS CO., LTD, ZHEJIANG, CHINA, FILED 7-3-2007.



OWNER OF INTERNATIONAL REGISTRATION 0937956 DATED 7-3-2007, EXPIRES 7-3-2017.

THE COLOR(S) BLUE, WHITE IS/ARE CLAIMED AS A FEATURE OF THE MARK.

THE COLOR WHITE APPEARS IN THE DEPICTION OF STYLIZED LETTERS "LM"; THE COLOR BLUE APPEARS IN THE DEPICTION OF THE RECTANGLE SURROUNDING THE STYLIZED LETTERS "LM".

FOR HOT AIR BATH PLUMBING FITTINGS, NAMELY, SPOUTS, DRAINS, TUB CONTROL VALVES, TRAPS, BIBS, COCKS, BAFFLES; BATH LININGS, NAMELY, FITTED LINERS FOR HOT TUBS OR SPAS; BATH TUBS FOR SITZ BATHS; PORTABLE TURKISH BATH CABINETS, NAMELY, SAUNAS; BIDETS; BATH-TUBS; PORTABLE TOILETS; FLUSHING APPARATUS, NAMELY, FLUSH LEVERS, FLUSH TOILETS, FLUSHOMETER VALVES, FLUSHOMETERS; SHOWER CUBICLES, NAMELY, SHOWER ENCLOSURES, SHOWER SURROUNDS; BATH INSTALLATIONS, NAMELY, WHIRLPOOL BATHS, SHOWERS, BATHTUBS, BIDETS; TOILET BOWLS (U.S. CLS. 13, 21, 23, 31 AND 34).

MICHAEL TANNER, EXAMINING ATTORNEY

CLASS 12—VEHICLES

SN 76-672,458. TOYOTA MATERIAL HANDLING U.S.A., INC., IRVINE, CA. FILED 2-7-2007.



THE COLOR(S) DARK GREEN, LIGHT GREEN AND WHITE IS/ARE CLAIMED AS A FEATURE OF THE MARK. THE DESIGN OF THE LIFT TRUCK IS IN WHITE, DISPLAYED ON A LEAF IN DIFFERENT SHADES OF GREEN. THE TOP PORTION OF THE LEAF IS LIGHT GREEN AND BLENDS TO DARK GREEN NEAR THE MIDDLE, STEM AND END OF LEAF. A LIGHT GREEN PORTION EXISTS BELOW THIS DARK GREEN AREA AND AGAIN BLENDS TO DARKER GREEN NEAR THE LEAF'S BOTTOM. THE WHEELS OF THE LIFT TRUCK ARE GREEN.

FOR FORK LIFT TRUCKS (U.S. CLS. 19, 21, 23, 31, 35 AND 44).

FIRST USE 9-15-2006; IN COMMERCE 9-15-2006.
MARY I. SPARROW, EXAMINING ATTORNEY

SN 76-677,433. HUANG, TAI CHUN, LONGTAN TOWNSHIP, TAOYUAN COUNTY 325, TAIWAN, FILED 5-25-2007.



OWNER OF TAIWAN REG. NO. 1292496, DATED 12-16-2007, EXPIRES 12-15-2017.

FOR WHEEL RIMS FOR AUTOMOBILES; WHEEL RIMS FOR VEHICLES; WHEEL RIMS FOR MOTOR CARS (U.S. CLS. 19, 21, 23, 31, 35 AND 44).
SUSAN LESLIE DUBOIS, EXAMINING ATTORNEY

SN 76-679,487. APEX MARINE, INC., ST. LOUIS, MI. FILED 7-13-2007.

GILL GETTER

THE MARK CONSISTS OF STANDARD CHARACTERS WITHOUT CLAIM TO ANY PARTICULAR FONT, STYLE, SIZE, OR COLOR.

FOR BOATS (U.S. CLS. 19, 21, 23, 31, 35 AND 44).
FIRST USE 2-28-2003; IN COMMERCE 2-28-2003.
AMEETA JORDAN, EXAMINING ATTORNEY

CLASS 12—(Continued).

SN 77-009,546. COVERCRAFT INDUSTRIES, INC., PAULS VALLEY, OK. FILED 9-28-2006.



THE COLOR(S) BLACK, WHITE AND GREY IS/ARE CLAIMED AS A FEATURE OF THE MARK.

THE MARK CONSISTS OF THE WORDS "QWIK COVER" WITH A STYLIZED "Q" AND A STYLIZED "C". THE COLOR BLACK APPEARS IN THE BACKGROUND OUTLINING THE WORDING "QWIK COVER"; THE COLOR WHITE APPEARS IN THE LETTERS "W", "I" AND "K" OF THE WORDING "QWIK", AND LETTERS "O", "V", "E" AND "R" OF THE WORDING "COVER"; THE COLOR GREY APPEARS IN THE LETTER "Q" OF THE WORDING "QWIK", AND THE LETTER "C" OF THE WORDING "COVER".

FOR FITTED VEHICLE COVERS (U.S. CLS. 19, 21, 23, 31, 35 AND 44).

SHAUNIA CARLYLE, EXAMINING ATTORNEY

SN 77-077,387. GALE BANKS ENGINEERING, AZUSA, CA. FILED 1-5-2007.

DIESEL DEUCE

THE MARK CONSISTS OF STANDARD CHARACTERS WITHOUT CLAIM TO ANY PARTICULAR FONT, STYLE, SIZE, OR COLOR.

NO CLAIM IS MADE TO THE EXCLUSIVE RIGHT TO USE "DIESEL", APART FROM THE MARK AS SHOWN.

FOR AUTOMOBILES (U.S. CLS. 19, 21, 23, 31, 35 AND 44).

FLORENTINA BLANDU, EXAMINING ATTORNEY

SN 77-109,892. DAWN J. BENNETT, CHEVY CHASE, MD. FILED 2-16-2007.

CLASSIC CHASE

THE MARK CONSISTS OF STANDARD CHARACTERS WITHOUT CLAIM TO ANY PARTICULAR FONT, STYLE, SIZE, OR COLOR.

FOR MOTORCYCLE PARTS AND ACCESSORIES, NAMELY, DERBY COVERS, TIMER COVERS FOR MOTORCYCLES, MOTORCYCLE AIR CLEANER INSERTS, NAMELY, COVERS, GAS CAP MEDALLIONS, FENDER SKIRTS, CONSOLE DOORS FOR FUEL TANKS, MOTORCYCLE VALVE CAPS, LICENSE PLATE FASTENERS, FOOT BOARD INSERTS, BRAKE PEDAL PADS, FOOT PEGS, SHIFTER PEGS, HEEL RESTS, FUEL TANK PANELS, HANDLE BAR GRIPS (U.S. CLS. 19, 21, 23, 31, 35 AND 44).

SUE LAWRENCE, EXAMINING ATTORNEY

CLASS 12—(Continued).

SN 77-113,882. AFTERMARKET TECHNOLOGY CORP.,
DOWNERS GROVE, IL. FILED 2-22-2007.

CRUISECONTROLLER

THE MARK CONSISTS OF STANDARD CHARACTERS
WITHOUT CLAIM TO ANY PARTICULAR FONT, STYLE,
SIZE, OR COLOR.

THE WORDING "CRUISECONTROLLER" HAS NO
MEANING IN A FOREIGN LANGUAGE.
FOR BICYCLE PARTS, NAMELY, GEAR SHIFTERS
(U.S. CLS. 19, 21, 23, 31, 35 AND 44).

FIRST USE 12-5-2006; IN COMMERCE 12-5-2006.
SUE LAWRENCE, EXAMINING ATTORNEY

CLASS 12—(Continued).

SN 77-127,585. ANDERSEN MANUFACTURING, INC., IDA-
HO FALLS, ID. FILED 3-9-2007.

IBT

THE MARK CONSISTS OF STANDARD CHARACTERS
WITHOUT CLAIM TO ANY PARTICULAR FONT, STYLE,
SIZE, OR COLOR.

FOR VEHICLE TOW BARS AND BALL MOUNTS FOR
ATTACHING TO VEHICLES FOR TOWING (U.S. CLS.
19, 21, 23, 31, 35 AND 44).

NATALIE POLZER, EXAMINING ATTORNEY

SN 77-117,380. THE VEHICLE PRODUCTION GROUP, LLC,
GLENCOE, IL. FILED 2-27-2007.



THE MARK CONSISTS OF THE WORDS "JUST GET IN"
WITH A PERSON IN A WHEELCHAIR POSITIONED
ABOVE THE WORD "JUST".

FOR MOTOR VEHICLES (U.S. CLS. 19, 21, 23, 31, 35
AND 44).

CORY BOONE, EXAMINING ATTORNEY

SN 77-130,814. AUTO METAL DIRECT, LLC, FLOWERY
BRANCH, GA. FILED 3-14-2007.

NORWOOD

THE MARK CONSISTS OF STANDARD CHARACTERS
WITHOUT CLAIM TO ANY PARTICULAR FONT, STYLE,
SIZE, OR COLOR.

FOR STRUCTURAL PARTS FOR AUTOMOBILES (U.S.
CLS. 19, 21, 23, 31, 35 AND 44).

WILLIAM VERHOSEK, EXAMINING ATTORNEY

SN 77-127,583. ANDERSEN MANUFACTURING, INC., IDA-
HO FALLS, ID. FILED 3-9-2007.

INTEGRAL

THE MARK CONSISTS OF STANDARD CHARACTERS
WITHOUT CLAIM TO ANY PARTICULAR FONT, STYLE,
SIZE, OR COLOR.

FOR VEHICLE TOW BARS AND VEHICLE BALL
MOUNTS USED FOR TOWING; VEHICLE AND TRAILER
HITCHES (U.S. CLS. 19, 21, 23, 31, 35 AND 44).

NATALIE POLZER, EXAMINING ATTORNEY

SN 77-132,783. OTRACO (INTERNATIONAL) PTY LTD.,
BENTLEY, AUSTRALIA, FILED 3-16-2007.

EAGLE

THE MARK CONSISTS OF STANDARD CHARACTERS
WITHOUT CLAIM TO ANY PARTICULAR FONT, STYLE,
SIZE, OR COLOR.

FOR WHEELS FOR EARTHMOVER VEHICLES IN
THE OFF-ROAD, MINING AND CONSTRUCTION IN-
DUSTRIES (U.S. CLS. 19, 21, 23, 31, 35 AND 44).

KELLY MCCOY, EXAMINING ATTORNEY

CLASS 12—(Continued).

SN 77-137,309. BERG, ROGER M., ALOHA, OR. FILED 3-22-2007.

ROCK & ROLL

THE MARK CONSISTS OF STANDARD CHARACTERS WITHOUT CLAIM TO ANY PARTICULAR FONT, STYLE, SIZE, OR COLOR.

FOR BABY STROLLERS (U.S. CLS. 19, 21, 23, 31, 35 AND 44).

FIRST USE 9-3-2005; IN COMMERCE 3-1-2007.

REBECCA EISINGER, EXAMINING ATTORNEY

CLASS 12—(Continued).

SN 77-141,891. CABCO GROUP LIMITED, AUCKLAND, NEW ZEALAND, FILED 3-27-2007.

MI KART

THE MARK CONSISTS OF STANDARD CHARACTERS WITHOUT CLAIM TO ANY PARTICULAR FONT, STYLE, SIZE, OR COLOR.

NO CLAIM IS MADE TO THE EXCLUSIVE RIGHT TO USE "CART", APART FROM THE MARK AS SHOWN.

FOR SHOPPING CARTS HAVING AT LEAST ONE FLAT PANEL DISPLAY SCREEN OR VIDEO DISPLAY SCREEN (U.S. CLS. 19, 21, 23, 31, 35 AND 44).

RICHARD A. STRASER, EXAMINING ATTORNEY

SN 77-140,211. ADAM J. PAPPALARDO, ATKINSON, NH. FILED 3-26-2007.

Trailer Gator

THE MARK CONSISTS OF STANDARD CHARACTERS WITHOUT CLAIM TO ANY PARTICULAR FONT, STYLE, SIZE, OR COLOR.

NO CLAIM IS MADE TO THE EXCLUSIVE RIGHT TO USE "TRAILER", APART FROM THE MARK AS SHOWN.

FOR METAL LOCKING DEVICE FOR TRAILER COUPLER (U.S. CLS. 19, 21, 23, 31, 35 AND 44).

AMY ALFIERI, EXAMINING ATTORNEY

SN 77-142,605. PEARSON COMPOSITES LLC, WARREN, RI. FILED 3-28-2007.

TRUE NORTH

THE MARK CONSISTS OF STANDARD CHARACTERS WITHOUT CLAIM TO ANY PARTICULAR FONT, STYLE, SIZE, OR COLOR.

FOR BOATS (U.S. CLS. 19, 21, 23, 31, 35 AND 44).

FIRST USE 1-1-2000; IN COMMERCE 1-1-2000.

BERYL GARDNER, EXAMINING ATTORNEY

SN 77-141,882. CABCO GROUP LIMITED, AUCKLAND, NEW ZEALAND, FILED 3-27-2007.

Mi-Kart

NO CLAIM IS MADE TO THE EXCLUSIVE RIGHT TO USE "CART", APART FROM THE MARK AS SHOWN.

THE MARK CONSISTS OF THE WORDS "MI KART". FOR SHOPPING CARTS HAVING AT LEAST ONE FLAT PANEL DISPLAY SCREEN OR VIDEO DISPLAY SCREEN (U.S. CLS. 19, 21, 23, 31, 35 AND 44).

RICHARD A. STRASER, EXAMINING ATTORNEY

SN 77-143,975. ONE STOP UNDERCAR, INC., SANTA ANA, CA. FILED 3-29-2007.



ProValue
Professional Quality Drums & Rotors

OWNER OF U.S. REG. NO. 2,564,222.

NO CLAIM IS MADE TO THE EXCLUSIVE RIGHT TO USE "PROFESSIONAL QUALITY DRUMS & ROTORS", APART FROM THE MARK AS SHOWN.

FOR AUTOMOTIVE PARTS AND ACCESSORIES, NAMELY, BRAKE ROTORS AND BRAKE DRUMS (U.S. CLS. 19, 21, 23, 31, 35 AND 44).

FIRST USE 11-30-2005; IN COMMERCE 11-30-2005.

ZACHARY BELLO, EXAMINING ATTORNEY

CLASS 12—(Continued).

SN 77-157,988. ONE STOP UNDERCAR, INC., SANTA ANA, CA. FILED 4-16-2007.



OWNER OF U.S. REG. NO. 2,564,222.
FOR AUTOMOTIVE PARTS AND ACCESSORIES, NAMELY, BRAKE PADS, CLUTCHES, HYDRAULIC BRAKE MASTER CYLINDERS, CLUTCH MASTER CYLINDERS AND CLUTCH SLAVE CYLINDERS (U.S. CLS. 19, 21, 23, 31, 35 AND 44).
ZACHARY BELLO, EXAMINING ATTORNEY

CLASS 12—(Continued).

SN 77-195,140. GSC TECHNOLOGIES CORPORATION, ST. JEAN, CANADA, FILED 6-1-2007.

EQUINOX

THE MARK CONSISTS OF STANDARD CHARACTERS WITHOUT CLAIM TO ANY PARTICULAR FONT, STYLE, SIZE, OR COLOR.
FOR PERSONAL WATERCRAFT, NAMELY, KAYAKS, CANOES, PEDAL BOATS, AND ROWBOATS (U.S. CLS. 19, 21, 23, 31, 35 AND 44).
PAUL F. GAST, EXAMINING ATTORNEY

SN 77-171,452. VALLEY CUSTOM TIRE, INC., VERNON, CA. FILED 5-2-2007.

EMBLINGZ

THE MARK CONSISTS OF STANDARD CHARACTERS WITHOUT CLAIM TO ANY PARTICULAR FONT, STYLE, SIZE, OR COLOR.
FOR VEHICLE ACCESSORIES IN THE NATURE OF EMBLEMS, NAMELY, HOOD ORNAMENTS (U.S. CLS. 19, 21, 23, 31, 35 AND 44).
JOHN DWYER, EXAMINING ATTORNEY

SN 77-195,157. GSC TECHNOLOGIES CORPORATION, ST. JEAN, CANADA, FILED 6-1-2007.



THE MARK CONSISTS OF TWO CONCENTRIC OVALS CONTAINING THE TERM "EQUINOX" IN STYLIZED FONT.
FOR PERSONAL WATERCRAFT, NAMELY, KAYAKS, CANOES, PEDAL BOATS, AND ROWBOATS (U.S. CLS. 19, 21, 23, 31, 35 AND 44).
PAUL F. GAST, EXAMINING ATTORNEY

SN 77-177,905. POLARIS INDUSTRIES INC., MEDINA, MN. FILED 5-10-2007.

RANGER CREW

THE MARK CONSISTS OF STANDARD CHARACTERS WITHOUT CLAIM TO ANY PARTICULAR FONT, STYLE, SIZE, OR COLOR.
FOR ALL-TERRAIN UTILITY VEHICLES AND STRUCTURAL PARTS THEREFOR (U.S. CLS. 19, 21, 23, 31, 35 AND 44).
ANGELA M. MICHELI, EXAMINING ATTORNEY

SN 77-209,366. MTD PRODUCTS INC, VALLEY CITY, OH. FILED 6-19-2007.

COLT

THE MARK CONSISTS OF STANDARD CHARACTERS WITHOUT CLAIM TO ANY PARTICULAR FONT, STYLE, SIZE, OR COLOR.
FOR GARDEN TRACTORS AND LAWN TRACTORS (U.S. CLS. 19, 21, 23, 31, 35 AND 44).
MARK SPARACINO, EXAMINING ATTORNEY

CLASS 12—(Continued).

SN 77-216,115. ACTIVECARE MEDICAL INC., COLUMBIA, SC. FILED 6-26-2007.

Wildcat

THE MARK CONSISTS OF STANDARD CHARACTERS WITHOUT CLAIM TO ANY PARTICULAR FONT, STYLE, SIZE, OR COLOR.
FOR WHEELCHAIRS (U.S. CLS. 19, 21, 23, 31, 35 AND 44).
FIRST USE 6-25-2007; IN COMMERCE 6-25-2007.
JASON ROTH, EXAMINING ATTORNEY

SN 77-216,137. ACTIVECARE MEDICAL INC., COLUMBIA, SC. FILED 6-26-2007.

Renegade

THE MARK CONSISTS OF STANDARD CHARACTERS WITHOUT CLAIM TO ANY PARTICULAR FONT, STYLE, SIZE, OR COLOR.
FOR WHEELCHAIRS (U.S. CLS. 19, 21, 23, 31, 35 AND 44).
FIRST USE 6-25-2007; IN COMMERCE 6-25-2007.
JASON ROTH, EXAMINING ATTORNEY

SN 77-222,910. NISSAN FORKLIFT CORPORATION, NORTH AMERICA, MARENGO, IL. FILED 7-5-2007.



FOR FORK LIFT TRUCKS; HAND TRUCKS; ELECTRIC PALLET FORK LIFT TRUCKS; PARTS FOR FORK LIFT TRUCKS, NAMELY, BRACKETS, AXLES, FORKS, FORK EXTENSIONS, SEATS, CUSHIONS, SEAT BELTS, SEAT SAFETY HARNESES, REARVIEW MIRRORS; PARTS FOR ELECTRONIC MOTORS FOR FORK LIFT TRUCKS, NAMELY, ARMATURES, BRUSHES, BRUSH HOLDERS, BEARINGS, FIELD COILS, AND MOTOR STUDS; WHEELS AND TIRES FOR FORK LIFT TRUCKS; BACK-UP AND FORWARD TRAVEL ALARMS AND HORNS FOR FORK LIFT TRUCKS, AND LOW BATTERY VOLTAGE WARNING ALARMS; FORK LIFT TRUCKS TRANSMISSIONS AND PARTS THEREOF (U.S. CLS. 19, 21, 23, 31, 35 AND 44).
KATINA MISTER, EXAMINING ATTORNEY

CLASS 12—(Continued).

SN 77-262,536. G & B DISTRIBUTION, ROCHESTER, MI. FILED 8-23-2007.



NO CLAIM IS MADE TO THE EXCLUSIVE RIGHT TO USE "WORLDWIDE AUTOMOTIVE PARTS DISTRIBUTOR" AND "GENUINE OE", APART FROM THE MARK AS SHOWN.

THE MARK CONSISTS OF A SEAL HAVING A JAGGED EDGED BORDER WITH THE WORDS "WORLDWIDE AUTOMOTIVE PARTS DISTRIBUTOR", A CIRCULAR CENTRAL PORTION WITH A BLACK GLOBE AND THE WORDS "GENUINE OE GENUINE G&B".

FOR GOODS RELATED TO REPAIR AND REPLACEMENT PARTS FOR VEHICLES, NAMELY, HUBS AND BEARINGS AND ASSEMBLIES THEREOF, ROLLER BEARINGS, TAPERED BEARINGS, VEHICLE DOOR AND WINDOW PARTS, NAMELY, ACTUATORS, MOTORS, REGULATORS AND ASSEMBLIES AND PARTS THEREOF, FUEL SYSTEMS AND MODULES, NAMELY, SENDING UNITS, FUEL INJECTORS, FUEL PUMPS AND FUEL REGULATORS (U.S. CLS. 19, 21, 23, 31, 35 AND 44).

FIRST USE 6-1-2004; IN COMMERCE 6-1-2004.
JOHN HWANG, EXAMINING ATTORNEY

SN 77-263,376. CAPRIO, RAY V., BASKING RIDGE, NJ. FILED 8-24-2007.

TRAVEL SHIELD

THE MARK CONSISTS OF STANDARD CHARACTERS WITHOUT CLAIM TO ANY PARTICULAR FONT, STYLE, SIZE, OR COLOR.

NO CLAIM IS MADE TO THE EXCLUSIVE RIGHT TO USE "SHIELD", APART FROM THE MARK AS SHOWN.

FOR MOTORCYCLE PARTS AND ACCESSORIES, NAMELY, WINDSHIELDS AND WINDSHIELD MOUNT KITS COMPRISED OF HINGED AND PIECE PARTS THAT MAKE UP A FOLDABLE AND REMOVABLE WINDSHIELD AND THE HARDWARE AND FASTENERS FOR MOUNTING THE SAME ON THE MOTORCYCLE, AND WINDSHIELD AND STOWAGE KITS COMPRISED OF CONTAINERS THAT ARE MOUNTABLE ON THE MOTORCYCLE AND IN WHICH THE WINDSHIELD CAN BE STOWED AND CARRIED (U.S. CLS. 19, 21, 23, 31, 35 AND 44).
MARK T. MULLEN, EXAMINING ATTORNEY

CLASS 12—(Continued).

SN 77-263,831. SALT SHAKER MARINE CUSTOM FABRI-
CATIONS, INC., PUNTA GORDA, FL. FILED 8-24-2007.

SALT  SHAKER

THE MARK CONSISTS OF THE WORDS "SALT SHAKER"
WITH AN IMAGE OF A SALT SHAKER AND MARLIN
FISH.

FOR BOAT HULLS; BOATS; BOATS AND STRUCTUR-
AL PARTS THEREFOR; FISHING BOATS; VESSELS (U.S.
CLS. 19, 21, 23, 31, 35 AND 44).

FIRST USE 1-1-1977; IN COMMERCE 1-1-1977.
KAREN K. BUSH, EXAMINING ATTORNEY

CLASS 12—(Continued).

SN 77-282,250. TREK BICYCLE CORPORATION, WATER-
LOO, WI. FILED 9-18-2007.

HiFi

THE MARK CONSISTS OF STANDARD CHARACTERS
WITHOUT CLAIM TO ANY PARTICULAR FONT, STYLE,
SIZE, OR COLOR.

FOR BICYCLES, BICYCLE FRAMES AND BICYCLE
STRUCTURAL PARTS THEREFORE (U.S. CLS. 19, 21, 23,
31, 35 AND 44).

FIRST USE 8-1-2006; IN COMMERCE 8-1-2006.
DEIRDRE ROBERTSON, EXAMINING ATTORNEY

SN 77-277,139. BRISA BRIDGESTONE SABANCI LASTIK
SANAYI VE TICARET ANONIM SIRKETI, ISTANBUL,
TURKEY, FILED 9-11-2007.

IMPETUS2

THE MARK CONSISTS OF STANDARD CHARACTERS
WITHOUT CLAIM TO ANY PARTICULAR FONT, STYLE,
SIZE, OR COLOR.

FOR INNER TUBES FOR VEHICLE TIRES; TIRES FOR
LAND VEHICLES (U.S. CLS. 19, 21, 23, 31, 35 AND 44).
JIM RINGLE, EXAMINING ATTORNEY

SN 77-282,274. TREK BICYCLE CORPORATION, WATER-
LOO, WI. FILED 9-18-2007.

GoBug

THE MARK CONSISTS OF STANDARD CHARACTERS
WITHOUT CLAIM TO ANY PARTICULAR FONT, STYLE,
SIZE, OR COLOR.

FOR BABY STROLLERS AND BICYCLE TRAILERS
(U.S. CLS. 19, 21, 23, 31, 35 AND 44).

FIRST USE 8-1-2006; IN COMMERCE 8-1-2006.
DEIRDRE ROBERTSON, EXAMINING ATTORNEY

SN 77-278,917. SAM J. JACOBSEN, MIDDLETON, WI. FILED
9-13-2007.

SAMSON

THE MARK CONSISTS OF STANDARD CHARACTERS
WITHOUT CLAIM TO ANY PARTICULAR FONT, STYLE,
SIZE, OR COLOR.

FOR OFF-ROAD UTILITY VEHICLES (U.S. CLS. 19, 21,
23, 31, 35 AND 44).

FRANK LATTUCA, EXAMINING ATTORNEY

SN 77-283,169. TREK BICYCLE CORPORATION, WATER-
LOO, WI. FILED S.R. 9-19-2007; AM. P.R. 12-31-2007.

Mendota

THE MARK CONSISTS OF STANDARD CHARACTERS
WITHOUT CLAIM TO ANY PARTICULAR FONT, STYLE,
SIZE, OR COLOR.

FOR BICYCLES, BICYCLE FRAMES AND BICYCLE
STRUCTURAL PARTS THEREFORE (U.S. CLS. 19, 21, 23,
31, 35 AND 44).

FIRST USE 8-1-2006; IN COMMERCE 8-1-2006.
SHAUNIA CARLYLE, EXAMINING ATTORNEY

CLASS 12—(Continued).

SN 77-286,950. GENERAL MOTORS CORPORATION, DETROIT, MI. FILED 9-24-2007.

CADILLAC BT3

THE MARK CONSISTS OF STANDARD CHARACTERS WITHOUT CLAIM TO ANY PARTICULAR FONT, STYLE, SIZE, OR COLOR.

OWNER OF U.S. REG. NOS. 1,570,808, 2,931,761 AND OTHERS.

FOR MOTOR LAND VEHICLES, NAMELY, AUTOMOBILES, SPORT UTILITY VEHICLES, TRUCKS AND VANS (U.S. CLS. 19, 21, 23, 31, 35 AND 44).

CAROLINE WOOD, EXAMINING ATTORNEY

SN 77-286,991. GENERAL MOTORS CORPORATION, DETROIT, MI. FILED 9-24-2007.

CADILLAC CT5

THE MARK CONSISTS OF STANDARD CHARACTERS WITHOUT CLAIM TO ANY PARTICULAR FONT, STYLE, SIZE, OR COLOR.

OWNER OF U.S. REG. NOS. 1,570,808, 2,931,761 AND OTHERS.

FOR MOTOR LAND VEHICLES, NAMELY, AUTOMOBILES, SPORT UTILITY VEHICLES, TRUCKS AND VANS (U.S. CLS. 19, 21, 23, 31, 35 AND 44).

CAROLINE WOOD, EXAMINING ATTORNEY

SN 77-287,181. GENERAL MOTORS CORPORATION, DETROIT, MI. FILED 9-24-2007.

CADILLAC CT6

THE MARK CONSISTS OF STANDARD CHARACTERS WITHOUT CLAIM TO ANY PARTICULAR FONT, STYLE, SIZE, OR COLOR.

OWNER OF U.S. REG. NOS. 1,570,808, 2,931,761 AND OTHERS.

FOR MOTOR LAND VEHICLES, NAMELY, AUTOMOBILES, SPORT UTILITY VEHICLES, TRUCKS AND VANS (U.S. CLS. 19, 21, 23, 31, 35 AND 44).

CAROLINE WOOD, EXAMINING ATTORNEY

CLASS 12—(Continued).

SN 77-287,204. CESSNA AIRCRAFT COMPANY, WICHITA, KS. FILED 9-24-2007.

XLS+

THE MARK CONSISTS OF STANDARD CHARACTERS WITHOUT CLAIM TO ANY PARTICULAR FONT, STYLE, SIZE, OR COLOR.

OWNER OF U.S. REG. NO. 3,096,032.

FOR AIRPLANES (U.S. CLS. 19, 21, 23, 31, 35 AND 44).

FIRST USE 11-30-2006; IN COMMERCE 11-30-2006.

ELI HELLMAN, EXAMINING ATTORNEY

SN 77-287,794. GENERAL MOTORS CORPORATION, DETROIT, MI. FILED 9-25-2007.

CADILLAC CTX

THE MARK CONSISTS OF STANDARD CHARACTERS WITHOUT CLAIM TO ANY PARTICULAR FONT, STYLE, SIZE, OR COLOR.

OWNER OF U.S. REG. NOS. 1,570,808, 2,931,761 AND OTHERS.

FOR MOTOR LAND VEHICLES, NAMELY, AUTOMOBILES, SPORT UTILITY VEHICLES, TRUCKS AND VANS (U.S. CLS. 19, 21, 23, 31, 35 AND 44).

CAROLINE WOOD, EXAMINING ATTORNEY

SN 77-287,805. GENERAL MOTORS CORPORATION, DETROIT, MI. FILED 9-25-2007.

CADILLAC DT7

THE MARK CONSISTS OF STANDARD CHARACTERS WITHOUT CLAIM TO ANY PARTICULAR FONT, STYLE, SIZE, OR COLOR.

OWNER OF U.S. REG. NOS. 1,570,808, 2,931,761 AND OTHERS.

FOR MOTOR LAND VEHICLES, NAMELY, AUTOMOBILES, SPORT UTILITY VEHICLES, TRUCKS AND VANS (U.S. CLS. 19, 21, 23, 31, 35 AND 44).

CAROLINE WOOD, EXAMINING ATTORNEY

CLASS 12—(Continued).

SN 77-287,845. GENERAL MOTORS CORPORATION, DETROIT, MI. FILED 9-25-2007.

CADILLAC DTX

THE MARK CONSISTS OF STANDARD CHARACTERS WITHOUT CLAIM TO ANY PARTICULAR FONT, STYLE, SIZE, OR COLOR.

OWNER OF U.S. REG. NOS. 1,570,808, 2,931,761 AND OTHERS.

FOR MOTOR LAND VEHICLES, NAMELY, AUTOMOBILES, SPORT UTILITY VEHICLES, TRUCKS AND VANS (U.S. CLS. 19, 21, 23, 31, 35 AND 44).

CAROLINE WOOD, EXAMINING ATTORNEY

CLASS 12—(Continued).

SN 77-291,609. LOAD RITE TRAILERS, INC., FAIRLESS HILLS, PA. FILED 9-28-2007.

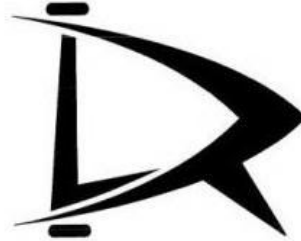

OWNER OF U.S. REG. NO. 1,306,928.

THE MARK CONSISTS OF "LR" STYLIZED AND DESIGN.

FOR TRAILERS (U.S. CLS. 19, 21, 23, 31, 35 AND 44).

FIRST USE 9-0-1999; IN COMMERCE 9-0-1999.

RICHARD A. STRASER, EXAMINING ATTORNEY

SN 77-291,186. RUFF & TUFF PRODUCTS, INC., WINN-BORO, SC. FILED 9-28-2007.

WHEEGO

THE MARK CONSISTS OF STANDARD CHARACTERS WITHOUT CLAIM TO ANY PARTICULAR FONT, STYLE, SIZE, OR COLOR.

FOR ELECTRIC AUTOMOBILES (U.S. CLS. 19, 21, 23, 31, 35 AND 44).

ANDREA K. NADELMAN, EXAMINING ATTORNEY

OFFICIAL PARTY BUSES

THE MARK CONSISTS OF STANDARD CHARACTERS WITHOUT CLAIM TO ANY PARTICULAR FONT, STYLE, SIZE, OR COLOR.

NO CLAIM IS MADE TO THE EXCLUSIVE RIGHT TO USE "PARTY BUSES", APART FROM THE MARK AS SHOWN.

FOR BUSES (U.S. CLS. 19, 21, 23, 31, 35 AND 44).

SAMUEL E. SHARPER JR., EXAMINING ATTORNEY

SN 77-291,538. CONTZEN, JAMES T, TRACY, TN. FILED 9-28-2007.



FOR BOAT ACCESSORIES, NAMELY, CANVAS COVERS, ENCLOSURES AND WINDOWS SOLD AS A UNIT AND AFFIXED TO THE BOAT FOR RECREATIONAL BOATING AND MARINE USE; BOAT HULLS; BOATS; BOATS AND STRUCTURAL PARTS THEREFOR; STRUCTURAL PARTS FOR BOATS (U.S. CLS. 19, 21, 23, 31, 35 AND 44).

FIRST USE 0-0-1972; IN COMMERCE 4-1-1996.

TARAH HARDY, EXAMINING ATTORNEY

SN 77-293,591. INO THERAPEUTICS LLC, CLINTON, NJ. FILED 10-2-2007.

INOCART

THE MARK CONSISTS OF STANDARD CHARACTERS WITHOUT CLAIM TO ANY PARTICULAR FONT, STYLE, SIZE, OR COLOR.

FOR HANDCART FOR USE IN TRANSPORTING STORAGE TANKS (U.S. CLS. 19, 21, 23, 31, 35 AND 44).

NAKWAMA ANKRAH, EXAMINING ATTORNEY

CLASS 12—(Continued).

SN 77-294,540. CREATION COMPOSITES, LLC, BEAVERTON, OR. FILED 10-2-2007.



THE MARK CONSISTS OF THE STYLIZED WORDS "TRAILTANK".

FOR OVERSIZED FUEL TANKS DESIGNED AND PRODUCED FOR SNOWMOBILE RECREATIONAL VEHICLES, WHICH ARE MOLDED FROM PLASTIC RESIN (U.S. CLS. 19, 21, 23, 31, 35 AND 44).

FIRST USE 2-20-2007; IN COMMERCE 2-20-2007.
ADA HAN, EXAMINING ATTORNEY

SN 77-295,252. TEROG MANUFACTURING CO., STEPHEN, MN. FILED 10-3-2007.



THE MARK CONSISTS OF STANDARD CHARACTERS WITHOUT CLAIM TO ANY PARTICULAR FONT, STYLE, SIZE, OR COLOR.

FOR TRAILER HITCHES (U.S. CLS. 19, 21, 23, 31, 35 AND 44).

DANIEL CAPSHAW, EXAMINING ATTORNEY

SN 77-296,448. IRON HORSE BICYCLE COMPANY, LLC, HOLBROOK, NY. FILED 10-4-2007.



THE MARK CONSISTS OF STANDARD CHARACTERS WITHOUT CLAIM TO ANY PARTICULAR FONT, STYLE, SIZE, OR COLOR.

FOR BICYCLES (U.S. CLS. 19, 21, 23, 31, 35 AND 44).
JENNIFER VASQUEZ, EXAMINING ATTORNEY

CLASS 12—(Continued).

SN 77-296,457. ABIIE, LLC, AUSTIN, TX. FILED 10-4-2007.



THE MARK CONSISTS OF STANDARD CHARACTERS WITHOUT CLAIM TO ANY PARTICULAR FONT, STYLE, SIZE, OR COLOR.

FOR BABY CARRIAGES; BABY CARRIAGES; BABY STROLLERS; CANOPIES FOR BABY STROLLERS; COVERS FOR BABY STROLLERS; PRAMS; RUBBER BABY BUGGY BUMPERS; UMBRELLAS TO BE AFFIXED TO BABY STROLLER; CHILD CARRYING TRAILERS FOR USE IN TRANSPORTING CHILDREN WHILE HIKING, JOGGING, WALKING, SKIING, SNOW SHOEING OR SKATING; CHILDREN'S CAR SEATS; CHILDREN'S SAFETY SEATS FOR CARS; CHILDREN'S SAFETY SEATS FOR VEHICLES; SAFETY SEATS FOR CHILDREN FOR MOTOR CARS; SAFETY SEATS FOR INFANTS AND CHILDREN FOR VEHICLES; SMALL WAGONS FOR CHILDREN; TIRES FOR CHILDREN'S BICYCLES; ANTI-THEFT ALARMS FOR VEHICLES; CHILD SAFETY HARNESSSES FOR VEHICLE SEATS; SEAT SAFETY HARNESSSES FOR MOTOR CARS; BOAT ACCESSORIES, NAMELY, CANVAS COVERS, ENCLOSURES AND WINDOWS SOLD AS A UNIT AND AFFIXED TO THE BOAT FOR RECREATIONAL BOATING AND MARINE USE; AUTOMOBILE SEAT CUSHIONS; CAR SEATS FOR PETS; CHILD RESTRAINTS FOR VEHICLE SEATS; PET SAFETY SEATS FOR USE IN VEHICLES; AUTOMOBILE HOLDERS FOR MP3 PLAYERS THAT ARE AFFIXED OR SPECIALLY ADAPTED TO THE AUTOMOBILE; CUP HOLDERS FOR USE IN VEHICLES; DRINK HOLDERS FOR VEHICLES; WATER BOTTLE HOLDERS FOR BICYCLES; TRACKED WHEELCHAIRS; WHEELCHAIR CUSHIONS; WHEELCHAIR PADS; WHEELCHAIRS (U.S. CLS. 19, 21, 23, 31, 35 AND 44).

FIRST USE 10-1-2007; IN COMMERCE 10-1-2007.
WILLIAM VERHOSEK, EXAMINING ATTORNEY

SN 77-296,582. AVX CORPORATION, FT. WORTH, TX. FILED 10-4-2007.



THE MARK CONSISTS OF STANDARD CHARACTERS WITHOUT CLAIM TO ANY PARTICULAR FONT, STYLE, SIZE, OR COLOR.

FOR AIRCRAFT, NAMELY HELICOPTERS (U.S. CLS. 19, 21, 23, 31, 35 AND 44).

BRIAN CALLAGHAN, EXAMINING ATTORNEY

CLASS 12—(Continued).

SN 77-296,594. AVX CORPORATION, FT. WORTH, TX. FILED 10-4-2007.

AVX AIRCRAFT

THE MARK CONSISTS OF STANDARD CHARACTERS WITHOUT CLAIM TO ANY PARTICULAR FONT, STYLE, SIZE, OR COLOR.

NO CLAIM IS MADE TO THE EXCLUSIVE RIGHT TO USE "AIRCRAFT", APART FROM THE MARK AS SHOWN. FOR AIRCRAFT, NAMELY HELICOPTERS (U.S. CLS. 19, 21, 23, 31, 35 AND 44).

BRIAN CALLAGHAN, EXAMINING ATTORNEY

SN 77-311,016. GENERAL MOTORS CORPORATION, DETROIT, MI. FILED 10-23-2007.

CADILLAC AT1

THE MARK CONSISTS OF STANDARD CHARACTERS WITHOUT CLAIM TO ANY PARTICULAR FONT, STYLE, SIZE, OR COLOR.

OWNER OF U.S. REG. NOS. 1,570,808, 2,931,761 AND OTHERS.

FOR MOTOR LAND VEHICLES, NAMELY, AUTOMOBILES, SPORT UTILITY VEHICLES, TRUCKS AND VANS (U.S. CLS. 19, 21, 23, 31, 35 AND 44).

CAROLINE WOOD, EXAMINING ATTORNEY

SN 77-311,040. GENERAL MOTORS CORPORATION, DETROIT, MI. FILED 10-23-2007.

CADILLAC BTX

THE MARK CONSISTS OF STANDARD CHARACTERS WITHOUT CLAIM TO ANY PARTICULAR FONT, STYLE, SIZE, OR COLOR.

OWNER OF U.S. REG. NOS. 1,570,808, 2,931,761 AND OTHERS.

FOR MOTOR LAND VEHICLES, NAMELY, AUTOMOBILES, SPORT UTILITY VEHICLES, TRUCKS AND VANS (U.S. CLS. 19, 21, 23, 31, 35 AND 44).

CAROLINE WOOD, EXAMINING ATTORNEY

CLASS 12—(Continued).

SN 77-312,076. BRITAX CHILD SAFETY, INC., CHARLOTTE, NC. FILED 10-24-2007.

FRONTIER

THE MARK CONSISTS OF STANDARD CHARACTERS WITHOUT CLAIM TO ANY PARTICULAR FONT, STYLE, SIZE, OR COLOR.

FOR CHILD SAFETY SEATS FOR USE IN CARS AND VEHICLES; CHILD SAFETY HARNESSSES FOR THE SEATS OF VEHICLES; CHILD SAFETY BELTS FOR THE SEATS OF VEHICLES; CHILD RESTRAINTS FOR USE IN VEHICLES; REPLACEMENT PARTS AND REPLACEMENT FITTINGS FOR ALL OF THE AFORESAID GOODS (U.S. CLS. 19, 21, 23, 31, 35 AND 44).

KAREN SEVERSON, EXAMINING ATTORNEY

SN 78-765,771. HUGH KING, LOS ANGELES, CA. FILED 12-2-2005.

CHOPPER KING

THE MARK CONSISTS OF STANDARD CHARACTERS WITHOUT CLAIM TO ANY PARTICULAR FONT, STYLE, SIZE, OR COLOR.

NO CLAIM IS MADE TO THE EXCLUSIVE RIGHT TO USE "CHOPPER", APART FROM THE MARK AS SHOWN. FOR MOTORCYCLES AND STRUCTURAL PARTS THEREFOR (U.S. CLS. 19, 21, 23, 31, 35 AND 44).

JENNIFER MARTIN, EXAMINING ATTORNEY

SN 78-819,280. FORD MOTOR COMPANY, DEARBORN, MI. FILED 2-21-2006.

E-SERIES

THE MARK CONSISTS OF STANDARD CHARACTERS WITHOUT CLAIM TO ANY PARTICULAR FONT, STYLE, SIZE, OR COLOR.

FOR LAND MOTOR VEHICLES, NAMELY, AUTOMOBILES, TRUCKS, VANS, AND CHASSIS (U.S. CLS. 19, 21, 23, 31, 35 AND 44).

KATHLEEN M. VANSTON, EXAMINING ATTORNEY

CLASS 12—(Continued).

SN 79-033,011. SOLIDEAL HOLDING S.A., L-2086 LUXEMBOURG, LUXEMBOURG, FILED 8-25-2006.

SOLIDEAL

THE MARK CONSISTS OF STANDARD CHARACTERS WITHOUT CLAIM TO ANY PARTICULAR FONT, STYLE, SIZE, OR COLOR.

OWNER OF INTERNATIONAL REGISTRATION 0908810 DATED 8-25-2006, EXPIRES 8-25-2016.

OWNER OF U.S. REG. NOS. 3,007,550, 3,082,923 AND OTHERS.

FOR LAND VEHICLES AND THEIR STRUCTURAL PARTS; APPARATUS FOR LOCOMOTION BY LAND, AIR OR WATER, NAMELY, AUTOMOBILES, AIRPLANES, AND BOATS; TIRES, WHEEL RIMS, WHEELS, AXLES, CASINGS FOR PNEUMATIC TIRES, TRACKS, DRIVING CHAINS, CHAIN SPROCKETS, LOAD-CARRYING AXLES, LOAD-CARRYING IDLERS, CHASSIS AND BRAKE PADS, ALL THESE GOODS FOR LAND VEHICLES; LOAD-CARRYING IDLERS FOR TRACKED TRANSPORT VEHICLES (U.S. CLS. 19, 21, 23, 31, 35 AND 44).

DEBRA LEE, EXAMINING ATTORNEY

CLASS 12—(Continued).

SN 79-041,637. SOLIDEAL HOLDING S.A., LUXEMBOURG, FILED 7-3-2007.

SOLIDTHANE

THE MARK CONSISTS OF STANDARD CHARACTERS WITHOUT CLAIM TO ANY PARTICULAR FONT, STYLE, SIZE, OR COLOR.

PRIORITY DATE OF 3-7-2007 IS CLAIMED.

OWNER OF INTERNATIONAL REGISTRATION 0932167 DATED 7-3-2007, EXPIRES 7-3-2017.

FOR LAND VEHICLES AND THEIR STRUCTURAL PARTS; APPARATUS FOR LOCOMOTION BY LAND, AIR OR WATER, NAMELY, AUTOMOBILES, AIRPLANES, AND BOATS; TIRES, RIMS, VEHICLE WHEELS, AXLES, CASINGS FOR PNEUMATIC TIRES, VEHICLE PARTS, NAMELY, TRACKS, DRIVING CHAINS, CHAIN SPROCKETS, LOAD-CARRYING AXLES, LOAD-CARRYING IDLERS, CHASSIS AND BRAKE PADS, ALL THESE GOODS FOR VEHICLES; LOAD-CARRYING IDLERS FOR TRACKED VEHICLES (U.S. CLS. 19, 21, 23, 31, 35 AND 44).

ALLISON HOLTZ, EXAMINING ATTORNEY

SN 79-037,257. SHENYANG JINBEI; AUTOMOTIVE COMPANY LIMITED, CHINA, FILED 3-26-2007.



OWNER OF INTERNATIONAL REGISTRATION 0920907 DATED 3-26-2007, EXPIRES 3-26-2017.

OWNER OF U.S. REG. NO. 3,060,519.

THE ENGLISH TRANSLATION OF THE FOREIGN WORD(S) IN THE MARK IS: "GOLD" AND "CUP", THE COMBINATION OF WHICH BEARS NO MEANING.

THE TRANSLITERATION OF THE NON-LATIN CHARACTERS IN THE MARK IS: JINBEI.

FOR AUTOMOBILES (U.S. CLS. 19, 21, 23, 31, 35 AND 44).

ELLEN BURNS, EXAMINING ATTORNEY

SN 79-043,887. JIANGSU LINHAI POWER; MACHINERY GROUP CORP., 225300 JIANGSU, CHINA, FILED 7-25-2007.



OWNER OF INTERNATIONAL REGISTRATION 0937620 DATED 7-25-2007, EXPIRES 7-25-2017.

THE MARK CONSISTS OF THREE LETTERS "LHY" IN STANDARD FORM.

FOR CYCLE CARS; SPORTS CARS; MOTORS FOR LAND VEHICLES; MOTORCYCLES; ELECTRIC VEHICLES, NAMELY, BICYCLES AND MOTORIZED SCOOTERS; LAND VEHICLES, AIRPLANES AND HELICOPTERS; BOATS AND SHIPS; RAIL VEHICLES, NAMELY, TRAINS; MOPEDS, MOTOR HOMES; CARS (U.S. CLS. 19, 21, 23, 31, 35 AND 44).

KELLEY WELLS, EXAMINING ATTORNEY

CLASS 13—FIREARMS

SN 77-136,835. SNAPDRAGON, LLC, BRIDGTON, ME. FILED 3-21-2007.

FASTMAG

THE MARK CONSISTS OF STANDARD CHARACTERS WITHOUT CLAIM TO ANY PARTICULAR FONT, STYLE, SIZE, OR COLOR.

FOR POCKETS IN THE NATURE OF SPECIALITY HOLSTERS TO BE ATTACHED TO GARMENTS OR HARNESES FOR CARRYING WEAPONS OR AMMUNITION CLIPS (U.S. CLS. 2 AND 9).

FIRST USE 3-21-2007; IN COMMERCE 3-21-2007.
PAUL F. GAST, EXAMINING ATTORNEY

SN 77-281,149. BEAL, HAROLD F., ROCKFORD, TN. FILED 9-17-2007.

BUBBA BULLETS

THE MARK CONSISTS OF STANDARD CHARACTERS WITHOUT CLAIM TO ANY PARTICULAR FONT, STYLE, SIZE, OR COLOR.

NO CLAIM IS MADE TO THE EXCLUSIVE RIGHT TO USE "BULLETS", APART FROM THE MARK AS SHOWN. FOR GUN AMMUNITION (U.S. CLS. 2 AND 9).

WILLIAM P. SHANAHAN, EXAMINING ATTORNEY

SN 78-827,512. GALAXY FIREWORKS, INC., TAMPA, FL. FILED 3-2-2006.



OWNER OF U.S. REG. NOS. 2,249,187, 2,888,504 AND OTHERS.

NO CLAIM IS MADE TO THE EXCLUSIVE RIGHT TO USE "FIREWORKS" AND "MAX LOAD", APART FROM THE MARK AS SHOWN.

THE COLORS BLUE, WHITE, RED, BLACK, ORANGE, PINK AND PURPLE ARE CLAIMED AS A FEATURE OF THE MARK.

THE MARK CONSISTS OF THE WORDS "PRIVATE STOCK" IN RED AND OUTLINED IN WHITE ARCHED OVER A BLUE CIRCLE OUTLINED IN PINK AND WHITE WHICH CONTAINS A ORANGE, RED, BLACK AND YELLOW PLANET WHICH HAS THE WORDS "GALAXY FIREWORKS" IN WHITE OUTLINED IN BLACK, WITH THE CIRCLE OVERLAID ON THREE DIFFERENT CO-

CLASS 13—(Continued).

LORED BOLTS PURPLE, PINK, AND YELLOW EACH WITH TWO WHITE STRIPES AT THE TOP AND THE WORDS "MAX LOAD" PRINTED IN BLACK ON THE YELLOW BOLT, ALL ON A BACK GROUND OF A BLUE SPACE FEATURING WHITE STARS WITH YELLOW AND WHITE TAILS AND CORONAS, WITH FOUR RECTANGULAR WHITE BOXES AT THE BOTTOM OVER A WHITE GRID LIKE IMAGE WITH RED, WHITE AND BLUE RECTANGULAR BOXES AT THE TOP AND BOTTOM WITH BLACK LINES RUNNING THROUGH THEM.

FOR CONSUMER FIREWORKS, NAMELY; MULTIPLE SHOT AERIAL FIREWORKS AND SPARKLERS (U.S. CLS. 2 AND 9).

FIRST USE 3-1-2003; IN COMMERCE 3-1-2003.
JASON TURNER, EXAMINING ATTORNEY

CLASS 14—JEWELRY

SN 76-675,312. FP & L INC., CITY OF INDUSTRY, CA. FILED 4-9-2007.

A Fine Mess

FOR WATCHES; WATCH STRAPS; BRACELETS; WATCH BUCKLES; JEWELRY; IMITATION JEWELRY; CLOCKS; ORNAMENTAL PINS; PRECIOUS METALS AND THEIR ALLOYS; GOODS IN PRECIOUS METALS OR COATED, NAMELY, CHARMS, RINGS, EARRINGS, ANKLE BRACELETS, BROOCHES AND CUFF LINKS; KEY RINGS AND KEY CHAINS MADE OF PRECIOUS METAL (U.S. CLS. 2, 27, 28 AND 50).

DAYNA BROWNE, EXAMINING ATTORNEY

SN 76-680,209. DWECK INDUSTRIES, INC., NEW YORK, NY. FILED 8-2-2007.

STEPHEN DWECK LUXURY

THE MARK CONSISTS OF STANDARD CHARACTERS WITHOUT CLAIM TO ANY PARTICULAR FONT, STYLE, SIZE, OR COLOR.

OWNER OF U.S. REG. NOS. 1,734,413, 3,084,346 AND OTHERS.

NO CLAIM IS MADE TO THE EXCLUSIVE RIGHT TO USE "LUXURY", APART FROM THE MARK AS SHOWN.

THE NAME "STEPHEN DWECK" IDENTIFIES A LIVING INDIVIDUAL WHOSE CONSENT IS OF RECORD.

FOR JEWELRY (U.S. CLS. 2, 27, 28 AND 50).
KRISTIN DAHLING, EXAMINING ATTORNEY

CLASS 14—(Continued).

SN 76-681,156. SAMARA, CHRISTINA, MARIETTA, GA.
FILED 8-27-2007.

EVERYTHING ANGELIC

THE MARK CONSISTS OF STANDARD CHARACTERS WITHOUT CLAIM TO ANY PARTICULAR FONT, STYLE, SIZE, OR COLOR.

FOR HANDMADE BRIDAL JEWELRY AND TIARAS (U.S. CLS. 2, 27, 28 AND 50).

FIRST USE 4-17-2003; IN COMMERCE 4-17-2003.

DOMINICK J. SALEMI, EXAMINING ATTORNEY

SN 77-103,941. DIRTY DOG FASHION GROUP, INC.,
SEATTLE, WA. FILED 2-9-2007.

WAKTU DESIGNS

THE MARK CONSISTS OF STANDARD CHARACTERS WITHOUT CLAIM TO ANY PARTICULAR FONT, STYLE, SIZE, OR COLOR.

NO CLAIM IS MADE TO THE EXCLUSIVE RIGHT TO USE "DESIGNS", APART FROM THE MARK AS SHOWN.

THE TERM "WAKTU" HAS NO DIRECT TRANSLATION IN ENGLISH. THE WORD IS USED TO INDICATE "TIME AS IT RELATES TO THE OCCASION OR OPPORTUNITY FOR PRAYER".

FOR JEWELRY (U.S. CLS. 2, 27, 28 AND 50).

ELLEN PERKINS, EXAMINING ATTORNEY

SN 77-112,546. OAKLEY, INC., FOOTHILL RANCH, CA.
FILED 2-21-2007.

GEARBOX

THE MARK CONSISTS OF STANDARD CHARACTERS WITHOUT CLAIM TO ANY PARTICULAR FONT, STYLE, SIZE, OR COLOR.

FOR TIME PIECES, NAMELY, CLOCKS, WATCHES AND COMPONENTS THEREOF (U.S. CLS. 2, 27, 28 AND 50).

LINDA ESTRADA, EXAMINING ATTORNEY

CLASS 14—(Continued).

SN 77-134,732. AMERICA'S COLLECTIBLES NETWORK, INC., KNOXVILLE, TN. FILED 3-19-2007.

IMPERIAL HESSONITE

THE MARK CONSISTS OF STANDARD CHARACTERS WITHOUT CLAIM TO ANY PARTICULAR FONT, STYLE, SIZE, OR COLOR.

NO CLAIM IS MADE TO THE EXCLUSIVE RIGHT TO USE "HESSONITE", APART FROM THE MARK AS SHOWN. FOR HESSONITE GEMSTONES (U.S. CLS. 2, 27, 28 AND 50).

FIRST USE 5-8-2006; IN COMMERCE 5-8-2006.

GENE MACIOL, EXAMINING ATTORNEY

SN 77-144,198. MESH, MIKEL, LAHAINA, HI. FILED 3-29-2007.

GOLDEN BAMBOO

THE MARK CONSISTS OF STANDARD CHARACTERS WITHOUT CLAIM TO ANY PARTICULAR FONT, STYLE, SIZE, OR COLOR.

NO CLAIM IS MADE TO THE EXCLUSIVE RIGHT TO USE "BAMBOO", APART FROM THE MARK AS SHOWN.

FOR JEWELRY, NAMELY, PENDANTS, EARRINGS, BRACELETS, CHAINS, RINGS, AND PINS ALL MADE WITH MEDAL, GEMS, STONES, GOLD AND DIAMONDS (U.S. CLS. 2, 27, 28 AND 50).

DAVID MURRAY, EXAMINING ATTORNEY

SN 77-146,308. THE TRUSTEE OF THE BYRON NELSON MARITAL TRUST, DALLAS, TX. FILED 4-2-2007.

BYRON NELSON SIGNATURE SERIES

THE MARK CONSISTS OF STANDARD CHARACTERS WITHOUT CLAIM TO ANY PARTICULAR FONT, STYLE, SIZE, OR COLOR.

OWNER OF U.S. REG. NOS. 1,725,794, 2,587,436 AND OTHERS.

NO CLAIM IS MADE TO THE EXCLUSIVE RIGHT TO USE "SIGNATURE SERIES", APART FROM THE MARK AS SHOWN.

THE NAME(S), PORTRAIT(S), AND/OR SIGNATURE(S) SHOWN IN THE MARK DOES NOT IDENTIFY A PARTICULAR LIVING INDIVIDUAL.

FOR CUFF LINKS, TIE PINS, LAPEL PINS, WATCHES (U.S. CLS. 2, 27, 28 AND 50).

BARBARA GAYNOR, EXAMINING ATTORNEY

CLASS 14—(Continued).

SN 77-160,841. BULOVA CORPORATION, WOODSIDE, NY.
FILED 4-19-2007.

KIRKWOOD

THE MARK CONSISTS OF STANDARD CHARACTERS
WITHOUT CLAIM TO ANY PARTICULAR FONT, STYLE,
SIZE, OR COLOR.

FOR WATCHES (U.S. CLS. 2, 27, 28 AND 50).
RUDY R. SINGLETON, EXAMINING ATTORNEY

SN 77-170,192. JANICE TATANGELO, LANCASTER, CA.
FILED 5-1-2007.

GOT NOTARY?

THE MARK CONSISTS OF STANDARD CHARACTERS
WITHOUT CLAIM TO ANY PARTICULAR FONT, STYLE,
SIZE, OR COLOR.

NO CLAIM IS MADE TO THE EXCLUSIVE RIGHT TO
USE "NOTARY", APART FROM THE MARK AS SHOWN.
FOR JEWELRY (U.S. CLS. 2, 27, 28 AND 50).
FIRST USE 4-27-2006; IN COMMERCE 7-1-2006.
RUSS HERMAN, EXAMINING ATTORNEY

SN 77-174,519. UNIVERSAL TIME CORPORATION, MARK-
HAM, ONTARIO, CANADA, FILED 5-7-2007.



THE NAME "PIERRE LAURENT" DOES NOT IDENTIFY
A LIVING INDIVIDUAL.
FOR WATCHES AND PARTS OF WATCHES (U.S. CLS.
2, 27, 28 AND 50).
FIRST USE 3-0-1989; IN COMMERCE 6-0-1996.
REBECCA EISINGER, EXAMINING ATTORNEY

CLASS 14—(Continued).

SN 77-185,233. STAPLETON, SEAN K., MT. VERNON, MO.
FILED 5-18-2007.



FOR BRACELETS (U.S. CLS. 2, 27, 28 AND 50).
FIRST USE 2-14-2000; IN COMMERCE 2-14-2000.
KEVIN DINALLO, EXAMINING ATTORNEY

SN 77-203,026. INTERNATIONAL BULLION AND METAL
BROKERS (USA) INC., SUNRISE, FL. FILED 6-11-2007.

THE SEVEN LUCKY HEARTS

THE MARK CONSISTS OF STANDARD CHARACTERS
WITHOUT CLAIM TO ANY PARTICULAR FONT, STYLE,
SIZE, OR COLOR.

NO CLAIM IS MADE TO THE EXCLUSIVE RIGHT TO
USE "SEVEN" AND "HEARTS", APART FROM THE MARK
AS SHOWN.

FOR JEWELRY (U.S. CLS. 2, 27, 28 AND 50).
FIRST USE 10-7-2005; IN COMMERCE 10-7-2005.
KHANH LE, EXAMINING ATTORNEY

SN 77-237,988. LATTO, LESLIE, CROTON ON HUDSON, NY.
FILED 7-25-2007.

LobeLites

THE MARK CONSISTS OF STANDARD CHARACTERS
WITHOUT CLAIM TO ANY PARTICULAR FONT, STYLE,
SIZE, OR COLOR.

FOR EARRINGS (U.S. CLS. 2, 27, 28 AND 50).
FRANK LATTUCA, EXAMINING ATTORNEY

SN 77-255,928. NEW UNDERSTANDINGS AWAKEN
WORLDWIDE, LLC, WILMINGTON, DE. FILED 8-15-2007.

NUAW NEW UNDERSTANDINGS AWAKEN WITHIN

THE MARK CONSISTS OF STANDARD CHARACTERS
WITHOUT CLAIM TO ANY PARTICULAR FONT, STYLE,
SIZE, OR COLOR.

FOR JEWELRY (U.S. CLS. 2, 27, 28 AND 50).
KYLE PEETE, EXAMINING ATTORNEY

CLASS 14—(Continued).

SN 77-256,135. NEW UNDERSTANDINGS AWAKEN WORLDWIDE, LLC, WILMINGTON, DE. FILED 8-15-2007.

**NUAW NEW UNDERSTANDINGS
AWAKEN WORLDWIDE**

THE MARK CONSISTS OF STANDARD CHARACTERS WITHOUT CLAIM TO ANY PARTICULAR FONT, STYLE, SIZE, OR COLOR.
FOR JEWELRY (U.S. CLS. 2, 27, 28 AND 50).
KYLE PEETE, EXAMINING ATTORNEY

SN 77-266,131. MICHAEL T ITMAN, WEST SAINT PAUL, MN. FILED 8-28-2007.

Jelly Backs

THE MARK CONSISTS OF STANDARD CHARACTERS WITHOUT CLAIM TO ANY PARTICULAR FONT, STYLE, SIZE, OR COLOR.
NO CLAIM IS MADE TO THE EXCLUSIVE RIGHT TO USE "BACKS", APART FROM THE MARK AS SHOWN.
FOR PIERCED EARRING BACKINGS (U.S. CLS. 2, 27, 28 AND 50).
FIRST USE 8-18-2007; IN COMMERCE 8-18-2007.
NELSON SNYDER, EXAMINING ATTORNEY

SN 77-272,816. LEE READ JEWELERS, INC., MERIDIAN, ID. FILED 9-6-2007.

**Nature's Most Romantic
Diamonds**

THE MARK CONSISTS OF STANDARD CHARACTERS WITHOUT CLAIM TO ANY PARTICULAR FONT, STYLE, SIZE, OR COLOR.
NO CLAIM IS MADE TO THE EXCLUSIVE RIGHT TO USE "DIAMONDS", APART FROM THE MARK AS SHOWN.
FOR DIAMOND JEWELRY (U.S. CLS. 2, 27, 28 AND 50).
BRIAN CALLAGHAN, EXAMINING ATTORNEY

CLASS 14—(Continued).

SN 77-275,645. PAJ, INC., DALLAS, TX. FILED 9-10-2007.

PAOLO RENNA

"THE NAME(S), PORTRAIT(S), AND/OR SIGNATURE(S) SHOWN IN THE MARK IDENTIFIES PAOLO RENNA, WHOSE CONSENT(S) TO REGISTER IS SUBMITTED."
THE MARK CONSISTS OF A STYLIZED DEPICTION OF THE NAME "PAOLO RENNA".
FOR JEWELRY (U.S. CLS. 2, 27, 28 AND 50).
NICHOLAS ALTREE, EXAMINING ATTORNEY

SN 77-278,816. OAK PATCH GIFTS, DBA JODY COYOTE, EUGENE, OR. FILED 9-13-2007.

Coyote Rose

THE MARK CONSISTS OF STANDARD CHARACTERS WITHOUT CLAIM TO ANY PARTICULAR FONT, STYLE, SIZE, OR COLOR.
NO CLAIM IS MADE TO THE EXCLUSIVE RIGHT TO USE "ROSE", APART FROM THE MARK AS SHOWN.
FOR JEWELRY (U.S. CLS. 2, 27, 28 AND 50).
FIRST USE 1-24-1994; IN COMMERCE 1-24-1994.
ROBERT LAVACHE, EXAMINING ATTORNEY

SN 77-280,967. PITSIRONIS, ROSEMARIE, DIX HILLS, NY. FILED 9-17-2007.

HUGITZ

THE MARK CONSISTS OF STANDARD CHARACTERS WITHOUT CLAIM TO ANY PARTICULAR FONT, STYLE, SIZE, OR COLOR.
FOR JEWELRY (U.S. CLS. 2, 27, 28 AND 50).
FIRST USE 9-1-2007; IN COMMERCE 9-15-2007.
JAMES MACFARLANE, EXAMINING ATTORNEY

CLASS 14—(Continued).

SN 77-282,127. GEORGE N. SAWYER, MINNEAPOLIS, MN. FILED S.R. 9-18-2007; AM. P.R. 1-3-2008.

george
sawyer

THE MARK CONSISTS OF THE WORD GEORGE IS DIRECTLY ABOVE THE WORD SAWYER IN BLACK CUSTOM FONT.

FOR (BASED ON USE IN COMMERCE) BRACELETS; BROOCHES; DIAMOND JEWELRY; GEMSTONE JEWELRY; JEWELRY; RINGS BEING JEWELRY (U.S. CLS. 2, 27, 28 AND 50).

FIRST USE 9-17-2007; IN COMMERCE 9-17-2007. PAUL E. FAHRENKOPF, EXAMINING ATTORNEY

SN 77-284,348. I.M. DAVIDSON, INC., NEW YORK, NY. FILED 9-20-2007.

NEW YORK HAT LADY

THE MARK CONSISTS OF STANDARD CHARACTERS WITHOUT CLAIM TO ANY PARTICULAR FONT, STYLE, SIZE, OR COLOR.

NO CLAIM IS MADE TO THE EXCLUSIVE RIGHT TO USE "NEW YORK", APART FROM THE MARK AS SHOWN. FOR JEWELRY (U.S. CLS. 2, 27, 28 AND 50). INGRID C. EULIN, EXAMINING ATTORNEY

SN 77-290,072. HARRIS, MICHAEL E., PALMER, MA. FILED 9-27-2007.

DIAMONDHER

THE MARK CONSISTS OF STANDARD CHARACTERS WITHOUT CLAIM TO ANY PARTICULAR FONT, STYLE, SIZE, OR COLOR.

FOR JEWELRY (U.S. CLS. 2, 27, 28 AND 50). BRENDAN REGAN, EXAMINING ATTORNEY

CLASS 14—(Continued).

SN 77-290,213. SEVILLE WATCH CORPORATION, NEW YORK, NY. FILED 9-27-2007.

TANGO BY RAYMOND WEIL

THE MARK CONSISTS OF STANDARD CHARACTERS WITHOUT CLAIM TO ANY PARTICULAR FONT, STYLE, SIZE, OR COLOR.

OWNER OF U.S. REG. NOS. 1,090,831 AND 1,474,908. THE NAME "RAYMOND WEIL" IDENTIFIES A LIVING INDIVIDUAL WHOSE CONSENT IS OF RECORD. FOR WATCHES (U.S. CLS. 2, 27, 28 AND 50). SANJEEV VOHRA, EXAMINING ATTORNEY

SN 77-291,564. HEARTS ON FIRE COMPANY, LLC, BOSTON, MA. FILED 9-28-2007.

PRECIOUS PRONG

THE MARK CONSISTS OF STANDARD CHARACTERS WITHOUT CLAIM TO ANY PARTICULAR FONT, STYLE, SIZE, OR COLOR.

NO CLAIM IS MADE TO THE EXCLUSIVE RIGHT TO USE "PRONG", APART FROM THE MARK AS SHOWN. FOR JEWELRY; PRECIOUS GEMSTONES (U.S. CLS. 2, 27, 28 AND 50).

FIRST USE 1-0-2007; IN COMMERCE 1-0-2007. CYNTHIA SLOAN, EXAMINING ATTORNEY

SN 77-292,115. LILA GEMS, INC., LOS ANGELES, CA. FILED 9-28-2007.

Magic Circle Potions

THE MARK CONSISTS OF STANDARD CHARACTERS WITHOUT CLAIM TO ANY PARTICULAR FONT, STYLE, SIZE, OR COLOR.

FOR BRACELETS; RINGS BEING JEWELRY; NECKLACES; EARRINGS; PENDANTS; BROOCHES (U.S. CLS. 2, 27, 28 AND 50).

JACLYN KIDWELL, EXAMINING ATTORNEY

CLASS 14—(Continued).

SN 77-292,212. FRANKLIN, STEVEN, ORO VALLEY, AZ.
FILED 9-29-2007.



THE COLOR(S) BLACK, YELLOW, AND GREEN IS/ARE CLAIMED AS A FEATURE OF THE MARK.

THE MARK CONSISTS OF A BLACK OUTSIDE BORDER CONTAINING AN INSIDE YELLOW BACKGROUND. SET ATOP THE YELLOW BACKGROUND ARE BLACK LETTERS COMPOSING THE NAME AND A CURVED GREEN ARROW.

FOR JEWELRY (U.S. CLS. 2, 27, 28 AND 50).
SHANNON TWOHIG, EXAMINING ATTORNEY

SN 77-293,047. SANDBERG & SIKORSKI CORPORATION,
NEW YORK, NY. FILED 10-1-2007.

Yours Truly

THE MARK CONSISTS OF STANDARD CHARACTERS WITHOUT CLAIM TO ANY PARTICULAR FONT, STYLE, SIZE, OR COLOR.

FOR DIAMOND JEWELRY; GEMSTONE JEWELRY; JEWELRY (U.S. CLS. 2, 27, 28 AND 50).
RENEE MCCRAY, EXAMINING ATTORNEY

SN 77-293,066. MIGHTY OAK ENTERTAINMENT, INC.,
NEWPORT BEACH, CA. FILED 10-1-2007.

WHACKED OUT

THE MARK CONSISTS OF STANDARD CHARACTERS WITHOUT CLAIM TO ANY PARTICULAR FONT, STYLE, SIZE, OR COLOR.

OWNER OF U.S. REG. NO. 3,282,024.
FOR JEWELRY (U.S. CLS. 2, 27, 28 AND 50).
GILBERT SWIFT, EXAMINING ATTORNEY

CLASS 14—(Continued).

SN 77-293,166. GENENDER INTERNATIONAL, INC.,
WHEELING, IL. FILED 10-1-2007.

CRONEL

THE MARK CONSISTS OF STANDARD CHARACTERS WITHOUT CLAIM TO ANY PARTICULAR FONT, STYLE, SIZE, OR COLOR.

FOR WATCHES (U.S. CLS. 2, 27, 28 AND 50).
MARTHA FROMM, EXAMINING ATTORNEY

SN 77-293,457. HAMILTON V. JAMES FREDERICK, LAKEVILLE, MN. FILED 10-2-2007.

Black Mountain Silver Company

THE MARK CONSISTS OF STANDARD CHARACTERS WITHOUT CLAIM TO ANY PARTICULAR FONT, STYLE, SIZE, OR COLOR.

NO CLAIM IS MADE TO THE EXCLUSIVE RIGHT TO USE "SILVER COMPANY", APART FROM THE MARK AS SHOWN.

FOR BEADS FOR USE IN THE MANUFACTURE OF JEWELRY; BRACELETS; BROOCHES; CHARMS; COSTUME JEWELRY; DIAMOND JEWELRY; GEMSTONE JEWELRY; IDENTIFICATION BRACELETS; JEWELRY; JEWELRY BOXES; JEWELRY BOXES NOT OF METAL; JEWELRY BOXES OF METAL; JEWELRY BOXES OF PRECIOUS METAL; JEWELRY CASES; JEWELRY CASES NOT OF PRECIOUS METAL; JEWELRY CASES OF PRECIOUS METAL; JEWELRY CASKETS; JEWELRY CASKETS OF PRECIOUS METAL (U.S. CLS. 2, 27, 28 AND 50).

FIRST USE 2-1-1991; IN COMMERCE 2-1-1991.
FRED CARL, EXAMINING ATTORNEY

SN 77-293,558. MARQUESA, INC., VAN NUYS, CA. FILED 10-2-2007.

CONGA LINE

THE MARK CONSISTS OF STANDARD CHARACTERS WITHOUT CLAIM TO ANY PARTICULAR FONT, STYLE, SIZE, OR COLOR.

FOR JEWELRY (U.S. CLS. 2, 27, 28 AND 50).
DOMINIC FATHY, EXAMINING ATTORNEY

CLASS 14—(Continued).

SN 77-294,618. CUFF-DADDY, LLC, NORTH POTOMAC, MD. FILED 10-2-2007.

CUFF-DADDY

THE MARK CONSISTS OF STANDARD CHARACTERS WITHOUT CLAIM TO ANY PARTICULAR FONT, STYLE, SIZE, OR COLOR.
FOR JEWELRY; CUFF-LINKS; KEY CHAINS OF PRECIOUS METAL; BRACELETS; ALARM CLOCKS (U.S. CLS. 2, 27, 28 AND 50).
FIRST USE 11-0-2004; IN COMMERCE 11-0-2004.
WARREN L. OLANDRIA, EXAMINING ATTORNEY

SN 77-297,807. GEO MANAGEMENT, LTD., LAS VEGAS, NV. FILED 10-5-2007.

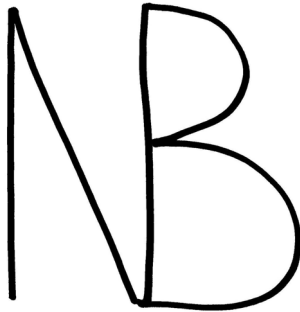

THE MARK CONSISTS OF THE INITIALS "NB" USING AS A FEATURE IN COMMON A VERTICAL LINE.
FOR JEWELRY (U.S. CLS. 2, 27, 28 AND 50).
TASNEEM HUSSAIN, EXAMINING ATTORNEY

SN 77-299,053. SANDBERG & SIKORSKI CORPORATION, NEW YORK, NY. FILED 10-9-2007.

JUST TRUE

THE MARK CONSISTS OF STANDARD CHARACTERS WITHOUT CLAIM TO ANY PARTICULAR FONT, STYLE, SIZE, OR COLOR.
FOR JEWELRY (U.S. CLS. 2, 27, 28 AND 50).
RENEE MCCRAY, EXAMINING ATTORNEY

CLASS 14—(Continued).

SN 77-307,474. SANDBERG & SIKORSKI CORPORATION, NEW YORK, NY. FILED 10-18-2007.

A DIAMOND IS A GIRL'S BEST FRIEND

THE MARK CONSISTS OF STANDARD CHARACTERS WITHOUT CLAIM TO ANY PARTICULAR FONT, STYLE, SIZE, OR COLOR.
OWNER OF U.S. REG. NO. 3,269,035.
NO CLAIM IS MADE TO THE EXCLUSIVE RIGHT TO USE "DIAMOND", APART FROM THE MARK AS SHOWN.
FOR JEWELRY (U.S. CLS. 2, 27, 28 AND 50).
RENEE MCCRAY, EXAMINING ATTORNEY

SN 77-308,709. SANDBERG & SIKORSKI CORPORATION, NEW YORK, NY. FILED 10-19-2007.

TWO HEARTS BEATING AS ONE

THE MARK CONSISTS OF STANDARD CHARACTERS WITHOUT CLAIM TO ANY PARTICULAR FONT, STYLE, SIZE, OR COLOR.
FOR JEWELRY (U.S. CLS. 2, 27, 28 AND 50).
RENEE MCCRAY, EXAMINING ATTORNEY

SN 77-313,790. SANDBERG & SIKORSKI CORPORATION, NEW YORK, NY. FILED 10-25-2007.

THE GIFT OF LIBERTY

THE MARK CONSISTS OF STANDARD CHARACTERS WITHOUT CLAIM TO ANY PARTICULAR FONT, STYLE, SIZE, OR COLOR.
FOR JEWELRY (U.S. CLS. 2, 27, 28 AND 50).
RENEE MCCRAY, EXAMINING ATTORNEY

CLASS 14—(Continued).

SN 77-315,766. SANDBERG & SIKORSKI CORPORATION,
NEW YORK, NY. FILED 10-29-2007.

AMERICAN CELEBRATION

THE MARK CONSISTS OF STANDARD CHARACTERS
WITHOUT CLAIM TO ANY PARTICULAR FONT, STYLE,
SIZE, OR COLOR.
FOR JEWELRY (U.S. CLS. 2, 27, 28 AND 50).
RENEE MCCRAY, EXAMINING ATTORNEY

SN 77-316,698. TOTLE, INC., OSSEO, MN. FILED 10-30-2007.

TOTLES

THE MARK CONSISTS OF STANDARD CHARACTERS
WITHOUT CLAIM TO ANY PARTICULAR FONT, STYLE,
SIZE, OR COLOR.
FOR JEWELRY; LEATHER JEWELRY AND ACCES-
SORY BOXES; CUFF LINKS; KEY RINGS OF PRECIOUS
METAL; STATUES, FIGURINES, AND WORKS OF ART
OF PRECIOUS METAL; WATCHES AND WATCH
BANDS, CASES, CHAINS, AND STRAPS (U.S. CLS. 2,
27, 28 AND 50).
MELVIN AXILBUND, EXAMINING ATTORNEY

SN 77-323,937. BELLISIO FOODS, INC., DBA MICHELINA'S,
INC., DULUTH, MN. FILED 11-7-2007.

THE FAMILY TABLE

THE MARK CONSISTS OF STANDARD CHARACTERS
WITHOUT CLAIM TO ANY PARTICULAR FONT, STYLE,
SIZE, OR COLOR.
FOR HOLIDAY ORNAMENTS AND DECORATIONS
OF PRECIOUS METAL, EXCLUDING TREE ORNA-
MENTS; CLOCKS (U.S. CLS. 2, 27, 28 AND 50).
JESSICA FATHY, EXAMINING ATTORNEY

CLASS 14—(Continued).

SN 77-340,445. SCHUMACHER, BERNARD, BISMARCK,
ND. FILED 11-29-2007.

REJOICE

THE MARK CONSISTS OF STANDARD CHARACTERS
WITHOUT CLAIM TO ANY PARTICULAR FONT, STYLE,
SIZE, OR COLOR.
FOR JEWELRY (U.S. CLS. 2, 27, 28 AND 50).
NAPOLEON SHARMA, EXAMINING ATTORNEY

SN 77-340,452. SCHUMACHER, BERNARD, BISMARCK,
ND. FILED 11-29-2007.

ENLIGHTEN

THE MARK CONSISTS OF STANDARD CHARACTERS
WITHOUT CLAIM TO ANY PARTICULAR FONT, STYLE,
SIZE, OR COLOR.
FOR JEWELRY (U.S. CLS. 2, 27, 28 AND 50).
NAPOLEON SHARMA, EXAMINING ATTORNEY

SN 77-344,927. SCHUMACHER, BERNARD, BISMARCK,
ND. FILED 12-5-2007.

ASSURED

THE MARK CONSISTS OF STANDARD CHARACTERS
WITHOUT CLAIM TO ANY PARTICULAR FONT, STYLE,
SIZE, OR COLOR.
FOR JEWELRY (U.S. CLS. 2, 27, 28 AND 50).
NAPOLEON SHARMA, EXAMINING ATTORNEY

SN 77-344,955. SCHUMACHER, BERNARD, BISMARCK,
ND. FILED 12-5-2007.

IRRESISTIBLE

THE MARK CONSISTS OF STANDARD CHARACTERS
WITHOUT CLAIM TO ANY PARTICULAR FONT, STYLE,
SIZE, OR COLOR.
FOR JEWELRY (U.S. CLS. 2, 27, 28 AND 50).
NAPOLEON SHARMA, EXAMINING ATTORNEY

CLASS 14—(Continued).

SN 77-344,983. SCHUMACHER, BERNARD, BISMARCK, ND. FILED 12-5-2007.

PLEASURE

THE MARK CONSISTS OF STANDARD CHARACTERS WITHOUT CLAIM TO ANY PARTICULAR FONT, STYLE, SIZE, OR COLOR.
FOR JEWELRY (U.S. CLS. 2, 27, 28 AND 50).
NAPOLEON SHARMA, EXAMINING ATTORNEY

SN 77-345,429. SCHUMACHER, BERNARD, BISMARCK, ND. FILED 12-6-2007.

ESTEEM

THE MARK CONSISTS OF STANDARD CHARACTERS WITHOUT CLAIM TO ANY PARTICULAR FONT, STYLE, SIZE, OR COLOR.
FOR JEWELRY (U.S. CLS. 2, 27, 28 AND 50).
NAPOLEON SHARMA, EXAMINING ATTORNEY

SN 77-345,436. SCHUMACHER, BERNARD, BISMARCK, ND. FILED 12-6-2007.

COMPASSION

THE MARK CONSISTS OF STANDARD CHARACTERS WITHOUT CLAIM TO ANY PARTICULAR FONT, STYLE, SIZE, OR COLOR.
FOR JEWELRY (U.S. CLS. 2, 27, 28 AND 50).
NAPOLEON SHARMA, EXAMINING ATTORNEY

SN 77-345,473. SCHUMACHER, BERNARD, BISMARCK, ND. FILED 12-6-2007.

GAIETY

THE MARK CONSISTS OF STANDARD CHARACTERS WITHOUT CLAIM TO ANY PARTICULAR FONT, STYLE, SIZE, OR COLOR.
FOR JEWELRY (U.S. CLS. 2, 27, 28 AND 50).
NAPOLEON SHARMA, EXAMINING ATTORNEY

CLASS 14—(Continued).

SN 77-345,475. SCHUMACHER, BERNARD, BISMARCK, ND. FILED 12-6-2007.

REVEL

THE MARK CONSISTS OF STANDARD CHARACTERS WITHOUT CLAIM TO ANY PARTICULAR FONT, STYLE, SIZE, OR COLOR.
FOR JEWELRY (U.S. CLS. 2, 27, 28 AND 50).
NAPOLEON SHARMA, EXAMINING ATTORNEY

SN 78-865,169. YANG, TONY, SAN DIEGO, CA. FILED 4-19-2006.

Isabelle

FOR HOROLOGICAL INSTRUMENTS, NAMELY, WATCHES AND CLOCKS (U.S. CLS. 2, 27, 28 AND 50).
LEIGH LOWRY, EXAMINING ATTORNEY

SN 78-955,048. MARTIN, ROBERT B. (JR.), LOS ANGELES, CA. FILED 8-18-2006.



THE MARK CONSISTS OF A LARGE BLACK, BLOCK LETTERED "M" POSITIONED CENTRALLY WITHIN A WHITE CIRCLE AND SURROUNDED BY A THICK BLACK RING.
FOR SHOE ORNAMENTS OF PRECIOUS STONES AND METALS (U.S. CLS. 2, 27, 28 AND 50).
STEVEN PEREZ, EXAMINING ATTORNEY

CLASS 14—(Continued).

SN 79-041,433. VINCENT BÉRARD SA, SWITZERLAND,
FILED 6-13-2007.

COMPAGNON DU TEMPS

THE MARK CONSISTS OF STANDARD CHARACTERS
WITHOUT CLAIM TO ANY PARTICULAR FONT, STYLE,
SIZE, OR COLOR.

OWNER OF INTERNATIONAL REGISTRATION 0931729
DATED 6-13-2007, EXPIRES 6-13-2017.

THE ENGLISH TRANSLATION OF THE FOREIGN
WORD(S) IN THE MARK IS: COMPANION OF TIME.

FOR PRECIOUS METALS AND THEIR ALLOYS,
JEWELRY, PRECIOUS STONES, HOROLOGICAL AND
CHRONOMETRIC INSTRUMENTS AND THEIR PARTS
(U.S. CLS. 2, 27, 28 AND 50).

JEFF DEFORD, EXAMINING ATTORNEY

SN 79-041,739. VINCENT BÉRARD SA, SWITZERLAND,
FILED 6-11-2007.

VINCENT BÉRARD

THE MARK CONSISTS OF STANDARD CHARACTERS
WITHOUT CLAIM TO ANY PARTICULAR FONT, STYLE,
SIZE, OR COLOR.

PRIORITY DATE OF 12-12-2006 IS CLAIMED.

OWNER OF INTERNATIONAL REGISTRATION 0932340
DATED 6-11-2007, EXPIRES 6-11-2017.

OWNER OF U.S. REG. NO. 3,073,752.

FOR WATCHES, WATCH PARTS, WATCH FITTINGS,
CLOCKS, CLOCK PARTS, JEWELLED WATCHES, JEW-
ELLED CLOCKS (U.S. CLS. 2, 27, 28 AND 50).

JEFF DEFORD, EXAMINING ATTORNEY

CLASS 15—MUSICAL INSTRUMENTS

SN 77-130,152. HARMONY INDUSTRIES, INC., ELK GROVE
VILLAGE, IL. FILED 3-13-2007.

HOLLYWOOD

THE MARK CONSISTS OF STANDARD CHARACTERS
WITHOUT CLAIM TO ANY PARTICULAR FONT, STYLE,
SIZE, OR COLOR.

FOR GUITARS (U.S. CLS. 2, 21 AND 36).

KELLY BOULTON, EXAMINING ATTORNEY

CLASS 15—(Continued).

SN 77-142,820. FIRST ACT INC., BOSTON, MA. FILED 3-28-
2007.

Delia LS

THE MARK CONSISTS OF STANDARD CHARACTERS
WITHOUT CLAIM TO ANY PARTICULAR FONT, STYLE,
SIZE, OR COLOR.

FOR MUSICAL INSTRUMENTS, NAMELY, GUITARS,
AND PARTS AND ACCESSORIES FOR THE PLAYING,
MAINTENANCE, REPAIR AND TRANSPORTATION OF
GUITARS, NAMELY, GUITAR STRAPS, STRINGWIN-
DERS, GUITAR STRINGS, GUITAR PICKS, TUNERS
FOR GUITARS, GUITAR STANDS, GUITAR CASES,
SHEET MUSIC STANDS, CAPOS, GUITAR NECK
STANDS, AND GUITAR SLIDES (U.S. CLS. 2, 21 AND
36).

MICHAEL WEBSTER, EXAMINING ATTORNEY

SN 77-147,826. DRUM WORKSHOP, INC., OXNARD, CA.
FILED 4-3-2007.



NO CLAIM IS MADE TO THE EXCLUSIVE RIGHT TO
USE "DRUM", APART FROM THE MARK AS SHOWN.

FOR DRUM PRACTICE PADS (U.S. CLS. 2, 21 AND
36).

CAROLYN CATALDO, EXAMINING ATTORNEY

CLASS 15—(Continued).

SN 77-148,963. EDWARDS, JON SCOTT, VENICE, CA. FILED 4-4-2007.

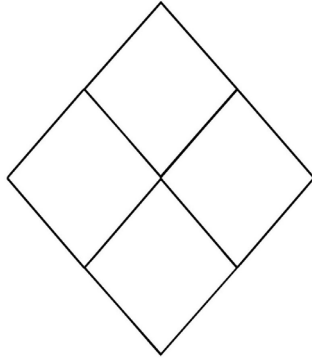

THE MARK CONSISTS OF FOUR SMALLER DIAMONDS WITHIN ONE LARGER DIAMOND.
 SEC. 2(F).
 FOR CARRYING CASES FOR MUSICAL INSTRUMENTS AND MUSICAL INSTRUMENT ACCESSORIES (U.S. CLS. 2, 21 AND 36).
 FIRST USE 7-1-1996; IN COMMERCE 7-1-1996.
 ROBERT C. CLARK JR., EXAMINING ATTORNEY

SN 77-210,730. ABA MUSIC, INC., SHAKER HEIGHTS, OH. FILED 6-20-2007.

EVIDA

THE MARK CONSISTS OF STANDARD CHARACTERS WITHOUT CLAIM TO ANY PARTICULAR FONT, STYLE, SIZE, OR COLOR.
 THE TERM EVIDA HAS NO MEANING IN ENGLISH.
 FOR MUSICAL INSTRUMENTS, NAMELY, FLUTES, PICCOLOS, CLARINETS, OBOES, BASSOONS, SAXOPHONES, ENGLISH HORNS, FRENCH HORNS, TRUMPETS, TROMBONES, FLUGELHORNS, BARITONES, TUBAS, SOUSAPHONES, AND DRUMS, AND PARTS THEREFOR (U.S. CLS. 2, 21 AND 36).
 FIRST USE 1-10-2006; IN COMMERCE 1-10-2006.
 STEVEN R. FINE, EXAMINING ATTORNEY

CLASS 15—(Continued).

SN 77-210,761. ABA MUSIC, INC., SHAKER HEIGHTS, OH. FILED 6-20-2007.

SOLEXA

THE MARK CONSISTS OF STANDARD CHARACTERS WITHOUT CLAIM TO ANY PARTICULAR FONT, STYLE, SIZE, OR COLOR.
 THE TERM "SOLEXA" HAS NO MEANING IN ENGLISH.
 FOR MUSICAL INSTRUMENTS, NAMELY, FLUTES, PICCOLOS, CLARINETS, OBOES, BASSOONS, SAXOPHONES, ENGLISH HORNS, FRENCH HORNS, TRUMPETS, TROMBONES, FLUGELHORNS, BARITONES, TUBAS, SOUSAPHONES, AND DRUMS, AND PARTS THEREFOR (U.S. CLS. 2, 21 AND 36).
 FIRST USE 1-10-2006; IN COMMERCE 1-10-2006.
 STEVEN R. FINE, EXAMINING ATTORNEY

SN 77-214,892. CHOI, JONG CHEUL, NORTHRIDGE, CA. FILED 6-25-2007.

TUNE

THE MARK CONSISTS OF STANDARD CHARACTERS WITHOUT CLAIM TO ANY PARTICULAR FONT, STYLE, SIZE, OR COLOR.
 FOR GUITARS, NAMELY ELECTRIC GUITARS AND BASS GUITARS; AND GUITAR PARTS AND ACCESSORIES, NAMELY, GUITAR STRAPS, GUITAR PICKS, GUITAR STRINGS, CARRYING CASES FOR GUITARS, AND GUITAR BAGS (U.S. CLS. 2, 21 AND 36).
 FIRST USE 3-31-2003; IN COMMERCE 1-18-2007.
 YAT SYE, LEE, EXAMINING ATTORNEY

SN 77-295,581. SOUND INNOVATIONS, LLC, VENTURA, CA. FILED 10-3-2007.



THE MARK CONSISTS OF THE STYLIZED TEXT "KICKSTAND" PLACED IN THE AREA OF THE NECK OF A CUSTOM STYLE GUITAR.
 FOR MUSICAL INSTRUMENT STANDS (U.S. CLS. 2, 21 AND 36).
 FIRST USE 9-14-2006; IN COMMERCE 9-20-2006.
 IRA J. GOODSAD, EXAMINING ATTORNEY

CLASS 15—(Continued).

SN 77-297,653. ROBIN LEONG, DBA AVA AMERICAN VIOLIN ALLIANCE, HONOLULU, HI. AND ROBERT L. RAY, DBA AVA AMERICAN VIOLIN ALLIANCE, OLYMPIA, WA. AND ROLAND FELLER, DBA AVA AMERICAN VIOLIN ALLIANCE, SAN FRANCISCO, CA. AND WILLIAM GAILES, DBA AVA AMERICAN VIOLIN ALLIANCE, COLLEGE PARK, MD. FILED 10-5-2007.

AUGUSTE DUBOIS

THE MARK CONSISTS OF STANDARD CHARACTERS WITHOUT CLAIM TO ANY PARTICULAR FONT, STYLE, SIZE, OR COLOR.

THE NAME(S), PORTRAIT(S), AND/OR SIGNATURE(S) SHOWN IN THE MARK DOES NOT IDENTIFY A PARTICULAR LIVING INDIVIDUAL.

FOR BOWS FOR MUSICAL INSTRUMENTS; MUSICAL INSTRUMENTS; STRING INSTRUMENTS (U.S. CLS. 2, 21 AND 36).

AMY MCMENAMIN, EXAMINING ATTORNEY

SN 78-872,376. JACKSON/CHARVEL MANUFACTURING, INC., DBA T&G COMPANY, SCOTTSDALE, AZ. FILED 4-28-2006.

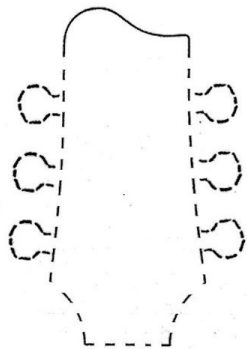

OWNER OF U.S. REG. NO. 2,339,365.

THE MARK CONSISTS OF THE UPPER MOST PORTION OF A GUITAR PEGHEAD FEATURING A CONVEX CURVE AT THE UPPER LEFT TOP THAT SLOPES DOWNWARD TO THE RIGHT. THE DOTTED LINES MERELY REPRESENT THE REMAINDER OF THE PEGHEAD AND LOCATION OF THE TUNING PEGS AND ARE NOT CLAIMED AS A PORTION OF THE MARK.

SEC. 2(F).

FOR GUITARS (U.S. CLS. 2, 21 AND 36).

FIRST USE 10-11-1996; IN COMMERCE 10-11-1996.

ALLISON SCHRODY, EXAMINING ATTORNEY

CLASS 16—PAPER GOODS AND PRINTED MATTER

SN 76-671,285. ABC TELECOM INC., ROSLYN HEIGHTS, NY. FILED 1-10-2007.

LANGOSTA

THE MARK CONSISTS OF STANDARD CHARACTERS WITHOUT CLAIM TO ANY PARTICULAR FONT, STYLE, SIZE, OR COLOR.

THE TRANSLATION OF LANGOSTA IS LOBSTER. FOR PREPAID TELEPHONE CARDS, NOT MAGNETICALLY ENCODED (U.S. CLS. 2, 5, 22, 23, 29, 37, 38 AND 50).

FIRST USE 9-26-2006; IN COMMERCE 9-26-2006.

HENRY S. ZAK, EXAMINING ATTORNEY

SN 76-674,379. DIAMOND PHONE CARD INC., ELMHURST, NY. FILED 3-20-2007.

MOTOCONCHO EXPRESS PHONE CARD

THE MARK CONSISTS OF STANDARD CHARACTERS WITHOUT CLAIM TO ANY PARTICULAR FONT, STYLE, SIZE, OR COLOR.

NO CLAIM IS MADE TO THE EXCLUSIVE RIGHT TO USE "PHONE CARD", APART FROM THE MARK AS SHOWN.

THE FOREIGN WORDING IN THE MARK TRANSLATES INTO ENGLISH AS MOTORING RAPIDLY.

FOR PREPAID TELEPHONE CALLING CARDS NOT MAGNETICALLY ENCODED (U.S. CLS. 2, 5, 22, 23, 29, 37, 38 AND 50).

FIRST USE 1-25-2007; IN COMMERCE 1-25-2007.

COLLEEN DOMBROW, EXAMINING ATTORNEY

SN 76-680,149. GILMAN, PETER A., TOLEDO, OH. FILED 8-1-2007.

STROKE BY STROKE

THE MARK CONSISTS OF STANDARD CHARACTERS WITHOUT CLAIM TO ANY PARTICULAR FONT, STYLE, SIZE, OR COLOR.

FOR GREETING CARDS (U.S. CLS. 2, 5, 22, 23, 29, 37, 38 AND 50).

RICHARD A. STRASER, EXAMINING ATTORNEY

CLASS 16—(Continued).

SN 76-682,403. OMNIGRAPHICS, INC., DETROIT, MI. FILED 9-28-2007.

Headquarters USA

THE MARK CONSISTS OF STANDARD CHARACTERS WITHOUT CLAIM TO ANY PARTICULAR FONT, STYLE, SIZE, OR COLOR.

OWNER OF U.S. REG. NO. 2,551,318.
SEC. 2(F).
FOR BUSINESS AND GOVERNMENT CONTACTS REFERENCE DIRECTORY BOOKS (U.S. CLS. 2, 5, 22, 23, 29, 37, 38 AND 50).
FIRST USE 10-30-2000; IN COMMERCE 10-30-2000.
JESSICA A. POWERS, EXAMINING ATTORNEY

CLASS 16—(Continued).

SN 77-020,535. REED ELSEVIER PROPERTIES INC., WILMINGTON, DE. FILED 10-13-2006.

CURRICULUM CONNECTIONS

THE MARK CONSISTS OF STANDARD CHARACTERS WITHOUT CLAIM TO ANY PARTICULAR FONT, STYLE, SIZE, OR COLOR.

NO CLAIM IS MADE TO THE EXCLUSIVE RIGHT TO USE "CURRICULUM", APART FROM THE MARK AS SHOWN.
FOR MAGAZINES PROVIDING INFORMATION IN THE FIELD OF PRINT, MULTIMEDIA, AND NEWS RESOURCES FOR ELEMENTARY, MIDDLE AND HIGH SCHOOLS (U.S. CLS. 2, 5, 22, 23, 29, 37, 38 AND 50).
FIRST USE 4-0-2004; IN COMMERCE 4-0-2004.
DARRYL SPRUILL, EXAMINING ATTORNEY

SN 76-682,554. PATRI, DANIEL C., VALLEY STREAM, NY. AND BLAKELY, WINSTON, VALLEY STREAM, NY. FILED 10-3-2007.



FOR COMIC BOOKS (U.S. CLS. 2, 5, 22, 23, 29, 37, 38 AND 50).
SCOTT SISUN, EXAMINING ATTORNEY

SN 77-054,286. HARCOURT ACHIEVE INC., AUSTIN, TX. FILED 11-30-2006.

LYNX

THE MARK CONSISTS OF STANDARD CHARACTERS WITHOUT CLAIM TO ANY PARTICULAR FONT, STYLE, SIZE, OR COLOR.

FOR PRINTED EDUCATIONAL AND INSTRUCTIONAL MATERIAL FOR MIDDLE SCHOOL STUDENTS TO IMPROVE READING SKILLS (U.S. CLS. 2, 5, 22, 23, 29, 37, 38 AND 50).
FIRST USE 1-9-2006; IN COMMERCE 1-9-2006.
CHRISTOPHER BUONGIORNO, EXAMINING ATTORNEY

SN 76-682,556. PATRI, DANIEL C., VALLEY STREAM, NY. AND BLAKELY, WINSTON, VALLEY STREAM, NY. FILED 10-3-2007.



FOR COMIC BOOKS (U.S. CLS. 2, 5, 22, 23, 29, 37, 38 AND 50).
SCOTT SISUN, EXAMINING ATTORNEY

SN 77-056,940. F+W PUBLICATIONS, INC., CINCINNATI, OH. FILED 12-5-2006.

EVERYTHING KIDS'

THE MARK CONSISTS OF STANDARD CHARACTERS WITHOUT CLAIM TO ANY PARTICULAR FONT, STYLE, SIZE, OR COLOR.

OWNER OF U.S. REG. NOS. 2,063,316, 2,379,837 AND 2,697,705.
NO CLAIM IS MADE TO THE EXCLUSIVE RIGHT TO USE "KIDS'", APART FROM THE MARK AS SHOWN.
SEC. 2(F).
FOR A SERIES OF NON-FICTION BOOKS FOR CHILDREN IN THE FIELDS OF ANIMALS, CARS AND TRUCKS, THE ENVIRONMENT, GAMES, JOKES, LANGUAGE, MATH, MONEY, NATURE, PIRATES, PRESIDENTS, PUZZLES, RELIGION, RIDDLES, SCIENCE, SPORTS AND THE STATES (U.S. CLS. 2, 5, 22, 23, 29, 37, 38 AND 50).
FIRST USE 4-0-2000; IN COMMERCE 4-0-2000.
MICHAEL LITZAU, EXAMINING ATTORNEY

CLASS 16—(Continued).

SN 77-062,808. A\ BOOK PUBLISHING COMPANY, NEW-ARK, DE. FILED 12-12-2006.

Precision of Reality

THE MARK CONSISTS OF STANDARD CHARACTERS WITHOUT CLAIM TO ANY PARTICULAR FONT, STYLE, SIZE, OR COLOR.

FOR BOOKS WITH MESSAGES ABOUT LIFE, EXISTENCE AND A WIDE VARIETY OF TOPICS BASED ON A COLLECTION OF DREAMS (U.S. CLS. 2, 5, 22, 23, 29, 37, 38 AND 50).

FIRST USE 12-1-2003; IN COMMERCE 12-1-2003.
TRACY WHITTAKER-BROWN, EXAMINING ATTORNEY

CLASS 16—(Continued).

SN 77-073,951. MORN SUN DEV. CO., LTD., CHANGHUA COUNTY, TAIWAN, FILED 12-31-2006.

MORN SUN

THE WORDING "MORN SUN" HAS NO MEANING IN A FOREIGN LANGUAGE.

FOR STATIONERY: OFFICE SUPPLIES, NAMELY, WRITING, PRINTING AND COPY PAPER, PAPER TRIMMING BOARDS, PAPER CUTTERS, PAPER SHREDDERS; SCHOOL SUPPLIES, NAMELY, STATIONERY, NOTEBOOK PAPER, DRAWING PAPER; ADHESIVE TAPES FOR STATIONERY OR HOUSEHOLD PURPOSES; GLUE FOR STATIONERY OR HOUSEHOLD USE; PENS, PENCILS AND MARKERS; DRAWING BOOKS; DRAWING RULERS; DRAWING BOARDS; WRITING MATS; PRINTED TEACHING MATERIALS IN THE FIELD OF NATURAL SCIENCE, CHALKBOARD DEMONSTRATION AIDS IN THE NATURE OF GEOMETRIC SHAPES, UNGRADUATED RULERS AND CHALK HOLDERS, STUDENT WRITING AIDS IN THE NATURE OF LETTER STENCILS; CUTTING MATS FOR USE IN ARTS AND CRAFTS; MODELING COMPOUNDS (U.S. CLS. 2, 5, 22, 23, 29, 37, 38 AND 50).

AMOS T. MATTHEWS, JR., EXAMINING ATTORNEY

SN 77-098,886. OLWIN, DEBRA A, ANACORTES, WA. AND OLWIN, JOHN P, ANACORTES, WA. FILED 2-5-2007.

SN 77-070,022. JAKKS PACIFIC, INC., MALIBU, CA. FILED 12-21-2006.

OH DOUGH!



THE MARK CONSISTS OF STANDARD CHARACTERS WITHOUT CLAIM TO ANY PARTICULAR FONT, STYLE, SIZE, OR COLOR.

NO CLAIM IS MADE TO THE EXCLUSIVE RIGHT TO USE "DOUGH", APART FROM THE MARK AS SHOWN.

FOR MODELING MATERIALS AND COMPOUNDS FOR USE BY CHILDREN (U.S. CLS. 2, 5, 22, 23, 29, 37, 38 AND 50).

JILL C. ALT, EXAMINING ATTORNEY

THE MARK CONSISTS OF CAPITAL LETTERS C AND P CONTAINED WITHIN A GRADIENT CIRCLE.

FOR SERIES OF NON-FICTION BOOKS IN THE NATURE OF REFERENCE BOOKS IN THE FIELD OF ART, MUSIC AND WRITING INSTRUCTION (U.S. CLS. 2, 5, 22, 23, 29, 37, 38 AND 50).

FIRST USE 12-1-2003; IN COMMERCE 12-1-2003.

EMILY CHUO, EXAMINING ATTORNEY

CLASS 16—(Continued).

SN 77-099,019. SCIENTIFIC AMERICAN, INC., NEW YORK, NY. FILED 2-5-2007.

CLASS 16—(Continued).

SN 77-110,558. WETZEL, DIANE, FULLERTON, CA. FILED 2-19-2007.

60-Second Science

THE MARK CONSISTS OF STANDARD CHARACTERS WITHOUT CLAIM TO ANY PARTICULAR FONT, STYLE, SIZE, OR COLOR.

NO CLAIM IS MADE TO THE EXCLUSIVE RIGHT TO USE "SCIENCE", APART FROM THE MARK AS SHOWN.

THE WORDING "60" HAS NO MEANING IN A FOREIGN LANGUAGE.

FOR PRINTED MATTER, NAMELY, MAGAZINES, PERIODICALS AND BOOKS IN THE FIELD OF SCIENCE (U.S. CLS. 2, 5, 22, 23, 29, 37, 38 AND 50).

NAKIA HENRY, EXAMINING ATTORNEY

Oral and Hardies

THE MARK CONSISTS OF STANDARD CHARACTERS WITHOUT CLAIM TO ANY PARTICULAR FONT, STYLE, SIZE, OR COLOR.

FOR GREETING CARDS, STATIONERY, ENVELOPES, NOTEBOOKS, FOLDERS, NOTE PADS, BUMPER STICKERS (U.S. CLS. 2, 5, 22, 23, 29, 37, 38 AND 50).

ELI HELLMAN, EXAMINING ATTORNEY

SN 77-101,163. BANK OF AMERICA CORPORATION, CHARLOTTE, NC. FILED 2-7-2007.

CONNECT TO OWN

THE MARK CONSISTS OF STANDARD CHARACTERS WITHOUT CLAIM TO ANY PARTICULAR FONT, STYLE, SIZE, OR COLOR.

FOR PRINTED MATERIALS, NAMELY, INVITATIONS, INFORMATIONAL FLYERS, RACK INFORMATIONAL CARDS, FORMS, AND CONTRACTS ALL IN THE FIELD OF MORTGAGE LENDING (U.S. CLS. 2, 5, 22, 23, 29, 37, 38 AND 50).

CAROLINE WOOD, EXAMINING ATTORNEY

SN 77-111,501. CIVIL MANAGEMENT LLC, BRONXVILLE, NY. FILED 2-20-2007.

SN 77-109,953. COLORADO BIKINI TEAM, ENGLEWOOD, CO. FILED 2-16-2007.

CIVILIZATION

Colorado Bikini Team

THE MARK CONSISTS OF STANDARD CHARACTERS WITHOUT CLAIM TO ANY PARTICULAR FONT, STYLE, SIZE, OR COLOR.

NO CLAIM IS MADE TO THE EXCLUSIVE RIGHT TO USE "COLORADO BIKINI", APART FROM THE MARK AS SHOWN.

FOR CALENDARS (U.S. CLS. 2, 5, 22, 23, 29, 37, 38 AND 50).

SEAN CROWLEY, EXAMINING ATTORNEY

THE MARK CONSISTS OF STANDARD CHARACTERS WITHOUT CLAIM TO ANY PARTICULAR FONT, STYLE, SIZE, OR COLOR.

FOR PERIODICAL MAGAZINES FEATURING INFORMATION IN THE FIELD OF ART, DESIGN AND CULTURE (U.S. CLS. 2, 5, 22, 23, 29, 37, 38 AND 50).

LESLIE RICHARDS, EXAMINING ATTORNEY

CLASS 16—(Continued).

SN 77-115,318. GABBACADABRA LLC, SAN FRANCISCO, CA. FILED 2-23-2007.

FOOFA

THE MARK CONSISTS OF STANDARD CHARACTERS WITHOUT CLAIM TO ANY PARTICULAR FONT, STYLE, SIZE, OR COLOR.

FOR PAPER GOODS AND PRINTED MATTER, NAMELY, COMIC BOOKS AND MAGAZINES FEATURING COMIC STRIPS AND SCIENCE FICTION THEMES, STORIES AND CHARACTERS; COMIC BOOK REFERENCE GUIDE BOOKS; A SERIES OF FICTION BOOKS FEATURING STORIES ON COMIC STRIPS AND SCIENCE FICTION THEMES, STORIES AND CHARACTERS IN ILLUSTRATED FORMS; NOVELS FEATURING GRAPHICAL ILLUSTRATIONS; GRAPHIC NOVELS; NOVELS; PRINTED POSTCARDS; PICTURE POSTCARDS; COMIC POSTCARDS; POSTCARDS; TRADING CARDS AND COLLECTORS CARDS FEATURING COMIC BOOK, COMIC STRIP, CARTOON AND LIVE ACTION CHARACTERS; NOTEBOOKS; BINDERS; DECALS; STICKERS; POSTERS; PHOTOGRAPH AND SCRAPBOOK ALBUMS; CALENDARS; GREETING CARDS; FOLDERS; DESK PADS; WRITING PADS; STATIONERY FOLDERS AND STATIONERY; PENS; PENCILS; ERASERS; VIDEO GAME STRATEGY MANUALS AND BOOKS; COMPUTER GAME INSTRUCTION MANUALS; PAPER TOWELS; PAPER STORAGE CONTAINERS; CHALK BOARDS; DRY ERASE WRITING BOARDS AND WRITING SURFACES; PAPER FLAGS; PAPER PENNANTS (U.S. CLS. 2, 5, 22, 23, 29, 37, 38 AND 50).

LANA PHAM, EXAMINING ATTORNEY

SN 77-117,908. RON KING PRODUCTIONS, INC., HEMPSTEAD, NY. FILED 2-28-2007.

UVC

THE MARK CONSISTS OF STANDARD CHARACTERS WITHOUT CLAIM TO ANY PARTICULAR FONT, STYLE, SIZE, OR COLOR.

FOR MAGAZINE (U.S. CLS. 2, 5, 22, 23, 29, 37, 38 AND 50).
FIRST USE 2-23-2007; IN COMMERCE 2-23-2007.
MELVIN AXILBUND, EXAMINING ATTORNEY

CLASS 16—(Continued).

SN 77-121,853. ELDER WISDOM CIRCLE, WALNUT CREEK, CA. FILED 3-4-2007.

ELDER WISDOM CIRCLE

THE MARK CONSISTS OF STANDARD CHARACTERS WITHOUT CLAIM TO ANY PARTICULAR FONT, STYLE, SIZE, OR COLOR.

FOR PRINTED PUBLICATIONS, NAMELY, ARTICLES, COLUMNS, NEWSLETTERS, AND BOOKS, FEATURING PRACTICAL ADVICE ON A BROAD RANGE OF TOPICS INCLUDING SELF IMPROVEMENT AND PERSONAL EMPOWERMENT THAT IS PROVIDED BY SENIORS (U.S. CLS. 2, 5, 22, 23, 29, 37, 38 AND 50).

PAUL E. FAHRENKOPF, EXAMINING ATTORNEY

SN 77-122,281. BLUSH PUBLICATIONS, LLC, ATLANTA, GA. FILED 3-5-2007.

BLUSH

THE MARK CONSISTS OF STANDARD CHARACTERS WITHOUT CLAIM TO ANY PARTICULAR FONT, STYLE, SIZE, OR COLOR.

FOR MAGAZINES DEVOTED TO WOMEN AND WOMEN'S ISSUES (U.S. CLS. 2, 5, 22, 23, 29, 37, 38 AND 50).
FIRST USE 11-1-2006; IN COMMERCE 11-1-2006.
ELLEN PERKINS, EXAMINING ATTORNEY

SN 77-123,792. DEBORAH DENISE WATKINS, SANTA BARBARA, CA. FILED 3-6-2007.



THE COLOR(S) SKY BLUE, BLUE, DARK BLUE, MIDNIGHT BLUE, BLACK, ORANGE AND YELLOW IS/ARE CLAIMED AS A FEATURE OF THE MARK.

THE MARK CONSISTS OF THE TOP PORTION OF THE TERM "DREAM" IS SKY BLUE AND THE BOTTOM PORTION IS BLUE. THE TERM "BIG" IS MIDNIGHT BLUE, THE WORDING "DREAM BIG" IS OUTLINED IN BLACK, AND THE CROSS IS BLUE AND WHITE AND SHADED IN DARK BLUE AND THE BACKGROUND IS ORANGE AND YELLOW.

FOR BOOKS IN THE FIELD OF PERSONAL GROWTH AND VISION (U.S. CLS. 2, 5, 22, 23, 29, 37, 38 AND 50).
MICHELE SWAIN, EXAMINING ATTORNEY

CLASS 16—(Continued).

SN 77-125,479. APEX MERCHANDISE GROUP, LLC, SCOTTSDALE, AZ. FILED 3-8-2007.

PH ION

THE MARK CONSISTS OF STANDARD CHARACTERS WITHOUT CLAIM TO ANY PARTICULAR FONT, STYLE, SIZE, OR COLOR.

NO CLAIM IS MADE TO THE EXCLUSIVE RIGHT TO USE "PH", APART FROM THE MARK AS SHOWN.

FOR PRINTED INSTRUCTIONAL, EDUCATIONAL, AND TEACHING MATERIALS IN THE FIELD OF NUTRITION (U.S. CLS. 2, 5, 22, 23, 29, 37, 38 AND 50).

FIRST USE 1-0-2003; IN COMMERCE 1-0-2003.
DAVID ELTON, EXAMINING ATTORNEY

CLASS 16—(Continued).

SN 77-130,447. JAKKS PACIFIC, INC., MALIBU, CA. FILED 3-14-2007.

HOT SPOT XL

THE MARK CONSISTS OF STANDARD CHARACTERS WITHOUT CLAIM TO ANY PARTICULAR FONT, STYLE, SIZE, OR COLOR.

OWNER OF U.S. REG. NO. 1,314,578.

FOR WRITING INSTRUMENTS (U.S. CLS. 2, 5, 22, 23, 29, 37, 38 AND 50).

C. DIONNE CLYBURN, EXAMINING ATTORNEY

SN 77-129,874. INVISTA NORTH AMERICA S.A.R.L., WILMINGTON, DE. FILED 3-13-2007.

FRESHFLEX

THE MARK CONSISTS OF STANDARD CHARACTERS WITHOUT CLAIM TO ANY PARTICULAR FONT, STYLE, SIZE, OR COLOR.

FOR SHEETS PRIMARILY OF PAPER AND CELLULOSE FOR MEDICAL OR SANITARY USE; BABIES' DIAPERS OF PAPER AND DISPOSABLE DIAPERS OF CELLULOSE; DIAPER-PANTS IN THE NATURE OF DISPOSABLE TRAINING PANTS MADE PRIMARILY OF PAPER AND CELLULOSE; ABSORBENT PADS OF PAPER AND CELLULOSE FOR USE IN MAKING INCONTINENCE PADS (U.S. CLS. 2, 5, 22, 23, 29, 37, 38 AND 50).

KAREN BRACEY, EXAMINING ATTORNEY

SN 77-132,349. UP WITH PAPER, LLC, MASON, OH. FILED 3-15-2007.

JUMPING JACK PRESS



THE MARK CONSISTS OF A DIAMOND SHAPE TO THE RIGHT OF THE LITERAL ELEMENT.

FOR SHEETS PRIMARILY OF PAPER AND CELLULOSE FOR MEDICAL OR SANITARY USE; BABIES' DIAPERS OF PAPER AND DISPOSABLE DIAPERS OF CELLULOSE; DIAPER-PANTS IN THE NATURE OF DISPOSABLE TRAINING PANTS MADE PRIMARILY OF PAPER AND CELLULOSE; ABSORBENT PADS OF PAPER AND CELLULOSE FOR USE IN MAKING INCONTINENCE PADS (U.S. CLS. 2, 5, 22, 23, 29, 37, 38 AND 50).

KAREN BRACEY, EXAMINING ATTORNEY

THE MARK CONSISTS OF STANDARD CHARACTERS WITHOUT CLAIM TO ANY PARTICULAR FONT, STYLE, SIZE, OR COLOR.

NO CLAIM IS MADE TO THE EXCLUSIVE RIGHT TO USE "PRESS", APART FROM THE MARK AS SHOWN.

FOR SERIES OF POP-UP CHILDREN'S BOOKS (U.S. CLS. 2, 5, 22, 23, 29, 37, 38 AND 50).

MAUREEN DALL, EXAMINING ATTORNEY

CLASS 16—(Continued).

SN 77-133,986. THURGOOD MARSHALL COLLEGE FUND, INC., NEW YORK, NY. FILED 3-19-2007.



OWNER OF U.S. REG. NOS. 2,512,547, 2,689,949 AND OTHERS.

NO CLAIM IS MADE TO THE EXCLUSIVE RIGHT TO USE "COLLEGE FUND", APART FROM THE MARK AS SHOWN.

THE NAME(S), PORTRAIT(S), AND/OR SIGNATURE(S) SHOWN IN THE MARK DOES NOT IDENTIFY A PARTICULAR LIVING INDIVIDUAL.

THE MARK CONSISTS OF A REPRESENTATION OF THREE GRADUATES IN CAPS AND GOWNS SUPERIMPOSED OVER A SOLID BACKGROUND.

FOR BOOK SERIES FEATURING TOPICS ON EDUCATION, CAREER DEVELOPMENT, LEADERSHIP, AND EDUCATIONAL AND PROFESSIONAL SUCCESS AND ACHIEVEMENT (U.S. CLS. 2, 5, 22, 23, 29, 37, 38 AND 50).
KAREN K. BUSH, EXAMINING ATTORNEY

SN 77-134,212. HOWE, FABIAN STAFORD, NEPTUNE, NJ. FILED 3-19-2007.

Generation Whisper

THE MARK CONSISTS OF STANDARD CHARACTERS WITHOUT CLAIM TO ANY PARTICULAR FONT, STYLE, SIZE, OR COLOR.

FOR CHILDREN BOOKS, BABY BOOKS, BOOKS ON THE SUBJECT OF BUILDING SELF-CONFIDENCE IN CHILDREN (U.S. CLS. 2, 5, 22, 23, 29, 37, 38 AND 50).

PAULA MAYS, EXAMINING ATTORNEY

CLASS 16—(Continued).

SN 77-134,258. HOWE, FABIAN STAFORD, NEPTUNE, NJ. FILED 3-19-2007.

Go Whisper

THE MARK CONSISTS OF STANDARD CHARACTERS WITHOUT CLAIM TO ANY PARTICULAR FONT, STYLE, SIZE, OR COLOR.

FOR CHILDREN BOOKS, BABY BOOKS, BOOKS ON THE SUBJECT OF SELF CONFIDENCE FOR CHILDREN (U.S. CLS. 2, 5, 22, 23, 29, 37, 38 AND 50).

PAULA MAYS, EXAMINING ATTORNEY

SN 77-134,259. BRISTOL-MYERS SQUIBB COMPANY, NEW YORK, NY. FILED 3-19-2007.

OH, YES I CAN

THE MARK CONSISTS OF STANDARD CHARACTERS WITHOUT CLAIM TO ANY PARTICULAR FONT, STYLE, SIZE, OR COLOR.

FOR PRINTED MATTER, NAMELY, PAMPHLETS AND BROCHURES RELATING TO HUMAN PHARMACEUTICALS (U.S. CLS. 2, 5, 22, 23, 29, 37, 38 AND 50).

MARK RADEMACHER, EXAMINING ATTORNEY

SN 77-134,441. SAWHNEY, AMRITA G., MONTCLAIR, NJ. FILED 3-19-2007.

Organized Health

THE MARK CONSISTS OF STANDARD CHARACTERS WITHOUT CLAIM TO ANY PARTICULAR FONT, STYLE, SIZE, OR COLOR.

NO CLAIM IS MADE TO THE EXCLUSIVE RIGHT TO USE "HEALTH", APART FROM THE MARK AS SHOWN.

FOR PERSONAL ORGANIZERS (U.S. CLS. 2, 5, 22, 23, 29, 37, 38 AND 50).

MARK SPACINO, EXAMINING ATTORNEY

CLASS 16—(Continued).

SN 77-136,115. PATRICIA L. RICKARD, CAMARILLO, CA. FILED 3-21-2007.

Coffee Time Meditations

THE MARK CONSISTS OF STANDARD CHARACTERS WITHOUT CLAIM TO ANY PARTICULAR FONT, STYLE, SIZE, OR COLOR.

NO CLAIM IS MADE TO THE EXCLUSIVE RIGHT TO USE "MEDITATIONS", APART FROM THE MARK AS SHOWN.

FOR SERIES OF NON-FICTION BOOKS IN THE FIELDS OF METAPHYSICS AND MEDITATION (U.S. CLS. 2, 5, 22, 23, 29, 37, 38 AND 50).

CAROLINE WOOD, EXAMINING ATTORNEY

CLASS 16—(Continued).

SN 77-138,516. TOWN MEDIA, INC., CINCINNATI, OH. FILED 3-23-2007.

FOR WEEKLY NEWS MAGAZINE FEATURING ENTERTAINMENT, CULTURE, GOSSIP, SPORTS, HEALTH, BUSINESS AND DEVELOPMENT, AND COMMUNITY NEWS IN THE GREATER CINCINNATI REGION (U.S. CLS. 2, 5, 22, 23, 29, 37, 38 AND 50).

STEVEN R. FOSTER, EXAMINING ATTORNEY

SN 77-136,796. DANSON, RICHARD D., SANTA BARBARA, CA. FILED 3-21-2007.

CONCIERGE

THE MARK CONSISTS OF STANDARD CHARACTERS WITHOUT CLAIM TO ANY PARTICULAR FONT, STYLE, SIZE, OR COLOR.

FOR PRINTED MEDICAL PUBLICATIONS, NAMELY, BOOKS, MAGAZINE, ARTICLES AND HEALTH BULLETINS ABOUT MEDICAL SUBJECTS; PRINTED HEALTHCARE PUBLICATIONS, NAMELY, BOOKS, MAGAZINES, ARTICLES AND HEALTH BULLETINS ABOUT HEALTHCARE; MEDICAL BOOKS, MAGAZINES, ARTICLES AND HEALTHCARE BULLETINS ABOUT MEDICAL SUBJECTS AND HEALTHCARE (U.S. CLS. 2, 5, 22, 23, 29, 37, 38 AND 50).

GINA FINK, EXAMINING ATTORNEY

SN 77-139,310. WANT, LLC, SAN DIEGO, CA. FILED 3-23-2007.

NO CLAIM IS MADE TO THE EXCLUSIVE RIGHT TO USE "MAGAZINE", APART FROM THE MARK AS SHOWN.

THE MARK CONSISTS OF THE WORD "WANT" VERTICALLY LOCATED AND THE WORD "MAGAZINE" HORIZONTALLY LOCATED AT THE BASE OF THE WORD "WANT" IN A SMALLER FONT.

FOR PRINTED MAGAZINES IN THE FIELD OF FEATURING THE LISTING OF SHOPPING INFORMATION FOR LOCALLY AVAILABLE GOODS AND SERVICES FEATURED AT RETAIL OUTLETS (U.S. CLS. 2, 5, 22, 23, 29, 37, 38 AND 50).

ELISSA GARBER KON, EXAMINING ATTORNEY

CLASS 16—(Continued).

SN 77-140,257. ZANER-BLOSER, INC., COLUMBUS, OH.
FILED 3-26-2007.

Zaner-Bloser Strategies for Writers

THE MARK CONSISTS OF STANDARD CHARACTERS WITHOUT CLAIM TO ANY PARTICULAR FONT, STYLE, SIZE, OR COLOR.

OWNER OF U.S. REG. NO. 2,763,322.

NO CLAIM IS MADE TO THE EXCLUSIVE RIGHT TO USE "STRATEGIES FOR WRITERS", APART FROM THE MARK AS SHOWN.

SEC. 2(F) "STRATEGIES FOR WRITERS".

FOR A SERIES OF BOOKS, WRITTEN ARTICLES, HANDOUTS AND WORKSHEETS IN THE FIELD OF WRITING (U.S. CLS. 2, 5, 22, 23, 29, 37, 38 AND 50).

FIRST USE 7-25-2002; IN COMMERCE 7-25-2002.

PAUL F. GAST, EXAMINING ATTORNEY

CLASS 16—(Continued).

SN 77-141,502. BRUCE W. HEINEMANN, ANACORTES, WA.
FILED 3-27-2007.

THE ART OF THE AMERICAN LANDSCAPE

THE MARK CONSISTS OF STANDARD CHARACTERS WITHOUT CLAIM TO ANY PARTICULAR FONT, STYLE, SIZE, OR COLOR.

OWNER OF U.S. REG. NO. 3,141,267.

FOR PRINTED MATERIALS, NAMELY, CALENDARS (U.S. CLS. 2, 5, 22, 23, 29, 37, 38 AND 50).

FIRST USE 11-0-2004; IN COMMERCE 11-0-2004.

ELLEN B. AWRICH, EXAMINING ATTORNEY

SN 77-143,825. DURATECH PLASTICS CORPORATION,
CARLSTADT, NJ. FILED 3-29-2007.

Duratuff

THE MARK CONSISTS OF STANDARD CHARACTERS WITHOUT CLAIM TO ANY PARTICULAR FONT, STYLE, SIZE, OR COLOR.

FOR PLASTIC GARBAGE BAGS (U.S. CLS. 2, 5, 22, 23, 29, 37, 38 AND 50).

FIRST USE 4-28-2005; IN COMMERCE 4-28-2005.

BARBARA GAYNOR, EXAMINING ATTORNEY

SN 77-141,316. REDLETTER DESIGN STUDIO LLC, ALTOONA, IA. FILED 3-27-2007.

KOOLACHIES

THE MARK CONSISTS OF STANDARD CHARACTERS WITHOUT CLAIM TO ANY PARTICULAR FONT, STYLE, SIZE, OR COLOR.

FOR PAPER PRODUCTS, NAMELY, BABY BOOKS, CHILDREN'S ACTIVITY BOOKS, COLORING BOOKS, COMIC BOOKS, NOTE BOOKS, STORY BOOKS, SCRAPBOOKS, BUMPER STICKERS, STICKERS, POSTERS, HOLIDAY CARDS, INVITATION CARDS, NOTE CARDS, OCCASION CARDS, TRADING CARDS, PRINTS, MAGAZINES FOR CHILDREN, MAGAZINES RELATED TO CRAFTS, WORKBOOKS RELATED TO CRAFTS, ADDRESS BOOKS, STATIONERY, CALENDARS, FOLDERS, ENVELOPES, POSTCARDS, GREETING CARDS, ADHESIVE NOTE PADS, BLANK WRITING JOURNALS, DIARIES, CHILDREN'S BOOKS; CHILDREN'S APPARATUS IN THE NATURE OF A COMBINATION PAPER HOLE PUNCH AND PAPER CUTTER FOR CREATING PAPER SHAPES AND EMBELLISHMENTS FOR USE IN CRAFT AND SCRAPBOOKING ACTIVITIES (U.S. CLS. 2, 5, 22, 23, 29, 37, 38 AND 50).

ELIZABETH HUGHITT, EXAMINING ATTORNEY

SN 77-144,027. OHZORA PUBLISHING, CO., SHINJUKU-KU, JAPAN, FILED 3-29-2007.



FOR COMIC BOOKS AND COMIC STRIPS; SERIES OF FICTION BOOKS; MAGAZINES IN THE FIELD OF COMIC STRIPS AND COMIC BOOKS; MAGAZINES IN THE FIELD OF FICTIONAL BOOKS (U.S. CLS. 2, 5, 22, 23, 29, 37, 38 AND 50).

ESTHER BELENKER, EXAMINING ATTORNEY

CLASS 16—(Continued).

SN 77-146,326. THE TRUSTEE OF THE BYRON NELSON MARITAL TRUST, DALLAS, TX. FILED 4-2-2007.

BYRON NELSON SIGNATURE SERIES

THE MARK CONSISTS OF STANDARD CHARACTERS WITHOUT CLAIM TO ANY PARTICULAR FONT, STYLE, SIZE, OR COLOR.

OWNER OF U.S. REG. NOS. 1,725,794, 2,587,436 AND OTHERS.

NO CLAIM IS MADE TO THE EXCLUSIVE RIGHT TO USE "SIGNATURE SERIES", APART FROM THE MARK AS SHOWN.

THE NAME(S), PORTRAIT(S), AND/OR SIGNATURE(S) SHOWN IN THE MARK DOES NOT IDENTIFY A PARTICULAR LIVING INDIVIDUAL.

FOR MONEY CLIPS (U.S. CLS. 2, 5, 22, 23, 29, 37, 38 AND 50).

BARBARA GAYNOR, EXAMINING ATTORNEY

CLASS 16—(Continued).

SN 77-148,019. ADAMS, AUGUSTUS G., WASHINGTON, DC. FILED 4-4-2007.



NO CLAIM IS MADE TO THE EXCLUSIVE RIGHT TO USE "PARODIES", APART FROM THE MARK AS SHOWN. THE COLOR(S) GREEN, ORANGE, PURPLE, BLUE, AND GRAY IS/ARE CLAIMED AS A FEATURE OF THE MARK.

THE MARK CONSISTS OF A FOUR-QUADRANT COLORED SQUARE AND THE WORDS "INTELLIGENT PARODIES" LOCATED ON A SINGLE LINE TO THE RIGHT OF THE SQUARE. THE COLORS GREEN, ORANGE, PURPLE, AND BLUE ARE USED FOR THE SQUARE'S FOUR QUADRANTS, AS WELL AS FOR SEVERAL INDIVIDUAL LETTERS OF "INTELLIGENT PARODIES" (GREEN FOR THE "G" AND "S", ORANGE FOR THE "P", PURPLE FOR THE DOTS OF THE "I" AND "I", AND BLUE FOR THE "E" AND "O"). THE COLOR GRAY IS USED FOR THE REMAINING LETTERS OF "INTELLIGENT PARODIES".

FOR SERIES OF FICTION BOOKS (U.S. CLS. 2, 5, 22, 23, 29, 37, 38 AND 50).

DOMINICK J. SALEMI, EXAMINING ATTORNEY

SN 77-152,324. PAIZO PUBLISHING, LLC, BELLEVUE, WA. FILED 4-9-2007.

PLANET STORIES

THE MARK CONSISTS OF STANDARD CHARACTERS WITHOUT CLAIM TO ANY PARTICULAR FONT, STYLE, SIZE, OR COLOR.

NO CLAIM IS MADE TO THE EXCLUSIVE RIGHT TO USE "STORIES", APART FROM THE MARK AS SHOWN.

FOR MAGAZINES FEATURING SCIENCE FICTION STORIES (U.S. CLS. 2, 5, 22, 23, 29, 37, 38 AND 50).

RENEE MCCRAY, EXAMINING ATTORNEY

SN 77-153,228. OLAS ENTERPRISES, INC., DANA POINT, CA. FILED 4-10-2007.

LOOK B4U LEAP

THE MARK CONSISTS OF STANDARD CHARACTERS WITHOUT CLAIM TO ANY PARTICULAR FONT, STYLE, SIZE, OR COLOR.

FOR BOOKS AND MAGAZINES ABOUT THE OCEAN, OCEAN SAFETY, WATER SPORTS, SKATEBOARDING (U.S. CLS. 2, 5, 22, 23, 29, 37, 38 AND 50).

DAVID MURRAY, EXAMINING ATTORNEY

SN 77-146,467. HEATHER PATTERSON, LITTLE ROCK, AR. FILED 4-2-2007.



NO CLAIM IS MADE TO THE EXCLUSIVE RIGHT TO USE "PLANNER", APART FROM THE MARK AS SHOWN. THE COLOR(S) BROWN IS/ARE CLAIMED AS A FEATURE OF THE MARK.

THE COLOR BROWN APPEARS IN THE TERM "PREGO PLANNER" AND THE CIRCLE SURROUNDING THE WORDING. THE BACKGROUND OF THE MARK IS TRANSLUCENT.

FOR DAILY PLANNERS (U.S. CLS. 2, 5, 22, 23, 29, 37, 38 AND 50).

JIM RINGLE, EXAMINING ATTORNEY

CLASS 16—(Continued).

SN 77-163,993. ICAN, INC., BOSSIER CITY, LA. FILED 4-24-2007.

I CAN PUBLISHING

THE MARK CONSISTS OF STANDARD CHARACTERS WITHOUT CLAIM TO ANY PARTICULAR FONT, STYLE, SIZE, OR COLOR.

NO CLAIM IS MADE TO THE EXCLUSIVE RIGHT TO USE "PUBLISHING", APART FROM THE MARK AS SHOWN.

FOR A SERIES OF BOOKS, WRITTEN ARTICLES, HANDOUTS AND WORKSHEETS IN THE FIELD OF NURSING AND HEALTHCARE FOR THE PURPOSE OF AIDING STUDENTS AND TEACHERS (U.S. CLS. 2, 5, 22, 23, 29, 37, 38 AND 50).

FIRST USE 1-0-1993; IN COMMERCE 1-0-1993.
ROBIN CHOSID, EXAMINING ATTORNEY

SN 77-167,587. MCCLATCHY U.S.A., INC., SACRAMENTO, CA. FILED 4-27-2007.

VINTAGES

THE MARK CONSISTS OF STANDARD CHARACTERS WITHOUT CLAIM TO ANY PARTICULAR FONT, STYLE, SIZE, OR COLOR.

FOR MAGAZINES FEATURING WINES, WINERIES, WINE COUNTRY INNS AND SPAS, AND RESTAURANTS THAT SHOWCASE WINES (U.S. CLS. 2, 5, 22, 23, 29, 37, 38 AND 50).

FIRST USE 2-1-1997; IN COMMERCE 2-1-1997.
JORDAN BAKER, EXAMINING ATTORNEY

SN 77-168,389. DUSCKAS, CORNELIA, ERIE, PA. FILED 4-28-2007.

Cornelia Creation

THE MARK CONSISTS OF STANDARD CHARACTERS WITHOUT CLAIM TO ANY PARTICULAR FONT, STYLE, SIZE, OR COLOR.

NO CLAIM IS MADE TO THE EXCLUSIVE RIGHT TO USE "CREATION", APART FROM THE MARK AS SHOWN.

FOR CHRISTMAS CARDS; GREETING CARDS; HOLIDAY CARDS; NOTE CARDS; OCCASION CARDS; SOCIAL NOTE CARDS; PAINTINGS; PAINTINGS AND CALLIGRAPHIC WORKS; PAINTINGS AND THEIR REPRODUCTIONS; WATER COLOURS (U.S. CLS. 2, 5, 22, 23, 29, 37, 38 AND 50).

FIRST USE 8-15-2003; IN COMMERCE 8-15-2003.
TASHIA BUNCH, EXAMINING ATTORNEY

CLASS 16—(Continued).

SN 77-168,983. IBASIS, INC., BURLINGTON, MA. FILED 4-30-2007.



THE COLOR(S) YELLOW, ORANGE AND BLUE IS/ARE CLAIMED AS A FEATURE OF THE MARK.

THE MARK CONSISTS OF THE TERM "H8" IN BLUE LETTERING WITH AN ORANGE BORDER AND YELLOW BACKGROUND. A DOLLAR SYMBOL IS IN YELLOW TEXT WITH AN ORANGE BORDER. THE WHITE COLOR IS INTENDED TO INDICATE BACKGROUND, OUTLINING, SHADING OR TRANSPARENT AREAS AND IS NOT PART OF THE MARK.

FOR PRE-PAID TELEPHONE CALLING CARDS, NOT MAGNETICALLY ENCODED; TELEPHONE CALLING CARDS, NOT MAGNETICALLY ENCODED (U.S. CLS. 2, 5, 22, 23, 29, 37, 38 AND 50).

JORDAN BAKER, EXAMINING ATTORNEY

SN 77-169,017. IBASIS, INC., BURLINGTON, MA. FILED 4-30-2007.

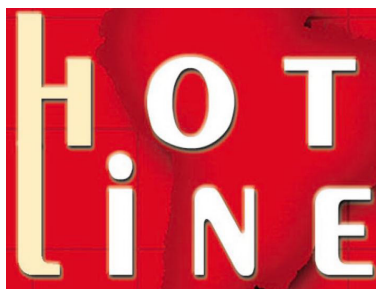

THE COLOR(S) COLORS RED, BEIGE, WHITE, AND BLACK IS/ARE CLAIMED AS A FEATURE OF THE MARK.

THE COLOR BEIGE APPEARS IN THE LETTERING THAT COMPRISES "H" AND "L"; THE COLOR WHITE APPEARS IN THE LETTERING "OT" AND "INE"; THE COLOR RED APPEARS IN THE BACKGROUND AND IN THE STYLIZED MAP OF THE SOUTH AMERICA CONTINENT; THE COLOR BLACK APPEARS AS HORIZONTAL AND VERTICAL LINES IN THE BACKGROUND AND IN SHADING AROUND THE BORDER OF THE SOUTH AMERICA CONTINENT; THE COLOR BLACK ALSO APPEARS AS SHADING AROUND ALL OF THE LETTERING IN THE MARK.

FOR PRE-PAID TELEPHONE CALLING CARDS, NOT MAGNETICALLY ENCODED; TELEPHONE CALLING CARDS, NOT MAGNETICALLY ENCODED (U.S. CLS. 2, 5, 22, 23, 29, 37, 38 AND 50).

JORDAN BAKER, EXAMINING ATTORNEY

CLASS 16—(Continued).

SN 77-170,218. THOSE CHARACTERS FROM CLEVELAND, INC., CLEVELAND, OH. FILED 5-1-2007.

MADBALLS

THE MARK CONSISTS OF STANDARD CHARACTERS WITHOUT CLAIM TO ANY PARTICULAR FONT, STYLE, SIZE, OR COLOR.

OWNER OF U.S. REG. NO. 2,447,827.

FOR GREETING CARDS; PAPER GIFT BAGS; PAPER NAPKINS; ERASERS; STATIONERY; STORY BOOKS; CHILDREN'S BOOKS; PAPER PARTY HATS; BOOKMARKS; CALENDARS; PEN AND PENCIL CASES AND BOXES; PENCILS; PENS; PAPER BANNERS; POSTERS; BLANK JOURNAL BOOKS; FOLDERS; MEMO PADS; WIRE-BOUND NOTEBOOKS; NOTE BOOKS; GIFT WRAP PAPER; TABLE CLOTHS OF PAPER; COLORING BOOKS; COMIC BOOKS; STICKERS (U.S. CLS. 2, 5, 22, 23, 29, 37, 38 AND 50).

KAPIL BHANOT, EXAMINING ATTORNEY

SN 77-174,444. MARYJANE BUTTERS, MOSCOW, ID. FILED 5-7-2007.

THE MARYJANE WAY

THE MARK CONSISTS OF STANDARD CHARACTERS WITHOUT CLAIM TO ANY PARTICULAR FONT, STYLE, SIZE, OR COLOR.

OWNER OF U.S. REG. NO. 3,105,914.

FOR SCRAPBOOKING AND PARTY CRAFT KITS CONSISTING OF ONE OR MORE OF THE FOLLOWING ITEMS: A SCRAPBOOK ALBUM, PAPER PLACE TAGS, PAPER PLACE MATS, PRINTED INVITATIONS, PAPER GIFT TAGS, PAPER GIFT BOXES, GREETING CARDS, EXCLUSIVE PAPER DECORATIONS, PAPER SHAPES AND DESIGNS, EMBELLISHMENTS, BORDER TRIM, PAPER CUT OUTS, PRINTED PAPER AND STICKERS; DRAWING RULERS, PAPER HOLE PUNCHES AND SCISSORS, SHEET PROTECTORS, PENS, PENCILS, GLUE FOR STATIONERY USE, GLITTER GLUE FOR STATIONERY USE, PAPER FRAMES AND BORDERING; DRAWING TEMPLATES; PAPER AND PRINTED EMBLEMS; PAPER BANNERS; PAPER TAGS AND PHOTO MOUNTING CORNERS, PRINTED INSTRUCTION MANUALS FOR SCRAPBOOKING AND PARTY CRAFT KITS; AND ORGANIZERS, NAMELY, STORAGE BOXES, FILE FOLDERS AND BINDERS (U.S. CLS. 2, 5, 22, 23, 29, 37, 38 AND 50).

KAREN K. BUSH, EXAMINING ATTORNEY

CLASS 16—(Continued).

SN 77-179,337. PINPOINT PUBLICATIONS, LLC, HENDERSON, NV. FILED 5-11-2007.

ZIP CODE MAGAZINES

THE MARK CONSISTS OF STANDARD CHARACTERS WITHOUT CLAIM TO ANY PARTICULAR FONT, STYLE, SIZE, OR COLOR.

NO CLAIM IS MADE TO THE EXCLUSIVE RIGHT TO USE "MAGAZINES", APART FROM THE MARK AS SHOWN.

FOR MAGAZINES FEATURING HOME, LIFESTYLE AND REGIONAL INFORMATION (U.S. CLS. 2, 5, 22, 23, 29, 37, 38 AND 50).

COLLEEN DOMBROW, EXAMINING ATTORNEY

SN 77-192,924. TALARIS RESEARCH INSTITUTE, SEATTLE, WA. FILED 5-30-2007.

CENTER FOR MIND, BRAIN AND LEARNING

THE MARK CONSISTS OF STANDARD CHARACTERS WITHOUT CLAIM TO ANY PARTICULAR FONT, STYLE, SIZE, OR COLOR.

OWNER OF U.S. REG. NO. 3,022,842.

NO CLAIM IS MADE TO THE EXCLUSIVE RIGHT TO USE "CENTER" AND "BRAIN AND LEARNING", APART FROM THE MARK AS SHOWN.

FOR MAGAZINES, NEWSLETTERS, A SERIES OF BOOKS, AND OTHER PRINTED MATERIAL, NAMELY, PAMPHLETS, BROCHURES, BOOKLETS, BOOKMARKS, LEAFLETS, TEACHING MANUALS, WALL CHARTS AND TIME LINES REGARDING PARENTING, EARLY LEARNING, BEHAVIORAL, SOCIAL AND EMOTIONAL DEVELOPMENT, AND EARLY BRAIN DEVELOPMENT (U.S. CLS. 2, 5, 22, 23, 29, 37, 38 AND 50).

JIM RINGLE, EXAMINING ATTORNEY

SN 77-196,756. JON A. RICHIE, MINNETONKA, MN. FILED 6-4-2007.

THE ORIGINAL MEGA FAN

THE MARK CONSISTS OF STANDARD CHARACTERS WITHOUT CLAIM TO ANY PARTICULAR FONT, STYLE, SIZE, OR COLOR.

NO CLAIM IS MADE TO THE EXCLUSIVE RIGHT TO USE "THE ORIGINAL", APART FROM THE MARK AS SHOWN.

FOR BIODEGRADABLE PAPER PULP-BASED TO-GO CONTAINERS FOR FOOD; AND FOOD CONTAINERS COMPRISED OF STARCH-BASED MATERIALS IN THE NATURE OF A PAPER SUBSTITUTE (U.S. CLS. 2, 5, 22, 23, 29, 37, 38 AND 50).

ELLEN B. AWRICH, EXAMINING ATTORNEY

CLASS 16—(Continued).

SN 77-198,090. RAY, TINA K., MILL SPRING, NC. FILED 6-5-2007.



THE MARK CONSISTS OF THE WORDS "WALKING IN THE WILDERNESS" WRITTEN ON A ROLLED OPEN SCROLLED BANNER OF PAPER. THE ENDS OF THE PAPER ARE CURLED UP ON THE LEFT AND DOWN ON THE RIGHT. AN OLIVE BRANCH WITH FRUIT ON IT LAYS BEHIND THE SCROLL, EXTENDING FROM THE BOTTOM LEFT CORNER TO THE TOP CENTER OF THE SCROLL.

FOR GREETING CARDS (U.S. CLS. 2, 5, 22, 23, 29, 37, 38 AND 50).
JANICE KIM, EXAMINING ATTORNEY

CLASS 16—(Continued).

SN 77-207,670. BOYKIN, HOWARD, SCOTCH PLAINS, NJ. FILED 6-15-2007.

SO BEAUTIFUL

THE MARK CONSISTS OF STANDARD CHARACTERS WITHOUT CLAIM TO ANY PARTICULAR FONT, STYLE, SIZE, OR COLOR.

FOR MAGAZINES FEATURING CELEBRITIES, CURRENT EVENTS, POPULAR CULTURE AND RELATED TOPICS (U.S. CLS. 2, 5, 22, 23, 29, 37, 38 AND 50).
ALYSSA PALADINO, EXAMINING ATTORNEY

SN 77-201,163. WAYNE PRINTING COMPANY, INC., GOLDSBORO, NC. FILED 6-8-2007.

The Wright Times

THE MARK CONSISTS OF STANDARD CHARACTERS WITHOUT CLAIM TO ANY PARTICULAR FONT, STYLE, SIZE, OR COLOR.

FOR DAILY NEWSPAPER (U.S. CLS. 2, 5, 22, 23, 29, 37, 38 AND 50).
FIRST USE 5-11-2007; IN COMMERCE 5-11-2007.
ERNEST SHOSHO, EXAMINING ATTORNEY

SN 77-215,534. CHAMPIONSHIP GAMING SERIES, LLC, WILMINGTON, DE. FILED 6-26-2007.

DALLAS VENOM

THE MARK CONSISTS OF STANDARD CHARACTERS WITHOUT CLAIM TO ANY PARTICULAR FONT, STYLE, SIZE, OR COLOR.

NO CLAIM IS MADE TO THE EXCLUSIVE RIGHT TO USE "DALLAS", APART FROM THE MARK AS SHOWN.

FOR ADDRESS BOOKS; BLANK WRITING JOURNALS; BOOK COVERS; BOOKMARKS; BROCHURES ABOUT VIDEO GAMES AND VIDEO GAME TOURNAMENTS; BUMPER STICKERS; CALENDARS; CARDBOARD BOXES; CARDBOARD CONTAINERS; DATE BOOKS; DECALS; DIARIES; ENVELOPES; GREETING CARDS; GUIDE BOOKS FEATURING PLAYING TECHNIQUES AND INSTRUCTION; INVITATION CARDS; MANUALS IN THE FIELD OF VIDEO GAMES; MEMO PADS; NOTE BOOKS; NOTE PAPER; NOTEBOOK PAPER; PAPER; PAPER BANNERS; PAPER GIFT BAGS; PAPER GIFT TAGS; PAPER NAPKINS; PAPER PARTY BAGS; PAPER PARTY DECORATIONS; PAPER PLACE MATS; PAPER TABLE CLOTHS; PEN OR PENCIL HOLDERS; PENCILS; PENS; PHOTOGRAPHS; POSTERS; PRINTED GUIDES FOR VIDEO GAMES; PRINTED INVITATIONS; QUICK REFERENCE POCKET GUIDES IN THE FIELD OF VIDEO GAMES; COIL-BOUND NOTEBOOKS; STICKERS; TEMPORARY TATTOOS, ALL OF THE PRECEDING ITEMS FOR USE IN CONJUNCTION WITH A SPORTS COMPUTER GAME LEAGUE (U.S. CLS. 2, 5, 22, 23, 29, 37, 38 AND 50).
TOBY BULLOFF, EXAMINING ATTORNEY

SN 77-207,414. MEREDITH CORPORATION, DES MOINES, IA. FILED 6-15-2007.

HEART HEALTHY LIVING

THE MARK CONSISTS OF STANDARD CHARACTERS WITHOUT CLAIM TO ANY PARTICULAR FONT, STYLE, SIZE, OR COLOR.

NO CLAIM IS MADE TO THE EXCLUSIVE RIGHT TO USE "HEART", APART FROM THE MARK AS SHOWN.

FOR PERIODIC PUBLICATION, NAMELY, A MAGAZINE USING UP-TO-DATE RESEARCH TO PROVIDE DIET, EXERCISE, NUTRITION, AND HEALTH INFORMATION (U.S. CLS. 2, 5, 22, 23, 29, 37, 38 AND 50).
FIRST USE 2-7-2006; IN COMMERCE 2-7-2006.

ZACHARY BELLO, EXAMINING ATTORNEY

CLASS 16—(Continued).

SN 77-218,063. GEORGIA-PACIFIC CONSUMER PRODUCTS LP, ATLANTA, GA. FILED 6-28-2007.

MARATHON GREEN

THE MARK CONSISTS OF STANDARD CHARACTERS WITHOUT CLAIM TO ANY PARTICULAR FONT, STYLE, SIZE, OR COLOR.

OWNER OF U.S. REG. NO. 790,719.
NO CLAIM IS MADE TO THE EXCLUSIVE RIGHT TO USE "GREEN", APART FROM THE MARK AS SHOWN.
FOR PAPER TOWELS; FACIAL TISSUE; TOILET TISSUE; PAPER NAPKINS; CELLULOSE WIPERS (U.S. CLS. 2, 5, 22, 23, 29, 37, 38 AND 50).
ROBERT C. CLARK JR., EXAMINING ATTORNEY

SN 77-220,705. LAURANE MAGLIARI, NEW YORK, NY. FILED 7-2-2007.

WHAT'S THE DEAL?

THE MARK CONSISTS OF STANDARD CHARACTERS WITHOUT CLAIM TO ANY PARTICULAR FONT, STYLE, SIZE, OR COLOR.

FOR CONVERSATION CARDS, NAMELY, PRINTED MATTER IN THE FORM OF CARDS, ON WHICH STORIES AND QUESTIONS ARE PRINTED IN ORDER TO ENCOURAGE CONVERSATION (U.S. CLS. 2, 5, 22, 23, 29, 37, 38 AND 50).
SCOTT SISUN, EXAMINING ATTORNEY

SN 77-223,590. PARKER PEN PRODUCTS, NEWHAVEN, EAST SUSSEX, ENGLAND, FILED 7-6-2007.

PARKER FACET

THE MARK CONSISTS OF STANDARD CHARACTERS WITHOUT CLAIM TO ANY PARTICULAR FONT, STYLE, SIZE, OR COLOR.

OWNER OF U.S. REG. NOS. 165,783, 1,842,892 AND OTHERS.
FOR WRITING INSTRUMENTS (U.S. CLS. 2, 5, 22, 23, 29, 37, 38 AND 50).
REBECCA EISINGER, EXAMINING ATTORNEY

CLASS 16—(Continued).

SN 77-225,104. DANGLE PENS, INC., ESCONDIDO, CA. FILED 7-9-2007.



OWNER OF U.S. REG. NOS. 3,304,926 AND 3,311,407.
NO CLAIM IS MADE TO THE EXCLUSIVE RIGHT TO USE "DANGLE PENS, INC.", APART FROM THE MARK AS SHOWN.

THE COLOR(S) BLUE, RED, GREEN, ORANGE, PINK, YELLOW, GRAY, BLACK, WHITE AND SILVER IS/ARE CLAIMED AS A FEATURE OF THE MARK.

THE MARK CONSISTS OF THE WORDS "DANGLE PENS, INC." WITH THE "D" IN DANGLE IN ORANGE, THE "A" IN DANGLE IN RED, THE "N" IN DANGLE IN BLUE, THE "G" IN DANGLE IN RED, THE "L" IN DANGLE IN GREEN, THE "E" IN DANGLE IN PINK AND THE WORD "PENS," IN GRAY WITH A BLACK BORDER AND THE ABBREVIATE "INC." IN BLACK. THE WORDS "HOW'S YOUR PEN DANGLING?" ARE IN BLUE. EACH LETTER IN "DANGLE" WHITE BUT OUTLINED IN COLOR, AND FEATURES SMALL REPEATING DESIGNS. THE LETTER "D" HAS YELLOW AND ORANGE FLOWERS, THE LETTER "A" HAS BLACK AND RED LADYBUGS, THE LETTER "N" HAS SILVER BELLS WITH BLUE RIBBONS, THE LETTER "G" HAS RED HEARTS, THE LETTER "L" HAS GREEN FOUR LEAF CLOVERS, AND THE LETTER "E" HAS PINK DOTS.
FOR WRITING INSTRUMENTS, NAMELY, PENS (U.S. CLS. 2, 5, 22, 23, 29, 37, 38 AND 50).

FIRST USE 7-15-2006; IN COMMERCE 12-6-2006.
JAMES GRIFFIN, EXAMINING ATTORNEY

SN 77-235,222. PRESCRIPTIVE MUSIC, LLC, WOODLAND HILLS, CA. FILED 7-20-2007.

ON KEY

THE MARK CONSISTS OF STANDARD CHARACTERS WITHOUT CLAIM TO ANY PARTICULAR FONT, STYLE, SIZE, OR COLOR.

FOR PRINTED PROMOTIONAL PACKAGING MADE OF PAPER OF VARYING WEIGHTS, FOR HOLDING GIFT CARDS, CARD KEYS AND CDS/DVDS (U.S. CLS. 2, 5, 22, 23, 29, 37, 38 AND 50).
ELLEN BURNS, EXAMINING ATTORNEY

CLASS 16—(Continued).

SN 77-240,609. GO PLANET DESIGN, RIDGEFIELD, CT.
FILED 7-27-2007.

Play Strong

THE MARK CONSISTS OF STANDARD CHARACTERS WITHOUT CLAIM TO ANY PARTICULAR FONT, STYLE, SIZE, OR COLOR.

FOR GREETING CARDS (U.S. CLS. 2, 5, 22, 23, 29, 37, 38 AND 50).

FIRST USE 2-1-2006; IN COMMERCE 7-1-2006.
DAVID YONTEF, EXAMINING ATTORNEY

CLASS 16—(Continued).

SN 77-246,072. THE LES TURNER AMYOTROPHIC LATERAL SCLEROSIS FOUNDATION, LTD., SKOKIE, IL.
FILED 8-2-2007.

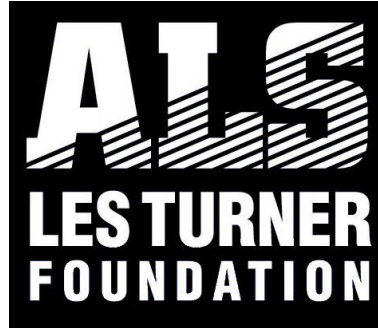

NO CLAIM IS MADE TO THE EXCLUSIVE RIGHT TO USE "ALS" AND "FOUNDATION", APART FROM THE MARK AS SHOWN.

THE NAME(S), PORTRAIT(S), AND/OR SIGNATURE(S) SHOWN IN THE MARK DOES NOT IDENTIFY A PARTICULAR LIVING INDIVIDUAL.

THE MARK CONSISTS OF THE WORDS "ALS LES TURNER FOUNDATION" IN CAPITAL LETTERS SET WITHIN A BOX WITH A BLACK BACKGROUND, WITH DIAGONAL LINES RUNNING THROUGH THE LOWER HALF OF THE LETTERS "ALS".

FOR PRINTED MATERIALS, NAMELY, BROCHURES, INFORMATIONAL AND EDUCATIONAL BOOKS AND NEWSLETTERS IN THE FIELD OF AMYOTROPHIC LATERAL SCLEROSIS (ALS) FOR PATIENTS, THEIR FAMILIES, AND HEALTHCARE PROFESSIONALS (U.S. CLS. 2, 5, 22, 23, 29, 37, 38 AND 50).

FIRST USE 12-0-2004; IN COMMERCE 3-0-2005.
WARREN L. OLANDRIA, EXAMINING ATTORNEY

SN 77-241,668. JOURNAL COMMUNICATIONS, INC.,
FRANKLIN, TN. FILED 7-30-2007.

American Journeys

THE MARK CONSISTS OF STANDARD CHARACTERS WITHOUT CLAIM TO ANY PARTICULAR FONT, STYLE, SIZE, OR COLOR.

NO CLAIM IS MADE TO THE EXCLUSIVE RIGHT TO USE "AMERICAN", APART FROM THE MARK AS SHOWN. FOR GENERAL FEATURE MAGAZINES (U.S. CLS. 2, 5, 22, 23, 29, 37, 38 AND 50).

FIRST USE 5-31-2007; IN COMMERCE 5-31-2007.
SETH A. RAPPAPORT, EXAMINING ATTORNEY

SN 77-248,679. THE LITTLE BLACK APRON, LLC, DIX HILLS, NY. FILED 8-7-2007.



THE MARK CONSISTS OF A STYLIZED APRON DESIGN ON THE LEFT OF THE STYLIZED WORDS "THE LITTLE BLACK APRON".

FOR MAGAZINES FEATURING RECIPES, COOKING TIPS AND ADVICE; COOK BOOKS; BOOKS IN THE FIELD OF COOKING (U.S. CLS. 2, 5, 22, 23, 29, 37, 38 AND 50).

RON FAIRBANKS, EXAMINING ATTORNEY

CLASS 16—(Continued).

SN 77-249,023. IDS MENUS, HOLBROOK, NY. FILED 8-7-2007.

IDSMENUS

THE MARK CONSISTS OF STANDARD CHARACTERS WITHOUT CLAIM TO ANY PARTICULAR FONT, STYLE, SIZE, OR COLOR.
FOR PRINTED PRODUCTS, NAMELY, MENU BOARDS (U.S. CLS. 2, 5, 22, 23, 29, 37, 38 AND 50).
FIRST USE 1-2-2002; IN COMMERCE 1-2-2002.
JENNIFER HETU, EXAMINING ATTORNEY

CLASS 16—(Continued).

SN 77-252,890. ICON AUTOMOTIVE GROUP, A LIMITED LIABILITY COMPANY, WAUKESHA, WI. FILED 8-10-2007.



NO CLAIM IS MADE TO THE EXCLUSIVE RIGHT TO USE "AUTOMOTIVE GROUP" AND "A LIMITED LIABILITY COMPANY", APART FROM THE MARK AS SHOWN.

THE COLOR(S) BLACK AND SILVER IS/ARE CLAIMED AS A FEATURE OF THE MARK.

THE MARK CONSISTS OF A BLACK SILHOUETTE OF THE UPPER PORTION OF AN AUTOMOBILE OVER THE WORD "ICON" WRITTEN WITH THREE DIMENSIONAL SILVER LETTERING. THE WORDING "AUTOMOTIVE GROUP" AND "A LIMITED LIABILITY COMPANY" IS WRITTEN IN "NEUROPOL" TYPE STANDARD BLACK FONT.

FOR A SERIES OF BOOKS AND WRITTEN ARTICLES IN THE FIELD OF AUTOMOTIVE BUYING AND SELLING; A SERIES OF BOOKS, WRITTEN ARTICLES, HANDOUTS AND WORKSHEETS IN THE FIELD OF AUTOMOTIVE BUYING, SELLING AND CUSTOMIZATION; GUIDE BOOKS FEATURING AUTOMOTIVE BUYING, SELLING AND CUSTOMIZATION; PAMPHLETS IN THE FIELD OF AUTOMOTIVE BUYING, SELLING AND CUSTOMIZATION (U.S. CLS. 2, 5, 22, 23, 29, 37, 38 AND 50).

SHAILA SETTLES, EXAMINING ATTORNEY

SN 77-252,337. DTG MAPS INC., BOZEMAN, MT. FILED 8-10-2007.

DTG Maps

THE MARK CONSISTS OF STANDARD CHARACTERS WITHOUT CLAIM TO ANY PARTICULAR FONT, STYLE, SIZE, OR COLOR.

NO CLAIM IS MADE TO THE EXCLUSIVE RIGHT TO USE "MAPS", APART FROM THE MARK AS SHOWN.

FOR MAPS (U.S. CLS. 2, 5, 22, 23, 29, 37, 38 AND 50).
FIRST USE 1-17-1994; IN COMMERCE 5-1-2007.

MARY CRAWFORD, EXAMINING ATTORNEY

SN 77-253,664. TOKYOPOP INC., LOS ANGELES, CA. FILED 8-13-2007.

Bombos vs. Everything

THE MARK CONSISTS OF STANDARD CHARACTERS WITHOUT CLAIM TO ANY PARTICULAR FONT, STYLE, SIZE, OR COLOR.

FOR A SERIES OF BOOKS AND WRITTEN ARTICLES IN THE FIELD OF GRAPHIC NOVELS, COMIC BOOKS, ADVERTISING BOARDS OF PAPER OR CARDBOARD, BOOKMARKS, CALENDARS, CATALOGS IN THE FIELD OF GRAPHIC NOVEL AND ANIMATION MERCHANDISE, COLORING BOOKS, GREETING CARDS, MANUALS IN THE FIELD OF COMIC BOOKS/ANIMATION/DIGITAL PROGRAMS, NEWSPAPER COMIC STRIPS, NOTEBOOKS, PHOTOGRAPHS, PICTURES, POSTERS, PRINTS, STATIONERY-TYPE PORTFOLIOS, STICKERS, TRADING CARDS (U.S. CLS. 2, 5, 22, 23, 29, 37, 38 AND 50).

ALLISON SCHRODY, EXAMINING ATTORNEY

CLASS 16—(Continued).

SN 77-254,141. AMERICAN AIRPOWER HERITAGE MUSEUM, MIDLAND, TX. FILED 8-13-2007.



THE MARK CONSISTS OF A BLACK AND WHITE DRAWING OF THE MARK THAT CONTAINS A PHOTOGRAPHIC IMAGE.

FOR PRINTED MATTER, NAMELY, NEWSLETTERS, BROCHURES, BOOKS IN THE FIELD OF AVIATION HISTORY; POSTCARDS, GREETING CARDS, POSTERS AND STATIONERY IN THE FIELD OF AVIATION HISTORY (U.S. CLS. 2, 5, 22, 23, 29, 37, 38 AND 50).

JAY FLOWERS, EXAMINING ATTORNEY

SN 77-255,953. NEW UNDERSTANDINGS AWAKEN WORLDWIDE, LLC, WILMINGTON, DE. FILED 8-15-2007.

NUAW NEW UNDERSTANDINGS AWAKEN WITHIN

THE MARK CONSISTS OF STANDARD CHARACTERS WITHOUT CLAIM TO ANY PARTICULAR FONT, STYLE, SIZE, OR COLOR.

FOR EDUCATIONAL PUBLICATIONS, NAMELY, TRAINING MANUALS AND BOOKS IN THE FIELD OF SELF AWARENESS, SPIRITUALITY, SELF-HELP AND PERSONAL EMPOWERMENT SUBJECT MATTERS (U.S. CLS. 2, 5, 22, 23, 29, 37, 38 AND 50).

KYLE PEETE, EXAMINING ATTORNEY

SN 77-256,172. NEW UNDERSTANDINGS AWAKEN WORLDWIDE, LLC, WILMINGTON, DE. FILED 8-15-2007.

NUAW NEW UNDERSTANDINGS AWAKEN WORLDWIDE

THE MARK CONSISTS OF STANDARD CHARACTERS WITHOUT CLAIM TO ANY PARTICULAR FONT, STYLE, SIZE, OR COLOR.

FOR EDUCATIONAL PUBLICATIONS, NAMELY, TRAINING MANUALS AND BOOKS IN THE FIELD OF SELF AWARENESS, SPIRITUALITY, SELF-HELP AND PERSONAL EMPOWERMENT SUBJECT MATTERS (U.S. CLS. 2, 5, 22, 23, 29, 37, 38 AND 50).

KYLE PEETE, EXAMINING ATTORNEY

CLASS 16—(Continued).

SN 77-256,696. MINGEE, GLORIA, NEWPORT NEWS, VA. FILED 8-16-2007.

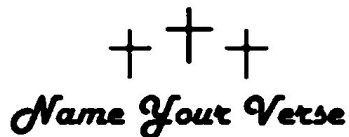

NO CLAIM IS MADE TO THE EXCLUSIVE RIGHT TO USE "VERSE", APART FROM THE MARK AS SHOWN.

THE MARK CONSISTS OF THE WORDS "NAME YOUR VERSE" IN A STYLIZED TEXT WITH THREE CROSSES CENTERED ABOVE THE WORDS.

FOR FRAMED AND UNFRAMED ART PRINTS OF ACROSTIC POEMS FEATURING SCRIPTURE VERSES (U.S. CLS. 2, 5, 22, 23, 29, 37, 38 AND 50).

FIRST USE 9-0-2006; IN COMMERCE 9-0-2006.

ELIZABETH HUGHITT, EXAMINING ATTORNEY

SN 77-259,196. CUATRO COMMUNICATIONS, INC., HOUSTON, TX. FILED 8-20-2007.

RECETAS DE ABUELITA

THE MARK CONSISTS OF STANDARD CHARACTERS WITHOUT CLAIM TO ANY PARTICULAR FONT, STYLE, SIZE, OR COLOR.

NO CLAIM IS MADE TO THE EXCLUSIVE RIGHT TO USE "RECETAS", APART FROM THE MARK AS SHOWN.

THE FOREIGN WORDING IN THE MARK TRANSLATES INTO ENGLISH AS GRANDMOTHER'S RECIPIES.

FOR NEWSPAPER COLUMN AND SYNDICATED NEWSPAPER COLUMN FEATURING RECIPES IN SPANISH LANGUAGE AIMED AT THE HISPANIC COMMUNITY (U.S. CLS. 2, 5, 22, 23, 29, 37, 38 AND 50).

FIRST USE 2-2-2004; IN COMMERCE 2-2-2004.

TINA L. SNAPP, EXAMINING ATTORNEY

SN 77-259,202. CUATRO COMMUNICATIONS, INC., HOUSTON, TX. FILED 8-20-2007.

EL PERICO VALEDOR

THE MARK CONSISTS OF STANDARD CHARACTERS WITHOUT CLAIM TO ANY PARTICULAR FONT, STYLE, SIZE, OR COLOR.

THE FOREIGN WORDING IN THE MARK TRANSLATES INTO ENGLISH AS PARROT SHOWN WILL NOT HOLD HIS TONGUE OR A HARD, STRAIGHT-TALKING PARROT.

FOR NEWSPAPER COLUMN AND SYNDICATED NEWSPAPER COLUMN FEATURING SPORTS IN SPANISH LANGUAGE AIMED AT THE HISPANIC COMMUNITY (U.S. CLS. 2, 5, 22, 23, 29, 37, 38 AND 50).

FIRST USE 2-1-2005; IN COMMERCE 2-1-2005.

TINA L. SNAPP, EXAMINING ATTORNEY

CLASS 16—(Continued).

SN 77-261,085. HIGH SCHOOL SPORTS-THE MAGAZINE, TULSA, OK. FILED 8-21-2007.

Triple Play

THE MARK CONSISTS OF STANDARD CHARACTERS WITHOUT CLAIM TO ANY PARTICULAR FONT, STYLE, SIZE, OR COLOR.

FOR MAGAZINE SECTIONS IN THE FIELD OF SPORTS (U.S. CLS. 2, 5, 22, 23, 29, 37, 38 AND 50).

FIRST USE 12-1-2005; IN COMMERCE 1-5-2006.

JOHN HWANG, EXAMINING ATTORNEY

SN 77-270,985. DAVIS, BARBARA NELL, BROOKHAVEN, MS. FILED 9-4-2007.

MIX @ MATCH
BY DESIGN

THE MARK CONSISTS OF "MIX" AND "MATCH" ARE SEPARATED BY A STYLIZED AMPERSAND (&). "BY DESIGN" IS JUSTIFIED LEFT AND RIGHT WITH THE WORD "MATCH" TO CREATE A DISTINGUISHED MARK (LOGO).

FOR WRITING PAPER HOLDERS; WRITING PAPER PADS; XEROGRAPHIC PAPER; TABLE NAPKINS OF PAPER; THERMOSENSITIVE PAPER; THICK JAPANESE PAPER; TISSUE PAPER; TISSUE PAPER FOR USE AS MATERIAL OF STENCIL PAPER (GANPISHI); TOILET PAPER; TOILET SEAT COVER PAPER; TRACING PAPER; TRADING CARD DISCS OF PAPER OR CARDBOARD; TREATED PAPER FOR WRAPPING FLOWERS AND FLORAL DISPLAYS; TYPEWRITER PAPER; UNFITTED FURNITURE COVERS OF PAPER; UNPRINTED PAPER; UNSENSITIZED PHOTO PAPER; WATERPROOF PAPER; WAX BOND PAPER; WAX PAPER; WORKS OF ART MADE FROM CUSTOM MANUFACTURED PAPER; WRAPPING PAPER; WRITING PAPER; ABSORBENT PADS OF PAPER AND CELLULOSE FOR USE IN FOOD PACKAGING; ACID-RESISTANT PAPER; ADDING MACHINE PAPER; ADHESIVE NOTE PAPER; ADVERTISING BOARDS OF PAPER OR CARDBOARD; ADVERTISING SIGNS OF PAPER OR CARDBOARD; ALUMINUM FOIL LAMINATED PAPER FOR PRINTING PURPOSES; ART PAPER; AUTOMATIC PAPER CLIP DISPENSING MACHINES FOR OFFICE OR STATIONERY USE; BABIES' DIAPERS OF PAPER; BANNERS OF PAPER; BIODEGRADABLE PAPER PULP-BASED TO-GO CONTAINERS FOR FOOD; BLANK OR PARTIALLY PRINTED PAPER LABELS; BLANK PAPER COMPUTER TAPES; BLANK PAPER COMPUTER TAPES FOR RECORDING PROGRAMS; BLANK PAPER NOTEBOOKS; BLANK PAPER TAPES AND CARDS FOR THE RECORDING OF COMPUTER PROGRAMS; BLOTTING PAPER; BOND PAPER; BOOK-COVER PAPER; BOXES OF PAPER; BOXES OF PAPER OR CARDBOARD; BURP PADS OF PAPER; BUSINESS CARD PAPER; CALENDAR-FINISHED PAPER; CALLIGRAPHY PAPER; CARBON PAPER; CARBON PAPER; CARDBOARD MADE FROM PAPER MULBERRY (SENKASI); CARRYING CASES MADE OF PAPER; CELLOPHANE PAPER; COASTERS MADE OF PAPER; COLLAPSIBLE BOXES OF PAPER; COMPUTER PAPER; CONSTRUCTION PAPER; CONTAINERS FOR ICE MADE OF PAPER OR CARDBOARD; COPIER PAPER; COPY PAPER; CORRUGATED BOARD AND PAPER CONTAINERS; CORRUGATED PAPER; COSMETIC REMOVING PAPER;

CLASS 16—(Continued).

CRAFT PAPER; CREPE PAPER; CREPE PAPER FOR MEDICAL, SANITARY OR DOMESTIC USE; CUSHIONING OR PADDING MADE OF PAPER FOR PACKING PURPOSES; DECORATIVE PAPER CENTERPIECES; DIGITAL PRINTING PAPER; DIRECTORY PAPER; DISPOSABLE PAPER SHEETS FOR PERSONAL HYGIENIC USE IN THE NATURE OF DISPOSABLE HEADREST COVERS NOT FOR MEDICAL USE; DRAWING PAPER; DUPLICATING PAPER; DYE-SUBLIMATION PRINT PAPER; EKG PAPER; ELECTROCARDIOGRAPH PAPER; ELECTROSTATIC PAPER; EMBROIDERY DESIGN PATTERNS; ENVELOPE PAPER; ENVELOPE PAPERS; FACSIMILE TRANSMISSION PAPER; FIBER PAPER; FILING FOLDERS, PAPER LABELS AND PRINTED INSTRUCTIONAL MATERIALS FOR ORGANIZING PERSONAL FILES; FILLER PAPER; FILTER PAPER; FLUORESCENT PAPER; FLUTING PAPER; GARBAGE BAGS OF PAPER; GARBAGE BAGS OF PAPER; GIFT WRAP PAPER; GIFT WRAPPING PAPER; GLASSINE PAPER; GRAPH PAPER; GROCERY PAPER; GUMMED PAPER; GUNPOWDER WRAPPING PAPER; HALLOWEEN GOODIE BAGS OF PAPER OR PLASTIC; HAND TOWELS OF PAPER; HAT BOXES OF PAPER; HEAT SENSITIVE PAPER; HEAT TRANSFER PAPER; HONEY-COMB PAPER; HYGIENIC PAPER; ILLUSTRATION PAPER; IMITATION LEATHER PAPER; INDIA PAPER; INDUSTRIAL PACKAGING CONTAINERS OF PAPER; JAPANESE CEREMONIAL PAPER STRINGS (MIZUHIKI); JAPANESE HANDICRAFT PAPER; JAPANESE PAPER; JAPANESE PAPER (TORINOKO-GAMI); KRAFT PAPER; LABEL PAPER; LAMINATED PAPER; LASER PRINT PAPER; LASER PRINTING PAPER; LETTER PAPER; LETTERHEAD PAPER; LINING PAPER; LOOSE LEAF PAPER; LUMINOUS PAPER; MAGAZINE PAPER; MAGNETIC PAPER; MANIFOLD PAPER; MASKING PAPER; METALLIC GIFT WRAPPING PAPER; METALLIC PAPER PARTY DECORATIONS; MILDEWPROOF PAPER; MIMEOGRAPH PAPER; MODELING MATERIALS FOR USE IN MAKING CAST PAPER SCULPTURED FLOWERS; MOISTUREPROOF CELLOPHANE PAPER; MULCH PAPER; NAPKIN PAPER; NEWSPRINT PAPER; NOTE PAPER; NOTE PAPERS; NOTEBOOK PAPER; OFFICE PAPER DRILL MACHINES; OFFICE PAPER STATIONERY; OFFSET PAPER; OFFSET PRINTING PAPER FOR PAMPHLETS; OILED PAPER FOR PAPER UMBRELLAS (KASA-GAMI); OILPROOF PAPER; ONION SKIN PAPER; OPAQUE PAPER; PACKAGING AND CONTAINERS COMPRISED OF STARCH-BASED MATERIALS IN THE NATURE OF A PAPER SUBSTITUTE FOR FOOD, BEVERAGES AND CONSUMER PRODUCTS; PACKING PAPER; PAPER; PAPER AND CARDBOARD; PAPER BABY BIBS; PAPER BADGES; PAPER BAGS; PAPER BAGS AND SACKS; PAPER BAGS FOR PACKAGING; PAPER BANNERS; PAPER BOARD; PAPER BOARDS; PAPER BOWS FOR GIFT WRAP; PAPER BOXES; PAPER BOXES FOR STORING GREETING CARDS; PAPER BUNTING; PAPER CAKE DECORATIONS; PAPER CARTON SEALING TAPE; PAPER CARTONS FOR DELIVERING GOODS; PAPER CLIP HOLDERS; PAPER CLIPS; PAPER CLOSURES FOR CONTAINERS; PAPER CLOSURES FOR SEALING CONTAINERS; PAPER CONTAINERS; PAPER CONTAINING MICA; PAPER COVERS FOR TELEPHONE RECEIVERS; PAPER CUTTERS; PAPER DIAPERS; PAPER DIE CUT SHAPES; PAPER DISPLAY BOXES; PAPER DOILIES; PAPER DROP CLOTHS; PAPER EGG CARTONS; PAPER EMBLEMS; PAPER EMBOSSERS; PAPER ENVELOPES FOR PACKAGING; PAPER EXPANDING FILES; PAPER FASTENERS; PAPER FILE JACKETS; PAPER FILTERS FOR COFFEE MAKERS; PAPER FLAGS; PAPER FLOOR MATS; PAPER FLOWER POT COVERS; PAPER FOLDERS; PAPER FOLDING MACHINES AS OFFICE REQUISITES; PAPER FOLDING MACHINES FOR OFFICE USE; PAPER FOR JAPANESE INDOOR SLIDING PARTITIONS (FUSUMA-GAMI); PAPER FOR JAPANESE SLIDING SCREENS (SHOJI-GAMI); PAPER FOR BAGS AND SACKS; PAPER FOR PHOTOCOPIES; PAPER FOR PHOTOCOPYING; PAPER FOR RECORDING MACHINES; PAPER FOR USE AS MATERIAL OF STOCK CERTIFICATES (SHOKENSHI); PAPER FOR USE IN THE GRAPHIC ARTS INDUSTRY; PAPER FOR USE IN THE MANUFACTURE OF WALLPAPER; PAPER FOR USE IN THE MANUFACTURE OF OFFICE SUPPLIES, PRESENTATION MATERIALS AND RESUME MATERIALS; PAPER FOR WRAPPING AND PACKAGING; PAPER FUTON COVERS; PAPER GARBAGE BAGS; PAPER GIFT BAGS; PAPER GIFT BAGS FOR WINE;

CLASS 16—(Continued).

PAPER GIFT TAGS; PAPER GIFT WRAP; PAPER GIFT WRAP BOWS; PAPER GIFT WRAPPING RIBBONS; PAPER HAND-TOWELS; PAPER HANDKERCHIEFS; PAPER HANDTOWELS; PAPER HANG TAGS; PAPER HOLE PUNCHES; PAPER IDENTIFICATION TAGS; PAPER ILLUSTRATION BOARDS; PAPER KNIVES; PAPER LABELS; PAPER LACE; PAPER LETTERS AND NUMBERS FOR USE IN MAKING EDUCATIONAL TOOLS, DISPLAYS AND SIGNAGE; PAPER LINERS FOR DIAPERS; PAPER MACHE; PAPER MACHE FIGURINES; PAPER MADE FROM PAPER MULBERRY (KOHZO-GAMI); PAPER MADE FROM PAPER MULBERRY (TENGUJOSI); PAPER MAIL POUCHES; PAPER MATS; PAPER NAME BADGES; PAPER NAPKINS; PAPER NOTE TABLETS; PAPER NOTEBOOKS; PAPER PACKAGING AND CONTAINERS FOR FOOD AND BEVERAGES COMPRISED OF MATERIALS DESIGNED TO LESSEN ADVERSE EFFECTS ON THE ENVIRONMENT; PAPER PADDING; PAPER PADS FOR CHANGING DIAPERS; PAPER PARTY BAGS; PAPER PARTY DECORATIONS; PAPER PARTY FAVORS; PAPER PARTY HATS; PAPER PATCHES FOR CLOTHING; PAPER PENNANTS; PAPER PET CRATE MATS; PAPER PICTURE MOUNTS; PAPER PILLOWCASES; PAPER PLACE MATS; PAPER POUCHES FOR PACKAGING; PAPER PRODUCTS, NAMELY, PAPER TUBES; PAPER PRODUCTS, NAMELY, PAPER TUBES AND PAPER CORES; PAPER RACKS; PAPER REFUSE BAGS; PAPER REPORT COVERS; PAPER RIBBONS; PAPER ROLLS FOR CALCULATING MACHINES; PAPER SHEETS FOR NOTE TAKING; PAPER SHOPPING BAGS; PAPER SHREDDERS; PAPER SIGN HOLDERS; PAPER STAPLERS; PAPER STAPLES; PAPER STATIONERY; PAPER STOCK; PAPER TABLE CLOTHS; PAPER TABLE LINENS; PAPER TAGS; PAPER TAKE-OUT CARTONS FOR FOOD; PAPER TAPE; PAPER TAPES; PAPER TAPES FOR CALCULATING MACHINES; PAPER TAPES FOR CALCULATORS; PAPER TEACHING MATERIALS IN THE FIELDS OF EDUCATION AND BUSINESS; PAPER TOWELS; PAPER TRANSPARENCIES; PAPER TRAY COVERS; PAPER WASHCLOTHS; PAPER WINE GIFT BAGS; PAPER-FEEDING MACHINES FOR OFFICE USE; PAPERS FOR HOUSEHOLD AND INDUSTRIAL USE; PAPERS FOR USE IN THE GRAPHIC ARTS INDUSTRY; PARAFFINED PAPER; PARCHMENT PAPER; PARTY GOODIE BAGS OF PAPER OR PLASTIC; PARTY ORNAMENTS OF PAPER; PHOTOCOPY PAPERS; PICTURE MOUNTS OF PAPER; PLACARDS OF PAPER OR CARDBOARD; PLACE MATS OF PAPER; PLASTIC OR PAPER BAGS FOR HOUSEHOLD USE; PLASTIC OR PAPER BAGS FOR MERCHANDISE PACKAGING; PLASTIC-COATED COPYING PAPER; PLOTTING PAPERS; POLYESTER FILM FOR USE AS A PAPER SUBSTITUTE FOR DRY TONER XEROGRAPHIC IMAGING, NAMELY, LASER PRINTING, COLOR COPIER PRINTING, DRY TONER PRINTING, SCREEN PRINTING, AND OFFSET PRINTING; POSTCARD PAPER; POSTERS MADE OF PAPER; PRINTED PAPER LABELS; PRINTED PAPER SIGNS; PRINTED PAPER SIGNS, NAMELY, TABLE TENTS; PRINTING PAPER; PRINTING PAPERS; PROOFING PAPER; PROTECTIVE COVERS FOR SHEETS OR PAPER AND PAGES OF BOOKS AND THE LIKE; PUBLICATION PAPER; RECYCLED BOND PAPER; RECYCLED PAPER; REEL PAPER FOR PRINTERS; REPRODUCTION PAPER; RICE PAPER; RUBBISH BAGS (MADE OF PAPER OR PLASTIC MATERIALS); RULED PAPER; SAFETY PAPER; SCENTED PAPER DRAWER LINERS; SCHOOL SUPPLY KITS CONTAINING VARIOUS COMBINATIONS OF SELECTED SCHOOL SUPPLIES, NAMELY, WRITING INSTRUMENTS, PENS, PENCILS, MECHANICAL PENCILS, ERASERS, MARKERS, CRAYONS, HIGHLIGHTERS, FOLDERS, NOTEBOOKS, PAPER, GRADUATED RULERS, PROTRACTORS, PAPER CLIPS, PENCIL SHARPENERS, WRITING GRIPS, GLUE AND BOOK MARKS; SEMI-PROCESSED PAPER; SHELF PAPER; SPECIALTY PAPERS, NAMELY VEGETABLE PARCHMENT, FOR USE IN FOOD WRAPPING, PREPARATION, PROCESSING AND PACKAGING

CLASS 16—(Continued).

APPLICATIONS; STATIONERY WRITING PAPER AND ENVELOPES; STENCIL PAPER; STENCIL PAPER; STENCILS AND PATTERNS, BEING OF PAPER AND PLASTIC, FOR THE TRANSFERRING OF GRAPHIC DESIGNS TO PUMPKINS, MINI-PUMPKINS, GOURDS, AND OTHER FRUITS AND VEGETABLES; STORAGE CONTAINERS MADE OF PAPER; STRIPS OF FANCY PAPER (TANZAKU); SUPERCALANDERED PRINTING PAPER; SYNTHETIC BOND PAPER; SYNTHETIC PAPER; TABLE CLOTHS OF PAPER; TABLE LINENS OF PAPER; TABLE MATS OF PAPER (U.S. CLS. 2, 5, 22, 23, 29, 37, 38 AND 50).

NICHOLAS ALTREE, EXAMINING ATTORNEY

SN 77-271,740. CADEL, BETSY, HARTSDALE, NY. FILED 9-5-2007.

KidSavvy

THE MARK CONSISTS OF STANDARD CHARACTERS WITHOUT CLAIM TO ANY PARTICULAR FONT, STYLE, SIZE, OR COLOR.

FOR A SERIES OF BOOKS AND WRITTEN ARTICLES IN THE FIELD OF EDUCATION, RECREATION, FAMILY ENTERTAINMENT AND OTHER CHILD REARING ISSUES (U.S. CLS. 2, 5, 22, 23, 29, 37, 38 AND 50).

FIRST USE 6-15-2003; IN COMMERCE 6-15-2003.

SHARON MEIER, EXAMINING ATTORNEY

SN 77-272,249. BEARZYBOO LLC, SAN DIEGO, CA. FILED 9-5-2007.

BearzyBoo 
GOOD FOR BABY GOOD FOR YOU!

NO CLAIM IS MADE TO THE EXCLUSIVE RIGHT TO USE "GOOD FOR BABY" OR "GOOD FOR YOU!", APART FROM THE MARK AS SHOWN.

THE COLOR(S) BLUE, RED, AND WHITE IS/ARE CLAIMED AS A FEATURE OF THE MARK.

THE MARK CONSISTS OF RED STYLIZED WORDING "BEARZYBOO", BLUE WORDING "GOOD FOR BABY" "GOOD FOR YOU!", AND BLUE BEAR HEAD DESIGN, ALL ON A WHITE BACKGROUND.

FOR CHILDREN'S BOOKS; CHILDREN'S STORYBOOKS (U.S. CLS. 2, 5, 22, 23, 29, 37, 38 AND 50).

BRIAN PINO, EXAMINING ATTORNEY

CLASS 16—(Continued).

SN 77-276,727. CREATIVE AGE COMMUNICATIONS, INC., VAN NUYS, CA. FILED 9-11-2007.

HAUTE STUFF

THE MARK CONSISTS OF STANDARD CHARACTERS WITHOUT CLAIM TO ANY PARTICULAR FONT, STYLE, SIZE, OR COLOR.

FOR TRADE MAGAZINE FOR DEPARTMENT STORE OWNERS AND BOUTIQUE OWNERS (U.S. CLS. 2, 5, 22, 23, 29, 37, 38 AND 50).

ANTHONY RINKER, EXAMINING ATTORNEY

SN 77-277,702. MALINOWSKI, MARYELLEN, DBA THE INFRARED LIGHT GALLERY, SAINT CHARLES, IL. FILED 9-12-2007.

The Infrared Light Gallery

THE MARK CONSISTS OF STANDARD CHARACTERS WITHOUT CLAIM TO ANY PARTICULAR FONT, STYLE, SIZE, OR COLOR.

SEC. 2(F).

FOR PICTORIAL PRINTS: INFRARED PHOTOGRAPHY AND IMAGERY, NAMELY, FRAMED AND UNFRAMED INFRARED PHOTOGRAPHIC PRINTS, POSTERS, JOURNALS FEATURING INFRARED LIGHT PICTORIAL IMAGES, GREETING CARDS, CALENDARS, PAPER BOOKS FEATURING INFRARED LIGHT PICTORIAL IMAGES (U.S. CLS. 2, 5, 22, 23, 29, 37, 38 AND 50).

FIRST USE 7-1-1997; IN COMMERCE 7-1-1997.
JENNIFER DIXON, EXAMINING ATTORNEY

SN 77-278,117. FRANCE PUBLICATIONS, INC., ATLANTA, GA. FILED 9-12-2007.

SHOPPING CENTER BUSINESS

THE MARK CONSISTS OF STANDARD CHARACTERS WITHOUT CLAIM TO ANY PARTICULAR FONT, STYLE, SIZE, OR COLOR.

NO CLAIM IS MADE TO THE EXCLUSIVE RIGHT TO USE "SHOPPING CENTER", APART FROM THE MARK AS SHOWN.

SEC. 2(F).

FOR (BASED ON USE IN COMMERCE) MAGAZINE SECTIONS IN THE FIELD OF COMMERCIAL REAL ESTATE DEVELOPMENT, OWNERSHIP, OPERATION, DESIGN AND FINANCE WITH RELATED NEWS AND FEATURES (U.S. CLS. 2, 5, 22, 23, 29, 37, 38 AND 50).

FIRST USE 5-1-1996; IN COMMERCE 5-1-1996.
ERIN FALK, EXAMINING ATTORNEY

CLASS 16—(Continued).

SN 77-279,010. 944 MEDIA, LLC, SCOTTSDALE, AZ. FILED 9-13-2007.

944

OWNER OF U.S. REG. NO. 3,273,648.
FOR (BASED ON USE IN COMMERCE) MAGAZINES FEATURING FASHION, ENTERTAINMENT, AND LIFESTYLE (U.S. CLS. 2, 5, 22, 23, 29, 37, 38 AND 50).
FIRST USE 2-1-2002; IN COMMERCE 2-1-2002.
ELI HELLMAN, EXAMINING ATTORNEY

SN 77-281,511. 944 MEDIA, LLC, SCOTTSDALE, AZ. FILED 9-17-2007.

944 LIFE

THE MARK CONSISTS OF STANDARD CHARACTERS WITHOUT CLAIM TO ANY PARTICULAR FONT, STYLE, SIZE, OR COLOR.

OWNER OF U.S. REG. NO. 3,273,648.

FOR (BASED ON USE IN COMMERCE) MAGAZINES FEATURING FASHION, ENTERTAINMENT, AND LIFESTYLE (U.S. CLS. 2, 5, 22, 23, 29, 37, 38 AND 50).

FIRST USE 2-1-2002; IN COMMERCE 2-1-2002.
ELI HELLMAN, EXAMINING ATTORNEY

SN 77-282,038. FRANCIS, MONICA, BRONX, NY. FILED 9-18-2007.



NO CLAIM IS MADE TO THE EXCLUSIVE RIGHT TO USE MAGAZINE, APART FROM THE MARK AS SHOWN.

THE MARK CONSISTS OF STYLIZED TEXT OF THE WORDING "VE VERSATILE ESSENTIALS MAGAZINE".

FOR MAGAZINES, FEATURING UNDERGROUND MUSIC, MUSICIANS, NIGHTCLUBS, DANCE CLUBS AND FASHION DESIGNERS (U.S. CLS. 2, 5, 22, 23, 29, 37, 38 AND 50).

BERYL GARDNER, EXAMINING ATTORNEY

CLASS 16—(Continued).

SN 77-283,408. MEADWESTVACO CORPORATION, GLEN ALLEN, VA. FILED 9-19-2007.

SNAP2POUR

THE MARK CONSISTS OF STANDARD CHARACTERS WITHOUT CLAIM TO ANY PARTICULAR FONT, STYLE, SIZE, OR COLOR.

FOR PAPERBOARD CARTONS AND CARTON BLANKS (U.S. CLS. 2, 5, 22, 23, 29, 37, 38 AND 50).
HEATHER BIDDULPH, EXAMINING ATTORNEY

SN 77-283,478. INSIGNIA SYSTEMS, INC., MAPLE GROVE, MN. FILED 9-19-2007.

CHECK THIS OUT!

THE MARK CONSISTS OF STANDARD CHARACTERS WITHOUT CLAIM TO ANY PARTICULAR FONT, STYLE, SIZE, OR COLOR.

OWNER OF U.S. REG. NO. 2,102,405.
FOR PRINTED CARDBOARD SIGNS FOR IN-STORE USE (U.S. CLS. 2, 5, 22, 23, 29, 37, 38 AND 50).
FIRST USE 7-10-1996; IN COMMERCE 7-10-1996.
KELLY MCCOY, EXAMINING ATTORNEY

SN 77-283,609. MEADWESTVACO CORPORATION, GLEN ALLEN, VA. FILED 9-19-2007.

HIPEX

THE MARK CONSISTS OF STANDARD CHARACTERS WITHOUT CLAIM TO ANY PARTICULAR FONT, STYLE, SIZE, OR COLOR.

FOR KRAFT PAPER (U.S. CLS. 2, 5, 22, 23, 29, 37, 38 AND 50).
HEATHER BIDDULPH, EXAMINING ATTORNEY

CLASS 16—(Continued).

SN 77-284,034. LUMINA SPHERE, LLC, BLACK CANYON CITY, AZ. FILED 9-19-2007.

lumina sphere

THE MARK CONSISTS OF STANDARD CHARACTERS WITHOUT CLAIM TO ANY PARTICULAR FONT, STYLE, SIZE, OR COLOR.

FOR GREETING CARDS; CALENDARS; POSTERS; STATIONERY (U.S. CLS. 2, 5, 22, 23, 29, 37, 38 AND 50).
RICHARD A. STRASER, EXAMINING ATTORNEY

SN 77-284,179. KING, UNA, SAN RAFAEL, CA. FILED 9-20-2007.

TUGBOAT CREW ENTERTAINMENT

THE MARK CONSISTS OF STANDARD CHARACTERS WITHOUT CLAIM TO ANY PARTICULAR FONT, STYLE, SIZE, OR COLOR.

NO CLAIM IS MADE TO THE EXCLUSIVE RIGHT TO USE "ENTERTAINMENT", APART FROM THE MARK AS SHOWN.

FOR CHILDREN'S BOOKS (U.S. CLS. 2, 5, 22, 23, 29, 37, 38 AND 50).

FIRST USE 2-15-2007; IN COMMERCE 9-1-2007.
ESTHER BELENKER, EXAMINING ATTORNEY

SN 77-285,670. CENTER OF THE AMERICAN WEST, BOULDER, CO. FILED 9-21-2007.

Turning Hindsight into Foresight

THE MARK CONSISTS OF STANDARD CHARACTERS WITHOUT CLAIM TO ANY PARTICULAR FONT, STYLE, SIZE, OR COLOR.

FOR RESEARCH REPORTS FEATURING TOPICS OF CRUCIAL INTEREST TO THE AMERICAN WEST, NAMELY MULTICULTURALISM, COMMUNITY BUILDING, FIRE POLICY, AND LAND, WATER, AND ENERGY USE; BOOKS IN THE FIELD OF TOPICS OF CRUCIAL INTEREST TO THE AMERICAN WEST, NAMELY MULTICULTURALISM, COMMUNITY BUILDING, FIRE POLICY, AND LAND, WATER, AND ENERGY USE (U.S. CLS. 2, 5, 22, 23, 29, 37, 38 AND 50).
ELLEN BURNS, EXAMINING ATTORNEY

CLASS 16—(Continued).

SN 77-285,794. KUDOLLA, JUSTIN PETER, CASPER, WY.
FILED 9-21-2007.

TREND BOOKS

THE MARK CONSISTS OF STANDARD CHARACTERS WITHOUT CLAIM TO ANY PARTICULAR FONT, STYLE, SIZE, OR COLOR.

NO CLAIM IS MADE TO THE EXCLUSIVE RIGHT TO USE "BOOKS", APART FROM THE MARK AS SHOWN. FOR BOOK-COVER PAPER (U.S. CLS. 2, 5, 22, 23, 29, 37, 38 AND 50).

DAWN FELDMAN, EXAMINING ATTORNEY

SN 77-286,027. UP COUNTRY INC., EAST PROVIDENCE, RI.
FILED 9-21-2007.

UP COUNTRY

THE MARK CONSISTS OF STANDARD CHARACTERS WITHOUT CLAIM TO ANY PARTICULAR FONT, STYLE, SIZE, OR COLOR.

OWNER OF U.S. REG. NO. 1,303,720. FOR NOTE CARDS, GREETING CARDS AND INVITATION CARDS (U.S. CLS. 2, 5, 22, 23, 29, 37, 38 AND 50).

ZACHARY BELLO, EXAMINING ATTORNEY

SN 77-286,983. BIG WOODS PRODUCTIONS, NORTH SMITHFIELD, RI. FILED 9-24-2007.

BIG WOODS BUCKS

THE MARK CONSISTS OF STANDARD CHARACTERS WITHOUT CLAIM TO ANY PARTICULAR FONT, STYLE, SIZE, OR COLOR.

NO CLAIM IS MADE TO THE EXCLUSIVE RIGHT TO USE "BUCKS", APART FROM THE MARK AS SHOWN. FOR PRINTED GUIDES FOR HUNTING (U.S. CLS. 2, 5, 22, 23, 29, 37, 38 AND 50).

FIRST USE 11-0-2003; IN COMMERCE 4-0-2007.
MATTHEW PAPPAS, EXAMINING ATTORNEY

CLASS 16—(Continued).

SN 77-287,612. HOSKINS, RICHARD B., GAINESVILLE, GA.
FILED 9-24-2007.



FOR BLUEPRINTS (U.S. CLS. 2, 5, 22, 23, 29, 37, 38 AND 50).

GRETTA YAO, EXAMINING ATTORNEY

SN 77-287,841. FIBERMARK NORTH AMERICA INC., BRATTLEBORO, VT. FILED 9-25-2007.

NATURALLY CREATIVE

THE MARK CONSISTS OF STANDARD CHARACTERS WITHOUT CLAIM TO ANY PARTICULAR FONT, STYLE, SIZE, OR COLOR.

FOR PAPER PRODUCTS, NAMELY, REPORT AND DOCUMENT COVERS, BROCHURE COVERS, STATIONERY-TYPE POCKET PORTFOLIOS, JOURNAL AND NOTEBOOK COVERS, INVITATIONS, FOLDING CARTONS FOR DELIVERING GOODS, AND TAGS (U.S. CLS. 2, 5, 22, 23, 29, 37, 38 AND 50).

DAVID ELTON, EXAMINING ATTORNEY

SN 77-288,336. KATHLEEN BEILFUSS, OSHKOSH, WI.
FILED 9-25-2007.

KATBLU

THE MARK CONSISTS OF STANDARD CHARACTERS WITHOUT CLAIM TO ANY PARTICULAR FONT, STYLE, SIZE, OR COLOR.

FOR STATIONERY; GREETING CARDS; INVITATIONS; NOTE CARDS; BOOK COVERS; BLANK JOURNAL BOOKS; BLANK WRITING JOURNALS; CALENDARS; PAPER PARTY DECORATIONS; PLACE CARDS; PAPER PLATES; PAPER NAPKINS; PAPER PLACE MATS; PAPER TABLE CLOTHS; PAPER WINDOW DECORATIONS; FRAMED ART PICTURES AND PRINTS; WORKS OF FINE ART CONSISTING OF PAINTINGS AND DRAWINGS; AND PRINTED MATTER, NAMELY, PUBLICATIONS, JOURNALS AND MANUALS, ALL IN THE FIELDS OF PERSONAL AND PROFESSIONAL GROWTH AND DEVELOPMENT AND PERSONAL MOTIVATION (U.S. CLS. 2, 5, 22, 23, 29, 37, 38 AND 50).

SANJEEV VOHRA, EXAMINING ATTORNEY

CLASS 16—(Continued).

SN 77-288,635. ME MEDIA, LLC, PORTLAND, OR. FILED 9-25-2007.

ME MEDIA KIDS

THE MARK CONSISTS OF STANDARD CHARACTERS WITHOUT CLAIM TO ANY PARTICULAR FONT, STYLE, SIZE, OR COLOR.

NO CLAIM IS MADE TO THE EXCLUSIVE RIGHT TO USE "MEDIA KIDS", APART FROM THE MARK AS SHOWN.

FOR CHILDREN'S BOOKS; BABY BOOKS (U.S. CLS. 2, 5, 22, 23, 29, 37, 38 AND 50).

SIMON TENG, EXAMINING ATTORNEY

SN 77-289,046. FRANCE PUBLICATIONS, INC., ATLANTA, GA. FILED 9-26-2007.

HEARTLAND REAL ESTATE BUSINESS

THE MARK CONSISTS OF STANDARD CHARACTERS WITHOUT CLAIM TO ANY PARTICULAR FONT, STYLE, SIZE, OR COLOR.

NO CLAIM IS MADE TO THE EXCLUSIVE RIGHT TO USE "REAL ESTATE BUSINESS", APART FROM THE MARK AS SHOWN.

SEC. 2(F).

FOR MAGAZINES FEATURING NEWS AND AREAS OF INTEREST TO THOSE INVOLVED IN THE OWNERSHIP, DEVELOPMENT AND OPERATION OF COMMERCIAL REAL ESTATE PROPERTIES IN THE MIDWEST REGION OF THE UNITED STATES (U.S. CLS. 2, 5, 22, 23, 29, 37, 38 AND 50).

FIRST USE 5-20-2002; IN COMMERCE 7-28-2002.

ERIN FALK, EXAMINING ATTORNEY

CLASS 16—(Continued).

SN 77-289,971. ELM EDUCATION MARKETING, PALM SPRINGS, CA. FILED 9-26-2007.



NO CLAIM IS MADE TO THE EXCLUSIVE RIGHT TO USE "WORLD TEASERS" AND "GLOBAL KNOWLEDGE", APART FROM THE MARK AS SHOWN.

THE COLOR(S) BLACK, PINK, PURPLE, BLUE, TURQUOISE, GREEN, YELLOW, ORANGE IS/ARE CLAIMED AS A FEATURE OF THE MARK.

THE MARK CONSISTS OF A STYLIZED QUESTION MARK WITH GRADATION OF COLOR BEGINNING WITH PINK AT THE TOP, CHANGING TO PURPLE, THEN BLUE, THEN TURQUOISE, THEN GREEN. THE PERIOD OF THE QUESTION MARK IS BLUE AND YELLOW/ORANGE DEPICTING A GLOBE OF THE EARTH. THE QUESTION MARK SITS ON A BLACK SPLASH. THE COLOR BLACK APPEARS IN THE WORDING "WORLD TEASERS" AND "SUPERSIZE YOUR GLOBAL KNOWLEDGE".

FOR EDUCATIONAL PUBLICATIONS, NAMELY, EDUCATIONAL LEARNING CARDS, FLASH CARDS, ACTIVITY CARDS, WORKBOOKS, TEXTBOOKS, ACTIVITY BOOKS, STORY BOOKS, PUZZLE BOOKS, PUZZLES, TEACHER GUIDES, MANUALS, POSTERS, EDUCATIONAL CARD GAMES AND EDUCATIONAL BOOKLETS IN THE FIELD OF SOCIAL STUDIES (U.S. CLS. 2, 5, 22, 23, 29, 37, 38 AND 50).

MARCIE MILONE, EXAMINING ATTORNEY

SN 77-290,713. MAESTRO FINANCIAL CORPORATION, DALLAS, TX. FILED 9-27-2007.

OpenPage

THE MARK CONSISTS OF STANDARD CHARACTERS WITHOUT CLAIM TO ANY PARTICULAR FONT, STYLE, SIZE, OR COLOR.

FOR BOOK HOLDERS; DOCUMENT HOLDERS; A PROTECTIVE COVER FOR BOOKS THAT HOLDS A BOOK OPEN WHEN READING (U.S. CLS. 2, 5, 22, 23, 29, 37, 38 AND 50).

FIRST USE 9-1-2007; IN COMMERCE 9-20-2007.

EUGENIA MARTIN, EXAMINING ATTORNEY

CLASS 16—(Continued).

SN 77-290,719. DAVID ALLEN & CO., OJAI, CA. FILED 9-27-2007.

CAPTURE CLARIFY COMPLETE
WIN

THE MARK CONSISTS OF STANDARD CHARACTERS WITHOUT CLAIM TO ANY PARTICULAR FONT, STYLE, SIZE, OR COLOR.

FOR PUBLICATIONS, NAMELY, BOOKS, BROCHURES, PAMPHLETS AND PRINTED SEMINAR COURSE MATERIALS ALL FEATURING THE DEVELOPMENT OF MANAGEMENT AND BUSINESS SKILLS, EFFICIENT WORK HABITS, PLANNING AND ORGANIZATIONAL TECHNIQUES, AND PERSONAL PRODUCTIVITY AND GROWTH; DESKTOP PLANNERS; WRITING PENCILS AND PENS; NOTEBOOKS, AND MEMO PADS (U.S. CLS. 2, 5, 22, 23, 29, 37, 38 AND 50).
FIRST USE 1-15-2005; IN COMMERCE 1-15-2005.
KATHRYN COWARD, EXAMINING ATTORNEY

SN 77-291,136. MARIE CLAIRE / HEARST, NEW YORK, NY. FILED 9-28-2007.

MORE THAN A PRETTY FACE

THE MARK CONSISTS OF STANDARD CHARACTERS WITHOUT CLAIM TO ANY PARTICULAR FONT, STYLE, SIZE, OR COLOR.

FOR MAGAZINES FEATURING INFORMATION ON FASHION, BEAUTY, FITNESS, HEALTH, NEWS, CAREERS, TRAVEL, RELATIONSHIPS, AND ENTERTAINMENT (U.S. CLS. 2, 5, 22, 23, 29, 37, 38 AND 50).
FIRST USE 5-15-2007; IN COMMERCE 5-15-2007.
COLLEEN DOMBROW, EXAMINING ATTORNEY

SN 77-291,192. SCRANTON GILLETTE COMMUNICATIONS, INC., ARLINGTON HEIGHTS, IL. FILED 9-28-2007.

LAWN & GARDEN RETAILER

THE MARK CONSISTS OF STANDARD CHARACTERS WITHOUT CLAIM TO ANY PARTICULAR FONT, STYLE, SIZE, OR COLOR.

OWNER OF U.S. REG. NO. 2,626,981.
SEC. 2(F).
FOR PRINTED PUBLICATIONS IN THE NATURE OF A TRADE PUBLICATION, NAMELY, MAGAZINES FEATURING INFORMATION IN THE FIELDS OF LAWN AND GARDENS DIRECTED TO RETAIL STORES (U.S. CLS. 2, 5, 22, 23, 29, 37, 38 AND 50).
FIRST USE 1-8-2002; IN COMMERCE 1-8-2002.
NAPOLEON SHARMA, EXAMINING ATTORNEY

CLASS 16—(Continued).

SN 77-291,206. KUDRON, LOREEN, CHICAGO, IL. FILED 9-28-2007.

Scruffbooking

THE MARK CONSISTS OF STANDARD CHARACTERS WITHOUT CLAIM TO ANY PARTICULAR FONT, STYLE, SIZE, OR COLOR.

FOR SCRAPBOOK ALBUMS; SCRAPBOOK PAGES; SCRAPBOOKS; A SERIES OF BOOKS, WRITTEN ARTICLES, HANDOUTS AND WORKSHEETS IN THE FIELD OF DOGS, AND OF SCRAPBOOKING; BOOK COVERS; BOOK HOLDERS; BOOKS IN THE FIELD OF DOGS, AND OF SCRAPBOOKING; DATA BOOKS; EDUCATIONAL PUBLICATIONS, NAMELY, EDUCATIONAL LEARNING CARDS, FLASH CARDS, ACTIVITY CARDS, WORKBOOKS, TEXTBOOKS, ACTIVITY BOOKS, STORY BOOKS, PUZZLE BOOKS, PUZZLES, TEACHER GUIDES, MANUALS, POSTERS, EDUCATIONAL CARD GAMES AND EDUCATIONAL BOOKLETS IN THE FIELD OF DOGS, AND OF SCRAPBOOKING; GUIDE BOOKS FEATURING DOGS, AND OF SCRAPBOOKING; MEMORY BOOKS; SERIES OF NON-FICTION BOOKS IN THE FIELD OF DOGS, AND OF SCRAPBOOKING; NEWSLETTERS IN THE FIELD OF DOGS, AND OF SCRAPBOOKING; BINDERS; PAPER; RUBBER STAMPS; STICKERS; ADHESIVE CORNERS FOR PHOTOGRAPHS (U.S. CLS. 2, 5, 22, 23, 29, 37, 38 AND 50).

FIRST USE 5-1-2006; IN COMMERCE 9-23-2007.
TOBY BULLOFF, EXAMINING ATTORNEY

SN 77-291,342. PENGUIN BOOKS LIMITED, LONDON, UNITED KINGDOM, FILED 9-28-2007.

PUFFIN

THE MARK CONSISTS OF STANDARD CHARACTERS WITHOUT CLAIM TO ANY PARTICULAR FONT, STYLE, SIZE, OR COLOR.

OWNER OF U.S. REG. NOS. 1,079,827, 2,242,908 AND OTHERS.
FOR CHILDREN'S BOOKS (U.S. CLS. 2, 5, 22, 23, 29, 37, 38 AND 50).
FIRST USE 0-0-1961; IN COMMERCE 0-0-1961.
ANDREA HACK, EXAMINING ATTORNEY

CLASS 16—(Continued).

SN 77-291,390. EVIDENT MUSIC GROUP, LLC, CORPUS CHRISTI, TX. FILED 9-28-2007.

COLORBLIND

THE MARK CONSISTS OF STANDARD CHARACTERS WITHOUT CLAIM TO ANY PARTICULAR FONT, STYLE, SIZE, OR COLOR.

FOR POSTERS, AUTOGRAPH BOOKS, DECALS, STICKERS AND PICTURES (U.S. CLS. 2, 5, 22, 23, 29, 37, 38 AND 50).

KATHLEEN LORENZO, EXAMINING ATTORNEY

SN 77-291,484. INTEK AMERICA, INC., TORRANCE, CA. FILED 9-28-2007.

EZ LIFT

THE MARK CONSISTS OF STANDARD CHARACTERS WITHOUT CLAIM TO ANY PARTICULAR FONT, STYLE, SIZE, OR COLOR.

FOR PAPER AND MEDIA SHREDDERS (U.S. CLS. 2, 5, 22, 23, 29, 37, 38 AND 50).

TASNEEM HUSSAIN, EXAMINING ATTORNEY

SN 77-291,509. KOLBE CORP, PHOENIX, AZ. FILED 9-28-2007.

Commitment Clarifier

THE MARK CONSISTS OF STANDARD CHARACTERS WITHOUT CLAIM TO ANY PARTICULAR FONT, STYLE, SIZE, OR COLOR.

NO CLAIM IS MADE TO THE EXCLUSIVE RIGHT TO USE "COMMITMENT", APART FROM THE MARK AS SHOWN.

FOR WORKBOOKS DIRECTED TO HUMAN RESOURCE DEVELOPMENT (U.S. CLS. 2, 5, 22, 23, 29, 37, 38 AND 50).

FIRST USE 7-0-2007; IN COMMERCE 7-0-2007.

LINDA MICKLEBURGH, EXAMINING ATTORNEY

CLASS 16—(Continued).

SN 77-291,510. SPENCE, BERNET B, BOYBTON BEACH, FL. FILED 9-28-2007.

JERK SAUSAGE

THE MARK CONSISTS OF STANDARD CHARACTERS WITHOUT CLAIM TO ANY PARTICULAR FONT, STYLE, SIZE, OR COLOR.

FOR ADDRESS LABELS; BAR CODE LABELS; BLANK OR PARTIALLY PRINTED PAPER LABELS; LABEL PAPER; LABEL PRINTING MACHINE RIBBONS; LABEL PRINTING MACHINES; OFFICE LABELING MACHINES; PAPER LABELS; PRINTED PAPER LABELS; SHIPPING LABELS (U.S. CLS. 2, 5, 22, 23, 29, 37, 38 AND 50).

TARAH HARDY, EXAMINING ATTORNEY

SN 77-291,535. SCARLETT ASSOCIATES, INC., DBA SCARLETT SURVEYS INTERNATIONAL, GREENVILLE, SC. FILED 9-28-2007.

OMNI 19

THE MARK CONSISTS OF STANDARD CHARACTERS WITHOUT CLAIM TO ANY PARTICULAR FONT, STYLE, SIZE, OR COLOR.

FOR QUESTIONNAIRES ON EMPLOYEE ENGAGEMENT, SATISFACTION (U.S. CLS. 2, 5, 22, 23, 29, 37, 38 AND 50).

FIRST USE 3-1-2007; IN COMMERCE 6-1-2007.

LINDA MICKLEBURGH, EXAMINING ATTORNEY

SN 77-291,588. AMG PUBLISHERS INC., CHATTANOOGA, TN. FILED 9-28-2007.

**FOLLOWING GOD FOR YOUTH
AND YOUNG ADULTS**

THE MARK CONSISTS OF STANDARD CHARACTERS WITHOUT CLAIM TO ANY PARTICULAR FONT, STYLE, SIZE, OR COLOR.

OWNER OF U.S. REG. NOS. 2,314,195, 2,395,961 AND 2,640,407.

FOR SERIES OF NON-FICTION BOOKS IN THE FIELD OF RELIGION AND BIBLE STUDY (U.S. CLS. 2, 5, 22, 23, 29, 37, 38 AND 50).

FIRST USE 12-31-2005; IN COMMERCE 5-30-2006.

TARAH HARDY, EXAMINING ATTORNEY

CLASS 16—(Continued).

SN 77-291,669. APPELLATION AMERICA (US), INC., LUNENBURG, CANADA, FILED 9-28-2007.

CLASS 16—(Continued).

SN 77-292,077. JONES, LAURIE BETH, PHOENIX, AZ. FILED 9-28-2007.

WINE EXPLORER

THE MARK CONSISTS OF STANDARD CHARACTERS WITHOUT CLAIM TO ANY PARTICULAR FONT, STYLE, SIZE, OR COLOR.

NO CLAIM IS MADE TO THE EXCLUSIVE RIGHT TO USE "WINE", APART FROM THE MARK AS SHOWN.

FOR MAGAZINES FEATURING WINES; NEWSLETTERS IN THE FIELD OF WINES; PUBLICATIONS, NAMELY, BROCHURES, BOOKLETS, AND TEACHING MATERIALS IN THE FIELD OF WINES; QUICK REFERENCE POCKET GUIDES IN THE FIELD OF WINES (U.S. CLS. 2, 5, 22, 23, 29, 37, 38 AND 50).

CURTIS FRENCH, EXAMINING ATTORNEY



SN 77-291,887. CREATIVE CONSULTING, L.L.C., GOODLAND, KS. FILED 9-28-2007.

BLENDING MOMENTS

THE MARK CONSISTS OF STANDARD CHARACTERS WITHOUT CLAIM TO ANY PARTICULAR FONT, STYLE, SIZE, OR COLOR.

FOR GREETING CARDS (U.S. CLS. 2, 5, 22, 23, 29, 38 AND 50).

RONALD MCMORROW, EXAMINING ATTORNEY



SN 77-291,888. CR MEDIA PTE LTD., SINGAPORE, SINGAPORE, FILED 9-28-2007.

TIC TALK

THE MARK CONSISTS OF STANDARD CHARACTERS WITHOUT CLAIM TO ANY PARTICULAR FONT, STYLE, SIZE, OR COLOR.

FOR MAGAZINE ON THE SUBJECTS OF WATCHES AND TIMEPIECES (U.S. CLS. 2, 5, 22, 23, 29, 37, 38 AND 50).

RONALD MCMORROW, EXAMINING ATTORNEY

SPIRITRENEUR

THE MARK CONSISTS OF STANDARD CHARACTERS WITHOUT CLAIM TO ANY PARTICULAR FONT, STYLE, SIZE, OR COLOR.

FOR PRINTED AND PAPER ITEMS, NAMELY, STATIONERY, A SERIES OF WRITTEN EDUCATIONAL MATERIALS IN THE FIELD OF BUSINESS AND SPIRITUALITY, PAMPHLETS IN THE FIELD OF BUSINESS AND SPIRITUALITY, PRINTED INSTRUCTIONAL MATERIALS IN THE FIELD OF BUSINESS AND SPIRITUALITY, BOOKLETS ABOUT BUSINESS AND SPIRITUALITY (U.S. CLS. 2, 5, 22, 23, 29, 37, 38 AND 50).

JOHN WILKE, EXAMINING ATTORNEY



SN 77-292,159. LUMINA SPHERE LLC, BLACK CANYON CITY, AZ. FILED 9-28-2007.



THE MARK CONSISTS OF AN EXCLAMATION MARK WITH: 1. THE TOP PORTION FORMED BY THE OUTLINE OF AN UPSIDEDOWN TEARDROP OR RAINDROP SHAPE. 2. THE BOTTOM PORTION COMPRISED OF A PARTIALLY SHADED CIRCLE - WITH THIS SHADING FORMING WITHIN THE CIRCLE THE SHAPE OF A CRESCENT..

FOR GREETING CARDS; CALENDARS; POSTERS; STATIONERY (U.S. CLS. 2, 5, 22, 23, 29, 37, 38 AND 50).

BILL DAWE, EXAMINING ATTORNEY

CLASS 16—(Continued).

SN 77-292,334. EDICT HOUSE, LLC, RUSTBURG, VA. FILED 9-29-2007.

Edict House Publishing Group, LLC

THE MARK CONSISTS OF STANDARD CHARACTERS WITHOUT CLAIM TO ANY PARTICULAR FONT, STYLE, SIZE, OR COLOR.

NO CLAIM IS MADE TO THE EXCLUSIVE RIGHT TO USE "PUBLISHING GROUP, LLC", APART FROM THE MARK AS SHOWN.

FOR CHILDREN'S ACTIVITY BOOKS; CHILDREN'S BOOKS; CHILDREN'S INTERACTIVE EDUCATIONAL BOOKS; COFFEE TABLE BOOKS FEATURING; COLORING BOOKS; SERIES OF FICTION AND NON-FICTION BOOKS ON A VARIETY OF TOPICS; SERIES OF FICTION BOOKS; SKETCH BOOKS; STORY BOOKS; TALKING CHILDREN'S BOOKS (U.S. CLS. 2, 5, 22, 23, 29, 37, 38 AND 50).

HANNO RITTNER, EXAMINING ATTORNEY

SN 77-292,665. RODGER LEO RADERMAN, SAN FRANCISCO, CA. FILED 10-1-2007.

The Bears Go Where

THE MARK CONSISTS OF STANDARD CHARACTERS WITHOUT CLAIM TO ANY PARTICULAR FONT, STYLE, SIZE, OR COLOR.

FOR CHILDREN'S STORYBOOKS (U.S. CLS. 2, 5, 22, 23, 29, 37, 38 AND 50).

ODESSA BIBBINS, EXAMINING ATTORNEY

SN 77-292,673. LEAKEY, TERESA, GARLAND, TX. AND BARRS, PETRA JO, MESQUITE, TX. FILED 10-1-2007.

BAGABILLIA

THE MARK CONSISTS OF STANDARD CHARACTERS WITHOUT CLAIM TO ANY PARTICULAR FONT, STYLE, SIZE, OR COLOR.

FOR FABRIC BAGS FOR GIFTS, CARDS, MONEY, LINGERIE AND TOYS (U.S. CLS. 2, 5, 22, 23, 29, 37, 38 AND 50).

KAREN BRACEY, EXAMINING ATTORNEY

CLASS 16—(Continued).

SN 77-292,774. THOMPSON, D. DESHAWN, MARIETTA, GA. FILED 10-1-2007.

Raindust

THE MARK CONSISTS OF STANDARD CHARACTERS WITHOUT CLAIM TO ANY PARTICULAR FONT, STYLE, SIZE, OR COLOR.

FOR PAINTINGS (U.S. CLS. 2, 5, 22, 23, 29, 37, 38 AND 50).

JANICE L. MCMORROW, EXAMINING ATTORNEY

SN 77-292,823. BECK & GLEE, LLC, BOULDER, CO. FILED 10-1-2007.

fl!p your thinking

THE MARK CONSISTS OF STANDARD CHARACTERS WITHOUT CLAIM TO ANY PARTICULAR FONT, STYLE, SIZE, OR COLOR.

FOR (BASED ON USE IN COMMERCE) A SERIES OF BOOKS, WRITTEN ARTICLES, HANDOUTS AND WORKSHEETS IN THE FIELD OF INSPIRATION; STATIONERY; PRINTED GIFT CARDS CONTAINING INSPIRATIONAL MESSAGES; (BASED ON INTENT TO USE) BUMPER STICKERS; STICKERS; CALENDARS; DESK CALENDARS; POCKET CALENDARS; PRINTED CALENDARS; WALL CALENDARS; ADHESIVE NOTE PADS; ADHESIVE NOTE PAPER; BLANK NOTE CARDS; NOTE BOOKS; NOTE CARDS; NOTE PAPER; NOTE PAPERS (U.S. CLS. 2, 5, 22, 23, 29, 37, 38 AND 50).

FIRST USE 3-1-2007; IN COMMERCE 3-1-2007.

CHRISTINE COOPER, EXAMINING ATTORNEY

SN 77-292,863. PROFORM TECHNOLOGIES, INC., RIVERTON, WY. FILED 10-1-2007.

BLOCK HEAD

THE MARK CONSISTS OF STANDARD CHARACTERS WITHOUT CLAIM TO ANY PARTICULAR FONT, STYLE, SIZE, OR COLOR.

FOR PAINT BRUSHES (U.S. CLS. 2, 5, 22, 23, 29, 37, 38 AND 50).

ESTHER A. BORSUK, EXAMINING ATTORNEY

CLASS 16—(Continued).

SN 77-293,059. VALOR BRANDS, INC., ALPHARETTA, GA. FILED 10-1-2007.

NURTURED BY NATURE

THE MARK CONSISTS OF STANDARD CHARACTERS WITHOUT CLAIM TO ANY PARTICULAR FONT, STYLE, SIZE, OR COLOR.
FOR DISPOSABLE DIAPERS AND TRAINING PANTS (U.S. CLS. 2, 5, 22, 23, 29, 37, 38 AND 50).
JORDAN BAKER, EXAMINING ATTORNEY

SN 77-293,185. MORGAN, T, FELTON, CA. FILED 10-1-2007.

MouseNator

THE MARK CONSISTS OF STANDARD CHARACTERS WITHOUT CLAIM TO ANY PARTICULAR FONT, STYLE, SIZE, OR COLOR.
FOR CHILDREN'S BOOKS (U.S. CLS. 2, 5, 22, 23, 29, 37, 38 AND 50).
MARTHA FROMM, EXAMINING ATTORNEY

SN 77-293,221. TREASURE BAY, INC., SAN ANSELMO, CA. FILED 10-1-2007.

HALF AND HALF

THE MARK CONSISTS OF STANDARD CHARACTERS WITHOUT CLAIM TO ANY PARTICULAR FONT, STYLE, SIZE, OR COLOR.
FOR A SERIES OF CHILDREN'S BOOKS (U.S. CLS. 2, 5, 22, 23, 29, 37, 38 AND 50).
JESSICA A. POWERS, EXAMINING ATTORNEY

CLASS 16—(Continued).

SN 77-293,340. INSTITUTIONAL JOBBERS COMPANY, DBA THE IJ COMPANY, LOUISVILLE, TN. FILED 10-1-2007.

IJ ESSENTIALS

THE MARK CONSISTS OF STANDARD CHARACTERS WITHOUT CLAIM TO ANY PARTICULAR FONT, STYLE, SIZE, OR COLOR.
FOR TRADE PUBLICATION ABOUT THE FOOD SERVICE INDUSTRY (U.S. CLS. 2, 5, 22, 23, 29, 37, 38 AND 50).
JUDITH HELFMAN, EXAMINING ATTORNEY

SN 77-293,355. HARPS, LYNN, WASHINGTON, AK. FILED 10-1-2007.

CRUMBSNATCHERS

THE MARK CONSISTS OF STANDARD CHARACTERS WITHOUT CLAIM TO ANY PARTICULAR FONT, STYLE, SIZE, OR COLOR.
FOR ANIMATION CELLS; CARTOON PRINTS; CARTOON STRIPS (U.S. CLS. 2, 5, 22, 23, 29, 37, 38 AND 50).
GRETTA YAO, EXAMINING ATTORNEY

SN 77-293,621. DESIRING GOD MINISTRIES, MINNEAPOLIS, MN. FILED 10-2-2007.

DON'T WASTE YOUR LIFE

THE MARK CONSISTS OF STANDARD CHARACTERS WITHOUT CLAIM TO ANY PARTICULAR FONT, STYLE, SIZE, OR COLOR.
FOR PRINTED INSTRUCTIONAL, EDUCATIONAL, AND TEACHING MATERIALS IN THE FIELD OF EXISTENTIAL, MORAL, ETHICAL, SOCIAL, PHILOSOPHICAL AND RELIGIOUS TOPICS AND ISSUES; A SERIES OF BOOKS AND WRITTEN ARTICLES IN THE FIELD OF EXISTENTIAL, MORAL, ETHICAL, SOCIAL, PHILOSOPHICAL AND RELIGIOUS TOPICS AND ISSUES (U.S. CLS. 2, 5, 22, 23, 29, 37, 38 AND 50).
FIRST USE 5-1-2003; IN COMMERCE 5-1-2003.
ATTIYA MALIK, EXAMINING ATTORNEY

CLASS 16—(Continued).

SN 77-293,681. SETPHENSON, SCOTT, STATE COLLEGE, PA. FILED 10-2-2007.

WISHING WINDOWS

THE MARK CONSISTS OF STANDARD CHARACTERS WITHOUT CLAIM TO ANY PARTICULAR FONT, STYLE, SIZE, OR COLOR.

FOR POSTERS; ADHESIVE PLASTIC FILM WITH REMOVABLE PAPER FOR MOUNTING IMAGES FOR DECORATIVE PURPOSES (U.S. CLS. 2, 5, 22, 23, 29, 37, 38 AND 50).

CORY BOONE, EXAMINING ATTORNEY

SN 77-293,687. PIVOT POINT INTERNATIONAL, INC., EVANSTON, IL. FILED 10-2-2007.

A DESIGNER'S APPROACH

THE MARK CONSISTS OF STANDARD CHARACTERS WITHOUT CLAIM TO ANY PARTICULAR FONT, STYLE, SIZE, OR COLOR.

NO CLAIM IS MADE TO THE EXCLUSIVE RIGHT TO USE "DESIGNER'S", APART FROM THE MARK AS SHOWN.

FOR TEXTBOOKS, TEACHER MANUALS AND OTHER PRINTED TEACHING MATERIALS CONTAINING A SERIES OF EDUCATIONAL MATERIALS RELATING TO HAIR SCULPTURE, HAIR DESIGN, HAIR COLORING, PERMANENTS AND TEXTURIZING OF HAIR, AND HAIRSTYLING FOR LONG HAIR (U.S. CLS. 2, 5, 22, 23, 29, 37, 38 AND 50).

JOHN WILKE, EXAMINING ATTORNEY

SN 77-293,858. CHECK SIX PRODUCTIONS, INC., STUDIO CITY, CA. FILED 10-2-2007.

TRAVEL DETECTIVE

THE MARK CONSISTS OF STANDARD CHARACTERS WITHOUT CLAIM TO ANY PARTICULAR FONT, STYLE, SIZE, OR COLOR.

OWNER OF U.S. REG. NOS. 2,690,448 AND 3,275,603.

NO CLAIM IS MADE TO THE EXCLUSIVE RIGHT TO USE "TRAVEL", APART FROM THE MARK AS SHOWN.

FOR BOOKS IN THE FIELD OF TRAVEL (U.S. CLS. 2, 5, 22, 23, 29, 37, 38 AND 50).

FIRST USE 0-0-2001; IN COMMERCE 0-0-2001.

GEOFFREY FOSDICK, EXAMINING ATTORNEY

CLASS 16—(Continued).

SN 77-293,908. MARLENE CUSTOM PILLOWS ETC., LLC, SAN FRANCISCO, CA. FILED 10-2-2007.

Resackables

THE MARK CONSISTS OF STANDARD CHARACTERS WITHOUT CLAIM TO ANY PARTICULAR FONT, STYLE, SIZE, OR COLOR.

FOR FABRIC GIFT BAGS (U.S. CLS. 2, 5, 22, 23, 29, 37, 38 AND 50).

FIRST USE 8-1-2007; IN COMMERCE 8-1-2007.

JAY FLOWERS, EXAMINING ATTORNEY

SN 77-294,028. CYCON, DEAN, ORANGE, MA. FILED 10-2-2007.

JAVA NOTES

THE MARK CONSISTS OF STANDARD CHARACTERS WITHOUT CLAIM TO ANY PARTICULAR FONT, STYLE, SIZE, OR COLOR.

NO CLAIM IS MADE TO THE EXCLUSIVE RIGHT TO USE "NOTES", APART FROM THE MARK AS SHOWN.

FOR NOTE CARDS; NOTE PAPER (U.S. CLS. 2, 5, 22, 23, 29, 37, 38 AND 50).

HENRY S. ZAK, EXAMINING ATTORNEY

SN 77-294,331. MACKAY & COMPANY, LOMBARD, IL. FILED 10-2-2007.

TEA

THE MARK CONSISTS OF STANDARD CHARACTERS WITHOUT CLAIM TO ANY PARTICULAR FONT, STYLE, SIZE, OR COLOR.

FOR NEWSLETTER RE MARKET INFORMATION AND FORECAST SERVICES FOR MANUFACTURERS, DISTRIBUTORS OR OTHERS WITH AN INTEREST IN TRUCKING, SHIPPING BY TRUCK, TRUCK USE AND ECONOMIC ACTIVITY IN THE TRUCKING INDUSTRY (U.S. CLS. 2, 5, 22, 23, 29, 37, 38 AND 50).

DORITT L. CARROLL, EXAMINING ATTORNEY

CLASS 16—(Continued).

SN 77-294,345. WILDLY SOPHISTICATED MEDIA, LLC, NY, NY. FILED 10-2-2007.

WORKS BY NICOLE WILLIAMS

THE MARK CONSISTS OF STANDARD CHARACTERS WITHOUT CLAIM TO ANY PARTICULAR FONT, STYLE, SIZE, OR COLOR.

THE NAME(S), PORTRAIT(S), AND/OR SIGNATURE(S) SHOWN IN THE MARK IDENTIFIES NICOLE WILLIAMS, WHOSE CONSENT(S) TO REGISTER IS MADE OF RECORD.

FOR A SERIES OF BOOKS, WRITTEN ARTICLES, HANDOUTS AND WORKSHEETS IN THE FIELD OF WOMEN'S CAREERS, TRAVEL, LIVING, STYLE AND FASHION; BLANK JOURNALS; DAY PLANNERS; NOTE CARDS (U.S. CLS. 2, 5, 22, 23, 29, 37, 38 AND 50).
KATHLEEN LORENZO, EXAMINING ATTORNEY



SN 77-294,704. ARIES, LLC, RACINE, WI. FILED 10-3-2007.

ARIES

THE MARK CONSISTS OF STANDARD CHARACTERS WITHOUT CLAIM TO ANY PARTICULAR FONT, STYLE, SIZE, OR COLOR.

FOR GREETING CARDS AND GRAPHIC ART REPRODUCTIONS (U.S. CLS. 2, 5, 22, 23, 29, 37, 38 AND 50).
JAMES A. RAUEN, EXAMINING ATTORNEY



SN 77-294,848. IVY ADVISING, LLC, INDIANAPOLIS, IN. FILED 10-3-2007.

INTERVIEW SURVIVAL KIT

THE MARK CONSISTS OF STANDARD CHARACTERS WITHOUT CLAIM TO ANY PARTICULAR FONT, STYLE, SIZE, OR COLOR.

NO CLAIM IS MADE TO THE EXCLUSIVE RIGHT TO USE "INTERVIEW AND KIT", APART FROM THE MARK AS SHOWN.

FOR EDUCATIONAL FLASH CARDS (U.S. CLS. 2, 5, 22, 23, 29, 37, 38 AND 50).
FIRST USE 3-1-2005; IN COMMERCE 3-1-2005.
REBECCA GILBERT, EXAMINING ATTORNEY

CLASS 16—(Continued).

SN 77-295,061. IN THE GAME, INC., BOCA RATON, FL. FILED 10-3-2007.

FAMOUS FABRICS

THE MARK CONSISTS OF STANDARD CHARACTERS WITHOUT CLAIM TO ANY PARTICULAR FONT, STYLE, SIZE, OR COLOR.

FOR TRADING CARDS (U.S. CLS. 2, 5, 22, 23, 29, 37, 38 AND 50).
ODESSA BIBBINS, EXAMINING ATTORNEY



SN 77-295,066. IN THE GAME, INC., BOCA RATON, FL. FILED 10-3-2007.

ENSHRINED

THE MARK CONSISTS OF STANDARD CHARACTERS WITHOUT CLAIM TO ANY PARTICULAR FONT, STYLE, SIZE, OR COLOR.

FOR TRADING CARDS (U.S. CLS. 2, 5, 22, 23, 29, 37, 38 AND 50).
ODESSA BIBBINS, EXAMINING ATTORNEY



SN 77-295,347. DOMTAR PAPER COMPANY, LLC, FORT MILL, SC. FILED 10-3-2007.

ENTERPRISE POSTAL ADVANTAGE

THE MARK CONSISTS OF STANDARD CHARACTERS WITHOUT CLAIM TO ANY PARTICULAR FONT, STYLE, SIZE, OR COLOR.

OWNER OF U.S. REG. NOS. 2,597,056, 2,927,947 AND 2,928,882.

NO CLAIM IS MADE TO THE EXCLUSIVE RIGHT TO USE "POSTAL", APART FROM THE MARK AS SHOWN.
FOR PAPER (U.S. CLS. 2, 5, 22, 23, 29, 37, 38 AND 50).
DAVID MURRAY, EXAMINING ATTORNEY

CLASS 16—(Continued).

SN 77-295,400. FOREST COUNTY POTAWATOMI COMMUNITY, DBA POTAWATOMI BINGO CASINO, CRANDON, WI. FILED 10-3-2007.



THE MARK CONSISTS OF THE WORD "ANTE" IN CAPITAL BLOCK LETTERING WITHIN A RECTANGULAR SHAPED BACKGROUND.

FOR GENERAL FEATURE MAGAZINES (U.S. CLS. 2, 5, 22, 23, 29, 37, 38 AND 50).

FIRST USE 2-19-2007; IN COMMERCE 2-19-2007.
CARYN GLASSER, EXAMINING ATTORNEY

CLASS 16—(Continued).

SN 77-295,590. LOVE ELF CREATIONS, LLC, ORLANDO, FL. FILED 10-3-2007.



THE MARK CONSISTS OF STANDARD CHARACTERS WITHOUT CLAIM TO ANY PARTICULAR FONT, STYLE, SIZE, OR COLOR.

FOR STICKERS (U.S. CLS. 2, 5, 22, 23, 29, 37, 38 AND 50).

FIRST USE 1-1-2007; IN COMMERCE 9-26-2007.
CYNTHIA SLOAN, EXAMINING ATTORNEY

SN 77-295,512. NEUTRON DYNAMIC SYSTEMS INC., CRESTON, CANADA, FILED 10-3-2007.



THE MARK CONSISTS OF STANDARD CHARACTERS WITHOUT CLAIM TO ANY PARTICULAR FONT, STYLE, SIZE, OR COLOR.

FOR MAGAZINES, NAMELY, PERIODICAL PUBLICATIONS IN THE FIELD OF ADULT ENTERTAINMENT; PHOTOGRAPHS; POSTERS AND CALENDARS (U.S. CLS. 2, 5, 22, 23, 29, 37, 38 AND 50).

CYNTHIA SLOAN, EXAMINING ATTORNEY

SN 77-295,790. S.P.E.A.K. MAGAZINE NFP, SUITE 300, IL. FILED 10-4-2007.



THE MARK CONSISTS OF STANDARD CHARACTERS WITHOUT CLAIM TO ANY PARTICULAR FONT, STYLE, SIZE, OR COLOR.

FOR MAGAZINE FOCUSED ON ISSUES OF IMPORTANCE TO CHILDREN AND YOUNG ADULTS (U.S. CLS. 2, 5, 22, 23, 29, 37, 38 AND 50).

FIRST USE 11-16-2006; IN COMMERCE 11-16-2006.
ELISSA GARBER KON, EXAMINING ATTORNEY

SN 77-295,527. FRANCE PUBLICATIONS, INC., ATLANTA, GA. FILED 10-3-2007.



THE MARK CONSISTS OF STANDARD CHARACTERS WITHOUT CLAIM TO ANY PARTICULAR FONT, STYLE, SIZE, OR COLOR.

NO CLAIM IS MADE TO THE EXCLUSIVE RIGHT TO USE "REAL ESTATE BUSINESS", APART FROM THE MARK AS SHOWN.

SEC. 2(F).

FOR (BASED ON USE IN COMMERCE) MAGAZINES FEATURING NEWS AND AREAS OF INTEREST TO THOSE INVOLVED IN THE OWNERSHIP, DEVELOPMENT AND OPERATION OF COMMERCIAL REAL ESTATE PROPERTIES (U.S. CLS. 2, 5, 22, 23, 29, 37, 38 AND 50).

FIRST USE 1-25-2000; IN COMMERCE 3-20-2000.
ERIN FALK, EXAMINING ATTORNEY

SN 77-296,064. ACADEMY OF GENERAL DENTISTRY, CHICAGO, IL. FILED 10-4-2007.



THE MARK CONSISTS OF STANDARD CHARACTERS WITHOUT CLAIM TO ANY PARTICULAR FONT, STYLE, SIZE, OR COLOR.

FOR MAGAZINES IN THE FIELD OF DENTISTRY (U.S. CLS. 2, 5, 22, 23, 29, 37, 38 AND 50).

FIRST USE 3-0-1978; IN COMMERCE 3-0-1978.
STEVEN JACKSON, EXAMINING ATTORNEY

CLASS 16—(Continued).

SN 77-296,220. DREAMBOX LEARNING, INC., BELLEVUE, WA. FILED 10-4-2007.

DreamBox Learning

THE MARK CONSISTS OF STANDARD CHARACTERS WITHOUT CLAIM TO ANY PARTICULAR FONT, STYLE, SIZE, OR COLOR.

NO CLAIM IS MADE TO THE EXCLUSIVE RIGHT TO USE "LEARNING", APART FROM THE MARK AS SHOWN. FOR NOTEBOOKS, PENS, STICKERS, DECALS (U.S. CLS. 2, 5, 22, 23, 29, 37, 38 AND 50).

SALLY SHIH, EXAMINING ATTORNEY

CLASS 16—(Continued).

SN 77-296,697. SALEK, SAFURA, LOS ANGELES, CA. AND SALEK, SANAM, LOS ANGELES, CA. FILED 10-4-2007.

suckit.

THE MARK CONSISTS OF STANDARD CHARACTERS WITHOUT CLAIM TO ANY PARTICULAR FONT, STYLE, SIZE, OR COLOR.

FOR BLANK CARDS; BLANK NOTE CARDS; CARDS BEARING UNIVERSAL GREETINGS; CHRISTMAS CARDS; CORRESPONDENCE CARDS; GIFT CARDS; GREETING CARDS; HOLIDAY CARDS; INVITATION CARDS; NOTE CARDS; OCCASION CARDS; SOCIAL NOTE CARDS (U.S. CLS. 2, 5, 22, 23, 29, 37, 38 AND 50). MICHELLE DUBOIS, EXAMINING ATTORNEY

SN 77-296,263. DREAMBOX LEARNING, INC., BELLEVUE, WA. FILED 10-4-2007.

DreamBox

THE MARK CONSISTS OF STANDARD CHARACTERS WITHOUT CLAIM TO ANY PARTICULAR FONT, STYLE, SIZE, OR COLOR.

FOR NOTEBOOKS, PENS, STICKERS, DECALS (U.S. CLS. 2, 5, 22, 23, 29, 37, 38 AND 50).

SALLY SHIH, EXAMINING ATTORNEY

SN 77-297,311. IVY ADVISING, LLC, INDIANAPOLIS, IN. FILED 10-5-2007.

ADMISSIONS SURVIVAL KIT

THE MARK CONSISTS OF STANDARD CHARACTERS WITHOUT CLAIM TO ANY PARTICULAR FONT, STYLE, SIZE, OR COLOR.

NO CLAIM IS MADE TO THE EXCLUSIVE RIGHT TO USE "ADMISSIONS" AND "KIT", APART FROM THE MARK AS SHOWN.

FOR EDUCATIONAL FLASH CARDS (U.S. CLS. 2, 5, 22, 23, 29, 37, 38 AND 50).

FIRST USE 10-5-2007; IN COMMERCE 10-5-2007. REBECCA GILBERT, EXAMINING ATTORNEY

SN 77-296,620. VALPAK DIRECT MARKETING SYSTEMS, INC., LARGO, FL. FILED 10-4-2007.

THE BLUE ENVELOPE

THE MARK CONSISTS OF STANDARD CHARACTERS WITHOUT CLAIM TO ANY PARTICULAR FONT, STYLE, SIZE, OR COLOR.

NO CLAIM IS MADE TO THE EXCLUSIVE RIGHT TO USE "ENVELOPE", APART FROM THE MARK AS SHOWN.

FOR ENVELOPES, BROCHURES, BOOKLETS, PAMPHLETS, AND COUPON BOOKS WHICH PROMOTE THE GOODS AND SERVICES OF OTHERS (U.S. CLS. 2, 5, 22, 23, 29, 37, 38 AND 50).

WENDY JUN, EXAMINING ATTORNEY

SN 77-297,316. SANTEE, CINDY, DARIEN, IL. FILED 10-5-2007.

Soulful Creation

THE MARK CONSISTS OF STANDARD CHARACTERS WITHOUT CLAIM TO ANY PARTICULAR FONT, STYLE, SIZE, OR COLOR.

FOR PRINTED INSTRUCTIONAL, EDUCATIONAL, AND TEACHING MATERIALS IN THE FIELD OF SELF-HELP (U.S. CLS. 2, 5, 22, 23, 29, 37, 38 AND 50).

SUSAN LESLIE DUBOIS, EXAMINING ATTORNEY

CLASS 16—(Continued).

SN 77-297,499. SOLOMON, HARVEY, TAKOMA PARK, MD.
FILED 10-5-2007.

CLASS 16—(Continued).

SN 77-300,087. ASHLEY-RUPP, ELIZABETH A., NORTH
TUSTIN, CA. FILED 10-9-2007.

GET THE 365 EDGE

THE MARK CONSISTS OF STANDARD CHARACTERS
WITHOUT CLAIM TO ANY PARTICULAR FONT, STYLE,
SIZE, OR COLOR.

FOR A SERIES OF BOOKS AND WRITTEN ARTICLES
IN THE FIELD OF POP CULTURE; APPOINTMENT
BOOKS (U.S. CLS. 2, 5, 22, 23, 29, 37, 38 AND 50).

FIRST USE 6-1-2007; IN COMMERCE 9-28-2007.

JOHN GARTNER, EXAMINING ATTORNEY



SN 77-298,255. AMG PUBLISHERS, INC., CHATTANOOGA,
TN. FILED 10-8-2007.

GOD AND COUNTRY PRESS

THE MARK CONSISTS OF STANDARD CHARACTERS
WITHOUT CLAIM TO ANY PARTICULAR FONT, STYLE,
SIZE, OR COLOR.

NO CLAIM IS MADE TO THE EXCLUSIVE RIGHT TO
USE "PRESS", APART FROM THE MARK AS SHOWN.

FOR SERIES OF FICTION AND NON-FICTION
BOOKS ON A VARIETY OF TOPICS (U.S. CLS. 2, 5, 22,
23, 29, 37, 38 AND 50).

KAREN BRACEY, EXAMINING ATTORNEY

FOR A SERIES OF BOOKS AND WRITTEN ARTICLES
IN THE FIELD OF FANTASY ADVENTURE FICTION; A
SERIES OF BOOKS, WRITTEN ARTICLES, HANDOUTS
AND WORKSHEETS IN THE FIELD OF FANTASY
ADVENTURE FICTION; ADDRESS BOOKS; ANNIVER-
SARY BOOKS; APPOINTMENT BOOKS; AUTOGRAPH
BOOKS; BABY BOOKS; BIRTHDAY BOOKS; BLANK
JOURNAL BOOKS; BOOK BINDINGS; BOOK COVERS;
BOOK HOLDERS; BOOK MARKERS OF PRECIOUS
METAL; BOOK PLATES; BOOK-COVER PAPER; BOOKS
IN THE FIELD OF FANTASY ADVENTURE FICTION;
BRAG BOOKS; CHILDREN'S ACTIVITY BOOKS; CHIL-
DREN'S BOOKS; CHILDREN'S INTERACTIVE EDUCA-
TIONAL BOOKS; COFFEE TABLE BOOKS FEATURING
FANTASY ADVENTURE FICTION; COLORING BOOKS;
COMIC BOOKS; COMPOSITION BOOKS; DATE BOOKS;
EDUCATIONAL BOOKS FEATURING FANTASY AD-
VENTURE FICTION; EDUCATIONAL PUBLICATIONS,
NAMELY, EDUCATIONAL LEARNING CARDS, FLASH
CARDS, ACTIVITY CARDS, WORKBOOKS, TEXT-
BOOKS, ACTIVITY BOOKS, STORY BOOKS, PUZZLE
BOOKS, PUZZLES, TEACHER GUIDES, MANUALS,
POSTERS, EDUCATIONAL CARD GAMES AND EDU-
CATIONAL BOOKLETS IN THE FIELD OF CHARAC-
TER BUILDING; ENGAGEMENT BOOKS; FLIP BOOKS;
GIFT BOOKS FEATURING FANTASY ADVENTURE
FICTION; MANUSCRIPT BOOKS; MEMORANDUM
BOOKS; MEMORY BOOKS; NOTE BOOKS; PICTURE
BOOKS; POCKET MEMORANDUM BOOKS; PROTEC-
TIVE COVERS FOR BOOKS; SCHOOL SUPPLY KITS
CONTAINING VARIOUS COMBINATIONS OF SE-
LECTED SCHOOL SUPPLIES, NAMELY, WRITING IN-
STRUMENTS, PENS, PENCILS, MECHANICAL
PENCILS, ERASERS, MARKERS, CRAYONS, HIGH-
LIGHTERS, FOLDERS, NOTEBOOKS, PAPER, GRADU-
ATED RULERS, PROTRACTORS, PAPER CLIPS, PENCIL
SHARPENERS, WRITING GRIPS, GLUE AND BOOK
MARKS; SCHOOL WRITING BOOKS; SERIES OF FIC-
TION BOOKS; SKETCH BOOKS; SONG BOOKS; STORY
BOOKS; TALKING CHILDREN'S BOOKS; TELEPHONE
NUMBER BOOKS; WIREBOUND BOOKS (U.S. CLS. 2, 5,
22, 23, 29, 37, 38 AND 50).

ELI HELLMAN, EXAMINING ATTORNEY

SN 77-299,681. HOSTESS WITH THE MOSTESS INC., SAN
DIEGO, CA. FILED 10-9-2007.

HOSTESS WITH THE MOSTESS

THE MARK CONSISTS OF STANDARD CHARACTERS
WITHOUT CLAIM TO ANY PARTICULAR FONT, STYLE,
SIZE, OR COLOR.

FOR BLANK PAPER JOURNALS; PRINTED INVITA-
TIONS; STATIONERY; PAPER NAPKINS; PAPER TABLE
RUNNERS; PAPER COASTERS; GIFT WRAPPING PA-
PER; PAPER GIFT BAGS; PAPER TABLECLOTHS; MA-
GAZINES FEATURING INFORMATION ON SOCIAL
ENTERTAINING; AND PAPER PARTY FAVORS (U.S.
CLS. 2, 5, 22, 23, 29, 37, 38 AND 50).

VIVIAN MICZNIK FIRST, EXAMINING ATTORNEY

CLASS 16—(Continued).

SN 77-302,474. CARGILL, INCORPORATED, WAYZATA, MN. FILED 10-12-2007.



OWNER OF U.S. REG. NOS. 798,187, 808,227 AND OTHERS.

THE COLOR(S) RED, WHITE, BLACK IS/ARE CLAIMED AS A FEATURE OF THE MARK.

THE MARK CONSISTS OF RED OUTLINED CIRCULAR PATTERN COMING TO A POINT AT THE TOP AND BOTTOM WITH A WHITE COLOR INSIDE THE CIRCULAR PATTERN AND "AGWAY" WRITTEN IN BLACK IN THE MIDDLE OF THE CIRCULAR PATTERN.

FOR HANDBOOKS AND GUIDES FOR USERS OF FERTILIZER, SEED, SPRAYS AND DUSTS, MANUALS AND GUIDES TO FEEDING AND MANAGEMENT OF DAIRY CATTLE AND OTHER STOCK, AND POULTRY GUIDES TO DAIRY AND POULTRY BUILDINGS AND EQUIPMENT INSTALLATIONS (U.S. CLS. 2, 5, 22, 23, 29, 37, 38 AND 50).

FIRST USE 3-5-1964; IN COMMERCE 3-5-1964.
BRENDAN REGAN, EXAMINING ATTORNEY

SN 77-305,397. 944 MEDIA, LLC, SCOTTSDALE, AZ. FILED 10-16-2007.

THE MOST POWERFUL
ENTERTAINMENT MAGAZINE

THE MARK CONSISTS OF STANDARD CHARACTERS WITHOUT CLAIM TO ANY PARTICULAR FONT, STYLE, SIZE, OR COLOR.

NO CLAIM IS MADE TO THE EXCLUSIVE RIGHT TO USE "ENTERTAINMENT MAGAZINE", APART FROM THE MARK AS SHOWN.

FOR MAGAZINES FEATURING FASHION, LIFESTYLE, ACTIVITIES, NIGHTLIFE, ENTERTAINMENT AND FEATURES SPECIFIC TO GEOGRAPHIC LOCATIONS (U.S. CLS. 2, 5, 22, 23, 29, 37, 38 AND 50).

ELI HELLMAN, EXAMINING ATTORNEY

SN 77-312,030. PROFORM TECHNOLOGIES, INC., RIVERTON, WY. FILED 10-24-2007.

HARDLINE

THE MARK CONSISTS OF STANDARD CHARACTERS WITHOUT CLAIM TO ANY PARTICULAR FONT, STYLE, SIZE, OR COLOR.

FOR PAINT BRUSHES (U.S. CLS. 2, 5, 22, 23, 29, 37, 38 AND 50).

ESTHER A. BORSUK, EXAMINING ATTORNEY

CLASS 16—(Continued).

SN 77-312,469. EVIDENT MUSIC GROUP, LLC, CORPUS CHRISTI, TX. FILED 10-24-2007.

EVIDENT MUSIC GROUP

THE MARK CONSISTS OF STANDARD CHARACTERS WITHOUT CLAIM TO ANY PARTICULAR FONT, STYLE, SIZE, OR COLOR.

FOR POSTERS, AUTOGRAPH BOOKS, DECALS, STICKERS AND PICTURES (U.S. CLS. 2, 5, 22, 23, 29, 37, 38 AND 50).

KATHLEEN LORENZO, EXAMINING ATTORNEY

SN 77-314,351. PROCOVERY INSTITUTE LLC, LOS ANGELES, CA. FILED 10-26-2007.

PROCOVERY CARDS

THE MARK CONSISTS OF STANDARD CHARACTERS WITHOUT CLAIM TO ANY PARTICULAR FONT, STYLE, SIZE, OR COLOR.

OWNER OF U.S. REG. NO. 3,256,127.

NO CLAIM IS MADE TO THE EXCLUSIVE RIGHT TO USE "CARDS", APART FROM THE MARK AS SHOWN.

FOR SERIES OF PRINTED CARDS FOR PERSONAL USE, FOR USE IN STRUCTURED SUPPORT GROUPS AND FOR USE FOR TRAINING AND INSTRUCTIONAL PURPOSES, IN THE FIELDS OF PERSONAL GROWTH, WELLNESS AND RECOVERY FROM LOSS, AND CARE AND TREATMENT OF MENTAL ILLNESS AND SERIOUS AND CHRONIC ILLNESSES, TRAUMAS AND ADDICTION (U.S. CLS. 2, 5, 22, 23, 29, 37, 38 AND 50).

FIRST USE 8-0-2004; IN COMMERCE 8-0-2004.

DAVID MILLER, EXAMINING ATTORNEY

SN 77-314,728. TONRA, MARK, SANTA FE, NM. FILED 10-26-2007.

THE KIDDIES DIFFERENT

THE MARK CONSISTS OF STANDARD CHARACTERS WITHOUT CLAIM TO ANY PARTICULAR FONT, STYLE, SIZE, OR COLOR.

NO CLAIM IS MADE TO THE EXCLUSIVE RIGHT TO USE "KIDDIES", APART FROM THE MARK AS SHOWN.

FOR COMIC STRIP (U.S. CLS. 2, 5, 22, 23, 29, 37, 38 AND 50).

LAURA HAMMEL, EXAMINING ATTORNEY

CLASS 16—(Continued).

SN 77-317,763. REED ELSEVIER PROPERTIES INC., WILMINGTON, DE. FILED 10-31-2007.

CRITICAS

THE MARK CONSISTS OF STANDARD CHARACTERS WITHOUT CLAIM TO ANY PARTICULAR FONT, STYLE, SIZE, OR COLOR.

OWNER OF U.S. REG. NO. 2,568,709.

THE ENGLISH TRANSLATION OF THE WORD "CRITICAS" IN THE MARK IS "CRITICISM".
SEC. 2(F).

FOR PRINTED PUBLICATIONS, NAMELY, MAGAZINES RELATING TO LITERATURE IN THE SPANISH LANGUAGE (U.S. CLS. 2, 5, 22, 23, 29, 37, 38 AND 50).

FIRST USE 6-1-2001; IN COMMERCE 6-1-2001.

SALLY SHIH, EXAMINING ATTORNEY

SN 77-318,856. BEILFUSS, KATHLEEN, OSHKOSH, WI. FILED 11-1-2007.

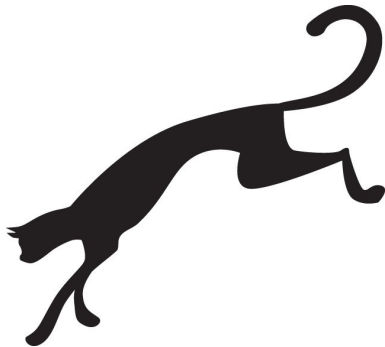

THE MARK CONSISTS OF A CAT.
FOR STATIONERY; GREETING CARDS; INVITATIONS; NOTE CARDS; BOOK COVERS; BLANK JOURNAL BOOKS; BLANK WRITING JOURNALS; CALENDARS; PAPER PARTY DECORATIONS; PLACE CARDS; PAPER PLATES; PAPER NAPKINS; PAPER PLACE MATS; PAPER TABLE CLOTHS; PAPER WINDOW DECORATIONS; FRAMED ART PICTURES AND PRINTS; WORKS OF FINE ART CONSISTING OF PAINTINGS AND DRAWINGS; AND PRINTED MATTER, NAMELY, PUBLICATIONS, JOURNALS AND MANUALS, ALL IN THE FIELDS OF PERSONAL AND PROFESSIONAL GROWTH AND DEVELOPMENT AND PERSONAL MOTIVATION (U.S. CLS. 2, 5, 22, 23, 29, 37, 38 AND 50).

SANJEEV VOHRA, EXAMINING ATTORNEY

CLASS 16—(Continued).

SN 77-323,324. REDCATS USA, L.P., INDIANAPOLIS, IN. FILED 11-7-2007.

FIT 4 U

THE MARK CONSISTS OF STANDARD CHARACTERS WITHOUT CLAIM TO ANY PARTICULAR FONT, STYLE, SIZE, OR COLOR.

FOR CHARTS IN THE FIELD OF CLOTHES SIZE DETERMINATION (U.S. CLS. 2, 5, 22, 23, 29, 37, 38 AND 50).

KEVIN DINALLO, EXAMINING ATTORNEY

SN 77-325,945. LISA FRANK, INC., TUSCON, AZ. FILED 11-9-2007.

THE QUALITY AND VALUE ARE
IN THE NAME, SO IS THE FUN!

THE MARK CONSISTS OF STANDARD CHARACTERS WITHOUT CLAIM TO ANY PARTICULAR FONT, STYLE, SIZE, OR COLOR.

FOR STICKERS, STICKER ALBUMS AND BOOKS, NOTEBOOKS, FOLDERS, BINDERS; PAPER PARTY GOODS, NAMELY, HATS, INVITATIONS, NAPKINS AND TABLECLOTHS; PAPER GIFTWRAP; STATIONERY, PENCILS AND PENS; ERASERS, PENCIL SHARPENERS, PAPER CLIPS, DIARIES, DRAWING RULERS; WORD OR MAZE PUZZLES ON PAPER; RUBBER STAMPS AND PADS, STAMP RINGS, COLORING BOOKS, COLOR MARKERS, CHALK, STENCILS, PUZZLE PADS, PLAYING CARDS, PAINT SETS FOR CHILDREN; ACTIVITY SETS FOR CHILDREN CONSISTING VARIOUSLY OF TWO OR MORE OF THE PRECEDING ITEMS (U.S. CLS. 2, 5, 22, 23, 29, 37, 38 AND 50).

FIRST USE 6-30-1992; IN COMMERCE 6-30-1992.

WENDY GOODMAN, EXAMINING ATTORNEY

SN 77-326,230. LISA FRANK, INC., TUSCON, AZ. FILED 11-9-2007.

STATIONERY DELIGHTS

THE MARK CONSISTS OF STANDARD CHARACTERS WITHOUT CLAIM TO ANY PARTICULAR FONT, STYLE, SIZE, OR COLOR.

NO CLAIM IS MADE TO THE EXCLUSIVE RIGHT TO USE "STATIONERY", APART FROM THE MARK AS SHOWN.

FOR STATIONERY ACTIVITY KIT CONTAINING TWO OR MORE OF THE FOLLOWING ITEMS— NOTE CARDS, ENVELOPES, STICKERS, CONFETTI, POSTERS FOR COLORING, MARKERS, CORDING, PLASTIC BEADS AND GEMS, AND FOAM ADHESIVE (U.S. CLS. 2, 5, 22, 23, 29, 37, 38 AND 50).

FIRST USE 12-31-2004; IN COMMERCE 12-31-2004.

WENDY GOODMAN, EXAMINING ATTORNEY

CLASS 16—(Continued).

SN 77-327,575. LINDA BOUTELLER, OKLAHOMA CITY, OK. FILED 11-12-2007.

THE HAPPY HALO KIDS AND FRIENDS

THE MARK CONSISTS OF STANDARD CHARACTERS WITHOUT CLAIM TO ANY PARTICULAR FONT, STYLE, SIZE, OR COLOR.

FOR PRINTED MATERIALS AND PAPER GOODS, NAMELY, CHILDREN'S BOOKS, PUBLICATIONS IN THE NATURE OF PAMPHLETS AND BROCHURES IN THE FIELD OF RELIGION AND VALUE BASED EDUCATION, GREETING CARDS, TRADING CARDS, STATIONERY, ENVELOPES, NOTE CARDS, INTERACTIVE CHILDREN'S BOOKS, CALENDARS, BOOK COVERS, BOOK MARKS, AND INSTRUCTIONAL, EDUCATIONAL, AND TEACHING MATERIALS, NAMELY, BOOKS, PAMPHLETS, AND TEACHING MATERIALS IN THE FIELD OF RELIGION AND VALUE BASED EDUCATION (U.S. CLS. 2, 5, 22, 23, 29, 37, 38 AND 50).
SHAILA SETTLES, EXAMINING ATTORNEY

SN 77-327,578. LINDA BOUTELLER, OKLAHOMA CITY, OK. FILED 11-12-2007.

THE HAPPY HALO KIDS

THE MARK CONSISTS OF STANDARD CHARACTERS WITHOUT CLAIM TO ANY PARTICULAR FONT, STYLE, SIZE, OR COLOR.

NO CLAIM IS MADE TO THE EXCLUSIVE RIGHT TO USE "KIDS", APART FROM THE MARK AS SHOWN.

FOR PRINTED MATERIALS AND PAPER GOODS, NAMELY, CHILDREN'S BOOKS, PUBLICATIONS IN THE NATURE OF PAMPHLETS AND BROCHURES IN THE FIELD OF RELIGION AND VALUE BASED EDUCATION, GREETING CARDS, TRADING CARDS, STATIONERY, ENVELOPES, NOTE CARDS, INTERACTIVE CHILDREN'S BOOKS, CALENDARS, BOOK COVERS, BOOK MARKS, AND INSTRUCTIONAL, EDUCATIONAL, AND TEACHING MATERIALS, NAMELY, BOOKS, PAMPHLETS, AND TEACHING MATERIALS IN THE FIELD OF RELIGION AND VALUE BASED EDUCATION (U.S. CLS. 2, 5, 22, 23, 29, 37, 38 AND 50).
SHAILA SETTLES, EXAMINING ATTORNEY

CLASS 16—(Continued).

SN 77-329,133. CABIN CREEK, LLC, PLEASANT GROVE, UT. FILED 11-14-2007.

EXPRESSIVES

THE MARK CONSISTS OF STANDARD CHARACTERS WITHOUT CLAIM TO ANY PARTICULAR FONT, STYLE, SIZE, OR COLOR.

FOR PRINTING FONTS (U.S. CLS. 2, 5, 22, 23, 29, 37, 38 AND 50).

FIRST USE 8-1-2007; IN COMMERCE 8-1-2007.
JERI J. FICKES, EXAMINING ATTORNEY

SN 77-330,469. SERGEANT'S PET CARE PRODUCTS, INC., OMAHA, NE. FILED 11-15-2007.

YIPPEE SKIPPY

THE MARK CONSISTS OF STANDARD CHARACTERS WITHOUT CLAIM TO ANY PARTICULAR FONT, STYLE, SIZE, OR COLOR.

FOR DISPOSABLE HOUSEBREAKING PADS FOR USE IN TRAINING PUPPIES (U.S. CLS. 2, 5, 22, 23, 29, 37, 38 AND 50).

BENJAMIN OKEKE, EXAMINING ATTORNEY

SN 78-323,478. BAYARD PRESSE (CANADA) INC., MONTREAL, QC, CANADA, FILED 11-5-2003.



FOR (BASED ON USE IN COMMERCE) PUBLICATIONS, NAMELY, MAGAZINES, BOOKS, PERIODICALS, NEWSPAPERS, NEWSLETTERS, COMIC BOOKS, BROCHURES, CATALOGUES, THEATRE PROGRAMS AND PAMPHLETS ALL FEATURING CHILDREN'S STORIES AND ACTIVITIES; (BASED ON INTENT TO USE) STATIONERY, NAMELY, CALENDARS, PAPER PADS, ENVELOPES, RECIPE CARDS, LABELS, NAME TAGS, COUPONS, NOTEBOOKS, NOTEPADS, DAYBOOKS, SHOPPING GUIDE, GREETING CARDS, ADDRESS BOOKS, WRITING PAPER; NOVELTY ITEMS, NAMELY, STICKERS, GIFT BOXES, GIFT WRAP, DECALS, PRINTED MATERIAL, NAMELY, FLYERS FEATURING CHILDREN'S STORIES AND ACTIVITIES, PHOTOGRAPHS, POSTCARDS, COLLECTOR'S ALBUMS, PRINTED GUIDES, COMIC STRIPS, COLORING

CLASS 16—(Continued).

BOOKS, GROWTH CHARTS, FOOD GUIDES, MAPS, MENUS, BUMPER STICKERS, PICTURES, MURALS, POSTERS, BANNERS; SCHOOL AND OFFICE SUPPLIES, NAMELY, BOOK MARKS, PENS, PENCILS, MARKERS, DIVIDERS, BOOK COVERS, BOOKENDS, FILE FOLDERS, BULLETIN BOARDS, CARDHOLDERS, PAPER HOLDERS, DOCUMENT CASES MADE OF CARDBOARD, ERASERS, PAPER CLIPS, GUEST BOOKS, PAPERWEIGHTS, PENCIL BOXES, PENCIL CASES, PENCIL SHARPENERS, PLACE CARDS, DIARIES, LETTER OPENERS, UNGRADUATED RULERS, PHOTO ALBUMS, STAMP BOOKLETS, DECORATIVE PAPER, SHELF PAPER, CONTACT PAPER, CALENDAR HOLDERS, PAINTBRUSHES, PAINT KITS, CRAYONS, COLORING PENCILS, TAPE DISPENSERS, LABEL HOLDERS, DAYBOOK HOLDERS, RUBBER STAMPS, ADHESIVE STAMPS, STAMP DISPENSERS, STICK-ON NUMBERS; LUGGAGE TAGS; PARTY ACCESSORIES, NAMELY, HATS, HORNS, FAVORS AND INVITATIONS ALL MADE OF PAPER (U.S. CLS. 2, 5, 22, 23, 29, 37, 38 AND 50).

FIRST USE 9-1-1999; IN COMMERCE 9-1-1999.
JAMES STEIN, EXAMINING ATTORNEY

SN 78-448,409. PEARSON EDUCATION, INC., UPPER SADDLE RIVER, NJ. FILED 7-9-2004.

**VISUAL
QUICKPROJECT**

THE MARK CONSISTS OF STANDARD CHARACTERS WITHOUT CLAIM TO ANY PARTICULAR FONT, STYLE, SIZE, OR COLOR.

OWNER OF U.S. REG. NOS. 1,945,728 AND 2,547,728.

NO CLAIM IS MADE TO THE EXCLUSIVE RIGHT TO USE "VISUAL", APART FROM THE MARK AS SHOWN.

FOR INSTRUCTIONAL HOW-TO AND SELF-HELP BOOKS, MANUALS, AND GUIDES FEATURING STEP-BY-STEP TUTORIALS FOR CREATING PROJECTS USING VARIOUS TYPES OF COMPUTER SOFTWARE, NAMELY, CREATING LETTERS, BUSINESS CARDS, RESUMES, FLYERS, NEWSLETTERS, SPREADSHEETS, CHARTS, DATABASES, PRESENTATIONS, PHOTO ALBUMS, SLIDESHOWS, MOVIES, AND WEB PAGES, ENHANCING WEB SITES, ORGANIZING AND EDITING PHOTOS, RETOUCHING PHOTOS, PUBLISHING BLOGS, REVIEWING DOCUMENTS, MANAGING PERSONAL FINANCES, CUSTOMIZING OPERATING SYSTEMS, MOVING TO DIFFERENT OPERATING SYSTEM, AND UPGRADING TO DIFFERENT OPERATING SYSTEM (U.S. CLS. 2, 5, 22, 23, 29, 37, 38 AND 50).

HEATHER BIDDULPH, EXAMINING ATTORNEY

CLASS 16—(Continued).

SN 78-846,453. WRIGHT, LAWRENCE D.M., PEMBROKE PINES, FL. FILED 3-27-2006.

**If you ain't a gator, you
must be gator bait!**

THE MARK CONSISTS OF STANDARD CHARACTERS WITHOUT CLAIM TO ANY PARTICULAR FONT, STYLE, SIZE, OR COLOR.

FOR BUMPER STICKERS, POSTERS, AND PAPER BANNERS (U.S. CLS. 2, 5, 22, 23, 29, 37, 38 AND 50).
KAREN K. BUSH, EXAMINING ATTORNEY

SN 78-861,283. DIETZ DESIGNS, HOUSTON, TX. FILED 4-13-2006.

MAGWRITER

THE MARK CONSISTS OF STANDARD CHARACTERS WITHOUT CLAIM TO ANY PARTICULAR FONT, STYLE, SIZE, OR COLOR.

FOR WRITING INSTRUMENTS, NAMELY, WRITING PENS (U.S. CLS. 2, 5, 22, 23, 29, 37, 38 AND 50).
JOHN KELLY, EXAMINING ATTORNEY

SN 78-866,724. THE TOY INSIDER, LLC, NEW YORK, NY. FILED 4-21-2006.

THE TOY INSIDER

THE MARK CONSISTS OF STANDARD CHARACTERS WITHOUT CLAIM TO ANY PARTICULAR FONT, STYLE, SIZE, OR COLOR.

NO CLAIM IS MADE TO THE EXCLUSIVE RIGHT TO USE "TOY", APART FROM THE MARK AS SHOWN.

FOR MAGAZINES FEATURING TOYS (U.S. CLS. 2, 5, 22, 23, 29, 37, 38 AND 50).

NAKWAMA ANKRAH, EXAMINING ATTORNEY

CLASS 16—(Continued).

SN 78-871,967. APDN (B.V.I.) INC., ROADTOWN, BR. VIRGIN ISLANDS, FILED 4-28-2006.

CLASS 16—(Continued).

SN 78-911,680. HOFSTADTER, NICHOLAS, LOS ANGELES, CA. FILED 6-19-2006.

SIGNATURE

THE MARK CONSISTS OF STANDARD CHARACTERS WITHOUT CLAIM TO ANY PARTICULAR FONT, STYLE, SIZE, OR COLOR.

FOR ANTI-COUNTERFEITING SYSTEM COMPRISED OF DNA COATING, NAMELY, MARKING INK AND COATINGS CONTAINING DNA FOR THE ENCRYPTION AND AUTHENTICATION OF OBJECTS (U.S. CLS. 2, 5, 22, 23, 29, 37, 38 AND 50).

FRANK LATTUCA, EXAMINING ATTORNEY



SN 78-900,230. BENNETT GROUP FINANCIAL SERVICES LLC, WASHINGTON, DC. FILED 6-5-2006.

CULTURAL FINANCIAL REVOLUTION

THE MARK CONSISTS OF STANDARD CHARACTERS WITHOUT CLAIM TO ANY PARTICULAR FONT, STYLE, SIZE, OR COLOR.

NO CLAIM IS MADE TO THE EXCLUSIVE RIGHT TO USE "FINANCIAL", APART FROM THE MARK AS SHOWN.

FOR PUBLICATIONS AND PRINTED MATTER, NAMELY, GAZETTES, NEWSPAPERS, MAGAZINES, BOOKS, BROCHURES, AND NEWSLETTERS FEATURING INFORMATION ON FINANCIAL AND BUSINESS MATTERS (U.S. CLS. 2, 5, 22, 23, 29, 37, 38 AND 50).

LYDIA BELZER, EXAMINING ATTORNEY



SN 78-910,156. INNOVA ART LTD, THORNWOOD, EPPING, UNITED KINGDOM, FILED 6-16-2006.

FIBAPRINT

THE MARK CONSISTS OF STANDARD CHARACTERS WITHOUT CLAIM TO ANY PARTICULAR FONT, STYLE, SIZE, OR COLOR.

FOR PAPER; FINE ART PAPER; BARYT PAPER; DIGITAL FIBER-BASED PAPER, WATERCOLOUR PAPER; CANVASES FOR ART; ART STATIONERY (U.S. CLS. 2, 5, 22, 23, 29, 37, 38 AND 50).

FIRST USE 1-0-2003; IN COMMERCE 1-0-2003.

DAVID YONTEF, EXAMINING ATTORNEY

SNACKS AND THE CITY

THE MARK CONSISTS OF STANDARD CHARACTERS WITHOUT CLAIM TO ANY PARTICULAR FONT, STYLE, SIZE, OR COLOR.

FOR MAGAZINE AND NEWSPAPER COLUMNS IN THE FIELD OF CUISINE (U.S. CLS. 2, 5, 22, 23, 29, 37, 38 AND 50).

FIRST USE 9-1-2002; IN COMMERCE 9-1-2002.

JANICE L. MCMORROW, EXAMINING ATTORNEY



SN 78-943,809. SOVEREIGN DEED, LLC, VERNON HILLS, IL. FILED 8-3-2006.

SOVEREIGN DEED DAILY

THE MARK CONSISTS OF STANDARD CHARACTERS WITHOUT CLAIM TO ANY PARTICULAR FONT, STYLE, SIZE, OR COLOR.

NO CLAIM IS MADE TO THE EXCLUSIVE RIGHT TO USE "DAILY", APART FROM THE MARK AS SHOWN.

FOR BATHROOM TISSUE; BIBLES; BLANK FORMS; BOOKLETS IN THE FIELD OF HOMELAND AND PERSONAL SECURITY, SAFETY AND EMERGENCIES; BOOKS IN THE FIELD OF HOMELAND AND PERSONAL SECURITY, SAFETY AND EMERGENCIES; BROCHURES ABOUT HOMELAND AND PERSONAL SECURITY, SAFETY AND EMERGENCIES; BULLETINS CONCERNING HOMELAND AND PERSONAL SECURITY, SAFETY AND EMERGENCIES; BUSINESS FORMS; CORRUGATED PAPER; EDUCATIONAL PUBLICATIONS, NAMELY, TRAINING MANUALS IN THE FIELDS OF SECURITY, SAFETY, EMERGENCY, MILITARY, MILITARY TACTICS AND STRATEGIES; ILLUSTRATION BOARDS; INK PENS; INSTRUCTION SHEETS; MANUALS IN THE FIELD OF HOMELAND AND PERSONAL SECURITY AND SAFETY; MAPS; MARKERS; MEDICAL IDENTIFICATION CARDS NOT MAGNETICALLY ENCODED; NEWS BULLETINS; NEWSPAPERS; ORDER FORMS; PAMPHLETS IN THE FIELD OF HOMELAND AND PERSONAL SECURITY, SAFETY AND EMERGENCIES; PAPER; PARTIALLY PRINTED FORMS; PLASTIC OR PAPER BAGS FOR

CLASS 16—(Continued).

HOUSEHOLD USE; PLASTIC WRAP; PRINTED CHARTS; PRINTED FORMS; PRINTED GRAPHS; PRINTED GUIDES FOR HOMELAND AND PERSONAL SECURITY, SAFETY AND EMERGENCIES; PRINTED INSTRUCTIONAL, EDUCATIONAL, AND TEACHING MATERIALS IN THE FIELD OF HOMELAND AND PERSONAL SECURITY, SAFETY AND EMERGENCIES; PRINTED INSTRUCTIONAL MATERIAL ON TELECOMMUNICATIONS; PRINTED PERIODICALS IN THE FIELD OF HOMELAND AND PERSONAL SECURITY, SAFETY AND EMERGENCIES; PRINTED REPORTS FEATURING HOMELAND AND PERSONAL SECURITY, SAFETY AND EMERGENCIES; PRINTED VISUALS IN THE NATURE OF INFORMATION GRAPHICS AND PROMOTIONAL MATERIALS; QUICK REFERENCE POCKET GUIDES IN THE FIELD OF HOMELAND AND PERSONAL SECURITY, SAFETY AND EMERGENCIES; RESEARCH REPORTS FEATURING HOMELAND AND PERSONAL SECURITY, SAFETY AND EMERGENCIES; ROAD MAPS (U.S. CLS. 2, 5, 22, 23, 29, 37, 38 AND 50).

LOURDES AYALA, EXAMINING ATTORNEY

CLASS 16—(Continued).

HOUSEHOLD USE; PLASTIC WRAP; PRINTED CHARTS; PRINTED FORMS; PRINTED GRAPHS; PRINTED GUIDES FOR HOMELAND AND PERSONAL SECURITY, SAFETY AND EMERGENCIES; PRINTED INSTRUCTIONAL, EDUCATIONAL, AND TEACHING MATERIALS IN THE FIELD OF HOMELAND AND PERSONAL SECURITY, SAFETY AND EMERGENCIES; PRINTED INSTRUCTIONAL MATERIAL ON TELECOMMUNICATIONS; PRINTED PERIODICALS IN THE FIELD OF HOMELAND AND PERSONAL SECURITY, SAFETY AND EMERGENCIES; PRINTED REPORTS FEATURING HOMELAND AND PERSONAL SECURITY, SAFETY AND EMERGENCIES; PRINTED VISUALS IN THE NATURE OF INFORMATION GRAPHICS AND PROMOTIONAL MATERIALS; QUICK REFERENCE POCKET GUIDES IN THE FIELD OF HOMELAND AND PERSONAL SECURITY, SAFETY AND EMERGENCIES; RESEARCH REPORTS FEATURING HOMELAND AND PERSONAL SECURITY, SAFETY AND EMERGENCIES; ROAD MAPS (U.S. CLS. 2, 5, 22, 23, 29, 37, 38 AND 50).

LOURDES AYALA, EXAMINING ATTORNEY

SN 78-943,819. SOVEREIGN DEED, LLC, VERNON HILLS, IL. FILED 8-3-2006.

SN 78-944,196. HACHETTE FILIPACCHI, S.A., MADRID, SPAIN, FILED 8-3-2006.

SOVEREIGN DEED NEWS

THE MARK CONSISTS OF STANDARD CHARACTERS WITHOUT CLAIM TO ANY PARTICULAR FONT, STYLE, SIZE, OR COLOR.

NO CLAIM IS MADE TO THE EXCLUSIVE RIGHT TO USE "NEWS", APART FROM THE MARK AS SHOWN.

FOR BATHROOM TISSUE; BIBLES; BLANK FORMS; BOOKLETS IN THE FIELD OF HOMELAND AND PERSONAL SECURITY, SAFETY AND EMERGENCIES; BOOKS IN THE FIELD OF HOMELAND AND PERSONAL SECURITY, SAFETY AND EMERGENCIES; BROCHURES ABOUT HOMELAND AND PERSONAL SECURITY, SAFETY AND EMERGENCIES; BULLETINS CONCERNING HOMELAND AND PERSONAL SECURITY, SAFETY AND EMERGENCIES; BUSINESS FORMS; CORRUGATED PAPER; EDUCATIONAL PUBLICATIONS, NAMELY, TRAINING MANUALS IN THE FIELDS OF SECURITY, SAFETY, EMERGENCY, MILITARY, MILITARY TACTICS AND STRATEGIES; ILLUSTRATION BOARDS; INK PENS; INSTRUCTION SHEETS; MANUALS IN THE FIELD OF HOMELAND AND PERSONAL SECURITY AND SAFETY; MAPS; MARKERS; MEDICAL IDENTIFICATION CARDS NOT MAGNETICALLY ENCODED; NEWS BULLETINS; NEWSPAPERS; ORDER FORMS; PAMPHLETS IN THE FIELD OF HOMELAND AND PERSONAL SECURITY, SAFETY AND EMERGENCIES; PAPER; PARTIALLY PRINTED FORMS; PLASTIC OR PAPER BAGS FOR

CASA DIEZ

THE MARK CONSISTS OF STANDARD CHARACTERS WITHOUT CLAIM TO ANY PARTICULAR FONT, STYLE, SIZE, OR COLOR.

PRIORITY CLAIMED UNDER SEC. 44(D) ON ERP CMNTY TM OFC APPLICATION NO. 5184701, FILED 7-7-2006, REG. NO. 5184701, DATED 6-7-2007, EXPIRES 7-7-2016.

NO CLAIM IS MADE TO THE EXCLUSIVE RIGHT TO USE "CASA", APART FROM THE MARK AS SHOWN.

THE FOREIGN WORDING IN THE MARK TRANSLATES INTO ENGLISH AS "HOME TEN".

FOR PUBLICATIONS, NAMELY, NEWSPAPERS, MAGAZINES AND BOOKS IN THE FIELD OF ARTS AND CRAFT, HOME, DECORATION, COOKING, FAMILY AND CHILD-REARING (U.S. CLS. 2, 5, 22, 23, 29, 37, 38 AND 50).

JILL C. ALT, EXAMINING ATTORNEY

CLASS 16—(Continued).

SN 78-950,162. TRI-COUNTY COUNCIL FOR SOUTHERN MARYLAND, HUGHESVILLE, MD. FILED 8-11-2006.

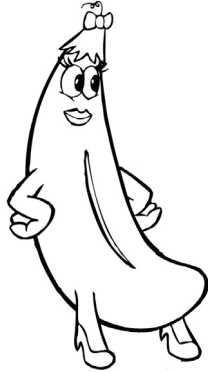

THE MARK CONSISTS OF A STYLIZED (CARTOON) FEMALE PEA POD, WITH ARMS, HUMAN HANDS, SHORT LEGS COMING OUT OF BOTTOM OF POD TIP, STYLISH SHOES, SLIT DOWN MIDDLE, FACE AT UPPER TIP OF POD WITH LARGE LIPS AND EYES WITH EYELASHES, HAIR, BOW ABOVE HAIR WITH A CURLY TENDRIL COMING OUT OF TOP OF BOW.

FOR EDUCATIONAL COLORING BOOKS FOR CHILDREN WITH ACTIVITIES, JOKES, AND MESSAGES TO PARENTS ABOUT THE IMPORTANCE OF SUPPORTING LOCAL FARMS INCLUDING CONSUMING FRESH FARM PRODUCTS, NUTRITION, EXERCISE AND HEALTH (U.S. CLS. 2, 5, 22, 23, 29, 37, 38 AND 50).
DOMINIC FATHY, EXAMINING ATTORNEY

SN 78-956,625. PAUL, JUDY, ATLANTA, GA. FILED 8-21-2006.

CH@T

THE MARK CONSISTS OF STANDARD CHARACTERS WITHOUT CLAIM TO ANY PARTICULAR FONT, STYLE, SIZE, OR COLOR.

FOR POSTERS; PENS; SOUVENIR BOOKS AND PROGRAMS, STORY BOOKS, PICTURE BOOKS, SHEET MUSIC BOOKS AND SONG BOOKS ALL RELATED TO THEATRICAL PERFORMANCES, STAGE ENTERTAINMENT AND MUSICALS; POSTCARDS; UNMOUNTED PHOTOGRAPHS; LITHOGRAPHS; STICKERS; DECALS; CALENDARS; NOTEBOOKS AND NOTEPADS; GREETING CARDS; AND STATIONERY (U.S. CLS. 2, 5, 22, 23, 29, 37, 38 AND 50).

MARY BOAGNI, EXAMINING ATTORNEY

CLASS 16—(Continued).

SN 78-979,660. THE UPPER ROOM, NASHVILLE, TN. FILED 5-17-2006.

THE WAY OF THE CHILD

THE MARK CONSISTS OF STANDARD CHARACTERS WITHOUT CLAIM TO ANY PARTICULAR FONT, STYLE, SIZE, OR COLOR.

FOR PRINTED PUBLICATIONS, NAMELY, BOOKLETS, GUIDEBOOKS, STUDY GUIDES, TRAINING AND INSTRUCTIONAL MATERIALS, AND WORKBOOKS, IN THE FIELDS OF CHRISTIANITY; CHRISTIAN, RELIGIOUS AND SPIRITUAL DEVELOPMENT; CHRISTIAN, RELIGIOUS AND SPIRITUAL MINISTRY; CONGREGATIONAL, INSPIRATIONAL AND RELIGIOUS PROGRAMS; DEVOTIONAL TOPICS; PERSONAL DEVELOPMENT; PERSONAL PIETY; PERSONAL TRANSFORMATION; PRAYER; RELIGION; RELIGIOUS CONGREGATIONS; RELIGIOUS EDUCATION; SPIRITUALITY; AND SPIRITUAL GROWTH (U.S. CLS. 2, 5, 22, 23, 29, 37, 38 AND 50).

RICHARD A. STRASER, EXAMINING ATTORNEY

SN 79-037,296. CURLYSUE CO., LTD., REPUBLIC OF KOREA, FILED 1-31-2007.

TØREAD

OWNER OF INTERNATIONAL REGISTRATION 0921038 DATED 1-31-2007, EXPIRES 1-31-2017.

FOR TAGS FOR INDEX CARDS; PRINTED CALCULATING TABLES FOR CALCULATING TAXES; NOTE BOOKS; RULED PAPER; LEDGERS BOOKS; MEMO PAPER; BUSINESS CARD PAPER; INDEX CARDS; ENVELOPES; WRITING PADS; PAPER FILE JACKETS FOR PAPERS; POCKET NOTEBOOKS; SKETCHBOOKS; PHOTO ALBUMS; FOUNTAIN PENS; BALL POINT PENS; WRITING BRUSHES; FELT PEN FOR WRITING; MECHANICAL SHARP PENCILS; PENCILS; STEEL PENS; PENS; PENHOLDERS; PAINT BOXES; ENGRAVING PLATES; CANVAS FOR PAINTING; CRAYONS; PASTELS; PAINTBRUSHES; PAINTERS' EASELS; PALLETES FOR PAINTERS; RUBBER ERASERS; RUBBER STAMPS; PAPER CLIPS FOR OFFICES; PUNCHES OFFICE REQUISITES; PHOTOGRAPH STANDS; FOLDERS FOR PAPERS; CORRECTING FLUIDS FOR TYPE; STAMP STANDS; STAMP PADS; CASES FOR STAMPS; THUMB TACKS; PENCIL SHARPENERS; PENCIL LEADS; PENCIL HOLDERS; SEALS; INK STANDS, NAMELY, INK RESERVOIRS; MAGNETIC BOARDS; TERRESTRIAL GLOBES; SHEETS OF PLASTICS PLACED UNDER A SHEET OF PAPER, NAMELY, PLASTIC-COATED COPYING PAPER; PAPER KNIVES; STANDS FOR PENS AND PENCILS; PEN CASES; LETTER STANDS, NAMELY, LETTER RACKS AND LETTER TRAYS; WRITING CASES, NAMELY, DESK SETS; PEN AND PENCIL CASES AND BOXES; STAPLERS; PICTURE POSTCARDS; SONG BOOKS; CALENDARS; DIAGRAMS FOR CHECKING SALES FIGURES; COMIC BOOKS; MUSICAL GREETING CARDS; STORY BOOKS; PRINTED PLANS; BANK CHECKS; WRITING OR DRAWING BOOKS; NEWSPAPERS; GREETING CARDS; POSTCARDS; BOOKS FOR USE IN THE TEACHING OF MUSIC; BUSINESS FORMS; PRINTED TIMETABLES; DIARIES; GENERAL FEATURE MAGAZINES; GEOGRAPHICAL MAPS; PRINTED TICKETS; POSTERS; STUDY BOOKS OR PAPERS, NAMELY, STUDY GUIDES; MUSICAL NOTES, NAMELY, SHEET MUSIC; YEARBOOKS (U.S. CLS. 2, 5, 22, 23, 29, 37, 38 AND 50).

WILLIAM ROSSMAN, EXAMINING ATTORNEY

CLASS 16—(Continued).

SN 79-043,806. J.T. RONNEFELDT KG, FED REP GERMANY, FILED 8-2-2007.

TEAVELOPE

THE MARK CONSISTS OF STANDARD CHARACTERS WITHOUT CLAIM TO ANY PARTICULAR FONT, STYLE, SIZE, OR COLOR.

OWNER OF INTERNATIONAL REGISTRATION 0838286 DATED 10-25-2004, EXPIRES 10-25-2014.

FOR PACKAGING MADE FROM CARDBOARD; PAPER FOR PACKAGING; PACKAGING MADE FROM PLASTICS, NAMELY, PLASTIC FOILS (U.S. CLS. 2, 5, 22, 23, 29, 37, 38 AND 50).

Laura Hammel, Examining Attorney

CLASS 17—(Continued).

SN 77-102,538. METZGER & MCGUIRE, BOW, NH. FILED 2-8-2007.

Metzger/McGuire

THE MARK CONSISTS OF STANDARD CHARACTERS WITHOUT CLAIM TO ANY PARTICULAR FONT, STYLE, SIZE, OR COLOR.

FOR EPOXY JOINT SEALANTS FOR INDUSTRIAL FLOORS AND CONCRETE FLOORS (U.S. CLS. 1, 5, 12, 13, 35 AND 50).

FIRST USE 10-31-1973; IN COMMERCE 11-15-1973.
Sara Thomas, Examining Attorney

CLASS 17—RUBBER GOODS

SN 76-663,460. RING INDUSTRIAL GROUP, L.P., OAKLAND, TN. FILED 7-21-2006.



OWNER OF U.S. REG. NOS. 2,647,481 AND 2,785,112.
FOR DRAIN FIELD PRODUCTS, MAINLY, PRE-ASSEMBLED, PLASTIC CONDUITS SURROUNDED BY A GEO-SYNTHETIC AGGREGATE FOR A WIDE VARIETY OF IN-GROUND INSTALLATION, SEPTIC AND DRAINAGE APPLICATIONS (U.S. CLS. 1, 5, 12, 13, 35 AND 50).
Renee McCray, Examining Attorney

SN 77-140,716. MIDSUN SPECIALTY PRODUCTS, INC., SOUTHLINGTON, CT. FILED 3-26-2007.

MIRACLE WRAP

THE MARK CONSISTS OF STANDARD CHARACTERS WITHOUT CLAIM TO ANY PARTICULAR FONT, STYLE, SIZE, OR COLOR.

NO CLAIM IS MADE TO THE EXCLUSIVE RIGHT TO USE "WRAP", APART FROM THE MARK AS SHOWN.

FOR MULTI-USE SILICONE TAPE (U.S. CLS. 1, 5, 12, 13, 35 AND 50).

FIRST USE 2-26-2003; IN COMMERCE 2-26-2003.
Henry S. Zak, Examining Attorney

SN 76-672,391. INTERTAPE POLYMER CORP., BRADENTON, FL. FILED 2-6-2007.

DTE

THE MARK CONSISTS OF STANDARD CHARACTERS WITHOUT CLAIM TO ANY PARTICULAR FONT, STYLE, SIZE, OR COLOR.

FOR DOUBLE TAMPER EVIDENT WATER ACTIVATED TAPE FOR INDUSTRIAL OR COMMERCIAL PURPOSES (U.S. CLS. 1, 5, 12, 13, 35 AND 50).

John Dwyer, Examining Attorney

SN 77-143,853. DYNAMIC CONTROL OF NORTH AMERICA, INC., HAMILTON, OH. FILED 3-29-2007.

DYNIL SOUND BARRIER

THE MARK CONSISTS OF STANDARD CHARACTERS WITHOUT CLAIM TO ANY PARTICULAR FONT, STYLE, SIZE, OR COLOR.

NO CLAIM IS MADE TO THE EXCLUSIVE RIGHT TO USE "SOUND BARRIER", APART FROM THE MARK AS SHOWN.

FOR ACOUSTICAL INSULATION BARRIER PANELS FOR USE IN SOUND PROOFING, VIBRATION DAMPING, ENERGY CONTAINMENT AND AS SOUND BARRIERS IN THE HOME AND STUDIO (U.S. CLS. 1, 5, 12, 13, 35 AND 50).

FIRST USE 9-8-2004; IN COMMERCE 11-15-2004.
Richard A. Straser, Examining Attorney

CLASS 17—(Continued).

SN 77-238,453. ADVANCED ELASTOMER SYSTEMS, L.P., AKRON, OH. FILED 7-25-2007.

GEOLAST

THE MARK CONSISTS OF STANDARD CHARACTERS WITHOUT CLAIM TO ANY PARTICULAR FONT, STYLE, SIZE, OR COLOR.

FOR THERMOPLASTIC COMPOUNDS, THERMOPLASTIC ELASTOMER RESINS AND THERMOPLASTIC CONCENTRATES IN PELLET FORM FOR USE IN MANUFACTURING IN A WIDE VARIETY OF INDUSTRIES (U.S. CLS. 1, 5, 12, 13, 35 AND 50).

FIRST USE 11-5-1985; IN COMMERCE 11-5-1985.
JORDAN BAKER, EXAMINING ATTORNEY

CLASS 17—(Continued).

SN 77-291,261. ENERGYSEAL AIR BARRIER SYSTEMS, MCCALL, ID. FILED 9-28-2007.

AQUABLOWN MIDFLEX

THE MARK CONSISTS OF STANDARD CHARACTERS WITHOUT CLAIM TO ANY PARTICULAR FONT, STYLE, SIZE, OR COLOR.

FOR URETHANE SPRAY FOAMS APPLIED AS INSULATION TO HOMES, COMMERCIAL BUILDINGS, AND INDUSTRIAL APPLICATIONS (U.S. CLS. 1, 5, 12, 13, 35 AND 50).

BRIAN PINO, EXAMINING ATTORNEY

SN 77-279,000. MCWANE, INC., BIRMINGHAM, AL. FILED 9-13-2007.

SURE STOP 350

THE MARK CONSISTS OF STANDARD CHARACTERS WITHOUT CLAIM TO ANY PARTICULAR FONT, STYLE, SIZE, OR COLOR.

NO CLAIM IS MADE TO THE EXCLUSIVE RIGHT TO USE "350", APART FROM THE MARK AS SHOWN.

FOR GASKETS MADE OF RUBBER FOR USE IN WATER AND SEWER PIPELINES (U.S. CLS. 1, 5, 12, 13, 35 AND 50).

SANJEEV VOHRA, EXAMINING ATTORNEY

SN 77-291,271. ENERGYSEAL AIR BARRIER SYSTEMS, MCCALL, ID. FILED 9-28-2007.

AQUABLOWN SOFTFLEX

THE MARK CONSISTS OF STANDARD CHARACTERS WITHOUT CLAIM TO ANY PARTICULAR FONT, STYLE, SIZE, OR COLOR.

FOR URETHANE SPRAY FOAMS APPLIED AS INSULATION TO HOMES, COMMERCIAL BUILDINGS, AND INDUSTRIAL APPLICATIONS (U.S. CLS. 1, 5, 12, 13, 35 AND 50).

BRIAN PINO, EXAMINING ATTORNEY

SN 77-289,979. ACKUE INTERNATIONAL, LLC, WINTER SPRINGS, FL. FILED 9-26-2007.

BEVONA

THE MARK CONSISTS OF STANDARD CHARACTERS WITHOUT CLAIM TO ANY PARTICULAR FONT, STYLE, SIZE, OR COLOR.

OWNER OF U.S. REG. NO. 3,351,188.

FOR PLASTIC COMPOSITE MATERIAL IN THE FORM OF PROFILES, BOARDS, SHEETS, BLOCKS, RODS, POWDER, AND PELLETS FOR USE IN MANUFACTURING (U.S. CLS. 1, 5, 12, 13, 35 AND 50).

FIRST USE 8-1-2001; IN COMMERCE 8-1-2001.
SAMUEL E. SHARPER JR., EXAMINING ATTORNEY

SN 77-291,395. AFM CORPORATION, BURNSVILLE, MN. FILED 9-28-2007.



OWNER OF U.S. REG. NO. 1,409,431.

NO CLAIM IS MADE TO THE EXCLUSIVE RIGHT TO USE "CORPORATION", APART FROM THE MARK AS SHOWN.

FOR FOAM INSULATION FOR BUILDING CONSTRUCTION AND PACKAGING (U.S. CLS. 1, 5, 12, 13, 35 AND 50).

SHAILA SETTLES, EXAMINING ATTORNEY

CLASS 17—(Continued).

SN 77-311,896. PREFERRED FILM CONVERTERS, INC., TULSA, OK. FILED 10-24-2007.

CORGON

THE MARK CONSISTS OF STANDARD CHARACTERS WITHOUT CLAIM TO ANY PARTICULAR FONT, STYLE, SIZE, OR COLOR.

THE WORDING "CORGON" HAS NO MEANING IN A FOREIGN LANGUAGE.

FOR CORELESS STRETCH FILM, NAMELY, PLASTIC FILM USED FOR INDUSTRIAL OR COMMERCIAL PACKING (U.S. CLS. 1, 5, 12, 13, 35 AND 50).

JAMES MACFARLANE, EXAMINING ATTORNEY

CLASS 17—(Continued).

SN 78-943,235. SAINT-GOBAIN PERFORMANCE PLASTICS CORPORATION, AURORA, OH. FILED 8-2-2006.

HPT

THE MARK CONSISTS OF STANDARD CHARACTERS WITHOUT CLAIM TO ANY PARTICULAR FONT, STYLE, SIZE, OR COLOR.

FOR FLEXIBLE PLASTIC AND SILICONE TUBING USED FOR TRANSPORT OF LIQUIDS AND BIOLOGICALS FOR USE IN THE PHARMACEUTICAL, BIOPHARMACEUTICAL AND MEDICAL INDUSTRIES (U.S. CLS. 1, 5, 12, 13, 35 AND 50).

MICHAEL GAAFAR, EXAMINING ATTORNEY

SN 77-318,540. 3FORM, INC., SALT LAKE CITY, UT. FILED 10-31-2007.

COLOR TO THE POWER OF 3

THE MARK CONSISTS OF STANDARD CHARACTERS WITHOUT CLAIM TO ANY PARTICULAR FONT, STYLE, SIZE, OR COLOR.

FOR PLASTIC SHEETS AND PANELS FOR USE IN CONSTRUCTION AND GENERAL USE (U.S. CLS. 1, 5, 12, 13, 35 AND 50).

FIRST USE 5-2-2007; IN COMMERCE 7-9-2007.

MARIAM MAHMOUDI, EXAMINING ATTORNEY

SN 77-318,567. 3FORM, INC., SALT LAKE CITY, UT. FILED 10-31-2007.

RECLAIM

THE MARK CONSISTS OF STANDARD CHARACTERS WITHOUT CLAIM TO ANY PARTICULAR FONT, STYLE, SIZE, OR COLOR.

FOR PLASTIC SHEETS AND PANELS FOR USE IN CONSTRUCTION AND GENERAL USE (U.S. CLS. 1, 5, 12, 13, 35 AND 50).

FIRST USE 9-26-2005; IN COMMERCE 9-26-2005.

MARIAM MAHMOUDI, EXAMINING ATTORNEY

SN 78-970,308. PACIFIC COAST BUILDING PRODUCTS, INC., RANCHO CORDOVA, CA. FILED 9-8-2006.

PABCO

THE MARK CONSISTS OF STANDARD CHARACTERS WITHOUT CLAIM TO ANY PARTICULAR FONT, STYLE, SIZE, OR COLOR.

OWNER OF U.S. REG. NOS. 1,207,247, 1,438,046 AND 1,736,590.

FOR DRYWALL JOINT COMPOUND (U.S. CLS. 1, 5, 12, 13, 35 AND 50).

FIRST USE 8-31-2006; IN COMMERCE 8-31-2006.

PAULA MAHONEY, EXAMINING ATTORNEY

SN 79-038,053. MUSTHANE, LOUVIL, FRANCE, FILED 3-28-2007.

AROMER

OWNER OF INTERNATIONAL REGISTRATION 0922912 DATED 3-28-2007, EXPIRES 3-28-2017.

FOR POLYMER COATED FABRIC FOR THE PRODUCTION OF TANKS USED TO STORE ALL LIQUIDS AND IN PARTICULAR HYDROCARBONS (U.S. CLS. 1, 5, 12, 13, 35 AND 50).

ADA HAN, EXAMINING ATTORNEY

CLASS 18—LEATHER GOODS

SN 76-681,176. TURKEY TAIL SAVER INC., MASON CITY, IA. FILED 8-27-2007.

TURKEY TAIL SAVER

THE MARK CONSISTS OF STANDARD CHARACTERS WITHOUT CLAIM TO ANY PARTICULAR FONT, STYLE, SIZE, OR COLOR.

NO CLAIM IS MADE TO THE EXCLUSIVE RIGHT TO USE "TURKEY TAIL", APART FROM THE MARK AS SHOWN.

FOR CARRYING CASES MADE OF SYNTHETIC OR NATURAL MATERIALS, FOR TURKEY TAIL STORAGE (U.S. CLS. 1, 2, 3, 22 AND 41).

FIRST USE 8-1-2007; IN COMMERCE 8-1-2007.
BRENDAN REGAN, EXAMINING ATTORNEY

CLASS 18—(Continued).

SN 77-131,118. SAMET, DONNA, BROOKLYN, NY. FILED 3-14-2007.

MY PET SHIRT

THE MARK CONSISTS OF STANDARD CHARACTERS WITHOUT CLAIM TO ANY PARTICULAR FONT, STYLE, SIZE, OR COLOR.

NO CLAIM IS MADE TO THE EXCLUSIVE RIGHT TO USE "PET SHIRT", APART FROM THE MARK AS SHOWN.

FOR ANIMAL CARRIERS; CLOTHING FOR DOMESTIC PETS (U.S. CLS. 1, 2, 3, 22 AND 41).

MONIQUE MILLER, EXAMINING ATTORNEY

SN 77-096,159. VEGAS.COM, LLC, HENDERSON, NV. FILED 1-31-2007.



OWNER OF U.S. REG. NOS. 3,129,210, 3,327,052 AND OTHERS.

THE COLOR(S) RED AND WHITE IS/ARE CLAIMED AS A FEATURE OF THE MARK.

THE COLOR RED APPEARS IN THE WORDING "SURVIVAL KIT" AND IN THE DESIGN ELEMENT OF AN ARROW; THE COLOR WHITE APPEARS IN THE WORDING "VEGAS" AND IN THE ARROW DESIGN ELEMENT AS A BORDER AND DOTS.

SEC. 2(F) AS TO "VEGAS".
FOR TOTE BAGS (U.S. CLS. 1, 2, 3, 22 AND 41).
AISHA SALEM, EXAMINING ATTORNEY

SN 77-141,079. NICHOLSON, COURTNEY, ALEXANDRIA, VA. FILED 3-27-2007.

PETDIOMS

THE MARK CONSISTS OF STANDARD CHARACTERS WITHOUT CLAIM TO ANY PARTICULAR FONT, STYLE, SIZE, OR COLOR.

FOR PET COLLAR ACCESSORIES, NAMELY, CLASPS, BOWS, CHARMS, PENDANTS AND ORNAMENTS (U.S. CLS. 1, 2, 3, 22 AND 41).

LESLEY LAMOTHE, EXAMINING ATTORNEY

SN 77-143,117. PRIMA ROYAL ENTERPRISES, LTD., IRWINDALE, CA. FILED 3-28-2007.

BOBBI BLU

THE MARK CONSISTS OF STANDARD CHARACTERS WITHOUT CLAIM TO ANY PARTICULAR FONT, STYLE, SIZE, OR COLOR.

THE NAME(S), PORTRAIT(S), AND/OR SIGNATURE(S) SHOWN IN THE MARK DOES NOT IDENTIFY A PARTICULAR LIVING INDIVIDUAL.

FOR ALL-PURPOSE ATHLETIC BAGS AND CARRYALL BAGS; ANIMAL CARRIERS; ATTACHE CASES; BACKPACKS; BARREL BAGS; BEACH BAGS; BELT BAGS; BILLFOLDS; BOOKBAGS; BRIEFCASES; BRIEFCASE-TYPE PORTFOLIOS; BUSINESS CARD CASES; CHANGE PURSES; CLUTCH BAGS; COSMETIC BAGS SOLD EMPTY; CREDIT CARD CASES; DIAPER BAGS; DUFFLE BAGS; GARMENT BAGS FOR TRAVEL; GYM BAGS; HANDBAGS; HIPSACKS; LEATHER KEY CHAINS AND CASES; LUGGAGE; MESSENGER BAGS; OVERNIGHT BAGS; POCKETBOOKS; PURSES; SHOULDER BAGS; SUIT BAGS; SUITCASES; TOILETRY CASES SOLD EMPTY; TRUNKS; UMBRELLAS AND UMBRELLA COVERS; WALLETS; WRISTLET BAGS; AND VANITY CASES SOLD EMPTY (U.S. CLS. 1, 2, 3, 22 AND 41).

LINDA M. KING, EXAMINING ATTORNEY

SN 77-127,320. TILLIE DESIGNS, INC., DENVER, CO. FILED 3-9-2007.

TILLIE

THE MARK CONSISTS OF STANDARD CHARACTERS WITHOUT CLAIM TO ANY PARTICULAR FONT, STYLE, SIZE, OR COLOR.

FOR ALL-PURPOSE CARRYING BAGS; GENERAL PURPOSE BAGS FOR CARRYING YOGA EQUIPMENT; TOTE BAGS AND BEACH BAGS (U.S. CLS. 1, 2, 3, 22 AND 41).

FIRST USE 5-13-2006; IN COMMERCE 5-24-2006.
LINDA LAVACHE, EXAMINING ATTORNEY

CLASS 18—(Continued).

SN 77-146,287. THE TRUSTEE OF THE BYRON NELSON MARITAL TRUST, DALLAS, TX. FILED 4-2-2007.

BYRON NELSON SIGNATURE SERIES

THE MARK CONSISTS OF STANDARD CHARACTERS WITHOUT CLAIM TO ANY PARTICULAR FONT, STYLE, SIZE, OR COLOR.

OWNER OF U.S. REG. NOS. 1,725,794, 2,587,436 AND OTHERS.

NO CLAIM IS MADE TO THE EXCLUSIVE RIGHT TO USE "SIGNATURE SERIES", APART FROM THE MARK AS SHOWN.

THE NAME(S), PORTRAIT(S), AND/OR SIGNATURE(S) SHOWN IN THE MARK DOES NOT IDENTIFY A PARTICULAR LIVING INDIVIDUAL.

FOR WALLET(S) AND LUGGAGE (U.S. CLS. 1, 2, 3, 22 AND 41).

BARBARA GAYNOR, EXAMINING ATTORNEY

SN 77-150,455. VANI USA, INC., NEW YORK, NY. FILED 4-6-2007.

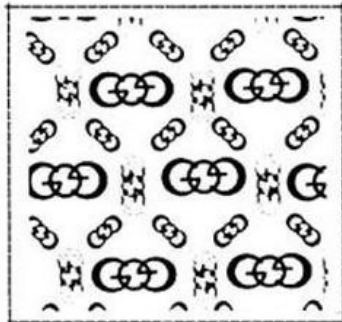

THE MARK CONSISTS OF A REPEATING PATTERN DESIGN OF THE WORDING "GOG". THE BROKEN LINES IN THE DRAWING ARE NOT A PART OF THE MARK, BUT SIGNIFY THAT THE MARK IS NOT LIMITED AS TO POSITION OR PLACEMENT.

FOR PURSES (U.S. CLS. 1, 2, 3, 22 AND 41).

LYDIA BELZER, EXAMINING ATTORNEY

SN 77-161,794. KAUFMAN, ALAN, BOCA RATON, FL. FILED 4-20-2007.

nubrella

THE MARK CONSISTS OF STANDARD CHARACTERS WITHOUT CLAIM TO ANY PARTICULAR FONT, STYLE, SIZE, OR COLOR.

FOR UMBRELLAS (U.S. CLS. 1, 2, 3, 22 AND 41).

RONALD AIKENS, EXAMINING ATTORNEY

CLASS 18—(Continued).

SN 77-230,049. MCKINLEY, MARY ANN, DALLAS, TX. FILED 7-15-2007.



THE COLOR(S) YELLOW AND BLUE IS/ARE CLAIMED AS A FEATURE OF THE MARK.

THE MARK CONSISTS OF THE COLORS BLUE AND YELLOW WHICH ARE CLAIMED AS A DISTINCTIVE FEATURE OF THE MARK. THE COLOR YELLOW APPEARS IN THE FIRST PART OF THE NAME - "DRINK"; THE COLOR BLUE APPEARS IN THE SECOND PART OF THE NAME - "BRELLA"; THE COLOR YELLOW ALSO APPEARS IN THE SECOND PART OF THE NAME TOGETHER WITH THE COLOR BLUE IN THE UMBRELLA CANOPY WHICH IS PART OF THE FIRST "L" AS WELL AS THE BEVERAGE GLASS WHICH REPRESENTS THE SECOND "L".

FOR BEACH UMBRELLAS; BEACH UMBRELLAS; FRAMES FOR UMBRELLAS; PARASOLS; PATIO UMBRELLAS; UMBRELLA BASES; UMBRELLA FRAMES; UMBRELLA HANDLES; UMBRELLAS; UMBRELLAS AND THEIR PARTS (U.S. CLS. 1, 2, 3, 22 AND 41).

KELLY BOULTON, EXAMINING ATTORNEY

SN 77-243,499. NEW YORK YANKEES PARTNERSHIP, BRONX, NY. FILED 7-31-2007.

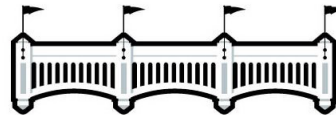

THE MARK CONSISTS OF A REPETITIVE ARCHED STADIUM FACADE FRIEZE WITH PENNANTS.

FOR ATHLETIC BAGS, OVERNIGHT BAGS, BACKPACKS, DUFFEL BAGS, TOTE BAGS, BEACH BAGS, KNAPSACKS, ATTACHE CASES, BRIEFCASES, PURSES, HANDBAGS, WALLETS, BILLFOLDS, FANNY PACKS, WAIST PACKS, COSMETIC CASES SOLD EMPTY, TOILETRY CASES SOLD EMPTY, KEY CASES, BUSINESS CARD CASES, LUGGAGE, LUGGAGE TAGS, SUITCASES, GARMENT BAGS FOR TRAVEL, TRUNKS FOR TRAVELING, UMBRELLAS, CANES, DOG COLLARS AND DOG LEASHES (U.S. CLS. 1, 2, 3, 22 AND 41).

CURTIS FRENCH, EXAMINING ATTORNEY

CLASS 18—(Continued).

SN 77-243,503. NEW YORK YANKEES PARTNERSHIP, BRONX, NY. FILED 7-31-2007.



THE MARK CONSISTS OF A REPETITIVE ARCHED STADIUM FACADE FRIEZE..

FOR ATHLETIC BAGS, OVERNIGHT BAGS, BACK-PACKS, DUFFEL BAGS, TOTE BAGS, BEACH BAGS, KNAPSACKS, ATTACHE CASES, BRIEFCASES, PURSES, HANDBAGS, WALLETS, BILLFOLDS, FANNY PACKS, WAIST PACKS, COSMETIC CASES SOLD EMPTY, TOILETRY CASES SOLD EMPTY, KEY CASES, BUSINESS CARD CASES, LUGGAGE, LUGGAGE TAGS, SUITCASES, GARMENT BAGS FOR TRAVEL, TRUNKS FOR TRAVELING, UMBRELLAS, CANES, DOG COLLARS AND DOG LEASHES (U.S. CLS. 1, 2, 3, 22 AND 41).

CURTIS FRENCH, EXAMINING ATTORNEY

SN 77-264,599. PARENTI, JOSLYN E, DBA JP MONKEY, SANTA BARBARA, CA. FILED 8-27-2007.



THE COLOR(S) BLACK, WHITE, AND RED IS/ARE CLAIMED AS A FEATURE OF THE MARK.

THE COLOR BLACK APPEARS IN THE WORDING "MADE FOR GOOD" AND IN THE DESIGN OF THE SQUARE BORDER APPEARING AROUND ALL OF THE OTHER WORDING. THE COLOR RED APPEARS IN THE DESIGN OF THE RECTANGLE. THE COLOR WHITE APPEARS IN THE WORDING "JP MONKEY" AND "JPMONKEY.COM".

FOR CARRY-ALL BAGS; TEXTILE SHOPPING BAGS (U.S. CLS. 1, 2, 3, 22 AND 41).

FIRST USE 12-15-2006; IN COMMERCE 7-15-2007.
AMY MCMENAMIN, EXAMINING ATTORNEY

CLASS 18—(Continued).

SN 77-270,579. NATIONAL FOOTBALL LEAGUE, NEW YORK, NY. FILED 9-4-2007.



OWNER OF U.S. REG. NOS. 886,055, 2,919,270 AND 3,138,589.

THE MARK CONSISTS OF A SHIELD CONTAINING THE STYLIZED LETTERS "NFL" WITHIN THE BOTTOM PORTION OF THE SHIELD, AND EIGHT STARS AND A FOOTBALL CONTAINED WITHIN THE TOP PORTION OF THE SHIELD.

FOR HANDBAGS, LUGGAGE, SHOULDER BAGS, BEACH BAGS, DUFFLE BAGS, CLUTCH BAGS, ALL PURPOSE SPORT BAGS, BAGS FOR SPORTS, ATTACHE CASES, SCHOOL BAGS, TOTE BAGS, CREDIT CARD CASES, DOCUMENT CASES, PASSPORT CASES, COSMETIC CASES SOLD EMPTY, KEY CASES, KNAPSACKS, RUCKSACKS, WALLETS, SUITCASES, TRAVEL BAGS, BACKPACKS, BRIEFCASES, VALISES, UMBRELLAS, LUGGAGE TAGS, WAIST PACKS (U.S. CLS. 1, 2, 3, 22 AND 41).

NAAKWAMA ANKRAH, EXAMINING ATTORNEY

SN 77-276,369. ALBA-FERANADEZ, JOSE, MALAGA, SPAIN, FILED 9-11-2007.

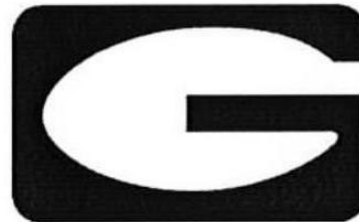

PEPE ALBA

THE NAME SHOWN IN THE MARK IDENTIFIES A LIVING INDIVIDUAL WHOSE CONSENT IS OF RECORD.

THE MARK CONSISTS OF THE STYLIZED LETTER "G" HAVING THE WORDING "PEPE ALBA" APPEARING BELOW.

FOR HANDBAGS, WALLETS, BRIEFCASES, TRAVELING BAGS, SUITCASES AND LUGGAGE SETS (U.S. CLS. 1, 2, 3, 22 AND 41).

MARY ROSSMAN, EXAMINING ATTORNEY

CLASS 18—(Continued).

SN 77-277,100. ECO TOTABLES, NORTH HOLLYWOOD, CA. FILED 9-11-2007.

Zero Paper Zero Plastic

THE MARK CONSISTS OF STANDARD CHARACTERS WITHOUT CLAIM TO ANY PARTICULAR FONT, STYLE, SIZE, OR COLOR.

FOR TOTE BAGS (U.S. CLS. 1, 2, 3, 22 AND 41).
FIRST USE 7-0-2007; IN COMMERCE 7-0-2007.
SUSAN STIGLITZ, EXAMINING ATTORNEY

CLASS 18—(Continued).

SN 77-282,454. COACH SERVICES, INC., NEW YORK, NY. FILED 9-18-2007.

COACH

THE MARK CONSISTS OF STANDARD CHARACTERS WITHOUT CLAIM TO ANY PARTICULAR FONT, STYLE, SIZE, OR COLOR.

OWNER OF U.S. REG. NO. 2,983,654.
FOR UMBRELLAS (U.S. CLS. 1, 2, 3, 22 AND 41).
FIRST USE 3-1-2002; IN COMMERCE 3-1-2002.
JIM RINGLE, EXAMINING ATTORNEY

SN 77-277,222. JONES, REGINA C., WEST COVINA, CA. FILED 9-12-2007.

Noy Handbags and Accessories

THE MARK CONSISTS OF STANDARD CHARACTERS WITHOUT CLAIM TO ANY PARTICULAR FONT, STYLE, SIZE, OR COLOR.

NO CLAIM IS MADE TO THE EXCLUSIVE RIGHT TO USE "HANDBAGS AND ACCESSORIES", APART FROM THE MARK AS SHOWN.

THE ENGLISH TRANSLATION OF THE FOREIGN WORDING "NOY" IN THE MARK IS "BEAUTY."

FOR LEATHER HANDBAGS (U.S. CLS. 1, 2, 3, 22 AND 41).
CORY BOONE, EXAMINING ATTORNEY

SN 77-284,843. YAKIRA, LLC, NEW YORK, NY. FILED 9-20-2007.

MARC ECKO

THE MARK CONSISTS OF STANDARD CHARACTERS WITHOUT CLAIM TO ANY PARTICULAR FONT, STYLE, SIZE, OR COLOR.

OWNER OF U.S. REG. NOS. 2,927,076, 3,159,906 AND OTHERS.

THE NAME "MARC ECKO" IDENTIFIES A LIVING INDIVIDUAL WHOSE CONSENT IS OF RECORD.

FOR BAGS, NAMELY, ALL PURPOSE ATHLETIC BAGS, BACKPACKS, BOOK BAGS, SCHOOL BAGS, DUFFEL BAGS, GYM BAGS, OVERNIGHT BAGS, SHOULDER BAGS, PURSES, TOTE BAGS, TRAVEL BAGS, AND GARMENT BAGS FOR TRAVEL, MADE OF LEATHER OR NON-LEATHER MATERIALS; SMALL LEATHER GOODS, NAMELY, WALLETS (U.S. CLS. 1, 2, 3, 22 AND 41).
ALICE BENMAMAN, EXAMINING ATTORNEY

SN 77-281,029. LEE, JOON H., TETERBORO, NY. FILED 9-17-2007.



THE COLOR(S) RED, BLACK AND GRAY IS/ARE CLAIMED AS A FEATURE OF THE MARK.

THE COLOR RED APPEARS IN THE BOX ON THE LEFT SIDE; THE COLOR BLACK APPEARS IN THE BOX ON THE RIGHT SIDE AND BEHIND THE RED BOX; THE COLOR GRAY APPEARS IN THE LETTERS "TL" AND THE OUTLINE OF THE BOX AROUND THE LETTERS.

FOR BACKPACKS, MESSENGER BAGS, TOTE BAGS, DUFFEL BAGS, LUGGAGE, AND BAGS, NAMELY, EVENING BAGS, BEACH BAGS, DIAPER BAGS AND HANDBAGS (U.S. CLS. 1, 2, 3, 22 AND 41).
LEIGH LOWRY, EXAMINING ATTORNEY

SN 77-285,180. EISNER, BRENDON, SOLON, OH. FILED 9-20-2007.



NO CLAIM IS MADE TO THE EXCLUSIVE RIGHT TO USE "BAGS", APART FROM THE MARK AS SHOWN.

THE ACORN APPEARS ATOP A CIRCULAR CARRIER. CENTERED ON THE ACORN IS AN IMAGE OF NORTH

CLASS 18—(Continued).

AMERICAN AND SOUTH AMERICAN LANDMASS. IN THE BACKGROUND OF THIS CIRCULAR CARRIER IS A SERIES OF OFFSET LINES WITH THE WORDING "BAGS FOR A BETTER WORLD" SEPARATED BY SMALL CIRCLES. SURROUNDING THIS CIRCULAR CARRIER IS A SERIES OF SEVEN CONCENTRIC CIRCLES OF VARYING WIDTH. THE THIRD CONCENTRIC CIRCLE FROM THE INSIDE CONTAINS TWO CIRCLES AND THE WORDING "BAGS FOR A BETTER WORLD" WHICH PARTIALLY ENCIRCLES THE INNER CONCENTRIC CIRCLES. THE MARK CONSISTS OF THE WORDING "BAGS FOR A BETTER WORLD", AND DESIGN ELEMENTS COMPRISING OF SMALL CIRCLES SEPARATING INDIVIDUAL INSTANCES OF THIS WORDING, AN ACORN, AND AN IMAGE OF THE NORTH AND SOUTH AMERICAN LANDMASS

FOR ALL-PURPOSE CARRYING BAGS (U.S. CLS. 1, 2, 3, 22 AND 41).

HOWARD B. LEVINE, EXAMINING ATTORNEY



SN 77-285,996. UP COUNTRY INC., EAST PROVIDENCE, RI. FILED 9-21-2007.

UP COUNTRY

THE MARK CONSISTS OF STANDARD CHARACTERS WITHOUT CLAIM TO ANY PARTICULAR FONT, STYLE, SIZE, OR COLOR.

OWNER OF U.S. REG. NO. 1,303,720. FOR COLLARS FOR PETS, PET LEADS, LEASHES FOR ANIMALS (U.S. CLS. 1, 2, 3, 22 AND 41).

FIRST USE 1-10-1983; IN COMMERCE 1-10-1983. ZACHARY BELLO, EXAMINING ATTORNEY



SN 77-289,484. YH FOREVER, INC., LOS ANGELES, CA. FILED 9-26-2007.



FOR (BASED ON INTENT TO USE) EVENING HANDBAGS; HANDBAG FRAMES; HANDBAGS; HANDBAGS FOR MEN; LEATHER HANDBAGS; STRAPS FOR HANDBAGS; SCHOOL BAGS; LEATHER BAGS, SUITCASES AND WALLETS; SMALL SUITCASES; SUITCASES (U.S. CLS. 1, 2, 3, 22 AND 41).

MICHAEL KAZAZIAN, EXAMINING ATTORNEY

CLASS 18—(Continued).

SN 77-291,012. CABOULI, STEVEN D., SAN DIEGO, CA. FILED 9-27-2007.

i-wallet

THE MARK CONSISTS OF STANDARD CHARACTERS WITHOUT CLAIM TO ANY PARTICULAR FONT, STYLE, SIZE, OR COLOR.

FOR WALLETS (U.S. CLS. 1, 2, 3, 22 AND 41). DAVID ELTON, EXAMINING ATTORNEY

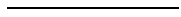

SN 77-291,169. CARNIVAL CORPORATION, MIAMI, FL. FILED 9-28-2007.

CruiseDOG

THE MARK CONSISTS OF THE WORDING "CRUISE DOG" WITH A PAW PRINT INSIDE THE LETTER "O" OF THE WORD "DOG".

FOR DOG CLOTHING; BEACH BAGS (U.S. CLS. 1, 2, 3, 22 AND 41). KATHERINE E. HALMEN, EXAMINING ATTORNEY

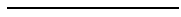

SN 77-291,408. AGOSTINI, LORI, CHICAGO, IL. FILED 9-28-2007.

CHICAGO REIGNS

THE MARK CONSISTS OF STANDARD CHARACTERS WITHOUT CLAIM TO ANY PARTICULAR FONT, STYLE, SIZE, OR COLOR.

NO CLAIM IS MADE TO THE EXCLUSIVE RIGHT TO USE "CHICAGO", APART FROM THE MARK AS SHOWN. FOR UMBRELLAS; UMBRELLAS FOR CHILDREN (U.S. CLS. 1, 2, 3, 22 AND 41).

TRICIA SONNEBORN, EXAMINING ATTORNEY

CLASS 18—(Continued).

SN 77-291,472. WALLFLOWER, INC., DBA MY BOSOM BUD, LEXINGTON, KY. FILED 9-28-2007.

My Bosom Bud

THE MARK CONSISTS OF STANDARD CHARACTERS WITHOUT CLAIM TO ANY PARTICULAR FONT, STYLE, SIZE, OR COLOR.
FOR BRASSIERE WALLET (U.S. CLS. 1, 2, 3, 22 AND 41).
KATHERINE CONNOLLY, EXAMINING ATTORNEY

CLASS 18—(Continued).

SN 77-293,308. WORDS FROM THE HEART LLC, HOWARD, OH. FILED 10-1-2007.



FOR DIAPER BAGS (U.S. CLS. 1, 2, 3, 22 AND 41).
ANNE MADDEN, EXAMINING ATTORNEY

SN 77-292,998. LUKA GLOBAL, INC., BLOOMFIELD HILLS, MI. FILED 10-1-2007.

TRAVEL CHIC

THE MARK CONSISTS OF STANDARD CHARACTERS WITHOUT CLAIM TO ANY PARTICULAR FONT, STYLE, SIZE, OR COLOR.
NO CLAIM IS MADE TO THE EXCLUSIVE RIGHT TO USE "TRAVEL", APART FROM THE MARK AS SHOWN.
FOR FASHION ACCESSORIES FOR TRAVEL, NAMELY, HANDLE COVERS FOR LUGGAGE (U.S. CLS. 1, 2, 3, 22 AND 41).
JOHN GARTNER, EXAMINING ATTORNEY

SN 77-294,179. BELVEDERE GROUP, INC., ENCINITAS, CA. FILED 10-2-2007.

Insta-Leash

THE MARK CONSISTS OF STANDARD CHARACTERS WITHOUT CLAIM TO ANY PARTICULAR FONT, STYLE, SIZE, OR COLOR.
FOR DOG COLLARS (U.S. CLS. 1, 2, 3, 22 AND 41).
FIRST USE 9-5-2006; IN COMMERCE 9-5-2006.
MICHAEL KEATING, EXAMINING ATTORNEY

SN 77-293,233. BROWN, WENDI, OMETRESS, FORT WASHINGTON, MD. FILED 10-1-2007.

Stallion Stiletto

THE MARK CONSISTS OF STANDARD CHARACTERS WITHOUT CLAIM TO ANY PARTICULAR FONT, STYLE, SIZE, OR COLOR.
FOR LEATHER HANDBAGS (U.S. CLS. 1, 2, 3, 22 AND 41).
RENEE SERVANCE, EXAMINING ATTORNEY

SN 77-294,799. MODERN FASHIONISTA, LLC, PHOENIXVILLE, PA. FILED 10-3-2007.

Modern Unity

THE MARK CONSISTS OF STANDARD CHARACTERS WITHOUT CLAIM TO ANY PARTICULAR FONT, STYLE, SIZE, OR COLOR.
FOR MULTI-PURPOSE PURSES (U.S. CLS. 1, 2, 3, 22 AND 41).
BARBARA BROWN, EXAMINING ATTORNEY

CLASS 18—(Continued).

SN 77-295,450. PLANAHEAD, LLC, SANTA MONICA, CA. FILED 10-3-2007.

CLASS 18—(Continued).

SN 77-296,272. DREAMBOX LEARNING, INC., BELLEVUE, WA. FILED 10-4-2007.

VOILA!

DreamBox

THE MARK CONSISTS OF STANDARD CHARACTERS WITHOUT CLAIM TO ANY PARTICULAR FONT, STYLE, SIZE, OR COLOR.

THE ENGLISH TRANSLATION OF THE WORD "VOILA" IN THE MARK IS "THERE IT IS".

FOR COSMETICS BAGS AND CASES SOLD EMPTY (U.S. CLS. 1, 2, 3, 22 AND 41).

HANNO RITTNER, EXAMINING ATTORNEY

THE MARK CONSISTS OF STANDARD CHARACTERS WITHOUT CLAIM TO ANY PARTICULAR FONT, STYLE, SIZE, OR COLOR.

FOR BAGS, NAMELY, TOTE BAGS, DUFFLE BAGS, BACKPACKS; UMBRELLAS (U.S. CLS. 1, 2, 3, 22 AND 41).

SALLY SHIH, EXAMINING ATTORNEY

SN 77-296,159. LIVE NATION WORLDWIDE, INC., BEVERLY HILLS, CA. FILED 10-4-2007.

SN 77-296,475. ALIMENT, MELINDA, PUYALLUP, WA. FILED 10-4-2007.

VENUE NATION

Boutikki

THE MARK CONSISTS OF STANDARD CHARACTERS WITHOUT CLAIM TO ANY PARTICULAR FONT, STYLE, SIZE, OR COLOR.

FOR BAGS, NAMELY, TOTE BAGS, ALL-PURPOSE CARRYING BAGS, BACKPACKS, DUFFEL BAGS, LEATHER KEY CHAINS (U.S. CLS. 1, 2, 3, 22 AND 41).

ERNEST SHOSHO, EXAMINING ATTORNEY

THE MARK CONSISTS OF STANDARD CHARACTERS WITHOUT CLAIM TO ANY PARTICULAR FONT, STYLE, SIZE, OR COLOR.

FOR ALL-PURPOSE CARRYING BAGS (U.S. CLS. 1, 2, 3, 22 AND 41).

FIRST USE 5-1-2007; IN COMMERCE 5-1-2007.

CURTIS FRENCH, EXAMINING ATTORNEY

SN 77-296,229. DREAMBOX LEARNING, INC., BELLEVUE, WA. FILED 10-4-2007.

SN 77-296,630. ALIMENT, MELINDA, PUYALLUP, WA. FILED 10-4-2007.

DreamBox Learning



THE MARK CONSISTS OF STANDARD CHARACTERS WITHOUT CLAIM TO ANY PARTICULAR FONT, STYLE, SIZE, OR COLOR.

NO CLAIM IS MADE TO THE EXCLUSIVE RIGHT TO USE "LEARNING", APART FROM THE MARK AS SHOWN.

FOR BAGS, NAMELY, TOTE BAGS, DUFFLE BAGS, BACKPACKS; UMBRELLAS (U.S. CLS. 1, 2, 3, 22 AND 41).

SALLY SHIH, EXAMINING ATTORNEY

THE MARK CONSISTS OF THE WORD "BOUTIKKI" WITH THE INITIAL "B" IN THE IMAGE OF A BUTTERFLY. FOR ALL-PURPOSE CARRYING BAGS (U.S. CLS. 1, 2, 3, 22 AND 41).

FIRST USE 5-1-2007; IN COMMERCE 5-1-2007.

CURTIS FRENCH, EXAMINING ATTORNEY

CLASS 18—(Continued).

SN 77-297,242. ABERCROMBIE & FITCH TRADING CO., NEW ALBANY, OH. FILED 10-5-2007.

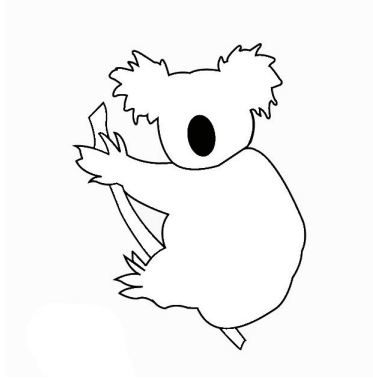

THE MARK CONSISTS OF A MISCELLANEOUS DESIGN FOR ALL-PURPOSE ATHLETIC BAGS; ALL-PURPOSE CARRYING BAGS; ATHLETIC BAGS; BEACH BAGS; BOOK BAGS; CARRY-ALL BAGS; CHANGE PURSES; CLUTCHES; COSMETIC BAGS SOLD EMPTY; GENERAL PURPOSE BAGS FOR CARRYING YOGA EQUIPMENT; GYM BAGS; HANDBAGS; OVERNIGHT BAGS; PURSES; SCHOOL BAGS; SHOULDER BAGS; SLING BAGS; TOILETRY BAGS SOLD EMPTY; TOTE BAGS; TRAVEL BAGS (U.S. CLS. 1, 2, 3, 22 AND 41). FLORENTINA BLANDU, EXAMINING ATTORNEY

SN 77-297,257. ABERCROMBIE & FITCH TRADING CO., NEW ALBANY, OH. FILED 10-5-2007.



THE MARK CONSISTS OF A MISCELLANEOUS DESIGN.. FOR ALL-PURPOSE ATHLETIC BAGS; ALL-PURPOSE CARRYING BAGS; ATHLETIC BAGS; BEACH BAGS; BOOK BAGS; CARRY-ALL BAGS; CHANGE PURSES; CLUTCHES; COSMETIC BAGS SOLD EMPTY; GENERAL PURPOSE BAGS FOR CARRYING YOGA EQUIPMENT; GYM BAGS; HANDBAGS; OVERNIGHT BAGS; PURSES; SCHOOL BAGS; SHOULDER BAGS; SLING BAGS; TOILETRY BAGS SOLD EMPTY; TOTE BAGS; TRAVEL BAGS (U.S. CLS. 1, 2, 3, 22 AND 41). FLORENTINA BLANDU, EXAMINING ATTORNEY

CLASS 18—(Continued).

SN 77-301,253. LAL, ANISHA A., ARLINGTON, VA. FILED 10-11-2007.

Purbrella

THE MARK CONSISTS OF STANDARD CHARACTERS WITHOUT CLAIM TO ANY PARTICULAR FONT, STYLE, SIZE, OR COLOR. FOR HANDBAGS (U.S. CLS. 1, 2, 3, 22 AND 41). LINDA ORNDORFF, EXAMINING ATTORNEY

SN 77-309,760. AGOSTINI, LORI, CHICAGO, IL. FILED 10-22-2007.

Re: mind the world

THE MARK CONSISTS OF STANDARD CHARACTERS WITHOUT CLAIM TO ANY PARTICULAR FONT, STYLE, SIZE, OR COLOR. FOR TOTE BAGS (U.S. CLS. 1, 2, 3, 22 AND 41). TRICIA SONNEBORN, EXAMINING ATTORNEY

SN 77-310,396. UNIVERSAL CITY STUDIOS LLLP, UNIVERSAL CITY, CA. FILED 10-22-2007.

GREEN IS UNIVERSAL

THE MARK CONSISTS OF STANDARD CHARACTERS WITHOUT CLAIM TO ANY PARTICULAR FONT, STYLE, SIZE, OR COLOR. FOR BACKPACKS, FANNY PACKS, TOTE BAGS, ALL PURPOSE CARRYING BAGS AND UMBRELLAS (U.S. CLS. 1, 2, 3, 22 AND 41). JEAN IM, EXAMINING ATTORNEY

CLASS 18—(Continued).

SN 77-318,356. CHOI, BYUNG MOON, LOS ANGELES, CA. FILED 10-31-2007.

6 AND 6

THE MARK CONSISTS OF STANDARD CHARACTERS WITHOUT CLAIM TO ANY PARTICULAR FONT, STYLE, SIZE, OR COLOR.

FOR EVENING HANDBAGS; HANDBAG FRAMES; HANDBAGS; HANDBAGS FOR MEN; LEATHER HANDBAGS; STRAPS FOR HANDBAGS (U.S. CLS. 1, 2, 3, 22 AND 41).

ELLEN BURNS, EXAMINING ATTORNEY

CLASS 18—(Continued).

SN 78-774,856. MAYER, JESSE B., SHILLINGTON, PA. FILED 12-16-2005.



NO CLAIM IS MADE TO THE EXCLUSIVE RIGHT TO USE "COLLECTION", APART FROM THE MARK AS SHOWN.

FOR HANDBAGS (U.S. CLS. 1, 2, 3, 22 AND 41). FIRST USE 11-13-2003; IN COMMERCE 11-13-2003. BRENDAN MCCAULEY, EXAMINING ATTORNEY

SN 77-318,510. UNIVERSAL CITY STUDIOS LLLP, UNIVERSAL CITY, CA. FILED 10-31-2007.



FOR BACKPACKS, FANNY PACKS, TOTE BAGS, ALL PURPOSE CARRYING BAGS AND UMBRELLAS (U.S. CLS. 1, 2, 3, 22 AND 41).

JEAN IM, EXAMINING ATTORNEY

SN 78-911,844. SIDECAR DESIGNS LLC, SEATTLE, WA. FILED 6-20-2006.

Sidecar Slings

THE MARK CONSISTS OF STANDARD CHARACTERS WITHOUT CLAIM TO ANY PARTICULAR FONT, STYLE, SIZE, OR COLOR.

NO CLAIM IS MADE TO THE EXCLUSIVE RIGHT TO USE "SLINGS", APART FROM THE MARK AS SHOWN.

FOR BABY CARRIERS WORN ON THE BODY THAT ARE NOT MADE OF LEATHER OR ARTIFICIAL LEATHER AND NOT DIRECTED TO THE LUXURY MARKET (U.S. CLS. 1, 2, 3, 22 AND 41).

FIRST USE 10-1-2004; IN COMMERCE 10-1-2004. SANDRA MANIOS, EXAMINING ATTORNEY

SN 77-319,648. SERGEANT'S PET CARE PRODUCTS, INC., OMAHA, NE. FILED 11-2-2007.

POOCHI

THE MARK CONSISTS OF STANDARD CHARACTERS WITHOUT CLAIM TO ANY PARTICULAR FONT, STYLE, SIZE, OR COLOR.

OWNER OF U.S. REG. NOS. 1,793,683, 2,817,121 AND 3,271,667.

FOR PET CLOTHING (U.S. CLS. 1, 2, 3, 22 AND 41). BENJAMIN OKEKE, EXAMINING ATTORNEY

SN 78-916,508. SHENANDOAH TRADING CO., LTD., HUWET TOWN, YUU LIN HSIEN, TAIWAN, FILED 6-26-2006.

STELLA LUNA

OWNER OF TAIWAN REG. NO. 01226109, DATED 9-1-2006, EXPIRES 8-31-2016.

OWNER OF U.S. REG. NO. 3,110,649.

THE FOREIGN WORDING IN THE MARK TRANSLATES INTO ENGLISH AS STAR MOON.

FOR TRAVELING BAGS, TRUNKS, HANDBAGS, ATTACHÉ CASES, BRIEFCASES, COIN PURSES, KEY CASES, NAME CARD CASES, POCKETBOOKS, UMBRELLAS, PARASOLS, WALKING STICKS (U.S. CLS. 1, 2, 3, 22 AND 41).

DEZMONA MIZELLE, EXAMINING ATTORNEY

CLASS 18—(Continued).

SN 78-955,353. SHENANDOAH TRADING CO., LTD., YUU LIN HSIEN, TAIWAN, FILED 8-18-2006.

WHAT FOR

THE MARK CONSISTS OF STANDARD CHARACTERS WITHOUT CLAIM TO ANY PARTICULAR FONT, STYLE, SIZE, OR COLOR.

OWNER OF TAIWAN REG. NO. 01262904, DATED 5-16-2007, EXPIRES 5-15-2017.

FOR TRAVELING BAGS, TRUNKS, HANDBAGS, ATTACHÉ CASES, BRIEFCASES, COIN PURSES, KEY CASES, NAME CARD CASES, POCKETBOOKS, UMBRELLAS, PARASOLS, WALKING STICKS (U.S. CLS. 1, 2, 3, 22 AND 41).

DEZMONA MIZELLE, EXAMINING ATTORNEY

CLASS 18—(Continued).

SN 78-978,898. TRIPLE FIVE SOUL, INC., BROOKLYN, NY, FILED 2-5-2004.



THE COLOR(S) GREEN, TAN, BLACK AND RED IS/ARE CLAIMED AS A FEATURE OF THE MARK.

THE MARK CONSISTS OF STYLIZED BAR CODE LABEL IN COLORS GREEN, TAN, BLACK AND RED.

FOR MEN'S, WOMEN'S AND CHILDREN'S HANDBAGS, TOTE BAGS, ATHLETIC BAGS, LUGGAGE, KNAPSACKS, AND PURSES (U.S. CLS. 1, 2, 3, 22 AND 41).

FIRST USE 3-1-2002; IN COMMERCE 3-1-2002.

BENJAMIN OKEKE, EXAMINING ATTORNEY

SN 78-955,370. SHENANDOAH TRADING CO., LTD., YUU LIN HSIEN, TAIWAN, FILED 8-18-2006.



OWNER OF TAIWAN REG. NO. 01239215, DATED 12-1-2006, EXPIRES 11-30-2016.

THE FOREIGN WORDING IN THE MARK TRANSLATES INTO ENGLISH AS STAR, PARTICLE, TINY BIT; CELESTIAL BEING, IMMORTAL; TO FULFIL, TO TREAD ON, TO WALK UPON.

THE NON-LATIN CHARACTER(S) IN THE MARK TRANSLITERATES INTO XING; XIAN; LU, AND THIS MEANS STAR, PARTICLE, TINY BIT; CELESTIAL BEING, IMMORTAL; TO FULFIL, TO TREAD ON, TO WALK UPON IN ENGLISH.

FOR TRAVELING BAGS, TRUNKS, HANDBAGS, ATTACHÉ CASES, BRIEFCASES, COIN PURSES, KEY CASES, NAME CARD CASES, POCKETBOOKS, UMBRELLAS, PARASOLS, WALKING STICKS (U.S. CLS. 1, 2, 3, 22 AND 41).

DEZMONA MIZELLE, EXAMINING ATTORNEY

SN 79-033,966. GABS DI GABBRIELLI FRANCO, I-50100 FIRENZE, ITALY, FILED 11-29-2006.

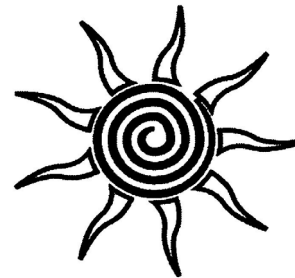

GABS

PRIORITY DATE OF 6-9-2006 IS CLAIMED.

OWNER OF INTERNATIONAL REGISTRATION 0911626 DATED 11-29-2006, EXPIRES 11-29-2016.

FOR LEATHER AND IMITATION LEATHER, GOODS MADE OF THESE MATERIALS NOT INCLUDED IN OTHER CLASSES, NAMELY, BAGS, HAND-BAGS, SHOULDER-BAGS, SHOPPING-BAGS, PURSES, BAGS FOR TRAVEL, SUITCASES, KEY CASES, BANDOLIERS IN LEATHER, WALLETS, CARD CASES, COIN WALLETS, RUCKSACKS; ANIMAL SKINS AND HIDES; TRUNKS AND SUITCASES; UMBRELLAS, PARASOLS AND WALKING STICKS; WHIPS AND SADDLERY (U.S. CLS. 1, 2, 3, 22 AND 41).

GINA HAYES, EXAMINING ATTORNEY

CLASS 18—(Continued).

SN 79-038,862. CELINE, FRANCE, FILED 2-23-2007.

BITTER SWEET

PRIORITY DATE OF 9-11-2006 IS CLAIMED.
OWNER OF INTERNATIONAL REGISTRATION 0925141
DATED 2-23-2007, EXPIRES 2-23-2017.

FOR LEATHER AND IMITATION LEATHER GOODS,
NAMELY, TRAVELLING BAGS, TRAVELING SETS
COMPRISED OF BAGS OR LUGGAGE, TRUNKS, SUIT-
CASES, GARMENT BAGS FOR TRAVEL PURPOSES,
VANITY CASES SOLD EMPTY, RUCKSACKS,
SHOULDER BAGS, HANDBAGS, ATTACHE CASES,
DOCUMENT CASES, BRIEFCASES, POUCHES, SMALL
HANDBAGS, CARD CASES, CARD HOLDERS, WAL-
LETS, PURSES, KEY CASES; UMBRELLAS (U.S. CLS. 1,
2, 3, 22 AND 41).

LA TONIA FISHER, EXAMINING ATTORNEY

**CLASS 19—NON-METALLIC BUILDING MA-
TERIALS**SN 76-682,515. KONTAKT US INTERNATIONAL, INC.,
PORT WASHINGTON, NY. FILED 10-2-2007.**KONTAKT STONE**

THE MARK CONSISTS OF STANDARD CHARACTERS
WITHOUT CLAIM TO ANY PARTICULAR FONT, STYLE,
SIZE, OR COLOR.

NO CLAIM IS MADE TO THE EXCLUSIVE RIGHT TO
USE "STONE", APART FROM THE MARK AS SHOWN.

FOR TRAVERTINE STONE TILES (U.S. CLS. 1, 12, 33
AND 50).

FIRST USE 9-1-2007; IN COMMERCE 9-1-2007.

GINA HAYES, EXAMINING ATTORNEY

SN 77-059,347. TEMBEC INDUSTRIES INC., MONTREAL,
CANADA, FILED 12-7-2006.**TEMPRO FJ**

THE MARK CONSISTS OF STANDARD CHARACTERS
WITHOUT CLAIM TO ANY PARTICULAR FONT, STYLE,
SIZE, OR COLOR.

PRIORITY CLAIMED UNDER SEC. 44(D) ON CANADA
APPLICATION NO. 1326083, FILED 11-29-2006, REG. NO.
TMA700532, DATED 11-9-2007, EXPIRES 11-9-2022.

NO CLAIM IS MADE TO THE EXCLUSIVE RIGHT TO
USE "FJ", APART FROM THE MARK AS SHOWN.

FOR LUMBER (U.S. CLS. 1, 12, 33 AND 50).

MICHELE SWAIN, EXAMINING ATTORNEY

CLASS 19—(Continued).SN 77-073,213. MONTGOMERY METAL CRAFT, INC.,
SPRINGFIELD, MO. FILED 12-29-2006.**MMC VINYL-ALUMINUM FENCING
& RAILING**

THE MARK CONSISTS OF STANDARD CHARACTERS
WITHOUT CLAIM TO ANY PARTICULAR FONT, STYLE,
SIZE, OR COLOR.

NO CLAIM IS MADE TO THE EXCLUSIVE RIGHT TO
USE "VINYL-ALUMINUM FENCING & RAILING", APART
FROM THE MARK AS SHOWN.

FOR VINYL FENCING , RAILING, DECKING, AND
GATES THEREFOR (U.S. CLS. 1, 12, 33 AND 50).

SETH A. RAPPAPORT, EXAMINING ATTORNEY

SN 77-127,770. SERIOUS MATERIALS, LLC, SUNNYVALE,
CA. FILED 3-10-2007.**Do What's Right**

THE MARK CONSISTS OF STANDARD CHARACTERS
WITHOUT CLAIM TO ANY PARTICULAR FONT, STYLE,
SIZE, OR COLOR.

FOR DRYWALL; MOLD RESISTANT DRYWALL;
CONSTRUCTION MATERIAL, NAMELY, FIBERGLASS
BOARD; CONSTRUCTION MATERIAL, NAMELY, NON-
METAL EXTERIOR BOARDS; HYDRAULIC CEMENT;
MAGNESIA CEMENT; NON-METAL FIRE-RESISTANT
BOARDS AND PANELS FOR CONSTRUCTION; NON-
METAL WATER-RESISTANT BOARDS AND PANELS
FOR CONSTRUCTION; PLASTER BOARDS; PORTLAND
CEMENT; SILICA CEMENT; SLABS OF CEMENT; SLABS
OF CONCRETE; WOOD-FIBER REINFORCED CEMENT
BOARDS; FIBERBOARD (U.S. CLS. 1, 12, 33 AND 50).

MICHELE SWAIN, EXAMINING ATTORNEY

SN 77-127,773. SERIOUS MATERIALS, LLC, SUNNYVALE,
CA. FILED 3-10-2007.**It's The Right Thing to Do**

THE MARK CONSISTS OF STANDARD CHARACTERS
WITHOUT CLAIM TO ANY PARTICULAR FONT, STYLE,
SIZE, OR COLOR.

FOR DRYWALL; MOLD RESISTANT DRYWALL;
CONSTRUCTION MATERIAL, NAMELY, FIBERGLASS
BOARD; CONSTRUCTION MATERIAL, NAMELY, NON-
METAL EXTERIOR BOARDS; HYDRAULIC CEMENT;
MAGNESIA CEMENT; NON-METAL FIRE-RESISTANT
BOARDS AND PANELS FOR CONSTRUCTION; NON-
METAL WATER-RESISTANT BOARDS AND PANELS
FOR CONSTRUCTION; PLASTER BOARDS; PORTLAND
CEMENT; SILICA CEMENT; SLABS OF CEMENT; SLABS
OF CONCRETE; WOOD-FIBER REINFORCED CEMENT
BOARDS; FIBERBOARD (U.S. CLS. 1, 12, 33 AND 50).

MICHELE SWAIN, EXAMINING ATTORNEY

CLASS 19—(Continued).

SN 77-133,370. B.R. CUSTOM SURFACE, WEST MONROE, LA. FILED 3-16-2007.



NO CLAIM IS MADE TO THE EXCLUSIVE RIGHT TO USE "INTERLOCKING INSTALLATION SYSTEM", APART FROM THE MARK AS SHOWN.

THE MARK CONSISTS OF "RAPID LOC" ELEMENT TOGETHER WITH A MISCELLANEOUS DESIGN INSERTED IN CIRCLE CONTAINING THE ELEMENTS "INTERLOCKING INSTALLATION SYSTEM".

FOR WOODEN FLOORING (U.S. CLS. 1, 12, 33 AND 50).

MICHAEL LITZAU, EXAMINING ATTORNEY

SN 77-134,431. COLUMBIA INSURANCE COMPANY, OMAHA, NE. FILED 3-19-2007.

VERSALOCK AG

THE MARK CONSISTS OF STANDARD CHARACTERS WITHOUT CLAIM TO ANY PARTICULAR FONT, STYLE, SIZE, OR COLOR.

OWNER OF U.S. REG. NO. 2,599,266.

FOR LAMINATE FLOORING (U.S. CLS. 1, 12, 33 AND 50).

FIRST USE 2-19-2007; IN COMMERCE 2-19-2007.

WILLIAM ROSSMAN, EXAMINING ATTORNEY

SN 77-134,440. CENTRAL FLOORS, INC., SAN JOSE, CA. FILED 3-19-2007.

AVANTI

THE MARK CONSISTS OF STANDARD CHARACTERS WITHOUT CLAIM TO ANY PARTICULAR FONT, STYLE, SIZE, OR COLOR.

FOR FLOORING, NAMELY, WOOD FLOORING, BAMBOO FLOORING, LAMINATE FLOORING (U.S. CLS. 1, 12, 33 AND 50).

FIRST USE 8-19-2003; IN COMMERCE 1-2-2004.

MARK SPARACINO, EXAMINING ATTORNEY

CLASS 19—(Continued).

SN 77-136,299. EVOORGANIC, LLC, VERSAILLES, KY. FILED 3-21-2007.



FOR GEOTEXTILES, NAMELY, FABRIC AND SHEETING FOR GARDENING CONSTRUCTION (U.S. CLS. 1, 12, 33 AND 50).

SIMON TENG, EXAMINING ATTORNEY

SN 77-140,594. OCEANSIDE GLASSTILE COMPANY, CARLSBAD, CA. FILED 3-26-2007.



THE MARK CONSISTS OF A RECTANGULAR DESIGN OF TWO WHITE SEMI-CIRCLES AGAINST A BLACK BACKGROUND FOLLOWED BY THE WORD "MANDALA".

FOR GLASS, PORCELAIN, CERAMIC AND STONE TILES FOR COMMERCIAL AND RESIDENTIAL USE ON WALLS, FLOORS, CEILINGS AND OTHER SURFACES (U.S. CLS. 1, 12, 33 AND 50).

FIRST USE 4-17-2007; IN COMMERCE 5-14-2007.

RICHARD A. STRASER, EXAMINING ATTORNEY

SN 77-156,002. COVERINGS ETC. INC., MIAMI, FL. FILED 4-13-2007.



OWNER OF U.S. REG. NOS. 2,949,867 AND 3,211,255. THE COLOR(S) GREEN IS/ARE CLAIMED AS A FEATURE OF THE MARK.

THE MARK CONSISTS OF THE WORDING "ECOVERINGS" AND THE DESIGN OF LEAF. THE COLOR GREEN APPEARS IN THE WORDING "ECOVERINGS" AND IN THE OUTLINE OF THE DESIGN OF A LEAF.

FOR CERAMIC TILES; GLASS TILES (U.S. CLS. 1, 12, 33 AND 50).

FIRST USE 3-1-2004; IN COMMERCE 3-1-2004.

TINA BROWN, EXAMINING ATTORNEY

CLASS 19—(Continued).

SN 77-163,847. BEST VINYL, LLC, AMERICAN FORK, UT. FILED 4-24-2007.

BEST VINYL

THE MARK CONSISTS OF STANDARD CHARACTERS WITHOUT CLAIM TO ANY PARTICULAR FONT, STYLE, SIZE, OR COLOR.

NO CLAIM IS MADE TO THE EXCLUSIVE RIGHT TO USE "VINYL", APART FROM THE MARK AS SHOWN.

SEC. 2(F).

FOR VINYL LANDSCAPING PRODUCTS, NAMELY, FENCING, DECKING, GATES, AND PORCH RAILINGS; VINYL LANDSCAPING PRODUCT ACCESSORIES, NAMELY, ARBORS, PERGOLAS, AND GAZEBOS (U.S. CLS. 1, 12, 33 AND 50).

FIRST USE 10-31-2000; IN COMMERCE 10-31-2000.
BRIAN PINO, EXAMINING ATTORNEY



SN 77-184,490. INDUSTRIAS AUXILIARES FAUS S.L., VELENCIA, SPAIN, FILED 5-18-2007.

VISIONS

THE MARK CONSISTS OF STANDARD CHARACTERS WITHOUT CLAIM TO ANY PARTICULAR FONT, STYLE, SIZE, OR COLOR.

FOR LAMINATE FLOORING (U.S. CLS. 1, 12, 33 AND 50).

HANNO RITTNER, EXAMINING ATTORNEY



SN 77-191,322. EAGLE MATERIALS IP LLC, DALLAS, TX. FILED 5-27-2007.

ILLINOIS CEMENT COMPANY

THE MARK CONSISTS OF STANDARD CHARACTERS WITHOUT CLAIM TO ANY PARTICULAR FONT, STYLE, SIZE, OR COLOR.

OWNER OF U.S. REG. NO. 2,023,201.

NO CLAIM IS MADE TO THE EXCLUSIVE RIGHT TO USE "CEMENT COMPANY", APART FROM THE MARK AS SHOWN.

SEC. 2(F).

FOR CONSTRUCTION PRODUCTS, NAMELY, HYDRAULIC CEMENT (U.S. CLS. 1, 12, 33 AND 50).

FIRST USE 7-0-1974; IN COMMERCE 7-0-1974.
MICHAEL WEBSTER, EXAMINING ATTORNEY

CLASS 19—(Continued).

SN 77-193,664. EAGLE MATERIALS IP LLC, DALLAS, TX. FILED 5-30-2007.



OWNER OF U.S. REG. NOS. 2,021,819 AND 2,023,200.
NO CLAIM IS MADE TO THE EXCLUSIVE RIGHT TO USE CEMENT COMPANY, APART FROM THE MARK AS SHOWN.

THE MARK CONSISTS OF THE WORDS WISCONSIN CEMENT COMPANY SUPERIMPOSED OVER A GRAPHIC OF THE STATE OF WISCONSIN.

SEC. 2(F).

FOR CONSTRUCTION PRODUCTS, NAMELY HYDRAULIC CEMENT (U.S. CLS. 1, 12, 33 AND 50).

FIRST USE 2-1-2007; IN COMMERCE 2-1-2007.
MICHAEL WEBSTER, EXAMINING ATTORNEY



SN 77-221,474. GUARDIAN BUILDING PRODUCTS DISTRIBUTION, INC., GREENVILLE, SC. FILED 7-3-2007.

GUARDVENT

THE MARK CONSISTS OF STANDARD CHARACTERS WITHOUT CLAIM TO ANY PARTICULAR FONT, STYLE, SIZE, OR COLOR.

FOR NON-METAL RIDGE VENTS FOR USE IN RESIDENTIAL CONSTRUCTION (U.S. CLS. 1, 12, 33 AND 50).

RENEE SERVANCE, EXAMINING ATTORNEY



SN 77-223,113. AUSZAC PTY LTD, PANOROMA, AUSTRALIA, FILED 7-6-2007.



THE MARK CONSISTS OF A LEAF WITH THE WORD "ECOBALSA", WITH THE LETTERS "ECO" IN STYLIZED CAPITALS AND A TREE DRAWN INSIDE THE LETTER "O", FOLLOWED BY THE WORD "BALSA" IN STYLIZED LOWER CASE.

FOR BUILDING PRODUCTS, NAMELY, BUILDING TIMBER, PARTLY PROCESSED TIMBER, AND SHAPED TIMBER, ALL MADE OF BALSA WOOD, FOR USE IN THE CONSTRUCTION, MODELING, COMPOSITE AND COMMERCIAL INDUSTRIES (U.S. CLS. 1, 12, 33 AND 50).

DEZMONA MIZELLE, EXAMINING ATTORNEY

CLASS 19—(Continued).

SN 77-229,847. INTERNATIONAL FOREST PRODUCTS, LLC, OVERLAND PARK, KS. FILED 7-14-2007.

RCA-500

THE MARK CONSISTS OF STANDARD CHARACTERS WITHOUT CLAIM TO ANY PARTICULAR FONT, STYLE, SIZE, OR COLOR.

FOR FLEXIBLE AND RIGID SURFACE TREATED WOOD PANELS (U.S. CLS. 1, 12, 33 AND 50).
FIRST USE 1-2-2006; IN COMMERCE 1-2-2006.
DAVID H. STINE, EXAMINING ATTORNEY

SN 77-232,472. CASEY'S STICKS & STONES, LLC, ELLENBURG CENTER, NY. FILED 7-18-2007.

White Mountain Fieldstone

THE MARK CONSISTS OF STANDARD CHARACTERS WITHOUT CLAIM TO ANY PARTICULAR FONT, STYLE, SIZE, OR COLOR.

NO CLAIM IS MADE TO THE EXCLUSIVE RIGHT TO USE "FIELDSTONE", APART FROM THE MARK AS SHOWN.

SEC. 2(F).

FOR BUILDING STONE (U.S. CLS. 1, 12, 33 AND 50).
FIRST USE 6-0-1987; IN COMMERCE 6-0-1987.
ALYSSA PALADINO, EXAMINING ATTORNEY

SN 77-238,574. CORING HOLE COVERS, INC., POMONA, CA. FILED 7-25-2007.



FOR NON-METAL COVERS FOR HOLES MADE DURING CONSTRUCTION (U.S. CLS. 1, 12, 33 AND 50).
JOHN WILKE, EXAMINING ATTORNEY

CLASS 19—(Continued).

SN 77-256,994. DENNY HASTINGS FLP 14, SHELBYVILLE, TN. FILED 8-16-2007.

FLOCMAT

THE MARK CONSISTS OF STANDARD CHARACTERS WITHOUT CLAIM TO ANY PARTICULAR FONT, STYLE, SIZE, OR COLOR.

FOR EROSION CONTROL FABRIC FOR USE AT CONSTRUCTION, ROADBUILDING, AND OTHER SITES WHERE SOIL HAS BEEN DISTURBED (U.S. CLS. 1, 12, 33 AND 50).

MICHELE SWAIN, EXAMINING ATTORNEY

SN 77-266,491. GIGACRETE, INC., SCOTTSDALE, AZ. FILED 8-28-2007.

STUCCOMAX

THE MARK CONSISTS OF STANDARD CHARACTERS WITHOUT CLAIM TO ANY PARTICULAR FONT, STYLE, SIZE, OR COLOR.

FOR NON-METALLIC, CEMENTITIOUS BUILDING MATERIAL IN THE NATURE OF PLASTER AND STUCCO FOR WALLS AND CEILINGS FOR INTERIOR AND EXTERIOR APPLICATIONS (U.S. CLS. 1, 12, 33 AND 50).

FIRST USE 7-31-2004; IN COMMERCE 7-31-2004.

SAMUEL E. SHARPER JR., EXAMINING ATTORNEY

SN 77-266,549. GIGACRETE, INC., SCOTTSDALE, AZ. FILED 8-28-2007.

PLASTERMAX

THE MARK CONSISTS OF STANDARD CHARACTERS WITHOUT CLAIM TO ANY PARTICULAR FONT, STYLE, SIZE, OR COLOR.

FOR NON-METALLIC, CEMENTITIOUS BUILDING MATERIAL IN THE NATURE OF PLASTER FINISH FOR WALLS AND CEILINGS FOR INTERIOR AND EXTERIOR APPLICATIONS (U.S. CLS. 1, 12, 33 AND 50).

FIRST USE 4-19-2006; IN COMMERCE 4-19-2006.

SAMUEL E. SHARPER JR., EXAMINING ATTORNEY

CLASS 19—(Continued).

SN 77-287,609. 3FORM, INC., SALT LAKE CITY, UT. FILED 9-24-2007.

ECOSKIN

THE MARK CONSISTS OF STANDARD CHARACTERS WITHOUT CLAIM TO ANY PARTICULAR FONT, STYLE, SIZE, OR COLOR.

FOR BUILDING MATERIALS, NAMELY, NONMETAL PANELS; NONMETAL EXTERIOR PANELS; NONMETAL EXTERIOR PANELS FOR USE AS CLADDING, RAINSCREEN, VENTILATED RAINSCREEN AND SOLAR CONTROL (U.S. CLS. 1, 12, 33 AND 50).

MARIAM MAHMOUDI, EXAMINING ATTORNEY

CLASS 19—(Continued).

SN 77-287,631. 3FORM, INC., SALT LAKE CITY, UT. FILED 9-24-2007.

ECO-CLAD

THE MARK CONSISTS OF STANDARD CHARACTERS WITHOUT CLAIM TO ANY PARTICULAR FONT, STYLE, SIZE, OR COLOR.

FOR BUILDING MATERIALS, NAMELY, NONMETAL PANELS; NONMETAL EXTERIOR PANELS; NONMETAL EXTERIOR PANELS FOR USE AS CLADDING, RAINSCREEN, VENTILATED RAINSCREEN AND SOLAR CONTROL (U.S. CLS. 1, 12, 33 AND 50).

MARIAM MAHMOUDI, EXAMINING ATTORNEY

SN 77-287,621. 3FORM, INC., SALT LAKE CITY, UT. FILED 9-24-2007.

ECO-SKIN

THE MARK CONSISTS OF STANDARD CHARACTERS WITHOUT CLAIM TO ANY PARTICULAR FONT, STYLE, SIZE, OR COLOR.

FOR BUILDING MATERIALS, NAMELY, NONMETAL PANELS; NONMETAL EXTERIOR PANELS; NONMETAL EXTERIOR PANELS FOR USE AS CLADDING, RAINSCREEN, VENTILATED RAINSCREEN AND SOLAR CONTROL (U.S. CLS. 1, 12, 33 AND 50).

MARIAM MAHMOUDI, EXAMINING ATTORNEY

SN 77-290,973. SAROYAN LUMBER COMPANY, INC., HUNTINGTON PARK, CA. FILED 9-27-2007.

Rosella

SN 77-287,626. 3FORM, INC., SALT LAKE CITY, UT. FILED 9-24-2007.

ECOCLAD

THE MARK CONSISTS OF STANDARD CHARACTERS WITHOUT CLAIM TO ANY PARTICULAR FONT, STYLE, SIZE, OR COLOR.

FOR BUILDING MATERIALS, NAMELY, NONMETAL PANELS; NONMETAL EXTERIOR PANELS; NONMETAL EXTERIOR PANELS FOR USE AS CLADDING, RAINSCREEN, VENTILATED RAINSCREEN AND SOLAR CONTROL (U.S. CLS. 1, 12, 33 AND 50).

MARIAM MAHMOUDI, EXAMINING ATTORNEY

THE MARK CONSISTS OF STANDARD CHARACTERS WITHOUT CLAIM TO ANY PARTICULAR FONT, STYLE, SIZE, OR COLOR.

FOR FLOOR BOARDS, WOODEN FLOORING (U.S. CLS. 1, 12, 33 AND 50).

FIRST USE 10-17-2003; IN COMMERCE 10-17-2003.
DEIRDRE ROBERTSON, EXAMINING ATTORNEY

CLASS 19—(Continued).

SN 77-291,111. G2 CORPORATION, DBA SCREEN TIGHT CORPORATION, GEORGETOWN, SC. FILED 9-28-2007.



OWNER OF U.S. REG. NO. 3,225,698.

NO CLAIM IS MADE TO THE EXCLUSIVE RIGHT TO USE "WRAP" AND "COLUMN WRAP", APART FROM THE MARK AS SHOWN.

THE MARK CONSISTS OF A STYLIZED SQUARE FRAME HAVING ONE OPEN SIDE CONTAINING THE WORD MARK "WRAP 'N SNAP COLUMN WRAP" SET AGAINST A WOOD-GRAINED BACKGROUND AND A RECTANGULAR BOX-SHAPED AREA AROUND THE "COLUMN WRAP" PORTION OF THE MARK.

FOR CONSTRUCTION MATERIAL, NAMELY, NON-METAL EXTERIOR BOARDS (U.S. CLS. 1, 12, 33 AND 50).

FIRST USE 1-5-2005; IN COMMERCE 1-5-2005.
BILL DAWE, EXAMINING ATTORNEY

SN 77-292,171. NORTHEAST SOLITE CORPORATION, RICHMOND, VA. FILED 9-28-2007.

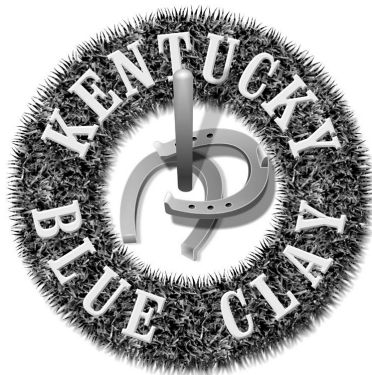

NO CLAIM IS MADE TO THE EXCLUSIVE RIGHT TO USE "KENTUCKY BLUE CLAY", APART FROM THE MARK AS SHOWN.

FOR KENTUCKY BLUE CLAY FOR HORSESHOE PITS (U.S. CLS. 1, 12, 33 AND 50).

BRIAN PINO, EXAMINING ATTORNEY

CLASS 19—(Continued).

SN 77-293,492. MCBRIDE, ROBERT W., NAVARRE, FL. FILED 10-2-2007.

HYDRA-SEAL

THE MARK CONSISTS OF STANDARD CHARACTERS WITHOUT CLAIM TO ANY PARTICULAR FONT, STYLE, SIZE, OR COLOR.

FOR MOISTURE BARRIER CONSTRUCTED PRIMARILY OF WOOD THAT INCORPORATES DOWELS, GLUE AND CHEMICALS FOR INSTALLATION ON EXPOSED WOODEN OBJECTS, NAMELY, DOORS AND WINDOWS (U.S. CLS. 1, 12, 33 AND 50).

ANTHONY RINKER, EXAMINING ATTORNEY

SN 77-294,775. DRAKE, RICHARD J., TALLAHASSEE, FL. FILED 10-3-2007.

FALL-BEHIND

THE MARK CONSISTS OF STANDARD CHARACTERS WITHOUT CLAIM TO ANY PARTICULAR FONT, STYLE, SIZE, OR COLOR.

FOR NON-METAL GUARD RAILS (U.S. CLS. 1, 12, 33 AND 50).

TARAH HARDY, EXAMINING ATTORNEY

SN 77-294,880. U.S. CONCRETE, INC., HOUSTON, TX. FILED 10-3-2007.

VapoSeal

THE MARK CONSISTS OF STANDARD CHARACTERS WITHOUT CLAIM TO ANY PARTICULAR FONT, STYLE, SIZE, OR COLOR.

FOR READY-MIX CONCRETE (U.S. CLS. 1, 12, 33 AND 50).

JOHN WILKE, EXAMINING ATTORNEY

CLASS 19—(Continued).

SN 77-295,950. SIGNATURE FENCING & FLOORING SYSTEMS, LLC, NEW YORK, NY. FILED 10-4-2007.

CLASS 19—(Continued).

SN 77-313,831. MID—ATLANTIC SUPPLY, LLC, MONROE, NC. FILED 10-25-2007.

AutoDeck

STURDIPOST

THE MARK CONSISTS OF STANDARD CHARACTERS WITHOUT CLAIM TO ANY PARTICULAR FONT, STYLE, SIZE, OR COLOR.
FOR NON-METAL FLOOR TILES (U.S. CLS. 1, 12, 33 AND 50).
FIRST USE 5-30-2007; IN COMMERCE 5-30-2007.
DANIEL CAPSHAW, EXAMINING ATTORNEY

THE MARK CONSISTS OF STANDARD CHARACTERS WITHOUT CLAIM TO ANY PARTICULAR FONT, STYLE, SIZE, OR COLOR.
FOR PRE-FABRICATED LOAD-BEARING ARCHITECTURAL COLUMNS (U.S. CLS. 1, 12, 33 AND 50).
RAUL CORDOVA, EXAMINING ATTORNEY

SN 77-303,888. AMBIENT BAMBOO PRODUCTS INC., HYATTSVILLE, MD. FILED 10-15-2007.

SN 77-324,010. BAY TREE TECHNOLOGIES USA, L.L.C., MEMPHIS, TN. FILED 11-7-2007.

Sustainable. Sound. Rustic. Elegant. Classic.

PUREWOOD SAHARA

THE MARK CONSISTS OF STANDARD CHARACTERS WITHOUT CLAIM TO ANY PARTICULAR FONT, STYLE, SIZE, OR COLOR.
FOR BAMBOO FLOORING (U.S. CLS. 1, 12, 33 AND 50).
NAAKWAMA ANKRAH, EXAMINING ATTORNEY

THE MARK CONSISTS OF STANDARD CHARACTERS WITHOUT CLAIM TO ANY PARTICULAR FONT, STYLE, SIZE, OR COLOR.
NO CLAIM IS MADE TO THE EXCLUSIVE RIGHT TO USE PUREWOOD, APART FROM THE MARK AS SHOWN.
FOR BUILDING MATERIALS, NAMELY, DECKING BOARDS; NON-METAL GATES AND FENCING; NON-METAL LATTICES; NON-METAL FLOATING DOCKS (U.S. CLS. 1, 12, 33 AND 50).
FIRST USE 12-13-2007; IN COMMERCE 12-13-2007.
TOBY BULLOFF, EXAMINING ATTORNEY

SN 77-312,280. HEB GROCERY COMPANY, LP, SAN ANTONIO, TX. FILED 10-24-2007.

SN 77-329,348. MOHAWK BRANDS, INC., WILMINGTON, DE. FILED 11-14-2007.

CHOSEN FOR TEXAS BY TEXANS

UNILOCK

THE MARK CONSISTS OF STANDARD CHARACTERS WITHOUT CLAIM TO ANY PARTICULAR FONT, STYLE, SIZE, OR COLOR.
FOR LANDSCAPING STONES, ROCKS, GRAVEL, SAND, AND DECORATIVE LANDSCAPING GLASS AND EARTHENWARE TILES; STATUES OF STONE OR CONCRETE; STATUETTES OF STONE OR CONCRETE; CAST STONE GARDEN AND LAWN ORNAMENTS; STEPPING STONES; OUTDOOR DECORATIONS, NAMELY, DECORATIVE WOOD FLAG POLES (U.S. CLS. 1, 12, 33 AND 50).
G. MAYERSCHOFF, EXAMINING ATTORNEY

THE MARK CONSISTS OF STANDARD CHARACTERS WITHOUT CLAIM TO ANY PARTICULAR FONT, STYLE, SIZE, OR COLOR.
FOR LAMINATE FLOORING (U.S. CLS. 1, 12, 33 AND 50).
BRENDAN REGAN, EXAMINING ATTORNEY

CLASS 19—(Continued).

SN 77-333,749. MOHAWK BRANDS, INC., WILMINGTON, DE. FILED 11-20-2007.

AMAZING WHAT A FLOOR CAN DO

THE MARK CONSISTS OF STANDARD CHARACTERS WITHOUT CLAIM TO ANY PARTICULAR FONT, STYLE, SIZE, OR COLOR.

FOR LAMINATE FLOORING (U.S. CLS. 1, 12, 33 AND 50).

FIRST USE 1-12-2007; IN COMMERCE 1-12-2007.
BRENDAN REGAN, EXAMINING ATTORNEY

SN 78-278,442. NEW RAVENNA, INC., EXMORE, VA. FILED 7-24-2003.

NEW RAVENNA

FOR NATURAL STONE TILES; MARBLE TILES; NON-METAL WALL, FLOOR, CEILING, AND COUNTER TILES; GLASS, MARBLE AND NATURAL STONE MOSAICS FOR BUILDING; MOSAIC TILES, NAMELY, GLASS, MARBLE AND NATURAL STONE MOSAIC TILES; GLASS MOSAICS FOR BUILDING; MARBLE AND NATURAL STONE MOSAICS FOR BUILDING; DECORATIVE MOSAIC GLASS, MARBLE AND NATURAL STONE TILE PANELS, TRIM BORDERS, AND SURFACES IN THE NATURE OF NON-METAL FLOOR TILES (U.S. CLS. 1, 12, 33 AND 50).

FIRST USE 10-0-1991; IN COMMERCE 10-0-1991.
COLLEEN DOMBROW, EXAMINING ATTORNEY

SN 78-779,874. WALKER & ZANGER, INC., SYLMAR, CA. FILED 12-22-2005.

PAVIA ANTICO

THE MARK CONSISTS OF STANDARD CHARACTERS WITHOUT CLAIM TO ANY PARTICULAR FONT, STYLE, SIZE, OR COLOR.

OWNER OF U.S. REG. NO. 2,783,387.

NO CLAIM IS MADE TO THE EXCLUSIVE RIGHT TO USE "ANTICO", APART FROM THE MARK AS SHOWN.

THE ENGLISH TRANSLATION OF THE ITALIAN WORD "ANTICO" IN THE MARK IS "ANCIENT" OR "ANTIQUÉ".

FOR STONE TILES USED FOR WALLS, FLOORS, COUNTERS AND BORDERS (U.S. CLS. 1, 12, 33 AND 50).

FIRST USE 1-1-1996; IN COMMERCE 1-1-1996.
MICHAEL WEBSTER, EXAMINING ATTORNEY

CLASS 19—(Continued).

SN 78-906,752. SWCS MARKETING GROUP INC., MINNEAPOLIS, MN. FILED 6-13-2006.

DIAMOND DRAINAGE BOARD

THE MARK CONSISTS OF STANDARD CHARACTERS WITHOUT CLAIM TO ANY PARTICULAR FONT, STYLE, SIZE, OR COLOR.

NO CLAIM IS MADE TO THE EXCLUSIVE RIGHT TO USE "DRAINAGE BOARD", APART FROM THE MARK AS SHOWN.

FOR NON-METALLIC BOARD USED FOR WATER-PROOFING OF BASEMENTS (U.S. CLS. 1, 12, 33 AND 50).

BENJAMIN OKEKE, EXAMINING ATTORNEY

SN 78-959,313. KNIGHT INDUSTRIES, LLC, PORTLAND, ME. FILED 8-24-2006.

Eco Quartz

THE MARK CONSISTS OF STANDARD CHARACTERS WITHOUT CLAIM TO ANY PARTICULAR FONT, STYLE, SIZE, OR COLOR.

NO CLAIM IS MADE TO THE EXCLUSIVE RIGHT TO USE "QUARTZ", APART FROM THE MARK AS SHOWN.

FOR NON-METAL FLOOR TILES (U.S. CLS. 1, 12, 33 AND 50).

DAVID COLLIER, EXAMINING ATTORNEY

CLASS 19—(Continued).

SN 78-969,055. PANEL REY, S.A., MONTERREY, NUEVO LEON, MEXICO, FILED 9-7-2006.



PRIORITY CLAIMED UNDER SEC. 44(D) ON MEXICO APPLICATION NO. 770426, FILED 3-8-2006, REG. NO. 928136, DATED 3-31-2006, EXPIRES 3-8-2016.

NO CLAIM IS MADE TO THE EXCLUSIVE RIGHT TO USE "EXTERIOR PANEL DE YESO" AND "SHEATHING EXTERIOR GYPSUM WALLBOARD", APART FROM THE MARK AS SHOWN.

THE COLOR(S) WHITE, DARK BLUE AND BROWN IS/ ARE CLAIMED AS A FEATURE OF THE MARK.

THE COLOR WHITE APPEARS IN ALL OF THE WORDING, IN THE CENTRAL CIRCLE, AND AS LINES EXTENDING HORIZONTALLY FROM THE CIRCLE; THE COLOR DARK BLUE APPEARS IN THE PARALLELOGRAM ABOVE THE HORIZONTAL LINE; THE COLOR BROWN APPEARS IN THE PARALLELOGRAM BELOW THE HORIZONTAL LINE AND IN THE CENTRAL CIRCLE AND DESIGN.

THE ENGLISH TRANSLATION OF THE SPANISH WORDING "EXTERIOR PANEL DE YESO" IS "EXTERIOR GYPSUM WALLBOARD."

FOR SHEATHING EXTERIOR GYPSUM WALLBOARD (U.S. CLS. 1, 12, 33 AND 50).

MELVIN AXILBUND, EXAMINING ATTORNEY

CLASS 20—(Continued).

SN 76-676,254. WEATHERCHEM CORPORATION, TWINSBURG, OH. FILED 4-30-2007.

FLAPMATE

OWNER OF U.S. REG. NOS. 2,744,393 AND 3,009,299. FOR NON-METAL END CLOSURES FOR DISPENSING CONTAINERS (U.S. CLS. 2, 13, 22, 25, 32 AND 50). ESTHER BELENKER, EXAMINING ATTORNEY

SN 76-676,255. WEATHERCHEM CORPORATION, TWINSBURG, OH. FILED 4-30-2007.

NUTRAGEN II

OWNER OF U.S. REG. NO. 2,744,393. NO CLAIM IS MADE TO THE EXCLUSIVE RIGHT TO USE "II", APART FROM THE MARK AS SHOWN. FOR NON-METAL END CLOSURES FOR DISPENSING CONTAINERS (U.S. CLS. 2, 13, 22, 25, 32 AND 50). ESTHER BELENKER, EXAMINING ATTORNEY

CLASS 20—FURNITURE AND ARTICLES NOT OTHERWISE CLASSIFIED

SN 76-660,016. GINNYCO INC., BARTLETT, IL. FILED 5-12-2006.

MATERIAL MEMORIES

THE MARK CONSISTS OF STANDARD CHARACTERS WITHOUT CLAIM TO ANY PARTICULAR FONT, STYLE, SIZE, OR COLOR.

FOR PERSONALIZED EMBROIDERED PILLOWS CREATED AS A MEMORIAL (U.S. CLS. 2, 13, 22, 25, 32 AND 50).

H. M. FISHER, EXAMINING ATTORNEY

SN 76-682,755. L&P PROPERTY MANAGEMENT COMPANY, SOUTH GATE, CA. FILED 10-10-2007.

WALLHUGGER

SN 76-676,251. WEATHERCHEM CORPORATION, TWINSBURG, OH. FILED 4-30-2007.

NUTRAGEN

OWNER OF U.S. REG. NO. 2,744,393. FOR NON-METAL END CLOSURES FOR DISPENSING CONTAINERS (U.S. CLS. 2, 13, 22, 25, 32 AND 50). ESTHER BELENKER, EXAMINING ATTORNEY

THE MARK CONSISTS OF STANDARD CHARACTERS WITHOUT CLAIM TO ANY PARTICULAR FONT, STYLE, SIZE, OR COLOR.

OWNER OF U.S. REG. NO. 990,155. FOR ADJUSTABLE BEDS (U.S. CLS. 2, 13, 22, 25, 32 AND 50).

FIRST USE 3-15-2000; IN COMMERCE 3-15-2000. CHRISTOPHER BUONGIORNO, EXAMINING ATTORNEY

CLASS 20—(Continued).

SN 77-002,614. FAGERDALA USA, INC., MARINE CITY, MI.
FILED 9-19-2006.



FOR NON-METAL, FOAM-LIKE TEMPERATURE CONTROL PACKAGING MATERIALS FOR COMMERCIAL USE, NAMELY, PACKING CONTAINERS PRIMARILY MADE OF PLASTIC USED TO PACKAGE, PROTECT, INSULATE, AND/OR ABSORB ENERGY FOR SHIPPING PHARMACEUTICALS, FOOD PRODUCTS AND TEMPERATURE-SENSITIVE BIOLOGICAL PRODUCTS (U.S. CLS. 2, 13, 22, 25, 32 AND 50).

FIRST USE 6-1-2006; IN COMMERCE 6-1-2006.
MICHELE SWAIN, EXAMINING ATTORNEY

SN 77-073,895. CLEMENT, FRANCOIS R, LIVERMORE, CA.
FILED 12-31-2006.

Ready To Work

THE MARK CONSISTS OF STANDARD CHARACTERS WITHOUT CLAIM TO ANY PARTICULAR FONT, STYLE, SIZE, OR COLOR.

FOR OFFICE AND HOME CUBICLES AND MODULAR OFFICE FURNITURE SYSTEMS AND OFFICE SPACE PARTITIONING AND COMPONENTS THEREOF SOLD TOGETHER AS A UNIT, NAMELY, TABLES AND DESKS, SHELVING AND STORAGE CABINETS, BOOKCASES, PARTITIONS AND PRIVACY SCREENS, FULL HEIGHT PARTITIONS, COMMERCIAL AND HOME WORK STATIONS; HOME OFFICE FURNITURE, OFFICE CHAIRS (U.S. CLS. 2, 13, 22, 25, 32 AND 50).

FIRST USE 2-1-2007; IN COMMERCE 2-1-2007.
KIMBERLY FRYE, EXAMINING ATTORNEY

CLASS 20—(Continued).

SN 77-117,424. PEREZ DELGADO, MARIA ANGELES, TENERIFE, SPAIN, FILED 2-27-2007.

EasyGUIDE WIRE

OWNER OF SPAIN REG. NO. 2.685.668, DATED 12-20-2005, EXPIRES 12-20-2015.

THE COLOR(S) BLACK, BLUE AND RED IS/ARE CLAIMED AS A FEATURE OF THE MARK.

THE TERM GUIDE WIRE APPEARING IN THE MARK HAS NO SIGNIFICANCE IN THE RELEVANT TRADE OR INDUSTRY OR AS APPLIED TO THE GOODS LISTED IN THE APPLICATION, NO GEOGRAPHICAL SIGNIFICANCE, NOR ANY MEANING IN A FOREIGN LANGUAGE. THE MARK CONSISTS OF THE WORD EASY IN STYLIZED BLACK LETTERS AND THE WORDS GUIDE WIRE IN STYLIZED RED LETTERS WITH A BLUE OUTER BORDER.

FOR CABLE CLIPS, NOT OF METAL; REELS, NOT OF METAL, NON-MECHANICAL, FOR FLEXIBLE TUBES AND CABLES; WINDING SPOOLS, NOT OF METAL, NON-MECHANICAL, FOR FLEXIBLE TUBES AND CABLES (U.S. CLS. 2, 13, 22, 25, 32 AND 50).

TINA L. SNAPP, EXAMINING ATTORNEY

SN 77-119,761. HNI TECHNOLOGIES INC., MUSCATINE, IA.
FILED 3-1-2007.

ACUITY

THE MARK CONSISTS OF STANDARD CHARACTERS WITHOUT CLAIM TO ANY PARTICULAR FONT, STYLE, SIZE, OR COLOR.

FOR FURNITURE (U.S. CLS. 2, 13, 22, 25, 32 AND 50).
KHANH LE, EXAMINING ATTORNEY

SN 77-127,700. HANGER NETWORK, INC., SANDY HOOK, CT. FILED 3-10-2007.



NO CLAIM IS MADE TO THE EXCLUSIVE RIGHT TO USE "CAR", APART FROM THE MARK AS SHOWN.

THE COLOR(S) WHITE, BLACK, ORANGE IS/ARE CLAIMED AS A FEATURE OF THE MARK.

THE MARK CONSISTS OF IMAGE OF WHITE HANGER ON ORANGE BACKGROUND WITH "CAR" WRITTEN IN SOLID BLACK BLOCK LETTERS AND "VALET" WRITTEN ON BLACK BACKGROUND IN SOLID WHITE BLOCK LETTERS.

FOR CLOTHES HANGERS; COAT HANGERS; HANGERS FOR CLOTHES (U.S. CLS. 2, 13, 22, 25, 32 AND 50).
FIRST USE 8-15-2006; IN COMMERCE 8-15-2006.
WANDA KAY PRICE, EXAMINING ATTORNEY

CLASS 20—(Continued).

SN 77-128,176. IN2 DESIGN SOLUTIONS, INC., VAUGHAN, CANADA, FILED 3-12-2007.

ROLFLEX

THE MARK CONSISTS OF STANDARD CHARACTERS WITHOUT CLAIM TO ANY PARTICULAR FONT, STYLE, SIZE, OR COLOR.

OWNER OF CANADA REG. NO. TMA698,307, DATED 10-12-2007, EXPIRES 10-12-2022.

FOR OFFICE FURNITURE (U.S. CLS. 2, 13, 22, 25, 32 AND 50).

KYLE PEETE, EXAMINING ATTORNEY

SN 77-141,565. SIMPLE INNOVATIVE PRODUCTS, HAVERHILL, MA. FILED 3-27-2007.

THE PENIS SCOPE

THE MARK CONSISTS OF STANDARD CHARACTERS WITHOUT CLAIM TO ANY PARTICULAR FONT, STYLE, SIZE, OR COLOR.

FOR NOVELTY GIFT ITEMS, NAMELY, PLASTIC CLIP FOR PRETEND COUPLING TO THE GENITALS TO AID IN NOT MISSING THE TOILET (U.S. CLS. 2, 13, 22, 25, 32 AND 50).

LOURDES AYALA, EXAMINING ATTORNEY

SN 77-146,762. PROVO STEEL & SUPPLY CO., PROVO, UT. FILED 4-2-2007.

DPX

THE MARK CONSISTS OF STANDARD CHARACTERS WITHOUT CLAIM TO ANY PARTICULAR FONT, STYLE, SIZE, OR COLOR.

FOR STORAGE SYSTEM FOR USE IN METAL SAFES, NAMELY, RACKS AND SHELVES FOR USE IN METAL SAFES (U.S. CLS. 2, 13, 22, 25, 32 AND 50).

KAPIL BHANOT, EXAMINING ATTORNEY

CLASS 20—(Continued).

SN 77-149,666. FABRIQUE DE MEUBLES DE COULOMBS, 28210 COULOMBS, FRANCE, FILED 4-5-2007.

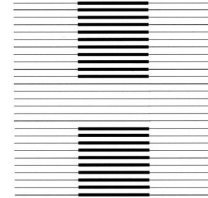

PHILIPPE HUREL

PRIORITY CLAIMED UNDER SEC. 44(D) ON FRANCE APPLICATION NO. 063454906, FILED 10-6-2006, REG. NO. 063454906, DATED 10-10-2006, EXPIRES 10-10-2016.

OWNER OF U.S. REG. NO. 1,541,562.

THE NAME "PHILIPPE HUREL" IDENTIFIES A LIVING INDIVIDUAL WHOSE CONSENT IS OF RECORD.

THE MARK CONSISTS OF A STYLIZED "H" LOGO ABOVE THE NAME "PHILIPPE HUREL".

FOR FURNITURE, MIRRORS, PICTURE FRAMES (U.S. CLS. 2, 13, 22, 25, 32 AND 50).

MELISSA VALLILLO, EXAMINING ATTORNEY

SN 77-168,751. SCHRECK, IRA, NEW YORK, NY. FILED 4-30-2007.

TV TOASTER

THE MARK CONSISTS OF STANDARD CHARACTERS WITHOUT CLAIM TO ANY PARTICULAR FONT, STYLE, SIZE, OR COLOR.

NO CLAIM IS MADE TO THE EXCLUSIVE RIGHT TO USE "TV", APART FROM THE MARK AS SHOWN.

FOR FURNITURE, NAMELY, CABINETS FOR HOME ENTERTAINMENT EQUIPMENT, NAMELY, TELEVISIONS, VIDEO AND DVD PLAYERS AND RECORDERS, CABLE EQUIPMENT, CD PLAYERS AND RECORDERS, AND SPEAKERS (U.S. CLS. 2, 13, 22, 25, 32 AND 50).

ANNE E. GUSTASON, EXAMINING ATTORNEY

SN 77-235,187. EBAY INC., SAN JOSE, CA. FILED 7-20-2007.

WINDORPHINS

THE MARK CONSISTS OF STANDARD CHARACTERS WITHOUT CLAIM TO ANY PARTICULAR FONT, STYLE, SIZE, OR COLOR.

FOR PLASTIC KEY CHAIN TAGS AND PLASTIC NOVELTY LICENSE PLATE FRAMES NOT FOR USE ON VEHICLES, SPECIFICALLY, NOT FOR THE FUNCTIONAL USE OF HOLDING A LICENSE PLATE ON A VEHICLE (U.S. CLS. 2, 13, 22, 25, 32 AND 50).

MARLENE BELL, EXAMINING ATTORNEY

CLASS 20—(Continued).

SN 77-247,713. ELY, SHERYL, DBA BABY CAKES COUTURE, ALPHARETTA, GA. FILED 8-6-2007.



THE MARK CONSISTS OF THE WORDS "BABY CAKES COUTURE" AND DESIGN OF BABY FOOTPRINTS. FOR NOVELTY GIFT ITEM FOR EXPECTANT OR NEW MOTHERS CONSISTING OF PAPER DIAPERS ARRANGED IN THE FORM OF AN INEDIBLE CAKE (U.S. CLS. 2, 13, 22, 25, 32 AND 50). FIRST USE 8-1-2006; IN COMMERCE 1-15-2007. ANTHONY RINKER, EXAMINING ATTORNEY

SN 77-257,561. MANLAPEG, CHRISTINE, LOS ANGELES, CA. FILED 8-16-2007.

Teacup and T-Bone

THE MARK CONSISTS OF STANDARD CHARACTERS WITHOUT CLAIM TO ANY PARTICULAR FONT, STYLE, SIZE, OR COLOR. FOR HOME FURNISHINGS, NAMELY, FURNITURE AND BEDS (U.S. CLS. 2, 13, 22, 25, 32 AND 50). ERNEST SHOSHO, EXAMINING ATTORNEY

SN 77-262,520. COMSEAT INC., LOS ANGELES, CA. FILED 8-23-2007.



FOR CHAIRS; TABLES (U.S. CLS. 2, 13, 22, 25, 32 AND 50). FIRST USE 4-15-2006; IN COMMERCE 4-15-2006. WENDY GOODMAN, EXAMINING ATTORNEY

CLASS 20—(Continued).

SN 77-263,846. CROSSROADS ENTERPRISE, INC., FULLERTON, CA. FILED 8-24-2007.



NO CLAIM IS MADE TO THE EXCLUSIVE RIGHT TO USE "CABINETRY", APART FROM THE MARK AS SHOWN. THE COLOR(S) 2 SHADES OF GREEN AND BROWN IS/ ARE CLAIMED AS A FEATURE OF THE MARK. THE MARK CONSISTS OF TWO FLAT OVERLAPPING LINES ON THE LEFT SIDE, REPRESENTING ROADS, FORMING AN X SYMBOL TO DEPICT A CROSSROADS. THESE LINES ARE A MEDIUM GREEN AND A LIGHT GREEN COLOR. THE WORD "CROSSROADS" IS PREDOMINATE IN THE CENTER OF THE MARK AND IS A MEDIUM BROWN COLOR. THE WORDS "CABINETRY REDEFINED" ARE LISTED DIRECTLY UNDERNEATH THE WORD "CROSSROADS" AND ARE A LIGHT GREEN COLOR. FOR KITCHEN CABINETS (U.S. CLS. 2, 13, 22, 25, 32 AND 50). CAROLYN GRAY, EXAMINING ATTORNEY

SN 77-270,121. SEDAG SYSTEM AG, PFAFIKKON CH8808, SWITZERLAND, FILED 9-1-2007.

COLLECTION 9

THE MARK CONSISTS OF STANDARD CHARACTERS WITHOUT CLAIM TO ANY PARTICULAR FONT, STYLE, SIZE, OR COLOR. NO CLAIM IS MADE TO THE EXCLUSIVE RIGHT TO USE "COLLECTION", APART FROM THE MARK AS SHOWN. FOR CABINETS; FURNITURE; FURNITURE HARDWARE, NAMELY, DRAWER SLIDES; FURNITURE PARTITIONS; FURNITURE, NAMELY, WALL UNITS; KITCHEN CABINETS; MIRRORED CABINETS; DRAWERS; DOORS FOR FURNITURE; STORAGE RACKS; WINE RACKS; TABLES; WOOD CHOPPING BLOCK TABLES; SHELVES (U.S. CLS. 2, 13, 22, 25, 32 AND 50). FIRST USE 8-6-2007; IN COMMERCE 8-6-2007. ROBERT C. CLARK JR., EXAMINING ATTORNEY

CLASS 20—(Continued).

SN 77-270,124. SEDAG SYSTEM AG, PFAFIKKON CH8808, SWITZERLAND, FILED 9-1-2007.

COLLECTION 5

THE MARK CONSISTS OF STANDARD CHARACTERS WITHOUT CLAIM TO ANY PARTICULAR FONT, STYLE, SIZE, OR COLOR.

NO CLAIM IS MADE TO THE EXCLUSIVE RIGHT TO USE "COLLECTION", APART FROM THE MARK AS SHOWN.

FOR CABINETS; FURNITURE; FURNITURE HARDWARE, NAMELY, DRAWER SLIDES; FURNITURE PARTITIONS; FURNITURE, NAMELY, WALL UNITS; KITCHEN CABINETS; MIRRORED CABINETS; DRAWERS; DOORS FOR FURNITURE; STORAGE RACKS; WINE RACKS; TABLES; WOOD CHOPPING BLOCK TABLES; SHELVES (U.S. CLS. 2, 13, 22, 25, 32 AND 50).

FIRST USE 8-6-2007; IN COMMERCE 8-6-2007.

ROBERT C. CLARK JR., EXAMINING ATTORNEY

SN 77-276,840. COTTAGE RATTAN, LLC, SAINT AUGUSTINE, FL. FILED 9-11-2007.



COTTAGE RATTAN

Purposeful Randomness

NO CLAIM IS MADE TO THE EXCLUSIVE RIGHT TO USE "COTTAGE RATTAN", APART FROM THE MARK AS SHOWN.

THE COLOR(S) BROWN, BLACK, LIGHT BROWN, GRAY IS/ARE CLAIMED AS A FEATURE OF THE MARK.

THE MARK CONSISTS OF A CLEAR GLASS BOTTLE WITH GRAY EDGES, STOPPED WITH A BROWN CORK, FILLED WITH LIGHT BROWN SAND, WITH STYLIZED WORD "COTTAGE" IN BLACK FONT COLOR AND ALL CAPITALIZED, WITH STYLIZED WORD "RATTAN" IN LIGHT BROWN FONT COLOR AND ALL CAPITALIZED, AND STYLIZED WORDS "PURPOSEFUL RANDOMNESS" IN BLACK FONT COLOR.

FOR RATTAN AND WICKER FURNITURE, NAMELY, CHAIRS, LOVESEATS, SOFAS, COUCHES, SETTEES, PLANT STANDS, TABLES, BENCHES, CHAISE LOUNGES, OTTOMANS, DESKS, BEDS, BUREAUS, ROCKERS, BOOKCASES, DRESSERS, MAGAZINE RACKS, FURNITURE CHESTS, WICKER TRUNKS, CHESTS OF DRAWERS, MIRRORS, NIGHT STANDS, BAR STOOLS, STOOLS, HEADBOARDS, TABLE BASES, ETAGERES, ARMOIRES; FABRIC PILLOWS, FABRIC CUSHIONS (U.S. CLS. 2, 13, 22, 25, 32 AND 50).

FIRST USE 1-0-2007; IN COMMERCE 9-0-2007.

KIMBERLY FRYE, EXAMINING ATTORNEY

CLASS 20—(Continued).

SN 77-281,070. DAHLGREN ENTERPRISES, INC., DBA D/B/ A CRYSTAL D, ST. PAUL, MN. FILED 9-17-2007.

Awards In Motion

THE MARK CONSISTS OF STANDARD CHARACTERS WITHOUT CLAIM TO ANY PARTICULAR FONT, STYLE, SIZE, OR COLOR.

NO CLAIM IS MADE TO THE EXCLUSIVE RIGHT TO USE "AWARDS", APART FROM THE MARK AS SHOWN.

FOR NON-METAL SCULPTURES FOR AWARDS AND TROPHIES (U.S. CLS. 2, 13, 22, 25, 32 AND 50).

FIRST USE 1-1-2007; IN COMMERCE 1-2-2007.

KEVON CHISOLM, EXAMINING ATTORNEY

SN 77-285,216. PRACTICAL PRODUCTS, LLC, SAN DIEGO, CA. FILED 9-20-2007.



NO CLAIM IS MADE TO THE EXCLUSIVE RIGHT TO USE PLANT, APART FROM THE MARK AS SHOWN.

THE MARK CONSISTS OF A ROUND MONKEY FACE WITH FOUR FLOWERS UNDER THE CHIN AND THE WORDS PLANT MONKEY AROUND THE TOP OF THE HEAD.

FOR PLANT RACKS (U.S. CLS. 2, 13, 22, 25, 32 AND 50).

FIRST USE 10-1-2007; IN COMMERCE 10-1-2007.

SHAUNIA CARLYLE, EXAMINING ATTORNEY

SN 77-285,446. RAMIREZ, RUDY, DOWNEY, CA. FILED 9-21-2007.

NICSSCORE

THE MARK CONSISTS OF STANDARD CHARACTERS WITHOUT CLAIM TO ANY PARTICULAR FONT, STYLE, SIZE, OR COLOR.

FOR NON-ELECTRIC, PLASTIC SCOREBOARDS FOR BASEBALL AND SOFTBALL (U.S. CLS. 2, 13, 22, 25, 32 AND 50).

ALLISON HOLTZ, EXAMINING ATTORNEY

CLASS 20—(Continued).

SN 77-286,627. WOLSETH, GARY L., AURORA, CO. FILED 9-23-2007.

RACKS OF WINE

THE MARK CONSISTS OF STANDARD CHARACTERS WITHOUT CLAIM TO ANY PARTICULAR FONT, STYLE, SIZE, OR COLOR.
FOR WINE RACKS (U.S. CLS. 2, 13, 22, 25, 32 AND 50).
BILL DAWE, EXAMINING ATTORNEY

SN 77-287,616. SANDI LAFRENIERE, WOODBURY, CT. FILED 9-24-2007.

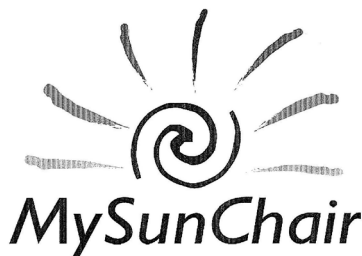

FOR FURNITURE FOR HOUSE, OFFICE AND GARDEN; LAWN FURNITURE; CHAIRS; DECK CHAIRS; LOUNGE CHAIRS; RECLINING CHAIRS; CHAIR PADS; PORTABLE BACK SUPPORT FOR USE WITH CHAIRS; TABLES; AND PLASTIC FURNITURE FOR GARDENS (U.S. CLS. 2, 13, 22, 25, 32 AND 50).
SIMON TENG, EXAMINING ATTORNEY

SN 77-288,362. ENVIRONMENTS, INC., BEAUFORT, SC. FILED 9-25-2007.

GO TOGETHERS

THE MARK CONSISTS OF STANDARD CHARACTERS WITHOUT CLAIM TO ANY PARTICULAR FONT, STYLE, SIZE, OR COLOR.
FOR FURNITURE (U.S. CLS. 2, 13, 22, 25, 32 AND 50).
FIRST USE 7-3-2007; IN COMMERCE 7-3-2007.
SUZANNE BLANE, EXAMINING ATTORNEY

CLASS 20—(Continued).

SN 77-288,449. SKIL-CARE CORPORATION, YONKERS, NY. FILED 9-25-2007.

HEELS-OFF

THE MARK CONSISTS OF STANDARD CHARACTERS WITHOUT CLAIM TO ANY PARTICULAR FONT, STYLE, SIZE, OR COLOR.
FOR LEG AND HEEL ELEVATING CUSHION (U.S. CLS. 2, 13, 22, 25, 32 AND 50).
FIRST USE 6-16-2006; IN COMMERCE 6-16-2006.
APRIL ROACH, EXAMINING ATTORNEY

SN 77-288,472. ENVIRONMENTS, INC., BEAUFORT, SC. FILED 9-25-2007.

PeekaBlue!

THE MARK CONSISTS OF STANDARD CHARACTERS WITHOUT CLAIM TO ANY PARTICULAR FONT, STYLE, SIZE, OR COLOR.
FOR FURNITURE (U.S. CLS. 2, 13, 22, 25, 32 AND 50).
FIRST USE 7-3-2007; IN COMMERCE 7-3-2007.
SUZANNE BLANE, EXAMINING ATTORNEY

SN 77-290,136. SITONIT OFFICE SEATING, INC., CYPRESS, CA. FILED 9-27-2007.

HABITAS

THE MARK CONSISTS OF STANDARD CHARACTERS WITHOUT CLAIM TO ANY PARTICULAR FONT, STYLE, SIZE, OR COLOR.
THE ENGLISH TRANSLATION OF THE WORD "HABITAS" IN THE MARK IS "YOU LIVE IN".
FOR FURNITURE (U.S. CLS. 2, 13, 22, 25, 32 AND 50).
PAUL CROWLEY, EXAMINING ATTORNEY

CLASS 20—(Continued).

SN 77-290,140. SITONIT OFFICE SEATING, INC., CYPRESS, CA. FILED 9-27-2007.

PROTOS

THE MARK CONSISTS OF STANDARD CHARACTERS WITHOUT CLAIM TO ANY PARTICULAR FONT, STYLE, SIZE, OR COLOR.

THE ENGLISH TRANSLATION OF THE WORD "PROTOS" IN THE MARK IS "FIRST," "PRIME," OR "PRIMARY". FOR FURNITURE (U.S. CLS. 2, 13, 22, 25, 32 AND 50). PAUL CROWLEY, EXAMINING ATTORNEY

SN 77-292,906. WILCOCK PRODUCTIONS, LLC, CUMMING, GA. FILED 10-1-2007.

SHELFANATOR

THE MARK CONSISTS OF STANDARD CHARACTERS WITHOUT CLAIM TO ANY PARTICULAR FONT, STYLE, SIZE, OR COLOR.

FOR SHELVING (U.S. CLS. 2, 13, 22, 25, 32 AND 50). FIRST USE 4-2-2007; IN COMMERCE 4-2-2007. KIMBERLY PERRY, EXAMINING ATTORNEY

SN 77-293,074. DOTY, PAMELA, POINT PLEASANT, NJ. FILED 10-1-2007.

HAPPY HARRY

THE MARK CONSISTS OF STANDARD CHARACTERS WITHOUT CLAIM TO ANY PARTICULAR FONT, STYLE, SIZE, OR COLOR.

FOR DEVICE FOR SCRATCHING PETS AND HUMANS, NAMELY, A GLOVE FOR SCRATCHING PETS AND HUMANS (U.S. CLS. 2, 13, 22, 25, 32 AND 50). TRACY WHITTAKER-BROWN, EXAMINING ATTORNEY

CLASS 20—(Continued).

SN 77-293,258. JASNIY, VICTOR, LAGUNA HILLS, CA. FILED 10-1-2007.

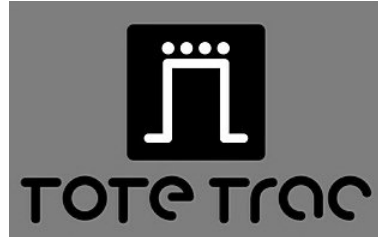

NO CLAIM IS MADE TO THE EXCLUSIVE RIGHT TO USE "TOTE", APART FROM THE MARK AS SHOWN.

THE MARK CONSISTS OF THE STYLIZED WORDS "TOTE TRAC" UNDERNEATH A SQUARE CONTAINING A STYLIZED IMAGE OF AN INVERTED-U SHAPED CHARACTER WITH FOUR DOTS ON TOP.

FOR STORAGE AND ORGANIZATION SYSTEMS COMPRISING SHELVES, DRAWERS, CUPBOARDS, BASKETS AND CLOTHES RODS, SOLD AS A UNIT; STORAGE RACKS (U.S. CLS. 2, 13, 22, 25, 32 AND 50).

FIRST USE 5-1-2007; IN COMMERCE 8-1-2007. CURTIS FRENCH, EXAMINING ATTORNEY

SN 77-293,913. SPIROPEDIC INC., COMMERCE, CA. FILED 10-2-2007.

SLEEP DEPOT

THE MARK CONSISTS OF STANDARD CHARACTERS WITHOUT CLAIM TO ANY PARTICULAR FONT, STYLE, SIZE, OR COLOR.

NO CLAIM IS MADE TO THE EXCLUSIVE RIGHT TO USE "SLEEP", APART FROM THE MARK AS SHOWN.

FOR SLEEP PRODUCTS, NAMELY, MATTRESSES, SPRING MATTRESSES, BOX SPRINGS AND MATTRESS FOUNDATIONS (U.S. CLS. 2, 13, 22, 25, 32 AND 50).

STEVEN R. FOSTER, EXAMINING ATTORNEY

SN 77-295,007. GARY WEEKS & COMPANY, WIMBERLEY, TX. FILED 10-3-2007.

The Weeks Rocker

THE MARK CONSISTS OF STANDARD CHARACTERS WITHOUT CLAIM TO ANY PARTICULAR FONT, STYLE, SIZE, OR COLOR.

NO CLAIM IS MADE TO THE EXCLUSIVE RIGHT TO USE "ROCKER", APART FROM THE MARK AS SHOWN.

FOR ROCKING CHAIRS (U.S. CLS. 2, 13, 22, 25, 32 AND 50).

FIRST USE 10-1-1997; IN COMMERCE 12-15-1997. PAUL F. GAST, EXAMINING ATTORNEY

CLASS 20—(Continued).

SN 77-295,836. THE CRAFT-ART COMPANY, INC., ATLANTA, GA. FILED 10-4-2007.

CRAFT-ART

THE MARK CONSISTS OF STANDARD CHARACTERS WITHOUT CLAIM TO ANY PARTICULAR FONT, STYLE, SIZE, OR COLOR.

FOR WOOD COUNTERTOPS AND TABLE TOPS (U.S. CLS. 2, 13, 22, 25, 32 AND 50).

FIRST USE 10-8-2001; IN COMMERCE 10-8-2001.
ELISSA GARBER KON, EXAMINING ATTORNEY

SN 77-296,240. RC GROUP, INC., LAGUNA NIGUEL, CA. FILED 10-4-2007.



THE MARK CONSISTS OF ABUTTING HOOKS FORMING THE LETTER "S".

FOR HANGING DEVICES, NAMELY, PLASTIC HOOKS FOR HANGING PURSES, BAGS, AND OTHER ITEMS (U.S. CLS. 2, 13, 22, 25, 32 AND 50).

FIRST USE 3-10-2007; IN COMMERCE 3-10-2007.
JAMES LOVELACE, EXAMINING ATTORNEY

SN 77-297,191. DAHLGREN ENTERPRISES, INC., DBA D/B/ A CRYSTAL D, ST. PAUL, MN. FILED 10-5-2007.

Wow idea!

THE MARK CONSISTS OF STANDARD CHARACTERS WITHOUT CLAIM TO ANY PARTICULAR FONT, STYLE, SIZE, OR COLOR.

FOR NON-METAL SCULPTURAL AWARDS, TROPHIES AND PLAQUES (U.S. CLS. 2, 13, 22, 25, 32 AND 50).

FIRST USE 1-31-2005; IN COMMERCE 1-31-2005.
KEVON CHISOLM, EXAMINING ATTORNEY

CLASS 20—(Continued).

SN 77-298,147. CROSSROADS ENTERPRISE, INC., FULLERTON, CA. FILED 10-7-2007.

CrossroadsUSA

THE MARK CONSISTS OF STANDARD CHARACTERS WITHOUT CLAIM TO ANY PARTICULAR FONT, STYLE, SIZE, OR COLOR.

NO CLAIM IS MADE TO THE EXCLUSIVE RIGHT TO USE "CABINTRY", APART FROM THE MARK AS SHOWN.

FOR KITCHEN CABINETS (U.S. CLS. 2, 13, 22, 25, 32 AND 50).

CAROLYN GRAY, EXAMINING ATTORNEY

SN 77-309,725. TONELERIA MAGREÑAN SL, ALFARO, SPAIN, FILED 10-22-2007.

MAGREÑAN COLECCION PRIVADA

THE MARK CONSISTS OF STANDARD CHARACTERS WITHOUT CLAIM TO ANY PARTICULAR FONT, STYLE, SIZE, OR COLOR.

OWNER OF U.S. REG. NO. 2,465,650.

NO CLAIM IS MADE TO THE EXCLUSIVE RIGHT TO USE "COLECCION PRIVADA", APART FROM THE MARK AS SHOWN.

THE ENGLISH TRANSLATION OF THE WORD "COLECCION PRIVADA" IN THE MARK IS "PRIVATE COLLECTION".

FOR WOOD BARRELS FOR WINE PRESERVATION, WOOD CASKS FOR WINE PRESERVATION, CONTAINERS NOT OF METAL FOR COMMERCIAL USE, WOOD CRATES, WOOD KEGS (U.S. CLS. 2, 13, 22, 25, 32 AND 50).

ESTHER A. BORSUK, EXAMINING ATTORNEY

SN 77-311,444. BLUMENTHAL DISTRIBUTING, INC., DBA OFFICE STAR PRODUCTS, ONTARIO, CA. FILED 10-23-2007.

OSP FURNITURE

THE MARK CONSISTS OF STANDARD CHARACTERS WITHOUT CLAIM TO ANY PARTICULAR FONT, STYLE, SIZE, OR COLOR.

NO CLAIM IS MADE TO THE EXCLUSIVE RIGHT TO USE "FURNITURE", APART FROM THE MARK AS SHOWN.

FOR OFFICE FURNITURE (U.S. CLS. 2, 13, 22, 25, 32 AND 50).

FIRST USE 9-30-2006; IN COMMERCE 9-30-2006.
DEZMONA MIZELLE, EXAMINING ATTORNEY

CLASS 20—(Continued).

SN 77-311,549. BLUMENTHAL DISTRIBUTING, INC., DBA OFFICE STAR PRODUCTS, ONTARIO, CA. FILED 10-23-2007.

OSP DESIGNS

THE MARK CONSISTS OF STANDARD CHARACTERS WITHOUT CLAIM TO ANY PARTICULAR FONT, STYLE, SIZE, OR COLOR.

NO CLAIM IS MADE TO THE EXCLUSIVE RIGHT TO USE "DESIGNS", APART FROM THE MARK AS SHOWN.

FOR OFFICE FURNITURE (U.S. CLS. 2, 13, 22, 25, 32 AND 50).

DEZMONA MIZELLE, EXAMINING ATTORNEY



SN 77-311,596. VERTICAL BRANDING, INC., ENCINO, CA. FILED 10-23-2007.

My Place

THE MARK CONSISTS OF STANDARD CHARACTERS WITHOUT CLAIM TO ANY PARTICULAR FONT, STYLE, SIZE, OR COLOR.

FOR COMPUTER FURNITURE; COMPUTER WORKSTATIONS COMPRISING PORTABLE LAPTOP TABLE (U.S. CLS. 2, 13, 22, 25, 32 AND 50).

CHRIS WELLS, EXAMINING ATTORNEY



SN 77-313,135. SERTA, INC., HOFFMAN ESTATES, IL. FILED 10-25-2007.

PRO-COMFORT

THE MARK CONSISTS OF STANDARD CHARACTERS WITHOUT CLAIM TO ANY PARTICULAR FONT, STYLE, SIZE, OR COLOR.

OWNER OF U.S. REG. NOS. 1,886,618, 3,319,300 AND OTHERS.

FOR MATTRESSES AND MATTRESS FOUNDATIONS (U.S. CLS. 2, 13, 22, 25, 32 AND 50).

PAUL CROWLEY, EXAMINING ATTORNEY

CLASS 20—(Continued).

SN 78-485,894. IDEASTREAM CONSUMER PRODUCTS, LLC, PARMA, OH. FILED 9-19-2004.

IDEASTREAM CONSUMER PRODUCTS

THE MARK CONSISTS OF STANDARD CHARACTERS WITHOUT CLAIM TO ANY PARTICULAR FONT, STYLE, SIZE, OR COLOR.

NO CLAIM IS MADE TO THE EXCLUSIVE RIGHT TO USE "CONSUMER PRODUCTS", APART FROM THE MARK AS SHOWN.

FOR (BASED ON USE IN COMMERCE) OFFICE STORAGE CONTAINERS, NAMELY, NON-METAL MONEY BOXES AND NON-METAL CRAFT BOXES; PLASTIC BOXES FOR STORAGE UNDER BEDS; AND (BASED ON INTENT TO USE) NON-METAL CONTAINERS FOR FIRST-AID KITS SOLD EMPTY (U.S. CLS. 2, 13, 22, 25, 32 AND 50).

FIRST USE 12-31-2003; IN COMMERCE 12-31-2003.

MELVIN AXILBUND, EXAMINING ATTORNEY



SN 78-808,990. HOOP-DEE-DOO, L.L.C., ATLANTIC HIGHLANDS, NJ. FILED 2-7-2006.

HOOP DEE DOO

THE MARK CONSISTS OF STANDARD CHARACTERS WITHOUT CLAIM TO ANY PARTICULAR FONT, STYLE, SIZE, OR COLOR.

FOR PET WASTE COLLECTION DEVICE COMPOSED OF A NON-METAL HOOP AND BAG ASSEMBLY FOR THE COLLECTION OF WASTE (U.S. CLS. 2, 13, 22, 25, 32 AND 50).

VERNA BETH RIRIE, EXAMINING ATTORNEY



SN 78-831,120. 37 ELEPHANTS MARKETING LLC, ATLANTA, GA. FILED 3-7-2006.

HERITAGE EGG COLLECTION

THE MARK CONSISTS OF STANDARD CHARACTERS WITHOUT CLAIM TO ANY PARTICULAR FONT, STYLE, SIZE, OR COLOR.

NO CLAIM IS MADE TO THE EXCLUSIVE RIGHT TO USE "EGG COLLECTION", APART FROM THE MARK AS SHOWN.

FOR ORNAMENTS, NOT CHRISTMAS TREE ORNAMENTS, MADE OF PRESERVED EGGSHELL FEATURING A PLASTIC COATING FOR DECORATIVE AND STRENGTHENING PURPOSES (U.S. CLS. 2, 13, 22, 25, 32 AND 50).

EDWARD NELSON, EXAMINING ATTORNEY

CLASS 20—(Continued).

SN 78-901,759. LELAND MANUFACTURING, LLC, FERDINAND, IN. FILED 6-6-2006.

Furniture Designs With Vision

THE MARK CONSISTS OF STANDARD CHARACTERS WITHOUT CLAIM TO ANY PARTICULAR FONT, STYLE, SIZE, OR COLOR.

FOR OFFICE FURNITURE (U.S. CLS. 2, 13, 22, 25, 32 AND 50).

FIRST USE 6-1-2005; IN COMMERCE 6-1-2005.

MARK RADEMACHER, EXAMINING ATTORNEY

SN 78-944,300. MERBETH, LAURA J., SUSSEX, WI. FILED 8-3-2006.

SHOWOFF

THE MARK CONSISTS OF STANDARD CHARACTERS WITHOUT CLAIM TO ANY PARTICULAR FONT, STYLE, SIZE, OR COLOR.

FOR RACKS FOR RETAINING AWARDS, RIBBONS, METALS OR TROPHIES (U.S. CLS. 2, 13, 22, 25, 32 AND 50).

KELLY BOULTON, EXAMINING ATTORNEY

SN 79-037,525. M & G S.P.A., ITALY, FILED 1-30-2007.



OWNER OF INTERNATIONAL REGISTRATION 0921550 DATED 1-30-2007, EXPIRES 1-30-2017.

NO CLAIM IS MADE TO THE EXCLUSIVE RIGHT TO USE IL FAMOSO MATERASSO, APART FROM THE MARK AS SHOWN.

THE COLOR(S) WHITE, RED AND BLACK IS/ARE CLAIMED AS A FEATURE OF THE MARK.

THE MARK CONSISTS OF A PICTURE OF A SLEEPING MAN WEARING RED, WHITE AND BLACK-STRIPED PYJAMAS; THE MAN IS LYING ABOVE THE WORD

CLASS 20—(Continued).

"PERMAFLEX", WRITTEN IN FANCY RED CHARACTERS AND CONTAINED WITHIN TWO PARALLEL BLACK SEGMENTS, UNDER WHICH THERE IS THE WORDING "IL FAMOSO MATERASSO" IN BLACK; AN ELLIPTICAL RED LINE CONTAINS THE TWO WORDINGS AND THE TWO SEGMENTS; THE SLEEPING MAN INTERRUPTS THE ELLIPTICAL LINE AND THE UPPER SEGMENT. HIS FACE AND FEET ARE WHITE. WHITE APPEARING WITHIN THE OVAL CONSTITUTES BACKGROUND ONLY AND IS NOT CLAIMED AS A FEATURE OF THE MARK.

"THE FOREIGN WORDING IN THE MARK TRANSLATES INTO ENGLISH AS THE FAMOUS MATTRESS."

FOR MATTRESSES; LATEX MATTRESSES; SPRING MATTRESSES; PILLOWS, LATEX PILLOWS; SPRUNG BED BASES (U.S. CLS. 2, 13, 22, 25, 32 AND 50).

REBECCA POVARCHUK, EXAMINING ATTORNEY

SN 79-039,901. CASSINA S.P.A., ITALY, FILED 4-16-2007.

MEX

THE MARK CONSISTS OF STANDARD CHARACTERS WITHOUT CLAIM TO ANY PARTICULAR FONT, STYLE, SIZE, OR COLOR.

PRIORITY DATE OF 1-26-2007 IS CLAIMED.

OWNER OF INTERNATIONAL REGISTRATION 0927814 DATED 4-16-2007, EXPIRES 4-16-2017.

FOR FURNITURE FOR LIVING ROOM AND BEDROOMS, GARDEN FURNITURE, STUFFED FURNITURE, OFFICE FURNITURE, CHAIRS, ARMCHAIRS, SOFAS, BOOKSHELVES, MIRRORS AND SMALL FURNITURE; DIVANS; SOFA BEDS; SETTEES; TABLES; WRITING DESKS; BEDS; CUSHIONS; PAPER PHOTO FRAMES (U.S. CLS. 2, 13, 22, 25, 32 AND 50).

MARK SPACINO, EXAMINING ATTORNEY

CLASS 21—HOUSEWARES AND GLASS

SN 76-664,460. CHOI, WOI SUK, LOS ANGELES, CA. FILED 8-10-2006.

Happy Cook

THE MARK CONSISTS OF STANDARD CHARACTERS WITHOUT CLAIM TO ANY PARTICULAR FONT, STYLE, SIZE, OR COLOR.

NO CLAIM IS MADE TO THE EXCLUSIVE RIGHT TO USE "COOK", APART FROM THE MARK AS SHOWN.

FOR KITCHEN UTENSILS AND KITCHENWARE, NAMELY, COOKING POT SETS, COOKING POTS AND PANS, POT AND PAN SCRAPERS, POT CLEANING BRUSHES, POT LIDS, POT STANDS, RICE COOKING, SHAVING POTS, TEA POTS NON-ELECTRIC, TEA POTS MADE OF PRECIOUS METALS; TEA POTS NOT OF PRECIOUS METAL, TEA POTS OF PRECIOUS METAL, ROLLING PINS, SPATULAS, TURNERS, WHISKS, LADDLES, FOOD BASTERS, SERVINGWARE FOR SERVING FOOD, PLATES, COLANDERS, PEPPER POTS, SUGAR BOWLS AND SALT SHAKERS NOT OF PRECIOUS METAL, DRINKING GLASSES (U.S. CLS. 2, 13, 23, 29, 30, 33, 40 AND 50).

REBECCA POVARCHUK, EXAMINING ATTORNEY

SN 76-680,431. JOYCE L. PEABODY, SARATOGA SPRINGS, NY. FILED 8-7-2007.

REFLECTIONS OF THE SOUL BY JOYCE

THE MARK CONSISTS OF STANDARD CHARACTERS WITHOUT CLAIM TO ANY PARTICULAR FONT, STYLE, SIZE, OR COLOR.

FOR ART GLASS PIECES, NAMELY, BOWLS, DISHES AND SERVING PLATTERS (U.S. CLS. 2, 13, 23, 29, 30, 33, 40 AND 50).

FIRST USE 12-1-2005; IN COMMERCE 6-2-2006.

ALICE BENMAMAN, EXAMINING ATTORNEY

SN 77-001,444. GOODY PRODUCTS, INC., ATLANTA, GA. FILED 9-18-2006.

STYLING THERAPY

THE MARK CONSISTS OF STANDARD CHARACTERS WITHOUT CLAIM TO ANY PARTICULAR FONT, STYLE, SIZE, OR COLOR.

NO CLAIM IS MADE TO THE EXCLUSIVE RIGHT TO USE "STYLING", APART FROM THE MARK AS SHOWN.

FOR HAIR BRUSHES AND COMBS (U.S. CLS. 2, 13, 23, 29, 30, 33, 40 AND 50).

HOWARD SMIGA, EXAMINING ATTORNEY

CLASS 21—(Continued).

SN 77-020,757. P&G BUSINESS SERVICES CANADA COMPANY, HALIFAX, CANADA, FILED 10-13-2006.

DUAL CLEAN

THE MARK CONSISTS OF STANDARD CHARACTERS WITHOUT CLAIM TO ANY PARTICULAR FONT, STYLE, SIZE, OR COLOR.

NO CLAIM IS MADE TO THE EXCLUSIVE RIGHT TO USE "CLEAN", APART FROM THE MARK AS SHOWN.

FOR REPLACEMENT HEADS FOR TOOTHBRUSHES (U.S. CLS. 2, 13, 23, 29, 30, 33, 40 AND 50).

CAROLINE WOOD, EXAMINING ATTORNEY

SN 77-123,989. EVRIHOLDER PRODUCTS, INC., ANAHEIM, CA. FILED 3-6-2007.

SHOE BEANS

THE MARK CONSISTS OF STANDARD CHARACTERS WITHOUT CLAIM TO ANY PARTICULAR FONT, STYLE, SIZE, OR COLOR.

NO CLAIM IS MADE TO THE EXCLUSIVE RIGHT TO USE "SHOE", APART FROM THE MARK AS SHOWN.

FOR SHOE TREES (U.S. CLS. 2, 13, 23, 29, 30, 33, 40 AND 50).

PAUL F. GAST, EXAMINING ATTORNEY

SN 77-123,990. EVRIHOLDER PRODUCTS, INC., ANAHEIM, CA. FILED 3-6-2007.

SLIPPER GENIE

THE MARK CONSISTS OF STANDARD CHARACTERS WITHOUT CLAIM TO ANY PARTICULAR FONT, STYLE, SIZE, OR COLOR.

NO CLAIM IS MADE TO THE EXCLUSIVE RIGHT TO USE "SLIPPER", APART FROM THE MARK AS SHOWN.

FOR SLIPPERS WITH MICROFIBER SOLES FOR CLEANING PURPOSES (U.S. CLS. 2, 13, 23, 29, 30, 33, 40 AND 50).

PAUL F. GAST, EXAMINING ATTORNEY

CLASS 21—(Continued).

SN 77-125,349. EVRIHOLDER PRODUCTS, INC., ANAHEIM, CA. FILED 3-8-2007.

BOOT MATES

THE MARK CONSISTS OF STANDARD CHARACTERS WITHOUT CLAIM TO ANY PARTICULAR FONT, STYLE, SIZE, OR COLOR.

NO CLAIM IS MADE TO THE EXCLUSIVE RIGHT TO USE "BOOT", APART FROM THE MARK AS SHOWN.

FOR BOOT TREES (U.S. CLS. 2, 13, 23, 29, 30, 33, 40 AND 50).

PAUL F. GAST, EXAMINING ATTORNEY

CLASS 21—(Continued).

SN 77-135,717. RABBITAT, INC., DIX HILLS, NY. FILED 3-20-2007.

BUNNIHOP LOUNGE

THE MARK CONSISTS OF STANDARD CHARACTERS WITHOUT CLAIM TO ANY PARTICULAR FONT, STYLE, SIZE, OR COLOR.

FOR CAGES FOR PETS (U.S. CLS. 2, 13, 23, 29, 30, 33, 40 AND 50).

MARY MUNSON, EXAMINING ATTORNEY

SN 77-130,290. BRYAN MANSFIELD, BRADENTON, FL. FILED 3-13-2007.

TUBE TOPPERS

THE MARK CONSISTS OF STANDARD CHARACTERS WITHOUT CLAIM TO ANY PARTICULAR FONT, STYLE, SIZE, OR COLOR.

FOR CUPS (U.S. CLS. 2, 13, 23, 29, 30, 33, 40 AND 50).

CAROL SPILS, EXAMINING ATTORNEY

SN 77-135,724. RABBITAT, INC., DIX HILLS, NY. FILED 3-20-2007.

HAPPITAT

THE MARK CONSISTS OF STANDARD CHARACTERS WITHOUT CLAIM TO ANY PARTICULAR FONT, STYLE, SIZE, OR COLOR.

FOR CAGES FOR PETS (U.S. CLS. 2, 13, 23, 29, 30, 33, 40 AND 50).

MARY MUNSON, EXAMINING ATTORNEY

SN 77-135,669. RABBITAT, INC., DIX HILLS, NY. FILED 3-20-2007.

RABISHACK

THE MARK CONSISTS OF STANDARD CHARACTERS WITHOUT CLAIM TO ANY PARTICULAR FONT, STYLE, SIZE, OR COLOR.

FOR CAGES FOR PETS (U.S. CLS. 2, 13, 23, 29, 30, 33, 40 AND 50).

MARY MUNSON, EXAMINING ATTORNEY

SN 77-148,488. EMERIL'S FOOD OF LOVE PRODUCTIONS, LLC, NEW ORLEANS, LA. FILED 4-4-2007.

REAL & RUSTIC

THE MARK CONSISTS OF STANDARD CHARACTERS WITHOUT CLAIM TO ANY PARTICULAR FONT, STYLE, SIZE, OR COLOR.

FOR COOKWARE, NAMELY, POTS AND PANS; BAKEDWARE (U.S. CLS. 2, 13, 23, 29, 30, 33, 40 AND 50).

KAREN BRACEY, EXAMINING ATTORNEY

CLASS 21—(Continued).

SN 77-160,492. GEOGLOBAL PARTNERS, LLC, SOUTH PLAINFIELD, NJ. FILED 4-19-2007.

CANINE CASTLES

THE MARK CONSISTS OF STANDARD CHARACTERS WITHOUT CLAIM TO ANY PARTICULAR FONT, STYLE, SIZE, OR COLOR.

NO CLAIM IS MADE TO THE EXCLUSIVE RIGHT TO USE "CANINE", APART FROM THE MARK AS SHOWN.

FOR INDOOR PET CAGES (U.S. CLS. 2, 13, 23, 29, 30, 33, 40 AND 50).

LESLIE RICHARDS, EXAMINING ATTORNEY



SN 77-162,291. INSECT LORE PRODUCTS, SHAFTER, CA. FILED 4-20-2007.

BULLFROG BOG

THE MARK CONSISTS OF STANDARD CHARACTERS WITHOUT CLAIM TO ANY PARTICULAR FONT, STYLE, SIZE, OR COLOR.

NO CLAIM IS MADE TO THE EXCLUSIVE RIGHT TO USE "BULLFROG", APART FROM THE MARK AS SHOWN.

FOR FROG HABITATS (U.S. CLS. 2, 13, 23, 29, 30, 33, 40 AND 50).

MICHAEL SOUDERS, EXAMINING ATTORNEY

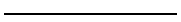

SN 77-162,463. MICHAEL DWORK, NEW YORK, NY. FILED 4-21-2007.

Luxury Disposable

THE MARK CONSISTS OF STANDARD CHARACTERS WITHOUT CLAIM TO ANY PARTICULAR FONT, STYLE, SIZE, OR COLOR.

NO CLAIM IS MADE TO THE EXCLUSIVE RIGHT TO USE DISPOSABLE, APART FROM THE MARK AS SHOWN.

FOR COMMEMORATIVE PLATES; DECORATIVE PLATES; DINNERWARE, NAMELY, PLATES, TRAYS, CUPS AND BOWLS; DISHES AND PLATES; DISPOSABLE TABLE PLATES; PLATES; PLATES FOR HORS D'OEUVRE (U.S. CLS. 2, 13, 23, 29, 30, 33, 40 AND 50).

GEORGIA CARTY, EXAMINING ATTORNEY

CLASS 21—(Continued).

SN 77-164,820. HUANG, PANG-YU, PORTLAND, OR. FILED 4-25-2007.



THE MARK CONSISTS OF A VASE WITH A SPLASH WAVE IN FRONT.

FOR MUGS; DINNERWARE, NAMELY, PLATES, CUPS, POTS, SPOONS (U.S. CLS. 2, 13, 23, 29, 30, 33, 40 AND 50).

DORITT L. CARROLL, EXAMINING ATTORNEY

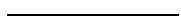

SN 77-212,382. LAMINATIONS, INC., SCRANTON, PA. FILED 6-21-2007.

THE BEST THING FOR YOUR GARDEN SINCE DIRT

THE MARK CONSISTS OF STANDARD CHARACTERS WITHOUT CLAIM TO ANY PARTICULAR FONT, STYLE, SIZE, OR COLOR.

FOR CONTAINER GARDENING SYSTEM CONSISTING OF A CONTAINER FOR GROWING VEGETABLES AND FLOWERS, A STAKING SYSTEM CONSISTING OF RIGID TUBING SECTIONS AND CONNECTORS THEREFOR AND PLANTING KIT CONSISTING OF POTTING MIX, DOLOMITE AND FERTILIZER, SOLD AS A UNIT (U.S. CLS. 2, 13, 23, 29, 30, 33, 40 AND 50).

LOURDES AYALA, EXAMINING ATTORNEY

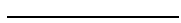

SN 77-212,408. LAMINATIONS, INC., SCRANTON, PA. FILED 6-21-2007.

MAKING FOOD HAPPEN WHERE IT COULDN'T BEFORE

THE MARK CONSISTS OF STANDARD CHARACTERS WITHOUT CLAIM TO ANY PARTICULAR FONT, STYLE, SIZE, OR COLOR.

FOR CONTAINER GARDENING SYSTEM CONSISTING OF A CONTAINER FOR GROWING VEGETABLES AND FLOWERS, A STAKING SYSTEM CONSISTING OF RIGID TUBING SECTIONS AND CONNECTORS THEREFOR AND PLANTING KIT CONSISTING OF POTTING MIX, DOLOMITE AND FERTILIZER, SOLD AS A UNIT (U.S. CLS. 2, 13, 23, 29, 30, 33, 40 AND 50).

LOURDES AYALA, EXAMINING ATTORNEY

CLASS 21—(Continued).

SN 77-218,071. GEORGIA-PACIFIC CONSUMER PRODUCTS LP, ATLANTA, GA. FILED 6-28-2007.

MARATHON GREEN

THE MARK CONSISTS OF STANDARD CHARACTERS WITHOUT CLAIM TO ANY PARTICULAR FONT, STYLE, SIZE, OR COLOR.

OWNER OF U.S. REG. NO. 790,719.
NO CLAIM IS MADE TO THE EXCLUSIVE RIGHT TO USE "GREEN", APART FROM THE MARK AS SHOWN.
FOR DISPENSERS FOR PAPER TOWELS; TOILET PAPER DISPENSERS (U.S. CLS. 2, 13, 23, 29, 30, 33, 40 AND 50).

ROBERT C. CLARK JR., EXAMINING ATTORNEY

SN 77-238,556. GLASHUETTE VALENTIN EISCH GMBH, FRAUENAU, FED REP GERMANY, FILED 7-25-2007.

EISCH GLASKULTUR

THE MARK CONSISTS OF STANDARD CHARACTERS WITHOUT CLAIM TO ANY PARTICULAR FONT, STYLE, SIZE, OR COLOR.

OWNER OF U.S. REG. NO. 3,248,804.
NO CLAIM IS MADE TO THE EXCLUSIVE RIGHT TO USE "GLASKULTUR", APART FROM THE MARK AS SHOWN.

THE ENGLISH TRANSLATION OF THE WORD "GLASKULTUR" IN THE MARK IS "GLASS CULTURE".

FOR DRINKING GLASSES; WINE GLASSES; MARTINI GLASSES; COCKTAIL GLASSES; CHAMPAGNE GLASSES; BEER GLASSES; DECANTERS; GLASS STOPPERS; STEMWARE; BEVERAGE WARE; BEVERAGE GLASSWARE (U.S. CLS. 2, 13, 23, 29, 30, 33, 40 AND 50).

FIRST USE 5-26-2004; IN COMMERCE 5-26-2004.

JOHN WILKE, EXAMINING ATTORNEY

SN 77-238,572. GLASHUETTE VALENTIN EISCH GMBH, FRAUENAU, FED REP GERMANY, FILED 7-25-2007.

BREATHABLE GLASS

THE MARK CONSISTS OF STANDARD CHARACTERS WITHOUT CLAIM TO ANY PARTICULAR FONT, STYLE, SIZE, OR COLOR.

OWNER OF U.S. REG. NO. 3,248,804.
NO CLAIM IS MADE TO THE EXCLUSIVE RIGHT TO USE "GLASS", APART FROM THE MARK AS SHOWN.

FOR DRINKING GLASSES; WINE GLASSES; CHAMPAGNE GLASSES (U.S. CLS. 2, 13, 23, 29, 30, 33, 40 AND 50).

FIRST USE 12-21-2004; IN COMMERCE 12-21-2004.

JOHN WILKE, EXAMINING ATTORNEY

CLASS 21—(Continued).

SN 77-244,456. EUROVAP PRODUCTS LIMITED, AVONDALE, AUCKLAND, NEW ZEALAND, FILED 8-1-2007.

EURO-CLOTH

THE MARK CONSISTS OF STANDARD CHARACTERS WITHOUT CLAIM TO ANY PARTICULAR FONT, STYLE, SIZE, OR COLOR.

FOR HOUSEHOLD CLEANING CLOTHS; KITS CONTAINING HOUSEHOLD CLEANING CLOTHS AND CLEANING SOLUTION (U.S. CLS. 2, 13, 23, 29, 30, 33, 40 AND 50).

FIRST USE 12-0-2003; IN COMMERCE 12-0-2003.

LINDA ESTRADA, EXAMINING ATTORNEY

SN 77-245,649. PIAO I ENTERPRISE CO., LTD., NANTOU COUNTY, TAIWAN, FILED 8-2-2007.

Travel Buddy

NO CLAIM IS MADE TO THE EXCLUSIVE RIGHT TO USE "TRAVEL", APART FROM THE MARK AS SHOWN.

FOR ENAMEL HOUSEHOLD UTENSILS, NAMELY, BASINS, BOWLS, TRAYS, TEA KETTLES AND CUPS; NON-PRECIOUS METAL CUPS, GLASS CUPS, NON-PRECIOUS METAL TEA JARS; NON-PRECIOUS METAL TEA SETS, NON-PRECIOUS METAL TEA STRAINERS, NON-ELECTRICAL AND NON-PRECIOUS METAL COFFEE MAKERS; PLASTIC HOUSEHOLD UTENSILS, NAMELY, SPATULAS (U.S. CLS. 2, 13, 23, 29, 30, 33, 40 AND 50).

FIRST USE 8-11-2002; IN COMMERCE 8-11-2002.

YAT SYE, LEE, EXAMINING ATTORNEY

SN 77-248,723. THE LITTLE BLACK APRON, LLC, DIX HILLS, NY. FILED 8-7-2007.



THE MARK CONSISTS OF A STYLIZED APRON DESIGN ON THE LEFT OF THE STYLIZED WORDS "THE LITTLE BLACK APRON".

FOR SPATULAS (U.S. CLS. 2, 13, 23, 29, 30, 33, 40 AND 50).

RON FAIRBANKS, EXAMINING ATTORNEY

CLASS 21—(Continued).

SN 77-275,728. ROCCADO INTL LLC, PORT CLINTON, OH. FILED 9-10-2007.

ROCCADO

THE MARK CONSISTS OF STANDARD CHARACTERS WITHOUT CLAIM TO ANY PARTICULAR FONT, STYLE, SIZE, OR COLOR.

THE WORDING "ROCCADO" HAS NO MEANING IN A FOREIGN LANGUAGE.

FOR DECORATIVE LIDS MADE OF PAPERBOARD AND LATEX RUBBER FOR USE ON BEVERAGE CONTAINERS (U.S. CLS. 2, 13, 23, 29, 30, 33, 40 AND 50).

FIRST USE 9-5-2007; IN COMMERCE 9-5-2007.
CURTIS FRENCH, EXAMINING ATTORNEY

CLASS 21—(Continued).

SN 77-281,756. INNOVATIVE IDEAS LIMITED, HONG KONG, HONG KONG, FILED 9-18-2007.

SN 77-278,513. LIFETIME BRANDS, INC., GARDEN CITY, NY. FILED 9-13-2007.

LOTUS

THE MARK CONSISTS OF STANDARD CHARACTERS WITHOUT CLAIM TO ANY PARTICULAR FONT, STYLE, SIZE, OR COLOR.

FOR TRASH BINS; TOILET BOWL BRUSH; PLUNGERS FOR CLEARING BLOCKED DRAINS; KITCHEN UTENSIL HOLDERS; GARBAGE CONTAINERS FOR HOUSEHOLD USE; PLASTIC STORAGE CONTAINERS FOR HOUSEHOLD USE (U.S. CLS. 2, 13, 23, 29, 30, 33, 40 AND 50).

REBECCA EISINGER, EXAMINING ATTORNEY

NO CLAIM IS MADE TO THE EXCLUSIVE RIGHT TO USE "KITCHEN", APART FROM THE MARK AS SHOWN. FOR UTENSILS FOR BARBECUES, NAMELY, FORKS, TONGS, TURNERS (U.S. CLS. 2, 13, 23, 29, 30, 33, 40 AND 50).

ALLISON HOLTZ, EXAMINING ATTORNEY

SN 77-282,177. LOLIPOP KIDS, INC., DBA NAME EXPRESS, COCONUT CREEK, FL. FILED 9-18-2007.

SN 77-281,058. ALUTA, INC., CINCINNATI, OH. FILED 9-17-2007.

NO CLAIM IS MADE TO THE EXCLUSIVE RIGHT TO USE "CARE", APART FROM THE MARK AS SHOWN. FOR DISPENSERS FOR LIQUID SOAP (U.S. CLS. 2, 13, 23, 29, 30, 33, 40 AND 50).

KEVON CHISOLM, EXAMINING ATTORNEY

FOR HAIR BRUSHES (U.S. CLS. 2, 13, 23, 29, 30, 33, 40 AND 50).

FIRST USE 9-15-2007; IN COMMERCE 9-15-2007.
DOMINIC FATHY, EXAMINING ATTORNEY

CLASS 21—(Continued).

SN 77-283,565. DELTA HOSPITAL SUPPLY, INC., NORWOOD, MA. FILED 9-19-2007.

GOURMET GLOVES

THE MARK CONSISTS OF STANDARD CHARACTERS WITHOUT CLAIM TO ANY PARTICULAR FONT, STYLE, SIZE, OR COLOR.

NO CLAIM IS MADE TO THE EXCLUSIVE RIGHT TO USE "GLOVES", APART FROM THE MARK AS SHOWN.

FOR DISPOSABLE LATEX, VINYL AND NITRILE GLOVES FOR FOOD HANDLING AND PREPARATION, COOKING AND CLEANING, RESTAURANT AND BANQUET SERVICE, AND ALL CULINARY USAGE (U.S. CLS. 2, 13, 23, 29, 30, 33, 40 AND 50).

FIRST USE 4-5-2007; IN COMMERCE 4-5-2007.

LOURDES AYALA, EXAMINING ATTORNEY

SN 77-283,785. OCEAN GLASS PUBLIC COMPANY LIMITED, BANGKOK, THAILAND, FILED 9-19-2007.

LUCARIS

THE MARK CONSISTS OF STANDARD CHARACTERS WITHOUT CLAIM TO ANY PARTICULAR FONT, STYLE, SIZE, OR COLOR.

FOR BEVERAGE GLASSWARE (U.S. CLS. 2, 13, 23, 29, 30, 33, 40 AND 50).

NAPOLEON SHARMA, EXAMINING ATTORNEY

SN 77-284,546. THE BOTTLE CREW, LLC, WEST BLOOMFIELD, MI. FILED 9-20-2007.



THE MARK CONSISTS OF A SUITCASE-LOOKING ITEM WITH THE LETTERS "iGo" IN THE MIDDLE.

FOR TRAVEL CONTAINERS SOLD EMPTY, NAMELY, BOTTLES, TUBES AND JARS; TOOTHBRUSH HOLDERS; SOAP HOLDERS (U.S. CLS. 2, 13, 23, 29, 30, 33, 40 AND 50).

FIRST USE 9-10-2007; IN COMMERCE 9-10-2007.

DAWN FELDMAN, EXAMINING ATTORNEY

CLASS 21—(Continued).

SN 77-286,038. UP COUNTRY INC., EAST PROVIDENCE, RI. FILED 9-21-2007.

UP COUNTRY

THE MARK CONSISTS OF STANDARD CHARACTERS WITHOUT CLAIM TO ANY PARTICULAR FONT, STYLE, SIZE, OR COLOR.

OWNER OF U.S. REG. NO. 1,303,720.
FOR PET FOOD BOWLS, CUPS AND CANISTERS (U.S. CLS. 2, 13, 23, 29, 30, 33, 40 AND 50).

ZACHARY BELLO, EXAMINING ATTORNEY

SN 77-287,938. CHURCH & DWIGHT CO., INC., PRINCETON, NJ. FILED 9-25-2007.

SPINBRUSH PRO WHITENING

THE MARK CONSISTS OF STANDARD CHARACTERS WITHOUT CLAIM TO ANY PARTICULAR FONT, STYLE, SIZE, OR COLOR.

OWNER OF U.S. REG. NOS. 2,710,298 AND 2,882,803.
NO CLAIM IS MADE TO THE EXCLUSIVE RIGHT TO USE "WHITENING", APART FROM THE MARK AS SHOWN.

SEC. 2(F) AS TO "SPINBRUSH".
FOR BATTERY POWERED TOOTHBRUSHES (U.S. CLS. 2, 13, 23, 29, 30, 33, 40 AND 50).

FIRST USE 1-9-2004; IN COMMERCE 1-9-2004.

JULIE GUTTADAURO, EXAMINING ATTORNEY

SN 77-288,444. SERGEANT'S PET CARE PRODUCTS, INC., OMAHA, NE. FILED 9-25-2007.

POOCHI

THE MARK CONSISTS OF STANDARD CHARACTERS WITHOUT CLAIM TO ANY PARTICULAR FONT, STYLE, SIZE, OR COLOR.

OWNER OF U.S. REG. NOS. 1,493,123 AND 3,271,667.
FOR PET GROOMING PRODUCTS, NAMELY, BRUSHES AND COMBS; PET FEEDING DISHES (U.S. CLS. 2, 13, 23, 29, 30, 33, 40 AND 50).

BENJAMIN OKEKE, EXAMINING ATTORNEY

CLASS 21—(Continued).

SN 77-289,195. MARY KAY INC., ADDISON, TX. FILED 9-26-2007.

COMPACT PRO

THE MARK CONSISTS OF STANDARD CHARACTERS WITHOUT CLAIM TO ANY PARTICULAR FONT, STYLE, SIZE, OR COLOR.

NO CLAIM IS MADE TO THE EXCLUSIVE RIGHT TO USE "COMPACT", APART FROM THE MARK AS SHOWN. FOR (BASED ON INTENT TO USE) COMPACTS SOLD EMPTY (U.S. CLS. 2, 13, 23, 29, 30, 33, 40 AND 50).

DORITT L. CARROLL, EXAMINING ATTORNEY

SN 77-291,329. VAN ART, ROGER L., COLORADO SPRINGS, CO. FILED 9-28-2007.

HydraGluv

THE MARK CONSISTS OF STANDARD CHARACTERS WITHOUT CLAIM TO ANY PARTICULAR FONT, STYLE, SIZE, OR COLOR.

FOR PERSONAL FLUID HYDRATION SYSTEMS COMPRISING A FLUID RESERVOIR, A DELIVERY TUBE, A MOUTHPIECE AND A CARRYING PACK (U.S. CLS. 2, 13, 23, 29, 30, 33, 40 AND 50).

RICHARD A. STRASER, EXAMINING ATTORNEY

SN 77-291,526. JONES, TREFOR THOMAS, BLOOMFIELD HILLS, MI. FILED 9-28-2007.

FlatTopps

THE MARK CONSISTS OF STANDARD CHARACTERS WITHOUT CLAIM TO ANY PARTICULAR FONT, STYLE, SIZE, OR COLOR.

FOR SERVING TRAYS (U.S. CLS. 2, 13, 23, 29, 30, 33, 40 AND 50).

LINDA E. BLOHM, EXAMINING ATTORNEY

CLASS 21—(Continued).

SN 77-291,882. TABLETOPS UNLIMITED, INC., CARSON, CA. FILED 9-28-2007.



OWNER OF U.S. REG. NOS. 3,127,527, 3,240,691 AND OTHERS.

NO CLAIM IS MADE TO THE EXCLUSIVE RIGHT TO USE "KITCHEN PREP", APART FROM THE MARK AS SHOWN.

FOR DISHES, PLATES, BOWLS, MUGS, CUPS, SAUCERS, NON-ELECTRIC IRON GRIDDLE, IRON BACON PRESS FOR COOKING, EGG RING FOR MAKING POACHED EGGS, EGG POACHER, COOKING POTS AND PANS, SLOTTED EGG TURNER, KITCHEN LADLE, FRYING PAN, CUTTING BOARDS, BAKING PANS, MIXING BOWLS, WHISKS, CULINARY BLOW TORCHES, ICE CREAM SCOOPS, HOUSEHOLD CONTAINERS FOR FOOD, MEASURING CUPS AND MEASURING SPOONS, COOKIE SHEETS, COOKERY MOLDS, MUFFIN PANS, LOAF PANS, IRON PANINI PAN, SERVING TONGS, NYLON SLOTTED TURNERS, CHOPSTICKS, STIR FRY PANS, COOKIE JARS, COOKIE CUTTERS, SERVING BOTTLES SOLD EMPTY, CUPS, CERAMIC CHOPSTICK HOLDERS, WOKS, POT LIDS, BASTING BRUSHES FOR USE WITH FOOD, COOKING STRAINERS, BAMBOO BASKETS WITH COVERS FOR HOLDING AND STORING FOOD, SEASONING SHAKERS, SALT AND PEPPER SHAKERS, OIL AND VINEGAR BOTTLES SOLD EMPTY, PASTA SERVING FORKS; CASSEROLE DISHES, COLANDERS FOR HOUSEHOLD USE, TEA KETTLES, CANISTER SETS, COMPOTE DISHES, FLOWER POTS, SOAP DISPENSERS, BEVERAGE GLASSWARE, SERVING DISHES; COOLING RACKS, NAMELY, RACKS ON WHICH TO PLACE HOT PANS, POTS OR DISHES TO COOL DOWN AFTER COOKING OR BAKING; PIZZA STONES, NAMELY, CERAMIC DISHES FOR BAKING PIZZA; DISHES; BAKEWARE; SERVING FORKS, SERVING SPOONS; HOUSEHOLD UTENSILS, NAMELY, SPATULAS; COOKING UTENSIL, NAMELY, IRON PRESS; SERVINGWARE FOR SERVING FOOD, NAMELY, RACKS FOR HOLDING SUSHI (U.S. CLS. 2, 13, 23, 29, 30, 33, 40 AND 50). FIRST USE 10-31-2003; IN COMMERCE 10-31-2003.

MARCIE MILONE, EXAMINING ATTORNEY

CLASS 21—(Continued).

SN 77-293,608. PHILOSOPHY, INC., PHOENIX, AZ. FILED 10-2-2007.

PHILOSOPHY

THE MARK CONSISTS OF STANDARD CHARACTERS WITHOUT CLAIM TO ANY PARTICULAR FONT, STYLE, SIZE, OR COLOR.

OWNER OF U.S. REG. NOS. 2,016,208, 2,388,010 AND OTHERS.

FOR COSMETIC BRUSHES (U.S. CLS. 2, 13, 23, 29, 30, 33, 40 AND 50).

FIRST USE 5-31-1996; IN COMMERCE 5-31-1996.
DAWN HAN, EXAMINING ATTORNEY

SN 77-294,064. HORVATH, GEORGE, NAPLES, FL. FILED 10-2-2007.



THE MARK CONSISTS OF THE LETTER "C" WITH THE FACE OF AN ANIMAL THAT APPEARS TO BE EITHER A DOG OR A CAT, WITH THE EARS ON THE OUSTIDE OF THE UPPER LEFT OF THE CURVE AND THE EYES, NOSE AND MOUTH IN THE MIDDLE OF THE "C".

FOR PET FOOD TRAY (U.S. CLS. 2, 13, 23, 29, 30, 33, 40 AND 50).

BENJAMIN ALLEN, EXAMINING ATTORNEY

SN 77-294,441. BRANDT ENTERPRISES, COMMERCE, CA. FILED 10-2-2007.

FACULA

THE MARK CONSISTS OF STANDARD CHARACTERS WITHOUT CLAIM TO ANY PARTICULAR FONT, STYLE, SIZE, OR COLOR.

FOR CANDLE HOLDERS (U.S. CLS. 2, 13, 23, 29, 30, 33, 40 AND 50).

SALLY SHIH, EXAMINING ATTORNEY

CLASS 21—(Continued).

SN 77-294,785. NIGEL RUDLIN, SAN FRANCISCO, CA. AND CYNTHIA BANCALE, SAN FRANCISCO, CA. FILED 10-3-2007.

FRENCH COAT

THE MARK CONSISTS OF STANDARD CHARACTERS WITHOUT CLAIM TO ANY PARTICULAR FONT, STYLE, SIZE, OR COLOR.

FOR INSULATING BLANKET FOR A BEVERAGE CONTAINER (U.S. CLS. 2, 13, 23, 29, 30, 33, 40 AND 50).
TARAH HARDY, EXAMINING ATTORNEY

SN 77-295,178. FILTREXX INTERNATIONAL LLC, GRAFTON, OH. FILED 10-3-2007.

GROEXX

THE MARK CONSISTS OF STANDARD CHARACTERS WITHOUT CLAIM TO ANY PARTICULAR FONT, STYLE, SIZE, OR COLOR.

FOR PLANTERS FOR FLOWERS AND PLANTS (U.S. CLS. 2, 13, 23, 29, 30, 33, 40 AND 50).

JAY BESCH, EXAMINING ATTORNEY

SN 77-295,982. CONNIE ELDER INTERNATIONAL, LLC, NASHVILLE, TN. FILED 10-4-2007.

UNDEROLOGY

THE MARK CONSISTS OF STANDARD CHARACTERS WITHOUT CLAIM TO ANY PARTICULAR FONT, STYLE, SIZE, OR COLOR.

FOR MAKE-UP BRUSHES (U.S. CLS. 2, 13, 23, 29, 30, 33, 40 AND 50).

RENEE MCCRAY, EXAMINING ATTORNEY

CLASS 21—(Continued).

SN 77-296,117. PARKER MANAGEMENT, LLC, PROVO, UT.
FILED 10-4-2007.



THE MARK CONSISTS OF THE LETTERS "EZ" IN LARGE FONT LETTERS WITH THE LETTER "O" DEPICTED AS THE JAR OPENER WITH A JAR IN ITS GRIP AND THE LETTERS "FF" IN SMALL FONT LETTERS.

FOR OPENERS FOR JARS AND BOTTLES (U.S. CLS. 2, 13, 23, 29, 30, 33, 40 AND 50).
FIRST USE 5-18-2004; IN COMMERCE 5-18-2004.
SUSAN STIGLITZ, EXAMINING ATTORNEY

SN 77-296,124. PARKER MANAGEMENT, LLC, PROVO, UT.
FILED 10-4-2007.



THE MARK CONSISTS OF STANDARD CHARACTERS WITHOUT CLAIM TO ANY PARTICULAR FONT, STYLE, SIZE, OR COLOR.

FOR OPENERS FOR JARS AND BOTTLES (U.S. CLS. 2, 13, 23, 29, 30, 33, 40 AND 50).
FIRST USE 5-18-2004; IN COMMERCE 5-18-2004.
SUSAN STIGLITZ, EXAMINING ATTORNEY

SN 77-296,270. DEXAS INTERNATIONAL. LTD., COPPELL, TX. FILED 10-4-2007.

CHOP N SCOOP

THE MARK CONSISTS OF STANDARD CHARACTERS WITHOUT CLAIM TO ANY PARTICULAR FONT, STYLE, SIZE, OR COLOR.

OWNER OF U.S. REG. NO. 3,285,413.
NO CLAIM IS MADE TO THE EXCLUSIVE RIGHT TO USE "CHOP", APART FROM THE MARK AS SHOWN.
FOR CUTTING BOARDS (U.S. CLS. 2, 13, 23, 29, 30, 33, 40 AND 50).
ROBIN CHOSID, EXAMINING ATTORNEY

CLASS 21—(Continued).

SN 77-301,922. THE CARTOON NETWORK, INC., ATLANTA, GA. FILED 10-11-2007.

BEN 10 ALIEN FORCE

THE MARK CONSISTS OF STANDARD CHARACTERS WITHOUT CLAIM TO ANY PARTICULAR FONT, STYLE, SIZE, OR COLOR.

OWNER OF U.S. REG. NOS. 3,080,336, 3,206,776 AND OTHERS.

FOR GLASS, CERAMIC AND EARTHENWARE GOODS, NAMELY, BEVERAGE GLASSWARE, COFFEE MUGS, MUGS, JUGS, BOWLS, PLATES, COASTERS, COFFEE CUPS AND CUPS; DEMITASSE SETS CONSISTING OF CUPS AND SAUCERS; SUGAR AND CREAMER SETS COMPRISING BOWLS AND CREAMER PITCHERS; COOKIE JARS; CERAMIC, GLASS AND CHINA FIGURINES; NON-ELECTRIC COFFEE POTS NOT OF PRECIOUS METAL; WASTEPAPER BASKETS; ICE BUCKETS; PLASTIC BUCKETS; SHOWER CADDIES; TEA CADDIES; CAKE MOLDS; SCRAPERS FOR HOUSEHOLD PURPOSES, AND CAKE SERVERS; CANTEENS; CHAMPAGNE BUCKETS; PLASTIC COASTERS, COCKTAIL SHAKERS; THERMAL INSULATED CONTAINERS FOR FOOD OR BEVERAGES; COOKIE CUTTERS, CORK SCREWS; CORN COB HOLDERS; PLASTIC WATER BOTTLES SOLD EMPTY; VACUUM BOTTLES; DECANTERS; DRINKING FLASKS; GARDENING GLOVES; RUBBER HOUSEHOLD GLOVES; DINNERWARE; NAMELY, PAPER PLATES AND PAPER CUPS; BRUSHES, NAMELY, HAIR BRUSHES, TOOTH BRUSHES, CLOTHES BRUSHES; KITCHEN UTENSILS, NAMELY, ROLLING PINS, SPATULAS, TURNERS, WHISKS, AND KITCHEN CONTAINERS, SOAP CONTAINERS, HOUSEHOLD FOOD CONTAINERS AND LUNCH BOXES; PLASTIC CUPS AND PLATES (U.S. CLS. 2, 13, 23, 29, 30, 33, 40 AND 50).

MICHAEL WEBSTER, EXAMINING ATTORNEY

SN 77-303,993. JORDAN DREW CORPORATION, TARRYTOWN, NY. FILED 10-15-2007.

SMART LIDZ

THE MARK CONSISTS OF STANDARD CHARACTERS WITHOUT CLAIM TO ANY PARTICULAR FONT, STYLE, SIZE, OR COLOR.

NO CLAIM IS MADE TO THE EXCLUSIVE RIGHT TO USE "LIDZ", APART FROM THE MARK AS SHOWN.
FOR SET OF UNIVERSAL LIDS FOR HOUSEHOLD USE THAT COVER BOWLS, CONTAINERS AND POTS (U.S. CLS. 2, 13, 23, 29, 30, 33, 40 AND 50).
ROSELLE HERRERA, EXAMINING ATTORNEY

CLASS 21—(Continued).

SN 77-305,680. FILTREXX INTERNATIONAL LLC, GRATON, OH. FILED 10-17-2007.

GROSOXX

THE MARK CONSISTS OF STANDARD CHARACTERS WITHOUT CLAIM TO ANY PARTICULAR FONT, STYLE, SIZE, OR COLOR.

FOR PLANTERS FOR FLOWERS AND PLANTS (U.S. CLS. 2, 13, 23, 29, 30, 33, 40 AND 50).

JAY BESCH, EXAMINING ATTORNEY

SN 77-315,386. D-GENERATION, INC., DAYTONA BEACH, FL. FILED 10-28-2007.

LIVE LAUGH LOVE

THE MARK CONSISTS OF STANDARD CHARACTERS WITHOUT CLAIM TO ANY PARTICULAR FONT, STYLE, SIZE, OR COLOR.

FOR CONTAINERS FOR HOUSEHOLD USE; KITCHEN URNS; MUGS; CAST STONE CONTAINERS FOR HOUSEHOLD AND GARDEN USE; CHOPPING BOARDS FOR KITCHEN USE (U.S. CLS. 2, 13, 23, 29, 30, 33, 40 AND 50).

FIRST USE 9-4-2002; IN COMMERCE 9-4-2002.
CARYN GLASSER, EXAMINING ATTORNEY

SN 77-325,947. ARABICA FUNDING, INC., MELVILLE, NY. FILED 11-9-2007.

LIFE IS SHORT. STAY AWAKE FOR IT.

THE MARK CONSISTS OF STANDARD CHARACTERS WITHOUT CLAIM TO ANY PARTICULAR FONT, STYLE, SIZE, OR COLOR.

OWNER OF U.S. REG. NOS. 2,000,062, 2,008,379 AND 2,967,034.

FOR MUGS AND TUMBLERS (U.S. CLS. 2, 13, 23, 29, 30, 33, 40 AND 50).

FIRST USE 12-31-1997; IN COMMERCE 12-31-1997.
SHAUNIA CARLYLE, EXAMINING ATTORNEY

CLASS 21—(Continued).

SN 77-340,950. HANDI-FOIL CORPORATION, WHEELING, IL. FILED 11-30-2007.

GOURMET TO GO

THE MARK CONSISTS OF STANDARD CHARACTERS WITHOUT CLAIM TO ANY PARTICULAR FONT, STYLE, SIZE, OR COLOR.

FOR CONTAINERS FORMED OF ALUMINUM FOIL WITH PLASTIC LIDS FOR HOUSEHOLD USE (U.S. CLS. 2, 13, 23, 29, 30, 33, 40 AND 50).

FIRST USE 12-18-2007; IN COMMERCE 12-18-2007.
REBECCA SMITH, EXAMINING ATTORNEY

SN 77-346,981. EVRIHOLDER PRODUCTS, INC., ANAHEIM, CA. FILED 12-7-2007.

EVRI-TWIST

THE MARK CONSISTS OF STANDARD CHARACTERS WITHOUT CLAIM TO ANY PARTICULAR FONT, STYLE, SIZE, OR COLOR.

FOR BOTTLE OPENER FOR PLASTIC BOTTLES AND CAPS (U.S. CLS. 2, 13, 23, 29, 30, 33, 40 AND 50).

JENNY PARK, EXAMINING ATTORNEY

SN 77-349,767. SUNBEAM PRODUCTS, INC., BOCA RATON, FL. FILED 12-12-2007.

SUNBEAM

THE MARK CONSISTS OF STANDARD CHARACTERS WITHOUT CLAIM TO ANY PARTICULAR FONT, STYLE, SIZE, OR COLOR.

OWNER OF U.S. REG. NOS. 145,335, 280,756 AND OTHERS.

FOR IRONING BOARDS (U.S. CLS. 2, 13, 23, 29, 30, 33, 40 AND 50).

FIRST USE 3-1-2006; IN COMMERCE 3-1-2006.
BRENDAN REGAN, EXAMINING ATTORNEY

CLASS 21—(Continued).

SN 77-362,535. HANDI-FOIL CORPORATION, WHEELING, IL. FILED 1-2-2008.

**Gourmet
TO-GO**

FOR CONTAINERS FORMED OF ALUMINUM FOIL WITH PLASTIC LIDS FOR HOUSEHOLD USE (U.S. CLS. 2, 13, 23, 29, 30, 33, 40 AND 50).

FIRST USE 12-18-2007; IN COMMERCE 12-18-2007.
REBECCA SMITH, EXAMINING ATTORNEY

CLASS 21—(Continued).

SN 78-805,085. BUYPRODUCT, INC., MERRICK, NY. FILED 2-2-2006.

GRUESOME GUZZLERS

THE MARK CONSISTS OF STANDARD CHARACTERS WITHOUT CLAIM TO ANY PARTICULAR FONT, STYLE, SIZE, OR COLOR.

FOR CUPS; DRINKING CUPS; DRINKING GLASSES; GLASS BEVERAGWARE; GLASS DISHES; GLASS MUGS; INSULATED FLASKS; INSULATING SLEEVE HOLDERS FOR BEVERAGE CANS; LUNCH BOXES; PLASTIC CUPS; THERMAL INSULATED CONTAINERS FOR FOOD OR BEVERAGE (U.S. CLS. 2, 13, 23, 29, 30, 33, 40 AND 50).

JENNY PARK, EXAMINING ATTORNEY

SN 78-660,126. MANUFACTURERS DISCOUNT FURNITURE & BEDDING, INC., DBA INDIA INK, LOS ANGELES, CA. FILED 6-28-2005.

IN HOME IDEAS

THE MARK CONSISTS OF STANDARD CHARACTERS WITHOUT CLAIM TO ANY PARTICULAR FONT, STYLE, SIZE, OR COLOR.

FOR BATHROOM ACCESSORIES, NAMELY, TOWELS BARS, TOWEL RINGS, TOWEL TREES, TOWEL HOLDERS, TOWEL RACKS, SOAP DISHES, LOTION DISPENSERS, LIQUID SOAP DISPENSERS, TOOTHBRUSH HOLDERS, BATHROOM CUP AND TOOTHBRUSH HOLDERS, DENTURE HOLDERS, TOILET TISSUE HOLDERS, TOILET TISSUE CANISTERS, TOILET TISSUE ROLL HOLDERS, TISSUE BOX HOLDERS, CERAMIC TISSUE BOX COVERS, TOILET BRUSH AND HOLDER SETS, TOILET BRUSHES, TOILET BRUSH HOLDERS, TUMBLERS, CUP HOLDERS, COTTON BALL/COTTON SWAB HOLDERS, CANDLE HOLDERS, PILLAR HOLDERS, PILLAR PLATES, AND VOTIVE HOLDERS NOT OF PRECIOUS METAL, POTPOURRI BOWLS, POTPOURRI DISHES, DRINKING GLASSES, PLATES, TRAYS, VANITY TRAYS, SHELVES, WASTE BASKETS, HAMPERS (U.S. CLS. 2, 13, 23, 29, 30, 33, 40 AND 50).

JUSTINE D. PARKER, EXAMINING ATTORNEY

SN 78-962,935. ROONEY, JAMES M., JACKSONVILLE, FL. FILED 8-29-2006.



OWNER OF U.S. REG. NO. 2,983,627.

NO CLAIM IS MADE TO THE EXCLUSIVE RIGHT TO USE "ATHLETIC GEAR", APART FROM THE MARK AS SHOWN.

THE COLOR(S) BLACK, YELLOW AND WHITE IS/ARE CLAIMED AS A FEATURE OF THE MARK.

THE MARK CONSISTS OF A WHITE SKULL OUTLINED IN BLACK WITH BLACK EYES AND NOSE OVER TWO TENNIS RACQUETS WITH BONE HANDLES CROSSED TO FORM AN "X". THE RACKETS ARE OUTLINED IN BLACK AND THE RACKET HEADS AND GRIPS ARE YELLOW WITH BLACK LINES AND WITH A WHITE BONE AS THE HANDLE. THE TITLE OVER THE SKULL IS "MERC ATHLETIC GEAR" IN BLACK. A WHITE BANNER OUTLINED IN BLACK OVER THE SKULL READS "GRIP IT" "RIP IT" IN BLACK AND A YELLOW TENNIS BALL SEPARATES THE TWO SAYINGS.

FOR BEER MUGS; GLASS MUGS; MUGS (U.S. CLS. 2, 13, 23, 29, 30, 33, 40 AND 50).

REBECCA GILBERT, EXAMINING ATTORNEY

CLASS 21—(Continued).

SN 79-026,511. STARCK PHILIPPE, FRANCE, FILED 7-18-2006.

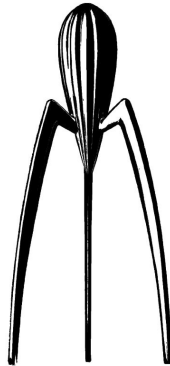

PRIORITY DATE OF 1-19-2006 IS CLAIMED.
 OWNER OF INTERNATIONAL REGISTRATION 0892234 DATED 7-18-2006, EXPIRES 7-18-2016.
 THE MARK CONSISTS OF THE CONFIGURATION OF THE GOODS WHICH FEATURE A WHIMSICAL SPIDER OR SQUID SHAPE WITH A "BODY" AND THREE LONG LEGS. SEC. 2(F).
 FOR NON-ELECTRIC CITRUS PRESSES (U.S. CLS. 2, 13, 23, 29, 30, 33, 40 AND 50).
 CHRISIE B. KING, EXAMINING ATTORNEY

CLASS 21—(Continued).

SN 79-036,620. DR. AUGUST OETKER NAHRUNGSMITTEL KG, FED REP GERMANY, FILED 3-9-2007.



OWNER OF INTERNATIONAL REGISTRATION 0723600 DATED 11-8-1999, EXPIRES 11-8-2009.
 OWNER OF U.S. REG. NOS. 1,684,928, 3,135,248 AND OTHERS.
 THE NAME "DR. OETKER" DOES NOT IDENTIFY A LIVING INDIVIDUAL.
 FOR UTENSILS USED IN PASTRY MAKING AND HOUSEHOLD OR KITCHEN UTENSILS, NAMELY, BAKING DISHES, CAKE TINS, BAKING SHEETS, BAKING AND GRILL PANS, PIZZA TRAYS, ROASTING AND BAKING DISHES, DECORATING SYRINGES, PASTRY PRESSES, PASTRY CUTTERS, ICING BAGS, ICE CREAM SCOOPS, CAKE DIVIDERS, CAKE SERVERS, CAKE RINGS, CAKE AND TART RACKS, SUGAR CASTERS, SALT AND PEPPER SHAKERS, MIXING BOWLS, MIXING CUPS, KITCHEN SIEVES FOR FLOUR AND ICING SUGAR, TEA-STRAINERS, PASTRY BRUSHES, TART AND CAKE PLATES, TART AND CAKE PLATTERS, DOUGH SCRAPERS, DOUGH SCRAPING CARDS, ROLLING PINS, PASTRY WHEELS, METAL KITCHEN ROLLERS, BASTING, MIXING AND SLOTTED SPOONS, WHISKS, SMALL PRALINE FORMS, PUDDING FORMS, SMALL DESSERT FORMS, COVERS FOR CAKES AND TARTS, COOLERS FOR TRANSPORT OF CAKES AND TARTS, CONTAINERS FOR HOUSEHOLD OR KITCHEN USE NOT OF PRECIOUS METAL, NON-ELECTRICAL FRUIT PRESSES, INSULATING CONTAINERS FOR FOOD AND BEVERAGES, GRATERS FOR HOUSEHOLD PURPOSES, BOWLS AND DISHES FOR HOUSEHOLD AND KITCHEN USE, FOOD TRAYS, FOOD CRUSHERS, PAPER BAKING CUPS (U.S. CLS. 2, 13, 23, 29, 30, 33, 40 AND 50).
 KRISTINA MORRIS, EXAMINING ATTORNEY

SN 79-038,052. SAVERGLASS, FRANCE, FILED 3-30-2007.



PRIORITY DATE OF 10-23-2006 IS CLAIMED.
 OWNER OF INTERNATIONAL REGISTRATION 0922911 DATED 3-30-2007, EXPIRES 3-30-2017.
 OWNER OF U.S. REG. NOS. 2,840,162 AND 2,840,207.
 NO CLAIM IS MADE TO THE EXCLUSIVE RIGHT TO USE "GLASS", APART FROM THE MARK AS SHOWN.
 FOR BOTTLES MADE OF GLASS, DRINKING FLASKS AND CARAFES MADE OF GLASS, DRINKING CONTAINERS MADE OF GLASS, NAMELY, GLASS BEVERAGEWARE, DECANTERS MADE OF GLASS, JARS MADE OF GLASS FOR FOODS AND COSMETICS, PERFUME BOTTLES AND PERFUME BURNERS MADE OF GLASS, AND GLASS STOPPERS, ALL OF THE ABOVE SOLD EMPTY (U.S. CLS. 2, 13, 23, 29, 30, 33, 40 AND 50).
 LEE-ANNE BERNS, EXAMINING ATTORNEY

CLASS 21—(Continued).

SN 79-038,137. WENZHOU HUIHUNDA; INDUSTRIAL TRADE CO., LTD., WENZHOU, ZHEJIANG, CHINA, FILED 3-21-2007.

Chinbull

OWNER OF INTERNATIONAL REGISTRATION 0923146 DATED 3-21-2007, EXPIRES 3-21-2017.

FOR GLASS BOWLS; RECEPTACLES, NAMELY, GLASS BULBS; CONTAINERS, NAMELY, GLASS FLASKS; CARBOYS, NAMELY, GLASS JARS FOR HOUSEHOLD PURPOSES; GLASS RECEPTACLES FOR HOUSEHOLD USE; RECEPTACLES, NAMELY, GLASS VIALS; PAINTED BEVERAGE GLASSWARE; BOWLS; BASINS; RECEPTACLES, NAMELY, HAND BASINS NOT PART OF A SANITARY INSTALLATIONS; POTS; BOTTLES, SOLD EMPTY; BOWLS; BUTTER DISHES; CUPS, NOT OF PRECIOUS METAL; DISHES, NOT OF PRECIOUS METAL; FRUIT CUPS; TABLE PLATES, NOT OF PRECIOUS METAL; TANKARDS, NOT OF PRECIOUS METAL; TRAYS FOR DOMESTIC PURPOSES, NOT OF PRECIOUS METAL; VEGETABLE DISHES; UTENSILS FOR HOUSEHOLD PURPOSES, NOT OF PRECIOUS METAL, NAMELY, CRUMB TRAYS, DISH COVERS, DISHES AND PLATES, JUGS; KITCHEN UTENSILS, NOT OF PRECIOUS METAL, NAMELY, NON-ELECTRIC COOKING POTS AND PANS, NON-ELECTRIC GRIDDLES, NON-ELECTRIC KETTLES, NON-ELECTRIC COFFEE POTS, TEA KETTLES, CRUETS, KNIFE RESTS, GRATERS, SIEVES, SPATULAS; CERAMICS FOR HOUSEHOLD PURPOSES, NAMELY, CERAMIC VASES, BOWLS, POTS, AND BASINS; WORKS OF ART, OF PORCELAIN, TERRACOTTA OR GLASS; TOILET UTENSILS, NAMELY, HAIR BRUSHES, COMBS, BUCKETS, TOILET PAPER HOLDERS, SOAP HOLDERS; TABLEWARE SERVICES, NOT OF PRECIOUS METAL, NAMELY, SCOOPS, SALT SHAKERS, SUGAR BOWLS, PEPPER POTS, CHOPSTICKS, AND COOKIE CUTTERS; TEA INFUSERS, NOT OF PRECIOUS METAL; DRINKING VESSELS (U.S. CLS. 2, 13, 23, 29, 30, 33, 40 AND 50).

MARILYN IZZI, EXAMINING ATTORNEY

CLASS 22—CORDAGE AND FIBERS

SN 77-144,431. SHANDONG HELON CO., LTD., SHANDONG PROVINCE, CHINA, FILED 3-30-2007.



NO CLAIM IS MADE TO THE EXCLUSIVE RIGHT TO USE THE NON-LATIN CHARACTERS THAT MEAN "SECURITY" AND "TEXTILE", APART FROM THE MARK AS SHOWN.

THE MARK CONSISTS OF THE WORD "ANTIFCELL" AND TWO CHINESE CHARACTERS.

THE NON-LATIN CHARACTERS IN THE MARK TRANSLITERATE TO "AN" AND "FANG" AND THESE MEAN "SECURITY" AND "TEXTILE" IN ENGLISH.

FOR CHEMICAL FIBERS FOR TEXTILE USE; NYLON WEED TRIMMER LINE; FABRIC AND POLYESTER MESH NET USED FOR STORING TOYS AND OTHER HOUSEHOLD ITEMS; RAW FIBROUS TEXTILE MATERIALS; RAW TEXTILE FIBERS; TEXTILE FIBERS; TEXTILE FILAMENTS; YARN FIBERS (U.S. CLS. 1, 2, 7, 19, 22, 42 AND 50).

SETH A. RAPPAPORT, EXAMINING ATTORNEY

SN 79-044,692. LAGOSTINA S.P.A., ITALY, FILED 8-27-2007.

MELODIA

THE MARK CONSISTS OF STANDARD CHARACTERS WITHOUT CLAIM TO ANY PARTICULAR FONT, STYLE, SIZE, OR COLOR.

OWNER OF INTERNATIONAL REGISTRATION 0939752 DATED 8-27-2007, EXPIRES 8-27-2017.

THE FOREIGN WORDING IN THE MARK TRANSLATES INTO ENGLISH AS "MELODY".

FOR KITCHEN LADLES, SERVING LADLES, BOTTLE OPENERS, NON-ELECTRIC PRESSURE COOKERS, RICE BASINS, CASSEROLES, PANS, NON-ELECTRIC MILK BOILERS, COLANDERS, DISH COVERS, NON-ELECTRIC ASPARAGUS COOKERS, NON-ELECTRIC KETTLES, NON-ELECTRIC COOKING UTENSILS, NAMELY, GRILLS, ROUND TRAYS, NON-ELECTRIC ESPRESSO COFFEE MAKERS, SUGAR BASINS, FRYING PANS, ALL NOT IN PRECIOUS METAL (U.S. CLS. 2, 13, 23, 29, 30, 33, 40 AND 50).

GILBERT SWIFT, EXAMINING ATTORNEY

SN 77-149,589. LEHIGH CONSUMER PRODUCTS CORPORATION, MACUNGIE, PA. FILED 4-5-2007.

SECURELINE

THE MARK CONSISTS OF STANDARD CHARACTERS WITHOUT CLAIM TO ANY PARTICULAR FONT, STYLE, SIZE, OR COLOR.

FOR ROPE, CORD, TWINE, CLOTHESLINE, NON-METAL SHOCK CORDS, TIE DOWN STRAPS, UTILITY STRAPS (U.S. CLS. 1, 2, 7, 19, 22, 42 AND 50).

ANDREA BUTLER, EXAMINING ATTORNEY

CLASS 22—(Continued).

SN 77-225,300. YOUNG, NANCY, TRACY, CA. AND YOUNG, MARCELLUS, TRACY, CA. FILED 7-9-2007.

Pull-EZ

THE MARK CONSISTS OF STANDARD CHARACTERS WITHOUT CLAIM TO ANY PARTICULAR FONT, STYLE, SIZE, OR COLOR.

FOR SACKS OR BAGS FOR THE TRANSPORTATION OR STORAGE OF MATERIALS IN BULK; POLY PROPYLENE BAGS USED FOR THE STORAGE OF RIBBON; CLOTH BAGS FOR STORAGE (U.S. CLS. 1, 2, 7, 19, 22, 42 AND 50).

ELLEN B. AWRICH, EXAMINING ATTORNEY

SN 77-241,965. POLYAIR CORPORATION, TORONTO, CANADA, FILED 7-30-2007.

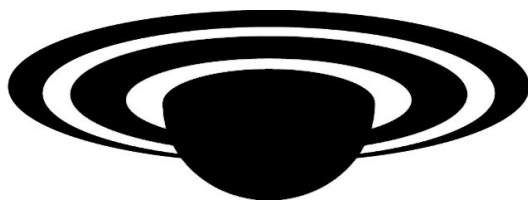

THE MARK CONSISTS OF TWO RINGS CIRCLING AN INVERTED DOME.

FOR UNFITTED SWIMMING POOL COVERS, NAMELY, HEATING BLANKET COVERS FOR SWIMMING POOLS (U.S. CLS. 1, 2, 7, 19, 22, 42 AND 50).

FIRST USE 1-30-2007; IN COMMERCE 1-30-2007.
CHRISTINA SOBRAL, EXAMINING ATTORNEY

SN 77-246,487. STAFFORD MANUFACTURING CORP., WILMINGTON, MA. FILED 8-3-2007.



NO CLAIM IS MADE TO THE EXCLUSIVE RIGHT TO USE "SLIPKNOT", APART FROM THE MARK AS SHOWN. THE COLOR(S) BLACK, YELLOW, RED IS/ARE CLAIMED AS A FEATURE OF THE MARK.

THE COLORS BLACK, YELLOW AND RED ARE CLAIMED AS A FEATURE OF THE MARK. THE MARK CONSISTS OF THE WORD SLIPKNOT ON A YELLOW RECTANGLE. THE LETTER K IN THE WORD SLIPKNOT IS RED AND THE REST OF THE WORD IS BLACK. THE WHITE IS NOT PART OF THE MARK AND REPRESENTS BACKGROUND AREA.

FOR ADJUSTABLE SECURING DEVICE COMPRISING A ROUND PLASTIC BAND FOR HOLDING ROPES AND NON-ELECTRICAL LINES IN PLACE. FOR USE PRIMARILY IN THE BOATING INDUSTRY (U.S. CLS. 1, 2, 7, 19, 22, 42 AND 50).

ELLEN B. AWRICH, EXAMINING ATTORNEY

CLASS 22—(Continued).

SN 78-979,429. BEAULIEU GROUP LLC, DALTON, GA. FILED 2-24-2006.



OWNER OF U.S. REG. NO. 2,911,344.
FOR SYNTHETIC FIBERS; TEXTILE FIBERS; YARN FIBERS; SYNTHETIC FIBERS AND FILAMENTS FOR USE IN THE MANUFACTURE OF FABRICS, TEXTILES, YARNS, AND CARPETS (U.S. CLS. 1, 2, 7, 19, 22, 42 AND 50).

MARCIE MILONE, EXAMINING ATTORNEY

CLASS 23—YARNS AND THREADS

SN 77-144,432. SHANDONG HELON CO., LTD., SHANDONG PROVINCE, CHINA, FILED 3-30-2007.



NO CLAIM IS MADE TO THE EXCLUSIVE RIGHT TO USE THE NON-LATIN CHARACTERS THAT MEAN SECURITY AND TEXTILE, APART FROM THE MARK AS SHOWN.

THE MARK CONSISTS OF THE WORD "ANTIFCELL" AND TWO CHINESE CHARACTERS.

THE NON-LATIN CHARACTERS IN THE MARK TRANSLITERATE TO AN AND FANG AND THESE MEAN SECURITY AND TEXTILE IN ENGLISH.

FOR CHEMICAL FIBER BASE MIXED THREAD AND YARN; CHEMICAL-FIBER THREADS AND YARNS FOR TEXTILE USE; MIXED SPUN THREADS AND YARNS; REGENERATED FIBER THREAD AND YARN; SEMI-SYNTHETIC FIBER THREAD AND YARN; SPUN YARN; THREAD FOR TEXTILE USE; THREADS AND YARNS; TWISTED YARN; YARN (U.S. CL. 43).

SETH A. RAPPAPORT, EXAMINING ATTORNEY

CLASS 24—FABRICS

CLASS 24—(Continued).

SN 76-679,469. BELLE MAISON U.S.A LTD, RICHMOND HILL, NY. FILED 7-13-2007.

SN 76-682,364. CHENAB ONE, LLC, NEW YORK, NY. FILED 9-27-2007.

STYLEMASTER

MYNT STITCH

THE MARK CONSISTS OF STANDARD CHARACTERS WITHOUT CLAIM TO ANY PARTICULAR FONT, STYLE, SIZE, OR COLOR.

THE MARK CONSISTS OF STANDARD CHARACTERS WITHOUT CLAIM TO ANY PARTICULAR FONT, STYLE, SIZE, OR COLOR.

FOR TEXTILES, NAMELY, BEDSPREADS, VALANCES, CURTAIN PANELS, KITCHEN CURTAINS, AND DRAPERIES, DOILIES, DUST RUFFLES AND TABLE CLOTHES (U.S. CLS. 42 AND 50).

FOR BED LINENS, NAMELY, COMFORTERS, BED SPREADS, COMFORTER COVERS, BED SHEETS, PILLOW CASES, PILLOW SHAMS, DUST RUFFLES, BED SKIRTS, AND DUVET COVERS; TABLE LINENS, NAMELY, FABRIC NAPKINS, PLACE MATS, TABLE CLOTHS AND TABLE ROUNDS; FABRIC SHOWER CURTAINS; FABRIC BLANKET THROWS; TOWELS, NAMELY, BATH TOWELS, HAND TOWELS, WASH-CLOTHS AND FINGERTIP TOWELS; FABRIC WINDOW TREATMENTS, NAMELY, CURTAINS, CURTAIN TIE BACKS, DRAPERIES, VALANCES, PANELS AND SWAGS (U.S. CLS. 42 AND 50).

FIRST USE 4-1-1997; IN COMMERCE 4-1-1997.
CAROLYN CATALDO, EXAMINING ATTORNEY

ROBERT STRUCK, EXAMINING ATTORNEY

SN 76-682,363. CHENAB ONE, LLC, NEW YORK, NY. FILED 9-27-2007.

SN 76-682,365. CHENAB ONE, LLC, NEW YORK, NY. FILED 9-27-2007.

PAUL & LEROY

LEDBURY MEWS

THE MARK CONSISTS OF STANDARD CHARACTERS WITHOUT CLAIM TO ANY PARTICULAR FONT, STYLE, SIZE, OR COLOR.

THE MARK CONSISTS OF STANDARD CHARACTERS WITHOUT CLAIM TO ANY PARTICULAR FONT, STYLE, SIZE, OR COLOR.

FOR BED LINENS, NAMELY, COMFORTERS, BED SPREADS, COMFORTER COVERS, BED SHEETS, PILLOW CASES, PILLOW SHAMS, DUST RUFFLES, BED SKIRTS, AND DUVET COVERS; TABLE LINENS, NAMELY, FABRIC NAPKINS, PLACE MATS, TABLE CLOTHS AND TABLE ROUNDS; FABRIC SHOWER CURTAINS; FABRIC BLANKET THROWS; TOWELS, NAMELY, BATH TOWELS, HAND TOWELS, WASH-CLOTHS AND FINGERTIP TOWELS; FABRIC WINDOW TREATMENTS, NAMELY, CURTAINS, CURTAIN TIE BACKS, DRAPERIES, VALANCES, PANELS AND SWAGS (U.S. CLS. 42 AND 50).

FOR BED LINENS, NAMELY, COMFORTERS, BED SPREADS, COMFORTER COVERS, BED SHEETS, PILLOW CASES, PILLOW SHAMS, DUST RUFFLES, BED SKIRTS, AND DUVET COVERS; TABLE LINENS, NAMELY, FABRIC NAPKINS, PLACE MATS, TABLE CLOTHS AND TABLE ROUNDS; FABRIC SHOWER CURTAINS; FABRIC BLANKET THROWS; TOWELS, NAMELY, BATH TOWELS, HAND TOWELS, WASH-CLOTHS AND FINGERTIP TOWELS; FABRIC WINDOW TREATMENTS, NAMELY, CURTAINS, CURTAIN TIE BACKS, DRAPERIES, VALANCES, PANELS AND SWAGS (U.S. CLS. 42 AND 50).

ROBERT STRUCK, EXAMINING ATTORNEY

ROBERT STRUCK, EXAMINING ATTORNEY

CLASS 24—(Continued).

SN 76-682,366. CHENAB ONE, LLC, NEW YORK, NY. FILED 9-27-2007.

AMHERST GATE

THE MARK CONSISTS OF STANDARD CHARACTERS WITHOUT CLAIM TO ANY PARTICULAR FONT, STYLE, SIZE, OR COLOR.

FOR BED LINENS, NAMELY, COMFORTERS, BED SPREADS, COMFORTER COVERS, BED SHEETS, PILLOW CASES, PILLOW SHAMS, DUST RUFFLES, BED SKIRTS, AND DUVET COVERS; TABLE LINENS, NAMELY, FABRIC NAPKINS, PLACE MATS, TABLE CLOTHS AND TABLE ROUNDS; FABRIC SHOWER CURTAINS; FABRIC BLANKET TROWS; TOWELS, NAMELY, BATH TOWELS, HAND TOWELS, WASH-CLOTHS AND FINGERTIP TOWELS; FABRIC WINDOW TREATMENTS, NAMELY, CURTAINS, CURTAIN TIE BACKS, DRAPERIES, VALANCES, PANELS AND SWAGS (U.S. CLS. 42 AND 50).

ROBERT STRUCK, EXAMINING ATTORNEY

SN 76-682,367. CHENAB ONE, LLC, NEW YORK, NY. FILED 9-27-2007.

NORTH MAIN

THE MARK CONSISTS OF STANDARD CHARACTERS WITHOUT CLAIM TO ANY PARTICULAR FONT, STYLE, SIZE, OR COLOR.

FOR BED LINENS, NAMELY, COMFORTERS, BED SPREADS, COMFORTER COVERS, BED SHEETS, PILLOW CASES, PILLOW SHAMS, DUST RUFFLES, BED SKIRTS, AND DUVET COVERS; TABLE LINENS, NAMELY, FABRIC NAPKINS, PLACE MATS, TABLE CLOTHS AND TABLE ROUNDS; FABRIC SHOWER CURTAINS; FABRIC BLANKET TROWS; TOWELS, NAMELY, BATH TOWELS, HAND TOWELS, WASH-CLOTHS AND FINGERTIP TOWELS; FABRIC WINDOW TREATMENTS, NAMELY, CURTAINS, CURTAIN TIE BACKS, DRAPERIES, VALANCES, PANELS AND SWAGS (U.S. CLS. 42 AND 50).

ROBERT STRUCK, EXAMINING ATTORNEY

SN 77-067,384. WYNN RESORTS HOLDINGS, LLC, LAS VEGAS, NV. FILED 12-19-2006.

WYNN TOWER SUITES

THE MARK CONSISTS OF STANDARD CHARACTERS WITHOUT CLAIM TO ANY PARTICULAR FONT, STYLE, SIZE, OR COLOR.

OWNER OF U.S. REG. NOS. 2,983,691, 3,140,111 AND OTHERS.

FOR BED LINENS, TABLE LINENS (U.S. CLS. 42 AND 50).

YONG KIM, EXAMINING ATTORNEY

CLASS 24—(Continued).

SN 77-110,704. CONFORTI, HARRY, WOBURN, MA. FILED 2-19-2007.

THERMAFLOW

THE MARK CONSISTS OF STANDARD CHARACTERS WITHOUT CLAIM TO ANY PARTICULAR FONT, STYLE, SIZE, OR COLOR.

FOR MOISTURE WICKING FABRIC FOR GOLF SHIRTS AND GOLF JACKETS, EXCLUDING INFANTS' CLOTHING (U.S. CLS. 42 AND 50).

EMILY CARLSEN, EXAMINING ATTORNEY

SN 77-148,549. JACK SCHWARTZ SHOES, INC., NEW YORK, NY. FILED 4-4-2007.

PERMA HIDE

THE MARK CONSISTS OF STANDARD CHARACTERS WITHOUT CLAIM TO ANY PARTICULAR FONT, STYLE, SIZE, OR COLOR.

NO CLAIM IS MADE TO THE EXCLUSIVE RIGHT TO USE "HIDE", APART FROM THE MARK AS SHOWN.

FOR FABRIC OF IMITATION ANIMAL SKIN FOR THE MANUFACTURE OF FOOTWEAR (U.S. CLS. 42 AND 50).

LINDA M. KING, EXAMINING ATTORNEY

SN 77-201,580. KRONLAND, SARAH JUDD, FISHERS, IN. FILED 6-8-2007.



THE NAME(S), PORTRAIT(S), AND/OR SIGNATURE(S) SHOWN IN THE MARK DOES NOT IDENTIFY A PARTICULAR LIVING INDIVIDUAL.

THE COLOR(S) BLUE, LIGHT BLUE, AND BROWN IS/ARE CLAIMED AS A FEATURE OF THE MARK.

THE MARK CONSISTS OF A LIGHT BLUE OVAL WITH AN AQUA BLUE SWIRL AROUND THE OVAL.

FOR CHILDREN'S BLANKETS (U.S. CLS. 42 AND 50). FIRST USE 2-1-2005; IN COMMERCE 4-1-2005.

FLORENTINA BLANDU, EXAMINING ATTORNEY

CLASS 24—(Continued).

SN 77-207,629. EMERGENCY ESSENTIALS, INC., OREM, UT. FILED 6-15-2007.

EMERGENCY ESSENTIALS

THE MARK CONSISTS OF STANDARD CHARACTERS WITHOUT CLAIM TO ANY PARTICULAR FONT, STYLE, SIZE, OR COLOR.

SEC. 2(F).
FOR BLANKETS, NAMELY, BLANKETS STORED IN COMPACT FORM READY FOR EMERGENCY USE AND HOODED BLANKETS (U.S. CLS. 42 AND 50).
FIRST USE 8-0-1988; IN COMMERCE 8-0-1988.
LESLEY LAMOTHE, EXAMINING ATTORNEY

SN 77-228,139. TEXSTYLE, LLC, CINCINNATI, OH. FILED 7-12-2007.

REGAL ELEGANCE

THE MARK CONSISTS OF STANDARD CHARACTERS WITHOUT CLAIM TO ANY PARTICULAR FONT, STYLE, SIZE, OR COLOR.

FOR TEXTILE FABRICS USED IN COMBINATION WITH FURNITURE COVERS (U.S. CLS. 42 AND 50).
GISELLE AGOSTO, EXAMINING ATTORNEY

SN 77-265,352. KIMBERLY-CLARK WORLDWIDE, INC., NEENAH, WI. FILED 8-27-2007.



OWNER OF U.S. REG. NOS. 2,553,520, 2,562,309 AND 2,936,929.
FOR LABORATORY TABLE COVERS CONSISTING OF NON-WOVEN FABRIC, NAMELY, UNFITTED BENCHTOP PROTECTORS (U.S. CLS. 42 AND 50).
KRISTIN DAHLING, EXAMINING ATTORNEY

CLASS 24—(Continued).

SN 77-276,885. PENDLETON WOOLEN MILLS, INC., PORTLAND, OR. FILED 9-11-2007.



THE MARK CONSISTS OF A TEEPEE DESIGN. FOR PILLOW CASES; PILLOW COVERS; PILLOW SHAMS; BED SHEETS; COVERLETS; QUILTS; BED SPREADS; TEXTILE NAPKINS; TABLE LINEN, NAMELY, NAPKINS; WOOLEN BLANKETS; BED BLANKETS; BLANKETS FOR OUTDOOR USE; CHILDREN'S BLANKETS; THROWS; COMFORTERS; DUVET COVERS (U.S. CLS. 42 AND 50).

FIRST USE 1-22-2007; IN COMMERCE 1-22-2007.
FRANK LATTUCA, EXAMINING ATTORNEY

SN 77-278,310. DIVATEX HOME FASHIONS, INC, NEW YORK, NY. FILED 9-12-2007.

North Lake

THE MARK CONSISTS OF STANDARD CHARACTERS WITHOUT CLAIM TO ANY PARTICULAR FONT, STYLE, SIZE, OR COLOR.

FOR BED SHEETS, PILLOWCASES, DUVETS, SHAMS, BED SKIRTS, COMFORTERS, QUILTS, THROWS (U.S. CLS. 42 AND 50).
LEIGH CAROLINE CASE, EXAMINING ATTORNEY

SN 77-278,596. FRANKEL DESIGN INC., WOODLAND HILLS, CA. FILED 9-13-2007.

MADE 2 FADE TECHNOLOGY

THE MARK CONSISTS OF STANDARD CHARACTERS WITHOUT CLAIM TO ANY PARTICULAR FONT, STYLE, SIZE, OR COLOR.

NO CLAIM IS MADE TO THE EXCLUSIVE RIGHT TO USE "TECHNOLOGY", APART FROM THE MARK AS SHOWN.
FOR FABRIC FOR THE MANUFACTURE OF CLOTHING (U.S. CLS. 42 AND 50).
FRANK LATTUCA, EXAMINING ATTORNEY

CLASS 24—(Continued).

SN 77-284,448. SUSAN G. LECY, INC., DBA ABBY-J, CHANHASSEN, MN. FILED 9-20-2007.

COT CUDDLEYS

THE MARK CONSISTS OF STANDARD CHARACTERS WITHOUT CLAIM TO ANY PARTICULAR FONT, STYLE, SIZE, OR COLOR.

FOR CHILDREN'S BLANKETS (U.S. CLS. 42 AND 50).
MICHAEL WIENER, EXAMINING ATTORNEY

SN 77-291,104. LUTZ & PATMOS, INC., NEW YORK, NY. FILED 9-28-2007.

LUTZ & PATMOS

THE MARK CONSISTS OF STANDARD CHARACTERS WITHOUT CLAIM TO ANY PARTICULAR FONT, STYLE, SIZE, OR COLOR.

OWNER OF U.S. REG. NO. 2,598,134.

FOR BED BLANKETS, DUVETS, THROWS, BED SHEETS, DUVET COVERS, BED LINENS, BED SPREADS, COMFORTERS, COVERLETS, QUILTS, SHAMS, PILLOWCASES, PILLOW COVERS, PILLOW SHAMS, CUSHION COVERS, BATH SHEETS, BATH TOWELS, HAND TOWELS, HOODED TOWELS, FACE TOWELS, TOWEL SETS, WASH CLOTHS, FABRIC GIFT WRAP, PET BLANKETS, HOUSEHOLD LINEN, PLACE MATS NOT OF PAPER, PLACE MATS OF TEXTILE MATERIALS, DINING LINEN, DISHCLOTHS, KITCHEN LINENS, KITCHEN TOWELS, TABLE LINENS, TEXTILE NAPKINS, TEXTILE PLACE MATS, KNITTED FABRICS, KNITTED FABRICS OF CHEMICAL -FIBER YARN, KNITTED FABRICS OF COTTON YARN, KNITTED FABRICS OF SILK YARN, KNITTED FABRICS OF WOOL YARN (U.S. CLS. 42 AND 50).

MATTHEW MCDOWELL, EXAMINING ATTORNEY

SN 77-293,257. FLAVIA'S LEGACY, LLC, SANTA BARBARA, CA. FILED 10-1-2007.

FLAVIA

THE MARK CONSISTS OF STANDARD CHARACTERS WITHOUT CLAIM TO ANY PARTICULAR FONT, STYLE, SIZE, OR COLOR.

OWNER OF U.S. REG. NOS. 2,728,767, 2,978,285 AND 3,169,310.

FOR BATH SHEETS; BED SHEETS; PILLOW CASES; PILLOW COVERS; PILLOW SHAMS; BED BLANKETS; BLANKET THROWS; THROWS; FABRIC WINDOW COVERINGS AND TREATMENTS, NAMELY, CURTAINS, DRAPERIES, SHEERS, SWAGS AND VALANCES; WINDOW CURTAINS; SHOWER CURTAINS; BATH TOWELS (U.S. CLS. 42 AND 50).

BRIAN CALLAGHAN, EXAMINING ATTORNEY

CLASS 24—(Continued).

SN 77-294,487. LATHAM MANUFACTURING CORP., LATHAM, NY. FILED 10-2-2007.

Bio-Shade

THE MARK CONSISTS OF STANDARD CHARACTERS WITHOUT CLAIM TO ANY PARTICULAR FONT, STYLE, SIZE, OR COLOR.

FOR FABRIC FOR THE MANUFACTURE OF SWIMMING POOL COVERS (U.S. CLS. 42 AND 50).
FIRST USE 6-0-2006; IN COMMERCE 7-0-2007.
LEE-ANNE BERNS, EXAMINING ATTORNEY

SN 77-295,990. TACT COMMUNICATIONS INC., TOKYO, JAPAN, FILED 10-4-2007.

ANGEL CAT SUGAR

THE MARK CONSISTS OF STANDARD CHARACTERS WITHOUT CLAIM TO ANY PARTICULAR FONT, STYLE, SIZE, OR COLOR.

FOR BATH TOWELS; BEACH TOWELS; CHILDREN'S TOWELS; FACE TOWELS; GOLF TOWELS; HAND TOWELS; HAND TOWELS OF TEXTILE; HAND-TOWELS MADE OF TEXTILE FABRICS; HOODED TOWELS; JAPANESE COTTON TOWELS (TENUGUI); KITCHEN TOWELS; LARGE BATH TOWELS; TEA TOWELS; TERRY TOWELS; TOWEL SETS; TOWELLING COVERLETS; TOWELS; TOWELS; BATH SHEETS; BED SHEETS; BED BLANKETS; BLANKET THROWS; BLANKETS FOR OUTDOOR USE; CASHMERE BLANKETS; CHILDREN'S BLANKETS; PET BLANKETS; RECEIVING BLANKETS; SILK BED BLANKETS; SILK BLANKETS; TEXTILE PRINTERS' BLANKETS; WOOLLEN BLANKETS (U.S. CLS. 42 AND 50).

FIRST USE 7-11-2003; IN COMMERCE 7-11-2003.
ALICE BENMAMAN, EXAMINING ATTORNEY

SN 77-296,931. CONNIE ELDER INTERNATIONAL, LLC, NASHVILLE, TN. FILED 10-5-2007.

UNDEROLOGY

THE MARK CONSISTS OF STANDARD CHARACTERS WITHOUT CLAIM TO ANY PARTICULAR FONT, STYLE, SIZE, OR COLOR.

FOR BED LINEN (U.S. CLS. 42 AND 50).
RENEE MCCRAY, EXAMINING ATTORNEY

CLASS 24—(Continued).

SN 77-309,952. INVISTA NORTH AMERICA S.A.R.L., WILMINGTON, DE. FILED 10-22-2007.

FABRICS THAT PAMPER AND CARE

THE MARK CONSISTS OF STANDARD CHARACTERS WITHOUT CLAIM TO ANY PARTICULAR FONT, STYLE, SIZE, OR COLOR.

FOR FABRICS, NAMELY, SYNTHETIC FIBER FABRICS (U.S. CLS. 42 AND 50).

ROBERT LAVACHE, EXAMINING ATTORNEY

SN 78-978,459. HOMESTEAD INTERNATIONAL GROUP LTD., NEW YORK, NY. FILED 5-4-2006.

PIPER & MEADOW

THE MARK CONSISTS OF STANDARD CHARACTERS WITHOUT CLAIM TO ANY PARTICULAR FONT, STYLE, SIZE, OR COLOR.

FOR BED LINENS, COMFORTERS, DUVET COVERS, SHAMS, BEDSKIRTS, SHEETS, DECORATIVE THROWS, FABRIC WINDOW TREATMENTS, NAMELY, CURTAIN PANELS AND VALANCES, WINDOW CURTAIN PANELS, PILLOW COVERS (U.S. CLS. 42 AND 50).

FIRST USE 9-0-2006; IN COMMERCE 2-0-2007.

MARGERIE A. TIERNEY, EXAMINING ATTORNEY

CLASS 25—CLOTHING

SN 74-620,618. SPORTS HERITAGE, U.S.A. INC., PITTSBURGH, PA. FILED 1-11-1995.

CHICAGO COLTS

NO CLAIM IS MADE TO THE EXCLUSIVE RIGHT TO USE "CHICAGO", APART FROM THE MARK AS SHOWN.

FOR CLOTHING, NAMELY, T-SHIRTS, SWEATSHIRTS, JERSEYS, HATS/CAPS, SPORT SHIRTS, AND JACKETS (U.S. CLS. 22 AND 39).

JACQUELINE A. LAVINE, EXAMINING ATTORNEY

CLASS 25—(Continued).

SN 76-583,165. LES VÊTEMENTS VAL & MIK INC., MONTREAL (QUEBEC) H2N 1N7, CANADA, FILED 3-26-2004.

GENUX

THE MARK CONSISTS OF STANDARD CHARACTERS WITHOUT CLAIM TO ANY PARTICULAR FONT, STYLE, SIZE, OR COLOR.

PRIORITY CLAIMED UNDER SEC. 44(D) ON CANADA APPLICATION NO. 1191902, FILED 10-1-2003, REG. NO. TMA675,129, DATED 10-17-2006, EXPIRES 10-17-2021.

FOR (BASED ON 44(E)) CLOTHING FOR MEN, WOMEN AND CHILDREN, NAMELY, SHIRTS, TOPS, NAMELY, TANKTOPS AND HALTER TOPS, PANTS, BLOUSES, SKIRTS, DRESSES, JEANS, OVERALLS, SWEATSHORTS, SWEATPANTS, TANK TOPS, T-SHIRTS, JACKETS, JOGGING SUITS; CLOTHING FOR INFANTS, NEWBORNS, TODDLERS AND CHILDREN, NAMELY, DRESSES, JEANS, JUMPSUITS, SWEATPANTS, SWEATSHIRTS, PANTS, SHIRTS, SHORTS, TIGHTS, FLEECE TOPS, JACKETS, T-SHIRTS; (BASED ON INTENT TO USE) CLOTHING FOR MEN, WOMEN AND CHILDREN, NAMELY, TOPS, HATS, HEADBANDS, SWEATERS, SOCKS, UNDERWEAR, BELTS AND SHOES; CLOTHING FOR INFANTS, NEWBORNS, TODDLERS AND CHILDREN, NAMELY, BABY BUNTINGS, BATHING SUITS, BATH ROBES, CLOTH BIBS, BONNETS, CAPS, BOOTIES, LAYETTES, COVERALLS, BODY SUITS, TEXTILE INFANT DIAPER COVERS, COATS, DRESSING GOWNS, JUMPERS, NIGHTGOWNS, PAJAMAS, ROMPERS, SOCKS, MITTENS, COATS, SNOW SUITS, UNDERWEAR (U.S. CLS. 22 AND 39).

ZHALEH DELANEY, EXAMINING ATTORNEY

SN 76-618,526. X-FACTOR SPORTSWEAR LLC, PLEASANT GROVE, UT. FILED 10-25-2004.

X FACTOR SPORTSWEAR

THE MARK CONSISTS OF STANDARD CHARACTERS WITHOUT CLAIM TO ANY PARTICULAR FONT, STYLE, SIZE, OR COLOR.

NO CLAIM IS MADE TO THE EXCLUSIVE RIGHT TO USE "SPORTSWEAR", APART FROM THE MARK AS SHOWN.

FOR CLOTHING, NAMELY MEN'S, WOMEN'S, AND CHILDREN'S PANTS, SLACKS, TROUSERS, JEANS, SHORTS, OVERALLS, SHIRTS, T-SHIRTS, BLOUSES, VESTS, SKIRTS, JACKETS, COATS, SPORT COATS, SWEATERS, SWEATSHIRTS, SWEATPANTS, HATS, HEADBANDS, TIES, BELTS, SOCKS AND SHOES (U.S. CLS. 22 AND 39).

STEVEN R. FINE, EXAMINING ATTORNEY

CLASS 25—(Continued).

SN 76-666,947. DUAN, SHIANG SHU, ROSEMEAD, CA.
FILED 10-3-2006.

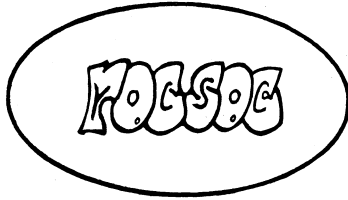

FOR FOOTWEAR, NAMELY, LADIES' WATER SHOES AND MEN'S WATER SHOES WITH SPECIALLY DESIGNED SOLES ALLOWING DRAINAGE (U.S. CLS. 22 AND 39).

FIRST USE 6-1-2006; IN COMMERCE 6-1-2006.
WENDY GOODMAN, EXAMINING ATTORNEY

SN 76-668,885. SEVENTY TWO, INC., LA PUENTE, CA.
FILED 11-13-2006.



THE MARK CONSISTS OF FLOWERS AND PLANTS SURROUNDING THE WORDING "BONAFIDE LOVE" IN STYLIZED LETTERING.

FOR CLOTHING, NAMELY, SHIRTS, I-SHIRTS, SWEATSHIRTS, TANKS-TOPS, COATS, JACKETS, SWEATERS, DRESSES, SKIRTS, BLOUSES, PULL-OVERS, ZIP UP HOODED SWEAT SHIRTS, SWEAT PANTS, PANTS, SHORTS AND VEST (U.S. CLS. 22 AND 39).

FIRST USE 5-2-2004; IN COMMERCE 5-2-2004.
TASHIA BUNCH, EXAMINING ATTORNEY

SN 76-672,584. MARES, FERNANDO, OAKLAND, CA.
FILED 2-12-2007.



NO CLAIM IS MADE TO THE EXCLUSIVE RIGHT TO USE "CLUB", APART FROM THE MARK AS SHOWN.

THE MARK CONSISTS OF THE WORDS "LOUNGERS CLUB," WITH THE LETTER "L" IN "LOUNGERS" FORMING THE DESIGN OF A LOUNGE CHAIR.

FOR T-SHIRTS; SHIRTS (U.S. CLS. 22 AND 39).
FIRST USE 6-15-2004; IN COMMERCE 6-15-2004.
MICHAEL LITZAU, EXAMINING ATTORNEY

CLASS 25—(Continued).

SN 76-672,684. HART, MARKIES, ANNANDALE, VA. FILED
2-14-2007.



THE MARK CONSISTS OF A CROWN WING ON BOTH SIDES OF IT AND "REBELLIOUS GENERATION" GOING THROUGH THE MIDDLE.

FOR MEN'S AND WOMEN'S CLOTHING, NAMELY, SHIRTS, JEANS, HOODS, SWEATERS, AND JACKETS (U.S. CLS. 22 AND 39).

GINA HAYES, EXAMINING ATTORNEY

SN 76-681,723. WEAL, JOANN, BRONX, NY. FILED 9-10-
2007.



THE MARK CONSISTS OF: CROWN EAGLE WITH WINGS WITH THE WORD "KENWEAL" UNDERNEATH EAGLE IN A STYLIZED FONT

FOR CLOTHING AND ACCESSORIES, NAMELY, T-SHIRTS, JACKETS, CAPS, SUITS, JEANS, SHORTS, SOCKS, COATS, AND SWEAT BANDS (U.S. CLS. 22 AND 39).

CHRIS WELLS, EXAMINING ATTORNEY

CLASS 25—(Continued).

SN 76-681,963. SAN ANTONIO SHOE, INC., SAN ANTONIO, TX. FILED 9-17-2007.

SAS

THE MARK CONSISTS OF STANDARD CHARACTERS WITHOUT CLAIM TO ANY PARTICULAR FONT, STYLE, SIZE, OR COLOR.

OWNER OF U.S. REG. NOS. 1,251,761, 1,509,326 AND OTHERS.

FOR SOCKS AND BELTS (U.S. CLS. 22 AND 39).
FIRST USE 3-31-1995; IN COMMERCE 3-31-1995.
RONALD MCMORROW, EXAMINING ATTORNEY

SN 76-682,148. COMPONENTS BY JOHN MCCOY, INC., NEW YORK, NY. FILED 9-20-2007.

M'S USA

THE MARK CONSISTS OF STANDARD CHARACTERS WITHOUT CLAIM TO ANY PARTICULAR FONT, STYLE, SIZE, OR COLOR.

NO CLAIM IS MADE TO THE EXCLUSIVE RIGHT TO USE "USA", APART FROM THE MARK AS SHOWN.

FOR CLOTHING, NAMELY, PANTS, SHIRTS, SWEATERS, COATS, JACKETS, SUITS, RAINCOATS, SKIRTS, SHORTS, SCARVES AND TIES (U.S. CLS. 22 AND 39).
MARY CRAWFORD, EXAMINING ATTORNEY

SN 76-682,454. AUSTELL, KARL, LEVITTOWN, PA. FILED 10-1-2007.

Definitely All Men Notice.

THE MARK CONSISTS OF STANDARD CHARACTERS WITHOUT CLAIM TO ANY PARTICULAR FONT, STYLE, SIZE, OR COLOR.

FOR SHIRTS, TEE SHIRTS, SKIRTS, SHIRTS (U.S. CLS. 22 AND 39).
JAQUELINE A. LAVINE, EXAMINING ATTORNEY

CLASS 25—(Continued).

SN 76-682,509. KWENDE, JOHN A., REVERE, MA. FILED 10-2-2007.



FOR CLOTHING AND FOOTWEAR, NAMELY, T-SHIRTS, SHORTS, TENNIS SHOES, SNEAKERS, JACKETS, DRESSES, SHIRTS, CAPS, HEAD WEAR, PANTS, SWEATERS BAGS, SOCKS AND JERSEYS AND TRACK-SUITS (U.S. CLS. 22 AND 39).
GINA HAYES, EXAMINING ATTORNEY

SN 77-004,055. MIA SHOES, INC., MIAMI, FL. FILED 9-21-2006.

MIA AMORE

THE MARK CONSISTS OF STANDARD CHARACTERS WITHOUT CLAIM TO ANY PARTICULAR FONT, STYLE, SIZE, OR COLOR.

OWNER OF U.S. REG. NO. 2,259,181.
THE FOREIGN WORDING IN THE MARK TRANSLATES INTO ENGLISH AS "LOVE".

FOR FOOTWEAR (U.S. CLS. 22 AND 39).
KRISTIN DAHLING, EXAMINING ATTORNEY

SN 77-013,315. MEADE EMPIRE ENTERTAINMENT LLC, CENTREVILLE, VA. FILED 10-4-2006.



THE STIPPLING IS FOR SHADING PURPOSES ONLY.
THE MARK CONSISTS OF A WOMAN AND THE STYLIZED TEXT OF THE WORDING "ROYAL PHATTY".

FOR BELTS; HATS; PANTS; SCARVES; SHIRTS; BRAS; LINGERIE; PANTIES; SOCKS; UNDERSHIRTS; BATHING SUITS; SHOES; SHORTS; TIGHTS; SKIRTS; TANK TOPS (U.S. CLS. 22 AND 39).
FIRST USE 7-0-2006; IN COMMERCE 7-0-2006.
PAULA MAHONEY, EXAMINING ATTORNEY

CLASS 25—(Continued).

SN 77-023,184. CHARLES RIVER APPAREL, INC., MEDFORD, MA. FILED 10-17-2006.



OWNER OF U.S. REG. NOS. 1,305,145, 1,340,938 AND 1,915,049.

NO CLAIM IS MADE TO THE EXCLUSIVE RIGHT TO USE "SPORT", APART FROM THE MARK AS SHOWN.

THE COLOR(S) ROYAL BLUE AND WHITE IS/ARE CLAIMED AS A FEATURE OF THE MARK.

THE MARK CONSISTS OF A PROFILE OF A ROWER IN ROYAL BLUE WITH A WHITE BACKGROUND, A RECTANGLE DESIGN IN ROYAL BLUE AND THE WORDING "CHARLES RIVER" AND "SPORT" IN WHITE.

FOR ANORAKS, ATHLETIC UNIFORMS, JACKETS, RAINCOATS, RAIN SHIRTS, PARKAS, PONCHOS, PULLOVERS, SLICKERS, SWEATSHIRTS, TOPS, AND WARM-UP SUITS, FOR MEN WOMEN AND CHILDREN (U.S. CLS. 22 AND 39).

KELLY BOULTON, EXAMINING ATTORNEY

SN 77-024,500. KING TECH INDUSTRY INC., SAN DIEGO, CA. FILED 10-19-2006.



THE MARK CONSISTS OF THE DESIGN OF MOUNTAINS ABOVE THE WORDS "CARRY ISLAND".

FOR JACKETS; PANTS (U.S. CLS. 22 AND 39).

FIRST USE 2-14-2006; IN COMMERCE 2-14-2006.

LEIGH CAROLINE CASE, EXAMINING ATTORNEY

CLASS 25—(Continued).

SN 77-027,722. ROLDEN TRUST, KWA ZULU NATAL, SOUTH AFRICA, FILED 10-24-2006.

CARRIWELL

THE MARK CONSISTS OF STANDARD CHARACTERS WITHOUT CLAIM TO ANY PARTICULAR FONT, STYLE, SIZE, OR COLOR.

FOR CLOTHING, NAMELY, MATERNITY WEAR, NAMELY, BLOUSES, PANTS, SKIRTS, PANTIES; FEEDING SHIRTS, FEEDING BRASSIERES, CLOTHING EXTENSION DEVICES, NAMELY, MATERNITY SUPPORT BELTS; FOOTWEAR; HEADWEAR (U.S. CLS. 22 AND 39).

ANDREA HACK, EXAMINING ATTORNEY

SN 77-032,279. MEADOR, MARK, SANTA CRUZ, BOLIVIA, FILED 10-30-2006.

¿ Y Me ?

THE MARK CONSISTS OF STANDARD CHARACTERS WITHOUT CLAIM TO ANY PARTICULAR FONT, STYLE, SIZE, OR COLOR.

FOR WOMEN'S CLOTHING, NAMELY, SHIRTS, PANTS, BELTS AND HATS (U.S. CLS. 22 AND 39).

ALICIA COLLINS, EXAMINING ATTORNEY

SN 77-071,797. OUT OF THE BLUE ENTERPRISES LLC, NEW YORK, NY. FILED 12-27-2006.

SUPER WHY

THE MARK CONSISTS OF STANDARD CHARACTERS WITHOUT CLAIM TO ANY PARTICULAR FONT, STYLE, SIZE, OR COLOR.

FOR BATHING SUITS, BATHROBES, BEACHWEAR, CLOTHING BELTS, SHORTS, JACKETS, COATS, SOCKS, FOOTWEAR, BANDANNAS, SWEATERS, HALLOWEEN COSTUMES, DRESSES, GLOVES, EAR MUFFS, NECKWEAR, PAJAMAS, SLEEPWEAR, PANTS, SHIRTS, T-SHIRTS, SPORTSWEAR, NAMELY, SWEATPANTS AND SWEATSHIRTS, SUN VISORS, SUSPENDERS, UNDERCLOTHES, VESTS, AND HEADWEAR (U.S. CLS. 22 AND 39).

DAVID COLLIER, EXAMINING ATTORNEY

CLASS 25—(Continued).

SN 77-077,732. GO MAN, INC., BROOKLYN, NY. FILED 1-8-2007.



THE COLOR(S) ORANGE IS/ARE CLAIMED AS A FEATURE OF THE MARK.

THE MARK CONSISTS OF AN ORANGE HAND. FOR BATHING SUITS; CAPS; FOOTWEAR FOR MEN AND WOMEN; GLOVES; HATS; HEADBANDS; HEADWEAR; INFANT AND TODDLER ONE PIECE CLOTHING; JACKETS; JERSEYS; JOGGING SUITS; PANTS; SCARVES; SHIRTS; SHOES; SHORTS; SLEEPWEAR; SNEAKERS; SOCKS; SWEATBANDS; SWEATERS; TIES; UNDERWEAR (U.S. CLS. 22 AND 39).

ALICE BENMAMAN, EXAMINING ATTORNEY

CLASS 25—(Continued).

SN 77-085,975. SPACE NEEDLE LLC, SEATTLE, WA. FILED 1-18-2007.

SKYQ

THE MARK CONSISTS OF STANDARD CHARACTERS WITHOUT CLAIM TO ANY PARTICULAR FONT, STYLE, SIZE, OR COLOR.

FOR CLOTHING, NAMELY, SHIRTS, SWEATSHIRTS, PANTS, JACKETS, TIES, SCARVES, GLOVES AND MITTENS; HEADWEAR, NAMELY, HATS, CAPS AND VISORS (U.S. CLS. 22 AND 39).

KRISTIN DAHLING, EXAMINING ATTORNEY

SN 77-090,695. SABOTAGE LIMITED, WORCESTER, UNITED KINGDOM, FILED 1-25-2007.

FLY53

SN 77-081,777. AZUSA PACIFIC UNIVERSITY, AZUSA, CA. FILED 1-12-2007.

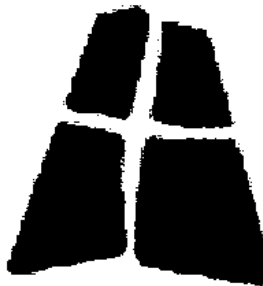

THE MARK CONSISTS OF A FLATTENED TRIANGLE CONTAINING A CROSS.

FOR CLOTHING, NAMELY, T-SHIRTS AND POLO SHIRTS (U.S. CLS. 22 AND 39).

FIRST USE 12-31-1998; IN COMMERCE 12-31-1998.

WANDA KAY PRICE, EXAMINING ATTORNEY

THE MARK CONSISTS OF STANDARD CHARACTERS WITHOUT CLAIM TO ANY PARTICULAR FONT, STYLE, SIZE, OR COLOR.

FOR CLOTHING, NAMELY, ANORAKS, ATHLETIC UNIFORMS, A-SHIRTS, BATHING COSTUMES FOR WOMEN, BATHING SUITS, BATHING TRUNKS, BEACHWEAR, BELTS, BERMUDA SHORTS, BIKINIS, BLAZERS, BLOUSES, BLOUSONS, BOARD SHORTS, BOTTOMS, BOXER BRIEFS, BOXER SHORTS, BRIEFS, CAMP SHIRTS, CAPES, CAPRI PANTS, CAPRIS, CARDIGANS, CARGO PANTS, COATS, DENIM PANTS, DRESS SHIRTS, DRESS SUITS, DRESSES, DUNGAREES, FLEECE PULLOVERS, FLEECE SHORTS, FROCKS, GLOVES, HALTER TOPS, JACKETS, JEANS, JERSEYS, JUMPERS, KNIT SHIRTS, LOUNGE PANTS, LOUNGEWEAR, TROUSERS, VESTS, MEN'S SOCKS, OVERCOATS, PARKAS, PIQUE SHIRTS, POLO SHIRTS, PULLOVERS, QUILTED VESTS, RAIN JACKETS, RAINCOATS, RAINPROOF JACKETS, RUGBY TOPS, SHIRTS, SHORT TROUSERS, SHORTS, SHORT-SLEEVED AND LONG-SLEEVED T-SHIRTS, SNOWBOARDING SUITS, SNOW PANTS, SNOW SUITS, SNOWBOARD GLOVES, SNOWBOARD PANTS, SUEDE JACKETS, SURFWEAR, SWEATPANTS, SWEATSHIRTS, SWEATSHORTS, SWEATSUITS, SWEATERS, SWEATSOCKS, SWIM TRUNKS, SWIMWEAR, TRACK PANTS, TRACKSUITS, TRENCH COATS, WATERPROOF JACKETS AND PANTS, WIND RESISTANT JACKETS, WINDCHECKERS, WINDJAMMERS, WINDJACKETS, WOMEN'S UNDERWEAR; HEADGEAR, NAMELY, BANDANAS, BEANIES, BERETS, CAPS, HEADWEAR, HATS, HOODED SWEATSHIRTS, HOODS, SWEATBANDS; AND FOOTWEAR (U.S. CLS. 22 AND 39).

INGRID C. EULIN, EXAMINING ATTORNEY

CLASS 25—(Continued).

SN 77-094,586. GRAPEVINE INTELLECTUAL PROPERTIES, LLC, HARRISON, NY. FILED 1-30-2007.

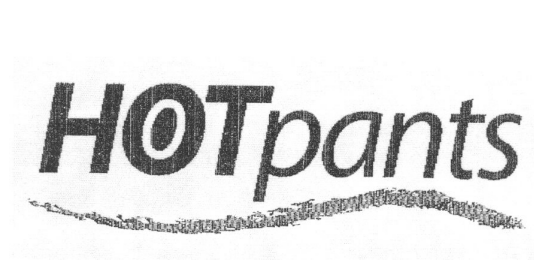

THE MARK CONSISTS OF "HOT PANTS" & DESIGN. FOR CLOTHING, NAMELY, ATHLETIC FOOTWEAR, BLAZERS, BLOUSES, MEN'S UNDERWEAR, COATS, DRESSES, FOOTWEAR, GLOVES, HOSIERY, JACKETS, LEATHER JACKETS, NECKTIES, NECKWEAR, NIGHT-GOWNS, JEANS, RAINWEAR, ROBES, SCARVES, SHIRTS, SHOES, BERMUDA SHORTS, SOCKS, SPORT COATS, SUITS, T-SHIRTS (U.S. CLS. 22 AND 39).
AISHA CLARKE, EXAMINING ATTORNEY

SN 77-095,064. CAI GLOBAL GROUP LTD., KOWLOON, HONG KONG, FILED 1-30-2007.

USA_g

THE MARK CONSISTS OF STANDARD CHARACTERS WITHOUT CLAIM TO ANY PARTICULAR FONT, STYLE, SIZE, OR COLOR.

FOR MEN'S, WOMEN'S AND CHILDREN'S CLOTHING, FOOTWEAR AND HEADGEAR, NAMELY, T-SHIRTS, TANK TOPS, POLO SHIRTS, KNIT SHIRTS, GOLF SHIRTS, HALTER TOPS, SPORT SHIRTS, BLOUSES, BANDANNAS, VISORS, BASEBALL CAPS, HATS, BERETS, HEAD BANDS, BATHING SUITS, BATHING TRUNKS, SWIMSUITS, BIKINIS, BEACHWEAR, WET SUITS, SHORTS, BERMUDA SHORTS, BOXER SHORTS, PANTS, DUNGAREES, JEANS, OVERALLS, SWEATERS, TURTLENECKS, V-NECK SWEATERS, JACKETS, WIND RESISTANT JACKETS, PONCHOS, COATS, RAIN COATS, RAINWEAR, BLAZERS, VESTS, DRESSES, SKIRTS, ATHLETIC UNIFORMS, TRACKSUITS, UNIFORMS, SWEAT BANDS, WRIST BANDS, JERSEYS, SWEAT PANTS, SWEAT SHIRTS, SWEAT SUITS, WARM-UP SUITS, SKI WEAR, SHORTS, GYM SHORTS, GYM SUITS, SWEAT SHORTS, SHOES, SLIPPERS, SNEAKERS, ATHLETIC FOOTWEAR, BOOTS, SOCKS, THERMAL SOCKS, HOSIERY, SWEAT SOCKS, LEG WARMERS, LEGGINGS, KNEE HIGHS, LEOTARDS, UNDERSHIRTS, UNDERWEAR, THERMAL UNDERWEAR, TIES, NECKTIES, BOW TIES, SCARVES, COVERALLS, PAJAMAS, NIGHT SHIRTS, SLEEPWEAR (U.S. CLS. 22 AND 39).
EMILY CARLSEN, EXAMINING ATTORNEY

CLASS 25—(Continued).

SN 77-100,474. ROLE MODEL INDUSTRIES INC., V.M.R., QUEBEC, CANADA, FILED 2-6-2007.

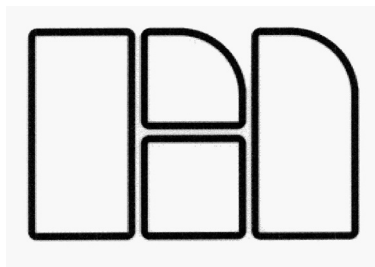

THE MARK CONSISTS OF TWO VERTICAL RECTANGULAR SHAPES WITH A SQUARE AND ABOVE THE SQUARE, A ROUNDED SQUARE, IN BETWEEN THEM.

FOR CLOTHING, NAMELY, T-SHIRTS, LONG-SLEEVED SHIRTS, SLEEVELESS T-SHIRTS, TANK TOPS, SWEATSHIRTS, JERSEYS, JACKETS, HOODED JACKETS, WIND RESISTANT JACKETS, COATS; SHORTS, TROUSERS, CARGO PANTS, JEANS; UNDERWEAR, NAMELY, THONGS, BRIEFS, UNDERPANTS; HATS, BASEBALL CAPS, BEANIES, BANDANAS (U.S. CLS. 22 AND 39).

FIRST USE 7-18-2002; IN COMMERCE 7-18-2002.
MARY BOAGNI, EXAMINING ATTORNEY

SN 77-103,642. MEDITECH INTERNATIONAL CORPORATION, BROOKLYN, NY. FILED 2-9-2007.

MEDIBRIEF

THE MARK CONSISTS OF STANDARD CHARACTERS WITHOUT CLAIM TO ANY PARTICULAR FONT, STYLE, SIZE, OR COLOR.

FOR SINGLE-USE MESH BRIEFS FOR MEDICAL USE (U.S. CLS. 22 AND 39).
RENEE SERVANCE, EXAMINING ATTORNEY

SN 77-108,806. SPACE NEEDLE LLC, SEATTLE, WA. FILED 2-15-2007.

SKY Q

THE MARK CONSISTS OF STANDARD CHARACTERS WITHOUT CLAIM TO ANY PARTICULAR FONT, STYLE, SIZE, OR COLOR.

FOR CLOTHING, NAMELY, SHIRTS, SWEATSHIRTS, PANTS, JACKETS, TIES, SCARVES, GLOVES AND MITTENS; HEADWEAR, NAMELY, HATS, CAPS AND VISORS (U.S. CLS. 22 AND 39).
KRISTIN DAHLING, EXAMINING ATTORNEY

CLASS 25—(Continued).

SN 77-108,816. SPACE NEEDLE LLC, SEATTLE, WA. FILED 2-15-2007.



FOR CLOTHING, NAMELY, SHIRTS, SWEATSHIRTS, PANTS, JACKETS, TIES, SCARVES, GLOVES AND MITTENS; HEADWEAR, NAMELY, HATS, CAPS AND VISORS (U.S. CLS. 22 AND 39).
KRISTIN DAHLING, EXAMINING ATTORNEY

SN 77-109,670. MEYNARD DESIGNS INC., WALTHAM, MA. FILED 2-16-2007.



THE MARK CONSISTS OF A STYLIZED LOWERCASE "E" WITH A LINE THROUGH IT.
FOR FOOTWEAR (U.S. CLS. 22 AND 39).
FIRST USE 2-0-2003; IN COMMERCE 2-0-2003.
KIMBERLY PERRY, EXAMINING ATTORNEY

SN 77-110,339. SYNDICATED EMINENT ENTERPRISES, NEW YORK, NY. FILED 2-18-2007.

YORKVILLE STUDIO

THE MARK CONSISTS OF STANDARD CHARACTERS WITHOUT CLAIM TO ANY PARTICULAR FONT, STYLE, SIZE, OR COLOR.

FOR AFTER SKI BOOTS; ANGLERS' SHOES; ANKLE BOOTS; ANKLE GARTERS; ANKLE SOCKS; ANORAKS; ANTI-PERSPIRANT SOCKS; APRES-SKI SHOES; APRONS; ASCOTS; ATHLETIC FOOTWEAR; ATHLETIC SHOES; ATHLETIC UNIFORMS; BABY BIBS NOT OF PAPER; BABY BUNTING; BABY DOLL PAJAMAS; BALACLAVAS; BALLET SHOES; BALLET SLIPPERS; BALLOON PANTS; BANDANAS; BANDEAUX; BASEBALL CAPS; BASEBALL SHOES; BASKETBALL SNEAKERS; BATH SLIPPERS; BATHING CAPS; BATHING COSTUMES; BATHING COSTUMES FOR WOMEN; BATHING SUITS; BATHING SUITS FOR MEN; BATHING TRUNKS; BATHROBES; BEACH COVERUPS; BEACH FOOTWEAR; BEACH SHOES; BEACHWEAR; BEANIES; BED JACKETS; BELTS; BELTS MADE OF LEATHER; BELTS OF TEXTILE; BERETS; BERMUDA SHORTS; BIB OVERALLS; BIBS NOT OF CLOTH OR PAPER; BICYCLE GLOVES; BICYCLING GLOVES; BIKINIS; BLAZERS; BLOOMERS; BLOUSES; BLOUSONS; BOARD SHORTS; BOAS; BODY SHAPERS; BODY SUITS; BOLEROS; BOLO TIES; BONNETS; BOOTIES; BOOTS; BOTTOMS; BOW TIES; BOWLING SHOES; BOXER BRIEFS; BOXER SHORTS; BOXING SHOES; BRAL-

CLASS 25—(Continued).

ETTES; BRAS; BRASSIERES; BREECHES; BRIEFS; BUSTIERS; BUSTLE HOLDER BANDS FOR OBI (OBIAGE); BUSTLES FOR OBI-KNOTS (OBIAGE-SHIN); BUTTON-FRONT ALOHA SHIRTS; CAFTANS; CAMISETTES; CAMISOLES; CAMP SHIRTS; CANVAS SHOES; CAP VISORS; CAPELETS; CAPES; CAPRI PANTS; CAPRIS; CAPS; CAPS WITH VISORS; CARDIGANS; CARGO PANTS; CASSOCKS; CHASUBLES; CHEF'S HATS; CHEMISES; CHEMISSETTES; CHILDREN'S AND INFANTS' CLOTH BIBS; CHILDREN'S CLOTH EATING BIBS; CHILDREN'S HEADWEAR; CHOIR ROBES; CLAM DIGGERS; CLEATS FOR ATTACHMENT TO SPORTS SHOES; CLIMBING BOOTS; CLOGS; CLOTH BIBS; CLOTH BIBS FOR ADULT DINERS; CLOTH BIBS FOR USE BY SENIOR CITIZENS OR PHYSICALLY- OR MENTALLY-CHALLENGED PERSONS; CLOTH DIAPERS; CLOTHING FOR WEAR IN JUDO PRACTICES; CLOTHING FOR WEAR IN WRESTLING GAMES; CLOTHING, NAMELY, ARM WARMERS; CLOTHING, NAMELY, FOLK COSTUMES; CLOTHING, NAMELY, KNEE WARMERS; CLOTHING, NAMELY, NECK TUBES; CLOTHING, NAMELY, WRAP-AROUNDS; COATS; COATS FOR MEN AND WOMEN; COATS MADE OF COTTON; COATS OF DENIM; COBBLERS' APRONS; COLLAR PROTECTORS; COLLARS; COMBINATIONS; COMPETITORS' NUMBERS OF TEXTILE; CORSELETS; CORSETS; COSTUMES FOR USE IN ROLE-PLAYING GAMES; COVERALLS; COVERUPS; CRAVATES; CRAVATS; CREEPERS; CROP TOPS; CUFFS; CULOTTES; CUMMERBUNDS; CYCLING SHOES; CYCLISTS' JERSEYS; DANCE COSTUMES; DECK-SHOES; DENIM JACKETS; DENIMS; DETACHABLE NECKPIECES FOR KIMONOS (HANERI); DICKIES; DISPOSABLE SLIPPERS; DISPOSABLE UNDERWEAR; DO RAGS; DOWN JACKETS; DRESS SHIELDS; DRESS SHIRTS; DRESS SUITS; DRESSES; DRESSES MADE FROM SKINS; DRESSING GOWNS; DRY SUITS; DUNGAREES; DUST COATS; DUSTERS; EAR MUFFS; EARBANDS; EMBOSSED SOLES AND HEELS OF RUBBER OR OF PLASTIC MATERIALS; ESPADRILLES; EVENING DRESSES; EVENING GOWNS; FABRIC BELTS; FIGURE SKATING CLOTHING, NAMELY, DRESSES, SKIRTS, LEOTARDS AND TIGHTS; FINISHED TEXTILE LININGS FOR GARMENTS; FISHERMEN'S JACKETS; FISHING VESTS; FISHING WADERS; FITTED SWIMMING COSTUMES WITH BRA CUPS; FLEECE PULLOVERS; FLEECE SHORTS; FLIGHT SUITS; FLIP FLOPS; FOAM PEDICURE SLIPPERS; FOOTBALL BOOTS AND STUDS THEREFOR; FOOTBALL SHOES; FOOTWEAR; FOOTWEAR FOR MEN AND WOMEN; FOOTWEAR FOR TRACK AND FIELD ATHLETICS; FOOTWEAR MADE OF WOOD; FOOTWEAR NOT FOR SPORTS; FOOTWEAR, NAMELY, PUMPS; FOOTWEAR, NAMELY, RUBBERS; FOUL WEATHER GEAR; FOULARDS; FOUNDATION GARMENTS; FROCKS; FULL-LENGTH KIMONOS (NAGAGI); FUR CLOAKS; FUR COATS AND JACKETS; FUR HATS; FUR MUFFS; FUR STOLE; G-STRINGS; GABERDINES; GAITERS; GALOSHES; GARTER BELTS; GAUCHOS; GIRDLES; GLOVES; GLOVES FOR PERSONAL HAND CONDITIONING USE; GLOVES INCLUDING THOSE MADE OF SKIN, HIDE OR FUR; GOLF CAPS; GOLF CLEATS; GOLF SHIRTS; GOLF SHOES; GOLF SPIKES; GOLF TROUSERS; GOWNS; GREATCOATS; GYM SHORTS; GYM SUITS; GYMNASTIC SHOES; HALLOWEEN COSTUMES; HALLOWEEN COSTUMES AND MASKS SOLD IN CONNECTION THEREWITH; HALTER TOPS; HANDBALL SHOES; HAT BANDS; HATS; HEAD SCARVES; HEAD SWEATBANDS; HEAD WEAR; HEADBANDS; HEADBANDS AGAINST SWEATING; HEADGEAR, NAMELY, HATS, CAPS, AND BERETS; HEADWEAR; HEAVY JACKETS; HIGH RAIN CLOGS (ASHIDA); HIKING BOOTS; HIPGUARDS ESPECIALLY MADE FOR FISHING; HOCKEY SHOES; HOODS; HOODS; HORSE-RIDING BOOTS; HOUSECOATS; HUNTING BOOT BAGS; HUNTING VESTS; INFANT AND TODDLER ONE PIECE CLOTHING; INFANT CLOTH DIAPERS; INFANT DIAPER COVERS; INFANT SLEEPERS; INFANTS' SHOES AND BOOTS; INFANTS' TROUSERS; INFANTWEAR; INNER SOLES; INSOLES; JACKET LINERS; JACKETS; JAPANESE FOOTWEAR OF RICE STRAW (WARAJI); JAPANESE SLEEPING ROBES (NEMAKI); JAPANESE SPLIT-TOED WORK FOOTWEAR (JIKATABI); JAPANESE STYLE CLOGS AND SANDALS; JAPANESE STYLE SANDALS (ZORI); JAPANESE STYLE SANDALS OF FELT; JAPANESE STYLE SANDALS OF LEATHER;

CLASS 25—(Continued).

JAPANESE STYLE SOCKS (TABI COVERS); JAPANESE STYLE SOCKS (TABI); JAPANESE STYLE WOODEN CLOGS (GETA); JAPANESE TOE-STRAP SANDALS (ASAURA-ZORI); JEANS; JERKINS; JERSEYS; JODHPURS; JOGGING OUTFITS; JOGGING PANTS; JOGGING SUITS; JUDO SUITS; JUMPERS; JUMPSUITS; KARATE SUITS; KENDO OUTFITS; KERCHIEFS; KILTS; KIMONOS; KNEE HIGHS; KNEE-HIGH STOCKINGS; KNICKERS; KNIT SHIRTS; KNITTED CAPS; KNITTED UNDERWEAR; LAB COATS; LACE BOOTS; LADIES' BOOTS; LADIES' SUITS; LADIES' UNDERWEAR; LAYETTES; LEATHER BELTS; LEATHER COATS; LEATHER HEADWEAR; LEATHER JACKETS; LEATHER PANTS; LEATHER SHOES; LEATHER SLIPPERS; LEG SHAPERS; LEG WARMERS; LEG-WARMERS; LEGGINGS; LEOTARDS AND TIGHTS FOR WOMEN, MEN AND CHILDREN OF NYLON, COTTON OR OTHER TEXTILE FIBERS; LIGHT-REFLECTING COATS; LIGHT-REFLECTING JACKETS; LINGERIE; LIVERIES; LONG JACKETS; LONG SLEEVED VESTS; LOUNGEWEAR; LOW WOODEN CLOGS (HIYORI-GETA); LOW WOODEN CLOGS (KOMA-GETA); MAILLOTS; MANTILLAS; MANTLES; MARTIAL ARTS UNIFORMS; MASQUERADE COSTUMES; MASQUERADE COSTUMES AND MASKS SOLD IN CONNECTION THEREWITH; MATERNITY LINGERIE; MATERNITY SLEEPWEAR; MEN AND WOMEN JACKETS, COATS, TROUSERS, VESTS; MEN'S SOCKS; MEN'S SUITS; MEN'S SUITS, WOMEN'S SUITS; METAL FITTINGS FOR JAPANESE STYLE WOODEN CLOGS; MINISKIRTS; MITTENS; MOCCASINS; MOCK TURTLE-NECK SWEATERS; MONEY BELTS; MORNING COATS; MOTORCYCLE GLOVES; MOTORCYCLIST BOOTS; MOUNTAINEERING BOOTS; MUFFLERS; MUFFS; MUKLUKS; MULES; MUSCLE TOPS; MUU MUUS; NECK BANDS; NECK GAITERS; NECKERCHIEFS; NECKERCHIEVES; NECKTIES; NECKWEAR; NEGLIGEEES; NIGHT GOWNS; NIGHT SHIRTS; NIGHTCAPS; NIGHTDRESSES; NIGHTIES; NIGHTWEAR; NON-DISPOSABLE CLOTH TRAINING PANTS; NOVELTY HEADWEAR WITH ATTACHED WIGS; NURSE DRESSES; NURSE OVERALLS; NURSE PANTS; NURSE'S APPAREL, NAMELY, DRESSES, SCRUBS NOT FOR MEDICAL PURPOSES, AND LAB COATS; NURSING APPAREL, NAMELY, T-SHIRTS AND TOPS; ONE PIECE GARMENT FOR INFANTS AND TODDLERS; OPEN-NECKED SHIRTS; OVER-TROUSERS; OVERALLS; OVERCOATS; OVERSHOES; PAJAMAS; PANTALOONS; PANTIES, SHORTS AND BRIEFS; PANTS; PANTSUITS; PANTYHOSE; PAPER HATS FOR USE AS CLOTHING ITEMS; PARAMETERS; PAREOS; PAREU; PARKAS; PEDAL PUSHERS; PEDICURE SANDALS; PEDICURE SLIPPERS; PEIGNOIRS; PELERINES; PELISSES; PERSPIRATION ABSORBENT UNDERWEAR CLOTHING; PETTI-PANTS; PETTICOATS; PINAFORES; PIQUE SHIRTS; PLASTIC BABY BIBS; PLAY SUITS; PLEATED SKIRTS FOR FORMAL KIMONOS (HAKAMA); PLUS FOURS; POCKET KERCHIEFS; POCKET SQUARES; POLO SHIRTS; PONCHOS; PROTECTIVE METAL MEMBERS FOR SHOES AND BOOTS; PULLOVERS; PUMPS; PUTTEES AND GAITERS; PAJAMAS; QUILTED VESTS; RAIN BOOTS; RAIN COATS; RAIN JACKETS; RAIN SLICKERS; RAIN SUITS; RAIN TROUSERS; RAINCOATS; RAINPROOF JACKETS; RAINWEAR; RASH GUARDS; REMOVABLE COLLARS; RIDING BOOTS; RIDING COATS; RIDING GLOVES; ROBES; ROMPERS; RUBBER SHOES; RUBBER SOLES FOR JIKATABI; RUBBERS; RUGBY SHOES; RUGBY SHORTS; RUGBY TOPS; RUNNING SHOES; SABOTS; SANDAL-CLOGS; SANDALS; SARIS; SASH BANDS FOR KIMONO (OBI); SASHES; SCARVES; SCHOOL UNIFORMS; SEDGE HATS (SUGEGASA); SERAPES; SHAMPOO CAPES; SHAWLS AND HEADSCARVES; STOLEES; SHIFTS; SHIRT FRONTS; SHIRT YOKES; SHIRTS; SHIRTS FOR SUITS; SHOE DOWELS; SHOE INSERTS FOR PRIMARILY NON-ORTHOPEDIC PURPOSES; SHOES; SHORT OVERCOAT FOR KIMONO (HAORI); SHORT PETTICOATS; SHORT SETS; SHORT TROUSERS; SHORT-SLEEVED OR LONG-SLEEVED T-SHIRTS; SHORT-SLEEVED SHIRTS; SHORTALLS; SHORTS; SHOULDER SCARVES; SHOULDER WRAPS; SHOWER CAPS; SHRUGS; SILK SCARVES; SINGLETS; SKATING OUTFITS; SKI AND SNOWBOARD SHOES AND PARTS THEREOF; SKI BIBS; SKI BOOT BAGS; SKI BOOTS; SKI GLOVES; SKI JACKETS; SKI MASKS; SKI PANTS; SKI SUITS; SKI SUITS FOR COMPETITION; SKI WEAR; SKIING SHOES; SKIRT SUITS; SKIRTS; SKIRTS AND DRESSES;

CLASS 25—(Continued).

SKORTS; SKULL CAPS; SKULLIES; SLACKS; SLEEP MASKS; SLEEP SHIRTS; SLEEPING GARMENTS; SLEEPWEAR; SLEEVED OR SLEEVELESS JACKETS; SLEEVELESS JERSEYS; SLIDING SHORTS; SLIPPER SOLES; SLIPPERS; SLIPS; SMALL HATS; SMOCKS; SMOKING JACKETS; SNEAKERS; SNOW BOARDING SUITS; SNOW PANTS; SNOW SUITS; SNOWBOARD BOOTS; SNOWBOARD GLOVES; SNOWBOARD PANTS; SOCCER BOOTS; SOCCER SHOES; SOCK SUSPENDERS; SOCKS AND STOCKINGS; SOLES; SOLES FOR JAPANESE STYLE SANDALS; SPORT COATS; SPORT SHIRTS; SPORTS BRA; SPORTS JACKETS; SPORTS JERSEYS AND BREECHES FOR SPORTS; SPORTS OVERUNIFORMS; SPORTS SHIRTS; SPORTS SHIRTS WITH SHORT SLEEVES; STOCKINGS; STOLEES; STRAPLESS BRAS; STRAPS FOR BRAS; STRING FASTENERS FOR HAORI (HAORI-HIMO); STUFF JACKETS; SUEDE JACKETS; SUIT COATS; SUITS; SUITS OF LEATHER; SUN SLEEVES; SUN VISORS; SUNSUITS; SURF WEAR; SUSPENDER BELTS FOR MEN; SUSPENDER BELTS FOR WOMEN; SUSPENDERS; SWADDLING CLOTHES; SWEAT BANDS; SWEAT PANTS; SWEAT SHIRTS; SWEAT SHORTS; SWEAT SUITS; SWEATBANDS; SWEATERS; SWEATSOCKS; SWIM CAPS; SWIM TRUNKS; SWIM WEAR; SWIM WEAR FOR GENTLEMEN AND LADIES; SWIMMING CAPS; SWIMMING CAPS; SWIMMING COSTUMES; SWIMMING TRUNKS; SWIMSUITS; T-SHIRTS; TAILLEURS; TANK-TOPS; TANKINIS; TAP PANTS; TAP SHOES; TEDDIES; TENNIS SHOES; TENNIS WEAR; TEXTILE DIAPERS; TEXTILE NAPPIES; THERMAL SOCKS; THERMAL UNDERWEAR; THONGS; TIES; TIGHTENING-UP STRINGS FOR KIMONOS (DATEJIME); TIGHTS; TIPS FOR FOOTWEAR; TOBOGGAN HATS, PANTS AND CAPS; TOE BOXES; TOE CAPS; TOE STRAPS FOR JAPANESE STYLE SANDALS; TOE STRAPS FOR JAPANESE STYLE WOODEN CLOGS; TOGAS; TONGUE OR PULLSTRAP FOR SHOES AND BOOTS; TOPCOATS; TOPS; TOQUES; TRACK AND FIELD SHOES; TRACK PANTS; TRACK SUITS; TRAINING SHOES; TRAINING SUITS; TRENCH COATS; TROUSERS; TROUSERS FOR SWEATING; TROUSERS OF LEATHER; TRUNKS; TUNICS; TUQUES; TURBANS; TURTLENECK SWEATERS; TURTLENECKS; TUXEDO BELTS; TUXEDOS; TWIN SETS; UNDER GARMENTS; UNDERARM CLOTHING SHIELDS; UNDERCLOTHES; UNDERGARMENTS; UNDERPANTS; UNDERSHIRTS; UNDERSHIRTS FOR KIMONOS (JUBAN); UNDERSHIRTS FOR KIMONOS (KOSHIMAKI); UNDERSKIRTS; UNDERWEAR; UNIFORMS; UNITARDS; UPPERS FOR JAPANESE STYLE SANDALS; UPPERS OF WOVEN RATTAN FOR JAPANESE STYLE SANDALS; V-NECK SWEATERS; VEILS; VEST EXTENDERS; VESTED SUITS; VESTS; VISORS; VOLLEYBALL SHOES; WAIST BELTS; WAIST STRINGS FOR KIMONOS (KOSHIHIMO); WAISTBANDS; WAISTCOATS; WALKING SHORTS; WARM UP SUITS; WATER SOCKS; WATERPROOF JACKETS AND PANTS; WEDDING DRESSES; WEDDING GOWNS; WET SUIT GLOVES; WET SUITS; WET SUITS FOR WATER-SKIING AND SUB-AQUA; WIND COATS; WIND RESISTANT JACKETS; WIND SHIRTS; WIND VESTS; WIND-JACKETS; WINDCHEATERS; WINDJAMMERS; WINDSHIRTS; WINTER BOOTS; WOMEN'S CEREMONIAL DRESSES; WOMEN'S SHOES; WOMEN'S UNDERWEAR; WOODEN MAIN BODIES OF JAPANESE STYLE WOODEN CLOGS; WOODEN SUPPORTS OF JAPANESE STYLE WOODEN CLOGS; WOOLLEN SOCKS; WOOLLY HATS; WORK SHOES AND BOOTS; WORKING OVERALLS; WOVEN OR KNITTED UNDERWEAR; WRAP BELTS FOR KIMONOS (DATEMAKI); WRAPS; WRISTBANDS; WRISTBANDS CONTAINING A COOLING SUBSTANCE TO COOL THE WEARER; YASHMAGHS; ZOOT SUITS; ZORI (U.S. CLS. 22 AND 39).

FIRST USE 4-1-1991; IN COMMERCE 4-1-1991.

NAKIA HENRY, EXAMINING ATTORNEY

CLASS 25—(Continued).

SN 77-111,527. NEW YORK FOOTBALL GIANTS, INC., EAST RUTHERFORD, NJ. FILED 2-20-2007.

GIANTS

THE MARK CONSISTS OF STANDARD CHARACTERS WITHOUT CLAIM TO ANY PARTICULAR FONT, STYLE, SIZE, OR COLOR.

OWNER OF U.S. REG. NOS. 1,174,597, 1,927,075 AND OTHERS.

FOR MEN'S, WOMEN'S AND CHILDREN'S CLOTHING, NAMELY, FLEECE TOPS AND BOTTOMS, HEADWEAR, CAPS, T-SHIRTS, SWEATSHIRTS, SHORTS, TANK TOPS, JACKETS, GOLF SHIRTS, KNIT SHIRTS, JERSEYS, WRISTBANDS, GLOVES, TIES; SLEEPWEAR, NAMELY, PAJAMAS; AND APRONS; ALL OF THE FOREGOING RELATING TO FOOTBALL OR A FOOTBALL TEAM (U.S. CLS. 22 AND 39).

FIRST USE 9-0-1983; IN COMMERCE 9-0-1983.

KATHERINE E. HALMEN, EXAMINING ATTORNEY

SN 77-113,971. T.I.S.S. LTD., EL SEGUNDO, CA. FILED 2-22-2007.

R.O.Y.A.L GIRL

THE MARK CONSISTS OF STANDARD CHARACTERS WITHOUT CLAIM TO ANY PARTICULAR FONT, STYLE, SIZE, OR COLOR.

NO CLAIM IS MADE TO THE EXCLUSIVE RIGHT TO USE "GIRL", APART FROM THE MARK AS SHOWN.

FOR FOOTWEAR (U.S. CLS. 22 AND 39).

FIRST USE 2-1-2007; IN COMMERCE 2-1-2007.

KEVIN CORWIN, EXAMINING ATTORNEY

SN 77-114,071. KIK-WEAR, INC., LOS ANGELES, CA. FILED 2-22-2007.

GHOSTS & ANGELS

THE MARK CONSISTS OF STANDARD CHARACTERS WITHOUT CLAIM TO ANY PARTICULAR FONT, STYLE, SIZE, OR COLOR.

FOR CLOTHING, NAMELY, PANTS, SHORTS, SKIRTS, DRESSES, TOPS, SWEATSHIRTS, VESTS, AND T-SHIRTS (U.S. CLS. 22 AND 39).

CAROLYN GRAY, EXAMINING ATTORNEY

CLASS 25—(Continued).

SN 77-116,942. SHRAM, MOSHE, LOS ANGELES, CA. FILED 2-27-2007.

FESTIVAL OF LIFE

THE MARK CONSISTS OF STANDARD CHARACTERS WITHOUT CLAIM TO ANY PARTICULAR FONT, STYLE, SIZE, OR COLOR.

FOR MEN'S, WOMEN'S AND CHILDREN'S CLOTHING, NAMELY, TOPS, BOTTOMS, WOVEN AND KNITS SHIRTS, T-SHIRTS, JACKETS, SWEATERS, SWEAT SHIRTS, ACTIVE WEAR, NAMELY, SWEAT PANTS AND SWEAT SUITS, SPORTS WEAR, NAMELY, SHORTS, JOGGING PANTS, JERSEYS, AND SWEAT PANTS, UNDERWEAR, PANTS, UNIFORMS, DRESSES, SLEEP WEAR, SWIM WEAR, SHORTS, JEANS, BLAZERS, HEADWEAR, AND HATS (U.S. CLS. 22 AND 39).

FIRST USE 3-15-2006; IN COMMERCE 3-15-2006.

MARK SPARACINO, EXAMINING ATTORNEY

SN 77-117,369. MUNOZ TORREGROSA, VICTORIA, ALTEA, ALICANTE, SPAIN, FILED 2-27-2007.

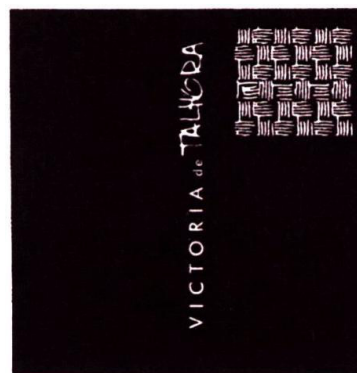

OWNER OF SPAIN REG. NO. 2.580.161, DATED 2-11-2004, EXPIRES 2-11-2014.

THE FOREIGN WORDING IN THE MARK TRANSLATES INTO ENGLISH AS VICTORY OF.

FOR SHAWLS, SCARVES AND FOULARDS (U.S. CLS. 22 AND 39).

REBECCA EISINGER, EXAMINING ATTORNEY

CLASS 25—(Continued).

SN 77-119,447. WENGER S.A., DELEMONT, SWITZERLAND, FILED 3-1-2007.

MAKER OF THE GENUINE SWISS
ARMY KNIFE

THE MARK CONSISTS OF STANDARD CHARACTERS WITHOUT CLAIM TO ANY PARTICULAR FONT, STYLE, SIZE, OR COLOR.

FOR CLOTHING FOR MEN, WOMEN AND CHILDREN, NAMELY, FOOTWEAR, SHOES, ATHLETIC FOOTWEAR, SLIPPERS, SANDALS, BOOTS, JACKETS, HATS, SWEAT PANTS, SWEAT SHIRTS, SWEATERS, SHIRTS, T-SHIRTS, POLO SHIRTS, DRESS SHIRTS, BLOUSES, DRESSES, SKIRTS, SCARVES, SOCKS, HOSIERY, PANTS, SHORTS, UNDERGARMENTS, COATS, PARKAS, WIND RESISTANT JACKETS, RAINWEAR, HEADWEAR (U.S. CLS. 22 AND 39).

HANNO RITTNER, EXAMINING ATTORNEY

CLASS 25—(Continued).

SN 77-122,775. JAMVELTZ LLC, WESTCHESTER, IL. FILED 3-5-2007.

ROBINANNIE

THE MARK CONSISTS OF STANDARD CHARACTERS WITHOUT CLAIM TO ANY PARTICULAR FONT, STYLE, SIZE, OR COLOR.

FOR CLOTHING, NAMELY, MASTECTOMY BRASSIERES, BRASSIERES, CAMISOLES, TAP PANTS, CHEMISES, LOUNGEWEAR, SHIRTS, DRESSES, JACKETS, SWEATERS, LINGERIE, T-SHIRTS, SWEATSHIRTS, PULLOVERS, CARDIGANS, TANK TOPS, BLOUSES, TRACK SHIRTS, DRESSING GOWNS, TROUSERS, GARBADINES, JEANS, PANTS AND LEGGINGS, SKIRTS, SWIMSUITS, SHORTS, BATHING SUITS, UNDERSKIRTS, VESTS, CROPPED PANTS, DUNGAREES, NIGHTGOWNS, NEGLIGEEES, BATHROBES, PAJAMAS, ROMPER STYLE DRESSES, TUNICS, TRACKSUITS, KNIT DRESSES, KNITS, SHIRT DRESSES, NIGHT SHIRTS, PANTIES, SLIPS, UNDERSHIRTS, FOUNDATION GARMENTS, BODYSHAPERS, BUSTIERS, BEACH COVERUPS, BODYSUITS, TUNICS (U.S. CLS. 22 AND 39).

MICHELE SWAIN, EXAMINING ATTORNEY

SN 77-120,873. PANAMA JACK INTERNATIONAL, INC., ORLANDO, FL. FILED 3-2-2007.

GUIDE & OUTFITTER BY PANAMA JACK

THE MARK CONSISTS OF STANDARD CHARACTERS WITHOUT CLAIM TO ANY PARTICULAR FONT, STYLE, SIZE, OR COLOR.

OWNER OF U.S. REG. NOS. 1,667,691, 2,847,769 AND OTHERS.

FOR CLOTHING, NAMELY, FOOTWEAR, HEADWEAR, SHIRTS, SHORTS, PANTS, JACKETS, SWEATSHIRTS, SWEATPANTS AND SWIMWEAR (U.S. CLS. 22 AND 39).

FIRST USE 12-0-2006; IN COMMERCE 12-0-2006.
BARNEY CHARLON, EXAMINING ATTORNEY

SN 77-123,000. WALLS INDUSTRIES, INC., CLEBURNE TEXAS, CLEBURNE, TX. FILED 3-6-2007.

WE ARE THE WEARABLE TOOL

THE MARK CONSISTS OF STANDARD CHARACTERS WITHOUT CLAIM TO ANY PARTICULAR FONT, STYLE, SIZE, OR COLOR.

NO CLAIM IS MADE TO THE EXCLUSIVE RIGHT TO USE "WEARABLE", APART FROM THE MARK AS SHOWN.

FOR MEN'S WOMEN'S AND CHILDREN'S CLOTHING, NAMELY, INSULATED AND NON-INSULATED JACKETS, SHOOTING COATS, HUNTING COATS, OVER COATS, PARKAS, VESTS, PANTS, SHIRTS, HATS, SWEATERS, SHORTS, INSULATED UNDERWEAR, SHOES, BOOTS, GLOVES (U.S. CLS. 22 AND 39).

FIRST USE 1-0-2006; IN COMMERCE 1-0-2006.
MARK SPARACINO, EXAMINING ATTORNEY

CLASS 25—(Continued).

SN 77-123,222. EAGLE CREST, INC., JACKSONVILLE, FL. FILED 3-6-2007.



THE MARK CONSISTS OF A BACKWARDS "K" FOLLOWED BY "A", "M", "P", ALL IN STENCIL STYLE FOR CLOTHING, NAMELY, HATS, SHIRTS, UNDERGARMENTS, SWIMSUITS, SWEATSHIRTS, SWEATERS, JACKETS, COATS, GLOVES, SCARVES, BELTS, HEADBANDS, WRISTBANDS, PANTS, SHORTS, SKIRTS, DRESSES, OVERALLS, SOCKS, STOCKINGS, AND LEGGINGS (U.S. CLS. 22 AND 39).
FIRST USE 1-24-2005; IN COMMERCE 1-24-2005.
CHRIS WELLS, EXAMINING ATTORNEY

SN 77-128,072. CASEY, DANIEL, MERRITT ISLAND, FL. AND CASEY, JANINE, MERRITT ISLAND, FL. FILED 3-12-2007.

KNOT ALL THERE

THE MARK CONSISTS OF STANDARD CHARACTERS WITHOUT CLAIM TO ANY PARTICULAR FONT, STYLE, SIZE, OR COLOR.
FOR APPAREL, NAMELY, T-SHIRTS, HATS, AND SHIRTS (U.S. CLS. 22 AND 39).
CHRISTOPHER BUONGIORNO, EXAMINING ATTORNEY

SN 77-129,772. HARTWELL INDUSTRIES, INC., HARTWELL, GA. FILED 3-13-2007.



NO CLAIM IS MADE TO THE EXCLUSIVE RIGHT TO USE "EST" AND "SINCE 1963", APART FROM THE MARK AS SHOWN.
FOR JACKETS, BASEBALL JACKETS, WINDSHIRTS, PULLOVERS (U.S. CLS. 22 AND 39).
FIRST USE 1-1-2006; IN COMMERCE 1-1-2006.
PAULA MAYS, EXAMINING ATTORNEY

CLASS 25—(Continued).

SN 77-131,753. NORTH COUNTY FIGHT CLUB, LLC, CARLSBAD, CA. FILED 3-15-2007.

ALPHA FIGHT GEAR

THE MARK CONSISTS OF STANDARD CHARACTERS WITHOUT CLAIM TO ANY PARTICULAR FONT, STYLE, SIZE, OR COLOR.
NO CLAIM IS MADE TO THE EXCLUSIVE RIGHT TO USE "FIGHT GEAR", APART FROM THE MARK AS SHOWN.
FOR CLOTHING AND ATHLETIC GEAR, NAMELY, SHORT SLEEVE T-SHIRTS, LONG SLEEVE T-SHIRTS, SLEEVELESS T-SHIRTS, ATHLETIC SHIRTS, TANK TOPS, SWEATERS, SWEATSHIRTS, PULLOVERS, HOODED SWEATSHIRT, RASH GUARD JERSEYS AND T-SHIRTS, JERSEYS, JACKETS, COATS, SHORTS, SWEAT PANTS, WARM UP PANTS, AND JACKETS, UNDERWEAR, CAPS, HATS, BEANIES, SKULL CAPS, SUN VISORS, HAND BANDS, SOCKS, BANDANNA, HEAD AND WRIST BANDS, AND FOOTWEAR (U.S. CLS. 22 AND 39).
FIRST USE 5-1-2004; IN COMMERCE 5-1-2004.
WENDY GOODMAN, EXAMINING ATTORNEY

SN 77-132,119. THE FRATELLIS, LONDON, UNITED KINGDOM, FILED 3-15-2007.

THE FRATELLIS

THE MARK CONSISTS OF STANDARD CHARACTERS WITHOUT CLAIM TO ANY PARTICULAR FONT, STYLE, SIZE, OR COLOR.
PRIORITY CLAIMED UNDER SEC. 44(D) ON ERPNCMNTY TM OFC APPLICATION NO. 5326251, FILED 9-20-2006, REG. NO. 005326251, DATED 10-31-2007, EXPIRES 9-20-2016.
THE ENGLISH TRANSLATION OF THE WORD "FRATELLIS" IN THE MARK IS "BROTHERS".
FOR T-SHIRTS, SWEATSHIRTS, JACKETS, TROUSERS AND HATS (U.S. CLS. 22 AND 39).
LEIGH CAROLINE CASE, EXAMINING ATTORNEY

SN 77-132,704. EVANS, WILLA B., LEAGUE CITY, TX. FILED 3-16-2007.

Crowning Glory

THE MARK CONSISTS OF STANDARD CHARACTERS WITHOUT CLAIM TO ANY PARTICULAR FONT, STYLE, SIZE, OR COLOR.
FOR WOMEN'S APPAREL, NAMELY, HEAD GEAR IN THE NATURE OF HATS, CAPS, AND NOVELTY HEADWEAR WITH ATTACHED WIGS (U.S. CLS. 22 AND 39).
MATTHEW PAPPAS, EXAMINING ATTORNEY

CLASS 25—(Continued).

SN 77-136,068. TOMAS, LAURA N., LOS ANGELES, CA. FILED 3-20-2007.

LAURALOVES

THE MARK CONSISTS OF STANDARD CHARACTERS WITHOUT CLAIM TO ANY PARTICULAR FONT, STYLE, SIZE, OR COLOR.

FOR UNDERWEAR; T-SHIRTS; PANTIES, SHORTS AND BRIEFS; SHORTS; JACKETS; DRESSES (U.S. CLS. 22 AND 39).

FIRST USE 5-15-1999; IN COMMERCE 8-1-2004.

ARETHA SOMERVILLE, EXAMINING ATTORNEY

CLASS 25—(Continued).

SN 77-141,007. DJ FASHIONS, LLC, FORT WASHINGTON, PA. FILED 3-27-2007.

NITE TRENDS

THE MARK CONSISTS OF STANDARD CHARACTERS WITHOUT CLAIM TO ANY PARTICULAR FONT, STYLE, SIZE, OR COLOR.

FOR WOMEN'S CLOTHING, NAMELY, DRESSES, SKIRTS, JACKETS, SWEATERS, BLOUSES AND PANTS (U.S. CLS. 22 AND 39).

ESTHER A. BORSUK, EXAMINING ATTORNEY

SN 77-137,267. SHANTOU SAYONA FOOTWEAR CO., LTD., SHANTOU, CHINA, FILED 3-22-2007.



THE COLOR(S) BROWN AND BLACK IS/ARE CLAIMED AS A FEATURE OF THE MARK.

THE COLOR BROWN APPEARS IN A RECTANGLE AND IN A SERIES OF FANNED-OUT SHOE SOLES, WITHIN THE BROWN RECTANGLE, THE TEXT "SAYONA" APPEARS IN BLACK. WHITE APPEARS IN THE DRAWING TO INDICATE A TRANSPARENT BACKGROUND.

FOR THONGS; FLIP FLOPS; FOOTWEAR FOR MEN; FOOTWEAR FOR MEN AND WOMEN; FOOTWEAR FOR WOMEN (U.S. CLS. 22 AND 39).

REBECCA EISINGER, EXAMINING ATTORNEY

SN 77-141,381. SWIFT, TAYLOR, HENDERSONVILLE, TN. FILED 3-27-2007.

TAYLOR SWIFT

SN 77-137,591. I-WEAR & CO. INC., NEW YORK, NY. FILED 3-22-2007.

RED POCKET

THE MARK CONSISTS OF STANDARD CHARACTERS WITHOUT CLAIM TO ANY PARTICULAR FONT, STYLE, SIZE, OR COLOR.

FOR SHIRTS; PANTS; HATS; CAPS; BELTS; SHOES; SOCKS; JACKETS; COATS; SKIRTS; DRESSES; SWEATERS; SHORTS; SUITS; UNDERWEAR; LOUNGEWEAR; SLEEPWEAR; SWIM WEAR (U.S. CLS. 22 AND 39).

PAULA MAYS, EXAMINING ATTORNEY

THE MARK CONSISTS OF STANDARD CHARACTERS WITHOUT CLAIM TO ANY PARTICULAR FONT, STYLE, SIZE, OR COLOR.

THE NAME "TAYLOR SWIFT" IDENTIFIES A LIVING INDIVIDUAL WHOSE CONSENT IS OF RECORD.

FOR CLOTHING, NAMELY, SHIRTS, T-SHIRTS, SWEATSHIRTS, JERSEYS, HATS AND CAPS (U.S. CLS. 22 AND 39).

FIRST USE 10-0-2000; IN COMMERCE 10-0-2000.

MICHAEL KEATING, EXAMINING ATTORNEY

CLASS 25—(Continued).

SN 77-141,871. BRENT POURCIAU, COVINGTON, LA.
FILED 3-27-2007.

CLASS 25—(Continued).

SN 77-143,234. MENOR, RICHARD M, SAN BERNARDINO,
CA. FILED 3-28-2007.

COCKY GEAR .COM

THE MARK CONSISTS OF STANDARD CHARACTERS WITHOUT CLAIM TO ANY PARTICULAR FONT, STYLE, SIZE, OR COLOR.

NO CLAIM IS MADE TO THE EXCLUSIVE RIGHT TO USE "GEAR.COM", APART FROM THE MARK AS SHOWN.

FOR CAPS; CHILDREN'S AND INFANTS' CLOTH BIBS; CHILDREN'S CLOTH EATING BIBS; CLOTH BIBS; CLOTH BIBS FOR ADULT DINERS; CLOTH BIBS FOR USE BY SENIOR CITIZENS OR PHYSICALLY OR MENTALLY CHALLENGED PERSONS; CLOTH DIAPERS; CLOTHING FOR WEAR IN JUDO PRACTICES; CLOTHING FOR WEAR IN WRESTLING GAMES; CLOTHING, NAMELY, ARM WARMERS; CLOTHING, NAMELY, FOLK COSTUMES; CLOTHING, NAMELY, KNEE WARMERS; CLOTHING, NAMELY, NECK TUBES; CLOTHING, NAMELY, WRAP-AROUNDS; CORSETS; DUSTERS; FIGURE SKATING CLOTHING, NAMELY, SHIRTS; FOULARDS; HOODS; INFANT AND TODDLER ONE PIECE CLOTHING; BELTS; BIBS NOT OF CLOTH OR PAPER; INFANT CLOTH DIAPERS; JERSEYS; LEATHER BELTS; MANTLES; MUFFLERS; NON-DISPOSABLE CLOTH TRAINING PANTS; PAPER HATS FOR USE AS CLOTHING ITEMS; PARTS OF CLOTHING, NAMELY, GUSSETS FOR TIGHTS, GUSSETS FOR STOCKINGS, GUSSETS FOR BATHING SUITS, GUSSETS FOR UNDERWEAR, GUSSETS FOR LEOTARDS AND GUSSETS FOR FOOTLETS; PERSPIRATION ABSORBENT UNDERWEAR CLOTHING; SHIRTS; SHORT SETS; SHOULDER WRAPS; SWADDLING CLOTHES; TIES; TOPS; UNDERARM CLOTHING SHIELDS; WRAPS (U.S. CLS. 22 AND 39).

FIRST USE 1-1-2006; IN COMMERCE 1-1-2006.
SIMON TENG, EXAMINING ATTORNEY



SN 77-143,130. JACOBS, LOUIS, MR., ROSLYN, NY. FILED 3-28-2007.

BLUE FAITH

THE MARK CONSISTS OF STANDARD CHARACTERS WITHOUT CLAIM TO ANY PARTICULAR FONT, STYLE, SIZE, OR COLOR.

NO CLAIM IS MADE TO THE EXCLUSIVE RIGHT TO USE BLUE, APART FROM THE MARK AS SHOWN.

FOR JEANS (U.S. CLS. 22 AND 39).
FIRST USE 3-8-2007; IN COMMERCE 3-8-2007.
LAURIE MAYES, EXAMINING ATTORNEY

NO CLAIM IS MADE TO THE EXCLUSIVE RIGHT TO USE "CLOTHING", APART FROM THE MARK AS SHOWN. THE COLOR(S) RED IS/ARE CLAIMED AS A FEATURE OF THE MARK.

THE MARK CONSISTS OF A DIRTBIKE AND RIDER WITH THE WORDING "DIRTY CLOTHING IN POPYRUS FONT, ALL APPEARING IN THE COLOR RED.

FOR SHIRTS; SHORT-SLEEVED OR LONG-SLEEVED T-SHIRTS; SHORT-SLEEVED SHIRTS; T-SHIRTS (U.S. CLS. 22 AND 39).

FIRST USE 4-16-2005; IN COMMERCE 4-16-2005.
HANNO RITTNER, EXAMINING ATTORNEY

CLASS 25—(Continued).

SN 77-144,352. KARP, ROBERT H, NEW YORK, NY. FILED 3-29-2007.

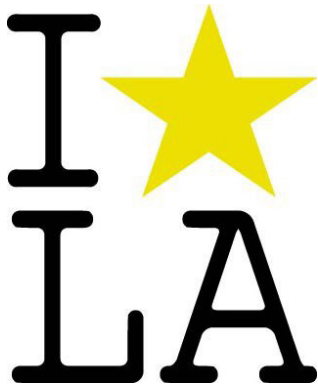

NO CLAIM IS MADE TO THE EXCLUSIVE RIGHT TO USE "LA", APART FROM THE MARK AS SHOWN.

THE COLOR(S) BLACK AND YELLOW IS/ARE CLAIMED AS A FEATURE OF THE MARK.

THE COLOR BLACK APPEARS IN THE WORDING "I" AND "LA", AND THE COLOR YELLOW APPEARS IN THE DESIGN OF THE STAR.

FOR BUTTON-FRONT ALOHA SHIRTS; CAMP SHIRTS; DRESS SHIRTS; GOLF SHIRTS; KNIT SHIRTS; NIGHT SHIRTS; OPEN-NECKED SHIRTS; PIQUE SHIRTS; POLO SHIRTS; SHIRT FRONTS; SHIRT YOKES; SHIRTS; SHIRTS FOR SUITS; SHORT-SLEEVED OR LONG-SLEEVED T-SHIRTS; SHORT-SLEEVED SHIRTS; SLEEP SHIRTS; SPORT SHIRTS; SPORTS SHIRTS; SPORTS SHIRTS WITH SHORT SLEEVES; SWEAT SHIRTS; T-SHIRTS; WIND SHIRTS; YOGA SHIRTS; BALLOON PANTS; CAPRI PANTS; CARGO PANTS; DENIMS; JOGGING PANTS; LEATHER PANTS; NON-DISPOSABLE CLOTH TRAINING PANTS; NURSE PANTS; PANTS; PETTI-PANTS; SKI PANTS; SNOW PANTS; SNOWBOARD PANTS; SWEAT PANTS; TAP PANTS; TOBOGGAN HATS, PANTS AND CAPS; TRACK PANTS; WATERPROOF JACKETS AND PANTS; YOGA PANTS; SKI BOOT BAGS; CHEF'S HATS; FUR HATS; HAT BANDS; HEADGEAR, NAMELY, HATS, HEADBANDS; SMALL HATS; WOOLLY HATS (U.S. CLS. 22 AND 39).

KAREN BRACEY, EXAMINING ATTORNEY

SN 77-146,076. THE TRUSTEE OF THE BYRON NELSON MARITAL TRUST, DALLAS, TX. FILED 4-2-2007.

**BYRON NELSON SIGNATURE
SERIES**

THE MARK CONSISTS OF STANDARD CHARACTERS WITHOUT CLAIM TO ANY PARTICULAR FONT, STYLE, SIZE, OR COLOR.

OWNER OF U.S. REG. NOS. 1,725,794, 2,587,436 AND OTHERS.

NO CLAIM IS MADE TO THE EXCLUSIVE RIGHT TO USE "SIGNATURE SERIES", APART FROM THE MARK AS SHOWN.

THE NAME(S), PORTRAIT(S), AND/OR SIGNATURE(S) SHOWN IN THE MARK DOES NOT IDENTIFY A PARTICULAR LIVING INDIVIDUAL.

FOR CLOTHING, NAMELY, DRESS SHIRTS, CAMP SHIRTS, POLO SHIRTS; SWEATERS, VESTS, JACKETS, SHORTS, PANTS (U.S. CLS. 22 AND 39).

FIRST USE 7-0-2006; IN COMMERCE 7-0-2006.

BARBARA GAYNOR, EXAMINING ATTORNEY

CLASS 25—(Continued).

SN 77-146,709. ALAIN KWIATKOWSKI, RAMATUELLE, FRANCE, FILED 4-2-2007.

KIWI ST TROPEZ

THE MARK CONSISTS OF STANDARD CHARACTERS WITHOUT CLAIM TO ANY PARTICULAR FONT, STYLE, SIZE, OR COLOR.

NO CLAIM IS MADE TO THE EXCLUSIVE RIGHT TO USE "ST. TROPEZ", APART FROM THE MARK AS SHOWN. FOR CLOTHING, NAMELY, SWIMSUITS, PAREOS, SHIRTS, TUNICS, HATS, PANTS, SHORTS, TOPS AND BOTTOMS (U.S. CLS. 22 AND 39).

FIRST USE 5-2-1995; IN COMMERCE 6-15-1997.

CURTIS FRENCH, EXAMINING ATTORNEY

SN 77-148,258. WILSON HUNT INTERNATIONAL, INC., SKOKIE, IL. FILED 4-4-2007.

DRI-GEAR

THE MARK CONSISTS OF STANDARD CHARACTERS WITHOUT CLAIM TO ANY PARTICULAR FONT, STYLE, SIZE, OR COLOR.

FOR ATHLETIC APPAREL, NAMELY, PANTS, SHORTS, SHIRTS, SWEATSHIRTS, SWEATPANTS, PLACKET SHIRTS, PARKAS, T-SHIRTS, CAPES, SWEATERS, ATHLETIC JERSEYS, ATHLETIC TEAM UNIFORMS, SKIRTS, JACKETS, THERMAL UNDERWEAR AND HATS FORMED WITH FABRIC HAVING MOISTURE WICKING PROPERTIES (U.S. CLS. 22 AND 39).

MELVIN AXILBUND, EXAMINING ATTORNEY

SN 77-149,219. PHILLIPS-VAN HEUSEN, NEW YORK, NY. FILED 4-5-2007.

CUSHION STEP

THE MARK CONSISTS OF STANDARD CHARACTERS WITHOUT CLAIM TO ANY PARTICULAR FONT, STYLE, SIZE, OR COLOR.

NO CLAIM IS MADE TO THE EXCLUSIVE RIGHT TO USE "CUSHION", APART FROM THE MARK AS SHOWN. FOR FOOTWEAR (U.S. CLS. 22 AND 39).

FIRST USE 12-15-2006; IN COMMERCE 12-15-2006.

GIANCARLO CASTRO, EXAMINING ATTORNEY

CLASS 25—(Continued).

SN 77-149,461. CAPRICORN INNOVATIONS LLC, DBA TEEN & TWEEN SENSATIONS, RHINEBECK, NY. FILED 4-5-2007.

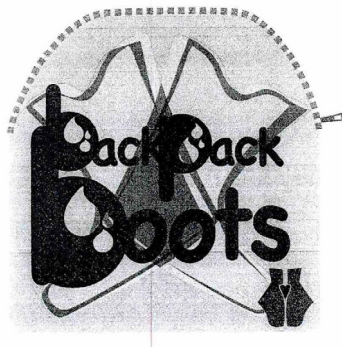

NO CLAIM IS MADE TO THE EXCLUSIVE RIGHT TO USE "BOOTS", APART FROM THE MARK AS SHOWN.

THE MARK CONSISTS OF A BAG THAT HAS A ZIPPER ON THE TOP AND A PAIR OF BOOTS ON THE FRONT WITH THE WORDS "BACK PACT BOOTS" STYLIZED.

FOR FOOTWEAR (U.S. CLS. 22 AND 39).

FIRST USE 10-19-2007; IN COMMERCE 10-19-2007.

KATHRYN COWARD, EXAMINING ATTORNEY

SN 77-151,162. VOUAMA, ULRICH A., DENVER, CO. AND CAO, CHEECH T., DENVER, CO. FILED 4-6-2007.



THE COLOR(S) RED, WHITE AND BLUE IS/ARE CLAIMED AS A FEATURE OF THE MARK.

THE MARK CONSISTS OF THE WORDING "TCHI TCHA" IN BLUE WITH FOUR RED DOTS IN BETWEEN AND "EMPOWERING DA URBAN GENERATION" IN RED WITH THE LETTER "E" AT THE BEGINNING OF THE TERM "EMPOWERING" IN RED, WHITE AND BLUE. ABOVE THE WORDING IS THE DEPICTION OF A CROWN IN RED AND BLUE.

THE FOREIGN WORDING IN THE MARK TRANSLATES INTO ENGLISH AS GRANDFATHER.

FOR FOOTWEAR (U.S. CLS. 22 AND 39).

KYLE PEETE, EXAMINING ATTORNEY

CLASS 25—(Continued).

SN 77-152,659. JAPNA INC., EDISON, NJ. FILED 4-10-2007.

FUN & FLIRT BY JAPNA

THE MARK CONSISTS OF STANDARD CHARACTERS WITHOUT CLAIM TO ANY PARTICULAR FONT, STYLE, SIZE, OR COLOR.

FOR CLOTHING, NAMELY, LADIES TOPS, TUNICS, SHIRTS, BLOUSES, SWEATERS, JERSEYS, SKIRTS, DRESSES AND SWIMSUITS (U.S. CLS. 22 AND 39).

BRENDAN MCCAULEY, EXAMINING ATTORNEY

SN 77-154,760. PIEGE CO., INC., CHATSWORTH, CA. FILED 4-12-2007.

PARAMOUR

THE MARK CONSISTS OF STANDARD CHARACTERS WITHOUT CLAIM TO ANY PARTICULAR FONT, STYLE, SIZE, OR COLOR.

FOR BRAS, PANTIES, GARTER BELTS, BUSTIERS, SLEEPWEAR, DAYWEAR, NAMELY, CAMISOLES, AND SHAPE WEAR, NAMELY, CORSETS (U.S. CLS. 22 AND 39).

JULIE WATSON, EXAMINING ATTORNEY

SN 77-156,985. COTTON DESIGNS S.A., LIMA, PERU, FILED 4-15-2007.



PRIORITY CLAIMED UNDER SEC. 44(D) ON PERU APPLICATION NO. 296214, FILED 11-7-2006.

OWNER OF PERU REG. NO. 126527, DATED 3-8-2007, EXPIRES 3-8-2017.

NO CLAIM IS MADE TO THE EXCLUSIVE RIGHT TO USE "NATURAL KNITS", APART FROM THE MARK AS SHOWN.

THE MARK CONSISTS OF A RECTANGLE INSIDE OF WHICH APPEAR FOUR PRE-INCAS SIGNS INSIDE FOUR SMALL SQUARES, ONE NEXT TO EACH OTHER; THE FIRST SIGN CONSISTS OF OCEAN WAVES, THE SECOND ONE CONSISTS OF A PORTION OF A SUN, THE THIRD ONE CONSISTS OF TWO SPIRALS AND THE FOURTH ONE CONSISTS OF FOUR STEPS. THE WORDS NATURAL KNITS APPEAR BENEATH THIS DRAWINGS IN STYLIZED CAPITAL LETTERS.

FOR CARDIGANS; SWEATERS; VESTS; HATS; TOPS; DRESSES; PANTS; SHIRTS; GLOVES; SKIRTS; PONCHOS; SCARVES; FOOTWEAR (U.S. CLS. 22 AND 39).

KATHY DE JONGE, EXAMINING ATTORNEY

CLASS 25—(Continued).

SN 77-163,796. SMITH, ELWOOD, MILWAUKEE, WI. FILED 4-24-2007.

CONRAD AFFILIAT

THE MARK CONSISTS OF STANDARD CHARACTERS WITHOUT CLAIM TO ANY PARTICULAR FONT, STYLE, SIZE, OR COLOR.

THE NAME "CONARD AFFILIAT" DOES NOT IDENTIFY A LIVING INDIVIDUAL.

THE WORDING IN THE MARK HAS NO MEANING OTHER THAN TRADEMARK SIGNIFICANCE FOR CLOTHING-, NAMELY, SHIRTS, HEADWEAR AND JERSEYS (U.S. CLS. 22 AND 39).

DAYNA BROWNE, EXAMINING ATTORNEY

SN 77-167,323. VIACOM INTERNATIONAL INC., NEW YORK, NY. FILED 4-27-2007.

YO! MTV RAPS

THE MARK CONSISTS OF STANDARD CHARACTERS WITHOUT CLAIM TO ANY PARTICULAR FONT, STYLE, SIZE, OR COLOR.

OWNER OF U.S. REG. NOS. 1,373,948, 2,992,592 AND OTHERS.

FOR BATHING SUITS, BATHROBES, BEACHWEAR, CLOTHING BELTS, SHORTS, JACKETS, COATS, SOCKS, FOOTWEAR, BANDANAS, SWEATERS, HALLOWEEN COSTUMES, DRESSES, GLOVES, GYM SHORTS, EAR MUFFS, NECKWEAR, PAJAMAS, PANTS, SHIRTS, SWEAT SHIRTS, SKI WEAR, SLACKS, SUN VISORS, SUSPENDERS, TURTLENECKS, UNDERCLOTHES, VESTS, WARM-UP SUITS, HEADWEAR (U.S. CLS. 22 AND 39).

FIRST USE 11-1-2003; IN COMMERCE 11-1-2003.
ELISSA GARBER KON, EXAMINING ATTORNEY

CLASS 25—(Continued).

SN 77-170,249. COOPER, DOUGLAS, POUND RIDGE, NY. FILED 5-1-2007.

IDENTICAL DNA

THE MARK CONSISTS OF STANDARD CHARACTERS WITHOUT CLAIM TO ANY PARTICULAR FONT, STYLE, SIZE, OR COLOR.

FOR MATCHING CLOTHES FOR OLDER AND YOUNGER INDIVIDUALS, NAMELY, FATHER AND SON, MOTHER AND DAUGHTER, NAMELY, ATHLETIC FOOTWEAR, ATHLETIC SHOES, BABY TOPS, BASEBALL CAPS, BATHING SUITS, BATHROBES, BEACHWEAR, BELTS, BERMUDA SHORTS, BLAZERS, BOOTS, CAPS, CARGO PANTS, CHILDREN'S HEADWEAR, COATS, DENIM JACKETS, DOWN JACKETS, DRESS SHIRTS, DRESS SUITS, DRESSES, DUNGAREES, ESPADRILLES, FABRIC BELTS, FLIP FLOPS, FOOTWEAR, FOUL WEATHER GEAR, GLOVES, GOLF SHIRTS, GOLF TROUSERS, GYM SHORTS, GYM SUITS, HEAVY JACKETS, HIKING BOOTS, INFANT WEAR, INFANT'S SHOES AND BOOTS, INFANT'S TROUSERS, JEANS, JERSEYS, JOGGING OUTFITS, KNIT SHIRTS, KNIT CAPS, LADIES' SUITS, LEATHER BELTS, LEATHER COATS, LEATHER JACKETS, LEATHER SHOES, LOUNGEWEAR, MEN'S SUITS, MOCK TURTLENECK SWEATERS, MUFFLERS, MUSCLE TOPS, NIGHTWEAR, OPEN-NECKED SHIRTS, OUTDOOR GLOVES, OUTDOOR MITTENS, OVERALLS, PAJAMA BOTTOMS, PAJAMAS, PANTS, POLO SHIRTS, PONCHOS, RAINCOATS, RAIN JACKETS, RAIN TROUSERS, ROBES, SANDALS, SCARVES, SHAWLS, SHIRTS AND DRESSES, SLACKS, SLEEPWEAR, SLIPPERS, SHORTS, SNOW PANTS, SOCKS, SPORT COATS, SPORT SHIRTS, SUITS, SWEAT PANTS, SWEAT SHIRTS, SWEATERS, SWIM WEAR, TEE SHIRTS, TIES, TROUSERS, TURTLENECKS, UNDERWEAR, V-NECK SWEATERS, WIND RESISTANT JACKETS, AND WINTER BOOTS (U.S. CLS. 22 AND 39).

DAVID I, EXAMINING ATTORNEY

SN 77-171,023. HATZIGIANNIDIS, ALEXANDROS, ROCHESTER, NY. FILED 5-2-2007.



THE MARK CONSISTS OF THE COUNTRY GREECE AND ITS HORIZONTAL REFLECTION ON BOTH SIDES OF A LONG BODY MASS WITH ANTENNAS. THIS IS MEANT TO LOOK LIKE A BUTTERFLY.

FOR HATS; JACKETS; JEANS; SCARVES; SOCKS; T-SHIRTS; UNDERWEAR (U.S. CLS. 22 AND 39).

FIRST USE 4-17-2007; IN COMMERCE 4-17-2007.
GEOFFREY FOSDICK, EXAMINING ATTORNEY

CLASS 25—(Continued).

SN 77-171,585. SHANE MAURICE HENDERSON, GEELONG, AUSTRALIA, FILED 5-3-2007.

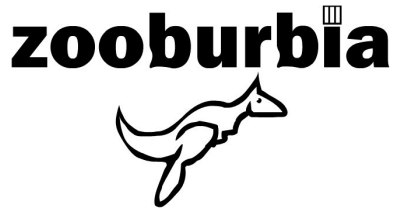

PRIORITY CLAIMED UNDER SEC. 44(D) ON AUSTRALIA APPLICATION NO. 1172290, FILED 4-20-2007. OWNER OF AUSTRALIA REG. NO. 1172290, DATED 4-20-2007, EXPIRES 4-20-2017. FOR BELTS; CAPS; HOODS; JERSEYS; LEATHER BELTS; TOPS (U.S. CLS. 22 AND 39). GEOFFREY FOSDICK, EXAMINING ATTORNEY

SN 77-171,955. CUMMINGS, KARY, CHESTNUT HILL, MA. FILED 5-3-2007.

SIMPLY HOOD AUTHENTIC STREET GARMENTS

THE MARK CONSISTS OF STANDARD CHARACTERS WITHOUT CLAIM TO ANY PARTICULAR FONT, STYLE, SIZE, OR COLOR. NO CLAIM IS MADE TO THE EXCLUSIVE RIGHT TO USE "AUTHENTIC STREET GARMENTS", APART FROM THE MARK AS SHOWN. FOR JACKETS; PANTS; SHIRTS; SHOES (U.S. CLS. 22 AND 39). FIRST USE 7-1-2005; IN COMMERCE 7-1-2006. SETH A. RAPPAPORT, EXAMINING ATTORNEY

SN 77-177,855. JOE BENBASSET, INC., NEW YORK, NY. FILED 5-10-2007.

STUDIO 253

THE MARK CONSISTS OF STANDARD CHARACTERS WITHOUT CLAIM TO ANY PARTICULAR FONT, STYLE, SIZE, OR COLOR. FOR CLOTHING, NAMELY, PANTS, SKIRTS, SHORTS, SHIRTS, JACKETS (U.S. CLS. 22 AND 39). RICHARD A. STRASER, EXAMINING ATTORNEY

CLASS 25—(Continued).

SN 77-178,026. CORNER RECORDS, SAGINAW, MI. FILED 5-10-2007.



THE MARK CONSISTS OF THE WORDS "CORNER" AND "WEAR" WITH A TRIANGLE DESIGN SEPARATING THE TWO WORDS. FOR CLOTHING, NAMELY, TEE SHIRTS, SHORTS, JEANS, JACKETS, COATS, PANTS, HATS, SWEAT-PANTS, DRESSES, SKIRTS, SOCKS, UNDERWEAR, FOOTWEAR, SHORTS, CAPS, BELTS FOR CLOTHING, HATS, SWEATERS, HEAD BANDS, SWIMSUITS, JERSEYS, PAJAMAS, SLEEPWEAR AND RAINWEAR (U.S. CLS. 22 AND 39). CAROLINE WOOD, EXAMINING ATTORNEY

SN 77-178,769. CAVE SPRINGS, INC., WILMINGTON, DE. FILED 5-11-2007.

TWO HEARTS

THE MARK CONSISTS OF STANDARD CHARACTERS WITHOUT CLAIM TO ANY PARTICULAR FONT, STYLE, SIZE, OR COLOR. OWNER OF U.S. REG. NO. 3,117,924. FOR CLOTHING FOR BABIES AND CHILDREN, NAMELY, SHIRTS, T-SHIRTS, SWEATERS, SWEAT-SHIRTS, JACKETS, PANTS, SKIRTS, COATS, CAPS, HATS, GLOVES, MITTENS, HEADWEAR, SCARVES, SNOWSUITS, SOCKS, FOOTWEAR, BIB OVERALLS, BIB SHORTALLS, JUMPERS, DRESSES, JEANS, DUNGAREES, TOPS, JUMPSUITS, SWIMWEAR, HOSIERY, BOOTIES, CREEPERS, ROMPERS, CLOTH BABY BIBS, SLEEPWEAR, AND UNDERGARMENTS (U.S. CLS. 22 AND 39). JIM RINGLE, EXAMINING ATTORNEY

SN 77-181,276. QVC, INC., WEST CHESTER, PA. FILED 5-15-2007.

GEAR BY PERSONIFY

THE MARK CONSISTS OF STANDARD CHARACTERS WITHOUT CLAIM TO ANY PARTICULAR FONT, STYLE, SIZE, OR COLOR. NO CLAIM IS MADE TO THE EXCLUSIVE RIGHT TO USE "GEAR", APART FROM THE MARK AS SHOWN. FOR MEN'S JEANS AND PANTS (U.S. CLS. 22 AND 39). BILL DAWE, EXAMINING ATTORNEY

CLASS 25—(Continued).

SN 77-183,153. PADDLE SURF HAWAII, LLC, AIEA, HI.
FILED 5-16-2007.



NO CLAIM IS MADE TO THE EXCLUSIVE RIGHT TO USE "PADDLE SURF HAWAII", APART FROM THE MARK AS SHOWN.

THE MARK CONSISTS OF THE STYLIZED WORDS "PADDLE SURF HAWAII" CENTERED IN BETWEEN TWO HORIZONTAL PADDLES; EACH PADDLE CONTAINS AN OVAL ON EACH END AND INSIDE EACH OVAL THERE IS A HUMAN FIGURE HOLDING A PADDLE IN THE AIR, STANDING ON A BOARD AND CATCHING A WAVE; THE WORDS "HIGH PERFORMANCE SURFBOARDS" ARE CENTERED BELOW THE BOTTOM PADDLE.

FOR CLOTHING, NAMELY, SHIRTS, SHORTS, T-SHIRTS, SWIM CAPS, SWIM TRUNKS, SWIM WEAR, WET SUITS, AND RASH GUARDS FOR MEN, WOMEN AND CHILDREN (U.S. CLS. 22 AND 39).

JAY FLOWERS, EXAMINING ATTORNEY

SN 77-189,195. AIRTIME GEAR, LLC, BEAVERTON, OR.
FILED 5-24-2007.

AIRTIME GEAR

THE MARK CONSISTS OF STANDARD CHARACTERS WITHOUT CLAIM TO ANY PARTICULAR FONT, STYLE, SIZE, OR COLOR.

NO CLAIM IS MADE TO THE EXCLUSIVE RIGHT TO USE "GEAR", APART FROM THE MARK AS SHOWN.

FOR CLOTHING, NAMELY, PARKAS, COATS, JACKETS, VESTS, PANTS, SHORTS; RAIN GEAR, NAMELY, RAIN COATS, RAIN JACKETS, RAIN SLICKERS, RAIN SUITS, RAIN TROUSERS, RAIN BIBS NOT OF CLOTH OR PAPER; OUTERWEAR, NAMELY, SKI BIBS, UNIFORMS (U.S. CLS. 22 AND 39).

JORDAN BAKER, EXAMINING ATTORNEY

CLASS 25—(Continued).

SN 77-189,204. AIRTIME GEAR, LLC, BEAVERTON, OR.
FILED 5-24-2007.

AIRTIME 911

THE MARK CONSISTS OF STANDARD CHARACTERS WITHOUT CLAIM TO ANY PARTICULAR FONT, STYLE, SIZE, OR COLOR.

FOR CLOTHING, NAMELY, PARKAS, COATS, JACKETS, VESTS, PANTS, SHORTS; RAIN GEAR, NAMELY, RAIN COATS, RAIN JACKETS, RAIN SLICKERS, RAIN SUITS, RAIN TROUSERS, RAIN BIBS NOT OF CLOTH OR PAPER; OUTERWEAR, NAMELY, SKI BIBS, UNIFORMS (U.S. CLS. 22 AND 39).

JORDAN BAKER, EXAMINING ATTORNEY

SN 77-189,206. AIRTIME GEAR, LLC, BEAVERTON, OR.
FILED 5-24-2007.

AIRTIME

THE MARK CONSISTS OF STANDARD CHARACTERS WITHOUT CLAIM TO ANY PARTICULAR FONT, STYLE, SIZE, OR COLOR.

FOR CLOTHING, NAMELY, PARKAS, COATS, JACKETS, VESTS, PANTS, SHORTS; RAIN GEAR, NAMELY, RAIN COATS, RAIN JACKETS, RAIN SLICKERS, RAIN SUITS, RAIN TROUSERS, RAIN BIBS NOT OF CLOTH OR PAPER; OUTERWEAR, NAMELY, SKI BIBS, UNIFORMS (U.S. CLS. 22 AND 39).

JORDAN BAKER, EXAMINING ATTORNEY

SN 77-190,015. OBOZ FOOTWEAR LLC, JACKSON, WY.
FILED 5-24-2007.

OBOZ

THE MARK CONSISTS OF STANDARD CHARACTERS WITHOUT CLAIM TO ANY PARTICULAR FONT, STYLE, SIZE, OR COLOR.

FOR CLOTHING, NAMELY, SHIRTS, PANTS, JACKETS, GLOVES AND SOCKS; FOOTWEAR, AND HEADGEAR, NAMELY, HATS AND CAPS (U.S. CLS. 22 AND 39).

KAREN K. BUSH, EXAMINING ATTORNEY

CLASS 25—(Continued).

SN 77-191,363. TAYLOR VAN D., STOCKBRIDGE, GA. AND HOLMES BRUCE C., MORROW, GA. FILED 5-27-2007.

TONY KITTENS

THE MARK CONSISTS OF STANDARD CHARACTERS WITHOUT CLAIM TO ANY PARTICULAR FONT, STYLE, SIZE, OR COLOR.

"TONY KITTENS" DOES NOT IDENTIFY A LIVING INDIVIDUAL.

FOR SHORT-SLEEVED OR LONG-SLEEVED T-SHIRTS (U.S. CLS. 22 AND 39).

EMILY CARLSEN, EXAMINING ATTORNEY

SN 77-199,543. STARZ MEDIA, LLC, BURBANK, CA. FILED 6-6-2007.



NO CLAIM IS MADE TO THE EXCLUSIVE RIGHT TO USE "KID", APART FROM THE MARK AS SHOWN.

THE MARK CONSISTS OF THE WORDS "EON KID THE TV SERIES" WITH A CLENCHED FIST EMERGING FROM THE "O" IN THE WORD "EON".

FOR CLOTHING, NAMELY, CHILDREN'S PANTS, SHORTS, SKIRTS, T-SHIRTS, PAJAMAS, SOCKS, CLOTH BIBS, HATS, COATS, JACKETS, SWEATERS, SLIPPERS, BOOTS, AND SHOES (U.S. CLS. 22 AND 39).

JOHN GARTNER, EXAMINING ATTORNEY

SN 77-201,036. ERNEST INDUSTRIES, NEW YORK, NY. FILED 6-8-2007.

MUSUNAHU

THE MARK CONSISTS OF STANDARD CHARACTERS WITHOUT CLAIM TO ANY PARTICULAR FONT, STYLE, SIZE, OR COLOR.

THE WORDING "MUSUNAHU" HAS NO MEANING IN A FOREIGN LANGUAGE.

FOR APPAREL, NAMELY, T-SHIRTS, JERSEYS, PULLOVERS, TANK TOPS, GLOVES, SWEATBANDS, JACKETS, TIGHTS, SHORTS, PANTS, TRACK SUITS, WARM UP SUITS, SWEAT SHIRTS, SWEAT PANTS, LEGGINGS, SOCKS, FOOTWEAR AND HEADWEAR (U.S. CLS. 22 AND 39).

WOODROW HARTZOG, EXAMINING ATTORNEY

CLASS 25—(Continued).

SN 77-204,448. INDONESIAN IMPORTS, INC., SAN FRANCISCO, CA. FILED 6-12-2007.

LUXY

THE MARK CONSISTS OF STANDARD CHARACTERS WITHOUT CLAIM TO ANY PARTICULAR FONT, STYLE, SIZE, OR COLOR.

FOR SHOES, BOOTS AND SANDALS (U.S. CLS. 22 AND 39).

SHAILA SETTLES, EXAMINING ATTORNEY

SN 77-210,487. COOMER, RODNEY D, CAMPBELLSVILLE, KY. AND PERKINS, ANDREW J, CAMPBELLSVILLE, KY. FILED 6-20-2007.

FINISHING SLICKS

THE MARK CONSISTS OF STANDARD CHARACTERS WITHOUT CLAIM TO ANY PARTICULAR FONT, STYLE, SIZE, OR COLOR.

NO CLAIM IS MADE TO THE EXCLUSIVE RIGHT TO USE "FINISHING", APART FROM THE MARK AS SHOWN.

FOR WORK SHOES AND BOOTS; WORK SHOES AND BOOTS FOR USE WHILE FINISHING CONCRETE (U.S. CLS. 22 AND 39).

FIRST USE 6-15-2006; IN COMMERCE 1-25-2007.

LA TONIA FISHER, EXAMINING ATTORNEY

SN 77-211,989. STREET BRANDS, NORTH BERGEN, NJ. FILED S.R. 6-21-2007; AM. P.R. 2-11-2008.

1+1=2

THE MARK CONSISTS OF STANDARD CHARACTERS WITHOUT CLAIM TO ANY PARTICULAR FONT, STYLE, SIZE, OR COLOR.

FOR CLOTHING, NAMELY, SHIRTS, T-SHIRTS, TANK TOPS, UNDERSHIRTS, NIGHT SHIRTS, SWEATERS, SWEATSHIRTS, VESTS, JACKETS, COATS, BELTS FOR CLOTHING, PANTS, TROUSERS, SHORTS, BOXER SHORTS, UNDERWEAR, BRIEFS, PAJAMA TOPS, PAJAMA BOTTOMS, SWEATPANTS, DRESSES, SKIRTS, SWIMWEAR, BOARD SHORTS, HOSIERY, SOCKS, JOGGING SUITS, SCARVES, RAIN COATS, WIND-RESISTANT JACKETS; HEADWEAR, NAMELY, HATS; AND FOOTWEAR, NAMELY, SHOES AND ATHLETIC FOOTWEAR (U.S. CLS. 22 AND 39).

FIRST USE 6-1-2007; IN COMMERCE 6-1-2007.

JILL PRATER, EXAMINING ATTORNEY

CLASS 25—(Continued).

SN 77-215,977. KIRSTEN PRICE, BROOKLYN, NY. FILED 6-26-2007.

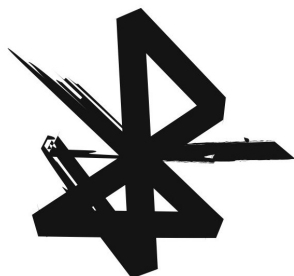

THE MARK CONSISTS OF A STAR LIKE DESIGN.
FOR CLOTHING; NAMELY, TEE SHIRTS, SWEAT-SHIRTS, TANK TOPS, CAPS, POLO SHIRTS, DRESS SHIRTS, SUIT JACKETS, JACKETS, COATS, PANTS, WIND RESISTANT COATS, SHORT PANTS, SWEAT SUITS, SWEAT PANTS, SKIRTS, BLOUSES, UNDER-GARMENTS, BELTS, WRISTBANDS AND VISORS (U.S. CLS. 22 AND 39).

FIRST USE 6-1-2007; IN COMMERCE 6-1-2007.
PAULA MAYS, EXAMINING ATTORNEY

SN 77-216,828. CHAMPIONSHIP GAMING SERIES, LLC, WILMINGTON, DE. FILED 6-27-2007.

CAROLINA CORE

THE MARK CONSISTS OF STANDARD CHARACTERS WITHOUT CLAIM TO ANY PARTICULAR FONT, STYLE, SIZE, OR COLOR.

NO CLAIM IS MADE TO THE EXCLUSIVE RIGHT TO USE "CAROLINA", APART FROM THE MARK AS SHOWN.

FOR BANDANAS; BELTS; BOXER SHORTS; CAPS; CHILDREN'S AND INFANTS' CLOTH BIBS; COATS; GLOVES; HATS; INFANT AND TODDLER ONE PIECE CLOTHING; JACKETS; JEANS; JERSEYS; KNITTED CAPS; NIGHT SHIRTS; POLO SHIRTS; ROBES; SCARVES; SHIRTS; SHOES; SHORT-SLEEVED OR LONG-SLEEVED T-SHIRTS; SHORTS; SKIRTS; SLIPPERS; SNOWBOARD GLOVES; SNOWBOARD PANTS; SOCKS; SPORTS JACKETS; SPORTS JERSEYS; SWEAT BANDS; SWEAT PANTS; SWEAT SHIRTS; SWEAT SHORTS; SWEATERS; T-SHIRTS; TANK TOPS; TIES; WRIST BANDS, ALL OF THE PRECEDING ITEMS FOR USE IN PROMOTION OF A VIDEO GAME SPORTS LEAGUE (U.S. CLS. 22 AND 39).

ALYSSA PALADINO, EXAMINING ATTORNEY

CLASS 25—(Continued).

SN 77-218,313. BLUHORSE APPAREL INC, NEW YORK, NY. FILED 6-28-2007.

BLUHORSE

THE MARK CONSISTS OF STANDARD CHARACTERS WITHOUT CLAIM TO ANY PARTICULAR FONT, STYLE, SIZE, OR COLOR.

FOR CLOTHING, NAMELY, TEE SHIRTS, SWEAT-SHIRTS, TANK TOPS, CAPS, POLO SHIRTS, DRESS SHIRTS, SUIT JACKETS, JACKETS, COATS, PANTS, WINDBREAKER COATS, SHORT PANTS, SWEAT SUITS, SWEAT PANTS, SKIRTS, BLOUSES, UNDER-GARMENTS, BELTS, WRISTBANDS AND VISORS (U.S. CLS. 22 AND 39).

FIRST USE 2-25-2007; IN COMMERCE 2-25-2007.
JANICE KIM, EXAMINING ATTORNEY

SN 77-218,858. ASADOURIAN, MEGERDICH, GLENDALE, CA. FILED 6-29-2007.

SAFARI BRAND

THE MARK CONSISTS OF STANDARD CHARACTERS WITHOUT CLAIM TO ANY PARTICULAR FONT, STYLE, SIZE, OR COLOR.

NO CLAIM IS MADE TO THE EXCLUSIVE RIGHT TO USE BRAND, APART FROM THE MARK AS SHOWN.

FOR CLOTHING AND APPAREL, NAMELY, T-SHIRTS, TANK TOPS, SWEATERS, JACKETS, AND PANTS (U.S. CLS. 22 AND 39).

FIRST USE 7-5-2000; IN COMMERCE 7-5-2000.
DARRYL SPRUILL, EXAMINING ATTORNEY

SN 77-218,881. ASADOURIAN, MEGERDICH, GLENDALE, CA. FILED 6-29-2007.



THE MARK CONSISTS OF STYLIZED LETTERING MGO. FOR CLOTHING AND APPAREL, NAMELY, T-SHIRTS, TANK TOPS, SWEATERS, JACKETS, AND PANTS (U.S. CLS. 22 AND 39).

FIRST USE 7-5-2000; IN COMMERCE 7-5-2000.
DARRYL SPRUILL, EXAMINING ATTORNEY

CLASS 25—(Continued).

SN 77-219,813. KINDELBERGER, DANIELLE L., LA CONNER, WA. FILED 6-30-2007.



THE MARK CONSISTS OF IMAGE IS BLACK ON WHITE SCREEN, A BABY IN A DIAPER WITH BUSINESS NAME ABOVE THE IMAGE.

FOR CLOTH DIAPERS (U.S. CLS. 22 AND 39).
FIRST USE 8-1-2006; IN COMMERCE 12-15-2006.
KIMBERLY PERRY, EXAMINING ATTORNEY

SN 77-222,954. DAVIS, ROBERT G., CASTLE ROCK, CO. FILED 7-5-2007.



NO CLAIM IS MADE TO THE EXCLUSIVE RIGHT TO USE REPRESENTATION OF THE GOLF BALL, APART FROM THE MARK AS SHOWN.

THE COLOR(S) MAROON, BLACK, WHITE, GRAY, YELLOW AND GREEN IS/ARE CLAIMED AS A FEATURE OF THE MARK.

THE MARK CONSISTS OF THE STYLIZED WORDS "BELOW THE HOLE" WITH A DEPICTION OF A GOLF HOLE AND FLAG PIN WITH THE FLAG PIN FORMING THE LETTER "L" IN THE WORD "BELOW", THE WORD "THE" IN AN OVAL REPRESENTING A GOLF HOLE AT THE BASE OF THE FLAG PIN BETWEEN THE WORDS "BELOW" AND "HOLE" AND A DEPICTION OF A GOLF BALL AS THE "O" IN THE WORD "HOLE". THE COLOR MAROON APPEARS IN THE LETTERING "BELOW" AND "HOLE" EXCEPT THAT THE GOLF BALL DESIGN REPRESENTING THE LETTER "O" IN "HOLE" IS WHITE AND GRAY WITH A BLACK BORDER; THE COLOR BLACK APPEARS AS OUTLINES TO ALL OF THE LETTERS, IN THE FLAG AND IN THE GOLF HOLE; THE COLOR YELLOW APPEARS IN THE FLAG AND THE COLOR GREEN APPEARS IN AN OVAL UNDER THE GOLF BALL DESIGN.

FOR GOLF CLOTHING, NAMELY, HATS, JACKETS, PANTS, SHORTS, SWEATERS, T-SHIRTS, SWEATSHIRTS, POLO SHIRTS AND GOLF SHIRTS (U.S. CLS. 22 AND 39).

PAUL CROWLEY, EXAMINING ATTORNEY

CLASS 25—(Continued).

SN 77-227,095. VIACOM INTERNATIONAL INC., NEW YORK, NY. FILED 7-11-2007.

TEAM UMIZOOMI

THE MARK CONSISTS OF STANDARD CHARACTERS WITHOUT CLAIM TO ANY PARTICULAR FONT, STYLE, SIZE, OR COLOR.

FOR CLOTHING, NAMELY, BATHING SUITS, BELTS, HALLOWEEN COSTUMES, COATS, SOCKS, CLOTHING BELTS, FOOTWEAR, BANDANNAS, DRESSES, GLOVES, GYM SHORTS, EAR MUFFS, NECK WEAR, JACKETS, PAJAMAS, PANTS, SHIRTS, SHORTS, SKI WEAR, SLACKS, SUN VISORS, SUSPENDERS, SWEATERS, TURTLENECKS, UNDERCLOTHES, VESTS, WARM-UP SUITS, HEADWEAR, BATHROBES, BEACHWEAR (U.S. CLS. 22 AND 39).

NATALIE POLZER, EXAMINING ATTORNEY

SN 77-230,209. BROWN JR., CLIMMEL, COLUMBIA, SC. FILED 7-16-2007.



NO CLAIM IS MADE TO THE EXCLUSIVE RIGHT TO USE "SOUTH CACK", APART FROM THE MARK AS SHOWN.

THE MARK CONSISTS OF INTERLOCKING DOUBLE BARRED DOLLAR SIGN AND THE LETTER "C" AS WELL AS THE WORDING "OUTH" AND "ACK" ATTACHED THERETO.

FOR CAPS; SHIRTS; HATS; JEANS; PANTS; SHORTS; BELTS (U.S. CLS. 22 AND 39).

MARTHA FROMM, EXAMINING ATTORNEY

SN 77-230,869. ARCHETYPE SOLUTIONS, INC., EMERYVILLE, CA. FILED 7-16-2007.

INDI

THE MARK CONSISTS OF STANDARD CHARACTERS WITHOUT CLAIM TO ANY PARTICULAR FONT, STYLE, SIZE, OR COLOR.

FOR CLOTHING AND FOOTWEAR, NAMELY, JEANS, DRESS SHIRTS, BLOUSES, TROUSERS, PANTS, JACKETS, OUTERWEAR, NAMELY JACKETS AND COATS, SKIRTS, SHOES, AND SPORTS APPAREL, NAMELY, SHIRTS AND T-SHIRTS (U.S. CLS. 22 AND 39).

LA TONIA FISHER, EXAMINING ATTORNEY

CLASS 25—(Continued).

SN 77-235,779. SHAH, PRINCE REZA, CARLSBAD, CA.
FILED 7-23-2007.

MARBRISA

THE MARK CONSISTS OF STANDARD CHARACTERS WITHOUT CLAIM TO ANY PARTICULAR FONT, STYLE, SIZE, OR COLOR.

THE FOREIGN WORDING IN THE MARK TRANSLATES INTO ENGLISH AS SEA BREEZE.

FOR HATS; GOLF CAPS; GOLF SHIRTS; T-SHIRTS (U.S. CLS. 22 AND 39).

KRISTINA MORRIS, EXAMINING ATTORNEY

SN 77-237,018. BLUE PLANET INT'L, INC., LOS ANGELES, CA. FILED 7-24-2007.

YUVA

THE MARK CONSISTS OF STANDARD CHARACTERS WITHOUT CLAIM TO ANY PARTICULAR FONT, STYLE, SIZE, OR COLOR.

THE WORDING "YUVA" HAS NO MEANING IN A FOREIGN LANGUAGE.

FOR BELTS; BLAZERS; BLOUSES; BOARDSHORTS; CARDIGANS; DENIMS; DRESSES; FLEECE PULL-OVERS; FLEECE SHORTS; HATS; JACKETS; JEANS; KNIT SHIRTS; POLO SHIRTS; SCARVES; SHORT TROUSERS; SHORTS; SLACKS; SWEAT SHIRTS; T-SHIRTS; TANK-TOPS; THERMAL UNDERWEAR; VESTS (U.S. CLS. 22 AND 39).

FIRST USE 2-10-2001; IN COMMERCE 2-10-2001.

TINA BROWN, EXAMINING ATTORNEY

CLASS 25—(Continued).

SN 77-237,548. TAKEONESHIRTS.COM LLC, N. ATTLEBORO, MA. FILED 7-24-2007.



NO CLAIM IS MADE TO THE EXCLUSIVE RIGHT TO USE "GYM WEAR", APART FROM THE MARK AS SHOWN.

THE MARK CONSISTS OF A GRIMACING DOG WITH THE BODY OF A HUMAN BODYBUILDER, LIFTING A HEAVY BARBELL. THE DOG IS WEARING A SPIKED COLLAR, VERY SMALL BRIEFS, AND A BANDANA. OVER THE DOG'S HEAD IS THE WORD "TEAM". BENEATH THE DOG'S FEET APPEAR THE WORDS "DIESEL DOGG GYMWEAR".

FOR CLOTHING, NAMELY, TANK TOPS, T-SHIRTS, JACKETS, SWEATPANTS, SHORTS, HATS, SWEATSHIRTS, TOPS IN THE NATURE OF RAG TOPS, SPORTS BRAS, PANTS, TOPS (U.S. CLS. 22 AND 39).

KATHERINE M. DUBRAY, EXAMINING ATTORNEY

SN 77-238,636. BAKER, PATRICK RYAN, SALT LAKE CITY, UT. FILED 7-25-2007.

BHood

THE MARK CONSISTS OF STANDARD CHARACTERS WITHOUT CLAIM TO ANY PARTICULAR FONT, STYLE, SIZE, OR COLOR.

FOR CLOTHING, NAMELY, SHIRTS, SWEATSHIRTS, HATS AND SNOWBOARD AND SKIING APPAREL, NAMELY, JACKETS, PANTS, AND SHIRTS (U.S. CLS. 22 AND 39).

SUE LAWRENCE, EXAMINING ATTORNEY

CLASS 25—(Continued).

SN 77-248,763. THE LITTLE BLACK APRON, LLC, DIX HILLS, NY. FILED 8-7-2007.



NO CLAIM IS MADE TO THE EXCLUSIVE RIGHT TO USE "BLACK APRON", APART FROM THE MARK AS SHOWN.

THE MARK CONSISTS OF A STYLIZED APRON DESIGN ON THE LEFT OF THE STYLIZED WORDS "THE LITTLE BLACK APRON".

FOR APRONS (U.S. CLS. 22 AND 39).

FIRST USE 10-14-2006; IN COMMERCE 5-1-2007.
RON FAIRBANKS, EXAMINING ATTORNEY

SN 77-248,889. CHERI B. INCORPORATED, BRONX, NY. FILED 8-7-2007.



FOR JACKETS; PANTS; SHIRTS; SHOES (U.S. CLS. 22 AND 39).

KIMBERLY FRYE, EXAMINING ATTORNEY

SN 77-249,331. CLANTEX LTD, LEEDS, UNITED KINGDOM, FILED 8-7-2007.

TRAVELER CREASE

THE MARK CONSISTS OF STANDARD CHARACTERS WITHOUT CLAIM TO ANY PARTICULAR FONT, STYLE, SIZE, OR COLOR.

FOR ARTICLES OF CLOTHING, NAMELY, SHIRTS, PANTS, JACKETS, SUITS, SOCKS, UNDERWEAR, COATS, WAISTCOATS, PAJAMAS, SKIRTS, DRESSES, BLOUSES, HOSIERY, GOWNS, SHAWLS, WRAPS, SCARVES, NIGHT DRESSES, DRESSING GOWNS, CULOTTES, T-SHIRTS, POLO SHIRT, SWEATSHIRTS, PULLOVERS, CARDIGANS, SWEATERS, NECKTIES, SHORTS, BATHING SUITS, SWIMWEAR; FOOTWEAR, AND HEADGEAR, NAMELY, HATS, CAPS, AND VISORS (U.S. CLS. 22 AND 39).

ADA HAN, EXAMINING ATTORNEY

CLASS 25—(Continued).

SN 77-250,519. PITT, ANTHONY J., RICHMOND, VA. FILED 8-8-2007.

MARLON ALVAMAR

THE MARK CONSISTS OF STANDARD CHARACTERS WITHOUT CLAIM TO ANY PARTICULAR FONT, STYLE, SIZE, OR COLOR.

THE NAME(S), PORTRAIT(S), AND/OR SIGNATURE(S) SHOWN IN THE MARK DOES NOT IDENTIFY A PARTICULAR LIVING INDIVIDUAL.

THE WORDING IN THE MARK HAS NO MEANING IN A FOREIGN LANGUAGE.

FOR CLOTHING, NAMELY, PANTS, SHIRTS, JACKETS, SHOES AND SUITS (U.S. CLS. 22 AND 39).

ALYSSA PALADINO, EXAMINING ATTORNEY

SN 77-250,546. PITT, ANTHONY J., RICHMOND, VA. FILED 8-8-2007.

JOHN ALVAMAR

THE MARK CONSISTS OF STANDARD CHARACTERS WITHOUT CLAIM TO ANY PARTICULAR FONT, STYLE, SIZE, OR COLOR.

THE NAME(S), PORTRAIT(S), AND/OR SIGNATURE(S) SHOWN IN THE MARK DOES NOT IDENTIFY A PARTICULAR LIVING INDIVIDUAL.

THE WORDING IN THE MARK HAS NO MEANING IN A FOREIGN LANGUAGE.

FOR CLOTHING, NAMELY, PANTS, SHIRTS, JACKETS, SHOES AND SUITS (U.S. CLS. 22 AND 39).

ALYSSA PALADINO, EXAMINING ATTORNEY

SN 77-250,564. P.I.R. CLOTHING CO., BOISE, ID. FILED 8-8-2007.

P.I.R.

THE MARK CONSISTS OF STANDARD CHARACTERS WITHOUT CLAIM TO ANY PARTICULAR FONT, STYLE, SIZE, OR COLOR.

FOR CLOTHING, NAMELY, SHIRTS, PANTS, HATS, VISORS, SHORTS, SOCKS, BANDANAS, SCARVES, HANDKERCHIEFS, BELTS, UNDERWEAR, SWIMWEAR, COATS, JACKETS, AND SWEATSHIRTS; TAILORED APPAREL, NAMELY, SUITS AND PANTS (U.S. CLS. 22 AND 39).

MICHAEL ENGEL, EXAMINING ATTORNEY

CLASS 25—(Continued).

SN 77-251,397. GED ALPINE, LLC, PORTSMOUTH, NH.
FILED 8-9-2007.

TÖDI

THE MARK CONSISTS OF STANDARD CHARACTERS WITHOUT CLAIM TO ANY PARTICULAR FONT, STYLE, SIZE, OR COLOR.

FOR FOOTWEAR (U.S. CLS. 22 AND 39).

SETH A. RAPPAPORT, EXAMINING ATTORNEY

SN 77-254,302. KINOKO MANAGEMENT LLC, ROCKAWAY PARK, NY. FILED 8-13-2007.



NO CLAIM IS MADE TO THE EXCLUSIVE RIGHT TO USE "PREMIUM CLOTHING", APART FROM THE MARK AS SHOWN.

FOR ADHESIVE BRAS; BRAS; FITTED SWIMMING COSTUMES WITH BRA CUPS; SPORTS BRA; STRAPLESS BRAS; ANKLE BOOTS; ANKLE SOCKS; ANKLETS; ANTI-PERSPIRANT SOCKS; JAPANESE STYLE SOCKS (TABI COVERS); JAPANESE STYLE SOCKS (TABI); MEN'S SOCKS; SOCKS; SOCKS AND STOCKINGS; THERMAL SOCKS; WATER SOCKS; WOOLLEN SOCKS; ATHLETIC FOOTWEAR; ATHLETIC SHOES; BUTTON-FRONT ALOHA SHIRTS; CAMP SHIRTS; DRESS SHIRTS; KNIT SHIRTS; LONG-SLEEVED SHIRTS; NIGHT SHIRTS; OPEN-NECKED SHIRTS; POLO SHIRTS; SHIRTS; SHIRTS FOR SUITS; SHORT-SLEEVED OR LONG-SLEEVED T-SHIRTS; SHORT-SLEEVED SHIRTS; SLEEP SHIRTS; SWEAT SHIRTS; TEE SHIRTS; WIND SHIRTS; YOGA SHIRTS; BABY BIBS NOT OF PAPER; BABY BODYSUITS; BABY BOTTOMS; BABY BUNTING; BABY DOLL PYJAMAS; BABY TOPS; BALLET SHOES; BALLET SLIPPERS; BALLOON PANTS; BATH SLIPPERS; BATHING SUITS; BATHING SUITS FOR MEN; BATHING TRUNKS; BATHROBES; BEACH COVER-UPS; BEACH FOOTWEAR; BEACH SHOES; BEANIES; BELTS; FABRIC BELTS; LEATHER BELTS; MONEY BELTS; SUSPENDER BELTS FOR MEN; TUXEDO BELTS; WAIST BELTS; WRAP BELTS FOR KIMONOS (DATEMAKI); BERETS; BERMUDA SHORTS; BOXER SHORTS; FLEECE SHORTS; GYM SHORTS; PANTIES, SHORTS AND BRIEFS; SHORT OVERCOAT FOR KIMONO (HAORI); SHORT PETTICOATS; SHORT SETS; SHORT TROUSERS; SLIDING SHORTS; SPORTS SHIRTS WITH SHORT SLEEVES; SWEAT SHORTS; UNDERWEAR, NAMELY, BOY SHORTS; WALKING SHORTS; BICYCLING GLOVES; GLOVES; GLOVES FOR PERSONAL HAND CONDITIONING USE; MOTORCYCLE GLOVES; OUTDOOR GLOVES; RIDING GLOVES; SKI GLOVES; SNOWBOARD GLOVES; WET SUIT GLOVES; BIKINIS; BLOOMERS; BLOUSES; BLAZERS; BODY SHAPERS; BODY SUITS; BOOTIES; CLIMBING BOOTS; FOOTWEAR, NAMELY, WORK

CLASS 25—(Continued).

BOOTS; HIKING BOOTS; HORSE-RIDING BOOTS; HUNTING BOOT BAGS; INFANTS' SHOES AND BOOTS; LADIES' BOOTS; MOTORCYCLIST BOOTS; RAIN BOOTS; RIDING BOOTS; SKI BOOTS; SNOWBOARD BOOTS; WINTER BOOTS; WORK SHOES AND BOOTS; BOTTOMS; PAJAMA BOTTOMS; BOW TIES; BOXER BRIEFS; BRALETTES; BRASSIERES; BUSTIERS; CAMISETTES; CAMISOLES; BOWLING SHOES; BOXING SHOES; CANVAS SHOES; CYCLING SHOES; GOLF SHOES; GYMNASTIC SHOES; LEATHER SHOES; SHOES; SKIING SHOES; TAP SHOES; TENNIS SHOES; TRACK AND FIELD SHOES; TRAINING SHOES; VOLLEYBALL SHOES; WOMEN'S SHOES; CAPRI PANTS; CAPRIS; BASEBALL CAPS; BATHING CAPS; GOLF CAPS; HEADGEAR, NAMELY, HATS; KNITTED CAPS; SKULL CAPS; SWIMMING CAPS; TOBOGGAN HATS; PANTS AND CAPS; CARDIGANS; CARGO PANTS; DENIMS; JOGGING PANTS; LEATHER PANTS; LOUNGE PANTS; NON-DISPOSABLE CLOTH TRAINING PANTS; NURSE PANTS; PANTS; SKI PANTS; SNOW PANTS; SNOWBOARD PANTS; SWEAT PANTS; TRACK PANTS; WATERPROOF JACKETS AND PANTS; WIND PANTS; YOGA PANTS; CHEMISES; CHILDREN'S AND INFANTS' CLOTH BIBS; CHILDREN'S CLOTH EATING BIBS; CHILDREN'S HEADWEAR; CHOIR ROBES; JAPANESE SLEEPING ROBES (NEMAKI); ROBES; CLOGS; HIGH RAIN CLOGS (ASHIDA); JAPANESE STYLE CLOGS AND SANDALS; JAPANESE STYLE WOODEN CLOGS (GETA); LOW WOODEN CLOGS (HIYORIGETA); LOW WOODEN CLOGS (KOMA-GETA); SANDAL-CLOGS; CLOTH BIBS; CLOTH BIBS FOR ADULT DINERS; CLOTH BIBS FOR USE BY SENIOR CITIZENS OR PHYSICALLY- OR MENTALLY-CHALLENGED PERSONS; CLOTH DIAPERS; CLOTHING FOR WEAR IN JUDO PRACTICES; CLOTHING FOR WEAR IN WRESTLING GAMES; CLOTHING, NAMELY, NECK TUBES; CLOTHING, NAMELY, WRAP-AROUNDS; INFANT AND TODDLER ONE PIECE CLOTHING; INFANT CLOTH DIAPERS; JERSEYS; PERSPIRATION ABSORBENT UNDERWEAR CLOTHING; SHOULDER WRAPS; TOPS; UNDERARM CLOTHING SHIELDS; WRAPS; MEN AND WOMEN JACKETS, COATS, TROUSERS, VESTS; MORNING COATS; OVER COATS; RAIN COATS; RIDING COATS; SUIT COATS; TOP COATS; TRENCH COATS; WIND COATS; COATS; COATS FOR MEN AND WOMEN; COATS MADE OF COTTON; COATS OF DENIM; DUST COATS; FUR COATS AND JACKETS; LAB COATS; LEATHER COATS; LIGHT-REFLECTING COATS; SPORT COATS; BEACH COVERUPS; COVERUPS; WARM UP SUITS; CREEPERS; CREWNECK SWEATERS; CREWNECKS; CROP TOPS; HALTER TOPS; MUSCLE TOPS; TANK TOPS; TUBE TOPS; DENIM JACKETS; DOWN JACKETS; HEAVY JACKETS; JACKETS; LONG JACKETS; RAIN JACKETS; RAINPROOF JACKETS; SKI JACKETS; SLEEVED OR SLEEVELESS JACKETS; SMOKING JACKETS; SUEDE JACKETS; WIND RESISTANT JACKETS; WIND-JACKETS; LEATHER JACKETS; LIGHT-REFLECTING JACKETS; DRESS SUITS; DRESSES; EVENING DRESSES; NURSE DRESSES; SKIRTS AND DRESSES; DUNGAREES; EAR MUFFS; EAR WARMERS; BOARD SHORTS; SHORTS; FOOTWEAR; FOOTWEAR FOR MEN AND WOMEN; FOOTWEAR, NAMELY, PUMPS; JAPANESE FOOTWEAR OF RICE STRAW (WARAJI); JAPANESE SPLIT-TOED WORK FOOTWEAR (JIKATABI); PUMPS; THONGS; FLIP FLOPS; FOOTWEAR FOR TRACK AND FIELD ATHLETICS; FOOTWEAR MADE OF WOOD; FULL-LENGTH KIMONOS (NAGAGI); KIMONOS; PLEATED SKIRTS FOR FORMAL KIMONOS (HAKAMA); SASH BANDS FOR KIMONO (OBI); UNDERSHIRTS FOR KIMONOS (JUBAN); UNDERSHIRTS FOR KIMONOS (KOSHIMAKI); WAIST STRINGS FOR KIMONOS (KOSHIHIMO); FUR CLOAKS; FUR HATS; FUR MUFFS; FUR STOLE; GLOVES INCLUDING THOSE MADE OF SKIN, HIDE OR FUR; GAUCHOS; CORSETS; FOUNDATION GARMENTS; GIRDLES; ONE PIECE GARMENT FOR INFANTS AND TODDLERS; SLEEPING GARMENTS; UNDER GARMENTS; GYM SUITS; G-STRINGS; HEAD SCARVES; HEAD SWEATBANDS; HEAD WEAR; INFANT SLEEPERS; INFANT WEAR; INFANTS' TROUSERS; JAPANESE STYLE SANDALS (ZORI); JAPANESE STYLE SANDALS OF FELT; JAPANESE STYLE SANDALS OF LEATHER; JEANS; JOGGING OUTFITS; JOGGING SUITS; DRY SUITS; JUDO SUITS; KARATE SUITS; LADIES' SUITS; MEN'S SUITS; WOMEN'S SUITS; ONE-PIECE PLAY SUITS; PLAY SUITS; RAIN SUITS; SKI SUITS; SKIRT SUITS; SNOW

CLASS 25—(Continued).

BOARDING SUITS; SNOW SUITS; WET SUITS; WET SUITS FOR WATER-SKIING AND SUB-AQUA; KNEE HIGHS; KNEE-HIGH STOCKINGS; LAYETTES; LEGGINGS; LEOTARDS; LEOTARDS AND TIGHTS FOR WOMEN, MEN AND CHILDREN OF NYLON, COTTON OR OTHER TEXTILE FIBERS; LINGERIE; MATERNITY LINGERIE; LOUNGEWEAR; MATERNITY SLEEPWEAR; SKIRTS; MOCKNECKS; NIGHT GOWNS; GOWNS; NIGHTIES; NURSE OVERALLS; PAJAMAS; PANTIES; STOCKINGS; RAIN TROUSERS; RUBBER SHOES; SARONGS; SCARVES; SHOULDER SCARVES; SILK SCARVES; SHAWLS; SHAWLS AND HEADSCARVES; SHAWLS AND STOLE; SLEEP MASKS; SLEEPWEAR; LEATHER SLIPPERS; SLIPPERS; SLIPS; SMOCKS; SNEAKERS; SURF WEAR; SWIM WEAR FOR GENTLEMEN AND LADIES; THONGS; MOCK TURTLE-NECK SWEATERS; SWEATERS; TURTLENECK SWEATERS; V-NECK SWEATERS; TROUSERS; TURTLENECKS; UNDERCLOTHES; UNDERPANTS; UNDERSHIRTS; ATHLETIC UNIFORMS; MARTIAL ARTS UNIFORMS; SCHOOL UNIFORMS; UNIFORMS; VESTS; WIND VESTS (U.S. CLS. 22 AND 39).

COLLEEN KEARNEY, EXAMINING ATTORNEY

SN 77-255,766. MCCRYSTAL, DAN, SAN DIEGO, CA. FILED 8-15-2007.

QUICK FLAP

THE MARK CONSISTS OF STANDARD CHARACTERS WITHOUT CLAIM TO ANY PARTICULAR FONT, STYLE, SIZE, OR COLOR.

NO CLAIM IS MADE TO THE EXCLUSIVE RIGHT TO USE "FLAP", APART FROM THE MARK AS SHOWN.

FOR CLOTHING, NAMELY, A REMOVABLE ACCESSORY THAT ATTACHES TO THE HAT OR CAP AND PROVIDES EAR AND NECK PROTECTION FROM SUN EXPOSURE (U.S. CLS. 22 AND 39).

STEVEN R. FINE, EXAMINING ATTORNEY

SN 77-255,958. NEW UNDERSTANDINGS AWAKEN WORLDWIDE, LLC, WILMINGTON, DE. FILED 8-15-2007.

NUAW NEW UNDERSTANDINGS AWAKEN WITHIN

THE MARK CONSISTS OF STANDARD CHARACTERS WITHOUT CLAIM TO ANY PARTICULAR FONT, STYLE, SIZE, OR COLOR.

FOR CLOTHING AND APPAREL, NAMELY, SHIRTS, T-SHIRTS, BLOUSES AND TOPS, SWEATERS, JACKETS, SWEATSHIRTS, PULLOVERS, COATS, DRESSES, SKIRTS, TROUSERS, PANTS, JEANS, SWEATPANTS, SHORTS, SWIMWEAR, UNDERWEAR, SLEEPWEAR, HOSIERY; HEADGEAR, NAMELY, HATS, CAPS, VISORS; ACCESSORIES, NAMELY, BELTS, TIES, NECKTIES, SCARVES AND GLOVES; FOOTWEAR, NAMELY, SOCKS, SHOES, BOOTS, SANDALS, SLIDES, THONGS AND SLIPPERS (U.S. CLS. 22 AND 39).

KYLE PEETE, EXAMINING ATTORNEY

CLASS 25—(Continued).

SN 77-256,196. NEW UNDERSTANDINGS AWAKEN WORLDWIDE, LLC, WILMINGTON, DE. FILED 8-15-2007.

NUAW NEW UNDERSTANDINGS AWAKEN WORLDWIDE

THE MARK CONSISTS OF STANDARD CHARACTERS WITHOUT CLAIM TO ANY PARTICULAR FONT, STYLE, SIZE, OR COLOR.

FOR CLOTHING AND APPAREL, NAMELY, SHIRTS, T-SHIRTS, BLOUSES AND TOPS, SWEATERS, JACKETS, SWEATSHIRTS, PULLOVERS, COATS, DRESSES, SKIRTS, TROUSERS, PANTS, JEANS, SWEATPANTS, SHORTS, SWIMWEAR, UNDERWEAR, SLEEPWEAR, HOSIERY; HEADGEAR, NAMELY, HATS, CAPS, VISORS; ACCESSORIES, NAMELY, BELTS, TIES, NECKTIES, SCARVES AND GLOVES; FOOTWEAR, NAMELY, SOCKS, SHOES, BOOTS, SANDALS, SLIDES, THONGS AND SLIPPERS (U.S. CLS. 22 AND 39).

KYLE PEETE, EXAMINING ATTORNEY

SN 77-258,134. SHAVATT, SERVICE & JAN, COLUMBIA, MD. FILED 8-17-2007.

Love the Truth

THE MARK CONSISTS OF STANDARD CHARACTERS WITHOUT CLAIM TO ANY PARTICULAR FONT, STYLE, SIZE, OR COLOR.

FOR CLOTHING FOR MEN, WOMEN AND CHILDREN, NAMELY, SWEAT SHIRTS, SWEAT PANTS, TEE SHIRTS, BELTS, CAPS, SHORTS, SOCKS, GLOVES, HEAD BANDS, WRIST BANDS (U.S. CLS. 22 AND 39).

SHARON MEIER, EXAMINING ATTORNEY

SN 77-258,185. BRAIME, YVONNE, OCEAN GROVE, NJ. FILED 8-17-2007.

That's what girls do...shop!

THE MARK CONSISTS OF STANDARD CHARACTERS WITHOUT CLAIM TO ANY PARTICULAR FONT, STYLE, SIZE, OR COLOR.

FOR SWEAT PANTS, T-SHIRTS, SWEAT SHIRTS, UNDERWEAR, JACKETS, HOODIES, CAPS AND TANK TOPS (U.S. CLS. 22 AND 39).

AMY MCMENAMIN, EXAMINING ATTORNEY

CLASS 25—(Continued).

SN 77-258,227. BRAIME, YVONNE, OCEAN GROVE, NJ. FILED 8-17-2007.

Choker Loser Slacker...Air Ball!

THE MARK CONSISTS OF STANDARD CHARACTERS WITHOUT CLAIM TO ANY PARTICULAR FONT, STYLE, SIZE, OR COLOR.

FOR SWEAT PANTS, T-SHIRTS, SWEAT SHIRTS, JACKETS, HOODIES, BASEBALL CAPS AND HEADBANDS (U.S. CLS. 22 AND 39).

AMY MCMENAMIN, EXAMINING ATTORNEY

SN 77-258,918. GARZA, RAYNALDO, MONARCH BEACH, CA. FILED 8-20-2007.



OWNER OF U.S. REG. NO. 3,053,627.

THE MARK CONSISTS OF THE WORD "LUV" WITH LETTER "U" FORMING A SMILING FACE.

FOR CLOTHING, NAMELY, PULLOVERS, SKIRTS, DRESSES, BLOUSES, JEANS, PANTS, TROUSERS, JACKETS, COATS, RAINCOATS, ANORAKS, SWEATERS, POLO SHIRTS, DRESS SHIRTS, SHIRTS, GOLF SHIRTS, T-SHIRTS, SWEATSHIRTS, SWEAT SUITS, JOGGING SUITS, JERSEYS, SUITS, SHORTS, OVERALLS, DENIM SHIRTS, DENIM PANTS, UNDERCLOTHING, UNDERGARMENTS, BODICES, BRASSIERES, CAMISOLES, UNDERPANTS, DRESSING GOWNS, BATH ROBES, BATHING SUITS, PAJAMAS, GLOVES, SKI SUITS, STOCKINGS; BELTS; TIES, FOULARDS, NECKTIES, SHAWLS, SCARVES, MUFFLERS, NECK SCARVES, SARONGS, COLLARS FOR DRESSES, MANIPLES, MUFFS, SUSPENDERS, BRACES FOR CLOTHING, COATS, BLAZERS, SPORTS JACKETS, GARTERS, TIES, TANK TOPS, LOUNGEWEAR, LINGERIE, VESTS, SOCKS, PANTIES, SWEATPANTS; HEADGEAR, NAMELY, BANDANAS, CAPS, HATS, BEANIES, KNITTED CAPS, BERETS, COWBOY HATS, TUXEDO HATS, DINNER WEAR HATS AND VISORS; FOOTWEAR, NAMELY, ATHLETIC SHOES; SNEAKERS, BOOTS, SANDALS, BEACH SHOES, BOAT SHOES, SLIPPERS, BOOTS, SNOW BOOTS, FLIP FLOPS, BEACH COVER-UPS, BEACHWEAR, BELTS, BODY SHAPERS, BOXER SHORTS, DRESSES, GLOVES, GOWNS, HALTER TOPS, HEADBANDS, HOSIERY, KNEE HIGHS, KNIT SHIRTS, KNIT TOPS, LEOTARDS, MITTENS, NEGLIGES, NIGHT GOWNS, NIGHT SHIRTS, PANTYHOSE, SLACKS, SLEEPWEAR, SLIPS, STOCKINGS, SWEAT SHORTS, SWIM WEAR, TAP PANTS, TEDDIES, TIGHTS, UNDERSHIRTS, UNDERWEAR AND VESTS, LINGERIE ACCESSORIES, NAMELY, REMOVABLE SILICONE BREAST ENHANCER PADS USED IN A BRA, MATERNITY LINGERIE; SPORTSWEAR, NAMELY, SPORTS JACKETS; BEACH CLOTHES, NAMELY, SWIMMING TRUNKS, KNITWEAR, NAMELY, KNIT SHIRTS; CLOTH BIBS, CLOTH DIAPERS, BANDS, NAMELY, HAT BANDS, HEAD BANDS AND WRIST BANDS; SPORTS SHOES, NAMELY, BASEBALL SHOES, SOCCER SHOES, FOOTBALL SHOES, BASKETBALL SHOES AND GOLF SHOES (U.S. CLS. 22 AND 39).

DAVID MURRAY, EXAMINING ATTORNEY

CLASS 25—(Continued).

SN 77-259,024. AZUL GROUP, INC., NEW YORK, NY. FILED 8-20-2007.

CHABE

THE MARK CONSISTS OF STANDARD CHARACTERS WITHOUT CLAIM TO ANY PARTICULAR FONT, STYLE, SIZE, OR COLOR.

THE WORDING CHABE HAS NO MEANING IN ANY FOREIGN LANGUAGE

FOR CLOTHING, NAMELY, JACKETS, VESTS, PANTS AND TOPS (U.S. CLS. 22 AND 39).

LINDA E. BLOHM, EXAMINING ATTORNEY

SN 77-263,139. ARCENEUX, DEAN, NEWMAN, CA. AND ARCENEUX, VERONICA, NEWMAN, CA. FILED 8-23-2007.

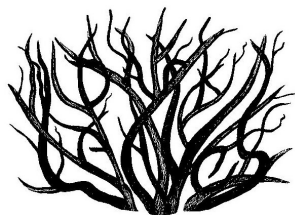

THE STIPLING IS A FEATURE OF THE MARK AND DOES NOT INDICATE COLOR.

THE MARK CONSISTS OF BARREN TREE BRANCHES INCORPORATING THE WORDS "DARK LEAVES".

FOR SWEAT PANTS; SWEAT SHIRTS; SHIRTS; HATS; BANDANAS; SKIRTS AND DRESSES (U.S. CLS. 22 AND 39).

MARY BOAGNI, EXAMINING ATTORNEY

CLASS 25—(Continued).

SN 77-263,231. TRIAXAN HOLDING COMPANY PTY LTD, ULTIMO, AUSTRALIA, FILED 8-23-2007.

BOGAN BOOTS

THE MARK CONSISTS OF STANDARD CHARACTERS WITHOUT CLAIM TO ANY PARTICULAR FONT, STYLE, SIZE, OR COLOR.

NO CLAIM IS MADE TO THE EXCLUSIVE RIGHT TO USE "BOOTS", APART FROM THE MARK AS SHOWN.

FOR CLOTHING, NAMELY, PANTS, SHORTS, SKIRTS, DRESSES, SHIRTS, T-SHIRTS, HOODS, JACKETS, COATS, TOPS, SINGLET, JUMPERS, UNDER-SHIRTS, GLOVES, NIGHTWEAR, HOSIERY, UNDERWEAR, SUITS, SCARVES, SHAWLS, SOCKS, JEANS, BOARD SHORTS, SWEAT PANTS, SWEAT SHIRTS, POLO SHIRTS, KNIT TOPS, KNIT BOTTOMS, PULLOVERS, SWEATERS, VESTS, PARKAS, BLOUSES, TANK TOPS, SWIMWEAR, LINGERIE; HEADGEAR, NAMELY, HATS, CAPS, VISORS, BANDANAS AND BEANIES; FOOTWEAR INCLUDING BOOTS, SHOES, SLIPPERS, FLIP-FLOPS AND SANDALS; INNER SOLES (U.S. CLS. 22 AND 39).

FRANK LATTUCA, EXAMINING ATTORNEY

CLASS 25—(Continued).

SN 77-264,281. HSIA, MICHAEL T., SAN GABRIEL, CA, FILED 8-25-2007.

Eco Threads

THE MARK CONSISTS OF STANDARD CHARACTERS WITHOUT CLAIM TO ANY PARTICULAR FONT, STYLE, SIZE, OR COLOR.

NO CLAIM IS MADE TO THE EXCLUSIVE RIGHT TO USE "THREADS", APART FROM THE MARK AS SHOWN.

FOR SHORT-SLEEVED OR LONG-SLEEVED T-SHIRTS; DRESS SHIRTS; GOLF SHIRTS; KNIT SHIRTS; LONG-SLEEVED SHIRTS; PIQUE SHIRTS; POLO SHIRTS; SHORT-SLEEVED SHIRTS; SLEEP SHIRTS; JACKETS (U.S. CLS. 22 AND 39).

KARANENDRA S. CHHINA, EXAMINING ATTORNEY

SN 77-263,806. ARNAUD, INC., LOS ANGELES, CA. FILED 8-24-2007.



THE COLOR(S) THREE SHADES OF GREEN IS/ARE CLAIMED AS A FEATURE OF THE MARK.

THE COLOR GREEN APPEARS IN THE MARK'S WORDING; THE COLORS DARK GREEN, GREEN AND LIGHT GREEN APPEAR IN CONCENTRIC CIRCLES IN THE PETALS OF THE MARK'S FLOWER DESIGN.

FOR A-SHIRTS; ANKLE SOCKS; BRIEFS; CAMP SHIRTS; CANVAS SHOES; CAPRI PANTS; CARGO PANTS; CHEF'S HATS; GOLF SHIRTS; GYM SHORTS; GYMNASTIC SHOES; HEADGEAR, NAMELY, HATS, CAPS; JOGGING PANTS; LONG-SLEEVED SHIRTS; LOUNGE PANTS; MEN'S SOCKS; NIGHT SHIRTS; NON-DISPOSABLE CLOTH TRAINING PANTS; OPEN-NECKED SHIRTS; PANTS; POLO SHIRTS; SHIRTS; SHOES; SHORT SETS; SHORT TROUSERS; SHORT-SLEEVED OR LONG-SLEEVED T-SHIRTS; SHORT-SLEEVED SHIRTS; SHORTS; SLEEP SHIRTS; SPORT SHIRTS; SPORTS SHIRTS WITH SHORT SLEEVES; SWEAT PANTS; SWEAT SHIRTS; SWEAT SHORTS; T-SHIRTS; TENNIS SHOES; THERMAL SOCKS; UNDERWEAR; WATERPROOF JACKETS AND PANTS; WIND SHIRTS; WOMEN'S SHOES; WRISTBANDS; YOGA PANTS; YOGA SHIRTS (U.S. CLS. 22 AND 39).

BARNEY CHARLON, EXAMINING ATTORNEY

SN 77-265,464. PATRICK, KANDI D., OLYMPIA, WA. FILED 8-27-2007.



GENUINE INACTIVE WEAR

NO CLAIM IS MADE TO THE EXCLUSIVE RIGHT TO USE "GENUINE INACTIVE WEAR", APART FROM THE MARK AS SHOWN.

THE MARK CONSISTS OF A CIRCLE HAVING INTERIOR CROSSING LINES IN THE FORM OF THE LETTER "Y" AND A CURVED LINE ON THE STEM OF THE "Y". THE WORD "YABUT" APPEARS IN CURVILINEAR TEXT ABOVE THE CIRCLE. THE WORDING "GENUINE INACTIVE WEAR" APPEARS BELOW THE CIRCLE.

FOR APPAREL, NAMELY, PANTS, SHORTS, SHIRTS, T-SHIRTS, PULLOVERS, SWEAT SHIRTS, SWEAT PANTS, UNDERWEAR, SPORTS BRAS, DRESSES, SKIRTS, SWEATERS, JACKETS, SOCKS, HEADWEAR, SWEATBANDS, GLOVES, BELTS, HOSIERY, COATS, VESTS (U.S. CLS. 22 AND 39).

FIRST USE 7-1-2007; IN COMMERCE 7-1-2007.

JORDAN BAKER, EXAMINING ATTORNEY

CLASS 25—(Continued).

SN 77-265,968. KIRSTIE PIKES, GUNNISON, CO. FILED 8-28-2007.

PROIS

THE MARK CONSISTS OF STANDARD CHARACTERS WITHOUT CLAIM TO ANY PARTICULAR FONT, STYLE, SIZE, OR COLOR.

THE WORDING "PROIS" HAS NO MEANING IN A FOREIGN LANGUAGE.

FOR JACKETS; PANTS; SHIRTS; VESTS; HEADGEAR, NAMELY, CAPS, HATS AND BEANIES; SWEATERS; COATS; SOCKS; THERMAL SOCKS; WOOLLEN SOCKS; GLOVES (U.S. CLS. 22 AND 39).

JANICE KIM, EXAMINING ATTORNEY

SN 77-267,190. TRICIA SIMPSON, ANAHEIM HILLS, CA. FILED 8-29-2007.

SMASHED CLOTHING BY TSJC

THE MARK CONSISTS OF STANDARD CHARACTERS WITHOUT CLAIM TO ANY PARTICULAR FONT, STYLE, SIZE, OR COLOR.

NO CLAIM IS MADE TO THE EXCLUSIVE RIGHT TO USE "CLOTHING", APART FROM THE MARK AS SHOWN.

FOR CLOTHING ITEMS, NAMELY, JACKETS, SWEATERS, SHORTS, SHIRTS, SWEATSHIRTS, HATS, VISORS, T-SHIRTS, SWEAT PANTS, JERSEYS, BATHING SUITS, BEANIES, UNDERWEAR, LINGERIE, DRESSES, NIGHTIES, TANK TOPS, CAPS, MITTENS, SCARVES, SOCKS, GLOVES, SHOES, JEANS, BANDANAS, HEADBANDS, WRISTBANDS, BELTS, ROBES, HOODED SWEATSHIRTS, PAJAMAS, AND TIES (U.S. CLS. 22 AND 39).

KAREN BRACEY, EXAMINING ATTORNEY

CLASS 25—(Continued).

SN 77-268,534. SCOOP INTERNATIONAL, LLC, DALLAS, TX. FILED 8-30-2007.



THE COLOR(S) ORANGE, BLUE AND BLACK IS/ARE CLAIMED AS A FEATURE OF THE MARK.

THE MARK CONSISTS OF A BLUE "2", ORANGE "SCOOPS", BLACK "WHAT'S YOUR FLAVOUR?", AN ICE CREAM BALL SHAPED FIGURE MADE OF BLUE AND ORANGE CIRCLES, ORANGE MOUTH, BLACK EYES AND LEGS, AND BLUE BALL FEET. CUSTOM TYPE, "2 SCOOPS WHAT'S YOUR FLAVOUR?"

FOR ATHLETIC SHOES; BALLET SHOES; BEACH SHOES; CANVAS SHOES; DECK-SHOES; GYMNASIIC SHOES; INFANTS' SHOES AND BOOTS; JAPANESE STYLE CLOGS AND SANDALS; JAPANESE STYLE SANDALS (ZORI); JAPANESE STYLE SANDALS OF FELT; JAPANESE STYLE SANDALS OF LEATHER; JAPANESE TOE-STRAP SANDALS (ASAURA-ZORI); LEATHER SHOES; RUBBER SHOES; RUNNING SHOES; SANDAL-CLOGS; SANDALS; SHOES; WOMEN'S SHOES (U.S. CLS. 22 AND 39).

FIRST USE 3-1-2007; IN COMMERCE 3-1-2007.

VIVIAN MICZNIK FIRST, EXAMINING ATTORNEY

SN 77-271,832. HEADMOST INTERNATIONAL, INC., ONTARIO, CA. FILED 9-5-2007.

Absorband

THE MARK CONSISTS OF STANDARD CHARACTERS WITHOUT CLAIM TO ANY PARTICULAR FONT, STYLE, SIZE, OR COLOR.

FOR HEADWEAR; HAT BANDS; HATS; HEADGEAR, NAMELY, HATS, CAPS; BASEBALL CAPS; CAP VISORS; CAPS; CAPS WITH VISORS; GOLF CAPS (U.S. CLS. 22 AND 39).

FIRST USE 4-1-2007; IN COMMERCE 4-1-2007.

KENNETH E. SHARPERSON, EXAMINING ATTORNEY

CLASS 25—(Continued).

SN 77-271,835. M RUBIN & SONS, INC., LIC, NY. FILED 9-5-2007.

COLOR AUTHORITY

THE MARK CONSISTS OF STANDARD CHARACTERS WITHOUT CLAIM TO ANY PARTICULAR FONT, STYLE, SIZE, OR COLOR.

FOR HEADGEAR, NAMELY, HATS AND CAPS; OVERALLS, PANTS, SHIRTS, TOPS, SKIRTS, SHORTS, SWEATSHIRTS, JACKETS, UNDERWEAR, ROMPERS, SINGLETs, ROBES, COATS, GLOVES AND MITTENS, PAJAMAS, SLIPPERS, HEAD BANDS, SOCKS, SCARVES, FOOTWEAR, NECKWEAR, SLEEPWEAR AND SWIM WEAR (U.S. CLS. 22 AND 39).

KENNETH E. SHARPERSON, EXAMINING ATTORNEY

CLASS 25—(Continued).

SN 77-273,996. TIMO, TEREZA, KEW GARDENS, NY. FILED 9-7-2007.

PRINCESS DANNIELYNN

THE MARK CONSISTS OF STANDARD CHARACTERS WITHOUT CLAIM TO ANY PARTICULAR FONT, STYLE, SIZE, OR COLOR.

"PRINCESS DANNIELYNN" DOES NOT IDENTIFY A LIVING INDIVIDUAL.

FOR BABY BIBS NOT OF PAPER; BABY BODYSUITS; BABY BOTTOMS; BABY TOPS; BELTS; CAPS; CHILDREN'S AND INFANTS' CLOTH BIBS; CLOTH BIBS; INFANT AND TODDLER ONE PIECE CLOTHING; INFANT CLOTH DIAPERS; JERSEYS; CHILDRENS CLOTHING, NAMELY, TROUSERS, DRESSES, SKIRTS, BLOUSES, SWEATERS, WARM-UP- SUITS, CARDIGANS, JACKETS, COATS, SHIRTS, T-SHIRTS, OVERALLS, SMOCKS, DRESS-TROUSERS, TUNICS, SHORTS, SKORTS, SOCKS, TIGHTS, SHAWL, BELTS, HEADBANDS, HEADWEAR, PAJAMAS, SHORTS, JUMPERS (U.S. CLS. 22 AND 39).

STEVEN JACKSON, EXAMINING ATTORNEY

SN 77-275,938. STAGING LANE PRODUCTIONS, INC., MONROVIA, CA. FILED 9-10-2007.

DUNGAREE DOLLS

THE MARK CONSISTS OF STANDARD CHARACTERS WITHOUT CLAIM TO ANY PARTICULAR FONT, STYLE, SIZE, OR COLOR.

OWNER OF U.S. REG. NO. 3,349,599.

NO CLAIM IS MADE TO THE EXCLUSIVE RIGHT TO USE "DUNGAREE", APART FROM THE MARK AS SHOWN.

FOR WEARING APPAREL, NAMELY, T-SHIRTS, DENIM SHIRTS, SLACKS, PANTS, DENIM JEANS, DENIM JACKETS, SHORTS, DENIM VESTS, BELTS, HATS, VISORS AND SHOES (U.S. CLS. 22 AND 39).

ALICE SUE CARRUTHERS, EXAMINING ATTORNEY

SN 77-273,072. WRANGLER APPAREL CORP., WILMINGTON, DE. FILED 9-6-2007.



OWNER OF U.S. REG. NOS. 809,323, 2,575,862 AND OTHERS.

THE MARK CONSISTS OF THE WORD "WRANGLER", STYLIZED.

FOR CLOTHING, NAMELY, JEANS, PANTS, SHIRTS, T-SHIRTS, VESTS, JACKETS, FOOTWEAR AND HEADGEAR, NAMELY, HATS AND CAPS (U.S. CLS. 22 AND 39).

THEODORE MCBRIDE, EXAMINING ATTORNEY

SN 77-277,390. CAPPUCCI, FRANCESCA M., PASADENA, CA. FILED 9-12-2007.

**All Is Fair In LOVE and
SOCCER
Todo está justo enamorado
y fútbol**

THE MARK CONSISTS OF STANDARD CHARACTERS WITHOUT CLAIM TO ANY PARTICULAR FONT, STYLE, SIZE, OR COLOR.

THE ENGLISH TRANSLATION OF "TODO ESTÁ JUSTO ENAMORADO Y FUTBOL" IS "ALL IS FAIR IN LOVE AND SOCCER".

FOR T-SHIRT, HATS (U.S. CLS. 22 AND 39).

MICHAEL WEBSTER, EXAMINING ATTORNEY

CLASS 25—(Continued).

SN 77-277,839. MODREWSKI-PICCINICH, ANNA, FAIRVIEW, NJ. FILED 9-12-2007.



THE COLOR(S) BLACK, WHITE, BLUE AND YELLOW IS/ARE CLAIMED AS A FEATURE OF THE MARK.

THE WORDS "IZZIEBELLIE..." ARE IN BLACK. THE BUMBLEBEE DESIGN IS OUTLINED IN BLACK WITH BLACK STRIPES AND FACIAL FEATURES ON A YELLOW BACKGROUND. THE BUMBLEBEE EARS ARE IN WHITE WITH A BLACK OUTLINE AND THE BUMBLEBEE EYES ARE BLUE WITH BLACK OUTLINE.

FOR BABY BODYSUITS; BABY BOTTOMS; BABY BUNTING; BABY TOPS; INFANT AND TODDLER ONE PIECE CLOTHING; SHORT SETS; SWADDLING CLOTHES; TOPS; CAPS; INFANT SLEEPERS; INFANT WEAR; INFANTS' TROUSERS; ONE PIECE GARMENT FOR INFANTS AND TODDLERS; HATS; SMALL HATS; WOOLLY HATS; ROMPERS; PAJAMA BOTTOMS; PAJAMAS; LONG-SLEEVED SHIRTS; SLEEP SHIRTS; T-SHIRTS; TEE SHIRTS; DRESSES; UNDERWEAR, NAMELY, BOY SHORTS; ANKLETS; BASEBALL CAPS; BATHING SUITS; BATHING TRUNKS; BATHROBES; BEACH COVER-UPS; BEACH COVERUPS; BEANIES; BERETS; BONNETS; BOOTIES; CHILDREN'S HEADWEAR; COVERALLS; CREEPERS; HEAD WEAR; HEADGEAR, NAMELY, INFANT, TODDLER AND CHILDREN'S HATS; INFANT, TODDLER AND CHILDREN'S CAPS; HEADWEAR; INFANTWEAR; JACKETS; JUMPERS; LAYETTES; ONE-PIECE PLAY SUITS; PLAY SUITS; PULLOVERS; SLEEPWEAR (U.S. CLS. 22 AND 39).

ERNEST SHOSHO, EXAMINING ATTORNEY

SN 77-277,889. LOT 6, LLC, LAKE SUCCESS, NY. FILED 9-12-2007.

CLUB KIDS BY HEATHERETTE

THE MARK CONSISTS OF STANDARD CHARACTERS WITHOUT CLAIM TO ANY PARTICULAR FONT, STYLE, SIZE, OR COLOR.

OWNER OF U.S. REG. NOS. 2,932,600 AND 3,164,534.

NO CLAIM IS MADE TO THE EXCLUSIVE RIGHT TO USE "KIDS", APART FROM THE MARK AS SHOWN.

FOR CLOTHING, NAMELY, SHIRTS, VESTS, SWEATERS, SHOES, CAPS, SHORTS, SWEAT SHIRTS, PANTS, BELTS FOR CLOTHING, SOCKS, SWIMWEAR, JACKETS, RAINWEAR, BLOUSES, DRESSES, FOOTWEAR, HOSIERY, SCARVES, HATS, HEAD BANDS, PAJAMAS AND SLEEPWEAR (U.S. CLS. 22 AND 39).

DOMINIC J. FERRAIUOLO, EXAMINING ATTORNEY

CLASS 25—(Continued).

SN 77-278,683. LOT 6, LLC, LAKE SUCCESS, NY. FILED 9-13-2007.

CLUB KIDS

THE MARK CONSISTS OF STANDARD CHARACTERS WITHOUT CLAIM TO ANY PARTICULAR FONT, STYLE, SIZE, OR COLOR.

NO CLAIM IS MADE TO THE EXCLUSIVE RIGHT TO USE "KIDS", APART FROM THE MARK AS SHOWN.

FOR CLOTHING, NAMELY, SHIRTS, VESTS, SWEATERS, SHOES, CAPS, SHORTS, SWEAT SHIRTS, PANTS, BELTS FOR CLOTHING, SOCKS, SWIMWEAR, JACKETS, RAINWEAR, BLOUSES, DRESSES, FOOTWEAR, HOSIERY, SCARVES, HATS, HEAD BANDS, PAJAMAS AND SLEEPWEAR (U.S. CLS. 22 AND 39).

DOMINIC J. FERRAIUOLO, EXAMINING ATTORNEY

SN 77-280,298. 808 APPAREL LLC, KANEOHE, HI. FILED 9-14-2007.

No Hesitation

THE MARK CONSISTS OF STANDARD CHARACTERS WITHOUT CLAIM TO ANY PARTICULAR FONT, STYLE, SIZE, OR COLOR.

FOR CLOTHING, NAMELY, T-SHIRTS, SWEATSHIRTS, TOPS, HOODS, JERSEYS, SHORTS, PANTS, GLOVES, SWIM SUITS, PANTS, JACKETS, BELTS, SKIRTS, DRESSES, FOOTWEAR, AND HEADGEAR, NAMELY, HATS, CAPS, HEADBANDS, AND VISORS (U.S. CLS. 22 AND 39).

LINDA ORNDORFF, EXAMINING ATTORNEY

SN 77-281,451. WESTRIM, INC., VAN NUYS, CA. FILED 9-17-2007.



THE MARK CONSISTS OF THE WORDS "SNAP" AND "ITZ" WITH A SMILING FACE DESIGN BETWEEN THE TWO WORDS.

FOR CLOTHING, NAMELY, SPORTS CLOGS, FLIP FLOPS, AND VISORS (U.S. CLS. 22 AND 39).

DAVID C. REIHNER, EXAMINING ATTORNEY

CLASS 25—(Continued).

SN 77-282,259. UTILIKILTS COMPANY, LLC, SEATTLE, WA.
FILED 9-18-2007.

think outside the boxers

THE MARK CONSISTS OF STANDARD CHARACTERS WITHOUT CLAIM TO ANY PARTICULAR FONT, STYLE, SIZE, OR COLOR.

FOR KILTS; BRIEFS; MEN AND WOMEN JACKETS, COATS, TROUSERS, VESTS; UNDERWEAR; CLOTHING, NAMELY, FOLK COSTUMES; COSTUMES FOR USE IN ROLE-PLAYING GAMES; MEN'S SUITS; WOMEN'S SUITS; SKIRT SUITS; SKIRTS; SKIRTS AND DRESSES; UNDER GARMENTS; BOXER BRIEFS; BOXER SHORTS; PANTIES, SHORTS AND BRIEFS (U.S. CLS. 22 AND 39).
APRIL ROACH, EXAMINING ATTORNEY

SN 77-283,221. KARMAN, INC., AURORA, CO. FILED 9-19-2007.

ROPER

OWNER OF U.S. REG. NOS. 1,488,574, 2,142,792 AND OTHERS.

THE MARK CONSISTS OF THE STYLIZED WORDING "ROPER".

FOR CLOTHING, NAMELY, SHIRTS, KNIT AND WOVEN SHIRTS, BLOUSES, JEANS, PANTS, SHORTS, SKIRTS, DRESSES, SWEATERS, SWEATSHIRTS, T-SHIRTS, JACKETS, COATS, HATS, BELTS, CAPS, SOCKS, FOOTWEAR AND HEADWEAR (U.S. CLS. 22 AND 39).

FIRST USE 3-10-1998; IN COMMERCE 3-10-1998.
LANA PHAM, EXAMINING ATTORNEY

SN 77-283,815. CHUBASCO SANDALS INC., SAN DIEGO, CA. FILED 9-19-2007.



THE MARK CONSISTS OF AN OCEAN WAVE WITH THE WORDS "CHUBASCO" IN STYLIZED TEXT.

THE ENGLISH TRANSLATION OF "CHUBASCO" IN THE MARK IS "SQUALL" OR "DOWNPOUR".

FOR SANDALS; SHOES (U.S. CLS. 22 AND 39).
FIRST USE 6-20-2005; IN COMMERCE 6-20-2007.
AISHA CLARKE, EXAMINING ATTORNEY

CLASS 25—(Continued).

SN 77-283,853. DON'T TASE ME, BRO!, LLC., WESTON, FL.
FILED 9-19-2007.

DON'T TASE ME, BRO!

THE MARK CONSISTS OF STANDARD CHARACTERS WITHOUT CLAIM TO ANY PARTICULAR FONT, STYLE, SIZE, OR COLOR.

FOR A-SHIRTS; BUTTON-FRONT ALOHA SHIRTS; CAMP SHIRTS; DRESS SHIRTS; GOLF SHIRTS; KNIT SHIRTS; LONG-SLEEVED SHIRTS; NIGHT SHIRTS; OPEN-NECKED SHIRTS; PIQUE SHIRTS; POLO SHIRTS; RUGBY SHIRTS; SHIRT FRONTS; SHIRTS; SHORT-SLEEVED OR LONG-SLEEVED T-SHIRTS; SHORT-SLEEVED SHIRTS; SLEEP SHIRTS; SPORT SHIRTS; SPORTS SHIRTS; SPORTS SHIRTS WITH SHORT SLEEVES; SWEAT SHIRTS; T-SHIRTS; TEE SHIRTS; WIND SHIRTS; YOGA SHIRTS; HATS; SMALL HATS; TOBOGGAN HATS, PANTS AND CAPS; WOOLLY HATS (U.S. CLS. 22 AND 39).

KATHLEEN LORENZO, EXAMINING ATTORNEY

SN 77-283,888. RENE RUIZ COUTURE, INC., CORAL GABLES, FL. FILED 9-19-2007.

Rene Ruiz

THE MARK CONSISTS OF STANDARD CHARACTERS WITHOUT CLAIM TO ANY PARTICULAR FONT, STYLE, SIZE, OR COLOR.

THE NAME(S), PORTRAIT(S), AND/OR SIGNATURE(S) SHOWN IN THE MARK IDENTIFIES RENE RUIZ, WHOSE CONSENT(S) TO REGISTER IS SUBMITTED.

FOR COATS FOR MEN AND WOMEN; MEN AND WOMEN JACKETS, COATS, TROUSERS, VESTS; MEN'S SUITS, WOMEN'S SUITS; WOMEN'S SHOES; DRESS SHIRTS; DRESS SUITS; DRESSES; EVENING DRESSES; SKIRTS AND DRESSES; WEDDING DRESSES; SHIRTS; SHIRTS FOR SUITS; SHORT-SLEEVED SHIRTS; BLOUSES; HALTER TOPS; TANK TOPS; TOP COATS; TOPS; SKIRT SUITS; SKIRTS; EVENING GOWNS; GOWNS; WEDDING GOWNS; SPORT COATS; SPORT SHIRTS; SPORTS JACKETS; MEN'S SUITS (U.S. CLS. 22 AND 39).

FIRST USE 1-1-1990; IN COMMERCE 1-1-1994.
INGA ERVIN, EXAMINING ATTORNEY

CLASS 25—(Continued).

SN 77-284,521. FASHION FEDS LLC, SO. OZONE PARK, NY.
FILED 9-20-2007.



NO CLAIM IS MADE TO THE EXCLUSIVE RIGHT TO USE "FASHION", APART FROM THE MARK AS SHOWN. THE MARK CONSISTS OF EAGLE WITH A DOUBLE "F" BADGE ON ITS CHEST. THE WORDS, "FASHION FED" IN STYLIZED TEXT.

FOR BELTS; JACKETS; PANTS; SWEAT SHIRTS; T-SHIRTS; HATS (U.S. CLS. 22 AND 39).

LINDA ORNDORFF, EXAMINING ATTORNEY

SN 77-285,128. I-FE APPAREL, INC., DBA PJ MARK, SOUTH HACKENSACK, NJ. FILED 9-20-2007.



OWNER OF U.S. REG. NO. 2,364,118.
THE STIPLING IS FOR SHADING PURPOSES ONLY.
SEC. 2(F).

FOR SHIRTS, PANTS, JACKETS, SHORTS, SWEATERS, VESTS, JOGGING SUITS, KNIT SHIRTS (U.S. CLS. 22 AND 39).

FIRST USE 1-20-1999; IN COMMERCE 1-20-1999.
SANJEEV VOHRA, EXAMINING ATTORNEY

SN 77-285,936. RIEK, KEVIN ALBERT, DBA LES VAINQUEURS, HUNTINGTON BEACH, CA. FILED 9-21-2007.



THE MARK CONSISTS OF THE NAME "LES VAINQUEURS", WHICH IS WRITTEN IN ASENINE FONT AND ALL LOWER-CASE LETTERS. BETWEEN "LES" AND "VAINQUEURS" IS A SIMPLE OUTLINE DRAWING OF A TROPHY CUP.

THE FOREIGN WORDING IN THE MARK TRANSLATES INTO ENGLISH AS "THE VICTORS".

FOR TROUSERS, MEN'S SUITS; DRESS SHIRTS (U.S. CLS. 22 AND 39).

FIRST USE 5-22-2007; IN COMMERCE 9-15-2007.
TARAH HARDY, EXAMINING ATTORNEY

CLASS 25—(Continued).

SN 77-285,939. WILLIAMS, ANDREW TAYLOR, LAS VEGAS, NV. FILED 9-21-2007.

Joe Villa

THE MARK CONSISTS OF STANDARD CHARACTERS WITHOUT CLAIM TO ANY PARTICULAR FONT, STYLE, SIZE, OR COLOR.

"THE NAME(S), PORTRAIT(S), AND/OR SIGNATURE(S) SHOWN IN THE MARK DOES NOT IDENTIFY A PARTICULAR LIVING INDIVIDUAL."

FOR CLOTHING, NAMELY, SHORTS, PANTS, SHIRTS, TANK TOPS, JERSEYS, SWEATERS, JACKETS, COATS, WARM-UP SUITS, DRESSES, SKIRTS, BLOUSES, FLEECE PULLOVERS, CAPRI PANTS, OVERALLS, SWEAT PANTS, T-SHIRTS, POLO SHIRTS, SWEATSHIRTS, PAJAMAS, SLEEP WEAR, BATH ROBES, SOCKS, UNDERWEAR, LINGERIE, TOPS, BRAS, PANTIES, THONGS, BIKINIS, TRUNKS, SWIMSUITS, THERMAL UNDERWEAR, BOXER SHORTS, BRIEFS, BOXER BRIEFS, HEADWEAR, HATS, CAPS, BEANIES, VISORS, HEADBANDS, GLOVES, UNITARDS, LEGGINGS, YOGA PANTS, NECKTIES, BANDANAS, LEATHER BELTS, CLOTH BELTS, SHOES, SANDALS, SKORTS AND WRAP SKIRTS (U.S. CLS. 22 AND 39).

BILL DAWE, EXAMINING ATTORNEY

SN 77-286,457. 630 STUDIOS, UPPER MARLBORO, MD.
FILED 9-22-2007.

FREE D.C.

THE MARK CONSISTS OF STANDARD CHARACTERS WITHOUT CLAIM TO ANY PARTICULAR FONT, STYLE, SIZE, OR COLOR.

NO CLAIM IS MADE TO THE EXCLUSIVE RIGHT TO USE "D.C.", APART FROM THE MARK AS SHOWN.

FOR MENS, WOMEN'S AND CHILDREN'S CLOTHING AND FASHION ACCESSORIES, NAMELY, T-SHIRTS, SHIRTS, DRESS SHIRTS, SHORTS, PANTS, DRESS PANTS, DENIM PANTS, SWEATERS, JACKETS, SUITS, COATS, SPORTS COATS, TIES, BELTS, GLOVES, SCARVES, BANDANNAS, KERCHIEFS, NECKERCHIEFS, UNDERWEAR, UNDERSHIRTS, ROBES, PAJAMAS, HEADWEAR AND FOOTWEAR (U.S. CLS. 22 AND 39).

RENEE MCCRAY, EXAMINING ATTORNEY

CLASS 25—(Continued).

SN 77-286,515. FLETCHER, DERRICK B., HENDERSON, NV. AND CLOGSTON, ISAAC A., HENDERSON, NV. FILED 9-22-2007.

submit u

THE MARK CONSISTS OF STANDARD CHARACTERS WITHOUT CLAIM TO ANY PARTICULAR FONT, STYLE, SIZE, OR COLOR.

FOR T-SHIRTS, SWEATSHIRTS, SHIRTS, UNDERWEAR, G-STRINGS, HATS AND CAPS, BEANIES, SKULL CAPS, SHORTS, TANK TOPS, JERSEYS, BRIEFS, THONG UNDERWEAR, WRISTBANDS, BELTS, SWEATPANTS AND JACKETS (U.S. CLS. 22 AND 39).
JAY BESCH, EXAMINING ATTORNEY

SN 77-286,565. CHATFIELD, MALCOLM F., LELAND, MI. AND CHATFIELD, CHRISTINE M., LELAND, MI. FILED 9-23-2007.



THE COLOR(S) LIGHT BLUE, FOREST GREEN, EMERALD GREEN, ROYAL BLUE AND LEMON YELLOW IS/ARE CLAIMED AS A FEATURE OF THE MARK.

THE MARK CONSISTS OF A CIRCULAR GRAPHIC IMAGE DESIGNED TO REPRESENT THE VIEW OF A COASTLINE AS SEEN THROUGH THE PORTHOLE OF A BOAT. THE TOP HALF OF THE IMAGE IS A LIGHT BLUE SKY. THE MIDDLE SECTION OF THE IMAGE CONTAINS A FOREST GREEN MASS DESIGNED TO REPRESENT A TREE-COVERED HILL. ALSO AT THE MIDDLE OF THE

CLASS 25—(Continued).

IMAGE ARE TWO SMALLER EMERALD GREEN CURVED SHAPES DESIGNED TO REPRESENT TREE-COVERED LAND AT THE HORIZON LINE. THE BOTTOM HALF OF THE IMAGE IS DOMINATED BY A ROYAL BLUE SHAPE THAT IS ROUGHLY AN OVAL, AND IS DESIGNED TO REPRESENT A BODY OF WATER FROM THE SHORELINE TO THE HORIZON. THE BOTTOM HALF OF THE IMAGE ALSO FEATURES A BRIGHT LEMON YELLOW CRESCENT SHAPE, WHICH IS DESIGNED TO REPRESENT THE BEACH ALONG A SHORELINE.

SEC. 2(F).
FOR CAMP SHIRTS; DRESS SHIRTS; KNIT SHIRTS; NIGHT SHIRTS; OPEN-NECKED SHIRTS; POLO SHIRTS; SHIRTS; SHORT-SLEEVED OR LONG-SLEEVED T-SHIRTS; SHORT-SLEEVED SHIRTS; SLEEP SHIRTS; SPORT SHIRTS; SPORTS SHIRTS; SPORTS SHIRTS WITH SHORT SLEEVES; SWEAT SHIRTS; T-SHIRTS; CAPRI PANTS; CARGO PANTS; DENIMS; JOGGING PANTS; LOUNGE PANTS; PANTS; SKI PANTS; SNOW PANTS; SNOWBOARD PANTS; SWEAT PANTS; TRACK PANTS; WATERPROOF JACKETS AND PANTS; WIND PANTS; YOGA PANTS; GOLF SHIRTS; HAT BANDS; HATS; WOOLLY HATS; BABY BIBS NOT OF PAPER; BABY BODYSUITS; BABY BOTTOMS; BABY BUNTING; BABY TOPS; BELTS; CAPS; CHILDREN'S AND INFANTS' CLOTH BIBS; CHILDREN'S CLOTH EATING BIBS; CLOTH BIBS; CLOTHING, NAMELY, KNEE WARMERS; CLOTHING, NAMELY, NECK TUBES; CLOTHING, NAMELY, WRAP-AROUNDS; HOODS; INFANT AND TODDLER ONE PIECE CLOTHING; INFANT CLOTH DIAPERS; JERSEYS; LEATHER BELTS; MANTLES; MUFFLERS; SHIRTS; SHORT SETS; SHOULDER WRAPS; SWADDLING CLOTHES; TIES; TOPS; WRAPS; BELTS MADE OF LEATHER; BELTS OF TEXTILE; FABRIC BELTS; GARTER BELTS; MONEY BELTS; SUSPENDER BELTS FOR MEN; SUSPENDER BELTS FOR WOMEN; WAIST BELTS; ATHLETIC SHOES; BEACH SHOES; CANVAS SHOES; DECK-SHOES; INFANTS' SHOES AND BOOTS; SHOES; TENNIS SHOES; WOMEN'S SHOES; BOLO TIES; BOW TIES; SANDALS; CLOTH DIAPERS; CLOTHING, NAMELY, ARM WARMERS; CLOTHING, NAMELY, HAND-WARMERS; PAJAMA BOTTOMS; PAJAMAS; BATH SLIPPERS; BATHING CAPS; BATHING COSTUMES; BATHING COSTUMES FOR WOMEN; BATHING SUITS; BATHING SUITS FOR MEN; BATHING TRUNKS; BATHROBES; ROBES; SWIMMING CAPS; HEAD SCARVES; SCARVES; SHOULDER SCARVES; SILK SCARVES; BASEBALL CAPS; CAP VISORS; CAPS WITH VISORS; GOLF CAPS; KNITTED CAPS; SHOWER CAPS; SKULL CAPS; SWIM CAPS; SWIMMING CAPS; BUTTON-FRONT ALOHA SHIRTS; STOCKINGS; SWEAT BANDS; SWEAT SHORTS; SWEAT SUITS; TROUSERS FOR SWEATING; BERMUDA SHORTS; BOARD SHORTS; BOXER SHORTS; FLEECE SHORTS; GYM SHORTS; PANTIES, SHORTS AND BRIEFS; RUGBY SHORTS; SHORT TROUSERS; SHORTS; UNDERWEAR, NAMELY, BOY SHORTS; WALKING SHORTS; BRIEFS; LADIES' UNDERWEAR; UNDERWEAR; WOMEN'S UNDERWEAR; WOVEN OR KNITTED UNDERWEAR; DRESSES; SKIRTS AND DRESSES; SKIRTS; MEN AND WOMEN JACKETS, COATS, TROUSERS, VESTS; QUILTED VESTS; VESTS; JACKETS; RAIN JACKETS; SKI JACKETS; SLEEVED OR SLEEVELESS JACKETS; SPORTS JACKETS; SUEDE JACKETS; WIND RESISTANT JACKETS; WIND-JACKETS; COATS; COATS FOR MEN AND WOMEN; COATS MADE OF COTTON; COATS OF DENIM; FUR COATS AND JACKETS; LEATHER COATS; LIGHT-REFLECTING COATS; OVER COATS; RAIN COATS; SPORT COATS; SUIT COATS; TOP COATS; TRENCH COATS; WIND COATS; CROP TOPS; HALTER TOPS; MUSCLE TOPS; RUGBY TOPS; TANK TOPS; TANK-TOPS; TUBE TOPS; BLOUSES; HEADBANDS; HEADBANDS AGAINST SWEATING; BANDANAS; GLOVES; MITTENS; OUTDOOR MITTENS (U.S. CLS. 22 AND 39).

FIRST USE 1-1-1995; IN COMMERCE 1-1-1995.
KATHY DE JONGE, EXAMINING ATTORNEY

CLASS 25—(Continued).

SN 77-288,462. KARL KNOX INC., ALPHARETTA, GA.
FILED 9-25-2007.

PORTA ROSSA

THE MARK CONSISTS OF STANDARD CHARACTERS WITHOUT CLAIM TO ANY PARTICULAR FONT, STYLE, SIZE, OR COLOR.

"PORTA" MEANS "DOOR" AND "ROSSA" MEANS "RED".

FOR NECKTIES AND SOCKS (U.S. CLS. 22 AND 39).
FIRST USE 3-28-2003; IN COMMERCE 3-28-2003.
SIMON TENG, EXAMINING ATTORNEY

SN 77-288,561. KARL KNOX INC., ALPHARETTA, GA.
FILED 9-25-2007.

KARL KNOX

THE MARK CONSISTS OF STANDARD CHARACTERS WITHOUT CLAIM TO ANY PARTICULAR FONT, STYLE, SIZE, OR COLOR.

THE NAME(S), PORTRAIT(S), AND/OR SIGNATURE(S) SHOWN IN THE MARK DOES NOT IDENTIFY A PARTICULAR LIVING INDIVIDUAL.

FOR SHIRTS AND NECKTIES (U.S. CLS. 22 AND 39).
FIRST USE 11-20-2000; IN COMMERCE 11-20-2000.
SIMON TENG, EXAMINING ATTORNEY

SN 77-289,199. ZI, ERIC, EL SEGUNDO, CA. AND ON,
DAVID, EL SEGUNDO, CA. FILED 9-26-2007.

GORILLA ROOTS

THE MARK CONSISTS OF STANDARD CHARACTERS WITHOUT CLAIM TO ANY PARTICULAR FONT, STYLE, SIZE, OR COLOR.

FOR PANTS; PULLOVERS; SHIRTS (U.S. CLS. 22 AND 39).

DAVID I, EXAMINING ATTORNEY

CLASS 25—(Continued).

SN 77-289,581. MMA AUTHENTICS, LLC, COLUMBUS, OH.
FILED 9-26-2007.



THE MARK CONSISTS OF THE WORDS "FAMILIA, GLADIATORIA", AND "EST. 264 BC", RESPECTIVELY, EACH DISPLAYED IN A SEPARATE LINE ON A SHIELD ABOVE AN OCTAGON CONTAINING A SIDE VIEW OF A STYLIZED HELMET.

FOR HEADWEAR; SHIRTS; SHORTS; JERSEYS; HOODS; SWEAT SHIRTS; SWEAT SUITS; WARM UP SUITS; GLOVES (U.S. CLS. 22 AND 39).

FIRST USE 8-25-2007; IN COMMERCE 8-25-2007.
GIANCARLO CASTRO, EXAMINING ATTORNEY

SN 77-289,945. SEVENTY TWO, INC., LA PUENTE, CA.
FILED 9-26-2007.



NO CLAIM IS MADE TO THE EXCLUSIVE RIGHT TO USE "COUTURE", APART FROM THE MARK AS SHOWN.

THE MARK CONSISTS OF THE DESIGN OF A KEY WITH A KEY HANDLE THAT IS COMPRISED OF TWO STYLIZED, CURVED LINES THAT ARE SHAPED SIMILAR TO A HEART. THE WORDS "BONAFIDE LOVE" ARE WRITTEN IN THE UPPER PART OF THE KEY BETWEEN THE CURVED LINES, AND THE LETTER "O" IN "LOVE" IS IN THE SHAPE OF A KEYHOLE. THE WORD "COUTURE" IS WRITTEN VERTICALLY ON THE LOWER PART OF THE KEY.

FOR SHIRTS; SWEAT SHIRTS; T-SHIRTS; TANK TOPS; COATS; JACKETS; SWEATERS; DRESSES; SKIRTS; BLOUSES; PULLOVERS; SWEAT PANTS; PANTS; SHORTS; VESTS (U.S. CLS. 22 AND 39).

MAUREEN DALL, EXAMINING ATTORNEY

CLASS 25—(Continued).

SN 77-290,133. TOMMY BAHAMA GROUP, INC., ATLANTA, GA. FILED 9-27-2007.

Cotton Lawn Chair

THE MARK CONSISTS OF STANDARD CHARACTERS WITHOUT CLAIM TO ANY PARTICULAR FONT, STYLE, SIZE, OR COLOR.

NO CLAIM IS MADE TO THE EXCLUSIVE RIGHT TO USE "COTTON", APART FROM THE MARK AS SHOWN. FOR (BASED ON INTENT TO USE) SHIRTS COMPRISED PRIMARILY OF COTTON (U.S. CLS. 22 AND 39).

CIMMERIAN COLEMAN, EXAMINING ATTORNEY

CLASS 25—(Continued).

SN 77-291,132. HANSON, POLLY, MINNEAPOLIS, MN. AND HUDELSON, KAREN, MINNEAPOLIS, MN. FILED 9-28-2007.

Sexy Jesus

THE MARK CONSISTS OF STANDARD CHARACTERS WITHOUT CLAIM TO ANY PARTICULAR FONT, STYLE, SIZE, OR COLOR.

FOR CLOTHING, NAMELY, T-SHIRTS, SHIRTS, PANTS, SHORTS, SWEATSHIRTS, SWEATPANTS, DRESSES, BELTS, AND HATS (U.S. CLS. 22 AND 39).

MARILYN IZZI, EXAMINING ATTORNEY

SN 77-290,704. MYERS, PAMELA, STRONGSVILLE, OH. FILED 9-27-2007.

FLOPOLOGY

THE MARK CONSISTS OF STANDARD CHARACTERS WITHOUT CLAIM TO ANY PARTICULAR FONT, STYLE, SIZE, OR COLOR.

FOR FOOTWEAR (U.S. CLS. 22 AND 39).
JAY FLOWERS, EXAMINING ATTORNEY

SN 77-291,233. ISACO INTERNATIONAL CORPORATION, MIAMI LAKES, FL. FILED 9-28-2007.

RECKLESS BY ISACO

THE MARK CONSISTS OF STANDARD CHARACTERS WITHOUT CLAIM TO ANY PARTICULAR FONT, STYLE, SIZE, OR COLOR.

OWNER OF U.S. REG. NOS. 1,326,028, 1,533,337 AND 2,114,668.
FOR UNDERWEAR; BOXER BRIEFS; BOXER SHORTS; SLEEPWEAR; HOSIERY (U.S. CLS. 22 AND 39).
CYNTHIA SLOAN, EXAMINING ATTORNEY

SN 77-290,994. AURI DESIGN GROUP, INC., LAGUNA BEACH, CA. FILED 9-27-2007.



THE MARK CONSISTS OF A STYLIZED LETTER A. FOR FOOTWEAR AND CLOTHING, NAMELY, HATS AND SHIRTS (U.S. CLS. 22 AND 39).
KAREN SEVERSON, EXAMINING ATTORNEY

SN 77-291,237. ALESNA, LESLIE, KAMUELA, HI. FILED 9-28-2007.

LANIKAI CLOTHING COMPANY

THE MARK CONSISTS OF STANDARD CHARACTERS WITHOUT CLAIM TO ANY PARTICULAR FONT, STYLE, SIZE, OR COLOR.

NO CLAIM IS MADE TO THE EXCLUSIVE RIGHT TO USE "CLOTHING COMPANY", APART FROM THE MARK AS SHOWN.

THE FOREIGN WORDING IN THE MARK TRANSLATES INTO ENGLISH AS "BEAUTIFUL WATERS".

FOR CLOTHING, NAMELY, SHORTS, JACKETS, CAPS, VISORS, SWEATERS, T-SHIRTS AND TANK TOPS (U.S. CLS. 22 AND 39).

CYNTHIA SLOAN, EXAMINING ATTORNEY

CLASS 25—(Continued).

SN 77-291,310. ZMZ TRADING, LOS ANGELES, CA. FILED 9-28-2007.

PALASSO

THE MARK CONSISTS OF STANDARD CHARACTERS WITHOUT CLAIM TO ANY PARTICULAR FONT, STYLE, SIZE, OR COLOR.

THE FOREIGN WORDING IN THE MARK TRANSLATES INTO ENGLISH AS PLACES.

FOR MEN'S SUITS (U.S. CLS. 22 AND 39).

FIRST USE 1-1-2003; IN COMMERCE 1-1-2003.

RICHARD A. STRASER, EXAMINING ATTORNEY

SN 77-291,317. APPAREL VENTURES, INC., LOS ANGELES, CA. FILED 9-28-2007.

LA BLANCA SPA

THE MARK CONSISTS OF STANDARD CHARACTERS WITHOUT CLAIM TO ANY PARTICULAR FONT, STYLE, SIZE, OR COLOR.

OWNER OF U.S. REG. NOS. 1,214,071, 2,168,456 AND OTHERS.

THE FOREIGN WORDING IN THE MARK TRANSLATES INTO ENGLISH AS A SPANISH COPPER, A HALFNOTE OR A WHITE FEMALE PERSON.

FOR CAPS; COVERUPS; DRESSES; FLIP FLOPS; HATS; JACKETS; JOGGING SUITS; JUMPSUITS; PANTS; ROBES; SARONGS; SHIRTS; SHORTS; SKIRTS; SLIPPERS; SWEAT PANTS; SWEAT SHIRTS; SWEATERS; T-SHIRTS; TANK TOPS; VESTS; WRAPS (U.S. CLS. 22 AND 39).

MIDGE BUTLER, EXAMINING ATTORNEY

SN 77-291,350. COSSIO, LUCIO, HOUSTON, TX. AND COSSIO, TREVA, HOUSTON, TX. FILED 9-28-2007.

je-babe

THE MARK CONSISTS OF STANDARD CHARACTERS WITHOUT CLAIM TO ANY PARTICULAR FONT, STYLE, SIZE, OR COLOR.

FOR CAPS; PANTS; SHIRTS; SHOES; SKIRTS (U.S. CLS. 22 AND 39).

BRENDAN MCCAULEY, EXAMINING ATTORNEY

CLASS 25—(Continued).

SN 77-291,353. INTERNATIONAL LIQUIDATORS LTD, QUEENSBURY, NY. FILED 9-28-2007.

I RODE BITCH TO

THE MARK CONSISTS OF STANDARD CHARACTERS WITHOUT CLAIM TO ANY PARTICULAR FONT, STYLE, SIZE, OR COLOR.

FOR BANDANAS; BLOUSES; HATS; SWEAT SHIRTS; T-SHIRTS; TANK TOPS (U.S. CLS. 22 AND 39).

REBECCA SMITH, EXAMINING ATTORNEY

SN 77-291,354. WILLIAMS, SAMUEL S., RENO, NV. FILED 9-28-2007.

Java Rocks

THE MARK CONSISTS OF STANDARD CHARACTERS WITHOUT CLAIM TO ANY PARTICULAR FONT, STYLE, SIZE, OR COLOR.

FOR T-SHIRTS; SWEAT SHIRTS; HATS; PANTS; JACKETS (U.S. CLS. 22 AND 39).

SUSAN LESLIE DUBOIS, EXAMINING ATTORNEY

SN 77-291,399. MATTEA, NICK, BRENTWOOD, CA. FILED 9-28-2007.

ANYCAL

THE MARK CONSISTS OF STANDARD CHARACTERS WITHOUT CLAIM TO ANY PARTICULAR FONT, STYLE, SIZE, OR COLOR.

FOR HATS; SHIRTS (U.S. CLS. 22 AND 39).

FIRST USE 11-24-2006; IN COMMERCE 3-11-2007.

TINA KUAN, EXAMINING ATTORNEY

CLASS 25—(Continued).

SN 77-291,497. COCKPIT USA LLC, DOVER, DE. FILED 9-28-2007.

MUNICIPAL

THE MARK CONSISTS OF STANDARD CHARACTERS WITHOUT CLAIM TO ANY PARTICULAR FONT, STYLE, SIZE, OR COLOR.

FOR CLOTHING, NAMELY, JACKETS, SHIRTS, T-SHIRTS, SWEATSHIRTS, SWEATERS, VESTS, SKIRTS, DRESSES, JEANS, PANTS, SHORTS, SUITS, RAINCOATS, OVERCOATS, SWIMSUITS, SCARVES, NECKTIES, BELTS, SUSPENDERS, GLOVES, LINGERIE, UNDERGARMENTS, PAJAMAS, NIGHTGOWNS, HOSIERY, SOCKS; FOOTWEAR, NAMELY, SHOES, BOOTS, SANDALS, ATHLETIC SHOES, SNEAKERS AND SLIPPERS; HEADGEAR, NAMELY, HATS, CAPS, HEAD WEAR AND HEAD BANDS (U.S. CLS. 22 AND 39).

BILL DAWE, EXAMINING ATTORNEY

SN 77-292,118. K-SWISS INC., WESTLAKE VILLAGE, CA. FILED 9-28-2007.

ROCK AND RULE

THE MARK CONSISTS OF STANDARD CHARACTERS WITHOUT CLAIM TO ANY PARTICULAR FONT, STYLE, SIZE, OR COLOR.

FOR ATHLETIC SHOES; CANVAS SHOES; DECKSHOES; RUNNING SHOES; SHOES; SANDALS; BEACH FOOTWEAR; FOOTWEAR FOR MEN AND WOMEN; POLO SHIRTS; SHIRTS; T-SHIRTS; SHORTS; JACKETS; WIND RESISTANT JACKETS; SWEATERS; LOUNGE PANTS; PANTS; CAPS; VISORS (U.S. CLS. 22 AND 39).

AMY HELLA, EXAMINING ATTORNEY

SN 77-292,160. FRAGOZA, MARK, MADERA, CA. FILED 9-28-2007.

FIGHT STAR "REAL MMA CLOTHING"

THE MARK CONSISTS OF STANDARD CHARACTERS WITHOUT CLAIM TO ANY PARTICULAR FONT, STYLE, SIZE, OR COLOR.

NO CLAIM IS MADE TO THE EXCLUSIVE RIGHT TO USE "MMA CLOTHING", APART FROM THE MARK AS SHOWN.

FOR BASEBALL CAPS; BEANIES; BELTS; FLIP FLOPS; HEADBANDS; JACKETS; JERSEYS; RASH GUARDS; SANDALS; SOCKS; SWEAT PANTS; SWEAT SHIRTS; T-SHIRTS; TANK TOPS; TRUNKS; UNDERSHIRTS; WRISTBANDS (U.S. CLS. 22 AND 39).

KATINA MISTER, EXAMINING ATTORNEY

CLASS 25—(Continued).

SN 77-292,316. MALUSO, JOSEPH A, MANASSAS, VA. FILED 9-29-2007.

Brand of the Free

THE MARK CONSISTS OF STANDARD CHARACTERS WITHOUT CLAIM TO ANY PARTICULAR FONT, STYLE, SIZE, OR COLOR.

FOR T-SHIRTS (U.S. CLS. 22 AND 39).

STEVEN JACKSON, EXAMINING ATTORNEY

SN 77-292,336. WILLIAMS, CONROY T, DBA KEMETIAN, BROOKLYN, NY. FILED 9-29-2007.



FOR SHORT-SLEEVED OR LONG-SLEEVED T-SHIRTS (U.S. CLS. 22 AND 39).

HANNO RITTNER, EXAMINING ATTORNEY

SN 77-292,339. AUSSIE SOLES INTERNATIONAL LLC, CARSON CITY, NV. FILED 9-29-2007.

AUSSIE SOULS

THE MARK CONSISTS OF STANDARD CHARACTERS WITHOUT CLAIM TO ANY PARTICULAR FONT, STYLE, SIZE, OR COLOR.

FOR CLOTHING, NAMELY, SHIRTS, T-SHIRTS, JACKETS, COATS, SPORT JACKETS, HOODS, SINGLET, POLO SHIRTS, TOPS, SWEATERS, UNDERSHIRTS, VESTS, PANTS, TROUSERS, SHORTS, UNDERPANTS, JEANS, OVERALLS, SUITS, BOXER SHORTS, DRESSES, SKIRTS, RAINCOATS, PARKAS, OVERCOATS, BATHING SUITS, BELTS, GLOVES, TIES, SOCKS, BATHROBES, LINGERIE, SLEEPWEAR, DRESSING GOWNS, PAJAMAS; HEADGEAR, NAMELY, HATS, CAPS, VISORS, BANDANAS AND BEANIES; FOOTWEAR (U.S. CLS. 22 AND 39).

HANNO RITTNER, EXAMINING ATTORNEY

CLASS 25—(Continued).

SN 77-292,354. FETCH LIFE, LLC, SANDY HOOK, CT. FILED 9-30-2007.

Fetch Life

THE MARK CONSISTS OF STANDARD CHARACTERS WITHOUT CLAIM TO ANY PARTICULAR FONT, STYLE, SIZE, OR COLOR.

FOR KNIT SHIRTS; LONG-SLEEVED SHIRTS; POLO SHIRTS; SHORT-SLEEVED OR LONG-SLEEVED T-SHIRTS; SHORT-SLEEVED SHIRTS; SWEAT SHIRTS; T-SHIRTS; FLEECE PULLOVERS; FLEECE VESTS; JACKETS; MEN AND WOMEN JACKETS; COATS, TROUSERS, VESTS; WIND-JACKETS; BASEBALL CAPS; CAPS; KNITTED CAPS; SKULL CAPS (U.S. CLS. 22 AND 39).

FIRST USE 3-5-2007; IN COMMERCE 3-5-2007.
DAVID H. STINE, EXAMINING ATTORNEY

CLASS 25—(Continued).

SN 77-292,429. JKM INNOVATIONS, LLC, DBA AZ VIZORS, LITCHFIELD PARK, AZ. FILED 9-30-2007.

 The logo for AZ Vizors features the text "AZ Vizors" in a stylized font. "AZ" is in gold, "Viz" is in red, and "ors" is in red. A stylized sun with rays is positioned between the "Z" and "V".

THE COLOR(S) GOLD, RED, AND YELLOW IS/ARE CLAIMED AS A FEATURE OF THE MARK.

THE MARK CONSISTS OF "AZ" IS GOLD, "VIZ RS" IS RED, THE SUN PLACED BETWEEN THE "Z" AND "R" IS A TRI-COLORED STYLIZED SUN CONSISTING OF GOLD, RED, AND YELLOW.

FOR CAP VISORS (U.S. CLS. 22 AND 39).
MICHAEL ENGEL, EXAMINING ATTORNEY

SN 77-292,433. YOUNG, IRENE, NEW YORK, NY. FILED 9-30-2007.

SN 77-292,415. REDDUCS HUNTING COMPANY, LP, TYLER, TX. FILED 9-30-2007.



THE COLOR(S) RED IS/ARE CLAIMED AS A FEATURE OF THE MARK.

THE MARK CONSISTS OF THREE RED CROSSES CONNECTED BY THE DOWNWARD CURVED HORIZONTAL LINE OF THE CENTER CROSS; THE VERTICAL LINES OF THE TWO OUTER CROSSES ARE CURVED INWARD TOWARDS THE CENTER CROSS TO RESEMBLE A SHIELD.

FOR FABRIC SOLD AS AN INTEGRAL COMPONENT OF FINISHED CLOTHING ITEMS, NAMELY, HUNTING AND CAMOUFLAGE APPAREL (U.S. CLS. 22 AND 39).

FIRST USE 10-1-2006; IN COMMERCE 10-1-2006.
RAUL CORDOVA, EXAMINING ATTORNEY



THE COLOR(S) BLUE, RED, GOLD, BLACK, AND WHITE IS/ARE CLAIMED AS A FEATURE OF THE MARK.

THE MARK CONSISTS OF A DARK BLUE FIVE POINTED STAR (01.01.03) OUTLINED IN GOLD WITH A WHITE BONE (03.13.02) TILTED ACROSS THE TOP POINT OF THE STAR. THE CENTER OF THE STAR HAS A SOLID GOLD CIRCLE (26.01.09), OUTLINED BY A THIN WHITE LINE CIRCLE. INSIDE THIS GOLD CIRCLE THAT IS IN THE CENTER OF THE STAR THERE ARE TWO BLACK DOG PAWS PRINTS (03.13.01). BELOW THE TWO BOTTOM POINTS OF THE STAR IS THE WORD AMERICAN IN WHITE OUTLINED BY RED WITH A BLACK DROP SHADOW. BELOW THE WORD AMERICAN, IS PUPSTAR IN RED TYPE THAT IS OUTLINED IN BLACK..

FOR (BASED ON USE IN COMMERCE) SHORT-SLEEVED OR LONG-SLEEVED T-SHIRTS (U.S. CLS. 22 AND 39).

FIRST USE 9-0-2007; IN COMMERCE 9-0-2007.
MICHAEL ENGEL, EXAMINING ATTORNEY

CLASS 25—(Continued).

SN 77-292,483. ALLEN, LLOYD, WESTON, CT. FILED 10-1-2007.

WARM IS NOT COOL

THE MARK CONSISTS OF STANDARD CHARACTERS WITHOUT CLAIM TO ANY PARTICULAR FONT, STYLE, SIZE, OR COLOR.

FOR SHORT-SLEEVED OR LONG-SLEEVED T-SHIRTS (U.S. CLS. 22 AND 39).

SAMUEL E. SHARPER JR., EXAMINING ATTORNEY

SN 77-292,484. LUO, WEIJING, ALBANY, CA. FILED 10-1-2007.

AROWWA

THE MARK CONSISTS OF STANDARD CHARACTERS WITHOUT CLAIM TO ANY PARTICULAR FONT, STYLE, SIZE, OR COLOR.

FOR JEANS; ANGLERS' SHOES; APRES-SKI SHOES; ATHLETIC SHOES; BALLET SHOES; BASEBALL SHOES; BEACH SHOES; BOWLING SHOES; BOXING SHOES; CANVAS SHOES; CLEATS FOR ATTACHMENT TO SPORTS SHOES; CYCLING SHOES; DECK-SHOES; DRIVERS; FOOTBALL SHOES; GOLF SHOES; GYMNASIUM SHOES; HANDBALL SHOES; HEEL PIECES FOR SHOES; HOCKEY SHOES; INFANTS' SHOES AND BOOTS; IN-SOLES; LEATHER SHOES; PAPER SHOES USED WHEN GOING THROUGH METAL DETECTORS TO KEEP FEET AND SOCKS CLEAN; PROTECTIVE METAL MEMBERS FOR SHOES AND BOOTS; RUBBER SHOES; RUGBY SHOES; RUNNING SHOES; SHOE DOWELS; SHOE INSERTS FOR PRIMARILY NON-ORTHOPEDIC PURPOSES; SHOE PEGS; SHOE SOLES; SHOES; SHOES SOLES FOR REPAIR; SKI AND SNOWBOARD SHOES AND PARTS THEREOF; SKIING SHOES; SOCCER SHOES; TAP SHOES; TENNIS SHOES; TONGUE OR PULLSTRAP FOR SHOES AND BOOTS; TRACK AND FIELD SHOES; TRAINING SHOES; VOLLEYBALL SHOES; WOMEN'S SHOES; WORK SHOES AND BOOTS; BELTS; BIBS NOT OF CLOTH OR PAPER; CAPS; CHILDREN'S AND INFANTS' CLOTH BIBS; CHILDREN'S CLOTH EATING BIBS; CLOTH BIBS; CLOTH BIBS FOR ADULT DINERS; CLOTH BIBS FOR USE BY SENIOR CITIZENS OR PHYSICALLY- OR MENTALLY-CHALLENGED PERSONS; CLOTH DIAPERS; CLOTHING FOR WEAR IN JUDO PRACTICES; CLOTHING FOR WEAR IN WRESTLING GAMES; CLOTHING, NAMELY, ARM WARMERS; CLOTHING, NAMELY, FOLK COSTUMES; CLOTHING, NAMELY, HAND-WARMERS; CLOTHING, NAMELY, KNEE WARMERS; CLOTHING, NAMELY, NECK TUBES; CLOTHING, NAMELY, WRAP-AROUNDS; CORSETS; DUSTERS; FOULARDS; HOODS; INFANT AND TODDLER ONE PIECE CLOTHING; INFANT CLOTH DIAPERS; JERSEYS; LEATHER BELTS; MANTLES; MUFFLERS; NON-DISPOSABLE CLOTH TRAINING PANTS; PAPER HATS FOR USE AS CLOTHING ITEMS; PARTS OF CLOTHING, NAMELY, GUSSETS FOR TIGHTS, GUSSETS FOR STOCKINGS, GUSSETS FOR BATHING SUITS, GUSSETS FOR UNDERWEAR, GUSSETS FOR LEOTARDS AND GUSSETS FOR FOOTLETS; PERSPIRATION ABSORBENT UNDERWEAR CLOTHING; SHIFTS; SHORT SETS; SHOULDER WRAPS; SWADDLING CLOTHES; TIES; TOPS; TRIATHLON CLOTHING, NAMELY TRIATHLON TIGHTS, TRIATHLON SHORTS, TRIATHLON SINGLETs,

CLASS 25—(Continued).

TRIATHLON SHIRTS, TRIATHLON SUITS; UNDER-ARM CLOTHING SHIELDS; WRAPS; CAPS WITH VISORS; GOLF CAPS; KNITTED CAPS; SHOWER CAPS; SKULL CAPS; SWIM CAPS; SWIMMING CAPS; SWIMMING CAPS; TOBOGGAN HATS, PANTS AND CAPS; TOE CAPS; BASEBALL CAPS; BATHING CAPS; CAP VISORS; ANKLE SOCKS; ANKLETS; ANTI-PERSPIRANT SOCKS; JAPANESE STYLE SOCKS (TABI COVERS); JAPANESE STYLE SOCKS (TABI); MEN'S SOCKS; SOCK SUSPENDERS; SOCKS; SOCKS AND STOCKINGS; THERMAL SOCKS; WATER SOCKS; WOOLLEN SOCKS; BALLOON PANTS; CAPRI PANTS; CARGO PANTS; DENIMS; JOGGING PANTS; LEATHER PANTS; LOUNGE PANTS; NURSE PANTS; PANTS; PETTI-PANTS; SKI PANTS; SNOW PANTS; SNOWBOARD PANTS; STRETCH PANTS; SWEAT PANTS; TAP PANTS; TRACK PANTS; WATERPROOF JACKETS AND PANTS; WIND PANTS; YOGA PANTS; A-SHIRTS; BUTTON-FRONT ALOHA SHIRTS; CAMP SHIRTS; DRESS SHIRTS; GOLF SHIRTS; KNIT SHIRTS; LONG-SLEEVED SHIRTS; NIGHT SHIRTS; OPEN-NECKED SHIRTS; PIQUE SHIRTS; POLO SHIRTS; RUGBY SHIRTS; SHIRT FRONTS; SHIRT YOKES; SHIRTS; SHIRTS FOR SUITS; SHORT-SLEEVED OR LONG-SLEEVED T-SHIRTS; SHORT-SLEEVED SHIRTS; SLEEP SHIRTS; SPORT SHIRTS; SPORTS SHIRTS; SPORTS SHIRTS WITH SHORT SLEEVES; SWEAT SHIRTS; T-SHIRTS; TEE SHIRTS; WIND SHIRTS; YOGA SHIRTS; BED JACKETS; DENIM JACKETS; DOWN JACKETS; FISHERMEN'S JACKETS; FUR COATS AND JACKETS; FUR JACKETS; HEAVY JACKETS; JACKET LINERS; JACKETS; LEATHER JACKETS; LIGHT-REFLECTING JACKETS; LONG JACKETS; MEN AND WOMEN JACKETS, COATS, TROUSERS, VESTS; RAIN JACKETS; RAINPROOF JACKETS; REVERSIBLE JACKETS; SHELL JACKETS; SKI JACKETS; SLEEVED OR SLEEVELESS JACKETS; SMOKING JACKETS; SPORTS JACKETS; STUFF JACKETS; SUEDE JACKETS; WIND RESISTANT JACKETS; WIND-JACKETS (U.S. CLS. 22 AND 39).

SAMUEL E. SHARPER JR., EXAMINING ATTORNEY

SN 77-292,499. SANGREAL MUSIC, INC., NORTH HOLLYWOOD, CA. FILED 10-1-2007.

DIVINE HERESY

THE MARK CONSISTS OF STANDARD CHARACTERS WITHOUT CLAIM TO ANY PARTICULAR FONT, STYLE, SIZE, OR COLOR.

FOR BASEBALL CAPS; HATS; HEAD SWEATBANDS; JACKETS; JERSEYS; LONG-SLEEVED SHIRTS; PANTIES; SHIRTS; SHORTS; SWEAT PANTS; SWEAT SHIRTS; T-SHIRTS; WIND RESISTANT JACKETS; WRISTBANDS (U.S. CLS. 22 AND 39).

MICHAEL ENGEL, EXAMINING ATTORNEY

CLASS 25—(Continued).

SN 77-292,741. SIMMONS, LONNIE, INGLEWOOD, CA. FILED 10-1-2007.



FOR BELTS; JEANS; PULLOVERS; SHIRTS; SHOES; SOCKS (U.S. CLS. 22 AND 39).
STEVEN R. FINE, EXAMINING ATTORNEY

SN 77-292,821. MARTINEZ, HECTOR, RIVER VALE, NJ. AND MARTINEZ, CHRISTINE, RIVER VALE, NJ. FILED 10-1-2007.

RUN FAST LIVE SLOW



THE MARK CONSISTS OF THE WORDS "RUN FAST LIVE SLOW" TOGETHER WITH STYLIZED HARE AND TORTOISE CHARACTERS.

FOR MEN'S, WOMEN'S AND CHILDREN'S T-SHIRTS, RUNNING SHIRTS, SHORTS, SOCKS, HATS, VISORS, WIND RESISTANT JACKETS, RUNNING JACKETS, WARM UP PANTS, SWEAT SHIRTS, SWEAT PANTS, HEAD BANDS, WRITST BANDS (U.S. CLS. 22 AND 39).
LINDA MICKLEBURGH, EXAMINING ATTORNEY

SN 77-292,830. FORD, SANDRA A, OCEANPORT, NJ. FILED 10-1-2007.

Biblesbibs

THE MARK CONSISTS OF STANDARD CHARACTERS WITHOUT CLAIM TO ANY PARTICULAR FONT, STYLE, SIZE, OR COLOR.

FOR BABY BIBS NOT OF PAPER; CHILDREN'S AND INFANTS' CLOTH BIBS; CHILDREN'S CLOTH EATING BIBS; CLOTH BIBS; CLOTH BIBS FOR ADULT DINERS; CLOTH BIBS FOR USE BY SENIOR CITIZENS OR PHYSICALLY- OR MENTALLY-CHALLENGED PERSONS (U.S. CLS. 22 AND 39).

JENNY PARK, EXAMINING ATTORNEY

CLASS 25—(Continued).

SN 77-292,927. ICDG LLC, LOS ANGELES, CA. FILED 10-1-2007.

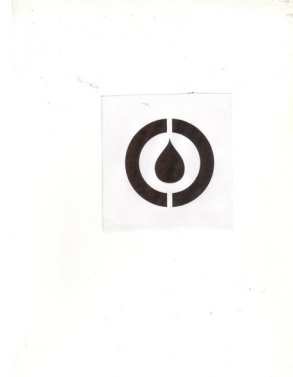

THE MARK CONSISTS OF A RAINDROP IN THE CENTER OF TWO SEMI-CIRCLES.

FOR CLOTHING, NAMELY, T-SHIRTS, SWEAT-SHIRTS, SWEATPANTS, BLOUSES, SWEATERS, SPORT SHIRTS, JERSEYS, RACING PANTS, SKI PANTS, JEANS, SUITS, UNDERWEAR, SOCKS, BELTS, COATS, JACKETS, HATS, VISORS AND CAPS; FOOTWEAR, HEADWEAR (U.S. CLS. 22 AND 39).

KIMBERLY PERRY, EXAMINING ATTORNEY

SN 77-292,988. DESIRING GOD MINISTRIES, MINNEAPOLIS, MN. FILED 10-1-2007.

DON'T WASTE YOUR LIFE

THE MARK CONSISTS OF STANDARD CHARACTERS WITHOUT CLAIM TO ANY PARTICULAR FONT, STYLE, SIZE, OR COLOR.

FOR SHIRTS (U.S. CLS. 22 AND 39).
FIRST USE 1-31-2007; IN COMMERCE 1-31-2007.
ATTIYA MALIK, EXAMINING ATTORNEY

SN 77-292,996. WILLIAMS, MATTHEW LAWRENCE, CHICAGO, IL. FILED 10-1-2007.

AC000000

THE MARK CONSISTS OF STANDARD CHARACTERS WITHOUT CLAIM TO ANY PARTICULAR FONT, STYLE, SIZE, OR COLOR.

FOR SHIRTS (U.S. CLS. 22 AND 39).
JOHN GARTNER, EXAMINING ATTORNEY

CLASS 25—(Continued).

SN 77-293,079. MIGHTY OAK ENTERTAINMENT, INC., NEWPORT BEACH, CA. FILED 10-1-2007.

CLASS 25—(Continued).

SN 77-293,199. J BRAND, INC., LOS ANGELES, CA. FILED 10-1-2007.

WHACKED OUT

THE MARK CONSISTS OF STANDARD CHARACTERS WITHOUT CLAIM TO ANY PARTICULAR FONT, STYLE, SIZE, OR COLOR.

OWNER OF U.S. REG. NO. 3,282,024.
FOR APRONS; BANDANAS; BELTS; FOOTWEAR; GLOVES; HEADBANDS; HEADWEAR; HOSIERY; JACKETS; PANTS; ROBES; SCARVES; SHIRTS; SHORTS; SKIRTS; SLEEPWEAR; SOCKS; SWEATERS; SWIM WEAR; T-SHIRTS; TIES; UNDERGARMENTS; WRISTBANDS (U.S. CLS. 22 AND 39).
GILBERT SWIFT, EXAMINING ATTORNEY

SN 77-293,131. JONES III, ARNOLD, SAN MATEO, CA. FILED 10-1-2007.

NEWPORT KNOTS

THE MARK CONSISTS OF STANDARD CHARACTERS WITHOUT CLAIM TO ANY PARTICULAR FONT, STYLE, SIZE, OR COLOR.

FOR BANDANAS; BELTS; CAPS; DRESSES; FLIP FLOPS; HATS; PANTS; POLO SHIRTS; SHIRTS; SHORTS; SWEAT SHIRTS; SWEATERS; SWIM TRUNKS; T-SHIRTS; TIES (U.S. CLS. 22 AND 39).
JENNIFER VASQUEZ, EXAMINING ATTORNEY

SN 77-293,157. TAWFIK, SONDRAL, LOS ALTOS HILLS, CA. FILED 10-1-2007.



THE MARK CONSISTS OF THE STYLIZED WORD "SONDRELLA" WITH A STYLIZED EYE.
FOR BATHING SUITS; PANTS; SHIRTS; TRACK SUITS (U.S. CLS. 22 AND 39).
DAVID HOFFMAN, EXAMINING ATTORNEY

R. a C.

THE MARK CONSISTS OF STANDARD CHARACTERS WITHOUT CLAIM TO ANY PARTICULAR FONT, STYLE, SIZE, OR COLOR.

FOR CLOTHING, NAMELY, DENIM JACKETS, JACKETS, SKIRTS AND SHIRTS (U.S. CLS. 22 AND 39).
FIRST USE 6-18-2007; IN COMMERCE 6-18-2007.
RENEE MCCRAY, EXAMINING ATTORNEY

SN 77-293,220. J BRAND, INC., LOS ANGELES, CA. FILED 10-1-2007.



OWNER OF U.S. REG. NO. 3,250,947.
NO CLAIM IS MADE TO THE EXCLUSIVE RIGHT TO USE "BRAND", APART FROM THE MARK AS SHOWN.
THE COLOR(S) RED, GRAY AND TAN IS/ARE CLAIMED AS A FEATURE OF THE MARK.
THE MARK CONSISTS OF "R. A C. BY J BRAND" IN STYLIZED FONT WITH CAPITAL "R." AND "C." LETTERS IN RED AND LOWERCASE "A" AND "BY J BRAND" IN GRAY, SET AGAINST TAN BACKGROUND.
FOR CLOTHING, NAMELY, DENIM JACKETS, JACKETS, SKIRTS AND SHIRTS (U.S. CLS. 22 AND 39).
FIRST USE 6-18-2007; IN COMMERCE 6-18-2007.
RENEE MCCRAY, EXAMINING ATTORNEY

CLASS 25—(Continued).

SN 77-293,231. FERNANDEZ, BRIAN S, DBA SNAPOUT (KAUAISBADBOYS), KAPAA, HI. FILED 10-1-2007.



THE MARK CONSISTS OF THE WORD "SNAPOUT" WRITTEN IN A STYLIZED FORM.

THE FOREIGN WORDING IN THE MARK TRANSLATES INTO ENGLISH AS TO BE IN FOCUS.

FOR T-SHIRTS; HATS; TANK-TOPS; JACKETS; WRISTBANDS; GOLF SHIRTS; LONG-SLEEVED SHIRTS; NIGHT SHIRTS; OPEN-NECKED SHIRTS; POLO SHIRTS; SHORT-SLEEVED OR LONG-SLEEVED T-SHIRTS; SHORT-SLEEVED SHIRTS; BOARD SHORTS; BOXER SHORTS; GYM SHORTS; SHORTS; SWEAT SHORTS; CARGO PANTS; PANTS (U.S. CLS. 22 AND 39).
RENEE SERVANCE, EXAMINING ATTORNEY

CLASS 25—(Continued).

SN 77-293,311. FLAVIA'S LEGACY, LLC, SANTA BARBARA, CA. FILED 10-1-2007.



OWNER OF U.S. REG. NO. 3,124,606.
NO CLAIM IS MADE TO THE EXCLUSIVE RIGHT TO USE "STUDIO", APART FROM THE MARK AS SHOWN.

FOR WOMENS, GIRLS AND INFANT APPAREL TOPS, NAMELY, KNIT FASHION TOPS, KNIT SHIRTS, T-SHIRTS, TANK TOPS, SWEAT SHIRTS AND FLEECE PULLOVERS (U.S. CLS. 22 AND 39).

BRIAN CALLAGHAN, EXAMINING ATTORNEY

SN 77-293,240. FLAMMER, JEFFERY G., PROVIDENCE, UT. FILED 10-1-2007.

WIGHT & WONG

THE MARK CONSISTS OF STANDARD CHARACTERS WITHOUT CLAIM TO ANY PARTICULAR FONT, STYLE, SIZE, OR COLOR.

FOR T-SHIRTS (U.S. CLS. 22 AND 39).
KATINA MISTER, EXAMINING ATTORNEY

SN 77-293,310. TESTERMAN, ROBERT, TRAVERSE CITY, MI. FILED 10-1-2007.

Hellyha

THE MARK CONSISTS OF STANDARD CHARACTERS WITHOUT CLAIM TO ANY PARTICULAR FONT, STYLE, SIZE, OR COLOR.

FOR BANDANAS; HATS; LONG-SLEEVED SHIRTS; SWEAT SHIRTS; T-SHIRTS; UNDERWEAR (U.S. CLS. 22 AND 39).

ANNE MADDEN, EXAMINING ATTORNEY

SN 77-293,334. ROFFWARG, ROBERT, MARIETTA, GA. FILED 10-1-2007.



THE MARK CONSISTS OF THE BUST OF A MALE CARICATURE.

FOR CLOTHING, NAMELY, SHIRTS, T-SHIRTS, JACKETS, SWEATSHIRTS, CAPS, HATS (U.S. CLS. 22 AND 39).

JILL C. ALT, EXAMINING ATTORNEY

CLASS 25—(Continued).

SN 77-293,352. ONE AKER HARVEST, INC., LAS VEGAS, NV. FILED 10-1-2007.



THE MARK CONSISTS OF THE STYLIZED HEAD OF A PRIMATE (MONKEY) WITH THE WORDS "YOU'RE ME MONKEY" NOTED ACROSS THE PICTURE AND SPECIFICALLY THE WORD "ME" FORMING THE UPPER MOST PART OF THE MONKEY'S HEAD AND HAIR.

FOR SHIRTS; T-SHIRTS; SWEATERS; TURTLENECK SWEATERS; V-NECK SWEATERS; CREWNECK SWEATERS; CARDIGANS; POLO SHIRTS; SHORT-SLEEVED OR LONG-SLEEVED T-SHIRTS; SHORT-SLEEVED SHIRTS; SLEEP SHIRTS; SWEAT PANTS; SWEAT SHIRTS; TEE SHIRTS (U.S. CLS. 22 AND 39).

ANDREA HACK, EXAMINING ATTORNEY

CLASS 25—(Continued).

SN 77-293,442. GOTTESMAN, ERIC J., OJAI, CA. FILED 10-2-2007.

SPAWN

THE MARK CONSISTS OF STANDARD CHARACTERS WITHOUT CLAIM TO ANY PARTICULAR FONT, STYLE, SIZE, OR COLOR.

FOR SHORT-SLEEVED OR LONG-SLEEVED T-SHIRTS; T-SHIRTS; CAMP SHIRTS; DRESS SHIRTS; GOLF SHIRTS; LONG-SLEEVED SHIRTS; POLO SHIRTS; SHIRTS; SPORTS SHIRTS; TEE SHIRTS; PANTS; JEANS; BOTTOMS; BERMUDA SHORTS; BOARD SHORTS; BOXER SHORTS; FLEECE SHORTS; GYM SHORTS; PANTIES, SHORTS AND BRIEFS; SHORTS; SWEAT SHORTS; LOUNGEWEAR; SLEEPWEAR; INFANT WEAR; SKI WEAR; SURF WEAR; SWIM WEAR; SWIM WEAR FOR GENTLEMEN AND LADIES; HEAD WEAR; INFANT AND TODDLER ONE PIECE CLOTHING; INFANTWEAR; SWEAT SHIRTS; BELTS; CAPS; HOODS; JERSEYS; LEATHER BELTS; TIES; TOPS; DENIM JACKETS; DOWN JACKETS; FUR COATS AND JACKETS; FUR JACKETS; HEAVY JACKETS; JACKETS; LEATHER JACKETS; MEN AND WOMEN JACKETS, COATS, TROUSERS, VESTS; RAIN JACKETS; SKI JACKETS; SPORTS JACKETS; SUEDE JACKETS; WATERPROOF JACKETS AND PANTS; WIND RESISTANT JACKETS; BIKINIS (U.S. CLS. 22 AND 39).

RONALD MCMORROW, EXAMINING ATTORNEY

SN 77-293,365. ONE AKER HARVEST, INC., LAS VEGAS, NV. FILED 10-1-2007.

You're me monkey

THE MARK CONSISTS OF STANDARD CHARACTERS WITHOUT CLAIM TO ANY PARTICULAR FONT, STYLE, SIZE, OR COLOR.

FOR SHIRTS; T-SHIRTS; SWEATERS; CARDIGANS; CREWNECK SWEATERS; TURTLENECK SWEATERS; V-NECK SWEATERS; POLO SHIRTS; NIGHT SHIRTS; TEE SHIRTS; SWEAT PANTS; SWEAT SHIRTS (U.S. CLS. 22 AND 39).

ANDREA HACK, EXAMINING ATTORNEY

SN 77-293,448. PRIZE PONY INC., LONDON, UNITED KINGDOM, FILED 10-2-2007.



FOR SHIRTS; SHORT-SLEEVED OR LONG-SLEEVED T-SHIRTS; SWEATERS; HATS; PANTS; SHOES (U.S. CLS. 22 AND 39).

FIRST USE 1-8-2007; IN COMMERCE 1-10-2007.

RONALD MCMORROW, EXAMINING ATTORNEY

CLASS 25—(Continued).

SN 77-293,478. RUE21, INC., WARRENDALE, PA. FILED 10-2-2007.



FOR MEN'S CLOTHING AND FOOTWEAR, NAMELY, WOVEN TOPS, KNIT TOPS, POLO SHIRTS, FLEECE TOPS, RUGBY SHIRTS, SWEATSHIRTS, SWEATPANTS, SWEAT SUITS, PANTS, DENIM JEANS, SHORTS, JACKETS, COATS, SANDALS, THONGS, SWEATERS, SHOES, SWIM TRUNKS (U.S. CLS. 22 AND 39).

FIRST USE 6-0-2003; IN COMMERCE 6-0-2003.
GIANCARLO CASTRO, EXAMINING ATTORNEY

SN 77-293,787. ISLAS, EDDIE, PHOENIX, AZ. FILED 10-2-2007.



THE MARK CONSISTS OF THE WORDS "OH WELL... OHWELLCLOTHING.COM" ON STYLIZED TEXT.

FOR T-SHIRTS; POLO SHIRTS; HATS; PANTS; SHORTS; DRESSES; SKIRTS; BEANIES; JACKETS; SWEATERS; HEADBANDS; UNDERWEAR; SOCKS; LINGERIE; PANTIES; WRISTBANDS (U.S. CLS. 22 AND 39).
ZACHARY BELLO, EXAMINING ATTORNEY

SN 77-293,917. INTERNATIONAL DIRECT GROUP INC, NEW YORK, NY. FILED 10-2-2007.

ONE EARTH, ONE WORLDWIDE
COMMUNITY

THE MARK CONSISTS OF STANDARD CHARACTERS WITHOUT CLAIM TO ANY PARTICULAR FONT, STYLE, SIZE, OR COLOR.

FOR MEN'S AND WOMEN'S APPAREL NAMELY, PANTS, SHORTS, SKIRTS, JACKETS, JEANS, SHIRTS, VESTS, DRESSES, SHORTALLS AND OVERALLS (U.S. CLS. 22 AND 39).

BRENDAN REGAN, EXAMINING ATTORNEY

CLASS 25—(Continued).

SN 77-294,012. HYDE, SANDRA, TEWKSBURY, NJ. FILED 10-2-2007.

STRAPWRAP

THE MARK CONSISTS OF STANDARD CHARACTERS WITHOUT CLAIM TO ANY PARTICULAR FONT, STYLE, SIZE, OR COLOR.

FOR STRAPS FOR BRAS (U.S. CLS. 22 AND 39).
INGA ERVIN, EXAMINING ATTORNEY

SN 77-294,030. RAINBOW SANDALS, INC., SAN CLEMENTE, CA. FILED 10-2-2007.

MOCCALOAF

THE MARK CONSISTS OF STANDARD CHARACTERS WITHOUT CLAIM TO ANY PARTICULAR FONT, STYLE, SIZE, OR COLOR.

FOR FOOTWEAR, NAMELY, SHOES (U.S. CLS. 22 AND 39).

HENRY S. ZAK, EXAMINING ATTORNEY

SN 77-294,100. ZENDOT, INC., CLEVELAND, OH. FILED 10-2-2007.

less talk, more monkey

THE MARK CONSISTS OF STANDARD CHARACTERS WITHOUT CLAIM TO ANY PARTICULAR FONT, STYLE, SIZE, OR COLOR.

FOR TOPS; SHIRTS; PANTS; JACKETS; COATS; SHORTS; SOCKS; SWIMWEAR; HATS; HEADGEAR, NAMELY, BANDANAS, VISORS, CAPS, HEADBANDS; FOOTWEAR; CAPES; APRONS; SWEAT SHIRTS; UNDERWEAR; RAINWEAR (U.S. CLS. 22 AND 39).

BENJAMIN ALLEN, EXAMINING ATTORNEY

CLASS 25—(Continued).

SN 77-294,523. TUNI & G, SAN DIEGO, CA. FILED 10-2-2007.

got my mind on
my mommy
&
my mommy on
my mind

THE MARK CONSISTS OF STANDARD CHARACTERS WITHOUT CLAIM TO ANY PARTICULAR FONT, STYLE, SIZE, OR COLOR.

FOR ADULT, CHILD AND INFANT CLOTHING, NAMELY, HATS, SOCKS, TANK TOPS, T-SHIRTS, LONG SLEEVE SHIRTS, SHORT SLEEVE SHIRTS, HOODED SHIRTS, SWEAT SHIRTS, SWEAT PANTS, RELAXED PANTS; WOMEN'S CLOTHING, NAMELY, MATERNITY SHIRTS; INFANT AND TODDLER CLOTHING, NAMELY, ONE-PIECE CLOTHING (U.S. CLS. 22 AND 39).

STEVEN R. FOSTER, EXAMINING ATTORNEY

SN 77-294,556. MINIDIS, JR., JAMES D., PALMDALE, CA. AND SADLER, DUSTIN R., QUARTZ HILL, CA. AND SCHULTZ, CALEN M., NEWPORT BEACH, CA. FILED 10-2-2007.

VETTE SETTA

THE MARK CONSISTS OF STANDARD CHARACTERS WITHOUT CLAIM TO ANY PARTICULAR FONT, STYLE, SIZE, OR COLOR.

FOR BANDANAS, BATHING SUITS, BEANIES, BELTS, BIKINIS, BLOUSES, BOARD SHORTS, BOXER BRIEFS, BOXER SHORTS, DRESSES, HATS, HEAD WEAR, HOODS, JACKETS, JEANS, JERSEYS, LONG-SLEEVED SHIRTS, SOCKS, PANTIES, SHORTS AND BRIEFS, PANTS, POLO SHIRTS, SHIRTS, SKIRTS, SHORTS, SOCKS, SWEAT PANTS, SWEAT SHIRTS, SWEATERS, SWIMWEAR, TANK TOPS, T-SHIRTS, AND UNDERWEAR (U.S. CLS. 22 AND 39).

KAREN BRACEY, EXAMINING ATTORNEY

SN 77-294,599. 3SUM CLOTHING, LLC, SUNLAND, CA. FILED 10-2-2007.



THE MARK CONSISTS OF THE SILHOUETTE OF THE

CLASS 25—(Continued).

PROFILE OF THREE WOMEN AS A COMPOSITE WHOLE, WHICH DEPICT THE SILHOUETTE HEAD SHOT OF A WOMAN. THE PROFILES ARE LOCATED TO THE RIGHT, TOP, AND LEFT OF THE HEAD SHOT. THE PROFILE ON TOP DEPICTS THE WOMAN EATING A CHERRY FROM THE STEM. THE PROFILE ON THE LEFT PORTRAY THE WOMAN TOUCHING HER LIP WITH THE TIP OF HER INDEX FINGER, INURING AN IMPRESSION OF CURIOSITY OR DESIRE TO THAT PROFILE. THE PROFILE ON THE LEFT DOES NOT PORTRAY ANY EXPRESSION.

FOR A-SHIRTS; BUTTON-FRONT ALOHA SHIRTS; CAMP SHIRTS; DRESS SHIRTS; GOLF SHIRTS; KNIT SHIRTS; LONG-SLEEVED SHIRTS; NIGHT SHIRTS; OPEN-NECKED SHIRTS; PIQUE SHIRTS; POLO SHIRTS; RUGBY SHIRTS; SHIRT FRONTS; SHIRT YOKES; SHIRTS; SHIRTS FOR SUITS; SHORT-SLEEVED OR LONG-SLEEVED T-SHIRTS; SHORT-SLEEVED SHIRTS; SLEEP SHIRTS; SPORT SHIRTS; SPORTS SHIRTS; SPORTS SHIRTS WITH SHORT SLEEVES; SWEAT SHIRTS; T-SHIRTS; TEE SHIRTS; WIND SHIRTS; YOGA SHIRTS; CHEF'S HATS; FUR HATS; HAT BANDS; HATS; SEDGE HATS (SUGE-GASA); SMALL HATS; TOBOGGAN HATS, PANTS AND CAPS; WOOLLY HATS; HUNTING BOOT BAGS; SKI BOOT BAGS; NURSE'S APPAREL, NAMELY, SHIRTS; NURSING APPAREL, NAMELY, SHIRTS; BALLOON PANTS; CAPRI PANTS; CARGO PANTS; DENIMS; JOGGING PANTS; LEATHER PANTS; LOUNGE PANTS; NON-DISPOSABLE CLOTH TRAINING PANTS; NURSE PANTS; PANTS; PETTI-PANTS; SKI PANTS; SNOW PANTS; SNOWBOARD PANTS; STRETCH PANTS; SWEAT PANTS; TAP PANTS; TRACK PANTS; WATERPROOF JACKETS AND PANTS; WIND PANTS; YOGA PANTS; ANKLE SOCKS; ANKLETS; ANTI-PERSPIRANT SOCKS; JAPANESE STYLE SOCKS (TABI COVERS); JAPANESE STYLE SOCKS (TABI); MEN'S SOCKS; PAPER SHOES USED WHEN GOING THROUGH METAL DETECTORS TO KEEP FEET AND SOCKS CLEAN; SOCK SUSPENDERS; SOCKS; SOCKS AND STOCKINGS; THERMAL SOCKS; WATER SOCKS; WOOLLEN SOCKS; ANGLERS' SHOES; APRES-SKI SHOES; ATHLETIC SHOES; BALLET SHOES; BASEBALL SHOES; BEACH SHOES; BOWLING SHOES; BOXING SHOES; CANVAS SHOES; CLEATS FOR ATTACHMENT TO SPORTS SHOES; CYCLING SHOES; DECK-SHOES; DRIVERS; FOOTBALL SHOES; GOLF SHOES; GYMNASTIC SHOES; HANDBALL SHOES; HEEL PIECES FOR SHOES; HOCKEY SHOES; INFANTS' SHOES AND BOOTS; INSOLES; LEATHER SHOES; PROTECTIVE METAL MEMBERS FOR SHOES AND BOOTS; RUBBER SHOES; RUGBY SHOES; RUNNING SHOES; SHOE DOWELS; SHOE INSERTS FOR PRIMARILY NON-ORTHOPEDIC PURPOSES; SHOE PEGS; SHOE SOLES; SHOES; SHOES SOLES FOR REPAIR; SKI AND SNOWBOARD SHOES AND PARTS THEREOF; SKIING SHOES; SOCCER SHOES; TAP SHOES; TENNIS SHOES; TONGUE OR PULLSTRAP FOR SHOES AND BOOTS; TRACK AND FIELD SHOES; TRAINING SHOES; VOLLEYBALL SHOES; WOMEN'S SHOES; WORK SHOES AND BOOTS; BED JACKETS; DENIM JACKETS; DOWN JACKETS; FISHERMEN'S JACKETS; FUR COATS AND JACKETS; FUR JACKETS; HEAVY JACKETS; JACKET LINERS; JACKETS; LEATHER JACKETS; LIGHT-REFLECTING JACKETS; LONG JACKETS; MEN AND WOMEN JACKETS, COATS, TROUSERS, VESTS; RAIN JACKETS; RAINPROOF JACKETS; REVERSIBLE JACKETS; SHELL JACKETS; SKI JACKETS; SLEEVED OR SLEEVELESS JACKETS; SMOKING JACKETS; SPORTS JACKETS; STUFF JACKETS; SUEDE JACKETS; WIND RESISTANT JACKETS; WIND-JACKETS; COATS; COATS FOR MEN AND WOMEN; COATS MADE OF COTTON; COATS OF DENIM; DUST COATS; FUR COATS; HEAVY COATS; LAB COATS; LEATHER COATS; LIGHT-REFLECTING COATS; MORNING COATS; OVER COATS; RAIN COATS; RIDING COATS; SPORT COATS; SUIT COATS; TOP COATS; TRENCH COATS; WIND COATS; CREWNECK SWEATERS; MOCK TURTLE-NECK SWEATERS; SWEATERS; TURTLENECK SWEATERS; V-NECK SWEATERS; BERMUDA SHORTS; BOARD SHORTS; BOXER SHORTS; FLEECE SHORTS; GYM SHORTS; PANTIES, SHORTS AND BRIEFS; RUGBY SHORTS; SHORT OVERCOAT FOR KIMONO (HAORI); SHORT PETTICOATS; SHORT SETS; SHORT TROUSERS; SHORTS; SLIDING SHORTS; SWEAT SHORTS; UNDERWEAR, NAMELY, BOY SHORTS; WALKING SHORTS; LINGERIE; LINGERIE ACCESSORIES, NAMELY, REMOVABLE SILICONE BREAST ENHANCER PADS USED IN A BRA; MATERNITY LINGERIE; BELTS; BELTS

CLASS 25—(Continued).

MADE OF LEATHER; BELTS OF TEXTILE; FABRIC BELTS; GARTER BELTS; LEATHER BELTS; MONEY BELTS; SUSPENDER BELTS FOR MEN; SUSPENDER BELTS FOR WOMEN; TUXEDO BELTS; WAIST BELTS; WRAP BELTS FOR KIMONOS (DATEMAKI); TUXEDOS; SLACKS; DRESS SHIELDS; DRESS SUITS; DRESSES; DRESSES MADE FROM SKINS; DRESSING GOWNS; EVENING DRESSES; NURSE DRESSES; SKIRTS AND DRESSES; WEDDING DRESSES; WOMEN'S CEREMONIAL DRESSES; BATHING SUITS FOR MEN; BODY SUITS; DRY SUITS; FLIGHT SUITS; GYM SUITS; JOGGING SUITS; JUDO SUITS; KARATE SUITS; LADIES' SUITS; MEN'S SUITS; MEN'S SUITS, WOMEN'S SUITS; ONE-PIECE PLAY SUITS; PARTS OF CLOTHING, NAMELY, GUSSETS FOR TIGHTS, GUSSETS FOR STOCKINGS, GUSSETS FOR BATHING SUITS, GUSSETS FOR UNDERWEAR, GUSSETS FOR LEOTARDS AND GUSSETS FOR FOOTLETS; PLAY SUITS; RAIN SUITS; SKI SUITS; SKI SUITS FOR COMPETITION; SKIRT SUITS; SNOW BOARDING SUITS; SNOW SUITS; SUITS; SUITS OF LEATHER; SWEAT SUITS; TRACK SUITS; TRAINING SUITS; UNION SUITS; VESTED SUITS; WARM UP SUITS; WET SUIT GLOVES; WET SUITS; WET SUITS FOR WATER-SKIING AND SUB-AQUA; ZOOT SUITS; BRIEFS; DISPOSABLE UNDERWEAR; KNITTED UNDERWEAR; LADIES' UNDERWEAR; LONG UNDERWEAR; PERSPIRATION ABSORBENT UNDERWEAR CLOTHING; THERMAL UNDERWEAR; THONGS; UNDERWEAR; WOMEN'S UNDERWEAR; WOVEN OR KNITTED UNDERWEAR; HOODS; HOODS; TANK TOPS; TANK-TOPS; APRONS; COBBLERS' APRONS; BEACH COVER-UPS; BEACH COVERUPS; BEACH FOOTWEAR; FITTED SWIMMING COSTUMES WITH BRA CUPS; SWIM CAPS; SWIM TRUNKS; SWIM WEAR; SWIM WEAR FOR GENTLEMEN AND LADIES; SWIMMING CAPS; SWIMMING CAPS; SWIMMING COSTUMES; SWIMMING TRUNKS; BALLET SLIPPERS; BLAZERS; BIKINIS; BLOUSES; BODY STOCKINGS; KNEE-HIGH STOCKINGS; STOCKINGS; STOCKINGS; AFTER SKI BOOTS; ANKLE BOOTS; BOOTS; CLIMBING BOOTS; FOOTBALL BOOTS AND STUDS THEREFOR; FOOTWEAR, NAMELY WORK BOOTS; HIKING BOOTS; HORSE-RIDING BOOTS; LACE BOOTS; LADIES' BOOTS; MOTORCYCLIST BOOTS; MOUNTAINEERING BOOTS; RAIN BOOTS; RIDING BOOTS; SKI BOOTS; SNOWBOARD BOOTS; SOCCER BOOTS; WINTER BOOTS; BATH SLIPPERS; DISPOSABLE SLIPPERS; FOAM PEDICURE SLIPPERS; LEATHER SLIPPERS; PEDICURE SLIPPERS; SLIPPER SOLES; SLIPPERS; BOXER BRIEFS; ADHESIVE BRAS; BRAS; SHAPEWEAR, NAMELY, BRA; SPORTS BRA; SPORTS BRAS; STRAPLESS BRAS; STRAPS FOR BRAS; BRIEFS; FISHING VESTS; FLEECE VESTS; HUNTING VESTS; LONG SLEEVED VESTS; QUILTED VESTS; VEST EXTENDERS; VESTS; WIND VESTS; CORSETS; FINISHED TEXTILE LININGS FOR GARMENTS; FOUNDATION GARMENTS; GIRDLES; ONE PIECE GARMENT FOR INFANTS AND TODDLERS; SLEEPING GARMENTS; UNDER GARMENTS; BABY TOPS; CROP TOPS; HALTER TOPS; MUSCLE TOPS; RUGBY TOPS; TOPS; TUBE TOPS; CYCLISTS' JERSEYS; JERSEYS; SLEEVELESS JERSEYS; SPORTS JERSEYS; SPORTS JERSEYS AND BREECHES FOR SPORTS; CARDIGANS; JUMPERS; SUN SLEEVES; CHEMISETTES (U.S. CLS. 22 AND 39).
MARY MUNSON, EXAMINING ATTORNEY

CLASS 25—(Continued).

SN 77-294,828. WILDLY SOPHISTICATED MEDIA, LLC, NEW YORK, NY. FILED 10-3-2007.

WORKS BY NICOLE WILLIAMS

THE MARK CONSISTS OF STANDARD CHARACTERS WITHOUT CLAIM TO ANY PARTICULAR FONT, STYLE, SIZE, OR COLOR.

THE NAME(S), PORTRAIT(S), AND/OR SIGNATURE(S) SHOWN IN THE MARK IDENTIFIES NICOLE WILLIAMS, WHOSE CONSENT(S) TO REGISTER IS MADE OF RECORD.

FOR SHIRTS; SKIRTS; BELTS; TEE SHIRTS; YOGA PANTS; JOGGING PANTS; PULLOVERS; JACKETS (U.S. CLS. 22 AND 39).

KATHLEEN LORENZO, EXAMINING ATTORNEY

SN 77-295,082. LOWERY, BAMBIE, LAKE HAVASU CITY, AZ. FILED 10-3-2007.

Sand Diva

THE MARK CONSISTS OF STANDARD CHARACTERS WITHOUT CLAIM TO ANY PARTICULAR FONT, STYLE, SIZE, OR COLOR.

FOR SHIRTS; HATS (U.S. CLS. 22 AND 39).

STEVEN PEREZ, EXAMINING ATTORNEY

SN 77-295,092. GILLESPIE, ROBERT, PENN YAN, NY. FILED 10-3-2007.

Green Grand Prix

THE MARK CONSISTS OF STANDARD CHARACTERS WITHOUT CLAIM TO ANY PARTICULAR FONT, STYLE, SIZE, OR COLOR.

FOR HATS; SWEAT SHIRTS; T-SHIRTS (U.S. CLS. 22 AND 39).

JAMES MACFARLANE, EXAMINING ATTORNEY

CLASS 25—(Continued).

SN 77-295,256. THE APPAREL SOURCE, DBA THE SOURCE, RENTON, WA. FILED 10-3-2007.



NO CLAIM IS MADE TO THE EXCLUSIVE RIGHT TO USE "ACTIVE", APART FROM THE MARK AS SHOWN.

THE COLOR(S) DARK GREEN, LIGHT GREEN AND WHITE IS/ARE CLAIMED AS A FEATURE OF THE MARK.

THE MARK CONSISTS OF THE LITERAL ELEMENTS "ECO ACTIVE" WITH THE WORD "ECO" IN DARK GREEN AND THE WORD "ACTIVE" IN LIGHT GREEN, STACKED TOP TO BOTTOM, TO THE LEFT OF A SQUARE COMPOSED OF LIGHT AND DARK GREEN SWATCHES SURROUNDING A FREE-FORM LEAF SHAPE ALSO IN DARK GREEN. THE COLOR WHITE APPEARS IN THE SQUARE AND LEAF DESIGN.

FOR MEN'S, LADIES' AND CHILDREN'S CLOTHING, NAMELY, T-SHIRTS; KNIT TOPS, SHORTS AND PANTS; SWEATSHIRTS AND SWEATPANTS; WOVEN SHIRTS AND PANTS; INFANT AND TODDLER LAYETTES AND SETS; ROBES AND GOWNS; SLEEPWEAR; LINGERIE; CAPS AND HATS; SHOES; SOCKS; STOCKINGS; AND SLIPPERS (U.S. CLS. 22 AND 39).

DAVID MURRAY, EXAMINING ATTORNEY

SN 77-295,312. AST SPORTSWEAR INC, NEW YORK CITY, NY. FILED 10-3-2007.

RIGHTEOUS THIEVES

THE MARK CONSISTS OF STANDARD CHARACTERS WITHOUT CLAIM TO ANY PARTICULAR FONT, STYLE, SIZE, OR COLOR.

FOR JEANS; PANTS; SWEAT SHIRTS; SHORTS; SWEATERS; JACKETS; COATS; HATS; HEADWEAR; SOCKS; SHIRTS; POLO SHIRTS; CAPRIS; TOPS; T-SHIRTS (U.S. CLS. 22 AND 39).

KIMBERLY FRYE, EXAMINING ATTORNEY

SN 77-295,430. SARKISIAN, ANNA, DULUTH, GA. FILED 10-3-2007.

textually active

THE MARK CONSISTS OF STANDARD CHARACTERS WITHOUT CLAIM TO ANY PARTICULAR FONT, STYLE, SIZE, OR COLOR.

FOR HATS; JACKETS; PANTS; SHIRTS; SHOES (U.S. CLS. 22 AND 39).

COLLEEN KEARNEY, EXAMINING ATTORNEY

CLASS 25—(Continued).

SN 77-295,456. GARDNER, ANTWAN D., WASHINGTON, DC. FILED 10-3-2007.

HIP Heavy In Prayer

THE MARK CONSISTS OF STANDARD CHARACTERS WITHOUT CLAIM TO ANY PARTICULAR FONT, STYLE, SIZE, OR COLOR.

FOR A-SHIRTS; BUTTON-FRONT ALOHA SHIRTS; CAMP SHIRTS; DRESS SHIRTS; GOLF SHIRTS; KNIT SHIRTS; LONG-SLEEVED SHIRTS; NIGHT SHIRTS; OPEN-NECKED SHIRTS; PIQUE SHIRTS; POLO SHIRTS; RUGBY SHIRTS; SHIRT FRONTS; SHIRT YOKES; SHIRTS; SHIRTS FOR SUITS; SHORT-SLEEVED OR LONG-SLEEVED T-SHIRTS; SHORT-SLEEVED SHIRTS; SLEEP SHIRTS; SPORT SHIRTS; SPORTS SHIRTS; SPORTS SHIRTS WITH SHORT SLEEVES; SWEAT SHIRTS; T-SHIRTS; TEE SHIRTS; TRIATHLON CLOTHING, NAMELY, TRIATHLON TIGHTS, TRIATHLON SHORTS, TRIATHLON SINGLETS, TRIATHLON SHIRTS, TRIATHLON SUITS; WIND SHIRTS; YOGA SHIRTS (U.S. CLS. 22 AND 39).

SUSAN LESLIE DUBOIS, EXAMINING ATTORNEY

SN 77-295,573. LINDLAND, CHRIS, SAN FRANCISCO, CA. FILED 10-3-2007.

cordarounds

THE MARK CONSISTS OF STANDARD CHARACTERS WITHOUT CLAIM TO ANY PARTICULAR FONT, STYLE, SIZE, OR COLOR.

FOR JACKETS; PANTS; T-SHIRTS; SHORTS; SKIRTS; INFANT WEAR (U.S. CLS. 22 AND 39).

FIRST USE 11-1-2004; IN COMMERCE 1-5-2005.

ALEX KEAM, EXAMINING ATTORNEY

CLASS 25—(Continued).

SN 77-295,619. TRUEGAMERZ LLC, EL SEGUNDO, CA. FILED 10-3-2007.

Para La Calle

THE MARK CONSISTS OF STANDARD CHARACTERS WITHOUT CLAIM TO ANY PARTICULAR FONT, STYLE, SIZE, OR COLOR.

THE FOREIGN WORDING IN THE MARK TRANSLATES INTO ENGLISH AS TO THE STREET.

FOR ATHLETIC SHOES; BASEBALL SHOES; GOLF SHIRTS; GOLF SHOES; JOGGING PANTS; KNIT SHIRTS; NON-DISPOSABLE CLOTH TRAINING PANTS; OPEN-NECKED SHIRTS; PANTS; POLO SHIRTS; RUNNING SHOES; SHIRTS; SHOES; SHORT-SLEEVED SHIRTS; SKI AND SNOWBOARD SHOES AND PARTS THEREOF; SOCCER SHOES; SPORT SHIRTS; SPORTS SHIRTS; SPORTS SHIRTS WITH SHORT SLEEVES; STRETCH PANTS; SWEAT PANTS; SWEAT SHIRTS; T-SHIRTS; TEE SHIRTS; TENNIS SHOES; TRACK AND FIELD SHOES; TRACK PANTS; TRAINING SHOES; TRIATHLON CLOTHING, NAMELY, TRIATHLON TIGHTS, TRIATHLON SHORTS, TRIATHLON SINGLETS, TRIATHLON SHIRTS, TRIATHLON SUITS; VOLLEYBALL SHOES; WATERPROOF JACKETS AND PANTS; WIND PANTS; BASEBALL CAPS; CAP VISORS; CAPS; CAPS WITH VISORS (U.S. CLS. 22 AND 39).
CHRIS WELLS, EXAMINING ATTORNEY

SN 77-295,631. TRUEGAMERZ LLC, EL SEGUNDO, CA. FILED 10-3-2007.

cierra la puerta

THE MARK CONSISTS OF STANDARD CHARACTERS WITHOUT CLAIM TO ANY PARTICULAR FONT, STYLE, SIZE, OR COLOR.

THE FOREIGN WORDING IN THE MARK TRANSLATES INTO ENGLISH AS "OUT THE DOOR".

FOR ATHLETIC SHOES; BASEBALL SHOES; CLEATS FOR ATTACHMENT TO SPORTS SHOES; DENIMS; FOOTBALL SHOES; GOLF SHIRTS; GOLF SHOES; HAT BANDS; HATS; HEADGEAR, NAMELY, CAPS; JOGGING PANTS; KNIT SHIRTS; LONG-SLEEVED SHIRTS; NON-DISPOSABLE CLOTH TRAINING PANTS; OPEN-NECKED SHIRTS; PANTS; POLO SHIRTS; RUNNING SHOES; SHIRTS; SHOES; SHORT-SLEEVED OR LONG-SLEEVED T-SHIRTS; SHORT-SLEEVED SHIRTS; SOCCER SHOES; SPORT SHIRTS; SPORTS SHIRTS; SPORTS SHIRTS WITH SHORT SLEEVES; STRETCH PANTS; SWEAT PANTS; SWEAT SHIRTS; T-SHIRTS; TEE SHIRTS; TENNIS SHOES; TRACK AND FIELD SHOES; TRACK PANTS; TRAINING SHOES; TRIATHLON CLOTHING, NAMELY, TRIATHLON TIGHTS, TRIATHLON SHORTS, TRIATHLON SINGLETS, TRIATHLON SHIRTS, TRIATHLON SUITS (U.S. CLS. 22 AND 39).
CHRIS WELLS, EXAMINING ATTORNEY

CLASS 25—(Continued).

SN 77-295,661. Y WATER, INC., LOS ANGELES, CA. FILED 10-3-2007.



FOR ADULT AND CHILDREN'S SHIRTS, T-SHIRTS, JACKETS, SWEATSHIRTS, PANTS, SWEAT PANTS, SHORTS, SKIRTS, DRESSES, HATS, SOCKS AND SHOES (U.S. CLS. 22 AND 39).

EMILY CARLSEN, EXAMINING ATTORNEY

SN 77-295,664. WILSON, TIFFANY, NORWALK, CT. FILED 10-3-2007.



THE MARK CONSISTS OF THE STYLIZED IMAGE OF A TREBLE CLEF.

FOR SHIRTS; JEANS; HATS; BELTS; DRESSES; SKIRTS; JACKETS; SOCKS; UNDERWEAR (U.S. CLS. 22 AND 39).

EMILY CARLSEN, EXAMINING ATTORNEY

CLASS 25—(Continued).

SN 77-295,713. COLLINS, JACQUELINE JANINE, BLUEFIELD, WV. AND HOUSTON-CLAYBROOK, SAMIR QAWI, BLUEFIELD, WV. FILED 10-3-2007.

Hood Pretty Hood Handsome

THE MARK CONSISTS OF STANDARD CHARACTERS WITHOUT CLAIM TO ANY PARTICULAR FONT, STYLE, SIZE, OR COLOR.
FOR SHIRTS; PANTS; DRESSES; SKIRTS (U.S. CLS. 22 AND 39).
JAMES LOVELACE, EXAMINING ATTORNEY

SN 77-295,840. SHOES FOR CREWS, LLC, WEST PALM BEACH, FL. FILED 10-4-2007.

SFC

THE MARK CONSISTS OF STANDARD CHARACTERS WITHOUT CLAIM TO ANY PARTICULAR FONT, STYLE, SIZE, OR COLOR.
OWNER OF U.S. REG. NOS. 2,355,155 AND 3,304,683.
FOR SHOES AND SANDALS (U.S. CLS. 22 AND 39).
FIRST USE 8-1-1998; IN COMMERCE 8-1-1998.
WENDY JUN, EXAMINING ATTORNEY

SN 77-295,991. BOWER III, EDWARD I, QUINCY, MA. FILED 10-4-2007.

U Got Mossed

THE MARK CONSISTS OF STANDARD CHARACTERS WITHOUT CLAIM TO ANY PARTICULAR FONT, STYLE, SIZE, OR COLOR.
FOR HATS; POLO SHIRTS; RUGBY SHIRTS; SHORT-SLEEVED OR LONG-SLEEVED T-SHIRTS; SHORT-SLEEVED SHIRTS; SPORT SHIRTS (U.S. CLS. 22 AND 39).
ALICE BENMAMAN, EXAMINING ATTORNEY

CLASS 25—(Continued).

SN 77-296,012. BOWER III, EDWARD I, QUINCY, MA. FILED 10-4-2007.

He Got Mossed

THE MARK CONSISTS OF STANDARD CHARACTERS WITHOUT CLAIM TO ANY PARTICULAR FONT, STYLE, SIZE, OR COLOR.
FOR POLO SHIRTS; RUGBY SHIRTS; SHIRTS; HATS; GOLF SHIRTS; SHORT-SLEEVED OR LONG-SLEEVED T-SHIRTS; SHORT-SLEEVED SHIRTS (U.S. CLS. 22 AND 39).
KAELIE KUNG, EXAMINING ATTORNEY

SN 77-296,023. EDDY, MICHAEL, ORMOND BEACH, FL. FILED 10-4-2007.

RABID FISH

THE MARK CONSISTS OF STANDARD CHARACTERS WITHOUT CLAIM TO ANY PARTICULAR FONT, STYLE, SIZE, OR COLOR.
FOR HATS; JACKETS; SWEAT SHIRTS; SWEATERS; T-SHIRTS; TANK TOPS (U.S. CLS. 22 AND 39).
JOHN WILKE, EXAMINING ATTORNEY

SN 77-296,162. LIVE NATION WORLDWIDE, INC., BEVERLY HILLS, CA. FILED 10-4-2007.

VENUE NATION

THE MARK CONSISTS OF STANDARD CHARACTERS WITHOUT CLAIM TO ANY PARTICULAR FONT, STYLE, SIZE, OR COLOR.
FOR CLOTHING, NAMELY, SHIRTS, T-SHIRTS, RUGBY SHIRTS, POLO SHIRTS, CARDIGANS, JERSEYS, UNIFORMS, PANTS, TANK TOPS, SWEAT SHIRTS, SWEAT PANTS, WARM-UP SUITS, AND JACKETS (U.S. CLS. 22 AND 39).
ERNEST SHOSHO, EXAMINING ATTORNEY

CLASS 25—(Continued).

SN 77-296,254. GRISWELL, PAUL, DBA PK ENTERPRISES, CLEBURNE, TX. AND GRISWELL, KAREN, DBA PK ENTERPRISES, CLEBURNE, TX. FILED 10-4-2007.

DONKEYBOY

THE MARK CONSISTS OF STANDARD CHARACTERS WITHOUT CLAIM TO ANY PARTICULAR FONT, STYLE, SIZE, OR COLOR.

FOR CLOTHING, NAMELY, T-SHIRTS AND CAPS (U.S. CLS. 22 AND 39).

FIRST USE 1-17-2007; IN COMMERCE 1-17-2007.

SAMUEL E. SHARPER JR., EXAMINING ATTORNEY

CLASS 25—(Continued).

SN 77-296,313. SPANX, INC., ATLANTA, GA. FILED 10-4-2007.

SLIM COGNITO

THE MARK CONSISTS OF STANDARD CHARACTERS WITHOUT CLAIM TO ANY PARTICULAR FONT, STYLE, SIZE, OR COLOR.

FOR WOMEN'S APPAREL, NAMELY, CAMISOLES, BODY SHAPERS, BODYSUITS, AND PANTIES (U.S. CLS. 22 AND 39).

FIRST USE 2-10-2005; IN COMMERCE 2-10-2005.

JENNIFER MARTIN, EXAMINING ATTORNEY

SN 77-296,295. SPANX, INC., ATLANTA, GA. FILED 10-4-2007.

BRA-LLELUJAH!

THE MARK CONSISTS OF STANDARD CHARACTERS WITHOUT CLAIM TO ANY PARTICULAR FONT, STYLE, SIZE, OR COLOR.

FOR WOMEN'S APPAREL, NAMELY, BRAS (U.S. CLS. 22 AND 39).

FIRST USE 2-0-2004; IN COMMERCE 2-0-2004.

JENNIFER MARTIN, EXAMINING ATTORNEY

SN 77-296,318. SAFEGUARD INDUSTRIAL SUPPLY, LLC, THOROFARE, NJ. FILED 10-4-2007.

IRON MOUNTAIN

THE MARK CONSISTS OF STANDARD CHARACTERS WITHOUT CLAIM TO ANY PARTICULAR FONT, STYLE, SIZE, OR COLOR.

FOR GLOVES (U.S. CLS. 22 AND 39).

LINDA M. KING, EXAMINING ATTORNEY

SN 77-296,303. SPANX, INC., ATLANTA, GA. FILED 10-4-2007.

HIDE & SLEEK

THE MARK CONSISTS OF STANDARD CHARACTERS WITHOUT CLAIM TO ANY PARTICULAR FONT, STYLE, SIZE, OR COLOR.

FOR WOMEN'S APPAREL, NAMELY, CAMISOLES, BODY SHAPERS, PANTIES, BODYSUITS, AND SLIPS (U.S. CLS. 22 AND 39).

FIRST USE 12-29-2004; IN COMMERCE 12-29-2004.

JENNIFER MARTIN, EXAMINING ATTORNEY

SN 77-296,322. SPANX, INC., ATLANTA, GA. FILED 10-4-2007.

TIGHT-END TIGHTS

THE MARK CONSISTS OF STANDARD CHARACTERS WITHOUT CLAIM TO ANY PARTICULAR FONT, STYLE, SIZE, OR COLOR.

NO CLAIM IS MADE TO THE EXCLUSIVE RIGHT TO USE "TIGHTS", APART FROM THE MARK AS SHOWN.

FOR WOMEN'S APPAREL, NAMELY, TIGHTS (U.S. CLS. 22 AND 39).

FIRST USE 6-19-2006; IN COMMERCE 6-19-2006.

JENNIFER MARTIN, EXAMINING ATTORNEY

CLASS 25—(Continued).

SN 77-296,470. TURPIN, COREY W, NEWPORT BEACH, CA. FILED 10-4-2007.

Serious Pride

THE MARK CONSISTS OF STANDARD CHARACTERS WITHOUT CLAIM TO ANY PARTICULAR FONT, STYLE, SIZE, OR COLOR.

FOR BASEBALL CAPS; BELTS; CAPS; CLOTHING FOR WEAR IN JUDO PRACTICES; CLOTHING FOR WEAR IN WRESTLING GAMES; GYM SHORTS; GYM SUITS; HATS; JACKETS; JERSEYS; JOGGING PANTS; PANTS; RUGBY SHIRTS; RUGBY SHORTS; SHIRTS; SHORT-SLEEVED OR LONG-SLEEVED T-SHIRTS; SHORTS; SKI JACKETS; SKI PANTS; SKULL CAPS; SNOWBOARD PANTS; SWEAT PANTS; SWEAT SHIRTS; SWEAT SHORTS; TENNIS SHOES; TRIATHLON CLOTHING, NAMELY, TRIATHLON TIGHTS, TRIATHLON SHORTS, TRIATHLON SINGLETS, TRIATHLON SHIRTS, TRIATHLON SUITS; WALKING SHORTS; WIND RESISTANT JACKETS; TOBOGGAN HATS, PANTS AND CAPS; TRACK PANTS; SPORTS SHIRTS WITH SHORT SLEEVES; POLO SHIRTS; BOARD SHORTS; BEACH SHOES (U.S. CLS. 22 AND 39).

REBECCA GILBERT, EXAMINING ATTORNEY

SN 77-296,507. TEXAS TWISTER PRODUCTIONS, SANTA MONICA, CA. FILED 10-4-2007.

CRISTI

THE MARK CONSISTS OF STANDARD CHARACTERS WITHOUT CLAIM TO ANY PARTICULAR FONT, STYLE, SIZE, OR COLOR.

FOR CREWNECK SWEATERS; DRESSES; KNIT SHIRTS; LONG-SLEEVED SHIRTS; MOCK TURTLENECK SWEATERS; OPEN-NECKED SHIRTS; SHIRTS; SKIRTS AND DRESSES; SWEATERS; T-SHIRTS; TURTLENECK SWEATERS; V-NECK SWEATERS (U.S. CLS. 22 AND 39).

CHRISTINA SOBRAL, EXAMINING ATTORNEY

SN 77-296,634. KUDRA DESIGNERS TEAM CRIACAO E CONSULTORIA LTDA., SAO PAULO, BRAZIL, FILED 10-4-2007.

KHUDRA

THE MARK CONSISTS OF STANDARD CHARACTERS WITHOUT CLAIM TO ANY PARTICULAR FONT, STYLE, SIZE, OR COLOR.

THE FOREIGN WORDING IN THE MARK TRANSLATES INTO ENGLISH AS GREEN OASIS.

FOR WOMEN'S SHOES (U.S. CLS. 22 AND 39).

EDWARD NELSON, EXAMINING ATTORNEY

CLASS 25—(Continued).

SN 77-296,666. CLEVELAND INDIANS BASEBALL COMPANY LIMITED PARTNERSHIP, CLEVELAND, OH. FILED 10-4-2007.

TRIBE TIME

THE MARK CONSISTS OF STANDARD CHARACTERS WITHOUT CLAIM TO ANY PARTICULAR FONT, STYLE, SIZE, OR COLOR.

FOR CLOTHING, NAMELY, CAPS, HATS, VISORS, KNITTED HEADWEAR, HEADBANDS, BANDANNAS, SHIRTS, T-SHIRTS, TANK TOPS, BLOUSES, SWEATERS, TURTLENECKS, PULLOVERS, VESTS, SHORTS, PANTS, SLACKS, DRESSES, SKIRTS, BASEBALL UNIFORMS, JERSEYS, WARM-UP SUITS, JOGGING SUITS, SWEATSHIRTS, SWEATPANTS, UNDERWEAR, BOXER SHORTS, ROBES, SLEEPWEAR, PAJAMAS, NIGHTSHIRTS, NIGHTGOWNS, SWIMWEAR, CLOTHING WRAPS, JACKETS, PONCHOS, CLOTH BIBS, INFANT WEAR, INFANT DIAPER COVERS, CLOTH DIAPER SETS WITH UNDERSHIRT AND DIAPER COVER, JUMPERS, ROMPERS, COVERALLS, CREEPERS, BABY BOOTIES, TIES, BELTS, MITTENS, GLOVES, WRISTBANDS, EARMUFFS, SCARVES, FOOTWEAR, SOCKS, HOSIERY, SLIPPERS, AND HALLOWEEN AND MASQUERADE COSTUMES (U.S. CLS. 22 AND 39).

BILL DAWE, EXAMINING ATTORNEY

SN 77-296,668. JESUS LOPEZ, VAN NUYS, CA. FILED 10-4-2007.

godsend

THE MARK CONSISTS OF STANDARD CHARACTERS WITHOUT CLAIM TO ANY PARTICULAR FONT, STYLE, SIZE, OR COLOR.

FOR CLOTHING, NAMELY, SHIRTS, BLAZERS, JACKETS, HOODED JACKETS, T-SHIRTS, SHORTS, DRESSES, LEATHER BELTS, HATS, SWEATERS, THERMAL UNDERSHIRTS, SLACKS, DENIMWEAR, NAMELY, PANTS AND JEANS (U.S. CLS. 22 AND 39).

FIRST USE 1-1-2005; IN COMMERCE 1-2-2005.

AHSEN KHAN, EXAMINING ATTORNEY

CLASS 25—(Continued).

SN 77-296,674. CLEVELAND INDIANS BASEBALL COMPANY LIMITED PARTNERSHIP, CLEVELAND, OH. FILED 10-4-2007.

IT'S TRIBE TIME

THE MARK CONSISTS OF STANDARD CHARACTERS WITHOUT CLAIM TO ANY PARTICULAR FONT, STYLE, SIZE, OR COLOR.

FOR CLOTHING, NAMELY, CAPS, HATS, VISORS, KNITTED HEADWEAR, HEADBANDS, BANDANNAS, SHIRTS, T-SHIRTS, TANK TOPS, BLOUSES, SWEATERS, TURTLENECKS, PULLOVERS, VESTS, SHORTS, PANTS, SLACKS, DRESSES, SKIRTS, BASEBALL UNIFORMS, JERSEYS, WARM-UP SUITS, JOGGING SUITS, SWEAT-SHIRTS, SWEATPANTS, UNDERWEAR, BOXER SHORTS, ROBES, SLEEPWEAR, PAJAMAS, NIGHT-SHIRTS, NIGHTGOWNS, SWIMWEAR, CLOTHING WRAPS, JACKETS, PONCHOS, CLOTH BIBS, INFANT WEAR, INFANT DIAPER COVERS, CLOTH DIAPER SETS WITH UNDERSHIRT AND DIAPER COVER, JUMPERS, ROMPERS, COVERALLS, CREEPERS, BABY BOOTIES, TIES, BELTS, MITTENS, GLOVES, WRISTBANDS, EARMUFFS, SCARVES, FOOTWEAR, SOCKS, HOSIERY, SLIPPERS, AND HALLOWEEN AND MASQUERADE COSTUMES (U.S. CLS. 22 AND 39).

BILL DAWE, EXAMINING ATTORNEY

SN 77-296,679. CLEVELAND INDIANS BASEBALL COMPANY LIMITED PARTNERSHIP, CLEVELAND, OH. FILED 10-4-2007.

IT'S TRIBE TIME NOW

THE MARK CONSISTS OF STANDARD CHARACTERS WITHOUT CLAIM TO ANY PARTICULAR FONT, STYLE, SIZE, OR COLOR.

FOR CLOTHING, NAMELY, CAPS, HATS, VISORS, KNITTED HEADWEAR, HEADBANDS, BANDANNAS, SHIRTS, T-SHIRTS, TANK TOPS, BLOUSES, SWEATERS, TURTLENECKS, PULLOVERS, VESTS, SHORTS, PANTS, SLACKS, DRESSES, SKIRTS, BASEBALL UNIFORMS, JERSEYS, WARM-UP SUITS, JOGGING SUITS, SWEAT-SHIRTS, SWEATPANTS, UNDERWEAR, BOXER SHORTS, ROBES, SLEEPWEAR, PAJAMAS, NIGHT-SHIRTS, NIGHTGOWNS, SWIMWEAR, CLOTHING WRAPS, JACKETS, PONCHOS, CLOTH BIBS, INFANT WEAR, INFANT DIAPER COVERS, CLOTH DIAPER SETS WITH UNDERSHIRT AND DIAPER COVER, JUMPERS, ROMPERS, COVERALLS, CREEPERS, BABY BOOTIES, TIES, BELTS, MITTENS, GLOVES, WRISTBANDS, EARMUFFS, SCARVES, FOOTWEAR, SOCKS, HOSIERY, SLIPPERS, AND HALLOWEEN AND MASQUERADE COSTUMES (U.S. CLS. 22 AND 39).

BILL DAWE, EXAMINING ATTORNEY

CLASS 25—(Continued).

SN 77-296,806. CAPUTO, SEAN A, BOCA RATON, FL. FILED 10-4-2007.

GameAggro

THE MARK CONSISTS OF STANDARD CHARACTERS WITHOUT CLAIM TO ANY PARTICULAR FONT, STYLE, SIZE, OR COLOR.

FOR SHIRTS (U.S. CLS. 22 AND 39).
GEORGE LORENZO, EXAMINING ATTORNEY

SN 77-296,827. TRUEGAMERZ LLC, EL SEGUNDO, CA. FILED 10-5-2007.

Chamquitos del Barrio

THE MARK CONSISTS OF STANDARD CHARACTERS WITHOUT CLAIM TO ANY PARTICULAR FONT, STYLE, SIZE, OR COLOR.

THE FOREIGN WORDING IN THE MARK TRANSLATES INTO ENGLISH AS "CHILDREN OF THE GHETTO".

FOR ATHLETIC SHOES; BASEBALL SHOES; GOLF SHIRTS; GOLF SHOES; JOGGING PANTS; KNIT SHIRTS; NON-DISPOSABLE CLOTH TRAINING PANTS; OPEN-NECKED SHIRTS; PANTS; POLO SHIRTS; RUNNING SHOES; SHIRTS; SHOES; SHORT-SLEEVED SHIRTS; SKI AND SNOWBOARD SHOES AND PARTS THEREOF; SOCCER SHOES; SPORT SHIRTS; SPORTS SHIRTS; SPORTS SHIRTS WITH SHORT SLEEVES; STRETCH PANTS; SWEAT PANTS; SWEAT SHIRTS; T-SHIRTS; TEE SHIRTS; TENNIS SHOES; TRACK AND FIELD SHOES; TRACK PANTS; TRAINING SHOES; TRIATHLON CLOTHING, NAMELY, TRIATHLON TIGHTS, TRIATHLON SHORTS, TRIATHLON SINGLETS, TRIATHLON SHIRTS, TRIATHLON SUITS; VOLLEYBALL SHOES; WATERPROOF JACKETS AND PANTS; WIND PANTS; BASEBALL CAPS; CAP VISORS; CAPS; CAPS WITH VISORS (U.S. CLS. 22 AND 39).

CHRIS WELLS, EXAMINING ATTORNEY

SN 77-296,947. CONNIE ELDER INTERNATIONAL, LLC, NASHVILLE, TN. FILED 10-5-2007.

UNDEROLOGY

THE MARK CONSISTS OF STANDARD CHARACTERS WITHOUT CLAIM TO ANY PARTICULAR FONT, STYLE, SIZE, OR COLOR.

FOR SWIM WEAR; BRAS; SHOES (U.S. CLS. 22 AND 39).

RENEE MCCRAY, EXAMINING ATTORNEY

CLASS 25—(Continued).

SN 77-297,061. IKEDA, ROBERT, LOS ANGELES, CA. AND PARK, CHUNGSIK, LOS ANGELES, CA. AND FOSTER, UMAR RASHID, LOS ANGELES, CA. FILED 10-5-2007.



THE MARK CONSISTS OF TWO STRIPED REDTAIL HAWK WING FEATHERS, HANGING DOWN, CURVED TO THE RIGHT, AND CROSSED AT THE STEM, WITH THE STYLIZED TEXT "FROHAWK TWO-FEATHERS". FOR (BASED ON INTENT TO USE) HATS; PANTS; PULLOVERS; SHIRTS; SHOES (U.S. CLS. 22 AND 39).
CHERYL CLAYTON, EXAMINING ATTORNEY

CLASS 25—(Continued).

SN 77-297,332. BABY LEGS, LLC, SEATTLE, WA. FILED 10-5-2007.

MY FIRST BABYLEGS

THE MARK CONSISTS OF STANDARD CHARACTERS WITHOUT CLAIM TO ANY PARTICULAR FONT, STYLE, SIZE, OR COLOR.

OWNER OF U.S. REG. NO. 3,182,811.
FOR CLOTHING, NAMELY, LEG AND ARM WARMERS FOR CHILDREN AND ADULTS (U.S. CLS. 22 AND 39).

BRIAN CALLAGHAN, EXAMINING ATTORNEY

SN 77-297,696. JONES, MATTHEW D, IRVINE, CA. FILED 10-5-2007.

myself

SN 77-297,251. BOERNER, JO ANN, BRADENTON, FL. FILED 10-5-2007.



THE MARK CONSISTS OF THE WORDS "HIGH" AND "FIN" WITH TWO DOLPHIN TAILS POINTING UPWARD AND TOUCHING.

FOR INFANT AND TODDLER ONE PIECE CLOTHING; JERSEYS; SHORT SETS; CAPS; TOPS (U.S. CLS. 22 AND 39).

FIRST USE 10-1-2007; IN COMMERCE 10-1-2007.
DANIEL CAPSHAW, EXAMINING ATTORNEY

THE MARK CONSISTS OF THIS MARK IS THE WORD "MYSELF" IN CENTURY GOTHIC FONT SLIGHTLY STRETCHED HORIZONTALLY WITH AN UPSIDE Y ROTATED 180 DEGREES.

FOR SHIRTS; T-SHIRTS; JEANS; SWEATERS; PANTIES; BRAS; LINGERIE; BOXER BRIEFS; BATHING SUITS; DRESSES; JACKETS; UNDERWEAR; PANTS; GLOVES; HATS; SOCKS; TIES; SUSPENDERS; SHORTS; SKIRTS; COATS; TANK TOPS (U.S. CLS. 22 AND 39).

AISHA CLARKE, EXAMINING ATTORNEY

SN 77-297,891. CROLLEY, JEFF C, WEST COLUMBIA, SC. FILED 10-6-2007.

Next Year's Finally Here

THE MARK CONSISTS OF STANDARD CHARACTERS WITHOUT CLAIM TO ANY PARTICULAR FONT, STYLE, SIZE, OR COLOR.

FOR T-SHIRTS; HATS (U.S. CLS. 22 AND 39).
JAMES LOVELACE, EXAMINING ATTORNEY

CLASS 25—(Continued).

SN 77-297,941. SOCOLOFF, SHAWN B, SCOTTSDALE, AZ.
FILED 10-6-2007.

ANGRY PANDA

THE MARK CONSISTS OF STANDARD CHARACTERS WITHOUT CLAIM TO ANY PARTICULAR FONT, STYLE, SIZE, OR COLOR.

FOR BELTS; CAPS; CHILDREN'S AND INFANTS' CLOTH BIBS; CORSETS; INFANT AND TODDLER ONE PIECE CLOTHING; JERSEYS; LEATHER BELTS; TIES; TOPS; CAPRI PANTS; CARGO PANTS; DENIMS; JOGGING PANTS; SKI PANTS; SNOW PANTS; SNOWBOARD PANTS; SWEAT PANTS; WATERPROOF JACKETS AND PANTS; YOGA PANTS; DRESS SHIRTS; GOLF SHIRTS; KNIT SHIRTS; LONG-SLEEVED SHIRTS; NIGHT SHIRTS; POLO SHIRTS; RUGBY SHIRTS; SHORT-SLEEVED SHIRTS; SWEAT SHIRTS; TEE SHIRTS; HATS; SHOES; SWIMWEAR; DRESSES; SOCKS; GLOVES; SCARVES; HEADBANDS; BANDANAS; LEG-WARMERS; WRISTBANDS; UNDERGARMENTS; PANTS; SHORTS; SHIRTS (U.S. CLS. 22 AND 39).

FIRST USE 6-1-2007; IN COMMERCE 7-1-2007.
BARBARA GAYNOR, EXAMINING ATTORNEY

SN 77-298,071. TRUEGAMERZ LLC, EL SEGUNDO, CA.
FILED 10-7-2007.

Raza Nueva

THE MARK CONSISTS OF STANDARD CHARACTERS WITHOUT CLAIM TO ANY PARTICULAR FONT, STYLE, SIZE, OR COLOR.

THE FOREIGN WORDING IN THE MARK TRANSLATES INTO ENGLISH AS "NEW RACE".

FOR ATHLETIC SHOES; BASEBALL SHOES; GOLF SHIRTS; GOLF SHOES; JOGGING PANTS; KNIT SHIRTS; NON-DISPOSABLE CLOTH TRAINING PANTS; OPEN-NECKED SHIRTS; PANTS; POLO SHIRTS; RUNNING SHOES; SHIRTS; SHOES; SHORT-SLEEVED SHIRTS; SKI AND SNOWBOARD SHOES AND PARTS THEREOF; SOCCER SHOES; SPORT SHIRTS; SPORTS SHIRTS; SPORTS SHIRTS WITH SHORT SLEEVES; STRETCH PANTS; SWEAT PANTS; SWEAT SHIRTS; T-SHIRTS; TEE SHIRTS; TENNIS SHOES; TRACK AND FIELD SHOES; TRACK PANTS; TRAINING SHOES; TRIATHLON CLOTHING, NAMELY, TRIATHLON TIGHTS, TRIATHLON SHORTS, TRIATHLON SINGLETTS, TRIATHLON SHIRTS, TRIATHLON SUITS; VOLLEYBALL SHOES; WATERPROOF JACKETS AND PANTS; WIND PANTS; BASEBALL CAPS; CAP VISORS; CAPS; CAPS WITH VISORS (U.S. CLS. 22 AND 39).

CHRIS WELLS, EXAMINING ATTORNEY

CLASS 25—(Continued).

SN 77-298,077. TRUEGAMERZ LLC, EL SEGUNDO, CA.
FILED 10-7-2007.

Anywear. Anytime.

THE MARK CONSISTS OF STANDARD CHARACTERS WITHOUT CLAIM TO ANY PARTICULAR FONT, STYLE, SIZE, OR COLOR.

FOR ATHLETIC SHOES; BASEBALL SHOES; GOLF SHIRTS; GOLF SHOES; JOGGING PANTS; KNIT SHIRTS; NON-DISPOSABLE CLOTH TRAINING PANTS; OPEN-NECKED SHIRTS; PANTS; POLO SHIRTS; RUNNING SHOES; SHIRTS; SHOES; SHORT-SLEEVED SHIRTS; SKI AND SNOWBOARD SHOES AND PARTS THEREOF; SOCCER SHOES; SPORT SHIRTS; SPORTS SHIRTS; SPORTS SHIRTS WITH SHORT SLEEVES; STRETCH PANTS; SWEAT PANTS; SWEAT SHIRTS; T-SHIRTS; TEE SHIRTS; TENNIS SHOES; TRACK AND FIELD SHOES; TRACK PANTS; TRAINING SHOES; TRIATHLON CLOTHING, NAMELY, TRIATHLON TIGHTS, TRIATHLON SHORTS, TRIATHLON SINGLETTS, TRIATHLON SHIRTS, TRIATHLON SUITS; VOLLEYBALL SHOES; WATERPROOF JACKETS AND PANTS; WIND PANTS; BASEBALL CAPS; CAP VISORS; CAPS; CAPS WITH VISORS (U.S. CLS. 22 AND 39).

CHRIS WELLS, EXAMINING ATTORNEY

SN 77-298,469. REDCATS USA, L.P., INDIANAPOLIS, IN.
FILED 10-8-2007.

METRO LIFT

THE MARK CONSISTS OF STANDARD CHARACTERS WITHOUT CLAIM TO ANY PARTICULAR FONT, STYLE, SIZE, OR COLOR.

FOR SUPPORT PANELS SOLD AS INTEGRAL COMPONENTS OF PANTS (U.S. CLS. 22 AND 39).

FIRST USE 3-0-2007; IN COMMERCE 3-0-2007.

KEVIN DINALLO, EXAMINING ATTORNEY

SN 77-298,509. HOTSENPILLER, TAMMY, DBA HUMANITY, ANAHEIM HILLS, CA. AND CHO, HELENA, DBA HUMANITY, GARDENA, CA. FILED 10-8-2007.

MAKE A DIFFERENCE

THE MARK CONSISTS OF STANDARD CHARACTERS WITHOUT CLAIM TO ANY PARTICULAR FONT, STYLE, SIZE, OR COLOR.

FOR CLOTHING, NAMELY, BELTS, DRESSES, PANTS, BLOUSES, SWEATERS, T-SHIRTS, POLO SHIRTS, TANK TOPS, SWEATSHIRTS, JOGGING SUITS, SHORTS, JACKETS, LINGERIE (U.S. CLS. 22 AND 39).

JAMES MACFARLANE, EXAMINING ATTORNEY

CLASS 25—(Continued).

SN 77-299,880. BABYLEGS, LLC, SEATTLE, WA. FILED 10-9-2007.

NOTSOX

THE MARK CONSISTS OF STANDARD CHARACTERS WITHOUT CLAIM TO ANY PARTICULAR FONT, STYLE, SIZE, OR COLOR.

FOR CLOTHING, NAMELY, LEG AND ARM WARMERS FOR CHILDREN AND ADULTS (U.S. CLS. 22 AND 39).

BRIAN CALLAGHAN, EXAMINING ATTORNEY

CLASS 25—(Continued).

SN 77-304,474. THOMPSON, KENNETH L, DBA CACTU-FLAGE, LAKE HAVASU, AZ. FILED 10-15-2007.

CACTUFLAGE

THE MARK CONSISTS OF STANDARD CHARACTERS WITHOUT CLAIM TO ANY PARTICULAR FONT, STYLE, SIZE, OR COLOR.

FOR FABRIC SOLD AS AN INTEGRAL COMPONENT OF FINISHED CLOTHING ITEMS, NAMELY, CAPS, PANTS, SHIRTS, HATS, UNDERWEAR, JACKETS, COATS, COVERALLS, HUNTING VESTS, RAINWEAR, SWEATSHIRTS, SWEAT PANTS, BOOTS AND APRONS (U.S. CLS. 22 AND 39).

EDWARD NELSON, EXAMINING ATTORNEY

SN 77-300,893. BROOKS, MARK, CASA GRANDE, AZ. FILED 10-10-2007.

MOTOLAND

THE MARK CONSISTS OF STANDARD CHARACTERS WITHOUT CLAIM TO ANY PARTICULAR FONT, STYLE, SIZE, OR COLOR.

FOR CAPS; HOODS; JERSEYS; TOPS (U.S. CLS. 22 AND 39).

FIRST USE 10-15-2004; IN COMMERCE 12-15-2005.
JAY FLOWERS, EXAMINING ATTORNEY

SN 77-305,678. GREGG DAVID DAVIS, DBA EDGY DESIGNS, WINNETKA, CA. FILED 10-17-2007.

Edgy Designs

THE MARK CONSISTS OF STANDARD CHARACTERS WITHOUT CLAIM TO ANY PARTICULAR FONT, STYLE, SIZE, OR COLOR.

NO CLAIM IS MADE TO THE EXCLUSIVE RIGHT TO USE "DESIGNS", APART FROM THE MARK AS SHOWN.

FOR T-SHIRTS (U.S. CLS. 22 AND 39).
TEJBIR SINGH, EXAMINING ATTORNEY

SN 77-304,197. GILES-JONES, TASHANDA, LONG BEACH, CA. AND RODGERS, LISA, LONG BEACH, CA. FILED 10-15-2007.

STRAWBERRY BISCUITS

THE MARK CONSISTS OF STANDARD CHARACTERS WITHOUT CLAIM TO ANY PARTICULAR FONT, STYLE, SIZE, OR COLOR.

FOR BELTS; DRESSES; GLOVES; HEADBANDS; JACKETS; OVERALLS; PANTS; SHIRTS; SHORTS; SOCKS; SWEATERS; SKIRTS; SWIM WEAR; TEE SHIRTS; UNDERWEAR; VESTS; WARM UP SUITS; WRISTBANDS; TENNIS WEAR (U.S. CLS. 22 AND 39).

DANIEL CAPSHAW, EXAMINING ATTORNEY

SN 77-305,915. THE HILLY KRISTAL FOUNDATION FOR ARTISTS AND MUSICIANS, NEW YORK, NY. FILED 10-17-2007.

The Mud Line

THE MARK CONSISTS OF STANDARD CHARACTERS WITHOUT CLAIM TO ANY PARTICULAR FONT, STYLE, SIZE, OR COLOR.

NO CLAIM IS MADE TO THE EXCLUSIVE RIGHT TO USE "LINE", APART FROM THE MARK AS SHOWN.

FOR INFANT AND TODDLER ONE PIECE CLOTHING; TOPS; T-SHIRTS; SHORT-SLEEVED OR LONG-SLEEVED T-SHIRTS; SHORT-SLEEVED SHIRTS; HATS; PANTS; CHILDREN'S HEADWEAR; CLOTH BIBS (U.S. CLS. 22 AND 39).

DANIEL CAPSHAW, EXAMINING ATTORNEY

CLASS 25—(Continued).

SN 77-306,176. MAIDENFORM, INC., ISELIN, NJ. FILED 10-17-2007.

IM IN MOTION

THE MARK CONSISTS OF STANDARD CHARACTERS WITHOUT CLAIM TO ANY PARTICULAR FONT, STYLE, SIZE, OR COLOR.

FOR INTIMATE APPAREL, NAMELY, BRAS AND PANTIES; SHAPEWEAR, NAMELY, BRIEFS, BOY SHORTS, THIGH SLIMMERS, PANT LINERS, BODY BRIEFERS, CAMISOLES, WAISTNIPPERS, SLIPS, UNITS; EXERCISE APPAREL, NAMELY, JOGGING BRAS (U.S. CLS. 22 AND 39).

JIM RINGLE, EXAMINING ATTORNEY

SN 77-306,213. MAIDENFORM, INC., ISELIN, NJ. FILED 10-17-2007.

LILYETTE IN MOTION

THE MARK CONSISTS OF STANDARD CHARACTERS WITHOUT CLAIM TO ANY PARTICULAR FONT, STYLE, SIZE, OR COLOR.

OWNER OF U.S. REG. NO. 775,013.
FOR INTIMATE APPAREL, NAMELY, BRAS AND PANTIES; SHAPEWEAR, NAMELY, BRIEFS, BOY SHORTS, THIGH SLIMMERS, PANT LINERS, BODY BRIEFERS, CAMISOLES, WAISTNIPPERS, SLIPS, UNITS; EXERCISE APPAREL, NAMELY, JOGGING BRAS (U.S. CLS. 22 AND 39).

JIM RINGLE, EXAMINING ATTORNEY

SN 77-306,236. MEYNARD DESIGNS INC., WALTHAM, MA. FILED 10-17-2007.

EXER-SHOE

THE MARK CONSISTS OF STANDARD CHARACTERS WITHOUT CLAIM TO ANY PARTICULAR FONT, STYLE, SIZE, OR COLOR.

FOR FOOTWEAR (U.S. CLS. 22 AND 39).
ALICE BENMAMAN, EXAMINING ATTORNEY

CLASS 25—(Continued).

SN 77-307,558. TRUEGAMERZ LLC, EL SEGUNDO, CA. FILED 10-18-2007.

New Raza

THE MARK CONSISTS OF STANDARD CHARACTERS WITHOUT CLAIM TO ANY PARTICULAR FONT, STYLE, SIZE, OR COLOR.

THE FOREIGN WORDING IN THE MARK TRANSLATES INTO ENGLISH AS RACE.

FOR ATHLETIC SHOES; BASEBALL SHOES; GOLF SHIRTS; GOLF SHOES; JOGGING PANTS; KNIT SHIRTS; NON-DISPOSABLE CLOTH TRAINING PANTS; OPEN-NECKED SHIRTS; PANTS; POLO SHIRTS; RUNNING SHOES; SHIRTS; SHOES; SHORT-SLEEVED SHIRTS; SKI AND SNOWBOARD SHOES AND PARTS THEREOF; SOCCER SHOES; SPORT SHIRTS; SPORTS SHIRTS; SPORTS SHIRTS WITH SHORT SLEEVES; STRETCH PANTS; SWEAT PANTS; SWEAT SHIRTS; T-SHIRTS; TEE SHIRTS; TENNIS SHOES; TRACK AND FIELD SHOES; TRACK PANTS; TRAINING SHOES; TRIATHLON CLOTHING, NAMELY, TRIATHLON TIGHTS, TRIATHLON SHORTS, TRIATHLON SINGLETS, TRIATHLON SHIRTS, TRIATHLON SUITS; VOLLEYBALL SHOES; WATERPROOF JACKETS AND PANTS; WIND PANTS; BASEBALL CAPS; CAP VISORS; CAPS; CAPS WITH VISORS (U.S. CLS. 22 AND 39).

CHRIS WELLS, EXAMINING ATTORNEY

SN 77-308,100. JOCKEY INTERNATIONAL, INC., KENOSHA, WI. FILED 10-19-2007.

SMOOTHFLEX

THE MARK CONSISTS OF STANDARD CHARACTERS WITHOUT CLAIM TO ANY PARTICULAR FONT, STYLE, SIZE, OR COLOR.

FOR UNDERWEAR AND T-SHIRTS (U.S. CLS. 22 AND 39).

ALICE SUE CARRUTHERS, EXAMINING ATTORNEY

CLASS 25—(Continued).

SN 77-309,103. FRANK, BARBARA, BRONX, NY. FILED 10-19-2007.



NO CLAIM IS MADE TO THE EXCLUSIVE RIGHT TO USE "COUTURE", APART FROM THE MARK AS SHOWN. THE COLOR(S) RED, BLUE, GREEN AND WHITE IS/ARE CLAIMED AS A FEATURE OF THE MARK.

THE SWATCH OF CLOTH CONTAINS HORIZONTAL AND VERTICAL LINES AND SQUARES IN THE COLORS RED, BLUE, GREEN AND WHITE.

FOR A-SHIRTS; BUTTON-FRONT ALOHA SHIRTS; CAMP SHIRTS; DRESS SHIRTS; GOLF SHIRTS; KNIT SHIRTS; LONG-SLEEVED SHIRTS; NIGHT SHIRTS; OPEN-NECKED SHIRTS; PIQUE SHIRTS; POLO SHIRTS; RUGBY SHIRTS; SHIRT FRONTS; SHIRT YOKES; SHIRTS; SHIRTS FOR SUITS; SHORT-SLEEVED OR LONG-SLEEVED T-SHIRTS; SHORT-SLEEVED SHIRTS (U.S. CLS. 22 AND 39).

EDWARD NELSON, EXAMINING ATTORNEY

CLASS 25—(Continued).

SN 77-312,482. EVIDENT MUSIC GROUP, LLC, CORPUS CHRISTI, TX. FILED 10-24-2007.

EVIDENT MUSIC GROUP

THE MARK CONSISTS OF STANDARD CHARACTERS WITHOUT CLAIM TO ANY PARTICULAR FONT, STYLE, SIZE, OR COLOR.

FOR CLOTHING, NAMELY, T-SHIRTS, SWEAT-SHIRTS, TANK TOPS, HATS AND JACKETS (U.S. CLS. 22 AND 39).

KATHLEEN LORENZO, EXAMINING ATTORNEY

SN 77-309,112. HORD, WIRT, FORT LAUDERDALE, FL. FILED 10-19-2007.



FOR SURF WEAR (U.S. CLS. 22 AND 39).
 NAPOLEON SHARMA, EXAMINING ATTORNEY

Zen Tini Liquid Nirvana

THE MARK CONSISTS OF STANDARD CHARACTERS WITHOUT CLAIM TO ANY PARTICULAR FONT, STYLE, SIZE, OR COLOR.

NO CLAIM IS MADE TO THE EXCLUSIVE RIGHT TO USE "NIRVANA", APART FROM THE MARK AS SHOWN. FOR SHIRTS (U.S. CLS. 22 AND 39).

CIMMERIAN COLEMAN, EXAMINING ATTORNEY

SN 77-310,408. UNIVERSAL CITY STUDIOS LLLP, UNIVERSAL CITY, CA. FILED 10-22-2007.



GREEN IS UNIVERSAL

THE MARK CONSISTS OF STANDARD CHARACTERS WITHOUT CLAIM TO ANY PARTICULAR FONT, STYLE, SIZE, OR COLOR.

FOR JACKETS, SHIRTS, T-SHIRTS, SWEATSHIRTS, SWEATPANTS, SHORTS, CAPS, CLOTH BIBS, INFANT-WEAR (U.S. CLS. 22 AND 39).

JEAN IM, EXAMINING ATTORNEY

THE MARK CONSISTS OF A FISH FACING RIGHT, WITH TAIL CURLED UPWARDS FROM LEFT TO RIGHT, AND MOUTH WIDE OPEN.

FOR BLAZERS, SHIRTS, POLO SHIRTS, DRESS SHIRTS, TURTLE NECK SHIRTS, TEE-SHIRTS, SWEAT-SHIRTS, KNIT SHIRTS, JACKETS, PARKAS, TROUSERS, SHORTS, BERMUDA SHORTS, TRACK SUIT TROUSERS, SKIRTS, DRESSES, SOCKS, HEAD BANDS, SCARVES, HEADWEAR, GLOVES, FOOTWEAR (U.S. CLS. 22 AND 39).

FIRST USE 2-5-2007; IN COMMERCE 2-5-2007.
 INGRID C. EULIN, EXAMINING ATTORNEY

CLASS 25—(Continued).

SN 77-315,159. PRIESTLY, AYINDE N, ALEXANDRIA, VA.
FILED 10-27-2007.



THE MARK CONSISTS OF THE WORD "ISION" IN UPPERCASE BLACK LETTERS DIRECTLY ABOVE THREE BLACK SINGLE LINE CIRCLES. FROM LEFT TO RIGHT, THE RIGHT PERIMETER OF THE FIRST CIRCLE SLIGHTLY TOUCHES THE LEFT PERIMETER OF THE SECOND CIRCLE AND THE RIGHT PERIMETER OF THE SECOND CIRCLE SLIGHTLY TOUCHES THE LEFT PERIMETER OF THE THIRD CIRCLE.

FOR SHOES & T-SHIRTS (U.S. CLS. 22 AND 39).
ZACHARY BELLO, EXAMINING ATTORNEY

CLASS 25—(Continued).

SN 77-318,505. UNIVERSAL CITY STUDIOS LLLP, UNIVERSAL CITY, CA. FILED 10-31-2007.



FOR JACKETS, SHIRTS, T-SHIRTS, SWEATSHIRTS, SWEATPANTS, SHORTS, CAPS, CLOTH BIBS, INFANTWEAR (U.S. CLS. 22 AND 39).

JEAN IM, EXAMINING ATTORNEY

SN 77-315,375. TRUEGAMERZ LLC, EL SEGUNDO, CA.
FILED 10-28-2007.

Pa' La Calle

THE MARK CONSISTS OF STANDARD CHARACTERS WITHOUT CLAIM TO ANY PARTICULAR FONT, STYLE, SIZE, OR COLOR.

THE FOREIGN WORDING IN THE MARK TRANSLATES INTO ENGLISH AS TO THE STREET.

FOR ATHLETIC SHOES; BASEBALL SHOES; GOLF SHIRTS; GOLF SHOES; JOGGING PANTS; KNIT SHIRTS; NON-DISPOSABLE CLOTH TRAINING PANTS; OPEN-NECKED SHIRTS; PANTS; POLO SHIRTS; RUNNING SHOES; SHIRTS; SHOES; SHORT-SLEEVED SHIRTS; SKI AND SNOWBOARD SHOES AND PARTS THEREOF; SOCCER SHOES; SPORT SHIRTS; SPORTS SHIRTS; SPORTS SHIRTS WITH SHORT SLEEVES; STRETCH PANTS; SWEAT PANTS; SWEAT SHIRTS; T-SHIRTS; TEE SHIRTS; TENNIS SHOES; TRACK AND FIELD SHOES; TRACK PANTS; TRAINING SHOES; TRIATHLON CLOTHING, NAMELY, TRIATHLON TIGHTS, TRIATHLON SHORTS, TRIATHLON SINGLETTS, TRIATHLON SHIRTS, TRIATHLON SUITS; VOLLEYBALL SHOES; WATERPROOF JACKETS AND PANTS; WIND PANTS; BASEBALL CAPS; CAP VISORS; CAPS; CAPS WITH VISORS (U.S. CLS. 22 AND 39).
CHRIS WELLS, EXAMINING ATTORNEY

SN 77-319,054. BENNETT, DUANE, SPRINGFIELD, MA.
FILED 11-1-2007.



THE MARK CONSISTS OF TRADE DRESS PRODUCT PACKAGING IN THE FORM OF A THREE-DIMENSIONAL CAGE SHAPE PACKAGE FOR THE CLOTHING..

FOR UNDERGARMENTS; THONGS; DRESS SHIRTS; KNIT SHIRTS; POLO SHIRTS; SHIRTS; SPORT SHIRTS; SWEAT SHIRTS; T-SHIRTS; SKIRTS AND DRESSES; DENIMS; PANTS; SWEAT PANTS; YOGA PANTS; SHOES; HATS; CAPS; VISORS; BRAS; SPORTS BRAS; BATHING SUITS; GYM SUITS; SUITS; SWIMWEAR; LINGERIE; JACKETS; BELTS; SWEATERS (U.S. CLS. 22 AND 39).

FIRST USE 8-31-2007; IN COMMERCE 8-31-2007.
DARRYL SPRUILL, EXAMINING ATTORNEY

CLASS 25—(Continued).

SN 77-320,294. SPANX, INC., ATLANTA, GA. FILED 11-2-2007.

FANTASTIC FIRMERS

THE MARK CONSISTS OF STANDARD CHARACTERS WITHOUT CLAIM TO ANY PARTICULAR FONT, STYLE, SIZE, OR COLOR.

FOR CLOTHING, NAMELY, BODY SHAPERS, CAMI-SOLES, AND PANTIES (U.S. CLS. 22 AND 39).

FIRST USE 6-14-2007; IN COMMERCE 6-14-2007.
JENNIFER MARTIN, EXAMINING ATTORNEY

SN 77-323,816. MPC PROPERTIES, LLC, JACKSON HEIGHTS, NY. FILED 11-7-2007.

MEET JACK HEIGHTS

THE MARK CONSISTS OF STANDARD CHARACTERS WITHOUT CLAIM TO ANY PARTICULAR FONT, STYLE, SIZE, OR COLOR.

THE NAME "JACK HEIGHTS" DOES NOT IDENTIFY A LIVING INDIVIDUAL.

FOR MEN'S, LADIES AND CHILDREN'S CLOTHING, NAMELY, SHOES, BOOTS, SNEAKERS, SLIPPERS, SHIRTS, SHORTS, BLOUSES, TEE SHIRTS, JACKETS, COATS, PANTS, HATS, SKIRTS, GLOVES, BELTS, TIES, SWEATERS, BATHING SUITS, ROBES, PAJAMAS, HOSIERY, SOCKS, UNDERWEAR, SUITS, DRESSES, SCARVES, EARMUFFS, CLOTH BIBS, AND GOWNS (U.S. CLS. 22 AND 39).

GILBERT SWIFT, EXAMINING ATTORNEY

SN 77-323,819. MPC PROPERTIES, LLC, JACKSON HEIGHTS, NY. FILED 11-7-2007.

JACK HEIGHTS

THE MARK CONSISTS OF STANDARD CHARACTERS WITHOUT CLAIM TO ANY PARTICULAR FONT, STYLE, SIZE, OR COLOR.

THE NAME "JACK HEIGHTS" DOES NOT IDENTIFY A LIVING INDIVIDUAL.

FOR MEN'S, LADIES AND CHILDREN'S CLOTHING, NAMELY, SHOES, BOOTS, SNEAKERS, SLIPPERS, SHIRTS, SHORTS, BLOUSES, TEE SHIRTS, JACKETS, COATS, PANTS, HATS, SKIRTS, GLOVES, BELTS, TIES, SWEATERS, BATHING SUITS, ROBES, PAJAMAS, HOSIERY, SOCKS, UNDERWEAR, SUITS, DRESSES, SCARVES, EARMUFFS, CLOTH BIBS, AND GOWNS (U.S. CLS. 22 AND 39).

GILBERT SWIFT, EXAMINING ATTORNEY

CLASS 25—(Continued).

SN 77-323,844. RUBIE'S COSTUME CO., INC., RICHMOND HILL, NY. FILED 11-7-2007.

RUBIE'S HORRORLAND

THE MARK CONSISTS OF STANDARD CHARACTERS WITHOUT CLAIM TO ANY PARTICULAR FONT, STYLE, SIZE, OR COLOR.

OWNER OF U.S. REG. NOS. 2,629,226, 2,743,091 AND 3,028,007.

FOR MASQUERADE COSTUMES AND MASKS SOLD IN CONNECTION THEREWITH (U.S. CLS. 22 AND 39).

JANICE L. MCMORROW, EXAMINING ATTORNEY

SN 77-325,987. ICDG LLC, LOS ANGELES, CA. FILED 11-9-2007.



THE MARK CONSISTS OF THE WORD "OAKBAY" IN STYLIZED FORM WITH A LOGO OF A RAINDROP BETWEEN TWO SEMI-CIRCLES DIRECTLY ABOVE IT.

FOR CLOTHING AND CLOTHING ACCESSORIES, NAMELY, T-SHIRTS, SWEATSHIRTS, SWEAT PANTS, BLOUSES, SWEATERS, SPORT SHIRTS, JERSEYS, RACING PANTS, SKI PANTS, JEANS, DRESS PANTS, SUITS, UNDERWEAR, SOCKS, BELTS, COATS, JACKETS, HATS, VISORS AND CAPS, FOOTWEAR, HEADWEAR (U.S. CLS. 22 AND 39).

FIRST USE 6-8-2007; IN COMMERCE 6-8-2007.
KIMBERLY PERRY, EXAMINING ATTORNEY

CLASS 25—(Continued).

SN 77-326,280. JONES, MATTHEW D, IRVINE, CA. FILED 11-9-2007.



THE MARK CONSISTS OF THE WORD "MYSELF" WITH AN UPSIDE DOWN Y WITH "MATT JONES" UNDER IT. EVERYTHING IS IN CENTURY GOTHIC FONT SLIGHTLY STRETCHED OUT.

FOR SHIRTS; PANTS; JEANS; JACKETS; PANTIES; UNDERWEAR; SKIRTS; LINGERIE; BOXER BRIEFS; BOXER SHORTS; SHORTS; SWEATERS; DRESSES; SUITS (U.S. CLS. 22 AND 39).

AISHA CLARKE, EXAMINING ATTORNEY

SN 77-328,122. K-SWISS INC., WESTLAKE VILLAGE, CA. FILED 11-13-2007.



OWNER OF U.S. REG. NOS. 1,029,423, 1,843,012 AND OTHERS.

THE MARK CONSISTS OF FIVE CURVED STRIPES. FOR ATHLETIC SHOES; BEACH SHOES; DECK-SHOES; RUNNING SHOES; SHOES; TENNIS SHOES (U.S. CLS. 22 AND 39).

AMY HELLA, EXAMINING ATTORNEY

CLASS 25—(Continued).

SN 77-328,765. HAND INDUSTRIES LLC, MELVILLE, NY. FILED 11-13-2007.



THE COLOR(S) DARK GREY, DARK RED, RED, DARK GREEN, GREEN, BLUE, DARK ORANGE, ORANGE AND DARK YELLOW IS/ARE CLAIMED AS A FEATURE OF THE MARK.

THE MARK CONSISTS OF A GOLFER IMAGE SILHOUETTE HOLDING A GOLF CLUB, WITH THE GOLF CLUB OUTLINED IN DARK GREY; THE GOLFER IMAGE HAVING A HEAD, UPPER BACK AND WAISTBAND OUTLINED IN DARK RED; LEFT TORSO OUTLINED IN RED; LEFT OUTER ARM OUTLINED IN DARK GREEN AND RIGHT OUTER ARM AND TORSO OUTLINED IN GREEN; RIGHT AND LEFT INNER ARMS OUTLINED IN BLUE; LEFT LEG OUTLINED IN ORANGE; LEFT INNER LEG OUTLINED IN DARK YELLOW; RIGHT OUTER AND INNER LEG OUTLINED IN DARK ORANGE; AND RIGHT AND LEFT FEET OUTLINED IN DARK GREY.

FOR CLOTHING, NAMELY, SHIRTS, SWEATERS, PANTS, SHORTS, JACKETS, COATS, TIES, SCARVES, SOCKS, BELTS, SHOES; HEADGEAR, NAMELY, HATS, CAPS, SUN VISORS (U.S. CLS. 22 AND 39).

FIRST USE 11-0-2007; IN COMMERCE 11-0-2007.

RENEE SERVANCE, EXAMINING ATTORNEY

SN 77-330,486. AMG PUBLISHERS, INC., CHATTANOOGA, TN. FILED 11-15-2007.

ORACLES OF FIRE

THE MARK CONSISTS OF STANDARD CHARACTERS WITHOUT CLAIM TO ANY PARTICULAR FONT, STYLE, SIZE, OR COLOR.

OWNER OF U.S. REG. NO. 3,285,211. FOR HATS; SHIRTS; SWEAT SHIRTS (U.S. CLS. 22 AND 39).

FIRST USE 10-15-2007; IN COMMERCE 10-18-2007.

KAREN BRACEY, EXAMINING ATTORNEY

CLASS 25—(Continued).

SN 77-340,131. LITTLE RAPIDS CORPORATION, GREEN BAY, WI. FILED 11-29-2007.

DISPOSACAPE

THE MARK CONSISTS OF STANDARD CHARACTERS WITHOUT CLAIM TO ANY PARTICULAR FONT, STYLE, SIZE, OR COLOR.
FOR DISPOSABLE CAPES FOR USE IN BEAUTY SALONS AND SPAS (U.S. CLS. 22 AND 39).
DAVID MILLER, EXAMINING ATTORNEY

SN 77-340,754. EPIC GAMES, INC., CARY, NC. FILED 11-30-2007.

GEARS OF WAR

THE MARK CONSISTS OF STANDARD CHARACTERS WITHOUT CLAIM TO ANY PARTICULAR FONT, STYLE, SIZE, OR COLOR.
OWNER OF U.S. REG. NOS. 3,022,153, 3,327,331 AND OTHERS.
FOR FOOTWEAR (U.S. CLS. 22 AND 39).
RON FAIRBANKS, EXAMINING ATTORNEY

SN 77-353,652. RAFAELLA APPAREL GROUP, INC., NEW YORK, NY. FILED 12-17-2007.

RAFAELLA WKND

THE MARK CONSISTS OF STANDARD CHARACTERS WITHOUT CLAIM TO ANY PARTICULAR FONT, STYLE, SIZE, OR COLOR.
OWNER OF U.S. REG. NOS. 2,075,889 AND 2,075,890.
FOR WOMEN'S SPORTSWEAR AND OUTWEAR CLOTHING, NAMELY, JEANS, PANTS, SHIRTS, JACKETS, BLAZERS, BLOUSES, T-SHIRTS, SWEATERS, SKIRTS, DRESSES, SUITS, VESTS AND SHORTS (U.S. CLS. 22 AND 39).
CHRISIE B. KING, EXAMINING ATTORNEY

CLASS 25—(Continued).

SN 77-975,117. POUT LIMITED, LONDON WC2H 9JE, UNITED KINGDOM, FILED 12-22-2006.

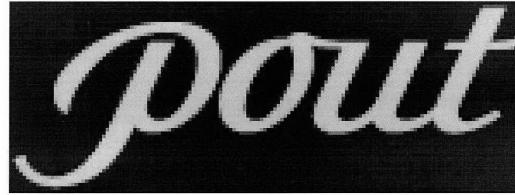

OWNER OF U.S. REG. NO. 3,081,118.
FOR NIGHTSGOWNS, ROBES AND SLIPPERS (U.S. CLS. 22 AND 39).
BRIAN PINO, EXAMINING ATTORNEY

SN 78-173,283. LARCO PTY LTD., ST. PETERS, NEW SOUTH WALES, AUSTRALIA, FILED 10-10-2002.



OWNER OF AUSTRALIA REG. NO. 925569, DATED 9-3-2002, EXPIRES 9-3-2012.
NO CLAIM IS MADE TO THE EXCLUSIVE RIGHT TO USE "AMERICA", APART FROM THE MARK AS SHOWN.
FOR ARTICLES OF CLOTHING, NAMELY, BLOUSES, CARDIGANS, DRESSES, DRESSING GOWNS, FOOTBALL JERSEYS, JACKETS, JEANS, JUMPERS, PAJAMAS AND NIGHT FROCKS, PANTS, PARKAS, SCARVES, SHOES, SHORTS, SINGLETs, SKIRTS, SKI WEAR COMPRISING PANTS AND JACKETS, SOCKS, SWEATSHIRTS, SWIMMING COSTUMES, T-SHIRTS, TRACKSUITS, UNDERPANTS, BRASSIERES, BELTS FOR MEN AND WOMEN, PANTYHOSE, TIES, SCARVES, EARMUFFS, BALACLAVAS, DRESS SUITS, JACKETS, PANTS, CASUAL JACKETS, INDUSTRIAL CLOTHING, NAMELY, BIBS, BRACES, BOILER SUITS, CAR RACING SUITS, BABY CLOTHES, NAMELY, SOCKS, SINGLETs, UNDERPANTS, CLOTH NAPPIES, TIGHTS, TRACKSUITS, SHIRTS, BLOUSES, BOOTIES, SHOES, MATINEE JACKETS, NIGHTIES, PETTICOATS, DRESSES, PANTS, MITTENS, GLOVES, BONNETS, CAPS, HATS, PILCHERS, NAMELY, DIAPER COVERS, LEGGINGS, ROMPER SUITS, NON-PAPER BIBS, SHAWLS, VESTS, CARDIGANS, PULLOVERS, JUMPERS, BERETS AND DRESSING GOWNS (U.S. CLS. 22 AND 39).
LINDA MICKLEBURGH, EXAMINING ATTORNEY

SN 78-249,466. CONVERSE INC., NORTH ANDOVER, MA. FILED 5-14-2003.

CONVERSE ICON

OWNER OF U.S. REG. NOS. 2,063,154 AND 2,098,296.
FOR ATHLETIC FOOTWEAR (U.S. CLS. 22 AND 39).
CAROLYN CATALDO, EXAMINING ATTORNEY

CLASS 25—(Continued).

SN 78-257,380. CONVERSE INC., NORTH ANDOVER, MA.
FILED 6-3-2003.

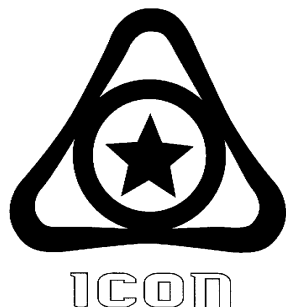

OWNER OF U.S. REG. NOS. 2,063,154 AND 2,098,296.
FOR ATHLETIC FOOTWEAR (U.S. CLS. 22 AND 39).
CAROLYN CATALDO, EXAMINING ATTORNEY

SN 78-447,235. SENIZERGUES, PIERRE ANDRE, NEWPORT
BEACH, CA. FILED 7-7-2004.



OWNER OF U.S. REG. NO. 2,898,280.
THE MARK CONSISTS OF THE TERM "G2" IN A
STYLIZED, THREE-DIMENSIONAL DESIGN, AND THE
WORDING "FULL IMPACT" AND "SYSTEM G2 FULL
IMPACT".

FOR SHOCK ABSORBING AND CUSHIONING COM-
PONENTS, NAMELY, INSOLES AND MIDSOLES, SOLD
AS INTEGRAL COMPONENTS OF FOOTWEAR (U.S.
CLS. 22 AND 39).

FIRST USE 6-30-2004; IN COMMERCE 6-30-2004.
JEAN IM, EXAMINING ATTORNEY

SN 78-526,974. DYNASTY APPAREL INDUSTRIES, INC.,
MIAMI, FL. FILED 12-3-2004.



NO CLAIM IS MADE TO THE EXCLUSIVE RIGHT TO
USE "ATHLETIC GEAR", APART FROM THE MARK AS
SHOWN.

THE COLOR(S) RED IS/ARE CLAIMED AS A FEATURE
OF THE MARK.

THE MARK CONSISTS OF THE WORDS "STITCHES
ATHLETIC GEAR" IN STYLIZED RED LETTERING.

FOR CLOTHING FOR ADULTS AND CHILDREN,
NAMELY, T-SHIRTS, JERSEYS, CARDIGANS, POLO
SHIRTS, FLEECE TOPS, PULLOVERS, JACKETS,
HOODED JACKETS, SHIRTS, SHORTS, AND SHIRT
AND SHORTS SETS (U.S. CLS. 22 AND 39).

FIRST USE 8-30-2004; IN COMMERCE 8-30-2004.
MICHAEL ENGEL, EXAMINING ATTORNEY

CLASS 25—(Continued).

SN 78-652,638. MY CREATURE COMFORT CREATIONS,
LLC D/B/A CREATURE COMFORT CREATIONS, SUGAR
LAND, TX. FILED 6-16-2005.



FOR SHIRTS, SHORTS, SKIRTS, DRESSES, PANTS,
LEGGINGS, JACKETS, PULLOVERS, LOUNGEWEAR,
SLEEPWEAR (U.S. CLS. 22 AND 39).
ALEXANDER L. POWERS, EXAMINING ATTORNEY

SN 78-724,163. TAG GROUP (HOLDINGS) S.A., LUXEM-
BOURG, LUXEMBOURG, FILED 9-30-2005.



OWNER OF BENELUX REG. NO. 438717, DATED 11-3-
1987, RENEWED AS REG. NO. 438717, DATED 11-3-2007,
EXPIRES 11-3-2017.

OWNER OF U.S. REG. NO. 1,471,988.
FOR SPORTS CLOTHING, NAMELY, JACKETS,
SHIRTS, T-SHIRTS, HATS, CAPS, TIES, SCARVES,
TROUSERS, SWEATSUITS, SHORTS, BELTS AND
SHOES (U.S. CLS. 22 AND 39).

CHRISTOPHER BUONGIORNO, EXAMINING ATTOR-
NEY

SN 78-742,817. COOKIE JAR ENTERTAINMENT INC., MON-
TREAL, CANADA, FILED 10-28-2005.



FOR MEN'S, WOMEN'S AND CHILDREN'S CLOTH-
ING, NAMELY, T-SHIRTS, SHIRTS, PANTS, SLACKS,
SHORTS, BOTTOMS, SKIRTS, TOPS, SUITS, TIES,
DRESSES, JACKETS, SWEATERS, COATS, PARKAS,
SCARVES, APRONS, SWIMWEAR, SOCKS, HOSIERY,
HATS, CAPS, GLOVES, MITTENS, SLEEPWEAR, PULL-
OVERS, VESTS, JOGGING SUITS, LOUNGEWEAR,
PLAY SUITS, JERSEYS, UNDERWEAR, RAINWEAR,
FOOTWEAR, INFANT WEAR (U.S. CLS. 22 AND 39).

KATHERINE E. HALMEN, EXAMINING ATTORNEY

CLASS 25—(Continued).

SN 78-750,936. JIAXING DEYONG TEXTILES CO., LTD., ZHEJIANG PROVINCE, CAPE VERDE, FILED 11-10-2005.

JDTEC

THE MARK CONSISTS OF STANDARD CHARACTERS WITHOUT CLAIM TO ANY PARTICULAR FONT, STYLE, SIZE, OR COLOR.
FOR BED CLOTHES, NAMELY, PAJAMAS AND NIGHT GOWNS (U.S. CLS. 22 AND 39).
BARBARA BROWN, EXAMINING ATTORNEY

SN 78-761,868. DIELSI, ANTHONY MR., HUNTINGTON BEACH, CA. FILED 11-28-2005.

SHARK BAIT

THE MARK CONSISTS OF STANDARD CHARACTERS WITHOUT CLAIM TO ANY PARTICULAR FONT, STYLE, SIZE, OR COLOR.
FOR COVERUPS; HATS; JACKETS; PANTS; SANDALS; SHORTS; SKIRTS; SWEAT SHIRTS; SWEATERS; SWIM WEAR; TOPS (U.S. CLS. 22 AND 39).
PAUL CROWLEY, EXAMINING ATTORNEY

SN 78-762,581. STUART JR, HAROLD R, LITTLETON, CO. FILED 11-29-2005.

I ♥ PORN

THE MARK CONSISTS OF HEARTS; HUMAN HEARTS, INCLUDING FIGURES OF HEARTS AS DEPICTED ON PLAYING CARDS.
SEC. 2(F).
FOR CLOTHING, NAMELY WOMENS'S AND MENS SHIRTS, SWEAT SHIRTS, TANK TOPS, PANTS, SHORTS, LINGERIE, CAPS, AND BELTS (U.S. CLS. 22 AND 39).
FIRST USE 10-17-1998; IN COMMERCE 9-29-1999.
MICHAEL W. BAIRD, EXAMINING ATTORNEY

CLASS 25—(Continued).

SN 78-771,011. ROSENTHAL, RICHARD D., NORWALK, CT. FILED 12-12-2005.

TAILOR GOLF

THE MARK CONSISTS OF STANDARD CHARACTERS WITHOUT CLAIM TO ANY PARTICULAR FONT, STYLE, SIZE, OR COLOR.
OWNER OF U.S. REG. NO. 3,170,539.
NO CLAIM IS MADE TO THE EXCLUSIVE RIGHT TO USE "GOLF", APART FROM THE MARK AS SHOWN.
SEC. 2(F) AS TO "TAILOR".
FOR CLOTHING, NAMELY, SHIRTS, BLOUSES, TANK TOPS, SWEATERS, PULLOVERS, PANTS, JEANS, SHORTS, SKIRTS, DRESSES, CULOTTES (U.S. CLS. 22 AND 39).
MARK RADEMACHER, EXAMINING ATTORNEY

SN 78-771,028. ROSENTHAL, RICHARD D., NORWALK, CT. FILED 12-12-2005.

TAILOR VINTAGE

THE MARK CONSISTS OF STANDARD CHARACTERS WITHOUT CLAIM TO ANY PARTICULAR FONT, STYLE, SIZE, OR COLOR.
OWNER OF U.S. REG. NO. 3,170,539.
NO CLAIM IS MADE TO THE EXCLUSIVE RIGHT TO USE "VINTAGE", APART FROM THE MARK AS SHOWN.
SEC. 2(F) AS TO "TAILOR".
FOR CLOTHING, NAMELY, SHIRTS, BLOUSES, TANK TOPS, SWEATERS, PULLOVERS, PANTS, JEANS, SHORTS, SKIRTS, DRESSES, CULOTTES (U.S. CLS. 22 AND 39).
MARK RADEMACHER, EXAMINING ATTORNEY

SN 78-798,399. TTN APPAREL PTRS. LLC, RED BANK, NJ. FILED 1-24-2006.

TOMMY TOUGHNUTS

THE MARK CONSISTS OF STANDARD CHARACTERS WITHOUT CLAIM TO ANY PARTICULAR FONT, STYLE, SIZE, OR COLOR.
FOR APPAREL, NAMELY, BEACHWEAR; BLOUSES; BOTTOMS; DRESSES; FOOTWEAR; HEADWEAR; HOSIERY; LINGERIE; LOUNGEWEAR; PAJAMAS; PANTS; SHIRTS; SHORTS; SKIRTS; SLEEPWEAR; SWIM WEAR; T-SHIRTS; TOPS; UNDERGARMENTS (U.S. CLS. 22 AND 39).
FIRST USE 11-23-2005; IN COMMERCE 11-23-2005.
BARBARA BROWN, EXAMINING ATTORNEY

CLASS 25—(Continued).

SN 78-798,421. TTN APPAREL PTRS. LLC, RED BANK, NJ.
FILED 1-24-2006.



"TOMMY TOUGHNUTS" AND THE PORTRAIT IN THE
MARK DO NOT IDENTIFY A LIVING INDIVIDUAL.

FOR APPAREL, NAMELY, BEACHWEAR; BLOUSES;
BOTTOMS; DRESSES; FOOTWEAR; HEADWEAR; HOSI-
ERY; LINGERIE; LOUNGEWEAR; PAJAMAS; PANTS;
SHIRTS; SHORTS; SKIRTS; SLEEPWEAR; SWIM WEAR;
T-SHIRTS; TOPS; UNDERGARMENTS (U.S. CLS. 22
AND 39).

FIRST USE 11-23-2005; IN COMMERCE 11-23-2005.
BARBARA BROWN, EXAMINING ATTORNEY

SN 78-807,135. HAM, ISAIAH, PHILADELPHIA, PA. FILED 2-
3-2006.

STATEMENT

THE MARK CONSISTS OF STANDARD CHARACTERS
WITHOUT CLAIM TO ANY PARTICULAR FONT, STYLE,
SIZE, OR COLOR.

FOR T-SHIRTS (U.S. CLS. 22 AND 39).
FIRST USE 2-3-2006; IN COMMERCE 2-3-2006.
TRACY WHITTAKER-BROWN, EXAMINING ATTOR-
NEY

CLASS 25—(Continued).

SN 78-808,142. MARTINEZ, JOHNNY C., HAYWARD, CA.
FILED 2-6-2006.

SKELETONZ

THE MARK CONSISTS OF STANDARD CHARACTERS
WITHOUT CLAIM TO ANY PARTICULAR FONT, STYLE,
SIZE, OR COLOR.

FOR CLOTHING, NAMELY, SHIRTS, T-SHIRTS,
SWEATSHIRTS, SWEATPANTS, PANTS, TANK TOPS,
JERSEYS, SHORTS, PAJAMAS, SPORT SHIRTS, SWEA-
TERS, BELTS, TIES, NIGHTSHIRTS, HATS, WARM-UP
SUITS, JACKETS, PARKAS, COATS, HEAD BANDS,
WRIST BANDS, APRONS, BOXER SHORTS, SLACKS,
CAPS, GLOVES, FOOTWEAR, AND SOCKS (U.S. CLS. 22
AND 39).

BARBARA RUTLAND, EXAMINING ATTORNEY

SN 78-868,522. THE VERY BEST, LOS ANGELES, CA. FILED
4-24-2006.

LOCAL CELEBRITY

THE MARK CONSISTS OF STANDARD CHARACTERS
WITHOUT CLAIM TO ANY PARTICULAR FONT, STYLE,
SIZE, OR COLOR.

FOR CLOTHING, NAMELY, T-SHIRTS, TANK TOPS,
SHIRTS, SWEAT SHIRTS, SWEAT PANTS, FLEECE
PANTS, SHORTS, FOOTWEAR, WRISTBANDS, HATS
AND CAPS (U.S. CLS. 22 AND 39).

FIRST USE 4-26-2004; IN COMMERCE 5-5-2004.
HEATHER SAPP, EXAMINING ATTORNEY

SN 78-868,532. THE VERY BEST, LOS ANGELES, CA. FILED
4-24-2006.

**LOCAL
CELEBRITY**

FOR CLOTHING, NAMELY, T-SHIRTS, TANK TOPS,
SHIRTS, SWEAT SHIRTS, SWEAT PANTS, FLEECE
PANTS, SHORTS, FOOTWEAR, WRISTBANDS, HATS
AND CAPS (U.S. CLS. 22 AND 39).

FIRST USE 4-26-2004; IN COMMERCE 5-5-2004.
HEATHER SAPP, EXAMINING ATTORNEY

CLASS 25—(Continued).

SN 78-887,283. TITUS, MICHAEL S, FAIRBANKS, AK. FILED 5-18-2006.



NO CLAIM IS MADE TO THE EXCLUSIVE RIGHT TO USE "WEAR", APART FROM THE MARK AS SHOWN.

THE MARK CONSISTS OF A STYLIZED LETTER "C" WITH THE WORD "WEAR" ATTACHED AND A MOON SLIVER ARCH ON THE INSIDE OF THE STYLIZED "C".

FOR ANKLE SOCKS; ANKLETS; ANTI-PERSPIRANT SOCKS; ATHLETIC SHOES; BALLET SHOES; BASEBALL CAPS; BASEBALL SHOES; BASKETBALL SNEAKERS; BEACH SHOES; BICYCLE GLOVES; BICYCLING GLOVES; BOWLING SHOES; BOXING SHOES; BRIEFS; CAMP SHIRTS; CAP VISORS; CAPRI PANTS; CAPS; CAPS WITH VISORS; COATS; COATS FOR MEN AND WOMEN; COATS MADE OF COTTON; COATS OF DENIM; CYCLING SHOES; DENIM JACKETS; DENIMS; DOWN JACKETS; DRESS SHIRTS; FISHERMEN'S JACKETS; FOOTBALL SHOES; FUR COATS AND JACKETS; FUR JACKETS; GLOVES; GOLF CAPS; GOLF SHIRTS; GOLF SHOES; GYMNAS TIC SHOES; HANDBALL SHOES; HAT BANDS; HATS; HEADBANDS; HEADBANDS AGAINST SWEATING; HEADGEAR, NAMELY, HATS, BASEBALL CAPS, SKULL CAPS, WINTER HATS; HEAVY JACKETS; HOCKEY SHOES; INFANTS' SHOES AND BOOTS; JACKETS; JOGGING PANTS; KNIT SHIRTS; KNITTED CAPS; KNITTED UNDERWEAR; LADIES' UNDERWEAR; LEATHER JACKETS; LIGHT-REFLECTING JACKETS; LONG JACKETS; LONG SLEEVED VESTS; MEN AND WOMEN JACKETS, COATS, TROUSERS, VESTS; MEN'S SOCKS; MOTOR-CYCLE GLOVES; NECK BANDS; NIGHT SHIRTS; NURSE PANTS; OPEN-NECKED SHIRTS; OVER COATS; PANTS; POLO SHIRTS; RAIN COATS; RAIN JACKETS; RAINPROOF JACKETS; RIDING GLOVES; RUBBER SHOES; RUGBY SHOES; RUNNING SHOES; SHIRT FRONTS; SHIRTS; SHIRTS FOR SUITS; SHOES; SHORT TROUSERS; SHORT-SLEEVED OR LONG-SLEEVED T-SHIRTS; SHORT-SLEEVED SHIRTS; SHORTS; SKI AND SNOWBOARD SHOES AND PARTS THEREOF; SKI GLOVES; SKI JACKETS; SKI PANTS; SKIING SHOES; SKULL CAPS; SLEEP SHIRTS; SLEEVED OR SLEEVELESS JACKETS; SMALL HATS; SNEAKERS; SNOW PANTS; SNOWBOARD GLOVES; SNOWBOARD PANTS; SOCCER SHOES; SOCKS; SPORT COATS; SPORT SHIRTS; SPORTS JACKETS; SPORTS SHIRTS; SPORTS SHIRTS WITH SHORT SLEEVES; SUEDE JACKETS; SUIT COATS; SWEAT BANDS; SWEAT PANTS; SWEAT SHIRTS; SWEAT SHORTS; SWIM CAPS; SWIMMING CAPS; T-SHIRTS; TAP PANTS; TENNIS SHOES; THERMAL SOCKS; THERMAL UNDERWEAR; THONGS; TRACK AND FIELD SHOES; TRACK PANTS; TRAINING SHOES; TRENCH COATS; TROUSERS; TROUSERS FOR SWEATING; UNDERWEAR; VESTS; VOLLEYBALL SHOES; WALKING SHORTS; WATER SOCKS; WATER-PROOF JACKETS AND PANTS; WET SUIT GLOVES; WIND COATS; WIND RESISTANT JACKETS; WIND SHIRTS; WIND VESTS; WIND-JACKETS; WOMEN'S SHOES; WOMEN'S UNDERWEAR; WOOLLEN SOCKS; WOOLLY HATS; WORK SHOES AND BOOTS; WOVEN OR KNITTED UNDERWEAR; WRIST BANDS; WRISTBANDS (U.S. CLS. 22 AND 39).

JASON ROTH, EXAMINING ATTORNEY

CLASS 25—(Continued).

SN 78-901,704. LI & FUNG (B.V.I.) LIMITED, ROAD TOWN, TORTOLA, BR.VIRGIN ISLANDS, FILED 6-6-2006.



LI & FUNG

OWNER OF HONG KONG REG. NO. 200015588, DATED 1-23-1998, EXPIRES 1-23-2015.

OWNER OF U.S. REG. NO. 2,299,648.

THE MARK CONSISTS OF A SHADED SQUARE THAT CONTAINS STYLIZED LETTERING AND DESIGNS, AS WELL AS WORDING BELOW THE SQUARE. THE WORDING BELOW THE SQUARE READS "LI & FUNG". THE LETTERING WITHIN THE SQUARE SPELLS OUT "L&F". THIS LETTERING IS BORDERED ON EACH SIDE BY TWO SMALL CIRCLES IN THE DESIGN. THE LETTERS AND CIRCLES IN THE DESIGN FORM A STYLIZED OVAL SHAPE WITHIN THE SQUARE.

THE FOREIGN WORDING "LI & FUNG" IN THE MARK TRANSLATES INTO ENGLISH AS "PROFIT" AND "ABUNDANCE."

FOR CLOTHING, NAMELY, HEADWEAR, FOOTWEAR, TOPS AND BOTTOMS, TANK TOPS, T-SHIRTS, SHIRTS, NECKTIES, ASCOTS, SWEATSHIRTS, SWEAT PANTS, SWEAT SUITS, ATHLETIC UNIFORMS, CARDIGANS, SWEATERS, JACKETS, SUITS, COATS, ANORAKS, JERSEYS, VESTS, PULLOVERS, PANTS, BLOUSES, LEGGINGS, SHORTS, SKORTS, ROMPERS, TROUSERS, JUMPSUITS, OVERALLS, SKIRTS, DRESSES, JUMPERS, BATHING SUITS, UNITARDS, LEOTARDS, TIGHTS, UNDERWEAR, SLEEPWEAR, SLEEP SHIRTS, PAJAMAS, ROBES, NIGHTGOWNS, SLIPPERS SOCKS, SOCKS, HOSIERY, BANDANNAS, SCARVES, MUFFLERS, HATS, CAPS, HEADBANDS, WRIST BANDS, GLOVES, BELTS, SUSPENDERS, RAINCOATS, GALOSHES (U.S. CLS. 22 AND 39).

CORY BOONE, EXAMINING ATTORNEY

CLASS 25—(Continued).

SN 78-901,735. LI & FUNG (B.V.I.) LIMITED, ROAD TOWN, TORTOLA, BR.VIRGIN ISLANDS, FILED 6-6-2006.



OWNER OF HONG KONG REG. NO. 199910437AA, DATED 1-23-1998, EXPIRES 1-23-2015.

OWNER OF U.S. REG. NO. 2,299,648.

THE MARK CONSISTS OF A SHADED SQUARE THAT CONTAINS STYLIZED LETTERING AND DESIGNS. THE LETTERING WITHIN THE SQUARE SPELLS OUT "L&F". THIS LETTERING IS BORDERED ON EACH SIDE BY TWO SMALL CIRCLES IN THE DESIGN. THE LETTERS AND CIRCLES IN THE DESIGN FORM A STYLIZED OVAL SHAPE WITHIN THE SQUARE.

FOR CLOTHING, NAMELY, HEADWEAR, FOOTWEAR, TOPS AND BOTTOMS, TANK TOPS, T-SHIRTS, SHIRTS, NECKTIES, ASCOTS, SWEATSHIRTS, SWEAT PANTS, SWEAT SUITS, ATHLETIC UNIFORMS, CARDIGANS, SWEATERS, JACKETS, SUITS, COATS, ANORAKS, JERSEYS, VESTS, PULLOVERS, PANTS, BLOUSES, LEGGINGS, SHORTS, SKORTS, ROMPERS, TROUSERS, JUMPSUITS, OVERALLS, SKIRTS, DRESSES, JUMPERS, BATHING SUITS, UNITARDS, LEOTARDS, TIGHTS, UNDERWEAR, SLEEPWEAR, SLEEP SHIRTS, PAJAMAS, ROBES, NIGHTGOWNS, SLIPPERS SOCKS, SOCKS, HOSIERY, BANDANNAS, SCARVES, MUFFLERS, HATS, CAPS, HEADBANDS, WRIST BANDS, GLOVES, BELTS, SUSPENDERS, RAINCOATS, GALOSHES (U.S. CLS. 22 AND 39).

CORY BOONE, EXAMINING ATTORNEY

SN 78-911,205. RITTER, ALICE, NEW YORK, NY. FILED 6-19-2006.

ALICE RITTER

THE MARK CONSISTS OF STANDARD CHARACTERS WITHOUT CLAIM TO ANY PARTICULAR FONT, STYLE, SIZE, OR COLOR.

THE NAME "ALICE RITTER" IDENTIFIES A LIVING INDIVIDUAL WHOSE CONSENT IS OF RECORD.

FOR CLOTHING FOR WOMEN, NAMELY, SHIRTS, SKIRTS, PANTS, BLOUSES, DRESSES, JACKETS, COATS, AND SWEATERS (U.S. CLS. 22 AND 39).

FIRST USE 1-9-2004; IN COMMERCE 1-9-2004.

TEJBIR SINGH, EXAMINING ATTORNEY

CLASS 25—(Continued).

SN 78-916,531. SHENANDOAH TRADING CO., LTD., HUWET TOWN, YUU LIN HSIEN, TAIWAN, FILED 6-26-2006.

STELLA LUNA

OWNER OF TAIWAN REG. NO. 01226386, DATED 9-1-2006, EXPIRES 8-31-2016.

OWNER OF U.S. REG. NO. 3,110,649.

THE FOREIGN WORDING IN THE MARK TRANSLATES INTO ENGLISH AS "STAR MOON".

FOR SUITS, JACKETS, DRESSES, SKIRTS, UNDERWEAR, SWIMSUITS, T-SHIRTS, PARKAS, SPORTS UNIFORMS, SHORTS, SHOES, BOOTS, SPORTS SHOES, SANDALS, HATS, SOCKS, GLOVES, BELTS FOR CLOTHING, TIES FOR CLOTHING, NECKERCHIEFS (U.S. CLS. 22 AND 39).

DEZMONA MIZELLE, EXAMINING ATTORNEY

SN 78-920,925. MCGOVERN, MICHAEL, CARLSBAD, CA. FILED 6-30-2006.

TOGABEACH

THE MARK CONSISTS OF STANDARD CHARACTERS WITHOUT CLAIM TO ANY PARTICULAR FONT, STYLE, SIZE, OR COLOR.

FOR CLOTHING, NAMELY, SHIRTS, T-SHIRTS, FOOTWEAR, SANDALS, SWIMWEAR AND SHORTS (U.S. CLS. 22 AND 39).

LINDA LAVACHE, EXAMINING ATTORNEY

SN 78-927,296. SLICE OF FASHION LLC, BOULDER, CO. FILED 7-11-2006.

Sliver Sleeve

THE MARK CONSISTS OF STANDARD CHARACTERS WITHOUT CLAIM TO ANY PARTICULAR FONT, STYLE, SIZE, OR COLOR.

NO CLAIM IS MADE TO THE EXCLUSIVE RIGHT TO USE "SLEEVE", APART FROM THE MARK AS SHOWN.

FOR CLOTHING, NAMELY, SLEEVES AND ARM COVERS WORN FOR FASHION (U.S. CLS. 22 AND 39).

FIRST USE 6-8-2006; IN COMMERCE 6-8-2006.

CORY BOONE, EXAMINING ATTORNEY

CLASS 25—(Continued).

SN 78-937,998. W. L. GORE & ASSOCIATES, INC., NEWARK, DE. FILED 7-26-2006.

GORE BIKE WEAR

THE MARK CONSISTS OF STANDARD CHARACTERS WITHOUT CLAIM TO ANY PARTICULAR FONT, STYLE, SIZE, OR COLOR.

OWNER OF U.S. REG. NOS. 1,670,825, 1,804,547 AND 1,983,461.

NO CLAIM IS MADE TO THE EXCLUSIVE RIGHT TO USE "BIKE WEAR", APART FROM THE MARK AS SHOWN.

FOR JERSEYS, JACKETS, PANTS, VESTS, SINGLETS, SHORTS, LEG WARMERS, KNEE WARMERS, GLOVES, FOOTWEAR, HEADGEAR, NAMELY, HATS, CAPS, NECK GAITERS, HEADBANDS (U.S. CLS. 22 AND 39).

MARY MUNSON, EXAMINING ATTORNEY

CLASS 25—(Continued).

SN 78-940,836. GEORGE, LARA L., BETHESDA, MD. FILED 7-31-2006.



THE COLOR(S) BLACK, BROWN, BEIGE, TAN AND RED IS/ARE CLAIMED AS A FEATURE OF THE MARK.

THE MARK CONSISTS OF A STYLIZED DESIGN OF A YOUNG KANGAROO'S HEAD. THE COLOR BLACK APPEARS AROUND THE PERIMETER OF THE FACE DEPICTED IN THE DESIGN, AND IN THE EYEBROWS, EYES, NOSE AND MOUTH OF THE FACE; THE COLOR BROWN APPEARS IN THE INTERIOR OF THE EARS ATTACHED TO THE FACE; THE COLOR BEIGE APPEARS AS SHADING AROUND THE EYES, NOSE AND MOUTH; THE COLOR TAN APPEARS AS SHADING AROUND THE EARS AND FACE; THE COLOR RED APPEARS IN THE TONGUE.

FOR BELTS; BIBS NOT OF CLOTH OR PAPER; CAMP SHIRTS; CAPS; CHILDREN'S AND INFANTS' CLOTH BIBS; CHILDREN'S CLOTH EATING BIBS; CLOTH BIBS; CLOTH DIAPERS; CLOTHING FOR WEAR IN JUDO PRACTICES; CLOTHING FOR WEAR IN WRESTLING GAMES; CLOTHING, NAMELY, ARM WARMERS; CLOTHING, NAMELY, FOLK COSTUMES; CLOTHING, NAMELY, KNEE WARMERS; CLOTHING, NAMELY, NECK TUBES; CLOTHING, NAMELY, WRAP-AROUNDS; CORSETS; DRESS SHIRTS; DUSTERS; GOLF SHIRTS; HATS; HEADBANDS AGAINST SWEATING; HOODS; INFANT AND TODDLER ONE PIECE CLOTHING; INFANT CLOTH DIAPERS; JERSEYS; KNIT SHIRTS; LEATHER BELTS; MANTLES; MUFFLERS; NIGHT SHIRTS; NON-DISPOSABLE CLOTH TRAINING PANTS; OPEN-NECKED SHIRTS; PARTS OF CLOTHING, NAMELY, GUSSETS FOR TIGHTS, GUSSETS FOR STOCKINGS, GUSSETS FOR BATHING SUITS, GUSSETS FOR UNDERWEAR, GUSSETS FOR LEOTARDS AND GUSSETS FOR FOOTLETS; PERSPIRATION ABSORBENT UNDERWEAR CLOTHING; PIQUET SHIRTS; POLO SHIRTS; SHIFTS; SHIRT FRONTS; SHIRTS; SHORT SETS; SHORT-SLEEVED OR LONG-SLEEVED T-SHIRTS; SHORT-SLEEVED SHIRTS; SHOULDER PADS FOR CLOTHING; SHOULDER WRAPS; SLEEP SHIRTS; SPORT SHIRTS; SPORTS SHIRTS; SPORTS SHIRTS WITH SHORT SLEEVES; STOCKINGS; SWADDLING CLOTHES; SWEAT BANDS; SWEAT PANTS; SWEAT SHIRTS; SWEAT SHORTS; SWEAT SUITS; T-SHIRTS; TIES; TOPS; TROUSERS FOR SWEATING; WIND SHIRTS; WRAPS (U.S. CLS. 22 AND 39).

BARNEY CHARLON, EXAMINING ATTORNEY

SN 78-941,237. JONES INVESTMENT CO. INC., WILMINGTON, DE. FILED 7-31-2006.

CHEEKSKIRT

THE MARK CONSISTS OF STANDARD CHARACTERS WITHOUT CLAIM TO ANY PARTICULAR FONT, STYLE, SIZE, OR COLOR.

FOR APRONS; BELTS ; BOTTOMS; SKIRTS (U.S. CLS. 22 AND 39).

MARILYN IZZI, EXAMINING ATTORNEY

CLASS 25—(Continued).

SN 78-953,895. PARAGONE WELLNESS, INC., EL DORADO HILLS, CA. FILED 8-16-2006.

TRAIN TO LIVE!

THE MARK CONSISTS OF STANDARD CHARACTERS WITHOUT CLAIM TO ANY PARTICULAR FONT, STYLE, SIZE, OR COLOR.

FOR ATHLETIC UNIFORMS, BANDANAS, SWEAT BANDS, HEAD BANDS, WRIST BANDS, BASEBALL CAPS, BLAZERS, BLOUSES, GLOVES, GOLF SHIRTS, SHIRTS, GYM SHORTS, SHORTS, HATS, HEAD WEAR, HOODS, JACKETS, WIND RESISTANT JACKETS, JOGGING SUITS, KNIT SHIRTS, POLO SHIRTS, PULL-OVERS, SWEATSHIRTS, SPORT SHIRTS, GYM SUITS, SWEAT SUITS, WARM-UP SUITS, SUN VISORS, SWEAT SHORTS, SWEAT PANTS, SWEATERS, T-SHIRTS, TOPS, TRACKSUITS, UNIFORMS, AND WIND SHIRTS (U.S. CLS. 22 AND 39).

CHARISMA HAMPTON, EXAMINING ATTORNEY

SN 78-953,896. PARAGONE WELLNESS, INC., EL DORADO HILLS, CA. FILED 8-16-2006.

WE TRAIN YOU FOR LIFE!

THE MARK CONSISTS OF STANDARD CHARACTERS WITHOUT CLAIM TO ANY PARTICULAR FONT, STYLE, SIZE, OR COLOR.

FOR ATHLETIC UNIFORMS, BANDANAS, SWEAT BANDS, HEAD BANDS, WRIST BANDS, BASEBALL CAPS, BLAZERS, BLOUSES, GLOVES, GOLF SHIRTS, SHIRTS, GYM SHORTS, SHORTS, HATS, HEAD WEAR, HOODS, JACKETS, WIND RESISTANT JACKETS, JOGGING SUITS, KNIT SHIRTS, POLO SHIRTS, PULL-OVERS, SWEATSHIRTS, SPORT SHIRTS, GYM SUITS, SWEAT SUITS, WARM-UP SUITS, SUN VISORS, SWEAT SHORTS, SWEAT PANTS, SWEATERS, T-SHIRTS, TOPS, TRACKSUITS, UNIFORMS, AND WIND SHIRTS (U.S. CLS. 22 AND 39).

CHARISMA HAMPTON, EXAMINING ATTORNEY

CLASS 25—(Continued).

SN 78-955,361. SHENANDOAH TRADING CO., LTD., YUU LIN HSIEN, TAIWAN, FILED 8-18-2006.

WHAT FOR

THE MARK CONSISTS OF STANDARD CHARACTERS WITHOUT CLAIM TO ANY PARTICULAR FONT, STYLE, SIZE, OR COLOR.

OWNER OF TAIWAN REG. NO. 01263050, DATED 5-16-2007, EXPIRES 5-15-2017.

FOR SUITS, JACKETS, DRESSES, SKIRTS, UNDERWEAR, SWIMSUITS, T-SHIRTS, PARKAS, SPORTS UNIFORMS, SHORTS, SHOES, BOOTS, SPORTS SHOES, SANDALS, HATS, SOCKS, GLOVES, BELTS FOR CLOTHING, TIES FOR CLOTHING, NECKERCHIEFS (U.S. CLS. 22 AND 39).

DEZMONA MIZELLE, EXAMINING ATTORNEY

SN 78-955,373. SHENANDOAH TRADING CO., LTD., YUU LIN HSIEN, TAIWAN, FILED 8-18-2006.



OWNER OF TAIWAN REG. NO. 01226389, DATED 9-1-2006, EXPIRES 8-31-2016.

THE FOREIGN WORDING IN THE MARK TRANSLATES INTO ENGLISH AS STAR, PARTICLE, TINY BIT; CELESTIAL BEING, IMMORTAL; TO FULFIL, TO TREAD ON, TO WALK UPON.

THE NON-LATIN CHARACTER(S) IN THE MARK TRANSLITERATES INTO XING; XIAN; LU, AND THIS MEANS STAR, PARTICLE, TINY BIT; CELESTIAL BEING, IMMORTAL; TO FULFIL, TO TREAD ON, TO WALK UPON IN ENGLISH.

FOR SUITS, JACKETS, DRESSES, SKIRTS, UNDERWEAR, SWIMSUITS, T-SHIRTS, PARKAS, SPORTS UNIFORMS, SHORTS, SHOES, BOOTS, SPORTS SHOES, SANDALS, HATS, SOCKS, GLOVES, BELTS FOR CLOTHING, TIES FOR CLOTHING, NECKERCHIEFS (U.S. CLS. 22 AND 39).

DEZMONA MIZELLE, EXAMINING ATTORNEY

CLASS 25—(Continued).

SN 78-956,983. SALAS, JOHN, GRAHAM, TX. FILED 8-21-2006.

RU2BZ4GOD

THE MARK CONSISTS OF STANDARD CHARACTERS WITHOUT CLAIM TO ANY PARTICULAR FONT, STYLE, SIZE, OR COLOR.
FOR SHIRTS (U.S. CLS. 22 AND 39).
KATHERINE CHANG, EXAMINING ATTORNEY

SN 78-957,455. HOME BOX OFFICE, INC., NEW YORK, NY. FILED 8-22-2006.

S&TC

THE MARK CONSISTS OF STANDARD CHARACTERS WITHOUT CLAIM TO ANY PARTICULAR FONT, STYLE, SIZE, OR COLOR.

FOR LINGERIE, PANTIES, UNDERWEAR, BRAS, NIGHTGOWNS, NIGHT SHIRTS, PAJAMAS, SLEEPWEAR, CAMISOLES, HOSIERY, ROBES, GARTERS, LOUNGEWEAR, PANTS, VESTS, JACKETS, T-SHIRTS, TANK TOPS, SWEAT PANTS, SHIRTS, SCARVES, HATS, COATS, JACKETS AND JEANS (U.S. CLS. 22 AND 39).
DORITT L. CARROLL, EXAMINING ATTORNEY

SN 78-959,292. TUTI FRUITI ORIGINALS LTD, NEW YORK, NY. FILED 8-24-2006.

TUTI TOTS

THE MARK CONSISTS OF STANDARD CHARACTERS WITHOUT CLAIM TO ANY PARTICULAR FONT, STYLE, SIZE, OR COLOR.

NO CLAIM IS MADE TO THE EXCLUSIVE RIGHT TO USE "TOTS", APART FROM THE MARK AS SHOWN.

FOR SPORTSWEAR FOR NEW BORN CHILDREN, NAMELY, CAPS, CLOTH BIBS, DRESSES, JUMPERS, SNEAKERS, SHOES, SLEEPERS, SOCKS, T-SHIRTS AND UNDERWEAR (U.S. CLS. 22 AND 39).

JOHN WILKE, EXAMINING ATTORNEY

CLASS 25—(Continued).

SN 78-959,556. CLOAK & DAGGER LLC, JERSEY CITY, NJ. FILED 8-24-2006.

Hellz Bellz

THE MARK CONSISTS OF STANDARD CHARACTERS WITHOUT CLAIM TO ANY PARTICULAR FONT, STYLE, SIZE, OR COLOR.

FOR MENS, WOMENS, AND CHILDRENS SHOES, SHIRTS, HATS, PANTS, DRESSES, AND SHORTS (U.S. CLS. 22 AND 39).

KATHERINE M. DUBRAY, EXAMINING ATTORNEY

SN 78-962,715. GLOBALTEX, INC., TAUNTON, MA. FILED 8-29-2006.

CR SPORT

THE MARK CONSISTS OF STANDARD CHARACTERS WITHOUT CLAIM TO ANY PARTICULAR FONT, STYLE, SIZE, OR COLOR.

NO CLAIM IS MADE TO THE EXCLUSIVE RIGHT TO USE "SPORT", APART FROM THE MARK AS SHOWN.

FOR INFANT, TODDLER AND CHILDREN'S CLOTHING, NAMELY, SHIRTS, PANTS, DRESSES, JUMPERS, SWEATERS AND JACKETS; SPORTSWEAR, NAMELY, T-SHIRTS, OVERALLS, BLOUSES, VESTS, SKIRTS; OUTERWEAR, NAMELY, LINED JACKETS (U.S. CLS. 22 AND 39).

FIRST USE 1-1-1992; IN COMMERCE 1-1-1992.
GISELLE AGOSTO, EXAMINING ATTORNEY

SN 78-968,021. CRAIG WRIGHT, ALTAMONTE SPRINGS, FL. FILED 9-6-2006.



NO CLAIM IS MADE TO THE EXCLUSIVE RIGHT TO USE "LINGERIE", APART FROM THE MARK AS SHOWN. THE COLOR(S) RED, PINK, AND BLACK IS/ARE CLAIMED AS A FEATURE OF THE MARK.

THE MARK CONSISTS OF A STYLIZED DESIGN OF A PAIR OF HUMAN LIPS WITH THE WORDING "SWEET LIPS LINGERIE" UNDERNEATH THE LIP DESIGN AND THE STYLIZED DESIGN OF FIVE HEARTS AROUND THE

CLASS 25—(Continued).

WORDING, WITH ONE OF THE HEARTS FUNCTIONING AS THE DOT ABOVE THE LETTER "I" IN THE WORD, "LIPS". THE COLOR RED APPEARS IN THE LIP DESIGN AND IN TWO OF THE HEARTS; THE COLOR PINK APPEARS IN THREE OF THE HEART DESIGNS AND THE COLOR BLACK APPEARS IN THE WORDING, "SWEET LIPS LINGERIE"; THERE IS GRAY SHADING AROUND THE LIP DESIGN AND THE WORDING AND THE BACKGROUND OF THE MARK IS WHITE WHICH IS INTENDED TO BE TRANSPARENT.

FOR WOMEN'S CLOTHING, NAMELY, SHIRTS, PANTS, HATS, SOCKS, AND DRESSES; LINGERIE; SWIMSUITS; WOMEN'S SHOES EXCLUDING SPECIALTY SHOES IN THE NATURE OF GYMNASTIC SHOES (U.S. CLS. 22 AND 39).

FIRST USE 3-29-2006; IN COMMERCE 8-27-2006.
PAUL CROWLEY, EXAMINING ATTORNEY

SN 78-970,772. DEATH DEALER INDUSTRIES L.L.C., PHOENIX, AZ. AND DEATH DEALER INDUSTRIES L.L.C., PHOENIX, AZ. FILED 9-9-2006.

Death Dealer Industries

NO CLAIM IS MADE TO THE EXCLUSIVE RIGHT TO USE "INDUSTRIES", APART FROM THE MARK AS SHOWN.

FOR SHORT SLEEVE T-SHIRTS, LONG SLEEVE T-SHIRTS, BASEBALL HATS, HOODED SWEATSHIRTS, JACKETS, SOCKS, BASKETBALL JERSEYS, BANDANAS, UNDERWEAR, SHORTS, STICKERS (U.S. CLS. 22 AND 39).

CAROLYN GRAY, EXAMINING ATTORNEY

SN 78-978,099. AALFS MANUFACTURING, INC., SIOUX CITY, IA. FILED 1-18-2006.

4 STROKE JEANS

THE MARK CONSISTS OF STANDARD CHARACTERS WITHOUT CLAIM TO ANY PARTICULAR FONT, STYLE, SIZE, OR COLOR.

NO CLAIM IS MADE TO THE EXCLUSIVE RIGHT TO USE "JEANS", APART FROM THE MARK AS SHOWN.

FOR WEARING APPAREL, NAMELY, JEANS, SKIRTS, JACKETS, T-SHIRTS AND FLEECE TOPS (U.S. CLS. 22 AND 39).

FIRST USE 10-20-2006; IN COMMERCE 10-20-2006.
MARK RADEMACHER, EXAMINING ATTORNEY

CLASS 25—(Continued).

SN 78-979,051. JUNG, TAEWON, SEOUL, REPUBLIC OF KOREA, FILED 8-8-2006.

UNITED COREA

THE MARK CONSISTS OF STANDARD CHARACTERS WITHOUT CLAIM TO ANY PARTICULAR FONT, STYLE, SIZE, OR COLOR.

PRIORITY CLAIMED UNDER SEC. 44(D) ON REPUBLIC OF KOREA APPLICATION NO. 2006002687, FILED 5-19-2006, REG. NO. 0698528, DATED 2-15-2007, EXPIRES 2-15-2017.

NO CLAIM IS MADE TO THE EXCLUSIVE RIGHT TO USE "KOREA", APART FROM THE MARK AS SHOWN.

FOR MONEY BELTS, LEATHER SHOES, RUBBER SHOES, GALOSHES, GOLF SHOES, SHOE SOLES, ANGLERS' SHOES, BASKETBALL SNEAKERS, SHOES, HEEL PIECES FOR SHOES, MOUNTAINEERING BOOTS, RUGBY SHOES, LACE BOOTS, BATH SLIPPERS, WINTER BOOTS, BOXING SHOES, BOOTS, BEACH SHOES, SANDALS, SKI BOOTS, SLIPPERS, INNER SOLES, TIPS FOR FOOTWEAR, TRAINING SHOES, BASEBALL SHOES, OVERSHOES, RAIN BOOTS, FOOTWEAR FOR TRACK AND FIELD ATHLETICS, WORK SHOES AND BOOTS, GYMNASTIC SHOES, FOOTBALL SHOES, LACE BOOTS, HOCKEY SHOES, HANDBALL SHOES, CYCLISTS' JERSEYS, WET SUITS FOR WATER-SKIING AND SUB-AQUA, ANORAKS, PARKAS, JUDO SUITS, GYM SUITS, BREECHES, RIDING BOOTS, FOUNDATION GARMENTS (U.S. CLS. 22 AND 39).

JAY FLOWERS, EXAMINING ATTORNEY

SN 78-979,655. JOHNSON, RIAL, CHANDLER, AZ. FILED S.R. 3-17-2006; AM. P.R. 1-3-2008.

CLUB CRASHERS

THE MARK CONSISTS OF STANDARD CHARACTERS WITHOUT CLAIM TO ANY PARTICULAR FONT, STYLE, SIZE, OR COLOR.

FOR CLOTHING, NAMELY, MEN'S AND WOMEN'S CAPS, HATS, JACKETS, SHIRTS AND T-SHIRTS (U.S. CLS. 22 AND 39).

DAVID YONTEF, EXAMINING ATTORNEY

CLASS 25—(Continued).

SN 79-024,348. FRANZ ZIENER GMBH & CO., FED REP GERMANY, FILED 3-9-2006.



PRIORITY DATE OF 12-14-2005 IS CLAIMED.
OWNER OF INTERNATIONAL REGISTRATION 0886259 DATED 3-9-2006, EXPIRES 3-9-2016.
THE COLOR(S) BLACK, RED, GREY IS/ARE CLAIMED AS A FEATURE OF THE MARK.
THE LITERAL ELEMENTS "HEATGENERAT" AND "R" APPEARS IN BLACK, THE STYLIZED "O" APPEARS IN RED, AND THE 6 POINTED STAR AROUND THE "O" APPEARS IN GRAY.
FOR CLOTHING, IN PARTICULAR, GLOVES; FOOTWEAR, NAMELY, SHOES, BOOTS, THONGS, SANDALS, SPORT SHOES; HEADGEAR, NAMELY, CAPS, HATS, TOQUES (U.S. CLS. 22 AND 39).
ANTHONY RINKER, EXAMINING ATTORNEY

SN 79-025,294. JONATHAN HUNTER, PERTH, AUSTRALIA, AND ALEXANDRA SCOTT, PERTH, AUSTRALIA, FILED 5-16-2006.

PRIORITY DATE OF 4-5-2006 IS CLAIMED.
OWNER OF INTERNATIONAL REGISTRATION 0888675 DATED 5-16-2006, EXPIRES 5-16-2016.
NO CLAIM IS MADE TO THE EXCLUSIVE RIGHT TO USE "DESIGN", APART FROM THE MARK AS SHOWN.
FOR CLOTHING, NAMELY, SHORTS, TOPS, VESTS, SINGLET, ONE PIECE SUITS, CAPS, GLOVES, HEADWEAR, ARM WARMERS, KNEE WARMERS, SHORT SETS, JACKETS, TEE-SHIRTS, POLO-SHIRTS, SWIM WEAR, CYCLING SHOES, TRACK PANTS, TRACK SUITS, SUN SLEEVES, ANKLE SOCKS, SWEAT SUITS, TRAINING SUITS, SNOW SUITS, WIND VESTS, LONG SLEEVED VESTS, RAIN JACKETS, HEAD SCARVES, HEAD SWEATBANDS, LEG WARMERS, BODY SUITS, SPORTS SHIRTS WITH SHORT SLEEVES, SPORTS SHIRTS, WIND SHIRTS, SHORT-SLEEVED OR LONG-SLEEVED T-SHIRTS, OPEN-NECKED SHIRTS, KNIT SHIRTS, CROP TOPS, MUSCLE TOPS, QUILTED VESTS, NON-DISPOSABLE CLOTH TRAINING PANTS, SPORTS JACKETS, SPORTS JERSEYS AND BREECHES FOR SPORTS (U.S. CLS. 22 AND 39).
LEIGH LOWRY, EXAMINING ATTORNEY

CLASS 25—(Continued).

SN 79-030,652. GRAYDON PRITCHARD, MALUA BAY, AUSTRALIA, AND JANETTE PRITCHARD, MALUA BAY, AUSTRALIA, FILED 8-30-2006.



OWNER OF INTERNATIONAL REGISTRATION 0902833 DATED 8-30-2006, EXPIRES 8-30-2016.
FOR KNITTED, WOVEN, OR NON-WOVEN CLOTHING, NAMELY, UNDERWEAR, SINGLET, BRAS, TOPS, T-SHIRTS, SHORTS, SKIRTS, DRESSES, TIGHTS, SOCKS, LEGGINGS, BOARD SHORTS, SWIMMERS BEING SWIMMING TRUNKS, SUN PROTECTION SHIRTS AND VESTS, WETSUITS, SWIM SUITS, JEANS, PANTS, TRACKSUITS, SLEEPWEAR, LOUNGEWEAR, CAPS, TRUCKER CAPS AND PEAKED CAPS, BEANIES, SCARVES, HEAD BANDS, GLOVES, MITTENS, SWEATERS, JACKETS, COATS, RAIN COATS, WET/EXTREME WEATHER JACKET AND PANTS, FISHING PANTS BEING FISHING WADERS, SNOW PANTS, SNOW JACKETS, ALL MAY OR MAY NOT INCORPORATE LIGHT REFLECTING OR FLUORESCENT ELEMENTS OR MATERIALS (U.S. CLS. 22 AND 39).
ATTIYA MALIK, EXAMINING ATTORNEY

SN 79-030,653. GRAYDON PRITCHARD, MALUA BAY, AUSTRALIA, AND JANETTE PRITCHARD, MALUA BAY, AUSTRALIA, FILED 8-30-2006.

THE MARK CONSISTS OF STANDARD CHARACTERS WITHOUT CLAIM TO ANY PARTICULAR FONT, STYLE, SIZE, OR COLOR.
OWNER OF INTERNATIONAL REGISTRATION 0902834 DATED 8-30-2006, EXPIRES 8-30-2016.
FOR KNITTED, WOVEN, OR NON-WOVEN CLOTHING, NAMELY, UNDERWEAR, SINGLET, BRAS, TOPS, T-SHIRTS, SHORTS, SKIRTS, DRESSES, TIGHTS, SOCKS, LEGGINGS, BOARD SHORTS, SWIMMERS BEING SWIMMING TRUNKS, SUN PROTECTION SHIRTS AND VESTS, WETSUITS, SWIM SUITS, JEANS, PANTS, TRACKSUITS, SLEEPWEAR, LOUNGEWEAR, CAPS, TRUCKER CAPS AND PEAKED CAPS, BEANIES, SCARVES, HEAD BANDS, GLOVES, MITTENS, SWEATERS, JACKETS, COATS, RAIN COATS, WET/EXTREME WEATHER JACKET AND PANTS, FISHING PANTS BEING FISHING WADERS, SNOW PANTS, SNOW JACKETS, ALL MAY OR MAY NOT INCORPORATE LIGHT REFLECTING OR FLUORESCENT ELEMENTS OR MATERIALS (U.S. CLS. 22 AND 39).
ATTIYA MALIK, EXAMINING ATTORNEY

CLASS 25—(Continued).

SN 79-035,424. UHLSPORT GMBH, FED REP GERMANY, FILED 2-21-2007.

KIKKSOKKE

PRIORITY DATE OF 8-22-2006 IS CLAIMED.
OWNER OF INTERNATIONAL REGISTRATION 0916060
DATED 2-21-2007, EXPIRES 2-21-2017.

THE WORDING "KIKKSOKKE" HAS NO MEANING IN A FOREIGN LANGUAGE.

FOR FOOTWEAR, SPORTS SHOES, AND PARTS THEREOF, NAMELY, SOLES, INSOLES, HEELS, HEEL SUPPORTS, HEEL REINFORCING BACKINGS, FORE-FOOT PLATES, AND SPORTS SHOE UPPERS; SPIKES AND STUDS FOR SOCCER SHOES (U.S. CLS. 22 AND 39).

SUSAN RICHARDS, EXAMINING ATTORNEY

SN 79-036,500. GOMES MARTINS DA SILVA, JORGE, SPAIN, AND DA SILVA MENDES, JOSE MANUEL, PORTUGAL, FILED 10-2-2006.



OWNER OF INTERNATIONAL REGISTRATION 0918836
DATED 10-2-2006, EXPIRES 10-2-2016.

THE COLOR(S) BLACK, WHITE, GRAY AND RED IS/ARE CLAIMED AS A FEATURE OF THE MARK.

THE COLOR GRAY APPEARS ON THE LETTER H, THE COLOR RED APPEARS ON THE CHEVRON DESIGN; THE COLOR WHITE APPEARS AS AN OUTLINE AROUND THE LETTER H AND THE CHEVRON, AND AS AN INTERIOR BORDER INSIDE THE CIRCLE AND OBLONG CARRIERS; THE COLOR BLACK APPEARS AS A BACKGROUND COLOR FOR THE MARK.

FOR CLOTHING FOR FOOTBALL, NAMELY, JERSEYS, PANTS, SOCKS, T-SHIRTS, TRACKSUITS; FOOTBALL BOOTS (U.S. CLS. 22 AND 39).

DEBRA LEE, EXAMINING ATTORNEY

CLASS 25—(Continued).

SN 79-036,984. HASEMA TEKSTIL TURIZM; SPOR MALZEMELERI VE AMBALAJ; SANAYI TICARET LIMITEDSSIRKETI, TURKEY, FILED 1-31-2007.



OWNER OF INTERNATIONAL REGISTRATION 0920205
DATED 1-31-2007, EXPIRES 1-31-2017.

FOR CLOTHING, NAMELY, JUMPERS, PULLOVERS, JACKETS, TROUSERS, SKIRTS, WAISTCOATS, SWEATERS, CARDIGANS, OVERCOATS, BLOUSES, TEE-SHIRTS, SUITS, SHIRTS, SWIM WEAR, SCARVES (U.S. CLS. 22 AND 39).

DAYNA BROWNE, EXAMINING ATTORNEY

SN 79-037,304. GALINAKIS EFTHIMIOS, VRILISSIA ATTIKIS, GREECE, FILED 3-27-2007.

MAN & MANETTI

OWNER OF INTERNATIONAL REGISTRATION 0921055
DATED 3-27-2007, EXPIRES 3-27-2017.

FOR SHIRTS, SWEATERS, CARDIGANS, TIES, BELTS, POLO-SHIRTS, T-SHIRTS, SCARVES (U.S. CLS. 22 AND 39).

ANDREW RHIM, EXAMINING ATTORNEY

CLASS 25—(Continued).

SN 79-038,434. SHANDONG LIANGTIAOTUI FUSHI; YOUXIAN GONGSI, CHINA, FILED 5-4-2007.

OWNER OF INTERNATIONAL REGISTRATION 0924017 DATED 5-4-2007, EXPIRES 5-4-2017.

THE FIRST CHINESE CHARACTER WHOSE TRANSLITERATION IS "LIANG" MEANS "TWO"; THE SECOND CHINESE CHARACTER WHOSE TRANSLITERATION IS "TIAO" MEANS "PIECE"; THE LAST CHINESE CHARACTER WHOSE TRANSLITERATION IS "TUI" MEANS "LEG"; THE COMBINATION OF THE THREE CHINESE CHARACTERS MEANS TWO LEGS.

THE TANSLITERATION OF THE NON-LATIN CHARACTERS IN THE MARK IS: LIANG TIAO TUI.

FOR CLOTHING, NAMELY, LAYETTES, GLOVES, TIES, SHOULDER WRAPS, WEDDING GOWNS, BASKETBALL SHOES, BASKETBALL SNEAKERS, T-SHIRTS, SHIRTS, SWEATSHIRTS, SWEATPANTS, PANTS, JERSEYS, SHORTS, PAJAMAS, SPORT SHIRTS, RUGBY SHIRTS, SWEATERS, NIGHTSHIRTS, JACKETS, WIND RESISTANT JACKETS, COATS, BOXER SHORTS, MITTENS, SCARVES, WOVEN AND KNIT SHIRTS, FOOTWEAR, HATS, HOSIERY; DOWN GARMENTS, NAMELY, DOWN JACKETS; NECKTIES; CRAVATS (U.S. CLS. 22 AND 39).

GEORGIA CARTY, EXAMINING ATTORNEY

CLASS 25—(Continued).

SN 79-039,510. XU JIANQIU, CHINA, FILED 5-30-2007.

OWNER OF INTERNATIONAL REGISTRATION 0926712 DATED 5-30-2007, EXPIRES 5-30-2017.

THE MARK CONSISTS OF TWO CHINESE CHARACTERS COMBINED WITH FIVE ENGLISH LETTERS.

THE WORD "MIDUO" IS THE CHINESE PINYIN FOR THE CHINESE CHARACTERS. THE WORD "MI" MEANS "HONEY" AND THE WORD "DUO" MEANS "MANY" IN ENGLISH, BUT THE COMBINATION "MIDUO" HAS NO MEANING IN ENGLISH.

THE NON-LATIN CHARACTERS IN THE MARK TRANSLITERATE INTO "MIDUO", WHICH HAS NO MEANING IN ENGLISH.

FOR BRACES FOR CLOTHING IN THE NATURE OF SUSPENDERS; BRAS; FITTED SWIMMING COSTUMES WITH BRA CUPS; SPORTS BRA; STRAPLESS BRAS; NIGHTGOWNS; NIGHTWEAR; NIGHTDRESSES; SWIMWEAR; SWIMSUITS; THERMAL UNDERWEAR; UNDERWEAR, NAMELY, BRIEFS; DISPOSABLE UNDERWEAR; LADIES' UNDERWEAR (U.S. CLS. 22 AND 39).

LINDA ESTRADA, EXAMINING ATTORNEY

SN 79-040,105. PAKUTA ANSTALT, LIECHTENSTEIN, FILED 1-4-2007.

SN 79-038,606. ZHU JIANBIN, CHINA, FILED 4-16-2007.

WORLD WIDE EAGLE

OWNER OF INTERNATIONAL REGISTRATION 0924521 DATED 4-16-2007, EXPIRES 4-16-2017.

THE MARK HAS NO SIGNIFICANCE IN THE RELEVANT TRADE OR INDUSTRY, OR ANY GEOGRAPHICAL SIGNIFICANCE.

FOR TEE-SHIRTS; READY-MADE CLOTHING, NAMELY, SHIRTS, T-SHIRTS, PANTS, TROUSERS, JEANS; CLOTHING, NAMELY, SHIRTS, T-SHIRTS, PANTS, TROUSERS, JEANS, BLOUSES, SKIRTS, DRESSES, GOWNS, SWEATERS; CAPS FOR HEADWEAR; GLOVES FOR CLOTHING; GYMNASTIC SHOES; HOSIERY; GIRDLES; BATHING TRUNKS, DRAWERS; BATHING SUITS; SPORTS JERSEYS; SPORTS SHOES; SPORTS BOOTS; FOOTBALL SHOES; FOOTBALL BOOTS (U.S. CLS. 22 AND 39).

ALICE BENMAMAN, EXAMINING ATTORNEY



OWNER OF INTERNATIONAL REGISTRATION 0928427 DATED 1-4-2007, EXPIRES 1-4-2017.

FOR CLOTHING, NAMELY, SHIRTS, SWEATERS, JACKETS, PANTS, SKI WEAR, SWEAT SUITS, AND UNDERWEAR; FOOTWEAR; HEADWEAR (U.S. CLS. 22 AND 39).

DANIEL CAPSHAW, EXAMINING ATTORNEY

CLASS 25—(Continued).

SN 79-040,477. ZHONGSHAN DONGYI SHOES; MANUFACTURING, LTD., XIAOLAN ZHONGSHAN CITY, CHINA, FILED 6-18-2007.



OWNER OF INTERNATIONAL REGISTRATION 0929351 DATED 6-18-2007, EXPIRES 6-18-2017.

THE NON-LATIN CHARACTERS IN THE MARK TRANSLITERATE TO "BAO" AND "TUO" AND THIS MEANS "TREASURE" AND "CAMEL" IN ENGLISH.

FOR CLOTHING, NAMELY, SHIRTS, PANTS, JACKETS, SUITS, DRESSES AND UNDERWEAR; CYCLISTS' CLOTHING, NAMELY, CYCLING PANTS; WATER-PROOF CLOTHING, NAMELY, WATERPROOF JACKETS AND PANTS; CLOTHING FOR DANCING, NAMELY, DANCING SHIRTS; SHOES; HATS; GLOVES; NECKTIES; CLOTHING IN THE NATURE OF BELTS (U.S. CLS. 22 AND 39).

JAMES STEIN, EXAMINING ATTORNEY

SN 79-040,904. SABATINI CALZATURE S.R.L., I-06040 SAN GIOVANNI DI BAIANO-SPOLETO, ITALY, FILED 4-4-2007.



OWNER OF INTERNATIONAL REGISTRATION 0643291 DATED 8-18-1995, EXPIRES 8-18-2015.

THE COLOR(S) WHITE, GRAY, FUCHSIA AND BLACK IS/ARE CLAIMED AS A FEATURE OF THE MARK.

THE WORD "SABATINI" IS IN BLACK. THE TWO CLOSEST RECTANGLES TO THE WORD ARE IN FUCHSIA AND THE OUTERMOST RECTANGLE IS IN BLACK. SURROUNDING THE RECTANGLES PARTWAY IS A GRAY SHAPE. THE BACKGROUND OF THE MARK IS WHITE.

FOR FOOTWEAR (U.S. CLS. 22 AND 39).
ERNEST SHOSH, EXAMINING ATTORNEY

CLASS 25—(Continued).

SN 79-041,133. LEINEWEBER GMBH & CO. KG, FED REP GERMANY, FILED 7-11-2007.

EUREX

PRIORITY DATE OF 1-24-2007 IS CLAIMED.
OWNER OF INTERNATIONAL REGISTRATION 0930868 DATED 7-11-2007, EXPIRES 7-11-2017.

FOR ARTICLES OF CLOTHING, NAMELY, PANTS, SHORTS, SKIRTS, OVERALLS, DRESSES, SHIRTS, T-SHIRTS, PULLOVERS, SWEATERS, VESTS, JACKETS, COATS, UNDERGARMENTS, GLOVES, SCARVES, BANDANNAS, SOCKS, SHOES, BELTS, HATS, AND CAPS (U.S. CLS. 22 AND 39).

WILLIAM VERHOSEK, EXAMINING ATTORNEY

SN 79-041,500. LEINEWEBER GMBH & CO. KG, FED REP GERMANY, FILED 7-11-2007.

RAPHAELA

PRIORITY DATE OF 1-24-2007 IS CLAIMED.
OWNER OF INTERNATIONAL REGISTRATION 0931868 DATED 7-11-2007, EXPIRES 7-11-2017.

"THE NAME(S), PORTRAIT(S), AND/OR SIGNATURE(S) SHOWN IN THE MARK DOES NOT IDENTIFY A PARTICULAR LIVING INDIVIDUAL."

FOR ARTICLES OF CLOTHING, NAMELY, PANTS, SHORTS, SKIRTS, OVERALLS, DRESSES, SHIRTS, T-SHIRTS, PULLOVERS, SWEATERS, VESTS, JACKETS, COATS, UNDERGARMENTS, GLOVES, SCARVES, BANDANNAS, SOCKS, SHOES, BELTS, HATS, AND CAPS (U.S. CLS. 22 AND 39).

WILLIAM VERHOSEK, EXAMINING ATTORNEY

SN 79-041,772. NHO, JUNG HO, SEONGDONG-GU; SEOUL, REPUBLIC OF KOREA, FILED 7-20-2007.

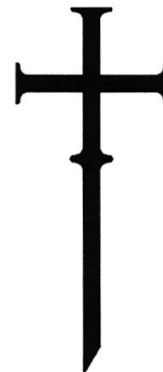

PRIORITY DATE OF 7-13-2007 IS CLAIMED.
OWNER OF INTERNATIONAL REGISTRATION 0932424 DATED 7-20-2007, EXPIRES 7-20-2017.

FOR BLUE JEANS, COATS, SHIRTS, JACKETS, JUMPERS, SWEATERS, T-SHIRTS, UNDERWEAR, NECKTIES, PANTS, SLACKS, GLOVES FOR CLOTHING, SOCKS, HEADWEAR, BELTS FOR CLOTHING (U.S. CLS. 22 AND 39).

SANDRA MANIOS, EXAMINING ATTORNEY

CLASS 25—(Continued).

SN 79-043,158. NARKON TEKSTIL IHRACAT ITHALAT; SANAYI VE TICARET LIMITED SIRKETI, TURKEY, FILED 6-4-2007.



OWNER OF INTERNATIONAL REGISTRATION 0935903 DATED 6-4-2007, EXPIRES 6-4-2017.

THE COLOR(S) BLACK AND WHITE IS/ARE CLAIMED AS A FEATURE OF THE MARK.

THE COLOR WHITE APPEARS IN THE WORD "BLACK" AND IN THE RECTANGULAR DESIGN SERVING AS A BACKGROUND FOR THE TERM "SPADE". THE COLOR BLACK APPEARS IN THE WORD "SPADE", IN THE OUTLINE SERVING AS A PERIMETER FOR ENCLOSING THE RECTANGULAR WHITE BACKGROUND FOR THE TERM "SPADE", AND IN THE RECTANGULAR DESIGN THAT SERVES AS A BACKGROUND FOR THE WORD "BLACK".

FOR CLOTHING, NAMELY, TROUSERS, JACKETS, OVERCOATS, COATS, SKIRTS, SUITS, JERSEYS, WAISTCOATS, SHIRT, T-SHIRTS, SWEATSHIRTS, DRESSES, BLOUSONS, PULLOVERS, UNDERWEARS, TRACKSUITS, RAINWEAR, SWIMWEAR, SHIRTS, PULLOVERS, KNITWEAR, NAMELY, KNIT SHIRTS, KNIT SWEATERS, KNIT SHORTS, KNITTED CAPS, KNITTED UNDERWEAR, JEANS WEAR, NAMELY, JEANS, JEAN SHORTS, JEAN SHIRTS, JEAN JACKETS, JEAN CAPS, SPORTS SHORTS, NAMELY, SHORTS, SWEAT SHORTS, WALKING SHORTS, RUGBY SHORTS, TENNIS SHORTS, GYM SHORTS, CLOTHING BELTS, SWIM CAPS, SHORTS, GLOVES, CAPS, SOCKS, STOCKINGS (U.S. CLS. 22 AND 39).

RUSS HERMAN, EXAMINING ATTORNEY

CLASS 25—(Continued).

SN 79-047,294. CROSS OVER CO., LTD., JAPAN, FILED 7-25-2007.



OWNER OF INTERNATIONAL REGISTRATION 0946288 DATED 7-25-2007, EXPIRES 7-25-2017.

FOR CLOTHING, NAMELY TOPS, SHIRTS, T-SHIRTS, JEANS PANTS, PAINTER'S PANTS, PANTS, JEANS SKIRTS, SKIRTS, TROUSERS, ANORAKS, OVERALLS, PARKAS, BLOUSES, TUNICS, CARDIGANS, COATS, OVERCOATS, TOPCOATS, DRESS SHIRTS, OPEN-NECKED SHIRTS, SPORTS SHIRTS, POLO SHIRTS, SWEAT SHIRTS; SWEAT PANTS, SWEATERS, PULL-OVERS, SOCKS, MUFFLERS, SCARVES, JEANS JACKETS, JACKETS, JUMPERS, SHORTS, JEANS VESTS, VESTS, WIND RESISTANT JACKETS; GARTERS; SUSPENDERS; SOCK SUSPENDERS; STOCKING SUSPENDERS; BELTS OF LEATHER AND NON-LEATHER FOR CLOTHING; ATHLETIC UNIFORMS; ATHLETIC FOOTWEAR; ATHLETICS SHOES; SHOES; BOOTS; HATS; CAPS, BERETS (U.S. CLS. 22 AND 39).

RAUL CORDOVA, EXAMINING ATTORNEY

CLASS 26—FANCY GOODS

SN 77-050,411. CLAYDON, ROSS M, HALSTEAD CO9, UNITED KINGDOM, FILED 11-24-2006.

I CAN'T BELIEVE IT'S NOT
TWICE THE PRICE

THE MARK CONSISTS OF STANDARD CHARACTERS WITHOUT CLAIM TO ANY PARTICULAR FONT, STYLE, SIZE, OR COLOR.

FOR BACK-HAIRPIECES FIXING PINS FOR JAPANESE HAIR STYLING (TABODOME); BACK-HAIRPIECES FOR JAPANESE HAIR STYLING (TABOMINO); BARRETTES; BROOCHES; CHIGNONS FOR JAPANESE HAIR STYLING (MAGE); CLAM CLIPS FOR HAIR; FALSE HAIR FOR JAPANESE HAIR STYLING (KAMOJI); HAIR ACCESSORIES, NAMELY, CLAW CLIPS; HAIR ACCESSORIES, NAMELY, JAW CLIPS; HAIR ACCESSORIES, NAMELY, SNAP CLIPS; HAIR ACCESSORIES, NAMELY, TWISTERS; HAIR BANDS; HAIR BOWS; HAIR BUCKLES; HAIR CLIPS; HAIR CURL CLIPS; HAIR CURLERS; HAIR EXTENSIONS; HAIR FROSTING CAPS; HAIR NETS; HAIR ORNAMENTS; HAIR ORNAMENTS IN THE FORM OF COMBS; HAIR ORNAMENTS IN THE NATURE OF HAIR WRAPS; HAIR PIECES; HAIR PINS; HAIR PINS AND GRIPS; HAIR RIBBONS; HAIR RIBBONS FOR JAPANESE HAIR STYLING (TEGARA); HAIR SCRUNCHIES; NON-ELECTRIC HAIR CURLERS; NON-ELECTRIC HAIR ROLLERS; ORIENTAL HAIR PINS; ORNAMENTAL HAIR PINS FOR JAPANESE HAIR STYLING (KOGAI); WIGS, HAIRPIECES, AND ADD-IN AND ADD-ON HAIR ACCESSORIES CONSTRUCTED PRIMARILY OF SYNTHETIC AND/OR HUMAN HAIR (U.S. CLS. 37, 39, 40, 42 AND 50).

FIRST USE 1-3-1991; IN COMMERCE 1-7-2003.
ALICE BENMAMAN, EXAMINING ATTORNEY

SN 79-047,163. POCHETTINI S.R.L., ITALY, FILED 9-12-2007.



THE MARK CONSISTS OF STANDARD CHARACTERS WITHOUT CLAIM TO ANY PARTICULAR FONT, STYLE, SIZE, OR COLOR.

OWNER OF INTERNATIONAL REGISTRATION 0945934 DATED 9-12-2007, EXPIRES 9-12-2017.

FOR CLOTHING, NAMELY, NECKTIES, BELTS, SWEATERS, CARDIGANS, PULLOVERS, WAISTCOATS, T-SHIRTS, JACKETS, OVERCOATS, SOCKS, STOCKINGS, PANTYHOSES, VESTS, PAJAMAS, SHIRTS, POLO SHIRTS, GOLF SHIRTS, COATS, SHORTS, BERMUDA SHORTS, GYM SHORTS, PANTS, JEANS, RAINCOATS, SASHES, BLOUSES, SUITS, DRESSES, SKIRTS, SHAWLS, SCARVES, GLOVES, FUR COATS, FUR JACKETS AND FUR STOLEES; UNDERWEAR, NAMELY, CAMISOLES, PETTICOATS, CORSETS, UNDERSHIRTS, UNDERPANTS AND SLIPS; LEATHER CLOTHING, NAMELY, JACKETS, COATS, PANTS, BELTS, WAISTCOATS AND SKIRTS; IMITATION LEATHER CLOTHING, NAMELY, JACKETS, COATS, PANTS, BELTS, WAISTCOATS AND SKIRTS; HEADGEAR, NAMELY, HATS, CAPS AND VISORS (U.S. CLS. 22 AND 39).

SETH A. RAPPAPORT, EXAMINING ATTORNEY

CLASS 26—(Continued).

SN 77-134,800. SMITH, EMILY, RANCHO SANTA MARGARITA, CA. FILED 3-19-2007.

BUBBLE BERRY

THE MARK CONSISTS OF STANDARD CHARACTERS WITHOUT CLAIM TO ANY PARTICULAR FONT, STYLE, SIZE, OR COLOR.

FOR HAIR ACCESSORIES, NAMELY, BARRETTES, HAIR BANDS, HAIR BOWS, HAIR BUCKLES, HAIR CLIPS, HAIR ORNAMENTS, HAIR RIBBONS, AND HAIR CLASPS (U.S. CLS. 37, 39, 40, 42 AND 50).

KAREN BRACEY, EXAMINING ATTORNEY

SN 77-143,124. PRIMA ROYAL ENTERPRISES, LTD., IRWINDALE, CA. FILED 3-28-2007.

BOBBI BLU

THE MARK CONSISTS OF STANDARD CHARACTERS WITHOUT CLAIM TO ANY PARTICULAR FONT, STYLE, SIZE, OR COLOR.

THE NAME(S), PORTRAIT(S), AND/OR SIGNATURE(S) SHOWN IN THE MARK DOES NOT IDENTIFY A PARTICULAR LIVING INDIVIDUAL.

FOR BARRETTES; BUCKLES FOR CLOTHING; BELT BUCKLES; BUTTONS FOR CLOTHING; CLOTH PATCHES FOR CLOTHING; CLASPS FOR CLOTHING; HAIR ACCESSORIES, NAMELY, CLAW CLIPS, JAW CLIPS, HAIR ORNAMENTS IN THE FORM OF COMBS, HAIR BANDS, HAIR BOWS, PONYTAIL HOLDERS AND HAIR ORNAMENTS; HAT ORNAMENTS AND HAT PINS; HAIR EXTENSIONS AND HAIR PIECES (U.S. CLS. 37, 39, 40, 42 AND 50).

LINDA M. KING, EXAMINING ATTORNEY

SN 77-149,489. CAPRICORN INNOVATIONS LLC, DBA TEEN & TWEEN SENSATIONS, RHINEBECK, NY. FILED 4-5-2007.

CLIQUE STRIPS



NO CLAIM IS MADE TO THE EXCLUSIVE RIGHT TO USE "STRIPS", APART FROM THE MARK AS SHOWN.

FOR ORNAMENTAL STRIPS FOR FOOTWEAR NOT OF PRECIOUS METAL (U.S. CLS. 37, 39, 40, 42 AND 50).

KATHRYN COWARD, EXAMINING ATTORNEY

CLASS 26—(Continued).

SN 77-166,615. LAMB-GRS, LLC, BEVERLY HILLS, CA. FILED 4-26-2007.

L.A.M.B.

THE MARK CONSISTS OF STANDARD CHARACTERS WITHOUT CLAIM TO ANY PARTICULAR FONT, STYLE, SIZE, OR COLOR.

OWNER OF U.S. REG. NOS. 3,174,447 AND 3,174,448.

FOR BELT BUCKLES NOT OF PRECIOUS METAL; HAIR BANDS; HAIR BARRETTES; HAIR BOWS; HAIR CLIPS; HAIR ORNAMENTS; HAIR RIBBONS; PONYTAIL HOLDERS; HOUSEHOLD APPLIANCE COVERS; SEWING BASKETS; SEWING BOXES; BROOCHES; ORNAMENTAL NOVELTY BUTTONS; BUTTONS FOR CLOTHING; SHOE BUCKLES; CLOTH PATCHES FOR CLOTHING; EMBROIDERED EMBLEMS; FABRIC APPLIQUES; BOWS FOR GIFT WRAPPING; RIBBONS FOR GIFT WRAPPING; SHOE LACES; ORNAMENTAL NOVELTY PINS; RIBBONS (U.S. CLS. 37, 39, 40, 42 AND 50).

JOHN KELLY, EXAMINING ATTORNEY

SN 77-220,351. TERRY, DARLENE, PLACENTIA, CA. FILED 7-2-2007.

THE ORIGINAL KNITTING BEE

THE MARK CONSISTS OF STANDARD CHARACTERS WITHOUT CLAIM TO ANY PARTICULAR FONT, STYLE, SIZE, OR COLOR.

NO CLAIM IS MADE TO THE EXCLUSIVE RIGHT TO USE "ORIGINAL" OR "KNITTING", APART FROM THE MARK AS SHOWN.

FOR KNITTING KIT COMPRISED OF KNITTING IMPLEMENTS, NAMELY, A HAND HELD LOOM, KNITTING TOOL AND ACCOMPANYING INSTRUCTION MANUAL (U.S. CLS. 37, 39, 40, 42 AND 50).

FIRST USE 9-7-2005; IN COMMERCE 5-15-2006.

HENRY S. ZAK, EXAMINING ATTORNEY

SN 77-290,798. DURHAM ENTERPRISES CORPORATION, SALT LAKE CITY, UT. FILED 9-27-2007.

Gimme Clips

THE MARK CONSISTS OF STANDARD CHARACTERS WITHOUT CLAIM TO ANY PARTICULAR FONT, STYLE, SIZE, OR COLOR.

NO CLAIM IS MADE TO THE EXCLUSIVE RIGHT TO USE "CLIPS", APART FROM THE MARK AS SHOWN.

FOR HAIR CLIPS (U.S. CLS. 37, 39, 40, 42 AND 50).

MAUREEN DALL, EXAMINING ATTORNEY

CLASS 26—(Continued).

SN 77-292,018. WIG USA INC., SAN DIEGO, CA. FILED 9-28-2007.

WIGPRO

THE MARK CONSISTS OF STYLIZED LETTERING.
FOR WIGS, HAIRPIECES, AND ADD-IN AND ADD-ON HAIR ACCESSORIES CONSTRUCTED PRIMARILY OF SYNTHETIC AND/OR HUMAN HAIR (U.S. CLS. 37, 39, 40, 42 AND 50).
FIRST USE 1-1-2000; IN COMMERCE 1-1-2000.
HEATHER SAPP, EXAMINING ATTORNEY

SN 77-295,562. PELED, ALON, LOS ANGELES, CA. FILED 10-3-2007.

EXTEND-IT

THE MARK CONSISTS OF STANDARD CHARACTERS WITHOUT CLAIM TO ANY PARTICULAR FONT, STYLE, SIZE, OR COLOR.
FOR WIGS, HAIRPIECES, AND ADD-IN AND ADD-ON HAIR ACCESSORIES CONSTRUCTED PRIMARILY OF SYNTHETIC AND/OR HUMAN HAIR (U.S. CLS. 37, 39, 40, 42 AND 50).
BRIAN CALLAGHAN, EXAMINING ATTORNEY

SN 79-047,365. ZHEJIANG SANDING WEAVING CO.,LTD., CHINA, FILED 9-25-2007.

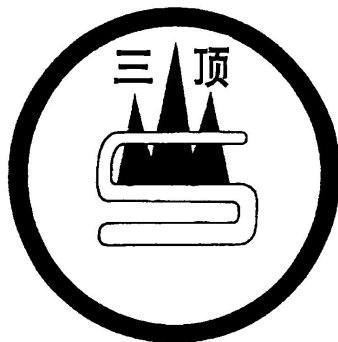

OWNER OF INTERNATIONAL REGISTRATION 0946520 DATED 9-25-2007, EXPIRES 9-25-2017.
THE WORD APPEARING IN THE MARK HAS NO SIGNIFICANCE IN THE RELEVANT TRADE OR INDUSTRY OR AS APPLIED TO THE GOODS LISTED IN THE APPLICATION, NE GEOGRAPHICAL SIGNIFICANCE.
THE TANSILTERATION OF THE NON-LATIN CHARACTERS IN THE MARK IS: SAN DING.
FOR LACE TRIMMINGS; HAIR BANDS; BRAIDS; SHOE LACES; CORDS FOR TRIMMING AND FOR CLOTHING (U.S. CLS. 37, 39, 40, 42 AND 50).
JOHN WILKE, EXAMINING ATTORNEY

CLASS 27—FLOOR COVERINGS

SN 77-223,709. JOY CARPETS, INC., FT. OGLETHORPE, GA. FILED 7-6-2007.

STAYTAC

THE MARK CONSISTS OF STANDARD CHARACTERS WITHOUT CLAIM TO ANY PARTICULAR FONT, STYLE, SIZE, OR COLOR.
FOR FLOOR COVERINGS AND CARPETS (U.S. CLS. 19, 20, 37, 42 AND 50).
ROBERT C. CLARK JR., EXAMINING ATTORNEY

SN 77-288,034. ALICE RUTTLE, PORT ST. LUCIE, FL. FILED 9-25-2007.

Shower Chair Dignity Mat

THE MARK CONSISTS OF STANDARD CHARACTERS WITHOUT CLAIM TO ANY PARTICULAR FONT, STYLE, SIZE, OR COLOR.
NO CLAIM IS MADE TO THE EXCLUSIVE RIGHT TO USE "SHOWER CHAIR" AND "MAT", APART FROM THE MARK AS SHOWN.
FOR BATH MATS; CHAIR MATS; FABRIC BATH MATS; PAPER BATH MATS (U.S. CLS. 19, 20, 37, 42 AND 50).
AISHA CLARKE, EXAMINING ATTORNEY

SN 77-291,933. CHAMLIAN ENTERPRISES, INC., FRESNO, CA. FILED 9-28-2007.

CHAMLIAN

THE MARK CONSISTS OF STANDARD CHARACTERS WITHOUT CLAIM TO ANY PARTICULAR FONT, STYLE, SIZE, OR COLOR.
FOR CARPET PADDING; CARPET UNDERLAY; CARPET UNDERLAYS; CARPET UNDERLINING (U.S. CLS. 19, 20, 37, 42 AND 50).
FIRST USE 3-2-1979; IN COMMERCE 3-2-1979.
BENJAMIN ALLEN, EXAMINING ATTORNEY

CLASS 27—(Continued).

SN 77-292,735. THE DIXIE GROUP, INC., CHATTANOOGA, TN. FILED 10-1-2007.

icarpet

THE MARK CONSISTS OF THE LETTER "I" AND THE WORD "CARPET."
FOR CARPETS (U.S. CLS. 19, 20, 37, 42 AND 50).
REBECCA GILBERT, EXAMINING ATTORNEY

SN 77-293,883. MOHAWK BRANDS, INC., WILMINGTON, DE. FILED 10-2-2007.

MOHAWK SHARE

THE MARK CONSISTS OF STANDARD CHARACTERS WITHOUT CLAIM TO ANY PARTICULAR FONT, STYLE, SIZE, OR COLOR.
OWNER OF U.S. REG. NOS. 1,099,660 AND 2,521,092.
FOR FLOOR COVERINGS (U.S. CLS. 19, 20, 37, 42 AND 50).
BRENDAN REGAN, EXAMINING ATTORNEY

SN 77-293,909. MOHAWK BRANDS, INC., WILMINGTON, DE. FILED 10-2-2007.

ECOLOGIC ELEGANCE

THE MARK CONSISTS OF STANDARD CHARACTERS WITHOUT CLAIM TO ANY PARTICULAR FONT, STYLE, SIZE, OR COLOR.
FOR CARPETS (U.S. CLS. 19, 20, 37, 42 AND 50).
BRENDAN REGAN, EXAMINING ATTORNEY

CLASS 27—(Continued).

SN 77-294,800. MOHAWK BRANDS, INC., WILMINGTON, DE. FILED 10-3-2007.

ECO-LIVING

THE MARK CONSISTS OF STANDARD CHARACTERS WITHOUT CLAIM TO ANY PARTICULAR FONT, STYLE, SIZE, OR COLOR.
FOR CARPETS (U.S. CLS. 19, 20, 37, 42 AND 50).
BRENDAN REGAN, EXAMINING ATTORNEY

SN 77-296,766. NEWLAND, JOHN, R., EUCLID, OH. FILED 10-4-2007.

MATADōR

THE MARK CONSISTS OF STANDARD CHARACTERS WITHOUT CLAIM TO ANY PARTICULAR FONT, STYLE, SIZE, OR COLOR.
FOR DOOR MAT (U.S. CLS. 19, 20, 37, 42 AND 50).
DOMINIC FATHY, EXAMINING ATTORNEY

SN 77-308,148. MOHAWK BRANDS, INC., WILMINGTON, DE. FILED 10-19-2007.

SENSIBLE STYLE

THE MARK CONSISTS OF STANDARD CHARACTERS WITHOUT CLAIM TO ANY PARTICULAR FONT, STYLE, SIZE, OR COLOR.
FOR CARPETING (U.S. CLS. 19, 20, 37, 42 AND 50).
BRENDAN REGAN, EXAMINING ATTORNEY

SN 77-312,381. HEB GROCERY COMPANY, LP, SAN ANTONIO, TX. FILED 10-24-2007.

CHOSEN FOR TEXAS BY TEXANS

THE MARK CONSISTS OF STANDARD CHARACTERS WITHOUT CLAIM TO ANY PARTICULAR FONT, STYLE, SIZE, OR COLOR.
FOR DOOR MATS AND NON-TEXTILE WALL HANGINGS (U.S. CLS. 19, 20, 37, 42 AND 50).
G. MAYERSCHOFF, EXAMINING ATTORNEY

CLASS 27—(Continued).

SN 78-816,157. MILLIKEN & COMPANY, SPARTANBURG, SC. FILED 2-16-2006.

GRAND ELEGANCE

THE MARK CONSISTS OF STANDARD CHARACTERS WITHOUT CLAIM TO ANY PARTICULAR FONT, STYLE, SIZE, OR COLOR.

FOR CARPETS, CARPET TILES, RUGS AND FLOOR MATS FOR USE IN RESIDENTIAL AND COMMERCIAL ESTABLISHMENTS (U.S. CLS. 19, 20, 37, 42 AND 50).

FIRST USE 6-27-1990; IN COMMERCE 6-27-1990.
VIVIAN MICZNIK FIRST, EXAMINING ATTORNEY

CLASS 28—TOYS AND SPORTING GOODS

SN 76-671,656. FRANK N FISH, LLC, OAKDALE, MN. FILED 1-22-2007.

PUL N SET

THE MARK CONSISTS OF STANDARD CHARACTERS WITHOUT CLAIM TO ANY PARTICULAR FONT, STYLE, SIZE, OR COLOR.

FOR SPRING LOADED ACTIVATED DEVICE USED TO ADJUST A MOUNTED FISHING ROD HOLDER (U.S. CLS. 22, 23, 38 AND 50).

FIRST USE 9-19-2006; IN COMMERCE 9-19-2006.
CHARLES L. JENKINS, EXAMINING ATTORNEY

SN 76-682,523. POOF-SLINKY, INC., PLYMOUTH, MI. FILED 10-3-2007.

FRANTIC FALL

THE MARK CONSISTS OF STANDARD CHARACTERS WITHOUT CLAIM TO ANY PARTICULAR FONT, STYLE, SIZE, OR COLOR.

FOR ACTION SKILL GAMES (U.S. CLS. 22, 23, 38 AND 50).

CHARLES L. JENKINS, EXAMINING ATTORNEY

CLASS 28—(Continued).

SN 77-000,306. PENN RACQUET SPORTS, INC., PHOENIX, AZ. FILED 9-15-2006.

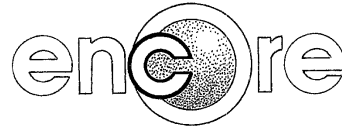

TECHNOLOGY

33% LONGER LASTING

NO CLAIM IS MADE TO THE EXCLUSIVE RIGHT TO USE "TECHNOLOGY" AND "33% LONGER LASTING", APART FROM THE MARK AS SHOWN.

THE MARK CONSISTS OF THE TERM "ENCORE TECHNOLOGY 33% LONGER LASTING", WHEREIN THE LETTER "O" IN THE TERM ENCORE STYLIZED AS A SPHERE AND OVERLAPS THE LETTER "C" IN THE TERM ENCORE WITH THE LETTER "O" INCLUDING STIPPLING THEREIN.

FOR ELASTOMER OR RUBBER POLYMER COMPOSITION IN THE FORM OF HOLLOW SPHERES AS AN INTEGRAL COMPONENT OF TENNIS BALLS TO LIMIT THE AMOUNT OF ELASTOMERIC SOFTENING (U.S. CLS. 22, 23, 38 AND 50).

FIRST USE 5-20-2005; IN COMMERCE 5-20-2005.
KAPIL BHANOT, EXAMINING ATTORNEY

SN 77-009,188. MARTENS RALPH A., SURREY, BRITISH COLUMBIA, CANADA, FILED 9-28-2006.

Trophy Reels

THE MARK CONSISTS OF STANDARD CHARACTERS WITHOUT CLAIM TO ANY PARTICULAR FONT, STYLE, SIZE, OR COLOR.

PRIORITY CLAIMED UNDER SEC. 44(D) ON CANADA APPLICATION NO. 1318227, FILED 9-27-2006.

NO CLAIM IS MADE TO THE EXCLUSIVE RIGHT TO USE "REELS", APART FROM THE MARK AS SHOWN.

FOR FISHING REELS (U.S. CLS. 22, 23, 38 AND 50).
FIRST USE 1-15-2006; IN COMMERCE 1-15-2006.

GRETTA YAO, EXAMINING ATTORNEY

SN 77-053,716. BOONE BAIT COMPANY, INC., WINTER PARK, FL. FILED 11-30-2006.

BOONE

THE MARK CONSISTS OF STANDARD CHARACTERS WITHOUT CLAIM TO ANY PARTICULAR FONT, STYLE, SIZE, OR COLOR.

SEC. 2(F).

FOR FISHING TACKLE (U.S. CLS. 22, 23, 38 AND 50).
FIRST USE 7-22-1975; IN COMMERCE 7-22-1975.

KATHERINE CHANG, EXAMINING ATTORNEY

CLASS 28—(Continued).

SN 77-064,039. LANDSCAPE STRUCTURES, INC., DELANO, MN. FILED 12-14-2006.

HEMISPHERE CLIMBER

THE MARK CONSISTS OF STANDARD CHARACTERS WITHOUT CLAIM TO ANY PARTICULAR FONT, STYLE, SIZE, OR COLOR.

NO CLAIM IS MADE TO THE EXCLUSIVE RIGHT TO USE "CLIMBER", APART FROM THE MARK AS SHOWN.

FOR PLAYGROUND EQUIPMENT, NAMELY, CLIMBING UNITS (U.S. CLS. 22, 23, 38 AND 50).

STEVEN JACKSON, EXAMINING ATTORNEY

CLASS 28—(Continued).

SN 77-077,425. MATTEL, INC., EL SEGUNDO, CA. FILED 1-5-2007.

JACK STRIKER

THE MARK CONSISTS OF STANDARD CHARACTERS WITHOUT CLAIM TO ANY PARTICULAR FONT, STYLE, SIZE, OR COLOR.

THE NAME(S), PORTRAIT(S), AND/OR SIGNATURE(S) SHOWN IN THE MARK DOES NOT IDENTIFY A PARTICULAR LIVING INDIVIDUAL.

FOR TOYS, GAMES AND PLAYTHINGS, NAMELY, TOY FIGURES AND ACCESSORIES THEREFOR (U.S. CLS. 22, 23, 38 AND 50).

CAROLYN CATALDO, EXAMINING ATTORNEY

SN 77-091,993. FALONDA HANIF, STONE MOUNTAIN, GA. FILED 1-26-2007.

AKA-OPOLY

THE MARK CONSISTS OF STANDARD CHARACTERS WITHOUT CLAIM TO ANY PARTICULAR FONT, STYLE, SIZE, OR COLOR.

FOR BOARD GAMES AND GAME COMPONENT PIECES SOLD AS A UNIT THEREWITH; EQUIPMENT SOLD AS A UNIT FOR PLAYING BOARD GAMES; PRINTED POSITIONABLE TOYS FOR USE IN BOARD GAMES; BOARD GAME PLAYED WITH MOVABLE PIECES; GAMES, NAMELY, BOARD GAMES, PARTY GAMES AND PARLOR GAMES AND COMPONENT PIECES THEREOF FOR USE AS A SET (U.S. CLS. 22, 23, 38 AND 50).

EMILY CARLSEN, EXAMINING ATTORNEY

SN 77-073,230. 1-800-TEDDYBEAR INC., STATEN ISLAND, NY. FILED 12-29-2006.

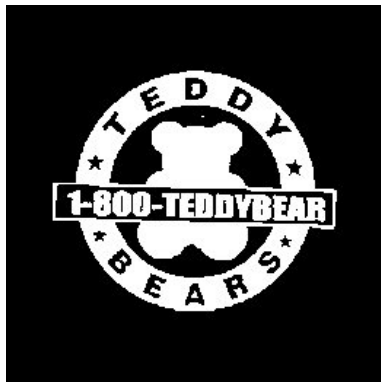

OWNER OF U.S. REG. NO. 3,346,947.
NO CLAIM IS MADE TO THE EXCLUSIVE RIGHT TO USE "1-800-TEDDY BEAR" AND "TEDDY BEARS", APART FROM THE MARK AS SHOWN.

THE MARK CONSISTS OF IMAGE OF A TEDDY BEAR WITHIN A CIRCLE BORDERED BY STARS AND STYLIZED TEXT.

FOR PLUSH TOYS; STUFFED TOY ANIMALS (U.S. CLS. 22, 23, 38 AND 50).

FIRST USE 3-1-2003; IN COMMERCE 3-1-2003.

KHANH LE, EXAMINING ATTORNEY

SN 77-109,578. BUY-GLOBAL, INC., WEST HEMPSTEAD, NY. FILED 2-16-2007.

GLOBAL PLUSH

THE MARK CONSISTS OF STANDARD CHARACTERS WITHOUT CLAIM TO ANY PARTICULAR FONT, STYLE, SIZE, OR COLOR.

NO CLAIM IS MADE TO THE EXCLUSIVE RIGHT TO USE "PLUSH", APART FROM THE MARK AS SHOWN.

FOR PLUSH TOYS; STUFFED TOY ANIMALS (U.S. CLS. 22, 23, 38 AND 50).

MARK SPARACINO, EXAMINING ATTORNEY

CLASS 28—(Continued).

SN 77-113,970. GLOD, DAVID, BATAVIA, IL. FILED 2-22-2007.

XLD

THE MARK CONSISTS OF STANDARD CHARACTERS WITHOUT CLAIM TO ANY PARTICULAR FONT, STYLE, SIZE, OR COLOR.
FOR GOLF CLUBS (U.S. CLS. 22, 23, 38 AND 50).
KEVIN CORWIN, EXAMINING ATTORNEY

SN 77-125,530. GAME ONE SAS, PARIS, FRANCE, FILED 3-8-2007.

GAME ONE

OWNER OF U.S. REG. NOS. 2,682,102 AND 2,863,917.
NO CLAIM IS MADE TO THE EXCLUSIVE RIGHT TO USE "GAME", APART FROM THE MARK AS SHOWN.
FOR HAND HELD ELECTRONIC GAMES; STAND ALONE VIDEO GAME MACHINES; COIN OPERATED VIDEO GAMES; PLAYTHINGS, NAMELY, BALLOONS, BALLS AND GLOVES FOR BASEBALL (U.S. CLS. 22, 23, 38 AND 50).
REBECCA POVARCHUK, EXAMINING ATTORNEY

SN 77-128,650. COLE, JOHN, ENCINITIAS, CA. FILED 3-12-2007.

FLEXSTEP

THE MARK CONSISTS OF STANDARD CHARACTERS WITHOUT CLAIM TO ANY PARTICULAR FONT, STYLE, SIZE, OR COLOR.
FOR SPORTING GOODS, NAMELY, A SPORTS TRAINING DEVICE TO IMPROVE STRENGTH, TONING, CONDITIONING, BALANCE, AND PROPRIOCEPTION (U.S. CLS. 22, 23, 38 AND 50).
ELLEN PERKINS, EXAMINING ATTORNEY

CLASS 28—(Continued).

SN 77-131,350. FUNK'D GOLF LTD., PRESTON, LANCA-SHIRE, UNITED KINGDOM, FILED 3-14-2007.

FUNK'D

THE MARK CONSISTS OF STANDARD CHARACTERS WITHOUT CLAIM TO ANY PARTICULAR FONT, STYLE, SIZE, OR COLOR.
PRIORITY CLAIMED UNDER SEC. 44(D) ON UNITED KINGDOM APPLICATION NO. 2433124, FILED 9-18-2006, REG. NO. 2433124, DATED 4-6-2007, EXPIRES 9-18-2016.
FOR GOLF EQUIPMENT AND ACCESSORIES, NAMELY, GOLF CLUB GRIPS; GOLF GLOVES; GOLF CLUBS; GOLF BALLS; GOLF TEES; GOLF BAGS, WITH OR WITHOUT WHEELS; CADDIE BAGS FOR GOLF CLUBS; GOLF CLUB BAGS; GOLF TEE BAGS; STANDS FOR GOLF BAGS; TROLLEY BAGS FOR GOLF EQUIPMENT; PARTS AND FITTINGS FOR ALL THE AFORESAID (U.S. CLS. 22, 23, 38 AND 50).
CURTIS FRENCH, EXAMINING ATTORNEY

SN 77-133,235. D. BAGUES, INC., MILWAUKIE, OR. FILED 3-16-2007.

KEYZ FOR KIDZ

THE MARK CONSISTS OF STANDARD CHARACTERS WITHOUT CLAIM TO ANY PARTICULAR FONT, STYLE, SIZE, OR COLOR.
NO CLAIM IS MADE TO THE EXCLUSIVE RIGHT TO USE "FOR KIDS", APART FROM THE MARK AS SHOWN.
FOR CHILDREN'S MULTIPLE ACTIVITY TOYS; MANIPULATIVE PUZZLES; CONSTRUCTION TOYS; BOARD GAMES; GAME TABLES (U.S. CLS. 22, 23, 38 AND 50).
NICHOLAS ALTREE, EXAMINING ATTORNEY

SN 77-136,284. MATTEL, INC., EL SEGUNDO, CA. FILED 3-21-2007.

STARS OF CARS

THE MARK CONSISTS OF STANDARD CHARACTERS WITHOUT CLAIM TO ANY PARTICULAR FONT, STYLE, SIZE, OR COLOR.
FOR TOYS, GAMES AND PLAYTHINGS, NAMELY, TOY VEHICLES AND ACCESSORIES THEREFOR (U.S. CLS. 22, 23, 38 AND 50).
NAKIA HENRY, EXAMINING ATTORNEY

CLASS 28—(Continued).

SN 77-138,803. KABUSHIKI KAISHA SEGA, DBA SEGA CORPORATION, OHTA-KU, TOKYO, JAPAN, FILED 3-23-2007.

SEGA-RACETV

THE MARK CONSISTS OF STANDARD CHARACTERS WITHOUT CLAIM TO ANY PARTICULAR FONT, STYLE, SIZE, OR COLOR.

PRIORITY CLAIMED UNDER SEC. 44(D) ON JAPAN APPLICATION NO. 2007-022720, FILED 3-15-2007, REG. NO. 5095172, DATED 11-30-2007, EXPIRES 11-30-2017.

OWNER OF U.S. REG. NOS. 1,566,116, 2,492,043 AND OTHERS.

FOR STAND ALONE VIDEO GAME MACHINES; ARCADE GAME MACHINES WITH BUILT-IN SCREENS (U.S. CLS. 22, 23, 38 AND 50).

DAVID MILLER, EXAMINING ATTORNEY

CLASS 28—(Continued).

SN 77-139,458. DEPALMA'S ACTION KARATE, LLC, MESA, AZ. FILED 3-23-2007.



THE MARK CONSISTS OF THE WORDING "DEPALMA'S" AND THE DESIGN OF A KICKER WITH A BALL BEHIND HIM.

FOR KARATE GLOVES; KARATE HEAD GUARDS; KARATE KICK PADS; KARATE SHIN PADS; KARATE TARGET PADS; SPORTS EQUIPMENT FOR BOXING, MARTIAL ARTS, AND THE LIKE, NAMELY, PROTECTIVE BRAS (U.S. CLS. 22, 23, 38 AND 50).

KAREN K. BUSH, EXAMINING ATTORNEY

SN 77-138,989. OUT O' SITE, LLC, SPRINGFIELD, MO. FILED 3-23-2007.

G-1

THE MARK CONSISTS OF STANDARD CHARACTERS WITHOUT CLAIM TO ANY PARTICULAR FONT, STYLE, SIZE, OR COLOR.

FOR TREE STANDS FOR HUNTING (U.S. CLS. 22, 23, 38 AND 50).

FIRST USE 6-0-2006; IN COMMERCE 6-0-2006.

JORDAN BAKER, EXAMINING ATTORNEY

SN 77-140,035. MINDPIX, INC., OREM, UT. FILED 3-26-2007.

SN 77-139,027. OUT O' SITE, LLC, SPRINGFIELD, MO. FILED 3-23-2007.

G-2

THE MARK CONSISTS OF STANDARD CHARACTERS WITHOUT CLAIM TO ANY PARTICULAR FONT, STYLE, SIZE, OR COLOR.

FOR TREE STANDS FOR HUNTING (U.S. CLS. 22, 23, 38 AND 50).

FIRST USE 6-0-2006; IN COMMERCE 6-0-2006.

JORDAN BAKER, EXAMINING ATTORNEY

TARGET PERFECT RESISTANCE

THE MARK CONSISTS OF STANDARD CHARACTERS WITHOUT CLAIM TO ANY PARTICULAR FONT, STYLE, SIZE, OR COLOR.

NO CLAIM IS MADE TO THE EXCLUSIVE RIGHT TO USE "RESISTANCE", APART FROM THE MARK AS SHOWN.

FOR EXERCISE EQUIPMENT, NAMELY, MANUALLY OPERATED RESISTANCE TRAINING DEVICES (U.S. CLS. 22, 23, 38 AND 50).

TINA BROWN, EXAMINING ATTORNEY

CLASS 28—(Continued).

SN 77-143,455. COTTONWOOD OUTDOORS CORP, JASPER, GA. FILED 3-29-2007.

COTTONWOOD ENTERPRISES LLP

THE MARK CONSISTS OF STANDARD CHARACTERS WITHOUT CLAIM TO ANY PARTICULAR FONT, STYLE, SIZE, OR COLOR.

NO CLAIM IS MADE TO THE EXCLUSIVE RIGHT TO USE "ENTERPRISES LLP", APART FROM THE MARK AS SHOWN.

FOR HUNTING EQUIPMENT, NAMELY, WEATHER-PROOF PADDED COVERS USED FOR TREESTAND RAILS AND WEATHERPROOF COVERS FOR TREE-STANDS (U.S. CLS. 22, 23, 38 AND 50).

FIRST USE 6-0-2004; IN COMMERCE 6-0-2004.
SANI KHOURI, EXAMINING ATTORNEY

CLASS 28—(Continued).

SN 77-146,942. WONG, CHI, BROOKLYN, NY. FILED 4-3-2007.

HOODY BEAR

THE MARK CONSISTS OF STANDARD CHARACTERS WITHOUT CLAIM TO ANY PARTICULAR FONT, STYLE, SIZE, OR COLOR.

NO CLAIM IS MADE TO THE EXCLUSIVE RIGHT TO USE "BEAR", APART FROM THE MARK AS SHOWN.

FOR ACTION FIGURES AND ACCESSORIES THEREFOR; PUSH TOYS; SNOW GLOBES; SOFT SCULPTURE PLUSH TOYS; SQUEEZABLE SQUEAKING TOYS; STUFFED DOLLS AND ANIMALS; STUFFED PUPPETS; STUFFED TOY ANIMALS; STUFFED TOY BEARS; STUFFED TOYS; TEDDY BEARS; TOY ACTION FIGURES AND ACCESSORIES THEREFOR; MODELED PLASTIC TOY FIGURINES; TOY WATER GLOBES (U.S. CLS. 22, 23, 38 AND 50).

MICHELE SWAIN, EXAMINING ATTORNEY

SN 77-147,175. MATTEL, INC., EL SEGUNDO, CA. FILED 4-3-2007.

WHIPLASH

THE MARK CONSISTS OF STANDARD CHARACTERS WITHOUT CLAIM TO ANY PARTICULAR FONT, STYLE, SIZE, OR COLOR.

FOR TOYS, GAMES AND PLAYTHINGS, NAMELY, TOY ACTION FIGURES, TOY FIGURES, AND ACCESSORIES FOR ALL OF THE FOREGOING (U.S. CLS. 22, 23, 38 AND 50).

JAMES A. RAUEN, EXAMINING ATTORNEY

SN 77-149,500. VOSPER, MICHAEL E., SR., CHARLOTTESVILLE, VA. FILED 4-5-2007.

TIC TAC RUM-MEE

THE MARK CONSISTS OF STANDARD CHARACTERS WITHOUT CLAIM TO ANY PARTICULAR FONT, STYLE, SIZE, OR COLOR.

NO CLAIM IS MADE TO THE EXCLUSIVE RIGHT TO USE "RUMMY", APART FROM THE MARK AS SHOWN.

FOR BOARD GAMES (U.S. CLS. 22, 23, 38 AND 50).
MICHAEL WEBSTER, EXAMINING ATTORNEY

SN 77-145,728. LEE LARCHEVEQUE, GRANBY, MA. FILED 4-1-2007.



THE MARK CONSISTS OF THE WORD "PITCHNUT". THE LETTER "P" IS CREATED BY A HAND MAKING A "FLICKING" MOTION (A "PICHENOTTE" IN FRENCH). BETWEEN THE WORDS "PITCH" AND "NUT" IS A CIRCLE CONSISTING OF SMALLER CIRCLES (THESE REPRESENT THE SET-UP OF PITCHNUT PIECES AT THE BEGINNING OF A GAME. A SMALL CIRCLE APPEARS AT THE CENTER OF THE LARGER CIRCLE.

FOR ACTION SKILL GAMES (U.S. CLS. 22, 23, 38 AND 50).

FIRST USE 9-1-2006; IN COMMERCE 12-1-2007.
NAAKWAMA ANKRAH, EXAMINING ATTORNEY

CLASS 28—(Continued).

SN 77-153,932. MATTEL, INC., EL SEGUNDO, CA. FILED 4-11-2007.

MALIBU PUP

THE MARK CONSISTS OF STANDARD CHARACTERS WITHOUT CLAIM TO ANY PARTICULAR FONT, STYLE, SIZE, OR COLOR.

NO CLAIM IS MADE TO THE EXCLUSIVE RIGHT TO USE "PUP", APART FROM THE MARK AS SHOWN.

FOR TOYS, GAMES AND PLAYTHINGS, NAMELY, DOLLS, DOLL CLOTHING AND DOLL ACCESSORIES, DOLL PLAYSETS, TOY FIGURES, TOY ANIMALS, AND ACCESSORIES FOR ALL OF THE FOREGOING (U.S. CLS. 22, 23, 38 AND 50).

KATHLEEN LORENZO, EXAMINING ATTORNEY

SN 77-155,896. MATTEL, INC., EL SEGUNDO, CA. FILED 4-13-2007.

LIGHT RIDER

THE MARK CONSISTS OF STANDARD CHARACTERS WITHOUT CLAIM TO ANY PARTICULAR FONT, STYLE, SIZE, OR COLOR.

NO CLAIM IS MADE TO THE EXCLUSIVE RIGHT TO USE "LIGHT", APART FROM THE MARK AS SHOWN.

FOR TOYS, GAMES AND PLAYTHINGS, NAMELY, TOY VEHICLES AND ACCESSORIES THEREFOR (U.S. CLS. 22, 23, 38 AND 50).

FIRST USE 12-13-2007; IN COMMERCE 12-13-2007.
 GEORGIA CARTY, EXAMINING ATTORNEY

CLASS 28—(Continued).

SN 77-165,931. SAVE YOUR WORLD, SHORT HILLS, NJ. FILED 4-25-2007.

Save your Games

THE MARK CONSISTS OF STANDARD CHARACTERS WITHOUT CLAIM TO ANY PARTICULAR FONT, STYLE, SIZE, OR COLOR.

NO CLAIM IS MADE TO THE EXCLUSIVE RIGHT TO USE "GAMES", APART FROM THE MARK AS SHOWN.

FOR ATHLETIC SPORTING GOODS, NAMELY, ATHLETIC WRIST AND JOINT SUPPORTS; BABY MULTIPLE ACTIVITY TOYS; BAGS SPECIALLY ADAPTED FOR SPORTS EQUIPMENT; BOARDS USED IN THE PRACTICE OF WATER SPORTS; BODY LIMB COMPRESSION SLEEVES FOR USE IN SOCCER AND OTHER SPORTS; CAMOUFLAGE SCREENS; CASES IN THE FORM OF QUIVERS FOR SPORTS IMPLEMENTS; CHEST PROTECTORS FOR SPORTS; CHILDREN'S ACTIVITY TABLES CONTAINING MANIPULATIVE TOYS WHICH CONVERT TO EASELS; CHILDREN'S MULTIPLE ACTIVITY TABLES; CHILDREN'S MULTIPLE ACTIVITY TOYS; CHILDREN'S MULTIPLE ACTIVITY TOYS SOLD AS A UNIT WITH PRINTED BOOKS; CHILDREN'S WIRE CONSTRUCTION AND ART ACTIVITY TOYS; DISCUSSES; ELECTRONIC SPORTS TRAINING SIMULATORS; ELECTRONIC TARGETS FOR GAMES AND SPORTS; FACE MASKS FOR OUTDOOR SPORTS, NAMELY, FISHING, PAINT BALL, LACROSSE, BASEBALL, FOOTBALL; HANDLE GRIPS FOR SPORTING EQUIPMENT; HURDLES; JAVELINS; MEN'S ATHLETIC SUPPORTERS; NEEDLES FOR PUMPS FOR INFLATING SPORTS EQUIPMENT; NON-MEDICATED TOPICALLY APPLIED OINTMENT OR GEL FOR IMPROVING HAND GRIP IN SPORTS ACTIVITIES; OUTDOOR ACTIVITY GAMES IN THE NATURE OF CHESS, BASEBALL, SOCCER, TWISTER; PADS FOR USE IN SPORTS, NAMELY, SHOULDER PADS FOR FOOTBALL, SHIN PADS FOR SOCCER, SHIN PADS FOR LACROSSE, SHIN PADS FOR FIELD HOCKEY, CHEST AND SHIN PADS FOR BASEBALL; PROTECTIVE PADDING FOR PLAYING SPORTS, NAMELY, SOCCER, BASEBALL, LACROSSE, FIELD HOCKEY, FOOTBALL, ICE HOCKEY; PUMPS FOR INFLATING SPORTS EQUIPMENT, NAMELY, BALLS OF ALL KINDS, INFLATABLE TOYS, INFLATABLE BOP BAGS, INFLATABLE RIDE ON TOYS, INFLATABLE POOL TOYS; SAFETY PADDING FOR SPORTS, NAMELY, FOOTBALL, LACROSSE, SOCCER; SCUBA EQUIPMENT, NAMELY, SPRING ACTIVATED SPEARGUNS; SHIN PADS FOR USE IN SPORTS, NAMELY, SOCCER, BASEBALL, ICE HOCKEY, FIELD HOCKEY; SPORT BALLS; SPORTING GOODS AND EQUIPMENT FOR SPEED TRAINING, NAMELY, RINGS, CONES, SPEED LADDERS, COACHING STICKS, TRAINING ARCHES, ANKLE BANDS, RESISTANCE CHUTES, HURDLES; SPORTS EQUIPMENT FOR BOXING, MARTIAL ARTS, AND THE LIKE, NAMELY PROTECTIVE BRAS; SPORTS EQUIPMENT, NAMELY, NORDIC WALKING POLES; SPORTS EQUIPMENT, NAMELY, INLINE ROLLER SKATING WHEELS AT THE END OF A CRUTCH-LIKE FRAME; SPORTS EQUIPMENT, NAMELY, LOWER BODY ALIGNMENT APPARATUS; SPORTS EQUIPMENT, NAMELY, SKY-DIVING SIMULATION APPARATUS IN THE NATURE OF VERTICAL WIND TUNNELS; SPORTS FIELD EQUIPMENT, NAMELY, CORNER FLAGS; SPORTS FIELD TRAINING GRIDS; SPORTS FITNESS RESTRAINT STRAPS FOR RUNNING IN TANDEM OR PAIRS; SPRING BOARDS; STARTING BLOCKS; STARTING BLOCKS; STORAGE RACKS FOR SKI AND SPORTS EQUIPMENT; STORAGE RACKS FOR SPORTING GOODS IN THE NATURE OF PAINT BALL GUNS; WEIGHT LIFTING BELTS (U.S. CLS. 22, 23, 38 AND 50).

MARY CRAWFORD, EXAMINING ATTORNEY

CLASS 28—(Continued).

SN 77-165,934. SAVE YOUR WORLD, SHORT HILLS, NJ.
FILED 4-25-2007.

Save your Toys

THE MARK CONSISTS OF STANDARD CHARACTERS WITHOUT CLAIM TO ANY PARTICULAR FONT, STYLE, SIZE, OR COLOR.

NO CLAIM IS MADE TO THE EXCLUSIVE RIGHT TO USE "TOYS", APART FROM THE MARK AS SHOWN.

FOR TOY MODEL VEHICLES AND RELATED ACCESSORIES SOLD AS UNITS; TOY MODELING DOUGH; TOY MUSIC BOXES; TOY NOISEMAKERS; TOY PIANOS; TOY PIANOS, SOLD AS A UNIT WITH PRINTED BOOKS IN THE FIELD OF MUSIC EDUCATION; TOY PISTOLS; TOY PRISM GLASSES; TOY PUTTY; TOY RECORD PLAYERS; TOY ROBOTS; TOY ROCKETS; TOY SCOOTERS; TOY SETS OF CARPENTERS' TOOLS; TOY SNOW GLOBES; TOY STAMPS; TOY SWORDS; TOY TRAINS AND PARTS AND ACCESSORIES THEREFOR; TOY VEHICLES; TOY VEHICLES AND ACCESSORIES THEREFOR; TOY VEHICLES WITH TRANSFORMING PARTS; TOY WATCHES; TOY WATER GLOBES; TOY WEAPONS; TOY WIND SOCKS; TOY XYLOPHONES; TOY ZIP GUNS; TOY, NAMELY, BATTERY-POWERED COMPUTER GAME WITH LCD SCREEN WHICH FEATURES ANIMATION AND SOUND EFFECTS; TOYS DESIGNED TO BE ATTACHED TO MECHANICAL ROBOTS; TOYS, NAMELY, A DISK TO TOSS IN PLAYING A GAME WHEREIN OTHER DISKS ARE FLIPPED AND COLLECTED; TRANSFORMING ROBOTIC TOY VEHICLES; TRANSFORMING ROBOTIC TOYS; WATER SQUIRTING TOYS; WIND-UP TOYS; WIND-UP WALKING TOYS; TOY CLOCKS AND WATCHES; TOY CONSTRUCTION BLOCKS; TOY CONSTRUCTION SETS; TOY FIGURES; TOY FILM CARTRIDGES AND VIEWERS; TOY FURNITURE; TOY GLIDERS; TOY GLOCKENSPIELS; TOY GUNS; TOY HARMONICAS; TOY HOLSTERS; TOY HOOP SETS; TOY HOUSES; TOY MAIL BOXES; TOY MASKS; TOY MOBILES; TOY MODEL CARS; TOY MODEL HOBBYCRAFT KITS; TOY MODEL KIT CARS; TOY MODEL TRAIN SETS; STUFFED TOY BEARS; STUFFED TOYS; TALKING TOYS; TESSELLATION TOYS; TOSSING DISC TOYS; TOY CHRISTMAS TREES; TOY ACTION FIGURES; TOY ACTION FIGURES AND ACCESSORIES THEREFOR; TOY AIRPLANES; TOY ANIMALS AND ACCESSORIES THEREFOR; TOY ARMOR; TOY ARTIFICIAL FINGERNAILS; TOY BAKEWARE AND COOKWARE; TOY BANKS; TOY BOWS AND ARROWS; TOY BOXES; TOY BUILDING BLOCKS; TOY BUILDING BLOCKS CAPABLE OF INTERCONNECTION; TOY BUTTERFLY NETS; TOY CAP PISTOLS; POSITIONABLE TWO DIMENSIONAL TOYS FOR USE IN GAMES; PRINTED POSITIONABLE TOYS FOR USE IN CHILDREN'S BOARD GAMES; PRINTING TOYS; PULL TOYS; PUNCHING TOYS; PUSH TOYS; RADIO CONTROLLED TOY VEHICLES; RADIO TRANSMITTERS FOR USE WITH RADIO-CONTROLLED TOYS; REMOTE CONTROL TOYS, NAMELY, HELICOPTERS, ATVS, CARS, RACE CARS, AIRPLANES, BOATS; RIDE-ON TOYS; RUBBER CHARACTER TOYS; SAND TOYS; SANDBOX TOYS; SKETCHING TOYS; SOFT SCULPTURE PLUSH TOYS; SOFT SCULPTURE TOYS; SQUEEZABLE SQUEAKING TOYS; SQUEEZE TOYS; STACKING TOYS; STUFFED TOY ANIMALS; MODEL TOY STEAM OPERATED TRACTION ENGINES; MODELED PLASTIC TOY FIGURINES; MOLDED TOY FIGURES; MUSIC BOX TOYS; MUSICAL TOYS; NON-ELECTRONIC TOY VEHICLES; NON-RIDING TRANSPORTATION TOYS; PARTY FAVORS IN THE NATURE OF SMALL TOYS; PET TOYS; PET TOYS CONTAINING CATNIP; PET TOYS MADE OF ROPE; PLASTIC CHARACTER TOYS; PLAY MATS CONTAINING INFANT TOYS; PLAY MATS FOR USE WITH TOY VEHICLES; PLUSH TOYS; POP UP TOYS; POSITIONABLE PRINTED TOY FIGURES FOR USE IN GAMES; POSITIONABLE PRINTED TOY FIGURES FOR USE IN PUZZLES; POSITIONABLE THREE DIMENSIONAL TOYS FOR USE IN GAMES; POSITIONABLE

CLASS 28—(Continued).

TOY FIGURES; ELECTRIC TOY TRAIN TRANSFORMERS; ELECTRONIC LEARNING TOYS; ELECTRONIC TOY BUILDING BLOCKS THAT LIGHT UP AS A NIGHT LIGHT; ELECTRONIC TOY VEHICLES; ELECTRONICALLY OPERATED TOY MOTOR VEHICLES; FANTASY CHARACTER TOYS; FLYING SAUCERS; INFANT ACTION CRIB TOYS; INFANT DEVELOPMENT TOYS; INFANT TOYS; INFLATABLE BATH TOYS; INFLATABLE RIDE-ON TOYS; INFLATABLE THIN RUBBER TOYS; INFLATABLE TOYS; INFLATABLE TOYS SHOWING DECORATIVE PICTURES; LEVER ACTION TOYS; MECHANICAL ACTION TOYS; MECHANICAL TOYS; MINIATURE TOY HELMETS; MODEL TOY STEAM ENGINES; BENDABLE TOYS; CAPS FOR TOY PISTOLS; CASES FOR TOY STRUCTURES; CASES FOR TOY VEHICLES; CAT TOYS; CHILDREN'S ACTIVITY TABLES CONTAINING MANIPULATIVE TOYS WHICH CONVERT TO EASELS; CHILDREN'S MULTIPLE ACTIVITY TOYS; CHILDREN'S MULTIPLE ACTIVITY TOYS SOLD AS A UNIT WITH PRINTED BOOKS; CHILDREN'S WIRE CONSTRUCTION AND ART ACTIVITY TOYS; CLOCKWORK TOYS OF METAL; CLOCKWORK TOYS OF PLASTIC; COLLECTABLE TOY FIGURES; CONSTRUCTION TOYS; CRIB TOYS; DISC TOSS TOYS; DOG TOYS; DRAWING TOYS; EDUCATIONAL TOY FOR THE PURPOSE OF THE DEMONSTRATION OF ALTERNATIVE ENERGY SOURCES; ELECTRIC ACTION TOYS; ELECTRIC EDUCATIONAL TOY USED TO DEMONSTRATE ALTERNATIVE ENERGY SOURCES; ARROWS; BABY MULTIPLE ACTIVITY TOYS; BATH TOYS; BATHTUB TOYS; BATTERY OPERATED ACTION TOYS (U.S. CLS. 22, 23, 38 AND 50).
MARY CRAWFORD, EXAMINING ATTORNEY

SN 77-167,317. VIACOM INTERNATIONAL INC., NEW YORK, NY. FILED 4-27-2007.

YO! MTV RAPS

THE MARK CONSISTS OF STANDARD CHARACTERS WITHOUT CLAIM TO ANY PARTICULAR FONT, STYLE, SIZE, OR COLOR.

OWNER OF U.S. REG. NOS. 1,985,017, 2,887,413 AND OTHERS.

FOR GAMES AND PLAYTHINGS, NAMELY, DOLLS; ACTION FIGURES AND ACCESSORIES THEREOF; STAND ALONE VIDEO GAME MACHINES UTILIZING CD ROM'S, STAND ALONE VIDEO GAME MACHINES, STAND ALONE AUDIO OUTPUT GAME MACHINES; SPORTING ARTICLES, NAMELY, GOLF CLUBS, BASEBALLS, FOOTBALLS, PADDLE BALLS, BASEBALL BATS; DECORATIONS FOR CHRISTMAS TREES (U.S. CLS. 22, 23, 38 AND 50).

ELISSA GARBER KON, EXAMINING ATTORNEY

CLASS 28—(Continued).

SN 77-172,527. MATTEL, INC., EL SEGUNDO, CA. FILED 5-3-2007.

RAYNA

THE MARK CONSISTS OF STANDARD CHARACTERS WITHOUT CLAIM TO ANY PARTICULAR FONT, STYLE, SIZE, OR COLOR.

FOR TOYS, GAMES AND PLAYTHINGS, NAMELY, DOLLS, DOLL CLOTHING AND DOLL ACCESSORIES, TOY FIGURES AND ACCESSORIES THEREFOR (U.S. CLS. 22, 23, 38 AND 50).

FIRST USE 10-9-2007; IN COMMERCE 10-9-2007.

KAPIL BHANOT, EXAMINING ATTORNEY

SN 77-172,738. ENOR CORPORATION, NORTHVALE, NJ. FILED 5-4-2007.

XXL 10 Pin Bowling

THE MARK CONSISTS OF STANDARD CHARACTERS WITHOUT CLAIM TO ANY PARTICULAR FONT, STYLE, SIZE, OR COLOR.

NO CLAIM IS MADE TO THE EXCLUSIVE RIGHT TO USE "10 PIN BOWLING", APART FROM THE MARK AS SHOWN.

FOR BOWLING BALLS; BOWLING PINS (U.S. CLS. 22, 23, 38 AND 50).

FIRST USE 1-2-2006; IN COMMERCE 1-2-2006.

HOWARD B. LEVINE, EXAMINING ATTORNEY

SN 77-173,630. TORRES, DANY, NEW YORK CITY, NY. FILED 5-4-2007.

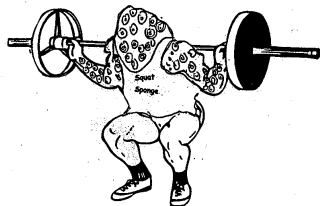

NO CLAIM IS MADE TO THE EXCLUSIVE RIGHT TO USE "SQUAT SPONGE", APART FROM THE MARK AS SHOWN.

FOR BAR FOR WEIGHT LIFTING WITH A LOAD-DISTRIBUTION CUSHION FOR PROTECTING THE CERVICAL SPINE OF A WEIGHTLIFTER (U.S. CLS. 22, 23, 38 AND 50).

ALEX KEAM, EXAMINING ATTORNEY

CLASS 28—(Continued).

SN 77-181,408. DJR HOLDINGS, LLC, NEW YORK, NY. FILED 5-15-2007.

DEF JAM

THE MARK CONSISTS OF STANDARD CHARACTERS WITHOUT CLAIM TO ANY PARTICULAR FONT, STYLE, SIZE, OR COLOR.

OWNER OF U.S. REG. NOS. 1,800,850, 2,361,626 AND OTHERS.

FOR GAMES AND PLAYTHINGS, NAMELY, DOLLS, BEANBAG DOLLS, SOFT SCULPTURE DOLLS, ACTION FIGURES, TOY FIGURINES AND ACCESSORIES THEREFOR; PLUSH TOYS, SOFT SCULPTURE PLUSH TOYS, INFLATABLE BATH TOYS; ELECTRONIC GAMES, NAMELY, ARCADE-TYPE ELECTRONIC EDUCATION VIDEO GAMES, AND HAND HELD UNIT FOR PLAYING ELECTRONIC GAMES; BOARD GAMES; CARD GAMES; JIGSAW PUZZLES; KITES; SPORTING ARTICLES, NAMELY, BASKETBALLS, HOCKEY STICKS, RUBBER ACTION BALLS, FOAM ACTION BALLS, PLASTIC ACTION BALLS, BOWLING BAGS, BOXING BAGS, GOLF BAGS, BASEBALLS, BOWLING BALLS, FOOTBALLS, GOLF BALLS, PLAYGROUND BALLS, RACKET BALLS, RUGBY BALLS, SOCCER BALLS, TENNIS BALLS, VOLLEY BALLS, BASEBALL BATTING GLOVES, BASEBALL BATTING TEES, BASEBALL MITTS, BASEBALL BATS, SOFTBALL BATS, WEIGHT LIFTING BELTS, BOWLING PINS, BOXING GLOVES, GOLF CLUBS, BILLIARD BALLS, POOL CUES, DARTS AND DART BOARD, GOLF GLOVES, HOCKEY GLOVES, SOFTBALL GLOVES, GOALKEEPERS' GLOVES, GOLF CLUB HEADS, GOLF TEES, HANDBALLS, ICE SKATES, LACROSSE BALLS, LACROSSE STICKS, HOCKEY PUCKS, TABLE TENNIS RACKETS AND BALLS, BADMINTON RACKETS, RUBBER BALLS, SURFBOARDS AND TENNIS RACKET COVERS; DECORATIONS FOR CHRISTMAS TREES (U.S. CLS. 22, 23, 38 AND 50).

MARK SPARACINO, EXAMINING ATTORNEY

SN 77-191,833. MATTEL, INC., EL SEGUNDO, CA. FILED 5-29-2007.

DRIVE-IN DRAGSTRIP

THE MARK CONSISTS OF STANDARD CHARACTERS WITHOUT CLAIM TO ANY PARTICULAR FONT, STYLE, SIZE, OR COLOR.

NO CLAIM IS MADE TO THE EXCLUSIVE RIGHT TO USE "DRAGSTRIP", APART FROM THE MARK AS SHOWN.

FOR TOYS, GAMES AND PLAYTHINGS, NAMELY, TOY VEHICLE PLAYSETS AND ACCESSORIES THEREFOR (U.S. CLS. 22, 23, 38 AND 50).

FIRST USE 12-18-2007; IN COMMERCE 12-18-2007.

JAMES MACFARLANE, EXAMINING ATTORNEY

CLASS 28—(Continued).

SN 77-191,922. AMS DESIGN CO., LTD., CHIBA, JAPAN,
FILED 5-29-2007.

IMASHAKER

THE MARK CONSISTS OF STANDARD CHARACTERS
WITHOUT CLAIM TO ANY PARTICULAR FONT, STYLE,
SIZE, OR COLOR.

PRIORITY CLAIMED UNDER SEC. 44(D) ON JAPAN
APPLICATION NO. 2007-053514, FILED 5-29-2007.

FOR FISHING EQUIPMENT, NAMELY, FISHING
LURES, FISHING RODS, FISHING LINES AND FISH-
ING REELS (U.S. CLS. 22, 23, 38 AND 50).

SARA THOMAS, EXAMINING ATTORNEY

SN 77-193,977. MATTEL, INC., EL SEGUNDO, CA. FILED 5-
31-2007.

NIGHT STORM

THE MARK CONSISTS OF STANDARD CHARACTERS
WITHOUT CLAIM TO ANY PARTICULAR FONT, STYLE,
SIZE, OR COLOR.

FOR TOYS, GAMES AND PLAYTHINGS, NAMELY,
TOY VEHICLES AND ACCESSORIES THEREFOR (U.S.
CLS. 22, 23, 38 AND 50).

FIRST USE 12-13-2007; IN COMMERCE 12-13-2007.
JAMES MACFARLANE, EXAMINING ATTORNEY

SN 77-194,454. LEGENDARY GAMES, INC., DERBY, KS.
FILED 5-31-2007.

Ninety-Nine or Bust

THE MARK CONSISTS OF STANDARD CHARACTERS
WITHOUT CLAIM TO ANY PARTICULAR FONT, STYLE,
SIZE, OR COLOR.

NO CLAIM IS MADE TO THE EXCLUSIVE RIGHT TO
USE "NINETY-NINE", APART FROM THE MARK AS
SHOWN.

FOR CARD GAMES (U.S. CLS. 22, 23, 38 AND 50).
FIRST USE 6-1-1999; IN COMMERCE 6-1-1999.
DAVID HOFFMAN, EXAMINING ATTORNEY

CLASS 28—(Continued).

SN 77-227,130. VIACOM INTERNATIONAL INC., NEW
YORK, NY. FILED 7-11-2007.

TEAM UMIZOOMI

THE MARK CONSISTS OF STANDARD CHARACTERS
WITHOUT CLAIM TO ANY PARTICULAR FONT, STYLE,
SIZE, OR COLOR.

FOR GAMES AND PLAYTHINGS, NAMELY, CARD
GAMES, PLAYING CARDS, DARTS, DOLLS; ACTION
FIGURES AND ACCESSORIES THEREOF; STAND
ALONE VIDEO GAME MACHINES UTILIZING CD
ROM'S, STAND ALONE VIDEO GAME MACHINES,
STAND ALONE AUDIO OUTPUT GAME MACHINES,
AND BOARD GAMES; SPORTING ARTICLES,
NAMELY, GOLF CLUBS, BASEBALLS, FOOTBALLS,
PADDLE BALLS, BASEBALL BATS; DECORATIONS
FOR CHRISTMAS TREES (U.S. CLS. 22, 23, 38 AND 50).
NATALIE POLZER, EXAMINING ATTORNEY

SN 77-229,472. DON WALKER, COSTA MESA, CA. FILED 7-
13-2007.

CARDIO LOUNGE

THE MARK CONSISTS OF STANDARD CHARACTERS
WITHOUT CLAIM TO ANY PARTICULAR FONT, STYLE,
SIZE, OR COLOR.

NO CLAIM IS MADE TO THE EXCLUSIVE RIGHT TO
USE "CARDIO", APART FROM THE MARK AS SHOWN.

FOR EXERCISE MACHINES (U.S. CLS. 22, 23, 38 AND
50).

KELLY MCCOY, EXAMINING ATTORNEY

SN 77-240,391. GINES, TIMOTHY, NEWBURGH, NY. AND
GINES, ANTHONY, NEWBURGH, NY. AND GINES,
SHAWN, NEWBURGH, NY. FILED 7-27-2007.

ULTIMATE PARTY KITS

THE MARK CONSISTS OF STANDARD CHARACTERS
WITHOUT CLAIM TO ANY PARTICULAR FONT, STYLE,
SIZE, OR COLOR.

NO CLAIM IS MADE TO THE EXCLUSIVE RIGHT TO
USE "PARTY KITS", APART FROM THE MARK AS
SHOWN.

FOR NOVELTY KITS COMPRISING FACE MASKS,
BREATH MINTS, BREATH SPRAYS, CONDOMS, CI-
GARS, COLOGNE, DISPOSABLE CAMERAS, SHOT
GLASSES, ASPIRIN, LIGHTER, MATCHES, FOR USE
BY GUESTS AT BACHELOR OR BACHELORETTE
PARTIES (U.S. CLS. 22, 23, 38 AND 50).

SOPHIA S. KIM, EXAMINING ATTORNEY

CLASS 28—(Continued).

SN 77-247,052. DISNEY ENTERPRISES, INC., BURBANK, CA. FILED 8-3-2007.

DISNEY'S HOLLYWOOD STUDIOS

THE MARK CONSISTS OF STANDARD CHARACTERS WITHOUT CLAIM TO ANY PARTICULAR FONT, STYLE, SIZE, OR COLOR.

OWNER OF U.S. REG. NOS. 1,162,727, 3,235,413 AND OTHERS.

NO CLAIM IS MADE TO THE EXCLUSIVE RIGHT TO USE HOLLYWOOD, APART FROM THE MARK AS SHOWN.

FOR TOY ACTION FIGURES AND ACCESSORIES THEREFOR; CHILDREN'S MULTIPLE ACTIVITY TOYS; BADMINTON SETS; BALLOONS; BASKETBALLS; BATH TOYS; BASEBALLS; BEACH BALLS; BEAN BAGS; BEAN BAG DOLLS; TOY BUILDING BLOCKS; BOWLING BALLS; BUBBLE MAKING WANDS AND SOLUTION SETS; CHILDREN'S PLAY COSMETICS; CHRISTMAS STOCKINGS; CHRISTMAS TREE DECORATIONS; COLLECTABLE TOY FIGURES; CRIB MOBILES; CRIB TOYS; DISC TOSS TOYS; DOLLS; DOLL CLOTHING; DOLL ACCESSORIES; DOLL PLAYSETS; ELECTRIC ACTION TOYS; FISHING TACKLE; GOLF BALLS; GOLF GLOVES; GOLF BALL MARKERS; HOCKEY PUCKS; INFLATABLE TOYS; JIGSAW PUZZLES; JUMP ROPES; KITES; MECHANICAL TOYS; MUSIC BOX TOYS; MUSICAL TOYS; PARTY FAVORS IN THE NATURE OF SMALL TOYS; PLUSH TOYS; PUPPETS; ROLLER SKATES; RUBBER BALLS; SKATEBOARDS; SNOW GLOBES; SOCCER BALLS; SPINNING TOPS; SQUEEZE TOYS; STUFFED TOYS; TABLE TENNIS TABLES; TALKING TOYS; TARGET GAMES; TEDDY BEARS; TENNIS BALLS; TOY BUCKET AND SHOVEL SETS; TOY MOBILES; TOY VEHICLES; TOY SCOOTERS; TOY CARS; TOY MODEL HOBBYCRAFT KITS; TOY FIGURES; TOY BANKS; TOY TRUCKS; TOY WATCHES; WIND-UP TOYS; YO-YOS (U.S. CLS. 22, 23, 38 AND 50).
STEPHEN AQUILA, EXAMINING ATTORNEY

SN 77-256,766. MORE THAN JUST A DOLL, BRIARWOOD, NY. FILED 8-16-2007.

**MORE THAN JUST A DOLL –
THE NAME SPEAKS FOR ITSELF!**

THE MARK CONSISTS OF STANDARD CHARACTERS WITHOUT CLAIM TO ANY PARTICULAR FONT, STYLE, SIZE, OR COLOR.

FOR HANDCRAFTED DOLLS (U.S. CLS. 22, 23, 38 AND 50).

DAWN FELDMAN, EXAMINING ATTORNEY

CLASS 28—(Continued).

SN 77-256,814. ATI MODEL PRODUCTS, INC., FARMINGDALE, NY. FILED 8-16-2007.

POSTAGE STAMP

THE MARK CONSISTS OF STANDARD CHARACTERS WITHOUT CLAIM TO ANY PARTICULAR FONT, STYLE, SIZE, OR COLOR.

FOR SCALE MODEL AIRCRAFT (U.S. CLS. 22, 23, 38 AND 50).

FIRST USE 7-0-1999; IN COMMERCE 7-0-1999.

LAURA KOVALSKY, EXAMINING ATTORNEY

SN 77-256,835. ATI MODEL PRODUCTS, INC., FARMINGDALE, NY. FILED 8-16-2007.

MANTUA

THE MARK CONSISTS OF STANDARD CHARACTERS WITHOUT CLAIM TO ANY PARTICULAR FONT, STYLE, SIZE, OR COLOR.

FOR SCALE MODEL TRAINS AND MODEL TRAIN SETS (U.S. CLS. 22, 23, 38 AND 50).

FIRST USE 0-0-1933; IN COMMERCE 0-0-1933.

LAURA KOVALSKY, EXAMINING ATTORNEY

SN 77-258,008. SIMON & SCHUSTER, INC., NEW YORK, NY. FILED 8-17-2007.

THE HARDY BOYS

THE MARK CONSISTS OF STANDARD CHARACTERS WITHOUT CLAIM TO ANY PARTICULAR FONT, STYLE, SIZE, OR COLOR.

OWNER OF U.S. REG. NO. 3,199,498.

THE NAME(S), PORTRAIT(S), AND/OR SIGNATURE(S) SHOWN IN THE MARK DOES NOT IDENTIFY A PARTICULAR LIVING INDIVIDUAL.

FOR DOLLS, MODELED PLASTIC TOY FIGURINES, CLOTHING AND ACCESSORIES FOR DOLLS, NONE RELATING TO WRESTLING PERSONALITIES (U.S. CLS. 22, 23, 38 AND 50).

FIRST USE 5-21-2007; IN COMMERCE 5-21-2007.

C. DIONNE CLYBURN, EXAMINING ATTORNEY

CLASS 28—(Continued).

SN 77-258,063. MATTEL, INC., EL SEGUNDO, CA. FILED 8-17-2007.

SPARKLIN' PETS

THE MARK CONSISTS OF STANDARD CHARACTERS WITHOUT CLAIM TO ANY PARTICULAR FONT, STYLE, SIZE, OR COLOR.

OWNER OF U.S. REG. NOS. 2,740,784, 3,229,301 AND 3,340,999.

NO CLAIM IS MADE TO THE EXCLUSIVE RIGHT TO USE "PETS", APART FROM THE MARK AS SHOWN.

FOR TOYS, GAMES AND PLAYTHINGS, NAMELY, DOLLS, DOLL CLOTHING AND DOLL ACCESSORIES, TOY FIGURES, TOY ANIMALS, AND ACCESSORIES FOR ALL OF THE FOREGOING (U.S. CLS. 22, 23, 38 AND 50).

FIRST USE 12-11-2007; IN COMMERCE 12-11-2007.
ESTHER BELENKER, EXAMINING ATTORNEY

CLASS 28—(Continued).

SN 77-262,389. EDUCATIONAL TECHNOLOGY LTD., NEWCASTLE ON TYNE, UNITED KINGDOM, FILED 8-23-2007.

Tactoids

THE MARK CONSISTS OF STANDARD CHARACTERS WITHOUT CLAIM TO ANY PARTICULAR FONT, STYLE, SIZE, OR COLOR.

PRIORITY CLAIMED UNDER SEC. 44(D) ON UNITED KINGDOM APPLICATION NO. 2448138, FILED 6-1-2007, REG. NO. 2448138, DATED 3-1-2007, EXPIRES 3-1-2017.

FOR CONSTRUCTION TOYS (U.S. CLS. 22, 23, 38 AND 50).

STEVEN R. FINE, EXAMINING ATTORNEY

SN 77-260,780. HORIZON HOBBY, INC., CHAMPAIGN, IL. FILED 8-21-2007.

RECOIL

THE MARK CONSISTS OF STANDARD CHARACTERS WITHOUT CLAIM TO ANY PARTICULAR FONT, STYLE, SIZE, OR COLOR.

FOR HOBBY MODEL VEHICLES AND PARTS THEREFOR (U.S. CLS. 22, 23, 38 AND 50).

FIRST USE 1-30-2007; IN COMMERCE 1-30-2007.
BARBARA RUTLAND, EXAMINING ATTORNEY

SN 77-263,196. BUSY BEE LEARNING, CORONA, CA. FILED 8-23-2007.



Enriching the lives of ALL children through American Sign Language (ASL).

SN 77-260,808. HORIZON HOBBY, INC., CHAMPAIGN, IL. FILED 8-21-2007.

SHOCKWAVE

THE MARK CONSISTS OF STANDARD CHARACTERS WITHOUT CLAIM TO ANY PARTICULAR FONT, STYLE, SIZE, OR COLOR.

FOR HOBBY MODEL BOATS AND PARTS THEREFOR (U.S. CLS. 22, 23, 38 AND 50).

FIRST USE 9-14-2000; IN COMMERCE 9-14-2000.
JOHN HWANG, EXAMINING ATTORNEY

NO CLAIM IS MADE TO THE EXCLUSIVE RIGHT TO USE "LEARNING", APART FROM THE MARK AS SHOWN.

THE MARK CONSISTS OF THE DESIGN OF THREE CONCENTRIC CIRCLES WITH THE DESIGN OF A BEE APPEARING IN THE CENTER CIRCLE. IN THE SECOND OUTER CIRCLE A BEEHIVE APPEARS ON BOTH SIDES OF THE BEE BETWEEN THE WORDING "BUSY BEE" ON TOP OF THE CIRCLE AND "LEARNING" ON THE BOTTOM OF THE CIRCLE. APPEARING UNDER THESE DESIGN ELEMENTS IS THE WORDING "ENRICHING THE LIVES OF ALL CHILDREN THROUGH AMERICAN SIGN LANGUAGE (ASL)."

FOR EDUCATIONAL PRODUCTS, NAMELY, WOODEN PUZZLES AND EDUCATIONAL BOARD AND BOARD GAMES FOR MATCHING AND SPELLING (U.S. CLS. 22, 23, 38 AND 50).

AMY MCMENAMIN, EXAMINING ATTORNEY

CLASS 28—(Continued).

SN 77-264,213. BARRAGAN, LILIAN, ANAHEIM, CA. FILED 8-24-2007.



THE MARK CONSISTS OF A CIRCLE WITH FIVE STARS WITHIN IT, THE WORDS "MY DREAM KEEPER" IN THE CENTER OF CIRCLE WITH THE WORD "MY" ABOVE "DREAM KEEPER".

FOR STUFFED TOY BEAR, NAMELY, A STUFFED TOY BEAR THAT WILL HOLD A JOURNAL BOOK INSIDE ITS BODY (U.S. CLS. 22, 23, 38 AND 50).
MORGAN WYNNE, EXAMINING ATTORNEY

SN 77-264,853. HUNTER'S SPECIALTIES, INC., CEDAR RAPIDS, IA. FILED 8-27-2007.

INFINITY LATEX

THE MARK CONSISTS OF STANDARD CHARACTERS WITHOUT CLAIM TO ANY PARTICULAR FONT, STYLE, SIZE, OR COLOR.

NO CLAIM IS MADE TO THE EXCLUSIVE RIGHT TO USE "LATEX", APART FROM THE MARK AS SHOWN.
FOR HUNTING GAME CALLS (U.S. CLS. 22, 23, 38 AND 50).

DANIEL CAPSHAW, EXAMINING ATTORNEY

SN 77-265,536. BALL & CHAIN LLC, AUBURN, WA. FILED 8-27-2007.

I.O.U

THE MARK CONSISTS OF STYLIZED LETTERS "I", "O" AND "U" WITH SMALL HEARTS AT THE BOTTOM OF AND BETWEEN THE LETTERS "I" AND "O" AND BETWEEN THE LETTERS "O" AND "U".

FOR CARD GAMES (U.S. CLS. 22, 23, 38 AND 50).
FIRST USE 11-11-2003; IN COMMERCE 11-11-2003.
LINDA MICKLEBURGH, EXAMINING ATTORNEY

CLASS 28—(Continued).

SN 77-266,447. MICHAEL L. MAGENER, TEMPLE CITY, CA. FILED 8-28-2007.

**The World's First Sensual
Teddy Bear**

THE MARK CONSISTS OF STANDARD CHARACTERS WITHOUT CLAIM TO ANY PARTICULAR FONT, STYLE, SIZE, OR COLOR.

NO CLAIM IS MADE TO THE EXCLUSIVE RIGHT TO USE "WORLD'S FIRST" AND "TEDDY BEAR", APART FROM THE MARK AS SHOWN.

FOR STUFFED TOYS (U.S. CLS. 22, 23, 38 AND 50).

FIRST USE 8-28-2007; IN COMMERCE 8-28-2007.

SALLY SHIH, EXAMINING ATTORNEY

SN 77-267,106. MORALES, DANIEL P., YORBA LINDA, CA. FILED 8-29-2007.

THE MOYO SAND STAND

THE MARK CONSISTS OF STANDARD CHARACTERS WITHOUT CLAIM TO ANY PARTICULAR FONT, STYLE, SIZE, OR COLOR.

NO CLAIM IS MADE TO THE EXCLUSIVE RIGHT TO USE "STAND", APART FROM THE MARK AS SHOWN.

THE ENGLISH TRANSLATION OF THE WORD "MOYO" IN THE MARK IS "SOUL".

FOR SURF BOARD HOLDER, NAMELY, PORTABLE STAND ESPECIALLY DESIGNED FOR STORING A SURFBOARD UPRIGHT WHILE IT IS NOT IN USE; SURF BOARD RACK, NAMELY, A PORTABLE RACK ESPECIALLY DESIGNED FOR STORING A SURFBOARD UPRIGHT WHILE IT IS NOT IN USE; AND SURF BOARD STAND, NAMELY, A PORTABLE STAND ESPECIALLY DESIGNED FOR STORING A SURFBOARD UPRIGHT WHILE IT IS NOT IN USE (U.S. CLS. 22, 23, 38 AND 50).

APRIL ROACH, EXAMINING ATTORNEY

SN 77-271,125. KEE ACTION SPORTS I LLC, SEWELL, NJ. FILED 9-4-2007.

CONTACT

THE MARK CONSISTS OF STANDARD CHARACTERS WITHOUT CLAIM TO ANY PARTICULAR FONT, STYLE, SIZE, OR COLOR.

FOR PAINTBALL SPORT GLOVES (U.S. CLS. 22, 23, 38 AND 50).

FIRST USE 10-0-2006; IN COMMERCE 10-0-2006.

JENNIFER VASQUEZ, EXAMINING ATTORNEY

CLASS 28—(Continued).

SN 77-272,456. BALL & CHAIN LLC, AUBURN, WA. FILED 9-5-2007.

THE MARK CONSISTS OF STYLIZED LETTERS "I", "O" AND "U" WITH PERIODS FOLLOWING THE "I" AND THE "O".

FOR CARD GAMES (U.S. CLS. 22, 23, 38 AND 50).
FIRST USE 1-30-2007; IN COMMERCE 1-30-2007.
LINDA MICKLEBURGH, EXAMINING ATTORNEY

SN 77-277,554. CIBER INTERNATIONAL CORP, CHANGHUA HSIEN, TAIWAN, FILED 9-12-2007.

THE MARK CONSISTS OF GREENLIFE AND DESIGN. FOR (BASED ON INTENT TO USE) EXERCISING PULLEYS; EXERCISE MACHINES; EXERCISE BALLS; EXERCISE EQUIPMENT, NAMELY, CHEST EXPANDERS; HANDLE GRIPS FOR SPORTING EQUIPMENT; GYMNASIAC APPARATUS; AEROBIC STEP MACHINES (U.S. CLS. 22, 23, 38 AND 50).
GEORGE LORENZO, EXAMINING ATTORNEY

SN 77-280,968. BONGIORNO, GERALD, QUEENSBURY, NY. AND MASTRATONI, PETER, QUEENSBURY, NY. AND BONGIORNO, LYSETTE, QUEENSBURY, NY. FILED 9-17-2007.

IMPROPISATION, "A CURTAIN
CALL GAME WHERE YOU'RE THE
STAR"

THE MARK CONSISTS OF STANDARD CHARACTERS WITHOUT CLAIM TO ANY PARTICULAR FONT, STYLE, SIZE, OR COLOR.
FOR BOARD GAMES (U.S. CLS. 22, 23, 38 AND 50).
JAMES MACFARLANE, EXAMINING ATTORNEY

CLASS 28—(Continued).

SN 77-284,930. HACKENBERG, JAMES A., EDGARTOWN, MA. FILED 9-20-2007.

GREEN ENVY PUTTER

THE MARK CONSISTS OF STANDARD CHARACTERS WITHOUT CLAIM TO ANY PARTICULAR FONT, STYLE, SIZE, OR COLOR.

NO CLAIM IS MADE TO THE EXCLUSIVE RIGHT TO USE "PUTTER", APART FROM THE MARK AS SHOWN, FOR GOLF PUTTERS (U.S. CLS. 22, 23, 38 AND 50).
ELLEN PERKINS, EXAMINING ATTORNEY

SN 77-285,651. FLTI, LITTLE ROCK, AR. FILED 9-21-2007.

OWNER OF U.S. REG. NO. 3,315,206.
THE MARK CONSISTS OF THE LETTER "A" IN THE SHAPE OF AN EVERGREEN TREE WITH A FIVE-POINTED STAR ON TOP; THE LETTERS "D-O-R-E" IN A STYLIZED FORMAT AND THE LETTERS "N-A-M-E-N-T-S" IN STANDARD CHARACTER FORMAT.

FOR CHRISTMAS TREE ORNAMENTS TEACHING THE BIBLICAL ACCOUNT OF THE BIRTH OF JESUS CHRIST BY EXPLAINING THE MEANINGS OF DIFFERENT NAMES OF JESUS (U.S. CLS. 22, 23, 38 AND 50).

FIRST USE 10-0-1996; IN COMMERCE 10-0-1996.
LANA PHAM, EXAMINING ATTORNEY

SN 77-285,984. UP COUNTRY INC., EAST PROVIDENCE, RI. FILED 9-21-2007.

UP COUNTRY

THE MARK CONSISTS OF STANDARD CHARACTERS WITHOUT CLAIM TO ANY PARTICULAR FONT, STYLE, SIZE, OR COLOR.

OWNER OF U.S. REG. NO. 1,303,720.
FOR PET TOYS (U.S. CLS. 22, 23, 38 AND 50).
ZACHARY BELLO, EXAMINING ATTORNEY

CLASS 28—(Continued).

SN 77-286,098. HPN HOLDINGS INC., CARSON CITY, NV.
FILED 9-21-2007.

HUMAN POWERED, NATURALLY

THE MARK CONSISTS OF STANDARD CHARACTERS WITHOUT CLAIM TO ANY PARTICULAR FONT, STYLE, SIZE, OR COLOR.

NO CLAIM IS MADE TO THE EXCLUSIVE RIGHT TO USE "HUMAN POWERED", APART FROM THE MARK AS SHOWN.

FOR MOBILE ELLIPTICALLY DRIVEN EXERCISE MACHINES (U.S. CLS. 22, 23, 38 AND 50).

ALEX KEAM, EXAMINING ATTORNEY

SN 77-286,611. WAI LANA PRODUCTIONS, LLC, MALIBU, CA. FILED 9-23-2007.

TRANQUILITY MAT

THE MARK CONSISTS OF STANDARD CHARACTERS WITHOUT CLAIM TO ANY PARTICULAR FONT, STYLE, SIZE, OR COLOR.

NO CLAIM IS MADE TO THE EXCLUSIVE RIGHT TO USE "MAT", APART FROM THE MARK AS SHOWN.

FOR YOGA EXERCISE EQUIPMENT, NAMELY, YOGA MATS, YOGA STRAPS FOR STRETCHING, YOGA BAGS FITTED FOR CARRYING YOGA MATS, YOGA BRICKS, YOGA BLOCKS, YOGA BOLSTERS, ZAFUS CUSHIONS FOR PRACTICING YOGA, YOGA WEDGES, YOGA BALLS AND PHYSIO BALLS (U.S. CLS. 22, 23, 38 AND 50).

JEAN IM, EXAMINING ATTORNEY

SN 77-286,621. MUNTZ, JAMES D, JR., WOODHAVEN, MI.
FILED 9-23-2007.

STOP 'N GO!

THE MARK CONSISTS OF STANDARD CHARACTERS WITHOUT CLAIM TO ANY PARTICULAR FONT, STYLE, SIZE, OR COLOR.

FOR EQUIPMENT SOLD AS A UNIT FOR PLAYING CARD GAMES (U.S. CLS. 22, 23, 38 AND 50).

FIRST USE 9-15-2007; IN COMMERCE 9-15-2007.

LINDA M. KING, EXAMINING ATTORNEY

CLASS 28—(Continued).

SN 77-286,660. IMAGINATION HOLDINGS PTY LTD, KENT TOWN, AUSTRALIA, FILED 9-23-2007.

STAT ATTACK

THE MARK CONSISTS OF STANDARD CHARACTERS WITHOUT CLAIM TO ANY PARTICULAR FONT, STYLE, SIZE, OR COLOR.

FOR TOYS, NAMELY, PARLOR GAMES, CARD GAMES AND BOARD GAMES (U.S. CLS. 22, 23, 38 AND 50).

JENNIFER MARTIN, EXAMINING ATTORNEY

SN 77-287,091. HODGDON/WRIGHT ENTERPRISES, L.L.C., OVERLAND PARK, KS. FILED 9-24-2007.

Glow-Stix

THE MARK CONSISTS OF STANDARD CHARACTERS WITHOUT CLAIM TO ANY PARTICULAR FONT, STYLE, SIZE, OR COLOR.

FOR FISHING BUOYS (U.S. CLS. 22, 23, 38 AND 50).

REGINA DRUMMOND, EXAMINING ATTORNEY

SN 77-288,696. STOS, INC., CANYON, TX. FILED 9-25-2007.

STOS BROADHEADS

THE MARK CONSISTS OF STANDARD CHARACTERS WITHOUT CLAIM TO ANY PARTICULAR FONT, STYLE, SIZE, OR COLOR.

NO CLAIM IS MADE TO THE EXCLUSIVE RIGHT TO USE "BROADHEADS", APART FROM THE MARK AS SHOWN.

FOR ARROWHEADS (U.S. CLS. 22, 23, 38 AND 50).

JAY FLOWERS, EXAMINING ATTORNEY

CLASS 28—(Continued).

SN 77-290,651. BHASIN DHERMINDER S, JERICHO, NY. FILED 9-27-2007.

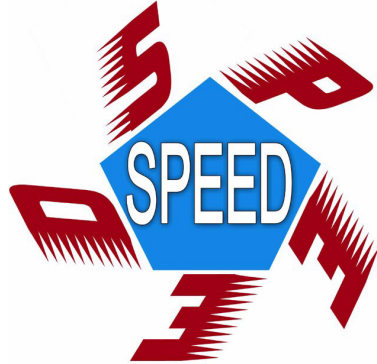

THE COLOR(S) RED, BLUE, WHITE. IS/ARE CLAIMED AS A FEATURE OF THE MARK.
THE MARK CONSISTS OF A BLUE PENTAGON SHAPED FIGURE WITH "SPEED" IN WHITE COLOR. ON THE OUTER CIRCUMFERENCE, "SPEED" IN RED COLOR.
FOR BALLS OF ALL KINDS (U.S. CLS. 22, 23, 38 AND 50).
AISHA CLARKE, EXAMINING ATTORNEY

SN 77-290,819. MESA CUSTOM MACHINING CORP., GILBERT, AZ. FILED 9-27-2007.

Advantage

THE MARK CONSISTS OF STANDARD CHARACTERS WITHOUT CLAIM TO ANY PARTICULAR FONT, STYLE, SIZE, OR COLOR.
FOR PAINTBALL SPORT ACCESSORIES, NAMELY, KNEE PADS FOR USE IN PAINTBALL SPORT, PROTECTIVE TANK COVER FOR PAINTBALL GUN AIR TANK AND POD HARNESS FOR CARRYING PAINTBALL PODS (U.S. CLS. 22, 23, 38 AND 50).
JAY FLOWERS, EXAMINING ATTORNEY

SN 77-291,274. MCVAN, MICHAEL, WELLINGTON, FL. FILED 9-28-2007.

PERFECT PECS

THE MARK CONSISTS OF STANDARD CHARACTERS WITHOUT CLAIM TO ANY PARTICULAR FONT, STYLE, SIZE, OR COLOR.
FOR EXERCISE EQUIPMENT, NAMELY, A HANDLE GRIP AND WRIST SUPPORT FOR ATTACHMENT TO CABLES OF EXERCISE MACHINES (U.S. CLS. 22, 23, 38 AND 50).
MICHAEL KEATING, EXAMINING ATTORNEY

CLASS 28—(Continued).

SN 77-291,312. TWIN TITAN INNOVATIONS INC., SCARBOROUGH, CANADA, FILED 9-28-2007.

Syl-la-bles

THE MARK CONSISTS OF STANDARD CHARACTERS WITHOUT CLAIM TO ANY PARTICULAR FONT, STYLE, SIZE, OR COLOR.
FOR BOARD GAMES (U.S. CLS. 22, 23, 38 AND 50).
DANIEL CAPSHAW, EXAMINING ATTORNEY

SN 77-292,715. HUNNICUTT, DEBORAH, NEW ALBANY, MS. FILED 10-1-2007.



THE COLOR(S) SILVER AND GOLD IS/ARE CLAIMED AS A FEATURE OF THE MARK.
THE MARK CONSISTS OF THE WORDS "ANGELS WATCHING OVER ME" IN WHICH THE "A" OF "ANGELS" IS A SILVER "A" OUTLINED IN GOLD ENCIRCLED BY A GOLD RING OUTLINED IN SILVER VIEWED AT AN ANGLE, AND THE REMAINING LETTERS OF THE PHRASE "ANGELS WATCHING OVER ME" ARE IN GOLD.
FOR DOLLS; SOFT SCULPTURE DOLLS; SOFT SCULPTURE PLUSH TOYS; SOFT SCULPTURE TOYS; INFANT TOYS; STUFFED TOYS; TOYS DESIGNED TO BE ATTACHED TO CRIBS AND OTHER FURNITURE ITEMS; PLUSH TOYS; CRIB TOYS (U.S. CLS. 22, 23, 38 AND 50).
SARA THOMAS, EXAMINING ATTORNEY

CLASS 28—(Continued).

SN 77-292,719. HUNNICUTT, DEBORAH, NEW ALBANY, MS. FILED 10-1-2007.

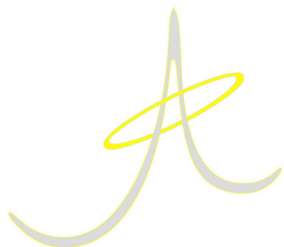

THE COLOR(S) GOLD AND SILVER IS/ARE CLAIMED AS A FEATURE OF THE MARK.

THE MARK CONSISTS OF A GOLD CIRCLE OUTLINED IN SILVER, VIEWED AT AN ANGLE, SURROUNDING A SILVER "A" THAT IS OUTLINED IN GOLD.

FOR DOLLS; SOFT SCULPTURE DOLLS; CRIB TOYS; INFANT TOYS; PLUSH TOYS; SOFT SCULPTURE PLUSH TOYS; SOFT SCULPTURE TOYS; STUFFED TOYS; TOYS DESIGNED TO BE ATTACHED TO CRIBS AND OTHER FURNITURE ITEMS (U.S. CLS. 22, 23, 38 AND 50).

SARA THOMAS, EXAMINING ATTORNEY

SN 77-293,083. OUTCAST! PRODUCTIONS, LLC, ANCHORAGE, AK. FILED 10-1-2007.

OutCast!

THE MARK CONSISTS OF STANDARD CHARACTERS WITHOUT CLAIM TO ANY PARTICULAR FONT, STYLE, SIZE, OR COLOR.

FOR BOARD GAMES (U.S. CLS. 22, 23, 38 AND 50).

FIRST USE 6-10-2003; IN COMMERCE 12-22-2006.

MARY BOAGNI, EXAMINING ATTORNEY

SN 77-293,092. OUTCAST! PRODUCTIONS, LLC, ANCHORAGE, AK. FILED 10-1-2007.

Improv-Ability

THE MARK CONSISTS OF STANDARD CHARACTERS WITHOUT CLAIM TO ANY PARTICULAR FONT, STYLE, SIZE, OR COLOR.

FOR BOARD GAMES (U.S. CLS. 22, 23, 38 AND 50).

MARY BOAGNI, EXAMINING ATTORNEY

CLASS 28—(Continued).

SN 77-293,337. CHEUNG, JASON, UNION CITY, CA. FILED 10-1-2007.

MONKEY SPELLER

THE MARK CONSISTS OF STANDARD CHARACTERS WITHOUT CLAIM TO ANY PARTICULAR FONT, STYLE, SIZE, OR COLOR.

NO CLAIM IS MADE TO THE EXCLUSIVE RIGHT TO USE "SPELLER", APART FROM THE MARK AS SHOWN.

FOR MANIPULATIVE GAMES (U.S. CLS. 22, 23, 38 AND 50).

GINA FINK, EXAMINING ATTORNEY

SN 77-293,366. J&H CONCEPTS, INC., NEW YORK, NY. FILED 10-1-2007.

Holiday Elegance Made Simple

THE MARK CONSISTS OF STANDARD CHARACTERS WITHOUT CLAIM TO ANY PARTICULAR FONT, STYLE, SIZE, OR COLOR.

FOR CHRISTMAS TREE ORNAMENTS; CHRISTMAS TREE ORNAMENT KITS CONTAINING ORNAMENTS, STOCKINGS, TREE SKIRTS, AND HANGING HARDWARE, ALL IN VARIOUS HOLIDAY THEMES; CHRISTMAS STOCKING HOLDERS; CHRISTMAS TREE SKIRTS; CHRISTMAS STOCKINGS; CHRISTMAS TREE STAND COVERS; CHRISTMAS TREE STANDS; ARTIFICIAL CHRISTMAS WREATHS (U.S. CLS. 22, 23, 38 AND 50).

JOHN WILKE, EXAMINING ATTORNEY

SN 77-293,889. BERENSTEIN, BARRY, TORONTO, ONTARIO, CANADA, FILED 10-2-2007.

CAMPANTICS

THE MARK CONSISTS OF STANDARD CHARACTERS WITHOUT CLAIM TO ANY PARTICULAR FONT, STYLE, SIZE, OR COLOR.

FOR BOARD GAMES (U.S. CLS. 22, 23, 38 AND 50).

BRIAN CALLAGHAN, EXAMINING ATTORNEY

CLASS 28—(Continued).

SN 77-294,033. SWIM FREE, LLC, PACIFIC PALISADES, CA. FILED 10-2-2007.

SWIM FREE

THE MARK CONSISTS OF STANDARD CHARACTERS WITHOUT CLAIM TO ANY PARTICULAR FONT, STYLE, SIZE, OR COLOR.

OWNER OF U.S. REG. NO. 2,548,249.

NO CLAIM IS MADE TO THE EXCLUSIVE RIGHT TO USE "SWIM", APART FROM THE MARK AS SHOWN.

FOR FLOATS FOR RECREATIONAL USE, SWIMBOARDS AND KICKBOARDS FOR RECREATIONAL USE, SWIM FINS AND WATER WING SWIM AIDS, INFLATABLE BATH TOYS, INFLATABLE FLOAT MATTRESSES AND PADS FOR RECREATIONAL USE, INFLATABLE RIDE ON TOYS (U.S. CLS. 22, 23, 38 AND 50).

HENRY S. ZAK, EXAMINING ATTORNEY

SN 77-294,309. FIRSTSTRING, LLC, RICHARDSON, TX. FILED 10-2-2007.

FLIGHTWIRE

THE MARK CONSISTS OF STANDARD CHARACTERS WITHOUT CLAIM TO ANY PARTICULAR FONT, STYLE, SIZE, OR COLOR.

FOR ARCHERY EQUIPMENT, NAMELY, BOW STRINGS, NON-TELESCOPIC BOW SIGHTS, AND DEVICES FOR REDUCING THE SOUND AND VIBRATION OF A BOW STRING (U.S. CLS. 22, 23, 38 AND 50).

GIANCARLO CASTRO, EXAMINING ATTORNEY

SN 77-294,368. FIRSTSTRING, LLC, RICHARDSON, TX. FILED 10-2-2007.

FIRSTSTRING

THE MARK CONSISTS OF STANDARD CHARACTERS WITHOUT CLAIM TO ANY PARTICULAR FONT, STYLE, SIZE, OR COLOR.

FOR ARCHERY EQUIPMENT, NAMELY, BOW STRINGS, NON-TELESCOPIC BOW SIGHTS, AND DEVICES FOR REDUCING THE SOUND AND VIBRATION OF A BOW STRING (U.S. CLS. 22, 23, 38 AND 50).

FIRST USE 7-3-2007; IN COMMERCE 7-3-2007.

GIANCARLO CASTRO, EXAMINING ATTORNEY

CLASS 28—(Continued).

SN 77-294,916. PARK, JONG CHOO, MARIETTA, GA. FILED 10-3-2007.



THE MARK CONSISTS OF UP-SIDE DOWN HEART SHAPE IN BLACK-COLORED BACKGROUND, FOR PLUSH TOYS (U.S. CLS. 22, 23, 38 AND 50).

SUSAN STIGLITZ, EXAMINING ATTORNEY

SN 77-295,187. VISION QUEST, INC., HONESDALE, PA. FILED 10-3-2007.

PHAT HEAD

THE MARK CONSISTS OF STANDARD CHARACTERS WITHOUT CLAIM TO ANY PARTICULAR FONT, STYLE, SIZE, OR COLOR.

NO CLAIM IS MADE TO THE EXCLUSIVE RIGHT TO USE "HEAD", APART FROM THE MARK AS SHOWN.

FOR ARROW POINTS, NAMELY, BROADHEADS AND BROADHEADS (U.S. CLS. 22, 23, 38 AND 50).

FIRST USE 4-10-2007; IN COMMERCE 4-10-2007.

CYNTHIA SLOAN, EXAMINING ATTORNEY

SN 77-295,293. VISION QUEST, INC., HONESDALE, PA. FILED 10-3-2007.

STEEL FORCE

THE MARK CONSISTS OF STANDARD CHARACTERS WITHOUT CLAIM TO ANY PARTICULAR FONT, STYLE, SIZE, OR COLOR.

NO CLAIM IS MADE TO THE EXCLUSIVE RIGHT TO USE STEEL, APART FROM THE MARK AS SHOWN.

FOR ARROW POINTS, NAMELY, BROADHEADS, ARROWHEADS, AND FISH TIPS; ARCHERY EQUIPMENT, SUPPLIES, AND ACCESSORIES, NAMELY, ARROW POINT SHARPENERS, ARROW POINT REPLACEMENT BLADES, BLEEDER BLADES AND GLOVE TABS (U.S. CLS. 22, 23, 38 AND 50).

FIRST USE 0-0-2001; IN COMMERCE 0-0-2001.

CYNTHIA SLOAN, EXAMINING ATTORNEY

CLASS 28—(Continued).

SN 77-295,297. WGU, LLC, PLANO, TX. FILED 10-3-2007.

learning in style

THE MARK CONSISTS OF STANDARD CHARACTERS WITHOUT CLAIM TO ANY PARTICULAR FONT, STYLE, SIZE, OR COLOR.

FOR GOLF CLUBS (U.S. CLS. 22, 23, 38 AND 50).
TASNEEM HUSSAIN, EXAMINING ATTORNEY

SN 77-295,315. HUMAN TOUCH, LLC, FORMERLY INTERACTIVE HEALTH, LLC, LONG BEACH, CA. FILED 10-3-2007.



THE MARK CONSISTS OF A DESIGN (THE LETTERS "H" AND "T" COMBINED TOGETHER TO FORM A CHAIR) FOLLOWED BY THE WORDS "HUMAN TOUCH" FOLLOWED BY THE WORDS "IJOY" AND "RIDE" SEPARATED BY A DESIGN LINE.

FOR ELECTROMECHANICAL EXERCISE APPARATUS, NAMELY, BALANCE BOARDS (U.S. CLS. 22, 23, 38 AND 50).

JILL PRATER, EXAMINING ATTORNEY

SN 77-295,783. MEGA BRANDS INTERNATIONAL, LUXEMBOURG, ZUG BRANCH, ZUG, SWITZERLAND, FILED 10-4-2007.



OWNER OF U.S. REG. NOS. 2,852,063, 2,856,972 AND OTHERS.

FOR MULTI-PART CONSTRUCTION TOYS (U.S. CLS. 22, 23, 38 AND 50).

JERI J. FICKES, EXAMINING ATTORNEY

CLASS 28—(Continued).

SN 77-295,784. MEGA BRANDS INTERNATIONAL, LUXEMBOURG, ZUG BRANCH, ZUG, SWITZERLAND, FILED 10-4-2007.



OWNER OF U.S. REG. NOS. 2,852,063, 2,856,972 AND OTHERS.

THE COLOR(S) BLUE, BLACK, WHITE, AND GOLD IS/ARE CLAIMED AS A FEATURE OF THE MARK.

THE MARK CONSISTS OF THE LETTERS "M," "A" AND "G" APPEARING IN BLUE, AND THE LETTERS "N," "E," "X" AND "T" APPEARING IN WHITE WITH A GOLD AREA APPEARING BETWEEN THE LETTERS "E" AND "X" WITH THE ENTIRE MARK OUTLINED IN BLACK.

FOR MULTI-PART CONSTRUCTION TOYS (U.S. CLS. 22, 23, 38 AND 50).

JERI J. FICKES, EXAMINING ATTORNEY

SN 77-296,044. REALRYDER LLC, LOS ANGELES, CA. FILED 10-4-2007.

REALRYDER

THE MARK CONSISTS OF STANDARD CHARACTERS WITHOUT CLAIM TO ANY PARTICULAR FONT, STYLE, SIZE, OR COLOR.

FOR EXERCISE EQUIPMENT, NAMELY, STATIONARY CYCLES (U.S. CLS. 22, 23, 38 AND 50).

LINDA ORNDORFF, EXAMINING ATTORNEY

SN 77-296,206. FRANKLIN SPORTS, INC., STOUGHTON, MA. FILED 10-4-2007.

PRE-GAME

THE MARK CONSISTS OF STANDARD CHARACTERS WITHOUT CLAIM TO ANY PARTICULAR FONT, STYLE, SIZE, OR COLOR.

FOR FOOTBALLS (U.S. CLS. 22, 23, 38 AND 50).

ERNEST SHOSHO, EXAMINING ATTORNEY

CLASS 28—(Continued).

SN 77-296,248. KANKAKEE SPIKEBALL, INC., CHICAGO, IL. FILED 10-4-2007.

SPIKEBALL

THE MARK CONSISTS OF STANDARD CHARACTERS WITHOUT CLAIM TO ANY PARTICULAR FONT, STYLE, SIZE, OR COLOR.

FOR SPORT BALLS; NETS FOR BALL GAMES; GAME TABLES; ACTION SKILL GAMES; ACTION TARGET GAMES; ACTION-TYPE TARGET GAMES; BALLS FOR GAMES; OUTDOOR ACTIVITY GAMES IN THE NATURE OF GAME FEATURING A SURFACE FOR BOUNCING A BALL; TRAMPOLINES; EQUIPMENT SOLD AS A UNIT FOR PLAYING ACTION TYPE TARGET GAMES; PARLOR GAMES; PARTY GAMES; TARGET GAMES; BEACH BALLS (U.S. CLS. 22, 23, 38 AND 50).
CYNTHIA SLOAN, EXAMINING ATTORNEY

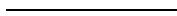

SN 77-296,260. TOY STATE INDUSTRIAL LTD., KOWLOON TSTE, HONG KONG, FILED 10-4-2007.

MASSIVE MACHINE

THE MARK CONSISTS OF STANDARD CHARACTERS WITHOUT CLAIM TO ANY PARTICULAR FONT, STYLE, SIZE, OR COLOR.

FOR TOY VEHICLES (U.S. CLS. 22, 23, 38 AND 50).
MELVIN AXILBUND, EXAMINING ATTORNEY

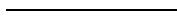

SN 77-296,769. BARNETT, SHERRY, LEBANON, OH. FILED 10-4-2007.

FRIENDLY TEMPLATES

THE MARK CONSISTS OF STANDARD CHARACTERS WITHOUT CLAIM TO ANY PARTICULAR FONT, STYLE, SIZE, OR COLOR.

NO CLAIM IS MADE TO THE EXCLUSIVE RIGHT TO USE "TEMPLATES", APART FROM THE MARK AS SHOWN.

FOR HOBBY CRAFT KIT COMPRISING TEXTILE AND PATTERNING MATERIALS AND TOOLS (U.S. CLS. 22, 23, 38 AND 50).

ANTHONY RINKER, EXAMINING ATTORNEY

CLASS 28—(Continued).

SN 77-296,861. BLACKWATER BAIT COMPANY, HIAWASSEE, GA. FILED 10-5-2007.

BLACKWATER

THE MARK CONSISTS OF STANDARD CHARACTERS WITHOUT CLAIM TO ANY PARTICULAR FONT, STYLE, SIZE, OR COLOR.

FOR ARTIFICIAL FISHING LURES (U.S. CLS. 22, 23, 38 AND 50).
FIRST USE 3-23-2006; IN COMMERCE 3-23-2006.
SALLY SHIH, EXAMINING ATTORNEY



SN 77-297,319. CE LICENSING, LLC, LOS ANGELES, CA. FILED 10-5-2007.

Electra-Pole

THE MARK CONSISTS OF STANDARD CHARACTERS WITHOUT CLAIM TO ANY PARTICULAR FONT, STYLE, SIZE, OR COLOR.

FOR PORTABLE SUPPORT STRUCTURES FOR DANCE AND OTHER EXERCISES (U.S. CLS. 22, 23, 38 AND 50).

DAVID MILLER, EXAMINING ATTORNEY



SN 77-297,874. MCCARTHY, JEREMIAH, WESTMINSTER, MD. AND HEIDENBERG, TIMOTHY M., COLLEGE PARK, MD. FILED 10-5-2007.

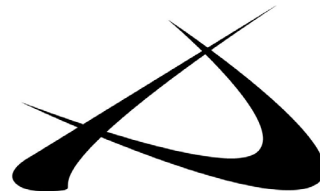

THE MARK CONSISTS OF A BOW.
FOR ATHLETIC SPORTING GOODS, NAMELY, ATHLETIC WRIST AND JOINT SUPPORTS; BAGS SPECIALLY ADAPTED FOR SPORTS EQUIPMENT (U.S. CLS. 22, 23, 38 AND 50).

ODESSA BIBBINS, EXAMINING ATTORNEY

CLASS 28—(Continued).

SN 77-297,878. MCCARTHY, JEREMIAH, WESTMINSTER, MD. AND HEIDENBERG, TIMOTHY M., COLLEGE PARK, MD. FILED 10-5-2007.

P.O.W.E.R. U

THE MARK CONSISTS OF STANDARD CHARACTERS WITHOUT CLAIM TO ANY PARTICULAR FONT, STYLE, SIZE, OR COLOR.

FOR ATHLETIC SPORTING GOODS, NAMELY, ATHLETIC WRIST AND JOINT SUPPORTS; BAGS SPECIALLY ADAPTED FOR SPORTS EQUIPMENT (U.S. CLS. 22, 23, 38 AND 50).

ODESSA BIBBINS, EXAMINING ATTORNEY

SN 77-304,631. QI-X CORPORATION, LOS ANGELES, CA. FILED 10-15-2007.

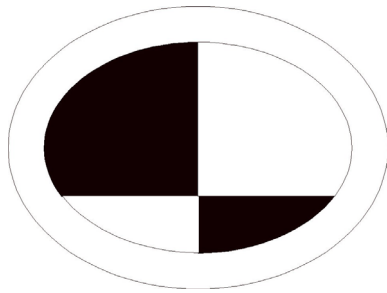

THE MARK CONSISTS OF TWO CONCENTRIC OVALS, WITH A BLACK AND WHITE CHECKERED PATTERN IN THE INNER OVAL.

FOR BAGS ESPECIALLY DESIGNED FOR SURFBOARDS; SURFBOARD FINS; SURFBOARD LEASHES; SURFBOARDS; SURF BOARDS; SURF FINS (U.S. CLS. 22, 23, 38 AND 50).

CYNTHIA SLOAN, EXAMINING ATTORNEY

SN 77-316,554. TOY STATE INDUSTRIAL LTD., TSTE KOWLOON, HONG KONG, FILED 10-30-2007.

FRIENDLY BUILDERS

THE MARK CONSISTS OF STANDARD CHARACTERS WITHOUT CLAIM TO ANY PARTICULAR FONT, STYLE, SIZE, OR COLOR.

FOR TOY FIGURES (U.S. CLS. 22, 23, 38 AND 50).

MELVIN AXILBUND, EXAMINING ATTORNEY

CLASS 28—(Continued).

SN 77-324,086. MUNTZ JR, JAMES D, WOODHAVEN, MI. FILED 11-7-2007.

Dress Me Up!

THE MARK CONSISTS OF STANDARD CHARACTERS WITHOUT CLAIM TO ANY PARTICULAR FONT, STYLE, SIZE, OR COLOR.

FOR EQUIPMENT SOLD AS A UNIT FOR PLAYING BOARD GAMES (U.S. CLS. 22, 23, 38 AND 50).

FIRST USE 11-7-2007; IN COMMERCE 11-7-2007.

LINDA M. KING, EXAMINING ATTORNEY

SN 77-324,413. LISA FRANK, INC., TUSCON, AZ. FILED 11-8-2007.

**MAKING THE VERY BEST FUN
STUFF JUST FOR YOU!**

THE MARK CONSISTS OF STANDARD CHARACTERS WITHOUT CLAIM TO ANY PARTICULAR FONT, STYLE, SIZE, OR COLOR.

FOR CHILDREN'S PARTY GAMES AND HOBBY CRAFT KITS CONSISTING VARIOUSLY OF BEADS, FEATHERS, SEQUINS, GLITTER, STICK-ON GEMS, PLASTIC STICKS, PLASTIC MESH, YARN, CORDING, EARRINGS, PINS, AND TOY JEWELRY ACCESSORIES (U.S. CLS. 22, 23, 38 AND 50).

FIRST USE 6-8-1995; IN COMMERCE 6-8-1995.

WENDY GOODMAN, EXAMINING ATTORNEY

SN 77-331,223. TOYS BY DAPHNE, INC., PHOENIX, AZ. FILED 11-16-2007.

**The Original Headcover
Company**

THE MARK CONSISTS OF STANDARD CHARACTERS WITHOUT CLAIM TO ANY PARTICULAR FONT, STYLE, SIZE, OR COLOR.

NO CLAIM IS MADE TO THE EXCLUSIVE RIGHT TO USE "HEADCOVER COMPANY", APART FROM THE MARK AS SHOWN.

SEC. 2(F).

FOR HEAD COVERS FOR GOLF CLUBS (U.S. CLS. 22, 23, 38 AND 50).

FIRST USE 0-0-1997; IN COMMERCE 0-0-1997.

GIANCARLO CASTRO, EXAMINING ATTORNEY

CLASS 28—(Continued).

SN 77-339,178. FRED WAGENHALS, SCOTTSDALE, AZ.
FILED 11-28-2007.



THE MARK CONSISTS OF THE WORD "FANDROID" WITH A STYLIZED LETTER "F" WITH THE ENTIRE WORD ENCIRCLED BY A BORDER.

FOR TOY ROBOTS (U.S. CLS. 22, 23, 38 AND 50).
MARILYN IZZI, EXAMINING ATTORNEY

SN 78-635,327. MICROSOFT CORPORATION, REDMOND, WA. FILED 5-23-2005.

BLUE DRAGON

THE MARK CONSISTS OF STANDARD CHARACTERS WITHOUT CLAIM TO ANY PARTICULAR FONT, STYLE, SIZE, OR COLOR.

PRIORITY CLAIMED UNDER SEC. 44(D) ON JAPAN APPLICATION NO. 2005-32,360, FILED 4-12-2005.

FOR (BASED ON INTENT TO USE) TOYS AND GAMES, NAMELY, ACTION FIGURES AND ACCESSORIES THEREFOR; BALLOONS; BATHTUB TOYS; TOY BUILDING BLOCKS; DOLLS AND ACCESSORIES THEREFOR; DOLL CLOTHING; BOARD GAMES; CARD GAMES; PLAY COSMETICS FOR CHILDREN; COSTUME MASKS; MINIATURE DIE CAST VEHICLES; TOY AIRPLANES AND HELICOPTERS; BATTERY OPERATED REMOTE CONTROLLED TOY VEHICLES; FLYING DISCS; INFLATABLE VINYL FIGURES; JIGSAW PUZZLES; KITES; MARBLES; INDOOR SLUMBER AND PLAY TENTS; PLUSH TOYS; HAND-HELD PUPPETS; SIT-IN AND RIDE-ON TOY VEHICLES; MODEL TRAIN SETS; PLAY SHAVING KITS; SKATEBOARDS; ROLLER SKATES; TOY BANKS; WATER SQUIRTING TOYS; TOY PISTOLS; CHRISTMAS TREE ORNAMENTS; PINBALL AND ARCADE GAME MACHINES; HAND-HELD UNITS FOR PLAYING ELECTRONIC GAMES; MODEL HOBBYCRAFT KITS OF TOY FIGURES; PLAYGROUND BALLS; SPORT BALLS; BASKETBALLS; GOLF BALLS; GOLF BALL MARKERS; TENNIS BALLS; BASEBALLS; RUBBER ACTION BALLS; RUBBER SPORTS BALLS; RUBBER PLAYING BALLS; SQUEEZABLE BALLS FOR HAND EXERCISE USED TO RELIEVE STRESS; BAGS FOR CARRYING GOLF EQUIPMENT; BAGS FOR CARRYING BASKETBALL EQUIPMENT; BAGS FOR CARRYING BASEBALL EQUIPMENT; BAGS FOR CARRYING TENNIS EQUIPMENT; MANIPULATIVE PUZZLES AND CONSTRUCTION TOYS; CRIB

CLASS 28—(Continued).

MOBILES; MOBILES FOR CHILDREN; TARGET SETS CONSISTING OF A TARGET, RUBBER SUCTION DARTS AND TOY DART GUN; PLAYING CARDS (BASED ON 44(D) PRIORITY APPLICATION) WAX FOR SKIS, AMUSEMENT GAME MACHINES AND AMUSEMENT PARK RIDES, TOYS FOR PETS, DOLLS, GO GAMES JAPANESE BOARD GAMES, UTAGARUTA JAPANESE PLAYING CARDS, SHOGI JAPANESE CHESS GAMES, DICE, SUGOROKU JAPANESE PARCHEESI GAMES, DICE CUPS, DIAMOND GAMES, CHESS GAMES, CHECKERS, CONJURING MAGIC TRICKS, DOMINOES, PLAYING CARDS, HANAFUDA JAPANESE PLAYING CARDS, MAHJONG GAMES, AMUSEMENT GAME MACHINES, BILLIARD GAME PLAYING EQUIPMENT, GYMNASIAC EQUIPMENT, NAMELY, GYMNASIAC APPARATUS, FISHING TACKLE, TOY INSECT COLLECTION KITS, VIDEO GAME APPARATUS FOR PERSONAL USE, NAMELY, HANDHELD UNITS FOR PLAYING VIDEO GAMES, ARCADE TYPE ELECTRONIC VIDEO GAME MACHINES (U.S. CLS. 22, 23, 38 AND 50).

VIVIAN MICZNIK FIRST, EXAMINING ATTORNEY

SN 78-752,492. KABUSHIKI KAISHA SHUEISHA, TA SHUEISHA INC., TOKYO, JAPAN, FILED 11-11-2005.

KAKASHI

THE MARK CONSISTS OF STANDARD CHARACTERS WITHOUT CLAIM TO ANY PARTICULAR FONT, STYLE, SIZE, OR COLOR.

THE ENGLISH TRANSLATION OF THE WORD "KAKASHI" IN THE MARK IS "SCARECROW".

FOR TOYS AND SPORTING GOODS ALL RELATING TO ANIME AND MANGA CHARACTERS, NAMELY, PLAY FIGURES AND ACCESSORIES THEREFOR, ACTION FIGURES AND ACCESSORIES THEREFOR, TOY FIGURES, ELECTRIC ACTION TOYS, MECHANICAL ACTION TOYS, DOLLS AND ACCESSORIES THEREFOR, DOLL PLAYSETS, PLUSH TOYS, STUFFED TOYS, PUPPETS, WINDUP TOYS, BOARD GAMES, CARD GAMES, DOMINOES, JIGSAW PUZZLES, MANIPULATIVE GAMES, MARBLES, PADDLE BALL GAMES, YO-YO'S, BALLOONS, JUMP ROPES, KITES AND ACCESSORIES THEREFOR, BUBBLE MAKING WANDS AND SOLUTION SETS, MAGIC TRICKS, BATH TOYS, PLAY SWIMMING POOLS, TOY VEHICLES AND ACCESSORIES THEREFOR, TOY MODEL HOBBY CRAFT KITS, TOY BANKS, TOY BOXES, TOY GUNS, TOY HOLSTERS, TOY ARCHERY BOWS AND ARROWS, TOY ROCKETS, TOY BUCKET AND SHOVEL SETS, CHILDREN'S PLAY COSMETICS, BABY RATTLES, BABY MULTIPLE ACTIVITY TOYS, TOY CONSTRUCTION BLOCKS, MUSICAL TOYS, TARGET GAMES, ACTION SKILL GAMES, BALLS, NAMELY, BILLIARD BALLS, BEACH BALLS, BASEBALLS, BASKETBALLS, FOOTBALLS, GOLF BALLS, TENNIS BALLS, PLAYGROUND BALLS, SPORT BALLS, SOCCER BALLS, VOLLEYBALLS, RUBBER BALLS, FOAM BALLS, BASEBALL BATS, BASEBALL GLOVES, FLYING DISKS, DISC TYPE TOSS TOYS, BODY BOARDS, BADMINTON SETS, DART FLIGHTS, GOLF CLUB HEAD COVERS, ROLLER SKATES, SKATEBOARDS, TOY SCOOTERS, SWIM FINNS, SWIM FLOATS FOR RECREATIONAL USE, FACE MASKS, PINBALL-TYPE GAMES, CHRISTMAS TREE DECORATIONS, EGG DECORATING KITS, HAND HELD UNITS FOR PLAYING ELECTRONIC GAMES, ARCADE GAME MACHINES, STAND-ALONE VIDEO GAME MACHINES, LCD GAME MACHINES, IN-LINE SKATES, RIDE-ON TOYS, TOY SWORDS, AND PLAYING CARDS (U.S. CLS. 22, 23, 38 AND 50).

SHANNON TWOHIG, EXAMINING ATTORNEY

CLASS 28—(Continued).

SN 78-797,692. PLEASANT ROWLAND EDUCATION PROGRAMS, INC., MADISON, WI. FILED 1-24-2006.

SUPERKIDS

THE MARK CONSISTS OF STANDARD CHARACTERS WITHOUT CLAIM TO ANY PARTICULAR FONT, STYLE, SIZE, OR COLOR.

FOR TOYS, NAMELY, BENDABLE FIGURES TO USE FOR ORAL LANGUAGE AND VOCABULARY DEVELOPMENT (U.S. CLS. 22, 23, 38 AND 50).

TIMOTHY FINNEGAN, EXAMINING ATTORNEY

SN 78-806,805. JAMZ SPORTS INC., SIDNEY, BRITISH COLUMBIA, FILED 2-3-2006.

JAMZ

THE MARK CONSISTS OF STANDARD CHARACTERS WITHOUT CLAIM TO ANY PARTICULAR FONT, STYLE, SIZE, OR COLOR.

FOR ATHLETIC EQUIPMENT, NAMELY, ROLLER SKATING WHEEL GUARDS FOR IN-LINE SKATES (U.S. CLS. 22, 23, 38 AND 50).

KATHLEEN M. VANSTON, EXAMINING ATTORNEY

SN 78-815,811. BLACK BOX, INC., CARLSBAD, CA. FILED 2-15-2006.

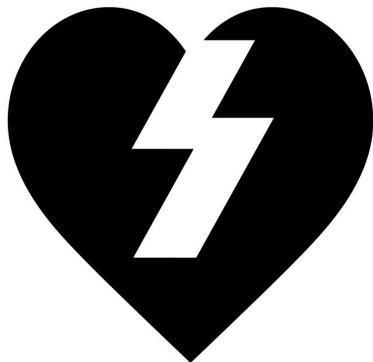

FOR SPORTING GOODS, NAMELY, SKATEBOARDS, SKATEBOARD WHEELS, AND STRUCTURAL PARTS THEREFOR (U.S. CLS. 22, 23, 38 AND 50).

FIRST USE 10-15-2003; IN COMMERCE 10-15-2003.

MICHAEL WEBSTER, EXAMINING ATTORNEY

CLASS 28—(Continued).

SN 78-928,547. ROBOTIS INC., SEOUL, REPUBLIC OF KOREA, FILED 7-13-2006.

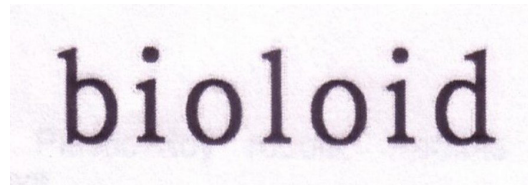

PRIORITY CLAIMED UNDER SEC. 44(D) ON REPUBLIC OF KOREA APPLICATION NO. 40-2006-0002, FILED 1-16-2006, REG. NO. 0688292, DATED 12-6-2006, EXPIRES 12-6-2016.

FOR METAL TOY ROBOTS, PLASTIC TOY ROBOTS, REMOTE CONTROLLED MOBILE TOYS, USER PROGRAMMABLE MOBILE TOYS (U.S. CLS. 22, 23, 38 AND 50).

MARY BOAGNI, EXAMINING ATTORNEY

SN 78-928,661. OWERKA-MOORE, ALYASHA, SAN DIEGO, CA. FILED 7-13-2006.



NO CLAIM IS MADE TO THE EXCLUSIVE RIGHT TO USE "WERECATS", APART FROM THE MARK AS SHOWN, FOR FANTASY CHARACTER DOLLS; PLUSH DOLLS (U.S. CLS. 22, 23, 38 AND 50).

KHANH LE, EXAMINING ATTORNEY

SN 78-950,759. MATTEL, INC., EL SEGUNDO, CA. FILED 8-11-2006.

HERO CRUSHERS

THE MARK CONSISTS OF STANDARD CHARACTERS WITHOUT CLAIM TO ANY PARTICULAR FONT, STYLE, SIZE, OR COLOR.

FOR TOYS, GAMES AND PLAYTHINGS, NAMELY, TOY VEHICLES AND ACCESSORIES THEREFOR (U.S. CLS. 22, 23, 38 AND 50).

FIRST USE 8-16-2007; IN COMMERCE 8-16-2007.

JENNIFER VASQUEZ, EXAMINING ATTORNEY

CLASS 28—(Continued).

SN 79-045,086. MAMAS & PAPAS (HOLDINGS) LIMITED, UNITED KINGDOM, FILED 7-2-2007.

BABYPLAY

OWNER OF INTERNATIONAL REGISTRATION 0940595 DATED 7-2-2007, EXPIRES 7-2-2017.

FOR TOYS, NAMELY, SOFT TOYS, MUSICAL TOYS, TALKING TOYS, TOYS FOR LEARNING, TEACHING AND THE DEVELOPMENT OF BABIES, YOUNG CHILDREN AND INFANTS, NAMELY, ELECTRONIC LEARNING TOYS, INFANT DEVELOPMENT TOYS; PLAYTHINGS, NAMELY, RIDE ON ROCKING HORSES AND OTHER RIDE ON ANIMALS, SWINGS; DOLLS AND TEDDY BEARS; TOY VEHICLES, TOY MODEL CARS; BATTERY OPERATED TOY VEHICLES; CHILDREN'S MULTIPLE ACTIVITY TOYS; TOY MOBILES; ACTIVITY GYMS FOR BABIES AND INFANTS IN THE NATURE OF MULTIPLE ACTIVITY TOYS (U.S. CLS. 22, 23, 38 AND 50).

DEBRA LEE, EXAMINING ATTORNEY

CLASS 29—(Continued).

SN 76-677,064. PERKINS, GREG, SAN ANTONIO, TX. FILED 5-18-2007.

HOTTIES

THE MARK CONSISTS OF STANDARD CHARACTERS WITHOUT CLAIM TO ANY PARTICULAR FONT, STYLE, SIZE, OR COLOR.

FOR POTATO CHIPS (U.S. CL. 46).

EDWARD FENNESSY, EXAMINING ATTORNEY

SN 76-678,696. ARGENTO FOOD CORPORATION, BROOKLYN, NY. FILED 6-25-2007.

MR. CALAMARI

THE MARK CONSISTS OF STANDARD CHARACTERS WITHOUT CLAIM TO ANY PARTICULAR FONT, STYLE, SIZE, OR COLOR.

FOR FROZEN SQUID (U.S. CL. 46).

DAVID MILLER, EXAMINING ATTORNEY

CLASS 29—MEATS AND PROCESSED FOODS

SN 76-666,650. NORTHSIDE MEAT CO., INC., CINCINNATI, OH. FILED 9-25-2006.

AMISH HERITAGE

THE MARK CONSISTS OF STANDARD CHARACTERS WITHOUT CLAIM TO ANY PARTICULAR FONT, STYLE, SIZE, OR COLOR.

NO CLAIM IS MADE TO THE EXCLUSIVE RIGHT TO USE "AMISH", APART FROM THE MARK AS SHOWN.

FOR POULTRY, NAMELY, CHICKEN AND TURKEY; HAMS; PORK; BEEF (U.S. CL. 46).

SALLY SHIH, EXAMINING ATTORNEY

SN 76-682,133. KOCH FOODS INCORPORATED, PARK RIDGE, IL. FILED 9-20-2007.

CHIC 'N TIME

THE MARK CONSISTS OF STANDARD CHARACTERS WITHOUT CLAIM TO ANY PARTICULAR FONT, STYLE, SIZE, OR COLOR.

NO CLAIM IS MADE TO THE EXCLUSIVE RIGHT TO USE "CHICKEN", APART FROM THE MARK AS SHOWN.

FOR PREPARED, PACKAGED ENTREES CONSISTING PRIMARILY OF CHICKEN (U.S. CL. 46).

FIRST USE 8-31-2006; IN COMMERCE 8-31-2006.

TINA L. SNAPP, EXAMINING ATTORNEY

SN 76-675,228. JB BRANDS COMPANY, LLC, PORTLAND, OR. FILED 4-9-2007.

TASTE ABOVE

THE MARK CONSISTS OF STANDARD CHARACTERS WITHOUT CLAIM TO ANY PARTICULAR FONT, STYLE, SIZE, OR COLOR.

FOR FROZEN VEGETARIAN ENTREES (U.S. CL. 46).

FIRST USE 3-9-2007; IN COMMERCE 3-9-2007.

KEVIN DINALLO, EXAMINING ATTORNEY

SN 77-015,596. OMSTEAD FOODS LIMITED, WHEATLEY, CANADA, FILED 10-6-2006.

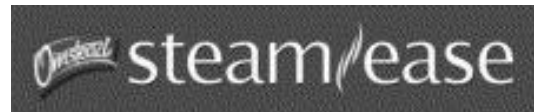

PRIORITY CLAIMED UNDER SEC. 44(D) ON CANADA APPLICATION NO. 1318963, FILED 10-4-2006, REG. NO. 705750, DATED 1-25-2008, EXPIRES 1-25-2023.

OWNER OF U.S. REG. NOS. 1,105,246 AND 1,487,660.

NO CLAIM IS MADE TO THE EXCLUSIVE RIGHT TO USE "STEAM", APART FROM THE MARK AS SHOWN.

FOR FROZEN VEGETABLES, FROZEN FRUITS AND FROZEN APPETIZERS, NAMELY, BATTERED AND BREADED CHEESE AND VEGETABLES (U.S. CL. 46).

JOHN KELLY, EXAMINING ATTORNEY

CLASS 29—(Continued).

SN 77-025,511. INDUSTRIAL COMERCIAL SAN MARTÍN, S.A., NANDAIME, GRANADA, NICARAGUA, FILED 10-20-2006.

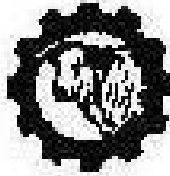

SAN MARTIN

OWNER OF NICARAGUA REG. NO. 60561LM, DATED 3-18-2004, EXPIRES 3-17-2014.
FOR MEATS, MEAT EXTRACTS, POULTRY (U.S. CL. 46).

DEIRDRE ROBERTSON, EXAMINING ATTORNEY

SN 77-051,550. SOFINA FOODS INC./ALIMENTS SOFINA INC., BRAMPTON, ONTARIO, CANADA, FILED 11-27-2006.

COUNTRY MANOR

THE MARK CONSISTS OF STANDARD CHARACTERS WITHOUT CLAIM TO ANY PARTICULAR FONT, STYLE, SIZE, OR COLOR.

FOR MEAT, PORK, CHICKEN, BEEF, TURKEY, BACON, BACK BACON, PEAMEAL BACON, BACON BITS AND ENDS, PORK BELLIES, FRESH OR FROZEN PORK, FRESH OR FROZEN BEEF, MARINATED MEAT, SLICED AND LOAF LUNCHEON AND MEATS, DELI MEATS, PICKLED MEATS, BOLOGNA, HAM, SMOKED HAM, COOKED HAM, BLACK FOREST HAM, KIELBASA, SAUSAGES, SMOKED SAUSAGE, POLISH SAUSAGE, FRESH SAUSAGES; BEER SAUSAGE, SALAMI, SUMMER SAUSAGE, SMOKED BEEF, SMOKED MEAT, CORNED BEEF, PASTRAMI, ROAST BEEF, PEPPERONI, SEASONED MEAT, FRESH MEAT, FROZEN MEAT, PROCESSED MEAT, SAUSAGE STICKS AND RINGS, BEEF BURGER PATTIES, TURKEY BURGER PATTIES, VEGGIE BURGER PATTIES, STEAKS, ROASTS, LIVER SAUSAGE, BEEF JERKY, CHILI CON CARNE, FRANKFURTERS, WIENERS, HOT DOGS, BRATWURST SAUSAGE, ITALIAN SAUSAGE, OKTOBERFEST SAUSAGE, HEADCHEESE, SPICED MEATS, SPARERIBS, BUFFALO WINGS, CHICKEN WINGS; SEMI-DRIED, DRIED AND DRY CURED BEEF, TURKEY, CHICKEN, PORK, SAUSAGE, PEPPERONI, BACON AND SHAVED MEATS; FROZEN OR REFRIGERATED, COOKED, PARTIALLY COOKED OR UNCOOKED TURKEY OR CHICKEN MEAT; FRESH TRAY PACKS OF TURKEY OR CHICKEN BREASTS, LEGS OR THIGHS; WINGS; FROZEN WHOLE TURKEYS AND CHICKENS, FRESH WHOLE TURKEYS AND CHICKENS; FROZEN OR REFRIGERATED, COOKED, PARTIALLY COOKED OR UNCOOKED BREADED AND BATTERED PORK, BEEF, TURKEY OR CHICKEN NUGGETS, CHICKEN, TURKEY AND BEEF FINGERS, SCHNITZEL, MEATBALLS AND POTATO FRITTERS (U.S. CL. 46).

JORDAN BAKER, EXAMINING ATTORNEY

CLASS 29—(Continued).

SN 77-059,031. TRANSNATIONAL FOODS, INC., MIAMI, FL. FILED 12-7-2006.

SO NATURAL

THE MARK CONSISTS OF STANDARD CHARACTERS WITHOUT CLAIM TO ANY PARTICULAR FONT, STYLE, SIZE, OR COLOR.

FOR CANNED, COOKED OR OTHERWISE PROCESSED TOMATOES (U.S. CL. 46).

FIRST USE 4-19-2006; IN COMMERCE 4-19-2006.

FRED CARL, EXAMINING ATTORNEY

SN 77-061,428. PRECISION FOODS, INC., ST. LOUIS, MO. FILED 12-11-2006.

Thick-It

THE MARK CONSISTS OF STANDARD CHARACTERS WITHOUT CLAIM TO ANY PARTICULAR FONT, STYLE, SIZE, OR COLOR.

FOR FRUIT AND VEGETABLE PUREES FOR USE AS FOOD; MEAT, POULTRY AND EGG PUREES (U.S. CL. 46).

FIRST USE 11-1-2006; IN COMMERCE 11-1-2006.

NAAKWAMA ANKRAH, EXAMINING ATTORNEY

SN 77-080,625. NONPAREIL CORPORATION, BLACKFOOT, ID. FILED 1-11-2007.

Teton Valley Ranch

THE MARK CONSISTS OF STANDARD CHARACTERS WITHOUT CLAIM TO ANY PARTICULAR FONT, STYLE, SIZE, OR COLOR.

NO CLAIM IS MADE TO THE EXCLUSIVE RIGHT TO USE "TETON VALLEY", APART FROM THE MARK AS SHOWN.

FOR PROCESSED POTATOES (U.S. CL. 46).

SCOTT BIBB, EXAMINING ATTORNEY

CLASS 29—(Continued).

SN 77-088,501. FIVE STAR FOODIES LTD., CINCINNATI, OH. FILED 1-23-2007.



NO CLAIM IS MADE TO THE EXCLUSIVE RIGHT TO USE "FOODIES", APART FROM THE MARK AS SHOWN.

THE COLOR(S) RED, BLACK, GOLD IS/ARE CLAIMED AS A FEATURE OF THE MARK.

THE MARK CONSISTS OF THE COLOR GOLD APPEARING IN THE FIVE STARS, THE WORDING "FIVE STAR", THE OVAL SURROUNDING THE WORD "FOODIES" AND AS SOME SHADING INSIDE THE WORD "FOODIES". THE COLOR BLACK APPEARS AS SHADOWING OF THE STARS AND THE WORDING "FIVE STAR FOODIES". THE COLOR RED APPEARS AS SHADING INSIDE THE WORD "FOODIES".

FOR INSTANT OR PRE-COOKED SOUP; VEGGIE BURGER PATTIES; FROZEN VEGETARIAN ENTREES (U.S. CL. 46).

MICHAEL WIENER, EXAMINING ATTORNEY

SN 77-091,856. TAYLOR FRESH FOODS, INC., SALINAS, CA. FILED 1-26-2007.

TAYLOR ORGANICS

THE MARK CONSISTS OF STANDARD CHARACTERS WITHOUT CLAIM TO ANY PARTICULAR FONT, STYLE, SIZE, OR COLOR.

OWNER OF U.S. REG. NOS. 2,068,252 AND 2,878,712. NO CLAIM IS MADE TO THE EXCLUSIVE RIGHT TO USE "ORGANICS", APART FROM THE MARK AS SHOWN.

FOR ORGANIC SALAD MIXES CONSISTING PRIMARILY OF PRE-CUT LETTUCE; ORGANIC SALAD MIXES CONSISTING PRIMARILY OF PRE-CUT LETTUCE AND PRE-CUT VEGETABLES, SERVED WITH SALAD DRESSINGS, PROTEINS, CROUTONS, SEEDS, NUTS, FRUITS AND CHEESES (U.S. CL. 46).

JAY BESCH, EXAMINING ATTORNEY

CLASS 29—(Continued).

SN 77-094,393. GARCIA VILLARRUBIA, VICENTE, JAEN, SPAIN, FILED 1-30-2007.



OWNER OF SPAIN REG. NO. 2682050, DATED 5-25-2006, EXPIRES 5-25-2016.

THE COLOR(S) GREEN AND GREEN-BLUE IS/ARE CLAIMED AS A FEATURE OF THE MARK.

THE MARK CONSISTS OF "OHO", WITH THE LETTER "H" IN GREEN-BLUE, QUOTATION MARKS AND THE TWO LETTERS "O" IN DARK GREEN, AND A BACKGROUND IN VARIOUS SHADES OF GREEN.

FOR EDIBLE OILS AND FATS (U.S. CL. 46).

STEVEN PEREZ, EXAMINING ATTORNEY

SN 77-098,419. VALLE DE OLIVOS S.A., SANTIAGO, CHILE, FILED 2-2-2007.

O-LIVE AND ME

THE MARK CONSISTS OF STANDARD CHARACTERS WITHOUT CLAIM TO ANY PARTICULAR FONT, STYLE, SIZE, OR COLOR.

PRIORITY CLAIMED UNDER SEC. 44(D) ON CHILE APPLICATION NO. 758697, FILED 1-15-2007, REG. NO. 795109, DATED 8-23-2007, EXPIRES 8-23-2017.

FOR OLIVE OIL (U.S. CL. 46).

SARA THOMAS, EXAMINING ATTORNEY

SN 77-098,440. VALLE DE OLIVOS S.A., SANTIAGO, CHILE, FILED 2-2-2007.

O-LIVE FOR ME

THE MARK CONSISTS OF STANDARD CHARACTERS WITHOUT CLAIM TO ANY PARTICULAR FONT, STYLE, SIZE, OR COLOR.

PRIORITY CLAIMED UNDER SEC. 44(D) ON CHILE APPLICATION NO. 758698, FILED 1-15-2007, REG. NO. 796126, DATED 9-6-2007, EXPIRES 9-6-2017.

FOR OLIVE OIL (U.S. CL. 46).

SARA THOMAS, EXAMINING ATTORNEY

CLASS 29—(Continued).

SN 77-098,448. VALLE DE OLIVOS S.A., SANTIAGO, CHILE, FILED 2-2-2007.

O-LIVE FOR US

THE MARK CONSISTS OF STANDARD CHARACTERS WITHOUT CLAIM TO ANY PARTICULAR FONT, STYLE, SIZE, OR COLOR.

PRIORITY CLAIMED UNDER SEC. 44(D) ON CHILE APPLICATION NO. 758699, FILED 1-15-2007, REG. NO. 796127, DATED 9-6-2007, EXPIRES 9-6-2017.

FOR OLIVE OIL (U.S. CL. 46).

SARA THOMAS, EXAMINING ATTORNEY

SN 77-130,613. CTC SALES GROUP, HOLBROOK, NY. FILED 3-14-2007.

NATURE'S BEST SNACKS

THE MARK CONSISTS OF STANDARD CHARACTERS WITHOUT CLAIM TO ANY PARTICULAR FONT, STYLE, SIZE, OR COLOR.

NO CLAIM IS MADE TO THE EXCLUSIVE RIGHT TO USE "BEST SNACKS", APART FROM THE MARK AS SHOWN.

FOR DRIED FRUITS; PROCESSED NUTS; ROASTED NUTS; SHELLED NUTS; SNACK MIX CONSISTING PRIMARILY OF PROCESSED FRUITS, PROCESSED NUTS AND/OR RAISINS (U.S. CL. 46).

FIRST USE 12-22-2002; IN COMMERCE 12-22-2002.

TINA L. SNAPP, EXAMINING ATTORNEY

SN 77-130,891. DALMATIA IMPORTS, INC., MIAMI, FL. FILED 3-14-2007.

DALMATIA

THE MARK CONSISTS OF STANDARD CHARACTERS WITHOUT CLAIM TO ANY PARTICULAR FONT, STYLE, SIZE, OR COLOR.

OWNER OF U.S. REG. NO. 2,918,383.

FOR FIG ORANGE SPREAD, FIG-BASED SPREADS CONTAINING COCOA, PLUM SPREAD, RED PEPPER SPREAD, FIG AND OLIVE TAPENADE, OLIVE OIL, QUINCE SPREAD; PROCESSED PEPPERS, PROCESSED EGGPLANT, PROCESSED GARLIC FOR USE AS A VEGETABLE (NOT SEASONING), PROCESSED GRAPES; DRIED, CANNED OR PROCESSED OLIVES; CHEESE (U.S. CL. 46).

KATHY DE JONGE, EXAMINING ATTORNEY

CLASS 29—(Continued).

SN 77-131,936. CASTRO CHEESE COMPANY, INC., HOUSTON, TX. FILED 3-15-2007.

EL MARRANITO

THE MARK CONSISTS OF STANDARD CHARACTERS WITHOUT CLAIM TO ANY PARTICULAR FONT, STYLE, SIZE, OR COLOR.

THE FOREIGN WORDING IN THE MARK TRANSLATES INTO ENGLISH AS THE LITTLE PIG.

FOR MEATS AND PROCESSED FOODS, NAMELY, CHORIZO, CHICHARRONES, CUERITOS, SAUSAGE, FRIED MEAT (U.S. CL. 46).

TASNEEM HUSSAIN, EXAMINING ATTORNEY

SN 77-132,423. CHIPPER SNAX, INC., SALT LAKE CITY, UT. FILED 3-15-2007.

CHIPPER MEAT MARKET FRESH

THE MARK CONSISTS OF STANDARD CHARACTERS WITHOUT CLAIM TO ANY PARTICULAR FONT, STYLE, SIZE, OR COLOR.

NO CLAIM IS MADE TO THE EXCLUSIVE RIGHT TO USE "MEAT MARKET FRESH", APART FROM THE MARK AS SHOWN.

FOR JERKY (U.S. CL. 46).

MARK SPARACINO, EXAMINING ATTORNEY

SN 77-132,463. CHIPPER SNAX, INC., SALT LAKE CITY, UT. FILED 3-15-2007.



NO CLAIM IS MADE TO THE EXCLUSIVE RIGHT TO USE "MEAT MARKET FRESH", APART FROM THE MARK AS SHOWN.

FOR JERKY (U.S. CL. 46).

MARK SPARACINO, EXAMINING ATTORNEY

CLASS 29—(Continued).

SN 77-139,586. NONPAREIL CORPORATION, BLACKFOOT, ID. FILED 3-24-2007.

Quick Sides

THE MARK CONSISTS OF STANDARD CHARACTERS WITHOUT CLAIM TO ANY PARTICULAR FONT, STYLE, SIZE, OR COLOR.

NO CLAIM IS MADE TO THE EXCLUSIVE RIGHT TO USE "SIDES", APART FROM THE MARK AS SHOWN.

FOR PROCESSED POTATOES (U.S. CL. 46).
SCOTT BIBB, EXAMINING ATTORNEY

CLASS 29—(Continued).

SN 77-144,057. FOUR SEASONS DAIRY INC., BROOKLYN, NY. FILED 3-29-2007.



SN 77-140,619. PRIMIZIE FINE FOODS, LLC, POUND RIDGE, NY. FILED 3-26-2007.

SAN VALENTINO

THE MARK CONSISTS OF STANDARD CHARACTERS WITHOUT CLAIM TO ANY PARTICULAR FONT, STYLE, SIZE, OR COLOR.

THE FOREIGN WORDING IN THE MARK TRANSLATES INTO ENGLISH AS "SAINT VALENTINE."

FOR OLIVE OIL (U.S. CL. 46).
MARK PILARO, EXAMINING ATTORNEY

NO CLAIM IS MADE TO THE EXCLUSIVE RIGHT TO USE "SULGUINI CHEESE" AND THE GEORGIAN CHARACTERS THAT TRANSLATE TO SULGUINI CHEESE, APART FROM THE MARK AS SHOWN.

THE COLOR(S) RED, WHITE, AND BLACK IS/ARE CLAIMED AS A FEATURE OF THE MARK.

THE MARK CONSISTS OF WORDS IN WHITE; A BARN, SILO AND COWS IN BLACK AND WHITE; A RED BACKGROUND.

THE FOREIGN WORDING IN THE MARK TRANSLATES INTO ENGLISH AS SULGUNI CHEESE.

THE GEORGIAN CHARACTERS IN THE MARK TRANSLITERATE TO SULGUINI AND THIS MEANS SULGUINI IN ENGLISH.

FOR CHEESE (U.S. CL. 46).

FIRST USE 1-10-1999; IN COMMERCE 1-10-1999.

MARGERY A. TIERNEY, EXAMINING ATTORNEY

SN 77-142,520. DALMATIA IMPORTS, INC., MIAMI, FL. FILED 3-28-2007.

DALMATIAN

THE MARK CONSISTS OF STANDARD CHARACTERS WITHOUT CLAIM TO ANY PARTICULAR FONT, STYLE, SIZE, OR COLOR.

OWNER OF U.S. REG. NO. 2,918,383.

FOR FIG ORANGE SPREAD, FIG-BASED SPREADS CONTAINING COCOA, PLUM SPREAD, RED PEPPER SPREAD, FIG AND OLIVE TAPENADE, OLIVE OIL, QUINCE SPREAD; PROCESSED PEPPERS, PROCESSED EGGPLANT, PROCESSED GARLIC FOR USE AS A VEGETABLE (NOT SEASONING), PROCESSED GRAPES; DRIED, CANNED OR PROCESSED OLIVES; CHEESE (U.S. CL. 46).

KATHY DE JONGE, EXAMINING ATTORNEY

SN 77-144,240. TRUE WORLD FOODS INTERNATIONAL, INC., SUMNER, WA. FILED 3-29-2007.

Shrimp Smart

THE MARK CONSISTS OF STANDARD CHARACTERS WITHOUT CLAIM TO ANY PARTICULAR FONT, STYLE, SIZE, OR COLOR.

NO CLAIM IS MADE TO THE EXCLUSIVE RIGHT TO USE "SHRIMP", APART FROM THE MARK AS SHOWN.

FOR SHRIMP MIXED WITH IMITATION CRAB MEAT WITH OMEGA 3 FATTY ACIDS ADDED (U.S. CL. 46).

DAWN FELDMAN, EXAMINING ATTORNEY

CLASS 29—(Continued).

SN 77-147,044. MM VITAOILS SDN BHD (394937-P), 40300 SHAH ALAM, MALAYSIA, FILED 4-3-2007.

PALM RICH

THE MARK CONSISTS OF STANDARD CHARACTERS WITHOUT CLAIM TO ANY PARTICULAR FONT, STYLE, SIZE, OR COLOR.

NO CLAIM IS MADE TO THE EXCLUSIVE RIGHT TO USE "PALM", APART FROM THE MARK AS SHOWN.

FOR MARGARINE; MARGARINE SUBSTITUTES; SHORTENING; COOKING OIL; EDIBLE OIL; VEGETABLE GHEE; SALAD OIL; VEGETABLE OILS, ALL MADE OF PALM OIL (U.S. CL. 46).

FIRST USE 11-30-2007; IN COMMERCE 11-30-2007.
PAUL E. FAHRENKOPF, EXAMINING ATTORNEY

SN 77-156,419. FUZE BEVERAGE LLC, ENGLEWOOD CLIFFS, NJ. FILED 4-13-2007.

FUZE VITAMIN BAR

THE MARK CONSISTS OF STANDARD CHARACTERS WITHOUT CLAIM TO ANY PARTICULAR FONT, STYLE, SIZE, OR COLOR.

OWNER OF U.S. REG. NOS. 2,599,318, 2,981,762 AND OTHERS.

NO CLAIM IS MADE TO THE EXCLUSIVE RIGHT TO USE "VITAMIN BAR", APART FROM THE MARK AS SHOWN.

FOR DAIRY-BASED AND FRUIT-BASED SNACK BARS (U.S. CL. 46).

MATTHEW PAPPAS, EXAMINING ATTORNEY

SN 77-157,149. SAFCOL USA, INC., CITY OF INDUSTRY, CA. FILED 4-16-2007.

DEEP COVE

THE MARK CONSISTS OF STANDARD CHARACTERS WITHOUT CLAIM TO ANY PARTICULAR FONT, STYLE, SIZE, OR COLOR.

OWNER OF U.S. REG. NO. 1,422,110.

FOR CANNED TUNA; TUNA POUCH MEALS; FRESH SEAFOOD, FROZEN SEAFOOD, CANNED SEAFOOD, PRECOOKED SEAFOOD, BROTH AND SOUP, READY TO EAT GOURMET MEALS; FROZEN ENTRÉE CONSISTING OF SEAFOOD, RED MEAT, OR POULTRY; PREPARE ENTRÉE CONSISTING OF SEAFOOD, RED MEAT, OR POULTRY; PACKAGED ENTREE CONSISTING OF SEAFOOD, RED MEAT, OR POULTRY (U.S. CL. 46).

FIRST USE 0-0-1984; IN COMMERCE 0-0-1984.
JEFF DEFORD, EXAMINING ATTORNEY

CLASS 29—(Continued).

SN 77-163,260. MM VITAOILS SDN BHD (394937-P), 40300 SHAH ALAM, MALAYSIA, FILED 4-23-2007.

OUR PALM OILS FOR THE WORLD

THE MARK CONSISTS OF STANDARD CHARACTERS WITHOUT CLAIM TO ANY PARTICULAR FONT, STYLE, SIZE, OR COLOR.

NO CLAIM IS MADE TO THE EXCLUSIVE RIGHT TO USE "PALM OILS", APART FROM THE MARK AS SHOWN.

FOR SHORTENING; COOKING OIL; EDIBLE OIL; SALAD OIL; VEGETABLE OILS; OIL, NAMELY, VEGETABLE GHEE; MARGARINE; MARGARINE SUBSTITUTES, ALL MADE OF PALM OIL (U.S. CL. 46).

PAUL E. FAHRENKOPF, EXAMINING ATTORNEY

SN 77-165,770. RIVIANA FOODS INC., HOUSTON, TX. FILED 4-25-2007.

MINUTE

THE MARK CONSISTS OF STANDARD CHARACTERS WITHOUT CLAIM TO ANY PARTICULAR FONT, STYLE, SIZE, OR COLOR.

OWNER OF U.S. REG. NOS. 52,119, 976,940 AND OTHERS. SEC. 2(F).

FOR READY-TO-SERVE MEALS, NAMELY, FROZEN, PREPARED AND PACKAGED MICROWAVABLE SIDE DISHES CONSISTING PRIMARILY OF POTATOES (U.S. CL. 46).

ROBERT C. CLARK JR., EXAMINING ATTORNEY

SN 77-171,555. K&K CHEESE LLC., CASHTON, WI. FILED 5-2-2007.

Lemonweir Gold

THE MARK CONSISTS OF STANDARD CHARACTERS WITHOUT CLAIM TO ANY PARTICULAR FONT, STYLE, SIZE, OR COLOR.

NO CLAIM IS MADE TO THE EXCLUSIVE RIGHT TO USE "LEMONWEIR", APART FROM THE MARK AS SHOWN.

FOR CHEESE (U.S. CL. 46).

FRANK LATTUCA, EXAMINING ATTORNEY

CLASS 29—(Continued).

SN 77-171,556. K&K CHEESE LLC., CASHTON, WI. FILED 5-2-2007.

Redstone Robust

THE MARK CONSISTS OF STANDARD CHARACTERS WITHOUT CLAIM TO ANY PARTICULAR FONT, STYLE, SIZE, OR COLOR.

NO CLAIM IS MADE TO THE EXCLUSIVE RIGHT TO USE "ROBUST", APART FROM THE MARK AS SHOWN. FOR CHEESE (U.S. CL. 46).
FRANK LATTUCA, EXAMINING ATTORNEY

SN 77-213,647. COLUMBUS MANUFACTURING, INC., HAYWARD, CA. FILED 6-22-2007.

COLUMBUS

OWNER OF U.S. REG. NOS. 936,718 AND 2,066,452. NO CLAIM IS MADE TO THE EXCLUSIVE RIGHT TO USE "SAN FRANCISCO SALUMERIA EST. 1917", APART FROM THE MARK AS SHOWN.

THE PORTRAIT IN THE MARK DOES NOT IDENTIFY A LIVING INDIVIDUAL.

THE MARK CONSISTS OF "COLUMBUS" IN A CIRCULAR SEAL UNDER THE WORD "COLUMBUS".

FOR CHEESES AND COOKED AND FERMENTED MEATS (U.S. CL. 46).
BERYL GARDNER, EXAMINING ATTORNEY

SN 77-218,248. SANTA MONICA SEAFOOD COMPANY, RANCHO DOMINGUEZ, CA. FILED 6-28-2007.

CRESCENT BAY

THE MARK CONSISTS OF STANDARD CHARACTERS WITHOUT CLAIM TO ANY PARTICULAR FONT, STYLE, SIZE, OR COLOR.

FOR FROZEN SEAFOOD (U.S. CL. 46).
ZHALEH DELANEY, EXAMINING ATTORNEY

CLASS 29—(Continued).

SN 77-223,003. GLOBAL BEVERAGE ENTERPRISES INC, FT LAUDERDALE, FL. FILED 7-5-2007.

SPARKLING YOGURT

THE MARK CONSISTS OF STANDARD CHARACTERS WITHOUT CLAIM TO ANY PARTICULAR FONT, STYLE, SIZE, OR COLOR.

NO CLAIM IS MADE TO THE EXCLUSIVE RIGHT TO USE "YOGURT", APART FROM THE MARK AS SHOWN. FOR YOGURT WITH CARBONATION (U.S. CL. 46).
G. MAYERSCHOFF, EXAMINING ATTORNEY

SN 77-231,894. BOX-O-BOX, LLC, FREEOLD, NJ. FILED 7-17-2007.

BOX-O-MESTER

THE MARK CONSISTS OF STANDARD CHARACTERS WITHOUT CLAIM TO ANY PARTICULAR FONT, STYLE, SIZE, OR COLOR.

FOR PRE-MADE KITS AND STUDENT CARE-PACKAGES FEATURING FRUIT BASED SNACK FOOD, MEAT BASED SNACK FOOD AND SNACK DIPS (U.S. CL. 46).

FIRST USE 6-1-2006; IN COMMERCE 6-1-2006.
G. MAYERSCHOFF, EXAMINING ATTORNEY

SN 77-237,600. HAINLINE, JEFFREY D., MISSOULA, MT. FILED 7-24-2007.



NO CLAIM IS MADE TO THE EXCLUSIVE RIGHT TO USE "ROCKY MOUNTAIN GOURMET STEAKS", APART FROM THE MARK AS SHOWN.

THE MARK CONSISTS OF AN OBLIQUE SHAPE LINED BY A WIDE BLACK BORDER IN WHICH APPEARS "ROCKY MOUNTAIN GOURMET STEAKS". THE INTERIOR OF THE OVAL CONTAINS THE LETTERS "RMGS" ARRANGED TO DEPICT A BRAND BURNED ONTO A WOODEN PLANK.

FOR MEAT (U.S. CL. 46).
FIRST USE 3-25-2004; IN COMMERCE 3-25-2004.
REBECCA EISINGER, EXAMINING ATTORNEY

CLASS 29—(Continued).

SN 77-255,250. WAL-MART STORES, INC., BENTONVILLE, AR. FILED 8-14-2007.

GRILL SIDE GOURMET

THE MARK CONSISTS OF STANDARD CHARACTERS WITHOUT CLAIM TO ANY PARTICULAR FONT, STYLE, SIZE, OR COLOR.

NO CLAIM IS MADE TO THE EXCLUSIVE RIGHT TO USE "GRILL" AND "GOURMET", APART FROM THE MARK AS SHOWN.

FOR MEAT; MEAT, FROZEN (U.S. CL. 46).
SOPHIA S. KIM, EXAMINING ATTORNEY

SN 77-255,258. WAL-MART STORES, INC., BENTONVILLE, AR. FILED 8-14-2007.

FIRE SIDE GOURMET

THE MARK CONSISTS OF STANDARD CHARACTERS WITHOUT CLAIM TO ANY PARTICULAR FONT, STYLE, SIZE, OR COLOR.

NO CLAIM IS MADE TO THE EXCLUSIVE RIGHT TO USE "GOURMET", APART FROM THE MARK AS SHOWN.

FOR MEAT; MEAT, FROZEN (U.S. CL. 46).
SOPHIA S. KIM, EXAMINING ATTORNEY

SN 77-262,179. PPC MARKETING, LTD., PITTSBURGH, TX. FILED 8-22-2007.

SNACK ZONE

THE MARK CONSISTS OF STANDARD CHARACTERS WITHOUT CLAIM TO ANY PARTICULAR FONT, STYLE, SIZE, OR COLOR.

FOR POULTRY; FROZEN AND COOKED POULTRY PRODUCTS, NAMELY, CHICKEN FRITTERS, CHICKEN NUGGETS AND CHICKEN PATTIES (U.S. CL. 46).

BARBARA BROWN, EXAMINING ATTORNEY

CLASS 29—(Continued).

SN 77-272,960. SEA PORT PRODUCTS CORPORATION, KIRKLAND, WA. FILED 9-6-2007.



THE COLOR(S) TEAL IS/ARE CLAIMED AS A FEATURE OF THE MARK.

THE MARK CONSISTS OF THE WORD "CNAMI", WITH LETTERING STYLIZED IN A WINDBLOWN LOOK, AND WITH THE "C" APPEARING AS AN OCEAN WAVE. THE COLOR TEAL APPEARS IN THE OUTLINE OF THE WORD "CNAMI". THE COLOR WHITE APPEARS ONLY AS BACKGROUND WITHIN THE OUTLINE OF THE LETTERS AND DESIGN IN THE TRADEMARK, AND WHITE IS NOT A PART OF THE TRADEMARK.

THE WORDING "CNAMI" HAS NO MEANING IN A FOREIGN LANGUAGE.

FOR FROZEN SEAFOOD (U.S. CL. 46).
WENDY GOODMAN, EXAMINING ATTORNEY

SN 77-275,394. READY PAC PRODUCE, INC., IRWINDALE, CA. FILED 9-10-2007.

READY FOR YOU!

THE MARK CONSISTS OF STANDARD CHARACTERS WITHOUT CLAIM TO ANY PARTICULAR FONT, STYLE, SIZE, OR COLOR.

FOR PACKAGED SALADS; VEGETABLE SALADS, PREPARED SALAD KITS CONSISTING OF LETTUCES, SALAD DRESSING, CROUTONS; PREPARED SALAD KITS CONSISTING OF LETTUCES, VEGETABLES, MEAT, SALAD DRESSING; PREPARED SALAD KITS CONSISTING OF LETTUCES, VEGETABLES, CHEESE, MEAT, SALAD DRESSING; PACKAGED CUT VEGETABLES; PACKAGED CUT VEGETABLES WITH DIP; PACKAGED VEGETABLES; PACKAGED CUT FRUIT; PACKAGED CUT FRUIT WITH DIP (U.S. CL. 46).

LESLIE RICHARDS, EXAMINING ATTORNEY

CLASS 29—(Continued).

SN 77-275,932. QVD USA, LLC, BELLEVUE, WA. FILED 9-10-2007.



OWNER OF U.S. REG. NO. 3,202,517.
 THE COLOR(S) YELLOW, BLUE AND WHITE IS/ARE CLAIMED AS A FEATURE OF THE MARK.
 THE MARK CONSISTS OF THE LETTERS "Q.V.D" BELOW THE IMAGE OF A YELLOW FISH WITH A BLUE BACKGROUND. THE LETTERS QVD APPEAR IN WHITE. FOR FROZEN AND FRESH IMPORTED SEAFOOD (U.S. CL. 46).
 DORITT L. CARROLL, EXAMINING ATTORNEY

SN 77-282,796. COLDANI, STEVEN M., LODI, CA. FILED 9-18-2007.

CALIVIRGIN

THE MARK CONSISTS OF STANDARD CHARACTERS WITHOUT CLAIM TO ANY PARTICULAR FONT, STYLE, SIZE, OR COLOR.
 FOR OLIVE OIL (U.S. CL. 46).
 PAM WILLIS, EXAMINING ATTORNEY

SN 77-282,992. KANSAS CITY STEAK COMPANY, LLC, KANSAS CITY, KS. FILED 9-19-2007.

THE ULTIMATE SOURCE FOR EVERYTHING BEEF

THE MARK CONSISTS OF STANDARD CHARACTERS WITHOUT CLAIM TO ANY PARTICULAR FONT, STYLE, SIZE, OR COLOR.
 NO CLAIM IS MADE TO THE EXCLUSIVE RIGHT TO USE "BEEF", APART FROM THE MARK AS SHOWN. FOR BEEF (U.S. CL. 46).
 ERIN FALK, EXAMINING ATTORNEY

CLASS 29—(Continued).

SN 77-284,877. FFX, INC., MILPITAS, CA. FILED 9-20-2007.

CASCADE VALLEY

THE MARK CONSISTS OF STANDARD CHARACTERS WITHOUT CLAIM TO ANY PARTICULAR FONT, STYLE, SIZE, OR COLOR.
 NO CLAIM IS MADE TO THE EXCLUSIVE RIGHT TO USE "CASCADE", APART FROM THE MARK AS SHOWN. FOR FROZEN POTATO PRODUCTS, NAMELY, FRENCH FRYING POTATOES AND FROZEN PROCESSED POTATOES (U.S. CL. 46).
 BARBARA BROWN, EXAMINING ATTORNEY

SN 77-284,884. FFX, INC., MILPITAS, CA. FILED 9-20-2007.

CASCADE PRIDE

THE MARK CONSISTS OF STANDARD CHARACTERS WITHOUT CLAIM TO ANY PARTICULAR FONT, STYLE, SIZE, OR COLOR.
 NO CLAIM IS MADE TO THE EXCLUSIVE RIGHT TO USE "CASCADE", APART FROM THE MARK AS SHOWN. FOR FROZEN POTATO PRODUCTS, NAMELY, FRENCH FRYING POTATOES AND FROZEN PROCESSED POTATOES (U.S. CL. 46).
 FIRST USE 7-31-2007; IN COMMERCE 7-31-2007.
 BARBARA BROWN, EXAMINING ATTORNEY

SN 77-284,886. FFX, INC., MILPITAS, CA. FILED 9-20-2007.

CASCADE GOLD

THE MARK CONSISTS OF STANDARD CHARACTERS WITHOUT CLAIM TO ANY PARTICULAR FONT, STYLE, SIZE, OR COLOR.
 NO CLAIM IS MADE TO THE EXCLUSIVE RIGHT TO USE "CASCADE", APART FROM THE MARK AS SHOWN. FOR FROZEN POTATO PRODUCTS, NAMELY, FRENCH FRYING POTATOES AND FROZEN PROCESSED POTATOES (U.S. CL. 46).
 FIRST USE 3-30-2007; IN COMMERCE 3-30-2007.
 BARBARA BROWN, EXAMINING ATTORNEY

CLASS 29—(Continued).

SN 77-284,898. PHILLIPS, RACHEL, DBA FILL-UPS NUTRITION, DANVILLE, CA. FILED 9-20-2007.

FILLUPS NUTRITION

THE MARK CONSISTS OF STANDARD CHARACTERS WITHOUT CLAIM TO ANY PARTICULAR FONT, STYLE, SIZE, OR COLOR.

NO CLAIM IS MADE TO THE EXCLUSIVE RIGHT TO USE "NUTRITION", APART FROM THE MARK AS SHOWN.

FOR PROTEIN BASED, NUTRIENT-DENSE SNACK BARS (U.S. CL. 46).

PAM WILLIS, EXAMINING ATTORNEY

SN 77-286,702. CARGILL MEAT SOLUTIONS CORPORATION, WICHITA, KS. FILED 9-24-2007.

SERRALO

THE MARK CONSISTS OF STANDARD CHARACTERS WITHOUT CLAIM TO ANY PARTICULAR FONT, STYLE, SIZE, OR COLOR.

FOR MEAT (U.S. CL. 46).

HEATHER SAPP, EXAMINING ATTORNEY

SN 77-286,734. NOANK AQUACULTURE COOPERATIVE, NOANK, CT. FILED 9-24-2007.

Peconic Pearls

THE MARK CONSISTS OF STANDARD CHARACTERS WITHOUT CLAIM TO ANY PARTICULAR FONT, STYLE, SIZE, OR COLOR.

NO CLAIM IS MADE TO THE EXCLUSIVE RIGHT TO USE "PECONIC", APART FROM THE MARK AS SHOWN. FOR SHELLFISH (U.S. CL. 46).

RENEE MCCRAY, EXAMINING ATTORNEY

CLASS 29—(Continued).

SN 77-286,781. IN-O-VATE TECHNOLOGIES, INC., JUPITER, FL. FILED 9-24-2007.

Yow Snacks

THE MARK CONSISTS OF STANDARD CHARACTERS WITHOUT CLAIM TO ANY PARTICULAR FONT, STYLE, SIZE, OR COLOR.

NO CLAIM IS MADE TO THE EXCLUSIVE RIGHT TO USE "SNACKS", APART FROM THE MARK AS SHOWN.

FOR DEHYDRATED FRUIT SNACKS; FRUIT-BASED SNACK FOOD; SNACK MIX CONSISTING PRIMARILY OF PROCESSED FRUITS, PROCESSED NUTS AND/OR RAISINS; PROCESSED EDIBLE SEEDS; PROCESSED NUTS; PROCESSED ALMONDS; PROCESSED BLUEBERRIES; PROCESSED FRUITS; ROASTED NUTS (U.S. CL. 46).

LAURIE KAUFMAN, EXAMINING ATTORNEY

SN 77-287,129. SF INVESTMENTS, INC., WILMINGTON, DE. FILED 9-24-2007.

EASY-KARV

THE MARK CONSISTS OF STANDARD CHARACTERS WITHOUT CLAIM TO ANY PARTICULAR FONT, STYLE, SIZE, OR COLOR.

OWNER OF U.S. REG. NO. 1,435,143.

FOR MEAT (U.S. CL. 46).

RONALD AIKENS, EXAMINING ATTORNEY

SN 77-287,864. BRAKEBUSH BROTHERS, INC., WEST-FIELD, WI. FILED 9-25-2007.

CHIK'N HOOPS

THE MARK CONSISTS OF STANDARD CHARACTERS WITHOUT CLAIM TO ANY PARTICULAR FONT, STYLE, SIZE, OR COLOR.

OWNER OF U.S. REG. NOS. 1,925,641, 3,118,303 AND OTHERS.

NO CLAIM IS MADE TO THE EXCLUSIVE RIGHT TO USE "CHICKEN", APART FROM THE MARK AS SHOWN.

FOR FURTHER PROCESSED CHICKEN (U.S. CL. 46).

LEIGH CAROLINE CASE, EXAMINING ATTORNEY

CLASS 29—(Continued).

SN 77-288,594. CARGILL MEAT SOLUTIONS CORPORATION, WICHITA, KS. FILED 9-25-2007.

CEDAR CANYON

THE MARK CONSISTS OF STANDARD CHARACTERS WITHOUT CLAIM TO ANY PARTICULAR FONT, STYLE, SIZE, OR COLOR.
FOR MEAT (U.S. CL. 46).
HEATHER SAPP, EXAMINING ATTORNEY

SN 77-289,601. CARGILL MEAT SOLUTIONS CORPORATION, WICHITA, KS. FILED 9-26-2007.



NO CLAIM IS MADE TO THE EXCLUSIVE RIGHT TO USE "MEATS", APART FROM THE MARK AS SHOWN.
THE MARK CONSISTS OF AN IMAGE OF AN OVAL, A TREE AND AN ABSTRACT MOUNTAIN.
FOR MEAT (U.S. CL. 46).
HEATHER SAPP, EXAMINING ATTORNEY

SN 77-290,049. ACR GROUP, INC., ASHBURN, VA. FILED 9-27-2007.

LES ARACHIDES DU VILLAGE

THE MARK CONSISTS OF STANDARD CHARACTERS WITHOUT CLAIM TO ANY PARTICULAR FONT, STYLE, SIZE, OR COLOR.
NO CLAIM IS MADE TO THE EXCLUSIVE RIGHT TO USE "LES ARACHIDES", APART FROM THE MARK AS SHOWN.
THE ENGLISH TRANSLATION OF THE MARK IS THE PEANUTS FROM THE VILLAGE.
FOR PROCESSED PEANUTS (U.S. CL. 46).
PAUL E. FAHRENKOPF, EXAMINING ATTORNEY

CLASS 29—(Continued).

SN 77-291,437. MANILDRA MILLING CORP., SHAWNEE MISSION, KS. FILED 9-28-2007.

GEMTEX

THE MARK CONSISTS OF STANDARD CHARACTERS WITHOUT CLAIM TO ANY PARTICULAR FONT, STYLE, SIZE, OR COLOR.
FOR TEXTURED VEGETABLE PROTEIN FOR USE AS A MEAT EXTENDER (U.S. CL. 46).
DANIEL CAPSHAW, EXAMINING ATTORNEY

SN 77-291,593. MB CONSULTANTS, LTD., SOUTH FALLS-BURG, NY. FILED 9-28-2007.

AS-SALAAM

THE MARK CONSISTS OF STANDARD CHARACTERS WITHOUT CLAIM TO ANY PARTICULAR FONT, STYLE, SIZE, OR COLOR.
THE ENGLISH TRANSLATION OF THE WORD "AS-SALAAM" IN THE MARK IS PEACE.
FOR POULTRY; CHICKEN (U.S. CL. 46).
FIRST USE 0-0-1994; IN COMMERCE 0-0-1996.
TARAH HARDY, EXAMINING ATTORNEY

SN 77-291,684. SCHRATTER FOODS INCORPORATED, FAIRFIELD, NJ. FILED 9-28-2007.

PALAZZINA

THE MARK CONSISTS OF STANDARD CHARACTERS WITHOUT CLAIM TO ANY PARTICULAR FONT, STYLE, SIZE, OR COLOR.
THE FOREIGN WORDING IN THE MARK TRANSLATES INTO ENGLISH AS LITTLE PLACE OR VILLAGE.
FOR CHEESE (U.S. CL. 46).
TARAH HARDY, EXAMINING ATTORNEY

CLASS 29—(Continued).

SN 77-291,905. INNOVA NUTRITION CORPORATION, MILL CREEK, WA. FILED 9-28-2007.

DIABETEZE

THE MARK CONSISTS OF STANDARD CHARACTERS WITHOUT CLAIM TO ANY PARTICULAR FONT, STYLE, SIZE, OR COLOR.

FOR PROTEIN BASED, NUTRIENT-DENSE SNACK BARS (U.S. CL. 46).

GIANCARLO CASTRO, EXAMINING ATTORNEY

SN 77-292,216. FIRST FRUITS BRANDS, LLC, DANVILLE, CA. FILED 9-29-2007.



NO CLAIM IS MADE TO THE EXCLUSIVE RIGHT TO USE "FRUITS", APART FROM THE MARK AS SHOWN.

THE COLOR(S) BURGUNDY, GREEN AND WHITE IS/ARE CLAIMED AS A FEATURE OF THE MARK.

THE MARK CONSISTS OF THE WORDS "NATURE'S FRUITS" IN SMUDGER PLAIN FONT IN BURGUNDY LETTERS ABOVE A GREEN FRUIT TREE BRANCH WITH GREEN LEAVES AND WHITE VEINS AND A WHITE BACKGROUND.

FOR DRIED FRUIT MIXES; DRIED FRUITS; FRUIT-BASED SNACK FOOD; SNACK MIX CONSISTING PRIMARILY OF PROCESSED FRUITS, PROCESSED NUTS AND/OR RAISINS (U.S. CL. 46).

LINDA M. KING, EXAMINING ATTORNEY

CLASS 29—(Continued).

SN 77-293,711. BALSZ, CAROLINE, SANTA MONICA, CA. FILED 10-2-2007.



THE MARK CONSISTS OF A LOTUS FLOWER WITH THE STYLIZED LETTERS HM IN THE CENTER, CIRCLING THE TOP OF THE LOTUS FLOWER ARE THE STYLIZED WORDS "ON A MISSION TO VIBRANT HEALTH". THE STYLIZED WORDS HEALING MOVEMENT ARE LOCATED UNDER THE LOTUS FLOWER.

FOR YOUNG COCONUT KEFIR AND CULTURED VEGETABLES (U.S. CL. 46).

MARK T. MULLEN, EXAMINING ATTORNEY

SN 77-294,234. HEB GROCERY COMPANY, LP, SAN ANTONIO, TX. FILED 10-2-2007.

TOPS IT ALL

THE MARK CONSISTS OF STANDARD CHARACTERS WITHOUT CLAIM TO ANY PARTICULAR FONT, STYLE, SIZE, OR COLOR.

FOR SNACK MIX CONSISTING PRIMARILY OF PROCESSED NUTS, PROCESSED FRUIT, CHOCOLATE CHIPS, WHITE CHOCOLATE DROPS, CHOCOLATE COOKIE DROPS, AND RAISINS (U.S. CL. 46).

G. MAYERSCHOFF, EXAMINING ATTORNEY

SN 77-294,249. HEB GROCERY COMPANY, LP, SAN ANTONIO, TX. FILED 10-2-2007.

FAB FIVE

THE MARK CONSISTS OF STANDARD CHARACTERS WITHOUT CLAIM TO ANY PARTICULAR FONT, STYLE, SIZE, OR COLOR.

FOR SNACK MIX CONSISTING PRIMARILY OF PROCESSED NUTS, PROCESSED FRUIT, AND CHOCOLATE RAISINS (U.S. CL. 46).

G. MAYERSCHOFF, EXAMINING ATTORNEY

CLASS 29—(Continued).

SN 77-294,773. DEMAKES ENTERPRISES, INC., LYNN, MA. FILED 10-3-2007.

CHILD MILD

THE MARK CONSISTS OF STANDARD CHARACTERS WITHOUT CLAIM TO ANY PARTICULAR FONT, STYLE, SIZE, OR COLOR.

FOR PROCESSED MEATS (U.S. CL. 46).
DAVID C. REIHNER, EXAMINING ATTORNEY

SN 77-295,409. PASTEURIZADORA RICA, C. POR A., SANTO DOMINGO, DOMINICAN REP, FILED 10-3-2007.

LISTAMILK

THE MARK CONSISTS OF STANDARD CHARACTERS WITHOUT CLAIM TO ANY PARTICULAR FONT, STYLE, SIZE, OR COLOR.

FOR MILK AND MILK-BASED DAIRY PRODUCTS, EXCLUDING ICE CREAM, ICE MILK, AND FROZEN YOGURT; CHOCOLATE MILK, ACIDOPHILUS MILK, AND MILK-BASED BEVERAGES CONTAINING COFFEE (U.S. CL. 46).

ALLISON SCHRODY, EXAMINING ATTORNEY

SN 77-298,660. WELL PICT, WATSONVILLE, CA. FILED 10-8-2007.

WELL PICT

THE MARK CONSISTS OF STANDARD CHARACTERS WITHOUT CLAIM TO ANY PARTICULAR FONT, STYLE, SIZE, OR COLOR.

FOR FROZEN FRUITS; FRUITS, NAMELY, FROZEN BERRIES (U.S. CL. 46).

JILL C. ALT, EXAMINING ATTORNEY

CLASS 29—(Continued).

SN 77-298,687. WELL PICT, WATSONVILLE, CA. FILED 10-8-2007.



NO CLAIM IS MADE TO THE EXCLUSIVE RIGHT TO USE "BERRIES", APART FROM THE MARK AS SHOWN.

THE COLOR(S) RED, WHITE AND BLACK IS/ARE CLAIMED AS A FEATURE OF THE MARK.

THE MARK CONSISTS OF THE WORDS "WELL PICT" IN WHITE WITH A WHITE DOT BETWEEN "WELL" AND "PICT", ALL WITHIN A RED OVAL SHAPE WITH BLACK LATERAL LINES WITHIN THE OVAL AND WHITE AND BLACK LINES AROUND THE BORDER OF THE OVAL WITH THE WORDS "BERRIES" IN WHITE WITHIN A BLACK QUADRILATERAL SHAPE CENTERED BELOW SAID OVAL SHAPE.

FOR FROZEN FRUITS; FRUITS, NAMELY, FROZEN BERRIES (U.S. CL. 46).

JILL C. ALT, EXAMINING ATTORNEY

SN 77-298,777. E. & J. GALLO WINERY, MODESTO, CA. FILED 10-8-2007.

ECCO DOMANI

THE MARK CONSISTS OF STANDARD CHARACTERS WITHOUT CLAIM TO ANY PARTICULAR FONT, STYLE, SIZE, OR COLOR.

OWNER OF U.S. REG. NO. 2,032,739.

THE ENGLISH TRANSLATION OF THE WORD "ECCO DOMANI" IN THE MARK IS HERE TOMORROW.

FOR OLIVE OILS (U.S. CL. 46).

MICHAEL KAZAZIAN, EXAMINING ATTORNEY

SN 77-304,900. DEAN INTELLECTUAL PROPERTY SERVICES II, L.P., DALLAS, TX. FILED 10-16-2007.

SUNSET DIPS

THE MARK CONSISTS OF STANDARD CHARACTERS WITHOUT CLAIM TO ANY PARTICULAR FONT, STYLE, SIZE, OR COLOR.

OWNER OF U.S. REG. NO. 1,088,838.

NO CLAIM IS MADE TO THE EXCLUSIVE RIGHT TO USE "DIPS", APART FROM THE MARK AS SHOWN.

FOR DAIRY-BASED DIPS (U.S. CL. 46).

FIRST USE 9-14-2007; IN COMMERCE 9-14-2007.

BILL DAWE, EXAMINING ATTORNEY

CLASS 29—(Continued).

SN 78-908,935. M/S PACHRANGA SYNDICATE PVT. LTD., PANIPAT-HARYANA, INDIA, FILED 6-15-2006.



OWNER OF U.S. REG. NO. 3,324,346.
NO CLAIM IS MADE TO THE EXCLUSIVE RIGHT TO USE "INTERNATIONAL, PANIPAT, (REGD), IN OIL, TRADEMARK, ACHAR OR ITS ENGLISH TRANSLATION EQUIVALENT PICKLE(S)", APART FROM THE MARK AS SHOWN.

THE COLOR(S) YELLOW, RED, BLACK, WHITE AND GREEN IS/ARE CLAIMED AS A FEATURE OF THE MARK.

THE COLOR BLACK APPEARS IN THE WORDING "PACHRANGA INTERNATIONAL PANIPAT (REGD), IN OIL, TRAD", AND "MAR". A RED RECTANGLE SURROUNDS THE WORDING "PACHRANGA INTERNATIONAL PANIPAT (REGD)". THERE IS A GREEN CIRCLE SURROUNDED BY A GREEN SQUARE TO THE RIGHT OF THE RECTANGLE. THE FOREIGN WORDING IS IN BLACK. THE WORDING "ACHAR PACHRANGA, PIP" AND THE NUMBER "5" APPEAR IN RED. THE DESIGN FEATURE OF A BANNER CONTAINING THE WORDING "TRADE IN OIL PEP" AND "MARK" IS IN WHITE. THE DESIGN FEATURES OF FRUITS BELOW THE WORDING "ACHAR PACHRANGA" APPEAR IN GREEN.

THE FOREIGN WORDING IN THE MARK TRANSLATES INTO ENGLISH AS "5 COLORS".

THE NON-LATIN CHARACTER(S) IN THE MARK TRANSLITERATES INTO "ACHAR PACHRANGA", AND THIS MEANS "PICKLE, 5 COLORS" IN ENGLISH.

FOR PRESERVED, DRIED AND COOKED FRUITS AND VEGETABLES; PICKLES (U.S. CL. 46).

FIRST USE 1-1-1983; IN COMMERCE 1-1-1983.
NAPOLEON SHARMA, EXAMINING ATTORNEY

SN 78-939,870. ZAXBY'S FRANCHISING, INC., ATHENS, GA. FILED 7-28-2006.

ZAX KIDZ

THE MARK CONSISTS OF STANDARD CHARACTERS WITHOUT CLAIM TO ANY PARTICULAR FONT, STYLE, SIZE, OR COLOR.

OWNER OF U.S. REG. NOS. 2,529,454, 2,868,595 AND OTHERS.

NO CLAIM IS MADE TO THE EXCLUSIVE RIGHT TO USE "KIDS", APART FROM THE MARK AS SHOWN.

FOR PREPARED MEALS FOR CHILDREN CONSISTING PRIMARILY OF CHICKEN AND SOLD WITH A TOY (U.S. CL. 46).

CURTIS FRENCH, EXAMINING ATTORNEY

CLASS 29—(Continued).

SN 78-953,118. OMSTEAD FOODS LIMITED, WHEATLEY, CANADA, FILED 8-16-2006.



OWNER OF CANADA REG. NO. TMA705489, DATED 1-23-2008, EXPIRES 1-23-2023.

OWNER OF U.S. REG. NOS. 1,105,246 AND 1,487,660.
NO CLAIM IS MADE TO THE EXCLUSIVE RIGHT TO USE "VEGGIES", APART FROM THE MARK AS SHOWN.

FOR FROZEN FOODS, NAMELY, MUSHROOMS, ZUCCHINI, POTATOES AND MIXED VEGETABLES (U.S. CL. 46).

JOHN KELLY, EXAMINING ATTORNEY

SN 78-954,352. CHINA ECONOMY INTERNATIONAL CORP., TORONTO, CANADA, FILED 8-17-2006.



OWNER OF CANADA REG. NO. TMA659189, DATED 2-16-2006, EXPIRES 2-16-2021.

THE COLOR(S) WHITE, GRAY, AND PINK IS/ARE CLAIMED AS A FEATURE OF THE MARK.

THE MARK CONSISTS OF A WHITE PIG WITH SPIRAL TAIL. THE EDGES OF THE PIG CONTAIN GREY SHADOWING. THE NOSE AND MOUTH PORTIONS OF THE PIG ARE PINK.

FOR CANNED COOKED MEAT PRODUCTS, NAMELY, CHOPPED PORK AND HAM; LUNCHEON MEATS; COOKED MEAT PRODUCTS, NAMELY, PORK SAUSAGE, PORK BELLY, AND HAM (U.S. CL. 46).

JACLYN KIDWELL, EXAMINING ATTORNEY

CLASS 29—(Continued).

SN 78-971,571. OMSTEAD FOODS LIMITED, WHEATLEY, CANADA, FILED 9-11-2006.



PRIORITY CLAIMED UNDER SEC. 44(D) ON CANADA APPLICATION NO. 1315933, FILED 9-8-2006, REG. NO. 705486, DATED 1-23-2008, EXPIRES 1-23-2023.
 OWNER OF U.S. REG. NOS. 1,105,246 AND 1,487,660.
 NO CLAIM IS MADE TO THE EXCLUSIVE RIGHT TO USE "VEGGIES", APART FROM THE MARK AS SHOWN.
 FOR FROZEN VEGETABLES (U.S. CL. 46).
 JOHN KELLY, EXAMINING ATTORNEY

SN 78-974,738. OMSTEAD FOODS LIMITED, WHEATLEY, CANADA, FILED 9-14-2006.

WHAT'S FRESH IN FROZEN

THE MARK CONSISTS OF STANDARD CHARACTERS WITHOUT CLAIM TO ANY PARTICULAR FONT, STYLE, SIZE, OR COLOR.
 PRIORITY CLAIMED UNDER SEC. 44(D) ON CANADA APPLICATION NO. 1316385, FILED 9-13-2006, REG. NO. TMA705495, DATED 1-23-2008, EXPIRES 1-23-2023.
 FOR FRESH, FROZEN AND COOKED FISH; COOKED SCALLOPS, OYSTERS AND SHRIMP AND PRECOOKED FISH PRODUCTS, NAMELY, BREADED AND BATTERED FISH; FROZEN VEGETABLES; FROZEN FRUITS; FROZEN APPETIZERS, NAMELY, BREADED OR BATTERED VEGETABLES AND CHEESE (U.S. CL. 46).
 DORITT L. CARROLL, EXAMINING ATTORNEY

CLASS 29—(Continued).

SN 79-030,365. DAQING CELESTIAL SUN MOON; STAR PROTEIN CO., LTD, CHINA, FILED 10-25-2006.



OWNER OF INTERNATIONAL REGISTRATION 0902110 DATED 10-25-2006, EXPIRES 10-25-2016.
 THE ENGLISH TRANSLATION OF RI YUX XING IS SUN MOON STAR.
 THE TRANSLITERATION OF THE NON-LATIN CHARACTERS IN THE MARK IS: RI YUE XING.
 FOR ALBUMEN FOR FOOD, PROTEIN FOR HUMAN CONSUMPTION, TOFU, BEAN CURD GOODS, NAMELY, FRESH BEAN CURD SHEETS, DRY BEAN CURD SHEETS, FRESH BEAN CURD STICKS AND DRIED BEAN CURD STICKS (U.S. CL. 46).
 PATRICIA EVANKO, EXAMINING ATTORNEY

SN 79-034,606. S.S. MARMARA ZEYTIN TARIM; SATIS KOOPERATIFLERI BIRLIGI; MARMARABIRLIK, TURKEY, FILED 12-27-2006.



OWNER OF INTERNATIONAL REGISTRATION 0913609 DATED 12-27-2006, EXPIRES 12-27-2016.
 THE COLOR(S) BROWN, BLACK AND WHITE IS/ARE CLAIMED AS A FEATURE OF THE MARK.
 THE COLOR BROWN APPEARS IN THE BACKGROUND RECTANGLE. THE COLOR WHITE APPEARS IN THE CIRCULAR DESIGN IN THE CENTER OF THE MARK. THE COLOR BLACK APPEARS IN THE LETTERING "MAR BİR" AND IN THE OLIVE BRANCH DESIGN.
 FOR CANNED PROCESSED OLIVES; PROCESSED OLIVES; BOTTLED PROCESSED OLIVES; PROCESSED PUREED OLIVES; PACKAGED OLIVES, NAMELY, PACKAGED PROCESSED OLIVES; PROCESSED FROZEN OLIVES; FRIED OLIVES; PREPARED PROCESSED OLIVES; PICKLED OLIVES; CURED OLIVES; OLIVE PASTES; PROCESSED OLIVE PUREE; PRESERVED OLIVES; DRIED OLIVES; COOKED OLIVES; TINNED OLIVES; EDIBLE FATS; MARGARINE; OLIVE OIL FOR FOOD; PROCESSED OILS AND FATS FOR FOOD (U.S. CL. 46).
 COLLEEN KEARNEY, EXAMINING ATTORNEY

CLASS 29—(Continued).

SN 79-038,212. S.A.S. MS SELECTION EXPORT, FRANCE, FILED 4-12-2007.

MON SIRE

OWNER OF INTERNATIONAL REGISTRATION 0923395 DATED 4-12-2007, EXPIRES 4-12-2017.
THE ENGLISH TRANSLATION OF THE FOREIGN WORDS IN THE MARK IS MY SIRE.
FOR CHEESES (U.S. CL. 46).
KATHERINE M. DUBRAY, EXAMINING ATTORNEY

SN 79-038,888. ARLA FOODS AMBA, DENMARK, FILED 5-26-2006.



OWNER OF INTERNATIONAL REGISTRATION 0786151 DATED 4-15-2002, EXPIRES 4-15-2012.
OWNER OF U.S. REG. NOS. 2,665,102, 2,951,392 AND OTHERS.
THE ENGLISH TRANSLATION OF THE WORDING "ARLA" IS EARLY.
FOR MILK AND MILK PRODUCTS, NAMELY, POWDERED MILK; CHEESE (U.S. CL. 46).
JENNY PARK, EXAMINING ATTORNEY

SN 79-039,206. LIDL STIFTUNG & CO. KG, FED REP GERMANY, FILED 5-22-2007.

TRAWLIC

THE MARK CONSISTS OF STANDARD CHARACTERS WITHOUT CLAIM TO ANY PARTICULAR FONT, STYLE, SIZE, OR COLOR.
OWNER OF INTERNATIONAL REGISTRATION 0880763 DATED 1-16-2006, EXPIRES 1-16-2016.
FOR FISH, FISH PRODUCTS, NAMELY, CANNED, PRESERVED, FROZEN, DRIED AND SMOKED FISH, FISH PIES, AND FISH SPREAD, ALL OF THE FOREMENTIONED PRODUCTS BEING MADE OF COALFISH, SALMON, CAVLAR, SCHELLERLOCKEN STRIPS OF SMOKED HADDOCK FILET, PLAICE FILLET, HERING, MACKEREL, EEL, PIKE, TROUT, CARP, WHITE FISH, SAIBLING, TENCH, OR PIKE-PERCH; READY TO SERVE MEALS CONSISTING OF PRIMARILY FISH, DEEP-FROZEN FISH (U.S. CL. 46).
CARYN GLASSER, EXAMINING ATTORNEY

CLASS 29—(Continued).

SN 79-039,419. YANGSHENGTANG ZHEJIANG; FOOD-STUFF CO., LTD, CHINA, FILED 5-30-2007.



OWNER OF INTERNATIONAL REGISTRATION 0926494 DATED 5-30-2007, EXPIRES 5-30-2017.
FOR MEAT; PREPARED MEALS CONSISTING PRIMARILY OF MEAT; PREPARED MEAT FILLETS; FISH; PREPARED MEALS CONSISTING PRIMARILY OF FISH; FISH FILLETS; FROZEN FRUITS; EGGS; MILK-BASED BEVERAGES CONTAINING FRUIT JUICE; MILK-BASED BEVERAGES CONTAINING FRUITS; MILK-BASED BEVERAGES CONTAINING COFFEE; MILK BEVERAGES WITH HIGH MILK CONTENT ; VEGETABLE SALAD; PROCESSED NUTS; CANNED COOKED MEAT (U.S. CL. 46).
ALICE BENMAMAN, EXAMINING ATTORNEY

SN 79-040,201. CONG TY CO PHAN THUY; HAI SAN MINH PHU, VIETNAM, FILED 2-12-2007.



OWNER OF INTERNATIONAL REGISTRATION 0928683 DATED 2-12-2007, EXPIRES 2-12-2017.
THE COLOR(S) BLUE, YELLOW AND WHITE IS/ARE CLAIMED AS A FEATURE OF THE MARK.
THE COLOR BLUE APPEARS IN THE WORDING "MINH PHU" AND IN THE GLOBE DESIGN; THE COLOR WHITE APPEARS AS THE LINES ACROSS THE GLOBE DESIGN AND AS THE SHRIMP DESIGN; THE COLOR YELLOW APPEARS AS THE PENINSULA DESIGN INSIDE THE GLOBE.
FOR PROCESSED FROZEN AQUATIC AND SEAFOOD PRODUCTS, NAMELY, SEASONED SEAFOOD, SEASONED FISH, SEASONED SHRIMP, SEASONED CRAB, SEAFOOD, MARINATED SEAFOOD, PROCESSED FISH ROE, CANNED FISH, CANNED TUNA, PICKLED FISH, FISH FILLETS (U.S. CL. 46).
KATHERINE E. HALMEN, EXAMINING ATTORNEY

CLASS 29—(Continued).

SN 79-044,090. LIDL STIFTUNG & CO. KG, FED REP GERMANY, FILED 7-16-2007.

DULANO

THE MARK CONSISTS OF STANDARD CHARACTERS WITHOUT CLAIM TO ANY PARTICULAR FONT, STYLE, SIZE, OR COLOR.

OWNER OF INTERNATIONAL REGISTRATION 0656456 DATED 5-21-1996, EXPIRES 5-21-2016.
OWNER OF U.S. REG. NO. 2,623,750.

FOR MEAT, MEAT PRODUCTS, NAMELY, MEAT PASTE, MEAT JUICES, SAUSAGES, MEAT-BASED MOUSSE, MEAT-BASED SPREADS, HAM, BACON, SALAMI, MORTADELLA, BACON RINDS, ROAST BEEF, CORNED BEEF, BEEF PATTIES, CANNED MEAT AND SAUSAGES, JELLIED MEAT, MEAT EXTRACTS (U.S. CL. 46).

MORGAN WYNNE, EXAMINING ATTORNEY

CLASS 30—STAPLE FOODS

SN 76-668,655. JOHNSON, ROBERT D., NEWMARKET, ONTARIO, CANADA, FILED 11-7-2006.

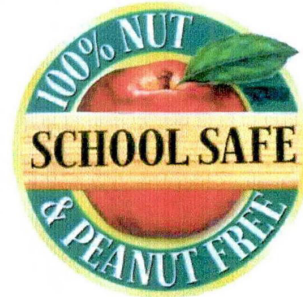

NO CLAIM IS MADE TO THE EXCLUSIVE RIGHT TO USE "100% NUT" AND "PEANUT FREE", APART FROM THE MARK AS SHOWN.

THE COLOR(S) GREEN, YELLOW, RED, BLACK, WHITE AND BROWN IS/ARE CLAIMED AS A FEATURE OF THE MARK.

THE COLOR GREEN APPEARS FOR THE LEAF, FILL COLOR BEHIND THE APPLE AND INNER AND OUTER RINGS OF THE DESIGN, YELLOW AND RED APPEARS FOR THE COLOR OF THE APPLE, BLACK APPEARS FOR "SCHOOL SAFE", WHITE APPEARS FOR "100% NUT & PEANUT FREE", BROWN APPEARS FOR THE WOODEN BACKGROUND BEHIND SCHOOLS SAFE.

FOR PROCESSED, ALLERGEN-SENSITIVE FOOD PRODUCTS, NAMELY, COOKIES, BREAD, ROLLS, PASTRIES AND CAKES (U.S. CL. 46).

FIRST USE 3-31-2006; IN COMMERCE 3-31-2006.
ANTHONY RINKER, EXAMINING ATTORNEY

SN 79-045,859. ARLA FOODS AMBA, DENMARK, FILED 9-6-2007.

DOFINØ

THE MARK CONSISTS OF STANDARD CHARACTERS WITHOUT CLAIM TO ANY PARTICULAR FONT, STYLE, SIZE, OR COLOR.

PRIORITY DATE OF 8-10-2007 IS CLAIMED.
OWNER OF INTERNATIONAL REGISTRATION 0942700 DATED 9-6-2007, EXPIRES 9-6-2017.
OWNER OF U.S. REG. NO. 864,323.

FOR MILK AND MILK PRODUCTS, NAMELY, POWDERED MILK, POWDERED CHEESE, POWDERED CREAM, STERILIZED MILK AND CREAM, CHEESE, MILK PROTEINS; EDIBLE OILS AND FATS (U.S. CL. 46).

ALLISON SCHRODY, EXAMINING ATTORNEY

SN 76-673,177. SEIDENBERG, JACK W., WOODMERE, NY, FILED 2-26-2007.

CHIOODLES

FOR PREPACKAGED OR BOXED SNACKS, NAMELY, CHINESE NOODLES COATED WITH SUBSTANCES IN THE NATURE OF CHOCOLATE, SALSA, AND SAUCES (U.S. CL. 46).

FIRST USE 1-24-2007; IN COMMERCE 1-24-2007.
PRISCILLA MILTON, EXAMINING ATTORNEY

SN 79-046,200. ARLA FOODS AMBA, DENMARK, FILED 11-6-2007.

BUKO

THE MARK CONSISTS OF STANDARD CHARACTERS WITHOUT CLAIM TO ANY PARTICULAR FONT, STYLE, SIZE, OR COLOR.

OWNER OF INTERNATIONAL REGISTRATION 0794425 DATED 12-16-2002, EXPIRES 12-16-2012.

FOR MILK AND MILK PRODUCTS, NAMELY POWDERED MILK, POWDERED CHEESE, POWDERED CREAM, STERILIZED MILK AND CREAM, CHEESE, AND MILK PROTEINS (U.S. CL. 46).

ALLISON SCHRODY, EXAMINING ATTORNEY

CLASS 30—(Continued).

SN 76-677,384. UNILEVER SUPPLY CHAIN, INC., CLINTON, CT. FILED 5-25-2007.

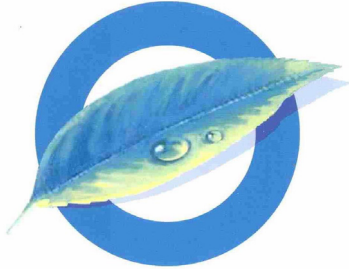

THE COLOR(S) BLUE, GREEN, YELLOW AND WHITE IS/ ARE CLAIMED AS A FEATURE OF THE MARK.

THE COLORS BLUE/GREEN AND YELLOW APPEAR IN THE DESIGN OF THE LEAF, WHICH IS SET AGAINST A BLUE CIRCLE. THE INSIDE OF THE CIRCLE APPEARS IN WHITE.

FOR TEA AND TEA-BASED BEVERAGES (U.S. CL. 46).

EMILY CARLSEN, EXAMINING ATTORNEY

SN 76-682,069. KATCHKIE FARM, LLC, NEW YORK, NY. FILED 9-19-2007.

KATCHKIE KETCHUP

THE MARK CONSISTS OF STANDARD CHARACTERS WITHOUT CLAIM TO ANY PARTICULAR FONT, STYLE, SIZE, OR COLOR.

NO CLAIM IS MADE TO THE EXCLUSIVE RIGHT TO USE "KETCHUP", APART FROM THE MARK AS SHOWN.

FOR CONDIMENTS, NAMELY, KETCHUP (U.S. CL. 46).

NICHOLAS ALTREE, EXAMINING ATTORNEY

SN 76-682,369. STRACHAN, JENNIFER, PARK CITY, UT. FILED 9-27-2007.

THE LITTLE SPICE COMPANY

THE MARK CONSISTS OF STANDARD CHARACTERS WITHOUT CLAIM TO ANY PARTICULAR FONT, STYLE, SIZE, OR COLOR.

NO CLAIM IS MADE TO THE EXCLUSIVE RIGHT TO USE "SPICE COMPANY", APART FROM THE MARK AS SHOWN.

FOR SPICES, BAKING SPICES AND SPICE BLENDS (U.S. CL. 46).

ALYSSA PALADINO, EXAMINING ATTORNEY

CLASS 30—(Continued).

SN 76-682,451. TAGHADDOS, SIAMAK, NEEDHAM, MA. FILED 10-1-2007.

THE QUICK ONE

THE MARK CONSISTS OF STANDARD CHARACTERS WITHOUT CLAIM TO ANY PARTICULAR FONT, STYLE, SIZE, OR COLOR.

FOR RICE (U.S. CL. 46).

JACQUELINE A. LAVINE, EXAMINING ATTORNEY

SN 76-682,614. SIMPLEHUMAN LLC, TORRANCE, CA. FILED 10-4-2007.

MOLTO COFFEE & TEA

THE MARK CONSISTS OF STANDARD CHARACTERS WITHOUT CLAIM TO ANY PARTICULAR FONT, STYLE, SIZE, OR COLOR.

OWNER OF U.S. REG. NOS. 3,236,453 AND 3,358,381.

NO CLAIM IS MADE TO THE EXCLUSIVE RIGHT TO USE "COFFEE & TEA", APART FROM THE MARK AS SHOWN.

THE ENGLISH TRANSLATION OF MOLTO IS "VERY" OR "MUCH" OR "MANY" OR "PLENTY".

FOR COFFEE AND PRE-PACKAGED COFFEE PODS, PRE-PACKAGED TEA PODS (U.S. CL. 46).

FIRST USE 1-1-2007; IN COMMERCE 1-1-2007.

NICHOLAS ALTREE, EXAMINING ATTORNEY

SN 76-682,665. R. C. BIGELOW, INC., FAIRFIELD, CT. FILED 10-5-2007.



OWNER OF U.S. REG. NOS. 737,616, 2,112,970 AND OTHERS.

SEC. 2(F).

FOR TEA (U.S. CL. 46).

SIMON TENG, EXAMINING ATTORNEY

CLASS 30—(Continued).

SN 77-000,825. BURNHAM & MORRILL COMPANY, PAR-SIPPANY, NJ. FILED 9-15-2006.

ORTEGA

THE MARK CONSISTS OF STANDARD CHARACTERS WITHOUT CLAIM TO ANY PARTICULAR FONT, STYLE, SIZE, OR COLOR.

OWNER OF U.S. REG. NOS. 1,049,767, 2,269,212 AND OTHERS.

SEC. 2(F).

FOR TORTILLAS AND TORTILLA CHIPS (U.S. CL. 46).

FIRST USE 1-0-2006; IN COMMERCE 1-0-2006.

TEJBIR SINGH, EXAMINING ATTORNEY

SN 77-000,833. BURNHAM & MORRILL COMPANY, PAR-SIPPANY, NJ. FILED 9-15-2006.



OWNER OF U.S. REG. NOS. 2,241,950, 2,269,212 AND OTHERS.

SEC. 2(F).

FOR TORTILLAS AND TORTILLA CHIPS (U.S. CL. 46).

FIRST USE 1-0-2006; IN COMMERCE 1-0-2006.

TEJBIR SINGH, EXAMINING ATTORNEY

SN 77-017,398. TOURISM POTENTIAL PTY LTD, CHAPEL HILL, AUSTRALIA, FILED 10-10-2006.

GRAINDROPS

THE MARK CONSISTS OF STANDARD CHARACTERS WITHOUT CLAIM TO ANY PARTICULAR FONT, STYLE, SIZE, OR COLOR.

FOR GRAIN-BASED BEVERAGES (U.S. CL. 46).

MICHAEL WEBSTER, EXAMINING ATTORNEY

CLASS 30—(Continued).

SN 77-019,705. NATUR-ALL PTY LTD., VICTORIA, AUSTRALIA, FILED 10-12-2006.



PRIORITY CLAIMED UNDER SEC. 44(D) ON AUSTRALIA APPLICATION NO. 1114684, FILED 5-22-2006, REG. NO. 1114684, DATED 5-22-2006, EXPIRES 5-22-2016.

NO CLAIM IS MADE TO THE EXCLUSIVE RIGHT TO USE "SUPER FOODS", APART FROM THE MARK AS SHOWN.

THE MARK CONSISTS OF A LEAF, ABOVE WHICH ARE THE WORDS "NATURES SUPER FOODS" WITH AN OVAL IN THE BACKGROUND.

FOR NUTRITIONAL HEALTH FOOD SNACKS, NAMELY, FLOUR OR GRAIN OR RICE-BASED HEALTH FOOD BARS CONTAINING FRUITS AND/OR NUTS; HEALTH FOOD BARS COVERED IN CAROB, YOGURT OR CHOCOLATE; BISCUITS, CAKES, PASTRIES; CONFECTIONERY, NAMELY, FRUIT COVERED IN CAROB, YOGURT OR CHOCOLATE (U.S. CL. 46).

MATTHEW MCDOWELL, EXAMINING ATTORNEY

SN 77-063,318. EL TARASCO MEAT MARKET, RANCHO CUCAMONGA, CA. FILED 12-13-2006.

EL TARASCO

THE MARK CONSISTS OF STANDARD CHARACTERS WITHOUT CLAIM TO ANY PARTICULAR FONT, STYLE, SIZE, OR COLOR.

THE ENGLISH TRANSLATION OF "EL TARASCO" IS THE "WICKED".

FOR BARBECUE SAUCE; READY-MADE SAUCES; SAUCES (U.S. CL. 46).

LYDIA BELZER, EXAMINING ATTORNEY

SN 77-084,776. ARTISAN CONFECTIONS COMPANY, HER-SHEY, PA. FILED 1-17-2007.

ROSEBERRY

THE MARK CONSISTS OF STANDARD CHARACTERS WITHOUT CLAIM TO ANY PARTICULAR FONT, STYLE, SIZE, OR COLOR.

FOR CANDY; CHOCOLATE (U.S. CL. 46).

FIRST USE 12-21-2001; IN COMMERCE 12-21-2001.

MARGARET POWER, EXAMINING ATTORNEY

CLASS 30—(Continued).

SN 77-089,313. CFR AND ASSOCIATES, LLC, LAS VEGAS, NV. FILED 1-23-2007.



NO CLAIM IS MADE TO THE EXCLUSIVE RIGHT TO USE "OKLAHOMA" AND "BBQ", APART FROM THE MARK AS SHOWN.
 FOR BARBECUE SAUCE (U.S. CL. 46).
 FIRST USE 3-0-1992; IN COMMERCE 3-0-1992.
 YONG KIM, EXAMINING ATTORNEY

SN 77-089,490. EL EDEN, INC., LANDOVER, MD. FILED 1-23-2007.

EL PULGARCITO

THE MARK CONSISTS OF STANDARD CHARACTERS WITHOUT CLAIM TO ANY PARTICULAR FONT, STYLE, SIZE, OR COLOR.
 THE FOREIGN WORDING IN THE MARK TRANSLATES INTO ENGLISH AS THE SMALL FLEA.
 FOR RICE; RICE AND SEASONING MIX COMBINED IN UNITARY PACKAGES; PASTA; BAKED GOODS, NAMELY, BREAD, CAKES, COOKIES, PASTRIES, BISCUITS, CRACKERS, DONUTS, CROUTONS, BAGEL CHIPS, BUNS AND MUFFINS; BREAKFAST CEREALS; CEREAL BARS; FROZEN AND PACKAGED ENTREES CONSISTING PRIMARILY OF PASTA AND RICE; PROCESSED CEREALS; WAFFLES; COFFEE BEANS; SNACK FOODS, NAMELY, CHEESE FLAVORED PUFFED CORN SNACKS, CORN CHIPS AND TORTILLA CHIPS; HOT SAUCE, PICO DE GALLO SAUCE; SAUCE MIXES; SAUCES FOR BARBEQUED MEAT; STEAK SAUCE (U.S. CL. 46).
 ANGELA GAW, EXAMINING ATTORNEY

CLASS 30—(Continued).

SN 77-089,494. EL EDEN, INC., LANDOVER, MD. FILED 1-23-2007.



THE COLOR(S) BLUE, GREEN, ORANGE, YELLOW AND BLACK IS/ARE CLAIMED AS A FEATURE OF THE MARK.
 THE MARK CONSISTS OF A LITTLE PERSON ON A BACKGROUND CONSISTING OF A REPRESENTATION OF "EL" SALVADOR IN BLUE WITHIN A CIRCLE IN SHADES OF GREEN AND ORANGE AND UNDERNEATH IS THE WORDING "EL PULGARCITO" IN YELLOW AND BLACK ON A BACKGROUND CONSISTING OF SHADES OF ORANGE AND YELLOW.
 THE FOREIGN WORDING IN THE MARK TRANSLATES INTO ENGLISH AS THE SMALL FLEA.
 FOR RICE; RICE AND SEASONING MIX COMBINED IN UNITARY PACKAGES; PASTA; BAKED GOODS, NAMELY, BREAD, CAKES, COOKIES, PASTRIES, BISCUITS, CRACKERS, DONUTS, CROUTONS, BAGEL CHIPS, BUNS AND MUFFINS; BREAKFAST CEREALS; CEREAL BARS; FROZEN AND PACKAGED ENTREES CONSISTING PRIMARILY OF PASTA AND RICE; PROCESSED CEREALS; WAFFLES; COFFEE BEANS; SNACK FOODS, NAMELY, CHEESE FLAVORED PUFFED CORN SNACKS, CORN CHIPS AND TORTILLA CHIPS; HOT SAUCE, PICO DE GALLO SAUCE; SAUCE MIXES; SAUCES FOR BARBEQUED MEAT; STEAK SAUCE (U.S. CL. 46).
 ANGELA GAW, EXAMINING ATTORNEY

SN 77-094,365. BAKERSFIELD BISCUIT & DRY GOODS CO., LOS ANGELES, CA. FILED 1-30-2007.



OWNER OF U.S. REG. NOS. 2,278,389, 3,114,079 AND OTHERS.
 NO CLAIM IS MADE TO THE EXCLUSIVE RIGHT TO USE "BISCUITS", "BRAND", AND "FLAPJACK SANDWICHES PANCAKE SANDWICHES WITH SAUSAGE & EGG", APART FROM THE MARK AS SHOWN.
 THE NAME(S), PORTRAIT(S), AND/OR SIGNATURE(S) SHOWN IN THE MARK IDENTIFIES DWIGHT YOAKAM, WHOSE CONSENT(S) TO REGISTER IS SUBMITTED.
 FOR SANDWICHES (U.S. CL. 46).
 JACLYN KIDWELL, EXAMINING ATTORNEY

CLASS 30—(Continued).

SN 77-104,017. SWEET CANDY COMPANY, SALT LAKE CITY, UT. FILED 2-9-2007.

CANDY CANE

THE MARK CONSISTS OF STANDARD CHARACTERS WITHOUT CLAIM TO ANY PARTICULAR FONT, STYLE, SIZE, OR COLOR.
FOR TAFFY (U.S. CL. 46).
FIRST USE 5-0-2006; IN COMMERCE 5-0-2006.
KELLY BOULTON, EXAMINING ATTORNEY

CLASS 30—(Continued).

SN 77-132,450. EARTH SOURCE, INC., SAN DIEGO, CA. FILED 3-15-2007.

RIGHTEOUSLY RAW

THE MARK CONSISTS OF STANDARD CHARACTERS WITHOUT CLAIM TO ANY PARTICULAR FONT, STYLE, SIZE, OR COLOR.
NO CLAIM IS MADE TO THE EXCLUSIVE RIGHT TO USE "RAW", APART FROM THE MARK AS SHOWN.
FOR CHOCOLATE BASED ORGANIC FOOD BARS (U.S. CL. 46).
MARK SPARACINO, EXAMINING ATTORNEY

SN 77-107,520. RICE, HOLLACE A., SAN DIEGO, CA. FILED 2-14-2007.

TEAZEN

THE MARK CONSISTS OF STANDARD CHARACTERS WITHOUT CLAIM TO ANY PARTICULAR FONT, STYLE, SIZE, OR COLOR.
FOR BEVERAGES MADE OF TEA; TEA; TEA-BASED BEVERAGES WITH FRUIT FLAVORING (U.S. CL. 46).
FIRST USE 5-11-2004; IN COMMERCE 2-11-2005.
KATHERINE E. HALMEN, EXAMINING ATTORNEY

SN 77-132,453. EARTH SOURCE, INC., SAN DIEGO, CA. FILED 3-15-2007.

JAVA GARDEN

THE MARK CONSISTS OF STANDARD CHARACTERS WITHOUT CLAIM TO ANY PARTICULAR FONT, STYLE, SIZE, OR COLOR.
NO CLAIM IS MADE TO THE EXCLUSIVE RIGHT TO USE "JAVA", APART FROM THE MARK AS SHOWN.
FOR COFFEE, TEA, SHAKES, ICE CREAM, PROTEIN SHAKES, FROZEN BEVERAGES MADE OF COFFEE, SPICES AND SAUCES (U.S. CL. 46).
MARK SPARACINO, EXAMINING ATTORNEY

SN 77-124,880. VIDAL GOLOSINAS, S.A., MURCIA, SPAIN, FILED 3-7-2007.

ROLLA-BELTA

THE MARK CONSISTS OF STANDARD CHARACTERS WITHOUT CLAIM TO ANY PARTICULAR FONT, STYLE, SIZE, OR COLOR.
OWNER OF ERPN CMNTY TM OFC REG. NO. 2942191, DATED 3-30-2004, EXPIRES 11-18-2012.
THE WORDING "ROLLA-BELTA" HAS NO MEANING IN A FOREIGN LANGUAGE.
FOR SWEETS, NAMELY, CHOCOLATE, CANDY, LICORICE, FRUIT GUM AND CHEWING GUM (U.S. CL. 46).
WOODROW HARTZOG, EXAMINING ATTORNEY

SN 77-132,457. EARTH SOURCE, INC., SAN DIEGO, CA. FILED 3-15-2007.

RIGHTEOUSLY

THE MARK CONSISTS OF STANDARD CHARACTERS WITHOUT CLAIM TO ANY PARTICULAR FONT, STYLE, SIZE, OR COLOR.
FOR COFFEE, TEA, SHAKES, ICE CREAM, PROTEIN SHAKES, FROZEN BEVERAGES MADE OF COFFEE, SPICES AND SAUCES; CHOCOLATE BASED ORGANIC FOOD BARS; RAW FOODS, NAMELY, RAW CHOCOLATE BROWNIES, RAW CHOCOLATE CANDY, RAW COOKIES, RAW CHOCOLATE BARS; CHOCOLATE BASED ORGANIC FOOD BARS (U.S. CL. 46).
MARK SPARACINO, EXAMINING ATTORNEY

CLASS 30—(Continued).

SN 77-135,589. TAMPA BAY RAYS BASEBALL LTD., ST. PETERSBURG, FL. FILED 3-20-2007.

STING 'EM DOG

THE MARK CONSISTS OF STANDARD CHARACTERS WITHOUT CLAIM TO ANY PARTICULAR FONT, STYLE, SIZE, OR COLOR.

NO CLAIM IS MADE TO THE EXCLUSIVE RIGHT TO USE "DOG", APART FROM THE MARK AS SHOWN.

THE WORDING "STING 'EM" HAS NO MEANING IN A FOREIGN LANGUAGE.

FOR FRANKFURTER SANDWICHES (U.S. CL. 46).
MICHAEL GAAFAR, EXAMINING ATTORNEY

SN 77-135,863. SARA LEE BAKERY GROUP, INC., DOWNERS GROVE, IL. FILED 3-20-2007.

EARTHGRAINS

THE MARK CONSISTS OF STANDARD CHARACTERS WITHOUT CLAIM TO ANY PARTICULAR FONT, STYLE, SIZE, OR COLOR.

OWNER OF U.S. REG. NOS. 1,028,835, 1,110,637 AND OTHERS.

FOR BAKERY PRODUCTS, NAMELY, BREAD, BUNS AND ROLLS (U.S. CL. 46).

THEODORE MCBRIDE, EXAMINING ATTORNEY

SN 77-144,586. UNILEVER SUPPLY CHAIN, INC., CLINTON, CT. FILED 3-30-2007.

LIPTON LINEA

THE MARK CONSISTS OF STANDARD CHARACTERS WITHOUT CLAIM TO ANY PARTICULAR FONT, STYLE, SIZE, OR COLOR.

OWNER OF U.S. REG. NOS. 2,088,996, 3,009,183 AND OTHERS.

NO CLAIM IS MADE TO THE EXCLUSIVE RIGHT TO USE LINEA, APART FROM THE MARK AS SHOWN.

"THE FOREIGN WORDING IN THE MARK TRANSLATES INTO ENGLISH AS "LINE"."

FOR TEA AND READY-TO-DRINK TEA-BASED BEVERAGES (U.S. CL. 46).

EMILY CARLSEN, EXAMINING ATTORNEY

CLASS 30—(Continued).

SN 77-156,635. PALACIOS & SONS, L.L.C., LAREDO, TX. FILED 4-13-2007.



THE MARK CONSISTS OF THE WORD "CHARRAS" AND A MAN ON A HORSE.

THE WORDING "CHARRAS" HAS NO MEANING IN A FOREIGN LANGUAGE.

FOR TORTILLA CHIPS; TOSTADAS; NACHOS CHIPS; SALSA; AND SAUCES (U.S. CL. 46).

FIRST USE 8-1-1996; IN COMMERCE 8-1-1996.

GEORGE LORENZO, EXAMINING ATTORNEY

SN 77-161,413. 200 KELSEY ASSOCIATES, LLC, NEW ROCHELLE, NY. FILED 4-20-2007.

KOOL SHAKE

THE MARK CONSISTS OF STANDARD CHARACTERS WITHOUT CLAIM TO ANY PARTICULAR FONT, STYLE, SIZE, OR COLOR.

FOR CANDY; CANDY BARS; CHOCOLATE CANDIES; CHOCOLATE (U.S. CL. 46).

JILL C. ALT, EXAMINING ATTORNEY

SN 77-162,552. AMBROSIA MOUNTAIN, LLC, LYNCHBURG, VA. FILED 4-22-2007.

Terra Sienna

THE MARK CONSISTS OF STANDARD CHARACTERS WITHOUT CLAIM TO ANY PARTICULAR FONT, STYLE, SIZE, OR COLOR.

THE FOREIGN WORDING IN THE MARK TRANSLATES INTO ENGLISH AS "EARTH OF SIENNA".

FOR SEASONINGS (U.S. CL. 46).

FIRST USE 3-2-2007; IN COMMERCE 3-2-2007.

JASON BLAIR, EXAMINING ATTORNEY

CLASS 30—(Continued).

SN 77-170,963. WM. WRIGLEY JR. COMPANY, CHICAGO, IL. FILED 5-2-2007.

WATERMELON RAPID

THE MARK CONSISTS OF STANDARD CHARACTERS WITHOUT CLAIM TO ANY PARTICULAR FONT, STYLE, SIZE, OR COLOR.

NO CLAIM IS MADE TO THE EXCLUSIVE RIGHT TO USE "WATERMELON", APART FROM THE MARK AS SHOWN.

FOR BUBBLE GUM; CHEWING GUM; CANDY MINTS; CANDY (U.S. CL. 46).

MORGAN WYNNE, EXAMINING ATTORNEY

CLASS 30—(Continued).

SN 77-189,999. CHOCOLADEFABRIKEN LINDT & SPRÜNGLI AG, KILCHBERG, SWITZERLAND, FILED 5-24-2007.



OWNER OF U.S. REG. NOS. 1,554,921 AND 1,558,287. FOR CHOCOLATE (U.S. CL. 46). FIRST USE 12-31-1989; IN COMMERCE 12-31-1989. THEODORE MCBRIDE, EXAMINING ATTORNEY

SN 77-174,502. MARS, INCORPORATED, MCLEAN, VA. FILED 5-7-2007.



SN 77-190,195. STARBUCKS U.S. BRANDS, LLC, MINDEN, NV. FILED 5-25-2007.

JOYA DEL DIA BLEND

THE MARK CONSISTS OF STANDARD CHARACTERS WITHOUT CLAIM TO ANY PARTICULAR FONT, STYLE, SIZE, OR COLOR.

NO CLAIM IS MADE TO THE EXCLUSIVE RIGHT TO USE "BLEND", APART FROM THE MARK AS SHOWN.

THE FOREIGN WORDING IN THE MARK TRANSLATES INTO ENGLISH AS JEWEL OF THE DAY.

FOR BEVERAGES MADE OF COFFEE; COFFEE; COFFEE BEANS; GROUND COFFEE BEANS (U.S. CL. 46).

PAUL E. FAHRENKOPF, EXAMINING ATTORNEY

FOR CONFECTIONERY, NAMELY, CANDY WITH CAFFEINE (U.S. CL. 46).

LYDIA BELZER, EXAMINING ATTORNEY

SN 77-210,060. KILLER MUNCHIES, LLC, SEATTLE, WA. FILED 6-19-2007.

HAPPY DANCE

THE MARK CONSISTS OF STANDARD CHARACTERS WITHOUT CLAIM TO ANY PARTICULAR FONT, STYLE, SIZE, OR COLOR.

FOR CANDY; MARSHMALLOWS; NO BAKE BAR COOKIES; CHOCOLATE CANDY, NAMELY, CHOCOLATE COVERED NUTS, FRUIT, CEREALS, CARAMEL, GANACHE, BUTTERCREAM, OR OTHER INCLUSIONS; CHOCOLATE BARKS; CARAMELS; FUDGES; TOFFEES; BRITTLES CONTAINING NUTS OR COCONUT; FLAVORED POPCORN AND CARAMEL CORN; COOKIES; BROWNIES AND BAR COOKIES (U.S. CL. 46).

APRIL ROACH, EXAMINING ATTORNEY

SN 77-180,616. THE BELL TEA COMPANY LIMITED, AUCKLAND, NEW ZEALAND, FILED 5-14-2007.

GRAVITY

THE MARK CONSISTS OF STANDARD CHARACTERS WITHOUT CLAIM TO ANY PARTICULAR FONT, STYLE, SIZE, OR COLOR.

FOR COFFEE; ARTIFICIAL COFFEE; TEA; COCOA; COFFEE AND TEA SUBSTITUTES; COFFEE BEANS; COFFEE BEVERAGES; FLOUR; BREAD; PASTRY (U.S. CL. 46).

FIRST USE 7-12-2005; IN COMMERCE 7-12-2005.

KELLEY WELLS, EXAMINING ATTORNEY

CLASS 30—(Continued).

SN 77-215,572. D'ELIA, RONALD, GREENWICH, CT. FILED 6-26-2007.

The logo for VITMiN features the word "VITMiN" in a bold, sans-serif font. The letter "i" is lowercase and has a dot above it. The letter "M" is uppercase and has a horizontal bar above it that extends across the width of the "i" and "M".

FOR PROCESSED CEREALS; CEREAL BASED SNACK FOOD; TEA, TEA-BASED BEVERAGES, BEVERAGES MADE OF TEA (U.S. CL. 46).
SUNG IN, EXAMINING ATTORNEY

SN 77-216,478. UNIVERSAL SWEET INDUSTRIES S.A., GUAYAQUIL, ECUADOR, FILED 6-27-2007.

The logo for MANICHO consists of the word "MANICHO" in a bold, serif font.

THE MARK CONSISTS OF STANDARD CHARACTERS WITHOUT CLAIM TO ANY PARTICULAR FONT, STYLE, SIZE, OR COLOR.
FOR CHOCOLATE (U.S. CL. 46).
PAM WILLIS, EXAMINING ATTORNEY

SN 77-220,832. LEE'S SANDWICHES INTERNATIONAL, INC., SAN JOSE, CA. FILED 7-2-2007.



OWNER OF U.S. REG. NOS. 3,097,415, 3,177,995 AND 3,195,637.

NO CLAIM IS MADE TO THE EXCLUSIVE RIGHT TO USE "SAIGON" OR "JAVA", APART FROM THE MARK AS SHOWN.

THE COLOR(S) RED, BLUE, WHITE, BROWN IS/ARE CLAIMED AS A FEATURE OF THE MARK.

THE COLOR "RED" APPEARS IN THE WORDING "SAIGON" AND THE "J" IN "JAVA" AND IN THE DESIGN OF THE STAR; THE COLOR "BLUE" APPEARS IN THE BORDER OVAL AND IN THE "AVA" IN "JAVA"; THE COLOR "WHITE" APPEARS IN THE BACKGROUND; THE COLOR "BROWN" APPEARS IN THE COFFEE BEAN THAT COMPRISES THE LETTER "O" IN "SAIGON".

FOR COFFEE; COFFEE-BASED BEVERAGE CONTAINING MILK; INSTANT COFFEE; PREPARED COFFEE AND COFFEE-BASED BEVERAGES (U.S. CL. 46).
FIRST USE 4-19-2007; IN COMMERCE 6-8-2007.

KRISTIN DAHLING, EXAMINING ATTORNEY

CLASS 30—(Continued).

SN 77-221,213. KERRY GROUP SERVICES INTERNATIONAL LIMITED, TRALEE, COUNTY KERRY, IRELAND, FILED 7-3-2007.

The logo for FMT consists of the letters "FMT" in a bold, serif font.

THE MARK CONSISTS OF STANDARD CHARACTERS WITHOUT CLAIM TO ANY PARTICULAR FONT, STYLE, SIZE, OR COLOR.

FOR FOOD ADDITIVES FOR NON-NUTRITIONAL PURPOSES FOR USE AS A FLAVORING; FOOD FLAVORINGS; FLAVORINGS FOR BEVERAGES (U.S. CL. 46).

THOMAS MANOR, EXAMINING ATTORNEY

SN 77-221,234. KERRY GROUP SERVICES INTERNATIONAL LIMITED, TRALEE, COUNTY KERRY, IRELAND, FILED 7-3-2007.

The logo for FMT2 consists of the letters "FMT2" in a bold, serif font.

THE MARK CONSISTS OF STANDARD CHARACTERS WITHOUT CLAIM TO ANY PARTICULAR FONT, STYLE, SIZE, OR COLOR.

FOR FOOD ADDITIVES FOR NON-NUTRITIONAL PURPOSES FOR USE AS A FLAVORING; FOOD FLAVORINGS; FLAVORINGS FOR BEVERAGES (U.S. CL. 46).

THOMAS MANOR, EXAMINING ATTORNEY

SN 77-221,484. FARALDO, JOSE HENRIQUE FERNANDES, BOTUCATU/SP, BRAZIL, FILED 7-3-2007.

The logo for AmazonHoney features the word "AmazonHoney" in a bold, sans-serif font. The letter "A" is stylized with a leaf-like shape on its left side.

NO CLAIM IS MADE TO THE EXCLUSIVE RIGHT TO USE AMAZON HONEY, APART FROM THE MARK AS SHOWN.

THE MARK CONSISTS OF THE WORDS AMAZON WITH A CAPITAL A AND HONEY WITH A CAPITAL H IN A STYLIZED FONT.

FOR ROYAL JELLY FOR FOOD PURPOSES; HONEY; MOLASSES SYRUP; MOLASSES FOR FOOD; PROPOLIS FOR FOOD PURPOSES (U.S. CL. 46).

H. M. FISHER, EXAMINING ATTORNEY

CLASS 30—(Continued).

SN 77-222,039. LIN, GINKGO, JILONG CITY, TAIWAN, FILED 7-4-2007.



"THE NAME(S), PORTRAIT(S), AND/OR SIGNATURE(S) SHOWN IN THE MARK IDENTIFIES A LIVING PERSON, WHOSE CONSENT(S) TO REGISTER IS SUBMITTED."

THE MARK CONSISTS OF AN ACTUAL PORTRAIT OF THE APPLICANT, THE ENGLISH WORDS GINKGO LIN AND THREE CHINESE CHARACTERS.

THE FOREIGN WORDING IN THE MARK TRANSLATES INTO ENGLISH AS FOREST; SLIVER OR COLOR OF SLIVER; AND APRICOT.

THE NON-LATIN CHARACTER(S) IN THE MARK TRANSLITERATE INTO LIN; YIN; AND XIN, AND THIS MEANS FOREST; SLIVER OR COLOR OF SLIVER; AND APRICOT IN ENGLISH.

FOR ALMOND PASTE; GINKGO IN POWDERED FORM FOR MAKING INTO PASTE FOR CONSUMPTION; CEREAL-BASED SNACK FOOD; CEREAL PREPARATIONS IN POWDERED FORM; BARLEY MEAL; FARINACEOUS FOOD PASTES; SESAME SEED IN POWDERED FORM FOR MAKING PASTE FOR CONSUMPTION; AND PORRIDGE PREPARATIONS, NAMELY, OATMEAL, WHEAT AND BARLEY PORRIDGE (U.S. CL. 46).

LINDA MICKLEBURGH, EXAMINING ATTORNEY

SN 77-224,925. MORRIS NATIONAL, INC., AZUSA, CA. FILED 7-9-2007.

JUST FOR FUN PAINT POP

THE MARK CONSISTS OF STANDARD CHARACTERS WITHOUT CLAIM TO ANY PARTICULAR FONT, STYLE, SIZE, OR COLOR.

OWNER OF U.S. REG. NOS. 2,960,606 AND 3,042,275. NO CLAIM IS MADE TO THE EXCLUSIVE RIGHT TO USE "POP", APART FROM THE MARK AS SHOWN.

FOR CANDY (U.S. CL. 46).
HENRY S. ZAK, EXAMINING ATTORNEY

CLASS 30—(Continued).

SN 77-224,964. MORRIS NATIONAL, INC., AZUSA, CA. FILED 7-9-2007.

JUST FOR FUN PAINT BOX

THE MARK CONSISTS OF STANDARD CHARACTERS WITHOUT CLAIM TO ANY PARTICULAR FONT, STYLE, SIZE, OR COLOR.

OWNER OF U.S. REG. NOS. 2,960,606 AND 3,042,275. FOR CANDY (U.S. CL. 46).
HENRY S. ZAK, EXAMINING ATTORNEY

SN 77-226,220. JARDINE FOODS, INC., BUDA, TX. FILED 7-10-2007.

RIDIN' HIGH TEXAS TRAIL MIX

THE MARK CONSISTS OF STANDARD CHARACTERS WITHOUT CLAIM TO ANY PARTICULAR FONT, STYLE, SIZE, OR COLOR.

NO CLAIM IS MADE TO THE EXCLUSIVE RIGHT TO USE "TEXAS TRAIL MIX", APART FROM THE MARK AS SHOWN.

FOR SNACK MIX CONSISTING PRIMARILY OF SESAME STICKS, ALMONDS, CASHEWS, PEPITAS AND SUNFLOWER SEEDS (U.S. CL. 46).

FIRST USE 7-3-2007; IN COMMERCE 7-3-2007.
WENDY JUN, EXAMINING ATTORNEY

SN 77-229,784. HORROCKS, JEFFREY, ELVERSON, PA. FILED 7-14-2007.

CHATTE

THE MARK CONSISTS OF STANDARD CHARACTERS WITHOUT CLAIM TO ANY PARTICULAR FONT, STYLE, SIZE, OR COLOR.

FOR HOT CHOCOLATE (U.S. CL. 46).
FIRST USE 12-1-2006; IN COMMERCE 1-15-2007.
FRED CARL, EXAMINING ATTORNEY

CLASS 30—(Continued).

SN 77-231,017. REX'S OUTRAGEOUS, LLC, DBA REX'S OUTRAGEOUS, JERICHO, VT. FILED 7-17-2007.

Road Crew Crunch

THE MARK CONSISTS OF STANDARD CHARACTERS WITHOUT CLAIM TO ANY PARTICULAR FONT, STYLE, SIZE, OR COLOR.

NO CLAIM IS MADE TO THE EXCLUSIVE RIGHT TO USE "CRUNCH", APART FROM THE MARK AS SHOWN.

FOR CEREAL BASED SNACK FOOD; CHOCOLATE (U.S. CL. 46).

FIRST USE 12-0-2005; IN COMMERCE 12-0-2005.
ERIN FALK, EXAMINING ATTORNEY

SN 77-237,362. PET INCORPORATED, MINNEAPOLIS, MN. FILED 7-24-2007.



OWNER OF U.S. REG. NOS. 398,874, 708,478 AND 1,430,438.

NO CLAIM IS MADE TO THE EXCLUSIVE RIGHT TO USE "AMERICA'S FAVORITE QUALITY", APART FROM THE MARK AS SHOWN.

THE LINING IS A FEATURE OF THE MARK AND DOES NOT INDICATE COLOR.

THE MARK CONSISTS OF A ROUND SEAL WITH A SCALLOPED EDGE CONTAINING 4 STARS, 2 SEMI-CIRCLE DESIGNS AND THE WORDING "PROGRESSO AMERICA'S FAVORITE QUALITY" CENTERED ON A RIBBON.

FOR BREAD CRUMBS (U.S. CL. 46).
FIRST USE 10-0-2006; IN COMMERCE 10-0-2006.
INGA ERVIN, EXAMINING ATTORNEY

CLASS 30—(Continued).

SN 77-254,248. TODDCO, LLC, SEVERNA PARK, MD. FILED 8-13-2007.

Todd's
DIRT

FOR SEASONINGS, MARINADES, DIPPING SAUCES, SALAD DRESSING (U.S. CL. 46).

SETH A. RAPPAPORT, EXAMINING ATTORNEY

SN 77-260,644. PASTRY SHOPPE INC., BROOKLYN, NY. FILED 8-21-2007.

BITE WISE

THE MARK CONSISTS OF STANDARD CHARACTERS WITHOUT CLAIM TO ANY PARTICULAR FONT, STYLE, SIZE, OR COLOR.

NO CLAIM IS MADE TO THE EXCLUSIVE RIGHT TO USE "BITE", APART FROM THE MARK AS SHOWN.

FOR BAKERY GOODS; BAKERY PRODUCTS, NAMELY, SWEET BAKERY GOODS; CONFECTIONERY CHIPS FOR BAKING; FROZEN BREADS; FROZEN CONFECTIONS; FROZEN CUSTARDS; FROZEN PIE CRUSTS; MIXES FOR BAKERY GOODS (U.S. CL. 46).

FIRST USE 4-1-2007; IN COMMERCE 4-1-2007.
SIMON TENG, EXAMINING ATTORNEY

SN 77-263,752. GITZ FAVORITE INC, BROOKLYN, NY. FILED 8-24-2007.

Gitz Favorites

THE MARK CONSISTS OF STANDARD CHARACTERS WITHOUT CLAIM TO ANY PARTICULAR FONT, STYLE, SIZE, OR COLOR.

FOR FOOD PRODUCTS, NAMELY, EXTRUDED WHEAT SNACKS, EXTRUDED WHEAT CHIPS, SWEETS, COOKIES, CANDY AND CHOCOLATE BARS (U.S. CL. 46).

FIRST USE 7-15-2007; IN COMMERCE 8-1-2007.
ANNE FARRELL, EXAMINING ATTORNEY

CLASS 30—(Continued).

SN 77-271,019. BERGER, KENNETH J., RIVIERA BEACH, FL. FILED 9-4-2007.

SPORTSMAN'S GOLD

THE MARK CONSISTS OF STANDARD CHARACTERS WITHOUT CLAIM TO ANY PARTICULAR FONT, STYLE, SIZE, OR COLOR.
FOR MARINADES FOR MEATS (U.S. CL. 46).
THEODORE MCBRIDE, EXAMINING ATTORNEY

CLASS 30—(Continued).

SN 77-277,495. WALKER PETER J, CARY, NC. FILED 9-12-2007.

SHADY ARBOUR

THE MARK CONSISTS OF STANDARD CHARACTERS WITHOUT CLAIM TO ANY PARTICULAR FONT, STYLE, SIZE, OR COLOR.
FOR (BASED ON INTENT TO USE) COFFEE (U.S. CL. 46).
GEORGE LORENZO, EXAMINING ATTORNEY

SN 77-271,220. PANMEX, S.A. DE C.V., AZCAPOTZALCO, MEXICO, FILED 9-4-2007.

PANMEX

THE MARK CONSISTS OF STANDARD CHARACTERS WITHOUT CLAIM TO ANY PARTICULAR FONT, STYLE, SIZE, OR COLOR.
OWNER OF U.S. REG. NO. 2,079,661.
FOR BREAD; PASTRIES; SWEET BREADS; MUFFINS; BAKERY GOODS (U.S. CL. 46).
BRENDAN MCCAULEY, EXAMINING ATTORNEY

SN 77-279,352. HACKER, NORMAN, SYDNEY, AUSTRALIA, FILED 9-14-2007.

BOINGO BEANS

THE MARK CONSISTS OF STANDARD CHARACTERS WITHOUT CLAIM TO ANY PARTICULAR FONT, STYLE, SIZE, OR COLOR.
NO CLAIM IS MADE TO THE EXCLUSIVE RIGHT TO USE "BEANS", APART FROM THE MARK AS SHOWN.
THE WORD "BOINGO" HAS NO MEANING IN A FOREIGN LANGUAGE.
FOR CANDY (U.S. CL. 46).
WENDY GOODMAN, EXAMINING ATTORNEY

SN 77-273,661. MACIAS, WILSON, HIALEAH, FL. FILED 9-6-2007.

VITA NUOVA
salsa para pastas

THE MARK CONSISTS OF STANDARD CHARACTERS WITHOUT CLAIM TO ANY PARTICULAR FONT, STYLE, SIZE, OR COLOR.
NO CLAIM IS MADE TO THE EXCLUSIVE RIGHT TO USE "SALSA PARA PASTAS", APART FROM THE MARK AS SHOWN.
THE FOREIGN WORDING IN THE MARK TRANSLATES INTO ENGLISH AS NEW LIFE PASTA SAUCE.
FOR PASTA SAUCE (U.S. CL. 46).
ALLISON SCHRODY, EXAMINING ATTORNEY

SN 77-281,440. HAPPYWELL, MOUNT PROSPECT, IL. FILED 9-17-2007.

VIVA 101

THE MARK CONSISTS OF STANDARD CHARACTERS WITHOUT CLAIM TO ANY PARTICULAR FONT, STYLE, SIZE, OR COLOR.
OWNER OF U.S. REG. NO. 3,328,685.
FOR ROYAL JELLY FOR FOOD PURPOSES (U.S. CL. 46).
FIRST USE 9-14-2007; IN COMMERCE 9-14-2007.
ELI HELLMAN, EXAMINING ATTORNEY

CLASS 30—(Continued).

SN 77-286,502. GAUGHEN HOLDINGS LLC, OXNARD, CA.
FILED 9-22-2007.

LUNA DE MIEL WEDDING
CONFECTION

THE MARK CONSISTS OF STANDARD CHARACTERS WITHOUT CLAIM TO ANY PARTICULAR FONT, STYLE, SIZE, OR COLOR.

OWNER OF U.S. REG. NOS. 2,692,857, 3,286,766 AND OTHERS.

NO CLAIM IS MADE TO THE EXCLUSIVE RIGHT TO USE "WEDDING CONFECTION", APART FROM THE MARK AS SHOWN.

THE FOREIGN WORDING IN THE MARK TRANSLATES INTO ENGLISH AS "HONEYMOON".

FOR CONFECTIONERY, NAMELY, CANDY, CANDY BARS, CANDY CHEWS, CHOCOLATES, WHITE CHOCOLATES, MILK CHOCOLATES, DARK CHOCOLATES, ALL-NATURAL CHOCOLATES, ORGANIC CHOCOLATES, BOXED CHOCOLATE PIECES, CHOCOLATE TRUFFLES, BONBONS, TURRON CANDY, PEANUT BRITTLE, NUT BRITTLE, DIVINITY, TAFFY, AND NOUGAT; HONEY-BASED CANDY, HONEY CANDIES, AND HONEY SWEETS; CHOCOLATES WITH A NON-ALCOHOLIC AND ALCOHOLIC BEVERAGE LIQUID FILLED CENTER; CHOCOLATES WITH A LIQUEUR CREAM CENTER; CHEWING GUM; CANDY MINTS; CHOCOLATE FOR BAKING PURPOSES, NAMELY, BAKING BARS, BAKING COCOA, AND CHOCOLATE CHIPS; HOT COCOA MIX; PREPARED COCOA AND COCOA-BASED BEVERAGES; CHOCOLATE-BASED READY-TO-EAT FOOD BARS; BREAKFAST CEREAL; ICE CREAM; FROZEN YOGURT; BREAD; PASTRY; COOKIES; CRACKERS; CAKES; HONEY; FLAVORED HONEY; COFFEE; COFFEE-BASED BEVERAGES; SPICES; SNACKS, NAMELY, NACHO TORTILLA CHIPS, CORN CHIPS, MICROWAVE POPCORN, CARAMEL POPCORN, PRETZELS, AND BREAD STICKS; TORTILLAS; BURRITOS; LASAGNA; MACARONI AND CHEESE; PIZZA; RAVIOLI; SPAGHETTI; TAMALES; NON-MEDICINAL TEAS, NAMELY, GINGER TEA, GREEN TEA, JASMINE TEA, AND OOLONG TEA; DESSERT TOPPINGS, NAMELY, TOPPING SYRUPS, CHOCOLATE SYRUPS, CANDY TOPPINGS, CANDY, CANDY SPRINKLES, FUDGE TOPPINGS, BUTTERS-COTCH TOPPINGS, AND MARSHMALLOW TOPPINGS; ICE CREAM TOPPINGS, NAMELY, CANDY SPRINKLES AND CHOCOLATE SYRUP; FOOD PRODUCTS, NAMELY, KETCHUP, RICE, MUSTARD, VINEGAR, FLOUR, SUGAR, BARBECUE SAUCE, TOMATO SAUCE, MARINARA SAUCE, MAYONNAISE, SALAD DRESSINGS, RELISH, PANCAKE AND WAFFLE SYRUP, SALSA, FROSTING, OATMEAL, AND PANCAKE MIX (U.S. CL. 46).

AHSEN KHAN, EXAMINING ATTORNEY

CLASS 30—(Continued).

SN 77-288,281. ASTROCHEF, INC., LOS ANGELES, CA.
FILED 9-25-2007.



NO CLAIM IS MADE TO THE EXCLUSIVE RIGHT TO USE "BAKERIES", APART FROM THE MARK AS SHOWN. FOR BAKERY GOODS (U.S. CL. 46). FIRST USE 11-30-2006; IN COMMERCE 11-30-2006. ELLEN BURNS, EXAMINING ATTORNEY

SN 77-289,549. SARA LEE FOODS, LLC, BLUE ASH, OH.
FILED 9-26-2007.

THE BIG JIMMY

THE MARK CONSISTS OF STANDARD CHARACTERS WITHOUT CLAIM TO ANY PARTICULAR FONT, STYLE, SIZE, OR COLOR.

FOR SANDWICHES (U.S. CL. 46).

CHARLES L. JENKINS, EXAMINING ATTORNEY

SN 77-290,160. WALLENFORD COFFEE COMPANY LIMITED, KINGSTON, JAMAICA, FILED 9-27-2007.

WALLENFORD

THE MARK CONSISTS OF STANDARD CHARACTERS WITHOUT CLAIM TO ANY PARTICULAR FONT, STYLE, SIZE, OR COLOR.

OWNER OF U.S. REG. NO. 2,634,011.

THE WORDING "WALLENFORD" HAS NO MEANING IN A FOREIGN LANGUAGE.

FOR COFFEE AND COFFEE BEANS (U.S. CL. 46).

FIRST USE 4-18-1968; IN COMMERCE 4-18-1968.

RON FAIRBANKS, EXAMINING ATTORNEY

CLASS 30—(Continued).

SN 77-290,332. GTC OATS, INC., WESTCHESTER, IL. FILED 9-27-2007.

OATVANTAGE

THE MARK CONSISTS OF STANDARD CHARACTERS WITHOUT CLAIM TO ANY PARTICULAR FONT, STYLE, SIZE, OR COLOR.

OWNER OF U.S. REG. NO. 3,329,799.
FOR PROCESSED GRAIN BASED INGREDIENT USED IN DIETARY AND NUTRITIONAL SUPPLEMENTS, VITAMINS, FOOD PRODUCTS AND BEVERAGES (U.S. CL. 46).

MICHAEL KAZAZIAN, EXAMINING ATTORNEY

CLASS 30—(Continued).

SN 77-290,968. OSJ, LLC, DBA O SWEET JESUS, EUREKA, CA. FILED 9-27-2007.



NO CLAIM IS MADE TO THE EXCLUSIVE RIGHT TO USE "SWEET", APART FROM THE MARK AS SHOWN.

THE COLOR(S) ORANGY-RED AND YELLOW IS/ARE CLAIMED AS A FEATURE OF THE MARK.

THE MARK CONSISTS OF THE WORDS "O SWEET JESUS" IN AN ARC AS IF IT'S BENT OVER THE TOP OF A CIRCLE. THE FONT IS MARKER FELT THIN. THE LETTERS ARE ORANGY-RED IN COLOR, AND ARE OUTLINED IN BRIGHT YELLOW. THE RATIO OF OUTLINE TO LETTER IS: 36 POINT ORANGY-RED LETTERS HAVE A 3 POINT YELLOW OUTLINE.

FOR CANDY (U.S. CL. 46).

FIRST USE 9-1-2007; IN COMMERCE 9-1-2007.

CAROLYN GRAY, EXAMINING ATTORNEY

SN 77-291,164. CARGILL, INCORPORATED, WAYZATA, MN. FILED 9-28-2007.

GELOGEN

THE MARK CONSISTS OF STANDARD CHARACTERS WITHOUT CLAIM TO ANY PARTICULAR FONT, STYLE, SIZE, OR COLOR.

FOR FLAVORING ADDITIVES FOR NON-NUTRITIONAL PURPOSES (U.S. CL. 46).

BRENDAN REGAN, EXAMINING ATTORNEY

SN 77-291,188. CRAZY SUSAN'S COOKIE COMPANY, LLC, OCEAN CITY, NJ. FILED 9-28-2007.



NO CLAIM IS MADE TO THE EXCLUSIVE RIGHT TO USE "COOKIES", APART FROM THE MARK AS SHOWN.

THE COLOR(S) RED, BLACK AND WHITE IS/ARE CLAIMED AS A FEATURE OF THE MARK.

THE MARK CONSISTS OF THE WORDING "CRAZY" AND "SUSAN'S" IN STYLIZED BLACK LETTERS WITH A WHITE OUTLINE IN A CIRCULAR LAYOUT. BETWEEN

SN 77-290,436. MATEJCEK, RICHARD A., VISALIA, CA. FILED 9-27-2007.



NO CLAIM IS MADE TO THE EXCLUSIVE RIGHT TO USE "COOKIES", APART FROM THE MARK AS SHOWN.

THE LIKENESS (OR, "PORTRAIT") IN THE MARK IDENTIFIES A LIVING INDIVIDUAL WHOSE CONSENT IS OF RECORD.

THE MARK CONSISTS OF THE WORD "FATTY" ABOVE A BANNER HAVING THE WORD "MATTY" ON IT WHICH IS ABOVE A FACE OF A MALE CHARACTER WITH THE WORD "COOKIES" BELOW THE FACE.

FOR COOKIES (U.S. CL. 46).

FIRST USE 9-24-2007; IN COMMERCE 9-24-2007.

LEIGH LOWRY, EXAMINING ATTORNEY

CLASS 30—(Continued).

THE WORDING THERE APPEARS A STYLIZED REPRESENTATION OF THE HEAD OF A WOMAN WITH BLACK HAIR, OUTLINED IN WHITE. A RED CIRCLE APPEARS BEHIND THE WORDING AND THE REPRESENTATION OF THE WOMAN. BELOW THESE ELEMENTS IS AN ELONGATED RED OVAL CONTAINING THE WORD "COOKIES" IN WHITE CAPITAL LETTERS. STYLIZED CURVED LINES RADIATE FROM EACH END OF THE OVAL. THE REMAINDER OF THE MARK IS TRANSPARENT.

FOR COOKIES (U.S. CL. 46).
FIRST USE 4-1-2007; IN COMMERCE 4-1-2007.
ANDREA K. NADELMAN, EXAMINING ATTORNEY

SN 77-291,265. STOTT, TERESA, PINOLE, CA. AND STOTT, MICHAEL, PINOLE, CA. FILED 9-28-2007.

BERANDA BEARCAKE

THE MARK CONSISTS OF STANDARD CHARACTERS WITHOUT CLAIM TO ANY PARTICULAR FONT, STYLE, SIZE, OR COLOR.

FOR BAKED GOODS, NAMELY, MUFFINS, SCONES, BISCUITS, COOKIES, DONUTS AND CAKES (U.S. CL. 46).

JAMES STEIN, EXAMINING ATTORNEY

SN 77-291,351. WILLIAMS, SAMUEL S., RENO, NV. FILED 9-28-2007.

Easy to Eat

THE MARK CONSISTS OF STANDARD CHARACTERS WITHOUT CLAIM TO ANY PARTICULAR FONT, STYLE, SIZE, OR COLOR.

FOR CANDY; CANDY BARS; CANDY WITH COCOA; CHOCOLATE CANDIES; CHOCOLATE BARS; CHOCOLATE COVERED NUTS; GRAIN-BASED FOOD BARS ALSO CONTAINING CHOCOLATE; CHOCOLATE-BASED READY-TO-EAT FOOD BARS (U.S. CL. 46).

SUSAN LESLIE DUBOIS, EXAMINING ATTORNEY

CLASS 30—(Continued).

SN 77-291,468. WILLIAMS, SAMUEL S., RENO, NV. FILED 9-28-2007.

Delighto

THE MARK CONSISTS OF STANDARD CHARACTERS WITHOUT CLAIM TO ANY PARTICULAR FONT, STYLE, SIZE, OR COLOR.

FOR CANDY; CANDY BARS; CANDY WITH COCOA; CHOCOLATE BARS; CHOCOLATE CANDIES; CHOCOLATE COVERED NUTS; CHOCOLATE-BASED READY-TO-EAT FOOD BARS; GRAIN-BASED FOOD BARS ALSO CONTAINING CHOCOLATE (U.S. CL. 46).

SUSAN LESLIE DUBOIS, EXAMINING ATTORNEY

SN 77-291,550. ARBY'S IP HOLDER TRUST, ATLANTA, GA. FILED 9-28-2007.

THE BIG KICKER TOASTED SUB

THE MARK CONSISTS OF STANDARD CHARACTERS WITHOUT CLAIM TO ANY PARTICULAR FONT, STYLE, SIZE, OR COLOR.

NO CLAIM IS MADE TO THE EXCLUSIVE RIGHT TO USE "TOASTED SUB", APART FROM THE MARK AS SHOWN.

FOR SANDWICHES FOR CONSUMPTION ON OR OFF THE PREMISES (U.S. CL. 46).

RICHARD A. STRASER, EXAMINING ATTORNEY

SN 77-291,726. SILVER LININGS, LLC, WILLIAMSBURG, VA. FILED 9-28-2007.

AROMACCINO

THE MARK CONSISTS OF STANDARD CHARACTERS WITHOUT CLAIM TO ANY PARTICULAR FONT, STYLE, SIZE, OR COLOR.

FOR BEVERAGES MADE OF COFFEE (U.S. CL. 46).

FIRST USE 5-31-2001; IN COMMERCE 5-31-2001.

REBECCA EISINGER, EXAMINING ATTORNEY

CLASS 30—(Continued).

SN 77-292,168. CRUZ, LISA, ROSELLE, IL. FILED 9-28-2007.

Pesto POPS

NO CLAIM IS MADE TO THE EXCLUSIVE RIGHT TO USE "PESTO", APART FROM THE MARK AS SHOWN.
THE MARK CONSISTS OF THE WORDING "PESTO POPS" WITH THE "O" IN "POPS" FEATURED AS AN ABSTRACT DESIGN OF A BASIL LEAF.
FOR SAUCES (U.S. CL. 46).
DEIRDRE ROBERTSON, EXAMINING ATTORNEY

SN 77-292,459. SNYDER, CARRIE R, WEST PALM BEACH, FL. FILED 9-30-2007.

Indulge your conscience.

THE MARK CONSISTS OF STANDARD CHARACTERS WITHOUT CLAIM TO ANY PARTICULAR FONT, STYLE, SIZE, OR COLOR.
FOR COFFEE (U.S. CL. 46).
KATHERINE E. HALMEN, EXAMINING ATTORNEY

SN 77-292,744. VALLS HOLDINGS, INC., MIAMI, FL. FILED 10-1-2007.

CAFÉ LA CARRETA

THE MARK CONSISTS OF STANDARD CHARACTERS WITHOUT CLAIM TO ANY PARTICULAR FONT, STYLE, SIZE, OR COLOR.
NO CLAIM IS MADE TO THE EXCLUSIVE RIGHT TO USE "CAFE", APART FROM THE MARK AS SHOWN.
THE FOREIGN WORDING IN THE MARK TRANSLATES INTO ENGLISH AS COFFEE CART.
FOR COFFEE; COFFEE BEANS; GROUND COFFEE BEANS; ROASTED COFFEE BEANS; ESPRESSO (U.S. CL. 46).
ALYSSA PALADINO, EXAMINING ATTORNEY

CLASS 30—(Continued).

SN 77-292,749. DOMANTI, SALVATORE, MIAMI BEACH, FL. FILED 10-1-2007.



THE MARK CONSISTS OF A SOLID OVAL WITH THE STYLIZED NAME "SPIZZIGO" INSIDE THE OVAL AND THERE IS A CURVED LINE GOING THROUGH THE OVAL.
FOR GELATO; PIZZA (U.S. CL. 46).
FIRST USE 2-11-2003; IN COMMERCE 2-11-2003.
GEORGE LORENZO, EXAMINING ATTORNEY

SN 77-292,773. JAZ PRODUCTS, INC., SANTA PAULA, CA. FILED 10-1-2007.

NITRO GOLD

THE MARK CONSISTS OF STANDARD CHARACTERS WITHOUT CLAIM TO ANY PARTICULAR FONT, STYLE, SIZE, OR COLOR.
FOR SALSA; HOT SAUCE (U.S. CL. 46).
FIRST USE 7-14-2005; IN COMMERCE 7-14-2005.
JANICE L. MCMORROW, EXAMINING ATTORNEY

SN 77-292,913. AMERICAN SUGAR REFINING, INC., YONKERS, NY. FILED 10-1-2007.

FROST & GLAZE

THE MARK CONSISTS OF STANDARD CHARACTERS WITHOUT CLAIM TO ANY PARTICULAR FONT, STYLE, SIZE, OR COLOR.
FOR SUGAR (U.S. CL. 46).
FIRST USE 12-31-1989; IN COMMERCE 12-31-1989.
KIMBERLY PERRY, EXAMINING ATTORNEY

CLASS 30—(Continued).

SN 77-293,113. LENNY & LARRY'S, INC., ENCINO, CA. FILED 10-1-2007.

GROWNOLA

THE MARK CONSISTS OF STANDARD CHARACTERS WITHOUT CLAIM TO ANY PARTICULAR FONT, STYLE, SIZE, OR COLOR.

FOR GRANOLA; GRANOLA SNACKS; GRANOLA-BASED SNACK BARS; COOKIES; CEREAL BASED SNACK FOOD; CEREAL-BASED SNACK FOODS; READY TO EAT, CEREAL DERIVED FOOD BARS; BAKERY GOODS (U.S. CL. 46).

JESSICA A. POWERS, EXAMINING ATTORNEY

SN 77-293,117. AMOUDI, WISSAM, DORAL, FL. FILED 10-1-2007.

MAGICARONI

THE MARK CONSISTS OF STANDARD CHARACTERS WITHOUT CLAIM TO ANY PARTICULAR FONT, STYLE, SIZE, OR COLOR.

FOR ALIMENTARY PASTA; DRIED PASTA; MACARONI; MACARONI; MACARONI AND CHEESE; PASTA; PASTA SHELLS (U.S. CL. 46).

FIRST USE 9-9-2007; IN COMMERCE 9-9-2007.
MORGAN WYNNE, EXAMINING ATTORNEY

SN 77-293,235. ARABICA FUNDING, INC., MELVILLE, NY. FILED 10-1-2007.

MAHOGANY

THE MARK CONSISTS OF STANDARD CHARACTERS WITHOUT CLAIM TO ANY PARTICULAR FONT, STYLE, SIZE, OR COLOR.

FOR COFFEE (U.S. CL. 46).
SHAUNIA CARLYLE, EXAMINING ATTORNEY

CLASS 30—(Continued).

SN 77-293,435. DOCKENDORF, ANNEMARIE, MELBOURNE, FL. FILED 10-2-2007.

CrappyFudge

THE MARK CONSISTS OF STANDARD CHARACTERS WITHOUT CLAIM TO ANY PARTICULAR FONT, STYLE, SIZE, OR COLOR.

FOR FUDGE (U.S. CL. 46).
FIRST USE 12-30-2003; IN COMMERCE 12-31-2003.
LINDA E. BLOHM, EXAMINING ATTORNEY

SN 77-293,631. KARL KUCERIS, KEITH KUCERIS AND RUSSELL HERTRICH, DBA USA SUBS, DERRY, NH. FILED 10-2-2007.

SAMMY'S STEAK BOMB

THE MARK CONSISTS OF STANDARD CHARACTERS WITHOUT CLAIM TO ANY PARTICULAR FONT, STYLE, SIZE, OR COLOR.

OWNER OF U.S. REG. NO. 3,249,292.
NO CLAIM IS MADE TO THE EXCLUSIVE RIGHT TO USE "STEAK", APART FROM THE MARK AS SHOWN.
FOR SANDWICHES (U.S. CL. 46).
MARIAM MAHMOUDI, EXAMINING ATTORNEY

SN 77-293,636. THE KARL KUCERIS, KEITH KUCERIS AND RUSSELL HERTRICH PARTNERSHIP, DBA USA SUBS, DERRY, NH. FILED 10-2-2007.

**GOURMET TOASTED SIGNATURE
SUBS**

THE MARK CONSISTS OF STANDARD CHARACTERS WITHOUT CLAIM TO ANY PARTICULAR FONT, STYLE, SIZE, OR COLOR.

NO CLAIM IS MADE TO THE EXCLUSIVE RIGHT TO USE "GOURMET TOASTED" AND "SUBS", APART FROM THE MARK AS SHOWN.
FOR SANDWICHES (U.S. CL. 46).
MARIAM MAHMOUDI, EXAMINING ATTORNEY

CLASS 30—(Continued).

SN 77-294,662. D & D FOODS, INC., COLUMBUS, GA. FILED 10-3-2007.

POP'S

THE MARK CONSISTS OF STANDARD CHARACTERS WITHOUT CLAIM TO ANY PARTICULAR FONT, STYLE, SIZE, OR COLOR.

FOR BARBECUE SAUCE (U.S. CL. 46).
FIRST USE 6-1-1950; IN COMMERCE 6-1-1950.
KATHLEEN LORENZO, EXAMINING ATTORNEY

SN 77-294,663. D & D FOODS, INC., COLUMBUS, GA. FILED 10-3-2007.

FOY'S

THE MARK CONSISTS OF STANDARD CHARACTERS WITHOUT CLAIM TO ANY PARTICULAR FONT, STYLE, SIZE, OR COLOR.

FOR BARBECUE SAUCE (U.S. CL. 46).
FIRST USE 12-1-1930; IN COMMERCE 12-1-1930.
KATHLEEN LORENZO, EXAMINING ATTORNEY

SN 77-294,890. GRAVYMASTER, INC., DBA DRYDEN & PALMER CO., BRANFORD, CT. FILED 10-3-2007.

KRYSTAL ROKS

THE MARK CONSISTS OF STANDARD CHARACTERS WITHOUT CLAIM TO ANY PARTICULAR FONT, STYLE, SIZE, OR COLOR.

NO CLAIM IS MADE TO THE EXCLUSIVE RIGHT TO USE "ROCKS", APART FROM THE MARK AS SHOWN.
FOR FLAVORED SUGAR CANDY (U.S. CL. 46).
DAVID MURRAY, EXAMINING ATTORNEY

CLASS 30—(Continued).

SN 77-294,965. KITTEN COFFEE LLC, BROOKLYN, NY. FILED 10-3-2007.



THE COLOR(S) GREEN, BLACK IS/ARE CLAIMED AS A FEATURE OF THE MARK.

THE MARK CONSISTS OF GREEN STYLISED CAT AT CENTER ON BLACK CIRCULAR BACKGROUND SURROUNDED BY AND WITHIN GREEN CIRCLE.

FOR ROASTED COFFEE BEANS (U.S. CL. 46).
VERNA BETH RIRIE, EXAMINING ATTORNEY

SN 77-295,274. CONSUMER GUILD FOODS, INC., TOLEDO, OH. FILED 10-3-2007.

JUST SWEET 'NUFF

THE MARK CONSISTS OF STANDARD CHARACTERS WITHOUT CLAIM TO ANY PARTICULAR FONT, STYLE, SIZE, OR COLOR.

FOR BARBECUE SAUCE (U.S. CL. 46).
FIRST USE 4-1-1984; IN COMMERCE 4-1-1984.
MICHAEL ENGEL, EXAMINING ATTORNEY

SN 77-295,375. PRECISION FOODS, INC., ST. LOUIS, MO. FILED 10-3-2007.

House of Vercada

THE MARK CONSISTS OF STANDARD CHARACTERS WITHOUT CLAIM TO ANY PARTICULAR FONT, STYLE, SIZE, OR COLOR.

FOR CAPPUCCINO MIX (U.S. CL. 46).
FIRST USE 8-24-2006; IN COMMERCE 8-24-2006.
BRIAN CALLAGHAN, EXAMINING ATTORNEY

CLASS 30—(Continued).

SN 77-295,384. D & D FOODS, INC., COLUMBUS, GA. FILED 10-3-2007.

DRESSED TO PARTY

THE MARK CONSISTS OF STANDARD CHARACTERS WITHOUT CLAIM TO ANY PARTICULAR FONT, STYLE, SIZE, OR COLOR.

FOR SALAD DRESSINGS AND MARINADES (U.S. CL. 46).

KATHLEEN LORENZO, EXAMINING ATTORNEY

CLASS 30—(Continued).

SN 77-295,911. MARGARETE'S FINE CHOCOLATES INC., TUPELO, MS. FILED 10-4-2007.

**MARGARETE'S FINE CHOCOLATES
FOR THOSE WHO DESERVE THE
VERY BEST**

THE MARK CONSISTS OF STANDARD CHARACTERS WITHOUT CLAIM TO ANY PARTICULAR FONT, STYLE, SIZE, OR COLOR.

NO CLAIM IS MADE TO THE EXCLUSIVE RIGHT TO USE "FINE CHOCOLATES", APART FROM THE MARK AS SHOWN.

FOR CANDY; CHOCOLATE CANDIES (U.S. CL. 46).

FIRST USE 6-30-2000; IN COMMERCE 6-30-2000.

BRENDAN MCCAULEY, EXAMINING ATTORNEY

SN 77-295,604. SMITH III, MARCUS, DBA THIZZLE, LOS ANGELES, CA. FILED 10-3-2007.

THIZZLE

THE MARK CONSISTS OF STANDARD CHARACTERS WITHOUT CLAIM TO ANY PARTICULAR FONT, STYLE, SIZE, OR COLOR.

FOR CANDY (U.S. CL. 46).

PATRICIA EVANKO, EXAMINING ATTORNEY

SN 77-297,334. DEAN INTELLECTUAL PROPERTY SERVICES II, L.P., DALLAS, TX. FILED 10-5-2007.

CHUG TO GO

THE MARK CONSISTS OF STANDARD CHARACTERS WITHOUT CLAIM TO ANY PARTICULAR FONT, STYLE, SIZE, OR COLOR.

OWNER OF U.S. REG. NOS. 2,187,950, 2,730,047 AND OTHERS.

NO CLAIM IS MADE TO THE EXCLUSIVE RIGHT TO USE "TO GO", APART FROM THE MARK AS SHOWN.

FOR MILK SHAKES (U.S. CL. 46).

BILL DAWE, EXAMINING ATTORNEY

SN 77-295,828. ONLINE FUTURE INC., PORT ST. LUCIE, FL. FILED 10-4-2007.

ZOFT

THE MARK CONSISTS OF STANDARD CHARACTERS WITHOUT CLAIM TO ANY PARTICULAR FONT, STYLE, SIZE, OR COLOR.

OWNER OF U.S. REG. NO. 3,271,260.

FOR NON-MEDICATED HERBAL CHEWING GUM (U.S. CL. 46).

FIRST USE 7-3-1997; IN COMMERCE 1-1-2006.

AMY ALFIERI, EXAMINING ATTORNEY

SN 77-297,873. SIGLER, BRIAN G., IRVINE, CA. AND MILLER, JR., WILLIAM G., CLOVIS, CA. AND BRANNON, JEFFREY L., CORONA, CA. AND BRIZENDINE, RYAN S., MISSION VIEJO, CA. FILED 10-5-2007.

SLUMPBUSTER

THE MARK CONSISTS OF STANDARD CHARACTERS WITHOUT CLAIM TO ANY PARTICULAR FONT, STYLE, SIZE, OR COLOR.

FOR CHEWING GUM; SUGARLESS CHEWING GUM (U.S. CL. 46).

KAPIL BHANOT, EXAMINING ATTORNEY

CLASS 30—(Continued).

SN 77-300,782. KRAFT FOODS HOLDINGS, INC., NORTH-FIELD, IL. FILED 10-10-2007.

STARMALLOWS

THE MARK CONSISTS OF STANDARD CHARACTERS WITHOUT CLAIM TO ANY PARTICULAR FONT, STYLE, SIZE, OR COLOR.
FOR MARSHMALLOWS (U.S. CL. 46).
STEVEN JACKSON, EXAMINING ATTORNEY

CLASS 30—(Continued).

SN 77-317,344. ORTEGA, RAFAEL, HOUSTON, TX. FILED 10-30-2007.

El Ahorro

THE MARK CONSISTS OF STANDARD CHARACTERS WITHOUT CLAIM TO ANY PARTICULAR FONT, STYLE, SIZE, OR COLOR.
OWNER OF U.S. REG. NO. 3,301,559.
THE FOREIGN WORDING IN THE MARK TRANSLATES INTO ENGLISH AS THE SAVINGS.
FOR TORTILLA CHIPS; TORTILLA SHELLS; TORTILLAS (U.S. CL. 46).
MIDGE BUTLER, EXAMINING ATTORNEY

SN 77-302,450. MARGARET C. MITSOCK, CREEDMOOR, NC. FILED 10-12-2007.

Fantaseasoning

THE MARK CONSISTS OF STANDARD CHARACTERS WITHOUT CLAIM TO ANY PARTICULAR FONT, STYLE, SIZE, OR COLOR.
FOR SEASONINGS (U.S. CL. 46).
ODESSA BIBBINS, EXAMINING ATTORNEY

SN 77-333,396. ACH FOOD COMPANIES, INC., CORDOVA, TN. FILED 11-19-2007.

GRIND'N GRILL

THE MARK CONSISTS OF STANDARD CHARACTERS WITHOUT CLAIM TO ANY PARTICULAR FONT, STYLE, SIZE, OR COLOR.
FOR SEASONINGS; SPICES (U.S. CL. 46).
FIRST USE 2-28-2007; IN COMMERCE 2-28-2007.
DARRYL SPRUILL, EXAMINING ATTORNEY

SN 77-313,108. TOPCO ASSOCIATES, LLC, SKOKIE, IL. FILED 10-25-2007.

CHIP-A-RIFFIC

THE MARK CONSISTS OF STANDARD CHARACTERS WITHOUT CLAIM TO ANY PARTICULAR FONT, STYLE, SIZE, OR COLOR.
FOR COOKIES (U.S. CL. 46).
MICHAEL GAAFAR, EXAMINING ATTORNEY

SN 77-343,834. ALPHA BAKING CO., INC., CHICAGO, IL. FILED 12-4-2007.

WEIGHT SENSE

THE MARK CONSISTS OF STANDARD CHARACTERS WITHOUT CLAIM TO ANY PARTICULAR FONT, STYLE, SIZE, OR COLOR.
FOR BAKERY PRODUCTS (U.S. CL. 46).
MICHAEL ENGEL, EXAMINING ATTORNEY

CLASS 30—(Continued).

SN 78-173,309. ZICAFFE S.P.A., MARSALA (TRAPANI), ITALY, FILED 10-10-2002.



PRIORITY CLAIMED UNDER SEC. 44(D) ON ITALY APPLICATION NO. RM2002C0039, FILED 7-10-2002, REG. NO. 879890, DATED 12-6-2002, EXPIRES 7-10-2022.

NO CLAIM IS MADE TO THE EXCLUSIVE RIGHT TO USE "CAFFÉ", APART FROM THE MARK AS SHOWN.

THE FOREIGN WORDING IN THE MARK TRANSLATES INTO ENGLISH AS "CAFFÉ".

FOR COFFEE BEANS, ROASTED AND UNROASTED, GRAIN OR CHICORY BASED COFFEE SUBSTITUTES; COFFEE BEANS, GROUND COFFEE, COFFEE BLENDS (U.S. CL. 46).

LOURDES AYALA, EXAMINING ATTORNEY

SN 78-300,685. COLOMBINA S.A., ZARZAL, COLOMBIA, FILED 9-15-2003.

BOMBABUM

OWNER OF COLOMBIA REG. NO. 126578, DATED 9-13-1994, RENEWED AS REG. NO. 126578, DATED 9-13-2004, EXPIRES 9-13-2014.

OWNER OF U.S. REG. NO. 2,175,919.

THE WORDING "BOMBABUM" HAS NO MEANING IN A FOREIGN LANGUAGE.

FOR LOLLIPOPS; BUBBLE GUM WITH OR WITHOUT FILLING; LOLLIPOPS, WITH FILLING AND WITHOUT; CHEWY LOLLIPOPS; CANDY STICKS; FILLED CANDIES, CANDY, BONBONS, TOFFEES, CARAMELS, MINTS, SUCKERS, CHOCOLATES, COOKIES (U.S. CL. 46).

MATTHEW KLINE, EXAMINING ATTORNEY

CLASS 30—(Continued).

SN 78-589,312. GOVERNMENT OF ETHIOPIA, ADDIS ABABA, ETHIOPIA, FILED 3-17-2005.

HARRAR

THE MARK CONSISTS OF STANDARD CHARACTERS WITHOUT CLAIM TO ANY PARTICULAR FONT, STYLE, SIZE, OR COLOR.

SEC. 2(F).

FOR COFFEE (U.S. CL. 46).

FIRST USE 12-31-1928; IN COMMERCE 12-31-1928.

KELLY BOULTON, EXAMINING ATTORNEY

SN 78-602,500. INTERSTATE BAKERIES CORPORATION, KANSAS CITY, MO. FILED 4-5-2005.

WHITE BREAD FANS

THE MARK CONSISTS OF STANDARD CHARACTERS WITHOUT CLAIM TO ANY PARTICULAR FONT, STYLE, SIZE, OR COLOR.

OWNER OF U.S. REG. NO. 2,843,564.

NO CLAIM IS MADE TO THE EXCLUSIVE RIGHT TO USE "WHITE BREAD", APART FROM THE MARK AS SHOWN.

FOR BREAD (U.S. CL. 46).

RENEE MCCRAY, EXAMINING ATTORNEY

CLASS 30—(Continued).

SN 78-811,852. THE MORRISON MILLING COMPANY, DENTON, TX. FILED 2-10-2006.

PETER PAN

THE MARK CONSISTS OF STANDARD CHARACTERS WITHOUT CLAIM TO ANY PARTICULAR FONT, STYLE, SIZE, OR COLOR.

OWNER OF U.S. REG. NOS. 691,365 AND 981,680.
FOR FLOUR, CORN MEAL, PREPARED BAKING MIXES AND COOKING MIXES, NAMELY, CORN BREAD, PANCAKE, BAKING MIXES, CHICKEN FRY MIX, FISH FRY MIX, COBBLER MIX, MUFFIN MIX, AND CORN MEAL MIX (U.S. CL. 46).
FIRST USE 10-7-1936; IN COMMERCE 10-7-1936.
LOURDES AYALA, EXAMINING ATTORNEY

SN 78-830,937. RHBB (IP) LTD., BUCKINGHAMSHIRE, UNITED KINGDOM, FILED 3-7-2006.

HOVIS

THE MARK CONSISTS OF STANDARD CHARACTERS WITHOUT CLAIM TO ANY PARTICULAR FONT, STYLE, SIZE, OR COLOR.

OWNER OF UNITED KINGDOM REG. NO. 191869, DATED 12-14-1895, EXPIRES 12-14-2017.
FOR COFFEE; TEA; COCOA; SUGAR; RICE; TAPIOCA; SAGO; FLOUR; FLOUR MIXES; PREPARATIONS MADE FROM CEREALS, NAMELY, PROCESSED CEREALS; BREAD; BREAD PRODUCTS FOR FOOD, NAMELY, CRUMPETS, SCONES, HOT CROSS BUNS, MUFFINS; CROISSANTS, BISCUITS, CAKES, TEA-CAKES, PANCAKES, PASTRIES; PASTRY PIES, PASTIES; ICES, NAMELY, FRUIT FLAVORED ICES; HONEY; TREACLE; SALT; MUSTARD; VINEGAR; SAUCES; SPICES; ICE (U.S. CL. 46).
KATHERINE CONNOLLY, EXAMINING ATTORNEY

SN 78-937,517. E & H DISTRIBUTING CO., NORTH LAS VEGAS, NV. FILED 7-26-2006.

RITUALS ESTATE

THE MARK CONSISTS OF STANDARD CHARACTERS WITHOUT CLAIM TO ANY PARTICULAR FONT, STYLE, SIZE, OR COLOR.

OWNER OF U.S. REG. NOS. 2,088,117 AND 3,004,484.
NO CLAIM IS MADE TO THE EXCLUSIVE RIGHT TO USE "ESTATE", APART FROM THE MARK AS SHOWN.
FOR COFFEE; TEA (U.S. CL. 46).
JENNIFER MARTIN, EXAMINING ATTORNEY

CLASS 30—(Continued).

SN 78-951,703. BRENNAN, WENDY, HANA, HI. FILED 8-14-2006.

Kaupoccino

THE MARK CONSISTS OF STANDARD CHARACTERS WITHOUT CLAIM TO ANY PARTICULAR FONT, STYLE, SIZE, OR COLOR.

NO CLAIM IS MADE TO THE EXCLUSIVE RIGHT TO USE "CAPPUCCINO", APART FROM THE MARK AS SHOWN.
FOR BEVERAGES MADE OF COFFEE (U.S. CL. 46).
FIRST USE 2-14-2005; IN COMMERCE 2-14-2005.
MATTHEW MCDOWELL, EXAMINING ATTORNEY

SN 79-036,315. DONGGUAN QIBAoyiding; FOOD CO., LTD., CHINA, FILED 11-28-2006.

OWNER OF INTERNATIONAL REGISTRATION 0918312 DATED 11-28-2006, EXPIRES 11-28-2016.

THE FIRST CHINESE CHARACTER MEANS "SEVEN", THE SECOND CHINESE CHARACTER MEANS "TREASURE", THE THIRD CHINESE CHARACTER MEANS "ONE", THE LAST CHINESE CHARACTER MEANS "THE FOURTH"; THE FOUR CHINESE CHARACTERS ARE OF NO MEANING IN COMBINATION.

THE NON-LATIN CHARACTERS IN THE MARK TRANSLITERATE TO QI BAO YI DING.

FOR BREAD; PASTRIES; RICE; WHEAT FLOUR; NOODLES AND RICE FLOUR PRODUCTS, NAMELY, DRIED SUGAR CAKES; TAPIOCA FLOUR FOR FOOD; FOOD STARCH; EDIBLE FLAVORED ICES; COOKING SALT; SOYA SAUCE; VINEGAR; CONFECTIONERY CHIPS FOR BAKING; TEA; SUGAR; SWEETENED BEAN PASTE; CORN STARCH BASED DRINK IN THE NATURE OF A FOOD BEVERAGE CONSISTING PRIMARILY OF MAIZE AND PORRIDGE; SPRING ROLLS; COFFEE; CHOCOLATE-BASED BEVERAGES NOT BEING DAIRY-BASED OR VEGETABLE BASED; PIES; FARINACEOUS DUMPLINGS; MUSTARD; FLAVOUR ENHANCERS USED IN FOOD AND BEVERAGE PRODUCTS; SAUCES; SEASONINGS (U.S. CL. 46).

VERNA BETH RIRIE, EXAMINING ATTORNEY

CLASS 30—(Continued).

SN 79-036,702. ZHENJIANG HENGFENG VINEGAR CO., LTD., CHINA, FILED 2-22-2007.



OWNER OF INTERNATIONAL REGISTRATION 0919495 DATED 2-22-2007, EXPIRES 2-22-2017.

THE NON-LATIN CHARACTERS IN THE MARK TRANSLITERATE TO BEI GU SHAN AND THIS MEANS NORTH FIRM MOUNTAIN IN ENGLISH.

FOR SOY SAUCE; VINEGAR; CONDIMENTS, NAMELY, CHILI OIL (U.S. CL. 46).

TINA BROWN, EXAMINING ATTORNEY

SN 79-037,150. R. SEELIG & HILLE OHG, FED REP GERMANY, FILED 2-15-2007.



PRIORITY DATE OF 8-17-2006 IS CLAIMED. OWNER OF INTERNATIONAL REGISTRATION 0920587 DATED 2-15-2007, EXPIRES 2-15-2017.

NO CLAIM IS MADE TO THE EXCLUSIVE RIGHT TO USE "CONTAINS PROTECTIVE ANTIOXIDANTS", APART FROM THE MARK AS SHOWN.

FOR TEA; TEA-LIKE PRODUCTS, NAMELY, HERBAL AND FRUIT TEA; TEA, HERBAL TEA, AND FRUIT TEA IN FLAVORED FORM, IN VITAMIN-ENRICHED FORM AND ALSO IN MINERAL-ENRICHED FORM, ALL OF THE AFOREMENTIONED GOODS NOT FOR MEDICINAL PURPOSES; TEA, HERBAL TEA, AND FRUIT TEA IN INSTANT FORM; ICED TEA; BEVERAGES MADE OF TEA, HERBAL TEA, OR FRUIT TEA; BEVERAGES MADE OF TEA, HERBAL TEA, OR FRUIT TEA IN READY-TO-DRINK FORM; BEVERAGES BASED ON TEA, HERBAL TEA, OR FRUIT TEA; BEVERAGES BASED ON TEA, HERBAL TEA, OR FRUIT TEA IN READY-TO-DRINK FORM; BEVERAGES BASED ON TEA, HERBAL TEA, OR FRUIT TEA CONTAINING FRUIT DRINKS; COCOA; COCOA EXTRACTS FOR HUMAN CONSUMPTION; CHOCOLATE POWDER AND CHOCOLATE POWDER MIXED WITH MILK POWDER FOR MAKING CHOCOLATE BEVERAGES (U.S. CL. 46).

HEATHER BIDDULPH, EXAMINING ATTORNEY

CLASS 30—(Continued).

SN 79-037,482. COMPANY "KARAVAN" LTD., RU-195220 SAINT-PETERSBURG, RUSSIAN FED., FILED 3-6-2007.

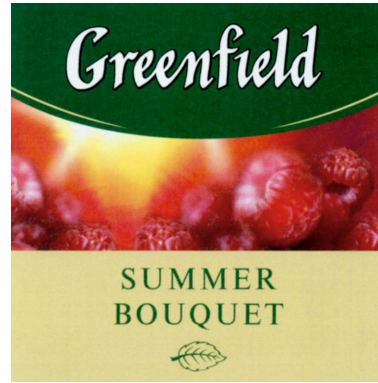

OWNER OF INTERNATIONAL REGISTRATION 0921446 DATED 3-6-2007, EXPIRES 3-6-2017.

OWNER OF U.S. REG. NO. 3,095,841.

THE COLOR(S) GREEN, WHITE, BLACK, YELLOW, RED, ORANGE AND BEIGE IS/ARE CLAIMED AS A FEATURE OF THE MARK.

THE MARK CONSISTS OF A SQUARE WITH THE TOP PORTION IN GREEN WITH THE CENTERED TERM "GREENFIELD" IN WHITE LETTERS, OUTLINED IN BLACK. THERE ARE TWO CURVED YELLOW LINES EXTENDING INWARD FROM THE SIDES OF THE UPPER PORTION OF THE SQUARE, WHICH FORM PART OF THE BOTTOM OF THE GREEN PORTION. THE MIDDLE OF THE SQUARE CONSISTS OF A DESIGN OF RED AND ORANGE SHARED RASPBERRIES WITH YELLOW AND WHITE CREATING A SUNLIGHT EFFECT OVER THE RASPBERRIES. THE BOTTOM PORTION OF THE MARK IS A BEIGE RECTANGLE WITH THE WORDS "SUMMER BOUQUET" IN GREEN. BELOW THESE CENTERED, STACKED TERMS IS A GREEN LEAF DESIGN.

FOR TEA, ICED TEA, TEA-BASED BEVERAGES (U.S. CL. 46).

PAULA MAHONEY, EXAMINING ATTORNEY

SN 79-038,568. LIDL STIFTUNG & CO. KG, FED REP GERMANY, FILED 5-9-2007.

SNACKDAY

THE MARK CONSISTS OF STANDARD CHARACTERS WITHOUT CLAIM TO ANY PARTICULAR FONT, STYLE, SIZE, OR COLOR.

OWNER OF INTERNATIONAL REGISTRATION 0871952 DATED 11-23-2005, EXPIRES 11-23-2015.

OWNER OF U.S. REG. NO. 2,723,275.

FOR CORN BASED SNACK FOODS, NAMELY, POPCORN AND PROCESSED UNPOPPED POPCORN (U.S. CL. 46).

CARYN GLASSER, EXAMINING ATTORNEY

CLASS 30—(Continued).

SN 79-038,858. DEUTSCHE EXTRAKT KAFFEE GMBH, FED REP GERMANY, FILED 2-5-2007.



The Taste that Tells

OWNER OF INTERNATIONAL REGISTRATION 0925135 DATED 2-5-2007, EXPIRES 2-5-2017. FOR COFFEE EXTRACTS AND COFFEE BEVERAGES IN LIQUID AND INSTANT FORM (U.S. CL. 46). SHARON MEIER, EXAMINING ATTORNEY

SN 79-043,239. J.T. RONNEFELDT KG, 60486 FRANKFURT, FED REP GERMANY, FILED 8-9-2007.

MORGENTAU

THE MARK CONSISTS OF STANDARD CHARACTERS WITHOUT CLAIM TO ANY PARTICULAR FONT, STYLE, SIZE, OR COLOR.

OWNER OF INTERNATIONAL REGISTRATION 0838285 DATED 10-25-2004, EXPIRES 10-25-2014. THE FOREIGN WORDING IN THE MARK TRANSLATES INTO ENGLISH AS "MORNING DEW". FOR TEA (U.S. CL. 46). LAURA HAMMEL, EXAMINING ATTORNEY

CLASS 31—NATURAL AGRICULTURAL PRODUCTS

SN 76-679,015. CITY DOGS, INC., STUART, FL. FILED 7-2-2007.



NO CLAIM IS MADE TO THE EXCLUSIVE RIGHT TO USE "DOG", APART FROM THE MARK AS SHOWN. FOR DOG FOOD, DOG TREATS (U.S. CLS. 1 AND 46). FIRST USE 5-15-2007; IN COMMERCE 6-1-2007. LINDA ORNDORFF, EXAMINING ATTORNEY

SN 77-084,166. HILMAR CHEESE COMPANY, HILMAR, CA. FILED 1-16-2007.



OWNER OF U.S. REG. NO. 3,103,139. NO CLAIM IS MADE TO THE EXCLUSIVE RIGHT TO USE "INGREDIENTS", APART FROM THE MARK AS SHOWN.

THE MARK CONSISTS OF STYLIZED VERSION OF THE WORDS "HI HILMAR INGREDIENTS".

FOR NON-MEDICATED ADDITIVES FOR ANIMAL FODDER; NON-MEDICATED ADDITIVES FOR ANIMAL FEED, NAMELY, PROTEIN FOR ANIMAL CONSUMPTION; ANIMAL FATTENING PREPARATIONS, NAMELY, ANIMAL FEED; AND PREPARATIONS FOR EGG LAYING POULTRY, NAMELY, ANIMAL FEED (U.S. CLS. 1 AND 46).

HEATHER BIDDULPH, EXAMINING ATTORNEY

SN 77-103,182. HOMER INDUSTRIES, LLC, LOCKPORT, IL. FILED 2-8-2007.

Nature's Blanket

THE MARK CONSISTS OF STANDARD CHARACTERS WITHOUT CLAIM TO ANY PARTICULAR FONT, STYLE, SIZE, OR COLOR.

FOR MULCH FOR PLAYGROUNDS OR LANDSCAPE (U.S. CLS. 1 AND 46). FIRST USE 1-1-2003; IN COMMERCE 1-1-2003. CHARLOTTE CORWIN, EXAMINING ATTORNEY

CLASS 31—(Continued).

SN 77-117,240. SEQUOIA ORANGE COMPANY, EXETER, CA. FILED 2-27-2007.

Sequoia

THE MARK CONSISTS OF STANDARD CHARACTERS WITHOUT CLAIM TO ANY PARTICULAR FONT, STYLE, SIZE, OR COLOR.

FOR FRESH LEMONS; FRESH ORANGES (U.S. CLS. 1 AND 46).

FIRST USE 11-20-1975; IN COMMERCE 11-20-1975.
SETH A. RAPPAPORT, EXAMINING ATTORNEY

CLASS 31—(Continued).

SN 77-183,667. MCCORKLE NURSERIES, INC., DEARING, GA. FILED 5-17-2007.

LIL' PUMPKIN

THE MARK CONSISTS OF STANDARD CHARACTERS WITHOUT CLAIM TO ANY PARTICULAR FONT, STYLE, SIZE, OR COLOR.

FOR LIVING PLANTS, NAMELY, ORNAMENTAL RAW AND FRESH PEPPERS (U.S. CLS. 1 AND 46).

SANJEEV VOHRA, EXAMINING ATTORNEY

SN 77-128,205. BATIZ GREENHOUSES INC., SAN DIEGO, CA. FILED 3-12-2007.

HEAVEN'S BEST

THE MARK CONSISTS OF STANDARD CHARACTERS WITHOUT CLAIM TO ANY PARTICULAR FONT, STYLE, SIZE, OR COLOR.

NO CLAIM IS MADE TO THE EXCLUSIVE RIGHT TO USE "BEST", APART FROM THE MARK AS SHOWN.

FOR FRESH FRUITS; FRESH VEGETABLES (U.S. CLS. 1 AND 46).

FIRST USE 6-1-2006; IN COMMERCE 6-1-2006.
ROSELLE HERRERA, EXAMINING ATTORNEY

SN 77-184,023. OMS INVESTMENTS, INC., LOS ANGELES, CA. FILED 5-17-2007.

ORGANIC CHOICE

THE MARK CONSISTS OF STANDARD CHARACTERS WITHOUT CLAIM TO ANY PARTICULAR FONT, STYLE, SIZE, OR COLOR.

OWNER OF U.S. REG. NOS. 2,936,644, 3,180,531 AND OTHERS.

NO CLAIM IS MADE TO THE EXCLUSIVE RIGHT TO USE "ORGANIC", APART FROM THE MARK AS SHOWN.

FOR GRASS SEED, FLOWER SEEDS, LIVE PLANTS, RAW BARK, NAMELY, PINE BARK AND PINE NUGGETS; MULCH, GRASS PRODUCTS, NAMELY, GRASS SOD AND GRASS PLUGS, WILD BIRD FOOD (U.S. CLS. 1 AND 46).

JOHN WILKE, EXAMINING ATTORNEY

SN 77-179,316. BEE SWEET CITRUS, INC., FOWLER, CA. FILED 5-11-2007.

PREFERRED CHEF

THE MARK CONSISTS OF STANDARD CHARACTERS WITHOUT CLAIM TO ANY PARTICULAR FONT, STYLE, SIZE, OR COLOR.

NO CLAIM IS MADE TO THE EXCLUSIVE RIGHT TO USE "PREFERRED", APART FROM THE MARK AS SHOWN.

FOR FRESH CITRUS FRUITS (U.S. CLS. 1 AND 46).
FIRST USE 11-30-2005; IN COMMERCE 11-30-2005.
JASON BLAIR, EXAMINING ATTORNEY

SN 77-235,962. FREY FARMS PRODUCE, LLC, KEENES, IL. FILED 7-23-2007.

GROW KIDS NATURALLY

THE MARK CONSISTS OF STANDARD CHARACTERS WITHOUT CLAIM TO ANY PARTICULAR FONT, STYLE, SIZE, OR COLOR.

OWNER OF U.S. REG. NO. 3,242,133.

FOR FRESH PRODUCE, NAMELY, FRESH FRUITS AND VEGETABLES (U.S. CLS. 1 AND 46).

KATINA MISTER, EXAMINING ATTORNEY

CLASS 31—(Continued).

SN 77-246,878. CROSS CREEK SEEDS, INC., RAEFORD, NC. FILED 8-3-2007.

CROSS CREEK SEED

THE MARK CONSISTS OF STANDARD CHARACTERS WITHOUT CLAIM TO ANY PARTICULAR FONT, STYLE, SIZE, OR COLOR.

NO CLAIM IS MADE TO THE EXCLUSIVE RIGHT TO USE "SEED", APART FROM THE MARK AS SHOWN. FOR AGRICULTURAL SEEDS (U.S. CLS. 1 AND 46). FIRST USE 12-31-2002; IN COMMERCE 12-31-2002. STEVEN R. FINE, EXAMINING ATTORNEY

SN 77-246,885. CROSS CREEK SEEDS, INC., RAEFORD, NC. FILED 8-3-2007.



NO CLAIM IS MADE TO THE EXCLUSIVE RIGHT TO USE "SEED", APART FROM THE MARK AS SHOWN.

THE MARK CONSISTS OF TWO CROSSED TOBACCO LEAVES ON A SHIELD WITH THE WORDS "CROSS CREEK" ABOVE THE SHIELD AND THE WORD "SEED" AT THE BOTTOM OF THE SHIELD.

FOR AGRICULTURAL SEEDS (U.S. CLS. 1 AND 46). FIRST USE 12-31-2002; IN COMMERCE 12-31-2002. STEVEN R. FINE, EXAMINING ATTORNEY

SN 77-263,447. D&PL TECHNOLOGY HOLDING CORPORATION, SCOTT, MS. FILED 8-24-2007.

YIELD. FIBER. MORE.

THE MARK CONSISTS OF STANDARD CHARACTERS WITHOUT CLAIM TO ANY PARTICULAR FONT, STYLE, SIZE, OR COLOR.

NO CLAIM IS MADE TO THE EXCLUSIVE RIGHT TO USE "YIELD" OR "FIBER", APART FROM THE MARK AS SHOWN.

FOR AGRICULTURAL SEEDS (U.S. CLS. 1 AND 46). ANDREW RHIM, EXAMINING ATTORNEY

CLASS 31—(Continued).

SN 77-277,188. WAGGEMS LIMITED, ADMIRALTY, HONG KONG, FILED 9-12-2007.



NO CLAIM IS MADE TO THE EXCLUSIVE RIGHT TO USE "LITTER", APART FROM THE MARK AS SHOWN.

THE COLOR(S) PURPLE IS/ARE CLAIMED AS A FEATURE OF THE MARK.

THE MARK CONSISTS OF THE WORDING "LITTER COMBAT WINNING THE BATTLE AGAINST BAD LITTER ODOUR". WRITTEN IN A STYLIZED PURPLE FONT. ALL WHITE IN THE MARK REPRESENTS TRANSPARENT BACKGROUND MATERIAL.

FOR ANIMAL LITTER; AROMATIC SAND FOR PETS; CAT LITTER; KITTY LITTER; SANDED PAPER FOR PETS; CAT LITTERS (U.S. CLS. 1 AND 46).

CORY BOONE, EXAMINING ATTORNEY

SN 77-285,874. CHERRYDALE MANUFACTURING, L.L.C., ALLENTOWN, PA. FILED 9-21-2007.

BARKTONS BAKERY

THE MARK CONSISTS OF STANDARD CHARACTERS WITHOUT CLAIM TO ANY PARTICULAR FONT, STYLE, SIZE, OR COLOR.

NO CLAIM IS MADE TO THE EXCLUSIVE RIGHT TO USE "BAKERY", APART FROM THE MARK AS SHOWN.

FOR DOG TREATS (U.S. CLS. 1 AND 46).

ELI HELLMAN, EXAMINING ATTORNEY

SN 77-290,094. GLOBAL ANIMAL PRODUCTS, INC., AMARILLO, TX. FILED 9-27-2007.

LiquiAde

THE MARK CONSISTS OF STANDARD CHARACTERS WITHOUT CLAIM TO ANY PARTICULAR FONT, STYLE, SIZE, OR COLOR.

FOR NUTRITIONAL ADDITIVES FOR LIVESTOCK FEED FOR NON-MEDICAL PURPOSES, NAMELY, WATER ACIDIFIER (U.S. CLS. 1 AND 46).

SANI KHOURI, EXAMINING ATTORNEY

CLASS 31—(Continued).

SN 77-292,788. PLANET VENTURES, INC., PORTLAND, ME.
FILED 10-1-2007.

TREAT SPOT STIX

THE MARK CONSISTS OF STANDARD CHARACTERS
WITHOUT CLAIM TO ANY PARTICULAR FONT, STYLE,
SIZE, OR COLOR.

OWNER OF U.S. REG. NO. 3,218,969.

NO CLAIM IS MADE TO THE EXCLUSIVE RIGHT TO
USE "TREAT" AND "STIX", APART FROM THE MARK AS
SHOWN.

FOR DOG TREATS (U.S. CLS. 1 AND 46).

FIRST USE 9-29-2007; IN COMMERCE 9-29-2007.
LAURA KOVALSKY, EXAMINING ATTORNEY

SN 77-293,520. VITAL SOJA S.A., BUENOS AIRES, ARGEN-
TINA, FILED 10-2-2007.

VITALCAN

THE MARK CONSISTS OF STANDARD CHARACTERS
WITHOUT CLAIM TO ANY PARTICULAR FONT, STYLE,
SIZE, OR COLOR.

FOR FOOD FOR ANIMALS (U.S. CLS. 1 AND 46).
ROSELLE HERRERA, EXAMINING ATTORNEY

SN 77-293,535. LAND O'LAKES PURINA FEED LLC.,
SHOREVIEW, MN. FILED 10-2-2007.

HOME GROWN

THE MARK CONSISTS OF STANDARD CHARACTERS
WITHOUT CLAIM TO ANY PARTICULAR FONT, STYLE,
SIZE, OR COLOR.

FOR ANIMAL FEED (U.S. CLS. 1 AND 46).
KATINA MISTER, EXAMINING ATTORNEY

CLASS 31—(Continued).

SN 77-293,541. VITAL SOJA S.A., BUENOS AIRES, ARGEN-
TINA, FILED 10-2-2007.

VITALCAT

THE MARK CONSISTS OF STANDARD CHARACTERS
WITHOUT CLAIM TO ANY PARTICULAR FONT, STYLE,
SIZE, OR COLOR.

FOR FOOD FOR ANIMALS (U.S. CLS. 1 AND 46).
ROSELLE HERRERA, EXAMINING ATTORNEY

SN 77-293,780. POTATO VARIETY MANAGEMENT INSTI-
TUTE, INC., BEND, OR. FILED 10-2-2007.

GROUNDBREAKER

THE MARK CONSISTS OF STANDARD CHARACTERS
WITHOUT CLAIM TO ANY PARTICULAR FONT, STYLE,
SIZE, OR COLOR.

FOR FRESH, RAW AND UNPROCESSED POTATOES
(U.S. CLS. 1 AND 46).
JESSICA A. POWERS, EXAMINING ATTORNEY

SN 77-293,802. POTATO VARIETY MANAGEMENT INSTI-
TUTE, INC., BEND, OR. FILED 10-2-2007.

GROUNDBLAZER

THE MARK CONSISTS OF STANDARD CHARACTERS
WITHOUT CLAIM TO ANY PARTICULAR FONT, STYLE,
SIZE, OR COLOR.

FOR FRESH, RAW AND UNPROCESSED POTATOES
(U.S. CLS. 1 AND 46).
JESSICA A. POWERS, EXAMINING ATTORNEY

CLASS 31—(Continued).

SN 77-293,884. CHANEY, KELLY COSTELLO, PITTSBURGH, PA. FILED 10-2-2007.



NO CLAIM IS MADE TO THE EXCLUSIVE RIGHT TO USE "PUPPY", APART FROM THE MARK AS SHOWN. THE COLOR(S) BROWN, WHITE, PINK, YELLOW, AND BLACK IS/ARE CLAIMED AS A FEATURE OF THE MARK. THE MARK CONSISTS OF A STYLIZED BROWN AND WHITE WORD PUPPY TO THE LEFT OF A STYLIZED PINK AND WHITE WORD CAKE IN FRONT OF A PINK BOWL CONTAINING A YELLOW CAKE WITH WHITE FROSTING AND A BONE. THE STYLIZED WORD MIX IN WHITE AND PINK IS LOCATED BELOW THE BOWL. THE INSIDE OF THE BOWL, THE OUTLINE OF THE BOWL, AND THE OUTLINE OF THE BONE APPEAR IN BLACK.
 FOR DOG TREATS (U.S. CLS. 1 AND 46).
 GEOFFREY FOSDICK, EXAMINING ATTORNEY

SN 77-297,634. FORT BOISE PRODUCE, PARMA, ID. FILED 10-5-2007.

KNOW WHERE YOUR PRODUCTS
CAME FROM

THE MARK CONSISTS OF STANDARD CHARACTERS WITHOUT CLAIM TO ANY PARTICULAR FONT, STYLE, SIZE, OR COLOR.
 FOR FRESH VEGETABLES; FRESH FRUITS (U.S. CLS. 1 AND 46).
 RENEE MCCRAY, EXAMINING ATTORNEY

SN 77-297,667. FORT BOISE PRODUCE, PARMA, ID. FILED 10-5-2007.

TRACE PRODUCE

THE MARK CONSISTS OF STANDARD CHARACTERS WITHOUT CLAIM TO ANY PARTICULAR FONT, STYLE, SIZE, OR COLOR.
 NO CLAIM IS MADE TO THE EXCLUSIVE RIGHT TO USE "PRODUCE", APART FROM THE MARK AS SHOWN. FOR FRESH FRUITS; FRESH VEGETABLES (U.S. CLS. 1 AND 46).
 FIRST USE 9-15-2007; IN COMMERCE 9-15-2007.
 RENEE MCCRAY, EXAMINING ATTORNEY

CLASS 31—(Continued).

SN 77-302,475. CARGILL, INCORPORATED, WAYZATA, MN. FILED 10-12-2007.



OWNER OF U.S. REG. NOS. 798,187, 808,227 AND OTHERS.
 THE COLOR(S) RED, WHITE, BLACK IS/ARE CLAIMED AS A FEATURE OF THE MARK.
 THE MARK CONSISTS OF RED OUTLINED CIRCULAR PATTERN COMING TO A POINT AT THE TOP AND BOTTOM OF THE PATTERN, WITH A WHITE COLOR INSIDE THE CIRCULAR PATTERN AND "AGWAY" WRITTEN IN BLACK IN THE MIDDLE OF THE CIRCULAR PATTERN.
 FOR ANIMAL FEED (U.S. CLS. 1 AND 46).
 FIRST USE 3-5-1964; IN COMMERCE 3-5-1964.
 BRENDAN REGAN, EXAMINING ATTORNEY

SN 77-306,755. HUNTER GROUP LTD. PART, HUAYKWANG, BANGKOK, THAILAND, FILED 10-17-2007.



FOR DOG FOOD, CAT FOOD (U.S. CLS. 1 AND 46).
 FIRST USE 8-30-2007; IN COMMERCE 8-30-2007.
 STEVEN PEREZ, EXAMINING ATTORNEY

SN 77-309,923. LAND O'LAKES PURINA FEED LLC., SHOREVIEW, MN. FILED 10-22-2007.

BUILDING BETTER CATTLE

THE MARK CONSISTS OF STANDARD CHARACTERS WITHOUT CLAIM TO ANY PARTICULAR FONT, STYLE, SIZE, OR COLOR.
 NO CLAIM IS MADE TO THE EXCLUSIVE RIGHT TO USE "BETTER CATTLE", APART FROM THE MARK AS SHOWN.
 FOR ANIMAL FEED (U.S. CLS. 1 AND 46).
 FIRST USE 5-31-2005; IN COMMERCE 5-31-2005.
 KATINA MISTER, EXAMINING ATTORNEY

CLASS 31—(Continued).

SN 77-311,843. LAND O'LAKES PURINA FEED LLC., SHOREVIEW, MN. FILED 10-24-2007.

NOBLE GOAT

THE MARK CONSISTS OF STANDARD CHARACTERS WITHOUT CLAIM TO ANY PARTICULAR FONT, STYLE, SIZE, OR COLOR.

NO CLAIM IS MADE TO THE EXCLUSIVE RIGHT TO USE "GOAT", APART FROM THE MARK AS SHOWN.

FOR ANIMAL FEED (U.S. CLS. 1 AND 46).
KATINA MISTER, EXAMINING ATTORNEY

CLASS 31—(Continued).

SN 77-330,488. SERGEANT'S PET CARE PRODUCTS, INC., OMAHA, NE. FILED 11-15-2007.

YIPPEE SKIPPY

THE MARK CONSISTS OF STANDARD CHARACTERS WITHOUT CLAIM TO ANY PARTICULAR FONT, STYLE, SIZE, OR COLOR.

FOR PET TREATS (U.S. CLS. 1 AND 46).

BENJAMIN OKEKE, EXAMINING ATTORNEY

SN 77-311,980. CARGILL, INCORPORATED, WAYZATA, MN. FILED 10-24-2007.

SIDEKICK PREMIUM

THE MARK CONSISTS OF STANDARD CHARACTERS WITHOUT CLAIM TO ANY PARTICULAR FONT, STYLE, SIZE, OR COLOR.

NO CLAIM IS MADE TO THE EXCLUSIVE RIGHT TO USE "PREMIUM", APART FROM THE MARK AS SHOWN.

FOR PET FOOD (U.S. CLS. 1 AND 46).
FIRST USE 8-24-2000; IN COMMERCE 8-24-2000.
BRENDAN REGAN, EXAMINING ATTORNEY

SN 78-691,798. MODERN MUTT LLC, SOUTFIELD, MI. FILED 8-12-2005.

JUMPIN' PUP

THE MARK CONSISTS OF STANDARD CHARACTERS WITHOUT CLAIM TO ANY PARTICULAR FONT, STYLE, SIZE, OR COLOR.

NO CLAIM IS MADE TO THE EXCLUSIVE RIGHT TO USE "PUP", APART FROM THE MARK AS SHOWN.

FOR DOG BISCUITS; DOG FOOD; EDIBLE DOG TREATS (U.S. CLS. 1 AND 46).
ALEX KEAM, EXAMINING ATTORNEY

SN 77-312,258. HEB GROCERY COMPANY, LP, SAN ANTONIO, TX. FILED 10-24-2007.

**DEVELOPED FOR TEXAS BY
TEXANS**

THE MARK CONSISTS OF STANDARD CHARACTERS WITHOUT CLAIM TO ANY PARTICULAR FONT, STYLE, SIZE, OR COLOR.

FOR GARDENING KITS COMPRISED PRIMARILY OF VEGETABLE OR FLOWER SEED PACKETS, VEGETABLE OR FLOWER PLANTING BULBS, AND ALSO CONTAINING POTTING SOIL AND PLANT CONTAINERS (U.S. CLS. 1 AND 46).

G. MAYERSCHOFF, EXAMINING ATTORNEY

SN 78-757,855. WEBER, ROBERT ERIC, CULVER CITY, CA. FILED 11-20-2005.

PETITE CUISINE

THE MARK CONSISTS OF STANDARD CHARACTERS WITHOUT CLAIM TO ANY PARTICULAR FONT, STYLE, SIZE, OR COLOR.

NO CLAIM IS MADE TO THE EXCLUSIVE RIGHT TO USE "CUISINE", APART FROM THE MARK AS SHOWN.

FOR PET FOOD, EDIBLE PET CHEWS, PET BEVERAGES (U.S. CLS. 1 AND 46).

MARIA-VICTORIA SUAREZ, EXAMINING ATTORNEY

CLASS 32—LIGHT BEVERAGES

SN 76-629,596. VÉO SPRINGS INC., MONTREAL, QUEBEC, CANADA, FILED 1-27-2005.

VEO

PRIORITY CLAIMED UNDER SEC. 44(D) ON CANADA APPLICATION NO. 1230217, FILED 9-14-2004, REG. NO. TMA697727, DATED 10-2-2007, EXPIRES 10-2-2022.
 FOR CARBONATED WATER, BOTTLED WATER, FLAVORED WATER, MINERAL WATER, SPRING WATER (U.S. CLS. 45, 46 AND 48).
 MATTHEW KLINE, EXAMINING ATTORNEY

SN 77-045,382. ANHEUSER-BUSCH, INCORPORATED, ST. LOUIS, MO. FILED 11-16-2006.

AMBERBOCK

THE MARK CONSISTS OF STANDARD CHARACTERS WITHOUT CLAIM TO ANY PARTICULAR FONT, STYLE, SIZE, OR COLOR.
 OWNER OF U.S. REG. NOS. 2,201,532, 3,062,534 AND OTHERS.
 SEC. 2(F).
 FOR BEER (U.S. CLS. 45, 46 AND 48).
 FIRST USE 5-31-1999; IN COMMERCE 5-31-1999.
 WILLIAM VERHOSEK, EXAMINING ATTORNEY

CLASS 32—(Continued).

SN 77-066,504. STARBUCKS U.S. BRANDS, LLC, MINDEN, NV. FILED 12-18-2006.



OWNER OF U.S. REG. NO. 3,086,771.
 NO CLAIM IS MADE TO THE EXCLUSIVE RIGHT TO USE "WATER", APART FROM THE MARK AS SHOWN.
 THE COLOR(S) BLUE, BLACK, AND WHITE IS/ARE CLAIMED AS A FEATURE OF THE MARK.
 THE MARK CONSISTS OF TWO RECTANGLE DESIGNS THAT MAKE UP ONE COMPLETE SQUARE. THE TOP RECTANGLE HAS THE BACKGROUND COLOR OF BLACK AND CONTAINS THE WORD "ETHOS" IN WHITE LETTERING. THE BOTTOM RECTANGLE HAS THE BACKGROUND COLOR OF BLUE AND CONTAINS THE WORD "WATER" IN WHITE LETTERING.
 FOR BOTTLED WATER, DRINKING WATER, PURIFIED WATER, MINERAL WATER (U.S. CLS. 45, 46 AND 48).
 FIRST USE 7-31-2005; IN COMMERCE 7-31-2005.
 JANICE L. MCMORROW, EXAMINING ATTORNEY

SN 77-067,704. TONY'S TAPS LLC DBA PAGOSA BREWING COMPANY, PAGOSA SPRINGS, CO. FILED 12-19-2006.



NO CLAIM IS MADE TO THE EXCLUSIVE RIGHT TO USE "PAGOSA" AND "BREWING CO", APART FROM THE MARK AS SHOWN.
 THE MARK CONSISTS OF STYLIZED LETTERING OF THE WORDS "PAGOSA BREWING CO." WITH ADDITIONAL GRAPHICS OF MOUNTAINS AND TREES.
 FOR ALE; BEER; BLACK BEER; BREWED MALT-BASED ALCOHOLIC BEVERAGE IN THE NATURE OF A BEER; GINGER ALE; GINGER BEER; MALT BEER; MALT LIQUOR; NON-ALCOHOLIC BEER; PALE BEER; PORTER; SOFT DRINKS; STOUT (U.S. CLS. 45, 46 AND 48).
 FIRST USE 3-17-2006; IN COMMERCE 6-19-2006.
 ROBIN CHOSID, EXAMINING ATTORNEY

CLASS 32—(Continued).

SN 77-070,898. DAYALS (FIJI) ARTESIAN WATERS LTD, YALALEVU, BA, FIJI, FILED 12-22-2006.



OWNER OF U.S. REG. NO. 3,216,989.

NO CLAIM IS MADE TO THE EXCLUSIVE RIGHT TO USE "ISLAND", "NATURAL MINERAL WATER" AND "BOTTLED AT SOURCE IN FIJI ISLANDS", APART FROM THE MARK AS SHOWN.

THE COLOR(S) GRAY, DARK GRAY, BLACK, WHITE, RED, LIGHT RED, GREEN, DARK GREEN, BLUE, DARK BLUE, AND LIGHT BROWN IS/ARE CLAIMED AS A FEATURE OF THE MARK.

THE BACKGROUND IS GRAY, THE WORDING "ISLAND CHILL" IS BLACK AND OUTLINED IN WHITE ON A DARK GRAY RECTANGLE OUTLINED IN RED, THE WORDING "NATURAL MINERAL WATER" IS WHITE, THE WORDING "BOTTLED AT THE SOURCE IN FIJI ISLANDS" IS BLACK AND OUTLINED IN WHITE, THE FLOWER IS RED WITH LIGHT RED SHADING AND A BLACK INTERIOR, AND THE STEM AND LEAVES ARE DARK GREEN AND GREEN, THE SKY IS BLUE WITH DARK BLUE SHADING AND WHITE CLOUDS, THE OCEAN IS BLUE WITH DARK BLUE SHADING AND WHITE WAVES, THE BEACH SAND IS TAN WITH BLACK SEAWEED.

FOR MINERAL AND AERATED WATERS, CARBONATED AND NON-CARBONATED SOFT DRINKS, FRUIT DRINKS, FRUIT JUICES AND SPORTS DRINKS; SYRUPS, CONCENTRATES AND POWDERS USED FOR MAKING BEVERAGES (U.S. CLS. 45, 46 AND 48).

MICHELE SWAIN, EXAMINING ATTORNEY

SN 77-097,644. THE COCA-COLA COMPANY, ATLANTA, GA. FILED 2-2-2007.

PIBB ZERO

THE MARK CONSISTS OF STANDARD CHARACTERS WITHOUT CLAIM TO ANY PARTICULAR FONT, STYLE, SIZE, OR COLOR.

OWNER OF U.S. REG. NOS. 965,188, 1,105,266 AND 2,806,692.

SEC. 2(F) "ZERO".

FOR NON-ALCOHOLIC BEVERAGES, NAMELY, SOFT DRINKS AND CONCENTRATES FOR THE MAKING OF THE SAME (U.S. CLS. 45, 46 AND 48).

FIRST USE 7-0-2005; IN COMMERCE 7-0-2005.

JOHN DWYER, EXAMINING ATTORNEY

CLASS 32—(Continued).

SN 77-108,933. AUTONOMOUS ASTRONAUTS CREATIVE CORPORATION, BROOKLYN, NY. FILED 2-15-2007.

**Ghetto Beer**

NO CLAIM IS MADE TO THE EXCLUSIVE RIGHT TO USE "BEER", APART FROM THE MARK AS SHOWN.

THE MARK CONSISTS OF A STYLIZED "GHETTO BEER" LETTERING WITH AN INVERTED CROWN.

FOR ALE; BEER; BREWED MALT-BASED ALCOHOLIC BEVERAGE IN THE NATURE OF A BEER; LAGER; LAGERS; MALT LIQUOR; PALE BEER; PILSNER; PORTER; STOUT (U.S. CLS. 45, 46 AND 48).

SARA THOMAS, EXAMINING ATTORNEY

SN 77-116,535. ROJAS FLORES, HUGO, MEXICO, MEXICO, FILED 2-26-2007.

LIVEAN

THE MARK CONSISTS OF STANDARD CHARACTERS WITHOUT CLAIM TO ANY PARTICULAR FONT, STYLE, SIZE, OR COLOR.

FOR NON-ALCOHOLIC FRUIT EXTRACTS USED IN THE PREPARATION OF BEVERAGES; CONCENTRATES, SYRUPS OR POWDERS USED IN THE PREPARATION OF SOFT DRINKS; SYRUPS FOR MAKING SOFT DRINKS; SYRUPS FOR MAKING BEVERAGES; PREPARATIONS FOR MAKING SOFT DRINKS AND FRUIT BEVERAGES (U.S. CLS. 45, 46 AND 48).

CAROLINE WOOD, EXAMINING ATTORNEY

SN 77-137,489. KEY WEST NATURAL PRODUCTS INC., POMPANO BEACH, FL. FILED 3-22-2007.

ISLAND BURST MANGO LIME

THE MARK CONSISTS OF STANDARD CHARACTERS WITHOUT CLAIM TO ANY PARTICULAR FONT, STYLE, SIZE, OR COLOR.

NO CLAIM IS MADE TO THE EXCLUSIVE RIGHT TO USE "MANGO LIME", APART FROM THE MARK AS SHOWN.

FOR FRUIT JUICES CONTAINING MANGO AND LIME (U.S. CLS. 45, 46 AND 48).

BARNEY CHARLON, EXAMINING ATTORNEY

CLASS 32—(Continued).

SN 77-137,992. REVERSE LLC, SANTA CLARA, UT. FILED 3-22-2007.



NO CLAIM IS MADE TO THE EXCLUSIVE RIGHT TO USE "BUBBLE TEA & SMOOTHIES", APART FROM THE MARK AS SHOWN.

THE COLOR(S) YELLOW, ORANGE, AND GREEN IS/ARE CLAIMED AS A FEATURE OF THE MARK.

THE MARK CONSISTS OF A STYLIZED LETTER "O" FILLED IN WITH YELLOW COLOR AND A GREEN STRAW EXTENDING FROM THE TOP LEFT QUARTER OF THE "O." THE WORD "THE" SITS DIRECTLY ABOVE THE WORD "ORANGE," AND THE WORDS "BUBBLE TEA & SMOOTHIES" WHICH APPEAR IN GREEN, DIRECTLY BELOW THE WORDS "ORANGE PEEL" WHICH APPEAR IN THE COLOR ORANGE.

FOR SMOOTHIES; FRUIT JUICES (U.S. CLS. 45, 46 AND 48).

FIRST USE 2-5-2007; IN COMMERCE 2-15-2007.
PAM WILLIS, EXAMINING ATTORNEY

CLASS 32—(Continued).

SN 77-140,225. D'ANGELO BRANDS LTD., MISSISSAUGA, ONTARIO, CANADA, FILED 3-26-2007.

STEELTUB

THE MARK CONSISTS OF STANDARD CHARACTERS WITHOUT CLAIM TO ANY PARTICULAR FONT, STYLE, SIZE, OR COLOR.

OWNER OF CANADA REG. NO. TMA676,882, DATED 11-14-2006, EXPIRES 11-14-2021.

FOR ALE; BEER; LAGER; STOUT (U.S. CLS. 45, 46 AND 48).

REBECCA EISINGER, EXAMINING ATTORNEY

SN 77-140,173. D'ANGELO BRANDS LTD., MISSISSAUGA, ONTARIO, CANADA, FILED 3-26-2007.

A FUSION OF GREAT TASTE

THE MARK CONSISTS OF STANDARD CHARACTERS WITHOUT CLAIM TO ANY PARTICULAR FONT, STYLE, SIZE, OR COLOR.

OWNER OF CANADA REG. NO. TMA677,116, DATED 11-16-2006, EXPIRES 11-16-2021.

FOR NON-ALCOHOLIC BEVERAGES, NAMELY, FRUIT DRINKS, FRUIT JUICES, SPORTS DRINKS, PROTEIN BASED DRINKS AND SOFT DRINKS (U.S. CLS. 45, 46 AND 48).

ROBIN CHOSID, EXAMINING ATTORNEY

SN 77-140,242. D'ANGELO BRANDS LTD., MISSISSAUGA, ONTARIO, CANADA, FILED 3-26-2007.

STEELBACK FAT TUB

THE MARK CONSISTS OF STANDARD CHARACTERS WITHOUT CLAIM TO ANY PARTICULAR FONT, STYLE, SIZE, OR COLOR.

OWNER OF CANADA REG. NO. TMA676,821, DATED 11-14-2006, EXPIRES 11-14-2021.

OWNER OF U.S. REG. NO. 3,242,559.

FOR ALE; BEER; LAGER; STOUT (U.S. CLS. 45, 46 AND 48).

ANTHONY RINKER, EXAMINING ATTORNEY

SN 77-140,217. D'ANGELO BRANDS LTD., MISSISSAUGA, ONTARIO, CANADA, FILED 3-26-2007.

STEELBACK TUB

THE MARK CONSISTS OF STANDARD CHARACTERS WITHOUT CLAIM TO ANY PARTICULAR FONT, STYLE, SIZE, OR COLOR.

OWNER OF CANADA REG. NO. TMA676,822, DATED 11-14-2006, EXPIRES 11-14-2021.

OWNER OF U.S. REG. NO. 3,242,559.
FOR ALE; BEER; LAGER; STOUT (U.S. CLS. 45, 46 AND 48).

MICHAEL WEBSTER, EXAMINING ATTORNEY

SN 77-140,255. D'ANGELO BRANDS LTD., MISSISSAUGA, ONTARIO, CANADA, FILED 3-26-2007.

STEELBACK STAINLESS STEEL

THE MARK CONSISTS OF STANDARD CHARACTERS WITHOUT CLAIM TO ANY PARTICULAR FONT, STYLE, SIZE, OR COLOR.

OWNER OF CANADA REG. NO. TMA676,951, DATED 11-15-2006, EXPIRES 11-15-2021.

OWNER OF U.S. REG. NO. 3,242,559.
FOR NON-ALCOHOLIC BEER (U.S. CLS. 45, 46 AND 48).

ROBIN CHOSID, EXAMINING ATTORNEY

CLASS 32—(Continued).

SN 77-140,611. WEINER, RUSSELL G., LAS VEGAS, NV.
FILED 3-26-2007.

ROCKSTAR ENERGY WATER

THE MARK CONSISTS OF STANDARD CHARACTERS WITHOUT CLAIM TO ANY PARTICULAR FONT, STYLE, SIZE, OR COLOR.

OWNER OF U.S. REG. NOS. 2,545,247, 3,181,547 AND OTHERS.

NO CLAIM IS MADE TO THE EXCLUSIVE RIGHT TO USE "ENERGY WATER", APART FROM THE MARK AS SHOWN.

FOR SPORTS DRINKS, NAMELY, ENERGY DRINKS (U.S. CLS. 45, 46 AND 48).

SALLY SHIH, EXAMINING ATTORNEY

SN 77-141,847. RG GLOBAL LIFESTYLES, INC., RANCHO SANTA MARGARITA, CA. FILED 3-27-2007.

INSANE

THE MARK CONSISTS OF STANDARD CHARACTERS WITHOUT CLAIM TO ANY PARTICULAR FONT, STYLE, SIZE, OR COLOR.

FOR ENERGY DRINKS (U.S. CLS. 45, 46 AND 48).

FIRST USE 9-30-2006; IN COMMERCE 10-7-2006.

WON TEAK OH, EXAMINING ATTORNEY

SN 77-143,232. SUNSHINE TRADING INC., WOBURN, MA.
FILED 3-28-2007.



THE COLOR(S) RED, BLUE, ORANGE, AND WHITE IS/ ARE CLAIMED AS A FEATURE OF THE MARK.

THE COLOR WHITE APPEARS IN THE WORDING "BOM DE MAIS"; THE COLOR RED APPEARS IN THE OVAL FIELD; THE COLOR BLUE APPEARS IN THE OVAL BAND AROUND THE OVAL FIELD; AND THE COLOR ORANGE APPEARS IN AN OVAL BAND AROUND THE BLUE OVAL BAND.

THE ENGLISH TRANSLATION OF THE WORDING "BOM DE MAIS" IN THE MARK IS A PORTUGUESE EXPRESSION OF HIGHEST PRAISE WITHOUT LITERAL TRANSLATION GENERALLY CONNOTING "WICKED GOOD".

FOR FRUIT JUICES; FRUIT NECTARS (U.S. CLS. 45, 46 AND 48).

FIRST USE 11-1-2006; IN COMMERCE 11-1-2006.

HANNO RITTNER, EXAMINING ATTORNEY

CLASS 32—(Continued).

SN 77-143,469. WM. BOLTHOUSE FARMS, INC., BAKERSFIELD, CA. FILED 3-29-2007.

BOLTHOUSE

THE MARK CONSISTS OF STANDARD CHARACTERS WITHOUT CLAIM TO ANY PARTICULAR FONT, STYLE, SIZE, OR COLOR.

OWNER OF U.S. REG. NOS. 1,700,694 AND 2,871,484.

FOR FRUIT DRINKS; FRUIT JUICES; VEGETABLE JUICE; VEGETABLE JUICES (U.S. CLS. 45, 46 AND 48).

FIRST USE 1-20-1990; IN COMMERCE 1-20-1990.

TEJBIR SINGH, EXAMINING ATTORNEY

SN 77-144,594. H2EARL, LLC, ORLANDO, FL. FILED 3-30-2007.

SPIRIT MOUNTAIN

THE MARK CONSISTS OF STANDARD CHARACTERS WITHOUT CLAIM TO ANY PARTICULAR FONT, STYLE, SIZE, OR COLOR.

FOR NATURAL WATER FOR DRINKING, SPRING, BOTTLED ARTESIAN AND GLACIAL WATER AND WATER-BASED BEVERAGES FOR DRINKING, NAMELY, SPARKLING WATER (U.S. CLS. 45, 46 AND 48).

LAURIE MAYES, EXAMINING ATTORNEY

SN 77-148,246. JONES, JEFF, FRANKLIN, TN. FILED 4-4-2007.

Blues Ale

THE MARK CONSISTS OF STANDARD CHARACTERS WITHOUT CLAIM TO ANY PARTICULAR FONT, STYLE, SIZE, OR COLOR.

NO CLAIM IS MADE TO THE EXCLUSIVE RIGHT TO USE "ALE", APART FROM THE MARK AS SHOWN.

FOR BEER (U.S. CLS. 45, 46 AND 48).

LEIGH CAROLINE CASE, EXAMINING ATTORNEY

CLASS 32—(Continued).

SN 77-151,190. SIERRA NEVADA BREWING CO., CHICO, CA. FILED 4-7-2007.

Hop Harmony

THE MARK CONSISTS OF STANDARD CHARACTERS WITHOUT CLAIM TO ANY PARTICULAR FONT, STYLE, SIZE, OR COLOR.

FOR BEER AND ALE (U.S. CLS. 45, 46 AND 48).
MARIAM MAHMOUDI, EXAMINING ATTORNEY

CLASS 32—(Continued).

SN 77-191,688. FLOREZ, STAN R., BONNEY LAKE, WA. FILED 5-29-2007.

QUIET WATERS

THE MARK CONSISTS OF STANDARD CHARACTERS WITHOUT CLAIM TO ANY PARTICULAR FONT, STYLE, SIZE, OR COLOR.

NO CLAIM IS MADE TO THE EXCLUSIVE RIGHT TO USE "WATERS", APART FROM THE MARK AS SHOWN.
FOR BOTTLED ARTESIAN WATER; BOTTLED DRINKING WATER; BOTTLED WATER (U.S. CLS. 45, 46 AND 48).
STEVEN R. FOSTER, EXAMINING ATTORNEY

SN 77-152,710. LIQUID ENERGY LLC, LEWES, DE. FILED 4-10-2007.

USA XL ENERGY BLAST

THE MARK CONSISTS OF STANDARD CHARACTERS WITHOUT CLAIM TO ANY PARTICULAR FONT, STYLE, SIZE, OR COLOR.

OWNER OF U.S. REG. NOS. 2,516,239 AND 3,131,934.
NO CLAIM IS MADE TO THE EXCLUSIVE RIGHT TO USE "USA" AND "ENERGY", APART FROM THE MARK AS SHOWN.

FOR NON-ALCOHOLIC BEVERAGES, NAMELY, ENERGY DRINKS (U.S. CLS. 45, 46 AND 48).
CHRISTINA SOBRAL, EXAMINING ATTORNEY

SN 77-208,545. MOREIRA, GILL COUTINHO, NORTH MIAMI BEACH, FL. FILED 6-18-2007.

NAPED NATURAL ACAI POWER ENERGY DRINK

THE MARK CONSISTS OF STANDARD CHARACTERS WITHOUT CLAIM TO ANY PARTICULAR FONT, STYLE, SIZE, OR COLOR.

OWNER OF U.S. REG. NO. 2,940,491.
NO CLAIM IS MADE TO THE EXCLUSIVE RIGHT TO USE "NATURAL ACAI" AND "ENERGY DRINK", APART FROM THE MARK AS SHOWN.

FOR FRUIT-BASED FOOD BEVERAGE CONTAINING ACAI; ENERGY BEVERAGE CONTAINING ACAI; ENERGY DRINK CONTAINING ACAI (U.S. CLS. 45, 46 AND 48).
PAUL E. FAHRENKOPF, EXAMINING ATTORNEY

SN 77-163,091. MCLAREN, STUART K, SALT LAKE CITY, UT. FILED 4-23-2007.

Tigers Blood

THE MARK CONSISTS OF STANDARD CHARACTERS WITHOUT CLAIM TO ANY PARTICULAR FONT, STYLE, SIZE, OR COLOR.

FOR SYRUPS FOR MAKING SOFT DRINKS (U.S. CLS. 45, 46 AND 48).
FIRST USE 3-5-2007; IN COMMERCE 3-5-2007.
BARBARA BROWN, EXAMINING ATTORNEY

SN 77-253,737. BOULEVARD BREWING ASSOCIATES LIMITED PARTNERSHIP, KANSAS CITY, MO. FILED 8-13-2007.

SMOKESTACK SERIES

THE MARK CONSISTS OF STANDARD CHARACTERS WITHOUT CLAIM TO ANY PARTICULAR FONT, STYLE, SIZE, OR COLOR.

NO CLAIM IS MADE TO THE EXCLUSIVE RIGHT TO USE "SERIES", APART FROM THE MARK AS SHOWN.
FOR BEER, ALE AND MALT LIQUOR (U.S. CLS. 45, 46 AND 48).
MARK SPARACINO, EXAMINING ATTORNEY

CLASS 32—(Continued).

SN 77-253,751. BOULEVARD BREWING ASSOCIATES LIMITED PARTNERSHIP, KANSAS CITY, MO. FILED 8-13-2007.

DOUBLEWIDE INDIA PALE ALE

THE MARK CONSISTS OF STANDARD CHARACTERS WITHOUT CLAIM TO ANY PARTICULAR FONT, STYLE, SIZE, OR COLOR.

NO CLAIM IS MADE TO THE EXCLUSIVE RIGHT TO USE "INDIA PALE ALE", APART FROM THE MARK AS SHOWN.

FOR BEER, ALE AND MALT LIQUOR (U.S. CLS. 45, 46 AND 48).

MARK SPARACINO, EXAMINING ATTORNEY

SN 77-253,770. BOULEVARD BREWING ASSOCIATES LIMITED PARTNERSHIP, KANSAS CITY, MO. FILED 8-13-2007.

THE SIXTH GLASS

THE MARK CONSISTS OF STANDARD CHARACTERS WITHOUT CLAIM TO ANY PARTICULAR FONT, STYLE, SIZE, OR COLOR.

FOR BEER, ALE AND MALT LIQUOR (U.S. CLS. 45, 46 AND 48).

MARK SPARACINO, EXAMINING ATTORNEY

SN 77-253,850. BOULEVARD BREWING ASSOCIATES LIMITED PARTNERSHIP, KANSAS CITY, MO. FILED 8-13-2007.

LONG STRANGE TRIPEL

THE MARK CONSISTS OF STANDARD CHARACTERS WITHOUT CLAIM TO ANY PARTICULAR FONT, STYLE, SIZE, OR COLOR.

FOR BEER, ALE AND MALT LIQUOR (U.S. CLS. 45, 46 AND 48).

MARK SPARACINO, EXAMINING ATTORNEY

CLASS 32—(Continued).

SN 77-254,693. CHRISTOPHER L BARNHILL, LAKESIDE, CA. FILED 8-14-2007.

Thunder Java

THE MARK CONSISTS OF STANDARD CHARACTERS WITHOUT CLAIM TO ANY PARTICULAR FONT, STYLE, SIZE, OR COLOR.

NO CLAIM IS MADE TO THE EXCLUSIVE RIGHT TO USE "JAVA", APART FROM THE MARK AS SHOWN.

FOR COFFEE-FLAVORED SOFT DRINK (U.S. CLS. 45, 46 AND 48).

KEVON CHISOLM, EXAMINING ATTORNEY

SN 77-255,965. ARCTIC NATURAL WATERS LIMITED, LONDON, ENGLAND, FILED 8-15-2007.



THE COLOR(S) YELLOW, BLUE AND GREEN IS/ARE CLAIMED AS A FEATURE OF THE MARK.

THE MARK CONSISTS OF A GREEN CORN HUSK OUTLINED IN BLUE MERGING INTO A YELLOW CORN COBB OUTLINED IN BLUE, MERGING INTO A BLUE BOTTLE. THE COLOR WHITE APPEARING ON THE BOTTLE DESIGN CONSTITUTES TRANSPARENT AREA AND IS NOT A PART OF THE MARK.

FOR BOTTLED AND PREPACKAGED DRINKING WATER (U.S. CLS. 45, 46 AND 48).

FIRST USE 1-8-2007; IN COMMERCE 1-8-2007.

LAURA HAMMEL, EXAMINING ATTORNEY

SN 77-261,548. BREWHAUS (AMERICA) INC., KELLER, TX. FILED 8-22-2007.

PRESTIGE

THE MARK CONSISTS OF STANDARD CHARACTERS WITHOUT CLAIM TO ANY PARTICULAR FONT, STYLE, SIZE, OR COLOR.

FOR ESSENCES FOR THE MANUFACTURE OF LIQUEURS (U.S. CLS. 45, 46 AND 48).

FIRST USE 12-1-1977; IN COMMERCE 12-1-1977.

REBECCA EISINGER, EXAMINING ATTORNEY

CLASS 32—(Continued).

SN 77-263,830. CINNABON, INC., ATLANTA, GA. FILED 8-24-2007.

CHILLATTAS

THE MARK CONSISTS OF STANDARD CHARACTERS WITHOUT CLAIM TO ANY PARTICULAR FONT, STYLE, SIZE, OR COLOR.

FOR NON-CARBONATED, NON-ALCOHOLIC FROZEN FLAVORED BEVERAGES, NAMELY HANDBLENDED BEVERAGES INCLUDING FRUIT, CARAMEL, CHOCOLATE, COFFEE OR CAPPUCCINO WITH A FRUIT, CARAMEL OR CHOCOLATE SWIRL (U.S. CLS. 45, 46 AND 48).

FIRST USE 5-7-2005; IN COMMERCE 5-7-2005.
KAREN K. BUSH, EXAMINING ATTORNEY

CLASS 32—(Continued).

SN 77-266,684. JJ SMOOTHY, TAMPA, FL. FILED 8-28-2007.

JJ SMOOTHY

THE MARK CONSISTS OF STANDARD CHARACTERS WITHOUT CLAIM TO ANY PARTICULAR FONT, STYLE, SIZE, OR COLOR.

THE NAME "JJ SMOOTHY" DOES NOT IDENTIFY A LIVING INDIVIDUAL.

FOR ENERGY DRINKS; SMOOTHIES (U.S. CLS. 45, 46 AND 48).

BARBARA BROWN, EXAMINING ATTORNEY

SN 77-264,883. NORTON, JOSEPH J., BRIGHTON, MI. FILED 8-27-2007.

V FRESH

THE MARK CONSISTS OF STANDARD CHARACTERS WITHOUT CLAIM TO ANY PARTICULAR FONT, STYLE, SIZE, OR COLOR.

NO CLAIM IS MADE TO THE EXCLUSIVE RIGHT TO USE "FRESH", APART FROM THE MARK AS SHOWN.

FOR BOTTLED WATER, FRUIT JUICE, VEGETABLE JUICE BEVERAGES AND FRUIT FLAVORED WATER (U.S. CLS. 45, 46 AND 48).

KATHY DE JONGE, EXAMINING ATTORNEY

SN 77-266,833. MARK K. INVESTMENTS, INC., PITTSBURGH, PA. FILED 8-29-2007.

THE BEER OF THE 'BURGH!

THE MARK CONSISTS OF STANDARD CHARACTERS WITHOUT CLAIM TO ANY PARTICULAR FONT, STYLE, SIZE, OR COLOR.

FOR BEER (U.S. CLS. 45, 46 AND 48).

JANET LEE, EXAMINING ATTORNEY

SN 77-264,914. NORTON, JOSEPH J., BRIGHTON, MI. FILED 8-27-2007.

REGENERADE

THE MARK CONSISTS OF STANDARD CHARACTERS WITHOUT CLAIM TO ANY PARTICULAR FONT, STYLE, SIZE, OR COLOR.

FOR BOTTLED WATER, FRUIT JUICE, VEGETABLE JUICE BEVERAGES AND FRUIT FLAVORED WATER (U.S. CLS. 45, 46 AND 48).

KATHY DE JONGE, EXAMINING ATTORNEY

SN 77-273,587. INTERNATIONAL SECURITIES PLUS INC, ESCONDIDO, CA. FILED 9-6-2007.

DIAMOND ELITE ENERGY DRINK

THE MARK CONSISTS OF STANDARD CHARACTERS WITHOUT CLAIM TO ANY PARTICULAR FONT, STYLE, SIZE, OR COLOR.

NO CLAIM IS MADE TO THE EXCLUSIVE RIGHT TO USE ENERGY DRINK, APART FROM THE MARK AS SHOWN.

FOR ENERGY DRINKS (U.S. CLS. 45, 46 AND 48).

THOMAS MANOR, EXAMINING ATTORNEY

CLASS 32—(Continued).

SN 77-275,647. SEA BREEZE FRUIT FLAVORS, INC., TOWACO, NJ. FILED 9-10-2007.

SEA BREEZE WATERS

THE MARK CONSISTS OF STANDARD CHARACTERS WITHOUT CLAIM TO ANY PARTICULAR FONT, STYLE, SIZE, OR COLOR.

NO CLAIM IS MADE TO THE EXCLUSIVE RIGHT TO USE WATERS, APART FROM THE MARK AS SHOWN.

FOR CONCENTRATES USED TO PREPARE SOFT DRINKS (U.S. CLS. 45, 46 AND 48).

H. M. FISHER, EXAMINING ATTORNEY

SN 77-276,834. SRB OPERATIONS, LLC, JACKSON, WY. FILED 9-11-2007.

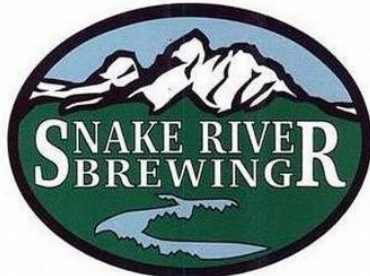

NO CLAIM IS MADE TO THE EXCLUSIVE RIGHT TO USE "BREWING", APART FROM THE MARK AS SHOWN. THE COLOR(S) GREEN, WHITE, BLUE AND BLACK IS/ARE CLAIMED AS A FEATURE OF THE MARK.

THE MARK CONSISTS OF AN OVAL WITH A BLACK BORDER. THE LITERAL ELEMENT CONSISTS OF THE WORDS SNAKE RIVER ON THE FIRST LINE AND THE WORD BREWING IN THE NEXT LINE BELOW. ALL WORDS IN WHITE STYLIZED LETTERS WITH A LARGE CAPITAL S OCCUPYING TWO LINES OF TEXT IN FRONT, AND A LARGE CAPITAL R (THE LAST R IN RIVER) OCCUPYING TWO LINES OF TEXT AT THE END OF THE LITERAL ELEMENT. BELOW THE LITERAL ELEMENT IS A DEPICTION OF A RIVER (THE SNAKE RIVER) IN BLUE, WINDING FROM THE LOWER RIGHT QUADRANT OF THE OVAL TO THE LOWER LEFT QUADRANT OF THE OVAL AND THEN TO CENTER OF THE OVAL. SURROUNDING THE LITERAL ELEMENT OF THE MARK AND THE DEPICTION OF THE RIVER THE OVAL IS SHADED IN DARK GREEN SUGGESTING FOREST. ABOVE THE LITERAL ELEMENT AND THE GREEN SHADE IS A DEPICTION OF THE GRAND TETONS MOUNTAIN RANGE IN WHITE SHADING, SUGGESTING SNOW, WITH HEAVY BLACK OUTLINING. THE SKY ABOVE THE MOUNTAINS IS BLUE.

SEC. 2(F) AS TO "SNAKE RIVER BREWING".

FOR BEER; BREWED MALT-BASED ALCOHOLIC BEVERAGE IN THE NATURE OF A BEER; MALT BEER; MALT LIQUOR (U.S. CLS. 45, 46 AND 48).

FIRST USE 1-1-1994; IN COMMERCE 1-1-1994.

KIMBERLY FRYE, EXAMINING ATTORNEY

CLASS 32—(Continued).

SN 77-282,130. PURE PACIFIC INTERNATIONAL, INC., GLENDALE, CA. FILED 9-18-2007.

ALOHA DEEP

THE MARK CONSISTS OF STANDARD CHARACTERS WITHOUT CLAIM TO ANY PARTICULAR FONT, STYLE, SIZE, OR COLOR.

FOR HAWAIIAN DEEP SEA BOTTLED WATER (U.S. CLS. 45, 46 AND 48).

NAKIA HENRY, EXAMINING ATTORNEY

SN 77-290,051. ALL NATURAL MAINE ROOT, LLC, AUSTIN, TX. FILED 9-27-2007.

MAINE ROOT

THE MARK CONSISTS OF STANDARD CHARACTERS WITHOUT CLAIM TO ANY PARTICULAR FONT, STYLE, SIZE, OR COLOR.

OWNER OF U.S. REG. NO. 3,128,218.

SEC. 2(F).

FOR SOFT DRINKS (U.S. CLS. 45, 46 AND 48).

FIRST USE 6-6-2002; IN COMMERCE 6-6-2002.

PAUL E. FAHRENKOPF, EXAMINING ATTORNEY

SN 77-290,813. FIRST WORLD ASIAN TRADING CORPORATION, FREMONT, CA. FILED 9-27-2007.

KICK BOX

THE MARK CONSISTS OF STANDARD CHARACTERS WITHOUT CLAIM TO ANY PARTICULAR FONT, STYLE, SIZE, OR COLOR.

FOR NONALCOHOLIC BEVERAGES; ENERGY DRINKS (U.S. CLS. 45, 46 AND 48).

YAT SYE, LEE, EXAMINING ATTORNEY

CLASS 32—(Continued).

SN 77-291,149. BREWDOG LTD., FRASERBURGH, SCOTLAND, FILED 9-28-2007.

BREWDOG

THE MARK CONSISTS OF STANDARD CHARACTERS WITHOUT CLAIM TO ANY PARTICULAR FONT, STYLE, SIZE, OR COLOR.

FOR BEER, ALE, LAGER, STOUT, PILSNER, PORTER AND NON-ALCOHOLIC MALT BEVERAGES (U.S. CLS. 45, 46 AND 48).

DOMINICK J. SALEMI, EXAMINING ATTORNEY

CLASS 32—(Continued).

SN 77-292,391. PICOZZI III, MICHAEL, MORRISTOWN, NJ, FILED 9-30-2007.

ANIMUS

THE MARK CONSISTS OF STANDARD CHARACTERS WITHOUT CLAIM TO ANY PARTICULAR FONT, STYLE, SIZE, OR COLOR.

FOR ENERGY DRINKS; ISOTONIC DRINKS; SOFT DRINKS; SPORTS DRINKS (U.S. CLS. 45, 46 AND 48). FIRST USE 9-27-2007; IN COMMERCE 9-27-2007.

RAUL CORDOVA, EXAMINING ATTORNEY

SN 77-291,252. TROPICANA PRODUCTS, INC., BRADENTON, FL. FILED 9-28-2007.

THIS CHANGES JUICE

THE MARK CONSISTS OF STANDARD CHARACTERS WITHOUT CLAIM TO ANY PARTICULAR FONT, STYLE, SIZE, OR COLOR.

FOR FRUIT JUICES AND FRUIT JUICE DRINKS (U.S. CLS. 45, 46 AND 48).

TERESA M. RUPP, EXAMINING ATTORNEY

SN 77-293,724. 2MORROWVISION INC., GLENDALE, CA, FILED 10-2-2007.

GRAB LIFE BY THE HEINE

THE MARK CONSISTS OF STANDARD CHARACTERS WITHOUT CLAIM TO ANY PARTICULAR FONT, STYLE, SIZE, OR COLOR.

FOR BEER (U.S. CLS. 45, 46 AND 48).

JENNY PARK, EXAMINING ATTORNEY

SN 77-292,132. LING, WILSON, SAN FRANCISCO, CA, FILED 9-28-2007.

DRINK FOR THE CURE

THE MARK CONSISTS OF STANDARD CHARACTERS WITHOUT CLAIM TO ANY PARTICULAR FONT, STYLE, SIZE, OR COLOR.

NO CLAIM IS MADE TO THE EXCLUSIVE RIGHT TO USE "DRINK", APART FROM THE MARK AS SHOWN. FOR ENERGY DRINKS (U.S. CLS. 45, 46 AND 48).

YAT SYE, LEE, EXAMINING ATTORNEY

SN 77-293,839. BERRY ENTERPRISES, INC., LAKE ORION, MI, FILED 10-2-2007.

THOSE GUYS

THE MARK CONSISTS OF STANDARD CHARACTERS WITHOUT CLAIM TO ANY PARTICULAR FONT, STYLE, SIZE, OR COLOR.

FOR BEER, ALE, LAGER, STOUT, PILSNER, PORTER AND NON-ALCOHOLIC MALT BEVERAGES (U.S. CLS. 45, 46 AND 48).

DAWN FELDMAN, EXAMINING ATTORNEY

CLASS 32—(Continued).

SN 77-293,940. TROPICANA PRODUCTS, INC., BRADENTON, FL. FILED 10-2-2007.



OWNER OF U.S. REG. NOS. 630,572, 1,303,002 AND OTHERS.

NO CLAIM IS MADE TO THE EXCLUSIVE RIGHT TO USE "EST. 1947" AND "PURE VALENCIA", APART FROM THE MARK AS SHOWN.

THE MARK CONSISTS OF A SQUARE CONTAINING THE WORDS EST. 1947 TROPICANA PURE VALENCIA WITH A SYMBOL BETWEEN THE WORD EST. AND NUMBER 1947 CONSISTING OF THE LETTER "T" IN A CIRCLE SURROUNDED BY A LEAF DESIGN.

FOR FRUIT JUICES AND FRUIT JUICE DRINKS (U.S. CLS. 45, 46 AND 48).

TERESA M. RUPP, EXAMINING ATTORNEY

SN 77-293,948. TROPICANA PRODUCTS, INC., BRADENTON, FL. FILED 10-2-2007.



OWNER OF U.S. REG. NOS. 630,572, 1,303,002 AND OTHERS.

NO CLAIM IS MADE TO THE EXCLUSIVE RIGHT TO USE "EST. 1947" AND "PURE 100% JUICE", APART FROM THE MARK AS SHOWN.

THE MARK CONSISTS OF THE WORDS EST. 1947 WITH A DESIGN BETWEEN EST. AND 1947 CONSISTING OF A LETTER "T" INSIDE A CIRCLE AND THE WORDS TROPICANA PURE 100% JUICE UNDERNEATH.

FOR FRUIT JUICES AND FRUIT JUICE DRINKS (U.S. CLS. 45, 46 AND 48).

TERESA M. RUPP, EXAMINING ATTORNEY

CLASS 32—(Continued).

SN 77-294,029. PULVER, JAMES D., RIVERVIEW, FL. FILED 10-2-2007.

LadyPink

THE MARK CONSISTS OF STANDARD CHARACTERS WITHOUT CLAIM TO ANY PARTICULAR FONT, STYLE, SIZE, OR COLOR.

FOR NON-ALCOHOLIC BEVERAGES, NAMELY, CARBONATED BEVERAGES (U.S. CLS. 45, 46 AND 48).

BENJAMIN ALLEN, EXAMINING ATTORNEY

SN 77-294,174. VOSS OF NORWAY ASA, N-0277 OSLO, NORWAY, FILED 10-2-2007.

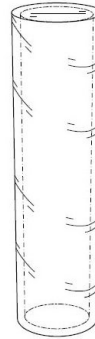

OWNER OF U.S. REG. NOS. 2,696,925 AND 3,259,981. THE MARK CONSISTS OF A CYLINDRICAL BEVERAGE CONTAINER.

SEC. 2(F).

FOR DRINKING WATER (U.S. CLS. 45, 46 AND 48).

FIRST USE 11-18-2000; IN COMMERCE 11-18-2000.

SUSAN LESLIE DUBOIS, EXAMINING ATTORNEY

SN 77-294,766. PEPSICO, INC., PURCHASE, NY. FILED 10-3-2007.

PEPSI LIGHT

THE MARK CONSISTS OF STANDARD CHARACTERS WITHOUT CLAIM TO ANY PARTICULAR FONT, STYLE, SIZE, OR COLOR.

OWNER OF U.S. REG. NOS. 824,150, 824,152 AND OTHERS.

NO CLAIM IS MADE TO THE EXCLUSIVE RIGHT TO USE "LIGHT", APART FROM THE MARK AS SHOWN.

FOR SOFT DRINKS, AND SYRUPS AND CONCENTRATES FOR MAKING THE SAME (U.S. CLS. 45, 46 AND 48).

BILL DAWE, EXAMINING ATTORNEY

CLASS 32—(Continued).

SN 77-294,930. FADED ENERGY DRINKS AND BEVERAGE, WHITTIER, CA. FILED 10-3-2007.

CLASS 32—(Continued).

SN 77-295,300. PEPSICO, INC., PURCHASE, NY. FILED 10-3-2007.

FADED ENERGY UNLEADED

THE MARK CONSISTS OF STANDARD CHARACTERS WITHOUT CLAIM TO ANY PARTICULAR FONT, STYLE, SIZE, OR COLOR.

NO CLAIM IS MADE TO THE EXCLUSIVE RIGHT TO USE "ENERGY", APART FROM THE MARK AS SHOWN. FOR ENERGY DRINKS (U.S. CLS. 45, 46 AND 48).
GIANCARLO CASTRO, EXAMINING ATTORNEY

PEPSI LITE

THE MARK CONSISTS OF STANDARD CHARACTERS WITHOUT CLAIM TO ANY PARTICULAR FONT, STYLE, SIZE, OR COLOR.

OWNER OF U.S. REG. NOS. 824,150, 824,152 AND OTHERS.

NO CLAIM IS MADE TO THE EXCLUSIVE RIGHT TO USE "LITE", APART FROM THE MARK AS SHOWN.

FOR SOFT DRINKS, AND SYRUPS AND CONCENTRATES FOR MAKING THE SAME (U.S. CLS. 45, 46 AND 48).

BILL DAWE, EXAMINING ATTORNEY

SN 77-295,228. CERVECERIA MODELO S.A. DE C.V., MEXICO, D.F., MEXICO, FILED 10-3-2007.



OWNER OF MEXICO REG. NO. 926242, DATED 3-28-2006, EXPIRES 1-13-2016.

NO CLAIM IS MADE TO THE EXCLUSIVE RIGHT TO USE "CERVEZA", APART FROM THE MARK AS SHOWN.

THE MARK CONSISTS OF THE WORDS CERVEZA AND BARRILITO APPEARING ON AN OVAL, AT THE TOP CENTER OF WHICH IS THE IMAGE OF A BARREL ON ITS SIDE WITH WHEAT STALKS SPROUTING FROM EACH SIDE OF THE BARREL.

THE ENGLISH TRANSLATION OF CERVEZA BARRILITO IS BEER AND LITTLE BARREL.

FOR BEERS (U.S. CLS. 45, 46 AND 48).

TOBY BULLOFF, EXAMINING ATTORNEY

SN 77-295,970. BAJA BREWING COMPANY S.A. DE C.V., SAN JOSE DEL CABO, BCS, MEXICO, FILED 10-4-2007.



SN 77-295,298. PEPSICO, INC., PURCHASE, NY. FILED 10-3-2007.

PEPSI PLAY

THE MARK CONSISTS OF STANDARD CHARACTERS WITHOUT CLAIM TO ANY PARTICULAR FONT, STYLE, SIZE, OR COLOR.

OWNER OF U.S. REG. NOS. 824,150, 824,152 AND OTHERS.

FOR SOFT DRINKS, AND SYRUPS AND CONCENTRATES FOR MAKING THE SAME (U.S. CLS. 45, 46 AND 48).

BILL DAWE, EXAMINING ATTORNEY

THE MARK CONSISTS OF SILHOUETTE OF A BRIDLED WALKING DONKEY OR BURRO FOLLOWING A BOTTLE ON A STRING ATTACHED TO A STICK ON ITS BACK.

FOR BEER (U.S. CLS. 45, 46 AND 48).

ANNE E. GUSTASON, EXAMINING ATTORNEY

CLASS 32—(Continued).

SN 77-295,973. BAJA BREWING COMPANY S.A. DE C.V., SAN JOSE DEL CABO, BCS, MEXICO, FILED 10-4-2007.



NO CLAIM IS MADE TO THE EXCLUSIVE RIGHT TO USE "HECHO EN BAJA" AND "CERVEZA PURA", APART FROM THE MARK AS SHOWN.

THE MARK CONSISTS OF STYLIZED LETTER "C" INTEGRATED WITH SILHOUETTE OF MERMAID WITH THE WORDS "HECHO EN BAJA" ABOVE IT AND "CABOTELLA" IN A BANNER BELOW THE LETTER "C" WITH "CERVEZ PURA" BELOW THE BANNER.

THE ENGLISH TRANSLATION OF "HECHO" AND "CERVEZA PURA" IS MADE AND PURE BEER. FOR BEER (U.S. CLS. 45, 46 AND 48). ANNE E. GUSTASON, EXAMINING ATTORNEY

SN 77-302,168. ACHOLONU, ANTHONY, LYNN, MA. FILED 10-11-2007.

Freshet

THE MARK CONSISTS OF STANDARD CHARACTERS WITHOUT CLAIM TO ANY PARTICULAR FONT, STYLE, SIZE, OR COLOR.

FOR FRUIT-BASED SOFT DRINKS FLAVORED WITH TEA; FRUIT-FLAVORED DRINKS; SOFT DRINKS FLAVORED WITH TEA; SOFT DRINKS, NAMELY, FRUIT AND TEA FLAVORED (U.S. CLS. 45, 46 AND 48). LINDA ESTRADA, EXAMINING ATTORNEY

SN 77-305,685. BREWDOG LTD., FRASERBURGH AB438UE, SCOTLAND, FILED 10-17-2007.

BREWDOG RIPTIDE

THE MARK CONSISTS OF STANDARD CHARACTERS WITHOUT CLAIM TO ANY PARTICULAR FONT, STYLE, SIZE, OR COLOR.

FOR BEER, ALE, LAGER, STOUT, PILSNER, PORTER AND NON-ALCOHOLIC MALT BEVERAGES (U.S. CLS. 45, 46 AND 48). DOMINICK J. SALEMI, EXAMINING ATTORNEY

CLASS 32—(Continued).

SN 77-305,989. TROPICANA PRODUCTS, INC., BRADENTON, FL. FILED 10-17-2007.

MADE BY ORANGES, SQUEEZED BY TROPICANA

THE MARK CONSISTS OF STANDARD CHARACTERS WITHOUT CLAIM TO ANY PARTICULAR FONT, STYLE, SIZE, OR COLOR.

OWNER OF U.S. REG. NOS. 630,572, 1,303,002 AND OTHERS. FOR FRUIT JUICES AND FRUIT JUICE DRINKS (U.S. CLS. 45, 46 AND 48). TERESA M. RUPP, EXAMINING ATTORNEY

SN 77-310,634. PEPSICO, INC., PURCHASE, NY. FILED 10-23-2007.

DIET PEPSI VIA

THE MARK CONSISTS OF STANDARD CHARACTERS WITHOUT CLAIM TO ANY PARTICULAR FONT, STYLE, SIZE, OR COLOR.

OWNER OF U.S. REG. NOS. 824,149, 824,152 AND OTHERS.

NO CLAIM IS MADE TO THE EXCLUSIVE RIGHT TO USE "DIET", APART FROM THE MARK AS SHOWN.

FOR SOFT DRINKS, AND SYRUPS AND CONCENTRATES FOR MAKING THE SAME (U.S. CLS. 45, 46 AND 48).

BILL DAWE, EXAMINING ATTORNEY

SN 77-312,908. PEPSICO, INC., PURCHASE, NY. FILED 10-25-2007.

PEPSI FREE

THE MARK CONSISTS OF STANDARD CHARACTERS WITHOUT CLAIM TO ANY PARTICULAR FONT, STYLE, SIZE, OR COLOR.

OWNER OF U.S. REG. NOS. 824,150, 2,988,284 AND OTHERS.

NO CLAIM IS MADE TO THE EXCLUSIVE RIGHT TO USE "FREE", APART FROM THE MARK AS SHOWN.

FOR SOFT DRINKS, AND SYRUPS AND CONCENTRATES FOR MAKING THE SAME (U.S. CLS. 45, 46 AND 48).

BILL DAWE, EXAMINING ATTORNEY

CLASS 32—(Continued).

SN 77-313,029. TROPICANA PRODUCTS, INC., BRADENTON, FL. FILED 10-25-2007.

CLASS 32—(Continued).

SN 77-313,053. TROPICANA PRODUCTS, INC., BRADENTON, FL. FILED 10-25-2007.



OWNER OF U.S. REG. NOS. 630,572, 1,170,481 AND 1,303,002.

NO CLAIM IS MADE TO THE EXCLUSIVE RIGHT TO USE THE DESIGN OF THE LEMON, APART FROM THE MARK AS SHOWN.

THE COLOR(S) YELLOW, GREEN, ORANGE, GRAY AND BLACK IS/ARE CLAIMED AS A FEATURE OF THE MARK.

THE MARK CONSISTS OF A YELLOW LEMON WITH YELLOW DOTS EXTENDING OUTWARDS LIKE SUNSHINE RAYS WITH THE WORDING "TROPICANA" IN GREEN, AN ORANGE LINE BELOW THE WORD "TROPICANA" AND THE WORD "BLISS" IN BLACK. THE DESIGNS AND WORDS APPEAR ON A GRAY RECTANGLE FOR FRUIT JUICES AND FRUIT JUICE DRINKS (U.S. CLS. 45, 46 AND 48).

TERESA M. RUPP, EXAMINING ATTORNEY

OWNER OF U.S. REG. NOS. 630,572, 1,170,481 AND 1,303,002.

NO CLAIM IS MADE TO THE EXCLUSIVE RIGHT TO USE THE DESIGN OF THE ORANGE, APART FROM THE MARK AS SHOWN.

THE COLOR(S) GREEN, ORANGE, GRAY AND BLACK IS/ARE CLAIMED AS A FEATURE OF THE MARK.

THE MARK CONSISTS OF AN ORANGE IN THE COLOR ORANGE WITH ORANGE DOTS EXTENDING OUTWARDS LIKE SUNSHINE RAYS WITH THE WORDING "TROPICANA" IN GREEN, AN ORANGE LINE BELOW THE WORD "TROPICANA" AND THE WORD "BLISS" IN BLACK. THE DESIGNS AND WORDS APPEAR ON A GRAY RECTANGLE FOR FRUIT JUICES AND FRUIT JUICE DRINKS (U.S. CLS. 45, 46 AND 48).

TERESA M. RUPP, EXAMINING ATTORNEY

CLASS 32—(Continued).

SN 77-313,097. TROPICANA PRODUCTS, INC., BRADENTON, FL. FILED 10-25-2007.



OWNER OF U.S. REG. NOS. 630,572, 1,170,481 AND 1,303,002.

NO CLAIM IS MADE TO THE EXCLUSIVE RIGHT TO USE THE DESIGN OF THE RASPBERRY, APART FROM THE MARK AS SHOWN.

THE COLOR(S) MAGENTA, YELLOW, GREEN, ORANGE, GRAY AND BLACK IS/ARE CLAIMED AS A FEATURE OF THE MARK.

THE MARK CONSISTS OF A MAGENTA RASPBERRY WITH MAGENTA DOTS EXTENDING OUTWARDS LIKE SUNSHINE RAYS WITH THE WORDING "TROPICANA" IN GREEN, AN ORANGE LINE BELOW THE WORD "TROPICANA" AND THE WORD "BLISS" IN BLACK. THE DESIGNS AND WORDS APPEAR ON A GRAY RECTANGLE.

FOR FRUIT JUICES AND FRUIT JUICE DRINKS (U.S. CLS. 45, 46 AND 48).

TERESA M. RUPP, EXAMINING ATTORNEY

SN 77-313,247. TROPICANA PRODUCTS, INC., BRADENTON, FL. FILED 10-25-2007.

PURELY STUNNING

THE MARK CONSISTS OF STANDARD CHARACTERS WITHOUT CLAIM TO ANY PARTICULAR FONT, STYLE, SIZE, OR COLOR.

FOR FRUIT JUICES AND FRUIT JUICE DRINKS (U.S. CLS. 45, 46 AND 48).

TERESA M. RUPP, EXAMINING ATTORNEY

CLASS 32—(Continued).

SN 77-315,518. PEPSICO, INC., PURCHASE, NY. FILED 10-29-2007.

MOUNTAIN DEW WARRIOR

THE MARK CONSISTS OF STANDARD CHARACTERS WITHOUT CLAIM TO ANY PARTICULAR FONT, STYLE, SIZE, OR COLOR.

OWNER OF U.S. REG. NOS. 820,362, 3,134,243 AND OTHERS.

FOR SOFT DRINKS, AND SYRUPS AND CONCENTRATES FOR MAKING THE SAME (U.S. CLS. 45, 46 AND 48).

BILL DAWE, EXAMINING ATTORNEY

SN 77-315,529. PEPSICO, INC., PURCHASE, NY. FILED 10-29-2007.

MOUNTAIN DEW FIRESTORM

THE MARK CONSISTS OF STANDARD CHARACTERS WITHOUT CLAIM TO ANY PARTICULAR FONT, STYLE, SIZE, OR COLOR.

OWNER OF U.S. REG. NOS. 820,362, 3,134,243 AND OTHERS.

FOR SOFT DRINKS, AND SYRUPS AND CONCENTRATES FOR MAKING THE SAME (U.S. CLS. 45, 46 AND 48).

BILL DAWE, EXAMINING ATTORNEY

SN 77-315,540. PEPSICO, INC., PURCHASE, NY. FILED 10-29-2007.

MOUNTAIN DEW ALL-4-1

THE MARK CONSISTS OF STANDARD CHARACTERS WITHOUT CLAIM TO ANY PARTICULAR FONT, STYLE, SIZE, OR COLOR.

OWNER OF U.S. REG. NOS. 820,362, 3,134,243 AND OTHERS.

FOR SOFT DRINKS, AND SYRUPS AND CONCENTRATES FOR MAKING THE SAME (U.S. CLS. 45, 46 AND 48).

BILL DAWE, EXAMINING ATTORNEY

CLASS 32—(Continued).

SN 77-316,475. RED BULL GMBH, FUSCHL AM SEE, AUSTRIA, FILED 10-29-2007.

VITALIZES BODY AND MIND

THE MARK CONSISTS OF STANDARD CHARACTERS WITHOUT CLAIM TO ANY PARTICULAR FONT, STYLE, SIZE, OR COLOR.

OWNER OF U.S. REG. NO. 2,505,532.
FOR NON-ALCOHOLIC BEVERAGES, NAMELY, SPORTS DRINKS, ENERGY DRINKS AND SOFT DRINKS (U.S. CLS. 45, 46 AND 48).
FIRST USE 1-19-2001; IN COMMERCE 1-31-2001.
HEATHER SAPP, EXAMINING ATTORNEY

SN 77-318,694. KONRAD OVERSEAS LTD., RAMAT GAN, ISRAEL, FILED 11-1-2007.

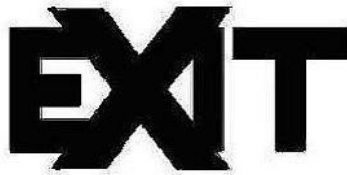

FOR BEERS; NON-ALCOHOLIC BEVERAGES, NAMELY, ENERGY DRINKS AND HYPERTONIC DRINKS, MINERAL WATERS, AERATED WATERS, CARBONATED WATERS, FLAVORED WATERS, NAMELY, SOFT DRINKS, SPORTS DRINKS; FRUIT DRINKS AND FRUIT JUICES; ENERGY DRINKS; NON-ALCOHOLIC COCKTAILS AND DRINKS IN THE NATURE OF SOFT DRINKS. NON-ALCOHOLIC MIXED COCKTAILS (U.S. CLS. 45, 46 AND 48).
STEVEN JACKSON, EXAMINING ATTORNEY

SN 77-326,158. BREWDOG LTD., FRASERBURGH, SCOTLAND, FILED 11-9-2007.

BREWDOG PARADOX

THE MARK CONSISTS OF STANDARD CHARACTERS WITHOUT CLAIM TO ANY PARTICULAR FONT, STYLE, SIZE, OR COLOR.

FOR BEER, ALE, LAGER, STOUT, PILSNER, PORTER AND NON-ALCOHOLIC MALT BEVERAGES (U.S. CLS. 45, 46 AND 48).
DOMINICK J. SALEMI, EXAMINING ATTORNEY

CLASS 32—(Continued).

SN 77-326,166. BREWDOG LTD., FRASERBURGH, SCOTLAND, FILED 11-9-2007.

BREWDOG PUNK IPA

THE MARK CONSISTS OF STANDARD CHARACTERS WITHOUT CLAIM TO ANY PARTICULAR FONT, STYLE, SIZE, OR COLOR.

NO CLAIM IS MADE TO THE EXCLUSIVE RIGHT TO USE "IPA", APART FROM THE MARK AS SHOWN.
FOR BEER, ALE, LAGER, STOUT, PILSNER, PORTER AND NON-ALCOHOLIC MALT BEVERAGES (U.S. CLS. 45, 46 AND 48).
DOMINICK J. SALEMI, EXAMINING ATTORNEY

SN 78-449,413. THE COCA-COLA COMPANY, ATLANTA, GA. FILED 7-12-2004.

SPRITE QUENCH

THE MARK CONSISTS OF STANDARD CHARACTERS WITHOUT CLAIM TO ANY PARTICULAR FONT, STYLE, SIZE, OR COLOR.

OWNER OF U.S. REG. NOS. 704,043, 1,927,996 AND 2,109,200.
FOR BEVERAGES, NAMELY, DRINKING WATERS, FLAVORED WATERS, MINERAL AND AERATED WATERS; AND OTHER NON-ALCOHOLIC BEVERAGES, NAMELY, SOFT DRINKS, ENERGY DRINKS AND SPORTS DRINKS; FRUIT DRINKS AND JUICES; SYRUPS, CONCENTRATES AND POWDERS FOR MAKING BEVERAGES, NAMELY, FLAVORED WATERS, MINERAL AND AERATED WATERS, SOFT DRINKS, ENERGY DRINKS, SPORTS DRINKS, FRUIT DRINKS AND JUICES (U.S. CLS. 45, 46 AND 48).
MICHAEL WEBSTER, EXAMINING ATTORNEY

CLASS 32—(Continued).

SN 78-669,492. TODD, COREY C., CROFTON, MD. FILED 7-13-2005.

Swagger

THE MARK CONSISTS OF STANDARD CHARACTERS WITHOUT CLAIM TO ANY PARTICULAR FONT, STYLE, SIZE, OR COLOR.

FOR MINERAL WATERS AND AERATED WATERS AND OTHER NON-ALCOHOLIC BEVERAGES, NAMELY, FLAVORED WATERS; FRUIT AND COLA FLAVORED SOFT DRINKS; FRUIT DRINKS AND FRUIT JUICES; ENERGY DRINKS, SPORTS DRINKS; POWDERS AND SYRUPS FOR MAKING SOFT DRINKS, FRUIT DRINKS AND FRUIT JUICES, ENERGY DRINKS IN THE NATURE OF SOFT DRINKS AND SPORTS DRINKS CONTAINING NATURAL ENERGY ENHANCEMENT INGREDIENTS; AND BEER AND MALT LIQUOR (U.S. CLS. 45, 46 AND 48).

CAROL SPILS, EXAMINING ATTORNEY

CLASS 32—(Continued).

SN 79-026,297. BITBURGER BRAUGRUPPE GMBH, FED REP GERMANY, FILED 2-6-2006.



SN 78-795,937. PRODUCTORA LA FLORIDA, S.A., SAN JOSE, COSTA RICA, FILED 1-20-2006.



OWNER OF U.S. REG. NOS. 2,825,158 AND 2,972,025.

NO CLAIM IS MADE TO THE EXCLUSIVE RIGHT TO USE "LA CERVEZA DE COSTA RICA", APART FROM THE MARK AS SHOWN.

THE APPLICANT CLAIMS COLOR AS A FEATURE OF THE MARK, NAMELY, SILVER, YELLOW, RED, BLACK AND WHITE.

THE MARK CONSISTS OF AN OVAL DESIGN, WITH A SILVER OUTER BORDER AND A BLACK INNER BORDER, CONTAINING: A BLACK EAGLE DESIGN HOLDING A SILVER BAND WITH ITS CLAWS, AND A SILVER SHIELD DESIGN WITH THE LETTERS "CCR" IN ITS CENTER COMPRISED OF A YELLOW OUTER BORDER AND A BLACK INNER BORDER, ALL OVER A YELLOW BACKGROUND; THE WORDS "LA CERVEZA DE COSTA RICA" IN WHITE LETTERS WITH A YELLOW BRANCH OF LEAVES ON EACH SIDE, ALL OVER A BLACK BACKGROUND; AND THE WORD "IMPERIAL" IN WHITE LETTERS WITH BLACK BORDERS OVER A RED BACKGROUND.

THE FOREIGN WORDING IN THE MARK TRANSLATES INTO ENGLISH AS THE BEER OF COSTA RICA.

FOR BEER (U.S. CLS. 45, 46 AND 48).

HEATHER THOMPSON, EXAMINING ATTORNEY

PRIORITY DATE OF 11-2-2005 IS CLAIMED.

OWNER OF INTERNATIONAL REGISTRATION 0891597 DATED 2-6-2006, EXPIRES 2-6-2016.

NO CLAIM IS MADE TO THE EXCLUSIVE RIGHT TO USE "WEIZEN, HEFE HELL, PRIVATBRAUEREI AND SEIT 1854", APART FROM THE MARK AS SHOWN.

THE COLOR(S) GOLD, GREEN, YELLOW, BROWN, BLACK AND RED, WHITE, BLUE AND ORANGE IS/ARE CLAIMED AS A FEATURE OF THE MARK.

THE COLOR GOLD APPEARS IN THE WHEAT AND THE BACKGROUND OF THE OVAL; THE COLOR GREEN APPEARS IN THE WORDING LICHER AND THE UNDERLINE, THE WORDING PRIVATBRAUEREI - SEIT 1854 - AUS DEM HERZEN DER NATUR, THE CASTLE, THE OVAL BORDERS, AND THE BACKGROUND OF THE MARK; THE COLOR YELLOW APPEARS IN THE BACKGROUND OF THE OVAL; THE COLOR BROWN APPEARS IN THE WORDING WEIZEN HEFE HELL AND THE STYLIZED WHEAT; THE COLOR BLACK APPEARS IN THE WORDING WEIZEN HEFE HELL AND THE STYLIZED WHEAT; THE COLOR RED APPEARS IN THE WOMAN; THE COLOR WHITE APPEARS IN THE OVAL BORDERS AND THE BACKGROUNDS OF THE CASTLE, WOMAN AND YEARS; THE COLOR BLUE APPEARS IN THE OVAL BORDERS AND THE BACKGROUNDS OF THE CASTLE, WOMAN AND YEARS; THE COLOR ORANGE APPEARS IN THE OVAL BORDERS.

THE MARK CONSISTS OF LABEL WITH BORDERS AND AN INTERIOR BORDER ON WHICH APPEARS THE WORDS PRIVATBRAUEREI ON BOTH SIDES AT THE TOP AND AUS DEM HERZEN DER NATUR ON THE BOTTOM. IN THE INTERIOR BACKGROUND OF THE OVAL THERE IS A REPRESENTATION OF TWO STALKS OF WHEAT. AT THE TOP OF THE LABEL IS A REPRESENTATION OF A CASTLE, A WOMAN AND THE WORDING "SEIT 1854." BELOW THAT IS THE WORD "LICHER", THE WORD "WEIZEN" WITH A REPRESENTATION OF WHEAT AND THE WORDS "HEFE HELL."

THE ENGLISH TRANSLATION OF WEIZEN IS "WHEAT," HEFE IS "YEAST," HELL IS "LIGHT" OR "LAGER," PRIVATBRAUEREI IS "PRIVATE BREWERY," SEIT 1854 IS "SINCE 1854" AND AUS DEM HERZEN DER NATUR IS "FROM THE HEART OF NATURE."

FOR BEER, WHEAT BEER, ALE, PORTER, ALL AFOREMENTIONED GOODS IN NON-ALCOHOLIC, LOW-ALCOHOL OR ALCOHOL-REDUCED FORM; MINERAL AND AERATED WATERS (U.S. CLS. 45, 46 AND 48).

LEIGH LOWRY, EXAMINING ATTORNEY

CLASS 32—(Continued).

SN 79-031,468. TAN MUEY HWA, SINGAPORE, FILED 9-14-2006.

WHATEVER

PRIORITY DATE OF 8-29-2006 IS CLAIMED.
OWNER OF INTERNATIONAL REGISTRATION 0904918
DATED 9-14-2006, EXPIRES 9-14-2016.

FOR MINERAL AND AERATED WATERS AND OTHER NON-ALCOHOLIC DRINKS, NAMELY, CARBONATED AND NON-CARBONATED SOFT DRINKS; BEERS; FRUIT DRINKS AND FRUIT JUICES; SYRUPS FOR MAKING BEVERAGES AND PREPARATIONS FOR MAKING FRUIT DRINKS AND SOFT DRINKS; CONCENTRATES FOR USE IN THE PREPARATION OF SOFT DRINKS; ISOTONIC DRINKS NOT FOR MEDICAL PURPOSES (U.S. CLS. 45, 46 AND 48).

WILLIAM VERHOSEK, EXAMINING ATTORNEY

SN 79-042,619. INBEV S.A., BELGIUM, FILED 7-19-2007.



PRIORITY DATE OF 7-5-2007 IS CLAIMED.
OWNER OF INTERNATIONAL REGISTRATION 0934501
DATED 7-19-2007, EXPIRES 7-19-2017.
OWNER OF U.S. REG. NOS. 1,156,584, 3,206,442 AND OTHERS.

NO CLAIM IS MADE TO THE EXCLUSIVE RIGHT TO USE "BIERE D'EXCEPTION" AND "ANNO 1366", APART FROM THE MARK AS SHOWN.

THE NAME "STELLA ARTOIS" DOES NOT IDENTIFY A LIVING INDIVIDUAL.

THE COLOR(S) RED, GOLD, BLUE, WHITE, GREY IS/ARE CLAIMED AS A FEATURE OF THE MARK.

THE MARK CONSISTS OF A RECTANGLE OUTLINE SURROUNDING A DEPICTION OF A HORN WITH A BANNER BELOW IT READING "ANNO 1366". THE BANNER HAS AN EIGHT-POINTED STAR BETWEEN THE WORD "ANNO" AND THE NUMBER "1366". SURROUNDING THE HORN AND THE BANNER ARE LINES EXTENDING AWAY FROM THE HORN AND THE BANNER. SUPERIMPOSED ABOVE THE DEPICTION OF THE HORN AND THE BANNER IS A SMALLER ROUNDED-EDGED RECTANGLE CONTAINING THE WORDING "STELLA ARTOIS". THIS SMALLER RECTANGULAR SHAPE IS ITSELF SURROUNDED BY FANCIFUL LEAFING, AND HAS A SMALLER VERSION OF THE HORN AND BANNER ABOVE IT. BELOW THIS SMALLER RECTANGULAR ELEMENT IS THE WORDING "NOBILIS" AND BELOW THAT THE WORDING "BIERE D'EXCEPTION". THE COLOR RED APPEARS AS THE COLOR OF THE SMALLER RECTANGULAR ELEMENT AND AS THE OUTLINE OF THE LARGER RECTANGLE. THE COLOR GOLD APPEARS AS THE COLOR OF THE LEAFING AND THE SMALLER HORN AND BANNER, AS WELL AS THE COLOR OF THE WORDING "NOBILIS". THE COLOR BLUE APPEARS AS

CLASS 32—(Continued).

SHADING IN THE WORDING "NOBILIS" AND AS THE COLOR OF THE WORDING "BIERE D'EXCEPTION". THE COLOR WHITE APPEARS AS THE COLOR OF THE WORDING "STELLA ARTOIS" AND AS THE BACKGROUND COLOR OF THE LARGER RECTANGLE. THE COLOR GRAY APPEARS IN THE DESIGN ELEMENT OF THE LARGER HORN AND BANNER AND THE LINES EXTENDING THEREFROM, AS WELL AS IN THE OUTLINING IN THE SMALLER RECTANGULAR DESIGN ELEMENT.

THE ENGLISH TRANSLATION OF "STELLA" IN THE MARK IS "STAR". THE ENGLISH TRANSLATION OF "NOBILIS" IN THE MARK IS "NOBLE". THE ENGLISH TRANSLATION OF "BIERE D'EXCEPTION" IN THE MARK IS "EXCEPTIONAL BEER". THE ENGLISH TRANSLATION OF "ANNO" IN THE MARK IS "YEAR".

FOR BEERS (U.S. CLS. 45, 46 AND 48).
ANDREA HACK, EXAMINING ATTORNEY

CLASS 33—WINES AND SPIRITS

SN 77-066,527. NAKED WINES, LLC, HOOD RIVER, OR. FILED 12-18-2006.

Naked Winery

NO CLAIM IS MADE TO THE EXCLUSIVE RIGHT TO USE "WINERY", APART FROM THE MARK AS SHOWN.
FOR WINE; NATURAL WINES; TABLE WINES; WHITE WINE; AND RED WINE (U.S. CLS. 47 AND 49).
TEJBIR SINGH, EXAMINING ATTORNEY

SN 77-070,521. OLIVER WINE CO., INC., BLOOMINGTON, IN. FILED 12-22-2006.

OLIVER

THE MARK CONSISTS OF STANDARD CHARACTERS WITHOUT CLAIM TO ANY PARTICULAR FONT, STYLE, SIZE, OR COLOR.

SEC. 2(F).
FOR WINE (U.S. CLS. 47 AND 49).
FIRST USE 0-0-1990; IN COMMERCE 0-0-1990.
REGINA DRUMMOND, EXAMINING ATTORNEY

CLASS 33—(Continued).

SN 77-087,665. VINE CLIFF WINERY, INC., NAPA, CA.
FILED 1-22-2007.



OWNER OF U.S. REG. NO. 3,322,894.
THE MARK CONSISTS OF A WINERY SURROUNDED
BY FIELDS OF GRAPES WITH MOUNTAINS IN THE
BACKGROUND.

FOR WINE (U.S. CLS. 47 AND 49).
FIRST USE 7-31-1991; IN COMMERCE 7-31-1991.
JAMES GRIFFIN, EXAMINING ATTORNEY

SN 77-091,900. KALAHARI DISTILLERS LIMITED, STEL-
LENBOSCH, SOUTH AFRICA, FILED 1-26-2007.

KALAHARI

THE MARK CONSISTS OF STANDARD CHARACTERS
WITHOUT CLAIM TO ANY PARTICULAR FONT, STYLE,
SIZE, OR COLOR.

OWNER OF SOUTH AFRICA REG. NO. 858724, DATED
12-6-1985, EXPIRES 12-6-2015.
FOR LIQUEURS (U.S. CLS. 47 AND 49).
WILLIAM VERHOSEK, EXAMINING ATTORNEY

SN 77-103,770. HERRERA ORENDAIN ELENA, ZAPOPAN,
MEXICO, FILED 2-9-2007.



NO CLAIM IS MADE TO THE EXCLUSIVE RIGHT TO
USE "TEQUILA", APART FROM THE MARK AS SHOWN.

THE MARK CONSISTS OF A DOUBLE CIRCLE, WITH A
SUN INSIDE THEM, INSIDE IT A THICKER CIRCLE AND
INSIDE IT A KIND OF SIX LEAVES CLOVER, ABOVE ALL
THIS THE WORDS "GRAN MARACAME TEQUILA" ARE
WRITTEN.

THE FOREIGN WORDING IN THE MARK TRANSLATES
INTO ENGLISH AS GREAT SHAMAN TEQUILA.
FOR TEQUILA (U.S. CLS. 47 AND 49).
MICHELLE DUBOIS, EXAMINING ATTORNEY

CLASS 33—(Continued).

SN 77-112,152. AMERICAN GIN CO. LLC, NEW YORK, NY.
FILED 2-21-2007.

THE NEW GENERATION

THE MARK CONSISTS OF STANDARD CHARACTERS
WITHOUT CLAIM TO ANY PARTICULAR FONT, STYLE,
SIZE, OR COLOR.

FOR DISTILLED SPIRITS (U.S. CLS. 47 AND 49).
SARA THOMAS, EXAMINING ATTORNEY

SN 77-114,214. LA CHABLISIENNE, CHABLIS, FRANCE,
FILED 2-23-2007.



OWNER OF U.S. REG. NOS. 1,545,578 AND 3,215,916.

THE MARK CONSISTS OF THE WORDING " LA CHA-
BLISIENNE " OVER THE SHADOW FIGURE OF A WOMAN
HOLDING A BOTTLE OF WINE.

"THE FOREIGN WORDING IN THE MARK TRANS-
LATES INTO ENGLISH AS THE WOMAN FROM CHABLIS."
FOR ALCOHOLIC BEVERAGES, NAMELY, WINES
(U.S. CLS. 47 AND 49).

STEVEN R. FINE, EXAMINING ATTORNEY

CLASS 33—(Continued).

SN 77-123,077. JORGE SALLES CUERVO Y SUCEORES SA DE CV, GUADALAJARA, MEXICO, FILED 3-6-2007.

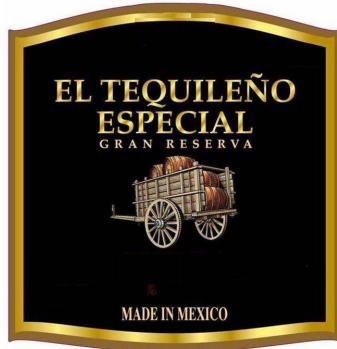

OWNER OF U.S. REG. NO. 3,224,278.
NO CLAIM IS MADE TO THE EXCLUSIVE RIGHT TO USE "GRAN RESERVA" AND "MADE IN MEXICO", APART FROM THE MARK AS SHOWN.

THE COLOR(S) BLACK, GOLD, BROWN AND GREY IS/ ARE CLAIMED AS A FEATURE OF THE MARK.

THE BORDER IS GOLD, THE BACKGROUND IS BLACK, THE WORDING "EL TEQUILEÑO ESPECIAL" IS GOLD, THE WORDING "GRAN RESERVA" AND "MADE IN MEXICO" IS LIGHT GOLD, THE CART IS BLACK AND GRAY, AND THE BARRELS ARE BROWN AND GOLD.

THE ENGLISH TRANSLATION OF "EL TEQUILEÑO" IN THE MARK IS THE SPECIAL NATIVE BORN PERSON OF TEQUILA, MEXICO, AND THE TRANSLATION OF "GRAN RESERVA" IS GRAND RESERVE.

FOR TEQUILA (U.S. CLS. 47 AND 49).
JEAN IM, EXAMINING ATTORNEY

SN 77-131,166. EINIG-ZENZEN GMBH & CO. KG, KAISERSESCH, FED REP GERMANY, FILED 3-14-2007.

SUN OF AFRICA

THE MARK CONSISTS OF STANDARD CHARACTERS WITHOUT CLAIM TO ANY PARTICULAR FONT, STYLE, SIZE, OR COLOR.

OWNER OF ERPN CMNTY TM OFC REG. NO. 4359931, DATED 3-28-2006, EXPIRES 3-29-2015.

NO CLAIM IS MADE TO THE EXCLUSIVE RIGHT TO USE "OF AFRICA", APART FROM THE MARK AS SHOWN.
FOR WINES (U.S. CLS. 47 AND 49).

SARA THOMAS, EXAMINING ATTORNEY

CLASS 33—(Continued).

SN 77-133,355. DESTILERIA LOS DANZANTES S.A. DE C.V., OAXACA DE JUAREZ, MEXICO, FILED 3-16-2007.

Alipus

THE MARK CONSISTS OF STANDARD CHARACTERS WITHOUT CLAIM TO ANY PARTICULAR FONT, STYLE, SIZE, OR COLOR.

FOR MEZCAL (U.S. CLS. 47 AND 49).
BRIAN PINO, EXAMINING ATTORNEY

SN 77-136,858. VINAS DEL BIERZO, SDAD. COOP. LTDA., CAMPONARAYA (LEON), SPAIN, FILED 3-21-2007.



THE MARK CONSISTS OF "DEMENCIA" IN STYLIZED LETTERS APPEARING WITHIN A SQUARE.

THE FOREIGN WORDING IN THE MARK TRANSLATES INTO ENGLISH AS "DEMENTIA".

FOR WINES (U.S. CLS. 47 AND 49).
BERNICE MIDDLETON, EXAMINING ATTORNEY

SN 77-140,246. LONG TAIL LIBATIONS INCORPORATED, ST. LOUIS, MO. FILED 3-26-2007.

POLANCO

THE MARK CONSISTS OF STANDARD CHARACTERS WITHOUT CLAIM TO ANY PARTICULAR FONT, STYLE, SIZE, OR COLOR.

FOR TEQUILA (U.S. CLS. 47 AND 49).
SALLY SHIH, EXAMINING ATTORNEY

CLASS 33—(Continued).

SN 77-141,940. KANDYMAN SPIRITS LLC, SAN FRANCISCO, CA. AND BAMBU IMPORTS LLC, NEW YORK, NY. FILED 3-27-2007.

JETT

THE MARK CONSISTS OF STANDARD CHARACTERS WITHOUT CLAIM TO ANY PARTICULAR FONT, STYLE, SIZE, OR COLOR.
FOR ALCOHOLIC BEVERAGES, NAMELY, DISTILLED SPIRITS (U.S. CLS. 47 AND 49).
MARGERY A. TIERNEY, EXAMINING ATTORNEY

SN 77-142,675. AFSHIN SHAFIL, ROCKVILLE, MD. FILED 3-28-2007.

SKR

THE MARK CONSISTS OF STANDARD CHARACTERS WITHOUT CLAIM TO ANY PARTICULAR FONT, STYLE, SIZE, OR COLOR.
FOR ALCOHOLIC BEVERAGES, NAMELY, RUM (U.S. CLS. 47 AND 49).
MORGAN WYNNE, EXAMINING ATTORNEY

SN 77-160,052. KING ESTATE WINERY, L.P., EUGENE, OR. FILED 4-18-2007.

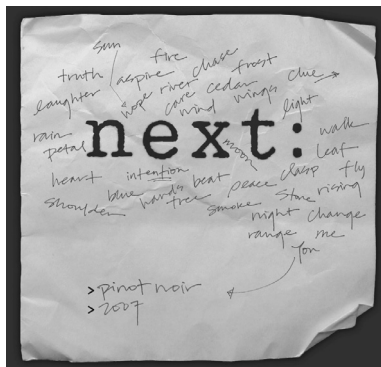

NO CLAIM IS MADE TO THE EXCLUSIVE RIGHT TO USE "PINOT NOIR" AND "2007", APART FROM THE MARK AS SHOWN.
THE MARK CONSIST OF THE TYPE WRITTEN WORD AND PUNCTUATION "NEXT:" APPEARING PROMINENTLY ON A PIECE OF PAPER WITH FURLED EDGES

CLASS 33—(Continued).

SURROUNDED RANDOMLY BY MUCH SMALLER HANDWRITTEN WORDS, "LAUGHTER, TRUTH, SUN, HOPE, ASPIRE, FIRE, RIVER, CARE, CHASE, MIND, CEDAR, FROST, WINGS, CLUE, LIGHT, RAIN, PETAL, MOON, WALK, LEAF, HEART, INTENTION, BEAT, PEACE, CLASP, FLY, SHOULDER, BLUE, HANDS, TREE, SMOKE, STONE, RISING, MIGHT, CHANGE, RANGE, ME, YOU" AND THE TERMS "PINOT NOIR" AND "2007" ON THE BOTTOM THIRD OF THE PAPER WITH DESIGNS OF DIRECTIONAL ARROWS.
FOR WINE (U.S. CLS. 47 AND 49).
SAMUEL E. SHARPER JR., EXAMINING ATTORNEY

SN 77-162,130. RAFFALDINI VINEYARDS & WINERY LLC, RONDA, NC. FILED 4-20-2007.

RAFFALDINI



OWNER OF U.S. REG. NO. 2,880,475.
THE MARK CONSISTS OF THE STYLIZED WORDING "RAFFALDINI" AND THE DESIGN OF A KNIGHT'S HELMET ABOVE A SHIELD CONTAINING TWO HERALDIC LIONS ON THE INNERMOST SECTION AND FOUR EAGLES ON THE OUTERMOST SECTION, AND FLORAL ORNAMENTATION AROUND THE SHIELD AND HELMET.
FOR WINE (U.S. CLS. 47 AND 49).
FIRST USE 4-15-2001; IN COMMERCE 4-15-2001.
JAY BESCH, EXAMINING ATTORNEY

SN 77-169,300. BANFI PRODUCTS CORPORATION, OLD BROOKVILLE, NY. FILED 4-30-2007.

VILLA MARZIA

THE MARK CONSISTS OF STANDARD CHARACTERS WITHOUT CLAIM TO ANY PARTICULAR FONT, STYLE, SIZE, OR COLOR.
THE WORDING "VILLA MARZIA" HAS NO MEANING IN A FOREIGN LANGUAGE.
FOR ALCOHOLIC BEVERAGES, NAMELY, LIMONCELLO (U.S. CLS. 47 AND 49).
TINA L. SNAPP, EXAMINING ATTORNEY

CLASS 33—(Continued).

SN 77-171,812. DISTILLED RESOURCES, INC., RIGBY, ID. FILED 5-3-2007.

SUPERBATCH

THE MARK CONSISTS OF STANDARD CHARACTERS WITHOUT CLAIM TO ANY PARTICULAR FONT, STYLE, SIZE, OR COLOR.

NO CLAIM IS MADE TO THE EXCLUSIVE RIGHT TO USE "DISTILLED SPIRITS", APART FROM THE MARK AS SHOWN.

FOR DISTILLED SPIRITS (U.S. CLS. 47 AND 49).
COLLEEN DOMBROW, EXAMINING ATTORNEY

SN 77-189,623. MICHEL-SCHLUMBERGER PARTNERS, L.P., HEALDSBURG, CA. FILED 5-24-2007.

COTEAUX SAUVAGES

THE MARK CONSISTS OF STANDARD CHARACTERS WITHOUT CLAIM TO ANY PARTICULAR FONT, STYLE, SIZE, OR COLOR.

THE ENGLISH TRANSLATION OF "COTEAUX SAUVAGES" IN THE MARK IS WILD SLOPES.

FOR WINE (U.S. CLS. 47 AND 49).
JENNIFER VASQUEZ, EXAMINING ATTORNEY

SN 77-199,490. DIAGEO NORTH AMERICA, INC., NORWALK, CT. FILED 6-6-2007.

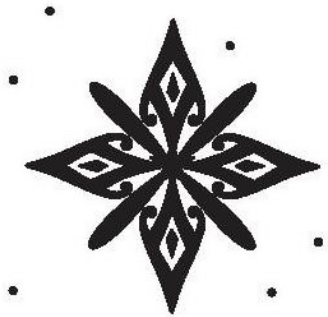

THE MARK CONSISTS OF A GEOMETRIC DESIGN SURROUNDED BY SIX DOTS.

FOR WINES (U.S. CLS. 47 AND 49).
FIRST USE 9-15-2007; IN COMMERCE 9-15-2007.
MARK SPARACINO, EXAMINING ATTORNEY

CLASS 33—(Continued).

SN 77-215,414. SOCIETE CIVILE DU CHATEAU GRAND PUY DUCASSE, PAULLAC, FRANCE, FILED 6-26-2007.

CHATEAU GRAND PUY DUCASSE

THE MARK CONSISTS OF STANDARD CHARACTERS WITHOUT CLAIM TO ANY PARTICULAR FONT, STYLE, SIZE, OR COLOR.

OWNER OF FRANCE REG. NO. 1303896, DATED 3-21-1985, EXPIRES 3-20-2015.

NO CLAIM IS MADE TO THE EXCLUSIVE RIGHT TO USE "CHATEAU", APART FROM THE MARK AS SHOWN. THE FOREIGN WORDING IN THE MARK TRANSLATES INTO ENGLISH AS "HOUSE OF GRAND PUY DUCASSE" OR "GRAND PUY DUCASSE ESTATE".

FOR WINES (U.S. CLS. 47 AND 49).
DOMINIC J. FERRAIUOLO, EXAMINING ATTORNEY

SN 77-223,201. TEQUILA GALERA VIEJA SA DE CV, ARANDAS, MEXICO, FILED 7-6-2007.



NO CLAIM IS MADE TO THE EXCLUSIVE RIGHT TO USE "NET. CONT.", "1 L.", "40 %", "ALC BY VOL.", "(80 PROOF)", "GOLD," AND "PRODUCT OF MEXICO", APART FROM THE MARK AS SHOWN.

THE NAME(S), PORTRAIT(S), AND/OR SIGNATURE(S) SHOWN IN THE MARK DOES NOT IDENTIFY A PARTICULAR LIVING INDIVIDUAL.

THE COLOR(S) GOLD, ORANGE, YELLOW, BLACK, SILVER AND RED IS/ARE CLAIMED AS A FEATURE OF THE MARK.

THE COLORS GOLD AND BLACK APPEAR IN THE RECTANGLE BORDER OF THE MARK; THE COLOR BLACK APPEARS IN THE WORDING "NET.CONT 1 L, 40% ALC BY VOL (80 PROOF)" AND IN THE DESIGN ELEMENT OF THE MAN WEARING THE SOMBRERO AND THE MEXICAN DANCING WOMAN; THE COLOR RED APPEARS IN THE WORDING "GOLD" AND "PRODUCT OF MEXICO" AND IN THE RIBBON DESIGN ELEMENT; THE COLOR WHITE APPEARS IN THE WORDING "RANCHO GRANDE" AND "PRODUCT OF MEXICO" AND IN THE BACKGROUND OF THE MARK; THE COLOR ORANGE APPEARS IN THE OVAL DESIGN ELEMENT, THE COLOR SILVER APPEARS IN THE BACKGROUND OF THE MARK AND IN THE AGAVE PLANT DESIGN ELEMENT.

THE FOREIGN WORDING IN THE MARK TRANSLATES INTO ENGLISH AS "BIG RANCH".

FOR MEZCAL; TEQUILA (U.S. CLS. 47 AND 49).
JOHN DALIER, EXAMINING ATTORNEY

CLASS 33—(Continued).

SN 77-227,705. O. PEIRO, HORACIO, DORAL, FL. FILED 7-12-2007.

OBELISCO

THE MARK CONSISTS OF STANDARD CHARACTERS WITHOUT CLAIM TO ANY PARTICULAR FONT, STYLE, SIZE, OR COLOR.

THE ENGLISH TRANSLATION OF THE FOREIGN WORD "OBELISCO" IS "OBELISK".

FOR WINES (U.S. CLS. 47 AND 49).

BARBARA A. GOLD, EXAMINING ATTORNEY

CLASS 33—(Continued).

SN 77-238,761. SINTRA IMPORTS, INC., DBA GRAPEMENTS, NEW BEDFORD, MA. FILED 7-25-2007.

CARM

THE MARK CONSISTS OF STANDARD CHARACTERS WITHOUT CLAIM TO ANY PARTICULAR FONT, STYLE, SIZE, OR COLOR.

FOR WINES (U.S. CLS. 47 AND 49).

FIRST USE 11-30-2002; IN COMMERCE 11-30-2002.

NICHOLAS ALTREE, EXAMINING ATTORNEY

SN 77-227,713. O. PEIRO, HORACIO, DORAL, FL. FILED 7-12-2007.

ADUENTUS

THE MARK CONSISTS OF STANDARD CHARACTERS WITHOUT CLAIM TO ANY PARTICULAR FONT, STYLE, SIZE, OR COLOR.

THE ENGLISH TRANSLATION OF THE LATIN WORD "ADUENTUS" IS "A NEW ARRIVAL".

FOR WINES (U.S. CLS. 47 AND 49).

BARBARA A. GOLD, EXAMINING ATTORNEY

SN 77-252,516. MAISON A.E. DOR, JARNAC, FRANCE, FILED 8-10-2007.

SIGN OF TIME

THE MARK CONSISTS OF STANDARD CHARACTERS WITHOUT CLAIM TO ANY PARTICULAR FONT, STYLE, SIZE, OR COLOR.

OWNER OF FRANCE REG. NO. 073478024, DATED 1-30-2007, EXPIRES 1-29-2017.

FOR DISTILLED SPIRITS INCLUDING COGNAC AND VODKA (U.S. CLS. 47 AND 49).

SANDRA MANIOS, EXAMINING ATTORNEY

SN 77-235,786. BODEGAS MONTECILLO, S.A, LA RI, SPAIN, FILED 7-23-2007.

VIÑA CUMBRERO

THE MARK CONSISTS OF STANDARD CHARACTERS WITHOUT CLAIM TO ANY PARTICULAR FONT, STYLE, SIZE, OR COLOR.

NO CLAIM IS MADE TO THE EXCLUSIVE RIGHT TO USE "VIÑA", APART FROM THE MARK AS SHOWN.

THE ENGLISH TRANSLATION OF "VIÑA" IN THE MARK IS VINEYARD. THE WORDING "CUMBRERO" HAS NO MEANING IN ENGLISH.

FOR WINES (U.S. CLS. 47 AND 49).

JULIE GUTTADAURO, EXAMINING ATTORNEY

SN 77-260,275. THE ARGENTO WINE COMPANY LIMITED, LONDON, UNITED KINGDOM, FILED 8-21-2007.

EL COLECTIVO

THE MARK CONSISTS OF STANDARD CHARACTERS WITHOUT CLAIM TO ANY PARTICULAR FONT, STYLE, SIZE, OR COLOR.

PRIORITY CLAIMED UNDER SEC. 44(D) ON BENELUX APPLICATION NO. 1133906, FILED 4-23-2007.

THE ENGLISH TRANSLATION OF "EL COLECTIVO" IS "THE PUBLIC BUS".

FOR WINES (U.S. CLS. 47 AND 49).

DANIEL CAPSHAW, EXAMINING ATTORNEY

CLASS 33—(Continued).

SN 77-273,458. B & D, INC., NASHVILLE, TN. FILED 9-6-2007.

COWBOY TOWN

THE MARK CONSISTS OF STANDARD CHARACTERS WITHOUT CLAIM TO ANY PARTICULAR FONT, STYLE, SIZE, OR COLOR.

FOR WINE, PREPARED WINE COCKTAILS, WINE COOLERS; PREPARED ALCOHOLIC COCKTAILS; LIQUORS, LIQUEURS, DISTILLED SPIRITS (U.S. CLS. 47 AND 49).

KAPIL BHANOT, EXAMINING ATTORNEY

CLASS 33—(Continued).

SN 77-275,992. THE WINE GROUP LLC, TRACY, CA. FILED 9-10-2007.

CALIFORNIA COLONY

THE MARK CONSISTS OF STANDARD CHARACTERS WITHOUT CLAIM TO ANY PARTICULAR FONT, STYLE, SIZE, OR COLOR.

OWNER OF U.S. REG. NO. 1,456,760.
NO CLAIM IS MADE TO THE EXCLUSIVE RIGHT TO USE "CALIFORNIA", APART FROM THE MARK AS SHOWN.

FOR WINE (U.S. CLS. 47 AND 49).
JAMES A. RAUEN, EXAMINING ATTORNEY

SN 77-275,262. VINA CARTA VIEJA S.A., VILLA ALEGRE, CHILE, FILED 9-10-2007.

Lucky Toki

THE MARK CONSISTS OF STANDARD CHARACTERS WITHOUT CLAIM TO ANY PARTICULAR FONT, STYLE, SIZE, OR COLOR.

THE WORDING "TOKI" HAS NO MEANING IN A FOREIGN LANGUAGE.

FOR WINES (U.S. CLS. 47 AND 49).
KELLEY WELLS, EXAMINING ATTORNEY

SN 77-281,604. MAGNIFICENT WINE COMPANY LLC, DBA C/O PRECEPT BRANDS LLC, SEATTLE, WA. FILED 9-17-2007.

STEAK HOUSE

THE MARK CONSISTS OF STANDARD CHARACTERS WITHOUT CLAIM TO ANY PARTICULAR FONT, STYLE, SIZE, OR COLOR.

FOR WINE (U.S. CLS. 47 AND 49).
FIRST USE 4-15-2007; IN COMMERCE 4-15-2007.
REBECCA EISINGER, EXAMINING ATTORNEY

SN 77-275,265. VINA CARTA VIEJA S.A., VILLA ALEGRE, CHILE, FILED 9-10-2007.

Lucky Winka

THE MARK CONSISTS OF STANDARD CHARACTERS WITHOUT CLAIM TO ANY PARTICULAR FONT, STYLE, SIZE, OR COLOR.

THE WORDING "WINKA" HAS NO MEANING IN A FOREIGN LANGUAGE.

FOR WINES (U.S. CLS. 47 AND 49).
KELLEY WELLS, EXAMINING ATTORNEY

SN 77-285,369. RESTAURANTS PACINI, INC., LA PRAIRIE, QUEBEC, CANADA, FILED 9-21-2007.

IL GUERRINO

THE MARK CONSISTS OF STANDARD CHARACTERS WITHOUT CLAIM TO ANY PARTICULAR FONT, STYLE, SIZE, OR COLOR.

PRIORITY CLAIMED UNDER SEC. 44(D) ON CANADA APPLICATION NO. 1359355, FILED 8-10-2007.

FOR WINES (U.S. CLS. 47 AND 49).
PATRICIA EVANKO, EXAMINING ATTORNEY

CLASS 33—(Continued).

SN 77-286,222. JEFFREY S. HOROWITZ, DBA RIO LAGO RANCH & VINEYARD, BERKELEY, CA. AND LYNN R. HOROWITZ, DBA RIO LAGO RANCH & VINEYARD, BERKELEY, CA. FILED 9-21-2007.

RIO LAGO RANCH & VINEYARD

THE MARK CONSISTS OF STANDARD CHARACTERS WITHOUT CLAIM TO ANY PARTICULAR FONT, STYLE, SIZE, OR COLOR.

NO CLAIM IS MADE TO THE EXCLUSIVE RIGHT TO USE "RANCH & VINEYARD", APART FROM THE MARK AS SHOWN.

THE ENGLISH TRANSLATION OF "RIO LAGO" IS RIVER LAKE.

FOR WINE (U.S. CLS. 47 AND 49).
SANJEEV VOHRA, EXAMINING ATTORNEY

SN 77-288,685. ADMIRAL WINE & LIQUOR CO., INC., CEDAR GROVE, NJ. FILED 9-25-2007.

LA TERRA FINA

THE MARK CONSISTS OF STANDARD CHARACTERS WITHOUT CLAIM TO ANY PARTICULAR FONT, STYLE, SIZE, OR COLOR.

THE FOREIGN WORDING IN THE MARK TRANSLATES INTO ENGLISH AS FINE EARTH.

FOR WINE (U.S. CLS. 47 AND 49).
FIRST USE 0-0-1998; IN COMMERCE 0-0-1998.
ANNE MADDEN, EXAMINING ATTORNEY

SN 77-289,029. GARGALO, S.L., PAZOS (VERIN) ORENSE, SPAIN, FILED 9-26-2007.

TERRA DO GARGALO

THE MARK CONSISTS OF STANDARD CHARACTERS WITHOUT CLAIM TO ANY PARTICULAR FONT, STYLE, SIZE, OR COLOR.

PRIORITY CLAIMED UNDER SEC. 44(D) ON ERPNCMNTY TM OFC APPLICATION NO. 6303051, FILED 9-24-2007.

THE FOREIGN WORDING IN THE MARK TRANSLATES INTO ENGLISH AS "LAND OF".

FOR WINES (U.S. CLS. 47 AND 49).
CHERYL CLAYTON, EXAMINING ATTORNEY

CLASS 33—(Continued).

SN 77-289,063. INTERCONTINENTAL PACKAGING CO., ST. PAUL, MN. FILED 9-26-2007.

GREENER PEACE

THE MARK CONSISTS OF STANDARD CHARACTERS WITHOUT CLAIM TO ANY PARTICULAR FONT, STYLE, SIZE, OR COLOR.

FOR WINES (U.S. CLS. 47 AND 49).
NAKIA HENRY, EXAMINING ATTORNEY

SN 77-290,424. MONTENEGRO S.R.L., ZOLA PREDOSA, BOLOGNA, ITALY, FILED 9-27-2007.

ROSSO ANTICO

THE MARK CONSISTS OF STANDARD CHARACTERS WITHOUT CLAIM TO ANY PARTICULAR FONT, STYLE, SIZE, OR COLOR.

NO CLAIM IS MADE TO THE EXCLUSIVE RIGHT TO USE "ROSSO", APART FROM THE MARK AS SHOWN.

THE ENGLISH TRANSLATION OF "ROSSO ANTICO" IS "OLD RED".

FOR ALCOHOLIC APERITIFS DERIVED FROM RED WINE (U.S. CLS. 47 AND 49).

H. M. FISHER, EXAMINING ATTORNEY

SN 77-290,539. E. & J. GALLO WINERY, MODESTO, CA. FILED 9-27-2007.

OPEN DOOR

THE MARK CONSISTS OF STANDARD CHARACTERS WITHOUT CLAIM TO ANY PARTICULAR FONT, STYLE, SIZE, OR COLOR.

FOR ALCOHOLIC BEVERAGES EXCEPT BEERS (U.S. CLS. 47 AND 49).

MICHAEL KAZAZIAN, EXAMINING ATTORNEY

CLASS 33—(Continued).

SN 77-290,548. E. & J. GALLO WINERY, MODESTO, CA.
FILED 9-27-2007.

CLASS 33—(Continued).

SN 77-292,431. FERRAIUOLO, ENZO MARCO, SAULHEIM,
FED REP GERMANY, AND CLASS, SEBASTIAN, VEN-
DERSHEIM, FED REP GERMANY, FILED 9-30-2007.

SMILING EYES

Golden Liaison

THE MARK CONSISTS OF STANDARD CHARACTERS
WITHOUT CLAIM TO ANY PARTICULAR FONT, STYLE,
SIZE, OR COLOR.
FOR ALCOHOLIC BEVERAGES EXCEPT BEERS (U.S.
CLS. 47 AND 49).
MICHAEL KAZAZIAN, EXAMINING ATTORNEY

THE MARK CONSISTS OF STANDARD CHARACTERS
WITHOUT CLAIM TO ANY PARTICULAR FONT, STYLE,
SIZE, OR COLOR.
FOR SPARKLING GRAPE WINE (U.S. CLS. 47 AND
49).
MICHAEL ENGEL, EXAMINING ATTORNEY

SN 77-291,334. QUADRO GROUP, L.L.C., IOWA CITY, IA.
FILED 9-28-2007.

SN 77-292,612. BODEGAS PALACIOS REMONDO, S.A.,
ALFARO [LA RIOJA], SPAIN, FILED 10-1-2007.

WE'VE GOT THE PROOF

LA MONTESA

THE MARK CONSISTS OF STANDARD CHARACTERS
WITHOUT CLAIM TO ANY PARTICULAR FONT, STYLE,
SIZE, OR COLOR.
FOR VODKA (U.S. CLS. 47 AND 49).
FIRST USE 4-28-2007; IN COMMERCE 4-28-2007.
BERYL GARDNER, EXAMINING ATTORNEY

THE MARK CONSISTS OF STANDARD CHARACTERS
WITHOUT CLAIM TO ANY PARTICULAR FONT, STYLE,
SIZE, OR COLOR.
THE FOREIGN WORDING IN THE MARK TRANSLATES
INTO ENGLISH AS THE MOUNTAINS.
FOR WINES (U.S. CLS. 47 AND 49).
FIRST USE 7-31-2006; IN COMMERCE 7-31-2006.
KAREN BRACEY, EXAMINING ATTORNEY

SN 77-291,695. KATZ, STEVEN, FORT LAUDERDALE, FL.
AND GIRAUD, CECILE, FORT LAUDERDALE, FL.
FILED 9-28-2007.

SN 77-292,626. BODEGAS PALACIOS REMONDO, S.A.,
ALFARO (LA RIOJA), SPAIN, FILED 10-1-2007.

Chocovine

PROPIEDAD

THE MARK CONSISTS OF STANDARD CHARACTERS
WITHOUT CLAIM TO ANY PARTICULAR FONT, STYLE,
SIZE, OR COLOR.
FOR WINE (U.S. CLS. 47 AND 49).
BARBARA BROWN, EXAMINING ATTORNEY

THE MARK CONSISTS OF STANDARD CHARACTERS
WITHOUT CLAIM TO ANY PARTICULAR FONT, STYLE,
SIZE, OR COLOR.
THE FOREIGN WORDING IN THE MARK TRANSLATES
INTO ENGLISH AS PROPERTY.
FOR WINES (U.S. CLS. 47 AND 49).
FIRST USE 7-31-2006; IN COMMERCE 7-31-2006.
KAREN BRACEY, EXAMINING ATTORNEY

CLASS 33—(Continued).

SN 77-292,638. BODEGAS PALACIOS REMONDO, S.A., ALFARO (LA RIOJA), SPAIN, FILED 10-1-2007.

PLACET

THE MARK CONSISTS OF STANDARD CHARACTERS WITHOUT CLAIM TO ANY PARTICULAR FONT, STYLE, SIZE, OR COLOR.

THE FOREIGN WORDING IN THE MARK TRANSLATES INTO ENGLISH AS APPROVAL.

FOR WINES (U.S. CLS. 47 AND 49).

FIRST USE 11-5-1998; IN COMMERCE 11-5-1998.

KAREN BRACEY, EXAMINING ATTORNEY

SN 77-292,958. SAN ANTONIO WINERY, INC., LOS ANGELES, CA. FILED 10-1-2007.

WINDBREAK

THE MARK CONSISTS OF STANDARD CHARACTERS WITHOUT CLAIM TO ANY PARTICULAR FONT, STYLE, SIZE, OR COLOR.

FOR WINES (U.S. CLS. 47 AND 49).

KRISTIN DAHLING, EXAMINING ATTORNEY

SN 77-293,823. BATCHELOR, RAYMOND O., UNION, NJ. FILED 10-2-2007.



NO CLAIM IS MADE TO THE EXCLUSIVE RIGHT TO USE "EST. 2001" AND "QUALITY HAITIAN CREMAS", APART FROM THE MARK AS SHOWN.

THE NAME(S), PORTRAIT(S), AND/OR SIGNATURE(S) SHOWN IN THE MARK DOES NOT IDENTIFY A PARTICULAR LIVING INDIVIDUAL.

THE COLOR(S) RED, GREEN, YELLOW, BROWN, TAN BLACK AND WHITE IS/ARE CLAIMED AS A FEATURE OF THE MARK.

THE MARK CONSISTS OF THE UPPER HALF OF A BARE CHEST WOMAN WITH TAN SKIN TONE, WEARING RED LIPSTICK OUTLINED IN BLACK, WITH WHITE AND BLACK HAIR, BLACK EYES AND NOSE AND THE LETTERS "BMS" ON HER ARM IN BLACK.; THE WOMAN IS ENCIRCLED BY A BLACK CIRCLE WITH YELLOW FLARES AND BLACK LINES EXTENDING FROM THE BORDER; THE MARK DISPLAYS 2 PALM TREES WITH GREEN LEAVES & BROWN TRUNKS WITH BLACK LINING, PLACED TO BE PARTIALLY HIDDEN BEHIND THE CIRCLE; WITHIN THE TOP PART OF THE CIRCLE THE

CLASS 33—(Continued).

MARK DISPLAYS THE WORD "BREASTMILKSHAKE" IN BLACK. BELOW THIS ARE THE LETTERS "VI" AND THE WORDS "GENERATIONS OF QUALITY HAITIAN CREMAS" BELOW THAT ALL IN BLACK. THE CIRCLE ALSO CONTAINS THE WORDS "EST. 2001" AND THE NUMERAL FIVE NEXT TO A STAR, ALL IN BLACK TO THE LEFT OF THE WOMAN AND A CROWN AND TWO GLASSES BOTH IN BLACK TO THE RIGHT OF THE WOMAN. ABOVE THE ENTIRE DESIGN IS THE WORD "BREASTMILKSHAKE" ALL IN BLACK.

THE ENGLISH TRANSLATION OF "CREMAS" IN THE MARK IS "CREAM".

FOR ALCOHOLIC COCKTAILS CONTAINING MILK (U.S. CLS. 47 AND 49).

FRANK LATTUCA, EXAMINING ATTORNEY

SN 77-294,447. LUZ MARIA DEL SOCORRO OROZCO GOMEZ, CIUDAD GUZMAN, MEXICO, FILED 10-2-2007.



OWNER OF MEXICO REG. NO. 688287, DATED 7-25-2005, EXPIRES 2-25-2015.

THE MARK CONSISTS OF A VOLCANO WITH THE WORDS "ARDIENTE PASIÓN" IN A BANNER GOING ACROSS THE VOLCANO.

THE FOREIGN WORDING IN THE MARK TRANSLATES INTO ENGLISH AS "HOT PASSION".

FOR ALCOHOLIC BEVERAGES EXCEPT BEERS; ALCOHOLIC BEVERAGES, NAMELY, TEQUILA; TEQUILA (U.S. CLS. 47 AND 49).

SALLY SHIH, EXAMINING ATTORNEY

SN 77-294,863. WHITE ROCK DISTILLERIES, INC., LEWISTON, ME. FILED 10-3-2007.

VOLGA

THE MARK CONSISTS OF STANDARD CHARACTERS WITHOUT CLAIM TO ANY PARTICULAR FONT, STYLE, SIZE, OR COLOR.

FOR VODKA (U.S. CLS. 47 AND 49).

REBECCA EISINGER, EXAMINING ATTORNEY

CLASS 33—(Continued).

SN 77-295,346. ZONIN U.S.A. INC., CHARLOTTESVILLE, VA. FILED 10-3-2007.

FIOROSA

THE MARK CONSISTS OF STANDARD CHARACTERS WITHOUT CLAIM TO ANY PARTICULAR FONT, STYLE, SIZE, OR COLOR.

FOR WINE (U.S. CLS. 47 AND 49).
CHARLES L. JENKINS, EXAMINING ATTORNEY

SN 77-295,475. MINSK, LEE, CALDWELL, NJ. FILED 10-3-2007.

50 CALIBER BULLET

THE MARK CONSISTS OF STANDARD CHARACTERS WITHOUT CLAIM TO ANY PARTICULAR FONT, STYLE, SIZE, OR COLOR.

FOR ALCOHOLIC MALT COOLERS; PREPARED WINE COCKTAILS; SPARKLING WINE; WINE COOLERS; FLAVORED BREWED MALT BEVERAGE; RUM; ALCOHOLIC BEVERAGE PRODUCED FROM A BREWED MALT BASE WITH NATURAL FLAVORS; ALCOHOLIC BEVERAGES OF FRUIT; PREPARED ALCOHOLIC COCKTAIL; VODKA; TEQUILA; ALCOHOLIC COCKTAIL MIXES; LIQUOR (U.S. CLS. 47 AND 49).
MARIA-VICTORIA SUAREZ, EXAMINING ATTORNEY

SN 77-295,489. HCA WINERY ACQUISITION LLC, DBA THE WINERY AT HOLY CROSS ABBEY, CANON CITY, CO. FILED 10-3-2007.

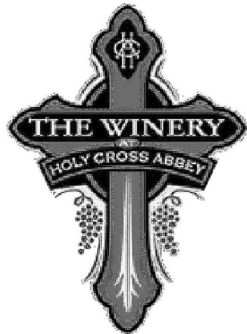

THE MARK CONSISTS OF STYLIZED CROSS .
FOR ALCOHOLIC BEVERAGES, NAMELY, WINES, DESSERT WINES, FORTIFIED WINES AND WINE BASED BEVERAGES (U.S. CLS. 47 AND 49).
FIRST USE 7-5-2002; IN COMMERCE 7-5-2002.
LESLIE RICHARDS, EXAMINING ATTORNEY

CLASS 33—(Continued).

SN 77-295,923. CHRISTIANSON CELLARS LLC, PALISADE, CO. FILED 10-4-2007.

CANYON WIND

THE MARK CONSISTS OF STANDARD CHARACTERS WITHOUT CLAIM TO ANY PARTICULAR FONT, STYLE, SIZE, OR COLOR.

FOR (BASED ON USE IN COMMERCE) WINE (U.S. CLS. 47 AND 49).
FIRST USE 11-19-1997; IN COMMERCE 8-6-1998.
MATTHEW PAPPAS, EXAMINING ATTORNEY

SN 77-296,483. HERMSMEYER, JOSHUA T, SANTA ROSA, CA. FILED 10-4-2007.

You had me at pinot

THE MARK CONSISTS OF STANDARD CHARACTERS WITHOUT CLAIM TO ANY PARTICULAR FONT, STYLE, SIZE, OR COLOR.

FOR WINE (U.S. CLS. 47 AND 49).
LINDA M. KING, EXAMINING ATTORNEY

SN 77-296,881. INTERCONTINENTAL PACKAGING CO., ST. PAUL, MN. FILED 10-5-2007.

FARMERS PATH

THE MARK CONSISTS OF STANDARD CHARACTERS WITHOUT CLAIM TO ANY PARTICULAR FONT, STYLE, SIZE, OR COLOR.

FOR WINES (U.S. CLS. 47 AND 49).
NAKIA HENRY, EXAMINING ATTORNEY

CLASS 33—(Continued).

SN 77-298,127. RJS, LLC, LOUISVILLE, KY. FILED 10-7-2007.

rhythm

THE MARK CONSISTS OF STANDARD CHARACTERS WITHOUT CLAIM TO ANY PARTICULAR FONT, STYLE, SIZE, OR COLOR.

FOR ALCOHOLIC BEVERAGES, NAMELY, CORDIALS AND LIQUEURS CONTAINING CAFFEINE (U.S. CLS. 47 AND 49).

ZACHARY BELLO, EXAMINING ATTORNEY

CLASS 33—(Continued).

SN 77-303,024. INTERCONTINENTAL PACKAGING CO., ST. PAUL, MN. FILED 10-12-2007.

EL COMPAÑERO

THE MARK CONSISTS OF STANDARD CHARACTERS WITHOUT CLAIM TO ANY PARTICULAR FONT, STYLE, SIZE, OR COLOR.

THE FOREIGN WORDING IN THE MARK TRANSLATES INTO ENGLISH AS "THE COMPANION".

FOR WINES (U.S. CLS. 47 AND 49).

FIRST USE 8-31-2007; IN COMMERCE 8-31-2007.

NAKIA HENRY, EXAMINING ATTORNEY

SN 77-298,132. RJS, LLC, LOUISVILLE, KY. FILED 10-7-2007.

e natural rhythm

THE MARK CONSISTS OF STANDARD CHARACTERS WITHOUT CLAIM TO ANY PARTICULAR FONT, STYLE, SIZE, OR COLOR.

FOR ALCOHOLIC BEVERAGES, NAMELY, CORDIALS AND LIQUEURS CONTAINING CAFFEINE (U.S. CLS. 47 AND 49).

ZACHARY BELLO, EXAMINING ATTORNEY

SN 77-298,135. RJS, LLC, LOUISVILLE, KY. FILED 10-7-2007.

What's Your Rhythm?

THE MARK CONSISTS OF STANDARD CHARACTERS WITHOUT CLAIM TO ANY PARTICULAR FONT, STYLE, SIZE, OR COLOR.

FOR ALCOHOLIC BEVERAGES, NAMELY, CORDIALS AND LIQUEURS CONTAINING CAFFEINE (U.S. CLS. 47 AND 49).

ZACHARY BELLO, EXAMINING ATTORNEY

SN 77-303,089. L'ORMARINS (PTY) LIMITED, CAPE TOWN, SOUTH AFRICA, FILED 10-12-2007.

JEAN ROI

THE MARK CONSISTS OF STANDARD CHARACTERS WITHOUT CLAIM TO ANY PARTICULAR FONT, STYLE, SIZE, OR COLOR.

OWNER OF SOUTH AFRICA REG. NO. 1972/00655, DATED 9-9-1974, EXPIRES 1-25-2012.

THE NAME "JEAN ROI" IN THE MARK DOES NOT IDENTIFY A LIVING INDIVIDUAL.

THE ENGLISH TRANSLATION OF "ROI" IS KING.

FOR WINES (U.S. CLS. 47 AND 49).

MICHAEL KEATING, EXAMINING ATTORNEY

SN 77-304,870. WHITE ROCK DISTILLERIES, INC., LEWISTON, ME. FILED 10-16-2007.

SUPERIA

THE MARK CONSISTS OF STANDARD CHARACTERS WITHOUT CLAIM TO ANY PARTICULAR FONT, STYLE, SIZE, OR COLOR.

FOR VODKA (U.S. CLS. 47 AND 49).

REBECCA EISINGER, EXAMINING ATTORNEY

CLASS 33—(Continued).

SN 77-306,531. MYCABO.COM, LA JOLLA, CA. FILED 10-17-2007.



OWNER OF U.S. REG. NO. 3,373,926.
THE COLOR(S) RED AND BLACK IS/ARE CLAIMED AS
A FEATURE OF THE MARK.

THE MARK CONSISTS OF THE LITERAL ELEMENT
"NADARED!", WHERE THE LETTERS "N" AND "R" ARE
DISPLAYED BACKWARDS, AND A DESIGN ELEMENT
COMPRISING A FIVE POINTED STAR FEATURING A
LARGE CRACK AND A HAMMER. THE COLOR RED
APPEARS IN THE WORD "RED!" AND IN THE STAR. THE
COLOR BLACK APPEARS IN THE WORD "NADA" AND IN
THE HAMMER. THE COLOR WHITE CONSTITUTES
BACKGROUND AND IS NOT A FEATURE OF THE MARK.

THE ENGLISH TRANSLATION OF THE WORD "NADA"
IN THE MARK IS NOTHING.

FOR CACHACA; RUM; TEQUILA; VODKA; WHISKEY
(U.S. CLS. 47 AND 49).

LAURIE KAUFMAN, EXAMINING ATTORNEY

CLASS 33—(Continued).

SN 77-316,431. SUTTER HOME WINERY, INC., ST. HELENA,
CA. FILED 10-29-2007.

TRIPLE T VINEYARD

THE MARK CONSISTS OF STANDARD CHARACTERS
WITHOUT CLAIM TO ANY PARTICULAR FONT, STYLE,
SIZE, OR COLOR.

NO CLAIM IS MADE TO THE EXCLUSIVE RIGHT TO
USE "VINEYARD", APART FROM THE MARK AS SHOWN.
FOR WINE (U.S. CLS. 47 AND 49).

GEORGE LORENZO, EXAMINING ATTORNEY

SN 77-321,025. INTERCONTINENTAL PACKAGING CO., ST.
PAUL, MN. FILED 11-5-2007.

RELEAF

THE MARK CONSISTS OF STANDARD CHARACTERS
WITHOUT CLAIM TO ANY PARTICULAR FONT, STYLE,
SIZE, OR COLOR.

FOR WINES (U.S. CLS. 47 AND 49).

NAKIA HENRY, EXAMINING ATTORNEY

SN 77-314,465. BISON CAPITAL LLC, VENICE, FL. FILED 10-
26-2007.

BLOOD HORSE

THE MARK CONSISTS OF STANDARD CHARACTERS
WITHOUT CLAIM TO ANY PARTICULAR FONT, STYLE,
SIZE, OR COLOR.

FOR DISTILLED SPIRITS (U.S. CLS. 47 AND 49).

COLLEEN KEARNEY, EXAMINING ATTORNEY

SN 77-343,232. INTERCONTINENTAL PACKAGING CO., ST.
PAUL, MN. FILED 12-4-2007.

PURIO

THE MARK CONSISTS OF STANDARD CHARACTERS
WITHOUT CLAIM TO ANY PARTICULAR FONT, STYLE,
SIZE, OR COLOR.

THE WORDING "PURIO" HAS NO MEANING IN A
FOREIGN LANGUAGE.

FOR WINES (U.S. CLS. 47 AND 49).

NAKIA HENRY, EXAMINING ATTORNEY

CLASS 33—(Continued).

SN 77-354,689. INTERCONTINENTAL PACKAGING CO., ST. PAUL, MN. FILED 12-18-2007.

BELLITALIA

THE MARK CONSISTS OF STANDARD CHARACTERS WITHOUT CLAIM TO ANY PARTICULAR FONT, STYLE, SIZE, OR COLOR.

THE WORDING "BELLITALIA" HAS NO MEANING IN A FOREIGN LANGUAGE.

FOR WINES (U.S. CLS. 47 AND 49).
FIRST USE 8-31-2007; IN COMMERCE 8-31-2007.
NAKIA HENRY, EXAMINING ATTORNEY

SN 78-724,898. GILA TEQUILA, INC., HOLLYWOOD, FL. FILED 10-3-2005.

COSTA AZUL

THE MARK CONSISTS OF STANDARD CHARACTERS WITHOUT CLAIM TO ANY PARTICULAR FONT, STYLE, SIZE, OR COLOR.

THE ENGLISH TRANSLATION OF "COSTA AZUL" IS BLUE COAST.

FOR VODKA (U.S. CLS. 47 AND 49).
PAUL CROWLEY, EXAMINING ATTORNEY

SN 78-829,377. SOCIEDADE QUINTA DO PORTAL, SA, PORTO, PORTUGAL, FILED 3-4-2006.

Portal

THE MARK CONSISTS OF STANDARD CHARACTERS WITHOUT CLAIM TO ANY PARTICULAR FONT, STYLE, SIZE, OR COLOR.

OWNER OF PORTUGAL REG. NO. 317790, DATED 4-21-1999, EXPIRES 4-21-2009.
SEC. 2(F).

FOR ALCOHOLIC BEVERAGES, NAMELY, WINE (U.S. CLS. 47 AND 49).
FIRST USE 0-0-1997; IN COMMERCE 7-29-2002.
SALLY SHIH, EXAMINING ATTORNEY

CLASS 33—(Continued).

SN 78-829,390. SOCIEDADE QUINTA DO PORTAL, SA, PORTO, PORTUGAL, FILED 3-4-2006.

Porto Alegre

THE MARK CONSISTS OF STANDARD CHARACTERS WITHOUT CLAIM TO ANY PARTICULAR FONT, STYLE, SIZE, OR COLOR.

OWNER OF PORTUGAL REG. NO. 004009908, DATED 5-16-2006, EXPIRES 9-3-2014.

OWNER OF PORTUGAL REG. NO. 316181, DATED 11-6-1996, RENEWED AS REG. NO. 316181, DATED 11-6-2006, EXPIRES 11-6-2016.

THE FOREIGN WORDING IN THE MARK TRANSLATES INTO ENGLISH AS HAPPY PORT.

FOR ALCOHOLIC BEVERAGES, NAMELY, PORT WINE (U.S. CLS. 47 AND 49).

FIRST USE 0-0-1998; IN COMMERCE 0-0-1999.
SALLY SHIH, EXAMINING ATTORNEY

SN 78-925,361. ALTA VISTA S.A., MENDOZA, ARGENTINA, FILED 7-10-2006.

**TERROIR EXPRESSION
WINEMAKERS**

THE MARK CONSISTS OF STANDARD CHARACTERS WITHOUT CLAIM TO ANY PARTICULAR FONT, STYLE, SIZE, OR COLOR.

OWNER OF ARGENTINA REG. NO. 1992962, DATED 9-27-2004, EXPIRES 9-24-2014.

NO CLAIM IS MADE TO THE EXCLUSIVE RIGHT TO USE "WINEMAKERS", APART FROM THE MARK AS SHOWN.

FOR WINES (U.S. CLS. 47 AND 49).
JENNIFER VASQUEZ, EXAMINING ATTORNEY

CLASS 33—(Continued).

SN 78-936,135. CANADIAN CLUB CANADA INC., OAKVILLE, ONTARIO, FILED 7-24-2006.



NO CLAIM IS MADE TO THE EXCLUSIVE RIGHT TO USE "1858", "PREMIUM" AND "QUALITY", APART FROM THE MARK AS SHOWN.

THE COLOR(S) RED, WHITE AND GOLD IS/ARE CLAIMED AS A FEATURE OF THE MARK.

THE MARK CONSISTS OF THE COLOR RED WHICH APPEARS IN THE SHIELD DESIGN; THE COLOR GOLD APPEARS AS TRIM TO THE SHIELD DESIGN, THE CROWN DESIGN, THE LION DESIGN ELEMENTS AND THE RIBBON DESIGN; THE COLOR WHITE APPEARS IN "1858", THE LETTERS "CC" AND THE WORDING "PREMIUM CANADIAN CLUB QUALITY".

SEC. 2(F) AS TO "CANADIAN".

FOR WHISKEY (U.S. CLS. 47 AND 49).

DAVID MURRAY, EXAMINING ATTORNEY

CLASS 33—(Continued).

SN 78-960,981. JAYBIRD SPIRITS CO., LLC, WILMINGTON, DE. FILED 8-25-2006.



JAYBIRD
VODKA

NO CLAIM IS MADE TO THE EXCLUSIVE RIGHT TO USE "VODKA", APART FROM THE MARK AS SHOWN.

THE COLOR(S) BLUE AND BLACK IS/ARE CLAIMED AS A FEATURE OF THE MARK.

THE MARK CONSISTS OF A DEPICTION OF A BIRD WITH A BLACK BODY AND A BLUE CREST; THE WORD "JAYBIRD" APPEARS BELOW THE IMAGE WITH "JAY" IN BLUE FONT AND "BIRD" IN BLACK FONT; THE WORD "VODKA" APPEARS BELOW THE WORD "JAYBIRD".

FOR VODKA (U.S. CLS. 47 AND 49).

SHAUNIA CARLYLE, EXAMINING ATTORNEY

SN 78-948,947. PHILIPS, DANIEL, OXNARD, CA. FILED 8-9-2006.

BLUESCREW

THE MARK CONSISTS OF STANDARD CHARACTERS WITHOUT CLAIM TO ANY PARTICULAR FONT, STYLE, SIZE, OR COLOR.

FOR WINES (U.S. CLS. 47 AND 49).

KELLY BOULTON, EXAMINING ATTORNEY

SN 79-030,500. LEGARIS S.L., SPAIN, FILED 10-20-2006.

ZENDO

THE MARK CONSISTS OF STANDARD CHARACTERS WITHOUT CLAIM TO ANY PARTICULAR FONT, STYLE, SIZE, OR COLOR.

PRIORITY DATE OF 5-29-2006 IS CLAIMED.

OWNER OF INTERNATIONAL REGISTRATION 0902477 DATED 10-20-2006, EXPIRES 10-20-2016.

FOR WINES (U.S. CLS. 47 AND 49).

JAY BESCH, EXAMINING ATTORNEY

CLASS 33—(Continued).

SN 79-035,227. FEDERAL STATE ENTERPRISE; "SOJUZPLODOIMPORT", RU-107139 MOSCOW, RUSSIAN FED., FILED 12-27-2006.



OWNER OF INTERNATIONAL REGISTRATION 0915515 DATED 12-27-2006, EXPIRES 12-27-2016.

NO CLAIM IS MADE TO THE EXCLUSIVE RIGHT TO USE "KUBANSKAYA" "IMPORTED FROM THE USSR," "VODKA," "40% (70% PROOF)," "DISTILLED AND BOTTLED IN THE USSR," "MOSCOW," "0.5 LITRE," "COOL BEFORE DRINKING," AND "RUSSIAN VODKA", APART FROM THE MARK AS SHOWN.

THE ENGLISH TRANSLATION OF THE WORD "KUBANSKAYA" IN THE MARK MEANS OF "THE KUBAN" – A REGION OF RUSSIA THAT EXISTED DURING THE RUSSIAN EMPIRE.

THE NON-LATIN CHARACTERS IN THE MARK TRANSLITERATE TO "SPI", WHICH, IN ENGLISH, ARE A SHORT-HAND WAY OF DESIGNATING SOJUZPLODOIMPORT.

FOR VODKA (U.S. CLS. 47 AND 49).

COLLEEN KEARNEY, EXAMINING ATTORNEY

SN 79-035,516. GFR CHATEAU MENTONE, FRANCE, FILED 2-9-2007.

CHATEAU MENTONE

THE MARK CONSISTS OF STANDARD CHARACTERS WITHOUT CLAIM TO ANY PARTICULAR FONT, STYLE, SIZE, OR COLOR.

PRIORITY DATE OF 9-5-2006 IS CLAIMED.

OWNER OF INTERNATIONAL REGISTRATION 0916334 DATED 2-9-2007, EXPIRES 2-9-2017.

NO CLAIM IS MADE TO THE EXCLUSIVE RIGHT TO USE "CHATEAU", APART FROM THE MARK AS SHOWN. FOR WINE (U.S. CLS. 47 AND 49).

REBECCA GILBERT, EXAMINING ATTORNEY

SN 79-038,236. ROUX PERE ET FILS, F-21190 MEURSAULT, FRANCE, FILED 4-10-2007.

ROUX PERE & FILS

THE MARK CONSISTS OF STANDARD CHARACTERS WITHOUT CLAIM TO ANY PARTICULAR FONT, STYLE, SIZE, OR COLOR.

PRIORITY DATE OF 1-8-2007 IS CLAIMED.

OWNER OF INTERNATIONAL REGISTRATION 0923456 DATED 4-10-2007, EXPIRES 4-10-2017.

THE ENGLISH TRANSLATION OF "PERE ET FILS" IN THE MARK IS FATHER & SONS.

FOR ALCOHOLIC BEVERAGES, NAMELY, WINES (U.S. CLS. 47 AND 49).

JENNIFER MARTIN, EXAMINING ATTORNEY

CLASS 33—(Continued).

SN 79-038,586. UTO NEDERLAND B.V., NETHERLANDS, FILED 5-8-2007.



PRIORITY DATE OF 11-10-2006 IS CLAIMED. OWNER OF INTERNATIONAL REGISTRATION 0924442 DATED 5-8-2007, EXPIRES 5-8-2017.

OWNER OF U.S. REG. NO. 3,117,324.

NO CLAIM IS MADE TO THE EXCLUSIVE RIGHT TO USE "XO", APART FROM THE MARK AS SHOWN.

THE NAME(S), PORTRAIT(S), AND/OR SIGNATURE(S) SHOWN IN THE MARK DOES NOT IDENTIFY A PARTICULAR LIVING INDIVIDUAL.

THE COLOR(S) BLACK, RED, GOLD AND WHITE IS/ARE CLAIMED AS A FEATURE OF THE MARK.

THE WORDING "JOSEPH GUY" IS BLACK; THE OUTLINE OF THE OVAL, THE DESIGN INSIDE THE OVAL, THE HORIZONTAL LINES, THE OUTLINING OF THE WORDING "JOSEPH GUY", THE LETTERS "XO" AND THE DOT BETWEEN THE LETTERS "X" AND "O" ARE ALL THE COLOR GOLD; THE INTERIOR OF THE OVAL IS SHADES OF RED; AND THE ENTIRE MARK IS ON A WHITE BACKGROUND.

FOR ALCOHOLIC BEVERAGES, NAMELY, HARD LIQUOR, EAUX-DE-VIE, LIQUERS AND COGNAC (U.S. CLS. 47 AND 49).

AMY MCMENAMIN, EXAMINING ATTORNEY

SN 79-038,587. UTO NEDERLAND B.V., NL-3111 PS SCHIEDAM, NETHERLANDS, FILED 5-8-2007.



PRIORITY DATE OF 11-10-2006 IS CLAIMED. OWNER OF INTERNATIONAL REGISTRATION 0924443 DATED 5-8-2007, EXPIRES 5-8-2017.

OWNER OF U.S. REG. NO. 3,117,324.

THE NAME(S), PORTRAIT(S), AND/OR SIGNATURE(S) SHOWN IN THE MARK DOES NOT IDENTIFY A PARTICULAR LIVING INDIVIDUAL.

THE COLOR(S) GOLD, BROWN, BLACK AND RED IS/ARE CLAIMED AS A FEATURE OF THE MARK.

THE WORDING "JOSEPH GUY" AND "DARE QUAM ACCIPERE", THE HORIZONTAL LINE ABOVE THE WORDING "JOSEPH GUY" AND THE DOTTED LINE BELOW THE STARS ARE ALL BLACK; THE BACKGROUND, OUTLINE OF THE OVAL, THE SIGNATURE, THE DESIGN IN THE OVAL AND THE MIDDLE OF THE BAR UNDER THE WORDING "JOSEPH GUY" ARE ALL GOLD; THE INTERIOR OF THE OVAL AND THE STARS ARE RED; AND THE ENDS OF THE BAR UNDER THE WORD "JOSEPH GUY" AND THE ENDS OF THE LINES IN THE LINED BACKGROUND SURROUNDING THE OVAL ARE ALL BROWN.

THE ENGLISH TRANSLATION OF THE WORDING "DARE QUAM ACCIPERE" IN THE MARK IS "IT IS BETTER TO GIVE THAN TO RECEIVE".

FOR ALCOHOLIC BEVERAGES, NAMELY, HARD LIQUOR, EAUX-DE-VIE, LIQUERS AND COGNAC (U.S. CLS. 47 AND 49).

JENNIFER VASQUEZ, EXAMINING ATTORNEY

CLASS 33—(Continued).

SN 79-038,691. UTO NEDERLAND B.V., NETHERLANDS, FILED 5-8-2007.

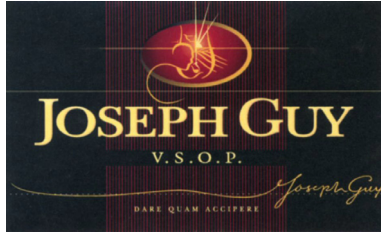

PRIORITY DATE OF 11-10-2006 IS CLAIMED.
 OWNER OF INTERNATIONAL REGISTRATION 0924749 DATED 5-8-2007, EXPIRES 5-8-2017.
 OWNER OF U.S. REG. NO. 3,117,324.
 NO CLAIM IS MADE TO THE EXCLUSIVE RIGHT TO USE "V.S.O.P.", APART FROM THE MARK AS SHOWN.
 THE NAME(S), PORTRAIT(S), AND/OR SIGNATURE(S) SHOWN IN THE MARK DOES NOT IDENTIFY A PARTICULAR LIVING INDIVIDUAL.
 THE COLOR(S) BLACK, RED AND GOLD IS/ARE CLAIMED AS A FEATURE OF THE MARK.
 THE BACKGROUND IS BLACK; THE OUTLINE OF THE OVAL, THE DESIGN INSIDE THE OVAL, THE HORIZONTAL LINES, THE SIGNATURE, THE WORDING "JOSEPH GUY", "V.S.O.P.", AND "DARE QUAM ACCIPERE" ARE ALL GOLD; THE INTERIOR OF THE OVAL AND THE VERTICAL STRIPES ARE ALL SHADES OF RED.
 THE ENGLISH TRANSLATION OF THE WORDING "DARE QUAM ACCIPERE" IN THE MARK IS IT IS BETTER TO GIVE THAN TO RECEIVE.
 FOR ALCOHOLIC BEVERAGES, NAMELY, HARD LIQUOR, EAUX-DE-VIE, LIQUERS AND COGNAC (U.S. CLS. 47 AND 49).
 DAVID MURRAY, EXAMINING ATTORNEY

SN 79-039,176. CANTINA SOCIALE VALLEBELBO; SOC. COOP. A.R.L., ITALY, FILED 3-27-2007.



PRIORITY DATE OF 11-10-2006 IS CLAIMED.
 OWNER OF INTERNATIONAL REGISTRATION 0925885 DATED 3-27-2007, EXPIRES 3-27-2017.
 THE COLOR(S) RED, ORANGE, BRICK RED, YELLOW, PALE YELLOW, PINK, DARK BLUE, LIGHT BLUE, SKY BLUE, LIGHT GREEN, DARK GREEN, YELLOWISH GREEN, BLACK AND BROWN IS/ARE CLAIMED AS A FEATURE OF THE MARK.
 THE DRAWING CONSISTS OF A RECTANGULAR IMPRESSION PLACED HORIZONTALLY WITH IRREGULAR AND INDENTED SIDES WITH A BACKGROUND IN THE

CLASS 33—(Continued).

COLORS RED, ORANGE, BRICK RED, YELLOW, PALE YELLOW, PINK, DARK BLUE, LIGHT BLUE, SKY BLUE, LIGHT GREEN, DARK GREEN, YELLOWISH GREEN, BLACK AND BROWN, INSIDE WHICH, PLACED ON TWO LINES AND ON THE LEFT SIDE WITHIN THE IMPRESSION, THE WORDS "DUE GRADI" APPEAR IN DISTINCTIVE LOWER CASE CHARACTERS WITH THE INITIAL LETTERS "D" AND "G" IN CAPITALS, IN THE COLORS SKY BLUE, DARK GREEN, YELLOW, BLACK AND ORANGE.
 THE ENGLISH TRANSLATION OF THE WORD "DUE GRADI" IN THE MARK IS TWO DEGREES.
 FOR ALCOHOLIC BEVERAGES NOT INCLUDING BEERS, NAMELY, RED WINE, WHITE WINE, SPARKLING WINE, ALCOHOLIC APERITIFS AND LIQUEURS, AND DISTILLED SPIRITS, NAMELY, SPIRITS DISTILLED FROM WINE OR MUST (U.S. CLS. 47 AND 49).
 TEJBIR SINGH, EXAMINING ATTORNEY

SN 79-039,399. COATES, CLAIRE, ODETTE, FRANCE, FILED 4-16-2007.



PRIORITY DATE OF 10-18-2006 IS CLAIMED.
 OWNER OF INTERNATIONAL REGISTRATION 0926454 DATED 4-16-2007, EXPIRES 4-16-2017.
 FOR ALCOHOLIC BEVERAGES, NAMELY, ALCOHOLIC BEVERAGES CONTAINING FRUIT, HARD CIDER, ALCOHOLIC FRUIT EXTRACTS, WINES, DISTILLED SPIRITS, AND LIQUEURS, APERITIFS, ALCOHOLIC BEVERAGES MADE WITH TEA (U.S. CLS. 47 AND 49).
 DORITT L. CARROLL, EXAMINING ATTORNEY

SN 79-039,736. "P.V. - PRODUÇÃO E COMÉRCIO DE PRODUTOS; VINÍCOLAS, S.A.", P-4481-911 VILA DO CONDE, PORTUGAL, FILED 5-7-2007.



THE MARK CONSISTS OF STANDARD CHARACTERS WITHOUT CLAIM TO ANY PARTICULAR FONT, STYLE, SIZE, OR COLOR.
 OWNER OF INTERNATIONAL REGISTRATION 0927301 DATED 5-7-2007, EXPIRES 5-7-2017.
 FOR WINE (U.S. CLS. 47 AND 49).
 GISELLE AGOSTO, EXAMINING ATTORNEY

CLASS 33—(Continued).

SN 79-040,572. BRUICHLADDICH DISTILLERY COMPANY LIMITED, UNITED KINGDOM, FILED 7-5-2007.

LOCHINDAAL

OWNER OF INTERNATIONAL REGISTRATION 0929633 DATED 7-5-2007, EXPIRES 7-5-2017.
FOR ALCOHOLIC BEVERAGES, NAMELY DISTILLED SPIRITS; WHISKY (U.S. CLS. 47 AND 49).
KAREN K. BUSH, EXAMINING ATTORNEY

SN 79-040,573. BRUICHLADDICH DISTILLERY COMPANY LIMITED, UNITED KINGDOM, FILED 7-5-2007.

X4-PERILIOUS

OWNER OF INTERNATIONAL REGISTRATION 0929635 DATED 7-5-2007, EXPIRES 7-5-2017.
FOR ALCOHOLIC BEVERAGES, NAMELY, DISTILLED SPIRITS; WHISKY (U.S. CLS. 47 AND 49).
KAREN K. BUSH, EXAMINING ATTORNEY

SN 79-042,004. E. REMY MARTIN & C^o, FRANCE, FILED 7-9-2007.

ST-RÉMY AUTHENTIC

THE MARK CONSISTS OF STANDARD CHARACTERS WITHOUT CLAIM TO ANY PARTICULAR FONT, STYLE, SIZE, OR COLOR.

PRIORITY DATE OF 1-12-2007 IS CLAIMED.
OWNER OF INTERNATIONAL REGISTRATION 0933051 DATED 7-9-2007, EXPIRES 7-9-2017.
OWNER OF U.S. REG. NOS. 749,501, 3,176,450 AND OTHERS.

NO CLAIM IS MADE TO THE EXCLUSIVE RIGHT TO USE "AUTHENTIC", APART FROM THE MARK AS SHOWN.

FOR BRANDY (U.S. CLS. 47 AND 49).
MARILYN IZZI, EXAMINING ATTORNEY

SN 79-043,265. ZILZIE WINES PTY LTD, KARADOC VIC 3496, AUSTRALIA, FILED 7-25-2007.

SELECTION 23, S23

THE MARK CONSISTS OF STANDARD CHARACTERS WITHOUT CLAIM TO ANY PARTICULAR FONT, STYLE, SIZE, OR COLOR.

OWNER OF INTERNATIONAL REGISTRATION 0936068 DATED 7-25-2007, EXPIRES 7-25-2017.

THE MARK "S23" AND "SELECTION 23" HAS NO MEANING IN A FOREIGN LANGUAGE.

FOR WINES (U.S. CLS. 47 AND 49).
SUSAN STIGLITZ, EXAMINING ATTORNEY

CLASS 33—(Continued).

SN 79-043,372. LIMITED LIABILITY COMPANY; "AST-INTERNATIONAL ENVIRONMENT", RUSSIAN FED., FILED 8-8-2007.

Simanto'ff

THE MARK CONSISTS OF STANDARD CHARACTERS WITHOUT CLAIM TO ANY PARTICULAR FONT, STYLE, SIZE, OR COLOR.

OWNER OF INTERNATIONAL REGISTRATION 0936356 DATED 8-8-2007, EXPIRES 8-8-2017.

FOR APERITIFS; LIQUOR, NAMELY, ARRACK; BRANDY; WINE; LIQUOR, NAMELY, PIQUETTE; WHISKEY; LIQUOR, NAMELY, ANISETTE; LIQUOR, NAMELY, KIRSCH; VODKA; GIN; LIQUEURS AND DISTILLED SPIRITS, NAMELY, DIGESTERS; PREPARED ALCOHOLIC COCKTAILS; CURACAO; LIQUEURS; ALCOHOLIC BEVERAGES, EXCEPT BEER; ALCOHOLIC BEVERAGES OF FRUIT; POTABLE SPIRITS; DISTILLED BEVERAGES, NAMELY, DISTILLED SPIRITS; HYDROMEL, NAMELY, MEAD; PEPPERMINT LIQUEUR; ALCOHOLIC BITTERS; RUM; SAKE; HARD CIDER; LIQUOR, NAMELY, PERRY; RICE ALCOHOL, NAMELY, DISTILLED SPIRITS OF RICE; ALCOHOLIC EXTRACTS; ALCOHOLIC FRUIT EXTRACTS; ALCOHOLIC ESSENCES (U.S. CLS. 47 AND 49).

CHRISTINA SOBRAL, EXAMINING ATTORNEY

SN 79-045,794. OFF-PISTE WINES LTD, UNITED KINGDOM, FILED 5-14-2007.

FROZÉ

PRIORITY DATE OF 5-2-2007 IS CLAIMED.

OWNER OF INTERNATIONAL REGISTRATION 0942505 DATED 5-14-2007, EXPIRES 5-14-2017.

THE WORD "FROZÉ" HAS NO MEANING IN ANY FOREIGN LANGUAGE.

FOR WINE; WINE THAT CONTAINS AN ALCOHOL CONTENT OF LESS THAN 1.2 BY VOLUME (U.S. CLS. 47 AND 49).

TINA BROWN, EXAMINING ATTORNEY

SN 79-047,095. MIGUEL TORRES S.A., SPAIN, FILED 10-4-2007.

EMPEDRADO

THE MARK CONSISTS OF STANDARD CHARACTERS WITHOUT CLAIM TO ANY PARTICULAR FONT, STYLE, SIZE, OR COLOR.

OWNER OF INTERNATIONAL REGISTRATION 0945749 DATED 10-4-2007, EXPIRES 10-4-2017.

THE ENGLISH TRANSLATION OF THE FOREIGN WORD(S) IN THE MARK IS: STONE PAVING.

FOR WINES (U.S. CLS. 47 AND 49).
RUSS HERMAN, EXAMINING ATTORNEY

CLASS 33—(Continued).

SN 79-047,098. MIGUEL TORRES S.A., SPAIN, FILED 10-19-2007.

LA PLAZA

THE MARK CONSISTS OF STANDARD CHARACTERS WITHOUT CLAIM TO ANY PARTICULAR FONT, STYLE, SIZE, OR COLOR.

OWNER OF INTERNATIONAL REGISTRATION 0945757 DATED 10-19-2007, EXPIRES 10-19-2017.

THE ENGLISH TRANSLATION OF THE WORD "LA PLAZA" IN THE MARK IS "THE SQUARE".

FOR WINES (U.S. CLS. 47 AND 49).
RUSS HERMAN, EXAMINING ATTORNEY

CLASS 33—(Continued).

SN 79-047,146. SICHUAN MIANZHU JIAN NAN; CHUN DISTILLERY CO., LTD, CHINA, FILED 7-23-2007.

天成祥

OWNER OF INTERNATIONAL REGISTRATION 0945905 DATED 7-23-2007, EXPIRES 7-23-2017.

THE ENGLISH TRANSLATION OF THE FOREIGN WORD(S) IN THE MARK IS: "TIAN" MEANS SKY, DAY OR NATURE; "CHENG" MEANS BECOME OR SUCCEED; "XIANG" MEANS AUSPICIOUS OR LUCKY; HOWEVER, THERE IS NO MEANING IN THE ORIGINAL CHINESE CHARACTERS COMBINATION.

THE TRANSLITERATION OF THE NON-LATIN CHARACTERS IN THE MARK IS: TIAN CHENG XIANG.

FOR ALCOHOLIC BEVERAGES NOT INCLUDING BEER, NAMELY, ALCOHOLIC FRUIT EXTRACTS; AR-RACK; DISTILLED BEVERAGES, NAMELY, DISTILLED LIQUOR AND SPIRITS; COCKTAILS, NAMELY, PREPARED ALCOHOLIC COCKTAILS AND WINE COCKTAILS; SPIRITS, NAMELY, BRANDY AND POTABLE SPIRITS; ALCOHOLIC BEVERAGES CONTAINING FRUIT; RICE ALCOHOL, NAMELY, DISTILLED SPIRITS OF RICE; AND WHISKY (U.S. CLS. 47 AND 49).

RAUL CORDOVA, EXAMINING ATTORNEY

SN 79-047,099. MIGUEL TORRES S.A., SPAIN, FILED 10-19-2007.

PAZO DEL OBISPO

THE MARK CONSISTS OF STANDARD CHARACTERS WITHOUT CLAIM TO ANY PARTICULAR FONT, STYLE, SIZE, OR COLOR.

OWNER OF INTERNATIONAL REGISTRATION 0945758 DATED 10-19-2007, EXPIRES 10-19-2017.

THE ENGLISH TRANSLATION OF THE FOREIGN WORD(S) IN THE MARK IS: BISHOP'S MANOR HOUSE.

FOR WINES (U.S. CLS. 47 AND 49).
RUSS HERMAN, EXAMINING ATTORNEY

CLASS 34—SMOKERS' ARTICLES

SN 76-565,205. NASCO PRODUCTS, INC., CLEMMONS, NC. FILED 12-15-2003.

AMBER

SN 79-047,103. MIGUEL TORRES S.A., SPAIN, FILED 10-19-2007.

NARVAL

THE MARK CONSISTS OF STANDARD CHARACTERS WITHOUT CLAIM TO ANY PARTICULAR FONT, STYLE, SIZE, OR COLOR.

OWNER OF INTERNATIONAL REGISTRATION 0945762 DATED 10-19-2007, EXPIRES 10-19-2017.

THE ENGLISH TRANSLATION OF THE FOREIGN WORD(S) IN THE MARK IS: NARWHAL.

FOR WINES (U.S. CLS. 47 AND 49).
RUSS HERMAN, EXAMINING ATTORNEY

THE MARK CONSISTS OF STANDARD CHARACTERS WITHOUT CLAIM TO ANY PARTICULAR FONT, STYLE, SIZE, OR COLOR.

FOR TOBACCO PRODUCTS, NAMELY CIGARETTES, CIGARS, AND ROLL YOUR OWN TOBACCO (U.S. CLS. 2, 8, 9 AND 17).

RICHARD A. STRASER, EXAMINING ATTORNEY

CLASS 34—(Continued).

SN 76-643,375. REPUBLIC TOBACCO, L.P., GLENVIEW, IL.
FILED 7-22-2005.

TRIPLE INFUSED FLAVOR

THE MARK CONSISTS OF STANDARD CHARACTERS WITHOUT CLAIM TO ANY PARTICULAR FONT, STYLE, SIZE, OR COLOR.

NO CLAIM IS MADE TO THE EXCLUSIVE RIGHT TO USE "INFUSED FLAVOR", APART FROM THE MARK AS SHOWN.

FOR CIGARETTE ROLLING PAPERS (U.S. CLS. 2, 8, 9 AND 17).

GRETTA YAO, EXAMINING ATTORNEY

SN 77-119,427. HOLT'S COMPANY, PHILADELPHIA, PA.
FILED 3-1-2007.

TRUST YOUR TASTE

THE MARK CONSISTS OF STANDARD CHARACTERS WITHOUT CLAIM TO ANY PARTICULAR FONT, STYLE, SIZE, OR COLOR.

FOR CIGARS; SMOKING TOBACCO; SMOKING PIPES; CIGAR ACCESSORIES, NAMELY, HUMIDORS, CIGAR CASES NOT OF PRECIOUS METAL, CIGAR BOXES NOT OF PRECIOUS METAL, CIGAR CUTTERS AND CIGAR TUBES (U.S. CLS. 2, 8, 9 AND 17).

CURTIS FRENCH, EXAMINING ATTORNEY

SN 77-131,921. JOHN PLAYER & SONS LIMITED, DUBLIN,
IRELAND, FILED 3-15-2007.



FOR TOBACCO, WHETHER MANUFACTURED OR UNMANUFACTURED; TOBACCO PRODUCTS, NAMELY, CIGARETTES, CIGARS, CHEWING TOBACCO, PIPE TOBACCO, AND HAND-ROLLING TOBACCO; SNUFF; TOBACCO SUBSTITUTES, NONE BEING FOR MEDICINAL OR CURATIVE PURPOSES; MATCHES AND SMOKERS ARTICLES, NAMELY, LIGHTERS NOT OF PRECIOUS METAL, PIPE CLEANERS AND PIPES; CIGARETTE PAPERS; CIGARETTE CASES; CIGARETTE TUBES; TOBACCO FILTERS; CIGARETTE ROLLING MACHINES; HAND HELD MACHINES FOR INJECTING TOBACCO INTO PAPER TUBES FOR SMOKING (U.S. CLS. 2, 8, 9 AND 17).

PAUL F. GAST, EXAMINING ATTORNEY

CLASS 34—(Continued).

SN 77-133,415. JOHN PLAYER & SONS LIMITED, DUBLIN,
IRELAND, FILED 3-16-2007.

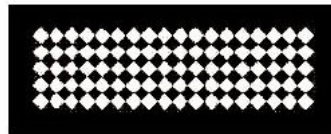

FOR TOBACCO, WHETHER MANUFACTURED OR UNMANUFACTURED; TOBACCO PRODUCTS, NAMELY, CIGARETTES, CIGARS, CHEWING TOBACCO, PIPE TOBACCO, AND HAND-ROLLING TOBACCO; SNUFF; TOBACCO SUBSTITUTES, NONE BEING FOR MEDICINAL OR CURATIVE PURPOSES; MATCHES AND SMOKERS ARTICLES, NAMELY, LIGHTERS NOT OF PRECIOUS METAL, PIPE CLEANERS AND PIPES; CIGARETTE PAPERS; CIGARETTE CASES; CIGARETTE TUBES; TOBACCO FILTERS; CIGARETTE ROLLING MACHINES; HAND HELD MACHINES FOR INJECTING TOBACCO INTO PAPER TUBES FOR SMOKING (U.S. CLS. 2, 8, 9 AND 17).

PAUL F. GAST, EXAMINING ATTORNEY

SN 77-292,533. PUROS INDIOS CIGARS, INC., MIAMI, FL.
FILED 10-1-2007.

ALIADOS

THE MARK CONSISTS OF STANDARD CHARACTERS WITHOUT CLAIM TO ANY PARTICULAR FONT, STYLE, SIZE, OR COLOR.

OWNER OF U.S. REG. NO. 2,039,757.

THE FOREIGN WORDING IN THE MARK TRANSLATES INTO ENGLISH AS UNITED.

FOR CIGARS (U.S. CLS. 2, 8, 9 AND 17).

FIRST USE 8-1-1957; IN COMMERCE 6-15-1978.

TINA BROWN, EXAMINING ATTORNEY

SN 77-294,107. MARGARET E. AGUIRRE, DBA MADD OG
BY CIANNA'S CREATIONS, CHULA VISTA, CA. FILED
10-2-2007.

MADD OG

THE MARK CONSISTS OF STANDARD CHARACTERS WITHOUT CLAIM TO ANY PARTICULAR FONT, STYLE, SIZE, OR COLOR.

FOR SMOKING PIPES (U.S. CLS. 2, 8, 9 AND 17).

FIRST USE 12-31-1990; IN COMMERCE 2-9-1998.

BENJAMIN ALLEN, EXAMINING ATTORNEY

CLASS 34—(Continued).

SN 77-294,411. TTNB INC, SUNNY ISLES BEACH, FL. FILED 10-2-2007.

DISCREET

THE MARK CONSISTS OF STANDARD CHARACTERS WITHOUT CLAIM TO ANY PARTICULAR FONT, STYLE, SIZE, OR COLOR.
FOR TOBACCO (U.S. CLS. 2, 8, 9 AND 17).
JUDITH HELFMAN, EXAMINING ATTORNEY

SN 77-296,443. GMB, INC., KING, NC. FILED 10-4-2007.

ORBS

THE MARK CONSISTS OF STANDARD CHARACTERS WITHOUT CLAIM TO ANY PARTICULAR FONT, STYLE, SIZE, OR COLOR.
FOR SMOKELESS TOBACCO (U.S. CLS. 2, 8, 9 AND 17).
WILLIAM VERHOSEK, EXAMINING ATTORNEY

SN 77-296,510. BASSO, KRIS, POMPANO BEACH, FL. FILED 10-4-2007.

PPD

THE MARK CONSISTS OF STANDARD CHARACTERS WITHOUT CLAIM TO ANY PARTICULAR FONT, STYLE, SIZE, OR COLOR.
FOR CIGARS (U.S. CLS. 2, 8, 9 AND 17).
BILL DAWE, EXAMINING ATTORNEY

CLASS 34—(Continued).

SN 77-303,144. NEW IMAGE GLOBAL, INC., CORONA, CA. FILED 10-12-2007.

ZIPARELLO

THE MARK CONSISTS OF STANDARD CHARACTERS WITHOUT CLAIM TO ANY PARTICULAR FONT, STYLE, SIZE, OR COLOR.
FOR SMOKING ARTICLES, NAMELY, CIGARS, CIGARETTES, TOBACCO, TOBACCO LEAVES AND FLAVORED TOBACCO LEAVES IN THE FORM OF A SHEET FOR USE IN ROLLING CIGARS AND CIGARETTES, ROLLING PAPERS, CIGARETTE HOLDERS, TOBACCO PIPES, CIGAR CUTTERS AND CHEWING TOBACCO (U.S. CLS. 2, 8, 9 AND 17).
JUSTINE D. PARKER, EXAMINING ATTORNEY

SN 77-324,047. PHILIP MORRIS USA INC., RICHMOND, VA. FILED 11-7-2007.



OWNER OF U.S. REG. NOS. 378,340, 2,578,092 AND OTHERS.

NO CLAIM IS MADE TO THE EXCLUSIVE RIGHT TO USE "MENTHOL", APART FROM THE MARK AS SHOWN. THE COLOR(S) WHITE, LIGHT GREEN, DARK GREEN, SILVER AND RED IS/ARE CLAIMED AS A FEATURE OF THE MARK.

THE MARK CONSISTS OF A RECTANGLE WITH A WHITE BORDER WITH HORIZONTAL CURVED BRUSH STROKES WITH A WHITE TO LIGHT GREEN TO DARK GREEN COLOR GRADATION INSIDE. THE WORD "PARLIAMENT" IS LOCATED IN THE UPPER THIRD OF THE RECTANGLE IN WHITE, OUTLINED IN DARK GREEN. THE WORD "MENTHOL" IS LOCATED IN THE MIDDLE THIRD OF THE RECTANGLE IN WHITE, OUTLINED IN DARK GREEN. THE WORD "FRESH" IS LOCATED IN THE LOWER THIRD OF THE RECTANGLE IN WHITE, OUTLINED IN DARK GREEN. THERE IS A DIAGONAL WHITE LINE LOCATED IN THE BOTTOM TWO THIRDS OF THE RECTANGLE, BEGINNING IN THE UPPER RIGHT-HAND CORNER OF THE MIDDLE THIRD AND ENDING IN THE LOWER LEFT-HAND CORNER OF THE LOWER THIRD. THERE IS A SILVER CHEVRON LOCATED IN THE LOWER RIGHT-HAND CORNER OF THE LOWER THIRD OF THE RECTANGLE ABOVE THE WORD "FRESH". THERE IS A RED OVAL WITH A SILVER "P" IN THE CENTER LOCATED IN THE UPPER CENTER OF THE SILVER CHEVRON.

FOR TOBACCO PRODUCTS, NAMELY, CIGARETTES (U.S. CLS. 2, 8, 9 AND 17).
FIRST USE 10-26-2007; IN COMMERCE 10-26-2007.
ESTHER BELENKER, EXAMINING ATTORNEY

CLASS 34—(Continued).

SN 77-348,676. PHILIP MORRIS USA INC., RICHMOND, VA.
FILED 12-11-2007.

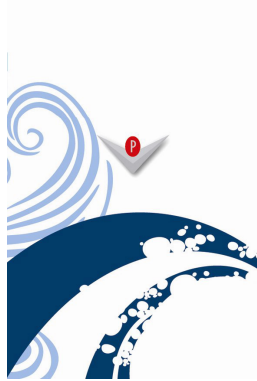

CLASS 34—(Continued).

SN 77-348,683. PHILIP MORRIS USA INC., RICHMOND, VA.
FILED 12-11-2007.



OWNER OF U.S. REG. NOS. 378,340, 2,578,092 AND OTHERS.

THE MARK CONSISTS OF A RECTANGULAR DESIGN. THERE ARE TWO SWIRL DESIGNS, WITH BUBBLES THROUGHOUT, BEGINNING IN THE LOWER THIRD AND ENDING IN THE MIDDLE THIRD OF THE RECTANGULAR DESIGN. THERE ARE NUMEROUS SWIRL DESIGNS BEGINNING IN THE MIDDLE THIRD AND ENDING IN THE UPPER AND LOWER THIRDS OF THE RECTANGULAR DESIGN. THERE IS A CHEVRON WITH AN OVAL WITH A P IN THE CENTER LOCATED IN THE MIDDLE THIRD OF THE RECTANGULAR DESIGN.

FOR TOBACCO PRODUCTS, NAMELY, CIGARETTES (U.S. CLS. 2, 8, 9 AND 17).

FIRST USE 8-0-2007; IN COMMERCE 8-0-2007.

ESTHER BELENKER, EXAMINING ATTORNEY

SN 77-349,160. PHILIP MORRIS USA INC., RICHMOND, VA.
FILED 12-11-2007.

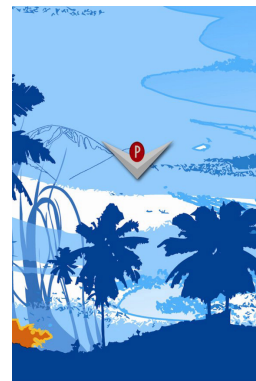

OWNER OF U.S. REG. NOS. 378,340, 2,578,092 AND OTHERS.

THE COLOR(S) WHITE, DARK BLUE, LIGHT BLUE, SILVER, AND RED IS/ARE CLAIMED AS A FEATURE OF THE MARK.

THE MARK CONSISTS OF A WHITE RECTANGULAR DESIGN. THERE ARE TWO DARK BLUE SWIRL DESIGNS, WITH WHITE BUBBLES THROUGHOUT, BEGINNING IN THE LOWER THIRD AND ENDING IN THE MIDDLE THIRD OF THE WHITE RECTANGULAR DESIGN. THERE ARE NUMEROUS LIGHT BLUE SWIRL DESIGNS BEGINNING IN THE MIDDLE THIRD AND ENDING IN THE UPPER AND LOWER THIRDS OF THE WHITE RECTANGULAR DESIGN. THERE IS A SILVER CHEVRON WITH A RED OVAL WITH A SILVER P IN THE CENTER LOCATED IN THE MIDDLE THIRD OF THE WHITE RECTANGULAR DESIGN.

FOR TOBACCO PRODUCTS, NAMELY, CIGARETTES (U.S. CLS. 2, 8, 9 AND 17).

FIRST USE 8-0-2007; IN COMMERCE 8-0-2007.

ESTHER BELENKER, EXAMINING ATTORNEY

OWNER OF U.S. REG. NOS. 378,340, 2,578,092 AND OTHERS.

THE COLOR(S) WHITE, DARK BLUE, LIGHT BLUE, BLUE ORANGE, DARK ORANGE, SILVER AND RED IS/ARE CLAIMED AS A FEATURE OF THE MARK.

THE MARK CONSISTS OF A RECTANGULAR DESIGN,

CLASS 34—(Continued).

FEATURING DARK BLUE PALM TREES AND BLUE TROPICAL GRASSES IN THE FOREGROUND, WITH THE OCEAN OR CLOUDS IN THE BACKGROUND IN LIGHT BLUE AND WHITE, WITH THE GROUND IN THE FOREGROUND IN DARK BLUE, WITH A BUSH AT THE LEFT SIDE OF THE MARK IN DARK ORANGE, OUTLINED IN LIGHT ORANGE, WITH A SILVER CHEVRON IN THE CENTER OF THE MARK, WITH A RED OVAL IN THE CENTER OF THE CHEVRON, CONTAINING A SILVER P IN THE OVAL.

FOR TOBACCO PRODUCTS, NAMELY, CIGARETTES (U.S. CLS. 2, 8, 9 AND 17).

FIRST USE 8-0-2007; IN COMMERCE 8-0-2007.

ESTHER BELENKER, EXAMINING ATTORNEY

SN 78-845,581. PHILIP MORRIS USA INC., RICHMOND, VA. FILED 3-24-2006.

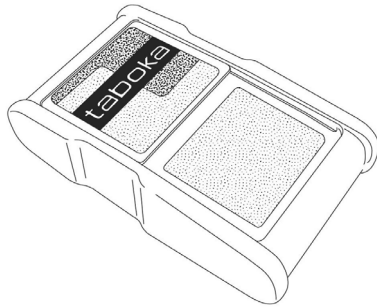

THE STIPPLING IS FOR SHADING PURPOSES ONLY. THE MARK CONSISTS OF THE THREE DIMENSIONAL CONFIGURATION OF THE DISTINCTIVE PACKAGING FOR THE GOODS. THE FRONT OF THE PACKAGE FEATURES A DESIGN OF TWO SQUARES, ONE ON TOP OF THE OTHER. THE SQUARE ON TOP IS COMPOSED OF TWO INTERLOCKING, GEOMETRIC "L" SHAPES AND IS DIVIDED HORIZONTALLY IN THE MIDDLE BY A RECTANGLE WITH THE WORD "TABOKA" IN THE MIDDLE. FOR MANUFACTURED TOBACCO, NAMELY, SMOKELESS TOBACCO (U.S. CLS. 2, 8, 9 AND 17). FIRST USE 6-30-2006; IN COMMERCE 6-30-2006. KHANH LE, EXAMINING ATTORNEY

SN 78-894,302. ENTERTAINMENT WAREHOUSE SERVICE GROUP, INC., AUSTIN, TX. FILED 5-26-2006.

DR. RUMNEY'S

THE MARK CONSISTS OF STANDARD CHARACTERS WITHOUT CLAIM TO ANY PARTICULAR FONT, STYLE, SIZE, OR COLOR.

THE NAME IN THE MARK DOES NOT IDENTIFY A PARTICULAR LIVING INDIVIDUAL.

FOR TOBACCO (U.S. CLS. 2, 8, 9 AND 17).

WANDA KAY PRICE, EXAMINING ATTORNEY

CLASS 34—(Continued).

SN 79-032,016. DAVIDOFF & CIE SA, CH-1200 GENEVA, SWITZERLAND, FILED 11-15-2006.

DAVIDOFF PRIMEROS

THE MARK CONSISTS OF STANDARD CHARACTERS WITHOUT CLAIM TO ANY PARTICULAR FONT, STYLE, SIZE, OR COLOR.

PRIORITY DATE OF 8-21-2006 IS CLAIMED.

OWNER OF INTERNATIONAL REGISTRATION 0906264 DATED 11-15-2006. EXPIRES 11-15-2016.

THE ENGLISH TRANSLATION OF THE WORD "PRIMEROS" IN THE MARK IS FIRST.

FOR RAW OR MANUFACTURED TOBACCO (EXCLUDING CIGARETTES); CIGARS; CIGARILLOS; CIGARS WITH PRE-CUT ENDS; SMOKING AND CHEWING TOBACCO; TOBACCO PIPES; TOBACCO PIPE CLEANERS; TOBACCO PIPE TAMPERS; FLINTS FOR LIGHTERS; MATCHES; SMOKER'S ARTICLES, NAMELY, CIGAR CUTTERS; NON-ELECTRICAL CIGAR AND CIGARETTE LIGHTERS NOT OF PRECIOUS METAL; CIGAR HUMIDIFIERS (U.S. CLS. 2, 8, 9 AND 17).

JAY FLOWERS, EXAMINING ATTORNEY

SN 79-032,556. SWEDISH MATCH NORTH EUROPE AB, SE-118 85 STOCKHOLM, SWEDEN, FILED 10-24-2006.



PRIORITY DATE OF 10-18-2006 IS CLAIMED. OWNER OF INTERNATIONAL REGISTRATION 0907664 DATED 10-24-2006. EXPIRES 10-24-2016.

OWNER OF U.S. REG. NOS. 3,032,437, 3,150,365 AND OTHERS.

FOR TOBACCO, SNUFF, SMOKERS' ARTICLES, NAMELY, SNUFF BOXES, ASHTRAYS AND CIGARETTE LIGHTERS NOT FOR AUTOMOBILES, AND MATCHES (U.S. CLS. 2, 8, 9 AND 17).

RON FAIRBANKS, EXAMINING ATTORNEY

CLASS 35—(Continued).

SERVICE MARKS

CLASS 35—ADVERTISING AND BUSINESS

SN 76-661,692. SULLIVAN AUTOMOTIVE GROUP, SANTA MONICA, CA. FILED 6-16-2006.

"IN SANTA MONICA, ON SANTA MONICA"

THE MARK CONSISTS OF STANDARD CHARACTERS WITHOUT CLAIM TO ANY PARTICULAR FONT, STYLE, SIZE, OR COLOR.

NO CLAIM IS MADE TO THE EXCLUSIVE RIGHT TO USE "SANTA MONICA", APART FROM THE MARK AS SHOWN.

SEC. 2(F).
FOR RETAIL STORE SERVICES IN THE FIELD OF MOTOR VEHICLES (U.S. CLS. 100, 101 AND 102).

FIRST USE 6-5-1998; IN COMMERCE 6-5-1998.
TINA L. SNAPP, EXAMINING ATTORNEY

CLASS 35—(Continued).

SN 76-668,321. A.H. MANAGEMENT GROUP, INC., ROLLING MEADOWS, IL. FILED 10-30-2006.



THE COLOR(S) RED, BLUE AND GRAY IS/ARE CLAIMED AS A FEATURE OF THE MARK.

THE COLOR BLUE APPEARS IN THE STAR. THE COLOR RED APPEARS IN THE WORDS AND THE UNDERLINING, AND THE COLOR GRAY APPEARS IN THE SHADOW BEHIND THE STAR.

FOR ADVERTISING (U.S. CLS. 100, 101 AND 102).
FIRST USE 1-9-2001; IN COMMERCE 3-17-2001.
ESTHER BELENKER, EXAMINING ATTORNEY

SN 76-671,810. AXIOS INSTITUTE, MOUNT JACKSON, VA. FILED 1-25-2007.

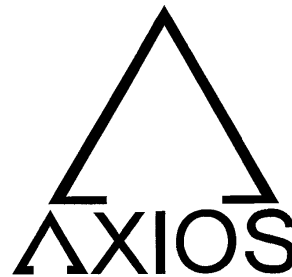

SN 76-664,315. EQUUSTYLE, INC., GOLDEN, CO. FILED 8-8-2006.



THE MARK CONSISTS OF THE WORDING "EQUUSTYLE", WITH A DESIGN OF A GALLOPING HORSE FORMING THE BACKGROUND BEHIND THE LETTERS "Y" AND "L". THE TAIL OF THE HORSE FORMS THE TOP OF THE LETTER "T".

FOR ON-LINE RETAIL STORE SERVICES, RETAIL STORE SERVICES, MAIL ORDER SERVICES, AND WHOLESALE STORES, FEATURING HOME FURNISHINGS, HOUSEWARES, FURNITURE, RUGS, LAMPS, BEDDING, LEATHER GOODS, TEXTILE GOODS, CLOTHING, CLOTHING ACCESSORIES, FOOTWEAR, HEADWEAR, LUGGAGE, HANDBAGS, BAGS, JEWELRY, STUFFED ANIMALS, ARTWORK, PRINTED MATTER, BOOKS, STAPLE FOODS, AND DOG BEDS, BUT EXCLUDING CANDLES AND CANDLE ACCESSORIES (U.S. CLS. 100, 101 AND 102).

RICHARD A. STRASER, EXAMINING ATTORNEY

THE MARK CONSISTS OF A STYLIZED "A" AND THE WORDING "AXIOS" WHERE THE "A" IN THE MARK ARE REPRESENTED BY AN INCOMPLETE TRIANGLE.

FOR PROMOTING PUBLIC AWARENESS OF ETHICS, MORAL PHILOSOPHY AND HUMAN VALUES; PROMOTING THE GOODS AND SERVICES OF OTHERS BY PROVIDING A WEBSITE AT WHICH USERS CAN LINK TO OTHER WEBSITES FEATURING INFORMATION IN THE FIELDS OF ETHICS, MORAL PHILOSOPHY AND HUMAN VALUES (U.S. CLS. 100, 101 AND 102).

FIRST USE 9-0-2006; IN COMMERCE 9-0-2006.
CHARISMA HAMPTON, EXAMINING ATTORNEY

CLASS 35—(Continued).

SN 76-671,880. MEGA FABRICATION EQUIPMENT, INC., HUTCHINSON, KS. FILED 1-26-2007.

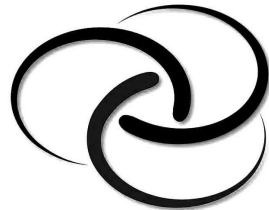

MegaFab

OWNER OF U.S. REG. NOS. 1,578,667 AND 1,646,627.
THE MARK CONSISTS OF LETTERS PRESENTED IN A DISTINCTIVE FONT AND THREE SEMI-CIRCLES ARRANGED ABOVE THE LETTERS.

FOR WHOLESALE DISTRIBUTORSHIPS OF PUNCH/PLASMA FABRICATING CUTTERS, IRONWORKERS, BENDING ROLLS, SECTION ROLLS, SHEARS, PRESS BRAKES, LASER CUTTING MACHINES, PLASMA CUTTING MACHINES, PORTABLE PRESSES, TOOLING GAUGING PRESSES AND STRUCTURAL PUNCHING EQUIPMENT (U.S. CLS. 100, 101 AND 102).

FIRST USE 9-30-2005; IN COMMERCE 9-30-2005.
LAURIE KAUFMAN, EXAMINING ATTORNEY

SN 76-672,087. STEIN DIAMONDS, INC., LOS ANGELES, CA. FILED 2-1-2007.

Stein Diamonds

THE MARK CONSISTS OF STANDARD CHARACTERS WITHOUT CLAIM TO ANY PARTICULAR FONT, STYLE, SIZE, OR COLOR.

NO CLAIM IS MADE TO THE EXCLUSIVE RIGHT TO USE "DIAMONDS", APART FROM THE MARK AS SHOWN. FOR RETAIL STORE SERVICES FEATURING JEWELRY (U.S. CLS. 100, 101 AND 102).

FIRST USE 1-1-2005; IN COMMERCE 1-1-2005.
ARETHA SOMERVILLE, EXAMINING ATTORNEY

CLASS 35—(Continued).

SN 76-672,852. ALISHOPS, LLC, MINNEAPOLIS, MN. FILED 2-20-2007.

ALI SHOPS

THE MARK CONSISTS OF STANDARD CHARACTERS WITHOUT CLAIM TO ANY PARTICULAR FONT, STYLE, SIZE, OR COLOR.

THE NAME "ALI" IDENTIFIES A LIVING INDIVIDUAL WHOSE CONSENT IS OF RECORD.

FOR PROVIDING INFORMATION IN THE FIELD OF RETAIL STORES AND PROMOTING THE GOODS AND SERVICES OF OTHERS BY PROVIDING A WEBSITE FEATURING RETAIL INFORMATION REGARDING PRODUCT AND SERVICE DISCOUNTS (U.S. CLS. 100, 101 AND 102).

FIRST USE 11-16-2006; IN COMMERCE 11-16-2006.
LINDA ESTRADA, EXAMINING ATTORNEY

SN 76-673,684. ADORABELLA, LLC, LOUISVILLE, KY. FILED 3-7-2007.

ADORABELLA

THE MARK CONSISTS OF STANDARD CHARACTERS WITHOUT CLAIM TO ANY PARTICULAR FONT, STYLE, SIZE, OR COLOR.

THE WORDING "ADORABELLA" HAS NO MEANING IN A FOREIGN LANGUAGE.

FOR RETAIL STORE, MAIL ORDER, AND ON-LINE RETAIL STORE SERVICES FEATURING CLOTHING AND ACCESSORIES, AND BEDROOM AND BATHROOM ACCESSORIES (U.S. CLS. 100, 101 AND 102).

CHRISTINE COOPER, EXAMINING ATTORNEY

SN 76-674,225. ALBANESE, ISABELLE, HINSDALE, IL. FILED 3-19-2007.

TRUTH DISCOVERY

THE MARK CONSISTS OF STANDARD CHARACTERS WITHOUT CLAIM TO ANY PARTICULAR FONT, STYLE, SIZE, OR COLOR.

FOR CONSULTING IN THE FIELD OF CONSUMER EVALUATION RESEARCH IN ADVERTISING, MARKETING AND PRODUCT PACKAGING (U.S. CLS. 100, 101 AND 102).

FIRST USE 5-18-2001; IN COMMERCE 5-18-2001.
KELLEY WELLS, EXAMINING ATTORNEY

CLASS 35—(Continued).

SN 76-674,226. ALBANESE, ISABELLE, HINSDALE, IL.
FILED 3-19-2007.

THE 4 CS OF TRUTH IN COMMUNICATIONS

THE MARK CONSISTS OF STANDARD CHARACTERS WITHOUT CLAIM TO ANY PARTICULAR FONT, STYLE, SIZE, OR COLOR.

FOR CONSULTING IN THE FIELD OF CONSUMER EVALUATION RESEARCH IN ADVERTISING, MARKETING AND PRODUCT PACKAGING (U.S. CLS. 100, 101 AND 102).

FIRST USE 8-8-2002; IN COMMERCE 8-8-2002.
KELLEY WELLS, EXAMINING ATTORNEY

SN 76-674,727. CALIFORNIA MILK PRODUCERS ADVISORY BOARD, IS AN INSTRUMENTALITY OF THE STATE OF CALIFORNIA, DEPARTMENT OF FOOD AND AGRICULTURE, SOUTH SAN FRANCISCO, CA. FILED 3-27-2007.

GREAT CHEESE COMES FROM HAPPY COWS

THE MARK CONSISTS OF STANDARD CHARACTERS WITHOUT CLAIM TO ANY PARTICULAR FONT, STYLE, SIZE, OR COLOR.

FOR PROMOTION AND MARKETING SERVICES, NAMELY, PROMOTING THE INTERESTS OF MILK PRODUCERS THROUGH COMMERCIAL ADVERTISEMENTS PROMOTING MILK AND MILK PRODUCTS IN THE FORM OF TELEVISION, RADIO, PRINT AND ELECTRONIC MEDIA, MARKETING PROGRAMS INVOLVING DISTRIBUTION OF PROMOTIONAL MATERIALS; BUSINESS CONSULTING SERVICES RELATED TO MILK PRODUCERS; DISTRIBUTION OF PRINTED ADVERTISING MATERIALS (U.S. CLS. 100, 101 AND 102).

FIRST USE 10-16-2000; IN COMMERCE 10-16-2000.
MICHAEL KAZAZIAN, EXAMINING ATTORNEY

SN 76-674,731. CALIFORNIA MILK PRODUCERS ADVISORY BOARD, IS AN INSTRUMENTALITY OF THE STATE OF CALIFORNIA, DEPARTMENT OF FOOD AND AGRICULTURE, SOUTH SAN FRANCISCO, CA. FILED 3-27-2007.

EL BUEN QUESO VIENE DE VACAS CONTENTAS – LAS VACAS CONTENTAS VIVEN EN CALIFORNIA

THE MARK CONSISTS OF STANDARD CHARACTERS WITHOUT CLAIM TO ANY PARTICULAR FONT, STYLE, SIZE, OR COLOR.

THE FOREIGN WORDING IN THE MARK TRANSLATES INTO ENGLISH AS GREAT CHEESE COMES FROM HAPPY COWS -HAPPY COWS COME FROM CALIFORNIA.

FOR PROMOTION AND MARKETING SERVICES, NAMELY, PROMOTING THE INTERESTS OF MILK PRODUCERS THROUGH COMMERCIAL ADVERTISEMENTS PROMOTING MILK AND MILK PRODUCTS IN THE FORM OF TELEVISION, RADIO, PRINT AND ELECTRONIC MEDIA, MARKETING PROGRAMS INVOLVING DISTRIBUTION OF PROMOTIONAL MATERIALS; BUSINESS CONSULTING SERVICES RELATED TO MILK PRODUCERS; DISTRIBUTION OF PRINTED ADVERTISING MATERIALS (U.S. CLS. 100, 101 AND 102).

FIRST USE 10-0-2004; IN COMMERCE 10-0-2004.
MICHAEL KAZAZIAN, EXAMINING ATTORNEY

CLASS 35—(Continued).

SN 76-675,408. ALLISON I. LEVITT, LLC, FREDERICK, MD.
FILED 4-12-2007.



OWNER OF U.S. REG. NO. 3,159,850.
THE COLOR(S) RED, WHITE, BLACK, GRAY, PINK, AND BROWN IS/ARE CLAIMED AS A FEATURE OF THE MARK.

THE COLOR RED APPEARS IN THE LETTERING OF "TWO PAWS UP!" ON THE BONE. THE COLOR WHITE APPEARS IN THE BONE. THE COLOR BLACK APPEARS IN THE OUTLINE OF THE DOG AND IN THE OUTLINE OF THE BONE. THE BODY OF THE DOG IS GRADATIONS OF BLACK, APPEARING AS GRAY. THE MOUTH AND TONGUE OF THE DOG ARE PINK. THE EYE IS BROWN.

FOR RETAIL BOUTIQUE IN THE FIELD OF DOG AND CAT SUPPLIES (U.S. CLS. 100, 101 AND 102).

FIRST USE 2-10-2006; IN COMMERCE 12-2-2006.
TINA L. SNAPP, EXAMINING ATTORNEY

SN 76-675,983. ALBANESE, ISABELLE, HINSDALE, IL.
FILED 4-25-2007.

THE BIG TRUTHS

THE MARK CONSISTS OF STANDARD CHARACTERS WITHOUT CLAIM TO ANY PARTICULAR FONT, STYLE, SIZE, OR COLOR.

FOR CONSULTING IN THE FIELD OF CONSUMER EVALUATION RESEARCH IN ADVERTISING, CONDUCTING MARKETING RESEARCH, MARKETING AND PRODUCT PACKAGING (U.S. CLS. 100, 101 AND 102).

FIRST USE 2-17-2006; IN COMMERCE 2-17-2006.
KELLEY WELLS, EXAMINING ATTORNEY

SN 76-677,879. F.C. KERBECK & SONS, INC., PALMYRA, NJ.
FILED 6-5-2007.

LIFE ISN'T ALWAYS FAIR BUT KERBECK IS

THE MARK CONSISTS OF STANDARD CHARACTERS WITHOUT CLAIM TO ANY PARTICULAR FONT, STYLE, SIZE, OR COLOR.

OWNER OF U.S. REG. NO. 3,041,462.
FOR AUTOMOBILE DEALERSHIPS (U.S. CLS. 100, 101 AND 102).

CHRISIE B. KING, EXAMINING ATTORNEY

CLASS 35—(Continued).

SN 76-678,111. GREATER FORT WORTH BUILDERS' ASSOCIATION, FORT WORTH, TX. FILED 6-12-2007.

KALEIDOSCOPE OF HOMES

THE MARK CONSISTS OF STANDARD CHARACTERS WITHOUT CLAIM TO ANY PARTICULAR FONT, STYLE, SIZE, OR COLOR.

NO CLAIM IS MADE TO THE EXCLUSIVE RIGHT TO USE "HOMES", APART FROM THE MARK AS SHOWN.

FOR PROMOTING THE REAL ESTATE SERVICES OF OTHERS BY DISTRIBUTING ADVERTISING MATERIALS THROUGH A VARIETY OF METHODS (U.S. CLS. 100, 101 AND 102).

FIRST USE 10-14-1988; IN COMMERCE 10-14-1988.
WENDY GOODMAN, EXAMINING ATTORNEY

SN 76-680,373. INNOVATION ADS, INC., NEW YORK, NY. FILED 8-6-2007.

INNOVATION ADS

THE MARK CONSISTS OF STANDARD CHARACTERS WITHOUT CLAIM TO ANY PARTICULAR FONT, STYLE, SIZE, OR COLOR.

OWNER OF U.S. REG. NO. 3,020,020.

NO CLAIM IS MADE TO THE EXCLUSIVE RIGHT TO USE "ADS", APART FROM THE MARK AS SHOWN.

FOR EDUCATIONAL INSTITUTION LEAD COLLECTION AND MATCHING SERVICES, NAMELY, GENERATING PROSPECTIVE STUDENT ENROLLMENT LEADS FOR EDUCATIONAL INSTITUTIONS AND CONNECTING INTERESTED STUDENTS WITH ACCREDITED EDUCATIONAL INSTITUTIONS; AND ADVERTISING SERVICES FOR EDUCATIONAL INSTITUTIONS, NAMELY, PROVIDING COLLEGES AND UNIVERSITIES WITH COST EFFECTIVE WAYS TO REACH OUT TO PROSPECTIVE STUDENTS TO APPLY AND ENROLL IN COLLEGES AND UNIVERSITIES (U.S. CLS. 100, 101 AND 102).

FIRST USE 6-15-2003; IN COMMERCE 6-15-2003.
REBECCA EISINGER, EXAMINING ATTORNEY

SN 76-681,977. CELERITY IT, MCLEAN, VA. FILED 9-17-2007.

CELERITY

THE MARK CONSISTS OF STANDARD CHARACTERS WITHOUT CLAIM TO ANY PARTICULAR FONT, STYLE, SIZE, OR COLOR.

OWNER OF U.S. REG. NO. 2,977,596.

FOR BUSINESS MANAGEMENT CONSULTING SERVICES (U.S. CLS. 100, 101 AND 102).

KARANENDRA S. CHHINA, EXAMINING ATTORNEY

CLASS 35—(Continued).

SN 76-682,353. GYMMAX CO., LTD., BANCIAO CITY, TAIPEI COUNTY, TAIWAN, FILED 9-26-2007.

GYMMAX

FOR EXPORT AND IMPORT AGENCY IN THE FIELD OF SPORTS EQUIPMENT AND HEALTH CARE PRODUCT; DEALERSHIPS IN THE FIELD OF SPORTS EQUIPMENT AND HEALTH CARE PRODUCT (U.S. CLS. 100, 101 AND 102).

FIRST USE 8-1-1988; IN COMMERCE 9-12-2003.
BARBARA RUTLAND, EXAMINING ATTORNEY

SN 76-682,654. CARE4ART, INC., PARK RIDGE, IL. FILED 10-5-2007.

CARE4ART

THE MARK CONSISTS OF STANDARD CHARACTERS WITHOUT CLAIM TO ANY PARTICULAR FONT, STYLE, SIZE, OR COLOR.

FOR DISTRIBUTORSHIP SERVICES FOR PICTURE HANGING DEVICES (U.S. CLS. 100, 101 AND 102).

FIRST USE 5-28-2007; IN COMMERCE 6-1-2007.
ELI HELLMAN, EXAMINING ATTORNEY

SN 77-013,264. DESIGNERFURNITUREOUTLETS.COM CORP., PENSACOLA, FL. FILED 10-4-2006.



THE COLOR(S) GREEN AND WHITE IS/ARE CLAIMED AS A FEATURE OF THE MARK.

THE TERM "DESIGNER" APPEARS ABOVE THE TERM "FURNITURE", WHICH APPEARS ABOVE THE TERM "OUTLETS.COM". THE LEFT HAND SIDE OF THE MARK IS COMPRISED OF THE LETTER "D" FROM THE TERM "DESIGNER", "F" FROM THE TERM "FURNITURE" AND "O" FROM THE TERM "OUTLETS.COM". THE LETTERS "DFO" APPEAR IN WHITE ENCAPSULATED IN A GREEN BLOCK. THE LETTERS "ESIGNER", "URNITURE", AND "UTLETS.COM" APPEAR IN GREEN. THE BACKGROUND OF THE MARK IS WHITE.

FOR RETAIL FURNITURE STORES (U.S. CLS. 100, 101 AND 102).

FIRST USE 5-19-2006; IN COMMERCE 5-19-2006.
PAULA MAHONEY, EXAMINING ATTORNEY

CLASS 35—(Continued).

SN 77-018,647. THRIFTY DRUG STORES, INC., MAPLE GROVE, MN. FILED 10-11-2006.



NO CLAIM IS MADE TO THE EXCLUSIVE RIGHT TO USE "DRUG", APART FROM THE MARK AS SHOWN.

THE MARK CONSISTS OF A SOLID RECTANGLE AND SIX SOLID SQUARES LINED UP TO FORM THE DESIGN OF A WAIVING FLAG.

FOR RETAIL PHARMACY AND DRUG STORE SERVICES; RETAIL STORE SERVICES FEATURING GENERAL CONSUMER MERCHANDISE (U.S. CLS. 100, 101 AND 102).

FIRST USE 0-0-1985; IN COMMERCE 0-0-1985.
SANDRA MANIOS, EXAMINING ATTORNEY

SN 77-020,572. PEAK IMPACT INC., OTTAWA, ONTARIO, CANADA, FILED 10-13-2006.

PEAK IMPACT

THE MARK CONSISTS OF STANDARD CHARACTERS WITHOUT CLAIM TO ANY PARTICULAR FONT, STYLE, SIZE, OR COLOR.

PRIORITY CLAIMED UNDER SEC. 44(D) ON CANADA APPLICATION NO. 1313669, FILED 8-16-2006, REG. NO. TMA703795, DATED 12-21-2007, EXPIRES 12-21-2022.

FOR ELECTRONIC COMMERCE SERVICES, NAMELY, THE OPERATION OF AN ON-LINE MARKETING AGENCY TO ASSIST POTENTIAL BUYERS OF COMMODITIES OR SERVICES OF ANY KIND IN FINDING SELLERS THEREOF IN THE NATURE OF PROVIDING BUSINESS LEADS AND TO PROVIDE BUSINESS INFORMATION RELATED TO LEAD GENERATION, EXCLUDING SUCH SERVICES AS THEY RELATE TO THE CONSTRUCTION INDUSTRY; MARKETING SERVICES, NAMELY, THE GENERATION, MANAGEMENT AND DELIVERY OF BUSINESS OPPORTUNITY LEADS FOR THIRD PARTIES, EXCLUDING SUCH SERVICES AS THEY RELATE TO THE CONSTRUCTION INDUSTRY; BUSINESS CONSULTING SERVICES IN THE FIELD OF ON-LINE BUSINESS, NAMELY, INCREASING BUSINESS PROFITABILITY AND REVENUES BY PROVIDING ADVICE WITH RESPECT TO WEBSITE DESIGN, INCREASING ON-LINE ADVERTISEMENT AND INCREASING TRAFFIC (U.S. CLS. 100, 101 AND 102).

DOMINIC FATHY, EXAMINING ATTORNEY

CLASS 35—(Continued).

SN 77-022,040. CASS, STEVEN P, SAN MATEO, CA. FILED 10-16-2006.



THE COLOR(S) GREEN AND ORANGE IS/ARE CLAIMED AS A FEATURE OF THE MARK.

THE COLOR GREEN APPEARS IN THE WORDING "ADDA" AND THE COLOR ORANGE APPEARS IN THE WORDING "STAFF" IN THE DESIGN OF THE PUZZLE PIECE AND THE LETTER "A"

FOR TEMPORARY STAFFING SERVICE (U.S. CLS. 100, 101 AND 102).

FIRST USE 3-1-2006; IN COMMERCE 3-1-2006.
SHAUNIA CARLYLE, EXAMINING ATTORNEY

SN 77-037,634. GNYHA VENTURES, INC., NEW YORK, NY. FILED 11-6-2006.

LINUXUS

THE MARK CONSISTS OF STANDARD CHARACTERS WITHOUT CLAIM TO ANY PARTICULAR FONT, STYLE, SIZE, OR COLOR.

FOR BUSINESS MANAGEMENT, BUSINESS CONSULTATION, AND BUSINESS ADMINISTRATION DIRECTED TO THE HEALTHCARE INDUSTRY RELATING TO THE ESTABLISHMENT OF BEST PRACTICES STANDARDS AND SOLUTIONS, PAYER-PROVIDER TRANSACTION PROCESSING, ELECTRONIC HEALTHCARE DATA EXCHANGE, ADMINISTRATIVE SIMPLIFICATION, AND COLLABORATION BETWEEN HEALTH CARE PROVIDERS AND PAYERS (U.S. CLS. 100, 101 AND 102).

ELI HELLMAN, EXAMINING ATTORNEY

SN 77-040,940. DIGITAL MUSIC GROUP, INC., SACRAMENTO, CA. FILED 11-9-2006.

DMGI

THE MARK CONSISTS OF STANDARD CHARACTERS WITHOUT CLAIM TO ANY PARTICULAR FONT, STYLE, SIZE, OR COLOR.

FOR WHOLESALE DISTRIBUTORSHIP FEATURING DIGITAL AUDIO AND AUDIOVISUAL WORKS; COMPUTERIZED ACCOUNTING SERVICES; PROMOTION AND MARKETING SERVICES AND RELATED CONSULTING IN THE FIELD OF DIGITAL AUDIO AND AUDIOVISUAL WORKS; LICENSING OF AUDIO AND AUDIOVISUAL WORKS (U.S. CLS. 100, 101 AND 102).

FIRST USE 11-9-2006; IN COMMERCE 11-9-2006.
MAUREEN DALL, EXAMINING ATTORNEY

CLASS 35—(Continued).

SN 77-046,621. SONY BMG MUSIC ENTERTAINMENT, NEW YORK, NY. FILED 11-17-2006.

MY MUSIC NETWORK

THE MARK CONSISTS OF STANDARD CHARACTERS WITHOUT CLAIM TO ANY PARTICULAR FONT, STYLE, SIZE, OR COLOR.

NO CLAIM IS MADE TO THE EXCLUSIVE RIGHT TO USE "MUSIC NETWORK", APART FROM THE MARK AS SHOWN.

FOR INTEGRATED TRACKING AND MANAGEMENT OF COMMERCIAL SALES TRANSACTIONS OF DIGITAL MUSIC AND MEDIA GOODS ON A GLOBAL COMPUTER NETWORK (U.S. CLS. 100, 101 AND 102).
KHANH LE, EXAMINING ATTORNEY

SN 77-049,197. COUPONS, INC., MOUNTAIN VIEW, CA. FILED 11-21-2006.

BRICKS

THE MARK CONSISTS OF STANDARD CHARACTERS WITHOUT CLAIM TO ANY PARTICULAR FONT, STYLE, SIZE, OR COLOR.

FOR ADVERTISING AND MARKETING SERVICES, NAMELY, PROMOTING THE GOODS AND SERVICES OF OTHERS THROUGH THE DISTRIBUTION OF COUPONS VIA THE INTERNET AND E-MAIL (U.S. CLS. 100, 101 AND 102).

FIRST USE 9-0-2000; IN COMMERCE 9-0-2000.
JASON TURNER, EXAMINING ATTORNEY

SN 77-049,760. SMARTFUNDIT.COM LIMITED, BASINGSTOKE, HAMPSHIRE, UNITED KINGDOM, FILED 11-22-2006.

SMARTFUNDIT.COM

THE MARK CONSISTS OF STANDARD CHARACTERS WITHOUT CLAIM TO ANY PARTICULAR FONT, STYLE, SIZE, OR COLOR.

FOR BUSINESS NETWORKING SERVICES, NAMELY, PROVISION OF AN ONLINE, INTERACTIVE WEBSITE SERVICE TO EFFECT BUSINESS INTRODUCTIONS IN RELATION TO THE SALE, PURCHASE, LICENSING, FINANCING, MAINTENANCE, INSTALLATION, MARKETING AND/OR IMPLEMENTATION OF COMPUTER SOFTWARE AND COMPUTER HARDWARE (U.S. CLS. 100, 101 AND 102).

FIRST USE 1-31-2006; IN COMMERCE 1-31-2006.
SANI KHOURI, EXAMINING ATTORNEY

CLASS 35—(Continued).

SN 77-056,080. UNITED STATES STEEL CORPORATION, PITTSBURGH, PA. FILED 12-4-2006.

ROSS BRIDGE VILLAGE CENTER

THE MARK CONSISTS OF STANDARD CHARACTERS WITHOUT CLAIM TO ANY PARTICULAR FONT, STYLE, SIZE, OR COLOR.

OWNER OF U.S. REG. NOS. 3,237,492 AND 3,362,583.

NO CLAIM IS MADE TO THE EXCLUSIVE RIGHT TO USE "VILLAGE CENTER", APART FROM THE MARK AS SHOWN.

FOR PROVIDING RETAIL SHOPS FEATURING A WIDE VARIETY OF CONSUMER GOODS; BUSINESS MANAGEMENT OF COMMERCIAL ESTABLISHMENTS AND RECREATIONAL FACILITIES (U.S. CLS. 100, 101 AND 102).

FIRST USE 11-1-2005; IN COMMERCE 12-1-2005.
STEVEN JACKSON, EXAMINING ATTORNEY

SN 77-058,767. WHALEY MARKETING COMMUNICATIONS, INC., EDEN PRAIRIE, MN. FILED 12-7-2006.

AMERICAN JUNK CLUB

THE MARK CONSISTS OF STANDARD CHARACTERS WITHOUT CLAIM TO ANY PARTICULAR FONT, STYLE, SIZE, OR COLOR.

NO CLAIM IS MADE TO THE EXCLUSIVE RIGHT TO USE "AMERICAN" AND "CLUB", APART FROM THE MARK AS SHOWN.

FOR ASSOCIATION SERVICES, NAMELY, PROMOTING THE INTERESTS OF COLLECTORS OF ANTIQUES AND COLLECTIBLES (U.S. CLS. 100, 101 AND 102).

TASHIA BUNCH, EXAMINING ATTORNEY

SN 77-062,850. GOODLANDDEALS.COM, LAS VEGAS, NV. FILED 12-12-2006.

GoodLandDeals.com

THE MARK CONSISTS OF STANDARD CHARACTERS WITHOUT CLAIM TO ANY PARTICULAR FONT, STYLE, SIZE, OR COLOR.

FOR DEVELOPMENT OF MARKETING STRATEGIES AND CONCEPTS; MARKETING PLAN DEVELOPMENT (U.S. CLS. 100, 101 AND 102).

FIRST USE 6-15-2001; IN COMMERCE 6-15-2001.
HEATHER BIDDULPH, EXAMINING ATTORNEY

CLASS 35—(Continued).

SN 77-063,295. EL TARASCO MEAT MARKET, RANCHO CUCAMONGA, CA. FILED 12-13-2006.

EL TARASCO

THE MARK CONSISTS OF STANDARD CHARACTERS WITHOUT CLAIM TO ANY PARTICULAR FONT, STYLE, SIZE, OR COLOR.

THE ENGLISH TRANSLATION OF "EL TARASCO" IS THE "WICKED".

FOR RETAIL CONVENIENCE STORES; RETAIL GROCERY STORES (U.S. CLS. 100, 101 AND 102).

FIRST USE 12-31-1999; IN COMMERCE 12-31-1999.
LYDIA BELZER, EXAMINING ATTORNEY

CLASS 35—(Continued).

SN 77-072,835. THE SAGE GROUP I, L.L.C., BELLEVUE, WA. FILED 12-28-2006.

THE SAGE GROUP

THE MARK CONSISTS OF STANDARD CHARACTERS WITHOUT CLAIM TO ANY PARTICULAR FONT, STYLE, SIZE, OR COLOR.

NO CLAIM IS MADE TO THE EXCLUSIVE RIGHT TO USE "GROUP", APART FROM THE MARK AS SHOWN.

FOR BUSINESS CONSULTATION SERVICES, NAMELY, IDENTIFYING COMPETITIVE ADVANTAGES FOR BUSINESSES USING PROPRIETARY ACCELERATION MODELS (U.S. CLS. 100, 101 AND 102).

GENE MACIOL, EXAMINING ATTORNEY

SN 77-079,565. GM WORLDWIDE ENTERTAINMENT, INC., LAS VEGAS, NV. FILED 1-10-2007.



NO CLAIM IS MADE TO THE EXCLUSIVE RIGHT TO USE "WORLDWIDE ENTERTAINMENT", APART FROM THE MARK AS SHOWN.

THE MARK CONSISTS OF A GLOBE DESIGN, THE LETTERS "GM" IN A STYLIZED FONT AND THE WORDS "WORLDWIDE ENTERTAINMENT".

FOR TALENT CONSULTANT SERVICES, NAMELY, REPRESENTATION OF ALL TYPES OF CREATIVE TALENT (U.S. CLS. 100, 101 AND 102).

TERESA M. RUPP, EXAMINING ATTORNEY

SN 77-063,762. RAT CITY ROLLERGIRLS, LLC, SEATTLE, WA. FILED 12-13-2006.



OWNER OF U.S. REG. NO. 3,305,666.
NO CLAIM IS MADE TO THE EXCLUSIVE RIGHT TO USE "ROLLERGIRLS", APART FROM THE MARK AS SHOWN.

FOR COORDINATION OF RECREATIONAL SPORTING OPPORTUNITIES FOR INDIVIDUALS WHO WISH TO PARTICIPATE IN TEAM LEAGUE SPORTS; PROMOTING SPORTS COMPETITIONS AND/OR EVENTS OF OTHERS (U.S. CLS. 100, 101 AND 102).

FIRST USE 5-1-2004; IN COMMERCE 5-1-2004.
AISHA SALEM, EXAMINING ATTORNEY

SN 77-079,911. S & C FOODS, INC., OLD HICKORY, TN. FILED 1-10-2007.

H.G. Hill Fresh Choice

THE MARK CONSISTS OF STANDARD CHARACTERS WITHOUT CLAIM TO ANY PARTICULAR FONT, STYLE, SIZE, OR COLOR.

NO CLAIM IS MADE TO THE EXCLUSIVE RIGHT TO USE "FRESH", APART FROM THE MARK AS SHOWN.

FOR RETAIL GROCERY STORES (U.S. CLS. 100, 101 AND 102).

CHRIS WELLS, EXAMINING ATTORNEY

CLASS 35—(Continued).

SN 77-085,501. SHARA TAYLOR LTD., BAYSIDE, NY. FILED 1-18-2007.



NO CLAIM IS MADE TO THE EXCLUSIVE RIGHT TO USE "SPY ASSOCIATES", APART FROM THE MARK AS SHOWN.

THE MARK CONSISTS OF A SILHOUETTE OF A MAN WEARING A TRENCH COAT AND HAT WITHIN AN UPRIGHT TRIANGULAR DESIGN APPEARING TO THE LEFT OF THE STYLIZED LETTERING "SPY", WHICH APPEARS ABOVE THE STYLIZED LETTERING "ASSOCIATES".

FOR ON-LINE RETAIL STORE SERVICES IN THE FIELD OF ELECTRIC AND ELECTRONIC AUDIO AND VIDEO SECURITY SURVEILLANCE, AND GLOBAL POSITIONING SYSTEMS AND DEVICES (U.S. CLS. 100, 101 AND 102).

FIRST USE 4-0-2005; IN COMMERCE 4-0-2005. LEE-ANNE BERNIS, EXAMINING ATTORNEY

CLASS 35—(Continued).

SN 77-095,433. SME SALES AND MARKETING EXECUTIVES, INC. OF SIOUX FALLS, SIOUX FALLS, SD. FILED 1-31-2007.

SME Distinguished Sales and Marketing Awards

THE MARK CONSISTS OF STANDARD CHARACTERS WITHOUT CLAIM TO ANY PARTICULAR FONT, STYLE, SIZE, OR COLOR.

NO CLAIM IS MADE TO THE EXCLUSIVE RIGHT TO USE "DISTINGUISHED SALES AND MARKETING AWARDS", APART FROM THE MARK AS SHOWN.

FOR PROMOTING THE GOODS AND SERVICES OF OTHERS BY ARRANGING FOR SPONSORS TO AFFILIATE THEIR GOODS AND SERVICES WITH AN AWARDS PROGRAM (U.S. CLS. 100, 101 AND 102).

FIRST USE 2-15-1965; IN COMMERCE 2-15-1965. FLORENTINA BLANDU, EXAMINING ATTORNEY

SN 77-096,105. VEGAS.COM, LLC, HENDERSON, NV. FILED 1-31-2007.

SN 77-092,558. REALAM, INC., LAS VEGAS, NV. FILED 1-26-2007.

REALTY AMERICA

THE MARK CONSISTS OF STANDARD CHARACTERS WITHOUT CLAIM TO ANY PARTICULAR FONT, STYLE, SIZE, OR COLOR.

SEC. 2(F).

FOR FRANCHISING SERVICES, NAMELY, OFFERING CONSULTATION AND ASSISTANCE IN THE ESTABLISHMENT AND/OR OPERATION OF REAL ESTATE AGENCIES AND REAL ESTATE BROKERAGES; BUSINESS MANAGEMENT; BUSINESS CONSULTATION; BUSINESS ADVICE AND INFORMATION; BUSINESS PLANNING; BUSINESS SUPERVISION; AND BUSINESS RESEARCH (U.S. CLS. 100, 101 AND 102).

TRACY CROSS, EXAMINING ATTORNEY



OWNER OF U.S. REG. NOS. 3,129,210, 3,327,052 AND OTHERS.

THE COLOR(S) RED AND WHITE IS/ARE CLAIMED AS A FEATURE OF THE MARK.

THE COLOR RED APPEARS IN THE WORDING "SURVIVAL KIT" AND IN THE DESIGN ELEMENT OF AN ARROW; THE COLOR WHITE APPEARS IN THE WORDING "VEGAS" AND IN THE ARROW DESIGN ELEMENT AS A BORDER AND DOTS.

SEC. 2(F) AS TO "VEGAS".

FOR PROMOTING THE SALE OF GOODS AND SERVICES OF OTHERS THROUGH THE DISTRIBUTION OF PRINTED MATERIAL AND PROMOTIONAL MERCHANDISE (U.S. CLS. 100, 101 AND 102).

AISHA SALEM, EXAMINING ATTORNEY

CLASS 35—(Continued).

SN 77-099,232. TWIN CITIES PUBLIC TELEVISION, INC., ST. PAUL, MN. FILED 2-5-2007.



OWNER OF U.S. REG. NO. 2,559,896.
THE COLOR(S) BLACK AND BLUE IS/ARE CLAIMED AS A FEATURE OF THE MARK.
THE MARK CONSISTS OF THE "TPT" LOGO COMPRISING THE LETTERS "TPT" IN THE COLOR BLACK WITH THE ACCENT ABOVE THE LETTER "P" IN THE COLOR BLUE.

FOR PRODUCTION OF TELEVISION COMMERCIALS AND PUBLIC SERVICE ANNOUNCEMENTS; PROMOTING PUBLIC AWARENESS OF THE NEED FOR EDUCATION AND ARTS; ADVERTISING AND PUBLICITY SERVICES, NAMELY, PROMOTING THE GOODS, SERVICES, BRAND IDENTITY AND/OR COMMERCIAL INFORMATION AND/OR NEWS OF THIRD PARTIES THROUGH PRINT, AUDIO, VIDEO, DIGITAL AND/OR ON-LINE MEDIUM; POST-PRODUCTION EDITING SERVICES FOR VIDEO AND AUDIO COMMERCIALS; ADVERTISING AND ADVERTISEMENT SERVICES; ADVERTISING AND MARKETING; ONLINE ORDERING SERVICES; PROMOTING THE CONCERTS OF OTHERS; PROMOTING THE GOODS AND SERVICES OF OTHERS BY ARRANGING FOR SPONSORS TO AFFILIATE THEIR GOODS AND/OR SERVICES WITH THE BROADCASTING OF PUBLIC TELEVISION PROGRAMMES; PROMOTING THE GOODS AND/OR SERVICES OF OTHERS BY PROVIDING HYPERTEXT LINKS TO THE WEB SITES OF OTHERS; DISSEMINATION OF ADVERTISING FOR OTHERS BY WAY OF THE INTERNET AND PRINT ADVERTISEMENTS; AND DISSEMINATION OF ADVERTISING MATTER (U.S. CLS. 100, 101 AND 102).

FIRST USE 5-1-2000; IN COMMERCE 5-1-2000.
INGA ERVIN, EXAMINING ATTORNEY

SN 77-099,582. REUTERS LIMITED, LONDON, UNITED KINGDOM, FILED 2-5-2007.

Reuters Expert Trust

THE MARK CONSISTS OF STANDARD CHARACTERS WITHOUT CLAIM TO ANY PARTICULAR FONT, STYLE, SIZE, OR COLOR.

OWNER OF U.S. REG. NOS. 1,008,206, 2,473,929 AND OTHERS.

FOR PROVIDING BUSINESS INFORMATION (U.S. CLS. 100, 101 AND 102).

TRACY CROSS, EXAMINING ATTORNEY

CLASS 35—(Continued).

SN 77-099,962. SEARCH SPECIALISTS, INC., LITHIA, FL. FILED 2-8-2007.

SEARCH SPECIALISTS, INC.

THE MARK CONSISTS OF STANDARD CHARACTERS WITHOUT CLAIM TO ANY PARTICULAR FONT, STYLE, SIZE, OR COLOR.

NO CLAIM IS MADE TO THE EXCLUSIVE RIGHT TO USE "INC.", APART FROM THE MARK AS SHOWN.

SEC. 2(F),
FOR PERSONNEL PLACEMENT AND RECRUITMENT (U.S. CLS. 100, 101 AND 102).

FIRST USE 1-1-1989; IN COMMERCE 1-1-1989.
STEVEN R. FINE, EXAMINING ATTORNEY

SN 77-101,305. NATIONAL PREMIUM, INC., PEWAUKEE, WI. FILED 2-7-2007.



THE MARK CONSISTS OF A RECTANGLE WITH A STAR IN A CIRCLE CENTERED OVER IT. THE WORDS "NATIONAL PREMIUM READY, WILLING & ABLE" ARE CENTERED UNDER THE DESIGN ELEMENT OF THE MARK.

FOR ADVERTISING AND MARKETING SERVICES, NAMELY, PROVIDING ADVERTISING, POINT-OF-SALE AND INCENTIVE AWARD PROGRAMS FOR PROMOTING THE SALES OF GOODS AND SERVICES OF OTHERS (U.S. CLS. 100, 101 AND 102).

FIRST USE 1-6-2004; IN COMMERCE 1-6-2004.
JEFFERY COWARD, EXAMINING ATTORNEY

SN 77-102,021. GENESIS FRANCHISE ENTERPRISES LLC, FIFE, WA. FILED 2-7-2007.

GENESIS FRANCHISE ENTERPRISES

THE MARK CONSISTS OF STANDARD CHARACTERS WITHOUT CLAIM TO ANY PARTICULAR FONT, STYLE, SIZE, OR COLOR.

NO CLAIM IS MADE TO THE EXCLUSIVE RIGHT TO USE "FRANCHISE ENTERPRISES", APART FROM THE MARK AS SHOWN.

FOR FRANCHISOR SERVICES IN THE FIELD OF REAL ESTATE, NAMELY, ASSISTANCE IN THE RUNNING OR MANAGEMENT OF INDUSTRIAL, COMMERCIAL, OR RESIDENTIAL REAL ESTATE ENTERPRISES (U.S. CLS. 100, 101 AND 102).

WOODROW HARTZOG, EXAMINING ATTORNEY

CLASS 35—(Continued).

SN 77-102,574. SERMO, INC., CAMBRIDGE, MA. FILED 2-8-2007.

KNOW MORE. KNOW EARLIER.

THE MARK CONSISTS OF STANDARD CHARACTERS WITHOUT CLAIM TO ANY PARTICULAR FONT, STYLE, SIZE, OR COLOR.

FOR CONDUCTING MARKETING STUDIES USING SOCIAL NETWORK THEORY, PREDICTION MARKETS AND METHODS OR SYSTEMS FOR THE ARBITRAGE OF INFORMATION INCLUDING THE DETECTION AND SURVEY OF TRENDS IN VARIOUS MARKETS; BUSINESS CONSULTING SERVICES IN THE FIELD OF CONNECTING EXPERTS WITH BUYERS WHO PURCHASE EXPERTISE AND SYSTEMS THAT COLLECTIVELY HARNESS THE INSIGHTS OF INDIVIDUALS (U.S. CLS. 100, 101 AND 102).

FIRST USE 6-1-2006; IN COMMERCE 6-1-2006.
STEVEN R. FINE, EXAMINING ATTORNEY

SN 77-104,488. GENNARI, MIRIAM A., ARLINGTON, VA. FILED 2-10-2007.

MetroMakeover

THE MARK CONSISTS OF STANDARD CHARACTERS WITHOUT CLAIM TO ANY PARTICULAR FONT, STYLE, SIZE, OR COLOR.

FOR ADVERTISING, MARKETING, AND PROMOTION SERVICES; PROVIDING BUSINESS MARKETING INFORMATION; PROVIDING ONLINE MARKETING SERVICES; WEB MARKETING, NAMELY, PROVIDING ONLINE BUSINESS DIRECTORIES TO BUSINESSES INVOLVING MAKEOVERS, NAMELY, BEAUTY AND COSMETIC CONSULTANTS, IMAGE CONSULTANTS, PERSONAL SHOPPERS, HAIR PRODUCTS, SALONS AND SERVICES, NAIL PRODUCTS AND SERVICES, SKIN PRODUCTS AND SERVICES, BODY PRODUCTS AND SERVICES, TANNING, STRESS REDUCTION, SPAS, YOGA AND MEDITATION, CHIROPRACTIC SERVICES, EXERCISE THERAPY, PHYSICAL THERAPY, SPORTS MEDICINE, NUTRITIONAL COUNSELING, HOLISTIC HEALTH/HERBAL HEALING, MEDICAL SERVICES, PLASTIC SURGEONS, BODY SHAPE PROCEDURES, BOTOX AND COLLAGEN INJECTIONS, RESTYLANE INJECTIONS, SCLEROTHERAPY, MESOTHERAPY, LASER HAIR REMOVAL, LASER VEIN AND SKIN DISCOLORATION TREATMENTS, LASER HAIR RESTORATION, HEALTH CLUBS AND SERVICES, WEIGHT LOSS SERVICES, DANCE, MARTIAL ARTS, SELF DEFENSE, GROUP SOCIAL EVENTS, SMOKING CESSATION SUPPORT, FITNESS ANALYSIS, FASHION MERCHANDISING, HOME DECORATING, HOME AND OFFICE ORGANIZATION, FINANCIAL PLANNING, LOANS/MORTGAGES, CAREER AND EDUCATION COUNSELING AND SERVICES, TATTOOS AND PIERCING; ADVERTISING AND MARKETING CONSULTATION SERVICES; PUBLIC RELATIONS SERVICES AND CONSULTATIONS IN THE FIELD OF CONSULTATION; PUBLIC RELATION SERVICES AND CONSULTATIONS IN THE FIELD OF

CLASS 35—(Continued).

PUBLIC RELATIONS; PUBLICITY SERVICES, NAMELY, PROMOTING THE GOODS, SERVICES, BRAND IDENTITY AND COMMERCIAL INFORMATION AND NEWS OF THIRD PARTIES THROUGH PRINT, AUDIO, VIDEO, DIGITAL AND ON-LINE MEDIUM; PROMOTING THE GOODS AND SERVICES OF OTHERS BY ARRANGING FOR SPONSORS TO AFFILIATE THEIR GOODS AND SERVICES WITH HEALTH AND FITNESS CLUBS, RESORTS, HOTELS, ENTERTAINMENT CLUBS, CONFERENCE CENTERS, HEALTH FAIRS, AND HEALTH AND FITNESS RELATED ACTIVITIES, NAMELY, MARATHONS, BASEBALL GAMES, FOOTBALL GAMES, BASKETBALL GAMES, VOLLEYBALL GAMES, SOCCER GAMES, TENNIS GAMES, GOLF GAMES, SWIMMING COMPETITIONS, VOLLEYBALL GAMES, COMPANY SPONSORED EVENTS; GENERAL BUSINESS NETWORKING REFERRAL SERVICES, NAMELY, PROMOTING THE GOODS AND SERVICES OF OTHERS BYPASSING BUSINESS LEADS AND REFERRALS AMONG GROUP MEMBERS (U.S. CLS. 100, 101 AND 102).

FIRST USE 11-16-2006; IN COMMERCE 11-16-2006.
GINA HAYES, EXAMINING ATTORNEY

SN 77-106,840. GENNARI, MIRIAM A., ARLINGTON, VA. AND GENNARI, PAUL A., ARLINGTON, VA. FILED 2-13-2007.

MetroMakeover

FOR ADVERTISING, MARKETING, AND PROMOTION SERVICES; PROVIDING BUSINESS MARKETING INFORMATION; PROVIDING ONLINE MARKETING SERVICES; WEB MARKETING, NAMELY, PROVIDING ONLINE BUSINESS DIRECTORIES TO BUSINESSES INVOLVING MAKEOVERS, NAMELY, BEAUTY AND COSMETIC CONSULTANTS, IMAGE CONSULTANTS, PERSONAL SHOPPERS, HAIR PRODUCTS, SALONS AND SERVICES, NAIL PRODUCTS AND SERVICES, SKIN PRODUCTS AND SERVICES, BODY PRODUCTS AND SERVICES, TANNING, STRESS REDUCTION, SPAS, YOGA AND MEDITATION, CHIROPRACTIC SERVICES, EXERCISE THERAPY, PHYSICAL THERAPY, SPORTS MEDICINE, NUTRITIONAL COUNSELING, HOLISTIC HEALTH/HERBAL HEALING, MEDICAL SERVICES, PLASTIC SURGEONS, BODY SHAPE PROCEDURES, BOTOX AND COLLAGEN INJECTIONS, RESTYLANE INJECTIONS, SCLEROTHERAPY, MESOTHERAPY, LASER HAIR REMOVAL, LASER VEIN AND SKIN DISCOLORATION TREATMENTS, LASER HAIR RESTORATION, HEALTH CLUBS AND SERVICES, WEIGHT LOSS SERVICES, DANCE, MARTIAL ARTS, SELF DEFENSE, GROUP SOCIAL EVENTS, SMOKING CESSATION SUPPORT, FITNESS ANALYSIS, FASHION MERCHANDISING, HOME DECORATING, HOME AND OFFICE ORGANIZATION, FINANCIAL PLANNING, LOANS/MORTGAGES, CAREER AND EDUCATION COUNSELING AND SERVICES, TATTOOS AND PIERCING; ADVERTISING AND MARKETING CONSULTATION SERVICES; PUBLIC RELATIONS SERVICES AND CONSULTATIONS IN THE FIELD OF CONSULTATION; PUBLIC RELATION SER-

CLASS 35—(Continued).

VICES AND CONSULTATIONS IN THE FIELD OF PUBLIC RELATIONS; PUBLICITY SERVICES, NAMELY, PROMOTING THE GOODS, SERVICES, BRAND IDENTITY AND COMMERCIAL INFORMATION AND NEWS OF THIRD PARTIES THROUGH PRINT, AUDIO, VIDEO, DIGITAL AND ON-LINE MEDIUM; PROMOTING THE GOODS AND SERVICES OF OTHERS BY ARRANGING FOR SPONSORS TO AFFILIATE THEIR GOODS AND SERVICES WITH HEALTH AND FITNESS CLUBS, RESORTS, HOTELS, ENTERTAINMENT CLUBS, CONFERENCE CENTERS, HEALTH FAIRS, AND HEALTH AND FITNESS RELATED ACTIVITIES, NAMELY, MARATHONS, BASEBALL GAMES, FOOTBALL GAMES, BASKETBALL GAMES, VOLLEYBALL GAMES, SOCCER GAMES, TENNIS GAMES, GOLF GAMES, SWIMMING COMPETITIONS, VOLLEYBALL GAMES, COMPANY SPONSORED EVENTS; GENERAL BUSINESS NETWORKING REFERRAL SERVICES, NAMELY, PROMOTING THE GOODS AND SERVICES OF OTHERS BY PASSING BUSINESS LEADS AND REFERRALS AMONG GROUP MEMBERS (U.S. CLS. 100, 101 AND 102).

FIRST USE 11-16-2006; IN COMMERCE 11-16-2006.
GINA HAYES, EXAMINING ATTORNEY

SN 77-106,933. BEANPOOL, LLC, NORCROSS, GA. FILED 2-14-2007.

PLEASE RATE US

THE MARK CONSISTS OF STANDARD CHARACTERS WITHOUT CLAIM TO ANY PARTICULAR FONT, STYLE, SIZE, OR COLOR.

FOR ADVERTISING AND ADVERTISEMENT SERVICES, NAMELY, PROMOTING THE GOODS AND SERVICES OF OTHERS BY ENCOURAGING CUSTOMERS TO WRITE REVIEWS, RATINGS AND RECOMMENDATIONS OF BUSINESSES AND PROFESSIONALS VIA THE INTERNET (U.S. CLS. 100, 101 AND 102).

HEATHER THOMPSON, EXAMINING ATTORNEY

SN 77-108,120. HOLMES, BENNIE D., BIRMINGHAM, AL. FILED 2-15-2007.

DA UNDERGROUND ALLSTARS

THE MARK CONSISTS OF STANDARD CHARACTERS WITHOUT CLAIM TO ANY PARTICULAR FONT, STYLE, SIZE, OR COLOR.

FOR ADVERTISING CONSULTATION; ADVERTISING, MARKETING AND PROMOTION SERVICES; PROMOTING SPORTS COMPETITIONS AND/OR EVENTS OF OTHERS; PROMOTING THE CONCERTS OF OTHERS; PROMOTING THE PARTIES AND SPECIAL EVENTS OF OTHERS (U.S. CLS. 100, 101 AND 102).

FIRST USE 2-0-2006; IN COMMERCE 12-0-2006.
DEIRDRE ROBERTSON, EXAMINING ATTORNEY

CLASS 35—(Continued).

SN 77-109,086. ALLIANCE TRADING, INC., COVINGTON, LA. FILED 2-16-2007.

SUPERIOR POOL PRODUCTS

THE MARK CONSISTS OF STANDARD CHARACTERS WITHOUT CLAIM TO ANY PARTICULAR FONT, STYLE, SIZE, OR COLOR.

NO CLAIM IS MADE TO THE EXCLUSIVE RIGHT TO USE "POOL PRODUCTS", APART FROM THE MARK AS SHOWN.

SEC. 2(F).

FOR DISTRIBUTORSHIP SERVICES IN THE FIELD OF SWIMMING POOLS AND SPAS; SWIMMING POOL AND SPA COMPONENTS; SWIMMING POOL AND SPA ACCESSORIES; SWIMMING POOL MAINTENANCE EQUIPMENT, NAMELY, BRUSHES, HOSES, SKIMMER NETS, VACUUMS, THERMOMETERS, POLES; SWIMMING POOL SAFETY EQUIPMENT, NAMELY, POOL ALARMS, SAFETY FENCING, SAFETY SIGNS, AND BUOYS; IRRIGATION PRODUCTS, NAMELY, IRRIGATION TOOLS CONSISTING OF PLUMBER'S PLIERS AND DIRECT CUT SHEARS; LANDSCAPING PRODUCTS SURROUNDING SWIMMING POOLS, NAMELY, DECK PAVERS, RETAINING WALLS AND LIGHTING; CONSTRUCTION MATERIALS TO CONSTRUCT SWIMMING POOLS AND SPAS; OUTDOOR LEISURE PRODUCTS; GRILLS; AND OUTDOOR FURNITURE (U.S. CLS. 100, 101 AND 102).

FIRST USE 12-31-1986; IN COMMERCE 12-31-1986.
LYDIA BELZER, EXAMINING ATTORNEY

SN 77-110,170. SUMMER HOUSE, INC., SEATTLE, WA. FILED 2-17-2007.



**SUMMER
HOUSE**

Furniture for the Home & Patio

NO CLAIM IS MADE TO THE EXCLUSIVE RIGHT TO USE "HOUSE" AND "FURNITURE FOR THE HOME & PATIO", APART FROM THE MARK AS SHOWN.

THE COLOR(S) OLIVE GREEN (PMS = 582); BLACK; WHITE IS/ARE CLAIMED AS A FEATURE OF THE MARK.

THE MARK CONSISTS OF ON LEFT, AN OLIVE-GREEN (PMS = 582) RECTANGLE WITH AN INSET DRAWING OF A WHITE STEAMER CHAIR. ON RIGHT THERE ARE, STACKED VERTICALLY FROM TOP TO BOTTOM, WORD "SUMMER" (FONT: HIGHTOWER, ROMAN, SMALL CAPS; COLOR: BLACK), HORIZONTAL OLIVE-GREEN (PMS = 582) LINE, WORD "HOUSE" (FONT = HIGHTOWER, ROMAN, SMALL CAPS; COLOR = BLACK), AND ITALICIZED STATEMENT "FURNITURE FOR THE HOME & PATIO" (FONT = HIGHTOWER, ITALIC; COLOR = BLACK).

FOR RETAIL STORE SERVICES FEATURING NEW PATIO AND GARDEN FURNITURE, UMBRELLAS, UMBRELLA BASES, ELECTRIC, GAS AND PROPANE HEATERS, MATERIALS FOR TOUCH-UP, RESTORATION, AND CLEANING PURPOSES, OUTDOOR RUGS, TABLE-TOP AND WALL-MOUNTED ACCESSORIES, AND LAMPS (U.S. CLS. 100, 101 AND 102).

FIRST USE 4-2-2005; IN COMMERCE 4-2-2005.

RICHARD A. STRASER, EXAMINING ATTORNEY

CLASS 35—(Continued).

SN 77-115,039. TRAFFORD HOLDINGS LTD., VICTORIA, CANADA, FILED 2-23-2007.

TRAFFORD

THE MARK CONSISTS OF STANDARD CHARACTERS WITHOUT CLAIM TO ANY PARTICULAR FONT, STYLE, SIZE, OR COLOR.
 FOR ONLINE RETAIL STORE SERVICES FEATURING BOOKS (U.S. CLS. 100, 101 AND 102).
 FIRST USE 0-0-1996; IN COMMERCE 0-0-1996.
 WENDY GOODMAN, EXAMINING ATTORNEY

SN 77-115,100. TRAFFORD HOLDINGS LTD., VICTORIA, CANADA, FILED 2-23-2007.

TRAFFORD PUBLISHING

THE MARK CONSISTS OF STANDARD CHARACTERS WITHOUT CLAIM TO ANY PARTICULAR FONT, STYLE, SIZE, OR COLOR.
 NO CLAIM IS MADE TO THE EXCLUSIVE RIGHT TO USE "PUBLISHING", APART FROM THE MARK AS SHOWN.
 FOR ONLINE RETAIL STORE SERVICES FEATURING BOOKS (U.S. CLS. 100, 101 AND 102).
 FIRST USE 0-0-1995; IN COMMERCE 0-0-1998.
 WENDY GOODMAN, EXAMINING ATTORNEY

SN 77-116,088. SEXY GIRL STUFF, LLC, CONCORD, NH. FILED 2-26-2007.



THE MARK CONSISTS OF THE WORDS SEXYGIRLSTUFF WITH THE SILHOUETTE OF A SHAPELY FEMALE STANDING BEHIND THE LETTER G.
 FOR COMPUTERIZED ON-LINE RETAIL STORE SERVICES IN THE FIELD OF ADULT NOVELTY PRODUCTS (U.S. CLS. 100, 101 AND 102).
 FIRST USE 2-12-2007; IN COMMERCE 2-12-2007.
 DAVID MURRAY, EXAMINING ATTORNEY

CLASS 35—(Continued).

SN 77-116,511. NATIONAL BUYERS FEDERATION, INC., DBA CAR QUOTES, DEERFIELD, IL. FILED 2-26-2007.



OWNER OF U.S. REG. NO. 2,375,749.
 NO CLAIM IS MADE TO THE EXCLUSIVE RIGHT TO USE "CARQUOTES CORPORATION", APART FROM THE MARK AS SHOWN.
 THE MARK CONSISTS OF FRONT OF VEHICLE IN DOUBLE CIRCLE FOLLOWED BY "CARQUOTES" WITH "CORPORATION" CENTERED UNDERNEATH.
 FOR INFORMATION SERVICES, NAMELY, PROVIDING VEHICLE PRICE QUOTATIONS AND INFORMATION REGARDING AUTOMOBILE DEALERSHIPS (U.S. CLS. 100, 101 AND 102).
 SARA THOMAS, EXAMINING ATTORNEY

SN 77-116,856. AMERICAN UNIVERSITY OF BEIRUT, NEW YORK, NY. FILED 2-27-2007.

**WORLDWIDE ALUMNI
 ASSOCIATION OF THE
 AMERICAN UNIVERSITY OF
 BEIRUT**

THE MARK CONSISTS OF STANDARD CHARACTERS WITHOUT CLAIM TO ANY PARTICULAR FONT, STYLE, SIZE, OR COLOR.
 OWNER OF U.S. REG. NOS. 2,873,126, 2,901,034 AND OTHERS.
 NO CLAIM IS MADE TO THE EXCLUSIVE RIGHT TO USE "WORLDWIDE ALUMNI ASSOCIATION", APART FROM THE MARK AS SHOWN.
 SEC. 2(F) AS TO "AMERICAN UNIVERSITY OF BEIRUT".
 FOR ASSOCIATION SERVICES, NAMELY, PROMOTING INTERESTS OF THE ALUMNI OF A UNIVERSITY (U.S. CLS. 100, 101 AND 102).
 FIRST USE 11-22-2006; IN COMMERCE 11-22-2006.
 MARK SPARACINO, EXAMINING ATTORNEY

CLASS 35—(Continued).

SN 77-116,930. AMERICAN UNIVERSITY OF BEIRUT, NEW YORK, NY. FILED 2-27-2007.

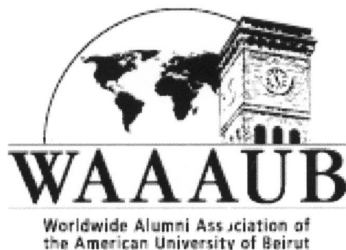

OWNER OF U.S. REG. NOS. 2,873,126, 2,901,034 AND OTHERS.

NO CLAIM IS MADE TO THE EXCLUSIVE RIGHT TO USE "WORLDWIDE ALUMNI ASSOCIATION", APART FROM THE MARK AS SHOWN.

THE MARK CONSISTS OF THE INITIALS "WAAAUB" AND THE NAME "WORLDWIDE ALUMNI ASSOCIATION OF THE AMERICAN UNIVERSITY OF BEIRUT" WRITTEN UNDER THE INITIALS IN ADDITION TO A HALF OF A CIRCLE DRAWING ABOVE THE NAME AND INITIALS WITHIN WHICH THERE IS A REPRESENTATION OF THE TERRESTRIAL GLOBE AND NEXT TO WHICH THERE IS A PICTURE OF A TOWER WITHIN WHICH THERE IS AN IMAGE OF A CLOCK. (THE INITIALS "WAAAUB" STAND FOR "WORLDWIDE ALUMNI ASSOCIATION OF THE AMERICAN UNIVERSITY OF BEIRUT").

SEC. 2(F) AS TO "AMERICAN UNIVERSITY OF BEIRUT".

FOR ASSOCIATION SERVICES, NAMELY, PROMOTING INTERESTS OF THE ALUMNI OF A UNIVERSITY (U.S. CLS. 100, 101 AND 102).

FIRST USE 1-12-2007; IN COMMERCE 1-12-2007.

MARK SPARACINO, EXAMINING ATTORNEY

SN 77-116,957. VANN'S, INC., MISSOULA, MT. FILED 2-27-2007.

LIVING LOFT

THE MARK CONSISTS OF STANDARD CHARACTERS WITHOUT CLAIM TO ANY PARTICULAR FONT, STYLE, SIZE, OR COLOR.

FOR RETAIL STORE SERVICES FEATURING APPLIANCES, NAMELY, REFRIGERATORS, OVENS, DISHWASHERS, FREEZERS, RANGES, CLOTHES WASHING MACHINES AND CLOTHES DRYERS (U.S. CLS. 100, 101 AND 102).

ERIN FALK, EXAMINING ATTORNEY

CLASS 35—(Continued).

SN 77-117,660. VANN'S, INC., MISSOULA, MT. FILED 2-27-2007.

LIVING STYLE

THE MARK CONSISTS OF STANDARD CHARACTERS WITHOUT CLAIM TO ANY PARTICULAR FONT, STYLE, SIZE, OR COLOR.

FOR RETAIL STORE SERVICES FEATURING APPLIANCES, NAMELY, REFRIGERATORS, OVENS, DISHWASHERS, FREEZERS, RANGES, CLOTHES WASHING MACHINES AND CLOTHES DRYERS (U.S. CLS. 100, 101 AND 102).

ERIN FALK, EXAMINING ATTORNEY

SN 77-118,193. NATIONAL CONTRACTING SERVICE INC, ALBANY, GA. FILED 2-28-2007.

TurboBid!

THE MARK CONSISTS OF STANDARD CHARACTERS WITHOUT CLAIM TO ANY PARTICULAR FONT, STYLE, SIZE, OR COLOR.

FOR ON-LINE TRADING SERVICES IN WHICH SELLER POSTS PRODUCTS TO BE AUCTIONED AND BIDDING IS DONE VIA THE INTERNET; ONLINE AUCTION BIDDING FOR OTHERS; PROVIDING A WEB SITE WHEREBY BUYERS OF GOODS OR SERVICES LOCATE AND RECEIVE QUOTATIONS FROM MULTIPLE COMPETITIVE SOURCES AND SELLERS OF GOODS OR SERVICES IDENTIFY AND BID ON MULTIPLE NEW SALES OPPORTUNITIES (U.S. CLS. 100, 101 AND 102).

FIRST USE 7-1-2003; IN COMMERCE 1-1-2004.

BARBARA BROWN, EXAMINING ATTORNEY

CLASS 35—(Continued).

SN 77-118,386. RADIATOR EXPRESS WAREHOUSE, INC., BENICIA, CA. FILED 2-28-2007.

THE RADIATOR HOTLINE

THE MARK CONSISTS OF STANDARD CHARACTERS WITHOUT CLAIM TO ANY PARTICULAR FONT, STYLE, SIZE, OR COLOR.

OWNER OF U.S. REG. NO. 1,849,670. SEC. 2(F).

FOR RETAIL AND WHOLESALE AUTOMOBILE PARTS AND ACCESSORIES STORES; RETAIL AND WHOLESALE TELEPHONE ORDERING SERVICES FEATURING VEHICLE PARTS AND ACCESSORIES; RETAIL AND WHOLESALE COMPUTERIZED ON-LINE ORDERING SERVICES FEATURING VEHICLE PARTS AND ACCESSORIES; AND FRANCHISE SERVICES, NAMELY, OFFERING TECHNICAL AND BUSINESS MANAGEMENT ASSISTANCE IN THE ESTABLISHMENT AND OPERATION OF RETAIL AND WHOLESALE STORE SERVICES, RETAIL AND WHOLESALE TELEPHONE ORDERING SERVICES AND RETAIL AND WHOLESALE COMPUTERIZED ON-LINE ORDERING SERVICES FEATURING VEHICLE PARTS AND ACCESSORIES (U.S. CLS. 100, 101 AND 102).

FIRST USE 1-1-1998; IN COMMERCE 1-1-1998. SUE LAWRENCE, EXAMINING ATTORNEY

SN 77-118,661. NATIONAL TECHNICAL INVESTIGATORS ASSOCIATION, HAMILTON, NJ. FILED 2-28-2007.

IN GOD WE TRUST, ALL OTHERS WE MONITOR

THE MARK CONSISTS OF STANDARD CHARACTERS WITHOUT CLAIM TO ANY PARTICULAR FONT, STYLE, SIZE, OR COLOR.

FOR ASSOCIATION SERVICES, NAMELY, PROMOTING THE INTERESTS OF LAW ENFORCEMENT, INTELLIGENCE PROFESSIONALS, AND THOSE ENGAGED IN TECHNICAL SURVEILLANCE, TACTICAL OPERATIONS, AND FORENSIC ACTIVITIES (U.S. CLS. 100, 101 AND 102).

SEAN CROWLEY, EXAMINING ATTORNEY

CLASS 35—(Continued).

SN 77-121,087. MILLSTONE, COLIN C., SAINT LOUIS, MO. FILED 3-2-2007.

BITNESS CORP

THE MARK CONSISTS OF STANDARD CHARACTERS WITHOUT CLAIM TO ANY PARTICULAR FONT, STYLE, SIZE, OR COLOR.

NO CLAIM IS MADE TO THE EXCLUSIVE RIGHT TO USE CORP, APART FROM THE MARK AS SHOWN.

FOR BUSINESS CONSULTING AND BUSINESS INFORMATION FOR ENTERPRISES (U.S. CLS. 100, 101 AND 102).

FIRST USE 2-23-2007; IN COMMERCE 2-23-2007. MORGAN WYNNE, EXAMINING ATTORNEY

SN 77-121,981. THE BIG PRINT LLC, SEATTLE, WA. FILED 3-5-2007.

Bio Banner

THE MARK CONSISTS OF STANDARD CHARACTERS WITHOUT CLAIM TO ANY PARTICULAR FONT, STYLE, SIZE, OR COLOR.

NO CLAIM IS MADE TO THE EXCLUSIVE RIGHT TO USE "BANNER", APART FROM THE MARK AS SHOWN.

FOR ADVERTISING SERVICES FOR OTHERS, NAMELY, UTILIZING ECO-FRIENDLY MATERIALS IN CREATING AND DESIGNING ADVERTISEMENTS FOR DISSEMINATION ON OUTDOOR BUILDING DISPLAYS, VEHICLE-BASED ADVERTISEMENTS, IN-STORE DISPLAYS, BILLBOARDS, AND BANNERS (U.S. CLS. 100, 101 AND 102).

DAVID I, EXAMINING ATTORNEY

SN 77-122,106. UNITED UNITS CORPORATION, PANAMA CITY, PANAMA, FILED 3-5-2007.

X-Analytics

THE MARK CONSISTS OF STANDARD CHARACTERS WITHOUT CLAIM TO ANY PARTICULAR FONT, STYLE, SIZE, OR COLOR.

FOR ADVERTISING AND MARKETING; ADVERTISING SERVICES, NAMELY, PROMOTING AND MARKETING THE GOODS AND SERVICES OF OTHERS THROUGH ALL PUBLIC COMMUNICATION MEANS; ADVERTISING, MARKETING AND PROMOTION SERVICES; ADVICE CONCERNING CHEMICAL PRODUCT MARKETING; ADVICE IN THE FIELD OF BUSINESS MANAGEMENT AND MARKETING; ADVICE ON THE ANALYSIS OF CONSUMER BUYING HABITS AND NEEDS PROVIDED WITH THE HELP OF SENSORY, QUALITY AND QUANTITY-RELATED DATA; ADVISORY SERVICE FOR ORGANIZATIONAL ISSUES AND BUSINESS ADMINISTRATION, WITH AND WITHOUT

CLASS 35—(Continued).

THE HELP OF ELECTRONIC DATA BASES; ANALYZING AND COMPILING DATA FOR MEASURING THE PERFORMANCE OF FINANCIAL MARKETS; ARRANGING AND CONDUCTING MARKETING PROMOTIONAL EVENTS FOR OTHERS; AUCTION MANAGEMENT SERVICES PROVIDED TO OTHERS OVER AN ON-LINE WEB SITE ACCESSED THROUGH A GLOBAL COMPUTER NETWORK; BUSINESS ADVICE AND ANALYSIS OF MARKETS; BUSINESS CONSULTATION AND MANAGEMENT REGARDING MARKETING ACTIVITIES AND LAUNCHING OF NEW PRODUCTS; BUSINESS MANAGEMENT CONSULTING WITH RELATION TO STRATEGY, MARKETING, PRODUCTION, PERSONNEL AND RETAIL SALE MATTERS; BUSINESS MARKETING AND DIRECT MAIL CONSULTING SERVICES; BUSINESS MARKETING CONSULTING SERVICES; BUSINESS MARKETING SERVICES; BUSINESS RESEARCH SERVICES, NAMELY, PROVIDING ANALYSIS OF RETAIL DATA ON SPECIFIC BUSINESS LOCATIONS; COLLECTION, PREPARATION, COMPOSITION, STORAGE, PROCESSING, ACQUISITION AND PROVISION OF BUSINESS INFORMATION, DATA, STATISTICS AND INDICES; COMMERCIAL INFORMATION AGENCIES; CONDUCTING BUSINESS AND MARKET RESEARCH SURVEYS; CONDUCTING MARKETING STUDIES; CONSULTATION SERVICES IN THE FIELD OF COMPANY, BUSINESS SECTOR AND INDUSTRY DATA AND RESEARCH; COOPERATIVE ADVERTISING AND MARKETING; COOPERATIVE ADVERTISING AND MARKETING SERVICES BY WAY OF SOLICITATION, CUSTOMER SERVICE AND PROVIDING MARKETING INFORMATION VIA WEBSITES ON A GLOBAL COMPUTER NETWORK; CREATION OF MARKETING TOOLS DESIGNED TO INCREASE A CLIENT COMPANY'S KNOWLEDGE OF CUSTOMER NEEDS, AND ITS COMPETITORS' PRODUCTS AND SERVICES, PRICING, ADVERTISING STRATEGY AND SALES STRATEGY; CREATIVE MARKETING DESIGN SERVICES; CUSTOM WRITING SERVICES COMPRISING PUBLIC RELATIONS AND MARKETING MATERIALS FOR THE AUDIO, VIDEO AND TECHNOLOGY INDUSTRIES; DATA COMPILING AND ANALYZING IN THE FIELD OF INSURANCE; DATA MANAGEMENT SERVICES FOR USE IN DEBT COLLECTION, NAMELY, ELECTRONIC DATA COLLECTION AND ONLINE CLAIMS MANAGEMENT; DATA PROCESSING SERVICES; DEVELOPMENT OF MARKETING STRATEGIES AND CONCEPTS; DIRECT MARKETING ADVERTISING FOR OTHERS; DIRECT MARKETING SERVICES; FLEA MARKETS; GENERAL BUSINESS MERCHANDISING SERVICES, NAMELY, MARKETING; GRAIN MARKET ANALYSIS; IMPLEMENTATION AND FOLLOW-UP OF ADVICE IN THE FIELDS OF MARKETING; INFORMATION AND DATA COMPILING AND ANALYZING RELATING TO BUSINESS MANAGEMENT; INFORMATION OR ENQUIRIES ON BUSINESS AND MARKETING; MARKET ANALYSIS; MARKET MANIPULATION, RESEARCH AND ANALYSIS, WHETHER OR NOT VIA THE INTERNET; MARKET OPINION POLLING STUDIES; MARKET REPORTS AND STUDIES; MARKET RESEARCH; MARKET RESEARCH CONSULTATION; MARKET RESEARCH SERVICES; MARKET RESEARCH STUDIES; MARKET SEGMENTATION CONSULTATION; MARKET STUDY AND ANALYSIS OF MARKET STUDIES; MARKETING CONSULTATION IN THE FIELD OF WEB TRAFFIC, WEB STATISTICS; MARKETING CONSULTING; MARKETING PLAN DEVELOPMENT; MARKETING SERVICES, NAMELY, PROVIDING INFORMATIONAL WEB PAGES DESIGNED TO GENERATE SALES TRAFFIC VIA HYPERLINKS TO OTHER WEB SITES; MEDIA PLANNING, NAMELY, ADVISING THE CLIENT ON THE CORRECT TIMES AND STATIONS TO ADVERTISE BASED ON MEDIA ANALYSIS OF THE MARKET FOR THAT MEDIA; MULTI-LEVEL MARKETING BUSINESS SERVICES; ON-LINE ADVERTISING AND MARKETING SERVICES; PROMOTING THE GOODS AND SERVICES OF OTHERS BY MEANS OF OPERATING AN ON-LINE SHOPPING MALL WITH LINKS TO THE RETAIL WEB SITES OF OTHERS; PROMOTING THE GOODS AND SERVICES OF OTHERS BY PROVIDING HYPERTEXT LINKS TO THE WEB SITES OF OTHERS; PROMOTING, ADVERTISING AND MARKETING OF THE ON-LINE WEBSITES OF OTHERS; PROMOTION AND MARKETING SERVICES AND RELATED CONSULTING; PROMOTION, ADVERTISING AND MARKETING OF ON-LINE WEBSITES; PROVIDING A WEB SITE AT WHICH USERS

CLASS 35—(Continued).

CAN OFFER GOODS FOR SALE AND BUY GOODS OFFERED BY OTHERS; PROVIDING A WEB SITE THAT ENABLES USERS TO POST ITEMS FOR SALE THROUGH ON-LINE CLASSIFIED ADVERTISEMENTS; PROVIDING A WEB SITE WHEREBY BUYERS OF GOODS OR SERVICES LOCATE AND RECEIVE QUOTATIONS FROM MULTIPLE COMPETITIVE SOURCES AND SELLERS OF GOODS OR SERVICES IDENTIFY AND BID ON MULTIPLE NEW SALES OPPORTUNITIES; PROVIDING A WEB SITE WHICH FEATURES ADVERTISEMENTS FOR THE GOODS AND SERVICES OF OTHERS ON A GLOBAL COMPUTER NETWORK; PROVIDING ADVERTISING, MARKETING AND PROMOTIONAL SERVICES FOR THE PHARMACEUTICAL AND MEDICAL INDUSTRY; PROVIDING ADVERTISING, MARKETING AND PROMOTIONAL SERVICES FOR THE PHARMACEUTICAL AND MEDICAL PRODUCTS OF OTHERS; PROVIDING BUSINESS INFORMATION, ALSO VIA INTERNET, THE CABLE NETWORK OR OTHER FORMS OF DATA TRANSFER; PROVIDING BUSINESS MARKETING INFORMATION; PROVIDING MARKETING AND PROMOTION OF SPECIAL EVENTS; PROVIDING ON-LINE DIRECTORY INFORMATION SERVICES ALSO FEATURING HYPERLINKS TO OTHER WEB SITES; PROVIDING PROMOTIONAL MARKETING SERVICES TO BUSINESSES IN THE BROADBAND AND MEDIA INDUSTRIES; PROVIDING SPACE AT A WEB SITE FOR THE ADVERTISEMENT OF THE GOODS AND SERVICES OF OTHERS; PROVIDING STATISTICAL INFORMATION; REAL ESTATE MARKETING SERVICES, NAMELY, ON-LINE SERVICES FEATURING TOURS OF RESIDENTIAL AND COMMERCIAL REAL ESTATE; RENTAL OF ADVERTISING SPACE ON WEB SITES; RENTAL OF ALL PUBLICITY AND MARKETING PRESENTATION MATERIALS; RENTAL OF DATA PROCESSING EQUIPMENT; STATISTICAL EVALUATIONS OF MARKETING DATA; UTILITY BILL MANAGEMENT SERVICES, NAMELY, TRACKING, REPORTING, ANALYZING AND DELIVERING ENERGY INFORMATION IN THE FORM OF UTILITY BILLS AND UTILITY METER DATA RATE SCHEDULES (U.S. CLS. 100, 101 AND 102).

LINDA POWELL, EXAMINING ATTORNEY

CLASS 35—(Continued).

SN 77-122,380. LEMONADE, INC., WILMINGTON, DE.
FILED 3-5-2007.

CLASS 35—(Continued).

SN 77-122,400. LEMONADE, INC., WILMINGTON, DE.
FILED 3-5-2007.

lemonade



FOR ON-LINE RETAIL STORE SERVICES FEATURING A WIDE VARIETY OF GENERAL MERCHANDISE AND GENERAL CONSUMER GOODS; COMPUTERIZED ON-LINE ORDERING FEATURING GENERAL CONSUMER, COMMERCIAL AND INDUSTRIAL MERCHANDISE; PROVIDING AN ON-LINE COMMERCIAL INFORMATION DIRECTORY; PROVIDING A SEARCHABLE DATABASE IN THE FIELD OF BUSINESS INFORMATION AVAILABLE VIA A GLOBAL COMPUTER NETWORK; PROVIDING A SEARCHABLE ON-LINE ADVERTISING GUIDE FEATURING THE GOODS AND SERVICE OF OTHERS; PREPARATION OF CUSTOM OR NON-CUSTOM ADVERTISING FOR BUSINESSES FOR DISSEMINATION VIA THE WEB; ONLINE TRADING SERVICES TO FACILITATE THE SALE OF GOODS AND SERVICES BY OTHERS VIA A GLOBAL COMMUNICATIONS NETWORK AND PROVIDING EVALUATIVE FEEDBACK AND RATINGS OF SELLERS' GOODS AND SERVICES, OPERATING ONLINE MARKETPLACES FOR SELLERS AND BUYERS OF GOODS AND SERVICES; CUSTOMER LOYALTY SERVICES AND CUSTOMER CLUB SERVICES FOR COMMERCIAL, PROMOTIONAL AND ADVERTISING PURPOSES; OFFERING DISCOUNTS AND SPECIAL MERCHANDISE RECOMMENDATIONS CUSTOMIZED FOR INDIVIDUALS AND ORGANIZATIONS VIA AN ON-LINE ELECTRONIC COMMUNICATIONS NETWORK; AUTOMATED AND COMPUTERIZED TRADING OF GOODS AND SERVICES FOR OTHERS PROVIDED OVER A GLOBAL COMMUNICATION INFORMATION NETWORK (U.S. CLS. 100, 101 AND 102).

FIRST USE 1-1-2007; IN COMMERCE 9-1-2007.
KEVON CHISOLM, EXAMINING ATTORNEY

FOR ON-LINE RETAIL STORE SERVICES FEATURING A WIDE VARIETY OF GENERAL MERCHANDISE AND GENERAL CONSUMER GOODS; COMPUTERIZED ON-LINE ORDERING FEATURING GENERAL CONSUMER, COMMERCIAL AND INDUSTRIAL MERCHANDISE; PROVIDING AN ON-LINE COMMERCIAL INFORMATION DIRECTORY; PROVIDING A SEARCHABLE DATABASE IN THE FIELD OF BUSINESS INFORMATION AVAILABLE VIA A GLOBAL COMPUTER NETWORK; PROVIDING A SEARCHABLE ON-LINE ADVERTISING GUIDE FEATURING THE GOODS AND SERVICE OF OTHERS; PREPARATION OF CUSTOM OR NON-CUSTOM ADVERTISING FOR BUSINESSES FOR DISSEMINATION VIA THE WEB; ONLINE TRADING SERVICES TO FACILITATE THE SALE OF GOODS AND SERVICES BY OTHERS VIA A GLOBAL COMMUNICATIONS NETWORK AND PROVIDING EVALUATIVE FEEDBACK AND RATINGS OF SELLERS' GOODS AND SERVICES, OPERATING ONLINE MARKETPLACES FOR SELLERS AND BUYERS OF GOODS AND SERVICES; CUSTOMER LOYALTY SERVICES AND CUSTOMER CLUB SERVICES FOR COMMERCIAL, PROMOTIONAL AND ADVERTISING PURPOSES; OFFERING DISCOUNTS AND SPECIAL MERCHANDISE RECOMMENDATIONS CUSTOMIZED FOR INDIVIDUALS AND ORGANIZATIONS VIA AN ON-LINE ELECTRONIC COMMUNICATIONS NETWORK; AUTOMATED AND COMPUTERIZED TRADING OF GOODS AND SERVICES FOR OTHERS PROVIDED OVER A GLOBAL COMMUNICATION INFORMATION NETWORK (U.S. CLS. 100, 101 AND 102).

FIRST USE 1-1-2007; IN COMMERCE 9-1-2007.
KEVON CHISOLM, EXAMINING ATTORNEY

CLASS 35—(Continued).

SN 77-122,416. LEMONADE, INC., WILMINGTON, DE.
FILED 3-5-2007.

E-COMMERCE FOR EVERYONE

THE MARK CONSISTS OF STANDARD CHARACTERS WITHOUT CLAIM TO ANY PARTICULAR FONT, STYLE, SIZE, OR COLOR.

FOR ON-LINE RETAIL STORE SERVICES FEATURING A WIDE VARIETY OF GENERAL MERCHANDISE AND GENERAL CONSUMER GOODS; COMPUTERIZED ON-LINE ORDERING FEATURING GENERAL CONSUMER, COMMERCIAL AND INDUSTRIAL MERCHANDISE; PROVIDING AN ON-LINE COMMERCIAL INFORMATION DIRECTORY; PROVIDING A SEARCHABLE DATABASE IN THE FIELD OF BUSINESS INFORMATION AVAILABLE VIA A GLOBAL COMPUTER NETWORK; PROVIDING A SEARCHABLE ON-LINE ADVERTISING GUIDE FEATURING THE GOODS AND SERVICE OF OTHERS; PREPARATION OF CUSTOM OR NON-CUSTOM ADVERTISING FOR BUSINESSES FOR DISSEMINATION VIA THE WEB; ONLINE TRADING SERVICES TO FACILITATE THE SALE OF GOODS AND SERVICES BY OTHERS VIA A GLOBAL COMMUNICATIONS NETWORK AND PROVIDING EVALUATIVE FEEDBACK AND RATINGS OF SELLERS' GOODS AND SERVICES, OPERATING ONLINE MARKETPLACES FOR SELLERS AND BUYERS OF GOODS AND SERVICES; CUSTOMER LOYALTY SERVICES AND CUSTOMER CLUB SERVICES FOR COMMERCIAL, PROMOTIONAL AND ADVERTISING PURPOSES; OFFERING DISCOUNTS AND SPECIAL MERCHANDISE RECOMMENDATIONS CUSTOMIZED FOR INDIVIDUALS AND ORGANIZATIONS VIA AN ON-LINE ELECTRONIC COMMUNICATIONS NETWORK; AUTOMATED AND COMPUTERIZED TRADING OF GOODS AND SERVICES FOR OTHERS PROVIDED OVER A GLOBAL COMMUNICATION INFORMATION NETWORK (U.S. CLS. 100, 101 AND 102).

FIRST USE 1-1-2007; IN COMMERCE 9-1-2007.
KEVON CHISOLM, EXAMINING ATTORNEY

CLASS 35—(Continued).

SN 77-122,434. LEMONADE, INC., WILMINGTON, DE.
FILED 3-5-2007.

LEMONADE

THE MARK CONSISTS OF STANDARD CHARACTERS WITHOUT CLAIM TO ANY PARTICULAR FONT, STYLE, SIZE, OR COLOR.

FOR ON-LINE RETAIL STORE SERVICES FEATURING A WIDE VARIETY OF GENERAL MERCHANDISE AND GENERAL CONSUMER GOODS; COMPUTERIZED ON-LINE ORDERING FEATURING GENERAL CONSUMER, COMMERCIAL AND INDUSTRIAL MERCHANDISE; PROVIDING AN ON-LINE COMMERCIAL INFORMATION DIRECTORY; PROVIDING A SEARCHABLE DATABASE IN THE FIELD OF BUSINESS INFORMATION AVAILABLE VIA A GLOBAL COMPUTER NETWORK; PROVIDING A SEARCHABLE ON-LINE ADVERTISING GUIDE FEATURING THE GOODS AND SERVICE OF OTHERS; PREPARATION OF CUSTOM OR NON-CUSTOM ADVERTISING FOR BUSINESSES FOR DISSEMINATION VIA THE WEB; ONLINE TRADING SERVICES TO FACILITATE THE SALE OF GOODS AND SERVICES BY OTHERS VIA A GLOBAL COMMUNICATIONS NETWORK AND PROVIDING EVALUATIVE FEEDBACK AND RATINGS OF SELLERS' GOODS AND SERVICES, OPERATING ONLINE MARKETPLACES FOR SELLERS AND BUYERS OF GOODS AND SERVICES; CUSTOMER LOYALTY SERVICES AND CUSTOMER CLUB SERVICES FOR COMMERCIAL, PROMOTIONAL AND ADVERTISING PURPOSES; OFFERING DISCOUNTS AND SPECIAL MERCHANDISE RECOMMENDATIONS CUSTOMIZED FOR INDIVIDUALS AND ORGANIZATIONS VIA AN ON-LINE ELECTRONIC COMMUNICATIONS NETWORK; AUTOMATED AND COMPUTERIZED TRADING OF GOODS AND SERVICES FOR OTHERS PROVIDED OVER A GLOBAL COMMUNICATION INFORMATION NETWORK (U.S. CLS. 100, 101 AND 102).

FIRST USE 1-1-2007; IN COMMERCE 9-1-2007.
KEVON CHISOLM, EXAMINING ATTORNEY

SN 77-122,483. TELEOS LEADERSHIP INSTITUTE, LLC,
PHILADELPHIA, PA. FILED 3-5-2007.

Teleos Leadership Institute

THE MARK CONSISTS OF STANDARD CHARACTERS WITHOUT CLAIM TO ANY PARTICULAR FONT, STYLE, SIZE, OR COLOR.

NO CLAIM IS MADE TO THE EXCLUSIVE RIGHT TO USE "LEADERSHIP INSTITUTE", APART FROM THE MARK AS SHOWN.

FOR EXECUTIVE MANAGEMENT CONSULTATION AND ADVISORY SERVICES IN THE FIELD OF LEADERSHIP DEVELOPMENT (U.S. CLS. 100, 101 AND 102).

FIRST USE 10-0-2004; IN COMMERCE 10-0-2004.
CHRISTINE COOPER, EXAMINING ATTORNEY

CLASS 35—(Continued).

SN 77-123,537. READY 2 RIDE, INCORPORATED, GEORGETOWN, IN. FILED 3-6-2007.



FOR ON-LINE RETAIL STORE SERVICES FEATURING BICYCLE PARTS, ACCESSORIES AND APPAREL FOR THE POWERSPORT INDUSTRY (U.S. CLS. 100, 101 AND 102).

FIRST USE 6-30-2006; IN COMMERCE 6-30-2006.
JENNIFER MARTIN, EXAMINING ATTORNEY

CLASS 35—(Continued).

SN 77-123,826. LANDWATCH LLC, BELLEVUE, WA. FILED 3-6-2007.

LANDWATCH.COM

THE MARK CONSISTS OF STANDARD CHARACTERS WITHOUT CLAIM TO ANY PARTICULAR FONT, STYLE, SIZE, OR COLOR.

FOR ONLINE MARKETING SERVICES IN THE AREA OF MATCHING CONSUMERS WITH VACANT LAND, RECREATIONAL LAND, LAND LEASES, HOMESITES, DEVELOPMENT PROPERTIES, LAND AUCTIONS; MATCHING CONSUMERS WITH REAL ESTATE PROFESSIONALS IN THE FIELD OF REAL ESTATE SERVICES VIA AN ONLINE WEBSITE; ADVERTISING SERVICES; ONLINE BUSINESS DIRECTORIES FEATURING THIRD-PARTY LAND-RELATED SERVICES SUCH AS LAND CLEARING, WELL DRILLING, FORESTRY SERVICES AND OUTDOOR ACTIVITIES SUCH AS HUNTING, FISHING, HIKING, EQUESTRIAN ACTIVITIES(BASED ON USE IN COMMERCE); ONLINE BUSINESS DIRECTORIES FEATURING OUTDOOR AND HUNTING-RELATED MERCHANDISE (BASED ON INTENT TO USE) (U.S. CLS. 100, 101 AND 102).

FIRST USE 7-24-2004; IN COMMERCE 7-24-2004.
GINA HAYES, EXAMINING ATTORNEY

SN 77-123,568. ACXIOM CORPORATION, LITTLE ROCK, AR. FILED 3-6-2007.

ACXIOM CONNECTIONPOINT-X

THE MARK CONSISTS OF STANDARD CHARACTERS WITHOUT CLAIM TO ANY PARTICULAR FONT, STYLE, SIZE, OR COLOR.

OWNER OF U.S. REG. NOS. 1,907,571, 3,108,579 AND OTHERS.

FOR BUSINESS INFORMATION SERVICES IN THE NATURE OF PROVIDING OTHERS WITH CONSUMER DATA FOR THE PURPOSE OF RECOGNIZING A CUSTOMER AT A CUSTOMER TOUCH POINT, ENHANCING KNOWLEDGE CONCERNING A CUSTOMER IDENTIFIED AT A CUSTOMER TOUCH POINT FOR THE PURPOSE OF SELECTING AND PRIORITIZING OFFERS FOR PRODUCT SALES AND FACILITATING THE CREATION OF OFFERS FOR PRODUCT SALES BY OTHERS (U.S. CLS. 100, 101 AND 102).

MORGAN WYNNE, EXAMINING ATTORNEY

SN 77-125,002. NOTES FROM GOD, PITTSBURGH, PA. FILED 3-7-2007.

Notes From God

THE MARK CONSISTS OF STANDARD CHARACTERS WITHOUT CLAIM TO ANY PARTICULAR FONT, STYLE, SIZE, OR COLOR.

NO CLAIM IS MADE TO THE EXCLUSIVE RIGHT TO USE "NOTES", APART FROM THE MARK AS SHOWN.

FOR RETAIL STORES FEATURING REFRIGERATOR MAGNETS, MAGNETS, NOTE CARDS, ADHESIVE NOTES, GREETING CARDS, STATIONERY, WALL HANGINGS, KEY CHAINS, PAPER BAGS, GIFT WRAP, GIFT BAGS (U.S. CLS. 100, 101 AND 102).

NELSON SNYDER, EXAMINING ATTORNEY

CLASS 35—(Continued).

SN 77-125,372. THE LUMINATIONS GROUP, LLC, HILLSBOROUGH, NJ. FILED 3-8-2007.

FLEXFORCE

THE MARK CONSISTS OF STANDARD CHARACTERS WITHOUT CLAIM TO ANY PARTICULAR FONT, STYLE, SIZE, OR COLOR.

FOR MARKETING SERVICES, NAMELY, MARKETING CONSULTATION AND INTERIM MARKETING AND MANAGEMENT OUTSOURCING (U.S. CLS. 100, 101 AND 102).

FIRST USE 6-2-2004; IN COMMERCE 6-2-2004.
PAULA MAHONEY, EXAMINING ATTORNEY

SN 77-125,727. UCC CORPORATION, FLINT, MI. FILED 3-8-2007.

CHAIN OF CLAIM

THE MARK CONSISTS OF STANDARD CHARACTERS WITHOUT CLAIM TO ANY PARTICULAR FONT, STYLE, SIZE, OR COLOR.

FOR BUSINESS MANAGEMENT SERVICES, NAMELY, PROVIDING INFORMATION AND MATERIALS TO OTHERS FOR ENABLING SUCH OTHERS TO ESTABLISH BETWEEN THEMSELVES AND THEIR CUSTOMERS ACCOUNTS RECEIVABLE AGREEMENTS, AND PROVIDING INFORMATION AND MATERIALS FOR USE BY SUCH OTHERS IN COLLECTING SUCH ACCOUNTS (U.S. CLS. 100, 101 AND 102).

BRENDAN MCCAULEY, EXAMINING ATTORNEY

SN 77-125,789. NATIONAL BALLROOM DANCE PRODUCTIONS, INC., BOSTON, MA. FILED 3-8-2007.

THE DIAMOND MINDS

THE MARK CONSISTS OF STANDARD CHARACTERS WITHOUT CLAIM TO ANY PARTICULAR FONT, STYLE, SIZE, OR COLOR.

NO CLAIM IS MADE TO THE EXCLUSIVE RIGHT TO USE "DIAMOND", APART FROM THE MARK AS SHOWN.

FOR ONLINE RETAIL STORE SERVICES AND RETAIL STORE SERVICES, ALL FEATURING A VARIETY OF JEWELRY AND PRECIOUS STONES, NAMELY, DIAMONDS, RINGS, EARRINGS, BRACELETS, BROOCHES, NECKLACES, TIMEPIECES AND PENDANTS (U.S. CLS. 100, 101 AND 102).

MICHELE SWAIN, EXAMINING ATTORNEY

CLASS 35—(Continued).

SN 77-126,314. PLAYPHONE INC., SAN JOSE, CA. FILED 3-8-2007.

RATEDPHONE

THE MARK CONSISTS OF STANDARD CHARACTERS WITHOUT CLAIM TO ANY PARTICULAR FONT, STYLE, SIZE, OR COLOR.

OWNER OF U.S. REG. NO. 2,959,000.
FOR ONLINE AND WIRELESS RETAIL STORE SERVICES FEATURING DOWNLOADABLE ENTERTAINMENT, NAMELY, PRERECORDED MUSIC, VIDEOS, RING TONES, VOICE ENTERTAINMENT, ELECTRONIC WALL PAPER AND GAMES (U.S. CLS. 100, 101 AND 102).

KAREN BRACEY, EXAMINING ATTORNEY

SN 77-126,608. BLACK DOG FURNITURE, LLC, ANACONDA, MT. FILED S.R. 3-9-2007; AM. P.R. 1-14-2008.



NO CLAIM IS MADE TO THE EXCLUSIVE RIGHT TO USE "FURNITURE", APART FROM THE MARK AS SHOWN.

"THE COLOR(S) RUST, BLACK, RED, BROWN, PINK IS/ ARE CLAIMED AS A FEATURE OF THE MARK."

"THE MARK CONSISTS OF THE COLORS RUST, BLACK, BROWN & PINK APPEAR IN THE DESIGN ELEMENT; BLACK LABRADOR RETRIEVER AND BRICKS. THE COLORS RED AND BLACK APPEAR IN THE WORDING; BLACK DOG FURNITURE "THE BEST FRIEND YOUR HOME EVER HAD"."

FOR RETAIL FURNITURE STORE (U.S. CLS. 100, 101 AND 102).

FIRST USE 3-1-2007; IN COMMERCE 5-25-2007.
SHAUNIA CARLYLE, EXAMINING ATTORNEY

CLASS 35—(Continued).

SN 77-127,000. COMMOTION COMMUNICATIONS INC., MONTREAL, CANADA, FILED 3-9-2007.



THE MARK CONSISTS OF THE WORDS "JOIN THE CONTROL REVOLUTION" AND THE DESIGN OF A HAND HOLDING A BEAKER.
FOR ADVERTISING SERVICES AND ADVERTISING CONSULTATION (U.S. CLS. 100, 101 AND 102).
RICHARD A. STRASER, EXAMINING ATTORNEY

CLASS 35—(Continued).

SN 77-127,923. RICH, CHAD J., WINTERVILLE, NC. FILED 3-11-2007.

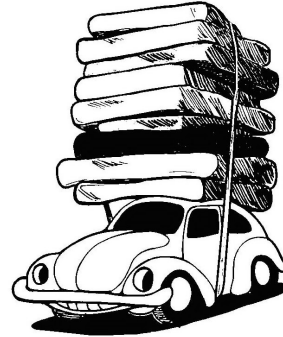

THE MARK CONSISTS OF AN AUTOMOBILE WITH NUMEROUS MATTRESSES STRAPPED TO THE ROOFTOP.
FOR RETAIL FURNITURE STORES (U.S. CLS. 100, 101 AND 102).
FIRST USE 8-0-1998; IN COMMERCE 8-0-1998.
GEORGIA CARTY, EXAMINING ATTORNEY

SN 77-129,666. 1-800-JACKPOT, INC., KANSAS CITY, MO. FILED 3-13-2007.

1-800-JACKPOT

SN 77-127,182. PLANT DEVELOPMENT SERVICES, INC., LOXLEY, AL. FILED 3-9-2007.

PLANTSBYMAIL.COM

THE MARK CONSISTS OF STANDARD CHARACTERS WITHOUT CLAIM TO ANY PARTICULAR FONT, STYLE, SIZE, OR COLOR.
SEC. 2(F).
FOR ON-LINE CATALOG SERVICES FEATURING LIVING PLANTS (U.S. CLS. 100, 101 AND 102).
FIRST USE 5-19-1998; IN COMMERCE 5-19-1998.
DAVID C. REIHNER, EXAMINING ATTORNEY

THE MARK CONSISTS OF STANDARD CHARACTERS WITHOUT CLAIM TO ANY PARTICULAR FONT, STYLE, SIZE, OR COLOR.
FOR PROVIDING AN ONLINE MARKETPLACE FOR THE COMPUTERIZED TRADING OF GOODS AND SERVICES OF OTHERS OVER A GLOBAL COMMUNICATION INFORMATION NETWORK; PROVIDING AN ONLINE AUCTION FOR THE TRADING OF GOODS AND SERVICES OF OTHERS; AUTOMATED AND COMPUTERIZED TRADING OF GOODS AND SERVICES OF OTHERS PROVIDED OVER A GLOBAL COMPUTER NETWORK; PROVIDING ONLINE INFORMATION IN THE FIELDS OF EMPLOYMENT, RECRUITMENT, CAREERS, JOB LISTINGS AND RESUMES; PROVIDING ONLINE INTERACTIVE EMPLOYMENT COUNSELING AND RECRUITMENT SERVICES; PROMOTING THE GOODS AND SERVICES OF OTHERS BY MEANS OF A PREFERRED CUSTOMER PROGRAM FEATURING REWARDS, COUPONS, AND REWARDS UPDATES; PROVIDING INFORMATION AND LINKS TO THE WEBSITES OF OTHERS FOR MEMBERSHIP CLUBS PROVIDING DISCOUNTS AND PROCESSING REBATES FOR THE GOODS AND SERVICES OF OTHERS; PROVIDING INFORMATION AND LINKS TO THE WEBSITES OF OTHERS FEATURING ASSOCIATIONS PROMOTING THE INTERESTS OF CONSUMERS; PROVIDING REAL ESTATE LISTINGS, LINKS TO THE WEBSITES OF OTHERS FEATURING REAL ESTATE AND REAL ESTATE INFORMATION VIA THE INTERNET (U.S. CLS. 100, 101 AND 102).
LESLEY LAMOTHE, EXAMINING ATTORNEY

CLASS 35—(Continued).

SN 77-129,846. 1-800-JACKPOT, INC., KANSAS CITY, MO. FILED 3-13-2007.

1800JACKPOT

THE MARK CONSISTS OF STANDARD CHARACTERS WITHOUT CLAIM TO ANY PARTICULAR FONT, STYLE, SIZE, OR COLOR.

FOR PROVIDING AN ONLINE MARKETPLACE FOR THE COMPUTERIZED TRADING OF GOODS AND SERVICES OF OTHERS OVER A GLOBAL COMMUNICATION INFORMATION NETWORK; PROVIDING AN ONLINE AUCTION FOR THE TRADING OF GOODS AND SERVICES OF OTHERS; AUTOMATED AND COMPUTERIZED TRADING OF GOODS AND SERVICES OF OTHERS PROVIDED OVER A GLOBAL COMPUTER NETWORK; PROVIDING ONLINE INFORMATION IN THE FIELDS OF EMPLOYMENT, RECRUITMENT, CAREERS, JOB LISTINGS AND RESUMES; PROVIDING ONLINE INTERACTIVE EMPLOYMENT COUNSELING AND RECRUITMENT SERVICES; PROMOTING THE GOODS AND SERVICES OF OTHERS BY MEANS OF A PREFERRED CUSTOMER PROGRAM FEATURING REWARDS, COUPONS, AND REWARDS UPDATES; PROVIDING INFORMATION AND LINKS TO THE WEBSITES OF OTHERS FOR MEMBERSHIP CLUBS PROVIDING DISCOUNTS AND PROCESSING REBATES FOR THE GOODS AND SERVICES OF OTHERS; PROVIDING INFORMATION AND LINKS TO THE WEBSITES OF OTHERS FEATURING ASSOCIATIONS PROMOTING THE INTERESTS OF CONSUMERS; PROVIDING REAL ESTATE LISTINGS, LINKS TO THE WEBSITES OF OTHERS FEATURING REAL ESTATE AND REAL ESTATE INFORMATION VIA THE INTERNET (U.S. CLS. 100, 101 AND 102).

LESLEY LAMOTHE, EXAMINING ATTORNEY

SN 77-130,815. 4REFUEL CANADA LTD, LANGLEY, CANADA, FILED 3-14-2007.

4Refuel

THE **LEADER** IN FUEL MANAGEMENT

NO CLAIM IS MADE TO THE EXCLUSIVE RIGHT TO USE "FOR REFUEL" AND "THE LEADER IN FUEL MANAGEMENT", APART FROM THE MARK AS SHOWN.

THE MARK CONSISTS OF THE MARK "4REFUEL" APPEARS ABOVE THE TAGLINE "THE LEADER IN FUEL MANAGEMENT".

FOR BUSINESS MANAGEMENT; FRANCHISING, NAMELY, CONSULTATION AND ASSISTANCE IN BUSINESS MANAGEMENT, ORGANIZATION AND PROMOTION (U.S. CLS. 100, 101 AND 102).

ELISSA GARBER KON, EXAMINING ATTORNEY

CLASS 35—(Continued).

SN 77-131,138. THE TRIANGLE COMPANIES, LLC., MIAMI BEACH, FL. FILED 3-14-2007.

TRIANGLE STORE

THE MARK CONSISTS OF STANDARD CHARACTERS WITHOUT CLAIM TO ANY PARTICULAR FONT, STYLE, SIZE, OR COLOR.

NO CLAIM IS MADE TO THE EXCLUSIVE RIGHT TO USE "STORE", APART FROM THE MARK AS SHOWN.

FOR RETAIL STORE SERVICES FEATURING HOME FURNISHINGS AND DÉCOR; WHOLESALE DISTRIBUTORSHIPS TO REAL ESTATE DEVELOPERS FEATURING HOME FURNISHINGS AND DÉCOR (U.S. CLS. 100, 101 AND 102).

THOMAS MANOR, EXAMINING ATTORNEY

SN 77-132,758. C.D. PEACOCK HOLDINGS L.L.C., WILKES-BARRE, PA. FILED 3-16-2007.

C.D. PEACOCK

THE MARK CONSISTS OF STANDARD CHARACTERS WITHOUT CLAIM TO ANY PARTICULAR FONT, STYLE, SIZE, OR COLOR.

OWNER OF U.S. REG. NO. 2,248,423.

FOR RETAIL STORE SERVICES IN THE FIELD OF JEWELRY, WATCHES, DIAMONDS AND GIFTS (U.S. CLS. 100, 101 AND 102).

FIRST USE 1-1-1837; IN COMMERCE 1-1-1837.

MATTHEW PAPPAS, EXAMINING ATTORNEY

SN 77-134,025. AMERICA'S COLLECTIBLES NETWORK, INC., KNOXVILLE, TN. FILED 3-19-2007.



THE MARK CONSISTS OF THE WORDS "GIRLFRIEND FRIDAY" WITH A DIAMOND AND STAR DESIGN.

FOR RETAIL INTERACTIVE TELEVISION AND ONLINE RETAIL STORE SERVICES FEATURING JEWELRY, GEMSTONES AND WATCHES (U.S. CLS. 100, 101 AND 102).

FIRST USE 10-0-2006; IN COMMERCE 10-0-2006.

GENE MACIOL, EXAMINING ATTORNEY

CLASS 35—(Continued).

SN 77-134,064. AMERICA'S COLLECTIBLES NETWORK, INC., KNOXVILLE, TN. FILED 3-19-2007.



THE MARK CONSISTS OF THE WORDS "GIRLFRIEND FRIDAY" WITH A DIAMOND DESIGN.
FOR RETAIL INTERACTIVE TELEVISION STORE SERVICES FEATURING JEWELRY, GEMSTONES AND WATCHES (U.S. CLS. 100, 101 AND 102).
FIRST USE 10-0-2006; IN COMMERCE 10-0-2006.
GENE MACIOL, EXAMINING ATTORNEY

CLASS 35—(Continued).

SN 77-135,192. PREMIER BRANDS, INC., SANTA ANA, CA. FILED 3-20-2007.



NO CLAIM IS MADE TO THE EXCLUSIVE RIGHT TO USE "PREMIER BRANDS, INC.", APART FROM THE MARK AS SHOWN.
THE MARK CONSISTS OF "PREMIER BRANDS, INC." UNDER THE LETTER "P".
FOR BUSINESS CONSULTING FOR SALES, MARKETING, AND DISTRIBUTION AND BRAND DEVELOPMENT IN THE FIELD OF WHOLESALE DISTRIBUTION (U.S. CLS. 100, 101 AND 102).
LEIGH CAROLINE CASE, EXAMINING ATTORNEY

SN 77-135,557. DASH ADVISORS, LLC, FAIRFAX, CA. FILED 3-20-2007.

SN 77-134,776. CASTLE FINANCIAL CORPORATION, TEMPE, AZ. FILED 3-19-2007.

TEAM JOYNER USA



THE MARK CONSISTS OF STANDARD CHARACTERS WITHOUT CLAIM TO ANY PARTICULAR FONT, STYLE, SIZE, OR COLOR.
NO CLAIM IS MADE TO THE EXCLUSIVE RIGHT TO USE "TEAM AND USA", APART FROM THE MARK AS SHOWN.
FOR RETAIL STORE SERVICES FEATURING OFF ROAD RECREATIONAL VEHICLES (U.S. CLS. 100, 101 AND 102).
FIRST USE 3-1-2006; IN COMMERCE 3-1-2006.
DANIEL CAPSHAW, EXAMINING ATTORNEY

THE MARK CONSISTS OF A STYLIZED OVAL DESIGN ABOVE THE WORDS "DASH ADVISORS TO INNOVATIVE FOOD AND BEVERAGE".
FOR MANAGEMENT AND BUSINESS CONSULTING SERVICES IN THE FIELD OF THE FOOD AND BEVERAGE INDUSTRY (U.S. CLS. 100, 101 AND 102).
FIRST USE 9-20-2007; IN COMMERCE 9-20-2007.
MAUREEN DALL, EXAMINING ATTORNEY

CLASS 35—(Continued).

SN 77-137,684. INTERMODAL ASSOCIATION OF NORTH AMERICA, CALVERTON, MD. FILED 3-22-2007.

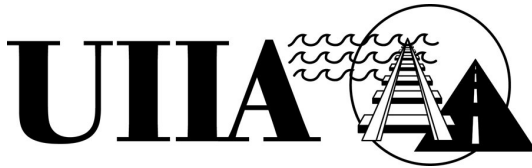

NO CLAIM IS MADE TO THE EXCLUSIVE RIGHT TO USE "UIIIA", APART FROM THE MARK AS SHOWN.

THE MARK CONSISTS OF THE ACRONYM "UIIIA" FOLLOWED BY A CIRCLE WITH WAVES ENTERING FROM THE LEFT, RAILROAD TRACKS COMING FROM THE BOTTOM LEFT AND ENDING AT A POINT IN THE CIRCLE, AND A ROAD ENTERING THE CIRCLE FROM THE BOTTOM RIGHT SIDE ENDING AT A POINT IN THE CIRCLE.

FOR ASSOCIATION SERVICES, NAMELY, PROMOTING THE INTERESTS OF INTERMODAL TRUCKING COMPANIES, OCEAN CARRIERS, RAIL CARRIERS AND EQUIPMENT LEASING COMPANIES IN THE TRANSPORTATION INDUSTRY THROUGH THE DEVELOPMENT OF UNIFORM INDUSTRY PROCESSES AND PROCEDURES GOVERNING THE INTERCHANGE OF INTERMODAL EQUIPMENT BETWEEN THESE PARTIES, THUS IMPROVING INTERMODAL TRANSPORTATION PRODUCTIVITY AND OPERATING EFFICIENCIES (U.S. CLS. 100, 101 AND 102).

FIRST USE 8-1-1999; IN COMMERCE 8-1-1999.
ANDREA BUTLER, EXAMINING ATTORNEY

SN 77-137,806. OX3 CORPORATION, AYER, MA. FILED 3-22-2007.

**We Move Semiconductors to
the Next Level**

THE MARK CONSISTS OF STANDARD CHARACTERS WITHOUT CLAIM TO ANY PARTICULAR FONT, STYLE, SIZE, OR COLOR.

FOR PACKAGING ELECTRONICS TO THE ORDER AND SPECIFICATION OF OTHERS, NAMELY, SEMICONDUCTOR TAPING, TUBING, AND TRAYING; DISTRIBUTORSHIP SERVICES FEATURING MATERIALS REQUIRED FOR SEMICONDUCTOR TAPING, BAKING, PROGRAMMING AND REPAIR, NAMELY, CARRIER TAPES, COVER TAPES, TRAYS, TUBES, STATIC SUPPLIES AND REELS (U.S. CLS. 100, 101 AND 102).

FIRST USE 6-1-2000; IN COMMERCE 6-1-2000.
HEATHER BIDDULPH, EXAMINING ATTORNEY

CLASS 35—(Continued).

SN 77-138,711. TNS CUSTOM RESEARCH, INC., HORSHAM, PA. FILED 3-23-2007.

**eSIP: A Share of Intake
Panel**

THE MARK CONSISTS OF STANDARD CHARACTERS WITHOUT CLAIM TO ANY PARTICULAR FONT, STYLE, SIZE, OR COLOR.

NO CLAIM IS MADE TO THE EXCLUSIVE RIGHT TO USE "PANEL", APART FROM THE MARK AS SHOWN.

SEC. 2(F).
FOR MARKET RESEARCH SERVICES (U.S. CLS. 100, 101 AND 102).

FIRST USE 2-0-2002; IN COMMERCE 2-0-2002.
RICHARD A. STRASER, EXAMINING ATTORNEY

SN 77-138,834. JOHN A. ENGERMAN, FT. WASHINGTON, MD. FILED 3-23-2007.

aRi Tax Services

THE MARK CONSISTS OF STANDARD CHARACTERS WITHOUT CLAIM TO ANY PARTICULAR FONT, STYLE, SIZE, OR COLOR.

NO CLAIM IS MADE TO THE EXCLUSIVE RIGHT TO USE "TAX SERVICES", APART FROM THE MARK AS SHOWN.

FOR TAX ADVISORY SERVICES; TAX AND TAXATION PLANNING, ADVICE, INFORMATION AND CONSULTANCY SERVICES; TAX CONSULTATION; TAX FILING SERVICES; TAX PREPARATION; ACCOUNTING SERVICES (U.S. CLS. 100, 101 AND 102).

FIRST USE 1-8-2003; IN COMMERCE 1-8-2003.
KATHRYN COWARD, EXAMINING ATTORNEY

SN 77-140,183. STEVEN GREENBERG, INC., MIAMI, FL. FILED 3-26-2007.

GADGET NATION

THE MARK CONSISTS OF STANDARD CHARACTERS WITHOUT CLAIM TO ANY PARTICULAR FONT, STYLE, SIZE, OR COLOR.

NO CLAIM IS MADE TO THE EXCLUSIVE RIGHT TO USE "GADGET", APART FROM THE MARK AS SHOWN.

FOR PRODUCING VIDEO AND ON-LINE INFOMERCIALS FOR OTHERS FEATURING NEW TECHNOLOGIES, INVENTIONS AND PRODUCTS; ON-LINE RETAIL STORE SERVICES FEATURING CLOTHING, BOOKS AND NEW TECHNOLOGIES (U.S. CLS. 100, 101 AND 102).

ALICE BENMAMAN, EXAMINING ATTORNEY

CLASS 35—(Continued).

SN 77-140,814. ARCELAY, KELVIN J, PEACHTREE CITY, GA. FILED 3-26-2007.

A ARCELAY & ASSOCIATES
SOLVING IT GOVERNANCE AND
COMPLIANCE CHALLENGES

THE MARK CONSISTS OF STANDARD CHARACTERS WITHOUT CLAIM TO ANY PARTICULAR FONT, STYLE, SIZE, OR COLOR.

NO CLAIM IS MADE TO THE EXCLUSIVE RIGHT TO USE "ASSOCIATES", APART FROM THE MARK AS SHOWN.

"A ARCELAY" DOES NOT IDENTIFY A LIVING INDIVIDUAL.

FOR BUSINESS MANAGEMENT CONSULTANCY AND ADVISORY SERVICES (U.S. CLS. 100, 101 AND 102).

FIRST USE 3-26-2007; IN COMMERCE 3-26-2007.
KAELIE KUNG, EXAMINING ATTORNEY

SN 77-142,015. PALISADES WATER INDEX ASSOCIATES LLC, SHERMAN OAKS, CA. FILED 3-27-2007.

PALISADES INDEXES

THE MARK CONSISTS OF STANDARD CHARACTERS WITHOUT CLAIM TO ANY PARTICULAR FONT, STYLE, SIZE, OR COLOR.

OWNER OF U.S. REG. NO. 3,292,788.

NO CLAIM IS MADE TO THE EXCLUSIVE RIGHT TO USE "INDEXES", APART FROM THE MARK AS SHOWN.

FOR COLLECTION, PREPARATION, COMPOSITION, STORAGE, PROCESSING, ACQUISITION AND PROVISION OF BUSINESS INFORMATION, DATA, STATISTICS AND INDICES (U.S. CLS. 100, 101 AND 102).

FIRST USE 5-18-2006; IN COMMERCE 5-18-2006.
MELVIN AXILBUND, EXAMINING ATTORNEY

SN 77-142,349. PRESS, GANEY ASSOCIATES, INC., SOUTH BEND, IN. FILED 3-28-2007.

SOLUTIONS STARTERS

THE MARK CONSISTS OF STANDARD CHARACTERS WITHOUT CLAIM TO ANY PARTICULAR FONT, STYLE, SIZE, OR COLOR.

OWNER OF U.S. REG. NO. 3,126,796.

FOR LIVE AND ON-LINE BUSINESS CONSULTING SERVICES IN THE FIELD OF IMPROVING HEALTHCARE PATIENT SATISFACTION AND PROVIDING PATIENT SATISFACTION SURVEY SERVICES IN THE HEALTHCARE FIELD (U.S. CLS. 100, 101 AND 102).

FIRST USE 11-0-2003; IN COMMERCE 11-0-2003.
AHSEN KHAN, EXAMINING ATTORNEY

CLASS 35—(Continued).

SN 77-142,776. UNITED PARCEL SERVICE OF AMERICA, INC., ATLANTA, GA. FILED 3-28-2007.

UPS FTZ FACILITATOR

THE MARK CONSISTS OF STANDARD CHARACTERS WITHOUT CLAIM TO ANY PARTICULAR FONT, STYLE, SIZE, OR COLOR.

OWNER OF U.S. REG. NOS. 2,973,108, 2,981,794 AND 3,240,195.

NO CLAIM IS MADE TO THE EXCLUSIVE RIGHT TO USE "FTZ FACILITATOR", APART FROM THE MARK AS SHOWN.

FOR LOGISTICS MANAGEMENT IN THE FIELD OF TRANSPORTATION OF GOODS AND PERSONAL PROPERTY; PROVIDING COMPUTERIZED TRACKING AND TRACING OF PACKAGES IN TRANSIT; FOREIGN TRADE INFORMATION AND CONSULTATION; ADVISORY AND CONSULTANCY SERVICES RELATING TO EXPORT AND IMPORT; ADVISORY AND CONSULTANCY SERVICES RELATING TO EXPORT AND IMPORT PROMOTION INFORMATION AND SERVICES; CUSTOMS CLEARANCE SERVICES; AND TRANSPORTATION NETWORK MANAGEMENT SOLUTION SERVICES (U.S. CLS. 100, 101 AND 102).

LINDA E. BLOHM, EXAMINING ATTORNEY

SN 77-142,852. PENINSULA REGIONAL MEDICAL CENTER, SALISBURY, MD. FILED 3-28-2007.

PENINSULA ACCESS CENTER

THE MARK CONSISTS OF STANDARD CHARACTERS WITHOUT CLAIM TO ANY PARTICULAR FONT, STYLE, SIZE, OR COLOR.

OWNER OF U.S. REG. NOS. 3,110,952 AND 3,125,420.

NO CLAIM IS MADE TO THE EXCLUSIVE RIGHT TO USE "ACCESS CENTER", APART FROM THE MARK AS SHOWN.

FOR HOSPITAL ADMINISTRATION SERVICES, NAMELY, PROVIDING EXPEDITED HOSPITAL ADMISSIONS SERVICES TO PHYSICIANS FOR THEIR PATIENTS (U.S. CLS. 100, 101 AND 102).

FIRST USE 5-14-2007; IN COMMERCE 5-14-2007.
STEPHEN AQUILA, EXAMINING ATTORNEY

CLASS 35—(Continued).

SN 77-143,040. HARTWELL INDUSTRIES, INC., HARTWELL, GA. FILED 3-28-2007.

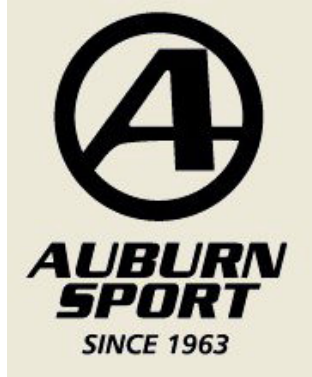

NO CLAIM IS MADE TO THE EXCLUSIVE RIGHT TO USE "SPORT" AND "SINCE 1963", APART FROM THE MARK AS SHOWN.

FOR CATALOG ORDERING SERVICE FEATURING CLOTHING; MAIL ORDER CATALOG SERVICES FEATURING CLOTHING (U.S. CLS. 100, 101 AND 102).

FIRST USE 1-1-2006; IN COMMERCE 1-1-2006.

PAULA MAYS, EXAMINING ATTORNEY

SN 77-143,720. ND RIGHTS, LLC, LAS VEGAS, NV. FILED 3-29-2007.

SPACELASVEGAS

THE MARK CONSISTS OF STANDARD CHARACTERS WITHOUT CLAIM TO ANY PARTICULAR FONT, STYLE, SIZE, OR COLOR.

FOR ADVERTISING, MARKETING AND PROMOTION SERVICES IN THE FIELD OF ENTERTAINMENT; AND CONCESSION STANDS FEATURING FOOD, DRINKS AND SOUVENIRS (U.S. CLS. 100, 101 AND 102).

INGRID C. EULIN, EXAMINING ATTORNEY

SN 77-144,943. TRUCKER LLC, CHICO, CA. FILED 3-30-2007.

Trucker

THE MARK CONSISTS OF STANDARD CHARACTERS WITHOUT CLAIM TO ANY PARTICULAR FONT, STYLE, SIZE, OR COLOR.

FOR RETAIL APPAREL STORES (U.S. CLS. 100, 101 AND 102).

FIRST USE 11-19-2003; IN COMMERCE 11-19-2003.

RONALD MCMORROW, EXAMINING ATTORNEY

CLASS 35—(Continued).

SN 77-145,330. PAULIDES, DAVID, LOS GATOS, CA. FILED 3-30-2007.



NO CLAIM IS MADE TO THE EXCLUSIVE RIGHT TO USE CALIFORNIA BIGFOOT SEARCH, APART FROM THE MARK AS SHOWN.

THE COLOR(S) WHITE, NAVY BLUE AND ORANGE IS/ ARE CLAIMED AS A FEATURE OF THE MARK.

THE COLOR WHITE APPEARS ON THE LITERAL PORTION OF THE MARK AND OUTLINES THE DESIGN, THE COLOR NAVY BLUE APPEARS ON THE SILHOUETTE OF "BIG FOOT" AND ON THE BACKGROUND OF THE MARK, THE COLOR ORANGE APPEARS BEHIND THE SILHOUETTE AND OUTLINES THE ENTIRE MARK.

FOR RESEARCH SERVICES IN THE FIELD OF THE BIGFOOT PHENOMENON, NAMELY, SCIENTIFIC RESEARCH (U.S. CLS. 100, 101 AND 102).

FIRST USE 5-1-2006; IN COMMERCE 5-1-2006.

ELIZABETH KAJUBI, EXAMINING ATTORNEY

SN 77-146,084. FOODIRECT, INC., BRONX, NY. FILED 4-2-2007.

FOODIRECT.COM

THE MARK CONSISTS OF STANDARD CHARACTERS WITHOUT CLAIM TO ANY PARTICULAR FONT, STYLE, SIZE, OR COLOR.

FOR ELECTRONIC WHOLESALE ORDERING SERVICES FEATURING FRESH AND FROZEN FOODS (U.S. CLS. 100, 101 AND 102).

FIRST USE 10-0-1997; IN COMMERCE 10-0-1997.

MARK T. MULLEN, EXAMINING ATTORNEY

CLASS 35—(Continued).

SN 77-146,474. IWEBTRACK HOLDINGS, INC., GAINESVILLE, FL. FILED 4-2-2007.

iwebtrack.com

THE MARK CONSISTS OF STANDARD CHARACTERS WITHOUT CLAIM TO ANY PARTICULAR FONT, STYLE, SIZE, OR COLOR.

FOR COLLECTION, PREPARATION, COMPOSITION, STORAGE, PROCESSING, ACQUISITION AND PROVISION OF BUSINESS INFORMATION, DATA, STATISTICS AND INDICES (U.S. CLS. 100, 101 AND 102).

FIRST USE 9-10-2003; IN COMMERCE 9-10-2003.
RICHARD A. STRASER, EXAMINING ATTORNEY

CLASS 35—(Continued).

SN 77-147,535. EZ VILLE, LTD., RONKONKOMA, NY. FILED 4-3-2007.



EZVille, Ltd.

SN 77-146,521. UNICORN TECHNOLOGIES LLC, GAINESVILLE, VA. FILED 4-2-2007.

FUSE

THE MARK CONSISTS OF STANDARD CHARACTERS WITHOUT CLAIM TO ANY PARTICULAR FONT, STYLE, SIZE, OR COLOR.

FOR ARRANGING AND CONDUCTING BUSINESS CONFERENCES IN THE FIELDS OF BUSINESS AND ECONOMIC EXPANSION AND DEVELOPMENT IN DEFINED GEOGRAPHICAL AREAS, AND COMMERCIALIZATION OF EMERGING AND NEW TECHNOLOGIES AND EXPLORING TECHNOLOGY DRIVEN BUSINESS OPPORTUNITIES (U.S. CLS. 100, 101 AND 102).

FIRST USE 3-1-2006; IN COMMERCE 3-20-2007.
SEAN CROWLEY, EXAMINING ATTORNEY

OWNER OF U.S. REG. NO. 3,262,436.
NO CLAIM IS MADE TO THE EXCLUSIVE RIGHT TO USE "LTD.", APART FROM THE MARK AS SHOWN.

THE MARK CONSISTS OF A CIRCULAR ELEMENT WITH A DESIGN OF TWO LEAVES, ABOVE THE WORDS "EZVILLE, LTD".

FOR DISTRIBUTORSHIP SERVICES IN THE FIELD OF DIETARY SUPPLEMENTS (U.S. CLS. 100, 101 AND 102).

FIRST USE 4-0-2005; IN COMMERCE 4-0-2005.
ELISSA GARBER KON, EXAMINING ATTORNEY

SN 77-147,708. NATIONAL ECZEMA ASSOCIATION FOR SCIENCE & EDUCATION, SAN RAFAEL, CA. FILED 4-3-2007.

life
Life Improvements
For Eczema

SN 77-146,929. YOURHEALTHEXCHANGE, INC., AUSTIN, TX. FILED 4-2-2007.

real doctors. real answers.

THE MARK CONSISTS OF STANDARD CHARACTERS WITHOUT CLAIM TO ANY PARTICULAR FONT, STYLE, SIZE, OR COLOR.

FOR PROVIDING AN ONLINE DIRECTORY INFORMATION SERVICE FEATURING MEDICAL INFORMATION AND INFORMATION ABOUT MEDICAL SERVICES (U.S. CLS. 100, 101 AND 102).

RUSS HERMAN, EXAMINING ATTORNEY

NO CLAIM IS MADE TO THE EXCLUSIVE RIGHT TO USE "ECZEMA", APART FROM THE MARK AS SHOWN.

THE MARK CONSISTS OF THE WORD PHRASE "LIFE" "LIFE IMPROVEMENTS FOR ECZEMA" WITH THE "I" IN THE FIRST WORD REPLACED BY AN EXCLAMATION MARK.

FOR PROMOTING AWARENESS OF ECZEMA AND ISSUES RELATING TO ITS TREATMENT AND CURE TO THE GENERAL PUBLIC, PATIENTS AND MEMBERS OF THE MEDICAL COMMUNITY (U.S. CLS. 100, 101 AND 102).

FIRST USE 3-6-2006; IN COMMERCE 7-17-2006.
JIM RINGLE, EXAMINING ATTORNEY

CLASS 35—(Continued).

SN 77-149,257. FOODIRECT, INC., BRONX, NY. FILED 4-5-2007.

FOODIRECT

THE MARK CONSISTS OF STANDARD CHARACTERS WITHOUT CLAIM TO ANY PARTICULAR FONT, STYLE, SIZE, OR COLOR.

FOR ELECTRONIC WHOLESALE ORDERING SERVICES FEATURING FRESH AND FROZEN FOODS (U.S. CLS. 100, 101 AND 102).

MARK T. MULLEN, EXAMINING ATTORNEY

SN 77-149,328. RIDEMAKERZ, LLC, FALLS CHURCH, VA. FILED 4-5-2007.

RIDEMILEZ

THE MARK CONSISTS OF STANDARD CHARACTERS WITHOUT CLAIM TO ANY PARTICULAR FONT, STYLE, SIZE, OR COLOR.

FOR RETAIL STORE SERVICES IN THE FIELD OF TOY VEHICLES, PARTS AND ACCESSORIES AND FEATURING BONUS INCENTIVE PROGRAM FOR CUSTOMERS (U.S. CLS. 100, 101 AND 102).

BILL DAWE, EXAMINING ATTORNEY

SN 77-149,998. PORTER NOVELLI, INC., NEW YORK, NY. FILED 4-5-2007.

NETFLUENCERS

THE MARK CONSISTS OF STANDARD CHARACTERS WITHOUT CLAIM TO ANY PARTICULAR FONT, STYLE, SIZE, OR COLOR.

FOR CONSUMER MARKET SERVICES, NAMELY, CONDUCTING CONSUMER MARKET SEGMENTATION STUDIES ON USERS OF COMMUNICATION TECHNOLOGY AND THE INTERNET (U.S. CLS. 100, 101 AND 102).

GIANCARLO CASTRO, EXAMINING ATTORNEY

CLASS 35—(Continued).

SN 77-150,219. RIDEMAKERZ, LLC, FALLS CHURCH, VA. FILED 4-5-2007.

**CHOOZE SONICIZE MOTORIZE
MOBILIZE CUSTOMIZE
PERSONALIZE CRUIZE**

THE MARK CONSISTS OF STANDARD CHARACTERS WITHOUT CLAIM TO ANY PARTICULAR FONT, STYLE, SIZE, OR COLOR.

FOR RETAIL STORE SERVICES AND ON-LINE RETAIL STORE SERVICES IN THE FIELD OF TOY VEHICLES, PARTS AND ACCESSORIES THEREFOR (U.S. CLS. 100, 101 AND 102).

BILL DAWE, EXAMINING ATTORNEY

SN 77-151,455. APPAREL ONLY AUCTIONS INC, ATLANTA, GA. FILED 4-9-2007.

APPAREL ONLY AUCTIONS
"WEAR FASHION BIDS"

NO CLAIM IS MADE TO THE EXCLUSIVE RIGHT TO USE "APPAREL ONLY AUCTIONS", APART FROM THE MARK AS SHOWN.

FOR ONLINE AUCTION SERVICES (U.S. CLS. 100, 101 AND 102).

FIRST USE 1-1-2006; IN COMMERCE 1-1-2006.

ANDREA K. NADELMAN, EXAMINING ATTORNEY

SN 77-151,643. BMC COUTURE, LLC, MAINEVILLE, OH. FILED 4-9-2007.



THE MARK CONSISTS OF THE WORDING "LA SILHOUETTE", WHICH IS SITUATED UNDERNEATH A DANCING FEMALE WITH STRETCHED LEGS AND ARMS, AND SCARVES EXTENDING FROM HER WRISTS TO HER WAIST, AS WELL AS THE SHADOWS OF THE AFOREMENTIONED DESIGN-ELEMENTS.

FOR RETAIL STORE SERVICES FEATURING WOMEN'S LINGERIE (U.S. CLS. 100, 101 AND 102).

REBECCA EISINGER, EXAMINING ATTORNEY

CLASS 35—(Continued).

SN 77-151,987. REVOLUTION HEALTH, LLC, MORRISTOWN, NJ. FILED 4-9-2007.

REVHEALTH

THE MARK CONSISTS OF STANDARD CHARACTERS WITHOUT CLAIM TO ANY PARTICULAR FONT, STYLE, SIZE, OR COLOR.

FOR CREATING SALES TRAINING MATERIALS DESIGNED TO INCREASE MANUFACTURERS OF HEALTHCARE PRODUCTS AND HEALTHCARE PROFESSIONALS' KNOWLEDGE OF CUSTOMER NEEDS, AND THEIR COMPETITORS' PRODUCTS AND SERVICES, PRICING, ADVERTISING STRATEGY AND SALES STRATEGY; PRODUCTION AND DISTRIBUTION OF RADIO AND TELEVISION COMMERCIALS (U.S. CLS. 100, 101 AND 102).

ROBIN CHOSID, EXAMINING ATTORNEY

SN 77-152,445. JAZZ PHARMACEUTICALS, INC., PALO ALTO, CA. FILED 4-10-2007.

JAZZ PHARMACEUTICALS

THE MARK CONSISTS OF STANDARD CHARACTERS WITHOUT CLAIM TO ANY PARTICULAR FONT, STYLE, SIZE, OR COLOR.

NO CLAIM IS MADE TO THE EXCLUSIVE RIGHT TO USE "PHARMACEUTICALS", APART FROM THE MARK AS SHOWN.

FOR MARKETING CONSULTATION IN THE FIELD OF MEDICAL AND PHARMACEUTICAL PRODUCTS; AND ARRANGING AND CONDUCTING TRADE SHOW EXHIBITIONS IN THE FIELDS OF MEDICINE AND PHARMACEUTICALS (U.S. CLS. 100, 101 AND 102).

FIRST USE 11-0-2005; IN COMMERCE 11-0-2005.
JOHN DWYER, EXAMINING ATTORNEY

SN 77-152,621. ESTELLE, INC., GLENSIDE, PA. FILED 4-10-2007.

UP SIDE DOWN SUPPLY

THE MARK CONSISTS OF STANDARD CHARACTERS WITHOUT CLAIM TO ANY PARTICULAR FONT, STYLE, SIZE, OR COLOR.

NO CLAIM IS MADE TO THE EXCLUSIVE RIGHT TO USE "SUPPLY", APART FROM THE MARK AS SHOWN.

FOR RETAIL STORES FEATURING CONTRACTOR TOOLS AND SAFETY EQUIPMENT; DISTRIBUTORSHIPS IN THE FIELD CONTRACTOR TOOLS AND SAFETY EQUIPMENT (U.S. CLS. 100, 101 AND 102).

MICHAEL WEBSTER, EXAMINING ATTORNEY

CLASS 35—(Continued).

SN 77-153,644. WFTV, INC., ORLANDO, FL. FILED 4-11-2007.

I AM THE ONE

THE MARK CONSISTS OF STANDARD CHARACTERS WITHOUT CLAIM TO ANY PARTICULAR FONT, STYLE, SIZE, OR COLOR.

FOR DISTRIBUTION OF PUBLIC SERVICE ANNOUNCEMENTS PROMOTING VOLUNTEERISM VIA TELEVISION, THE INTERNET, AND PRINT (U.S. CLS. 100, 101 AND 102).

FIRST USE 3-30-2007; IN COMMERCE 3-30-2007.
TOBY BULLOFF, EXAMINING ATTORNEY

SN 77-154,390. PHILIP RESTIFO, LAS VEGAS, NV. FILED 4-11-2007.

Fortunate 500 Water Company

THE MARK CONSISTS OF STANDARD CHARACTERS WITHOUT CLAIM TO ANY PARTICULAR FONT, STYLE, SIZE, OR COLOR.

NO CLAIM IS MADE TO THE EXCLUSIVE RIGHT TO USE "WATER COMPANY", APART FROM THE MARK AS SHOWN.

FOR ADVERTISING AND BUSINESS SERVICES, NAMELY, SECURING AIRTIME ON ALL FORMS OF MEDIA COMMUNICATIONS STATIONS, SYSTEMS, NETWORKS, AND SERVICES FOR THE PURPOSE OF PROMOTING THE GOODS AND SERVICES OF OTHERS; ADVERTISING AND COMMERCIAL INFORMATION SERVICES, VIA THE INTERNET; ADVERTISING AND MARKETING; ADVERTISING AND PROMOTION SERVICES AND RELATED CONSULTING; ADVERTISING AND PUBLICITY SERVICES; ADVERTISING AND PUBLICITY SERVICES, NAMELY, PROMOTING THE GOODS, SERVICES, BRAND IDENTITY AND COMMERCIAL INFORMATION AND NEWS OF THIRD PARTIES THROUGH PRINT, AUDIO, VIDEO, DIGITAL AND ON-LINE MEDIUM; ADVERTISING BUSINESS ESPECIALLY IN THE FIELD OF TELEMATIC AND TELEPHONE NETWORKS; ADVERTISING BY TRANSMISSION OF ON-LINE PUBLICITY FOR THIRD PARTIES THROUGH ELECTRONIC COMMUNICATIONS NETWORKS; ADVERTISING CONSULTATION; ADVERTISING FLYER DISTRIBUTION; ADVERTISING PARTICULARLY SERVICES FOR THE PROMOTION OF GOODS; ADVERTISING RELATING TO PHARMACEUTICAL PRODUCTS AND IN-VIVO IMAGING PRODUCTS; ADVERTISING SERVICES; ADVERTISING SERVICES FOR PROMOTING THE BROKERAGE OF STOCKS AND OTHER SECURITIES; ADVERTISING SERVICES OF A RADIO AND TELEVISION ADVERTISING AGENCY; ADVERTISING SERVICES, FOR THIRD PARTIES, IN CONNECTION WITH THE COMMERCIALIZATION AND SALE OF PERFUMERY AND COSMETIC ARTICLES, PRODUCTS FOR HOUSEHOLD PURPOSES, OPTICAL PRODUCTS, CLOCKS AND TIMEPIECES, JEWELLERY, FURNISHING ARTICLES; ADVERTISING SERVICES, NAMELY, PROVIDING ADVERTISING SPACE IN A PERIODICAL; ADVERTISING SERVICES, NAMELY, CREATING CORPORATE AND BRAND IDENTITY FOR OTHERS; ADVERTISING SERVICES, NAMELY, CREATING CORPORATE LOGOS FOR OTHERS; ADVERTISING AGENCIES; ADVERTISING AGENCIES, NAMELY, PROMOTING THE GOODS AND SERVICES OF OTHERS; ADVERTISING AGENCIES, NAMELY, PROMOTING THE SERVICES OF

CLASS 35—(Continued).

WATER PRODUCTS THROUGH THE DISTRIBUTION OF PRINTED AND AUDIO PROMOTIONAL MATERIALS AND BY RENDERING SALES PROMOTION ADVICE; ADVERTISING AND ADVERTISEMENT SERVICES; ADVERTISING AND BUSINESS ADVICE RELATING TO TELEMATICS' SERVICES; ADVERTISING AND BUSINESS MANAGEMENT CONSULTANCY; ADVERTISING SERVICES, NAMELY, PROMOTING THE FOOD AND WINE OF OTHERS; ADVERTISING SERVICES, NAMELY, PROMOTING THE GIFT CARDS OF OTHERS; ADVERTISING THROUGH ALL PUBLIC COMMUNICATION MEANS; ADVERTISING VIA ELECTRONIC MEDIA AND SPECIFICALLY THE INTERNET; ADVERTISING, INCLUDING PROMOTION OF PRODUCTS AND SERVICES OF THIRD PARTIES THROUGH SPONSORING ARRANGEMENTS AND LICENCE AGREEMENTS RELATING TO INTERNATIONAL SPORTS' EVENTS; ADVERTISING, INCLUDING PROMOTION RELATING TO THE SALE OF ARTICLES AND SERVICES FOR THIRD PARTIES BY THE TRANSMISSION OF ADVERTISING MATERIAL AND THE DISSEMINATION OF ADVERTISING MESSAGES ON COMPUTER NETWORKS; ADVERTISING, MARKETING AND PROMOTION SERVICES; AGENCIES FOR ADVERTISING TIME AND SPACE; ARRANGING AND CONDUCTING OF FAIRS AND EXHIBITIONS FOR BUSINESS AND ADVERTISING PURPOSES; CINEMA ADVERTISING; COOPERATIVE ADVERTISING AND MARKETING; COOPERATIVE ADVERTISING AND MARKETING SERVICES BY WAY OF SOLICITATION, CUSTOMER SERVICE AND PROVIDING MARKETING INFORMATION VIA WEBSITES ON A GLOBAL COMPUTER NETWORK; CREATING AND UPDATING ADVERTISING MATERIAL; CREATION OF MARKETING TOOLS DESIGNED TO INCREASE A CLIENT COMPANY'S KNOWLEDGE OF CUSTOMER NEEDS, AND ITS COMPETITORS' PRODUCTS AND SERVICES, PRICING, ADVERTISING STRATEGY AND SALES STRATEGY; CUSTOMER LOYALTY SERVICES AND CUSTOMER CLUB SERVICES, FOR COMMERCIAL, PROMOTIONAL AND/OR ADVERTISING PURPOSES; DESIGN OF ADVERTISING MATERIALS FOR OTHERS; DIRECT MAIL ADVERTISING; DIRECT MARKETING ADVERTISING FOR OTHERS; DISPLAYING ADVERTISEMENTS FOR OTHERS; ADVERTISING SERVICES, NAMELY, PROMOTING AND MARKETING THE GOODS AND SERVICES OF OTHERS THROUGH ALL PUBLIC COMMUNICATION MEANS; DISSEMINATION OF ADVERTISEMENTS AND OF ADVERTISING MATERIAL; DISSEMINATION OF ADVERTISING FOR OTHERS VIA AN ON-LINE COMMUNICATIONS NETWORK ON THE INTERNET; DISSEMINATION OF ADVERTISING FOR OTHERS VIA THE INTERNET; DISSEMINATION OF ADVERTISING MATERIAL; DISSEMINATION OF ADVERTISING MATTER; DISSEMINATION OF ADVERTISING, SCHEDULING AND MANAGING OF TRAINING COURSES AND PROGRAMS FOR OTHERS VIA A GLOBAL COMPUTER NETWORK; DISTRIBUTION AND DISSEMINATION OF ADVERTISING MATERIALS; DISTRIBUTION OF ADVERTISEMENTS AND COMMERCIAL ANNOUNCEMENTS; DISTRIBUTION OF ADVERTISING MAIL AND OF ADVERTISING SUPPLEMENTS ATTACHED TO REGULAR EDITIONS; DISTRIBUTION OF PRODUCTS FOR ADVERTISING PURPOSES; ELECTRONIC BILLBOARD ADVERTISING; ELECTRONIC COMMERCE SERVICES, NAMELY, PROVIDING INFORMATION ABOUT PRODUCTS VIA TELECOMMUNICATION NETWORKS FOR ADVERTISING AND SALES PURPOSES; ENTERTAINMENT MARKETING SERVICES, NAMELY, MARKETING, PROMOTION AND ADVERTISING FOR INDEPENDENT RECORDING ARTISTS; ISSUING AND UPDATING OF ADVERTISING TEXTS; LAYOUT SERVICES FOR ADVERTISING PURPOSES; MEDIA BUYING ADVICE, NAMELY, ADVISING THE CLIENT HOW MUCH MEDIA TIME, AND AT WHAT TIMES THE CLIENT SHOULD BE PURCHASING ADVERTISING; MEDIA PLANNING, NAMELY, ADVISING THE CLIENT ON THE CORRECT TIMES AND STATIONS TO ADVERTISE BASED ON MEDIA ANALYSIS OF THE MARKET FOR THAT MEDIA; MEDIATION OF ADVERTISING; MODELING FOR ADVERTISING OR SALES PROMOTION; MODELING SERVICES FOR ADVERTISING OR SALES PROMOTION; ON-LINE ADVERTISING AND MARKETING SERVICES; ON-LINE ADVERTISING ON COMPUTER COMMUNICATION NETWORKS; ORGANISATION AND HOLDING OF

CLASS 35—(Continued).

FAIRS FOR COMMERCIAL OR ADVERTISING PURPOSES; ORGANIZING EXHIBITIONS FOR WATER PRODUCTS; PLACING ADVERTISEMENTS FOR OTHERS; PLANNING AND CONDUCTING OF TRADE FAIRS, EXHIBITIONS AND PRESENTATIONS FOR ECONOMIC OR ADVERTISING PURPOSES; PREPARATION AND REALIZATION OF MEDIA AND ADVERTISING PLANS AND CONCEPTS; PREPARATION OF CUSTOM ADVERTISEMENTS FOR OTHERS; PREPARATION OF CUSTOM OR NON-CUSTOM ADVERTISING FOR BUSINESSES FOR DISSEMINATION VIA THE WEB, CD OR DVD FOR OPTIONAL UPLOAD OR DOWNLOAD TO A COMPUTER; PREPARING ADVERTISEMENTS FOR OTHERS; PREPARING AND PLACING ADVERTISEMENTS FOR OTHERS; PREPARING AND PLACING ADVERTISEMENTS OF ADVERTISEMENTS; PREPARING AND PLACING OUTDOOR ADVERTISEMENTS FOR OTHERS; PREPARING AUDIO-VISUAL DISPLAYS IN THE FIELD OF WATER PRODUCTS; PREPARING AUDIO-VISUAL PRESENTATIONS FOR USE IN ADVERTISING; PROCESSING TELEPHONE INQUIRIES REGARDING ADVERTISED GOODS AND SERVICES; PROMOTING THE GOODS AND SERVICES OF OTHERS BY DISTRIBUTING ADVERTISING MATERIALS THROUGH A VARIETY OF METHODS; PROMOTING THE GOODS AND SERVICES OF OTHERS BY PREPARING AND PLACING ADVERTISEMENTS IN AN ELECTRONIC MAGAZINE ACCESSED THROUGH A GLOBAL COMPUTER NETWORK; PROMOTING, ADVERTISING AND MARKETING OF THE ON-LINE WEBSITES OF OTHERS; PROMOTION, ADVERTISING AND MARKETING OF ON-LINE WEBSITES; TELEVISION ADVERTISING AGENCIES; SERVICES TO DETERMINE THE AUDIENCE AFFECTED BY ADVERTISEMENTS; RENTAL OF SIGNS FOR ADVERTISING PURPOSES; RENTAL OF ADVERTISING SPACE ON WEB SITES; RENTAL OF ADVERTISING SPACE; RENTAL OF ADVERTISEMENT SPACE AND ADVERTISING MATERIAL; REAL ESTATE ADVERTISING SERVICES; PUBLISHING OF ADVERTISING TEXTS; PROVISION OF ADVERTISING SPACE BY ELECTRONIC MEANS AND GLOBAL INFORMATION NETWORKS; PROVIDING TELEVISION ADVERTISING FOR OTHERS; PROVIDING SPACE AT A WEB SITE FOR THE ADVERTISEMENT OF THE GOODS AND SERVICES OF OTHERS; PROVIDING AND RENTAL OF ADVERTISING SPACE ON THE INTERNET; PROVIDING ADVERTISING, MARKETING AND PROMOTIONAL SERVICES, NAMELY, DEVELOPMENT OF ADVERTISING CAMPAIGNS FOR WATER PRODUCTS; PROVIDING ADVERTISING, MARKETING AND PROMOTIONAL SERVICES FOR THE PHARMACEUTICAL AND MEDICAL PRODUCTS OF OTHERS; PROVIDING ADVERTISING, MARKETING AND PROMOTIONAL SERVICES FOR THE PHARMACEUTICAL AND MEDICAL INDUSTRY; PROVIDING ADVERTISING SERVICES USING 3D AND ANIMATION DESIGNS; PROVIDING A WEB SITE WHICH FEATURES ADVERTISEMENTS FOR THE GOODS AND SERVICES OF OTHERS ON A GLOBAL COMPUTER NETWORK; PROVIDING A WEB SITE THAT ENABLES USERS TO POST ITEMS FOR SALE THROUGH ON-LINE CLASSIFIED ADVERTISEMENTS; PROVIDING A SEARCHABLE ONLINE ADVERTISING GUIDE FEATURING THE GOODS AND SERVICES OF OTHER ON-LINE VENDORS ON THE INTERNET; BUSINESS MANAGEMENT CONSULTING WITH RELATION TO STRATEGY, MARKETING, PRODUCTION, PERSONNEL AND RETAIL SALE MATTERS; INVENTORY AND SHELF ARRANGEMENT, NAMELY, REPLENISHING AND RESETTING ITEMS FOR SALE; MARKETING SERVICES, NAMELY, PROVIDING INFORMATIONAL WEB PAGES DESIGNED TO GENERATE SALES TRAFFIC VIA HYPERLINKS TO OTHER WEB SITES; MEDIATION OF AGREEMENTS REGARDING THE SALE AND PURCHASE OF GOODS; MEDIATION OF CONTRACTS FOR PURCHASE AND SALE OF PRODUCTS; PROVIDING A

CLASS 35—(Continued).

WEB SITE WHEREBY BUYERS OF GOODS OR SERVICES LOCATE AND RECEIVE QUOTATIONS FROM MULTIPLE COMPETITIVE SOURCES AND SELLERS OF GOODS OR SERVICES IDENTIFY AND BID ON MULTIPLE NEW SALES OPPORTUNITIES; PUBLICITY AND SALES PROMOTION RELATING TO GOODS AND SERVICES, OFFERED AND ORDERED BY TELECOMMUNICATION OR THE ELECTRONIC WAY; SALES PROMOTION SERVICES; SALES DEMONSTRATION; RETAIL SERVICES BY DIRECT SOLICITATION BY SALES AGENTS IN THE FIELD OF WATER PRODUCTS (U.S. CLS. 100, 101 AND 102).

ADA HAN, EXAMINING ATTORNEY

SN 77-156,621. SUPERIOR LIVING PRODUCTS, LLC, POTTS-TOWN, PA. FILED 4-13-2007.

SUPERIOR CARING PRODUCTS

THE MARK CONSISTS OF STANDARD CHARACTERS WITHOUT CLAIM TO ANY PARTICULAR FONT, STYLE, SIZE, OR COLOR.

NO CLAIM IS MADE TO THE EXCLUSIVE RIGHT TO USE SUPERIOR OR PRODUCTS, APART FROM THE MARK AS SHOWN.

FOR ON-LINE RETAIL STORE SERVICES FEATURING MOBILITY, SAFETY, AND ACCESSIBILITY AIDS FOR THE HOME, NAMELY, WALK-IN BATHTUBS, ADJUSTABLE BEDS, BATHLIFTERS, GRAB BARS, HEATING PADS, WHIRLPOOLS, SPAS, SAUNA AND STEAM ROOMS, MEDICAL ALERT SYSTEMS, AIR PURIFIERS, BARRIER FREE BATHING SYSTEMS, ELECTRIC WHEEL CHAIRS / SCOOTERS, DRY HYDROTHERAPY MASSAGE BEDS, MASSAGE CHAIRS, PERSONAL OXYGEN PRODUCTS I:E OXYGENATED WATER DISPENSERS, PERSONAL OXYGEN MACHINES, WHEEL CHAIR RAMPS, AND ELEVATORS; RETAIL STORE SERVICES FEATURING MOBILITY, SAFETY, AND ACCESSIBILITY AIDS FOR THE HOME, NAMELY, WALK-IN BATHTUBS, ADJUSTABLE BEDS, BATHLIFTERS, GRAB BARS, HEATING PADS, WHIRLPOOLS, SPAS, SAUNA AND STEAM ROOMS, MEDICAL ALERT SYSTEMS, AIR PURIFIERS, BARRIER FREE BATHING SYSTEMS, ELECTRIC WHEEL CHAIRS/SCOOTERS, DRY HYDROTHERAPY MASSAGE BEDS, MASSAGE CHAIRS, PERSONAL OXYGEN PRODUCTS I:E OXYGENATED WATER DISPENSERS, PERSONAL OXYGEN MACHINES, WHEEL CHAIR RAMPS, AND ELEVATORS (U.S. CLS. 100, 101 AND 102).

FIRST USE 5-1-2007; IN COMMERCE 5-1-2007.
JAMES A. RAUEN, EXAMINING ATTORNEY

CLASS 35—(Continued).

SN 77-157,066. PALISADES WATER INDEX ASSOCIATES LLC, SHERMAN OAKS, CA. FILED 4-15-2007.

Palisades European Water Index

THE MARK CONSISTS OF STANDARD CHARACTERS WITHOUT CLAIM TO ANY PARTICULAR FONT, STYLE, SIZE, OR COLOR.

NO CLAIM IS MADE TO THE EXCLUSIVE RIGHT TO USE "EUROPEAN WATER INDEX", APART FROM THE MARK AS SHOWN.

FOR COLLECTION, PREPARATION, COMPOSITION, STORAGE, PROCESSING, ACQUISITION AND PROVISION OF BUSINESS INFORMATION, DATA, STATISTICS AND INDICES (U.S. CLS. 100, 101 AND 102).

MELVIN AXILBUND, EXAMINING ATTORNEY

SN 77-162,234. THE EMPLOYER GROUP, INC., MADISON, WI. FILED 4-20-2007.



THE EMPLOYER GROUP
OPERATE SMARTER

NO CLAIM IS MADE TO THE EXCLUSIVE RIGHT TO USE "THE EMPLOYER GROUP", APART FROM THE MARK AS SHOWN.

THE COLOR(S) TEAL, DARK BLUE, LIGHT BLUE, MEDIUM GREY AND WHITE IS/ARE CLAIMED AS A FEATURE OF THE MARK.

THE MARK CONSISTS OF FOUR LINES SWIRLING TO A CENTER WHITE CIRCLE WITH EACH LINE BEING TEAL, DARK BLUE, LIGHT BLUE AND MEDIUM GREY RESPECTIVELY.

FOR EMPLOYEE LEASING (U.S. CLS. 100, 101 AND 102).

FIRST USE 4-10-2002; IN COMMERCE 4-10-2002.
LA TONIA FISHER, EXAMINING ATTORNEY

SN 77-163,005. WORLD PEACE ONE, PITTSBURGH, PA. FILED 4-23-2007.

There's more than one way to fight for your country.

THE MARK CONSISTS OF STANDARD CHARACTERS WITHOUT CLAIM TO ANY PARTICULAR FONT, STYLE, SIZE, OR COLOR.

FOR PROVIDING POLITICAL NON-PARTISAN INFORMATION VIA A GLOBAL COMPUTER INFORMATION NETWORK (U.S. CLS. 100, 101 AND 102).

FIRST USE 9-15-2005; IN COMMERCE 3-15-2007.
SHAUNIA CARLYLE, EXAMINING ATTORNEY

CLASS 35—(Continued).

SN 77-164,222. LEWIS, KIM, CORONA, CA. FILED 4-24-2007.

The Christ Connection

THE MARK CONSISTS OF STANDARD CHARACTERS WITHOUT CLAIM TO ANY PARTICULAR FONT, STYLE, SIZE, OR COLOR.

FOR ON-LINE RETAIL STORE SERVICES FEATURING STOCK PHOTOGRAPHY, GRAPHIC DESIGN TEMPLATES, WEB TEMPLATES AND NEWSLETTER TEMPLATES (U.S. CLS. 100, 101 AND 102).

JAMES LOVELACE, EXAMINING ATTORNEY

SN 77-164,645. DIAMOND TREE, LLC, TUSTIN, CA. FILED 4-24-2007.

Celebrate Life!

THE MARK CONSISTS OF STANDARD CHARACTERS WITHOUT CLAIM TO ANY PARTICULAR FONT, STYLE, SIZE, OR COLOR.

FOR DIRECT MARKETING BUSINESS SERVICES, IN THE NATURE OF PROVIDING MARKETING AND INCOME OPPORTUNITIES TO OTHERS IN THE FIELDS OF NUTRITIONAL AND PERSONAL CARE PRODUCTS; DISTRIBUTORSHIP SERVICES IN THE FIELD OF NUTRITIONAL AND DIETARY SUPPLEMENTS, BOTTLED DRINKING WATER, AND PERSONAL CARE PRODUCTS; ONLINE RETAIL STORE SERVICES FEATURING NUTRITIONAL AND DIETARY SUPPLEMENTS, BOTTLED DRINKING WATER, AND PERSONAL CARE PRODUCTS (U.S. CLS. 100, 101 AND 102).

FIRST USE 2-15-2007; IN COMMERCE 2-15-2007.
BENJAMIN OKEKE, EXAMINING ATTORNEY

SN 77-164,649. ALLIED 100 LLC, ARBOR VITAE, WI. FILED 4-24-2007.

AEDSUPERSTORE

THE MARK CONSISTS OF STANDARD CHARACTERS WITHOUT CLAIM TO ANY PARTICULAR FONT, STYLE, SIZE, OR COLOR.

OWNER OF U.S. REG. NO. 3,030,841.
SEC. 2(F).

FOR ONLINE RETAIL STORE SERVICES FEATURING AUTOMATED EXTERNAL DEFIBRILLATORS, CPR TRAINING MASKS, CPR AND AUTOMATED EXTERNAL DEFIBRILLATION TRAINING DEVICES, CPR TRAINING MANNEQUINS, FIRST-AID OXYGEN TANKS, AND AUTOMATED EXTERNAL DEFIBRILLATION ACCESSORIES, INCLUDING TRAINING DEFIBRILLATION PADS, DEFIBRILLATION PADS, AND CARRYING CASES (U.S. CLS. 100, 101 AND 102).

FIRST USE 4-1-2002; IN COMMERCE 4-1-2002.
SIMON TENG, EXAMINING ATTORNEY

CLASS 35—(Continued).

SN 77-165,122. POTTER, RYAN, SAN DIEGO, CA. FILED 4-25-2007.

Fractalize

THE MARK CONSISTS OF STANDARD CHARACTERS WITHOUT CLAIM TO ANY PARTICULAR FONT, STYLE, SIZE, OR COLOR.

FOR ON-LINE RETAIL STORE SERVICES FEATURING CLOTHING, ART, JEWELRY, GLASS, CRYSTAL, AND SKATEBOARDING EQUIPMENT; RETAIL STORE SERVICES FEATURING CLOTHING, ART, JEWELRY, GLASS, CRYSTAL, AND SKATEBOARDING EQUIPMENT (U.S. CLS. 100, 101 AND 102).

FIRST USE 5-1-2006; IN COMMERCE 5-1-2006.
JORDAN BAKER, EXAMINING ATTORNEY

SN 77-166,062. SITE-CONTROLS, LLC, AUSTIN, TX. FILED 4-26-2007.

**Site Controls**

THE MARK CONSISTS OF DESIGN OF A BUTTERFLY. FOR ENERGY USAGE MANAGEMENT (U.S. CLS. 100, 101 AND 102).

FIRST USE 3-0-2006; IN COMMERCE 3-0-2006.
GISELLE AGOSTO, EXAMINING ATTORNEY

SN 77-168,130. NATIONAL PREMIUM, INC., PEWAUKEE, WI. FILED 4-27-2007.



NO CLAIM IS MADE TO THE EXCLUSIVE RIGHT TO USE "EUROPE", APART FROM THE MARK AS SHOWN.

THE MARK CONSISTS OF A RECTANGLE WITH A STAR IN A CIRCLE CENTERED OVER IT. THE WORDS "NATIONAL PREMIUM EUROPE" ARE CENTERED UNDER THE STAR AND BAR DESIGN.

FOR ADVERTISING AND MARKETING SERVICES, NAMELY, PROVIDING ADVERTISING, POINT-OF-SALE AND INCENTIVE AWARD PROGRAMS FOR PROMOTING THE SALES OF GOODS AND SERVICES OF OTHERS (U.S. CLS. 100, 101 AND 102).

JEFFERY COWARD, EXAMINING ATTORNEY

CLASS 35—(Continued).

SN 77-168,995. TACODA, INC., NEW YORK, NY. FILED 4-30-2007.

AUDIENCE SERVICES

THE MARK CONSISTS OF STANDARD CHARACTERS WITHOUT CLAIM TO ANY PARTICULAR FONT, STYLE, SIZE, OR COLOR.

NO CLAIM IS MADE TO THE EXCLUSIVE RIGHT TO USE "SERVICES", APART FROM THE MARK AS SHOWN, FOR ON-LINE ADVERTISING SERVICES (U.S. CLS. 100, 101 AND 102).

CHRISTINE COOPER, EXAMINING ATTORNEY

CLASS 35—(Continued).

SERVICES; BUSINESS MANAGEMENT INFORMATION ON A WIDE VARIETY OF TOPICS TO SERVICE PROVIDING PROFESSIONALS; BUSINESS MANAGEMENT PLANNING; BUSINESS MARKETING CONSULTING SERVICES; BUSINESS MERGER CONSULTATION; BUSINESS ORGANISATION AND MANAGEMENT CONSULTING SERVICES; BUSINESS ORGANIZATION ADVICE; BUSINESS ORGANIZATION AND OPERATION CONSULTANCY; BUSINESS ORGANIZATIONAL CONSULTATION; BUSINESS PLANNING; BUSINESS RESEARCH AND SURVEYS; BUSINESS RESEARCH CONSULTATION; BUSINESS RESEARCH USING FOCUS GROUPS; BUSINESS SERVICES, NAMELY, MATCHING POTENTIAL PRIVATE INVESTORS WITH ENTREPRENEURS NEEDING FUNDING; BUSINESS SERVICES, NAMELY, PROCURING QUALIFIED AND CREDENTIALLED THIRD-PARTY EXPERTS, PROFESSIONALS AND OTHER QUALIFIED PERSONNEL, AND DOCUMENTATION AND INFORMATION ALL ON BEHALF OF OTHERS; BUSINESS SUCCESSION PLANNING (U.S. CLS. 100, 101 AND 102).

FIRST USE 5-10-2005; IN COMMERCE 5-10-2005.
PAM WILLIS, EXAMINING ATTORNEY

SN 77-172,143. CHERRY MARKETING INSTITUTE, INC., LANSING, MI. FILED 5-3-2007.

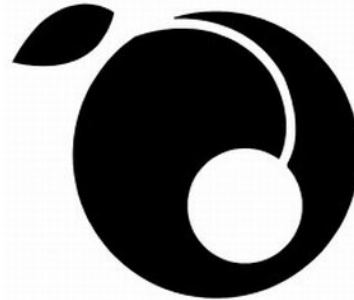

THE MARK CONSISTS OF A CHERRY, FOR ASSOCIATION SERVICES, NAMELY, PROMOTING THE INTERESTS OF CHERRY PRODUCERS BY PROMOTING THE SALE, USE, AND CONSUMPTION OF CHERRIES (U.S. CLS. 100, 101 AND 102).

SETH A. RAPPAPORT, EXAMINING ATTORNEY

SN 77-175,576. GERZABEK HOLDINGS, LLC, PARKER, CO. FILED 5-8-2007.

At Your Door Pet Store

THE MARK CONSISTS OF STANDARD CHARACTERS WITHOUT CLAIM TO ANY PARTICULAR FONT, STYLE, SIZE, OR COLOR.

NO CLAIM IS MADE TO THE EXCLUSIVE RIGHT TO USE "PET STORE", APART FROM THE MARK AS SHOWN, FOR RETAIL PET STORES (U.S. CLS. 100, 101 AND 102).

FIRST USE 1-12-2006; IN COMMERCE 1-12-2006.
KEVON CHISOLM, EXAMINING ATTORNEY

SN 77-169,617. 4-PROFIT LLC, RIVERDALE, NY. FILED 5-1-2007.

4-Profit

THE MARK CONSISTS OF STANDARD CHARACTERS WITHOUT CLAIM TO ANY PARTICULAR FONT, STYLE, SIZE, OR COLOR.

FOR ASSISTANCE IN MANAGEMENT OF BUSINESS ACTIVITIES; ASSISTANCE WITH BUSINESS MANAGEMENT AND PLANNING; BUSINESS CONSULTATION; BUSINESS CONSULTATION AND MANAGEMENT REGARDING MARKETING ACTIVITIES AND LAUNCHING OF NEW PRODUCTS; BUSINESS CONSULTATION IN THE FIELD OF TELECOMMUNICATIONS EXPENSE MANAGEMENT; BUSINESS CONSULTATION SERVICES; BUSINESS CONSULTING AND BUSINESS INFORMATION FOR ENTERPRISES; BUSINESS CONSULTING AND INFORMATION SERVICES; BUSINESS CONSULTING SERVICES IN THE FIELD OF BUSINESS KNOWLEDGE TRANSFER THROUGH AUDIO TOOLS, NAMELY, RECORDING INTERVIEWS WITH SUBJECT MATTER EXPERTS FOR AN ORGANIZATION'S CAPTURE AND FUTURE USE; BUSINESS CONSULTING, MANAGEMENT, PLANNING AND SUPERVISION; BUSINESS INFORMATION SERVICES AND APPRAISALS; BUSINESS LEADERSHIP DEVELOPMENT; BUSINESS MANAGEMENT; BUSINESS MANAGEMENT AND ADVICE; BUSINESS MANAGEMENT AND CONSULTATION; BUSINESS MANAGEMENT CONSULTANCY AND ADVISORY SERVICES; BUSINESS MANAGEMENT CONSULTANCY AS WELL AS DEVELOPMENT OF PROCESSES FOR THE ANALYSIS AND THE IMPLEMENTATION OF STRATEGY PLANS AND MANAGEMENT PROJECTS; BUSINESS MANAGEMENT CONSULTANCY SERVICES; BUSINESS MANAGEMENT CONSULTATION; BUSINESS MANAGEMENT CONSULTATION IN THE FIELD OF EXECUTIVE AND LEADERSHIP DEVELOPMENT; BUSINESS MANAGEMENT CONSULTING AND ADVISORY

CLASS 35—(Continued).

SN 77-175,693. MID-AMERICA INTERNATIONAL AGRICULTURE TRADE COUNCIL, CHICAGO, IL. FILED 5-8-2007.

FOOD SHOW PLUS

THE MARK CONSISTS OF STANDARD CHARACTERS WITHOUT CLAIM TO ANY PARTICULAR FONT, STYLE, SIZE, OR COLOR.

NO CLAIM IS MADE TO THE EXCLUSIVE RIGHT TO USE "FOOD SHOW", APART FROM THE MARK AS SHOWN.

SEC. 2(F) AS TO "FOOD SHOW".

FOR BUSINESS CONSULTATION SERVICES, NAMELY, CONSULTATION FOR ENTITIES WISHING TO EXHIBIT THEIR GOODS AT INTERNATIONAL TRADE SHOWS; TRANSPORTATION LOGISTICS SERVICES, NAMELY, ARRANGING THE TRANSPORTATION OF GOODS FOR OTHERS (U.S. CLS. 100, 101 AND 102).

FIRST USE 0-0-1999; IN COMMERCE 0-0-1999.
DAWN FELDMAN, EXAMINING ATTORNEY

CLASS 35—(Continued).

SN 77-177,726. KIJJI INTERNATIONAL LIMITED, DUBLIN 15, IRELAND, FILED 5-10-2007.

LOQUO

THE MARK CONSISTS OF STANDARD CHARACTERS WITHOUT CLAIM TO ANY PARTICULAR FONT, STYLE, SIZE, OR COLOR.

OWNER OF ERPN CMNTY TM OFC REG. NO. 004414157, DATED 4-19-2006, EXPIRES 4-29-2015.

THE WORDING "LOQUO" HAS NO MEANING IN A FOREIGN LANGUAGE.

FOR ADVERTISING AND INFORMATION DISTRIBUTION SERVICES, NAMELY, PROVIDING CLASSIFIED ADVERTISING SPACE VIA GLOBAL COMPUTER AND WIRELESS NETWORKS; PROVIDING CONSUMER PRODUCT AND SERVICE INFORMATION VIA GLOBAL COMPUTER AND WIRELESS NETWORKS; PROMOTING THE GOODS AND SERVICES OF OTHERS OVER GLOBAL COMPUTER AND WIRELESS NETWORKS; PROVIDING AN ONLINE COMMERCIAL BUSINESS INFORMATION DIRECTORY ON GLOBAL COMPUTER AND WIRELESS NETWORKS (U.S. CLS. 100, 101 AND 102).

JASON LOTT, EXAMINING ATTORNEY

SN 77-177,704. FOODIRECT, INC., BRONX, NY. FILED 5-10-2007.

FOODIRECT

THE MARK CONSISTS OF STANDARD CHARACTERS WITHOUT CLAIM TO ANY PARTICULAR FONT, STYLE, SIZE, OR COLOR.

FOR ELECTRONIC WHOLESALE ORDERING SERVICES FEATURING FRESH AND FROZEN FOODS (U.S. CLS. 100, 101 AND 102).

FIRST USE 11-0-1997; IN COMMERCE 11-0-1997.
MARK T. MULLEN, EXAMINING ATTORNEY

SN 77-177,870. CANDLE BEE FARM, LLC, FISHERVILLE, KY. FILED 5-10-2007.

NATURE TAILS

THE MARK CONSISTS OF STANDARD CHARACTERS WITHOUT CLAIM TO ANY PARTICULAR FONT, STYLE, SIZE, OR COLOR.

FOR ON-LINE RETAIL STORE SERVICES FEATURING ANIMAL FOODS AND SUPPLEMENTS, ANIMAL HEALTH AND TRAINING AIDS AND RELATED INSTRUCTIONAL MATERIALS CONSISTING OF BOOKS, PAMPHLETS, AND VIDEOS (U.S. CLS. 100, 101 AND 102).

STEVEN R. FINE, EXAMINING ATTORNEY

CLASS 35—(Continued).

SN 77-180,393. CHERRY MARKETING INSTITUTE, INC., LANSING, MI. FILED 5-14-2007.

NOT JUST ANOTHER SUPER
FRUIT

THE MARK CONSISTS OF STANDARD CHARACTERS WITHOUT CLAIM TO ANY PARTICULAR FONT, STYLE, SIZE, OR COLOR.

NO CLAIM IS MADE TO THE EXCLUSIVE RIGHT TO USE "SUPER FRUIT", APART FROM THE MARK AS SHOWN.

FOR ASSOCIATION SERVICES, NAMELY, PROMOTING THE INTERESTS OF CHERRY PRODUCERS BY PROMOTING THE SALE, USE, AND CONSUMPTION OF CHERRIES (U.S. CLS. 100, 101 AND 102).

SETH A. RAPPAPORT, EXAMINING ATTORNEY

CLASS 35—(Continued).

SN 77-180,488. PREFERRED HOTEL GROUP, INC., CHICAGO, IL. FILED 5-14-2007.



NO CLAIM IS MADE TO THE EXCLUSIVE RIGHT TO USE "GLOBAL GUEST BENEFIT PROGRAM", APART FROM THE MARK AS SHOWN.

THE MARK CONSISTS OF THE WORDS "I PREFER" AND "GLOBAL GUEST BENEFIT PROGRAM" STACKED IN STYLIZED LETTERS WITH A PINEAPPLE/LOTUS FLOWER DESIGN AT THE TOP.

FOR ADMINISTRATION OF A MEMBERSHIP CLUB PROGRAM FOR ENABLING PARTICIPANTS TO RECEIVE IMPROVED SERVICES THROUGH DISCOUNTS ON GOODS AND SERVICES AND EXCLUSIVE OFFERS AT HOTELS AND RESORTS THROUGH USE OF A MEMBERSHIP CARD (U.S. CLS. 100, 101 AND 102).

FIRST USE 11-0-2005; IN COMMERCE 11-0-2005.
VERNA BETH RIRIE, EXAMINING ATTORNEY

SN 77-180,440. PREFERRED HOTEL GROUP, INC., CHICAGO, IL. FILED 5-14-2007.

I PREFER

THE MARK CONSISTS OF STANDARD CHARACTERS WITHOUT CLAIM TO ANY PARTICULAR FONT, STYLE, SIZE, OR COLOR.

FOR ADMINISTRATION OF A MEMBERSHIP CLUB PROGRAM FOR ENABLING PARTICIPANTS TO RECEIVE IMPROVED SERVICES THROUGH DISCOUNTS ON GOODS AND SERVICES AND EXCLUSIVE OFFERS AT HOTELS AND RESORTS THROUGH USE OF A MEMBERSHIP CARD (U.S. CLS. 100, 101 AND 102).

FIRST USE 11-0-2005; IN COMMERCE 11-0-2005.
VERNA BETH RIRIE, EXAMINING ATTORNEY

SN 77-183,031. SALESFORCE.COM, INC., SAN FRANCISCO, CA. FILED 5-16-2007.



THE STIPPLING IS A FEATURE OF THE MARK AND DOES NOT INDICATE COLOR; THE STIPPLING IS FOR SHADING PURPOSES ONLY.

THE MARK CONSISTS OF LIGHT BULB ABOVE THE WORD "IDEAEXCHANGE".

FOR PROVIDING A WEBSITE, ONLINE DIRECTORY, AND AN ONLINE SEARCHABLE DATABASE FEATURING INFORMATION ABOUT THE PRODUCTS AND SERVICES OF OTHERS; PROVIDING A WEBSITE FEATURING REVIEWS OF PRODUCTS AND SERVICES AND A COMPILATION AND USER COMMENTS REGARDING PRODUCTS AND SERVICES VIA THE INTERNET; PROVIDING A WEB SITE WHERE USERS CAN POST RATINGS, REVIEWS AND RECOMMENDATIONS ON PRODUCTS AND SERVICES (U.S. CLS. 100, 101 AND 102).

FIRST USE 10-9-2006; IN COMMERCE 10-9-2006.
ROSELLE HERRERA, EXAMINING ATTORNEY

CLASS 35—(Continued).

SN 77-183,769. SITE-CONTROLS, LLC, AUSTIN, TX. FILED 5-17-2007.

Clean Energy. Clear
Visibility.

THE MARK CONSISTS OF STANDARD CHARACTERS WITHOUT CLAIM TO ANY PARTICULAR FONT, STYLE, SIZE, OR COLOR.

FOR ENERGY USAGE MANAGEMENT (U.S. CLS. 100, 101 AND 102).

GISELLE AGOSTO, EXAMINING ATTORNEY

SN 77-193,720. OSTROWSKI, GREGG, SPARTA, NJ. FILED 5-30-2007.

WHAT'S YOUR PEEVE?

THE MARK CONSISTS OF STANDARD CHARACTERS WITHOUT CLAIM TO ANY PARTICULAR FONT, STYLE, SIZE, OR COLOR.

FOR ON-LINE RETAIL STORE SERVICES FEATURING T-SHIRTS, SWEATSHIRTS, HATS, AND STICKERS; RETAIL STORES FEATURING T-SHIRTS, HATS, SWEATSHIRTS AND STICKERS (U.S. CLS. 100, 101 AND 102).

MARK SPARACINO, EXAMINING ATTORNEY

SN 77-193,935. SWIACKI, NEIL C., HARRISBURG, NC. FILED 5-31-2007.

LEAKY BUCKET

THE MARK CONSISTS OF STANDARD CHARACTERS WITHOUT CLAIM TO ANY PARTICULAR FONT, STYLE, SIZE, OR COLOR.

FOR BUSINESS RESEARCH, NAMELY, EVALUATING CUSTOMER BEHAVIOR FOR CUSTOMER RETENTION IN THE FINANCIAL AND AUTOMOTIVE INDUSTRIES (U.S. CLS. 100, 101 AND 102).

FIRST USE 1-31-2006; IN COMMERCE 1-31-2006.

SALLY SHIH, EXAMINING ATTORNEY

CLASS 35—(Continued).

SN 77-194,294. ASBURY AUTOMOTIVE GROUP, INC., NEW YORK, NY. FILED 5-31-2007.



NO CLAIM IS MADE TO THE EXCLUSIVE RIGHT TO USE "AUTO GROUP", APART FROM THE MARK AS SHOWN.

THE MARK CONSISTS OF AN OVAL WITH THE WORDS "COURTESY AUTOGROUP" INSIDE.

FOR AUTOMOBILE DEALERSHIPS (U.S. CLS. 100, 101 AND 102).

FIRST USE 9-0-1998; IN COMMERCE 9-0-1998.

IRA J. GOODSaid, EXAMINING ATTORNEY

SN 77-194,393. ZIEGLERWORLD LLC, TRENTON, NJ. FILED 5-31-2007.

ZIEGLERWORLD

THE MARK CONSISTS OF STANDARD CHARACTERS WITHOUT CLAIM TO ANY PARTICULAR FONT, STYLE, SIZE, OR COLOR.

FOR ON-LINE RETAIL STORE SERVICES FEATURING GAME ROOM EQUIPMENT IN THE NATURE OF DISCOUNT TABLE SHUFFLEBOARD AND GAME ROOM FURNISHINGS (U.S. CLS. 100, 101 AND 102).

FIRST USE 5-17-2005; IN COMMERCE 5-17-2005.

MARTHA FROMM, EXAMINING ATTORNEY

SN 77-194,394. ZIEGLERWORLD LLC, TRENTON, NJ. FILED 5-31-2007.

WE SHIP FASTER THAN FAST!

THE MARK CONSISTS OF STANDARD CHARACTERS WITHOUT CLAIM TO ANY PARTICULAR FONT, STYLE, SIZE, OR COLOR.

FOR ON-LINE RETAIL STORE SERVICES FEATURING GAME ROOM EQUIPMENT IN THE NATURE OF DISCOUNT TABLE SHUFFLEBOARD AND GAME ROOM FURNISHINGS (U.S. CLS. 100, 101 AND 102).

FIRST USE 5-17-2005; IN COMMERCE 5-17-2005.

MARTHA FROMM, EXAMINING ATTORNEY

CLASS 35—(Continued).

SN 77-196,519. RIDEMAKERZ, LLC, FALLS CHURCH, VA. FILED 6-4-2007.

DO-IT-YOURSELF-TOGETHER

THE MARK CONSISTS OF STANDARD CHARACTERS WITHOUT CLAIM TO ANY PARTICULAR FONT, STYLE, SIZE, OR COLOR.

FOR RETAIL STORE SERVICES AND COMPUTERIZED ON-LINE RETAIL STORE SERVICES IN THE FIELDS OF TOY VEHICLES, PARTS, AND ACCESSORIES THEREFOR (U.S. CLS. 100, 101 AND 102).

BILL DAWE, EXAMINING ATTORNEY

SN 77-196,533. RIDEMAKERZ, LLC, FALLS CHURCH, VA. FILED 6-4-2007.

YOU ARE THE STEERING COMMITTEE

THE MARK CONSISTS OF STANDARD CHARACTERS WITHOUT CLAIM TO ANY PARTICULAR FONT, STYLE, SIZE, OR COLOR.

FOR RETAIL STORE SERVICES AND COMPUTERIZED ON-LINE RETAIL STORE SERVICES IN THE FIELDS OF TOY VEHICLES, PARTS, AND ACCESSORIES THEREFOR (U.S. CLS. 100, 101 AND 102).

BILL DAWE, EXAMINING ATTORNEY

SN 77-196,543. CITI TRENDS, INC., SAVANNAH, GA. FILED 6-4-2007.

CITI TRENDZ

THE MARK CONSISTS OF STANDARD CHARACTERS WITHOUT CLAIM TO ANY PARTICULAR FONT, STYLE, SIZE, OR COLOR.

OWNER OF U.S. REG. NOS. 2,621,881, 2,625,829 AND 2,860,305.

FOR ON-LINE RETAIL STORE SERVICES FEATURING CLOTHING AND CLOTHING ACCESSORIES; RETAIL DEPARTMENT STORES (U.S. CLS. 100, 101 AND 102).

STEVEN R. FOSTER, EXAMINING ATTORNEY

CLASS 35—(Continued).

SN 77-196,546. CITI TRENDS, INC., SAVANNAH, GA. FILED 6-4-2007.



OWNER OF U.S. REG. NOS. 2,621,881, 2,625,829 AND 2,860,305.

THE COLOR(S) TEAL AND YELLOW IS/ARE CLAIMED AS A FEATURE OF THE MARK.

THE DOT IN THE FIRST "I" IN THE WORD "CITI" HAS A YELLOW INTERIOR WITH A TEAL BORDER. THE REMAINDER OF THE STYLIZED LETTERING FORMING THE WORDS "CITI TRENDS" IS IN TEAL.

FOR ON-LINE RETAIL STORE SERVICES FEATURING CLOTHING AND CLOTHING ACCESSORIES (U.S. CLS. 100, 101 AND 102).

FIRST USE 2-1-2001; IN COMMERCE 2-1-2001. STEVEN R. FOSTER, EXAMINING ATTORNEY

SN 77-207,023. TAYLOR, CATHY L., WHITE PLAINS, NY. FILED 6-15-2007.

Bea Starr

THE MARK CONSISTS OF STANDARD CHARACTERS WITHOUT CLAIM TO ANY PARTICULAR FONT, STYLE, SIZE, OR COLOR.

THE NAME BEA STARR DOES NOT IDENTIFY A LIVING INDIVIDUAL.

FOR RETAIL STORE SERVICES AND RETAIL STORE SERVICES AVAILABLE VIA A GLOBAL COMPUTER NETWORK FEATURING GIRLS' FASHION ACCESSORIES AND CLOTHING, COSTUME JEWELRY, HOME FURNISHINGS AND HOUSEHOLD DECORATIVE PRODUCTS, PICTURE FRAMING MATERIALS, PHOTO ALBUMS, JOURNALS, DIARIES, HOBBY AND ART SUPPLIES, STATIONARY ITEMS, MUSIC, GAMES, BOOKS AND VIDEOS (U.S. CLS. 100, 101 AND 102).

AHSEN KHAN, EXAMINING ATTORNEY

SN 77-212,028. BAY N BAY, INC., BELL, CA. FILED 6-21-2007.

BAY N BAY

THE MARK CONSISTS OF STANDARD CHARACTERS WITHOUT CLAIM TO ANY PARTICULAR FONT, STYLE, SIZE, OR COLOR.

FOR DISTRIBUTORSHIP SERVICES IN THE FIELD OF CLOTHING; GOODS IMPORT-EXPORT AGENCY IN THE FIELD OF CLOTHING; WHOLESALE DISTRIBUTORSHIPS AND ORDERING SERVICES IN THE FIELD OF CLOTHING (U.S. CLS. 100, 101 AND 102).

FIRST USE 6-10-2006; IN COMMERCE 6-10-2006. MARK SPARACINO, EXAMINING ATTORNEY

CLASS 35—(Continued).

SN 77-212,232. IN A NUTSHELL, INC., SAN LEANDRO, CA. FILED 6-21-2007.

IN A NUTSHELL

THE MARK CONSISTS OF STANDARD CHARACTERS WITHOUT CLAIM TO ANY PARTICULAR FONT, STYLE, SIZE, OR COLOR.

FOR WHOLESALE DISTRIBUTORSHIPS FEATURING NUTS, SPICES, HERBS, SALTS, FRUITS, GRAINS, LEGUMES, CHOCOLATE, FOOD LEAVENING AGENTS, FOOD FLAVORING, SWEETENERS, AND COOKING SPRAY (U.S. CLS. 100, 101 AND 102).

FIRST USE 10-1-1989; IN COMMERCE 10-1-1989.
LEE-ANNE BERNS, EXAMINING ATTORNEY

SN 77-213,611. UNITED AUCTION, L.L.P., SADDLE BROOK, NJ. FILED 6-22-2007.



NO CLAIM IS MADE TO THE EXCLUSIVE RIGHT TO USE "LLP", "AUCTION", "LIQUIDATORS", "APPRAISERS" AND "AUCTIONEERS", APART FROM THE MARK AS SHOWN.

THE COLOR(S) BLUE, BLACK, AND WHITE IS/ARE CLAIMED AS A FEATURE OF THE MARK.

THE MARK CONSISTS OF DARK BLUE LETTER "U" INTERSECTING AT THE LOWER RIGHT SIDE WITH A LIGHTER BLUE LETTER "A". THE AREA OF INTERSECTION AND OVERLAP IS WHITE. WHITE LETTERS "L.L.P." AT THE BOTTOM OF THE RIGHT LEG OF THE "A". THE WORDS "UNITED AUCTION" IN BLACK NEXT TO THE LETTERS, WITH A FOUR-POINT BLUE RULE BENEATH IT AND OVER THE PHRASE "LIQUIDATORS, APPRAISERS AND AUCTIONEERS" IN BLACK.

FOR ARRANGING AND CONDUCTION OF AUCTION SALES; AUCTION MANAGEMENT SERVICES PROVIDED TO OTHERS OVER AN ON-LINE WEB SITE ACCESSED THROUGH A GLOBAL COMPUTER NETWORK; AUCTIONEERING; AUCTIONING VIA TELECOMMUNICATION NETWORKS; BUSINESS MANAGEMENT ASSISTANCE AND PARTICULARLY CARRYING OUT TASKS NECESSARY FOR THE SMOOTH CONDUCT OF SALES BY AUCTION; INDUSTRIAL ASSET MANAGEMENT SERVICES, NAMELY, AUCTIONING, LIQUIDATING AND REMARKETING INDUSTRIAL ASSETS OF OTHERS; ON-LINE CONSIGNMENT SERVICES WHEREBY GOODS ARE RECEIVED ON CONSIGNMENT FOR AUCTION ON AN ONLINE AUCTION SITE; ON-LINE TRADING SERVICES IN WHICH SELLER POSTS PRODUCTS TO BE AUCTIONED AND BIDDING IS DONE VIA THE INTERNET; ONLINE AUCTION SERVICES; ORGANISATION OF INTERNET AUCTIONS (U.S. CLS. 100, 101 AND 102).

FIRST USE 1-1-1999; IN COMMERCE 1-1-1999.
RUDY R. SINGLETON, EXAMINING ATTORNEY

CLASS 35—(Continued).

SN 77-214,929. CENRGY, LLC, WASHINGTON, DC. FILED 6-25-2007.



THE COLOR(S) BLUE AND WHITE IS/ARE CLAIMED AS A FEATURE OF THE MARK.

THE MARK CONSISTS OF STYLIZED LETTERS "C", "E", "N", "R", "G" AND "Y". THE LETTERS "C", "E", "R", "G" AND "Y" ARE BLUE WITH A HORIZONTAL WHITE LINE THROUGH THE MIDDLE, STARTING AT THE MIDDLE OF THE LEFT LINE OF THE LETTER "N" THERE IS A VERTICAL WHITE LINE ON THE UPPER LEFT TIP, STARTING AT THE MIDDLE OF THE LETTER "N" ON THE RIGHT LINE, THERE IS A VERTICAL WHITE LINE ON THE LOWER RIGHT TIP OF THE RIGHT LINE OF THE LETTER "N" AND A WHITE DIAGONAL LINE THROUGH THE MIDDLE PORTION OF THE LETTER "N". THE BORDER OF THE WHITE LINE IS BLUE. THE REST OF THE LETTER "N" IS BLUE. THE WORDS SYNCHRONIZING LIFE TO A HEALTHY BEAT ARE IN BLUE.

FOR PROVIDING ASSISTANCE, FITNESS EVALUATION AND CONSULTATION TO CORPORATE CLIENTS TO HELP THEIR EMPLOYEES MAKE HEALTH, WELLNESS AND NUTRITIONAL CHANGES IN THEIR DAILY LIVING TO INCREASE PRODUCTIVITY AND LOWER HEALTH CARE COSTS (U.S. CLS. 100, 101 AND 102).

FIRST USE 6-10-2007; IN COMMERCE 6-15-2007.
YAT SYE, LEE, EXAMINING ATTORNEY

SN 77-215,408. GARDNER, PAUL W., II, BALTIMORE, MD. FILED 6-26-2007.



NO CLAIM IS MADE TO THE EXCLUSIVE RIGHT TO USE "CORPORATE AND ENTERTAINMENT LAW GROUP", APART FROM THE MARK AS SHOWN.

THE COLOR(S) BLUE, BLACK AND GRAY IS/ARE CLAIMED AS A FEATURE OF THE MARK.

THE COLOR BLACK APPEARS IN THE WORDING "GARDNER". THE COLOR GREY APPEARS IN THE WORDING "CORPORATE & ENTERTAINMENT LAW GROUP" AND IN THE DESIGN TO THE LEFT OF THIS WORDING. THE COLOR BLUE APPEARS IN THE DESIGN TO THE FAR LEFT OF THE WORDING AND IN THE DESIGN OVER THE WORDING "GARDNER".

FOR ADVERTISING AND PROMOTING LEGAL SERVICES (U.S. CLS. 100, 101 AND 102).

DOMINIC J. FERRAIUOLO, EXAMINING ATTORNEY

CLASS 35—(Continued).

SN 77-215,491. ZUMIEZ INC., EVERETT, WA. FILED 6-26-2007.

100K

THE MARK CONSISTS OF STANDARD CHARACTERS WITHOUT CLAIM TO ANY PARTICULAR FONT, STYLE, SIZE, OR COLOR.

FOR CONDUCTING EMPLOYEE INCENTIVE AWARD PROGRAMS TO PROMOTE THE ACHIEVEMENT OF SALES QUOTAS, PRODUCTIVITY, HIGH MORALE AND CUSTOMER RELATIONS (U.S. CLS. 100, 101 AND 102).

ROSELLE HERRERA, EXAMINING ATTORNEY

SN 77-217,145. HOUSE OF PLANTS FLORIST, INC., AKRON, OH. FILED 6-27-2007.

HOUSE OF PLANTS

THE MARK CONSISTS OF STANDARD CHARACTERS WITHOUT CLAIM TO ANY PARTICULAR FONT, STYLE, SIZE, OR COLOR.

NO CLAIM IS MADE TO THE EXCLUSIVE RIGHT TO USE "PLANTS", APART FROM THE MARK AS SHOWN.

FOR RETAIL FLORIST SHOP SERVICES (U.S. CLS. 100, 101 AND 102).

FIRST USE 6-1-1974; IN COMMERCE 6-1-1974.
TIMOTHY FINNEGAN, EXAMINING ATTORNEY

SN 77-217,621. PAWS & REMEMBER LLC, BROADVIEW, IL. FILED 6-28-2007.

PAWS & REMEMBER

THE MARK CONSISTS OF STANDARD CHARACTERS WITHOUT CLAIM TO ANY PARTICULAR FONT, STYLE, SIZE, OR COLOR.

OWNER OF U.S. REG. NOS. 3,341,295 AND 3,363,306.
FOR FRANCHISE SERVICES, NAMELY, OFFERING TECHNICAL AND BUSINESS MANAGEMENT ASSISTANCE IN THE ESTABLISHMENT AND/OR OPERATION OF BUSINESSES PROVIDING PET CREMATION SERVICES AND RELATED FUNERARY AND MEMORIALIZATION PRODUCTS FOR PETS (U.S. CLS. 100, 101 AND 102).

PAULA MAYS, EXAMINING ATTORNEY

CLASS 35—(Continued).

SN 77-217,786. ZUMIEZ INC., EVERETT, WA. FILED 6-28-2007.

ZUMIEZ 100K

THE MARK CONSISTS OF STANDARD CHARACTERS WITHOUT CLAIM TO ANY PARTICULAR FONT, STYLE, SIZE, OR COLOR.

FOR CONDUCTING EMPLOYEE INCENTIVE AWARD PROGRAMS TO PROMOTE THE ACHIEVEMENT OF SALES QUOTAS, PRODUCTIVITY, HIGH MORALE AND CUSTOMER RELATIONS (U.S. CLS. 100, 101 AND 102).

FIRST USE 0-0-1988; IN COMMERCE 0-0-1993.
ROSELLE HERRERA, EXAMINING ATTORNEY

SN 77-219,983. OJEFUA,EHIMARE I, BROOKLYN, NY. FILED 7-1-2007.



FOR CATALOG ORDERING SERVICE FEATURING CLOTHING; DISCOUNT STORES IN THE FIELD OF WOMEN'S CLOTHING, MEN'S CLOTHING, INFANT CLOTHING, TODDLER CLOTHING; DISTRIBUTORSHIPS IN THE FIELD OF CLOTHING; MAIL ORDER CATALOG SERVICES FEATURING CLOTHING; MAIL ORDER SERVICES FEATURING CLOTHING; ONLINE RETAIL CONSIGNMENT STORES FEATURING CLOTHING; RETAIL CLOTHING BOUTIQUES; RETAIL CLOTHING STORES; RETAIL CONSIGNMENT STORES FEATURING CLOTHING; RETAIL CONSIGNMENT STORES IN THE FIELD OF CLOTHING; RETAIL DISCOUNT STORE SERVICES IN THE FIELD OF CLOTHING; RETAIL STORES FEATURING CLOTHING; RETAIL CLOTHING STORES; SECOND HAND DEALERSHIPS FEATURING CLOTHING; WHOLESALE DISTRIBUTORSHIPS FEATURING CLOTHING; WHOLESALE STORES FEATURING CLOTHING (U.S. CLS. 100, 101 AND 102).

ELI HELLMAN, EXAMINING ATTORNEY

CLASS 35—(Continued).

SN 77-221,174. ADVANCED TECHNOLOGIES GROUP, INC., LOMBARD, IL. FILED 7-3-2007.

ADVANCED TECHNOLOGIES GROUP

THE MARK CONSISTS OF STANDARD CHARACTERS WITHOUT CLAIM TO ANY PARTICULAR FONT, STYLE, SIZE, OR COLOR.

SEC. 2(F).

FOR BUSINESS INFORMATION MANAGEMENT CONSULTING SERVICES, NAMELY, COMBINING EXPERIENCE IN FACILITY MANAGEMENT, PLANNING AND INFORMATION TECHNOLOGY TO HELP ORGANIZATIONS MAKE BETTER USE OF HIGHLY VALUABLE FACILITY AND REAL ESTATE INFORMATION (U.S. CLS. 100, 101 AND 102).

FIRST USE 4-4-1988; IN COMMERCE 4-4-1988.

Laura KOVALSKY, EXAMINING ATTORNEY

SN 77-223,041. THERMOTEK LLC, SPOKANE, WA. FILED 7-5-2007.

ENERGY DOCTORS

THE MARK CONSISTS OF STANDARD CHARACTERS WITHOUT CLAIM TO ANY PARTICULAR FONT, STYLE, SIZE, OR COLOR.

NO CLAIM IS MADE TO THE EXCLUSIVE RIGHT TO USE "ENERGY", APART FROM THE MARK AS SHOWN.

FOR ENERGY AUDITING (U.S. CLS. 100, 101 AND 102).

FIRST USE 5-1-2006; IN COMMERCE 5-1-2006.

Russ HERMAN, EXAMINING ATTORNEY

SN 77-223,960. RIVERWOODS MILL, INC., ST. GEORGE, UT. FILED 7-6-2007.

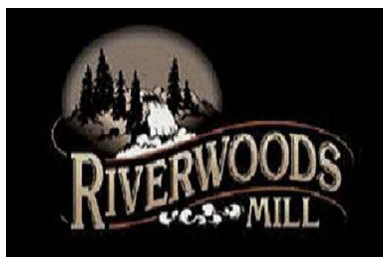

THE COLOR(S) BLACK, WHITE, BROWN AND TAN IS/ ARE CLAIMED AS A FEATURE OF THE MARK.

"THE COLOR BLACK APPEARS IN THE TREES, ACCENTS ON THE HILL DESIGN, OUTLINING ON THE

CLASS 35—(Continued).

WATERFALL DESIGN AND THE OVERALL BACKGROUND: THE COLOR WHITE APPEARS IN THE WATERFALL DESIGN AND THE FLORAL DESIGN UNDER THE TERM RIVERWOODS AND TO THE LEFT OF THE TERM MILL; THE COLOR BROWN APPEARS AS THE BACKGROUND DIRECTLY BEHIND THE TREES, WATERFALL AND HILL DESIGN AND IN THE HILL DESIGN ITSELF AND THE UNDERLINING AND OVERLINING SURROUNDING THE TERM RIVERWOODS; THE COLOR TAN APPEARS IN THE TERMS RIVERWOODS AND MILL."

FOR RETAIL STORE SERVICES FEATURING HOUSEHOLD APPLIANCES, HARDWARE, AND WOOD WINDOWS (U.S. CLS. 100, 101 AND 102).

FIRST USE 1-1-2002; IN COMMERCE 1-1-2002.

RICHARD WHITE, EXAMINING ATTORNEY

SN 77-226,006. IMPACT GROUP TRANSITIONS, LLC, ST. LOUIS, MO. FILED 7-10-2007.

Talent Alliance

THE MARK CONSISTS OF STANDARD CHARACTERS WITHOUT CLAIM TO ANY PARTICULAR FONT, STYLE, SIZE, OR COLOR.

OWNER OF U.S. REG. NO. 2,383,516.

NO CLAIM IS MADE TO THE EXCLUSIVE RIGHT TO USE ALLIANCE, APART FROM THE MARK AS SHOWN.

SEC. 2(F).

FOR EMPLOYMENT HIRING, RECRUITING, PLACEMENT, STAFFING AND CAREER NETWORKING SERVICES (U.S. CLS. 100, 101 AND 102).

FIRST USE 1-1-1997; IN COMMERCE 1-1-1997.

STEVEN JACKSON, EXAMINING ATTORNEY

SN 77-226,546. THE RUMPF CORPORATION, TOLEDO, OH. FILED 7-11-2007.

JOB1EXCHANGE

THE MARK CONSISTS OF STANDARD CHARACTERS WITHOUT CLAIM TO ANY PARTICULAR FONT, STYLE, SIZE, OR COLOR.

FOR EMPLOYMENT PLACEMENT SERVICES FOR EMPLOYERS AND PROSPECTIVE EMPLOYEES; TEMPORARY EMPLOYMENT PLACEMENT SERVICES FOR EMPLOYERS AND PROSPECTIVE EMPLOYEES; EMPLOYMENT COUNSELING AND RECRUITING; PERSONNEL MANAGEMENT AND PERSONNEL MANAGEMENT CONSULTATION SERVICES; EMPLOYEE LEASING SERVICES; EMPLOYMENT AGENCY SERVICES, NAMELY, RECRUITING, INTERVIEWING, PLACING, COORDINATING AND SUPERVISING PERSONNEL BEING PROVIDED UNDER CONTRACT OR LONG TERM LEASE (U.S. CLS. 100, 101 AND 102).

RICHARD WHITE, EXAMINING ATTORNEY

CLASS 35—(Continued).

SN 77-228,559. SOCIETY FOR MAINTENANCE AND RELIABILITY PROFESSIONALS, MCLEAN, VA. FILED 7-12-2007.

SOCIETY FOR MAINTENANCE
AND RELIABILITY
PROFESSIONALS

THE MARK CONSISTS OF STANDARD CHARACTERS WITHOUT CLAIM TO ANY PARTICULAR FONT, STYLE, SIZE, OR COLOR.

OWNER OF U.S. REG. NOS. 1,985,400 AND 2,985,459.

SEC. 2(F).

FOR ASSOCIATION SERVICES, NAMELY, PROMOTING THE INTERESTS OF THOSE INVOLVED WITH UPKEEP AND REPAIR OF EQUIPMENT USED IN SERVICE AND MANUFACTURING AREAS (U.S. CLS. 100, 101 AND 102).

FIRST USE 0-0-1991; IN COMMERCE 0-0-1991.

REBECCA SMITH, EXAMINING ATTORNEY

SN 77-229,001. ESTESS ROBERT W., BOSSIER CITY, LA. FILED 7-13-2007.



THE COLOR(S) WHITE, BLACK, DARK BLUE, LIGHT BLUE, GOLD, BROWN IS/ARE CLAIMED AS A FEATURE OF THE MARK.

THE MARK CONSISTS OF A GOLD RECTANGULAR BORDER OUTLINED IN BLACK, SURROUNDING A BLUE BACKGROUND DIVIDED BY A SIDEWAYS V POINTING TO THE RIGHT. THE LEFT SIDE OF THE RECTANGLE IS DARK BLUE WITH A TOP-TO-BOTTOM FADE TO LIGHT BLUE. THE RIGHT SIDE HAS A LIGHT BLUE BACKGROUND. THE LETTERS "TD" AND THE WORDING "YOUR ONLINE SOURCE FOR ALL OF YOUR SHOPPING NEEDS" ARE IN WHITE. THE WORDING "TRADERDAN" AND THE PYRAMID DESIGN ARE IN GOLD. THERE ARE SHADES OF BROWN ON THE PYRAMID GIVING THE APPEARANCE OF SHADOWS.

FOR ON-LINE RETAIL STORE SERVICES FEATURING STERLING SILVER RINGS, NECKLACES, BRACELETS AND EARRINGS INLAID WITH TURQUOISE AND SEMIPRECIOUS STONES, IMPORTED HANDMADE WOOL RUGS, BLANKETS, WALL TAPESTRIES, SERAPES, RUNNERS AND SADDLEBLANKETS ALL OF VARYING SIZES AND MAKES WITH ALL HAVING A SOUTHWESTERN, INDIAN OR WESTERN DESIGN WOVEN INTO THE MATERIAL; PROVIDING AN ON-LINE SHOWROOM FOR THE SIGNATURE GOODS OF OTHERS IN THE FIELDS OF HANDMADE POTTERY, PAINTINGS, LEATHERCRAFT, HANDMADE WOODEN FURNITURE, SADDLES, APPAREL, PLACEMATS, PURSES, DREAMCATCHERS AND LARIATS (U.S. CLS. 100, 101 AND 102).

KRISTIN DAHLING, EXAMINING ATTORNEY

CLASS 35—(Continued).

SN 77-230,550. ODESSE, INC., CHATSWORTH, CA. FILED 7-16-2007.

SUGARCASH

THE MARK CONSISTS OF STANDARD CHARACTERS WITHOUT CLAIM TO ANY PARTICULAR FONT, STYLE, SIZE, OR COLOR.

FOR MARKETING CONSULTATION IN THE FIELD OF ONLINE AFFILIATE MARKETING SERVICES; AFFILIATE MARKETING SERVICES; PROMOTING THE GOODS AND SERVICES OF OTHERS BY ARRANGING FOR THE PLACEMENT OF SPONSORS' PRODUCTS AT PERSONAL APPEARANCES BY CELEBRITIES; AFFILIATE MARKETING PROGRAM, NAMELY, PROMOTING THE GOODS AND SERVICES OF OTHERS BY PREPARING AND PLACING PROMOTIONAL ADVERTISEMENTS, BANNERS, AND GRAPHICS ON WEB SITES ACCESSED THROUGH A GLOBAL COMPUTER NETWORK; AND PROVIDING INTEGRATED TRACKING AND MANAGEMENT OF COMMERCIAL TRANSACTIONS ON A GLOBAL COMPUTER NETWORK (U.S. CLS. 100, 101 AND 102).

APRIL ROACH, EXAMINING ATTORNEY

SN 77-230,880. EVENTPRO STRATEGIES, INC., TEMPE, AZ. FILED 7-16-2007.

[eventpro strategies]

OWNER OF U.S. REG. NO. 3,079,486.

THE MARK CONSISTS OF A BRACKET CONTAINING THE WORDS "EVENTPRO STRATEGIES" IN A STYLIZED FONT.

FOR ADVERTISING, MARKETING AND PROMOTION SERVICES; ARRANGING AND CONDUCTING MARKETING AND PROMOTIONAL EVENTS FOR OTHERS; PROVIDING MARKETING AND PROMOTION OF SPECIAL EVENTS, NAMELY, PROVIDING EVENT STAFFING, EVENT LOGISTICS, EVENT EXECUTION, AND EVENT MANAGEMENT SERVICES; PROMOTIONAL MODELING AND CASTING SERVICES FOR ADVERTISING AND SALES PROMOTION; MANAGEMENT AND COMPILATION OF COMPUTERIZED DATABASES (U.S. CLS. 100, 101 AND 102).

FIRST USE 5-31-2003; IN COMMERCE 5-31-2003.

KAREN BRACEY, EXAMINING ATTORNEY

CLASS 35—(Continued).

SN 77-231,171. EVENTPRO STRATEGIES, INC., TEMPE, AZ.
FILED 7-17-2007.

EPS TALENT VAULT

THE MARK CONSISTS OF STANDARD CHARACTERS WITHOUT CLAIM TO ANY PARTICULAR FONT, STYLE, SIZE, OR COLOR.

OWNER OF U.S. REG. NO. 3,157,340.

NO CLAIM IS MADE TO THE EXCLUSIVE RIGHT TO USE "TALENT", APART FROM THE MARK AS SHOWN.

FOR ADVERTISING, MARKETING AND PROMOTION SERVICES; ARRANGING AND CONDUCTING MARKETING AND PROMOTIONAL EVENTS FOR OTHERS; PROVIDING MARKETING AND PROMOTION OF SPECIAL EVENTS, NAMELY, PROVIDING EVENT STAFFING, EVENT LOGISTICS, EVENT EXECUTION, AND EVENT MANAGEMENT SERVICES; PROMOTIONAL MODELING AND CASTING SERVICES FOR ADVERTISING AND SALES PROMOTION; MANAGEMENT AND COMPILATION OF COMPUTERIZED DATABASES (U.S. CLS. 100, 101 AND 102).

FIRST USE 5-31-2003; IN COMMERCE 5-31-2003.

KAREN BRACEY, EXAMINING ATTORNEY

CLASS 35—(Continued).

SN 77-233,438. GRAPHIC ATTACK, INC., HARBINGER, NC.
FILED 7-19-2007.

GRAPHIC ATTACK

THE MARK CONSISTS OF STANDARD CHARACTERS WITHOUT CLAIM TO ANY PARTICULAR FONT, STYLE, SIZE, OR COLOR.

NO CLAIM IS MADE TO THE EXCLUSIVE RIGHT TO USE "GRAPHIC", APART FROM THE MARK AS SHOWN.

FOR WHOLESALE ORDERING SERVICES FEATURING T-SHIRTS, STICKERS, FLAGS AND HATS WITH SILK SCREEN AND EMBROIDERED DESIGNS (U.S. CLS. 100, 101 AND 102).

FIRST USE 1-1-1992; IN COMMERCE 12-19-1994.

ELIZABETH HUGHITT, EXAMINING ATTORNEY

SN 77-233,888. EVENTPRO STRATEGIES, INC., TEMPE, AZ.
FILED 7-19-2007.

SN 77-233,012. PIEDMONT TRANSCRIPTION, INC., THOMASVILLE, NC. FILED 7-18-2007.

EPS TRACKER SYSTEM**Piedmont Transcription,
Inc.**

THE MARK CONSISTS OF STANDARD CHARACTERS WITHOUT CLAIM TO ANY PARTICULAR FONT, STYLE, SIZE, OR COLOR.

NO CLAIM IS MADE TO THE EXCLUSIVE RIGHT TO USE "TRANSCRIPTION, INC.", APART FROM THE MARK AS SHOWN.

FOR MEDICAL TRANSCRIPTION SERVICES (U.S. CLS. 100, 101 AND 102).

FIRST USE 3-23-2007; IN COMMERCE 3-23-2007.

NAKWAMA ANKRAH, EXAMINING ATTORNEY

THE MARK CONSISTS OF STANDARD CHARACTERS WITHOUT CLAIM TO ANY PARTICULAR FONT, STYLE, SIZE, OR COLOR.

OWNER OF U.S. REG. NO. 3,157,340.

NO CLAIM IS MADE TO THE EXCLUSIVE RIGHT TO USE "TRACKER SYSTEM", APART FROM THE MARK AS SHOWN.

FOR ADVERTISING, MARKETING AND PROMOTION SERVICES; ARRANGING AND CONDUCTING MARKETING AND PROMOTIONAL EVENTS FOR OTHERS; PROVIDING MARKETING AND PROMOTION OF SPECIAL EVENTS, NAMELY, PROVIDING EVENT STAFFING, EVENT LOGISTICS, EVENT EXECUTION, AND EVENT MANAGEMENT SERVICES; PROMOTIONAL MODELING AND CASTING SERVICES FOR ADVERTISING AND SALES PROMOTION; MANAGEMENT AND COMPILATION OF COMPUTERIZED DATABASES (U.S. CLS. 100, 101 AND 102).

FIRST USE 5-31-2003; IN COMMERCE 5-31-2003.

KAREN BRACEY, EXAMINING ATTORNEY

CLASS 35—(Continued).

SN 77-235,573. FINER, LAURA TAYLOR, FORT WORTH, TX. FILED 7-22-2007.



NO CLAIM IS MADE TO THE EXCLUSIVE RIGHT TO USE "FREELANCE", APART FROM THE MARK AS SHOWN.

THE MARKS CONSISTS OF THE WORDING "FINER FREELANCE" IN STYLIZED FORM, WHEREIN THE WORD "FINER" ALSO HAS THE WORD "FINER" ON THE LEFT VERTICAL PORTION OF EACH LETTER IN THE WORD "FINER".

FOR CREATIVE MARKETING DESIGN SERVICES; DESIGN OF ADVERTISING MATERIALS FOR OTHERS (U.S. CLS. 100, 101 AND 102).

FIRST USE 5-1-2007; IN COMMERCE 5-1-2007.
BRIAN PINO, EXAMINING ATTORNEY



SN 77-241,023. SPECIALTY SURGICAL INSTRUMENTATION, INC., DBA SSI, NASHVILLE, TN. FILED 7-27-2007.

YOUR SPECIALIST IN SURGERY

THE MARK CONSISTS OF STANDARD CHARACTERS WITHOUT CLAIM TO ANY PARTICULAR FONT, STYLE, SIZE, OR COLOR.

OWNER OF U.S. REG. NO. 2,678,853.
SEC. 2(F).

FOR RETAIL SERVICES BY DIRECT SOLICITATION BY SALES AGENTS, AND RETAIL MAIL ORDER CATALOG SERVICES, ALL IN THE FIELD OF MEDICAL AND SURGICAL APPARATUS AND INSTRUMENTS (U.S. CLS. 100, 101 AND 102).

FIRST USE 12-31-1980; IN COMMERCE 12-31-1980.
ELLEN B. AWRICH, EXAMINING ATTORNEY

CLASS 35—(Continued).

SN 77-243,041. 2HATS NETWORK LLC, BROOKLYN, NY. FILED 7-31-2007.



NO CLAIM IS MADE TO THE EXCLUSIVE RIGHT TO USE "NETWORK LLC", APART FROM THE MARK AS SHOWN.

THE COLOR(S) ORANGE AND BLUE IS/ARE CLAIMED AS A FEATURE OF THE MARK.

THE MARK CONSISTS OF A DESIGN OF TWO WOMEN, ONE CARRYING A BRIEFCASE AND ONE CARRYING A BABY, BOTH DEPICTED IN BLUE, AND THE WORDS "2HATS NETWORK LLC", WITH THE "2" AND THE WORDS "NETWORK LLC" DEPICTED IN BLUE AND THE WORD "HATS" DEPICTED IN ORANGE.

FOR ADVICE IN THE FIELD OF BUSINESS MANAGEMENT AND MARKETING; EMPLOYMENT HIRING, RECRUITING, PLACEMENT, STAFFING AND CAREER NETWORKING SERVICES (U.S. CLS. 100, 101 AND 102).

FIRST USE 1-15-2007; IN COMMERCE 1-15-2007.
DEIRDRE ROBERTSON, EXAMINING ATTORNEY



SN 77-243,066. 2HATS NETWORK LLC, BROOKLYN, NY. FILED 7-31-2007.

2Hats

THE MARK CONSISTS OF STANDARD CHARACTERS WITHOUT CLAIM TO ANY PARTICULAR FONT, STYLE, SIZE, OR COLOR.

FOR ADVICE IN THE FIELD OF BUSINESS MANAGEMENT AND MARKETING; EMPLOYMENT HIRING, RECRUITING, PLACEMENT, STAFFING AND CAREER NETWORKING SERVICES (U.S. CLS. 100, 101 AND 102).

FIRST USE 1-15-2007; IN COMMERCE 1-15-2007.
DEIRDRE ROBERTSON, EXAMINING ATTORNEY

CLASS 35—(Continued).

SN 77-244,039. CELGENE CORPORATION, SUMMIT, NJ.
FILED 8-1-2007.

CELGENE

THE MARK CONSISTS OF STANDARD CHARACTERS WITHOUT CLAIM TO ANY PARTICULAR FONT, STYLE, SIZE, OR COLOR.

OWNER OF U.S. REG. NOS. 2,888,517, 3,150,915 AND OTHERS.

FOR ADMINISTRATION OF PATIENT REIMBURSEMENT PROGRAMS; ADMINISTERING PHARMACY REIMBURSEMENT PROGRAMS AND SERVICES (U.S. CLS. 100, 101 AND 102).

FIRST USE 1-1-2006; IN COMMERCE 1-1-2006.

KATHRYN COWARD, EXAMINING ATTORNEY

SN 77-245,370. FORTE CEO SERVICES, INC., NORTH-BROOK, IL. FILED 8-2-2007.

FORTECEO GROUP

THE MARK CONSISTS OF STANDARD CHARACTERS WITHOUT CLAIM TO ANY PARTICULAR FONT, STYLE, SIZE, OR COLOR.

NO CLAIM IS MADE TO THE EXCLUSIVE RIGHT TO USE "GROUP", APART FROM THE MARK AS SHOWN.

FOR BUSINESS AND BUSINESS MANAGEMENT CONSULTATION SERVICES AND PROVIDING MANAGEMENT PERSONNEL PLACEMENT ON AN INTERIM BASIS (U.S. CLS. 100, 101 AND 102).

FIRST USE 3-1-2005; IN COMMERCE 3-1-2005.

ASMAT KHAN, EXAMINING ATTORNEY

SN 77-246,541. ARTSINDIA.COM LLC, NEW YORK, NY.
FILED 8-3-2007.

AICON GALLERY

THE MARK CONSISTS OF STANDARD CHARACTERS WITHOUT CLAIM TO ANY PARTICULAR FONT, STYLE, SIZE, OR COLOR.

NO CLAIM IS MADE TO THE EXCLUSIVE RIGHT TO USE "GALLERY", APART FROM THE MARK AS SHOWN.

FOR ART GALLERIES (U.S. CLS. 100, 101 AND 102).

FIRST USE 2-23-2007; IN COMMERCE 2-23-2007.

ZHALEH DELANEY, EXAMINING ATTORNEY

CLASS 35—(Continued).

SN 77-246,600. ARTSINDIA.COM LLC, NEW YORK, NY.
FILED 8-3-2007.



The logo for Aicon Gallery features the word "aicon" in a lowercase, sans-serif font, followed by "gallery" in a similar font. A small, stylized brushstroke element is positioned above the letter "i" in "aicon".

NO CLAIM IS MADE TO THE EXCLUSIVE RIGHT TO USE "GALLERY", APART FROM THE MARK AS SHOWN.

THE MARK CONSISTS OF THE WORDS "AICON GALLERY" WITH A BRUSHSTROKE ELEMENT OVER THE "I".

FOR ART GALLERIES (U.S. CLS. 100, 101 AND 102).

FIRST USE 2-23-2007; IN COMMERCE 2-23-2007.

ZHALEH DELANEY, EXAMINING ATTORNEY

SN 77-247,277. MARTIN PERLMUTTER, TIBURON, CA.
FILED 8-4-2007.

VIDEOVITA

THE MARK CONSISTS OF STANDARD CHARACTERS WITHOUT CLAIM TO ANY PARTICULAR FONT, STYLE, SIZE, OR COLOR.

THE WORDING IN THE MARK HAS NO MEANING IN A FOREIGN LANGUAGE.

FOR EMPLOYMENT SERVICES, NAMELY, PROVIDING ON-LINE RESUME AND ON-LINE VIDEO RESUME PRODUCTION AND PUBLICATION SERVICES (U.S. CLS. 100, 101 AND 102).

DAYNA BROWNE, EXAMINING ATTORNEY

SN 77-250,070. INFOUSA INC., OMAHA, NE. FILED 8-8-2007.

YESMAIL EXPRESS

THE MARK CONSISTS OF STANDARD CHARACTERS WITHOUT CLAIM TO ANY PARTICULAR FONT, STYLE, SIZE, OR COLOR.

OWNER OF U.S. REG. NOS. 2,416,913, 2,548,743 AND 2,799,195.

NO CLAIM IS MADE TO THE EXCLUSIVE RIGHT TO USE "EXPRESS", APART FROM THE MARK AS SHOWN.

FOR ONLINE MARKETING SERVICES, NAMELY, DISSEMINATION OF ADVERTISING FOR OTHERS VIA A GLOBAL COMPUTER NETWORK AND VIA ELECTRONIC MAIL OVER A GLOBAL COMPUTER NETWORK (U.S. CLS. 100, 101 AND 102).

FIRST USE 1-0-2007; IN COMMERCE 1-0-2007.

JENNIFER MARTIN, EXAMINING ATTORNEY

CLASS 35—(Continued).

SN 77-250,127. INFOUSA INC., OMAHA, NE. FILED 8-8-2007.

YESMAIL ENTERPRISE

THE MARK CONSISTS OF STANDARD CHARACTERS WITHOUT CLAIM TO ANY PARTICULAR FONT, STYLE, SIZE, OR COLOR.

OWNER OF U.S. REG. NOS. 2,416,913, 2,548,743 AND 2,799,195.

NO CLAIM IS MADE TO THE EXCLUSIVE RIGHT TO USE "ENTERPRISE", APART FROM THE MARK AS SHOWN.

FOR ONLINE MARKETING SERVICES, NAMELY, DISSEMINATION OF ADVERTISING FOR OTHERS VIA A GLOBAL COMPUTER NETWORK AND VIA ELECTRONIC MAIL OVER A GLOBAL COMPUTER NETWORK (U.S. CLS. 100, 101 AND 102).

FIRST USE 6-0-2006; IN COMMERCE 6-0-2006.
JENNIFER MARTIN, EXAMINING ATTORNEY

SN 77-251,745. PERFORMSTER.COM, INC., SPRINGFIELD, VA. FILED 8-9-2007.

Upload your potential

THE MARK CONSISTS OF STANDARD CHARACTERS WITHOUT CLAIM TO ANY PARTICULAR FONT, STYLE, SIZE, OR COLOR.

FOR ONLINE BUSINESS NETWORKING SERVICES (U.S. CLS. 100, 101 AND 102).

FIRST USE 1-1-2007; IN COMMERCE 1-1-2007.
FLORENTINA BLANDU, EXAMINING ATTORNEY

SN 77-252,655. CHS LIFE LIMITED LIABILITY COMPANY, BRANFORD, CT. FILED 8-10-2007.

CHS Life

THE MARK CONSISTS OF STANDARD CHARACTERS WITHOUT CLAIM TO ANY PARTICULAR FONT, STYLE, SIZE, OR COLOR.

THE LETTERS "CHS" OR THE WORDING "LIFE" HAS NO MEANING OTHER THAN TRADEMARK SIGNIFICANCE.

FOR CONSULTING SERVICES IN THE COST AND PAYMENT MANAGEMENT OF HEALTH CARE (U.S. CLS. 100, 101 AND 102).

FIRST USE 5-9-2005; IN COMMERCE 5-9-2005.
WON TEAK OH, EXAMINING ATTORNEY

CLASS 35—(Continued).

SN 77-253,698. LIFT MEDIA, INC., SAN FRANCISCO, CA. FILED 8-13-2007.

LIFT MEDIA

THE MARK CONSISTS OF STANDARD CHARACTERS WITHOUT CLAIM TO ANY PARTICULAR FONT, STYLE, SIZE, OR COLOR.

NO CLAIM IS MADE TO THE EXCLUSIVE RIGHT TO USE "MEDIA", APART FROM THE MARK AS SHOWN.

FOR ADVERTISING SERVICES, NAMELY, PROMOTING AND MARKETING THE GOODS AND SERVICES OF OTHERS THROUGH THE INTERNET (U.S. CLS. 100, 101 AND 102).

FIRST USE 9-13-2006; IN COMMERCE 9-13-2006.
VIVIAN MICZNIK FIRST, EXAMINING ATTORNEY

SN 77-255,181. RIGHT PATH MARKETING LLC, HOUSTON, TX. FILED 8-14-2007.

ROBOTIC MARKETING

THE MARK CONSISTS OF STANDARD CHARACTERS WITHOUT CLAIM TO ANY PARTICULAR FONT, STYLE, SIZE, OR COLOR.

NO CLAIM IS MADE TO THE EXCLUSIVE RIGHT TO USE "MARKETING", APART FROM THE MARK AS SHOWN.

FOR MARKETING SERVICES, NAMELY, PROMOTING OR ADVERTISING THE GOODS AND SERVICES OF OTHERS (U.S. CLS. 100, 101 AND 102).

FIRST USE 6-1-2006; IN COMMERCE 6-1-2006.
JESSICA A. POWERS, EXAMINING ATTORNEY

SN 77-255,706. HALL, JULIA, NEW PORT RICHEY, FL. FILED 8-15-2007.

CMYK PRINT SOLUTIONS

THE MARK CONSISTS OF STANDARD CHARACTERS WITHOUT CLAIM TO ANY PARTICULAR FONT, STYLE, SIZE, OR COLOR.

NO CLAIM IS MADE TO THE EXCLUSIVE RIGHT TO USE "CMYK PRINT", APART FROM THE MARK AS SHOWN.

FOR INDEPENDENT SALES REPRESENTATIVES IN THE FIELD OF WEB OFFSET AND SHEETFED PRINTING (U.S. CLS. 100, 101 AND 102).

FIRST USE 5-12-2007; IN COMMERCE 5-15-2007.
NAKIA HENRY, EXAMINING ATTORNEY

CLASS 35—(Continued).

SN 77-256,032. NEW UNDERSTANDINGS AWAKEN WORLDWIDE, LLC, WILMINGTON, DE. FILED 8-15-2007.

**NUAW NEW UNDERSTANDINGS
AWAKEN WITHIN**

THE MARK CONSISTS OF STANDARD CHARACTERS WITHOUT CLAIM TO ANY PARTICULAR FONT, STYLE, SIZE, OR COLOR.

FOR ON-LINE RETAIL STORE SERVICES FEATURING JEWELRY, NAMELY, RINGS, BRACELETS, AND PINS; ON-LINE RETAIL STORE SERVICES FEATURING CLOTHING AND APPAREL, NAMELY, SHIRTS, T-SHIRTS, BLOUSES AND TOPS, SWEATERS, JACKETS, SWEATSHIRTS, PULLOVERS, COATS, DRESSES, SKIRTS, TROUSERS, PANTS, JEANS, SWEATPANTS, SHORTS, SWIMWEAR, UNDERWEAR, SLEEPWEAR, HOSIERY; ON-LINE RETAIL STORE SERVICES FEATURING HEADGEAR, NAMELY, HATS, CAPS, VISORS; ON-LINE RETAIL STORE SERVICES FEATURING ACCESSORIES, NAMELY, BELTS, TIES, NECKTIES, SCARVES AND GLOVES; ON-LINE RETAIL STORE SERVICES FEATURING FOOTWEAR, NAMELY, SOCKS, SHOES, BOOTS, SANDALS, SLIDES, THONGS AND SLIPPERS; ON-LINE RETAIL STORE SERVICES FEATURING EDUCATIONAL PUBLICATIONS, NAMELY, TRAINING MANUALS AND BOOKS IN THE FIELD OF SELF AWARENESS, SPIRITUALITY, SELF-HELP AND PERSONAL EMPOWERMENT SUBJECT MATTERS (U.S. CLS. 100, 101 AND 102).

KYLE PEETE, EXAMINING ATTORNEY

SN 77-256,222. NEW UNDERSTANDINGS AWAKEN WORLDWIDE, LLC, WILMINGTON, DE. FILED 8-15-2007.

**NUAW NEW UNDERSTANDINGS
AWAKEN WORLDWIDE**

THE MARK CONSISTS OF STANDARD CHARACTERS WITHOUT CLAIM TO ANY PARTICULAR FONT, STYLE, SIZE, OR COLOR.

FOR ON-LINE RETAIL STORE SERVICES FEATURING JEWELRY, NAMELY, RINGS, BRACELETS, AND PINS; ON-LINE RETAIL STORE SERVICES FEATURING CLOTHING AND APPAREL, NAMELY, SHIRTS, T-SHIRTS, BLOUSES AND TOPS, SWEATERS, JACKETS, SWEATSHIRTS, PULLOVERS, COATS, DRESSES, SKIRTS, TROUSERS, PANTS, JEANS, SWEATPANTS, SHORTS, SWIMWEAR, UNDERWEAR, SLEEPWEAR, HOSIERY; ON-LINE RETAIL STORE SERVICES FEATURING HEADGEAR, NAMELY, HATS, CAPS, VISORS; ON-LINE RETAIL STORE SERVICES FEATURING ACCESSORIES, NAMELY, BELTS, TIES, NECKTIES, SCARVES AND GLOVES; ON-LINE RETAIL STORE SERVICES FEATURING FOOTWEAR, NAMELY, SOCKS, SHOES, BOOTS, SANDALS, SLIDES, THONGS AND SLIPPERS; ON-LINE RETAIL STORE SERVICES FEATURING EDUCATIONAL PUBLICATIONS, NAMELY, TRAINING MANUALS AND BOOKS IN THE FIELD OF SELF AWARENESS, SPIRITUALITY, SELF-HELP AND PERSONAL EMPOWERMENT SUBJECT MATTERS (U.S. CLS. 100, 101 AND 102).

KYLE PEETE, EXAMINING ATTORNEY

CLASS 35—(Continued).

SN 77-257,033. COMMON SENSE ISSUES, INC., CINCINNATI, OH. FILED 8-16-2007.

COMMON SENSE ISSUES

THE MARK CONSISTS OF STANDARD CHARACTERS WITHOUT CLAIM TO ANY PARTICULAR FONT, STYLE, SIZE, OR COLOR.

NO CLAIM IS MADE TO THE EXCLUSIVE RIGHT TO USE "ISSUES", APART FROM THE MARK AS SHOWN.

FOR PROMOTING PUBLIC AWARENESS OF ISSUES IN THE FIELD OF POLITICS AND PUBLIC POLICY (U.S. CLS. 100, 101 AND 102).

CIMMERIAN COLEMAN, EXAMINING ATTORNEY

SN 77-258,239. ULIANO, JOSEPH, LOS ANGELES, CA. FILED 8-17-2007.

GORGEOUSLY GREEN

THE MARK CONSISTS OF STANDARD CHARACTERS WITHOUT CLAIM TO ANY PARTICULAR FONT, STYLE, SIZE, OR COLOR.

NO CLAIM IS MADE TO THE EXCLUSIVE RIGHT TO USE "GREEN", APART FROM THE MARK AS SHOWN.

FOR (BASED ON USE IN COMMERCE) PROVIDING CONSUMER INFORMATION IN THE FIELD OF ENVIRONMENTALLY-FRIENDLY GOODS AND SERVICES (BASED ON INTENT TO USE) ON-LINE RETAIL STORE SERVICES FEATURING ENVIRONMENTALLY-FRIENDLY PRODUCTS (U.S. CLS. 100, 101 AND 102).

FIRST USE 7-1-2006; IN COMMERCE 2-1-2007.

AMY MCMENAMIN, EXAMINING ATTORNEY

SN 77-259,138. CONCEPT-LOGIC, LLC, CROWN POINT, IN. FILED 8-20-2007.

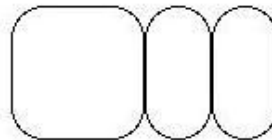

Concept-Logic, LLC

NO CLAIM IS MADE TO THE EXCLUSIVE RIGHT TO USE "LLC", APART FROM THE MARK AS SHOWN.

THE MARK CONSISTS OF THREE ROUNDED CORNER BOXES SIDE BY SIDE, THE FIRST BEING SQUARE, SECOND IS RECTANGULAR, THIRD IS ALSO RECTANGULAR.

FOR DISTRIBUTORSHIPS IN THE FIELD OF INDUSTRIAL PARTS AND MACHINERY, NAMELY, CONVEYOR BELTS, AIR COMPRESSORS, AIR HOSES, DRYERS FOR THE REMOVAL OF WATER VAPOR FROM COMPRESSED AIR AND GASSES (U.S. CLS. 100, 101 AND 102).

FIRST USE 7-3-2006; IN COMMERCE 7-10-2006.

RICHARD A. STRASER, EXAMINING ATTORNEY

CLASS 35—(Continued).

SN 77-259,386. AQUENT LLC, BOSTON, MA. FILED 8-20-2007.

ELOQUENT STAFFING

THE MARK CONSISTS OF STANDARD CHARACTERS WITHOUT CLAIM TO ANY PARTICULAR FONT, STYLE, SIZE, OR COLOR.

NO CLAIM IS MADE TO THE EXCLUSIVE RIGHT TO USE "STAFFING", APART FROM THE MARK AS SHOWN.

FOR EMPLOYMENT AGENCIES; TEMPORARY EMPLOYMENT AGENCIES; RECRUITMENT AND PLACEMENT OF COMPUTER-SKILLED PERSONNEL ON A TEMPORARY, CONTRACT, OR PERMANENT BASIS; RECRUITMENT AND PLACEMENT OF INFORMATION TECHNOLOGY SPECIALISTS ON A TEMPORARY, CONTRACT, OR PERMANENT BASIS; RECRUITMENT AND PLACEMENT OF GRAPHIC ARTISTS AND MULTI-MEDIA SPECIALISTS ON A TEMPORARY, CONTRACT, OR PERMANENT BASIS; RECRUITMENT AND PLACEMENT OF MARKETING PERSONNEL ON A TEMPORARY, CONTRACT, OR PERMANENT BASIS; PAYROLL PROCESSING SERVICES; EMPLOYMENT INFORMATION SERVICES, NAMELY, THE PROVISION OF EMPLOYMENT OPPORTUNITY INFORMATION TO PROSPECTIVE EMPLOYEES AND THE PROVISION OF RESUME INFORMATION TO PROSPECTIVE EMPLOYERS, BY MEANS OF COMPUTER, FACSIMILE, TELEPHONE, AND OTHER COMMUNICATION DEVICES (U.S. CLS. 100, 101 AND 102).

WOODROW HARTZOG, EXAMINING ATTORNEY

CLASS 35—(Continued).

SN 77-264,305. BARKER'S MORE 4 LESS, INCORPORATED, ALBANY, MN. FILED 8-25-2007.

More 4 Less

THE MARK CONSISTS OF STANDARD CHARACTERS WITHOUT CLAIM TO ANY PARTICULAR FONT, STYLE, SIZE, OR COLOR.

FOR RETAIL THRIFT STORE SERVICES FEATURING CLOTHING, PERSONAL ACCESSORIES, TOYS, BOOKS, GAMES, KITCHENWARE, ELECTRONICS, HOME DECOR ITEMS, BATHWARE, HARDWARE, PARTS FOR AUTOMOBILES AND FARM IMPLEMENTS, OUTDOOR AND CAMPING ITEMS, TOOLS, AND MUSIC CDS AND CASSETTES (U.S. CLS. 100, 101 AND 102).

FIRST USE 3-1-2005; IN COMMERCE 3-1-2005.
STEVEN R. FINE, EXAMINING ATTORNEY

SN 77-264,998. ALLERGAN, INC., IRVINE, CA. FILED 8-27-2007.

ALLERGAN PARTNER PRIVILEGES

SN 77-262,976. LIFE SCIENCE INTELLIGENCE, INC., HUNTINGTON BEACH, CA. FILED 8-23-2007.



NO CLAIM IS MADE TO THE EXCLUSIVE RIGHT TO USE "LIFE SCIENCE INTELLIGENCE", APART FROM THE MARK AS SHOWN.

FOR MARKET RESEARCH (U.S. CLS. 100, 101 AND 102).

FIRST USE 12-20-2006; IN COMMERCE 12-20-2006.
DORITT L. CARROLL, EXAMINING ATTORNEY

THE MARK CONSISTS OF STANDARD CHARACTERS WITHOUT CLAIM TO ANY PARTICULAR FONT, STYLE, SIZE, OR COLOR.

OWNER OF U.S. REG. NOS. 1,711,041, 3,129,304 AND OTHERS.

NO CLAIM IS MADE TO THE EXCLUSIVE RIGHT TO USE "PARTNER PRIVILEGES", APART FROM THE MARK AS SHOWN.

FOR PHYSICIAN INCENTIVE AWARD PROGRAM TO PROMOTE PHYSICIAN LOYALTY WHICH PROVIDES INCENTIVES AND REWARDS FOR FREQUENT PURCHASES OF AESTHETIC PRODUCTS (U.S. CLS. 100, 101 AND 102).

APRIL ROACH, EXAMINING ATTORNEY

CLASS 35—(Continued).

SN 77-266,928. BATES, ANDREE, LONDON, ENGLAND, FILED 8-29-2007.

CAMPBELL BELMAN

THE MARK CONSISTS OF STANDARD CHARACTERS WITHOUT CLAIM TO ANY PARTICULAR FONT, STYLE, SIZE, OR COLOR.

THE NAME "CAMPBELL BELMAN" DOES NOT IDENTIFY A LIVING INDIVIDUAL.

FOR ADVERTISING AND ADVERTISEMENT SERVICES; ADVERTISING, MARKETING AND PROMOTION SERVICES; ADVERTISING AND PROMOTION SERVICES AND RELATED CONSULTING; ADVERTISING CONSULTATION; CONDUCTING MARKETING STUDIES; MARKET ANALYSIS; MARKET RESEARCH CONSULTATION; MARKET RESEARCH STUDIES; PROMOTION AND MARKETING SERVICES AND RELATED CONSULTING; PROVIDING ADVERTISING, MARKETING AND PROMOTIONAL SERVICES FOR THE PHARMACEUTICAL AND MEDICAL INDUSTRY (U.S. CLS. 100, 101 AND 102).

FIRST USE 9-1-2006; IN COMMERCE 9-1-2006.
LAURA HAMMEL, EXAMINING ATTORNEY

SN 77-267,016. GLOBAL COACHING ALLIANCE, LLC, PHILADELPHIA, PA. FILED 8-29-2007.

Effortless Leadership

THE MARK CONSISTS OF STANDARD CHARACTERS WITHOUT CLAIM TO ANY PARTICULAR FONT, STYLE, SIZE, OR COLOR.

NO CLAIM IS MADE TO THE EXCLUSIVE RIGHT TO USE "LEADERSHIP", APART FROM THE MARK AS SHOWN.

FOR EDUCATION LEADERSHIP DEVELOPMENT (U.S. CLS. 100, 101 AND 102).
SCOTT SISUN, EXAMINING ATTORNEY

SN 77-267,213. NAVIGATE ADVISORS LLC, STAMFORD, CT. FILED 8-29-2007.

NAVIGATE  ADVISORS

NO CLAIM IS MADE TO THE EXCLUSIVE RIGHT TO USE "ADVISORS", APART FROM THE MARK AS SHOWN. THE COLOR(S) BLACK AND GREEN IS/ARE CLAIMED AS A FEATURE OF THE MARK.

THE MARK CONSISTS OF THE TERM "NAVIGATE ADVISORS" IN BLACK SEPARATED BY A LITTLE GREEN DIAMOND BORDERED BY TWO BLACK UP CARETS.

FOR FULL OR PARTIAL PERSONNEL OUTSOURCING (U.S. CLS. 100, 101 AND 102).
FIRST USE 3-10-2007; IN COMMERCE 3-10-2007.
DOMINIC J. FERRAIUOLO, EXAMINING ATTORNEY

CLASS 35—(Continued).

SN 77-267,921. GREATER JOHNSTOWN/CAMBRIA COUNTY CONVENTION AND VISITORS BUREAU, JOHNSTOWN, PA. FILED 8-30-2007.



NO CLAIM IS MADE TO THE EXCLUSIVE RIGHT TO USE "JOHNSTOWN PA", APART FROM THE MARK AS SHOWN.

THE MARK CONSISTS OF THE WORD "JOHNSTOWN" CENTERED INSIDE AN OVAL THAT IS ABOVE THE LETTERS "PA"; A CURVED LINE IS ABOVE A WAVE-LIKE DESIGN WHICH ARE BOTH ABOVE THE WORD "JOHNSTOWN".

FOR PROMOTING AND MARKETING BUSINESSES AND TOURISM IN THE JOHNSTOWN AND CAMBRIA COUNTY, PENNSYLVANIA AREAS (U.S. CLS. 100, 101 AND 102).

FIRST USE 4-30-2002; IN COMMERCE 4-30-2002.
ELISSA GARBER KON, EXAMINING ATTORNEY

SN 77-270,635. WGS PRODUCTIONS, LLC, BRATENAHL, OH. FILED 9-4-2007.

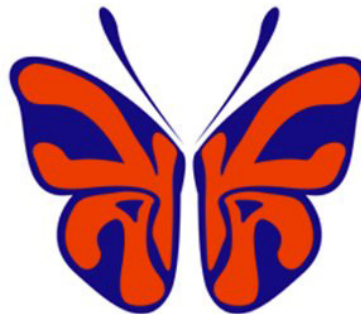

THE COLOR(S) BLUE AND RED IS/ARE CLAIMED AS A FEATURE OF THE MARK.

THE MARK CONSISTS OF A BUTTERFLY DESIGN IN BLUE WITH RED K & A LETTERS IN THE WINGS.

FOR ART GALLERIES (U.S. CLS. 100, 101 AND 102).
FIRST USE 6-1-2007; IN COMMERCE 6-1-2007.
BRENDAN MCCAULEY, EXAMINING ATTORNEY

CLASS 35—(Continued).

SN 77-270,665. THUNDERBIRD SCHOOL OF GLOBAL MANAGEMENT, GLENDALE, AZ. FILED 9-4-2007.

THUNDERBIRD ALUMNI NETWORK

THE MARK CONSISTS OF STANDARD CHARACTERS WITHOUT CLAIM TO ANY PARTICULAR FONT, STYLE, SIZE, OR COLOR.

OWNER OF U.S. REG. NOS. 2,487,077 AND 2,539,656.

NO CLAIM IS MADE TO THE EXCLUSIVE RIGHT TO USE "ALUMNI NETWORK", APART FROM THE MARK AS SHOWN.

FOR ASSOCIATION SERVICES, NAMELY, PROMOTING THE INTERESTS OF THE ALUMNI OF A GRADUATE SCHOOL IN THE FIELD OF INTERNATIONAL MANAGEMENT (U.S. CLS. 100, 101 AND 102).

FIRST USE 3-0-2007; IN COMMERCE 3-0-2007.

SARA THOMAS, EXAMINING ATTORNEY

SN 77-270,741. UR-NEW HOME LLC, CENTERLINE, MI. FILED 9-4-2007.

UR-NEW HOME

THE MARK CONSISTS OF STANDARD CHARACTERS WITHOUT CLAIM TO ANY PARTICULAR FONT, STYLE, SIZE, OR COLOR.

NO CLAIM IS MADE TO THE EXCLUSIVE RIGHT TO USE "HOME", APART FROM THE MARK AS SHOWN.

FOR REAL ESTATE SALES MANAGEMENT (U.S. CLS. 100, 101 AND 102).

MIDGE BUTLER, EXAMINING ATTORNEY

SN 77-272,778. ASSOCIATED BUILDERS AND CONTRACTORS, INC., ARLINGTON, VA. FILED 9-6-2007.

ABC PAC

THE MARK CONSISTS OF STANDARD CHARACTERS WITHOUT CLAIM TO ANY PARTICULAR FONT, STYLE, SIZE, OR COLOR.

OWNER OF U.S. REG. NOS. 2,543,909 AND 2,545,907.

NO CLAIM IS MADE TO THE EXCLUSIVE RIGHT TO USE "PAC", APART FROM THE MARK AS SHOWN.

FOR POLITICAL ACTION COMMITTEE SERVICES, NAMELY, PROMOTING THE INTERESTS OF BUILDERS AND CONTRACTORS (U.S. CLS. 100, 101 AND 102).

FIRST USE 0-0-1978; IN COMMERCE 0-0-1978.

WILLIAM ROSSMAN, EXAMINING ATTORNEY

CLASS 35—(Continued).

SN 77-274,719. DAISY-DOT LLC, VILLANOVA, PA. FILED 9-7-2007.

DAISY-DOT

THE MARK CONSISTS OF STANDARD CHARACTERS WITHOUT CLAIM TO ANY PARTICULAR FONT, STYLE, SIZE, OR COLOR.

FOR RETAIL STORE SERVICES FEATURING FASHION ACCESSORIES; RETAIL MERCHANDISING SERVICES FEATURING FASHION ACCESSORIES; ONLINE RETAIL STORE SERVICES FEATURING FASHION ACCESSORIES (U.S. CLS. 100, 101 AND 102).

ELI HELLMAN, EXAMINING ATTORNEY

SN 77-277,254. INVENTIV HEALTH, INC., SOMERSET, NJ. FILED 9-12-2007.

HEALTH PRODUCTS RESEARCH

THE MARK CONSISTS OF STANDARD CHARACTERS WITHOUT CLAIM TO ANY PARTICULAR FONT, STYLE, SIZE, OR COLOR.

NO CLAIM IS MADE TO THE EXCLUSIVE RIGHT TO USE "RESEARCH", APART FROM THE MARK AS SHOWN. SEC. 2(F).

FOR MARKETING RESEARCH AND CONSULTATION SERVICES FOR THE HEALTH CARE PRODUCTS INDUSTRY, UTILIZING COMPUTERIZED STATISTICAL AND MATHEMATICAL MODELLING (U.S. CLS. 100, 101 AND 102).

FIRST USE 8-31-1973; IN COMMERCE 8-31-1973.

ANGELA M. MICHELI, EXAMINING ATTORNEY

SN 77-277,986. FISCH, STEPHANIE, MIAMI, FL. FILED 9-12-2007.

SPIRITUALLY SLIM

THE MARK CONSISTS OF STANDARD CHARACTERS WITHOUT CLAIM TO ANY PARTICULAR FONT, STYLE, SIZE, OR COLOR.

FOR WHOLESALE DISTRIBUTORSHIPS FEATURING CANDLES, INCENSE, CLOTHING, YOGA MATS, MEDITATION CUSHIONS, CALENDARS, WATER BOTTLES, BOOKS, AUDIO TAPES, CDS, DVDS AND VIDEO TAPES; ON-LINE RETAIL STORE SERVICES FEATURING CANDLES, INCENSE, CLOTHING, YOGA MATS, MEDITATION CUSHIONS, CALENDARS, WATER BOTTLES, BOOKS, AUDIO TAPES, CDS, DVDS AND VIDEO TAPES (U.S. CLS. 100, 101 AND 102).

DOMINICK J. SALEMI, EXAMINING ATTORNEY

CLASS 35—(Continued).

SN 77-278,335. LIGHTWIND ENERGY, LLC, PALO ALTO, CA. FILED 9-12-2007.

LIGHTWIND

THE MARK CONSISTS OF STANDARD CHARACTERS WITHOUT CLAIM TO ANY PARTICULAR FONT, STYLE, SIZE, OR COLOR.

FOR PROVIDING INFORMATION IN THE FIELD OF ENERGY CONSUMPTION, COSTS, EFFICIENCY, USE MANAGEMENT, AND CONSERVATION, AND ENERGY PRODUCT SELECTION; PROVIDING INFORMATION ONLINE IN THE FIELD OF ENERGY CONSUMPTION, COSTS, EFFICIENCY, USE MANAGEMENT, AND CONSERVATION, AND ENERGY PRODUCT SELECTION (U.S. CLS. 100, 101 AND 102).

LOURDES AYALA, EXAMINING ATTORNEY

CLASS 35—(Continued).

SN 77-279,635. NOVAK, KIM, GEORGETOWN, TX. FILED 9-14-2007.



NO CLAIM IS MADE TO THE EXCLUSIVE RIGHT TO USE "COWGIRL", APART FROM THE MARK AS SHOWN. THE MARK CONSISTS OF THE WORDS "HIPPIE COWGIRL" SURROUNDED BY AN OVAL SHAPED DESIGN RESEMBLING A BELT BUCKLE.

FOR RETAIL STORE SERVICES FEATURING WOMEN'S APPAREL AND ACCESSORIES SUCH AS SHIRTS, JEANS, COWGIRL HATS, CAPS, BELTS, SHOES, FLIP FLOPS, PURSES, CELL PHONE COVERS, JEWELRY (U.S. CLS. 100, 101 AND 102).

FIRST USE 5-1-2005; IN COMMERCE 8-15-2005.

KELLY BOULTON, EXAMINING ATTORNEY

SN 77-278,450. WHITE, RITA M., HAMMOND, IN. FILED 9-13-2007.

ACTUAL STRATEGY

THE MARK CONSISTS OF STANDARD CHARACTERS WITHOUT CLAIM TO ANY PARTICULAR FONT, STYLE, SIZE, OR COLOR.

FOR DEVELOPMENT OF MARKETING STRATEGIES AND CONCEPTS (U.S. CLS. 100, 101 AND 102).

MORGAN WYNNE, EXAMINING ATTORNEY

SN 77-280,628. JEROME JACKSON, DBA ROCK CITY RECORDS, CLEVELAND, OH. FILED 9-16-2007.

ROCK CITY RECORDS

THE MARK CONSISTS OF STANDARD CHARACTERS WITHOUT CLAIM TO ANY PARTICULAR FONT, STYLE, SIZE, OR COLOR.

NO CLAIM IS MADE TO THE EXCLUSIVE RIGHT TO USE "RECORDS", APART FROM THE MARK AS SHOWN.

FOR ENTERTAINMENT MARKETING SERVICES, NAMELY, MARKETING, PROMOTION AND ADVERTISING FOR INDEPENDENT RECORDING ARTISTS (U.S. CLS. 100, 101 AND 102).

MARY CRAWFORD, EXAMINING ATTORNEY

CLASS 35—(Continued).

SN 77-281,327. H20 PARTNERS, INC., AUSTIN, TX. FILED 9-17-2007.

PATOOLSUSA

THE MARK CONSISTS OF STANDARD CHARACTERS WITHOUT CLAIM TO ANY PARTICULAR FONT, STYLE, SIZE, OR COLOR.

FOR BUSINESS MANAGEMENT CONSULTING SERVICES; BUSINESS MANAGEMENT CONSULTING SERVICES TO PERSONS AND ENTITIES REGARDING OBTAINING GOVERNMENT FINANCIAL BENEFITS, NAMELY, PUBLIC ASSISTANCE AND DISASTER RELIEF FUNDS (U.S. CLS. 100, 101 AND 102).
DAWN FELDMAN, EXAMINING ATTORNEY

SN 77-281,362. BYON, KYUNOH, BUENA PARK, CA. FILED 9-17-2007.

Berry Cool

THE MARK CONSISTS OF STANDARD CHARACTERS WITHOUT CLAIM TO ANY PARTICULAR FONT, STYLE, SIZE, OR COLOR.

NO CLAIM IS MADE TO THE EXCLUSIVE RIGHT TO USE "BERRY", APART FROM THE MARK AS SHOWN.

FOR RETAIL STORE SERVICES FEATURING FROZEN YOGURT, SMOOTHIES, GELATO, ICE CREAMS AND BLENDED DRINKS (U.S. CLS. 100, 101 AND 102).
BILL DAWE, EXAMINING ATTORNEY

SN 77-281,715. POWELL, CORY K., BROOKLYN, NY. FILED 9-17-2007.

FASHIONABLE ENT.

THE MARK CONSISTS OF STANDARD CHARACTERS WITHOUT CLAIM TO ANY PARTICULAR FONT, STYLE, SIZE, OR COLOR.

FOR DESIGN OF ADVERTISING FLYERS FOR OTHERS; BUSINESS CARD DESIGN SERVICES; ADVERTISING, MARKETING AND PROMOTION SERVICES; ADVERTISING, PROMOTION AND MARKETING SERVICES IN THE NATURE OF E-MAIL BLAST CAMPAIGNS FOR OTHERS; PROVIDING SPACE AT A WEB SITE FOR THE ADVERTISEMENT OF THE GOODS AND SERVICES OF OTHERS; ARRANGING AND CONDUCTING MARKETING PROMOTIONAL EVENTS FOR OTHERS; PROMOTING THE PARTIES AND SPECIAL EVENTS OF OTHERS; PROVIDING MARKETING AND PROMOTION OF SPECIAL EVENTS (U.S. CLS. 100, 101 AND 102).

FIRST USE 10-0-2006; IN COMMERCE 10-0-2006.
YAT SYE, LEE, EXAMINING ATTORNEY

CLASS 35—(Continued).

SN 77-281,974. O'NEAL, JAMES, LAKE GROVE, NY. FILED 9-18-2007.

SOLEWERKS

THE MARK CONSISTS OF STANDARD CHARACTERS WITHOUT CLAIM TO ANY PARTICULAR FONT, STYLE, SIZE, OR COLOR.

FOR ON-LINE RETAIL STORE SERVICES FEATURING SHOES, CLOTHING AND ACCESSORIES (U.S. CLS. 100, 101 AND 102).

APRIL ROACH, EXAMINING ATTORNEY

SN 77-282,017. BUY BUY BABY, INC., GARDEN CITY, NY. FILED 9-18-2007.

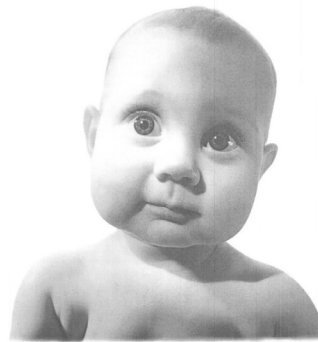

THE LIKENESS (OR, "PORTRAIT") IN THE MARK DOES NOT IDENTIFY A LIVING INDIVIDUAL.

FOR RETAIL STORE SERVICES AND COMPUTER ON-LINE STORE SERVICES FEATURING A WIDE VARIETY OF CONSUMER GOODS OF OTHERS (U.S. CLS. 100, 101 AND 102).

FIRST USE 5-15-1996; IN COMMERCE 5-15-1996.
KELLY BOULTON, EXAMINING ATTORNEY

CLASS 35—(Continued).

SN 77-282,104. ROYAL PACIFIC LTD., ALBUQUERQUE, NM. FILED 9-18-2007.

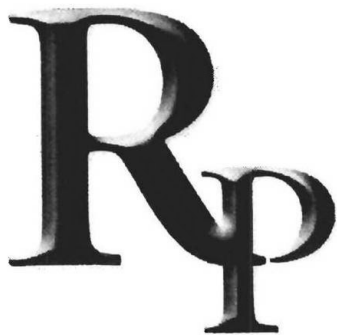

THE MARK CONSISTS OF THE STYLIZED LETTERS "R" AND "p"

FOR GOODS IMPORT AGENCIES, NAMELY, IMPORTATION OF RECESSED LIGHTING FIXTURES, TRACK LIGHTING FEATURES, UNDER CABINET LIGHTING FEATURES, CEILING FANS, BATHROOM FANS, OUTDOOR LIGHTING FIXTURES, DECORATIVE INDOOR LIGHTING FIXTURES, STEP LIGHTING FIXTURES, LIGHT BULBS, GROUND FAULT CIRCUIT INTERRUPTERS, EXIT SIGNS, EMERGENCY LIGHTS, DOOR CHIMES, ADDRESS LIGHTS, CIRCUIT BREAKERS, SMOKE ALARMS, AND ACCESSORIES FOR THE FOREGOING; DISTRIBUTORSHIPS IN THE FIELD OF RECESSED LIGHTING FIXTURES, TRACK LIGHTING FEATURES, UNDER CABINET LIGHTING FEATURES, CEILING FANS, BATHROOM FANS, OUTDOOR LIGHTING FIXTURES, DECORATIVE INDOOR LIGHTING FIXTURES, STEP LIGHTING FIXTURES, LIGHT BULBS, GROUND FAULT CIRCUIT INTERRUPTERS, EXIT SIGNS, EMERGENCY LIGHTS, DOOR CHIMES, ADDRESS LIGHTS, CIRCUIT BREAKERS, SMOKE ALARMS, AND ACCESSORIES FOR THE FOREGOING (U.S. CLS. 100, 101 AND 102).

FIRST USE 12-31-2004; IN COMMERCE 12-31-2004.
KELLY MCCOY, EXAMINING ATTORNEY

CLASS 35—(Continued).

SN 77-282,220. FREEHAVEN INVESTMENTS, LTD., CHARLESTOWN, ST. CHRIST-NEVIS, FILED 9-18-2007.

ORTHAHEEL

THE MARK CONSISTS OF STANDARD CHARACTERS WITHOUT CLAIM TO ANY PARTICULAR FONT, STYLE, SIZE, OR COLOR.

OWNER OF U.S. REG. NO. 1,832,064.

FOR RETAIL AND WHOLESALE STORE SERVICES IN THE FIELD OF FOOTWEAR, ORTHOPEDIC FOOTWEAR, ORTHOTIC AND ORTHOPEDIC DEVICES, CORRECTIVE FOOTWEAR, FOOTWEAR INSERTS, FOOTWEAR INSOLES, ORTHOTIC AND ORTHOPEDIC ARTICLES, PODIATRY AND CHIROPODY PRODUCTS AND AIDS FOR THE CORRECTION OF THE FEET, NON-MEDICATED FOOT CARE PRODUCTS AND PREPARATIONS INCLUDING PREPARATIONS FOR CORNS, BUNIONS, AND CALLUSES, SPRAYS, POWDERS, BALMS, GELS, CREAMS, LOTIONS, FOOT BUTTER AND FOOT DEODORANTS, PLASTERS, PADS AND BANDAGES INCLUDING PADS FOR CORNS, BUNIONS AND CALLUSES, SCIENTIFIC AND MEASURING APPARATUS, INSTRUMENTS AND EQUIPMENT FOR USE IN PODIATRY, CHIROPODY AND FOR THE TREATMENT OF THE FEET, MACHINES FOR ADJUSTING FOOT ARCH SUPPORTS AND FOOT EXERCISE EQUIPMENT AND APPARATUS, STOCKINGS, SOCKS AND OTHER FOOTWEAR FOR USE IN PREVENTING DEEP VEIN THROMBOSIS, AND, STOCKINGS, SOCKS AND OTHER FOOTWEAR FOR USE IN PREVENTING AND TREATING VARICOSE VEINS (U.S. CLS. 100, 101 AND 102).

HEATHER SAPP, EXAMINING ATTORNEY

SN 77-282,698. NOVOGRADAC & COMPANY LLP, SAN FRANCISCO, CA. FILED 9-18-2007.

novoco

THE MARK CONSISTS OF STANDARD CHARACTERS WITHOUT CLAIM TO ANY PARTICULAR FONT, STYLE, SIZE, OR COLOR.

FOR TAX ADVISORY SERVICES; INCOME TAX CONSULTATION; INCOME TAX PREPARATION; TAX AND TAXATION PLANNING, ADVICE, INFORMATION AND CONSULTANCY SERVICES; TAX CONSULTATION; TAX PREPARATION; ACCOUNT AUDITING; ACCOUNTANCY SERVICES; ACCOUNTING CONSULTATION; ACCOUNTING SERVICES (U.S. CLS. 100, 101 AND 102).

FIRST USE 1-1-1996; IN COMMERCE 1-1-1996.
JENNIFER MARTIN, EXAMINING ATTORNEY

CLASS 35—(Continued).

SN 77-282,916. THE TRIUM GROUP, SAN FRANCISCO, CA. FILED 9-18-2007.

THE TRIUM GROUP

THE MARK CONSISTS OF STANDARD CHARACTERS WITHOUT CLAIM TO ANY PARTICULAR FONT, STYLE, SIZE, OR COLOR.
NO CLAIM IS MADE TO THE EXCLUSIVE RIGHT TO USE "GROUP", APART FROM THE MARK AS SHOWN.
FOR BUSINESS MANAGEMENT CONSULTING (U.S. CLS. 100, 101 AND 102).
FIRST USE 1-0-1999; IN COMMERCE 1-0-1999.
KATHERINE M. DUBRAY, EXAMINING ATTORNEY

CLASS 35—(Continued).

SN 77-283,415. RYERO CORPORATION, POWELL'S POINT, NC. FILED 9-19-2007.

SLAB SEARCH

THE MARK CONSISTS OF STANDARD CHARACTERS WITHOUT CLAIM TO ANY PARTICULAR FONT, STYLE, SIZE, OR COLOR.
NO CLAIM IS MADE TO THE EXCLUSIVE RIGHT TO USE "SEARCH", APART FROM THE MARK AS SHOWN.
FOR PROVIDING ONLINE PRICE COMPARISONS AND PRICE QUOTES FOR COUNTER TOPS AND COUNTER TOP INSTALLATION (U.S. CLS. 100, 101 AND 102).
ROBIN MITTLER, EXAMINING ATTORNEY

SN 77-283,395. JPMORGAN CHASE & CO., NEW YORK, NY. FILED 9-19-2007.

CHASE NEXT

THE MARK CONSISTS OF STANDARD CHARACTERS WITHOUT CLAIM TO ANY PARTICULAR FONT, STYLE, SIZE, OR COLOR.
OWNER OF U.S. REG. NOS. 1,653,196, 2,653,456 AND OTHERS.
FOR PROMOTING THE SALE OF CREDIT CARD ACCOUNTS THROUGH THE ADMINISTRATION OF INCENTIVE AWARDS PROGRAMS (U.S. CLS. 100, 101 AND 102).
LAURA HAMMEL, EXAMINING ATTORNEY

SN 77-283,466. JPMORGAN CHASE & CO., NEW YORK, NY. FILED 9-19-2007.

CHASE PAUSE IT!

THE MARK CONSISTS OF STANDARD CHARACTERS WITHOUT CLAIM TO ANY PARTICULAR FONT, STYLE, SIZE, OR COLOR.
OWNER OF U.S. REG. NOS. 1,653,196, 2,653,456 AND OTHERS.
FOR PROMOTING THE SALE OF CREDIT CARD ACCOUNTS THROUGH THE ADMINISTRATION OF INCENTIVE AWARDS PROGRAMS (U.S. CLS. 100, 101 AND 102).
LAURA HAMMEL, EXAMINING ATTORNEY

SN 77-283,399. PAREXEL INTERNATIONAL CORPORATION, WALTHAM, MA. FILED 9-19-2007.

THE FUSION OF EXPERTISE

THE MARK CONSISTS OF STANDARD CHARACTERS WITHOUT CLAIM TO ANY PARTICULAR FONT, STYLE, SIZE, OR COLOR.
FOR BUSINESS CONSULTING SERVICES IN THE PHARMACEUTICAL, BIOTECHNOLOGY AND MEDICAL DEVICE FIELDS (U.S. CLS. 100, 101 AND 102).
FIRST USE 1-31-2007; IN COMMERCE 1-31-2007.
DOMINIC J. FERRAIUOLO, EXAMINING ATTORNEY

SN 77-283,486. JPMORGAN CHASE & CO., NEW YORK, NY. FILED 9-19-2007.

CHASE SMOOTH IT!

THE MARK CONSISTS OF STANDARD CHARACTERS WITHOUT CLAIM TO ANY PARTICULAR FONT, STYLE, SIZE, OR COLOR.
OWNER OF U.S. REG. NOS. 1,653,196, 2,653,456 AND OTHERS.
FOR PROMOTING THE SALE OF CREDIT CARD ACCOUNTS THROUGH THE ADMINISTRATION OF INCENTIVE AWARDS PROGRAMS (U.S. CLS. 100, 101 AND 102).
LAURA HAMMEL, EXAMINING ATTORNEY

CLASS 35—(Continued).

SN 77-284,243. SEARS BRANDS, LLC, HOFFMAN ESTATES, IL. FILED 9-20-2007.

MY SPIN

THE MARK CONSISTS OF STANDARD CHARACTERS WITHOUT CLAIM TO ANY PARTICULAR FONT, STYLE, SIZE, OR COLOR.

FOR RETAIL DEPARTMENT STORE SERVICES; RETAIL STORE SERVICES FEATURING CLOTHING, FOOTWEAR AND CLOTHING ACCESSORIES (U.S. CLS. 100, 101 AND 102).

DAWN HAN, EXAMINING ATTORNEY

SN 77-284,248. SEARS BRANDS, LLC, HOFFMAN ESTATES, IL. FILED 9-20-2007.

MY LOOK

THE MARK CONSISTS OF STANDARD CHARACTERS WITHOUT CLAIM TO ANY PARTICULAR FONT, STYLE, SIZE, OR COLOR.

FOR RETAIL DEPARTMENT STORE SERVICES; RETAIL STORE SERVICES FEATURING CLOTHING, FOOTWEAR AND CLOTHING ACCESSORIES (U.S. CLS. 100, 101 AND 102).

DAWN HAN, EXAMINING ATTORNEY

SN 77-284,252. SEARS BRANDS, LLC, HOFFMAN ESTATES, IL. FILED 9-20-2007.

FOR HER

THE MARK CONSISTS OF STANDARD CHARACTERS WITHOUT CLAIM TO ANY PARTICULAR FONT, STYLE, SIZE, OR COLOR.

FOR RETAIL DEPARTMENT STORE SERVICES; RETAIL STORE SERVICES FEATURING CLOTHING, FOOTWEAR AND CLOTHING ACCESSORIES (U.S. CLS. 100, 101 AND 102).

DAWN HAN, EXAMINING ATTORNEY

CLASS 35—(Continued).

SN 77-284,395. PENNWELL CORPORATION, TULSA, OK. FILED 9-20-2007.



OWNER OF U.S. REG. NO. 2,769,144.
NO CLAIM IS MADE TO THE EXCLUSIVE RIGHT TO USE 'INTERNATIONAL', APART FROM THE MARK AS SHOWN.

FOR ARRANGING AND CONDUCTING BUSINESS CONFERENCES AND TRADE SHOW EXHIBITIONS IN THE FIELD OF EXPLORATION AND DEVELOPMENT OF DEEPWATER RESERVES OF OIL AND GAS (U.S. CLS. 100, 101 AND 102).

FIRST USE 6-30-2007; IN COMMERCE 6-30-2007.
SHAUNIA CARLYLE, EXAMINING ATTORNEY

SN 77-284,517. LMGBM MANAGEMENT, LLC, WEST CONSHOHOCKEN, PA. FILED 9-20-2007.

LENDINGCHOICE

THE MARK CONSISTS OF STANDARD CHARACTERS WITHOUT CLAIM TO ANY PARTICULAR FONT, STYLE, SIZE, OR COLOR.

FOR REFERRALS IN THE FIELD OF MORTGAGE LENDING BROKEAGE (U.S. CLS. 100, 101 AND 102).

MICHAEL WIENER, EXAMINING ATTORNEY

SN 77-284,519. AQUA CLEAR SYSTEMS, MARIETTA, GA. FILED 9-20-2007.

AquaClear Systems



NO CLAIM IS MADE TO THE EXCLUSIVE RIGHT TO USE "SYSTEMS", APART FROM THE MARK AS SHOWN.
THE MARK CONSISTS OF WAVES WITH THE WORDS "AQUACLEAR SYSTEMS" IN STYLIZED TEXT.

FOR RETAIL STORES FEATURING WATER PURIFICATION SYSTEMS (U.S. CLS. 100, 101 AND 102).

FIRST USE 1-13-2006; IN COMMERCE 1-13-2006.
DAVID TOOLEY, EXAMINING ATTORNEY

CLASS 35—(Continued).

SN 77-284,834. ENTERPRISE SOLVED LLC, SCOTTSDALE, AZ. FILED 9-20-2007.

ENTERPRISE SOLVED

THE MARK CONSISTS OF STANDARD CHARACTERS WITHOUT CLAIM TO ANY PARTICULAR FONT, STYLE, SIZE, OR COLOR.

NO CLAIM IS MADE TO THE EXCLUSIVE RIGHT TO USE "ENTERPRISE", APART FROM THE MARK AS SHOWN.

FOR PROVIDING ORGANIZATIONAL DEVELOPMENT CONSULTING SERVICES (U.S. CLS. 100, 101 AND 102).

FIRST USE 8-12-2002; IN COMMERCE 8-12-2002.
MARY MUNSON, EXAMINING ATTORNEY

SN 77-285,056. DIGITALCOMPETITOR LLC, BEACHWOOD, OH. FILED 9-20-2007.

Mixing Business with Measure

THE MARK CONSISTS OF STANDARD CHARACTERS WITHOUT CLAIM TO ANY PARTICULAR FONT, STYLE, SIZE, OR COLOR.

FOR ADVERTISING AND MARKETING; BUSINESS MARKETING CONSULTING SERVICES; BUSINESS RESEARCH; BUSINESS RESEARCH AND SURVEYS; BUSINESS RESEARCH CONSULTATION; BUSINESS RESEARCH SERVICES, NAMELY, PROVIDING ANALYSIS OF RETAIL DATA ON SPECIFIC BUSINESS LOCATIONS; BUSINESS RESEARCH USING FOCUS GROUPS; CREATION OF MARKETING TOOLS DESIGNED TO INCREASE A CLIENT COMPANY'S KNOWLEDGE OF CUSTOMER NEEDS, AND ITS COMPETITORS' PRODUCTS AND SERVICES, PRICING, ADVERTISING STRATEGY AND SALES STRATEGY; DESIGN OF INTERNET ADVERTISING; DEVELOPMENT OF MARKETING STRATEGIES AND CONCEPTS; DIRECT MARKETING CONSULTING SERVICES; INTERNET ADVERTISING SERVICES; MARKET ANALYSIS; MARKET MANIPULATION, RESEARCH AND ANALYSIS, WHETHER OR NOT VIA THE INTERNET; MARKET OPINION POLLING STUDIES; MARKET REPORTS AND STUDIES; MARKET RESEARCH; MARKET RESEARCH CONSULTATION; MARKET RESEARCH SERVICES; MARKET RESEARCH STUDIES; MARKET SEGMENTATION CONSULTATION; MARKET STUDY AND ANALYSIS OF MARKET STUDIES; MARKETING CONSULTATION IN THE FIELD OF BUSINESS COMMUNICATIONS; MARKETING CONSULTING; MARKETING PLAN DEVELOPMENT; MARKETING SERVICES IN THE FIELD OF PLANNED-GIVING FOR NON-PROFIT AND CHARITABLE ORGANIZATIONS; MARKETING SERVICES, NAMELY, PROVIDING INFORMATIONAL WEB PAGES DESIGNED TO GENERATE SALES TRAFFIC VIA HYPERLINKS TO OTHER WEB SITES; MEDIA BUYING ADVICE, NAMELY, ADVISING THE CLIENT HOW MUCH MEDIA TIME, AND AT WHAT TIMES THE CLIENT SHOULD BE PURCHASING ADVERTISING; MEDIA PLANNING, NAMELY,

CLASS 35—(Continued).

ADVISING THE CLIENT ON THE CORRECT TIMES AND STATIONS TO ADVERTISE BASED ON MEDIA ANALYSIS OF THE MARKET FOR THAT MEDIA; MODELING FOR ADVERTISING OR SALES PROMOTION; MODELING SERVICES FOR ADVERTISING OR SALES PROMOTION; ON-LINE ADVERTISING AND MARKETING SERVICES; PREPARATION AND REALIZATION OF MEDIA AND ADVERTISING PLANS AND CONCEPTS; PROVIDING BUSINESS MARKETING INFORMATION; PROVIDING INFORMATION IN THE FIELD OF MARKETING AND ON-LINE MARKETING MEDIA VIA THE INTERNET; PROVIDING MARKETING AND PROMOTION OF SPECIAL EVENTS; PROVIDING PROMOTIONAL MARKETING SERVICES TO BUSINESSES IN THE BROADBAND AND MEDIA INDUSTRIES; SERVICES TO DETERMINE THE AUDIENCE AFFECTED BY ADVERTISEMENTS; SHOPPING BY RESEARCHERS WHO POSE AS CUSTOMERS TO EVALUATE THE QUALITY OF SERVICE DELIVERED; STATISTICAL EVALUATIONS OF MARKETING DATA (U.S. CLS. 100, 101 AND 102).

FIRST USE 9-18-2007; IN COMMERCE 9-18-2007.
PAUL MORENO, EXAMINING ATTORNEY

SN 77-285,141. GOLDEN CACHE, INC., DBA D/B/A DEJA & CO., SARATOGA, CA. FILED 9-20-2007.

DEJA & CO.

THE MARK CONSISTS OF STANDARD CHARACTERS WITHOUT CLAIM TO ANY PARTICULAR FONT, STYLE, SIZE, OR COLOR.

NO CLAIM IS MADE TO THE EXCLUSIVE RIGHT TO USE "& CO.", APART FROM THE MARK AS SHOWN.

THE ENGLISH TRANSLATION OF DEJA IS "ALREADY". FOR RETAIL JEWELRY STORE SERVICES (U.S. CLS. 100, 101 AND 102).

FIRST USE 3-15-2004; IN COMMERCE 9-1-2004.
NICHOLAS ALTREE, EXAMINING ATTORNEY

CLASS 35—(Continued).

SN 77-285,363. 69 BOYZ M.C., LLC, DAYTON, OH. FILED 9-21-2007.



NO CLAIM IS MADE TO THE EXCLUSIVE RIGHT TO USE "BOYS", APART FROM THE MARK AS SHOWN.

THE MARK CONSISTS OF THE NUMBER "69" AND WORD "BOYZ" WITH A FEMALE DESIGN.

FOR CLUB SERVICES, NAMELY, PROMOTING THE INTERESTS OF MOTORCYCLISTS (U.S. CLS. 100, 101 AND 102).

FIRST USE 3-15-2003; IN COMMERCE 3-15-2003.
PATRICIA EVANKO, EXAMINING ATTORNEY

SN 77-285,389. VIRGINIA HISPANIC CHAMBER OF COMMERCE, RICHMOND, VA. FILED 9-21-2007.



NO CLAIM IS MADE TO THE EXCLUSIVE RIGHT TO USE "VIRGINIA HISPANIC CHAMBER OF COMMERCE", APART FROM THE MARK AS SHOWN.

THE MARK CONSISTS OF "VIRGINIA HISPANIC CHAMBER OF COMMERCE" PLUS BRIDGE LOGO DESIGN.

FOR TRADE ASSOCIATION SERVICES TO PROMOTE AND ENHANCE BUSINESS GROWTH AND OPPORTUNITIES FOR HISPANICS/LATINOS (U.S. CLS. 100, 101 AND 102).

FIRST USE 11-15-2003; IN COMMERCE 11-15-2003.
MARGARET POWER, EXAMINING ATTORNEY

CLASS 35—(Continued).

SN 77-285,496. FL FOOD LION, INC., SALISBURY, NC. FILED 9-21-2007.



OWNER OF U.S. REG. NOS. 1,427,887, 2,810,339 AND OTHERS.

NO CLAIM IS MADE TO THE EXCLUSIVE RIGHT TO USE "PET" AND "FOOD", APART FROM THE MARK AS SHOWN.

FOR RETAIL GROCERY STORE SERVICES FEATURING BONUS INCENTIVE PROGRAMS FOR CUSTOMERS TO RECEIVE DISCOUNTS AND DISCOUNT COUPONS FOR PET PRODUCTS (U.S. CLS. 100, 101 AND 102).

FIRST USE 9-26-2007; IN COMMERCE 9-26-2007.
WANDA KAY PRICE, EXAMINING ATTORNEY

SN 77-285,784. A. JOHN SOUZA & CO. DIAMONDS, INC., DBA D/B/A A JEWELRY STATEMENT, SARATOGA, CA. AND GOLDEN CACHE, INC., DBA D/B/A DEJA & CO., SARATOGA, CA. FILED 9-21-2007.

A JEWELRY STATEMENT

THE MARK CONSISTS OF STANDARD CHARACTERS WITHOUT CLAIM TO ANY PARTICULAR FONT, STYLE, SIZE, OR COLOR.

NO CLAIM IS MADE TO THE EXCLUSIVE RIGHT TO USE "JEWELRY", APART FROM THE MARK AS SHOWN.

FOR RETAIL JEWELRY STORE SERVICES (U.S. CLS. 100, 101 AND 102).

FIRST USE 10-1-2003; IN COMMERCE 10-1-2003.
NICHOLAS ALTREE, EXAMINING ATTORNEY

SN 77-286,182. TOWNS, KRISTA, ST. CHARLES, IL. FILED 9-21-2007.

Eponaire

THE MARK CONSISTS OF STANDARD CHARACTERS WITHOUT CLAIM TO ANY PARTICULAR FONT, STYLE, SIZE, OR COLOR.

FOR ONLINE RETAIL STORE SERVICES OFFERING SPECIALTY EQUESTRIAN PRODUCTS (U.S. CLS. 100, 101 AND 102).

FIRST USE 1-1-2003; IN COMMERCE 1-1-2003.
TINA BROWN, EXAMINING ATTORNEY

CLASS 35—(Continued).

SN 77-286,287. CONVERGENCE LAW INSTITUTE, LLC, DBA CONVERGENCE LAW INSTITUTE, DENVER, CO. FILED 9-21-2007.

IP Switchboard

THE MARK CONSISTS OF STANDARD CHARACTERS WITHOUT CLAIM TO ANY PARTICULAR FONT, STYLE, SIZE, OR COLOR.

NO CLAIM IS MADE TO THE EXCLUSIVE RIGHT TO USE "IP", APART FROM THE MARK AS SHOWN.

FOR PROMOTING PUBLIC AWARENESS OF INTELLECTUAL PROPERTY ISSUES THAT AFFECT U.S. AND FOREIGN PUBLIC POLICY (U.S. CLS. 100, 101 AND 102).
STEVEN PEREZ, EXAMINING ATTORNEY

SN 77-286,297. NIMBUS CAPITAL, LLC, BROOKLINE, MA. FILED 9-21-2007.



THE MARK CONSISTS OF AN ABSTRACT DESIGN IN THE FORM OF A CIRCLE WITH IMAGES IN THE FORM OF PEOPLE IN THE CIRCLE AND THE STYLIZED TEXT "ISUGGEST".

FOR PROVIDING A WEBSITE FEATURING SUGGESTIONS FROM USERS ABOUT CONSUMER GOODS AND SERVICES OF OTHERS IN THE FIELDS OF BOOKS, MOVIES, MUSIC, TRAVEL DESTINATIONS, SHOPPING, SPORTS, WEBSITES, BRANDS, FOODS, DRINKS, VIDEO GAMES, HOBBIES (U.S. CLS. 100, 101 AND 102).
TINA BROWN, EXAMINING ATTORNEY

SN 77-286,510. LANDEN RESOURCE CORPORATION, DBA LANDEN CONSULTING GROUP, LAKE FOREST, IL. FILED 9-22-2007.

Success at Work

THE MARK CONSISTS OF STANDARD CHARACTERS WITHOUT CLAIM TO ANY PARTICULAR FONT, STYLE, SIZE, OR COLOR.

FOR CONSULTING SERVICES IN THE FIELD OF HUMAN RESOURCES AND EMPLOYEE DEVELOPMENT, NAMELY, FOR THE PROMOTION OF EMPLOYEE RETENTION, CAREER GROWTH, AND INCREASED PRODUCTIVITY AND BUSINESS RESULTS FOR EMPLOYEES AND EMPLOYERS (U.S. CLS. 100, 101 AND 102).

JAY BESCH, EXAMINING ATTORNEY

CLASS 35—(Continued).

SN 77-286,757. CHORDUS, INC., PELHAM, AL. FILED 9-24-2007.

ContainerShare

THE MARK CONSISTS OF STANDARD CHARACTERS WITHOUT CLAIM TO ANY PARTICULAR FONT, STYLE, SIZE, OR COLOR.

FOR ADMINISTRATION OF A PROGRAM FOR ENABLING PARTICIPANTS TO OBTAIN DISCOUNTS ON GOODS AND RECEIVE IMPROVED SERVICES (U.S. CLS. 100, 101 AND 102).

CURTIS FRENCH, EXAMINING ATTORNEY

SN 77-286,859. BAR ACTION, NORTH HOLLYWOOD, CA. FILED 9-24-2007.



NO CLAIM IS MADE TO THE EXCLUSIVE RIGHT TO USE "BAR", APART FROM THE MARK AS SHOWN.

FOR ON-LINE BUSINESS DIRECTORIES FEATURING BARS; ONLINE BUSINESS NETWORKING SERVICES; PROVIDING MARKETING AND PROMOTION OF SPECIAL EVENTS (U.S. CLS. 100, 101 AND 102).

SIMON TENG, EXAMINING ATTORNEY

SN 77-286,918. EXACT STAFF, INC., WOODLAND HILLS, CA. FILED 9-24-2007.

EXACT LEGAL STAFF

THE MARK CONSISTS OF STANDARD CHARACTERS WITHOUT CLAIM TO ANY PARTICULAR FONT, STYLE, SIZE, OR COLOR.

OWNER OF U.S. REG. NO. 2,475,358.

NO CLAIM IS MADE TO THE EXCLUSIVE RIGHT TO USE "LEGAL STAFF", APART FROM THE MARK AS SHOWN.

FOR EMPLOYMENT PLACEMENT SERVICES (U.S. CLS. 100, 101 AND 102).

MARGARET POWER, EXAMINING ATTORNEY

CLASS 35—(Continued).

SN 77-286,920. EXACT STAFF, INC., WOODLAND HILLS, CA. FILED 9-24-2007.

EXACT MEDICAL STAFF

THE MARK CONSISTS OF STANDARD CHARACTERS WITHOUT CLAIM TO ANY PARTICULAR FONT, STYLE, SIZE, OR COLOR.

OWNER OF U.S. REG. NO. 2,475,358.

NO CLAIM IS MADE TO THE EXCLUSIVE RIGHT TO USE "MEDICAL STAFF", APART FROM THE MARK AS SHOWN.

FOR EMPLOYMENT PLACEMENT SERVICES (U.S. CLS. 100, 101 AND 102).

MARGARET POWER, EXAMINING ATTORNEY

SN 77-287,055. EXACT STAFF, INC., WOODLAND HILLS, CA. FILED 9-24-2007.

EXACT ACCOUNTING STAFF

THE MARK CONSISTS OF STANDARD CHARACTERS WITHOUT CLAIM TO ANY PARTICULAR FONT, STYLE, SIZE, OR COLOR.

OWNER OF U.S. REG. NO. 2,475,358.

NO CLAIM IS MADE TO THE EXCLUSIVE RIGHT TO USE "ACCOUNTING STAFF", APART FROM THE MARK AS SHOWN.

FOR EMPLOYMENT PLACEMENT SERVICES (U.S. CLS. 100, 101 AND 102).

MARGARET POWER, EXAMINING ATTORNEY

SN 77-287,206. RENT-A-CENTER WEST, INC., PLANO, TX. FILED 9-24-2007.

RAC WORRY FREE GUARANTEE

THE MARK CONSISTS OF STANDARD CHARACTERS WITHOUT CLAIM TO ANY PARTICULAR FONT, STYLE, SIZE, OR COLOR.

OWNER OF U.S. REG. NO. 3,161,654.

NO CLAIM IS MADE TO THE EXCLUSIVE RIGHT TO USE "GUARANTEE", APART FROM THE MARK AS SHOWN.

FOR RETAIL STORE SERVICES FEATURING HOME ENTERTAINMENT PRODUCTS, CONSUMER ELECTRONICS, HOME APPLIANCES, FURNITURE, HOME FURNISHINGS, COMPUTER EQUIPMENT AND COMPUTERS (U.S. CLS. 100, 101 AND 102).

JILL C. ALT, EXAMINING ATTORNEY

CLASS 35—(Continued).

SN 77-287,250. QUAD COUNTY CORN PROCESSORS CO-OPERATIVE, GALVA, IA. FILED 9-24-2007.



THE MARK CONSISTS OF AN OVAL WITH THE WORD "POWERPLANT" AND A NUMBER "20" AT THE END AND ABOVE THE WORD "POWERPLANT". A PARTIAL OVAL IS INSIDE THE OVAL UNDER THE WORD "POWERPLANT" AND INCREASES IN WIDTH AT THE RIGHT HAND SIDE OF THE MARK AND DECREASES AT THE NUMBER "20".

FOR FARM COOPERATIVE STORE SERVICES, NAMELY, OFFERING GOODS USED TO PRODUCE AGRICULTURAL PRODUCTS AT A DISCOUNT TO FARMERS WHO COMMIT TO SELLING THEIR PRODUCTS THROUGH THE COOPERATIVE (U.S. CLS. 100, 101 AND 102).

FIRST USE 8-1-2007; IN COMMERCE 8-1-2007.

DOMINIC J. FERRAIUOLO, EXAMINING ATTORNEY

SN 77-287,337. MD JOHNSON, INC., ENUMCLAW, WA. FILED 9-24-2007.



NO CLAIM IS MADE TO THE EXCLUSIVE RIGHT TO USE "INC.", APART FROM THE MARK AS SHOWN.

THE NAME "M D JOHNSON" IDENTIFIES A LIVING INDIVIDUAL WHOSE CONSENT IS OF RECORD.

THE COLOR(S) MAROON, GREY, WHITE IS/ARE CLAIMED AS A FEATURE OF THE MARK.

THE MARK CONSISTS OF AN ISOSCELES TRIANGLE WITH MAROON, WHITE, AND GREY STRIPES ON THE FAR LEFT AND NO BORDER. A THIN GREY LINE IN A CRESCENT SHAPE OVERLAPS THE TRIANGLE AND SEPARATES THE GREY AND MAROON FROM EACH OTHER ON THE TRIANGLE. TO THE RIGHT OF THE TRIANGLE/CRESCENT, IN LARGE CAPITAL LETTERS ARE THE WORDS "MD" IN MAROON WRITING AND "JOHNSON" "INC" IS WRITTEN IN SMALLER CAPITAL LETTERS TO THE RIGHT OF "JOHNSON" IN THE SAME GREY COLOR.

FOR BUSINESS ACQUISITION AND MERGER CONSULTATION (U.S. CLS. 100, 101 AND 102).

FIRST USE 1-1-2004; IN COMMERCE 1-1-2004.

JOHN DWYER, EXAMINING ATTORNEY

CLASS 35—(Continued).

SN 77-287,340. LOCAL LEADERS, LLC, IPSWICH, MA. FILED 9-24-2007.



THE COLOR(S) BLACK AND RED IS/ARE CLAIMED AS A FEATURE OF THE MARK.

THE MARK CONSISTS OF THE CAPITALIZED WORDS "LOCAL", "MOST TRUSTED" AND "MOST EXPERIENCED" IN BLACK AND THE WORD "LEADERS" IN RED AND A RED LIGHTENING BOLT.

FOR PROVIDING A WEB SITE WHERE USERS CAN POST RATINGS, REVIEWS AND RECOMMENDATIONS ON PRODUCTS AND SERVICES; PROVIDING A SEARCHABLE ONLINE ADVERTISING GUIDE FEATURING THE GOODS AND SERVICES OF OTHER ONLINE VENDORS ON THE INTERNET; REFERRALS IN THE FIELD OF ARCHITECTURE, BUILDING AND CONSTRUCTION, INTERIOR AND LANDSCAPE DESIGN, REAL ESTATE AND BANKING SERVICES; COMMERCIAL INFORMATION AND ADVICE FOR CONSUMERS (U.S. CLS. 100, 101 AND 102).

JOHN DWYER, EXAMINING ATTORNEY

CLASS 35—(Continued).

SN 77-287,473. CD CENTRAL LLC, SARASOTA, FL. FILED 9-24-2007.



THE COLOR(S) BLUE, GRAY, WHITE, AND BLACK IS/ARE CLAIMED AS A FEATURE OF THE MARK.

THE MARK CONSISTS OF A FANCIFUL GRAPHIC OF THE LETTERS "CD" WITH THE LETTER "C" IN BLUE AND THE LETTER "D" IN BLACK WHITE STRIPES WITH GRAY SHADING ALL ABOVE THE WORDS "BANKCDCENTRAL" WHERE "BANK" AND "CENTRAL" ARE IN BLUE AND "CD" IS IN GRAY.

FOR REFERRALS IN THE FIELD OF INSURANCE AND FINANCIAL ANNUITIES; PROVIDING INSURANCE AND FINANCIAL ANNUITIES SALES LEADS FOR OTHERS (U.S. CLS. 100, 101 AND 102).

FIRST USE 8-0-2007; IN COMMERCE 8-0-2007. BENJAMIN OKEKE, EXAMINING ATTORNEY

SN 77-287,347. KENNEDY, SHANNON, FALLSTON, MD. FILED 9-24-2007.

**CONTROL YOUR BUSINESS!
LIVE YOUR LIFE!**

THE MARK CONSISTS OF STANDARD CHARACTERS WITHOUT CLAIM TO ANY PARTICULAR FONT, STYLE, SIZE, OR COLOR.

FOR BUSINESS MANAGEMENT CONSULTANCY SERVICES (U.S. CLS. 100, 101 AND 102).

FIRST USE 10-15-2006; IN COMMERCE 10-15-2006. KYLE PEETE, EXAMINING ATTORNEY

SN 77-287,521. FLEETWOOD GAMING, INC., BILLINGS, MT. FILED 9-24-2007.

BRILLIANT CONCEPTS

THE MARK CONSISTS OF STANDARD CHARACTERS WITHOUT CLAIM TO ANY PARTICULAR FONT, STYLE, SIZE, OR COLOR.

FOR RETAIL STORES FEATURING LIGHTING (U.S. CLS. 100, 101 AND 102).

CURTIS FRENCH, EXAMINING ATTORNEY

SN 77-287,348. GREATER SUMMERVILLE/DORCHESTER COUNTY CHAMBER OF COMMERCE, SUMMERVILLE, SC. FILED 9-24-2007.

Small Town, Big Charm

THE MARK CONSISTS OF STANDARD CHARACTERS WITHOUT CLAIM TO ANY PARTICULAR FONT, STYLE, SIZE, OR COLOR.

FOR CHAMBER OF COMMERCE SERVICES, NAMELY, PROMOTING BUSINESS AND TOURISM IN THE GREATER SUMMERVILLE/DORCHESTER COUNTY AREA (U.S. CLS. 100, 101 AND 102).

FIRST USE 11-1-2001; IN COMMERCE 11-1-2001. COLLEEN KEARNEY, EXAMINING ATTORNEY

SN 77-287,809. SKYLARK SPORT MAKETING CORPORATION, VISTA, CA. FILED 9-25-2007.

PRANA

THE MARK CONSISTS OF STANDARD CHARACTERS WITHOUT CLAIM TO ANY PARTICULAR FONT, STYLE, SIZE, OR COLOR.

OWNER OF U.S. REG. NOS. 1,803,298, 2,569,537 AND 2,677,150.

FOR RETAIL STORES FEATURING APPAREL AND ACCESSORIES FOR HIKING, BIKING, CLIMBING AND YOGA (U.S. CLS. 100, 101 AND 102).

JUDITH HELFMAN, EXAMINING ATTORNEY

CLASS 35—(Continued).

SN 77-287,822. PATRICK WILEN, NEW YORK, NY. FILED 9-25-2007.

XARTCOLLECTION

THE MARK CONSISTS OF STANDARD CHARACTERS WITHOUT CLAIM TO ANY PARTICULAR FONT, STYLE, SIZE, OR COLOR.

FOR REPRESENTATION OF VISUAL ARTISTS IN THE LEASING OF ARTWORKS TO OTHERS; REPRESENTATION OF VISUAL ARTISTS IN THE SALE OF ARTWORKS TO OTHERS (U.S. CLS. 100, 101 AND 102).

FIRST USE 9-24-2007; IN COMMERCE 9-24-2007.
SUZANNE BLANE, EXAMINING ATTORNEY

SN 77-288,229. BID BINGO, LLC, LOS ANGELES, CA. FILED 9-25-2007.

BIDROCKS

THE MARK CONSISTS OF STANDARD CHARACTERS WITHOUT CLAIM TO ANY PARTICULAR FONT, STYLE, SIZE, OR COLOR.

FOR AUCTION MANAGEMENT SERVICES PROVIDED TO OTHERS OVER AN ON-LINE WEB SITE ACCESSED THROUGH A GLOBAL COMPUTER NETWORK FEATURING JEWELRY; AND ON-LINE MEDIATION OF AGREEMENTS REGARDING THE SALE AND PURCHASE OF AUCTIONED GOODS, NAMELY, JEWELRY (U.S. CLS. 100, 101 AND 102).

ALEXANDER L. POWERS, EXAMINING ATTORNEY

SN 77-288,518. GLENN F. SCHAEFER, PITTSFORD, NY. FILED 9-25-2007.

All trails lead to New York

THE MARK CONSISTS OF STANDARD CHARACTERS WITHOUT CLAIM TO ANY PARTICULAR FONT, STYLE, SIZE, OR COLOR.

FOR DISSEMINATION OF ADVERTISING MATTER, NAMELY, DEPLIANTS IN THE NATURE OF BROCHURES, INVITATIONS, MAPS, AND POSTERS ABOUT EVENTS CONCERNING WINE, CANALS, WATER TRAILS, NATURE TRAILS, MOUNTAIN TRAILS OR TOURISM IN NEW YORK (U.S. CLS. 100, 101 AND 102).

MARIAM MAHMOUDI, EXAMINING ATTORNEY

CLASS 35—(Continued).

SN 77-288,938. METAVERSE CORPORATION, HAMILTON, NJ. FILED 9-26-2007.



OWNER OF U.S. REG. NOS. 2,957,199 AND 3,293,209.
THE COLOR(S) BLUE AND GRAY IS/ARE CLAIMED AS A FEATURE OF THE MARK.

THE WORDING "FULCRUM" AND ".COM" APPEAR IN BLUE. THE WORDING "GALLERY" APPEARS IN GRAY. THE GEOMETRIC DESIGN APPEARS IN BLUE AND GRAY.

FOR RETAIL AND WHOLESALE STORE SERVICES FEATURING ORIGINAL ARTWORK, LIMITED EDITION ARTWORK AND DUPLICATE PRINTS (U.S. CLS. 100, 101 AND 102).

FIRST USE 10-10-2002; IN COMMERCE 10-10-2002.
TRACY CROSS, EXAMINING ATTORNEY

SN 77-288,995. PETER J POSER, SOUTH SALEM, NY. FILED 9-26-2007.

Inspired by a
challenge...Committed to a
solution

THE MARK CONSISTS OF STANDARD CHARACTERS WITHOUT CLAIM TO ANY PARTICULAR FONT, STYLE, SIZE, OR COLOR.

FOR (BASED ON INTENT TO USE) SALES PROMOTION SERVICES; ADVERTISING AND PROMOTION SERVICES AND RELATED CONSULTING; ADVERTISING SERVICES, NAMELY, CREATING CORPORATE AND BRAND IDENTITY FOR OTHERS; ADVERTISING SERVICES, NAMELY, CREATING CORPORATE LOGOS FOR OTHERS; ADVERTISING, MARKETING AND PROMOTION SERVICES; CUSTOMER LOYALTY SERVICES AND CUSTOMER CLUB SERVICES, FOR COMMERCIAL, PROMOTIONAL AND/OR ADVERTISING PURPOSES; DESIGN OF ADVERTISING FLYERS FOR OTHERS; DESIGN OF ADVERTISING MATERIALS FOR OTHERS; DIRECT MARKETING ADVERTISING FOR OTHERS; DISSEMINATION OF ADVERTISING MATERIAL; DISSEMINATION OF ADVERTISING MATTER; CONTESTS AND INCENTIVE AWARD PROGRAMS TO PROMOTE THE SALE OF PRODUCTS AND SERVICES OF OTHERS; DEVELOPING PROMOTIONAL CAMPAIGNS FOR BUSINESS; DISTRIBUTION OF PRODUCTS FOR ADVERTISING PURPOSES; PROMOTING THE SALE OF CREDIT CARD ACCOUNTS THROUGH THE ADMINISTRATION OF INCENTIVE AWARD PROGRAMS; PROMOTING THE SALE OF GOODS AND SERVICES OF OTHERS THROUGH THE DISTRIBUTION OF PRINTED MATERIAL AND PROMOTIONAL CONTESTS; PROMOTION AND MARKETING SERVICES AND RELATED CONSULTING; PROVIDING ADVERTISING, MARKETING AND PROMOTIONAL SERVICES FOR THE PHARMACEUTICAL AND MEDICAL INDUSTRY; PUBLICITY AND SALES PROMOTION SERVICES (U.S. CLS. 100, 101 AND 102).

JACQUELINE A. LAVINE, EXAMINING ATTORNEY

CLASS 35—(Continued).

SN 77-289,058. SPRING-GREEN LAWN CARE CORP., PLAINFIELD, IL. FILED 9-26-2007.

Flex Start

THE MARK CONSISTS OF STANDARD CHARACTERS WITHOUT CLAIM TO ANY PARTICULAR FONT, STYLE, SIZE, OR COLOR.

FOR FRANCHISE SERVICES, NAMELY, OFFERING TECHNICAL AND BUSINESS MANAGEMENT ASSISTANCE IN THE ESTABLISHMENT AND OPERATION OF A LAWN AND TREE CARE FRANCHISE (U.S. CLS. 100, 101 AND 102).

FIRST USE 3-30-2006; IN COMMERCE 3-30-2006.
SHARON MEIER, EXAMINING ATTORNEY

CLASS 35—(Continued).

SN 77-289,238. CARLTON STRATEGIC STAFFING, INC., DBA CARLTON STAFFING, INC., HOUSTON, TX. FILED 9-26-2007.



NO CLAIM IS MADE TO THE EXCLUSIVE RIGHT TO USE "STAFFING", APART FROM THE MARK AS SHOWN.

THE MARK CONSISTS OF A LEFT-FACING WAVING FLAG WITH THE STYLIZED WORDS "CARLTON STAFFING" BENEATH THE FLAG ON THE LEFT.

FOR EMPLOYMENT HIRING, RECRUITING, PLACEMENT, STAFFING AND CAREER NETWORKING SERVICES (U.S. CLS. 100, 101 AND 102).

FIRST USE 4-13-1995; IN COMMERCE 4-13-1995.
WANDA KAY PRICE, EXAMINING ATTORNEY

SN 77-289,088. PEREZ, WINSTON, LOS ANGELES, CA. FILED 9-26-2007.

Concept Modeling

NO CLAIM IS MADE TO THE EXCLUSIVE RIGHT TO USE "CONCEPT MODELING", APART FROM THE MARK AS SHOWN.

THE COLOR(S) LIGHT GREY, DARK GRAY AND BLACK IS/ARE CLAIMED AS A FEATURE OF THE MARK. THE WORD "CONCEPT" AND THE DOT OVER THE "I" IN "MODELING" ARE DARK GRAY, THE OVAL IS LIGHT GRAY, AND THE WORD "MODELING" AND THE LINES INSIDE THE OVAL ARE BLACK.

FOR PROMOTION AND MARKETING SERVICES AND RELATED CONSULTING; CONSULTANCY SERVICES REGARDING BUSINESS STRATEGIES; CONSULTING SERVICES IN BUSINESS ORGANIZATION AND MANAGEMENT; ADVERTISING AND BUSINESS MANAGEMENT CONSULTANCY; BUSINESS ADMINISTRATION CONSULTANCY; BUSINESS MANAGEMENT CONSULTANCY AND ADVISORY SERVICES; BUSINESS ORGANIZATION AND OPERATION CONSULTANCY (U.S. CLS. 100, 101 AND 102).

FIRST USE 9-1-2007; IN COMMERCE 9-1-2007.
ALICE SUE CARRUTHERS, EXAMINING ATTORNEY

SN 77-289,471. RICHARD LAKE & ASSOCIATES LLC, DBA USA INCOME TAX SERVICES, BURNEY, CA. FILED 9-26-2007.



NO CLAIM IS MADE TO THE EXCLUSIVE RIGHT TO USE "USA" AND "INCOME TAX SERVICE" AND "GET YOUR TAX REFUND TODAY", APART FROM THE MARK AS SHOWN.

THE COLOR(S) RED, WHITE, BLUE, YELLOW IS/ARE CLAIMED AS A FEATURE OF THE MARK.

THE MARK CONSISTS OF WHITE EAGLE HEAD WITH YELLOW BEAK, RED & BLUE FLAG ON EAGLE FACE, BLUE CAPITOL DOME BEHIND EAGLE HEAD, BLUE LETTERING FOR "USA & GET YOUR TAX REFUND TODAY". RED LETTERING "INCOME TAX SERVICES".

FOR INCOME TAX CONSULTATION; INCOME TAX PREPARATION; TAX CONSULTATION; TAX FILING SERVICES; TAX PREPARATION (U.S. CLS. 100, 101 AND 102).

FIRST USE 7-1-2007; IN COMMERCE 7-1-2007.
JEFF DEFORD, EXAMINING ATTORNEY

CLASS 35—(Continued).

SN 77-289,514. NORTHERN HEMISPHERE HOLDINGS LLC, NEW YORK, NY. FILED 9-26-2007.

**NORTHERN HEMISPHERE
BUSINESS CONNECTION**

THE MARK CONSISTS OF STANDARD CHARACTERS WITHOUT CLAIM TO ANY PARTICULAR FONT, STYLE, SIZE, OR COLOR.

NO CLAIM IS MADE TO THE EXCLUSIVE RIGHT TO USE "BUSINESS", APART FROM THE MARK AS SHOWN.

FOR BUSINESS CONSULTING SERVICES RELATING TO PRODUCT DISTRIBUTION, OPERATIONS MANAGEMENT SERVICES, LOGISTICS, REVERSE LOGISTICS, SUPPLY CHAIN, AND PRODUCTION SYSTEMS AND DISTRIBUTION SOLUTIONS; BUSINESS MANAGEMENT CONSULTANCY AS WELL AS DEVELOPMENT OF PROCESSES FOR THE ANALYSIS AND THE IMPLEMENTATION OF STRATEGY PLANS AND MANAGEMENT PROJECTS (U.S. CLS. 100, 101 AND 102).
ZACHARY BELLO, EXAMINING ATTORNEY

SN 77-289,520. GREATER MEDIA, INC., BRAINTREE, MA. FILED 9-26-2007.

GREATER MEDIA, INC.

THE MARK CONSISTS OF STANDARD CHARACTERS WITHOUT CLAIM TO ANY PARTICULAR FONT, STYLE, SIZE, OR COLOR.

NO CLAIM IS MADE TO THE EXCLUSIVE RIGHT TO USE "MEDIA, INC.", APART FROM THE MARK AS SHOWN.

FOR ADVERTISING, MARKETING AND PROMOTING THE CONSUMER GOODS AND SERVICES OF OTHERS (U.S. CLS. 100, 101 AND 102).

FIRST USE 6-30-1972; IN COMMERCE 6-30-1972.
ESTHER BELENKER, EXAMINING ATTORNEY

SN 77-289,537. GREATER MEDIA, INC., BRAINTREE, MA. FILED 9-26-2007.

GREATER MEDIA

THE MARK CONSISTS OF STANDARD CHARACTERS WITHOUT CLAIM TO ANY PARTICULAR FONT, STYLE, SIZE, OR COLOR.

NO CLAIM IS MADE TO THE EXCLUSIVE RIGHT TO USE "MEDIA", APART FROM THE MARK AS SHOWN.

FOR ADVERTISING, MARKETING AND PROMOTING THE CONSUMER GOODS AND SERVICES OF OTHERS (U.S. CLS. 100, 101 AND 102).

FIRST USE 6-30-1972; IN COMMERCE 6-30-1972.
ESTHER BELENKER, EXAMINING ATTORNEY

CLASS 35—(Continued).

SN 77-289,559. NEATSTUFF COLLECTIBLES, LLC, NORTH BERGEN, NJ. FILED 9-26-2007.

**REPRESENTED PRIVATE TREATY
(RPT)**

THE MARK CONSISTS OF STANDARD CHARACTERS WITHOUT CLAIM TO ANY PARTICULAR FONT, STYLE, SIZE, OR COLOR.

NO CLAIM IS MADE TO THE EXCLUSIVE RIGHT TO USE "REPRESENTED PRIVATE TREATY", APART FROM THE MARK AS SHOWN.

FOR ON-LINE CONSIGNMENT SERVICES WHEREBY GOODS ARE RECEIVED ON CONSIGNMENT FOR AUCTION ON AN ONLINE AUCTION SITE; ONLINE RETAIL CONSIGNMENT STORES FEATURING CLOTHING, TOYS, HOUSEHOLD APPLIANCES, COLLECTIBLE TOYS, COLLECTIBLE COMIC BOOKS, COLLECTIBLE TRADING CARDS; RETAIL CONSIGNMENT STORES FEATURING CLOTHING, TOYS, HOUSEHOLD APPLIANCES, COLLECTIBLE TOYS, COLLECTIBLE COMIC BOOKS, COLLECTIBLE TRADING CARDS; PROVIDING A WEB SITE AT WHICH USERS CAN OFFER GOODS FOR SALE AND BUY GOODS OFFERED BY OTHERS; PROVIDING A WEB SITE THAT ENABLES USERS TO POST ITEMS FOR SALE THROUGH ON-LINE CLASSIFIED ADVERTISEMENTS; PROVIDING A WEB SITE WHEREBY BUYERS OF GOODS OR SERVICES LOCATE AND RECEIVE QUOTATIONS FROM MULTIPLE COMPETITIVE SOURCES AND SELLERS OF GOODS OR SERVICES IDENTIFY AND BID ON MULTIPLE NEW SALES OPPORTUNITIES (U.S. CLS. 100, 101 AND 102).
CHARLES L. JENKINS, EXAMINING ATTORNEY

SN 77-289,747. ANTI-DEFAMATION LEAGUE OF B'NAI BRITH, NEW YORK, NY. FILED 9-26-2007.



NO CLAIM IS MADE TO THE EXCLUSIVE RIGHT TO USE "NO NUCLEAR IRAN", APART FROM THE MARK AS SHOWN.

THE MARK CONSISTS OF THE WORDS "NO NUCLEAR IRAN" IN A STYLIZED FONT, WITH STRIPES ABOVE AND BELOW THE WORDS, AND A STRIPE BEHIND THE WORD "NUCLEAR". THE LETTER "I" IN THE WORD "IRAN" IS DEPICTED BY A STYLIZED DRAWING OF A NUCLEAR MISSILE.

FOR PUBLIC ADVOCACY TO PROMOTE AWARENESS OF THE NUCLEAR THREAT TO OTHER COUNTRIES BY IRAN (U.S. CLS. 100, 101 AND 102).

FIRST USE 8-31-2007; IN COMMERCE 8-31-2007.
WANDA KAY PRICE, EXAMINING ATTORNEY

CLASS 35—(Continued).

SN 77-289,936. HOLOVISIONS LLC, MINNEAPOLIS, MN. FILED 9-26-2007.



THE COLOR(S) RED, YELLOW, GREEN, BLUE, PURPLE, LIGHT BLUE AND GRAY IS/ARE CLAIMED AS A FEATURE OF THE MARK.

THE MARK CONSISTS OF THE STYLIZED WORD "VIRTUAL", IN AN UPWARD-BENT ARCH, WITH LETTERS IN A RAINBOW OF COLORS, FROM LEFT TO RIGHT – RED TO YELLOW TO GREEN TO BLUE TO PURPLE – WITH A GRAY DROP-SHADOW BEHIND THE COLORED LETTERS; ON TOP OF A GRADIATED LIGHT BLUE RECTANGULAR BACKGROUND.

FOR ADVERTISING SERVICES, NAMELY, CREATING CORPORATE LOGOS FOR OTHERS (U.S. CLS. 100, 101 AND 102).

SHAUNIA CARLYLE, EXAMINING ATTORNEY

SN 77-289,965. TEACH FOR AMERICA, INC., NEW YORK, NY. FILED 9-26-2007.

TEACH FOR ALL

THE MARK CONSISTS OF STANDARD CHARACTERS WITHOUT CLAIM TO ANY PARTICULAR FONT, STYLE, SIZE, OR COLOR.

FOR PERSONNEL PLACEMENT AND RECRUITMENT OF TEACHERS; PUBLIC ADVOCACY TO PROMOTE AWARENESS OF THE IMPORTANCE OF IMPROVING EDUCATION (U.S. CLS. 100, 101 AND 102).

LEIGH CAROLINE CASE, EXAMINING ATTORNEY

SN 77-290,031. JUST SAY PLEASE LIMITED, BIRMINGHAM, UNITED KINGDOM, FILED 9-27-2007.

lingerieplease

THE MARK CONSISTS OF STANDARD CHARACTERS WITHOUT CLAIM TO ANY PARTICULAR FONT, STYLE, SIZE, OR COLOR.

FOR OPERATING AN ONLINE SHOPPING SITE IN THE FIELD OF LINGERIE AND UNDERWEAR (U.S. CLS. 100, 101 AND 102).

FIRST USE 1-11-2006; IN COMMERCE 1-11-2006. JUDITH HELFMAN, EXAMINING ATTORNEY

CLASS 35—(Continued).

SN 77-290,080. D. ROY ENTERPRISES, LLC, ATLANTA, GA. FILED 9-27-2007.

SHAREFAM

THE MARK CONSISTS OF STANDARD CHARACTERS WITHOUT CLAIM TO ANY PARTICULAR FONT, STYLE, SIZE, OR COLOR.

FOR PROVIDING AN ONLINE DIRECTORY INFORMATION SERVICE FEATURING INFORMATION REGARDING , AND IN THE NATURE OF, FAMILY LIFE, CLASSIFIEDS, VIRTUAL COMMUNITY, AND SOCIAL NETWORKING (U.S. CLS. 100, 101 AND 102).

ESTHER A. BORSUK, EXAMINING ATTORNEY

SN 77-290,101. D. ROY ENTERPRISES, LLC, ATLANTA, GA. FILED 9-27-2007.

WHERE FAMILIES CONNECT

THE MARK CONSISTS OF STANDARD CHARACTERS WITHOUT CLAIM TO ANY PARTICULAR FONT, STYLE, SIZE, OR COLOR.

FOR PROVIDING AN ONLINE DIRECTORY INFORMATION SERVICE FEATURING INFORMATION REGARDING , AND IN THE NATURE OF, FAMILY LIFE, CLASSIFIEDS, VIRTUAL COMMUNITY, AND SOCIAL NETWORKING (U.S. CLS. 100, 101 AND 102).

ESTHER A. BORSUK, EXAMINING ATTORNEY

SN 77-290,127. AMERICAN BOARD OF PLASTIC SURGERY, INC., PHILADELPHIA, PA. FILED 9-27-2007.

MOC-PS

THE MARK CONSISTS OF STANDARD CHARACTERS WITHOUT CLAIM TO ANY PARTICULAR FONT, STYLE, SIZE, OR COLOR.

FOR ADMINISTERING EXAMINATIONS AND EVALUATING THE COMPETENCE OF PROFESSIONALS IN THE FIELD OF PLASTIC SURGERY; PREPARATION, SCORING, ANALYSIS AND EVALUATION OF EXAMINATIONS, AND EXAMINATION QUESTIONS FOR TESTING INDIVIDUALS TO ASCERTAIN THEIR COMPETENCE IN THE FIELD OF PLASTIC SURGERY AND ADMINISTRATION OF SUCH EXAMINATIONS (U.S. CLS. 100, 101 AND 102).

FIRST USE 3-1-2006; IN COMMERCE 3-1-2006. BRIAN PINO, EXAMINING ATTORNEY

CLASS 35—(Continued).

SN 77-290,186. SHOE SHOW, INC., DBA BURLINGTON SHOES, CONCORD, NC. FILED 9-27-2007.

GOOD SERVICE COMES FROM
THE HEART

THE MARK CONSISTS OF STANDARD CHARACTERS WITHOUT CLAIM TO ANY PARTICULAR FONT, STYLE, SIZE, OR COLOR.

FOR RETAIL SHOE STORE SERVICES (U.S. CLS. 100, 101 AND 102).

FIRST USE 7-28-2007; IN COMMERCE 7-28-2007.
ELLEN PERKINS, EXAMINING ATTORNEY

SN 77-290,214. FLOATEC, LLC, HOUSTON, TX. FILED 9-27-2007.

BLUE OCEAN

THE MARK CONSISTS OF STANDARD CHARACTERS WITHOUT CLAIM TO ANY PARTICULAR FONT, STYLE, SIZE, OR COLOR.

FOR OPERATING OFFSHORE PLATFORMS FOR OIL AND GAS EXPLORATION AND PRODUCTION FOR OTHERS (U.S. CLS. 100, 101 AND 102).

JEAN IM, EXAMINING ATTORNEY

SN 77-290,329. EMPLOYEEBUDDY.COM, LLC, MADISON, WI. FILED 9-27-2007.



NO CLAIM IS MADE TO THE EXCLUSIVE RIGHT TO USE ".COM" OR "LLC", APART FROM THE MARK AS SHOWN.

THE COLOR(S) BLUE, BLACK, GREEN, GREY IS/ARE CLAIMED AS A FEATURE OF THE MARK.

THE MARK CONSISTS OF THE WORD "EMPLOYEE" WHICH IS CAPITALIZED AND COLORED A ROBIN'S EGG

CLASS 35—(Continued).

BLUE. THE WORD "BUDDY" IS CAPITALIZED AND IS COLORED BLACK. "BUDDY" FOLLOWS "EMPLOYEE" WITHOUT A SPACE. AN EIGHT POINTED STAR-LIKE DOT FOLLOWS, WHICH IS COLORED GREEN AND CONSISTS OF A CENTRAL DOT AND EIGHT OTHER DOTS LOCATED ON EIGHT SPOKES EMANATING FROM THE CENTRAL DOT. THE WORD "COM" FOLLOWS, NOT CAPITALIZED, AND COLORED DARK GREY. A COMMA AND THE ABBREVIATION "LLC", CAPITALIZED, FOLLOWS IN LIGHT GREY AND SMALLER FONT.

FOR PROVIDING AN ON-LINE SEARCHABLE DATABASE FEATURING CLASSIFIED AD LISTINGS AND EMPLOYMENT OPPORTUNITIES (U.S. CLS. 100, 101 AND 102).

FIRST USE 9-5-2007; IN COMMERCE 9-26-2007.

MATTHEW MCDOWELL, EXAMINING ATTORNEY

SN 77-290,565. ABDUR-RAHIM, DELICIA, GRANITE BAY, CA. AND DEWITT, NYEISHA, ANTIOCH, CA. FILED 9-27-2007.

T IN THE B

THE MARK CONSISTS OF STANDARD CHARACTERS WITHOUT CLAIM TO ANY PARTICULAR FONT, STYLE, SIZE, OR COLOR.

FOR ON-LINE RETAIL STORE SERVICES FEATURING CHILDREN'S CLOTHING, CHILDREN'S FOOTWEAR, CHILDREN'S HEADWEAR, EDUCATIONAL PRODUCTS, TOYS, CRAFT PRODUCTS, COLLECTIBLES (U.S. CLS. 100, 101 AND 102).

JENNIFER HETU, EXAMINING ATTORNEY

SN 77-290,571. SERAFUND, INC., BROOKLYN, NY. FILED 9-27-2007.

Serafund

THE MARK CONSISTS OF STANDARD CHARACTERS WITHOUT CLAIM TO ANY PARTICULAR FONT, STYLE, SIZE, OR COLOR.

FOR (BASED ON INTENT TO USE) BUSINESS SERVICES, NAMELY, MATCHING POTENTIAL PRIVATE INVESTORS WITH ENTREPRENEURS NEEDING FUNDING (U.S. CLS. 100, 101 AND 102).

JENNIFER HETU, EXAMINING ATTORNEY

CLASS 35—(Continued).

SN 77-290,747. ZIMMERMAN, MICHAEL A., WACO, TX. FILED 9-27-2007.

Mi Trabajo USA

THE MARK CONSISTS OF STANDARD CHARACTERS WITHOUT CLAIM TO ANY PARTICULAR FONT, STYLE, SIZE, OR COLOR.

NO CLAIM IS MADE TO THE EXCLUSIVE RIGHT TO USE "TRABAJO USA", APART FROM THE MARK AS SHOWN.

THE FOREIGN WORDING IN THE MARK TRANSLATES INTO ENGLISH AS MY WORK USA.

FOR CONSULTANCY OF PERSONNEL RECRUITMENT; EMPLOYMENT COUNSELING AND RECRUITING (U.S. CLS. 100, 101 AND 102).

KRISTINA MORRIS, EXAMINING ATTORNEY

CLASS 35—(Continued).

SN 77-291,199. BROWN, MELINDA DARLENE KIRSCH, PLANTATION, FL. FILED 9-28-2007.

YOU CAN'T TOUCH LOVE BUT YOU CAN FEEL LOVE YOU CAN'T TOUCH GOD BUT YOU CAN FEEL GOD

THE MARK CONSISTS OF STANDARD CHARACTERS WITHOUT CLAIM TO ANY PARTICULAR FONT, STYLE, SIZE, OR COLOR.

FOR ON-LINE RETAIL STORE SERVICES FEATURING T-SHIRTS, MUGS, POSTERS, PLAQUES, BUMPER STICKERS, AND GIFT ITEMS; WHOLESALE STORES FEATURING T-SHIRTS, MUGS, POSTERS, PLAQUES, BUMPER STICKERS, AND GIFT ITEMS (U.S. CLS. 100, 101 AND 102).

JAMES LOVELACE, EXAMINING ATTORNEY

SN 77-291,066. CLIFTON, DON & ST. GEORGE, JEREMIAH PARTNERSHIPS, THE, SEATTLE, WA. FILED 9-28-2007.

RIDE THE S.L.U.T.

THE MARK CONSISTS OF STANDARD CHARACTERS WITHOUT CLAIM TO ANY PARTICULAR FONT, STYLE, SIZE, OR COLOR.

FOR PROMOTING BUSINESS AND TOURISM AND TRANSPORTATION AND MASS TRANSIT IN SEATTLE, WA, AND IN PARTICULAR, IN THE SOUTH LAKE UNION THEREOF, I.E. THE AREA TO BE TRANSITED BY THE SOUTH LAKE UNION STREETCAR (U.S. CLS. 100, 101 AND 102).

FIRST USE 8-31-2007; IN COMMERCE 8-31-2007.
SUSAN STIGLITZ, EXAMINING ATTORNEY

SN 77-291,300. SUNQUBE, INC., RIVERSIDE, CA. FILED 9-28-2007.



THE MARK CONSISTS OF THE WORDS "SUNQUBE" IN STYLIZED TEXT. TO THE LEFT THERE IS A THREE DIMENSIONAL ROUND BALL OPENED UP IN HALF.

FOR WHOLESALE DISTRIBUTORSHIPS FEATURING SOLAR PANELS ESPECIALLY PV MODULES, SOLAR CHARGE CONTROLLERS ESPECIALLY REGULATORS, BATTERY CHARGERS, SOLAR INVERTERS ESPECIALLY SOLAR CONVERTERS, ENERGY SAVING BULBS (U.S. CLS. 100, 101 AND 102).

MATTHEW MCDOWELL, EXAMINING ATTORNEY

SN 77-291,071. HEAVENLY HANA, LLC, TORRANCE, CA. FILED 9-28-2007.

HEAVENLY HANA

THE MARK CONSISTS OF STANDARD CHARACTERS WITHOUT CLAIM TO ANY PARTICULAR FONT, STYLE, SIZE, OR COLOR.

FOR COMPUTERIZED ON-LINE RETAIL STORE SERVICES IN THE FIELD OF GENERAL MERCHANDISE FOR THE PORCH, PATIO, BACKYARD AND OTHER AREAS OUTSIDE THE HOME (U.S. CLS. 100, 101 AND 102).

GILBERT SWIFT, EXAMINING ATTORNEY

SN 77-291,318. L&S MOTOR'S INC., DBA HUNTINGTON HONDA, HUNTINGTON, NY. FILED 9-28-2007.

Make The Click

THE MARK CONSISTS OF STANDARD CHARACTERS WITHOUT CLAIM TO ANY PARTICULAR FONT, STYLE, SIZE, OR COLOR.

FOR ADVERTISING, MARKETING AND PROMOTIONAL SERVICES FOR AUTOMOTIVE DEALERSHIPS (U.S. CLS. 100, 101 AND 102).

KATHY DE JONGE, EXAMINING ATTORNEY

CLASS 35—(Continued).

SN 77-291,326. GOOD-HEARTED GROCERIES, INC., SANTA ANA, CA. FILED 9-28-2007.

Vegan For a Day

THE MARK CONSISTS OF STANDARD CHARACTERS WITHOUT CLAIM TO ANY PARTICULAR FONT, STYLE, SIZE, OR COLOR.

FOR PUBLIC ADVOCACY TO PROMOTE AWARENESS OF ANIMAL-FREE GROCERY PRODUCTS AND MORE SPECIFICALLY, THE BENEFICIAL IMPACT THAT BEING VEGAN FOR A DAY HAS ON ANIMAL WELFARE (U.S. CLS. 100, 101 AND 102).
DAVID TAYLOR, EXAMINING ATTORNEY

CLASS 35—(Continued).

SN 77-291,360. WILLIAMS, SAMUEL S., RENO, NV. FILED 9-28-2007.

Idea Quarry

THE MARK CONSISTS OF STANDARD CHARACTERS WITHOUT CLAIM TO ANY PARTICULAR FONT, STYLE, SIZE, OR COLOR.

FOR PROMOTION OF BUSINESS OPPORTUNITIES; BUSINESS DEVELOPMENT SERVICES, NAMELY, PROVIDING START-UP SUPPORT FOR BUSINESSES OF OTHERS (U.S. CLS. 100, 101 AND 102).
SUSAN LESLIE DUBOIS, EXAMINING ATTORNEY

SN 77-291,357. GRACIOUS ELOISE LLC, NEW YORK, NY. FILED 9-28-2007.

GRACIOUS ELOISE

THE MARK CONSISTS OF STANDARD CHARACTERS WITHOUT CLAIM TO ANY PARTICULAR FONT, STYLE, SIZE, OR COLOR.

FOR ON-LINE RETAIL STORE SERVICES FEATURING CUSTOM-DESIGNED, PERSONALIZED STATIONERY PRODUCTS (U.S. CLS. 100, 101 AND 102).
YAT SYE, LEE, EXAMINING ATTORNEY

SN 77-291,363. WILLIAMS, SAMUEL S., RENO, NE. FILED 9-28-2007.

Occasion Creating

THE MARK CONSISTS OF STANDARD CHARACTERS WITHOUT CLAIM TO ANY PARTICULAR FONT, STYLE, SIZE, OR COLOR.

FOR PROMOTION OF BUSINESS OPPORTUNITIES; BUSINESS DEVELOPMENT SERVICES, NAMELY, PROVIDING START-UP SUPPORT FOR BUSINESSES OF OTHERS (U.S. CLS. 100, 101 AND 102).
SUSAN LESLIE DUBOIS, EXAMINING ATTORNEY

SN 77-291,358. WILLIAMS, SAMUEL S., RENO, NV. FILED 9-28-2007.

Hiding In Plain Sight

THE MARK CONSISTS OF STANDARD CHARACTERS WITHOUT CLAIM TO ANY PARTICULAR FONT, STYLE, SIZE, OR COLOR.

FOR PROMOTION OF BUSINESS OPPORTUNITIES; BUSINESS DEVELOPMENT SERVICES, NAMELY, PROVIDING START-UP SUPPORT FOR BUSINESSES OF OTHERS (U.S. CLS. 100, 101 AND 102).
SUSAN LESLIE DUBOIS, EXAMINING ATTORNEY

SN 77-291,376. WILLIAMS, SAMUEL S., RENO, NV. FILED 9-28-2007.

Incuvation

THE MARK CONSISTS OF STANDARD CHARACTERS WITHOUT CLAIM TO ANY PARTICULAR FONT, STYLE, SIZE, OR COLOR.

FOR PROMOTION OF BUSINESS OPPORTUNITIES; BUSINESS DEVELOPMENT SERVICES, NAMELY, PROVIDING START-UP SUPPORT FOR BUSINESSES OF OTHERS (U.S. CLS. 100, 101 AND 102).
SUSAN LESLIE DUBOIS, EXAMINING ATTORNEY

CLASS 35—(Continued).

SN 77-291,401. INTERNET DOCTOR, RALEIGH, NC. FILED 9-28-2007.

INTERNET DOCTOR

THE MARK CONSISTS OF STANDARD CHARACTERS WITHOUT CLAIM TO ANY PARTICULAR FONT, STYLE, SIZE, OR COLOR.

NO CLAIM IS MADE TO THE EXCLUSIVE RIGHT TO USE "INTERNET", APART FROM THE MARK AS SHOWN.

FOR CONSULTING SERVICES PROVIDED TO SERVICE INDUSTRY PROFESSIONALS, NAMELY, MARKET ANALYSIS AND THE PROVISION OF INFORMATION AND ANALYSIS, ALL OF THE FOREGOING IN THE FIELD OF INTERNET WEBSITE BUSINESS (U.S. CLS. 100, 101 AND 102).

FIRST USE 5-8-2007; IN COMMERCE 5-8-2007.
SHAILA SETTLES, EXAMINING ATTORNEY

SN 77-291,407. ACOUSTIC VIBES MUSIC, INC., TEMPE, AZ. FILED 9-28-2007.

ACOUSTIC VIBES

THE MARK CONSISTS OF STANDARD CHARACTERS WITHOUT CLAIM TO ANY PARTICULAR FONT, STYLE, SIZE, OR COLOR.

FOR ON-LINE RETAIL STORE SERVICES FEATURING NEW AND USED MUSICAL INSTRUMENTS, PARTS AND ACCESSORIES; RETAIL STORE SERVICES FEATURING NEW AND USED MUSICAL INSTRUMENTS, PARTS AND ACCESSORIES (U.S. CLS. 100, 101 AND 102).

BRENDAN MCCAULEY, EXAMINING ATTORNEY

SN 77-291,518. HAZEL GROUP, LLC, CHICAGO, IL. FILED 9-28-2007.

Hazel Group

THE MARK CONSISTS OF STANDARD CHARACTERS WITHOUT CLAIM TO ANY PARTICULAR FONT, STYLE, SIZE, OR COLOR.

NO CLAIM IS MADE TO THE EXCLUSIVE RIGHT TO USE GROUP, APART FROM THE MARK AS SHOWN.

FOR ADVERTISING AND MARKETING SERVICES (U.S. CLS. 100, 101 AND 102).

TARAH HARDY, EXAMINING ATTORNEY

CLASS 35—(Continued).

SN 77-291,525. INSTITUTIONAL JOBBERS COMPANY, DBA THE IJ COMPANY, LOUISVILLE, TN. FILED 9-28-2007.



THE MARK CONSISTS OF THE LETTERS "I" AND "J" IN LOWERCASE, CONNECTED TOGETHER AND SURROUNDED BY TWO OVALS AT THEIR BASE.

FOR DISTRIBUTORSHIP SERVICES IN THE FIELDS OF FOOD AND FOOD SERVICE SUPPLIES (U.S. CLS. 100, 101 AND 102).

FIRST USE 8-31-2006; IN COMMERCE 8-31-2006.
JUDITH HELFMAN, EXAMINING ATTORNEY

SN 77-291,553. GREEN PAGES, LLC, INDIANTOWN, FL. FILED 9-28-2007.

gogoflorida.com

THE MARK CONSISTS OF STANDARD CHARACTERS WITHOUT CLAIM TO ANY PARTICULAR FONT, STYLE, SIZE, OR COLOR.

FOR ADVERTISING BUSINESS SERVICES, NAMELY, PROVIDING A SEARCHABLE ONLINE ADVERTISING GUIDE FEATURING THE GOODS AND SERVICES OF OTHER VENDORS VIA THE INTERNET (U.S. CLS. 100, 101 AND 102).

JOHN WILKE, EXAMINING ATTORNEY

SN 77-291,611. CAYMAX, LLC, SOUTHAMPTON, NJ. FILED 9-28-2007.

CAYMAX

THE MARK CONSISTS OF STANDARD CHARACTERS WITHOUT CLAIM TO ANY PARTICULAR FONT, STYLE, SIZE, OR COLOR.

FOR (BASED ON INTENT TO USE) BUSINESS CONSULTATION SERVICES (U.S. CLS. 100, 101 AND 102).

LINDA MICKLEBURGH, EXAMINING ATTORNEY

CLASS 35—(Continued).

SN 77-291,630. REXI MEDIA, DANVILLE, CA. FILED 9-28-2007.

Rexify

THE MARK CONSISTS OF STANDARD CHARACTERS WITHOUT CLAIM TO ANY PARTICULAR FONT, STYLE, SIZE, OR COLOR.

FOR BUSINESS ADVISORY SERVICES, CONSULTANCY AND INFORMATION (U.S. CLS. 100, 101 AND 102).

CURTIS FRENCH, EXAMINING ATTORNEY

SN 77-291,634. GREEN PAGES, LLC, INDIANTOWN, FL. FILED 9-28-2007.

The Green People Team

THE MARK CONSISTS OF STANDARD CHARACTERS WITHOUT CLAIM TO ANY PARTICULAR FONT, STYLE, SIZE, OR COLOR.

FOR ADVERTISING BUSINESS SERVICES, NAMELY, PROVIDING A SEARCHABLE ONLINE ADVERTISING GUIDE FEATURING THE GOODS AND SERVICES OF OTHER VENDORS VIA THE INTERNET (U.S. CLS. 100, 101 AND 102).

JOHN WILKE, EXAMINING ATTORNEY

SN 77-291,648. REXI MEDIA, DANVILLE, CA. FILED 9-28-2007.

Rexification

THE MARK CONSISTS OF STANDARD CHARACTERS WITHOUT CLAIM TO ANY PARTICULAR FONT, STYLE, SIZE, OR COLOR.

FOR BUSINESS ADVISORY SERVICES, CONSULTANCY AND INFORMATION (U.S. CLS. 100, 101 AND 102).

CURTIS FRENCH, EXAMINING ATTORNEY

CLASS 35—(Continued).

SN 77-291,659. REXI MEDIA, DANVILLE, CA. FILED 9-28-2007.

Distinguish Your People

THE MARK CONSISTS OF STANDARD CHARACTERS WITHOUT CLAIM TO ANY PARTICULAR FONT, STYLE, SIZE, OR COLOR.

FOR BUSINESS ADVISORY SERVICES, CONSULTANCY AND INFORMATION (U.S. CLS. 100, 101 AND 102).

CURTIS FRENCH, EXAMINING ATTORNEY

SN 77-291,690. GREEN PAGES, LLC, INDIANTOWN, FL. FILED 9-28-2007.

The New Color of Business is Green

THE MARK CONSISTS OF STANDARD CHARACTERS WITHOUT CLAIM TO ANY PARTICULAR FONT, STYLE, SIZE, OR COLOR.

FOR ADVERTISING BUSINESS SERVICES, NAMELY, PROVIDING A SEARCHABLE ONLINE ADVERTISING GUIDE FEATURING THE GOODS AND SERVICES OF OTHER VENDORS VIA THE INTERNET (U.S. CLS. 100, 101 AND 102).

JOHN WILKE, EXAMINING ATTORNEY

SN 77-291,880. CREATIVE MANAGEMENT SERVICES, LLC, CHESTNUT RIDGE, NY. FILED 9-28-2007.

MC2

THE MARK CONSISTS OF STANDARD CHARACTERS WITHOUT CLAIM TO ANY PARTICULAR FONT, STYLE, SIZE, OR COLOR.

OWNER OF U.S. REG. NO. 2,500,274.

FOR PROMOTING THE SALE OF GOODS AND SERVICES OF OTHERS THROUGH THE DESIGN, PRODUCTION AND MANAGEMENT OF EXHIBITS, MARKETING EVENTS, BUSINESS MEETINGS, ELECTRONIC MEDIA, ENTERTAINMENT AND EXPOSITIONS (U.S. CLS. 100, 101 AND 102).

FIRST USE 7-0-1999; IN COMMERCE 7-0-1999.

REBECCA SMITH, EXAMINING ATTORNEY

CLASS 35—(Continued).

SN 77-291,892. KMS COMMUNICATIONS, LLC, AUSTIN, TX. FILED 9-28-2007.

Silver Papery

THE MARK CONSISTS OF STANDARD CHARACTERS WITHOUT CLAIM TO ANY PARTICULAR FONT, STYLE, SIZE, OR COLOR.

NO CLAIM IS MADE TO THE EXCLUSIVE RIGHT TO USE "PAPERIE", APART FROM THE MARK AS SHOWN.

FOR RETAIL AND ON-LINE STORE SERVICES FEATURING INVITATIONS, BUSINESS CARDS, STATIONARY AND RELATED PAPER PRODUCTS (U.S. CLS. 100, 101 AND 102).

RONALD MCMORROW, EXAMINING ATTORNEY

CLASS 35—(Continued).

SN 77-292,091. KENSINGTON SERVICES, INC., OAK BROOK, IL. FILED 9-28-2007.

WEB2DEAL

THE MARK CONSISTS OF STANDARD CHARACTERS WITHOUT CLAIM TO ANY PARTICULAR FONT, STYLE, SIZE, OR COLOR.

FOR ACQUISITION AND MERGER CONSULTATION; CONSULTATION IN THE FIELD OF BUSINESS ACQUISITIONS (U.S. CLS. 100, 101 AND 102).

EVELYN BRADLEY, EXAMINING ATTORNEY

SN 77-291,959. CAR WASH ENTERPRISES, INC., SEATTLE, WA. FILED 9-28-2007.

WASH GREEN. CRUISE CLEAN.

THE MARK CONSISTS OF STANDARD CHARACTERS WITHOUT CLAIM TO ANY PARTICULAR FONT, STYLE, SIZE, OR COLOR.

FOR PUBLIC ADVOCACY TO PROMOTE AWARENESS OF USING ENVIRONMENTALLY RESPONSIBLE CAR WASHES; PROMOTION, ADVERTISING AND MARKETING OF ENVIRONMENTALLY RESPONSIBLE CAR WASHES (U.S. CLS. 100, 101 AND 102).

FIRST USE 6-30-2005; IN COMMERCE 6-30-2005.
JUDITH HELFMAN, EXAMINING ATTORNEY

SN 77-292,070. ELATIONS HEALTH, LLC, WHEATON, IL. FILED 9-28-2007.

ELATIONS HEALTH

THE MARK CONSISTS OF STANDARD CHARACTERS WITHOUT CLAIM TO ANY PARTICULAR FONT, STYLE, SIZE, OR COLOR.

NO CLAIM IS MADE TO THE EXCLUSIVE RIGHT TO USE "HEALTH", APART FROM THE MARK AS SHOWN.

FOR ADMINISTRATION OF A DISCOUNT PROGRAM FOR ENABLING PARTICIPANTS TO OBTAIN DISCOUNTS ON GOODS AND SERVICES THROUGH USE OF A DISCOUNT MEMBERSHIP CARD; MEMBERSHIP CLUB SERVICES PROVIDING DISCOUNTS AND PROCESSING REBATES FOR THE SERVICES OF OTHERS; PROMOTING THE GOODS AND SERVICES OF OTHERS THROUGH THE DISTRIBUTION OF DISCOUNT CARDS (U.S. CLS. 100, 101 AND 102).

FIRST USE 9-14-2007; IN COMMERCE 9-14-2007.
MELISSA VALLILLO, EXAMINING ATTORNEY

SN 77-292,127. TRAIL7 CONSULTING, LLC, DBA TRAIL7, HOUSTON, TX. FILED 9-28-2007.



THE COLOR(S) BLUE AND YELLOW IS/ARE CLAIMED AS A FEATURE OF THE MARK.

THE MARK CONSISTS OF THE WORD "TRAIL" IN BLUE AND THE NUMBER "7" IN YELLOW, THE TOP ARCH IN THE CURVED TRIANGLE IS YELLOW, THE LOWER TWO BEAMS ARE BLUE.

FOR ADVERTISING AND MARKETING; ADVERTISING SERVICES, NAMELY, PROMOTING AND MARKETING THE GOODS AND SERVICES OF OTHERS THROUGH ALL PUBLIC COMMUNICATION MEANS; ADVERTISING SERVICES, PUBLIC RELATIONS AND MARKETING SERVICES, NAMELY, PROMOTING AND MARKETING THE GOODS AND SERVICES OF OTHERS THROUGH ALL PUBLIC COMMUNICATION MEANS; ADVERTISING, MARKETING AND PROMOTION SERVICES; ADVERTISING, MARKETING AND PROMOTIONAL SERVICES FOR AUTOMOTIVE DEALERSHIPS; ADVERTISING, PROMOTION AND MARKETING SERVICES IN THE NATURE OF E-MAIL BLAST CAMPAIGNS FOR OTHERS; ADVICE IN THE FIELD OF BUSINESS MANAGEMENT AND MARKETING; BUSINESS ADVICE AND ANALYSIS OF MARKETS; BUSINESS CONSULTATION AND MANAGEMENT REGARDING MARKETING ACTIVITIES AND LAUNCHING OF NEW PRODUCTS; BUSINESS MANAGEMENT CONSULTING WITH RELATION TO STRATEGY, MARKETING, PRODUCTION, PERSONNEL AND RETAIL SALE MATTERS; BUSINESS MARKETING AND DIRECT MAIL CONSULTING SERVICES; BUSINESS MARKETING CONSULTING SERVICES; BUSINESS MARKETING SERVICES; CREATION OF MARKETING TOOLS DESIGNED TO INCREASE A CLIENT COMPANY'S KNOWLEDGE OF CUSTOMER NEEDS, AND ITS COMPETITORS' PRODUCTS AND SERVICES, PRICING, ADVERTISING STRATEGY AND SALES STRATEGY; CREATIVE MARKETING DESIGN SERVICES; CUSTOM WRITING SERVICES COMPRISING PUBLIC RELATIONS AND MARKETING MATERIALS FOR THE AUDIO, VIDEO AND TECHNOLOGY INDUSTRIES; DEVELOPMENT OF MARKETING STRA-

CLASS 35—(Continued).

TEGIES AND CONCEPTS; DIRECT MARKETING ADVERTISING FOR OTHERS; ENTERTAINMENT MARKETING SERVICES, NAMELY, MARKETING, PROMOTION AND ADVERTISING FOR INDEPENDENT RECORDING ARTISTS; MARKETING CONSULTING; MARKETING PLAN DEVELOPMENT; MARKETING SERVICES IN THE FIELD OF PLANNED-GIVING FOR NON-PROFIT AND CHARITABLE ORGANIZATIONS; MEDIA PLANNING, NAMELY, ADVISING THE CLIENT ON THE CORRECT TIMES AND STATIONS TO ADVERTISE BASED ON MEDIA ANALYSIS OF THE MARKET FOR THAT MEDIA; ON-LINE ADVERTISING AND MARKETING SERVICES; PROMOTING, ADVERTISING AND MARKETING OF THE ON-LINE WEBSITES OF OTHERS; PROMOTION AND MARKETING SERVICES AND RELATED CONSULTING; PROMOTION, ADVERTISING AND MARKETING OF ON-LINE WEBSITES; ADVERTISING AGENCIES, NAMELY, PROMOTING THE GOODS AND SERVICES OF OTHERS; ADVERTISING AND ADVERTISEMENT SERVICES (U.S. CLS. 100, 101 AND 102).

AMY HELLA, EXAMINING ATTORNEY

SN 77-292,204. CHOOSEI INC., FOREST HILLS, NY. FILED 9-29-2007.

CHOOSEI

THE MARK CONSISTS OF STANDARD CHARACTERS WITHOUT CLAIM TO ANY PARTICULAR FONT, STYLE, SIZE, OR COLOR.

FOR (BASED ON USE IN COMMERCE) PROVIDING AN ON-LINE SEARCHABLE DATABASE FEATURING CLASSIFIED AD LISTINGS AND EMPLOYMENT OPPORTUNITIES (U.S. CLS. 100, 101 AND 102).

FIRST USE 9-24-2007; IN COMMERCE 9-24-2007.
LINDA M. KING, EXAMINING ATTORNEY

CLASS 35—(Continued).

SN 77-292,214. LOUNGE 22 LLC, GLENDALE, CA. FILED 9-29-2007.

FACTOR22

THE MARK CONSISTS OF STANDARD CHARACTERS WITHOUT CLAIM TO ANY PARTICULAR FONT, STYLE, SIZE, OR COLOR.

FOR ADVERTISING SERVICES, NAMELY, CREATING CORPORATE AND BRAND IDENTITY FOR OTHERS; CONCEPT AND BRAND DEVELOPMENT IN THE FIELD OF AUTOMOTIVES, MANUFACTURING, RESTAURANTS, RETAIL, AND HIGH TECHNOLOGY COMPANIES; DESIGN OF ADVERTISING MATERIAL FOR OTHERS; ADVICE IN THE FIELD OF BUSINESS MANAGEMENT AND MARKETING; BUSINESS CONSULTATION AND MANAGEMENT REGARDING MARKETING ACTIVITIES AND LAUNCHING OF NEW PRODUCTS; CREATING MARKETING DESIGN SERVICES; DEVELOPMENT OF MARKETING STRATEGIES AND CONCEPTS; BUSINESS MANAGEMENT CONSULTING WITH RELATION TO STRATEGY, MARKETING, PRODUCTION, PERSONNEL AND RETAIL SALES MATTERS; AND MARKETING CONSULTING, PROMOTION AND MARKETING SERVICES AND RELATED CONSULTING (U.S. CLS. 100, 101 AND 102).

LINDA M. KING, EXAMINING ATTORNEY

SN 77-292,320. AUTONOTO INC., SANTA CLARA, CA. FILED 9-29-2007.

Autonoto

THE MARK CONSISTS OF STANDARD CHARACTERS WITHOUT CLAIM TO ANY PARTICULAR FONT, STYLE, SIZE, OR COLOR.

FOR ADVERTISING AND COMMERCIAL INFORMATION SERVICES, VIA THE INTERNET (U.S. CLS. 100, 101 AND 102).

FIRST USE 9-15-2007; IN COMMERCE 9-15-2007.

DEIRDRE ROBERTSON, EXAMINING ATTORNEY

SN 77-292,372. EMPIRE CONSULTING, INC., ELBURN, IL. FILED 9-30-2007.

Biz Blind Date

THE MARK CONSISTS OF STANDARD CHARACTERS WITHOUT CLAIM TO ANY PARTICULAR FONT, STYLE, SIZE, OR COLOR.

NO CLAIM IS MADE TO THE EXCLUSIVE RIGHT TO USE 'BIZ', APART FROM THE MARK AS SHOWN.

FOR ONLINE BUSINESS NETWORKING SERVICES (U.S. CLS. 100, 101 AND 102).

KAREN K. BUSH, EXAMINING ATTORNEY

CLASS 35—(Continued).

SN 77-292,390. SAGE MARKETING AND DESIGN, STUART, FL. FILED 9-30-2007.



THE COLOR(S) RED, WHITE, BLUE, YELLOW, AND BLACK IS/ARE CLAIMED AS A FEATURE OF THE MARK. THE MARK CONSISTS OF A SUPER HERO CAPSULE; THE UPPER PORTION OF CAPSULE IS BLUE; THE LOWER PORTION OF CAPSULE IS WHITE; THE "RX" SYMBOL HOLDING THE RED CAPE ON THE CAPSULE IS YELLOW; THE LETTERING SPELLING "ANDY BIOTIC", THE EYES AND THE OUTLINE OF THE MARK ARE BLACK; THE ARMS AND LEGS ARE WHITE.

FOR ADVERTISING AND COMMERCIAL INFORMATION SERVICES, VIA THE INTERNET; ADVERTISING AND PUBLICITY SERVICES, NAMELY, PROMOTING THE GOODS, SERVICES, BRAND IDENTITY AND COMMERCIAL INFORMATION AND NEWS OF THIRD PARTIES THROUGH PRINT, AUDIO, VIDEO, DIGITAL AND ON-LINE MEDIUM (U.S. CLS. 100, 101 AND 102).
RAUL CORDOVA, EXAMINING ATTORNEY

SN 77-292,474. TLD ENTERPRISES, INC, SILVERDALE, WA. FILED 9-30-2007.

DOLLAR BEAR

THE MARK CONSISTS OF STANDARD CHARACTERS WITHOUT CLAIM TO ANY PARTICULAR FONT, STYLE, SIZE, OR COLOR.

OWNER OF U.S. REG. NO. 3,357,853.
FOR DISCOUNT STORES IN THE FIELD OF GENERAL CONSUMER MERCHANDISE, FOOD (U.S. CLS. 100, 101 AND 102).

FIRST USE 10-22-2006; IN COMMERCE 10-22-2006.
CARYN GLASSER, EXAMINING ATTORNEY

SN 77-292,488. ARMY OF MOMS, INC., AUSTIN, TX. FILED 10-1-2007.

ARMY OF MOMS

THE MARK CONSISTS OF STANDARD CHARACTERS WITHOUT CLAIM TO ANY PARTICULAR FONT, STYLE, SIZE, OR COLOR.

FOR EMPLOYMENT AGENCIES (U.S. CLS. 100, 101 AND 102).

KEVIN DINALLO, EXAMINING ATTORNEY

CLASS 35—(Continued).

SN 77-292,511. INTEGRITY NEWS MEDIA, INC., LA JOLLA, CA. FILED 10-1-2007.

Birthday Wishes

THE MARK CONSISTS OF STANDARD CHARACTERS WITHOUT CLAIM TO ANY PARTICULAR FONT, STYLE, SIZE, OR COLOR.

NO CLAIM IS MADE TO THE EXCLUSIVE RIGHT TO USE "BIRTHDAY", APART FROM THE MARK AS SHOWN.

FOR COMPUTERIZED ON-LINE GIFT ORDERING SERVICE WHICH MATCHES THE GIFT GIVER'S REQUIREMENTS WITH THE GIFT RECIPIENT'S WANTS AND NEEDS (U.S. CLS. 100, 101 AND 102).

FIRST USE 10-1-2007; IN COMMERCE 10-1-2007.
REBECCA GILBERT, EXAMINING ATTORNEY

SN 77-292,578. CVS PHARMACY, INC., WOONSOCKET, RI. FILED 10-1-2007.

FOR ALL THE WAYS YOU CARE

THE MARK CONSISTS OF STANDARD CHARACTERS WITHOUT CLAIM TO ANY PARTICULAR FONT, STYLE, SIZE, OR COLOR.

FOR RETAIL STORE SERVICES, NAMELY, PHARMACY, RETAIL DRUG STORE AND GENERAL MERCHANDISE STORE SERVICES, PROVIDED VIA APPLICANT'S STORES AND VIA THE INTERNET (U.S. CLS. 100, 101 AND 102).

ZACHARY BELLO, EXAMINING ATTORNEY

CLASS 35—(Continued).

SN 77-292,635. E & H DISTRIBUTING CO., NORTH LAS VEGAS, NV. FILED 10-1-2007.



OWNER OF U.S. REG. NOS. 2,582,532, 3,017,715 AND OTHERS.

NO CLAIM IS MADE TO THE EXCLUSIVE RIGHT TO USE SENIORLIVING, APART FROM THE MARK AS SHOWN.

THE COLOR(S) RED AND BLUE IS/ARE CLAIMED AS A FEATURE OF THE MARK.

THE MARK CONSISTS OF THREE STYLIZED RED WAVY LINES FOLLOWED BY A THIN RED HORIZONTAL LINE. THE WORD SENIORLIVING APPEARS IN BLUE ABOVE THE RED LINE. THE WORDS U.S. FOODSERVICE APPEAR IN BLUE BELOW THE RED LINE.

SEC. 2(F) "U.S. FOODSERVICE HAS BECOME DISTINCTIVE OF THE GOODS/SERVICES THROUGH THE APPLICANT'S SUBSTANTIALLY EXCLUSIVE AND CONTINUOUS USE IN COMMERCE FOR AT LEAST THE FIVE YEARS IMMEDIATELY BEFORE THE DATE OF THIS STATEMENT."

FOR WHOLESALE DISTRIBUTORSHIPS FEATURING FOOD, PAPER PRODUCTS, SUPPLIES AND EQUIPMENT RELATED TO THE FOOD SERVICE INDUSTRY (U.S. CLS. 100, 101 AND 102).

LOURDES AYALA, EXAMINING ATTORNEY

SN 77-292,644. LAWSON, KARA N., SANTA ANA, CA. FILED 10-1-2007.

Eli's Lids

THE MARK CONSISTS OF STANDARD CHARACTERS WITHOUT CLAIM TO ANY PARTICULAR FONT, STYLE, SIZE, OR COLOR.

NO CLAIM IS MADE TO THE EXCLUSIVE RIGHT TO USE "LIDS", APART FROM THE MARK AS SHOWN.

FOR ON-LINE RETAIL STORE SERVICES FEATURING HATS, STUFFED TOYS, BIBS, BLANKETS, JACKETS, AND SHIRTS (U.S. CLS. 100, 101 AND 102).

FIRST USE 1-1-2007; IN COMMERCE 1-1-2007.

MIDGE BUTLER, EXAMINING ATTORNEY

CLASS 35—(Continued).

SN 77-292,675. BENARI JEWELERS OF EXTON, INC., EXTON, PA. FILED 10-1-2007.

serious about diamonds

THE MARK CONSISTS OF STANDARD CHARACTERS WITHOUT CLAIM TO ANY PARTICULAR FONT, STYLE, SIZE, OR COLOR.

NO CLAIM IS MADE TO THE EXCLUSIVE RIGHT TO USE "DIAMONDS", APART FROM THE MARK AS SHOWN.

FOR RETAIL JEWELRY STORES FEATURING DIAMOND JEWELRY (U.S. CLS. 100, 101 AND 102).

FIRST USE 9-28-2007; IN COMMERCE 9-28-2007.

BRIAN CALLAGHAN, EXAMINING ATTORNEY

SN 77-292,711. 336 LIQUOR STORE, INC., NEW YORK, NY. FILED 10-1-2007.

THE TRUTH IS IN THE BOTTLE

THE MARK CONSISTS OF STANDARD CHARACTERS WITHOUT CLAIM TO ANY PARTICULAR FONT, STYLE, SIZE, OR COLOR.

FOR CATALOG ORDERING SERVICE FEATURING WINES AND SPIRITS; MAIL ORDER SERVICES FEATURING WINES AND SPIRITS; ON-LINE RETAIL STORE SERVICES FEATURING WINES AND SPIRITS; RETAIL STORE SERVICES FEATURING WINES AND SPIRITS (U.S. CLS. 100, 101 AND 102).

FIRST USE 7-15-2006; IN COMMERCE 7-15-2006.

REBECCA GILBERT, EXAMINING ATTORNEY

SN 77-292,765. MCCUTCHEON, PAM, WICHITA, KS. FILED 10-1-2007.

THE CLUTTER CUTTER

THE MARK CONSISTS OF STANDARD CHARACTERS WITHOUT CLAIM TO ANY PARTICULAR FONT, STYLE, SIZE, OR COLOR.

FOR PROFESSIONAL ORGANIZING SERVICES (U.S. CLS. 100, 101 AND 102).

FIRST USE 4-15-2003; IN COMMERCE 4-15-2003.

JANICE L. MCMORROW, EXAMINING ATTORNEY

CLASS 35—(Continued).

SN 77-292,809. EXD3, PAHRUMP, NV. FILED 10-1-2007.

eXD3

THE MARK CONSISTS OF STANDARD CHARACTERS WITHOUT CLAIM TO ANY PARTICULAR FONT, STYLE, SIZE, OR COLOR.

FOR ON-LINE RETAIL STORE SERVICES AND RETAIL STORE SERVICES FEATRING BOBBLE HEAD DOLLS AND TOY COLLECTIBLES; ADVERTISING SERVICES FOR THIRD PARTIES IN CONNECTION WITH THE COMMERCIALIZATION AND SALE OF TOY COLLECTIBLES (U.S. CLS. 100, 101 AND 102).

ALICE BENMAMAN, EXAMINING ATTORNEY

CLASS 35—(Continued).

SN 77-292,904. SOLANA CORPORATION, LOS ALTOS HILLS, CA. FILED 10-1-2007.

CINCH

THE MARK CONSISTS OF STANDARD CHARACTERS WITHOUT CLAIM TO ANY PARTICULAR FONT, STYLE, SIZE, OR COLOR.

FOR PROMOTING THE SALE OF GOODS AND SERVICES OF OTHERS THROUGH THE ADMINISTRATION OF CUSTOMER LOYALTY, REWARD, PROMOTIONS, AND REDEMPTION PROGRAMS VIA ELECTRONIC FINANCIAL TRANSACTIONS (U.S. CLS. 100, 101 AND 102).

DAVID HOFFMAN, EXAMINING ATTORNEY

SN 77-292,827. THE SQUARE AGENCY, LLC, PHILADELPHIA, PA. FILED 10-1-2007.

SQUARECANVAS

THE MARK CONSISTS OF STANDARD CHARACTERS WITHOUT CLAIM TO ANY PARTICULAR FONT, STYLE, SIZE, OR COLOR.

FOR PROVIDING ONLINE INFORMATION IN THE FIELD OF ADVERTISING (U.S. CLS. 100, 101 AND 102).

CHRISTINE COOPER, EXAMINING ATTORNEY

SN 77-292,949. NEXGEN RXMARKETING, CHERRY HILL, NJ. FILED 10-1-2007.

CVChannel

THE MARK CONSISTS OF STANDARD CHARACTERS WITHOUT CLAIM TO ANY PARTICULAR FONT, STYLE, SIZE, OR COLOR.

FOR ADVERTISING, MARKETING AND PROMOTION SERVICES (U.S. CLS. 100, 101 AND 102).

JASON BLAIR, EXAMINING ATTORNEY

SN 77-292,876. VIZI INC., NEW YORK, NY. FILED 10-1-2007.

Meet Your Audience

THE MARK CONSISTS OF STANDARD CHARACTERS WITHOUT CLAIM TO ANY PARTICULAR FONT, STYLE, SIZE, OR COLOR.

FOR ADVERTISING AND ADVERTISEMENT SERVICES; ADVERTISING AND MARKETING; ADVERTISING BY TRANSMISSION OF ON-LINE PUBLICITY FOR THIRD PARTIES THROUGH ELECTRONIC COMMUNICATIONS NETWORKS; ADVERTISING SERVICES; ADVERTISING VIA ELECTRONIC MEDIA AND SPECIFICALLY THE INTERNET (U.S. CLS. 100, 101 AND 102).

FIRST USE 5-0-2006; IN COMMERCE 5-0-2006.
DAVID MURRAY, EXAMINING ATTORNEY

SN 77-292,984. PAYPERPOST, INC., ORLANDO, FL. FILED 10-1-2007.

CloudShout

THE MARK CONSISTS OF STANDARD CHARACTERS WITHOUT CLAIM TO ANY PARTICULAR FONT, STYLE, SIZE, OR COLOR.

FOR DISSEMINATION OF ADVERTISING FOR OTHERS VIA THE INTERNET (U.S. CLS. 100, 101 AND 102).

ATTIYA MALIK, EXAMINING ATTORNEY

CLASS 35—(Continued).

SN 77-293,002. PAYPERPOST, INC., ORLANDO, FL. FILED 10-1-2007.

bzzooka

THE MARK CONSISTS OF STANDARD CHARACTERS WITHOUT CLAIM TO ANY PARTICULAR FONT, STYLE, SIZE, OR COLOR.

FOR DISSEMINATION OF ADVERTISING FOR OTHERS VIA THE INTERNET (U.S. CLS. 100, 101 AND 102).

ATTIYA MALIK, EXAMINING ATTORNEY

SN 77-293,010. WAGNER ID LLC, BERKELEY, CA. FILED 10-1-2007.

Executive Attache

THE MARK CONSISTS OF STANDARD CHARACTERS WITHOUT CLAIM TO ANY PARTICULAR FONT, STYLE, SIZE, OR COLOR.

NO CLAIM IS MADE TO THE EXCLUSIVE RIGHT TO USE "EXECUTIVE", APART FROM THE MARK AS SHOWN.

FOR BUSINESS ADMINISTRATION AND OFFICE WORK; BUSINESS CONSULTATION SERVICES; ACCOUNTANCY SERVICES; ACCOUNTING SERVICES; ACCOUNTS RECEIVABLE SERVICES; ADMINISTRATION OF BUSINESS PAYROLL FOR OTHERS; ADMINISTRATION, BILLING AND RECONCILIATION OF ACCOUNTS ON BEHALF OF OTHERS; ADMINISTRATIVE ACCOUNTING; ADMINISTRATIVE PROCESSING OF PURCHASE ORDERS; ADVERTISING AGENCIES, NAMELY, PROMOTING THE GOODS AND SERVICES OF OTHERS; ADVERTISING AND ADVERTISEMENT SERVICES; ADVERTISING AND BUSINESS SERVICES, NAMELY, SECURING AIRTIME ON ALL FORMS OF MEDIA COMMUNICATIONS STATIONS, SYSTEMS, NETWORKS, AND SERVICES FOR THE PURPOSE OF PROMOTING THE GOODS AND SERVICES OF OTHERS; ADVERTISING AND COMMERCIAL INFORMATION SERVICES, VIA THE INTERNET; ADVERTISING AND PROMOTION SERVICES AND RELATED CONSULTING; ADVERTISING AND PUBLICITY SERVICES; ADVERTISING AND PUBLICITY SERVICES, NAMELY, PROMOTING THE GOODS, SERVICES, BRAND IDENTITY AND COMMERCIAL INFORMATION AND NEWS OF THIRD PARTIES THROUGH PRINT, AUDIO, VIDEO, DIGITAL AND ON-LINE MEDIUM; ADVERTISING PARTICULARLY SERVICES FOR THE PROMOTION OF GOODS; ADVERTISING SERVICES; ADVERTISING SERVICES, NAMELY, PROMOTING PROPERTIES FOR SALE BY OWNER VIA THE INTERNET; ADVERTISING SERVICES, NAMELY, PROVIDING ADVERTISING SPACE IN A PERIODICAL; ADVERTISING SERVICES, NAMELY, CREATING CORPORATE AND BRAND IDENTITY FOR OTHERS; ADVERTISING SERVICES, NAMELY, CREATING CORPORATE LOGOS FOR OTHERS; ADVERTISING SERVICES, NAMELY, PROMOTING AND MARKETING THE GOODS AND SERVICES OF OTHERS THROUGH ALL PUBLIC COMMUNICATION MEANS; ADVERTISING SERVICES, NAMELY, PROMOTING THE FOOD AND WINE OF OTHERS; ADVERTISING SERVICES, NAMELY, PROMOTING THE GIFT CARDS OF OTHERS; ADVERTISING SERVICES, PUBLIC RELATIONS AND MARKETING SERVICES, NAMELY, PRO-

CLASS 35—(Continued).

MOTING AND MARKETING THE GOODS AND SERVICES OF OTHERS THROUGH ALL PUBLIC COMMUNICATION MEANS; ADVERTISING, INCLUDING PROMOTION OF PRODUCTS AND SERVICES OF THIRD PARTIES THROUGH SPONSORING ARRANGEMENTS AND LICENSE AGREEMENTS RELATING TO INTERNATIONAL SPORTS' EVENTS; ADVERTISING, INCLUDING PROMOTION RELATING TO THE SALE OF ARTICLES AND SERVICES FOR THIRD PARTIES BY THE TRANSMISSION OF ADVERTISING MATERIAL AND THE DISSEMINATION OF ADVERTISING MESSAGES ON COMPUTER NETWORKS; ADVERTISING, MARKETING AND PROMOTION SERVICES; ADVERTISING, PROMOTION AND MARKETING SERVICES IN THE NATURE OF E-MAIL BLAST CAMPAIGNS FOR OTHERS; ADVICE AND INFORMATION ABOUT CUSTOMER SERVICES AND PRODUCT MANAGEMENT AND PRICES ON INTERNET SITES IN CONNECTION WITH PURCHASES MADE OVER THE INTERNET; ADVISORY SERVICE FOR ORGANIZATIONAL ISSUES AND BUSINESS ADMINISTRATION, WITH AND WITHOUT THE HELP OF ELECTRONIC DATA BASES; ADVISORY SERVICES RELATING TO BUSINESS MANAGEMENT AND BUSINESS OPERATIONS; APPOINTMENT SCHEDULING SERVICES; BUSINESS ADMINISTRATION AND MANAGEMENT; BUSINESS ADMINISTRATION CONSULTANCY; BUSINESS ADVISORY SERVICES, CONSULTANCY AND INFORMATION; BUSINESS CARD DESIGN SERVICES; BUSINESS CONSULTATION SERVICES TO ASSIST NON-PROFIT ORGANIZATIONS IN PLANNING, MANAGING, AND CONDUCTING FUND RAISING ACTIVITIES VIA A GLOBAL COMPUTER NETWORK; BUSINESS CONSULTING AND INFORMATION SERVICES; BUSINESS CONSULTING SERVICE IN THE FIELD OF MEDICAL IMAGING CENTERS; BUSINESS CONSULTING SERVICES IN THE FIELD OF BUSINESS KNOWLEDGE TRANSFER THROUGH AUDIO TOOLS, NAMELY, RECORDING INTERVIEWS WITH SUBJECT MATTER EXPERTS FOR AN ORGANIZATION'S CAPTURE AND FUTURE USE; BUSINESS CONSULTING SERVICES RELATING TO PRODUCT DISTRIBUTION, OPERATIONS MANAGEMENT SERVICES, LOGISTICS, REVERSE LOGISTICS, SUPPLY CHAIN, AND PRODUCTION SYSTEMS AND DISTRIBUTION SOLUTIONS; BUSINESS CONSULTING SERVICES, NAMELY, ASSISTING LEGAL PROFESSIONALS IN ORGANIZING AND SETTING UP THEIR PRACTICES FOR OFFERING DIVORCE PLANNING AND FACILITATION AND LEGAL DOCUMENT SERVICES TO THEIR CLIENTS; BUSINESS DEVELOPMENT SERVICES, NAMELY, PROVIDING START-UP SUPPORT FOR BUSINESSES OF OTHERS; BUSINESS INFORMATION AND ACCOUNTING ADVISORY SERVICES; BUSINESS INTERMEDIARY AND ADVISORY SERVICES IN THE FIELD OF SELLING PRODUCTS AND RENDERING SERVICES; BUSINESS INVOICING SERVICES; BUSINESS MANAGEMENT CONSULTANCY AND ADVISORY SERVICES; BUSINESS MANAGEMENT CONSULTANCY SERVICES; BUSINESS MANAGEMENT CONSULTING AND ADVISORY SERVICES; BUSINESS MARKETING AND DIRECT MAIL CONSULTING SERVICES; BUSINESS MARKETING CONSULTING SERVICES; BUSINESS MARKETING SERVICES; BUSINESS OPERATION, BUSINESS ADMINISTRATION AND OFFICE FUNCTIONS; BUSINESS ORGANIZATION AND MANAGEMENT CONSULTING SERVICES; BUSINESS RESEARCH SERVICES, NAMELY, PROVIDING ANALYSIS OF RETAIL DATA ON SPECIFIC BUSINESS LOCATIONS; BUSINESS SERVICES, NAMELY, FACILITIES MANAGEMENT OF TECHNICAL OPERATIONS; BUSINESS SERVICES, NAMELY, MATCHING POTENTIAL PRIVATE INVESTORS WITH ENTREPRENEURS NEEDING FUNDING; BUSINESS SERVICES, NAMELY, REGISTERING, SCREENING, CREDENTIALING, AND ORGANIZING THIRD-PARTY VENDORS, SUPPLIERS, AND CONTRACTORS, AND DOCUMENTATION AND INFORMATION ON BEHALF OF OTHERS; COMPARISON SHOPPING SERVICES; CONSULTANCY SERVICES REGARDING BUSINESS STRATEGIES; CONSULTATION SERVICES IN THE FIELD OF COMPANY, BUSINESS SECTOR AND INDUSTRY DATA AND RESEARCH; CONSULTING SERVICES IN BUSINESS ORGANIZATION AND MANAGEMENT; CONSULTING SERVICES IN THE AREA OF SUSTAINABLE BUSINESS SOLUTIONS; CONSULTING SERVICES RELATING TO PUBLICITY; CORPORATE IMAGE CON-

CLASS 35—(Continued).

SULTING SERVICES; CREATION OF MARKETING TOOLS DESIGNED TO INCREASE A CLIENT COMPANY'S KNOWLEDGE OF CUSTOMER NEEDS, AND ITS COMPETITORS' PRODUCTS AND SERVICES, PRICING, ADVERTISING STRATEGY AND SALES STRATEGY; CREATIVE MARKETING DESIGN SERVICES; CUSTOM WRITING SERVICES COMPRISING PUBLIC RELATIONS AND MARKETING MATERIALS FOR THE AUDIO, VIDEO AND TECHNOLOGY INDUSTRIES; CUSTOMER LOYALTY SERVICES AND CUSTOMER CLUB SERVICES, FOR COMMERCIAL, PROMOTIONAL AND/OR ADVERTISING PURPOSES; DIRECT MARKETING CONSULTING SERVICES; DIRECT MARKETING SERVICES; DRIVE-THROUGH RETAIL STORE SERVICES FEATURING COFFEE AND RELATED GOODS; EXECUTIVE SEARCH AND PLACEMENT SERVICES; GENERAL BUSINESS NETWORKING REFERRAL SERVICES, NAMELY, PROMOTING THE GOODS AND SERVICES OF OTHERS BY PASSING BUSINESS LEADS AND REFERRALS AMONG GROUP MEMBERS; INTERNET ADVERTISING SERVICES; INVOICING SERVICES; ISSUING GIFT CERTIFICATES WHICH MAY THEN BE REDEEMED FOR GOODS OR SERVICES; LAYOUT SERVICES FOR ADVERTISING PURPOSES; MARKET RESEARCH SERVICES; MARKETING SERVICES, NAMELY, PROVIDING INFORMATIONAL WEB PAGES DESIGNED TO GENERATE SALES TRAFFIC VIA HYPERLINKS TO OTHER WEB SITES; MEMBERSHIP CLUB SERVICES PROVIDING DISCOUNTS AND PROCESSING REBATES FOR THE SERVICES OF OTHERS; MOVING AND RELOCATION SERVICES, NAMELY, PLANNING AND IMPLEMENTING MOVES OF HOMES AND OFFICES; NEW BUSINESS VENTURE DEVELOPMENT AND FORMATION CONSULTING SERVICES; ON-LINE ADVERTISING AND MARKETING SERVICES; ONLINE BUSINESS NETWORKING SERVICES; ORGANIZATIONAL SERVICES FOR BUSINESS PURPOSES; RETAIL DELICATESSEN SERVICES; RETAIL DEPARTMENT STORE SERVICES; RETAIL STORE SERVICES FEATURING A WIDE VARIETY OF CONSUMER GOODS OF OTHERS; SALES PROMOTION FOR OTHERS PROVIDED THROUGH THE DISTRIBUTION AND THE ADMINISTRATION OF PRIVILEGED USER CARDS; SALES PROMOTION SERVICES; SECRETARIAL AND CLERICAL SERVICES; SERVICES RELATING TO THE ANALYSIS, EVALUATION, CREATION AND BRAND ESTABLISHMENT OF TRADEMARKS, TRADE NAMES AND DOMAIN NAMES; TAX ADVISORY SERVICES; TAX AND TAXATION PLANNING, ADVICE, INFORMATION AND CONSULTANCY SERVICES; TAX DECLARATION PROCEDURE SERVICES; TAX FILING SERVICES; TELEPHONE ANSWERING SERVICE; WORD PROCESSING AND TYPING SERVICES; WORD PROCESSING SERVICES (U.S. CLS. 100, 101 AND 102).
ATTIYA MALIK, EXAMINING ATTORNEY

SN 77-293,020. PAYERPOST, INC., ORLANDO, FL. FILED 10-1-2007.

tremblor

THE MARK CONSISTS OF STANDARD CHARACTERS WITHOUT CLAIM TO ANY PARTICULAR FONT, STYLE, SIZE, OR COLOR.
FOR DISSEMINATION OF ADVERTISING FOR OTHERS VIA THE INTERNET (U.S. CLS. 100, 101 AND 102).
ATTIYA MALIK, EXAMINING ATTORNEY

CLASS 35—(Continued).

SN 77-293,102. PLAYER, CLIFF, JACKSONVILLE, FL. FILED 10-1-2007.

PLAYERFINANCIALRESOURCES

THE MARK CONSISTS OF STANDARD CHARACTERS WITHOUT CLAIM TO ANY PARTICULAR FONT, STYLE, SIZE, OR COLOR.

FOR EMPLOYMENT HIRING, RECRUITING, PLACEMENT, STAFFING AND CAREER NETWORKING SERVICES (U.S. CLS. 100, 101 AND 102).
FIRST USE 6-1-2007; IN COMMERCE 6-1-2007.
JENNIFER HETU, EXAMINING ATTORNEY

SN 77-293,143. SOLANA CORPORATION, LOS ALTOS HILLS, CA. FILED 10-1-2007.



THE MARK CONSISTS OF THE WORD CINCH PARTIALLY ENCIRCLED BY THREE STYLIZED CURVED LINES EACH FORMING THE LETTER "C".

FOR PROMOTING THE SALE OF GOODS AND SERVICES OF OTHERS THROUGH THE ADMINISTRATION OF CUSTOMER LOYALTY, REWARD, PROMOTIONS, AND REDEMPTION PROGRAMS VIA ELECTRONIC FINANCIAL TRANSACTIONS (U.S. CLS. 100, 101 AND 102).
DAVID HOFFMAN, EXAMINING ATTORNEY

SN 77-293,241. JOCALE, LLC, MARYLAND HEIGHTS, MO. FILED 10-1-2007.

JOCALE FASHION JEWELRY

THE MARK CONSISTS OF STANDARD CHARACTERS WITHOUT CLAIM TO ANY PARTICULAR FONT, STYLE, SIZE, OR COLOR.

NO CLAIM IS MADE TO THE EXCLUSIVE RIGHT TO USE "FASHION JEWELRY", APART FROM THE MARK AS SHOWN.

FOR ON-LINE RETAIL STORE SERVICES FEATURING JEWELRY & RETAIL STORE SERVICES FEATURING JEWELRY (U.S. CLS. 100, 101 AND 102).
FIRST USE 9-17-2007; IN COMMERCE 9-17-2007.
CURTIS FRENCH, EXAMINING ATTORNEY

CLASS 35—(Continued).

SN 77-293,262. THE INSTITUTE FOR INNOVATION, INTEGRATION & IMPACT, INC., EMERALD HILLS, CA. FILED 10-1-2007.

REP

THE MARK CONSISTS OF STANDARD CHARACTERS WITHOUT CLAIM TO ANY PARTICULAR FONT, STYLE, SIZE, OR COLOR.

FOR BUSINESS CONSULTATION SERVICES (U.S. CLS. 100, 101 AND 102).

FIRST USE 4-0-2007; IN COMMERCE 4-0-2007.

DOMINIC J. FERRAIUOLO, EXAMINING ATTORNEY

SN 77-293,273. JOCALE, LLC, MARYLAND HEIGHTS, MO. FILED 10-1-2007.

NO CLAIM IS MADE TO THE EXCLUSIVE RIGHT TO USE "FASHION JEWELRY", APART FROM THE MARK AS SHOWN.

THE MARK CONSISTS OF THE STYLIZED LETTERING "J JOCALE FASHION JEWELRY", THE "J" IS UNDERNEATH AND "JOCALE" IS ON TOP WITH "FASHION JEWELRY" BELOW IT.

FOR ON-LINE RETAIL STORE SERVICES FEATURING JEWELRY & RETAIL STORE SERVICES FEATURING JEWELRY (U.S. CLS. 100, 101 AND 102).

FIRST USE 9-17-2007; IN COMMERCE 9-17-2007.

CURTIS FRENCH, EXAMINING ATTORNEY

SN 77-293,306. DRAY, SCOTT, TROY, MI. FILED 10-1-2007.

EVERYTHINGTOLIVE

THE MARK CONSISTS OF STANDARD CHARACTERS WITHOUT CLAIM TO ANY PARTICULAR FONT, STYLE, SIZE, OR COLOR.

FOR (BASED ON INTENT TO USE) ON-LINE TRADING SERVICES IN WHICH SELLER POSTS PRODUCTS TO BE AUCTIONED AND BIDDING IS DONE VIA THE INTERNET; PROVIDING A WEB SITE THAT ENABLES USERS TO POST ITEMS FOR SALE THROUGH ON-LINE CLASSIFIED ADVERTISEMENTS (U.S. CLS. 100, 101 AND 102).

ANNE MADDEN, EXAMINING ATTORNEY

CLASS 35—(Continued).

SN 77-293,336. NET X MEDIA INC., COQUITLAM, CANADA, FILED 10-1-2007.

THELEARNINGDOOR

THE MARK CONSISTS OF STANDARD CHARACTERS WITHOUT CLAIM TO ANY PARTICULAR FONT, STYLE, SIZE, OR COLOR.

FOR PROVIDING AN ONLINE DIRECTORY INFORMATION SERVICE FEATURING INFORMATION REGARDING EDUCATION AND TRAINING, NAMELY, PROVIDING AN ON-LINE SEARCHABLE BUSINESS DIRECTORY FEATURING AN ON-LINE REGISTRY OF EDUCATIONAL TRAINING AND EDUCATION PROVIDERS, EDUCATIONAL TRAINING AND EDUCATION COURSES; PROVIDING ON-LINE REGISTRATION SERVICES FOR EDUCATION AND TRAINING COURSES SELECTED FROM AN ON-LINE REGISTRY OF TRAINING AND EDUCATION COURSES; DISSEMINATION OF ADVERTISING FOR OTHERS VIA AN ON-LINE COMMUNICATIONS NETWORK ON THE INTERNET; PROMOTING THE GOODS AND SERVICES OF OTHERS BY PROVIDING A WEB SITE AT WHICH USERS CAN LINK TO EDUCATION AND EDUCATIONAL TRAINING SERVICE PROVIDERS; ONLINE BUSINESS NETWORKING SERVICES (U.S. CLS. 100, 101 AND 102).

CARYN GLASSER, EXAMINING ATTORNEY

SN 77-293,368. THREAD ME, LLC, DBA THREADME, LOS ANGELES, CA. FILED 10-1-2007.

FOR MARKETING SERVICES, NAMELY, PROVIDING INFORMATIONAL WEB PAGES DESIGNED TO GENERATE SALES TRAFFIC VIA HYPERLINKS TO OTHER WEB SITES; PROMOTING THE GOODS AND SERVICES OF OTHERS BY MEANS OF OPERATING AN ON-LINE SHOPPING MALL WITH LINKS TO THE RETAIL WEB SITES OF OTHERS; PROMOTING THE GOODS AND SERVICES OF OTHERS BY PROVIDING HYPERTEXT LINKS TO THE WEB SITES OF OTHERS; PROVIDING A WEB SITE AT WHICH USERS CAN OFFER GOODS FOR SALE AND BUY GOODS OFFERED BY OTHERS; PROVIDING A WEB SITE THAT ENABLES USERS TO POST ITEMS FOR SALE THROUGH ON-LINE CLASSIFIED ADVERTISEMENTS; PROVIDING A WEB SITE WHERE USERS CAN POST RATINGS, REVIEWS AND RECOMMENDATIONS ON PRODUCTS AND SERVICES; PROVIDING A WEB SITE WHEREBY BUYERS OF

CLASS 35—(Continued).

GOODS OR SERVICES LOCATE AND RECEIVE QUOTATIONS FROM MULTIPLE COMPETITIVE SOURCES AND SELLERS OF GOODS OR SERVICES IDENTIFY AND BID ON MULTIPLE NEW SALES OPPORTUNITIES; PROVIDING A WEB SITE WHICH FEATURES ADVERTISEMENTS FOR THE GOODS AND SERVICES OF OTHERS ON A GLOBAL COMPUTER NETWORK; PROVIDING ON-LINE DIRECTORY INFORMATION SERVICES ALSO FEATURING HYPERLINKS TO OTHER WEB SITES; PROVIDING SPACE AT A WEB SITE FOR THE ADVERTISEMENT OF THE GOODS AND SERVICES OF OTHERS; RENTAL OF ADVERTISING SPACE ON WEB SITES; CONDUCTING AN ON-LINE TRADESHOW EXHIBITION, IN THE FIELD OF FASHION; GENERAL BUSINESS NETWORKING REFERRAL SERVICES, NAMELY, PROMOTING THE GOODS AND SERVICES OF OTHERS BY PASSING BUSINESS LEADS AND REFERRALS AMONG GROUP MEMBERS; ON-LINE BUSINESS DIRECTORIES FEATURING FASHION; ONLINE BUSINESS NETWORKING SERVICES (U.S. CLS. 100, 101 AND 102).

SHANNON TWOHIG, EXAMINING ATTORNEY

CLASS 35—(Continued).

SN 77-293,841. ENGAGEMENT STRATEGIES, INC., BEVERLY HILLS, CA. FILED 10-2-2007.

ENGAGEMENT STRATEGIES

THE MARK CONSISTS OF STANDARD CHARACTERS WITHOUT CLAIM TO ANY PARTICULAR FONT, STYLE, SIZE, OR COLOR.

NO CLAIM IS MADE TO THE EXCLUSIVE RIGHT TO USE "STRATEGIES", APART FROM THE MARK AS SHOWN.

FOR MANAGEMENT AND BUSINESS CONSULTING SERVICES IN THE FIELD OF PROGRAMS TO ENHANCE EMPLOYEE AND CUSTOMER LOYALTY (U.S. CLS. 100, 101 AND 102).

FIRST USE 6-1-2005; IN COMMERCE 6-1-2005.
DAWN FELDMAN, EXAMINING ATTORNEY

SN 77-293,595. VCOM INTERNATIONAL MULTIMEDIA CORPORATION, SOUTH HACKENSACK, NJ. FILED 10-2-2007.

Comprehensive

FOR MAIL ORDER, DISTRIBUTORSHIP AND ON-LINE RETAIL STORE SERVICES IN THE FIELD OF VIDEO, AUDIO AND COMPUTER EQUIPMENT AND CABLE ASSEMBLIES, AND PARTS AND ACCESSORIES THEREFOR (U.S. CLS. 100, 101 AND 102).

FIRST USE 8-30-1976; IN COMMERCE 10-30-1976.
NAAKWAMA ANKRAH, EXAMINING ATTORNEY

SN 77-293,921. PAYPERPOST, INC., ORLANDO, FL. FILED 10-2-2007.

izea

PLATFORM for Performance

THE MARK CONSISTS OF STANDARD CHARACTERS WITHOUT CLAIM TO ANY PARTICULAR FONT, STYLE, SIZE, OR COLOR.

FOR HUMAN RESOURCES MANAGEMENT (U.S. CLS. 100, 101 AND 102).

FIRST USE 8-7-2007; IN COMMERCE 8-7-2007.
JAMES MACFARLANE, EXAMINING ATTORNEY

THE MARK CONSISTS OF STANDARD CHARACTERS WITHOUT CLAIM TO ANY PARTICULAR FONT, STYLE, SIZE, OR COLOR.

FOR DISSEMINATION OF ADVERTISING FOR OTHERS VIA THE INTERNET (U.S. CLS. 100, 101 AND 102).

ATTIYA MALIK, EXAMINING ATTORNEY

CLASS 35—(Continued).

SN 77-294,000. NEW YORK CITY ECONOMIC DEVELOPMENT CORPORATION, NEW YORK, NY. FILED 10-2-2007.



OWNER OF U.S. REG. NO. 2,079,235.
THE MARK CONSISTS OF AN ARROW INSIDE SQUARES.

FOR ECONOMIC DEVELOPMENT SERVICES, NAMELY, PROMOTION AND MARKETING OF NEW YORK CITY AS A GLOBAL BUSINESS CENTER AND PLACE TO LOCATE BUSINESSES (U.S. CLS. 100, 101 AND 102).

FIRST USE 9-0-1994; IN COMMERCE 9-0-1994.
ERNEST SHOSHO, EXAMINING ATTORNEY

SN 77-294,187. ADVERTISING.COM, INC., BALTIMORE, MD. FILED 10-2-2007.

WE MAKE THE WORLD CLICK

THE MARK CONSISTS OF STANDARD CHARACTERS WITHOUT CLAIM TO ANY PARTICULAR FONT, STYLE, SIZE, OR COLOR.

FOR ADVERTISING, MARKETING, AND PROMOTIONAL SERVICES, NAMELY, PLACEMENT AND DISSEMINATION OF ADVERTISING FOR OTHERS VIA THE INTERNET, GLOBAL COMPUTER NETWORKS, AND CABLE AND SATELLITE TELEVISION; ONLINE ADVERTISING SERVICES IN THE NATURE OF PROVIDING A SYSTEM OF CONTEXTUAL HYPERLINKING BETWEEN WEBSITE CONTENT AND THE ADVERTISEMENTS OF OTHERS; DISTRIBUTION OF THE ADVERTISEMENTS OF OTHERS VIA A VARIETY OF METHODS, NAMELY, VIA ADVERTISING NEWSLETTERS, E-MAIL, WIRELESS DEVICES, AND INTERACTIVE TELEVISION; PLACEMENT OF THE ADVERTISEMENTS OF OTHERS ON SEARCH ENGINES AND WEBSITES; PROVIDING ADVERTISING CAMPAIGN MANAGEMENT SERVICES IN THE NATURE OF TRACKING, ANALYZING, AND REPORTING ON CONSUMER DATA, DEMOGRAPHICS, AND CONSUMER BEHAVIORAL INFORMATION, COMPUTER NETWORK USE AND USERS FOR BUSINESS PURPOSES, AND CONSUMER RESPONSES TO ADVERTISEMENTS AND PROMOTIONAL MATERIALS; MANAGEMENT AND COMPILATION OF COMPUTERIZED DATABASES, NAMELY, CREATING AND MANAGING CUSTOMER LISTS AND CUSTOMER DATA IN A COMPUTER DATABASE FOR OTHERS; CONDUCTING MARKET RESEARCH, CONSUMER RESEARCH, AND CONSUMER OPINION AND MARKET RESEARCH SURVEYS; CONSULTING SERVICES IN THE FIELD OF ADVERTISING, MARKETING, AND PROMOTION; CREATION AND PREPARATION OF ADVERTISING AND MARKETING MATERIALS FOR OTHERS; PRO-

CLASS 35—(Continued).

MOTING THE GOODS AND SERVICES OF OTHERS THROUGH THE ELECTRONIC DISTRIBUTION OF COUPONS AND THROUGH THE ADMINISTRATION OF INCENTIVE AWARD PROGRAMS, SWEEPSTAKES CONTESTS, PROMOTIONAL CONTESTS, AND SPECIAL OFFER PROGRAMS; PROCUREMENT SERVICES, NAMELY, PURCHASING AND MANAGING ADVERTISING SPACE FOR WEBSITE OWNERS, NEWSLETTER PUBLISHERS AND E-MAIL PUBLISHERS ON INTERNET WEBSITES, IN E-MAIL NEWSLETTERS, AND IN INTERNET SEARCH LISTINGS; MANAGEMENT ASSISTANCE, NAMELY, ASSISTING WEBSITE OWNERS, PUBLISHERS OF E-MAIL NEWSLETTERS, AND INTERNET SEARCH LISTING PROVIDERS WITH THE MANAGEMENT OF THEIR INTERACTIVE ADVERTISING INVENTORY. ON-LINE TRADING SERVICES IN THE FIELD OF ADVERTISING IN WHICH SELLER POSTS WEBSITE TRAFFIC TO BE AUCTIONED AND BUYER BIDS FOR SUCH TRAFFIC VIA THE INTERNET; BUSINESS SERVICES, NAMELY, MATCHING ADVERTISERS NEEDING ADVERTISING VENUES WITH WEBSITE PUBLISHERS (U.S. CLS. 100, 101 AND 102).

NATALIE POLZER, EXAMINING ATTORNEY

SN 77-294,215. COLORECTAL CANCER COALITION, INC., ALEXANDRIA, VA. FILED 10-2-2007.

COVER YOUR BUTT

THE MARK CONSISTS OF STANDARD CHARACTERS WITHOUT CLAIM TO ANY PARTICULAR FONT, STYLE, SIZE, OR COLOR.

FOR PROMOTING PUBLIC AWARENESS OF PATIENT ISSUES RELATING TO COLORECTAL CANCER PREVENTION AND TREATMENT TO THE PUBLIC AND RESEARCHERS, PHYSICIANS AND POLICY MAKERS IN THE MEDICAL FIELD (U.S. CLS. 100, 101 AND 102).

FIRST USE 10-2-2007; IN COMMERCE 10-2-2007.
DAVID MURRAY, EXAMINING ATTORNEY

SN 77-294,273. O'NEILL, MIKELL E., DBA CHARMED ATTITUDES, COSTA MESA, CA. FILED 10-2-2007.

DO YOU DANGLE

THE MARK CONSISTS OF STANDARD CHARACTERS WITHOUT CLAIM TO ANY PARTICULAR FONT, STYLE, SIZE, OR COLOR.

FOR MAIL ORDER SERVICES FEATURING JEWELRY; STREET VENDOR SERVICES FEATURING JEWELRY; VENDING IN THE FIELD OF JEWELRY (U.S. CLS. 100, 101 AND 102).

FIRST USE 1-15-2007; IN COMMERCE 1-15-2007.
LINDA ORNDORFF, EXAMINING ATTORNEY

CLASS 35—(Continued).

SN 77-294,423. VUE MODEL MANAGEMENT, INC., LOS ANGELES, CA. FILED 10-2-2007.

VUE MODEL MANAGEMENT

THE MARK CONSISTS OF STANDARD CHARACTERS WITHOUT CLAIM TO ANY PARTICULAR FONT, STYLE, SIZE, OR COLOR.

NO CLAIM IS MADE TO THE EXCLUSIVE RIGHT TO USE "MODEL MANAGEMENT", APART FROM THE MARK AS SHOWN.

FOR MODELING AND TALENT AGENT SERVICES (U.S. CLS. 100, 101 AND 102).

FIRST USE 9-13-2007; IN COMMERCE 9-13-2007.
JENNY PARK, EXAMINING ATTORNEY

CLASS 35—(Continued).

SN 77-294,627. WRIGHT, CHRISTOPHER W., ADDISON, IL. FILED 10-2-2007.

luckymotors.com

THE MARK CONSISTS OF STANDARD CHARACTERS WITHOUT CLAIM TO ANY PARTICULAR FONT, STYLE, SIZE, OR COLOR.

FOR AUTOMOBILE DEALERSHIPS (U.S. CLS. 100, 101 AND 102).

FIRST USE 6-15-2007; IN COMMERCE 6-15-2007.
MARIAM MAHMOUDI, EXAMINING ATTORNEY

SN 77-294,605. SOLANO, RICHARD, LUTZ, FL. FILED 10-2-2007.

Valueshoring

THE MARK CONSISTS OF STANDARD CHARACTERS WITHOUT CLAIM TO ANY PARTICULAR FONT, STYLE, SIZE, OR COLOR.

FOR BUSINESS MANAGEMENT AND CONSULTATION; BUSINESS MANAGEMENT AND CONSULTATION IN THE FIELD OF INFORMATION TECHNOLOGY AND BUSINESS PROCESS SERVICES SOURCING (U.S. CLS. 100, 101 AND 102).

MARY MUNSON, EXAMINING ATTORNEY

SN 77-294,821. BULLSEYE TELECOM, INC., OAK PARK, MI. FILED 10-3-2007.

CostAdvantage

THE MARK CONSISTS OF STANDARD CHARACTERS WITHOUT CLAIM TO ANY PARTICULAR FONT, STYLE, SIZE, OR COLOR.

FOR COST MANAGEMENT IN THE FIELD OF TELECOMMUNICATIONS (U.S. CLS. 100, 101 AND 102).

FIRST USE 7-1-2007; IN COMMERCE 7-1-2007.
JOHN WILKE, EXAMINING ATTORNEY

SN 77-294,610. SOLANO, RICHARD, LUTZ, FL. FILED 10-2-2007.

Value-shoring

THE MARK CONSISTS OF STANDARD CHARACTERS WITHOUT CLAIM TO ANY PARTICULAR FONT, STYLE, SIZE, OR COLOR.

FOR BUSINESS MANAGEMENT AND CONSULTATION; BUSINESS MANAGEMENT AND CONSULTATION IN THE FIELD OF INFORMATION TECHNOLOGY AND BUSINESS PROCESS SERVICES SOURCING (U.S. CLS. 100, 101 AND 102).

MARY MUNSON, EXAMINING ATTORNEY

SN 77-294,925. ARNOLD, MICHELLE, KEAAU, HI. AND KAE0, JENNIFER, KEAAU, HI. FILED 10-3-2007.

Go Deep In The Bush

THE MARK CONSISTS OF STANDARD CHARACTERS WITHOUT CLAIM TO ANY PARTICULAR FONT, STYLE, SIZE, OR COLOR.

FOR RETAIL STORE SERVICES FEATURING CAMOUFLAGE APPAREL AND HUNTING GEAR (U.S. CLS. 100, 101 AND 102).

FIRST USE 1-0-2007; IN COMMERCE 6-0-2007.
GIANCARLO CASTRO, EXAMINING ATTORNEY

CLASS 35—(Continued).

SN 77-294,934. KLUBACK, EDWARD, SCARSDALE, NY. FILED 10-3-2007.

Shoe York

THE MARK CONSISTS OF STANDARD CHARACTERS WITHOUT CLAIM TO ANY PARTICULAR FONT, STYLE, SIZE, OR COLOR.

NO CLAIM IS MADE TO THE EXCLUSIVE RIGHT TO USE "SHOE", APART FROM THE MARK AS SHOWN.

FOR ON-LINE RETAIL STORE SERVICES FEATURING SNEAKERS, CLOTHING AND ACCESSORIES (U.S. CLS. 100, 101 AND 102).

FIRST USE 11-2-2004; IN COMMERCE 11-2-2004.
GIANCARLO CASTRO, EXAMINING ATTORNEY

CLASS 35—(Continued).

SN 77-295,139. NAGASE & CO., LTD., NISHI-KU, OSAKA-SHI, JAPAN, FILED 10-3-2007.



THE MARK CONSISTS OF THE STYLIZED LETTERS N AND D SHOWN INSIDE A TRIANGLE.

FOR IMPORT AND EXPORT AGENCY SERVICES; WHOLESALE DISTRIBUTORSHIP SERVICES FEATURING DYESTUFFS, CHEMICALS, PLASTICS, COSMETICS, PHARMACEUTICALS, HEALTHY FOODS, PLASTIC PROCESSING MACHINES AND APPARATUS, AUTOMOTIVE PRODUCTS, TEXTILES, HOUSING EQUIPMENT, BUILDING MATERIALS, SEMICONDUCTOR MACHINES AND APPARATUS, LIQUID CRYSTAL DISPLAY MANUFACTURING MACHINES AND APPARATUS, DIGITAL HARDWARE AND SOFTWARE, AND COMPUTER PROGRAMS; MARKETING RESEARCH; MARKETING RESEARCH STUDIES; SALES PROMOTION SERVICES FOR OTHERS (U.S. CLS. 100, 101 AND 102).

H. M. FISHER, EXAMINING ATTORNEY

SN 77-295,015. LENDETHICS, LLC, QUEEN CREEK, AZ. FILED 10-3-2007.



NO CLAIM IS MADE TO THE EXCLUSIVE RIGHT TO USE "LEND", APART FROM THE MARK AS SHOWN.

THE COLOR(S) RED AND GRAY IS/ARE CLAIMED AS A FEATURE OF THE MARK.

THE MARK CONSISTS OF THE WORD "LENDETHICS" WITH "LEND" IN RED AND "ETHICS" IN GRAY, AND ABOVE THE "ICS" A STYLIZED DESIGN OF THE ROOF AND CHIMNEY OF A HOUSE IN GREY WITH A RED HALO ABOVE THE CHIMNEY..

FOR PROVIDING A WEB SITE WHERE USERS CAN POST RATINGS, REVIEWS AND RECOMMENDATIONS ON LOAN PROFESSIONALS; MATCHING BORROWERS WITH POTENTIAL LENDERS IN THE FIELD OF CONSUMER AND MORTGAGE LENDING VIA THE INTERNET AND VIA A GLOBAL TELECOMMUNICATIONS NETWORK (U.S. CLS. 100, 101 AND 102).

NAAKWAMA ANKRAH, EXAMINING ATTORNEY

SN 77-295,183. STOKES, SUSAN G., DBA ANYTHING UNDER THE SUN, TORRANCR, CA. FILED 10-3-2007.



Anything Under The Sun

THE COLOR(S) DARK BLUE, LIGHT BLUE, YELLOW, BLACK IS/ARE CLAIMED AS A FEATURE OF THE MARK.

THE MARK CONSISTS OF THE LITERAL ELEMENT ANYTHING UNDER THE SUN AND ASSOCIATED DESIGN. THE DESIGN ELEMENT IS A SMALL ISLAND WITH A PALM TREE IN BLACK APPEARING IN THE MIDDLE OF THE MARK, WITH DARK AND LIGHT BLUE WATER AROUND IT, AND BEHIND THE ISLAND IS A LARGE YELLOW SUN SETTING ON THE HORIZON AND LIGHT BLUE SKY. THE WORDS "ANYTHING UNDER THE SUN" APPEAR IN BLACK BELOW THE DESIGN. NO EXTERIOR BACKGROUND COLOR TO THE LITERAL ELEMENT IS CLAIMED.

FOR ONLINE RETAIL CONSIGNMENT STORES FEATURING CLOTHING, NOVELTY GIFT ITEMS, JEWELRY (U.S. CLS. 100, 101 AND 102).

JUDITH HELFMAN, EXAMINING ATTORNEY

CLASS 35—(Continued).

SN 77-295,225. MEDSOL, INC., ORANGE PARK, FL. FILED 10-3-2007.



NO CLAIM IS MADE TO THE EXCLUSIVE RIGHT TO USE "LABORATORIES", APART FROM THE MARK AS SHOWN.

THE COLOR(S) BLACK AND BLUE IS/ARE CLAIMED AS A FEATURE OF THE MARK.

THE MARK CONSISTS OF A BLACK TELEPHONE HANDSET FORMING THE LETTER "C" INSIDE A BLUE RECTANGULAR BOX. THE LETTER "C" FORMS PART OF THE WORD "CALL" WHICH IS ALSO IN BLACK. TO THE RIGHT OF THE RECTANGLE IS THE WORDING "COMPREHENSIVE ASSISTANCE FOR LEADING LABORATORIES" IN BLACK EXCEPT FOR THE FIRST LETTER OF EACH OF THE WORDS WHICH ARE IN BLUE.

FOR BUSINESS MANAGEMENT AND CONSULTATION IN THE FIELD OF CLINICAL LABORATORY SETUP AND OPERATION (U.S. CLS. 100, 101 AND 102).
TARAH HARDY, EXAMINING ATTORNEY

CLASS 35—(Continued).

SN 77-295,399. TIME INC., NEW YORK, NY. FILED 10-3-2007.

INSTYLE

THE MARK CONSISTS OF STANDARD CHARACTERS WITHOUT CLAIM TO ANY PARTICULAR FONT, STYLE, SIZE, OR COLOR.

OWNER OF U.S. REG. NOS. 2,564,142, 3,194,185 AND OTHERS.

FOR PROVIDING AN ON-LINE COMPUTER DATABASE IN THE FIELD OF LOCATING PRODUCTS, DESCRIBING PRODUCTS, RATING PRODUCTS, PRICING PRODUCTS AND COMPARING PRICES OF PRODUCTS; PROVIDING CONSUMER PRODUCT INFORMATION VIA THE INTERNET; PROMOTING THE GOODS AND SERVICES OF OTHERS BY PROVIDING A WEBSITE FEATURING PRICE-COMPARISON INFORMATION, PRODUCT REVIEWS, DISCOUNT INFORMATION AND LINKS TO THE RETAIL WEBSITES OF OTHERS FEATURING APPAREL, HANDBAGS, WATCHES AND JEWELRY, FASHION ACCESSORIES, COSMETICS, FRAGRANCES, HEALTH AND BEAUTY PRODUCTS, BOOKS, AUDIO AND VIDEO RECORDINGS, ELECTRIC AND ELECTRONIC PRODUCTS, HOUSEHOLD APPLIANCES, PENS, PENCILS, STATIONERY ITEMS, FURNITURE, HOUSEWARES, DECORATIVE ITEMS, CUTLERY, LAMPS AND LIGHTING FIXTURES, TOWELS, SHEETS, BLANKETS, PILLOWS, NAPKINS, KITCHENWARE, CANDLES, FLOWERS, FOODS AND BEVERAGES, GLASSES, BOWLS, PLATES AND VASES; CONTESTS AND INCENTIVE AWARD PROGRAMS TO PROMOTE THE SALE OF PRODUCTS AND SERVICES OF OTHERS (U.S. CLS. 100, 101 AND 102).

FIRST USE 8-31-2005; IN COMMERCE 8-31-2005.
DOMINIC FATHY, EXAMINING ATTORNEY

SN 77-295,292. FULL AUTUMN MOON LLC, AUSTIN, TX. FILED 10-3-2007.

Choose Naturally

THE MARK CONSISTS OF STANDARD CHARACTERS WITHOUT CLAIM TO ANY PARTICULAR FONT, STYLE, SIZE, OR COLOR.

NO CLAIM IS MADE TO THE EXCLUSIVE RIGHT TO USE "NATURALLY", APART FROM THE MARK AS SHOWN.

FOR PROMOTING THE GOODS AND SERVICES OF OTHERS BY PROVIDING A WEBSITE FEATURING COUPONS, REBATES, PRICE-COMPARISON INFORMATION, PRODUCT REVIEWS, LINKS TO THE RETAIL WEBSITES OF OTHERS, AND DISCOUNT INFORMATION (U.S. CLS. 100, 101 AND 102).

FIRST USE 4-5-2007; IN COMMERCE 8-10-2007.

KATHLEEN LORENZO, EXAMINING ATTORNEY

SN 77-295,422. FORBA HOLDINGS, LLC, NASHVILLE, TN. FILED 10-3-2007.



THE MARK CONSISTS OF THE LETTER "F" DEPICTED AS A SWINGING DOOR.

FOR PERSONNEL RECRUITING SERVICES FOR DENTAL OFFICES (U.S. CLS. 100, 101 AND 102).

ALEX KEAM, EXAMINING ATTORNEY

CLASS 35—(Continued).

SN 77-295,515. NEUTRON DYNAMIC SYSTEMS INC., CRESTON, CANADA, FILED 10-3-2007.

MISCHIEVIOUS

THE MARK CONSISTS OF STANDARD CHARACTERS WITHOUT CLAIM TO ANY PARTICULAR FONT, STYLE, SIZE, OR COLOR.

FOR OPERATION OF A RETAIL OUTLET FEATURING PRERECORDED DIGITAL VIDEO DISCS (DVD'S) CONTAINING ADULT CONTENT AND PRERECORDED VIDEO TAPES CONTAINING ADULT CONTENT (U.S. CLS. 100, 101 AND 102).

CYNTHIA SLOAN, EXAMINING ATTORNEY



SN 77-295,516. FORBA HOLDINGS, LLC, NASHVILLE, TN. FILED 10-3-2007.

BETTER ACCESS FOR A BETTER AMERICA

THE MARK CONSISTS OF STANDARD CHARACTERS WITHOUT CLAIM TO ANY PARTICULAR FONT, STYLE, SIZE, OR COLOR.

FOR PERSONNEL RECRUITING SERVICES FOR DENTAL OFFICES (U.S. CLS. 100, 101 AND 102).

ALEX KEAM, EXAMINING ATTORNEY



SN 77-295,524. OFFSET ENTERPRISES, SACRAMENTO, CA. FILED 10-3-2007.

EARTHPOINTS

THE MARK CONSISTS OF STANDARD CHARACTERS WITHOUT CLAIM TO ANY PARTICULAR FONT, STYLE, SIZE, OR COLOR.

FOR PROMOTING THE GOODS AND SERVICES OF OTHERS BY ARRANGING FOR SPONSORS TO AFFILIATE THEIR GOODS AND SERVICES WITH PARTICIPATION IN CARBON OFFSET PROGRAMS (U.S. CLS. 100, 101 AND 102).

ALEX KEAM, EXAMINING ATTORNEY

CLASS 35—(Continued).

SN 77-295,613. Y INVESTMENT PROPERTIES, LLC, DULUTH, GA. FILED 10-3-2007.

FREIDOM

THE MARK CONSISTS OF STANDARD CHARACTERS WITHOUT CLAIM TO ANY PARTICULAR FONT, STYLE, SIZE, OR COLOR.

FOR PROVIDING REAL ESTATE LEADS FOR PROSPECTIVE PURCHASERS; REAL ESTATE ADVERTISING SERVICES; REAL ESTATE MARKETING SERVICES IN THE FIELD OF UNIMPROVED, RESIDENTIAL, COMMERCIAL, INDUSTRIAL, AND MIXED USE PROPERTIES INCLUDING SINGLE-FAMILY, MULTI-FAMILY, APARTMENT, CONDOMINIUM, COOPERATIVE, TOWNHOUSE, AND OFFICE REAL ESTATE PROPERTIES; REAL ESTATE MARKETING SERVICES, NAMELY, ON-LINE SERVICES FEATURING TOURS OF RESIDENTIAL AND COMMERCIAL REAL ESTATE (U.S. CLS. 100, 101 AND 102).

DAVID MILLER, EXAMINING ATTORNEY



SN 77-295,678. MERIDIAN ENTERTAINMENT, INC., OAKBROOK TERRACE, IL. FILED 10-3-2007.

got talent?

THE MARK CONSISTS OF STANDARD CHARACTERS WITHOUT CLAIM TO ANY PARTICULAR FONT, STYLE, SIZE, OR COLOR.

FOR MODELING AGENCIES; TALENT AGENCIES (U.S. CLS. 100, 101 AND 102).

ALLISON SCHRODY, EXAMINING ATTORNEY



SN 77-295,694. WILK, JASON P., WEST HOLLYWOOD, CA. FILED 10-3-2007.

1DAYSPO RTS.COM

THE MARK CONSISTS OF STANDARD CHARACTERS WITHOUT CLAIM TO ANY PARTICULAR FONT, STYLE, SIZE, OR COLOR.

FOR ON-LINE RETAIL STORE SERVICES FEATURING GOLF PRODUCTS AND SPORTING GOODS (U.S. CLS. 100, 101 AND 102).

FIRST USE 8-0-2006; IN COMMERCE 8-0-2006.

TEJBIR SINGH, EXAMINING ATTORNEY

CLASS 35—(Continued).

SN 77-295,732. CRAIG W. CAMERON, PROSPECT, KY. FILED 10-4-2007.

WHEALTHYWISE
"Turning Your Health into
Whealth"

THE MARK CONSISTS OF STANDARD CHARACTERS WITHOUT CLAIM TO ANY PARTICULAR FONT, STYLE, SIZE, OR COLOR.

FOR CONSULTING SERVICES IN THE COST AND PAYMENT MANAGEMENT OF HEALTH CARE; COST MANAGEMENT FOR THE HEALTH CARE BENEFIT PLANS OF OTHERS; HEALTH CARE COST REVIEW (U.S. CLS. 100, 101 AND 102).

CHRISTINA SOBRAL, EXAMINING ATTORNEY

CLASS 35—(Continued).

SN 77-295,998. GREATER MINNEAPOLIS CONVENTION & VISITORS ASSOCIATION, MINNEAPOLIS, MN. FILED 10-4-2007.

**Minneapolis St. Paul More
to Life**

THE MARK CONSISTS OF STANDARD CHARACTERS WITHOUT CLAIM TO ANY PARTICULAR FONT, STYLE, SIZE, OR COLOR.

NO CLAIM IS MADE TO THE EXCLUSIVE RIGHT TO USE "MINNEAPOLIS ST. PAUL", APART FROM THE MARK AS SHOWN.

FOR PROMOTION AND MARKETING SERVICES AND RELATED CONSULTING OF THE GREATER MINNEAPOLIS ST. PAUL AREA AS A DESTINATION SITE FOR BUSINESS, EMPLOYMENT, TRADE SHOWS, MEETINGS, TOURISM, LEISURE, TRAVEL AND EVENTS (U.S. CLS. 100, 101 AND 102).

HEATHER BIDDULPH, EXAMINING ATTORNEY

SN 77-296,011. KWARTLER, DAVID, SUNNY ISLES BEACH, FL. FILED 10-4-2007.

GOFIPO

THE MARK CONSISTS OF STANDARD CHARACTERS WITHOUT CLAIM TO ANY PARTICULAR FONT, STYLE, SIZE, OR COLOR.

FOR CLUB SERVICES, NAMELY, PROMOTING THE INTERESTS OF GOLFERS, FISHERMEN AND POKER PLAYERS (U.S. CLS. 100, 101 AND 102).

FIRST USE 11-27-2003; IN COMMERCE 9-14-2005.

KAELIE KUNG, EXAMINING ATTORNEY

SN 77-295,936. TRUE PARTNERS CONSULTING LLC, CHICAGO, IL. FILED 10-4-2007.

**TRUE PARTNERS CONSULTING
INTERNATIONAL**

THE MARK CONSISTS OF STANDARD CHARACTERS WITHOUT CLAIM TO ANY PARTICULAR FONT, STYLE, SIZE, OR COLOR.

OWNER OF U.S. REG. NO. 3,341,526.

NO CLAIM IS MADE TO THE EXCLUSIVE RIGHT TO USE "CONSULTING INTERNATIONAL", APART FROM THE MARK AS SHOWN.

FOR BUSINESS ADVISORY AND CONSULTANCY SERVICES RELATING TO TAX ACCOUNTING METHODS, BANKRUPTCY, BUSINESS RESTRUCTURING, CONTROVERSIES; ACCOUNTING FOR INCOME TAXES, MERGERS AND ACQUISITIONS, OPERATIONAL CONSULTING, PROPERTY TAX CONSULTING, TAX REFUND REVIEWS, SARBANES-OXLEY COMPLIANCE, SITE SELECTION AND NEGOTIATED INCENTIVES, TAX DUE DILIGENCE AND UNCLAIMED PROPERTY; TAX COMPLIANCE SERVICES; TAX ADVISORY SERVICES; TAX ADVISORY SERVICES IN THE NATURE OF RESEARCHING STATE TAX CREDITS AVAILABLE TO OFFSET CORPORATE INCOME TAX; AND TAX ADVISORY SERVICES CONCERNING ECONOMIC DEVELOPMENT INCENTIVES AVAILABLE TO COMPANIES (U.S. CLS. 100, 101 AND 102).

TARAH HARDY, EXAMINING ATTORNEY

SN 77-296,022. TIRECORE INT'L LTD, HUNTINGTON BEACH, CA. FILED 10-4-2007.

"EVERYTHING ROLLS"

THE MARK CONSISTS OF STANDARD CHARACTERS WITHOUT CLAIM TO ANY PARTICULAR FONT, STYLE, SIZE, OR COLOR.

FOR EXPORT AND IMPORT AGENCIES; WHOLESALE DISTRIBUTORSHIPS FEATURING TIRES (U.S. CLS. 100, 101 AND 102).

FIRST USE 1-1-2005; IN COMMERCE 1-1-2005.

KAELIE KUNG, EXAMINING ATTORNEY

CLASS 35—(Continued).

SN 77-296,030. GREATER MINNEAPOLIS CONVENTION & VISITORS ASSOCIATION, MINNEAPOLIS, MN. FILED 10-4-2007.

More to Life

THE MARK CONSISTS OF STANDARD CHARACTERS WITHOUT CLAIM TO ANY PARTICULAR FONT, STYLE, SIZE, OR COLOR.

FOR PROMOTION AND MARKETING SERVICES AND RELATED CONSULTING OF THE GREATER MINNEAPOLIS ST. PAUL AREA AS A DESTINATION SITE FOR BUSINESS, EMPLOYMENT, TRADE SHOWS, MEETINGS, TOURISM, LEISURE, TRAVEL AND EVENTS (U.S. CLS. 100, 101 AND 102).

HEATHER BIDDULPH, EXAMINING ATTORNEY

SN 77-296,034. WAGNER, STEVEN J., DBA KUDZU CONSULTANCY, GREENVILLE, SC. FILED 10-4-2007.



THE COLOR(S) BLACK AND GREEN IS/ARE CLAIMED AS A FEATURE OF THE MARK.

THE MARK CONSISTS OF GREEN "KUDZU" STAR WITH BLACK LETTERING.

FOR ADVERTISING AND BUSINESS MANAGEMENT CONSULTANCY; ADVERTISING AND MARKETING; ADVERTISING, MARKETING AND PROMOTION SERVICES; ADVERTISING, MARKETING AND PROMOTIONAL SERVICES FOR AUTOMOTIVE DEALERSHIPS; ADVICE IN THE FIELD OF BUSINESS MANAGEMENT AND MARKETING; ARRANGING AND CONDUCTING MARKETING PROMOTIONAL EVENTS FOR OTHERS; MARKETING CONSULTATION IN THE FIELD OF STRATEGY; MARKETING CONSULTING; PROMOTION AND MARKETING SERVICES AND RELATED CONSULTING; PROMOTION, ADVERTISING AND MARKETING OF ON-LINE WEBSITES; PROVIDING INFORMATION IN THE FIELD OF MARKETING AND ON-LINE MARKETING MEDIA VIA THE INTERNET (U.S. CLS. 100, 101 AND 102).

FIRST USE 3-1-2007; IN COMMERCE 3-1-2007.

RICHARD A. STRASER, EXAMINING ATTORNEY

CLASS 35—(Continued).

SN 77-296,134. MCNEELY MEDIA, DBA DBA/ JUSTTRUCKINGJOBS.COM, TRUCKDRIVINGJOBFINDER.COM, ELITETRUCKDRIVINGJOBS.COM, WILTON, AL. FILED 10-4-2007.

Power App

THE MARK CONSISTS OF STANDARD CHARACTERS WITHOUT CLAIM TO ANY PARTICULAR FONT, STYLE, SIZE, OR COLOR.

FOR (BASED ON INTENT TO USE) JOB PLACEMENT (U.S. CLS. 100, 101 AND 102).

GIANCARLO CASTRO, EXAMINING ATTORNEY

SN 77-296,148. ULTRAACCURRENT, INC., APTOS, CA. FILED 10-4-2007.

ONTOAUCTIONS

THE MARK CONSISTS OF STANDARD CHARACTERS WITHOUT CLAIM TO ANY PARTICULAR FONT, STYLE, SIZE, OR COLOR.

FOR BUSINESS ADVICE AND COMMERCIAL INFORMATION; DISSEMINATION OF ADVERTISING FOR OTHERS VIA THE INTERNET; PROVIDING CONSUMER PRODUCT INFORMATION VIA THE INTERNET; COMPARISON SHOPPING SERVICES; PROVIDING ON-LINE DIRECTORY INFORMATION SERVICES ALSO FEATURING HYPERLINKS TO OTHER WEB SITES; ON-LINE ADVERTISING AND MARKETING SERVICES (U.S. CLS. 100, 101 AND 102).

THEODORE MCBRIDE, EXAMINING ATTORNEY

SN 77-296,151. ULTRAACCURRENT, INC., APTOS, CA. FILED 10-4-2007.

ONTOWIKIS

THE MARK CONSISTS OF STANDARD CHARACTERS WITHOUT CLAIM TO ANY PARTICULAR FONT, STYLE, SIZE, OR COLOR.

FOR BUSINESS ADVICE AND COMMERCIAL INFORMATION; DISSEMINATION OF ADVERTISING FOR OTHERS VIA THE INTERNET; PROVIDING CONSUMER PRODUCT INFORMATION VIA THE INTERNET; COMPARISON SHOPPING SERVICES; PROVIDING ON-LINE DIRECTORY INFORMATION SERVICES ALSO FEATURING HYPERLINKS TO OTHER WEB SITES; ON-LINE ADVERTISING AND MARKETING SERVICES (U.S. CLS. 100, 101 AND 102).

THEODORE MCBRIDE, EXAMINING ATTORNEY

CLASS 35—(Continued).

SN 77-296,154. ULTRACONCURRENT, INC., APTOS, CA. FILED 10-4-2007.

ONTOSHOP

THE MARK CONSISTS OF STANDARD CHARACTERS WITHOUT CLAIM TO ANY PARTICULAR FONT, STYLE, SIZE, OR COLOR.

FOR BUSINESS ADVICE AND COMMERCIAL INFORMATION; DISSEMINATION OF ADVERTISING FOR OTHERS VIA THE INTERNET; PROVIDING CONSUMER PRODUCT INFORMATION VIA THE INTERNET; COMPARISON SHOPPING SERVICES; PROVIDING ON-LINE DIRECTORY INFORMATION SERVICES ALSO FEATURING HYPERLINKS TO OTHER WEB SITES; ON-LINE ADVERTISING AND MARKETING SERVICES (U.S. CLS. 100, 101 AND 102).

THEODORE MCBRIDE, EXAMINING ATTORNEY

SN 77-296,258. ELLA BAKER CENTER FOR HUMAN RIGHTS, OAKLAND, CA. FILED 10-4-2007.

GREEN FOR ALL

THE MARK CONSISTS OF STANDARD CHARACTERS WITHOUT CLAIM TO ANY PARTICULAR FONT, STYLE, SIZE, OR COLOR.

FOR CONDUCTING A PUBLIC AWARENESS CAMPAIGN TO PROMOTE, PROTECT AND ADVANCE ENVIRONMENTALISM AND HUMAN RIGHTS THROUGH PUBLIC EDUCATION AND DISSEMINATION OF INFORMATION RELATED TO THOSE ISSUES; PUBLIC ADVOCACY TO PROMOTE AWARENESS OF THE IMPORTANCE OF CREATING EMPLOYMENT OPPORTUNITIES AND JOB TRAINING IN THE AREAS OF ENERGY AND CLIMATE CHANGE (U.S. CLS. 100, 101 AND 102).

FIRST USE 9-25-2007; IN COMMERCE 9-25-2007.
ROBIN CHOSID, EXAMINING ATTORNEY

CLASS 35—(Continued).

SN 77-296,476. POPPIN' JAY INC., DBA BLUE CHIP MARKETING & COMMUNICATIONS, INC., NORTHBROOK, IL. FILED 10-4-2007.

Uniting Brand to Sales.

THE MARK CONSISTS OF STANDARD CHARACTERS WITHOUT CLAIM TO ANY PARTICULAR FONT, STYLE, SIZE, OR COLOR.

FOR (BASED ON USE IN COMMERCE) ADVERTISING AGENCIES, NAMELY, PROMOTING THE GOODS AND SERVICES OF OTHERS; ADVERTISING SERVICES, NAMELY, CREATING CORPORATE AND BRAND IDENTITY FOR OTHERS; ADVERTISING SERVICES, PUBLIC RELATIONS AND MARKETING SERVICES, NAMELY, PROMOTING AND MARKETING THE GOODS AND SERVICES OF OTHERS THROUGH ALL PUBLIC COMMUNICATION MEANS; ADVERTISING AND BUSINESS SERVICES, NAMELY, SECURING AIRTIME ON ALL FORMS OF MEDIA COMMUNICATIONS STATIONS, SYSTEMS, NETWORKS, AND SERVICES FOR THE PURPOSE OF PROMOTING THE GOODS AND SERVICES OF OTHERS; ADVERTISING AND PROMOTION SERVICES AND RELATED CONSULTING; ADVERTISING AND PUBLICITY SERVICES, NAMELY, PROMOTING THE GOODS, SERVICES, BRAND IDENTITY AND COMMERCIAL INFORMATION AND NEWS OF THIRD PARTIES THROUGH PRINT, AUDIO, VIDEO, DIGITAL AND ON-LINE MEDIUM; ADVERTISING PARTICULARLY SERVICES FOR THE PROMOTION OF GOODS; COOPERATIVE ADVERTISING AND MARKETING; CREATING AND UPDATING ADVERTISING MATERIAL; CREATION OF MARKETING TOOLS DESIGNED TO INCREASE A CLIENT COMPANY'S KNOWLEDGE OF CUSTOMER NEEDS, AND ITS COMPETITORS' PRODUCTS AND SERVICES, PRICING, ADVERTISING STRATEGY AND SALES STRATEGY; DESIGN OF ADVERTISING MATERIALS FOR OTHERS; DISTRIBUTION AND DISSEMINATION OF ADVERTISING MATERIALS; MEDIA PLANNING, NAMELY, ADVISING THE CLIENT ON THE CORRECT TIMES AND STATIONS TO ADVERTISE BASED ON MEDIA ANALYSIS OF THE MARKET FOR THAT MEDIA; PREPARATION AND REALIZATION OF MEDIA AND ADVERTISING PLANS AND CONCEPTS; ARRANGING AND CONDUCTING MARKETING PROMOTIONAL EVENTS FOR OTHERS; BUSINESS CONSULTATION AND MANAGEMENT REGARDING MARKETING ACTIVITIES AND LAUNCHING OF NEW PRODUCTS; BUSINESS MANAGEMENT CONSULTING WITH RELATION TO STRATEGY, MARKETING, PRODUCTION, PERSONNEL AND RETAIL SALE MATTERS; CREATIVE MARKETING DESIGN SERVICES; DEVELOPMENT OF MARKETING STRATEGIES AND CONCEPTS; MARKET RESEARCH CONSULTATION; MARKET STUDY AND ANALYSIS OF MARKET STUDIES; MARKETING PLAN DEVELOPMENT; PROVIDING ADVERTISING, MARKETING AND PROMOTIONAL SERVICES, NAMELY, DEVELOPMENT OF ADVERTISING CAMPAIGNS FOR FILM, RADIO, PRINT, OUTDOOR AND INTERACTIVE MEDIA; PRODUCTION AND DISTRIBUTION OF RADIO AND TELEVISION COMMERCIALS; SERVICES WITH REGARD TO PRODUCT PRESENTATION TO THE PUBLIC; DIRECT MARKETING ADVERTISING FOR OTHERS; DIRECT MARKETING CONSULTING SERVICES (U.S. CLS. 100, 101 AND 102).

FIRST USE 3-1-2002; IN COMMERCE 3-1-2002.
LINDA M. KING, EXAMINING ATTORNEY

CLASS 35—(Continued).

SN 77-296,544. D.L. RYAN & COMPANIES, LTD., WILTON, CT. FILED 10-4-2007.

CONTEMPO

THE MARK CONSISTS OF STANDARD CHARACTERS WITHOUT CLAIM TO ANY PARTICULAR FONT, STYLE, SIZE, OR COLOR.
FOR BUSINESS MARKETING SERVICES (U.S. CLS. 100, 101 AND 102).
MARK PILARO, EXAMINING ATTORNEY

SN 77-296,551. HOMEKNOWLEDGE, INC., BRENTWOOD, CA. FILED 10-4-2007.

HOMEKNOWLEDGE

THE MARK CONSISTS OF STANDARD CHARACTERS WITHOUT CLAIM TO ANY PARTICULAR FONT, STYLE, SIZE, OR COLOR.
FOR MATCHING CONSUMERS WITH PROFESSIONALS IN THE FIELD OF RESIDENTIAL AND COMMERCIAL SERVICES VIA COMPUTER NETWORK (U.S. CLS. 100, 101 AND 102).
MICHAEL ENGEL, EXAMINING ATTORNEY

SN 77-296,590. CREATIVE & RESPONSE RESEARCH SERVICES, INC., CHICAGO, IL. FILED 10-4-2007.

YOUTHBEAT

THE MARK CONSISTS OF STANDARD CHARACTERS WITHOUT CLAIM TO ANY PARTICULAR FONT, STYLE, SIZE, OR COLOR.
FOR RESEARCH SERVICES, NAMELY, CONDUCTING RESEARCH SURVEYS AND INTERVIEWS TO OBTAIN AN ASSESSMENT OF PRODUCTS, SERVICES, ADVERTISEMENTS AND PROMOTIONS (U.S. CLS. 100, 101 AND 102).
LINDA E. BLOHM, EXAMINING ATTORNEY

CLASS 35—(Continued).

SN 77-296,599. CREATIVE & RESPONSE RESEARCH SERVICES, INC., CHICAGO, IL. FILED 10-4-2007.

MOMSEYES

THE MARK CONSISTS OF STANDARD CHARACTERS WITHOUT CLAIM TO ANY PARTICULAR FONT, STYLE, SIZE, OR COLOR.
FOR RESEARCH SERVICES, NAMELY, CONDUCTING RESEARCH SURVEYS AND INTERVIEWS TO OBTAIN AN ASSESSMENT OF PRODUCTS, SERVICES, ADVERTISEMENTS AND PROMOTIONS (U.S. CLS. 100, 101 AND 102).
LINDA E. BLOHM, EXAMINING ATTORNEY

SN 77-296,623. VALPAK DIRECT MARKETING SYSTEMS, INC., LARGO, FL. FILED 10-4-2007.

THE BLUE ENVELOPE

THE MARK CONSISTS OF STANDARD CHARACTERS WITHOUT CLAIM TO ANY PARTICULAR FONT, STYLE, SIZE, OR COLOR.
FOR PROMOTING THE GOODS AND SERVICES OF OTHERS BY DESIGNING AND DISTRIBUTING THE ADVERTISING MATERIALS OF OTHERS AND PROMOTING THE GOODS AND SERVICES OF OTHERS BY DESIGNING AND DISTRIBUTING THE ADVERTISING MATERIALS OF OTHERS VIA A GLOBAL COMPUTER NETWORK (U.S. CLS. 100, 101 AND 102).
WENDY JUN, EXAMINING ATTORNEY

SN 77-296,626. LENDETHICS, LLC, QUEEN CREEK, AZ. FILED 10-4-2007.

**Rated by the people. For
the people.**

THE MARK CONSISTS OF STANDARD CHARACTERS WITHOUT CLAIM TO ANY PARTICULAR FONT, STYLE, SIZE, OR COLOR.
FOR PROVIDING A WEB SITE WHERE USERS CAN POST RATINGS, REVIEWS AND RECOMMENDATIONS ON LOAN PROFESSIONALS; MATCHING BORROWERS WITH POTENTIAL LENDERS IN THE FIELD OF CONSUMER AND MORTGAGE LENDING VIA THE INTERNET AND VIA A GLOBAL TELECOMMUNICATIONS NETWORK (U.S. CLS. 100, 101 AND 102).
NAAKWAMA ANKRAH, EXAMINING ATTORNEY

CLASS 35—(Continued).

SN 77-296,737. SMART & FINAL STORES LLC, COMMERCE, CA. FILED 10-4-2007.

HOT PRICE

THE MARK CONSISTS OF STANDARD CHARACTERS WITHOUT CLAIM TO ANY PARTICULAR FONT, STYLE, SIZE, OR COLOR.

FOR WHOLESALE AND RETAIL STORES FEATURING GROCERIES AND JANITORIAL AND RESTAURANT SUPPLIES (U.S. CLS. 100, 101 AND 102).
RICHARD WHITE, EXAMINING ATTORNEY

CLASS 35—(Continued).

SN 77-297,181. KARI D'AMATO INC., DENVER, CO. FILED 10-5-2007.

The Friendly Neighbor

THE MARK CONSISTS OF STANDARD CHARACTERS WITHOUT CLAIM TO ANY PARTICULAR FONT, STYLE, SIZE, OR COLOR.

FOR DISSEMINATION OF ADVERTISING MATERIAL; ADVERTISING FLYER DISTRIBUTION; DISTRIBUTION OF ADVERTISEMENTS AND COMMERCIAL ANNOUNCEMENTS; DESIGN OF ADVERTISING FLYERS FOR OTHERS (U.S. CLS. 100, 101 AND 102).
FIRST USE 1-1-2006; IN COMMERCE 1-1-2006.

RICHARD WHITE, EXAMINING ATTORNEY

SN 77-297,206. INTERNATIONAL FEDERATION OF DENTAL EDUCATORS AND ASSOCIATIONS, WASHINGTON, DC. FILED 10-5-2007.

IFDEA

THE MARK CONSISTS OF STANDARD CHARACTERS WITHOUT CLAIM TO ANY PARTICULAR FONT, STYLE, SIZE, OR COLOR.

FOR PROMOTING PUBLIC AWARENESS OF DENTAL EDUCATION AND ORAL HEALTH CARE (U.S. CLS. 100, 101 AND 102).

FIRST USE 7-11-2007; IN COMMERCE 7-11-2007.
AISHA CLARKE, EXAMINING ATTORNEY

SN 77-297,254. PRECURSOR LLC, MC LEAN, VA. FILED 10-5-2007.

STOP INTERNET CORRUPTION

THE MARK CONSISTS OF STANDARD CHARACTERS WITHOUT CLAIM TO ANY PARTICULAR FONT, STYLE, SIZE, OR COLOR.

NO CLAIM IS MADE TO THE EXCLUSIVE RIGHT TO USE "INTERNET", APART FROM THE MARK AS SHOWN.

FOR PUBLIC ADVOCACY TO PROMOTE AWARENESS OF THE NEED TO HALT ILLEGAL PRACTICES ON THE INTERNET INCLUDING ILLEGAL INTERNET USAGE (U.S. CLS. 100, 101 AND 102).

FLORENTINA BLANDU, EXAMINING ATTORNEY

SN 77-297,169. ABERCROMBIE & FITCH TRADING CO., NEW ALBANY, OH. FILED 10-5-2007.



THE MARK CONSISTS OF A MISCELLANEOUS DESIGN FOR ON-LINE RETAIL STORE SERVICES FEATURING CLOTHING, INTIMATE APPAREL AND ACCESSORIES, ATHLETIC WEAR AND ACCESSORIES, SWIM WEAR AND ACCESSORIES, FASHION ACCESSORIES, BAGS, FRAGRANCES, JEWELRY AND CANDLES; RETAIL STORES FEATURING CLOTHING, INTIMATE APPAREL AND ACCESSORIES, ATHLETIC WEAR AND ACCESSORIES, SWIM WEAR AND ACCESSORIES, FASHION ACCESSORIES, BAGS, FRAGRANCES, JEWELRY AND CANDLES; CATALOG ORDERING SERVICE FEATURING CLOTHING, INTIMATE APPAREL AND ACCESSORIES, ATHLETIC WEAR AND ACCESSORIES, SWIM WEAR AND ACCESSORIES, FASHION ACCESSORIES, BAGS, FRAGRANCES, JEWELRY AND CANDLES (U.S. CLS. 100, 101 AND 102).

FLORENTINA BLANDU, EXAMINING ATTORNEY

CLASS 35—(Continued).

SN 77-297,356. BULLSEYE TELECOM, INC., OAK PARK, MI. FILED 10-5-2007.

CORPORATE ADVANTAGE

THE MARK CONSISTS OF STANDARD CHARACTERS WITHOUT CLAIM TO ANY PARTICULAR FONT, STYLE, SIZE, OR COLOR.

FOR BUSINESS MANAGEMENT OF TELECOMMUNICATIONS AND INFORMATION TECHNOLOGY SYSTEMS FOR OTHERS (U.S. CLS. 100, 101 AND 102).

FIRST USE 12-17-2002; IN COMMERCE 12-17-2002.

JOHN WILKE, EXAMINING ATTORNEY

CLASS 35—(Continued).

SN 77-297,806. SWANSON, TERESA, SAN DIEGO, CA. FILED 10-5-2007.

TZTUDIO

THE MARK CONSISTS OF STANDARD CHARACTERS WITHOUT CLAIM TO ANY PARTICULAR FONT, STYLE, SIZE, OR COLOR.

FOR RETAIL STORE SERVICES FEATURING HAND CRAFTED AND DESIGNED JEWELRY, AS WELL AS VARIOUS PIECES OF ARTWORK, INCLUDING BUT NOT LIMITED TO PAINTINGS, DRAWINGS AND MURALS (U.S. CLS. 100, 101 AND 102).

FLORENTINA BLANDU, EXAMINING ATTORNEY

FLORENTINA BLANDU, EXAMINING ATTORNEY

SN 77-297,395. APPLEBEE'S INTERNATIONAL, INC., OVERLAND PARK, KS. FILED 10-5-2007.

APPLEBEE'S TOGETHER IS GOOD

THE MARK CONSISTS OF STANDARD CHARACTERS WITHOUT CLAIM TO ANY PARTICULAR FONT, STYLE, SIZE, OR COLOR.

FOR FRANCHISING, NAMELY, OFFERING TECHNICAL ASSISTANCE IN THE ESTABLISHMENT AND OPERATION OF RESTAURANTS (U.S. CLS. 100, 101 AND 102).

AISHA CLARKE, EXAMINING ATTORNEY

SN 77-298,304. REDCATS USA, L.P., INDIANAPOLIS, IN. FILED 10-8-2007.

CONVENIENCE IS KING

THE MARK CONSISTS OF STANDARD CHARACTERS WITHOUT CLAIM TO ANY PARTICULAR FONT, STYLE, SIZE, OR COLOR.

OWNER OF U.S. REG. NOS. 931,531, 2,706,494 AND OTHERS.

FOR ON-LINE RETAIL STORE SERVICES FEATURING MEN'S APPAREL, FOOTWEAR AND ACCESSORIES; MAIL ORDER CATALOG SERVICES FEATURING MEN'S APPAREL, FOOTWEAR AND ACCESSORIES (U.S. CLS. 100, 101 AND 102).

KEVIN DINALLO, EXAMINING ATTORNEY

SN 77-297,420. SUBPORTS INC., BROOKLYN, NY. FILED 10-5-2007.

Subports

THE MARK CONSISTS OF STANDARD CHARACTERS WITHOUT CLAIM TO ANY PARTICULAR FONT, STYLE, SIZE, OR COLOR.

FOR PROMOTING AND FACILITATING THE SALE OF THE GOODS AND SERVICES OF OTHERS BY MEANS OF OPERATING PORTABLE AND FIXED STOREFRONTS, DISPLAYS AND KIOSKS (U.S. CLS. 100, 101 AND 102).

FIRST USE 9-0-2006; IN COMMERCE 9-0-2006.

REBECCA GILBERT, EXAMINING ATTORNEY

SN 77-298,320. PERLMAN ERIC, GRANADA HILLS, CA. FILED 10-8-2007.

IT'S YOUR LIFE...FREE IT UP!

THE MARK CONSISTS OF STANDARD CHARACTERS WITHOUT CLAIM TO ANY PARTICULAR FONT, STYLE, SIZE, OR COLOR.

FOR COMPUTERIZED ON-LINE GIFT ORDERING SERVICE WHICH MATCHES THE GIFT GIVER'S REQUIREMENTS WITH THE GIFT RECIPIENT'S WANTS AND NEEDS (U.S. CLS. 100, 101 AND 102).

JORDAN BAKER, EXAMINING ATTORNEY

CLASS 35—(Continued).

SN 77-298,674. ULTRACONCURRENT, INC., APTOS, CA.
FILED 10-8-2007.

ONTOORG

THE MARK CONSISTS OF STANDARD CHARACTERS WITHOUT CLAIM TO ANY PARTICULAR FONT, STYLE, SIZE, OR COLOR.

FOR BUSINESS ADVICE AND COMMERCIAL INFORMATION; DISSEMINATION OF ADVERTISING FOR OTHERS VIA THE INTERNET; PROVIDING CONSUMER PRODUCT INFORMATION VIA THE INTERNET; COMPARISON SHOPPING SERVICES; PROVIDING ON-LINE DIRECTORY INFORMATION SERVICES ALSO FEATURING HYPERLINKS TO OTHER WEB SITES; ON-LINE ADVERTISING AND MARKETING SERVICES (U.S. CLS. 100, 101 AND 102).

THEODORE MCBRIDE, EXAMINING ATTORNEY

SN 77-299,352. CHRISTMAS PLACE, INC., PIGEON FORGE,
TN. FILED 10-9-2007.

CHRISTMAS PLACE TV

THE MARK CONSISTS OF STANDARD CHARACTERS WITHOUT CLAIM TO ANY PARTICULAR FONT, STYLE, SIZE, OR COLOR.

OWNER OF U.S. REG. NOS. 2,006,068, 2,307,808 AND OTHERS.

NO CLAIM IS MADE TO THE EXCLUSIVE RIGHT TO USE "TV", APART FROM THE MARK AS SHOWN.

FOR INTERACTIVE TELEVISION RETAIL SERVICES FEATURING GIFT ITEMS AND CHRISTMAS SPECIALTY GOODS (U.S. CLS. 100, 101 AND 102).

LINDA MICKLEBURGH, EXAMINING ATTORNEY

SN 77-299,373. ULTRACONCURRENT, INC., APTOS, CA.
FILED 10-9-2007.

ONTOVISUAL

THE MARK CONSISTS OF STANDARD CHARACTERS WITHOUT CLAIM TO ANY PARTICULAR FONT, STYLE, SIZE, OR COLOR.

FOR BUSINESS ADVICE AND COMMERCIAL INFORMATION; DISSEMINATION OF ADVERTISING FOR OTHERS VIA THE INTERNET; PROVIDING CONSUMER PRODUCT INFORMATION VIA THE INTERNET; COMPARISON SHOPPING SERVICES; PROVIDING ON-LINE DIRECTORY INFORMATION SERVICES ALSO FEATURING HYPERLINKS TO OTHER WEB SITES; ON-LINE ADVERTISING AND MARKETING SERVICES (U.S. CLS. 100, 101 AND 102).

THEODORE MCBRIDE, EXAMINING ATTORNEY

CLASS 35—(Continued).

SN 77-300,930. BROOKS, MARK, CASA GRANDE, AZ.
FILED 10-10-2007.

MOTOLAND

THE MARK CONSISTS OF STANDARD CHARACTERS WITHOUT CLAIM TO ANY PARTICULAR FONT, STYLE, SIZE, OR COLOR.

FOR COMPUTERIZED ON-LINE RETAIL STORE SERVICES IN THE FIELD OF MOTORCYCLES AND RELATED PARTS, CLOTHING AND ACCESSORIES; DISCOUNT STORES IN THE FIELD OF MOTORCYCLES AND RELATED PARTS, CLOTHING AND ACCESSORIES; ONLINE RETAIL CONSIGNMENT STORES FEATURING MOTORCYCLES AND RELATED PARTS, CLOTHING AND ACCESSORIES; RETAIL APPAREL STORES; RETAIL AUTOMOBILE PARTS AND ACCESSORIES STORES; RETAIL CLOTHING STORES; RETAIL CONSIGNMENT STORES FEATURING MOTORCYCLES AND RELATED PARTS, CLOTHING AND ACCESSORIES; RETAIL SPORTING GOODS STORES; RETAIL STORE SERVICES FEATURING A WIDE VARIETY OF CONSUMER GOODS OF OTHERS; RETAIL STORES FEATURING MOTORCYCLES AND RELATED PARTS, CLOTHING AND ACCESSORIES; RETAIL MOTORCYCLES AND RELATED PARTS, CLOTHING AND ACCESSORIES STORES; VIDEO STORES (U.S. CLS. 100, 101 AND 102).

FIRST USE 10-15-2004; IN COMMERCE 12-15-2005.

JAY FLOWERS, EXAMINING ATTORNEY

SN 77-301,431. LINCOLN NATIONAL CORPORATION,
RADNOR, PA. FILED 10-11-2007.

NOTES FROM YOUR FUTURESELF

THE MARK CONSISTS OF STANDARD CHARACTERS WITHOUT CLAIM TO ANY PARTICULAR FONT, STYLE, SIZE, OR COLOR.

FOR RECORDKEEPING SERVICES FOR OTHERS, NAMELY, INTERNAL REVENUE SECTION, 401(A), 401(K), 403(B), 457 AND 529 PLANS AND SIMPLIFIED PENSION PLANS; ADVERTISING, PUBLICITY AND BUSINESS SERVICES, NAMELY, SECURING AIRTIME ON ALL FORMS OF MEDIA COMMUNICATIONS STATIONS, SYSTEMS, NETWORKS AND INTERNET FOR THE PURPOSE OF PROMOTING THE GOODS AND SERVICES OF OTHERS; PROMOTING THE GOODS AND SERVICES OF OTHERS BY ARRANGING FOR SPONSORS TO AFFILIATE THEIR GOODS AND SERVICES WITH AN AWARDS PROGRAM, A SPORTS COMPETITION OR SPORTING ACTIVITIES; PROMOTING THE CONCERTS OF OTHERS; PROMOTING THE GOODS, SERVICES, BRAND IDENTITY AND COMMERCIAL INFORMATION AND NEWS OF THIRD PARTIES THROUGH PRINTED MATERIAL, AUDIO, VIDEO, DIGITAL AND ON-LINE MEDIUM, HYPertext LINKS TO WEB SITES OF OTHERS, AND PROMOTIONAL CONTESTS; ADVERTISING CONSULTATION; PRODUCTION, NAMELY, PRODUCTION OF INTERNET, TELEVISION AND RADIO COMMERCIALS AND PUBLIC SERVICE ANNOUNCEMENTS; AND PROMOTING SPORTS COMPETITIONS AND EVENTS OF OTHERS (U.S. CLS. 100, 101 AND 102).

EDWARD NELSON, EXAMINING ATTORNEY

CLASS 35—(Continued).

SN 77-301,435. LINCOLN NATIONAL CORPORATION, RADNOR, PA. FILED 10-11-2007.

CLASS 35—(Continued).

SN 77-301,438. LINCOLN NATIONAL CORPORATION, RADNOR, PA. FILED 10-11-2007.

LISTEN TO YOUR FUTURESELF

GET TO KNOW YOUR FUTURESELF

THE MARK CONSISTS OF STANDARD CHARACTERS WITHOUT CLAIM TO ANY PARTICULAR FONT, STYLE, SIZE, OR COLOR.

FOR RECORDKEEPING SERVICES FOR OTHERS, NAMELY, INTERNAL REVENUE SECTION, 401(A), 401(K), 403(B), 457 AND 529 PLANS AND SIMPLIFIED PENSION PLANS; ADVERTISING, PUBLICITY AND BUSINESS SERVICES, NAMELY, SECURING AIRTIME ON ALL FORMS OF MEDIA COMMUNICATIONS STATIONS, SYSTEMS, NETWORKS AND INTERNET FOR THE PURPOSE OF PROMOTING THE GOODS AND SERVICES OF OTHERS; PROMOTING THE GOODS AND SERVICES OF OTHERS BY ARRANGING FOR SPONSORS TO AFFILIATE THEIR GOODS AND SERVICES WITH AN AWARDS PROGRAM, A SPORTS COMPETITION OR SPORTING ACTIVITIES; PROMOTING THE CONCERTS OF OTHERS; PROMOTING THE GOODS, SERVICES, BRAND IDENTITY AND COMMERCIAL INFORMATION AND NEWS OF THIRD PARTIES THROUGH PRINTED MATERIAL, AUDIO, VIDEO, DIGITAL AND ON-LINE MEDIUM, HYPERTEXT LINKS TO WEB SITES OF OTHERS, AND PROMOTIONAL CONTESTS; ADVERTISING CONSULTATION; PRODUCTION, NAMELY, PRODUCTION OF INTERNET, TELEVISION AND RADIO COMMERCIALS AND PUBLIC SERVICE ANNOUNCEMENTS; AND PROMOTING SPORTS COMPETITIONS AND EVENTS OF OTHERS (U.S. CLS. 100, 101 AND 102).

EDWARD NELSON, EXAMINING ATTORNEY

THE MARK CONSISTS OF STANDARD CHARACTERS WITHOUT CLAIM TO ANY PARTICULAR FONT, STYLE, SIZE, OR COLOR.

FOR RECORDKEEPING SERVICES FOR OTHERS, NAMELY, INTERNAL REVENUE SECTION, 401(A), 401(K), 403(B), 457 AND 529 PLANS AND SIMPLIFIED PENSION PLANS; ADVERTISING, PUBLICITY AND BUSINESS SERVICES, NAMELY, SECURING AIRTIME ON ALL FORMS OF MEDIA COMMUNICATIONS STATIONS, SYSTEMS, NETWORKS AND INTERNET FOR THE PURPOSE OF PROMOTING THE GOODS AND SERVICES OF OTHERS; PROMOTING THE GOODS AND SERVICES OF OTHERS BY ARRANGING FOR SPONSORS TO AFFILIATE THEIR GOODS AND SERVICES WITH AN AWARDS PROGRAM, A SPORTS COMPETITION OR SPORTING ACTIVITIES; PROMOTING THE CONCERTS OF OTHERS; PROMOTING THE GOODS, SERVICES, BRAND IDENTITY AND COMMERCIAL INFORMATION AND NEWS OF THIRD PARTIES THROUGH PRINTED MATERIAL, AUDIO, VIDEO, DIGITAL AND ON-LINE MEDIUM, HYPERTEXT LINKS TO WEB SITES OF OTHERS, AND PROMOTIONAL CONTESTS; ADVERTISING CONSULTATION; PRODUCTION, NAMELY, PRODUCTION OF INTERNET, TELEVISION AND RADIO COMMERCIALS AND PUBLIC SERVICE ANNOUNCEMENTS; AND PROMOTING SPORTS COMPETITIONS AND EVENTS OF OTHERS (U.S. CLS. 100, 101 AND 102).

EDWARD NELSON, EXAMINING ATTORNEY

CLASS 35—(Continued).

SN 77-301,443. LINCOLN NATIONAL CORPORATION, RADNOR, PA. FILED 10-11-2007.

CLASS 35—(Continued).

SN 77-301,770. ULTRACONCURRENT, INC., APTOS, CA. FILED 10-11-2007.

FUTURESELF

THE MARK CONSISTS OF STANDARD CHARACTERS WITHOUT CLAIM TO ANY PARTICULAR FONT, STYLE, SIZE, OR COLOR.

FOR RECORDKEEPING SERVICES FOR OTHERS, NAMELY, INTERNAL REVENUE SECTION, 401(A), 401(K), 403(B), 457 AND 529 PLANS AND SIMPLIFIED PENSION PLANS; ADVERTISING, PUBLICITY AND BUSINESS SERVICES, NAMELY, SECURING AIRTIME ON ALL FORMS OF MEDIA COMMUNICATIONS STATIONS, SYSTEMS, NETWORKS AND INTERNET FOR THE PURPOSE OF PROMOTING THE GOODS AND SERVICES OF OTHERS; PROMOTING THE GOODS AND SERVICES OF OTHERS BY ARRANGING FOR SPONSORS TO AFFILIATE THEIR GOODS AND SERVICES WITH AN AWARDS PROGRAM, A SPORTS COMPETITION OR SPORTING ACTIVITIES; PROMOTING THE CONCERTS OF OTHERS; PROMOTING THE GOODS, SERVICES, BRAND IDENTITY AND COMMERCIAL INFORMATION AND NEWS OF THIRD PARTIES THROUGH PRINTED MATERIAL, AUDIO, VIDEO, DIGITAL AND ON-LINE MEDIUM, HYPERTEXT LINKS TO WEB SITES OF OTHERS, AND PROMOTIONAL CONTESTS; ADVERTISING CONSULTATION; PRODUCTION, NAMELY, PRODUCTION OF INTERNET, TELEVISION AND RADIO COMMERCIALS AND PUBLIC SERVICE ANNOUNCEMENTS; AND PROMOTING SPORTS COMPETITIONS AND EVENTS OF OTHERS (U.S. CLS. 100, 101 AND 102).

EDWARD NELSON, EXAMINING ATTORNEY

ONTOTASKS

THE MARK CONSISTS OF STANDARD CHARACTERS WITHOUT CLAIM TO ANY PARTICULAR FONT, STYLE, SIZE, OR COLOR.

FOR BUSINESS ADVICE AND COMMERCIAL INFORMATION; DISSEMINATION OF ADVERTISING FOR OTHERS VIA THE INTERNET; PROVIDING CONSUMER PRODUCT INFORMATION VIA THE INTERNET; COMPARISON SHOPPING SERVICES; PROVIDING ON-LINE DIRECTORY INFORMATION SERVICES ALSO FEATURING HYPERLINKS TO OTHER WEB SITES; ON-LINE ADVERTISING AND MARKETING SERVICES (U.S. CLS. 100, 101 AND 102).

THEODORE MCBRIDE, EXAMINING ATTORNEY

SN 77-301,772. ULTRACONCURRENT, INC., APTOS, CA. FILED 10-11-2007.

SN 77-301,766. ULTRACONCURRENT, INC., APTOS, CA. FILED 10-11-2007.

ONTOSCHEDULE

THE MARK CONSISTS OF STANDARD CHARACTERS WITHOUT CLAIM TO ANY PARTICULAR FONT, STYLE, SIZE, OR COLOR.

FOR BUSINESS ADVICE AND COMMERCIAL INFORMATION; DISSEMINATION OF ADVERTISING FOR OTHERS VIA THE INTERNET; PROVIDING CONSUMER PRODUCT INFORMATION VIA THE INTERNET; COMPARISON SHOPPING SERVICES; PROVIDING ON-LINE DIRECTORY INFORMATION SERVICES ALSO FEATURING HYPERLINKS TO OTHER WEB SITES; ON-LINE ADVERTISING AND MARKETING SERVICES (U.S. CLS. 100, 101 AND 102).

THEODORE MCBRIDE, EXAMINING ATTORNEY

ONTOPORN

THE MARK CONSISTS OF STANDARD CHARACTERS WITHOUT CLAIM TO ANY PARTICULAR FONT, STYLE, SIZE, OR COLOR.

FOR (BASED ON INTENT TO USE) BUSINESS ADVICE AND COMMERCIAL INFORMATION; DISSEMINATION OF ADVERTISING FOR OTHERS VIA THE INTERNET; PROVIDING CONSUMER PRODUCT INFORMATION VIA THE INTERNET; COMPARISON SHOPPING SERVICES; PROVIDING ON-LINE DIRECTORY INFORMATION SERVICES ALSO FEATURING HYPERLINKS TO OTHER WEB SITES; ON-LINE ADVERTISING AND MARKETING SERVICES (U.S. CLS. 100, 101 AND 102).

THEODORE MCBRIDE, EXAMINING ATTORNEY

CLASS 35—(Continued).

SN 77-301,777. ULTRA CONCURRENT, INC., APTOS, CA.
FILED 10-11-2007.

ONTODRUGS

THE MARK CONSISTS OF STANDARD CHARACTERS WITHOUT CLAIM TO ANY PARTICULAR FONT, STYLE, SIZE, OR COLOR.

FOR BUSINESS ADVICE AND COMMERCIAL INFORMATION; DISSEMINATION OF ADVERTISING FOR OTHERS VIA THE INTERNET; PROVIDING CONSUMER PRODUCT INFORMATION VIA THE INTERNET; COMPARISON SHOPPING SERVICES; PROVIDING ON-LINE DIRECTORY INFORMATION SERVICES ALSO FEATURING HYPERLINKS TO OTHER WEB SITES; ON-LINE ADVERTISING AND MARKETING SERVICES (U.S. CLS. 100, 101 AND 102).

THEODORE MCBRIDE, EXAMINING ATTORNEY

SN 77-303,517. CAR GUY GARAGE, INC., CHICAGO, IL.
FILED 10-13-2007.

Make the garage another room in your house

THE MARK CONSISTS OF STANDARD CHARACTERS WITHOUT CLAIM TO ANY PARTICULAR FONT, STYLE, SIZE, OR COLOR.

FOR ON-LINE RETAIL STORE SERVICES FEATURING GARAGE STORAGE AND ORGANIZATION (U.S. CLS. 100, 101 AND 102).

FIRST USE 9-6-2007; IN COMMERCE 9-6-2007.
RONALD AIKENS, EXAMINING ATTORNEY

SN 77-304,465. TEDDLETON, FELECIA, RUTHERFORD, TN.
FILED 10-15-2007.

Felecia Bella

THE MARK CONSISTS OF STANDARD CHARACTERS WITHOUT CLAIM TO ANY PARTICULAR FONT, STYLE, SIZE, OR COLOR.

THE ENGLISH TRANSLATION OF "BELLA" IN THE MARK IS "BEAUTIFUL".

FOR RETAIL CLOTHING BOUTIQUES (U.S. CLS. 100, 101 AND 102).

FIRST USE 0-0-2002; IN COMMERCE 0-0-2002.
EDWARD NELSON, EXAMINING ATTORNEY

CLASS 35—(Continued).

SN 77-304,960. HARTFORD FIRE INSURANCE COMPANY,
HARTFORD, CT. FILED 10-16-2007.

THE HARTFORD'S REPAIR CONNECTION

THE MARK CONSISTS OF STANDARD CHARACTERS WITHOUT CLAIM TO ANY PARTICULAR FONT, STYLE, SIZE, OR COLOR.

OWNER OF U.S. REG. NOS. 1,155,051, 3,106,181 AND OTHERS.

NO CLAIM IS MADE TO THE EXCLUSIVE RIGHT TO USE "REPAIR", APART FROM THE MARK AS SHOWN.

FOR PROVIDING A REFERRAL PROGRAM FOR CUSTOMERS, NAMELY, COORDINATING BETWEEN CUSTOMER AND AUTOMOBILE REPAIR SHOPS FOR COLLISION REPAIRS (U.S. CLS. 100, 101 AND 102).

BRENDAN REGAN, EXAMINING ATTORNEY

SN 77-305,443. ULTRA CONCURRENT, INC., APTOS, CA.
FILED 10-16-2007.

ONTOFRIENDS

THE MARK CONSISTS OF STANDARD CHARACTERS WITHOUT CLAIM TO ANY PARTICULAR FONT, STYLE, SIZE, OR COLOR.

FOR BUSINESS ADVICE AND COMMERCIAL INFORMATION; DISSEMINATION OF ADVERTISING FOR OTHERS VIA THE INTERNET; PROVIDING CONSUMER PRODUCT INFORMATION VIA THE INTERNET; COMPARISON SHOPPING SERVICES; PROVIDING ON-LINE DIRECTORY INFORMATION SERVICES ALSO FEATURING HYPERLINKS TO OTHER WEB SITES; ON-LINE ADVERTISING AND MARKETING SERVICES (U.S. CLS. 100, 101 AND 102).

THEODORE MCBRIDE, EXAMINING ATTORNEY

SN 77-305,559. PIR & ASSOCIATES INC, SAN DIEGO, CA.
FILED 10-16-2007.



NO CLAIM IS MADE TO THE EXCLUSIVE RIGHT TO USE "ASSOCIATES INC" AND "FRANCHISE", APART FROM THE MARK AS SHOWN.

THE MARK CONSISTS OF A HUMAN FORM INSIDE A PARTIAL SLANTED OVAL WITH ARMS OUTSTRETCHED HOLDING THE EARTH IN ONE ARM APPEARING IN THE UPPER LEFT WITH WORDING TO THE RIGHT AND BELOW.

FOR BUSINESS CONSULTATION SERVICES (U.S. CLS. 100, 101 AND 102).

FIRST USE 5-26-2004; IN COMMERCE 5-26-2004.
LINDA M. KING, EXAMINING ATTORNEY

CLASS 35—(Continued).

SN 77-309,300. INTEGRITY NEWS MEDIA, INC., LA JOLLA, CA. FILED 10-20-2007.

Enhanced Random

THE MARK CONSISTS OF STANDARD CHARACTERS WITHOUT CLAIM TO ANY PARTICULAR FONT, STYLE, SIZE, OR COLOR.

FOR INTERNET ADVERTISING SERVICES (U.S. CLS. 100, 101 AND 102).

FIRST USE 9-18-2007; IN COMMERCE 9-18-2007.
REBECCA GILBERT, EXAMINING ATTORNEY

SN 77-310,737. BELK STORES SERVICES, INC., CHARLOTTE, NC. FILED 10-23-2007.

STAY @ HOME

THE MARK CONSISTS OF STANDARD CHARACTERS WITHOUT CLAIM TO ANY PARTICULAR FONT, STYLE, SIZE, OR COLOR.

FOR RETAIL DEPARTMENT STORE SERVICES (U.S. CLS. 100, 101 AND 102).

FIRST USE 11-0-2006; IN COMMERCE 11-0-2006.
BARBARA GAYNOR, EXAMINING ATTORNEY

SN 77-312,484. PAWLISHED PAWS BOUTIQUE & SPA, RIVERSIDE, CA. FILED 10-24-2007.



NO CLAIM IS MADE TO THE EXCLUSIVE RIGHT TO USE "BOUTIQUE & SPA", APART FROM THE MARK AS SHOWN.

THE COLOR(S) LIGHT PINK, DARK PINK GREY, WHITE, BLACK, TAN, ORANGE, RED IS/ARE CLAIMED AS A FEATURE OF THE MARK.

THE MARK CONSISTS OF FEMALE IN DRESS AND BOOTS WALKING A STANDARD POODLE. TAN IS SKIN COLOR, GREY IS COLOR OF DOG WITH WHITE MAIN,

CLASS 35—(Continued).

AND BLACK SUNGLASSES. GIRL IS WEARING A DARK PINK DRESS WITH DARK PINK BOOTS, HAIR IS ORANGE, LIPS ARE RED, SUNGLASSES ARE BLACK WITH A LIGHT PINK BACKGROUND. GIRLS BANDANA IS DARK PINK AND HER BRACELET IS GREY. DOGS BANDANA AND COLOR ARE LIGHT PINK. THERE ARE WHITE STARS IN THE BACKGROUND. THE WORDS "PAWLISHED PAWS BOUTIQUE & SPA" ARE SPELLED IN BLACK AND A LIGHT PINK LINE DEVIDES THE WORDS "PAWLISHED PAWS FROM BOUTIQUE & SPA".

FOR RETAIL PET STORES (U.S. CLS. 100, 101 AND 102).

MIDGE BUTLER, EXAMINING ATTORNEY

SN 77-312,784. ULTRACONCURRENT, INC., APTOS, CA. FILED 10-24-2007.

ONTOEROTIC

THE MARK CONSISTS OF STANDARD CHARACTERS WITHOUT CLAIM TO ANY PARTICULAR FONT, STYLE, SIZE, OR COLOR.

FOR BUSINESS ADVICE AND COMMERCIAL INFORMATION; DISSEMINATION OF ADVERTISING FOR OTHERS VIA THE INTERNET; PROVIDING CONSUMER PRODUCT INFORMATION VIA THE INTERNET; COMPARISON SHOPPING SERVICES; PROVIDING ON-LINE DIRECTORY INFORMATION SERVICES ALSO FEATURING HYPERLINKS TO OTHER WEB SITES; ON-LINE ADVERTISING AND MARKETING SERVICES (U.S. CLS. 100, 101 AND 102).

THEODORE MCBRIDE, EXAMINING ATTORNEY

SN 77-313,803. L & W SUPPLY CORPORATION, CHICAGO, IL. FILED 10-25-2007.

YOU BUILD EXCELLENCE WE DELIVER IT

THE MARK CONSISTS OF STANDARD CHARACTERS WITHOUT CLAIM TO ANY PARTICULAR FONT, STYLE, SIZE, OR COLOR.

FOR RETAIL AND WHOLESALE STORE SERVICES FEATURING BUILDING CONSTRUCTION MATERIALS (U.S. CLS. 100, 101 AND 102).

STEPHEN AQUILA, EXAMINING ATTORNEY

CLASS 35—(Continued).

SN 77-319,757. BANK OF AMERICA CORPORATION, CHARLOTTE, NC. FILED 11-2-2007.

ARTS ON US

THE MARK CONSISTS OF STANDARD CHARACTERS WITHOUT CLAIM TO ANY PARTICULAR FONT, STYLE, SIZE, OR COLOR.

NO CLAIM IS MADE TO THE EXCLUSIVE RIGHT TO USE "ARTS", APART FROM THE MARK AS SHOWN.

FOR PROMOTING THE GOODS AND SERVICES OF OTHERS THROUGH A PROGRAM THAT PERMITS BANK CUSTOMERS TO OBTAIN ADMISSION TO ENTERTAINMENT VENUES (U.S. CLS. 100, 101 AND 102).
JANET LEE, EXAMINING ATTORNEY

SN 77-321,726. ULTRAACCURRENT, INC., APTOS, CA. FILED 11-5-2007.

ONTOQUOTE

THE MARK CONSISTS OF STANDARD CHARACTERS WITHOUT CLAIM TO ANY PARTICULAR FONT, STYLE, SIZE, OR COLOR.

FOR BUSINESS ADVICE AND COMMERCIAL INFORMATION; DISSEMINATION OF ADVERTISING FOR OTHERS VIA THE INTERNET; PROVIDING CONSUMER PRODUCT INFORMATION VIA THE INTERNET; COMPARISON SHOPPING SERVICES; PROVIDING ON-LINE DIRECTORY INFORMATION SERVICES ALSO FEATURING HYPERLINKS TO OTHER WEB SITES; ON-LINE ADVERTISING AND MARKETING SERVICES (U.S. CLS. 100, 101 AND 102).

THEODORE MCBRIDE, EXAMINING ATTORNEY

SN 77-322,932. ULTRAACCURRENT, INC., APTOS, CA. FILED 11-6-2007.

ONTOSUBSUME

THE MARK CONSISTS OF STANDARD CHARACTERS WITHOUT CLAIM TO ANY PARTICULAR FONT, STYLE, SIZE, OR COLOR.

FOR BUSINESS ADVICE AND COMMERCIAL INFORMATION; DISSEMINATION OF ADVERTISING FOR OTHERS VIA THE INTERNET; PROVIDING CONSUMER PRODUCT INFORMATION VIA THE INTERNET; COMPARISON SHOPPING SERVICES; PROVIDING ON-LINE DIRECTORY INFORMATION SERVICES ALSO FEATURING HYPERLINKS TO OTHER WEB SITES; ON-LINE ADVERTISING AND MARKETING SERVICES (U.S. CLS. 100, 101 AND 102).

THEODORE MCBRIDE, EXAMINING ATTORNEY

CLASS 35—(Continued).

SN 77-323,694. ACS MARKETING, L.P., DALLAS, TX. FILED 11-7-2007.

EXPERTISE IN ACTION

THE MARK CONSISTS OF STANDARD CHARACTERS WITHOUT CLAIM TO ANY PARTICULAR FONT, STYLE, SIZE, OR COLOR.

FOR DATA PROCESSING SERVICES; BUSINESS CONSULTING SERVICES IN THE FIELD OF INFORMATION MANAGEMENT AND INFORMATION TECHNOLOGY; BUSINESS MANAGEMENT AND CONSULTATION; COMPUTERIZED DATABASE MANAGEMENT; OUTSOURCING IN THE FIELDS OF MANUFACTURING, INSURANCE, HEALTHCARE, TRANSPORTATION, HUMAN RESOURCES, PAYMENT PROCESSES, LOGISTICS AND DISTRIBUTION, FINANCE AND ADMINISTRATION, SALES, MARKETING, AND CUSTOMER RELATIONSHIP MANAGEMENT; BUSINESS INFORMATION MANAGEMENT IN THE FIELDS OF MANUFACTURING, INSURANCE, HEALTHCARE, TRANSPORTATION, HUMAN RESOURCES, PAYMENT PROCESSES, LOGISTICS AND DISTRIBUTION, FINANCE AND ADMINISTRATION, SALES, MARKETING, AND CUSTOMER RELATIONSHIP MANAGEMENT; MANAGEMENT OF TELEPHONE CALL CENTERS FOR OTHERS; OPERATION OF TELEPHONE CALL CENTERS FOR OTHERS; TELEMARKETING; OPERATION OF CUSTOMER SERVICE INTERACTION TELEPHONE CALL CENTERS FOR OTHERS; OPERATION OF TELEPHONE CALL CENTERS FOR OTHERS; DATA PROCESSING SERVICES, NAMELY, MANUAL AND AUTOMATED DATA CAPTURE; MAILROOM SERVICES, NAMELY, MAIL SORTING, HANDLING AND RECEIVING (U.S. CLS. 100, 101 AND 102).

COLLEEN DOMBROW, EXAMINING ATTORNEY

SN 77-324,528. PRECURSOR LLC, MC LEAN, VA. FILED 11-8-2007.

HONORABLE COMMERCE

THE MARK CONSISTS OF STANDARD CHARACTERS WITHOUT CLAIM TO ANY PARTICULAR FONT, STYLE, SIZE, OR COLOR.

FOR ASSOCIATION SERVICES, NAMELY, PROMOTING THE INTERESTS OF LEGAL USAGE OF THE INTERNET AND PROTECTION OF DIGITAL PROPERTY AND INTELLECTUAL PROPERTY; PUBLIC ADVOCACY TO PROMOTE AWARENESS OF THE IMPORTANCE OF THE LEGAL USAGE OF THE INTERNET AND PROTECTION OF DIGITAL PROPERTY AND INTELLECTUAL PROPERTY (U.S. CLS. 100, 101 AND 102).

FLORENTINA BLANDU, EXAMINING ATTORNEY

CLASS 35—(Continued).

SN 77-324,880. ULTRACONCURRENT, INC., APTOS, CA. FILED 11-8-2007.

ONTOPROVENANCE

THE MARK CONSISTS OF STANDARD CHARACTERS WITHOUT CLAIM TO ANY PARTICULAR FONT, STYLE, SIZE, OR COLOR.

FOR BUSINESS ADVICE AND COMMERCIAL INFORMATION; DISSEMINATION OF ADVERTISING FOR OTHERS VIA THE INTERNET; PROVIDING CONSUMER PRODUCT INFORMATION VIA THE INTERNET; COMPARISON SHOPPING SERVICES; PROVIDING ON-LINE DIRECTORY INFORMATION SERVICES ALSO FEATURING HYPERLINKS TO OTHER WEB SITES; ON-LINE ADVERTISING AND MARKETING SERVICES (U.S. CLS. 100, 101 AND 102).

THEODORE MCBRIDE, EXAMINING ATTORNEY

SN 77-324,886. ULTRACONCURRENT, INC., APTOS, CA. FILED 11-8-2007.

ONTOCELEB

THE MARK CONSISTS OF STANDARD CHARACTERS WITHOUT CLAIM TO ANY PARTICULAR FONT, STYLE, SIZE, OR COLOR.

FOR BUSINESS ADVICE AND COMMERCIAL INFORMATION; DISSEMINATION OF ADVERTISING FOR OTHERS VIA THE INTERNET; PROVIDING CONSUMER PRODUCT INFORMATION VIA THE INTERNET; COMPARISON SHOPPING SERVICES; PROVIDING ON-LINE DIRECTORY INFORMATION SERVICES ALSO FEATURING HYPERLINKS TO OTHER WEB SITES; ON-LINE ADVERTISING AND MARKETING SERVICES (U.S. CLS. 100, 101 AND 102).

THEODORE MCBRIDE, EXAMINING ATTORNEY

SN 77-328,858. KEYCORP, CLEVELAND, OH. FILED 11-14-2007.

KEYCLUB

THE MARK CONSISTS OF STANDARD CHARACTERS WITHOUT CLAIM TO ANY PARTICULAR FONT, STYLE, SIZE, OR COLOR.

OWNER OF U.S. REG. NOS. 2,665,769, 3,226,846 AND OTHERS.

FOR CUSTOMER LOYALTY SERVICES AND CUSTOMER CLUB SERVICES FOR PROMOTIONAL AND ADVERTISING PURPOSES (U.S. CLS. 100, 101 AND 102).

ANTHONY RINKER, EXAMINING ATTORNEY

CLASS 35—(Continued).

SN 77-328,862. KEYCORP, CLEVELAND, OH. FILED 11-14-2007.



OWNER OF U.S. REG. NOS. 1,722,378, 2,035,538 AND OTHERS.

FOR CUSTOMER LOYALTY SERVICES AND CUSTOMER CLUB SERVICES FOR PROMOTIONAL AND ADVERTISING PURPOSES (U.S. CLS. 100, 101 AND 102).

ANTHONY RINKER, EXAMINING ATTORNEY

SN 77-328,885. ACADEMY OF GENERAL DENTISTRY, CHICAGO, IL. FILED 11-14-2007.

AGD

THE MARK CONSISTS OF STANDARD CHARACTERS WITHOUT CLAIM TO ANY PARTICULAR FONT, STYLE, SIZE, OR COLOR.

FOR ASSOCIATION SERVICES, NAMELY, PROMOTING THE INTERESTS OF DENTAL PROFESSIONALS (U.S. CLS. 100, 101 AND 102).

FIRST USE 0-0-1952; IN COMMERCE 0-0-1952.

STEVEN JACKSON, EXAMINING ATTORNEY

SN 77-328,957. PLANET VENTURES, INC., PORTAND, ME. FILED 11-14-2007.



OWNER OF U.S. REG. NOS. 2,169,756, 2,916,527 AND OTHERS.

NO CLAIM IS MADE TO THE EXCLUSIVE RIGHT TO USE "MADE IN THE U.S.A.", APART FROM THE MARK AS SHOWN.

THE COLOR(S) RED, WHITE AND BLUE IS/ARE CLAIMED AS A FEATURE OF THE MARK.

THE MARK CONSISTS OF AN IMAGE OF A DOG'S PAWPRINT WITH AN AMERICAN FLAG MOTIF, SPECI-

CLASS 35—(Continued).

FICALLY, WITH RED AND WHITE STRIPES IN THE CENTER OF THE PAW AND THE TWO RIGHT TOES, A BLUE FIELD WITH WHITE STARS IN THE LEFT-CENTER TOE, AND A BLUE FIELD WITH WHITE STAR AND RED STRIPE IN THE LEFT TOE; WITH THE RED WORDS "LET FREEDOM ROMP!" OVER THE PAWPRINT AND THE BLUE WORDS "DID YOU KNOW ALL OF PLANET DOG'S ORBEE-TUFF TOYS ARE NOW MADE IN THE U.S.A.?" BELOW THE PAWPRINT; ALL INSIDE A RECTANGULAR BLUE FRAME.

FOR RETAIL STORE SERVICES FEATURING PET TOYS (U.S. CLS. 100, 101 AND 102).
LAURA KOVALSKY, EXAMINING ATTORNEY

SN 77-329,299. PRECURSOR LLC, MC LEAN, VA. FILED 11-14-2007.

STOP CORRUPTION

THE MARK CONSISTS OF STANDARD CHARACTERS WITHOUT CLAIM TO ANY PARTICULAR FONT, STYLE, SIZE, OR COLOR.

FOR PUBLIC ADVOCACY TO PROMOTE AWARENESS OF THE NEED TO HALT ILLEGAL PRACTICES ON THE INTERNET INCLUDING ILLEGAL INTERNET USAGE (U.S. CLS. 100, 101 AND 102).
FLORENTINA BLANDU, EXAMINING ATTORNEY

SN 77-330,480. ULTRACONCURRENT, INC., APTOS, CA. FILED 11-15-2007.

ONTOSOCIAL

THE MARK CONSISTS OF STANDARD CHARACTERS WITHOUT CLAIM TO ANY PARTICULAR FONT, STYLE, SIZE, OR COLOR.

FOR BUSINESS ADVICE AND COMMERCIAL INFORMATION; DISSEMINATION OF ADVERTISING FOR OTHERS VIA THE INTERNET; PROVIDING CONSUMER PRODUCT INFORMATION VIA THE INTERNET; COMPARISON SHOPPING SERVICES; PROVIDING ON-LINE DIRECTORY INFORMATION SERVICES ALSO FEATURING HYPERLINKS TO OTHER WEB SITES; ON-LINE ADVERTISING AND MARKETING SERVICES (U.S. CLS. 100, 101 AND 102).

THEODORE MCBRIDE, EXAMINING ATTORNEY

CLASS 35—(Continued).

SN 77-330,485. ULTRACONCURRENT, INC., APTOS, CA. FILED 11-15-2007.

ONTOREVIEWS

THE MARK CONSISTS OF STANDARD CHARACTERS WITHOUT CLAIM TO ANY PARTICULAR FONT, STYLE, SIZE, OR COLOR.

FOR BUSINESS ADVICE AND COMMERCIAL INFORMATION; DISSEMINATION OF ADVERTISING FOR OTHERS VIA THE INTERNET; PROVIDING CONSUMER PRODUCT INFORMATION VIA THE INTERNET; COMPARISON SHOPPING SERVICES; PROVIDING ON-LINE DIRECTORY INFORMATION SERVICES ALSO FEATURING HYPERLINKS TO OTHER WEB SITES; ON-LINE ADVERTISING AND MARKETING SERVICES (U.S. CLS. 100, 101 AND 102).

THEODORE MCBRIDE, EXAMINING ATTORNEY

SN 77-334,205. ULTRACONCURRENT, INC., APTOS, CA. FILED 11-20-2007.

ONTOCLASS

THE MARK CONSISTS OF STANDARD CHARACTERS WITHOUT CLAIM TO ANY PARTICULAR FONT, STYLE, SIZE, OR COLOR.

FOR BUSINESS ADVICE AND COMMERCIAL INFORMATION; DISSEMINATION OF ADVERTISING FOR OTHERS VIA THE INTERNET; PROVIDING CONSUMER PRODUCT INFORMATION VIA THE INTERNET; COMPARISON SHOPPING SERVICES; PROVIDING ON-LINE DIRECTORY INFORMATION SERVICES ALSO FEATURING HYPERLINKS TO OTHER WEB SITES; ON-LINE ADVERTISING AND MARKETING SERVICES (U.S. CLS. 100, 101 AND 102).

THEODORE MCBRIDE, EXAMINING ATTORNEY

SN 77-334,208. ULTRACONCURRENT, INC., APTOS, CA. FILED 11-20-2007.

ONTOSET

THE MARK CONSISTS OF STANDARD CHARACTERS WITHOUT CLAIM TO ANY PARTICULAR FONT, STYLE, SIZE, OR COLOR.

FOR BUSINESS ADVICE AND COMMERCIAL INFORMATION; DISSEMINATION OF ADVERTISING FOR OTHERS VIA THE INTERNET; PROVIDING CONSUMER PRODUCT INFORMATION VIA THE INTERNET; COMPARISON SHOPPING SERVICES; PROVIDING ON-LINE DIRECTORY INFORMATION SERVICES ALSO FEATURING HYPERLINKS TO OTHER WEB SITES; ON-LINE ADVERTISING AND MARKETING SERVICES (U.S. CLS. 100, 101 AND 102).

THEODORE MCBRIDE, EXAMINING ATTORNEY

CLASS 35—(Continued).

SN 77-334,345. THE INSTITUTE FOR INNOVATION, INTEGRATION & IMPACT, INC., EMERALD HILLS, CA. FILED 11-20-2007.



THE MARK CONSISTS OF THE LETTERS "REP" (LOWER CASE) WITH A LINE OVER THE LETTER "E".
FOR BUSINESS CONSULTATION SERVICES (U.S. CLS. 100, 101 AND 102).
FIRST USE 4-0-2007; IN COMMERCE 4-0-2007.
DOMINIC J. FERRAIUOLO, EXAMINING ATTORNEY

SN 77-334,394. ULTRA CONCURRENT, INC., APTOS, CA. FILED 11-20-2007.

ONTOREFLECT

THE MARK CONSISTS OF STANDARD CHARACTERS WITHOUT CLAIM TO ANY PARTICULAR FONT, STYLE, SIZE, OR COLOR.
FOR BUSINESS ADVICE AND COMMERCIAL INFORMATION; DISSEMINATION OF ADVERTISING FOR OTHERS VIA THE INTERNET; PROVIDING CONSUMER PRODUCT INFORMATION VIA THE INTERNET; COMPARISON SHOPPING SERVICES; PROVIDING ON-LINE DIRECTORY INFORMATION SERVICES ALSO FEATURING HYPERLINKS TO OTHER WEB SITES; ON-LINE ADVERTISING AND MARKETING SERVICES (U.S. CLS. 100, 101 AND 102).
THEODORE MCBRIDE, EXAMINING ATTORNEY

SN 77-337,056. ULTRA CONCURRENT, INC., APTOS, CA. FILED 11-26-2007.

ONTORANK

THE MARK CONSISTS OF STANDARD CHARACTERS WITHOUT CLAIM TO ANY PARTICULAR FONT, STYLE, SIZE, OR COLOR.
FOR BUSINESS ADVICE AND COMMERCIAL INFORMATION; DISSEMINATION OF ADVERTISING FOR OTHERS VIA THE INTERNET; PROVIDING CONSUMER PRODUCT INFORMATION VIA THE INTERNET; COMPARISON SHOPPING SERVICES; PROVIDING ON-LINE DIRECTORY INFORMATION SERVICES ALSO FEATURING HYPERLINKS TO OTHER WEB SITES; ON-LINE ADVERTISING AND MARKETING SERVICES (U.S. CLS. 100, 101 AND 102).
THEODORE MCBRIDE, EXAMINING ATTORNEY

CLASS 35—(Continued).

SN 77-337,059. ULTRA CONCURRENT, INC., APTOS, CA. FILED 11-26-2007.

ONTORATING

THE MARK CONSISTS OF STANDARD CHARACTERS WITHOUT CLAIM TO ANY PARTICULAR FONT, STYLE, SIZE, OR COLOR.
FOR BUSINESS ADVICE AND COMMERCIAL INFORMATION; DISSEMINATION OF ADVERTISING FOR OTHERS VIA THE INTERNET; PROVIDING CONSUMER PRODUCT INFORMATION VIA THE INTERNET; COMPARISON SHOPPING SERVICES; PROVIDING ON-LINE DIRECTORY INFORMATION SERVICES ALSO FEATURING HYPERLINKS TO OTHER WEB SITES; ON-LINE ADVERTISING AND MARKETING SERVICES (U.S. CLS. 100, 101 AND 102).
THEODORE MCBRIDE, EXAMINING ATTORNEY

SN 77-337,061. ULTRA CONCURRENT, INC., APTOS, CA. FILED 11-26-2007.

ONTOMETA

THE MARK CONSISTS OF STANDARD CHARACTERS WITHOUT CLAIM TO ANY PARTICULAR FONT, STYLE, SIZE, OR COLOR.
FOR BUSINESS ADVICE AND COMMERCIAL INFORMATION; DISSEMINATION OF ADVERTISING FOR OTHERS VIA THE INTERNET; PROVIDING CONSUMER PRODUCT INFORMATION VIA THE INTERNET; COMPARISON SHOPPING SERVICES; PROVIDING ON-LINE DIRECTORY INFORMATION SERVICES ALSO FEATURING HYPERLINKS TO OTHER WEB SITES; ON-LINE ADVERTISING AND MARKETING SERVICES (U.S. CLS. 100, 101 AND 102).
THEODORE MCBRIDE, EXAMINING ATTORNEY

SN 77-340,948. BDSRCO, INC., WILMINGTON, DE. FILED 11-30-2007.

GIVE THE FLORIDA LIFESTYLE

THE MARK CONSISTS OF STANDARD CHARACTERS WITHOUT CLAIM TO ANY PARTICULAR FONT, STYLE, SIZE, OR COLOR.
FOR RETAIL DEPARTMENT STORE SERVICES (U.S. CLS. 100, 101 AND 102).
FIRST USE 11-0-2005; IN COMMERCE 11-0-2005.
MIDGE BUTLER, EXAMINING ATTORNEY

CLASS 35—(Continued).

SN 77-346,769. DRESSER, INC., ADDISON, TX. FILED 12-7-2007.

RAPID PARTS

THE MARK CONSISTS OF STANDARD CHARACTERS WITHOUT CLAIM TO ANY PARTICULAR FONT, STYLE, SIZE, OR COLOR.

OWNER OF U.S. REG. NO. 2,439,598.

NO CLAIM IS MADE TO THE EXCLUSIVE RIGHT TO USE "PARTS", APART FROM THE MARK AS SHOWN. SEC. 2(F).

FOR RETAIL AND WHOLESALE SUPPLY SERVICES IN THE FIELD OF OEM VALVE COMPONENTS FOR INDUSTRIAL PLANTS FEATURING REPLACEMENT PARTS FOR THE MAINTENANCE AND REPAIR OF MANUAL AND AUTOMATIC CONTROL VALVES, ACTUATORS, ELECTRO-PNEUMATIC AND PNEUMATIC VALVE POSITIONERS, DIGITAL VALVE POSITIONERS, CURRENT TO PRESSURE TRANSDUCERS, PNEUMATIC AND DIGITAL LEVEL CONTROLLERS, LIQUID LEVEL TRANSMITTERS, PRESSURE CONTROLLERS, PRESSURE REDUCING REGULATORS, AND BACK PRESSURE REGULATORS, PROVIDED IN AN EFFICIENT AND TIMELY MANNER (U.S. CLS. 100, 101 AND 102).

FIRST USE 6-4-1998; IN COMMERCE 6-4-1998. DANIEL BRODY, EXAMINING ATTORNEY

SN 77-360,111. ULTRACONCURRENT, INC., APTOS, CA. FILED 12-27-2007.

ONTOFAMILY

THE MARK CONSISTS OF STANDARD CHARACTERS WITHOUT CLAIM TO ANY PARTICULAR FONT, STYLE, SIZE, OR COLOR.

FOR BUSINESS ADVICE AND COMMERCIAL INFORMATION; DISSEMINATION OF ADVERTISING FOR OTHERS VIA THE INTERNET; PROVIDING CONSUMER PRODUCT INFORMATION VIA THE INTERNET; COMPARISON SHOPPING SERVICES; PROVIDING ON-LINE DIRECTORY INFORMATION SERVICES ALSO FEATURING HYPERLINKS TO OTHER WEB SITES; ON-LINE ADVERTISING AND MARKETING SERVICES (U.S. CLS. 100, 101 AND 102).

THEODORE MCBRIDE, EXAMINING ATTORNEY

CLASS 35—(Continued).

SN 77-360,112. ULTRACONCURRENT, INC., APTOS, CA. FILED 12-27-2007.

ONTOOR

THE MARK CONSISTS OF STANDARD CHARACTERS WITHOUT CLAIM TO ANY PARTICULAR FONT, STYLE, SIZE, OR COLOR.

FOR BUSINESS ADVICE AND COMMERCIAL INFORMATION; DISSEMINATION OF ADVERTISING FOR OTHERS VIA THE INTERNET; PROVIDING CONSUMER PRODUCT INFORMATION VIA THE INTERNET; COMPARISON SHOPPING SERVICES; PROVIDING ON-LINE DIRECTORY INFORMATION SERVICES ALSO FEATURING HYPERLINKS TO OTHER WEB SITES; ON-LINE ADVERTISING AND MARKETING SERVICES (U.S. CLS. 100, 101 AND 102).

THEODORE MCBRIDE, EXAMINING ATTORNEY

SN 77-360,115. ULTRACONCURRENT, INC., APTOS, CA. FILED 12-27-2007.

ONTONOT

THE MARK CONSISTS OF STANDARD CHARACTERS WITHOUT CLAIM TO ANY PARTICULAR FONT, STYLE, SIZE, OR COLOR.

FOR BUSINESS ADVICE AND COMMERCIAL INFORMATION; DISSEMINATION OF ADVERTISING FOR OTHERS VIA THE INTERNET; PROVIDING CONSUMER PRODUCT INFORMATION VIA THE INTERNET; COMPARISON SHOPPING SERVICES; PROVIDING ON-LINE DIRECTORY INFORMATION SERVICES ALSO FEATURING HYPERLINKS TO OTHER WEB SITES; ON-LINE ADVERTISING AND MARKETING SERVICES (U.S. CLS. 100, 101 AND 102).

THEODORE MCBRIDE, EXAMINING ATTORNEY

SN 77-360,116. ULTRACONCURRENT, INC., APTOS, CA. FILED 12-27-2007.

ONTOAND

THE MARK CONSISTS OF STANDARD CHARACTERS WITHOUT CLAIM TO ANY PARTICULAR FONT, STYLE, SIZE, OR COLOR.

FOR BUSINESS ADVICE AND COMMERCIAL INFORMATION; DISSEMINATION OF ADVERTISING FOR OTHERS VIA THE INTERNET; PROVIDING CONSUMER PRODUCT INFORMATION VIA THE INTERNET; COMPARISON SHOPPING SERVICES; PROVIDING ON-LINE DIRECTORY INFORMATION SERVICES ALSO FEATURING HYPERLINKS TO OTHER WEB SITES; ON-LINE ADVERTISING AND MARKETING SERVICES (U.S. CLS. 100, 101 AND 102).

THEODORE MCBRIDE, EXAMINING ATTORNEY

CLASS 35—(Continued).

SN 77-975,101. ERIE COUNTY MEDICAL CENTER CORPORATION, BUFFALO, NY. FILED 1-25-2007.

WNY Hospital of Choice

THE MARK CONSISTS OF STANDARD CHARACTERS WITHOUT CLAIM TO ANY PARTICULAR FONT, STYLE, SIZE, OR COLOR.

NO CLAIM IS MADE TO THE EXCLUSIVE RIGHT TO USE "WNY HOSPITAL", APART FROM THE MARK AS SHOWN.

FOR DEVELOPMENT OF HOSPITAL MANAGEMENT SYSTEMS; HOSPITAL ADMINISTRATION SERVICES; HOSPITAL MANAGEMENT (U.S. CLS. 100, 101 AND 102).

KIM SAITO, EXAMINING ATTORNEY

SN 78-470,468. M.H. RESOURCES, INC., NEW YORK, NY. FILED 8-19-2004.

Smarti Solutions

THE MARK CONSISTS OF STANDARD CHARACTERS WITHOUT CLAIM TO ANY PARTICULAR FONT, STYLE, SIZE, OR COLOR.

NO CLAIM IS MADE TO THE EXCLUSIVE RIGHT TO USE "SOLUTIONS", APART FROM THE MARK AS SHOWN.

FOR ADVERTISING AND MARKETING (U.S. CLS. 100, 101 AND 102).

FIRST USE 8-13-2004; IN COMMERCE 8-13-2004.
NELSON SNYDER, EXAMINING ATTORNEY

SN 78-656,942. CUMBERLAND GENERAL STORE, LLC, ALPHARETTA, GA. FILED 6-23-2005.

CUMBERLAND GENERAL STORE

THE MARK CONSISTS OF STANDARD CHARACTERS WITHOUT CLAIM TO ANY PARTICULAR FONT, STYLE, SIZE, OR COLOR.

NO CLAIM IS MADE TO THE EXCLUSIVE RIGHT TO USE "GENERAL STORE", APART FROM THE MARK AS SHOWN.

FOR RETAIL CATALOG MAIL ORDER SERVICES IN THE FIELD OF OLD TIME GENERAL CONSUMER MERCHANDISE (U.S. CLS. 100, 101 AND 102).

FIRST USE 12-31-1976; IN COMMERCE 12-31-1976.
VERNA BETH RIRIE, EXAMINING ATTORNEY

CLASS 35—(Continued).

SN 78-666,648. HRX, INC., RANCHOS DE TAOS, NM. FILED 7-8-2005.

HRX Human Resource Excellence

THE MARK CONSISTS OF STANDARD CHARACTERS WITHOUT CLAIM TO ANY PARTICULAR FONT, STYLE, SIZE, OR COLOR.

NO CLAIM IS MADE TO THE EXCLUSIVE RIGHT TO USE "HUMAN RESOURCE", APART FROM THE MARK AS SHOWN.

FOR PROVIDING CONSULTING SERVICES IN THE FIELD OF EMPLOYEE COMMUNICATION IN THE WORKPLACE, EMPLOYEE RELATIONS, GENERAL OPERATIONAL MANAGEMENT, NEW EMPLOYEE ASSESSMENT AND ORIENTATION, BUSINESS INTEGRATION AND DOWNSIZING, EMPLOYEE PERFORMANCE MANAGEMENT, TALENT SCOUTING AND RECRUITMENT (U.S. CLS. 100, 101 AND 102).

FIRST USE 3-4-1994; IN COMMERCE 3-4-1994.
DOMINICK J. SALEMI, EXAMINING ATTORNEY

SN 78-687,121. HEALTH CARE POLICY ROUNDTABLE, L.L.C., WASHINGTON, DC. FILED 8-6-2005.

RETIREE HEALTH ACCESS

THE MARK CONSISTS OF STANDARD CHARACTERS WITHOUT CLAIM TO ANY PARTICULAR FONT, STYLE, SIZE, OR COLOR.

SEC. 2(F).

FOR BUSINESS INTERMEDIARY SERVICES IN THE FIELD OF PROVIDING HEALTH-INSURANCE REFERRALS TO CERTAIN RETIREES TO PROVIDE THEM ACCESS TO HEALTH-INSURANCE COVERAGE FOR THEM AND THEIR SPOUSES AND DEPENDENTS (U.S. CLS. 100, 101 AND 102).

FIRST USE 11-7-2004; IN COMMERCE 11-7-2004.
WANDA KAY PRICE, EXAMINING ATTORNEY

CLASS 35—(Continued).

SN 78-707,852. INNOVATIVE STAFF SOLUTIONS, INC., MATTOON, IL. FILED 9-7-2005.



NO CLAIM IS MADE TO THE EXCLUSIVE RIGHT TO USE "STAFF SOLUTIONS", APART FROM THE MARK AS SHOWN.

THE MARK CONSISTS OF A STYLIZED REPRESENTATION OF THE WORDS "INNOVATIVE" AND "STAFF SOLUTIONS" SURROUNDING A CIRCULAR TARGETING SYMBOL ALSO HAVING FOUR LINES, TWO HORIZONTAL AND TWO VERTICAL, AS PART OF THE TARGETING SYMBOL, WITH THE "I" IN "INNOVATIVE" CREATED BY THE VERTICAL LINE FROM SAID TARGETING SYMBOL ON THE UPPER PORTION OF THE MARK, SAID TARGETING SYMBOL ALSO INCORPORATING TWO SURROUNDING ELLIPTICAL RINGS.

FOR EMPLOYMENT STAFFING SERVICES, NAMELY, PROVIDING TEMP-TO-HIRE SERVICES, TEMPORARY HELP FULL-TIME OR PROFESSIONAL CAREER EMPLOYEES; EMPLOYMENT STAFFING SERVICES, NAMELY, THE EVALUATION OF THE NEEDS OF A CLIENT'S BUSINESS AND CONDUCTING INTERVIEWS AND SKILLS TESTING TO PLACE THE BEST CANDIDATES IN THE DESIRED POSITION (U.S. CLS. 100, 101 AND 102).

FIRST USE 3-31-2002; IN COMMERCE 3-31-2002.
JEFF DEFORD, EXAMINING ATTORNEY

SN 78-721,043. AUTOZONE PARTS, INC., MEMPHIS, TN. FILED 9-27-2005.

DURALAST BUILT TO LAST

THE MARK CONSISTS OF STANDARD CHARACTERS WITHOUT CLAIM TO ANY PARTICULAR FONT, STYLE, SIZE, OR COLOR.

OWNER OF U.S. REG. NOS. 1,467,999, 2,763,813 AND OTHERS.

FOR RETAIL STORE SERVICES FEATURING AUTOMOBILE PARTS AND ACCESSORIES AND TOOLS EXCEPT FOR THOSE TOOLS SPECIFICALLY DESIGNED AND INTENDED FOR USE IN ROOFING APPLICATIONS (U.S. CLS. 100, 101 AND 102).

STEVEN PEREZ, EXAMINING ATTORNEY

CLASS 35—(Continued).

SN 78-741,064. MODELL'S II, INC., NEW YORK, NY. FILED 10-26-2005.

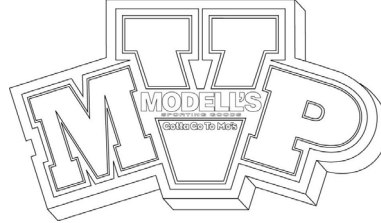

OWNER OF U.S. REG. NOS. 2,176,220, 2,292,322 AND OTHERS.

NO CLAIM IS MADE TO THE EXCLUSIVE RIGHT TO USE "SPORTING GOODS", APART FROM THE MARK AS SHOWN.

THE MARK CONSISTS OF THE LETTERS "MVP" AND THE WORDS "MODELL'S SPORTING GOODS GOTTA GO TO MO'S".

FOR RETAIL STORE SERVICES IN THE FIELDS OF MEN'S, WOMEN'S AND CHILDREN'S SPORTING GOODS, FOOTWEAR AND APPAREL FEATURING A FREQUENT BUYER PLAN FOR INCENTIVE AWARDS (U.S. CLS. 100, 101 AND 102).

AMY ALFIERI, EXAMINING ATTORNEY

SN 78-785,556. FLORIDA ASSOCIATION OF COUNTIES, INC., TALLAHASSEE, FL. FILED 1-5-2006.



NO CLAIM IS MADE TO THE EXCLUSIVE RIGHT TO USE "FLORIDA ASSOCIATION OF COUNTIES" AND THE PICTORIAL REPRESENTATION OF THE STATE OF FLORIDA, APART FROM THE MARK AS SHOWN.

THE COLOR(S) WHITE, BLUE AND GRAY IS/ARE CLAIMED AS A FEATURE OF THE MARK.

THE MARK CONSISTS OF THE LETTERS "FAC" IN BLUE AND THE WORDS "FLORIDA ASSOCIATION OF COUNTIES" WITH "FLORIDA" IN BLUE, "ASSOCIATION OF" IN GRAY AND "COUNTIES" IN BLUE AND AN IMAGE OF THE STATE OF FLORIDA IN GRAY. THE WORDS "ALL ABOUT FLORIDA" IN BLUE. THERE IS AN ARCH OVER THE TOP OF THE SERVICE MARK IN BLUE. THE DESIGN MARK IS SET AGAINST A WHITE BACKGROUND.

FOR ASSOCIATION SERVICES, NAMELY, PROMOTING THE INTERESTS OF COUNTY GOVERNMENTS IN THE STATE OF FLORIDA (U.S. CLS. 100, 101 AND 102).

REBECCA EISINGER, EXAMINING ATTORNEY

CLASS 35—(Continued).

SN 78-787,200. RED RYDER ENTERPRISES, INC., TAMPA, FL. FILED 1-9-2006.



OWNER OF U.S. REG. NOS. 1,617,691, 2,319,187 AND OTHERS.

NO CLAIM IS MADE TO THE EXCLUSIVE RIGHT TO USE "DEPENDABLE QUALITY AND VALUE", APART FROM THE MARK AS SHOWN.

FOR PROMOTING PUBLIC AWARENESS OF THE NEED TO SUPPORT THE DEPENDABLE QUALITY AND VALUE OF GOODS AND SERVICES MADE IN THE U.S. AND TO ENCOURAGE PEOPLE TO PURCHASE U.S. MADE PRODUCTS TO GIVE A SENSE OF PRIDE TO THE PEOPLE WHO MAKE THEM (U.S. CLS. 100, 101 AND 102).

FIRST USE 12-0-2005; IN COMMERCE 12-0-2005. TINA BROWN, EXAMINING ATTORNEY

CLASS 35—(Continued).

SN 78-828,008. POWER EQUIPMENT DIRECT, INC., BO-LINGBROOK, IL. FILED 3-2-2006.



NO CLAIM IS MADE TO THE EXCLUSIVE RIGHT TO USE "POWER EQUIPMENT DIRECT", APART FROM THE MARK AS SHOWN.

FOR ONLINE RETAIL STORE SERVICES FEATURING POWER EQUIPMENT (U.S. CLS. 100, 101 AND 102). FIRST USE 1-12-2006; IN COMMERCE 2-23-2006.

ROBERT C. CLARK JR., EXAMINING ATTORNEY

SN 78-867,967. CANGEMI, SEBASTIAN M., SOLON, OH. FILED 4-24-2006.

SN 78-810,913. NMC ASSOCIATES, LLC, NEW CITY, NY. FILED 2-9-2006.

New City Florist

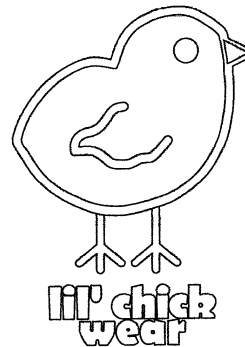

THE MARK CONSISTS OF STANDARD CHARACTERS WITHOUT CLAIM TO ANY PARTICULAR FONT, STYLE, SIZE, OR COLOR.

NO CLAIM IS MADE TO THE EXCLUSIVE RIGHT TO USE "FLORIST", APART FROM THE MARK AS SHOWN. SEC. 2(F).

FOR ONLINE RETAIL FLORIST SHOPS (U.S. CLS. 100, 101 AND 102). FIRST USE 7-0-1980; IN COMMERCE 7-0-1980. AMY MCMENAMIN, EXAMINING ATTORNEY

NO CLAIM IS MADE TO THE EXCLUSIVE RIGHT TO USE "WEAR", APART FROM THE MARK AS SHOWN.

FOR RETAIL STORE SERVICES FEATURING CLOTHING AND APPAREL (U.S. CLS. 100, 101 AND 102). ATTIYA MALIK, EXAMINING ATTORNEY

CLASS 35—(Continued).

SN 78-878,090. MERCURY GROUP, INC., ALEXANDRIA, VA. FILED 5-5-2006.

MERCURY GROUP

THE MARK CONSISTS OF STANDARD CHARACTERS WITHOUT CLAIM TO ANY PARTICULAR FONT, STYLE, SIZE, OR COLOR.

NO CLAIM IS MADE TO THE EXCLUSIVE RIGHT TO USE "GROUP", APART FROM THE MARK AS SHOWN.

FOR PUBLIC RELATIONS; ADVERTISING SERVICES; POLITICAL CONSULTANCY IN THE FIELDS OF MEDIA RELATIONS AND COALITION BUILDING; BUSINESS CONSULTING AND BUSINESS MANAGEMENT SERVICES IN THE FIELDS OF COMMUNICATIONS, PUBLIC AFFAIRS, PUBLIC RELATIONS, MEDIA, POLITICS, BUSINESS ISSUES, AND GOVERNMENT AFFAIRS (U.S. CLS. 100, 101 AND 102).

FIRST USE 6-1-1995; IN COMMERCE 6-1-1995.

RENEE MCCRAY, EXAMINING ATTORNEY

SN 78-881,357. BATH & BODY WORKS, INC., REYNOLDSBURG, OH. FILED 5-11-2006.

CURE FOR WINTER WEARY LIPS

THE MARK CONSISTS OF STANDARD CHARACTERS WITHOUT CLAIM TO ANY PARTICULAR FONT, STYLE, SIZE, OR COLOR.

FOR RETAIL STORE SERVICES, MAIL ORDER RETAIL SERVICES AND ONLINE RETAIL STORE SERVICES ALL IN THE FIELD OF PERSONAL CARE PRODUCTS, COSMETICS AND HOME FRAGRANCE PRODUCTS (U.S. CLS. 100, 101 AND 102).

TIMOTHY FINNEGAN, EXAMINING ATTORNEY

SN 78-881,362. BATH & BODY WORKS, INC., REYNOLDSBURG, OH. FILED 5-11-2006.

CURE FOR THIRSTY CHEEKS

THE MARK CONSISTS OF STANDARD CHARACTERS WITHOUT CLAIM TO ANY PARTICULAR FONT, STYLE, SIZE, OR COLOR.

FOR RETAIL STORE SERVICES, MAIL ORDER RETAIL SERVICES AND ONLINE RETAIL STORE SERVICES ALL IN THE FIELD OF PERSONAL CARE PRODUCTS, COSMETICS HOME FRAGRANCE PRODUCTS (U.S. CLS. 100, 101 AND 102).

TIMOTHY FINNEGAN, EXAMINING ATTORNEY

CLASS 35—(Continued).

SN 78-881,371. BATH & BODY WORKS, INC., REYNOLDSBURG, OH. FILED 5-11-2006.

CURE FOR DRY ALL OVER

THE MARK CONSISTS OF STANDARD CHARACTERS WITHOUT CLAIM TO ANY PARTICULAR FONT, STYLE, SIZE, OR COLOR.

FOR RETAIL STORE SERVICES, MAIL ORDER RETAIL SERVICES AND ONLINE RETAIL STORE SERVICES ALL IN THE FIELD OF PERSONAL CARE PRODUCTS, COSMETICS AND HOME FRAGRANCE PRODUCTS (U.S. CLS. 100, 101 AND 102).

TIMOTHY FINNEGAN, EXAMINING ATTORNEY

SN 78-881,380. BATH & BODY WORKS, INC., REYNOLDSBURG, OH. FILED 5-11-2006.

CURE FOR CABIN FEVER

THE MARK CONSISTS OF STANDARD CHARACTERS WITHOUT CLAIM TO ANY PARTICULAR FONT, STYLE, SIZE, OR COLOR.

FOR RETAIL STORE SERVICES, MAIL ORDER RETAIL SERVICES AND ONLINE RETAIL STORE SERVICES ALL IN THE FIELD OF PERSONAL CARE PRODUCTS, COSMETICS AND HOME FRAGRANCE PRODUCTS (U.S. CLS. 100, 101 AND 102).

TIMOTHY FINNEGAN, EXAMINING ATTORNEY

SN 78-881,390. BATH & BODY WORKS, INC., REYNOLDSBURG, OH. FILED 5-11-2006.

CURE FOR A GROGGY MORNING

THE MARK CONSISTS OF STANDARD CHARACTERS WITHOUT CLAIM TO ANY PARTICULAR FONT, STYLE, SIZE, OR COLOR.

FOR RETAIL STORE SERVICES, MAIL ORDER RETAIL SERVICES AND ONLINE RETAIL STORE SERVICES ALL IN THE FIELD OF PERSONAL CARE PRODUCTS, COSMETICS AND HOME FRAGRANCE PRODUCTS (U.S. CLS. 100, 101 AND 102).

TIMOTHY FINNEGAN, EXAMINING ATTORNEY

CLASS 35—(Continued).

SN 78-881,407. BATH & BODY WORKS, INC., REYNOLDSBURG, OH. FILED 5-11-2006.

CURE FOR COUNTING SHEEP

THE MARK CONSISTS OF STANDARD CHARACTERS WITHOUT CLAIM TO ANY PARTICULAR FONT, STYLE, SIZE, OR COLOR.

FOR RETAIL STORE SERVICES, MAIL ORDER RETAIL SERVICES AND ONLINE RETAIL STORE SERVICES ALL IN THE FIELD OF PERSONAL CARE PRODUCTS, COSMETICS AND HOME FRAGRANCE PRODUCTS (U.S. CLS. 100, 101 AND 102).

TIMOTHY FINNEGAN, EXAMINING ATTORNEY

SN 78-881,419. BATH & BODY WORKS, INC., REYNOLDSBURG, OH. FILED 5-11-2006.

CURE FOR A STRESSFUL DAY

THE MARK CONSISTS OF STANDARD CHARACTERS WITHOUT CLAIM TO ANY PARTICULAR FONT, STYLE, SIZE, OR COLOR.

FOR RETAIL STORE SERVICES, MAIL ORDER RETAIL SERVICES AND ONLINE RETAIL STORE SERVICES ALL IN THE FIELD OF PERSONAL CARE PRODUCTS, COSMETICS, HOME FRAGRANCE PRODUCTS AND ACCESSORIES (U.S. CLS. 100, 101 AND 102).

TIMOTHY FINNEGAN, EXAMINING ATTORNEY

SN 78-881,490. BATH & BODY WORKS, INC., REYNOLDSBURG, OH. FILED 5-11-2006.

CURE FOR THE WINTER BLUES

THE MARK CONSISTS OF STANDARD CHARACTERS WITHOUT CLAIM TO ANY PARTICULAR FONT, STYLE, SIZE, OR COLOR.

FOR RETAIL STORE SERVICES, MAIL ORDER RETAIL SERVICES AND ONLINE RETAIL STORE SERVICES ALL IN THE FIELD OF PERSONAL CARE PRODUCTS, COSMETICS AND HOME FRAGRANCE PRODUCTS (U.S. CLS. 100, 101 AND 102).

TIMOTHY FINNEGAN, EXAMINING ATTORNEY

CLASS 35—(Continued).

SN 78-888,714. BUEGE'S INC., FAIRMONT, WV. FILED 5-22-2006.

CYCLEMART

THE MARK CONSISTS OF STANDARD CHARACTERS WITHOUT CLAIM TO ANY PARTICULAR FONT, STYLE, SIZE, OR COLOR.

SEC. 2(F).

FOR RETAIL AND WHOLESALE STORE SERVICES FEATURING MOTORCYCLE AND ALL TERRAIN VEHICLE PARTS (U.S. CLS. 100, 101 AND 102).

FIRST USE 11-0-1999; IN COMMERCE 11-0-1999.

ROBERT STRUCK, EXAMINING ATTORNEY

SN 78-898,978. CLYDE CHEMISTS, LTD., NEW YORK, NY. FILED 6-2-2006.



OWNER OF U.S. REG. NOS. 2,344,118 AND 2,466,076. NO CLAIM IS MADE TO THE EXCLUSIVE RIGHT TO USE "MADISON", APART FROM THE MARK AS SHOWN.

FOR RETAIL PHARMACY SERVICES, NAMELY, RETAIL STORE SERVICES FEATURING PHARMACEUTICALS (U.S. CLS. 100, 101 AND 102).

FIRST USE 7-0-2002; IN COMMERCE 7-0-2002.

EMILY CARLSEN, EXAMINING ATTORNEY

CLASS 35—(Continued).

SN 78-899,002. CLYDE CHEMISTS, LTD., NEW YORK, NY.
FILED 6-2-2006.

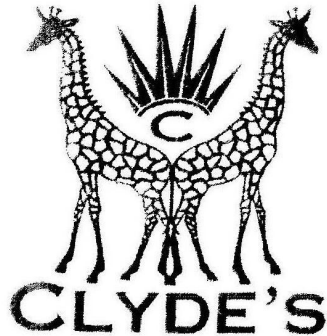

OWNER OF U.S. REG. NOS. 2,344,118 AND 2,466,076.
FOR RETAIL PHARMACY SERVICES, NAMELY, RE-
TAIL STORE SERVICES FEATURING PHARMACEUTI-
CALS (U.S. CLS. 100, 101 AND 102).
FIRST USE 7-0-2002; IN COMMERCE 7-0-2002.
CAROLYN CATALDO, EXAMINING ATTORNEY

CLASS 35—(Continued).

SN 78-905,357. BUCZAK, SUSAN E DBA WEB CONNEC-
TION/CHRISTIANANNY.COM, SEVIERVILLE, TN.
FILED 6-10-2006.

Christian Nanny

SN 78-902,881. SHENANDOAH TRADING CO., LTD., HU-
WET TOWN, TAIWAN, FILED 6-7-2006.

STELLA SOL

THE MARK CONSISTS OF STANDARD CHARACTERS
WITHOUT CLAIM TO ANY PARTICULAR FONT, STYLE,
SIZE, OR COLOR.

OWNER OF TAIWAN REG. NO. 01251530, DATED 2-16-
2007, EXPIRES 2-15-2017.

THE FOREIGN WORDING IN THE MARK TRANSLATES
INTO ENGLISH AS "STAR SUN".

FOR IMPORT AND EXPORT AGENCIES; SALE PRO-
MOTION FOR OTHERS; RETAIL STORE, COMPUTER-
IZED ONLINE RETAIL AND RETAIL
DISTRIBUTORSHIP SERVICES ALL FEATURING TRAVELING
BAGS, TRUNKS, HANDBAGS, ATTACHE
CASES, UMBRELLAS, PARASOLS, SUITS, JACKETS,
DRESSES, SKIRTS, UNDERWEAR, SWIMSUITS, T-
SHIRTS, PARKAS, SPORTS UNIFORMS, SHORTS,
SHOES, BOOTS, SPORTS SHOES, SANDALS, HATS,
SOCKS, GLOVES, BELTS, TIES, AND NECKERCHIEFS
(U.S. CLS. 100, 101 AND 102).

DEZMONA MIZELLE, EXAMINING ATTORNEY

NO CLAIM IS MADE TO THE EXCLUSIVE RIGHT TO
USE "CHRISTIAN NANNY", APART FROM THE MARK AS
SHOWN.

THE STIPPLING IS FOR SHADING PURPOSES ONLY.
THE COLOR(S) WHITE, BLACK AND GREY IS/ARE
CLAIMED AS A FEATURE OF THE MARK.

THE MARK CONSISTS OF SCRIPT ITALIC OF THE
WORDS "CHRISTIAN" AND "NANNY" WITH A CROSS IN
THE MIDDLE, WHITE LETTERS AND CROSS, LIT FROM
THE LEFT PRODUCING A RAISED 3D APPEARANCE OF
THE LOGO, WITH BLACK AND GREY SHADOWS TO THE
RIGHT AND BOTTOM.

SEC. 2(F).
FOR EMPLOYMENT HIRING, RECRUITING, PLACE-
MENT, STAFFING AND CAREER NETWORKING SER-
VICES (U.S. CLS. 100, 101 AND 102).

FIRST USE 11-20-2000; IN COMMERCE 11-20-2000.
JULIE GUTTADAURO, EXAMINING ATTORNEY

CLASS 35—(Continued).

SN 78-911,807. PAYNE, KENT B, SAN DIEGO, CA. FILED 6-19-2006.

CLASS 35—(Continued).

SN 78-911,819. PAYNE, KENT B, SAN DIEGO, CA. FILED 6-19-2006.

StudioBath

StudioKitchen

THE MARK CONSISTS OF STANDARD CHARACTERS WITHOUT CLAIM TO ANY PARTICULAR FONT, STYLE, SIZE, OR COLOR.

FOR MAIL ORDER CATALOG SERVICES FEATURING KITCHEN PLUMBING FIXTURES, HARDWARE, CABINETS, APPLIANCES, ACCESSORIES, LIGHTING, FURNITURE, COUNTERTOPS, WALL AND FLOOR COVERINGS; MAIL ORDER SERVICES FEATURING KITCHEN PLUMBING FIXTURES, HARDWARE, CABINETS, APPLIANCES, ACCESSORIES, LIGHTING, FURNITURE, COUNTERTOPS, WALL AND FLOOR COVERINGS; ON-LINE ORDERING SERVICES FEATURING KITCHEN PLUMBING FIXTURES, HARDWARE, CABINETS, APPLIANCES, ACCESSORIES, LIGHTING, FURNITURE, COUNTERTOPS, WALL AND FLOOR COVERINGS; ON-LINE RETAIL STORE SERVICES FEATURING KITCHEN PLUMBING FIXTURES, HARDWARE, CABINETS, APPLIANCES, ACCESSORIES, LIGHTING, FURNITURE, COUNTERTOPS, WALL AND FLOOR COVERINGS; RETAIL STORES FEATURING KITCHEN PLUMBING FIXTURES, HARDWARE, CABINETS, APPLIANCES, ACCESSORIES, LIGHTING, FURNITURE, COUNTERTOPS, WALL AND FLOOR COVERINGS; WHOLESALE STORES FEATURING KITCHEN PLUMBING FIXTURES, HARDWARE, CABINETS, APPLIANCES, ACCESSORIES, LIGHTING, FURNITURE, COUNTERTOPS, WALL AND FLOOR COVERINGS (U.S. CLS. 100, 101 AND 102).

CHRIS WELLS, EXAMINING ATTORNEY

THE MARK CONSISTS OF STANDARD CHARACTERS WITHOUT CLAIM TO ANY PARTICULAR FONT, STYLE, SIZE, OR COLOR.

FOR MAIL ORDER CATALOG SERVICES FEATURING BATHROOM PLUMBING FIXTURES, HARDWARE, VANITIES, ACCESSORIES, LIGHTING, MIRRORS, FURNITURE, COUNTERTOPS, WALL AND FLOOR COVERINGS; MAIL ORDER SERVICES FEATURING BATHROOM PLUMBING FIXTURES, HARDWARE, VANITIES, ACCESSORIES, LIGHTING, MIRRORS, FURNITURE, COUNTERTOPS, WALL AND FLOOR COVERINGS; ON-LINE ORDERING SERVICES FEATURING BATHROOM PLUMBING FIXTURES, HARDWARE, VANITIES, ACCESSORIES, LIGHTING, MIRRORS, FURNITURE, COUNTERTOPS, WALL AND FLOOR COVERINGS; ON-LINE RETAIL STORE SERVICES FEATURING BATHROOM PLUMBING FIXTURES, HARDWARE, VANITIES, ACCESSORIES, LIGHTING, MIRRORS, FURNITURE, COUNTERTOPS, WALL AND FLOOR COVERINGS; RETAIL STORE SERVICES FEATURING A WIDE VARIETY OF CONSUMER GOODS OF OTHERS; RETAIL STORES FEATURING BATHROOM PLUMBING FIXTURES, HARDWARE, VANITIES, ACCESSORIES, LIGHTING, MIRRORS, FURNITURE, COUNTERTOPS, WALL AND FLOOR COVERINGS; WHOLESALE STORES FEATURING BATHROOM PLUMBING FIXTURES, HARDWARE, VANITIES, ACCESSORIES, LIGHTING, MIRRORS, FURNITURE, COUNTERTOPS, WALL AND FLOOR COVERINGS (U.S. CLS. 100, 101 AND 102).

CHRIS WELLS, EXAMINING ATTORNEY

SN 78-930,038. MERVYN'S BRANDS, LLC, HAYWARD, CA. FILED 7-14-2006.

MERVYNS BIG REWARDS

THE MARK CONSISTS OF STANDARD CHARACTERS WITHOUT CLAIM TO ANY PARTICULAR FONT, STYLE, SIZE, OR COLOR.

OWNER OF U.S. REG. NOS. 1,063,553 AND 1,946,614. NO CLAIM IS MADE TO THE EXCLUSIVE RIGHT TO USE "REWARDS", APART FROM THE MARK AS SHOWN. FOR PROMOTING THE SALE OF CREDIT CARD ACCOUNTS THROUGH THE ADMINISTRATION OF FREQUENT RETAIL PURCHASER INCENTIVE AWARD PROGRAMS (U.S. CLS. 100, 101 AND 102).

JACLYN KIDWELL, EXAMINING ATTORNEY

CLASS 35—(Continued).

SN 78-942,021. WHERE 2 GET IT, INC., WHEELING, IL. FILED 8-1-2006.

Slippymap

THE MARK CONSISTS OF STANDARD CHARACTERS WITHOUT CLAIM TO ANY PARTICULAR FONT, STYLE, SIZE, OR COLOR.

FOR COMMERCIAL INFORMATION AND DIRECTORY AGENCY SERVICES PROVIDED BY MEANS OF A GLOBAL COMPUTER NETWORK (U.S. CLS. 100, 101 AND 102).

DAVID MURRAY, EXAMINING ATTORNEY

SN 78-950,141. TRI-COUNTY COUNCIL FOR SOUTHERN MARYLAND, HUGHESVILLE, MD. FILED 8-11-2006.

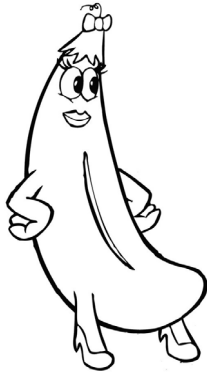

THE MARK CONSISTS OF A STYLIZED (CARTOON) FEMALE PEA POD, WITH ARMS, HUMAN HANDS, SHORT LEGS COMING OUT OF BOTTOM OF POD TIP, STYLISH SHOES, SLIT DOWN MIDDLE, FACE AT UPPER TIP OF POD WITH LARGE LIPS AND EYES WITH EYELASHES, HAIR, BOW ABOVE HAIR WITH A CURLY TENDRIL COMING OUT OF TOP OF BOW.

FOR ADVERTISING, MARKETING AND PROMOTION SERVICES; PROMOTING PUBLIC AWARENESS OF FARMS, FARM GOODS AND SERVICES, HEALTH; PROMOTING THE ECONOMIC DEVELOPMENT IN THE FIVE COUNTIES OF SOUTHERN MARYLAND IN THE STATE OF MARYLAND; PROMOTING THE GOODS AND SERVICES OF OTHERS BY DISTRIBUTING ADVERTISING MATERIALS THROUGH A VARIETY OF METHODS; PROMOTING THE GOODS AND SERVICES OF OTHERS BY PROVIDING A WEB SITE AT WHICH USERS CAN LINK TO FARMS, FARM AGENCIES, ECONOMIC DEVELOPMENT AGENCIES, AGRICULTURAL EDUCATION PROGRAMS; PROMOTING THE GOODS AND SERVICES OF OTHERS BY PROVIDING HYPERTEXT LINKS TO THE WEB SITES OF OTHERS; PROMOTION USING AUDIOVISUAL MEDIA (U.S. CLS. 100, 101 AND 102).

DOMINIC FATHY, EXAMINING ATTORNEY

CLASS 35—(Continued).

SN 78-955,366. SHENANDOAH TRADING CO., LTD., YU LIN HSIEN, TAIWAN, FILED 8-18-2006.

WHAT FOR

THE MARK CONSISTS OF STANDARD CHARACTERS WITHOUT CLAIM TO ANY PARTICULAR FONT, STYLE, SIZE, OR COLOR.

OWNER OF TAIWAN REG. NO. 01255065, DATED 3-16-2007, EXPIRES 3-15-2017.

FOR IMPORT AND EXPORT AGENCIES; SALE PROMOTION FOR OTHERS; RETAIL STORE, COMPUTERIZED ONLINE RETAIL AND RETAIL DISTRIBUTORSHIP SERVICES ALL FEATURING TRAVELING BAGS, TRUNKS, HANDBAGS, ATTACHE CASES, UMBRELLAS, PARASOLS, SUITS, JACKETS, DRESSES, SKIRTS, UNDERWEAR, SWIMSUITS, T-SHIRTS, PARKAS, SPORTS UNIFORMS, SHORTS, SHOES, BOOTS, SPORTS SHOES, SANDALS, HATS, SOCKS, GLOVES, BELTS, TIES, AND NECKERCHIEFS (U.S. CLS. 100, 101 AND 102).

DEZMONA MIZELLE, EXAMINING ATTORNEY

SN 78-955,379. SHENANDOAH TRADING CO., LTD., YU LIN HSIEN, TAIWAN, FILED 8-18-2006.



OWNER OF TAIWAN REG. NO. 01229436, DATED 9-16-2006, EXPIRES 9-15-2016.

THE FOREIGN WORDING IN THE MARK TRANSLATES INTO ENGLISH AS STAR, PARTICLE, TINY BIT; CELESTIAL BEING, IMMORTAL; TO FULFILL, TO TREAD ON, TO WALK UPON.

THE NON-LATIN CHARACTER(S) IN THE MARK TRANSLITERATES INTO XING; XIAN; LU, AND THIS MEANS STAR, PARTICLE, TINY BIT; CELESTIAL BEING, IMMORTAL; TO FULFILL, TO TREAD ON, TO WALK UPON IN ENGLISH.

FOR IMPORT AND EXPORT AGENCIES; SALE PROMOTION FOR OTHERS; RETAIL STORE, COMPUTERIZED ONLINE RETAIL AND RETAIL DISTRIBUTORSHIP SERVICES ALL FEATURING TRAVELING BAGS, TRUNKS, HANDBAGS, ATTACHE CASES, UMBRELLAS, PARASOLS, SUITS, JACKETS, DRESSES, SKIRTS, UNDERWEAR, SWIMSUITS, T-SHIRTS, PARKAS, SPORTS UNIFORMS, SHORTS, SHOES, BOOTS, SPORTS SHOES, SANDALS, HATS, SOCKS, GLOVES, BELTS, TIES, AND NECKERCHIEFS (U.S. CLS. 100, 101 AND 102).

DEZMONA MIZELLE, EXAMINING ATTORNEY

CLASS 35—(Continued).

SN 78-961,042. WP OPERATIONS, INC., HURST, TX. FILED 8-25-2006.

CLASS 35—(Continued).

SN 78-970,078. CBC NEW MEDIA GROUP, LLC, RALEIGH, NC. FILED 9-8-2006.

IguanaWarehouse

GOLO.COM

THE MARK CONSISTS OF STANDARD CHARACTERS WITHOUT CLAIM TO ANY PARTICULAR FONT, STYLE, SIZE, OR COLOR.
FOR COMPUTERIZED ON-LINE RETAIL STORE SERVICES IN THE FIELD OF MEDICAL UNIFORMS (U.S. CLS. 100, 101 AND 102).
FIRST USE 8-25-2006; IN COMMERCE 8-25-2006.
DAVID MURRAY, EXAMINING ATTORNEY

THE MARK CONSISTS OF STANDARD CHARACTERS WITHOUT CLAIM TO ANY PARTICULAR FONT, STYLE, SIZE, OR COLOR.
FOR PROVIDING SEARCHABLE COMPUTER DATABASES OVER A GLOBAL COMPUTER NETWORK AND WIRELESS NETWORKS FEATURING INFORMATION ABOUT COMMUNITY AND CHARITABLE ORGANIZATIONS, COMMUNITY ASSOCIATIONS, COMMUNITY SERVICE PROGRAMS, POLITICS, BUSINESS EVENTS, CONSUMER INFORMATION, PROFILES OF COMMUNITY RESIDENTS, COMMUNITY ACTIVITIES, AND BUSINESS CONFERENCES AND BUSINESS MEETINGS HOSTED OR SPONSORED BY LOCAL AND NATIONAL BUSINESSES AND ORGANIZATIONS RELATED TO COMMERCIAL BUSINESS AND COMMERCIAL INFORMATION, ECONOMIC FORECASTING AND ANALYSIS, BUSINESS DEVELOPMENT NEWS, BUSINESS DEVELOPMENT OPPORTUNITIES, AND GOVERNMENT AFFAIRS; PROMOTION OF BUSINESS AND TOURISM IN THE SOUTHEASTERN UNITED STATES; PROMOTING THE GOODS AND SERVICES OF OTHERS BY PROVIDING A WEB SITE AT WHICH USERS CAN LINK TO OTHER WEB SITES IN THE FIELDS OF LOCAL BUSINESS INFORMATION, SPECIAL EVENTS, GOVERNMENT, THE ARTS, DINING, ENTERTAINMENT, RECREATION, AND SPORTS; PROVIDING ON LINE SHOPPERS' GUIDE INFORMATION SERVICES; PROVIDING ON LINE BUSINESS DIRECTORIES FEATURING RESTAURANTS, RECREATIONAL FACILITIES, BARS, SHOPS, AND OTHER BUSINESS ESTABLISHMENTS IN THE COMMUNITY, NAMELY, RETAIL STORES AND MALLS, PERSONAL CARE SERVICE ESTABLISHMENTS AND PROVIDERS, HOSPITALITY SERVICE ESTABLISHMENTS AND PROVIDERS, HOME IMPROVEMENT, REPAIR AND MAINTENANCE SERVICE PROVIDERS, SPORTS, RECREATION AND ENTERTAINMENT FACILITIES AND SERVICES; PROMOTING THE GOODS AND SERVICES OF OTHERS THROUGH THE DISTRIBUTION PROMOTIONAL COUPONS, PROMOTIONAL CONTESTS AND PROMOTIONAL GIFT CARDS; DISSEMINATING ADVERTISING MATTER FOR OTHERS; ADMINISTRATION OF DISCOUNT PROGRAMS FOR ENABLING PARTICIPANTS TO OBTAIN DISCOUNTS ON GOODS AND SERVICES THROUGH USE OF A DISCOUNT MEMBERSHIP CARD; ADMINISTRATION OF DISCOUNT PROGRAMS VIA A WEBSITE FOR ENABLING PARTICIPANTS TO OBTAIN DISCOUNTS ON GOODS AND SERVICES THROUGH USE OF ELECTRONIC COUPONS AND PROMOTIONAL CODES; PROVIDING DISCOUNTS, REWARDS AND INCENTIVE AWARD PROGRAMS AT PARTICIPATING ESTABLISHMENTS OF OTHERS THROUGH USE OF MEMBERSHIP CARDS AND COUPON BOOKLETS; PROMOTING THE GOODS AND SERVICES OF OTHERS THROUGH CUSTOMER LOYALTY, DISCOUNT AND REWARD PROGRAMS PROVIDED THROUGH USE OF A WEBSITE, MEMBERSHIP CARDS AND MEMBERSHIP BOOKLETS, CUSTOMER LOYALTY SERVICES AND CUSTOMER CLUB SERVICES FOR COMMERCIAL, PROMOTIONAL AND ADVERTISING PURPOSES PROVIDED THROUGH USE OF A WEBSITE, MEMBERSHIP CARDS AND MEMBERSHIP BOOKLETS (U.S. CLS. 100, 101 AND 102).
WENDY GOODMAN, EXAMINING ATTORNEY

SN 78-969,173. AGILE NETWORK, LLC, ST. CHARLES, MO. FILED 9-7-2006.



NO CLAIM IS MADE TO THE EXCLUSIVE RIGHT TO USE "NETWORK", APART FROM THE MARK AS SHOWN.
FOR BUSINESS MANAGEMENT AND CONSULTING SERVICES IN THE FIELD OF SUPPLY CHAIN COST SAVINGS (U.S. CLS. 100, 101 AND 102).
FIRST USE 8-1-2006; IN COMMERCE 8-1-2006.
ELLEN B. AWRICH, EXAMINING ATTORNEY

CLASS 36—INSURANCE AND FINANCIAL

SN 76-657,312. IQ CREDIT UNION, VANCOUVER, WA. FILED 3-27-2006.

FINANCIAL INTELLIGENCE PAYS OFF

THE MARK CONSISTS OF STANDARD CHARACTERS WITHOUT CLAIM TO ANY PARTICULAR FONT, STYLE, SIZE, OR COLOR.

NO CLAIM IS MADE TO THE EXCLUSIVE RIGHT TO USE "FINANCIAL INTELLIGENCE", APART FROM THE MARK AS SHOWN.

FOR FINANCIAL SERVICES, NAMELY, BANKING; ON-LINE BANKING SERVICES; CREDIT UNION SERVICES; MORTGAGE BANKING; ELECTRONIC FUNDS TRANSFER; ELECTRONIC PAYMENT, NAMELY, ELECTRONIC PROCESSING AND TRANSMISSION OF BILL PAYMENT DATA; ACCOUNT PAYMENT AND MONITORING SERVICES, NAMELY, BILL PAYMENT SERVICES; FINANCIAL PORTFOLIO MANAGEMENT; FINANCIAL INFORMATION PROVIDED BY ELECTRONIC MEANS; FINANCIAL INFORMATION PROCESSING, INVESTMENT MANAGEMENT, CONSULTATION, AND BROKERAGE; INSURANCE AGENCY AND BROKERAGE; AUTOMATED FINANCIAL CLEARING HOUSE; FINANCIAL CLEARING HOUSE; FINANCIAL MANAGEMENT, NAMELY FINANCIAL ACCOUNT MANAGEMENT; PROVIDING FINANCIAL ACCOUNT BALANCING VIA A GLOBAL COMPUTER NETWORK AND TELECOMMUNICATIONS NETWORKS; FINANCIAL MANAGEMENT, NAMELY, PROVIDING AGGREGATION OF INFORMATION ABOUT MULTIPLE FINANCIAL ACCOUNTS AND DATA VIA A GLOBAL COMPUTER NETWORK AND TELECOMMUNICATIONS NETWORKS; FINANCIAL INFORMATION PROVIDED BY ELECTRONIC MEANS, NAMELY, PROVIDING CUSTOMIZED ONLINE WEB PAGES TO TRACK AND REVIEW CREDITOR ACCOUNTS AND INFORMATION IN THE NATURE OF BILL PAYMENT AND CONSOLIDATION SERVICES; PROVIDING LINKS TO WEB SITES OF OTHERS FEATURING FINANCE AND FINANCIAL ACCOUNTS (U.S. CLS. 100, 101 AND 102).

FIRST USE 4-5-2004; IN COMMERCE 4-5-2004.
ROBERT C. CLARK JR., EXAMINING ATTORNEY

SN 76-673,500. BEST LOANS EVER.COM, LLC, PALM HARBOR, FL. FILED 3-2-2007.

BEST LOANS EVER

THE MARK CONSISTS OF STANDARD CHARACTERS WITHOUT CLAIM TO ANY PARTICULAR FONT, STYLE, SIZE, OR COLOR.

NO CLAIM IS MADE TO THE EXCLUSIVE RIGHT TO USE "BEST LOANS", APART FROM THE MARK AS SHOWN.

FOR FINANCIAL SERVICES, NAMELY, LOAN FINANCING SERVICES RELATING TO REAL ESTATE, REVOLVING CREDIT, EDUCATION, MOTOR VEHICLES, MARINE WATERCRAFT, AIRCRAFT, MANUFACTURING EQUIPMENT, BUSINESS RELATED EQUIPMENT, COMMERCIAL AND PERSONAL PROPERTY (U.S. CLS. 100, 101 AND 102).

FIRST USE 1-18-2000; IN COMMERCE 12-0-2006.
HOWARD SMIGA, EXAMINING ATTORNEY

CLASS 36—(Continued).

SN 76-674,000. R.M.S.C.O. INC., LIVERPOOL, NY. FILED 3-13-2007.

RSOLUTIONZ

THE MARK CONSISTS OF STANDARD CHARACTERS WITHOUT CLAIM TO ANY PARTICULAR FONT, STYLE, SIZE, OR COLOR.

FOR INSURANCE ADMINISTRATION SERVICES, NAMELY, PROVIDING A WEBSITE ENABLING ACCESS TO INSURANCE COVERAGE AND CLAIM INQUIRIES FOR HEALTH BENEFITS, WORKERS' COMPENSATION, SHORT AND LONG TERM DISABILITY, DISABILITY CLAIMS, EMPLOYEE BENEFITS, FLEXIBLE BENEFITS, PRESCRIPTION BENEFIT MANAGEMENT, PROPERTY AND CASUALTY, CASUALTY CLAIMS, AND HEALTH RISK ASSESSMENT AND DISEASE MANAGEMENT (U.S. CLS. 100, 101 AND 102).

FIRST USE 1-8-2007; IN COMMERCE 1-8-2007.
PAUL E. FAHRENKOPF, EXAMINING ATTORNEY

SN 76-674,422. APPLIED BANK, FORMERLY APPLIED CARD BANK, WILMINGTON, DE. FILED 3-22-2007.



OWNER OF U.S. REG. NOS. 2,328,599, 2,699,666 AND 2,752,332.

NO CLAIM IS MADE TO THE EXCLUSIVE RIGHT TO USE "BANK", APART FROM THE MARK AS SHOWN.

FOR BANKING AND FINANCING SERVICES (U.S. CLS. 100, 101 AND 102).
LINDA E. BLOHM, EXAMINING ATTORNEY

SN 76-674,423. APPLIED BANK, FORMERLY APPLIED CARD BANK, WILMINGTON, DE. FILED 3-22-2007.



FOR BANKING AND FINANCING SERVICES (U.S. CLS. 100, 101 AND 102).
LINDA E. BLOHM, EXAMINING ATTORNEY

CLASS 36—(Continued).

SN 76-674,424. APPLIED BANK, FORMERLY APPLIED CARD BANK, WILMINGTON, DE. FILED 3-22-2007.

MAKING THE MOST OF YOUR TIME AND MONEY

THE MARK CONSISTS OF STANDARD CHARACTERS WITHOUT CLAIM TO ANY PARTICULAR FONT, STYLE, SIZE, OR COLOR.

FOR BANKING AND FINANCING SERVICES (U.S. CLS. 100, 101 AND 102).
LINDA E. BLOHM, EXAMINING ATTORNEY

SN 76-674,430. APPLIED BANK, FORMERLY APPLIED CARD BANK, WILMINGTON, DE. FILED 3-22-2007.



OWNER OF U.S. REG. NOS. 2,328,599, 2,752,332 AND OTHERS.

NO CLAIM IS MADE TO THE EXCLUSIVE RIGHT TO USE "BANK", APART FROM THE MARK AS SHOWN.

FOR BANKING AND FINANCING SERVICES (U.S. CLS. 100, 101 AND 102).
LINDA E. BLOHM, EXAMINING ATTORNEY

SN 76-676,433. KEW MANAGEMENT CORPORATION, NEW YORK, NY. FILED 5-7-2007.



THE COLOR(S) GREEN, GREY AND ORANGE IS/ARE CLAIMED AS A FEATURE OF THE MARK.

THE COLOR ORANGE APPEARS IN THE WORDING "KEW," THE COLOR GREEN APPEARS IN THE RECTANGLE AND UPPER TRIANGLE OF THE DESIGN ELEMENT OF THE APPLICANT'S MARK. THE COLOR GREY APPEARS IN THE LOWER TRIANGLE IN THE DESIGN.

FOR REAL ESTATE MANAGEMENT (U.S. CLS. 100, 101 AND 102).

FIRST USE 5-2-2007; IN COMMERCE 5-2-2007.
GEOFFREY FOSDICK, EXAMINING ATTORNEY

SN 76-676,435. KEW MANAGEMENT CORPORATION, NEW YORK, NY. FILED 5-7-2007.

The Madison Square Advantage

THE MARK CONSISTS OF STANDARD CHARACTERS WITHOUT CLAIM TO ANY PARTICULAR FONT, STYLE, SIZE, OR COLOR.

FOR REAL ESTATE MANAGEMENT (U.S. CLS. 100, 101 AND 102).

FIRST USE 1-24-2003; IN COMMERCE 1-24-2003.
GEOFFREY FOSDICK, EXAMINING ATTORNEY

CLASS 36—(Continued).

SN 76-678,364. GRAM'S PROMISE CHARITABLE FOUNDATION, INC., KINGSVILLE, MD. FILED 6-18-2007.

*Gram's Promise
Charitable Foundation, Inc.*



NO CLAIM IS MADE TO THE EXCLUSIVE RIGHT TO USE "CHARITABLE FOUNDATION, INC.", APART FROM THE MARK AS SHOWN.

THE COLOR(S) GOLD AND BLACK IS/ARE CLAIMED AS A FEATURE OF THE MARK.

THE MARK CONSIST THE COLOR BLACK APPEARS IN THE WORDING "GRAM'S PROMISE CHARITABLE FOUNDATION, INC." AND THE COLOR GOLD APPEARS IN THE DESIGN OF THE HEART AS WELL AS THE THREE RIBBONS LOCATED WITHIN THE HEART.

FOR CHARITABLE FUNDRAISING SERVICES FOR WORKING WITH AND ENCOURAGING OUR CHILDREN TO LIVE TOBACCO FREE LIFESTYLES, AND PROVIDING MONETARY AWARDS, NAMELY, EDUCATIONAL SCHOLARSHIPS TO CHILDREN AND TEENS WHO ACTIVELY PROMOTE THIS CONCEPT IN OUR COMMUNITY (U.S. CLS. 100, 101 AND 102).

FIRST USE 7-27-2006; IN COMMERCE 7-27-2006.
MICHAEL SOUDERS, EXAMINING ATTORNEY

SN 76-681,972. HOMEVESTORS OF AMERICA, INC., DALLAS, TX. FILED 9-17-2007.

UG INVESTS.COM

THE MARK CONSISTS OF STANDARD CHARACTERS WITHOUT CLAIM TO ANY PARTICULAR FONT, STYLE, SIZE, OR COLOR.

OWNER OF U.S. REG. NOS. 2,935,916, 3,263,978 AND OTHERS.

NO CLAIM IS MADE TO THE EXCLUSIVE RIGHT TO USE "INVESTS.COM", APART FROM THE MARK AS SHOWN.

FOR REAL ESTATE SERVICES, NAMELY, PURCHASE, FINANCE, ACQUISITION AND BROKERAGE OF RESIDENTIAL REAL ESTATE PROPERTIES (U.S. CLS. 100, 101 AND 102).

FIRST USE 7-1-2007; IN COMMERCE 7-1-2007.
RONALD MCMORROW, EXAMINING ATTORNEY

CLASS 36—(Continued).

SN 76-682,318. PENNSYLVANIA HIGHER EDUCATION ASSISTANCE AGENCY, DBA AMERICAN EDUCATION SERVICES, HARRISBURG, PA. FILED 9-25-2007.

NETWORK CONSOLIDATION

THE MARK CONSISTS OF STANDARD CHARACTERS WITHOUT CLAIM TO ANY PARTICULAR FONT, STYLE, SIZE, OR COLOR.

NO CLAIM IS MADE TO THE EXCLUSIVE RIGHT TO USE "CONSOLIDATION", APART FROM THE MARK AS SHOWN.

FOR PROVIDING, CONSOLIDATING, AND GUARANTEEING STUDENT AND EDUCATIONAL LOANS; LOAN COLLECTION SERVICES RELATING TO STUDENT AND EDUCATIONAL LOAN PROGRAMS; ADMINISTRATION OF EDUCATIONAL LOAN AND GRANT PROGRAMS; PROVIDING FINANCIAL AID INFORMATION (U.S. CLS. 100, 101 AND 102).

FIRST USE 8-1-1987; IN COMMERCE 8-1-1987.
NAPOLEON SHARMA, EXAMINING ATTORNEY

SN 76-682,380. AQUESTA BANK, CORNELIUS, NC. FILED 9-27-2007.

AQUESTA

THE MARK CONSISTS OF STANDARD CHARACTERS WITHOUT CLAIM TO ANY PARTICULAR FONT, STYLE, SIZE, OR COLOR.

FOR BANKING (U.S. CLS. 100, 101 AND 102).
FIRST USE 11-1-2005; IN COMMERCE 11-1-2005.
STEVEN R. FINE, EXAMINING ATTORNEY

CLASS 36—(Continued).

SN 76-682,436. COREFIRST BANK & TRUST, TOPEKA, KS. FILED 10-1-2007.

**CONVENIENCE IS OUR CORE
AND YOU COME FIRST!**

THE MARK CONSISTS OF STANDARD CHARACTERS WITHOUT CLAIM TO ANY PARTICULAR FONT, STYLE, SIZE, OR COLOR.

FOR FINANCIAL AND BANKING SERVICES, NAMELY, ACCOUNTS RECEIVABLE FINANCING; BUSINESS FINANCE PROCUREMENT SERVICES; EQUIPMENT FINANCING SERVICES; FACILITATING AND ARRANGING FOR THE FINANCING OF COMMERCIAL LOANS, AGRICULTURAL LOANS, REAL ESTATE SECURED LOANS AND PERSONAL LOANS; FINANCIAL ANALYSIS AND CONSULTATION; FINANCIAL CLEARING HOUSES; FINANCIAL FORECASTING; FINANCIAL GUARANTY AND SURETY; FINANCIAL INFORMATION PROVIDED BY ELECTRONIC MEANS; FINANCIAL INFORMATION PROCESSING; FINANCIAL INVESTMENT IN THE FIELD OF SECURITIES, REAL ESTATE AND PROPERTY MANAGEMENT; FINANCIAL MANAGEMENT; FINANCIAL PLANNING; FINANCIAL PORTFOLIO MANAGEMENT; FINANCIAL SERVICES IN THE NATURE OF INVESTMENT SECURITY; FINANCIAL SERVICES IN THE FIELD OF MONEY LENDING; FINANCING SERVICES, NAMELY, LEASE PURCHASE FINANCING AND LOAN FINANCING; SOLICITATION AND ARRANGEMENT OF DEMAND DEPOSITS, SAVINGS DEPOSITS, INVESTMENT RETIREMENT ACCOUNTS, TIME DEPOSITS AND TERM INVESTMENTS, AND REPURCHASE AGREEMENTS; AND FACILITATION AND ARRANGEMENT OF CASH MANAGEMENT SERVICES AND TAX DEFERRED COMMODITY SALES (U.S. CLS. 100, 101 AND 102).

JULIE WATSON, EXAMINING ATTORNEY

SN 76-683,151. OM FINANCIAL LIFE INSURANCE COMPANY, BALTIMORE, MD. FILED 10-19-2007.

OMFN INCOME ADVANTAGE

THE MARK CONSISTS OF STANDARD CHARACTERS WITHOUT CLAIM TO ANY PARTICULAR FONT, STYLE, SIZE, OR COLOR.

NO CLAIM IS MADE TO THE EXCLUSIVE RIGHT TO USE "INCOME", APART FROM THE MARK AS SHOWN.

FOR FIXED ANNUITY UNDERWRITING SERVICES (U.S. CLS. 100, 101 AND 102).
RICHARD A. STRASER, EXAMINING ATTORNEY

CLASS 36—(Continued).

SN 77-006,513. MARKEL CORPORATION, GLEN ALLEN, VA. FILED 9-25-2006.

OUTBREAK CONTINGENCY COVER

THE MARK CONSISTS OF STANDARD CHARACTERS WITHOUT CLAIM TO ANY PARTICULAR FONT, STYLE, SIZE, OR COLOR.

OWNER OF CANADA REG. NO. TMA693941, DATED 8-13-2007, EXPIRES 8-13-2022.

NO CLAIM IS MADE TO THE EXCLUSIVE RIGHT TO USE "CONTINGENCY" AND "COVER", APART FROM THE MARK AS SHOWN.

FOR INSURANCE UNDERWRITING IN THE FIELD OF BUSINESS INTERRUPTION, DISRUPTION OR SUSPENSION (U.S. CLS. 100, 101 AND 102).

JOHN DALIER, EXAMINING ATTORNEY

CLASS 36—(Continued).

SN 77-019,876. DREYFUS SERVICE CORPORATION, NEW YORK, NY. FILED 10-12-2006.



OWNER OF U.S. REG. NO. 3,339,698.

THE MARK CONSISTS OF A STYLIZED SUN IMAGE EMITTING SUN RAYS OF VARYING SIZES BELOW WHICH IS THE TERM "NEW BEGINNINGS." "NEW" IS LARGER IN SIZE THAN "BEGINNINGS."

FOR RETIREMENT PLANNING AND MUTUAL FUND SERVICES, SECURITIES BROKERAGE, COLLECTIVE TRUSTS AND OTHER POOLED INVESTMENT PRODUCTS (U.S. CLS. 100, 101 AND 102).

FIRST USE 7-6-2006; IN COMMERCE 7-6-2006.

FRED MANDIR, EXAMINING ATTORNEY

SN 77-017,106. CB RICHARD ELLIS REALTY TRUST, LOS ANGELES, CA. FILED 10-9-2006.

ACCESS THE POWER OF GLOBAL
REAL ESTATE

THE MARK CONSISTS OF STANDARD CHARACTERS WITHOUT CLAIM TO ANY PARTICULAR FONT, STYLE, SIZE, OR COLOR.

NO CLAIM IS MADE TO THE EXCLUSIVE RIGHT TO USE "GLOBAL REAL ESTATE", APART FROM THE MARK AS SHOWN.

FOR REAL ESTATE INVESTMENT TRUST SERVICES (U.S. CLS. 100, 101 AND 102).

SANDRA MANIOS, EXAMINING ATTORNEY

SN 77-029,072. OMNIAMERICAN BANK, FORT WORTH, TX. FILED 10-25-2006.

OMNIAMERICAN FINANCIAL
SERVICES

THE MARK CONSISTS OF STANDARD CHARACTERS WITHOUT CLAIM TO ANY PARTICULAR FONT, STYLE, SIZE, OR COLOR.

OWNER OF U.S. REG. NOS. 2,087,317, 2,848,421 AND OTHERS.

NO CLAIM IS MADE TO THE EXCLUSIVE RIGHT TO USE "FINANCIAL SERVICES", APART FROM THE MARK AS SHOWN.

FOR BANKING SERVICES (U.S. CLS. 100, 101 AND 102).

FIRST USE 7-1-2002; IN COMMERCE 1-3-2006.

ELISSA GARBER KON, EXAMINING ATTORNEY

CLASS 36—(Continued).

SN 77-029,138. OMNIAMERICAN BANK, FORT WORTH, TX. FILED 10-25-2006.

OMNIAMERICAN MORTGAGE GROUP

THE MARK CONSISTS OF STANDARD CHARACTERS WITHOUT CLAIM TO ANY PARTICULAR FONT, STYLE, SIZE, OR COLOR.

OWNER OF U.S. REG. NOS. 2,087,317, 2,848,421 AND OTHERS.

NO CLAIM IS MADE TO THE EXCLUSIVE RIGHT TO USE "MORTGAGE GROUP", APART FROM THE MARK AS SHOWN.

FOR BANKING SERVICES (U.S. CLS. 100, 101 AND 102).

FIRST USE 4-1-2006; IN COMMERCE 4-1-2006.

ELISSA GARBER KON, EXAMINING ATTORNEY

SN 77-029,229. OMNIAMERICAN BANK, FORT WORTH, TX. FILED 10-25-2006.

OMNIAMERICAN

THE MARK CONSISTS OF STANDARD CHARACTERS WITHOUT CLAIM TO ANY PARTICULAR FONT, STYLE, SIZE, OR COLOR.

OWNER OF U.S. REG. NOS. 2,087,317, 2,848,421 AND OTHERS.

FOR BANKING SERVICES (U.S. CLS. 100, 101 AND 102).

FIRST USE 0-0-1992; IN COMMERCE 1-3-2006.

ELISSA GARBER KON, EXAMINING ATTORNEY

SN 77-029,674. NEW YORK COMMUNITY BANCORP, INC., WESTBURY, NY. FILED 10-26-2006.

**NEW YORK
COMMERCIAL BANK** 

NO CLAIM IS MADE TO THE EXCLUSIVE RIGHT TO USE "NEW YORK COMMERCIAL BANK", APART FROM THE MARK AS SHOWN.

THE MARK CONSISTS OF WORDING NEW YORK ON TOP OF THE WORDING COMMERCIAL BANK WITH THE LETTERING NYCB FRAMED BY TWO SQUARES TO THE RIGHT.

FOR BANKING SERVICES (U.S. CLS. 100, 101 AND 102).

FIRST USE 1-27-2006; IN COMMERCE 1-27-2006.

TRICIA SONNEBORN, EXAMINING ATTORNEY

CLASS 36—(Continued).

SN 77-048,151. PETROLEUM INDUSTRY RESEARCH ASSOCIATES, INC., DBA PIRA ENERGY GROUP, NEW YORK, NY. FILED 11-20-2006.

PIRF

THE MARK CONSISTS OF STANDARD CHARACTERS WITHOUT CLAIM TO ANY PARTICULAR FONT, STYLE, SIZE, OR COLOR.

OWNER OF U.S. REG. NO. 2,391,517.

FOR FINANCIAL ANALYSIS AND CONSULTATION, NAMELY, PROVIDING MARKET CONDITIONS AND PRICE FORECASTS FOR CRUDE OIL, REFINED PETROLEUM PRODUCTS, NATURAL GAS, COAL, AND GREENHOUSE GAS TRADING AND PETROLEUM PRODUCT FREIGHT RATE FORECASTING (U.S. CLS. 100, 101 AND 102).

ALEX KEAM, EXAMINING ATTORNEY

SN 77-049,797. SMARTFUNDIT.COM LIMITED, BASINGSTOKE, HAMPSHIRE, UNITED KINGDOM, FILED 11-22-2006.

SMARTFUNDIT.COM

THE MARK CONSISTS OF STANDARD CHARACTERS WITHOUT CLAIM TO ANY PARTICULAR FONT, STYLE, SIZE, OR COLOR.

FOR FINANCING SERVICES IN RELATION TO THE SALE, PURCHASE, LICENSING, MAINTENANCE, INSTALLATION, MARKETING, AND/OR IMPLEMENTATION OF COMPUTER SOFTWARE AND COMPUTER HARDWARE; FINANCE BROKERAGE IN RELATION TO THE FINANCING OF COMPUTER SOFTWARE AND COMPUTER HARDWARE; PROVISION OF AN ONLINE, INTERACTIVE WEBSITE ENABLING USERS TO SEARCH FOR, COMPARE, AND ARRANGE FINANCING OF COMPUTER SOFTWARE AND COMPUTER HARDWARE WITH A VARIETY OF FINANCIAL PROVIDERS; PROVISION OF AN ONLINE, INTERACTIVE WEBSITE WHICH ALLOWS BUSINESSES TO MANAGE THE FINANCIAL RELATIONSHIPS BETWEEN THEIR CUSTOMERS AND FINANCE PROVIDERS PERTAINING TO FINANCING OF COMPUTER SOFTWARE AND COMPUTER HARDWARE; PROVISION OF ONLINE INFORMATION RELATING TO FINANCING OF COMPUTER SOFTWARE AND COMPUTER HARDWARE (U.S. CLS. 100, 101 AND 102).

FIRST USE 1-31-2006; IN COMMERCE 1-31-2006.

SANI KHOURI, EXAMINING ATTORNEY

CLASS 36—(Continued).

SN 77-050,475. THE GMS GROUP, L.L.C., LIVINGSTON, NJ. FILED 11-24-2006.

PATRIOT TRUST

THE MARK CONSISTS OF STANDARD CHARACTERS WITHOUT CLAIM TO ANY PARTICULAR FONT, STYLE, SIZE, OR COLOR.

NO CLAIM IS MADE TO THE EXCLUSIVE RIGHT TO USE "TRUST", APART FROM THE MARK AS SHOWN.

FOR FINANCIAL SERVICES, NAMELY, COMMODITY BROKERAGE, ESTATE TRUST MANAGEMENT AND INVESTMENT BROKERAGE SERVICES IN THE FIELDS OF MUNICIPAL BONDS, CORPORATE BONDS, MORTGAGE-BACKED SECURITIES, UNIT INVESTMENT TRUSTS, BOND SWAPS, MUTUAL FUNDS, STOCKS AND OPTIONS, PROVIDING FINANCIAL RESEARCH, RETIREMENT PLANNING SERVICES FEATURING IRAS AND ADMINISTRATION OF IRA ACCOUNTS, EMPLOYEE PENSION PLANS AND PROFIT SHARING PLANS (U.S. CLS. 100, 101 AND 102).

FIRST USE 12-1-2006; IN COMMERCE 12-1-2006.
GENE MACIOL, EXAMINING ATTORNEY

SN 77-052,446. SOUTHERN UNITED FIRE INSURANCE COMPANY, MOBILE, AL. FILED 11-28-2006.

Southern United Fire Insurance Company

THE MARK CONSISTS OF STANDARD CHARACTERS WITHOUT CLAIM TO ANY PARTICULAR FONT, STYLE, SIZE, OR COLOR.

NO CLAIM IS MADE TO THE EXCLUSIVE RIGHT TO USE "FIRE INSURANCE COMPANY", APART FROM THE MARK AS SHOWN.

FOR INSURANCE SERVICES, NAMELY, WRITING PROPERTY AND CASUALTY INSURANCE (U.S. CLS. 100, 101 AND 102).

FIRST USE 0-0-1989; IN COMMERCE 0-0-1989.
DAVID COLLIER, EXAMINING ATTORNEY

SN 77-056,455. GOLDMAN, SACHS & CO., NEW YORK, NY. FILED 12-4-2006.

PREFERPAY HYBRID

THE MARK CONSISTS OF STANDARD CHARACTERS WITHOUT CLAIM TO ANY PARTICULAR FONT, STYLE, SIZE, OR COLOR.

NO CLAIM IS MADE TO THE EXCLUSIVE RIGHT TO USE "HYBRID", APART FROM THE MARK AS SHOWN.

FOR FINANCIAL SERVICES, NAMELY, MORTGAGE LOAN SERVICES; VALUATION AND PROCUREMENT OF MORTGAGE LOANS FOR SECURITIZATION FOR OTHERS (U.S. CLS. 100, 101 AND 102).

REBECCA POVARCHUK, EXAMINING ATTORNEY

CLASS 36—(Continued).

SN 77-076,951. DOMAIN CAPITAL, LLC, FORT LEE, NJ. FILED 1-5-2007.



NO CLAIM IS MADE TO THE EXCLUSIVE RIGHT TO USE "DOMAIN CAPITAL", APART FROM THE MARK AS SHOWN.

THE COLOR(S) SILVER, GRAY, LIGHT GREEN AND DARK GREEN IS/ARE CLAIMED AS A FEATURE OF THE MARK.

THE MARK CONSISTS OF STYLIZED SILVER, GRAY, LIGHT GREEN AND DARK GREEN CIRCLES ADJACENT TO THE STYLIZED NAME "DOMAIN CAPITAL" IN GRAY AND SILVER WITH A STYLIZED FONT. THE WORDS "DOMAIN" AND "CAPITAL" ARE SEPARATED BY A COLON AND A DOUBLE FORWARD SLASH.

FOR FACILITATING AND ARRANGING FOR THE FINANCING OF DOMAIN NAMES (U.S. CLS. 100, 101 AND 102).

FIRST USE 12-20-2005; IN COMMERCE 12-20-2005.
YAT SYE, LEE, EXAMINING ATTORNEY

SN 77-089,938. OPTION II ADVISORS LLC, PHOENIX, AZ. FILED 1-24-2007.

OPTION II ADVISORS

THE MARK CONSISTS OF STANDARD CHARACTERS WITHOUT CLAIM TO ANY PARTICULAR FONT, STYLE, SIZE, OR COLOR.

NO CLAIM IS MADE TO THE EXCLUSIVE RIGHT TO USE "ADVISORS", APART FROM THE MARK AS SHOWN.

FOR CHARITABLE FUND RAISING; FINANCIAL REVIEW SERVICES IN THE NATURE OF FINANCIAL ANALYSIS AND REPORTING; BUSINESS VALUATION SERVICES; FINANCIAL FORECASTING (U.S. CLS. 100, 101 AND 102).

WENDY GOODMAN, EXAMINING ATTORNEY

SN 77-090,084. SAVANT CAPITAL MANAGEMENT, INC., ROCKFORD, IL. FILED 1-24-2007.



THE MARK CONSISTS OF A PARALLELOGRAM FORMED BY HORIZONTAL LINES THAT HAVE A THINNER LEFT PORTION AND THICKER RIGHT PORTION; THE DESIGN ELEMENT OCCURS BEFORE THE WORD "SAVANT".

FOR INVESTMENT MANAGEMENT SERVICES, FINANCIAL PLANNING FOR RETIREMENT, FINANCIAL PLANNING, INVESTMENT CONSULTATION AND ESTATE PLANNING SERVICES (U.S. CLS. 100, 101 AND 102).

FIRST USE 6-29-2001; IN COMMERCE 6-29-2001.
MONIQUE MILLER, EXAMINING ATTORNEY

CLASS 36—(Continued).

SN 77-102,118. VAN WALDICK, DAVID, CARLSBAD, CA. FILED 2-7-2007.

ePrequal.com

THE MARK CONSISTS OF STANDARD CHARACTERS WITHOUT CLAIM TO ANY PARTICULAR FONT, STYLE, SIZE, OR COLOR.

SEC. 2(F).

FOR MORTGAGE SERVICES, NAMELY, BUYER PRE-QUALIFICATION OF MORTGAGES FOR MORTGAGE BROKERS AND BANKS (U.S. CLS. 100, 101 AND 102).

FIRST USE 10-30-1999; IN COMMERCE 10-30-1999.

NAKIA HENRY, EXAMINING ATTORNEY

SN 77-104,824. OPENMLS, INC., ORLANDO, FL. FILED 2-12-2007.

OpenMLS

THE MARK CONSISTS OF STANDARD CHARACTERS WITHOUT CLAIM TO ANY PARTICULAR FONT, STYLE, SIZE, OR COLOR.

FOR PROVIDING ON-LINE COMPUTER DATABASE AND ON-LINE SEARCHABLE DATABASES FEATURING INFORMATION, CLASSIFIED LISTINGS AND ANNOUNCEMENTS ABOUT RESIDENTIAL REAL ESTATE, COMMERCIAL REAL ESTATE, AND RENTAL AND LEASING LISTINGS REGARDING SAME (U.S. CLS. 100, 101 AND 102).

FIRST USE 9-0-2002; IN COMMERCE 9-0-2002.

KARANENDRA S. CHHINA, EXAMINING ATTORNEY

SN 77-108,815. UNIVERSAL CASUALTY COMPANY, ELK GROVE VILLAGE, IL. FILED 2-15-2007.



THE COLOR(S) BLACK, RUSSET AND WHITE IS/ARE CLAIMED AS A FEATURE OF THE MARK.

THE COLOR BLACK APPEARS IN THE WORDING "UCC". THE COLOR RUSSET APPEARS IN THE LOGOS THE COLOR WHITE APPEARS IN THE CENTER STRIPE OF THE LOGO.

FOR INSURANCE SERVICES, NAMELY, WRITING PROPERTY AND CASUALTY INSURANCE (U.S. CLS. 100, 101 AND 102).

FIRST USE 6-8-2006; IN COMMERCE 6-12-2006.

CIMMERIAN COLEMAN, EXAMINING ATTORNEY

CLASS 36—(Continued).

SN 77-115,373. JAZZ PHARMACEUTICALS, INC., PALO ALTO, CA. FILED 2-23-2007.



OWNER OF U.S. REG. NO. 3,005,004.

NO CLAIM IS MADE TO THE EXCLUSIVE RIGHT TO USE "PHARMACEUTICALS", APART FROM THE MARK AS SHOWN.

THE COLOR(S) PURPLE, GOLD AND WHITE IS/ARE CLAIMED AS A FEATURE OF THE MARK.

THE MARK CONSISTS OF THE WORDING JAZZ PHARMACEUTICALS IN THE COLOR PURPLE POSITIONED TO THE RIGHT OF A CIRCULAR LOGO WITH CONCENTRIC CIRCLES OF PURPLE AND WHITE CONTAINING A STYLIZED DEPICTION OF THE LETTERS JP IN THE COLOR WHITE WHICH VERTICALLY SPLITS THE CIRCLE SHOWING GOLD ON THE RIGHT PORTION AND PURPLE ON THE LEFT PORTION OF THE CIRCLE.

FOR PROVIDING INFORMATION IN INSURANCE MATTERS; INSURANCE CONSULTATION; HEALTH CARE INSURANCE CONSULTATION IN THE NATURE OF PROVIDING ASSISTANCE TO OTHERS IN OBTAINING INSURANCE REIMBURSEMENT OF MEDICAL EXPENSES FOR PHARMACEUTICALS (U.S. CLS. 100, 101 AND 102).

FIRST USE 4-21-2006; IN COMMERCE 4-21-2006.

EMILY CHUO, EXAMINING ATTORNEY

SN 77-118,600. FCC, LLC, WEST PALM BEACH, FL. FILED 2-28-2007.

FIRST GROWTH CAPITAL BANK

THE MARK CONSISTS OF STANDARD CHARACTERS WITHOUT CLAIM TO ANY PARTICULAR FONT, STYLE, SIZE, OR COLOR.

OWNER OF U.S. REG. NOS. 1,966,916, 2,277,010 AND 2,991,709.

NO CLAIM IS MADE TO THE EXCLUSIVE RIGHT TO USE "CAPITAL BANK", APART FROM THE MARK AS SHOWN.

SEC. 2(F).

FOR BANKING SERVICES; FINANCIAL SERVICES, NAMELY, LOANS, AND REAL ESTATE AND ASSET-BASED LENDING SERVICES (U.S. CLS. 100, 101 AND 102).

SAIMA MAKHDOOM, EXAMINING ATTORNEY

CLASS 36—(Continued).

SN 77-118,680. MODERN WOODMEN OF AMERICA, ROCK ISLAND, IL. FILED 2-28-2007.

**Modern Woodmen of America
Maximizer**

THE MARK CONSISTS OF STANDARD CHARACTERS WITHOUT CLAIM TO ANY PARTICULAR FONT, STYLE, SIZE, OR COLOR.

NO CLAIM IS MADE TO THE EXCLUSIVE RIGHT TO USE "OF AMERICA", APART FROM THE MARK AS SHOWN.

FOR PROVIDING FRATERNAL SOCIETY BENEFITS, NAMELY, ANNUITY UNDERWRITING, AND THE ISSUANCE AND ADMINISTRATION OF ANNUITIES (U.S. CLS. 100, 101 AND 102).

PAUL E. FAHRENKOPF, EXAMINING ATTORNEY



SN 77-119,915. OMNIAMERICAN BANK, FORT WORTH, TX. FILED 3-1-2007.



OWNER OF U.S. REG. NOS. 2,087,317, 2,692,041 AND OTHERS.

THE MARK CONSISTS OF A STYLIZED "O" IN BETWEEN THE WORDS "OMNI" AND "AMERICAN".

FOR BANKING (U.S. CLS. 100, 101 AND 102).
FIRST USE 1-3-2006; IN COMMERCE 1-3-2006.

ELISSA GARBER KON, EXAMINING ATTORNEY



SN 77-121,016. AMERICAN FAMILY LIFE ASSURANCE COMPANY OF COLUMBUS, COLUMBUS, GA. FILED 3-2-2007.

AFLAC TO THE RESCUE

THE MARK CONSISTS OF STANDARD CHARACTERS WITHOUT CLAIM TO ANY PARTICULAR FONT, STYLE, SIZE, OR COLOR.

OWNER OF U.S. REG. NOS. 1,570,222, 3,249,462 AND OTHERS.

FOR INSURANCE UNDERWRITING SERVICES IN THE FIELDS OF DENTAL, HEALTH, LIFE, CANCER, HOSPITAL INTENSIVE CARE, ACCIDENT AND DISABILITY, HOSPITAL INDEMNITY, HOSPITAL CONFINEMENT INDEMNITY, MEDICARE SUPPLEMENT, SICKNESS, HOME HEALTHCARE, LONG-TERM HEALTHCARE, AND CONVALESCENT HEALTH CARE (U.S. CLS. 100, 101 AND 102).

JENNIFER VASQUEZ, EXAMINING ATTORNEY

CLASS 36—(Continued).

SN 77-122,871. NATIONAL OSTEOPOROSIS FOUNDATION, WASHINGTON, DC. FILED 3-6-2007.

STEPS FOR STRONG BONES

THE MARK CONSISTS OF STANDARD CHARACTERS WITHOUT CLAIM TO ANY PARTICULAR FONT, STYLE, SIZE, OR COLOR.

FOR CHARITABLE FUNDRAISING SERVICES USED TO SUPPORT EVENTS PROMOTING PUBLIC AWARENESS OF OSTEOPOROSIS; FINANCIAL SPONSORSHIP OF EVENTS PROMOTING PUBLIC AWARENESS OF OSTEOPOROSIS TO THE PUBLIC, PATIENTS, AND HEALTH CARE PROFESSIONALS (U.S. CLS. 100, 101 AND 102).

FIRST USE 6-21-2007; IN COMMERCE 6-21-2007.
SETH A. RAPPAPORT, EXAMINING ATTORNEY



SN 77-123,478. WACHOVIA CORPORATION, CHARLOTTE, NC. FILED 3-6-2007.

VERTICE

THE MARK CONSISTS OF STANDARD CHARACTERS WITHOUT CLAIM TO ANY PARTICULAR FONT, STYLE, SIZE, OR COLOR.

FOR MORTGAGE BANKING SERVICES, NAMELY, ORIGINATION, ACQUISITION, SERVICING, SECURITIZATION AND BROKERAGE OF MORTGAGE LOANS (U.S. CLS. 100, 101 AND 102).

SIMON TENG, EXAMINING ATTORNEY

CLASS 36—(Continued).

SN 77-126,335. VISA INTERNATIONAL SERVICE ASSOCIATION, FOSTER CITY, CA. FILED 3-9-2007.

CLASS 36—(Continued).

SN 77-126,884. JAZZ PHARMACEUTICALS, INC., PALO ALTO, CA. FILED 3-9-2007.



PAYWAVE

OWNER OF U.S. REG. NO. 3,005,004.
THE COLOR(S) PURPLE, GOLD AND WHITE IS/ARE CLAIMED AS A FEATURE OF THE MARK.

THE MARK CONSISTS OF CONCENTRIC CIRCLES OF PURPLE AND WHITE CONTAINING A STYLIZED DEPICTION OF THE LETTERS JP IN THE COLOR WHITE WHICH VERTICALLY SPLITS THE CIRCLE SHOWING GOLD ON THE RIGHT PORTION AND PURPLE ON THE LEFT PORTION OF THE CIRCLE.

FOR PROVIDING INFORMATION IN INSURANCE MATTERS; INSURANCE CONSULTATION; HEALTH CARE INSURANCE CONSULTATION IN THE NATURE OF PROVIDING ASSISTANCE TO OTHERS IN OBTAINING INSURANCE REIMBURSEMENT OF MEDICAL EXPENSES FOR PHARMACEUTICALS (U.S. CLS. 100, 101 AND 102).

FIRST USE 4-21-2006; IN COMMERCE 4-21-2006.
JOHN DWYER, EXAMINING ATTORNEY

SN 77-127,030. SUMMIT ALLIANCE FINANCIAL, LLP, DALLAS, TX. FILED 3-9-2007.

THE MARK CONSISTS OF STANDARD CHARACTERS WITHOUT CLAIM TO ANY PARTICULAR FONT, STYLE, SIZE, OR COLOR.

FOR FINANCIAL SERVICES, NAMELY, BANKING SERVICES, CREDIT CARD SERVICES, DEBIT CARD SERVICES, AND PREPAID CARD SERVICES, NAMELY, PROCESSING ELECTRONIC PAYMENTS MADE THROUGH PREPAID CARDS; PAYMENT CARD SERVICES OFFERED BY MEANS OF RADIO FREQUENCY IDENTIFICATION DEVICES, NAMELY, PROCESSING ELECTRONIC PAYMENTS MADE THROUGH CREDIT CARDS, DEBIT CARDS, AND PREPAID CARDS; ELECTRONIC FUNDS TRANSFER AND CURRENCY EXCHANGE SERVICES; ELECTRONIC PAYMENT PROCESSING SERVICES; PREPAID PHONE CARD SERVICES; CREDIT CARD, DEBIT CARD, AND PREPAID CARD TRANSACTION AUTHORIZATION AND SETTLEMENT SERVICES; DEPOSIT ACCESS AND AUTOMATED TELLER MACHINE SERVICES; CREDIT, DEBIT, AND PREPAID CARD PAYMENT VERIFICATION SERVICES; PERSON-TO-PERSON PAYMENT SERVICES THROUGH ELECTRONIC MEANS; TRAVEL INSURANCE BROKERAGE SERVICES; PAYMENT IDENTIFICATION SERVICES, NAMELY, PAYMENT TRANSACTION, AUTHENTICATION, AND VERIFICATION SERVICES; ADVISORY SERVICES RELATING TO ALL OF THE AFORESAID SERVICES (U.S. CLS. 100, 101 AND 102).

EMILY CARLSEN, EXAMINING ATTORNEY

SUMMIT ALLIANCE

THE MARK CONSISTS OF STANDARD CHARACTERS WITHOUT CLAIM TO ANY PARTICULAR FONT, STYLE, SIZE, OR COLOR.

FOR LIFE-INSURANCE BROKERAGE FOR AGENTS AND RETAIL CUSTOMERS; INSURANCE CONSULTATION SERVICES FOR LIFE-INSURANCE AGENTS IN THE FIELD OF ESTATE PLANNING AND CHARITABLE GIVING; BROKERAGE SERVICES, NAMELY, BROKERING FUNDING SOURCES AND PROVIDING FUNDING FOR THE ACQUISITION OF LIFE-INSURANCE POLICIES FOR VIATICAL AND LIFE SETTLEMENTS; BROKERAGE OF LIFE-INSURANCE PREMIUM-FINANCE PROGRAMS; DISTRIBUTION OF ANNUITIES (U.S. CLS. 100, 101 AND 102).

FIRST USE 9-30-2000; IN COMMERCE 9-30-2000.
JOHN DWYER, EXAMINING ATTORNEY

CLASS 36—(Continued).

SN 77-127,189. SUMMIT ALLIANCE FINANCIAL, LLP, DALLAS, TX. FILED 3-9-2007.



NO CLAIM IS MADE TO THE EXCLUSIVE RIGHT TO USE "COMPANIES", APART FROM THE MARK AS SHOWN.

THE COLOR(S) RED, WHITE AND BLACK IS/ARE CLAIMED AS A FEATURE OF THE MARK.

THE MARK CONSISTS OF THE WORDS "SUMMIT ALLIANCE COMPANIES" IN BLACK WITH A WHITE STYLIZED MOUNTAIN RANGE ABOVE THE WORDS SURROUNDED IN RED.

FOR LIFE-INSURANCE BROKERAGE FOR AGENTS AND RETAIL CUSTOMERS; INSURANCE CONSULTATION SERVICES FOR LIFE-INSURANCE AGENTS IN THE FIELD OF ESTATE PLANNING AND CHARITABLE GIVING; BROKERAGE SERVICES, NAMELY, BROKERING FUNDING SOURCES AND PROVIDING FUNDING FOR THE ACQUISITION OF LIFE-INSURANCE POLICIES FOR VIATICAL AND LIFE SETTLEMENTS; BROKERAGE OF LIFE-INSURANCE PREMIUM-FINANCE PROGRAMS; DISTRIBUTION OF ANNUITIES (U.S. CLS. 100, 101 AND 102).

FIRST USE 4-30-2001; IN COMMERCE 4-30-2001.
JOHN DWYER, EXAMINING ATTORNEY

CLASS 36—(Continued).

SN 77-128,984. ING GROEP N.V., AMSTERDAM, NETHERLANDS, FILED 3-12-2007.

ING DIAL DISABILITY INCOME ASSISTANCE LINE

THE MARK CONSISTS OF STANDARD CHARACTERS WITHOUT CLAIM TO ANY PARTICULAR FONT, STYLE, SIZE, OR COLOR.

NO CLAIM IS MADE TO THE EXCLUSIVE RIGHT TO USE "DISABILITY INCOME ASSISTANCE LINE", APART FROM THE MARK AS SHOWN.

FOR PROVIDING INFORMATION AND COUNSELING IN THE FIELD OF DISABILITY INCOME COVERAGE (U.S. CLS. 100, 101 AND 102).

FIRST USE 2-25-2004; IN COMMERCE 7-1-2004.
ERIN FALK, EXAMINING ATTORNEY

SN 77-128,016. BIRMINGHAM, ANDREW W., DENVER, CO. FILED 3-12-2007.

SN 77-129,751. 1-800-JACKPOT, INC., KANSAS CITY, MO. FILED 3-13-2007.

1-800-JACKPOT

Snake River

THE MARK CONSISTS OF STANDARD CHARACTERS WITHOUT CLAIM TO ANY PARTICULAR FONT, STYLE, SIZE, OR COLOR.

FOR FINANCIAL SERVICES, NAMELY, INVESTMENT BANKING SERVICES, REAL ESTATE INVESTMENT, MERCHANT BANKING SERVICES, ASSET MANAGEMENT SERVICES, AND VENTURE CAPITAL FUNDING SERVICES TO EMERGING AND START-UP COMPANIES (U.S. CLS. 100, 101 AND 102).

CHARLOTTE CORWIN, EXAMINING ATTORNEY

THE MARK CONSISTS OF STANDARD CHARACTERS WITHOUT CLAIM TO ANY PARTICULAR FONT, STYLE, SIZE, OR COLOR.

FOR PROVIDING INFORMATION IN THE FIELDS OF FINANCE, CREDIT CARD SERVICES, DEBIT CARD SERVICES, CHARGE CARD SERVICES, CHARITABLE FUNDRAISING, AND COMMODITY AND SECURITIES TRADING; PROVIDING LINKS TO THE WEBSITES OF OTHERS IN THE FIELD OF FINANCE, CREDIT CARD SERVICES, DEBIT CARD SERVICES, CHARGE CARD SERVICES, CHARITABLE FUNDRAISING AND COMMODITY TRADING; CHARITABLE SERVICES, NAMELY, ADMINISTERING MONETARY DONATIONS ON BEHALF OF MEMBERS TO CHARITIES (U.S. CLS. 100, 101 AND 102).

LESLEY LAMOTHE, EXAMINING ATTORNEY

CLASS 36—(Continued).

SN 77-131,599. CLIMATE LEADERS FUND MANAGEMENT LTD., LONDON, UNITED KINGDOM, FILED 3-15-2007.



NO CLAIM IS MADE TO THE EXCLUSIVE RIGHT TO USE "INVESTMENT FUND", APART FROM THE MARK AS SHOWN.

THE MARK CONSISTS OF AN IMAGE OF THE EARTH INSIDE A CIRCLE WITH THREE ARROWS COMING OUT OF THE CIRCLE ABOVE THE WORDS "CLIMATE LEADERS".

FOR FINANCIAL SERVICES, NAMELY, FUNDS INVESTMENT AND INVESTMENT MANAGEMENT SERVICES; INVESTMENT ADVICE SERVICES, INVESTMENT BANKING SERVICES, INVESTMENT BROKERAGE SERVICES, INVESTMENT CONSULTATION, INVESTMENT OF FUNDS FOR OTHERS, MANAGEMENT OF A CAPITAL INVESTMENT FUND, PRIVATE EQUITY FUND INVESTMENT SERVICES (U.S. CLS. 100, 101 AND 102).

TEJBIR SINGH, EXAMINING ATTORNEY

SN 77-132,290. ING DIRECT BANCORP, WILMINGTON, DE. FILED 3-15-2007.

THE ROAD TO HAPPINESS

THE MARK CONSISTS OF STANDARD CHARACTERS WITHOUT CLAIM TO ANY PARTICULAR FONT, STYLE, SIZE, OR COLOR.

FOR BANKING SERVICES; SAVINGS ACCOUNT SERVICES; INTERNET BANKING SERVICES (U.S. CLS. 100, 101 AND 102).

FIRST USE 3-14-2007; IN COMMERCE 3-14-2007.
JASON TURNER, EXAMINING ATTORNEY

CLASS 36—(Continued).

SN 77-134,767. RIVERON CONSULTING, LP, DALLAS, TX. FILED 3-19-2007.



NO CLAIM IS MADE TO THE EXCLUSIVE RIGHT TO USE "CONSULTING", APART FROM THE MARK AS SHOWN.

THE COLOR(S) BLUE, WHITE AND BLACK IS/ARE CLAIMED AS A FEATURE OF THE MARK.

THE MARK CONSISTS OF THE CAPITAL LETTER "R" WITH A WAVY LINE DIRECTLY UNDERNEATH IT BOTH IN THE COLOR WHITE, SURROUNDED BY A RECTANGULAR BOX COMPRISED OF THE COLOR BLUE, WITH THE COLOR BLACK APPEARING IN THE WORDING "RIVERON CONSULTING" UNDERNEATH THE DESIGN, WITH A BLUE LINE UNDERNEATH THE TEXT.

FOR FINANCIAL ANALYSIS AND CONSULTATION; FINANCIAL DUE DILIGENCE; FINANCIAL CONSULTATION (U.S. CLS. 100, 101 AND 102).

FIRST USE 8-15-2006; IN COMMERCE 8-15-2006.
MATTHEW PAPPAS, EXAMINING ATTORNEY

SN 77-134,783. RIVERON CONSULTING, LP, DALLAS, TX. FILED 3-19-2007.

RIVERON

THE MARK CONSISTS OF STANDARD CHARACTERS WITHOUT CLAIM TO ANY PARTICULAR FONT, STYLE, SIZE, OR COLOR.

FOR FINANCIAL ANALYSIS AND CONSULTATION; FINANCIAL CONSULTATION; FINANCIAL DUE DILIGENCE (U.S. CLS. 100, 101 AND 102).

FIRST USE 8-15-2006; IN COMMERCE 8-15-2006.
MATTHEW PAPPAS, EXAMINING ATTORNEY

CLASS 36—(Continued).

SN 77-135,336. THE BEAR STEARNS COMPANIES INC., NEW YORK, NY. FILED 3-20-2007.

MANAGED ACCOUNT EDGE

THE MARK CONSISTS OF STANDARD CHARACTERS WITHOUT CLAIM TO ANY PARTICULAR FONT, STYLE, SIZE, OR COLOR.

NO CLAIM IS MADE TO THE EXCLUSIVE RIGHT TO USE "MANAGED ACCOUNT", APART FROM THE MARK AS SHOWN.

FOR FINANCIAL SERVICES, NAMELY, BROKERAGE OF SHARES OR STOCKS AND OTHER SECURITIES AND FINANCIAL AND INVESTMENT INSTRUMENTS, SECURITIES CUSTODY, SECURITIES TRADE EXECUTION AND CLEARING SERVICES, AND PROVISION OF INFORMATION REGARDING THIRD-PARTY PROVIDERS OF MONEY MANAGEMENT SERVICES AND FACILITATION OF CLIENT ACCESS TO AND USE OF SUCH PROVIDERS (U.S. CLS. 100, 101 AND 102).

LINDA M. KING, EXAMINING ATTORNEY

CLASS 36—(Continued).

SN 77-138,699. OMNIAMERICAN BANK, FORT WORTH, TX. FILED 3-23-2007.

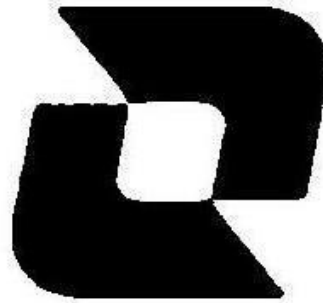

OWNER OF U.S. REG. NOS. 2,087,317 AND 2,692,041. THE MARK CONSISTS OF STYLIZED "O" FOR BANKING SERVICES (U.S. CLS. 100, 101 AND 102).

ELISSA GARBER KON, EXAMINING ATTORNEY

SN 77-135,495. UNITED TALENT AGENCY, BEVERLY HILLS, CA. FILED 3-20-2007.

UTA

THE MARK CONSISTS OF STANDARD CHARACTERS WITHOUT CLAIM TO ANY PARTICULAR FONT, STYLE, SIZE, OR COLOR.

OWNER OF U.S. REG. NO. 2,695,035.

FOR CONSULTING SERVICES IN THE FIELD OF CHARITABLE FUND RAISING (U.S. CLS. 100, 101 AND 102).

FIRST USE 4-30-2004; IN COMMERCE 4-30-2004. CARRIE GENOVESE, EXAMINING ATTORNEY

SN 77-139,123. THE WILLIAM J. CLINTON FOUNDATION, LITTLE ROCK, AR. FILED 3-23-2007.

EITC 365

SN 77-138,445. RIISNET, LLC, DAPHNE, AL. FILED 3-23-2007.

ITIC

THE MARK CONSISTS OF STANDARD CHARACTERS WITHOUT CLAIM TO ANY PARTICULAR FONT, STYLE, SIZE, OR COLOR.

FOR PROVIDING INFORMATION IN THE FIELD OF REAL ESTATE VIA THE INTERNET FOR USE IN SELLING, PURCHASING, AND EXCHANGING REAL ESTATE ASSETS; REAL ESTATE EQUITY SHARING, NAMELY, ARRANGING FOR AND MANAGING THE CO-OWNERSHIP OF REAL ESTATE; INSURANCE SERVICES, NAMELY, CONSULTATION AND UNDERWRITING IN THE FIELD OF REAL ESTATE AND INSURANCE BROKERAGE SERVICES IN THE FIELD OF REAL ESTATE (U.S. CLS. 100, 101 AND 102).

DAVID TOOLEY, EXAMINING ATTORNEY

THE MARK CONSISTS OF STANDARD CHARACTERS WITHOUT CLAIM TO ANY PARTICULAR FONT, STYLE, SIZE, OR COLOR.

NO CLAIM IS MADE TO THE EXCLUSIVE RIGHT TO USE EITC, APART FROM THE MARK AS SHOWN.

FOR PROVIDING ECONOMIC EMPOWERMENT SERVICES TO EARNED INCOME TAX CREDIT RECIPIENTS, NAMELY, FINANCIAL LITERACY COUNSELING, MONEY MANAGEMENT COUNSELING, AND BUDGET, CREDIT AND INVESTMENT COUNSELING (U.S. CLS. 100, 101 AND 102).

MICHELLE DUBOIS, EXAMINING ATTORNEY

CLASS 36—(Continued).

SN 77-139,218. FALCONHEAD CAPITAL, LLC, NEW YORK, NY. FILED 3-23-2007.

SPORTS CAPITAL PARTNERS

THE MARK CONSISTS OF STANDARD CHARACTERS WITHOUT CLAIM TO ANY PARTICULAR FONT, STYLE, SIZE, OR COLOR.

OWNER OF U.S. REG. NO. 2,448,494.
NO CLAIM IS MADE TO THE EXCLUSIVE RIGHT TO USE "PARTNERS", APART FROM THE MARK AS SHOWN. SEC. 2(F).

FOR FINANCIAL SERVICES, NAMELY, INVESTMENT ADVISORY SERVICES, INVESTMENT OF FUNDS FOR OTHERS, FUNDS INVESTMENT (U.S. CLS. 100, 101 AND 102).

FIRST USE 2-0-1999; IN COMMERCE 2-0-1999.
BARBARA GAYNOR, EXAMINING ATTORNEY

SN 77-143,465. RIISNET, LLC, DAPHNE, AL. FILED 3-29-2007.



THE MARK CONSISTS OF THE WORD "RIISNET" WITH FOUR CUBES OUTLINED BENEATH.

FOR PROVIDING INFORMATION IN THE FIELD OF REAL ESTATE VIA THE INTERNET FOR USE IN SELLING, PURCHASING, AND EXCHANGING REAL ESTATE ASSETS (U.S. CLS. 100, 101 AND 102).

FIRST USE 6-1-2006; IN COMMERCE 6-1-2006.
DAVID TOOLEY, EXAMINING ATTORNEY

SN 77-143,524. TALARIS RESEARCH INSTITUTE, DBA TALARIS INSTITUTE, SEATTLE, WA. FILED 3-29-2007.

CENTER FOR MIND, BRAIN AND LEARNING

THE MARK CONSISTS OF STANDARD CHARACTERS WITHOUT CLAIM TO ANY PARTICULAR FONT, STYLE, SIZE, OR COLOR.

OWNER OF U.S. REG. NO. 3,022,842.
NO CLAIM IS MADE TO THE EXCLUSIVE RIGHT TO USE "CENTER" AND "BRAIN AND LEARNING", APART FROM THE MARK AS SHOWN.

FOR CHARITABLE FUND RAISING IN THE AREA OF RESEARCH AND STUDY REGARDING PARENTING, EARLY LEARNING, BEHAVIORAL, SOCIAL AND EMOTIONAL DEVELOPMENT, AND EARLY BRAIN DEVELOPMENT (U.S. CLS. 100, 101 AND 102).

JIM RINGLE, EXAMINING ATTORNEY

CLASS 36—(Continued).

SN 77-146,028. JPMORGAN CHASE & CO., NEW YORK, NY. FILED 4-2-2007.

PREFERRED CUSTOMER ADVANCE RAL

THE MARK CONSISTS OF STANDARD CHARACTERS WITHOUT CLAIM TO ANY PARTICULAR FONT, STYLE, SIZE, OR COLOR.

NO CLAIM IS MADE TO THE EXCLUSIVE RIGHT TO USE RAL, APART FROM THE MARK AS SHOWN.

FOR BANKING AND FINANCIAL SERVICES NAMELY, REFUND ANTICIPATION LOANS BASED ON TAX RETURNS (U.S. CLS. 100, 101 AND 102).

FIRST USE 10-13-2006; IN COMMERCE 10-13-2006.
MARK T. MULLEN, EXAMINING ATTORNEY

SN 77-146,069. AMERICAN MEDICAL AND LIFE INSURANCE COMPANY, HICKSVILLE, NY. FILED 4-2-2007.



OWNER OF U.S. REG. NO. 2,626,081.
NO CLAIM IS MADE TO THE EXCLUSIVE RIGHT TO USE "AMERICAN MEDICAL AND LIFE INSURANCE COMPANY AND INSURANCE SOLUTIONS COAST-TO-COAST", APART FROM THE MARK AS SHOWN.

FOR INSURANCE UNDERWRITING IN THE FIELD OF GROUP HEALTH INSURANCE AND LIFE INSURANCE (U.S. CLS. 100, 101 AND 102).

FIRST USE 1-13-2006; IN COMMERCE 1-13-2006.
BERYL GARDNER, EXAMINING ATTORNEY

CLASS 36—(Continued).

SN 77-150,831. PANAMERICAN REALTY CORPORATION, JACKSON HEIGHTS, NY. FILED 4-6-2007.

CLASS 36—(Continued).

SN 77-161,590. MOBILEKASH, FARMERS BRANCH, TX. FILED 4-20-2007.

CERTIFIED MARKET VALUE

THE MARK CONSISTS OF STANDARD CHARACTERS WITHOUT CLAIM TO ANY PARTICULAR FONT, STYLE, SIZE, OR COLOR.

NO CLAIM IS MADE TO THE EXCLUSIVE RIGHT TO USE "MARKET VALUE", APART FROM THE MARK AS SHOWN.

FOR REAL ESTATE SALES AND BROKERAGE SERVICES, NAMELY, LEASING OF REAL ESTATE, REAL ESTATE AGENCIES, REAL ESTATE BROKERAGES, APARTMENT LOCATING SERVICES FOR OTHER, HOUSING AGENCIES, FINANCING SERVICES FOR DEVELOPMENT OF REAL ESTATE, ARRANGING FOR FINANCIAL INVESTMENTS IN THE FIELD OF REAL ESTATE, RENT COLLECTION AGENCIES, LEASE-PURCHASE FINANCING, FINANCIAL EVALUATION OF REAL ESTATE, REAL ESTATE AGENCY SERVICES FOR BUILDINGS, LICENSED REAL ESTATE AGENCIES, REAL ESTATE APPRAISAL AND REAL ESTATE MANAGEMENT (U.S. CLS. 100, 101 AND 102).

ELLEN B. AWRICH, EXAMINING ATTORNEY



SN 77-152,915. BIRMINGHAM, ANDREW W., DENVER, CO. FILED 4-10-2007.

Hydrogenica

THE MARK CONSISTS OF STANDARD CHARACTERS WITHOUT CLAIM TO ANY PARTICULAR FONT, STYLE, SIZE, OR COLOR.

FOR FINANCIAL SERVICES, NAMELY, INVESTMENT BANKING SERVICES, REAL ESTATE INVESTMENT, MERCHANT BANKING SERVICES, ASSET MANAGEMENT SERVICES, AND VENTURE CAPITAL FUNDING SERVICES TO EMERGING AND START-UP COMPANIES (U.S. CLS. 100, 101 AND 102).

FIRST USE 3-31-2001; IN COMMERCE 3-31-2001. CHARLOTTE CORWIN, EXAMINING ATTORNEY

Digital Allowance

THE MARK CONSISTS OF STANDARD CHARACTERS WITHOUT CLAIM TO ANY PARTICULAR FONT, STYLE, SIZE, OR COLOR.

NO CLAIM IS MADE TO THE EXCLUSIVE RIGHT TO USE "DIGITAL", APART FROM THE MARK AS SHOWN.

FOR ELECTRONIC COMMERCE PAYMENT SERVICES, NAMELY, ESTABLISHING FUNDED ACCOUNTS USED TO PURCHASE GOODS AND SERVICES ON THE INTERNET; ELECTRONIC FUNDS TRANSFER BY TELECOMMUNICATIONS; ELECTRONIC FUNDS TRANSFER; ACCEPTING AND ADMINISTERING MONETARY CHARITABLE CONTRIBUTIONS; BILL PAYMENT SERVICES; FINANCIAL SERVICES, NAMELY, PROVIDING ON-LINE STORED VALUE ACCOUNTS IN AN ELECTRONIC ENVIRONMENT; FINANCIAL TRANSACTION SERVICES, NAMELY, PROVIDING SECURE COMMERCIAL TRANSACTIONS AND PAYMENT OPTIONS USING A MOBILE DEVICE AT A POINT OF SALE; ELECTRONIC PAYMENT, NAMELY, ELECTRONIC PROCESSING AND TRANSMISSION OF BILL PAYMENT DATA; PRE-PAID PURCHASE CARD SERVICES, NAMELY, PROCESSING ELECTRONIC PAYMENTS MADE THROUGH PREPAID CARDS; PRE-PAID PURCHASE CARD SERVICES, NAMELY, PROCESSING ELECTRONIC PAYMENTS THROUGH PRE-PAID CARDS; PROVIDING MULTIPLE PAYMENT OPTIONS BY MEANS OF CUSTOMER-OPERATED ELECTRONIC TERMINALS AVAILABLE ON-SITE IN RETAIL STORES (U.S. CLS. 100, 101 AND 102).

SUSAN LESLIE DUBOIS, EXAMINING ATTORNEY



SN 77-167,443. PHILADELPHIA PRIVATE CAPITAL, LLC., PHILADELPHIA, PA. FILED 4-27-2007.

INTREPID

THE MARK CONSISTS OF STANDARD CHARACTERS WITHOUT CLAIM TO ANY PARTICULAR FONT, STYLE, SIZE, OR COLOR.

FOR FINANCIAL INVESTMENT SERVICES IN THE FIELD OF REAL ESTATE, NAMELY, MANAGEMENT OF PRIVATE EQUITY FUNDS AND REAL ESTATE EQUITY SHARING, NAMELY MANAGING AND ARRANGING FOR CO-OWNERSHIP OF REAL ESTATE (U.S. CLS. 100, 101 AND 102).

ALICIA COLLINS, EXAMINING ATTORNEY

CLASS 36—(Continued).

SN 77-168,452. FAMILY ENTERTAINMENT ASSOCIATION, GRAND RAPIDS, MI. FILED 4-28-2007.

FAMILY ENTERTAINMENT CENTRAL

THE MARK CONSISTS OF STANDARD CHARACTERS WITHOUT CLAIM TO ANY PARTICULAR FONT, STYLE, SIZE, OR COLOR.

NO CLAIM IS MADE TO THE EXCLUSIVE RIGHT TO USE "FAMILY ENTERTAINMENT", APART FROM THE MARK AS SHOWN.

FOR CHARITABLE SERVICES, NAMELY, PROVIDING FINANCIAL SUPPORT FOR INDIVIDUALS AND ORGANIZATIONS THAT PROMOTE PUBLIC AND ENTERTAINMENT INDUSTRY AWARENESS OF THE NEED FOR THE CREATION, PRODUCTION, DISTRIBUTION AND CONSUMPTION OF WHOLESOME FAMILY ENTERTAINMENT (U.S. CLS. 100, 101 AND 102). ELLEN B. AWRICH, EXAMINING ATTORNEY

SN 77-169,123. UNITED COUNTRY ROGUE COAST REALTY, GOLD BEACH, OR. FILED 4-30-2007.

Rogue Coast roguecoast

THE MARK CONSISTS OF STANDARD CHARACTERS WITHOUT CLAIM TO ANY PARTICULAR FONT, STYLE, SIZE, OR COLOR.

FOR LAND ACQUISITION, NAMELY, REAL ESTATE BROKERAGE; LEASING OF REAL ESTATE; LEASING OF REAL PROPERTY; PROVIDING INFORMATION IN THE FIELD OF REAL ESTATE BY MEANS OF LINKING THE WEB SITE TO OTHER WEB SITES FEATURING REAL ESTATE INFORMATION; PROVIDING INFORMATION IN THE FIELD OF REAL ESTATE VIA THE INTERNET; PROVIDING REAL ESTATE LISTINGS AND REAL ESTATE INFORMATION VIA THE INTERNET; REAL ESTATE AGENCIES; REAL ESTATE BROKERAGE; REAL ESTATE CONSULTANCY; REAL ESTATE CONSULTATION; REAL ESTATE EQUITY SHARING, NAMELY, MANAGING AND ARRANGING FOR CO-OWNERSHIP OF REAL ESTATE; REAL ESTATE INVESTMENT; REAL ESTATE LISTING; REAL ESTATE MANAGEMENT; REAL ESTATE MANAGEMENT CONSULTATION; REAL ESTATE MULTIPLE LISTING SERVICES; REAL ESTATE PROCUREMENT FOR OTHERS; REAL ESTATE SERVICES, NAMELY, RENTAL OF VACATION HOMES, CONDOMINIUMS, CABINS, AND VILLAS USING PAY PER CLICK ADVERTISING ON A GLOBAL COMPUTER NETWORK; REAL ESTATE TIME-SHARING (U.S. CLS. 100, 101 AND 102). ANTHONY RINKER, EXAMINING ATTORNEY

CLASS 36—(Continued).

SN 77-170,930. PLAINTIFF SUPPORT SERVICES, AMHERST, NY. FILED 5-2-2007.

Plaintiff Support Services

THE MARK CONSISTS OF STANDARD CHARACTERS WITHOUT CLAIM TO ANY PARTICULAR FONT, STYLE, SIZE, OR COLOR.

NO CLAIM IS MADE TO THE EXCLUSIVE RIGHT TO USE "SUPPORT SERVICES", APART FROM THE MARK AS SHOWN.

SEC. 2(F).

FOR FINANCIAL SERVICES, NAMELY, INVESTMENT FUND TRANSFER AND TRANSACTION SERVICES; FUNDS INVESTMENT; FACILITATING AND ARRANGING FOR THE FINANCING OF LITIGATION FOR PLAINTIFFS; FINANCING SERVICES (U.S. CLS. 100, 101 AND 102).

FIRST USE 1-30-1999; IN COMMERCE 1-30-1999.

JENNIFER VASQUEZ, EXAMINING ATTORNEY

SN 77-173,311. ITG SOFTWARE SOLUTIONS, INC., CULVER CITY, CA. FILED 5-4-2007.

POSIT VWAP

THE MARK CONSISTS OF STANDARD CHARACTERS WITHOUT CLAIM TO ANY PARTICULAR FONT, STYLE, SIZE, OR COLOR.

OWNER OF U.S. REG. NO. 1,530,044.

NO CLAIM IS MADE TO THE EXCLUSIVE RIGHT TO USE "VWAP", APART FROM THE MARK AS SHOWN.

FOR COMPUTERIZED STOCK BROKERAGE SERVICES (U.S. CLS. 100, 101 AND 102).

TARAH HARDY, EXAMINING ATTORNEY

SN 77-174,845. ING GROEP N.V., AMSTERDAM, NETHERLANDS, FILED 5-7-2007.

ING'S TRANSITION COUNSELING

THE MARK CONSISTS OF STANDARD CHARACTERS WITHOUT CLAIM TO ANY PARTICULAR FONT, STYLE, SIZE, OR COLOR.

NO CLAIM IS MADE TO THE EXCLUSIVE RIGHT TO USE "TRANSITION COUNSELING", APART FROM THE MARK AS SHOWN.

FOR CONSULTATION SERVICES IN THE FIELD OF RETIREMENT PLAN OPTIONS (U.S. CLS. 100, 101 AND 102).

FIRST USE 2-0-2004; IN COMMERCE 2-0-2004.

ERIN FALK, EXAMINING ATTORNEY

CLASS 36—(Continued).

SN 77-179,701. LAURO, GEORGE, SARATOGA, CA. FILED 5-13-2007.

Alteon Capital

THE MARK CONSISTS OF STANDARD CHARACTERS WITHOUT CLAIM TO ANY PARTICULAR FONT, STYLE, SIZE, OR COLOR.

NO CLAIM IS MADE TO THE EXCLUSIVE RIGHT TO USE "CAPITAL", APART FROM THE MARK AS SHOWN.

FOR INVESTMENT SERVICES, NAMELY, VENTURE CAPITAL ADVISORY AND FUNDING SERVICES TO TECHNOLOGY COMPANIES AND HIGH-TECHNOLOGY PRODUCT COMPANIES; FUNDS INVESTMENT CONSULTATION, INVESTMENT MANAGEMENT; MANAGEMENT OF VENTURE CAPITAL FUNDS (U.S. CLS. 100, 101 AND 102).

FIRST USE 3-30-2007; IN COMMERCE 3-30-2007.
MARGARET POWER, EXAMINING ATTORNEY

SN 77-181,329. WESTERN NATIONAL BANK, PHOENIX, AZ. FILED 5-15-2007.



OWNER OF U.S. REG. NO. 3,168,152.

NO CLAIM IS MADE TO THE EXCLUSIVE RIGHT TO USE "SPECIALTY MARKETS BANK" AND "A DIVISION OF WESTERN NATIONAL BANK", APART FROM THE MARK AS SHOWN.

THE MARK CONSISTS OF THE WORD "SPECIALTY" CENTERED OVER THE WORDS "MARKETS BANC" WITH THE TOP HALF OF AN ELLIPSE OVER THE WORDING STARTING AT THE S IN SPECIALTY AND ENDING OVER THE L IN "SPECIALTY".

FOR COMMERCIAL BANKING SERVICES FOR AND DEDICATED TO PROPERTY MANAGEMENT COMPANIES, NAMELY, PROVIDING LINES OF CREDIT, REAL ESTATE AND SBA LOANS, CONSTRUCTION LOANS, EQUIPMENT AND VEHICLE LOANS, BANK ACCOUNTS; ON-LINE COMMERCIAL BANKING SERVICES FOR AND DEDICATED TO PROPERTY MANAGEMENT COMPANIES, NAMELY, ELECTRONIC CHECK PROCESSING, PAPER CHECK AND PAYMENT COUPON CONVERSION, AND ACCOUNT ACCESS MANAGEMENT TOOLS; LOCKBOX SERVICES FOR PAYMENTS RECEIVED FOR AND DEDICATED TO PROPERTY MANAGEMENT COMPANIES (U.S. CLS. 100, 101 AND 102).

FIRST USE 6-13-2006; IN COMMERCE 6-13-2006.
MICHAEL LITZAU, EXAMINING ATTORNEY

CLASS 36—(Continued).

SN 77-182,372. SYNAPSE INVESTMENT MANAGEMENT LLP, LONDON, ENGLAND, FILED 5-16-2007.

SYNAPSE

THE MARK CONSISTS OF STANDARD CHARACTERS WITHOUT CLAIM TO ANY PARTICULAR FONT, STYLE, SIZE, OR COLOR.

FOR FINANCIAL SERVICES, NAMELY, INVESTMENT ADVISORY SERVICES, INVESTMENT MANAGEMENT SERVICES AND ASSET MANAGEMENT SERVICES (U.S. CLS. 100, 101 AND 102).

FIRST USE 4-2-2007; IN COMMERCE 4-2-2007.
ANNE E. GUSTASON, EXAMINING ATTORNEY

SN 77-183,400. BLUE BIRD INVESTMENT CORPORATION, WILMINGTON, DE. FILED 5-17-2007.

BLUE BIRD FINANCIAL SERVICES

THE MARK CONSISTS OF STANDARD CHARACTERS WITHOUT CLAIM TO ANY PARTICULAR FONT, STYLE, SIZE, OR COLOR.

OWNER OF U.S. REG. NO. 2,915,170.

NO CLAIM IS MADE TO THE EXCLUSIVE RIGHT TO USE "FINANCIAL SERVICES", APART FROM THE MARK AS SHOWN.

FOR FINANCING SERVICES FOR LEASING, INVENTORY FINANCING AND OWNERSHIP OF BUSES, BUS FLEETS, STREETCARS, TRUCKS, TRAILERS, RECREATIONAL VEHICLES AND OTHER LIGHT, MEDIUM AND HEAVY DUTY TRANSPORTATION ASSETS (U.S. CLS. 100, 101 AND 102).

FIRST USE 3-14-2007; IN COMMERCE 3-14-2007.
MARTHA FROMM, EXAMINING ATTORNEY

SN 77-185,012. INVESTING MINDS, INC., CHICAGO, IL. FILED 5-18-2007.

InvestingMinds

THE MARK CONSISTS OF STANDARD CHARACTERS WITHOUT CLAIM TO ANY PARTICULAR FONT, STYLE, SIZE, OR COLOR.

FOR PROVIDING AN ONLINE DATABASE FEATURING FINANCIAL INFORMATION, IMAGES AND OTHER DATA IN THE FIELD OF FINANCE (U.S. CLS. 100, 101 AND 102).

ELISSA GARBER KON, EXAMINING ATTORNEY

CLASS 36—(Continued).

SN 77-187,535. KOCH GLOBAL CAPITAL, LLC, SCOTTSDALE, AZ. FILED 5-22-2007.

PINNACLE PEAK

THE MARK CONSISTS OF STANDARD CHARACTERS WITHOUT CLAIM TO ANY PARTICULAR FONT, STYLE, SIZE, OR COLOR.

FOR MANAGEMENT OF PORTFOLIOS COMPRISING SECURITIES (U.S. CLS. 100, 101 AND 102).
MARGARET POWER, EXAMINING ATTORNEY

SN 77-190,839. GS ADMINISTRATORS, INC., HOUSTON, TX. FILED 5-25-2007.



THE COLOR(S) BLACK, BLUE, LIGHT BLUE, WHITE AND GRAY IS/ARE CLAIMED AS A FEATURE OF THE MARK.

THE COLOR BLACK APPEARS IN THE WORDING "SECUREDRIVE." THE COLOR BLUE APPEARS IN THE WORDING "CHOICE" AND IN THE BORDER, INTERIOR SHADING, AND LEFT LOWER EDGE OF THE DESIGN ELEMENT. THE COLOR WHITE APPEARS IN THE WAVY LINE THAT APPEARS WITHIN THE DESIGN ELEMENT AND IN THE INTERIOR SHADING OF THE DESIGN ELEMENT. THE COLOR LIGHT BLUE APPEARS IN THE RIGHT LOWER EDGE OF THE DESIGN ELEMENT AND THE COLOR GRAY APPEARS IN THE SHADOW BENEATH THE DESIGN ELEMENT.

FOR FINANCIAL SERVICES, NAMELY, AUTOMOTIVE INSURANCE UNDERWRITING AND PROVIDING EXTENDED WARRANTIES ON AUTOMOBILES; FINANCIAL SERVICES, NAMELY, UNDERWRITING SERVICE CONTRACTS, EXTENDED WARRANTY CONTRACTS, AND INSURANCE CONTRACTS IN THE FIELD OF AUTOMOBILES; INSURANCE SERVICES, NAMELY, UNDERWRITING SERVICE CONTRACTS, EXTENDED WARRANTY CONTRACTS AND INSURANCE CONTRACTS IN THE FIELD OF AUTOMOBILES (U.S. CLS. 100, 101 AND 102).

ROBERT LAVACHE, EXAMINING ATTORNEY

SN 77-190,856. GS ADMINISTRATORS, INC., HOUSTON, TX. FILED 5-25-2007.



THE COLOR(S) BLACK, BLUE, LIGHT BLUE, WHITE AND GRAY IS/ARE CLAIMED AS A FEATURE OF THE MARK.

THE COLOR BLACK APPEARS IN THE WORDING

CLASS 36—(Continued).

"SECUREDRIVE." THE COLOR BLUE APPEARS IN THE WORDING "PLUS" AND IN THE BORDER, INTERIOR SHADING, AND LEFT LOWER EDGE OF THE DESIGN ELEMENT. THE COLOR WHITE APPEARS IN THE WAVY LINE THAT APPEARS WITHIN THE DESIGN ELEMENT AND IN THE INTERIOR SHADING OF THE DESIGN ELEMENT. THE COLOR LIGHT BLUE APPEARS IN THE RIGHT LOWER EDGE OF THE DESIGN ELEMENT AND THE COLOR GRAY APPEARS IN THE SHADOW BENEATH THE DESIGN ELEMENT.

FOR FINANCIAL SERVICES, NAMELY, AUTOMOTIVE INSURANCE UNDERWRITING AND PROVIDING EXTENDED WARRANTIES ON AUTOMOBILES; FINANCIAL SERVICES, NAMELY, UNDERWRITING SERVICE CONTRACTS, EXTENDED WARRANTY CONTRACTS AND INSURANCE CONTRACTS IN THE FIELD OF AUTOMOBILES; INSURANCE SERVICES, NAMELY, UNDERWRITING SERVICE CONTRACTS, EXTENDED WARRANTY CONTRACTS AND INSURANCE CONTRACTS IN THE FIELD OF AUTOMOBILES (U.S. CLS. 100, 101 AND 102).

ROBERT LAVACHE, EXAMINING ATTORNEY

SN 77-191,314. ZONTA SERVICE FUND OF CINCINNATI, INC., CINCINNATI, OH. FILED 5-27-2007.

Quilts for Change

THE MARK CONSISTS OF STANDARD CHARACTERS WITHOUT CLAIM TO ANY PARTICULAR FONT, STYLE, SIZE, OR COLOR.

FOR CHARITABLE FUND RAISING (U.S. CLS. 100, 101 AND 102).

FIRST USE 9-1-2005; IN COMMERCE 9-1-2005.

ROBIN CHOSID, EXAMINING ATTORNEY

SN 77-192,228. THE PRUDENTIAL INSURANCE COMPANY OF AMERICA, NEWARK, NJ. FILED 5-29-2007.

TRUEINCOME

THE MARK CONSISTS OF STANDARD CHARACTERS WITHOUT CLAIM TO ANY PARTICULAR FONT, STYLE, SIZE, OR COLOR.

OWNER OF U.S. REG. NO. 2,932,799.

FOR FINANCIAL SERVICES, NAMELY, THE ORIGIN, UNDERWRITING, DISTRIBUTION, INVESTMENT MANAGEMENT, AND ADMINISTRATION OF ANNUITIES, MUTUAL FUNDS AND SECURITIES (U.S. CLS. 100, 101 AND 102).

RICHARD A. STRASER, EXAMINING ATTORNEY

CLASS 36—(Continued).

SN 77-192,241. NATIONS DIRECT MORTGAGE, LLC, IRVINE, CA. FILED 5-29-2007.

Nations Direct Mortgage, LLC

THE MARK CONSISTS OF STANDARD CHARACTERS WITHOUT CLAIM TO ANY PARTICULAR FONT, STYLE, SIZE, OR COLOR.

NO CLAIM IS MADE TO THE EXCLUSIVE RIGHT TO USE "DIRECT MORTGAGE, LLC", APART FROM THE MARK AS SHOWN.

FOR MORTGAGE BANKING SERVICES, NAMELY, ORIGINATION, ACQUISITION, SERVICING, SECURITIZATION AND BROKERAGE OF MORTGAGE LOANS (U.S. CLS. 100, 101 AND 102).

FIRST USE 2-2-2007; IN COMMERCE 2-2-2007.
MICHAEL LITZAU, EXAMINING ATTORNEY

CLASS 36—(Continued).

SN 77-200,288. COTA-CHILDREN'S ORGAN TRANSPLANT ASSOCIATION, INC., BLOOMINGTON, IN. FILED 6-7-2007.

Children's Organ Transplant Association

THE MARK CONSISTS OF STANDARD CHARACTERS WITHOUT CLAIM TO ANY PARTICULAR FONT, STYLE, SIZE, OR COLOR.

NO CLAIM IS MADE TO THE EXCLUSIVE RIGHT TO USE "ASSOCIATION", APART FROM THE MARK AS SHOWN.

SEC. 2(F).
FOR PROVIDING FUNDRAISING SERVICES FOR FAMILIES OF CHILDREN WHO NEED ORGAN TRANSPLANTS (U.S. CLS. 100, 101 AND 102).

FIRST USE 4-0-1987; IN COMMERCE 4-0-1987.
AMY MCMENAMIN, EXAMINING ATTORNEY

SN 77-192,776. CLAYMORE SECURITIES, INC., LISLE, IL. FILED 5-30-2007.

CLAYMORE BLUEPRINTS

THE MARK CONSISTS OF STANDARD CHARACTERS WITHOUT CLAIM TO ANY PARTICULAR FONT, STYLE, SIZE, OR COLOR.

OWNER OF U.S. REG. NOS. 2,800,058, 2,802,044 AND 2,802,050.

FOR FINANCIAL SERVICES, NAMELY, INVESTMENT ADVISORY SERVICES; SECURITIES BROKERAGE SERVICES; MUTUAL FUND BROKERAGE, DISTRIBUTION AND INVESTMENT SERVICES; RESEARCH SERVICES IN THE FIELD OF INVESTMENTS; PROVIDING AN INTERACTIVE WEB SITE FOR INVESTMENT ADVISORS TO SELECT AND BLEND INVESTMENT PORTFOLIOS AND GENERATE REPORTS FOR INVESTORS THERETO (U.S. CLS. 100, 101 AND 102).

WILLIAM VERHOSEK, EXAMINING ATTORNEY

SN 77-207,476. PRIVATEBANCORP, INC., CHICAGO, IL. FILED 6-15-2007.



THE PRIVATEWEALTH TRUST COMPANY

OWNER OF U.S. REG. NO. 1,702,620.
NO CLAIM IS MADE TO THE EXCLUSIVE RIGHT TO USE "PRIVATE WEALTH TRUST COMPANY", APART FROM THE MARK AS SHOWN.

FOR TRUST SERVICES, NAMELY, INVESTMENT AND TRUST COMPANY SERVICES; FIDUCIARY REPRESENTATIVE SERVICES; FINANCIAL PORTFOLIO MANAGEMENT SERVICES; INVESTMENT SERVICES, NAMELY, ASSET ACQUISITION, CONSULTATION, DEVELOPMENT AND MANAGEMENT SERVICES (U.S. CLS. 100, 101 AND 102).

FLORENTINA BLANDU, EXAMINING ATTORNEY

SN 77-199,410. TOLLESON LAND INVESTMENT PROPERTIES, LLC, PERRY, GA. FILED 6-6-2007.



Tolleson Land Investment Properties, LLC

NO CLAIM IS MADE TO THE EXCLUSIVE RIGHT TO USE "LAND" AND "INVESTMENT PROPERTIES, LLC", APART FROM THE MARK AS SHOWN.

FOR REAL ESTATE INVESTMENT SERVICES; CONSULTATION IN THE FIELD OF LAND INVESTMENTS (U.S. CLS. 100, 101 AND 102).

FIRST USE 3-27-2007; IN COMMERCE 3-27-2007.
LAURA HAMMEL, EXAMINING ATTORNEY

SN 77-211,096. CINNAMON MCCANN, WASHINGTON, DC. FILED 6-20-2007.

STOCKS AND STILETTOS

THE MARK CONSISTS OF STANDARD CHARACTERS WITHOUT CLAIM TO ANY PARTICULAR FONT, STYLE, SIZE, OR COLOR.

NO CLAIM IS MADE TO THE EXCLUSIVE RIGHT TO USE "STOCKS", APART FROM THE MARK AS SHOWN.

FOR FINANCIAL INFORMATION PROVIDED BY ELECTRONIC MEANS (U.S. CLS. 100, 101 AND 102).

FIRST USE 1-11-2007; IN COMMERCE 1-11-2007.
RAMONA ORTIGA, EXAMINING ATTORNEY

CLASS 36—(Continued).

SN 77-213,568. NOVARE GROUP HOLDINGS, LLC, ATLANTA, GA. FILED 6-22-2007.

GREAUX

THE MARK CONSISTS OF STANDARD CHARACTERS WITHOUT CLAIM TO ANY PARTICULAR FONT, STYLE, SIZE, OR COLOR.

FOR COMMERCIAL, OFFICE, RETAIL AND MULTI-FAMILY REAL ESTATE ACQUISITIONS, LEASING, DEVELOPMENT AND BROKERAGE SERVICES (U.S. CLS. 100, 101 AND 102).

MATTHEW MCDOWELL, EXAMINING ATTORNEY

CLASS 36—(Continued).

SN 77-231,627. HAMPTON ROADS REALTORS ASSOCIATION, INC., VIRGINIA BEACH, VA. FILED 7-17-2007.

IS YOUR BROKER ONE?

THE MARK CONSISTS OF STANDARD CHARACTERS WITHOUT CLAIM TO ANY PARTICULAR FONT, STYLE, SIZE, OR COLOR.

FOR REAL ESTATE BROKERAGE SERVICES (U.S. CLS. 100, 101 AND 102).

FIRST USE 1-0-2006; IN COMMERCE 1-0-2006.
CHRISTINE COOPER, EXAMINING ATTORNEY

SN 77-214,516. HEALTHCARE EXTRANETS, LLC, ALBUQUERQUE, NM. FILED 6-25-2007.

HEALTHCARE EXTRANETS

THE MARK CONSISTS OF STANDARD CHARACTERS WITHOUT CLAIM TO ANY PARTICULAR FONT, STYLE, SIZE, OR COLOR.

OWNER OF U.S. REG. NO. 2,463,007.

NO CLAIM IS MADE TO THE EXCLUSIVE RIGHT TO USE "EXTRANETS", APART FROM THE MARK AS SHOWN.

SEC. 2(F).

FOR PROVIDING INFORMATION IN THE FIELD OF HEALTHCARE CLAIM ADMINISTRATION VIA THE INTERNET, NAMELY, VERIFICATION OF PATIENT ELIGIBILITY, CLAIM STATUS, AND AUTHORIZATION VERIFICATION (U.S. CLS. 100, 101 AND 102).

FIRST USE 10-22-1999; IN COMMERCE 10-22-1999.
GIANCARLO CASTRO, EXAMINING ATTORNEY

SN 77-231,659. HAMPTON ROADS REALTORS ASSOCIATION, INC., VIRGINIA BEACH, VA. FILED 7-17-2007.

I AM ONE

THE MARK CONSISTS OF STANDARD CHARACTERS WITHOUT CLAIM TO ANY PARTICULAR FONT, STYLE, SIZE, OR COLOR.

FOR REAL ESTATE BROKERAGE SERVICES (U.S. CLS. 100, 101 AND 102).

FIRST USE 12-0-2004; IN COMMERCE 12-0-2004.
CHRISTINE COOPER, EXAMINING ATTORNEY

SN 77-231,547. HAMPTON ROADS REALTORS ASSOCIATION, INC., VIRGINIA BEACH, VA. FILED 7-17-2007.

IS YOUR AGENT ONE?

THE MARK CONSISTS OF STANDARD CHARACTERS WITHOUT CLAIM TO ANY PARTICULAR FONT, STYLE, SIZE, OR COLOR.

FOR REAL ESTATE BROKERAGE SERVICES (U.S. CLS. 100, 101 AND 102).

FIRST USE 10-0-2004; IN COMMERCE 10-0-2004.
CHRISTINE COOPER, EXAMINING ATTORNEY

SN 77-231,827. ONEAMERICA FINANCIAL PARTNERS, INC., INDIANAPOLIS, IN. FILED 7-17-2007.

LOCAL COLLABORATIVE BUSINESS APPROACH

THE MARK CONSISTS OF STANDARD CHARACTERS WITHOUT CLAIM TO ANY PARTICULAR FONT, STYLE, SIZE, OR COLOR.

FOR FINANCIAL ADMINISTRATION OF RETIREMENT PLANS; FINANCIAL PLANNING FOR RETIREMENT; FINANCIAL ANALYSIS AND CONSULTATION (U.S. CLS. 100, 101 AND 102).

FIRST USE 3-0-2007; IN COMMERCE 3-0-2007.
SARA THOMAS, EXAMINING ATTORNEY

CLASS 36—(Continued).

SN 77-234,944. BANK OF AMERICA CORPORATION, CHARLOTTE, NC. FILED 7-20-2007.

PUT US TO WORK FOR YOU

THE MARK CONSISTS OF STANDARD CHARACTERS WITHOUT CLAIM TO ANY PARTICULAR FONT, STYLE, SIZE, OR COLOR.
FOR BANKING AND RELATED FINANCIAL SERVICES (U.S. CLS. 100, 101 AND 102).
TINA BROWN, EXAMINING ATTORNEY

SN 77-241,489. NEW JERSEY COMMUNITY BANCORP, INC., PERRINEVILLE, NJ. FILED 7-29-2007.



NO CLAIM IS MADE TO THE EXCLUSIVE RIGHT TO USE "NEW JERSEY COMMUNITY BANK", APART FROM THE MARK AS SHOWN.
THE COLOR(S) BLUE, GOLD AND WHITE IS/ARE CLAIMED AS A FEATURE OF THE MARK.
THE MARK CONSISTS OF A STYLIZED SHAPE OF THE STATE OF "NEW JERSEY" IN GOLD WITH WHITE RADIALS THROUGHOUT. THE WORDING "NEW JERSEY COMMUNITY BANK" IS BLUE. THE HORIZONTAL LINE BELOW THE WORDING IS GOLD.
FOR BANKING; ON-LINE BANKING; BANKING BY TELEPHONE; MORTGAGE BANKING; INVESTMENT BANKING; CREDIT CARD SERVICES; FINANCIAL LOANS AND BANKING CONSULTATION (U.S. CLS. 100, 101 AND 102).
BARBARA GAYNOR, EXAMINING ATTORNEY

SN 77-241,996. ICASHDIRECT, INC., NEWPORT BEACH, CA. FILED 7-30-2007.

QuickBucksDirect

THE MARK CONSISTS OF STANDARD CHARACTERS WITHOUT CLAIM TO ANY PARTICULAR FONT, STYLE, SIZE, OR COLOR.
FOR CONSUMER LENDING SERVICES, NAMELY, ON-LINE PAY-DAY LENDING SERVICES (U.S. CLS. 100, 101 AND 102).
FIRST USE 7-30-2007; IN COMMERCE 7-30-2007.
PAUL F. GAST, EXAMINING ATTORNEY

CLASS 36—(Continued).

SN 77-243,391. MUTUAL OF OMAHA INSURANCE COMPANY, OMAHA, NE. FILED 7-31-2007.

That Works For Me

THE MARK CONSISTS OF STANDARD CHARACTERS WITHOUT CLAIM TO ANY PARTICULAR FONT, STYLE, SIZE, OR COLOR.
FOR INSURANCE UNDERWRITING IN THE FIELD OF DISABILITY INSURANCE (U.S. CLS. 100, 101 AND 102).
FIRST USE 5-7-2007; IN COMMERCE 5-7-2007.
ARETHA SOMERVILLE, EXAMINING ATTORNEY

SN 77-243,549. INDEPENDENCE HOLDING COMPANY, STAMFORD, CT. FILED 7-31-2007.

**STANDARD SECURITY LIFE
INSURANCE COMPANY OF NEW
YORK**

THE MARK CONSISTS OF STANDARD CHARACTERS WITHOUT CLAIM TO ANY PARTICULAR FONT, STYLE, SIZE, OR COLOR.
NO CLAIM IS MADE TO THE EXCLUSIVE RIGHT TO USE "LIFE INSURANCE COMPANY OF NEW YORK", APART FROM THE MARK AS SHOWN.
FOR UNDERWRITING AND ADMINISTRATION OF LIFE, HEALTH AND DISABILITY INSURANCE (U.S. CLS. 100, 101 AND 102).
FIRST USE 1-1-1958; IN COMMERCE 1-1-1958.
ANDREA BUTLER, EXAMINING ATTORNEY

SN 77-243,677. TXP INVESTMENTS, WEST HARTFORD, CT. FILED 7-31-2007.



THE STIPPLING IS FOR SHADING PURPOSES ONLY.
THE MARK CONSISTS OF THE STYLIZED TEXT "TXP" PLACED ON TOP OF EACH OTHER INSIDE A SHIELD WITH THE STYLIZED WORDS "THE XPERIENCE" WRITTEN UNDERNEATH.
FOR FINANCIAL INVESTMENT IN THE FIELD OF REAL ESTATE (U.S. CLS. 100, 101 AND 102).
MARK SPARACINO, EXAMINING ATTORNEY

CLASS 36—(Continued).

SN 77-245,701. SMITH, CHRISTOPHER J., WEXFORD, PA.
FILED 8-2-2007.



NO CLAIM IS MADE TO THE EXCLUSIVE RIGHT TO USE "CONDO RENTALS", APART FROM THE MARK AS SHOWN.

THE COLOR(S) YELLOW, WHITE AND BROWN IS/ARE CLAIMED AS A FEATURE OF THE MARK.

THE MARK CONSISTS OF A YELLOW FISH ON CROSSED YELLOW GOLF CLUBS AND A YELLOW BANNER CONTAINING THE WORDS "YELLOWFIN CONDO RENTALS" COLORED YELLOW. THE DESIGN OF A WHITE GOLF BALL FORMS THE LETTER "O" IN "YELLOWFIN".

FOR CONDOMINIUM RENTALS (U.S. CLS. 100, 101 AND 102).

FIRST USE 4-30-2007; IN COMMERCE 4-30-2007.
GEORGIA CARTY, EXAMINING ATTORNEY

SN 77-258,089. MCALLISTER, ROBERT, SOLANA BEACH, CA. FILED 8-17-2007.

Monster Conferencing

THE MARK CONSISTS OF STANDARD CHARACTERS WITHOUT CLAIM TO ANY PARTICULAR FONT, STYLE, SIZE, OR COLOR.

NO CLAIM IS MADE TO THE EXCLUSIVE RIGHT TO USE "CONFERENCING", APART FROM THE MARK AS SHOWN.

FOR TELECOMMUNICATIONS RESELLER SERVICES, NAMELY, TELECOMMUNICATIONS AIR TIME BROKERAGE SERVICES (U.S. CLS. 100, 101 AND 102).

NAAKWAMA ANKRAH, EXAMINING ATTORNEY

CLASS 36—(Continued).

SN 77-259,028. MILLENNIUM TECHNOLOGY SERVICES, INC., ITASCA, IL. FILED 8-20-2007.

PROPERTY PREDICTR

THE MARK CONSISTS OF STANDARD CHARACTERS WITHOUT CLAIM TO ANY PARTICULAR FONT, STYLE, SIZE, OR COLOR.

NO CLAIM IS MADE TO THE EXCLUSIVE RIGHT TO USE "PROPERTY", APART FROM THE MARK AS SHOWN.

FOR PROPERTY AND CASUALTY INSURANCE RISK ASSESSMENT SERVICES (U.S. CLS. 100, 101 AND 102).

FIRST USE 4-15-2005; IN COMMERCE 4-15-2005.
RUSS HERMAN, EXAMINING ATTORNEY

SN 77-259,050. MILLENNIUM TECHNOLOGY SERVICES, INC., ITASCA, IL. FILED 8-20-2007.



NO CLAIM IS MADE TO THE EXCLUSIVE RIGHT TO USE "PROPERTY", APART FROM THE MARK AS SHOWN.

THE MARK CONSISTS OF A LINE OF SEVEN VERTICAL BARS, DESCENDING IN HEIGHT FROM THE TALLEST BAR ON THE LEFT TO THE SHORTEST BAR ON THE RIGHT, EACH BAR IS SHADED, GRADUATING FROM DARK AT THE TOP TO LIGHT AT THE BOTTOM. THE WORDS "PROPERTY PREDICTR" APPEAR ADJACENT THE SEVEN VERTICAL BARS.

FOR PROPERTY AND CASUALTY INSURANCE RISK ASSESSMENT SERVICES (U.S. CLS. 100, 101 AND 102).

FIRST USE 10-12-2005; IN COMMERCE 10-12-2005.
RUSS HERMAN, EXAMINING ATTORNEY

SN 77-261,683. NAS INSURANCE SERVICES, INC., ENCINO, CA. FILED 8-22-2007.

e-MD

THE MARK CONSISTS OF STANDARD CHARACTERS WITHOUT CLAIM TO ANY PARTICULAR FONT, STYLE, SIZE, OR COLOR.

FOR INSURANCE SERVICES, NAMELY, UNDERWRITING, ISSUING AND ADMINISTRATION OF INSURANCE TO HEALTHCARE ENTITY NETWORKS IN THE FIELD OF INSURANCE PROTECTION FOR HEALTHCARE ENTITIES AGAINST ALLEGATIONS ARISING FROM UNAUTHORIZED ACCESS EVENTS (U.S. CLS. 100, 101 AND 102).

FIRST USE 1-1-2000; IN COMMERCE 1-1-2000.
JOHN HWANG, EXAMINING ATTORNEY

CLASS 36—(Continued).

SN 77-261,715. UNIVERSAL INSURANCE COMPANY OF NORTH AMERICA, SARASOTA, FL. FILED 8-22-2007.

UNIVERSAL NORTH AMERICA

THE MARK CONSISTS OF STANDARD CHARACTERS WITHOUT CLAIM TO ANY PARTICULAR FONT, STYLE, SIZE, OR COLOR.

OWNER OF U.S. REG. NO. 3,144,001.

NO CLAIM IS MADE TO THE EXCLUSIVE RIGHT TO USE "NORTH AMERICA", APART FROM THE MARK AS SHOWN.

FOR INSURANCE UNDERWRITING IN THE FIELD OF PROPERTY-CASUALTY INSURANCE (U.S. CLS. 100, 101 AND 102).

CAROLINE WOOD, EXAMINING ATTORNEY

SN 77-262,432. WOOLMAN FINANCIAL GROUP, FORT WAYNE, IN. FILED 8-23-2007.

WHO Plan

THE MARK CONSISTS OF STANDARD CHARACTERS WITHOUT CLAIM TO ANY PARTICULAR FONT, STYLE, SIZE, OR COLOR.

NO CLAIM IS MADE TO THE EXCLUSIVE RIGHT TO USE "PLAN", APART FROM THE MARK AS SHOWN.

FOR ESTATE PLANNING; FINANCIAL PLANNING; FINANCIAL PLANNING CONSULTATION; FINANCIAL PLANNING FOR RETIREMENT; FINANCIAL PLANNING, NAMELY, THE CREATION OF PERSONALIZED STRATEGIES TO ACHIEVE FINANCIAL INDEPENDENCE; PROVIDING ONLINE INFORMATION IN THE FIELD OF CHARITABLE MONETARY GIVING THROUGH FINANCIAL AND ESTATE PLANNING (U.S. CLS. 100, 101 AND 102).

FIRST USE 8-23-2007; IN COMMERCE 8-23-2007.

DANNEAN HETZEL, EXAMINING ATTORNEY

SN 77-262,596. NAS INSURANCE SERVICES, INC., ENCINO, CA. FILED 8-23-2007.

NetGuard

THE MARK CONSISTS OF STANDARD CHARACTERS WITHOUT CLAIM TO ANY PARTICULAR FONT, STYLE, SIZE, OR COLOR.

FOR INSURANCE SERVICES, NAMELY, UNDERWRITING, ISSUING AND ADMINISTRATION OF INSURANCE TO SERVICE BUSINESSES IN THE FIELD OF INSURANCE PROTECTION FOR SERVICE BUSINESSES AGAINST ALLEGATIONS ARISING FROM UNAUTHORIZED ACCESS EVENTS (U.S. CLS. 100, 101 AND 102).

FIRST USE 1-1-2000; IN COMMERCE 1-1-2000.

JOHN HWANG, EXAMINING ATTORNEY

CLASS 36—(Continued).

SN 77-264,781. BUYBESTHOMES LLC, SUGAR LAND, TX. FILED 8-27-2007.

福達地產**Fuda Realty**

NO CLAIM IS MADE TO THE EXCLUSIVE RIGHT TO USE THE NON-LATIN CHARACTERS THAT MEAN "REALTY" AND THE WORD "REALTY", APART FROM THE MARK AS SHOWN.

THE ENGLISH TRANSLATION OF "FUDA" IN THE MARK IS LUCKY.

THE NON-LATIN CHARACTERS IN THE MARK TRANSLITERATE INTO FU DA DI CHAN, AND THIS MEANS LUCKY REALTY IN ENGLISH.

FOR REAL ESTATE ACQUISITION SERVICES; REAL ESTATE AGENCIES; REAL ESTATE BROKERAGE; REAL ESTATE LISTING; REAL ESTATE MULTIPLE LISTING SERVICES; REAL ESTATE PROCUREMENT FOR OTHERS (U.S. CLS. 100, 101 AND 102).

STEVEN R. FOSTER, EXAMINING ATTORNEY

SN 77-265,756. ARAG INSURANCE COMPANY, DES MOINES, IA. FILED 8-28-2007.

SENIORADVOCATE

THE MARK CONSISTS OF STANDARD CHARACTERS WITHOUT CLAIM TO ANY PARTICULAR FONT, STYLE, SIZE, OR COLOR.

OWNER OF U.S. REG. NO. 2,493,688.

SEC. 2(F).

FOR ADMINISTRATION OF EMPLOYEE BENEFIT PLANS CONCERNING INSURANCE AND FINANCE, NAMELY, INSURED AND NON-INSURED EMPLOYEE BENEFITS SERVICE PLANS; PROVIDING FINANCIAL PLANNING IN CONNECTION WITH AN EMPLOYEE BENEFITS PROGRAM VIA THE TELEPHONE (U.S. CLS. 100, 101 AND 102).

FIRST USE 9-1-1999; IN COMMERCE 9-1-1999.

LEE-ANNE BERNS, EXAMINING ATTORNEY

SN 77-266,446. ANHEUSER-BUSCH EMPLOYEES' CREDIT UNION, ST. LOUIS, MO. FILED 8-28-2007.

**High Yield eChecking**

NO CLAIM IS MADE TO THE EXCLUSIVE RIGHT TO USE "E" AND "HIGH YIELD ECHECKING", APART FROM THE MARK AS SHOWN.

THE MARK CONSISTS OF IN PART, THE LETTER "E" AND A CHECK MARK WITHIN A TRIANGLE.

FOR CREDIT UNION SERVICES (U.S. CLS. 100, 101 AND 102).

SALLY SHIH, EXAMINING ATTORNEY

CLASS 36—(Continued).

SN 77-268,918. BIENER, STACY, DBA BUYTOGETHERREALTY, TUSTIN, CA. FILED 8-30-2007.

BuyTogetherRealty

THE MARK CONSISTS OF STANDARD CHARACTERS WITHOUT CLAIM TO ANY PARTICULAR FONT, STYLE, SIZE, OR COLOR.

FOR (BASED ON USE IN COMMERCE) REAL ESTATE INVESTMENT SERVICES IN THE NATURE OF PURCHASING AND SELLING OF REAL ESTATE FOR OTHERS; PROVIDING INFORMATION IN THE FIELD OF REAL ESTATE VIA THE INTERNET (U.S. CLS. 100, 101 AND 102).

FIRST USE 8-15-2007; IN COMMERCE 8-15-2007.
MICHAEL KEATING, EXAMINING ATTORNEY

SN 77-268,977. TSIMMER, LEO, NEW YORK, NY. FILED 8-31-2007.

SLEEPY HUDSON

THE MARK CONSISTS OF STANDARD CHARACTERS WITHOUT CLAIM TO ANY PARTICULAR FONT, STYLE, SIZE, OR COLOR.

FOR REAL ESTATE ACQUISITION SERVICES; INVESTMENT SERVICES, NAMELY, ASSET ACQUISITION, CONSULTATION, DEVELOPMENT AND MANAGEMENT SERVICES; LAND ACQUISITION, NAMELY, REAL ESTATE BROKERAGE; REAL ESTATE EQUITY SHARING, NAMELY, MANAGING AND ARRANGING FOR CO-OWNERSHIP OF REAL ESTATE; REAL ESTATE INVESTMENT (U.S. CLS. 100, 101 AND 102).

DOMINIC J. FERRAIUOLO, EXAMINING ATTORNEY

SN 77-277,238. AF HOLDINGS, L.P., PHILADELPHIA, PA. FILED 9-12-2007.

FRANKLIN SQUARE CAPITAL PARTNERS

THE MARK CONSISTS OF STANDARD CHARACTERS WITHOUT CLAIM TO ANY PARTICULAR FONT, STYLE, SIZE, OR COLOR.

NO CLAIM IS MADE TO THE EXCLUSIVE RIGHT TO USE "CAPITAL PARTNERS", APART FROM THE MARK AS SHOWN.

FOR INVESTMENT OF FUNDS FOR OTHERS; MANAGEMENT OF INVESTMENT OF FUNDS FOR OTHERS (U.S. CLS. 100, 101 AND 102).

ANGELA M. MICHELI, EXAMINING ATTORNEY

CLASS 36—(Continued).

SN 77-277,251. RURAL AMERICA CAPITAL GROUP, FLORENCE, SC. FILED 9-12-2007.



NO CLAIM IS MADE TO THE EXCLUSIVE RIGHT TO USE "RURAL AMERICA" AND "CAPITAL GROUP", APART FROM THE MARK AS SHOWN.

THE MARK CONSISTS OF A HIGHLY STYLIZED SUNRISE WITH THE WORDS "RURAL AMERICA CAPITAL GROUP" SUPERIMPOSED THEREOVER BELOW THE HORIZON.

FOR FINANCIAL SERVICES, NAMELY, ASSISTING OTHERS WITH THE COMPLETION OF FINANCIAL TRANSACTIONS FOR STOCKS, BONDS, SECURITIES AND EQUITIES; FINANCIAL ANALYSIS AND CONSULTATION (U.S. CLS. 100, 101 AND 102).

FIRST USE 6-13-2006; IN COMMERCE 6-13-2006.
ANGELA M. MICHELI, EXAMINING ATTORNEY

SN 77-277,912. UNION NATIONAL MORTGAGE CO., STRONGSVILLE, OH. FILED 9-12-2007.

UNION NATIONAL HOME LOAN

THE MARK CONSISTS OF STANDARD CHARACTERS WITHOUT CLAIM TO ANY PARTICULAR FONT, STYLE, SIZE, OR COLOR.

NO CLAIM IS MADE TO THE EXCLUSIVE RIGHT TO USE NATIONAL HOME LOAN, APART FROM THE MARK AS SHOWN.

FOR FINANCIAL SERVICES, NAMELY, LOAN ORIGINATION SERVICES AND HOME FINANCING SERVICES (U.S. CLS. 100, 101 AND 102).

KEVON CHISOLM, EXAMINING ATTORNEY

SN 77-278,094. BIEG, KURT, WEST CHESTER, PA. FILED 9-12-2007.

ETHON

THE MARK CONSISTS OF STANDARD CHARACTERS WITHOUT CLAIM TO ANY PARTICULAR FONT, STYLE, SIZE, OR COLOR.

FOR CHARITABLE FUNDRAISING SERVICES FOR VARIOUS ORGANIZATIONS CONDUCTED VIA GLOBAL COMPUTER NETWORK (U.S. CLS. 100, 101 AND 102).

MICHAEL LEWIS, EXAMINING ATTORNEY

CLASS 36—(Continued).

SN 77-279,799. HELIOS EDUCATION FOUNDATION, PHOENIX, AZ. FILED 9-14-2007.

ENGAGING MINDS. ENRICHING LIVES.

THE MARK CONSISTS OF STANDARD CHARACTERS WITHOUT CLAIM TO ANY PARTICULAR FONT, STYLE, SIZE, OR COLOR.

FOR CHARITABLE SERVICES, NAMELY, GRANTING FUNDS TO SCHOOLS AND EDUCATIONAL ORGANIZATIONS (U.S. CLS. 100, 101 AND 102).

APRIL ROACH, EXAMINING ATTORNEY

SN 77-279,851. CARRICA, XAVIER L, DBA XLC REALTY, LOS ANGELES, CA. FILED 9-14-2007.

XLC REALTY

THE MARK CONSISTS OF STANDARD CHARACTERS WITHOUT CLAIM TO ANY PARTICULAR FONT, STYLE, SIZE, OR COLOR.

NO CLAIM IS MADE TO THE EXCLUSIVE RIGHT TO USE "REALTY", APART FROM THE MARK AS SHOWN.

FOR REAL ESTATE CONSULTANCY; REAL ESTATE CONSULTATION; REAL ESTATE EQUITY SHARING, NAMELY, MANAGING AND ARRANGING FOR CO-OWNERSHIP OF REAL ESTATE; REAL ESTATE ESCROW SERVICES; REAL ESTATE INVESTMENT; REAL ESTATE INVESTMENT SERVICES IN THE NATURE OF PURCHASING AND SELLING OF REAL ESTATE FOR OTHERS; REAL ESTATE LENDING SERVICES; REAL ESTATE LISTING; REAL ESTATE MANAGEMENT; REAL ESTATE MANAGEMENT CONSULTATION; REAL ESTATE MULTIPLE LISTING SERVICES; REAL ESTATE PROCUREMENT FOR OTHERS; REAL ESTATE SERVICES IN THE FORM OF PROVIDING PHYSICAL ACCESS TO AVAILABLE PROPERTIES VIA A REMOTE CALL-IN LOCKING DEVICE; REAL ESTATE SERVICES, NAMELY, RENTAL OF SHORT-TERM FURNISHED APARTMENTS; REAL ESTATE SERVICES, NAMELY, RENTAL OF VACATION HOMES, CONDOMINIUMS, CABINS, AND VILLAS USING PAY PER CLICK ADVERTISING ON A GLOBAL COMPUTER NETWORK; REAL ESTATE SYNDICATION; REAL ESTATE TIME-SHARING; REAL ESTATE TRUSTEE SERVICES; REAL ESTATE VALUATION SERVICES; REAL ESTATE VALUATIONS; FINANCIAL VALUATION OF PERSONAL PROPERTY AND REAL ESTATE; LAND ACQUISITION, NAMELY, REAL ESTATE BROKERAGE; LEASING OF REAL ESTATE; PROVIDING INFORMATION IN THE FIELD OF REAL ESTATE BY MEANS OF LINKING THE WEB SITE TO OTHER WEB SITES FEATURING REAL ESTATE INFORMATION; PROVIDING INFORMATION IN THE FIELD OF REAL ESTATE VIA THE INTERNET; PROVIDING REAL ESTATE LISTINGS AND REAL ESTATE INFORMATION VIA THE INTERNET; REAL ESTATE ACQUISITION SERVICES; REAL ESTATE AGENCIES; REAL ESTATE APPRAISAL; REAL ESTATE BROKERAGE; APPRAISAL OF REAL ESTATE (U.S. CLS. 100, 101 AND 102).

APRIL ROACH, EXAMINING ATTORNEY

CLASS 36—(Continued).

SN 77-280,022. LEVERAGED GREEN ENERGY, LLC, MCLEAN, VA. FILED 9-14-2007.



NO CLAIM IS MADE TO THE EXCLUSIVE RIGHT TO USE "LEVERAGED GREEN ENERGY", APART FROM THE MARK AS SHOWN.

THE COLOR(S) YELLOW AND GREEN IS/ARE CLAIMED AS A FEATURE OF THE MARK.

THE MARK CONSISTS OF A YELLOW SWOOP WITH FOUR TRIANGLE RAYS REPRESENTING THE SUN, ALONG WITH THE WORDS LEVERAGED GREEN ENERGY IN GREEN.

FOR FINANCIAL INVESTMENT IN THE FIELD OF RENEWABLE ENERGY (U.S. CLS. 100, 101 AND 102).

FIRST USE 12-15-2006; IN COMMERCE 1-31-2007.
CHRISTINE COOPER, EXAMINING ATTORNEY

SN 77-280,665. LIA WAITZ, RIVER EDGE, NJ. FILED 9-16-2007.



THE COLOR(S) DARK BLUE, LIGHT BLUE, BLACK, AND LIGHT YELLOW IS/ARE CLAIMED AS A FEATURE OF THE MARK.

THE MARK CONSISTS OF A DARK BLUE HOUSE OUTLINED IN BLACK. THERE ARE WINGS CONNECTED TO THE HOUSE IN DARK BLUE FADING TO LIGHT BLUE FROM BOTTOM TO TOP. THE WINGS HAVE A BLACK OUTLINE. THE MARK HAS A LIGHT YELLOW BACKGROUND WITH A BLACK OUTLINE.

FOR REAL PROPERTY EVALUATION, CONSULTING, LEASING, INVESTING, BROKERAGE AND FINANCING SERVICE (U.S. CLS. 100, 101 AND 102).

KAPIL BHANOT, EXAMINING ATTORNEY

SN 77-280,789. THE MEDVE GROUP, INC., ST. LOUIS, MO. FILED 9-17-2007.

THE ARTS APARTMENTS

THE MARK CONSISTS OF STANDARD CHARACTERS WITHOUT CLAIM TO ANY PARTICULAR FONT, STYLE, SIZE, OR COLOR.

NO CLAIM IS MADE TO THE EXCLUSIVE RIGHT TO USE "APARTMENTS", APART FROM THE MARK AS SHOWN.

FOR REAL ESTATE SERVICES, NAMELY, RENTAL AND LEASING OF APARTMENTS; AND APARTMENT MANAGEMENT (U.S. CLS. 100, 101 AND 102).

FIRST USE 11-9-2006; IN COMMERCE 11-9-2006.
KIM SAITO, EXAMINING ATTORNEY

CLASS 36—(Continued).

SN 77-282,216. PURPOSE INTELLECTUAL PROPERTY MANAGEMENT II, INC., LAS VEGAS, NV. FILED 9-18-2007.

**Purpose
CashAdvance**

NO CLAIM IS MADE TO THE EXCLUSIVE RIGHT TO USE CASH ADVANCE, APART FROM THE MARK AS SHOWN.

FOR PROVIDING SHORT TERM CASH ADVANCES; INSTALLMENT LOANS; PAYDAY LOANS; FINANCIAL SERVICES, NAMELY, CREDIT, DEBIT AND CASH-ADVANCE TRANSACTION SERVICES OFFERED VIA ELECTRONIC KIOSKS (U.S. CLS. 100, 101 AND 102).

MORGAN WYNNE, EXAMINING ATTORNEY

SN 77-282,380. HARLEYSVILLE MUTUAL INSURANCE COMPANY, HARLEYSVILLE, PA. FILED 9-18-2007.

Signature Plus

THE MARK CONSISTS OF STANDARD CHARACTERS WITHOUT CLAIM TO ANY PARTICULAR FONT, STYLE, SIZE, OR COLOR.

FOR INSURANCE UNDERWRITING CONSULTATION; INSURANCE UNDERWRITING IN THE FIELD OF HOMEOWNERS INSURANCE (U.S. CLS. 100, 101 AND 102).

FIRST USE 7-11-2007; IN COMMERCE 8-21-2007.

BRIAN NEVILLE, EXAMINING ATTORNEY

SN 77-283,511. WARNER, TODD R., PHOENIX, AZ. FILED 9-19-2007.

VStreet Realty Advisors

THE MARK CONSISTS OF STANDARD CHARACTERS WITHOUT CLAIM TO ANY PARTICULAR FONT, STYLE, SIZE, OR COLOR.

NO CLAIM IS MADE TO THE EXCLUSIVE RIGHT TO USE "REALTY ADVISORS", APART FROM THE MARK AS SHOWN.

FOR (BASED ON USE IN COMMERCE) INVESTMENT SERVICES, NAMELY, ASSET ACQUISITION, CONSULTATION, DEVELOPMENT AND MANAGEMENT SERVICES; REAL ESTATE INVESTMENT SERVICES IN THE NATURE OF PURCHASING AND SELLING OF REAL ESTATE FOR OTHERS (U.S. CLS. 100, 101 AND 102).

FIRST USE 3-15-2007; IN COMMERCE 5-4-2007.

DOMINIC J. FERRAIUOLO, EXAMINING ATTORNEY

CLASS 36—(Continued).

SN 77-283,568. SUNTX CAPITAL MANAGEMENT CORPORATION, DALLAS, TX. FILED 9-19-2007.

SUNTX

THE MARK CONSISTS OF STANDARD CHARACTERS WITHOUT CLAIM TO ANY PARTICULAR FONT, STYLE, SIZE, OR COLOR.

FOR INVESTMENT ADVISORY AND INVESTMENT MANAGEMENT SERVICES (U.S. CLS. 100, 101 AND 102).

FIRST USE 2-0-2000; IN COMMERCE 2-0-2000.

TIMOTHY FINNEGAN, EXAMINING ATTORNEY

SN 77-284,442. SPECIAL FINANCIAL PROGRAMS, INC., WEST CHESTER, PA. FILED 9-20-2007.

SPECIAL

THE MARK CONSISTS OF STANDARD CHARACTERS WITHOUT CLAIM TO ANY PARTICULAR FONT, STYLE, SIZE, OR COLOR.

FOR FINANCIAL CONSULTING SERVICES, NAMELY, OFFERING ADVICE ON SPECIFIC FINANCIAL PRODUCTS AND PROGRAMS AND ADVICE FOR SHELTERING INCOME AND ASSETS FROM TAXES FOR PROFESSIONAL AND EXECUTIVE PERSONNEL (U.S. CLS. 100, 101 AND 102).

FIRST USE 8-15-1972; IN COMMERCE 9-12-1972.

DAWN FELDMAN, EXAMINING ATTORNEY

SN 77-285,948. LEHMAN BROTHERS INC., NEW YORK, NY. FILED 9-21-2007.

**GRANITE MESA GUARANTY
COMPANY**

THE MARK CONSISTS OF STANDARD CHARACTERS WITHOUT CLAIM TO ANY PARTICULAR FONT, STYLE, SIZE, OR COLOR.

NO CLAIM IS MADE TO THE EXCLUSIVE RIGHT TO USE "GUARANTY COMPANY", APART FROM THE MARK AS SHOWN.

FOR MORTGAGE INSURANCE SERVICES (U.S. CLS. 100, 101 AND 102).

ALEXANDER L. POWERS, EXAMINING ATTORNEY

CLASS 36—(Continued).

SN 77-286,463. MICHAEL MCDONALD, LA QUINTA, CA. FILED 9-22-2007.

GLOBAL WARMING ENERGY FUND

THE MARK CONSISTS OF STANDARD CHARACTERS WITHOUT CLAIM TO ANY PARTICULAR FONT, STYLE, SIZE, OR COLOR.

NO CLAIM IS MADE TO THE EXCLUSIVE RIGHT TO USE "ENERGY FUND", APART FROM THE MARK AS SHOWN.

FOR ESTABLISHING MUTUAL FUNDS AND HEDGE FUNDS FOR OTHERS; INVESTMENT ADVISORY SERVICES (U.S. CLS. 100, 101 AND 102).

TEJBIR SINGH, EXAMINING ATTORNEY



SN 77-286,742. LIFELINK FOUNDATION, INC., TAMPA, FL. FILED 9-24-2007.

LifeLink Legacy Fund

THE MARK CONSISTS OF STANDARD CHARACTERS WITHOUT CLAIM TO ANY PARTICULAR FONT, STYLE, SIZE, OR COLOR.

OWNER OF U.S. REG. NO. 3,339,352.

NO CLAIM IS MADE TO THE EXCLUSIVE RIGHT TO USE "LEGACY FUND", APART FROM THE MARK AS SHOWN.

FOR CHARITABLE FUNDRAISING SERVICES IN SUPPORT OF MEDICAL CARE, DIRECT PATIENT ASSISTANCE, PATIENT CARE, RESEARCH AND DEVELOPMENT, ENDOWMENT, ORGAN PROCUREMENT, HUMAN ORGAN AND TISSUE TRANSPLANTATION AND DONATION, MEDICATIONS FOR PATIENTS, AND SERVICES RELATED TO THE MEDICAL FIELD (U.S. CLS. 100, 101 AND 102).

FIRST USE 6-30-1998; IN COMMERCE 12-0-1998.

CURTIS FRENCH, EXAMINING ATTORNEY



SN 77-286,784. METROPOLITAN INDIANAPOLIS BOARD OF REALTORS, INDIANAPOLIS, IN. FILED 9-24-2007.

THE STATS HOUSE

THE MARK CONSISTS OF STANDARD CHARACTERS WITHOUT CLAIM TO ANY PARTICULAR FONT, STYLE, SIZE, OR COLOR.

NO CLAIM IS MADE TO THE EXCLUSIVE RIGHT TO USE "STATS", APART FROM THE MARK AS SHOWN.

FOR PROVIDING REAL ESTATE INFORMATION THROUGH AN ONLINE DATABASE FEATURING CENSUS DATA AND HOUSING MARKET TRENDS (U.S. CLS. 100, 101 AND 102).

FIRST USE 2-1-2007; IN COMMERCE 2-1-2007.

ADA HAN, EXAMINING ATTORNEY

CLASS 36—(Continued).

SN 77-287,306. DRI CAPITAL INC., TORONTO, ONTARIO, CANADA, FILED 9-24-2007.

DRI CAPITAL

THE MARK CONSISTS OF STANDARD CHARACTERS WITHOUT CLAIM TO ANY PARTICULAR FONT, STYLE, SIZE, OR COLOR.

NO CLAIM IS MADE TO THE EXCLUSIVE RIGHT TO USE "CAPITAL", APART FROM THE MARK AS SHOWN.

THE WORDING "DRI" HAS NO MEANING IN A FOREIGN LANGUAGE.

FOR INVESTMENT MANAGEMENT SERVICES IN THE FIELD OF HEALTHCARE (U.S. CLS. 100, 101 AND 102).

BILL DAWE, EXAMINING ATTORNEY



SN 77-287,558. BLUE CROSS AND BLUE SHIELD OF MONTANA, INC., HELENA, MT. FILED 9-24-2007.

LIVE SMART. LIVE HEALTHY.

THE MARK CONSISTS OF STANDARD CHARACTERS WITHOUT CLAIM TO ANY PARTICULAR FONT, STYLE, SIZE, OR COLOR.

FOR INSURANCE UNDERWRITING IN THE FIELD OF HEALTH; INSURANCE ADMINISTRATION IN THE FIELD OF HEALTH (U.S. CLS. 100, 101 AND 102).

MICHAEL WIENER, EXAMINING ATTORNEY



SN 77-288,087. AUCTOS CAPITAL MANAGEMENT LLC, CHICAGO, IL. FILED 9-25-2007.

AUCTOS CAPITAL MANAGEMENT

THE MARK CONSISTS OF STANDARD CHARACTERS WITHOUT CLAIM TO ANY PARTICULAR FONT, STYLE, SIZE, OR COLOR.

NO CLAIM IS MADE TO THE EXCLUSIVE RIGHT TO USE "CAPITAL MANAGEMENT", APART FROM THE MARK AS SHOWN.

FOR FINANCIAL SERVICES, NAMELY, OPERATION AND MANAGEMENT OF HEDGE FUNDS, COMMODITY POOLS AND OTHER COLLECTIVE INVESTMENT VEHICLES, AND TRADING FOR OTHERS OF SECURITIES, OPTIONS, FUTURES, DERIVATIVES, DEBT INSTRUMENTS AND COMMODITIES (U.S. CLS. 100, 101 AND 102).

MICHAEL KAZAZIAN, EXAMINING ATTORNEY

CLASS 36—(Continued).

SN 77-288,247. WORLD MARKET CENTER VENTURE, LLC,
LAS VEGAS, NV. FILED 9-25-2007.

WMC

THE MARK CONSISTS OF STANDARD CHARACTERS WITHOUT CLAIM TO ANY PARTICULAR FONT, STYLE, SIZE, OR COLOR.

FOR LEASING TRADE AND SHOWROOM EXHIBITION SPACE TO MANUFACTURERS OF GOODS IN THE FIELDS OF HOME AND HOSPITALITY FURNISHINGS, FURNITURE, HOME DECOR AND INTERIOR DESIGN; REAL ESTATE SERVICES, NAMELY, PROVIDING AND OPERATING MARKETPLACES AND TRADE SHOWROOMS FOR SELLERS OF GOODS AND/OR SERVICES (U.S. CLS. 100, 101 AND 102).

FIRST USE 4-1-2001; IN COMMERCE 4-1-2001.
ARETHA SOMERVILLE, EXAMINING ATTORNEY

SN 77-288,686. FIRST NET FINANCIAL, INC., CAMPBELL,
CA. FILED 9-25-2007.

SILVER OAK PROPERTIES

THE MARK CONSISTS OF STANDARD CHARACTERS WITHOUT CLAIM TO ANY PARTICULAR FONT, STYLE, SIZE, OR COLOR.

NO CLAIM IS MADE TO THE EXCLUSIVE RIGHT TO USE "PROPERTIES", APART FROM THE MARK AS SHOWN.

FOR REAL ESTATE AND MORTGAGE BROKERAGE SERVICES (U.S. CLS. 100, 101 AND 102).

FIRST USE 1-6-2003; IN COMMERCE 1-6-2003.
DEZMONA MIZELLE, EXAMINING ATTORNEY

SN 77-289,032. DENNIS J. RIEDMILLER, CINCINNATI, OH.
FILED 9-26-2007.

MY GENERATION

THE MARK CONSISTS OF STANDARD CHARACTERS WITHOUT CLAIM TO ANY PARTICULAR FONT, STYLE, SIZE, OR COLOR.

FOR INSURANCE SERVICES, NAMELY, BROKERAGE SERVICES IN THE FIELD OF HEALTH INSURANCE (U.S. CLS. 100, 101 AND 102).

DEIRDRE ROBERTSON, EXAMINING ATTORNEY

CLASS 36—(Continued).

SN 77-289,487. MICHAEL MCDONALD, LA QUINTA, CA.
FILED 9-26-2007.

GLOBAL WARMING FUND

THE MARK CONSISTS OF STANDARD CHARACTERS WITHOUT CLAIM TO ANY PARTICULAR FONT, STYLE, SIZE, OR COLOR.

NO CLAIM IS MADE TO THE EXCLUSIVE RIGHT TO USE "FUND", APART FROM THE MARK AS SHOWN.

FOR ESTABLISHING MUTUAL FUNDS AND HEDGE FUNDS FOR OTHERS; INVESTMENT ADVISORY SERVICES (U.S. CLS. 100, 101 AND 102).

TEJBIR SINGH, EXAMINING ATTORNEY

SN 77-289,505. MCDONALD, MICHAEL, LA QUINTA, CA.
FILED 9-26-2007.

**GLOBAL WARMING TECHNOLOGY
FUND**

THE MARK CONSISTS OF STANDARD CHARACTERS WITHOUT CLAIM TO ANY PARTICULAR FONT, STYLE, SIZE, OR COLOR.

NO CLAIM IS MADE TO THE EXCLUSIVE RIGHT TO USE "TECHNOLOGY FUND", APART FROM THE MARK AS SHOWN.

FOR ESTABLISHING MUTUAL FUNDS AND HEDGE FUNDS FOR OTHERS; INVESTMENT ADVISORY SERVICES (U.S. CLS. 100, 101 AND 102).

TEJBIR SINGH, EXAMINING ATTORNEY

SN 77-289,515. MICHAEL MCDONALD, LA QUINTA, CA.
FILED 9-26-2007.

GLOBAL WARMING WORLD FUND

THE MARK CONSISTS OF STANDARD CHARACTERS WITHOUT CLAIM TO ANY PARTICULAR FONT, STYLE, SIZE, OR COLOR.

NO CLAIM IS MADE TO THE EXCLUSIVE RIGHT TO USE "WORLD FUND", APART FROM THE MARK AS SHOWN.

FOR ESTABLISHING MUTUAL FUNDS AND HEDGE FUNDS FOR OTHERS; INVESTMENT ADVISORY SERVICES (U.S. CLS. 100, 101 AND 102).

TEJBIR SINGH, EXAMINING ATTORNEY

CLASS 36—(Continued).

SN 77-289,523. MICHAEL MCDONALD, LA QUINTA, CA. FILED 9-26-2007.

GLOBAL WARMING GLOBAL FUND

THE MARK CONSISTS OF STANDARD CHARACTERS WITHOUT CLAIM TO ANY PARTICULAR FONT, STYLE, SIZE, OR COLOR.

NO CLAIM IS MADE TO THE EXCLUSIVE RIGHT TO USE "GLOBAL FUND", APART FROM THE MARK AS SHOWN.

FOR ESTABLISHING MUTUAL FUNDS AND HEDGE FUNDS FOR OTHERS; INVESTMENT ADVISORY SERVICES (U.S. CLS. 100, 101 AND 102).

TEJBIR SINGH, EXAMINING ATTORNEY

SN 77-289,531. MICHAEL MCDONALD, LA QUINTA, CA. FILED 9-26-2007.

GLOBAL WARMING INTERNATIONAL FUND

THE MARK CONSISTS OF STANDARD CHARACTERS WITHOUT CLAIM TO ANY PARTICULAR FONT, STYLE, SIZE, OR COLOR.

NO CLAIM IS MADE TO THE EXCLUSIVE RIGHT TO USE "INTERNATIONAL FUND", APART FROM THE MARK AS SHOWN.

FOR ESTABLISHING MUTUAL FUNDS AND HEDGE FUNDS FOR OTHERS; INVESTMENT ADVISORY SERVICES (U.S. CLS. 100, 101 AND 102).

TEJBIR SINGH, EXAMINING ATTORNEY

SN 77-289,543. MCDONALD, MICHAEL, LA QUINTA, CA. FILED 9-26-2007.

GLOBAL WARMING CAPITAL PARTNERS

THE MARK CONSISTS OF STANDARD CHARACTERS WITHOUT CLAIM TO ANY PARTICULAR FONT, STYLE, SIZE, OR COLOR.

NO CLAIM IS MADE TO THE EXCLUSIVE RIGHT TO USE "CAPITAL PARTNERS", APART FROM THE MARK AS SHOWN.

FOR ESTABLISHING MUTUAL FUNDS AND HEDGE FUNDS FOR OTHERS; INVESTMENT ADVISORY SERVICES (U.S. CLS. 100, 101 AND 102).

TEJBIR SINGH, EXAMINING ATTORNEY

CLASS 36—(Continued).

SN 77-289,548. MCDONALD, MICHAEL, LA QUINTA, CA. FILED 9-26-2007.

GLOBAL WARMING INVESTMENT PARTNERS

THE MARK CONSISTS OF STANDARD CHARACTERS WITHOUT CLAIM TO ANY PARTICULAR FONT, STYLE, SIZE, OR COLOR.

NO CLAIM IS MADE TO THE EXCLUSIVE RIGHT TO USE "INVESTMENT PARTNERS", APART FROM THE MARK AS SHOWN.

FOR ESTABLISHING MUTUAL FUNDS AND HEDGE FUNDS FOR OTHERS; INVESTMENT ADVISORY SERVICES (U.S. CLS. 100, 101 AND 102).

TEJBIR SINGH, EXAMINING ATTORNEY

SN 77-290,060. HUNTSVILLE HOSPITAL FOUNDATION, HUNTSVILLE, AL. FILED 9-27-2007.



NO CLAIM IS MADE TO THE EXCLUSIVE RIGHT TO USE "ONLINE" AND "GIFTS", APART FROM THE MARK AS SHOWN.

THE MARK CONSISTS OF THE WORDS "ONLINE LIFELINE" SEPARATED BY A HEART-PULSE TYPE LINE THAT RUNS UNDERNEATH BOTH WORDS AND JUTS UP BETWEEN THEM. THE LINE IS SIMILAR TO A HEART RHYTHM MONITOR LINE. THE WORDS "GIFTS THAT HEAL" ARE LOCATED BELOW THAT LINE.

FOR CHARITABLE DONATIONS SERVICES; CHARITABLE FUND RAISING SERVICES NAMELY BY PROVIDING DONORS WITH THE INFORMATION AND OPPORTUNITY TO MAKE MONETARY DONATIONS TO THEIR FAVORITE CHARITY; ACCEPTING AND ADMINISTERING MONETARY CHARITABLE DONATIONS (U.S. CLS. 100, 101 AND 102).

ADA HAN, EXAMINING ATTORNEY

CLASS 36—(Continued).

SN 77-290,066. HUNTSVILLE HOSPITAL FOUNDATION, HUNTSVILLE, AL. FILED 9-27-2007.



NO CLAIM IS MADE TO THE EXCLUSIVE RIGHT TO USE "SWIM", APART FROM THE MARK AS SHOWN.

THE MARK CONSISTS OF THE WORD "SWIM" WITH THE WORD "FOR" UNDERNEATH AND TO THE RIGHT AND BOTH TO THE LEFT OF THE WORD "MELISSA" WHICH IS ATOP THE WORDS "MAKING MIRACLES HAPPEN", WITH A DESIGN OF WAVES AND SPLASHES OF WATER TO THE LEFT OF ALL LETTERING.

FOR CHARITABLE FUND RAISING SERVICES; CHARITABLE FUND RAISING SERVICES BY MEANS OF ENTERTAINMENT EVENTS AND RECREATIONAL SPORTING EVENTS; ACCEPTING AND ADMINISTERING MONETARY CHARITABLE CONTRIBUTIONS (U.S. CLS. 100, 101 AND 102).

FIRST USE 3-31-2006; IN COMMERCE 3-31-2006.
ADA HAN, EXAMINING ATTORNEY

SN 77-290,543. MORRISON HOLDING COMPANY, LAS VEGAS, NV. FILED 9-27-2007.



OWNER OF U.S. REG. NOS. 1,006,514, 2,909,531 AND OTHERS.

THE MARK CONSISTS OF THE WORD "MPOWER" IN A HALF HEART WITH THE WORDS "THE MORRISON WAY OF CARING" UNDERNEATH.

FOR CHARITABLE FUNDRAISING SERVICES, NAMELY, SOLICITING CONTRIBUTIONS OF FUNDS, SUCH FUNDS TO BE USED IN PROVIDING FINANCIAL SUPPORT TO VARIOUS CHARITIES IN THE HEALTHCARE INDUSTRY, NAMELY, THOSE THAT PROVIDE FINANCIAL ASSISTANCE TO ILL AND TERMINALLY ILL CHILDREN AND THEIR FAMILIES, AND TO VICTIMS OF NATURAL DISASTERS (U.S. CLS. 100, 101 AND 102).

MARK PILARO, EXAMINING ATTORNEY

CLASS 36—(Continued).

SN 77-291,075. CALIFORNIA REAL ESTATE NETWORK, INC., ANAHEIM, CA. FILED 9-28-2007.

Servicing Your Needs In Real Estate

THE MARK CONSISTS OF STANDARD CHARACTERS WITHOUT CLAIM TO ANY PARTICULAR FONT, STYLE, SIZE, OR COLOR.

FOR APPRAISAL OF REAL ESTATE; ASSESSMENT AND MANAGEMENT OF REAL ESTATE; EVALUATION OF REAL PROPERTY; FINANCIAL VALUATION OF PERSONAL PROPERTY AND REAL ESTATE; HOUSING SERVICES, NAMELY, REAL PROPERTY ACQUISITION AND CONSUMER FINANCING TO FACILITATE HOME OWNERSHIP; LAND ACQUISITION, NAMELY, REAL ESTATE BROKERAGE; LEASING OF REAL ESTATE; LEASING OF REAL PROPERTY; PROVIDING INFORMATION IN THE FIELD OF REAL ESTATE BY MEANS OF LINKING THE WEB SITE TO OTHER WEB SITES FEATURING REAL ESTATE INFORMATION; PROVIDING INFORMATION IN THE FIELD OF REAL ESTATE VIA THE INTERNET; PROVIDING REAL ESTATE LISTINGS AND REAL ESTATE INFORMATION VIA THE INTERNET; REAL ESTATE ACQUISITION SERVICES; REAL ESTATE AGENCIES; REAL ESTATE APPRAISAL; REAL ESTATE BROKERAGE; REAL ESTATE CONSULTANCY; REAL ESTATE CONSULTATION; REAL ESTATE EQUITY SHARING, NAMELY, MANAGING AND ARRANGING FOR CO-OWNERSHIP OF REAL ESTATE; REAL ESTATE ESCROW SERVICES; REAL ESTATE INVESTMENT; REAL ESTATE INVESTMENT SERVICES IN THE NATURE OF PURCHASING AND SELLING OF REAL ESTATE FOR OTHERS; REAL ESTATE LENDING SERVICES; REAL ESTATE LISTING; REAL ESTATE MANAGEMENT; REAL ESTATE MANAGEMENT CONSULTATION; REAL ESTATE MULTIPLE LISTING SERVICES; REAL ESTATE PROCUREMENT FOR OTHERS; REAL ESTATE SERVICES IN THE FORM OF PROVIDING PHYSICAL ACCESS TO AVAILABLE PROPERTIES VIA A REMOTE CALL-IN LOCKING DEVICE; REAL ESTATE SERVICES, NAMELY, RENTAL OF SHORT-TERM FURNISHED APARTMENTS; REAL ESTATE SERVICES, NAMELY, RENTAL OF VACATION HOMES, CONDOMINIUMS, CABINS, AND VILLAS USING PAY PER CLICK ADVERTISING ON A GLOBAL COMPUTER NETWORK; REAL ESTATE SYNDICATION; REAL ESTATE TIME-SHARING; REAL ESTATE TRUSTEE SERVICES; REAL ESTATE VALUATION SERVICES; REAL ESTATE VALUATIONS; VACATION REAL ESTATE TIMESHARE SERVICES; VACATION REAL ESTATE TIME-SHARING; VACATION REAL ESTATE TIME SHARE EXCHANGE SERVICES (U.S. CLS. 100, 101 AND 102).

MATTHEW MCDOWELL, EXAMINING ATTORNEY

SN 77-291,083. TAX & FINANCIAL EMPOWERMENT INC., KELLER, TX. FILED 9-28-2007.

Empower Your Money

THE MARK CONSISTS OF STANDARD CHARACTERS WITHOUT CLAIM TO ANY PARTICULAR FONT, STYLE, SIZE, OR COLOR.

FOR FINANCIAL PLANNING (U.S. CLS. 100, 101 AND 102).

ROBIN MITTLER, EXAMINING ATTORNEY

CLASS 36—(Continued).

SN 77-291,193. BANK OF AMERICA CORPORATION, CHARLOTTE, NC. FILED 9-28-2007.

BankAmericard

OWNER OF U.S. REG. NO. 845,618.
THE MARK CONSISTS OF THE WORD "BANKAMERICARD" IN A STYLIZED FONT.
FOR CREDIT CARD SERVICES (U.S. CLS. 100, 101 AND 102).
FIRST USE 8-0-2006; IN COMMERCE 8-0-2006.
JANET LEE, EXAMINING ATTORNEY

SN 77-291,488. MERCHANTS' GATE CAPITAL LP, NEW YORK, NY. FILED 9-28-2007.

MERCHANTS' GATE CAPITAL LP

THE MARK CONSISTS OF STANDARD CHARACTERS WITHOUT CLAIM TO ANY PARTICULAR FONT, STYLE, SIZE, OR COLOR.
NO CLAIM IS MADE TO THE EXCLUSIVE RIGHT TO USE "CAPITAL LP", APART FROM THE MARK AS SHOWN.
FOR FINANCIAL SERVICES, NAMELY, ASSET MANAGEMENT SERVICES, INVESTMENT MANAGEMENT SERVICES AND INVESTMENT ADVISORY SERVICES (U.S. CLS. 100, 101 AND 102).
FIRST USE 8-0-2007; IN COMMERCE 8-0-2007.
TOBY BULLOFF, EXAMINING ATTORNEY

SN 77-291,876. SCOTT LOYE, SHREVEPORT, LA. FILED 9-28-2007.

Diamond Realty Group

THE MARK CONSISTS OF STANDARD CHARACTERS WITHOUT CLAIM TO ANY PARTICULAR FONT, STYLE, SIZE, OR COLOR.
NO CLAIM IS MADE TO THE EXCLUSIVE RIGHT TO USE "REALTY GROUP", APART FROM THE MARK AS SHOWN.
FOR REAL ESTATE BROKERAGE (U.S. CLS. 100, 101 AND 102).
JOHN WILKE, EXAMINING ATTORNEY

CLASS 36—(Continued).

SN 77-292,495. JAMES, TIMOTHY D, SAN JUAN CAPISTRANO, CA. AND JAMES, JEFFREY W, SAN JUAN CAPISTRANO, CA. FILED 10-1-2007.

Home, James!

THE MARK CONSISTS OF STANDARD CHARACTERS WITHOUT CLAIM TO ANY PARTICULAR FONT, STYLE, SIZE, OR COLOR.
FOR REAL ESTATE AGENCIES (U.S. CLS. 100, 101 AND 102).
FIRST USE 9-28-2007; IN COMMERCE 9-28-2007.
ELLEN PERKINS, EXAMINING ATTORNEY

SN 77-292,560. SWIFTCOLLECT LLC, NEW YORK, NY. FILED 10-1-2007.

SwiftCollect

THE MARK CONSISTS OF STANDARD CHARACTERS WITHOUT CLAIM TO ANY PARTICULAR FONT, STYLE, SIZE, OR COLOR.
FOR COLLECTION OF DEBTS; COLLECTION AGENCIES; CREDIT RECOVERY AND COLLECTION; DEBT RECOVERY AND COLLECTION AGENCIES; DEBT COUNSELING SERVICES; DEBT MANAGEMENT CONSULTATION (U.S. CLS. 100, 101 AND 102).
BRENDAN MCCAULEY, EXAMINING ATTORNEY

SN 77-292,752. CALIFORNIA UNITED BANK, ENCINO, CA. FILED 10-1-2007.

CALIFORNIA UNITED BANK

THE MARK CONSISTS OF STANDARD CHARACTERS WITHOUT CLAIM TO ANY PARTICULAR FONT, STYLE, SIZE, OR COLOR.
NO CLAIM IS MADE TO THE EXCLUSIVE RIGHT TO USE "CALIFORNIA" AND "BANK", APART FROM THE MARK AS SHOWN.
FOR BANKING SERVICES (U.S. CLS. 100, 101 AND 102).
FIRST USE 5-23-2005; IN COMMERCE 5-23-2005.
REBECCA GILBERT, EXAMINING ATTORNEY

CLASS 36—(Continued).

SN 77-292,817. PLANET VENTURES, INC., PORTLAND, ME. FILED 10-1-2007.

Woofminster Dog Show

THE MARK CONSISTS OF STANDARD CHARACTERS WITHOUT CLAIM TO ANY PARTICULAR FONT, STYLE, SIZE, OR COLOR.

NO CLAIM IS MADE TO THE EXCLUSIVE RIGHT TO USE "DOG SHOW", APART FROM THE MARK AS SHOWN. FOR CHARITABLE FUND RAISING (U.S. CLS. 100, 101 AND 102).

LAURA KOVALSKY, EXAMINING ATTORNEY

SN 77-292,839. ALPHASHARES, INC., WALNUT CREEK, CA. FILED 10-1-2007.

CHINA FACTOR

THE MARK CONSISTS OF STANDARD CHARACTERS WITHOUT CLAIM TO ANY PARTICULAR FONT, STYLE, SIZE, OR COLOR.

NO CLAIM IS MADE TO THE EXCLUSIVE RIGHT TO USE "CHINA", APART FROM THE MARK AS SHOWN.

FOR FINANCIAL RATING SERVICES, NAMELY, A RATING OR SCORE DESIGNED TO MEASURE THE POSITIVE OR NEGATIVE FINANCIAL IMPACT OF BUSINESSES IN CHINA ON THE ECONOMIC PROSPERITY OF U.S. OR INTERNATIONAL COMPANIES (U.S. CLS. 100, 101 AND 102).

JESSICA A. POWERS, EXAMINING ATTORNEY

SN 77-292,926. SOLANA CORPORATION, LOS ALTOS HILLS, CA. FILED 10-1-2007.

CINCH

THE MARK CONSISTS OF STANDARD CHARACTERS WITHOUT CLAIM TO ANY PARTICULAR FONT, STYLE, SIZE, OR COLOR.

FOR ELECTRONIC FINANCIAL TRANSACTIONS, NAMELY, TRANSFER OF FUNDS; PROVIDING FUND TRANSFER AND TRANSACTION SERVICES, NAMELY, FINANCIAL TRANSACTION AUTHORIZATION AND SETTLEMENT SERVICES, AND PAYMENT TRANSACTION AUTHENTICATION, VERIFICATION AND SETTLEMENT SERVICES (U.S. CLS. 100, 101 AND 102).

DAVID HOFFMAN, EXAMINING ATTORNEY

CLASS 36—(Continued).

SN 77-292,968. SMARTRAISE LLC, CLAYTON, NJ. FILED 10-1-2007.

SmartRaise

THE MARK CONSISTS OF STANDARD CHARACTERS WITHOUT CLAIM TO ANY PARTICULAR FONT, STYLE, SIZE, OR COLOR.

FOR CHARITABLE FUND RAISING (U.S. CLS. 100, 101 AND 102).

FIRST USE 3-1-2007; IN COMMERCE 9-18-2007.

JASON BLAIR, EXAMINING ATTORNEY

SN 77-293,031. PHALANX FINANCIAL GROUP LLC, CINCINNATI, OH. FILED 10-1-2007.



Advance + Protect

THE MARK CONSISTS OF SHIELD AND SPEARS OVER THE WORDS "ADVANCE + PROTECT".

FOR FINANCIAL PLANNING SERVICES (U.S. CLS. 100, 101 AND 102).

FIRST USE 9-6-2007; IN COMMERCE 9-6-2007.

C. DIONNE CLYBURN, EXAMINING ATTORNEY

SN 77-293,153. SOLANA CORPORATION, LOS ALTOS HILLS, CA. FILED 10-1-2007.



THE MARK CONSISTS OF THE WORD CINCH PARTIALLY ENCIRCLED BY THREE STYLIZED CURVED LINES EACH FORMING THE LETTER "C".

FOR ELECTRONIC FINANCIAL TRANSACTIONS, NAMELY, TRANSFER OF FUNDS; PROVIDING FUND TRANSFER AND TRANSACTION SERVICES, NAMELY, FINANCIAL TRANSACTION AUTHORIZATION AND SETTLEMENT SERVICES, AND PAYMENT TRANSACTION AUTHENTICATION, VERIFICATION AND SETTLEMENT SERVICES (U.S. CLS. 100, 101 AND 102).

DAVID HOFFMAN, EXAMINING ATTORNEY

CLASS 36—(Continued).

SN 77-293,173. AMERISIGHT, INC., CHICAGO, IL. FILED 10-1-2007.

QUALSIGHT

THE MARK CONSISTS OF STANDARD CHARACTERS WITHOUT CLAIM TO ANY PARTICULAR FONT, STYLE, SIZE, OR COLOR.

FOR MEDICAL BENEFITS ADMINISTRATION AND MANAGEMENT SERVICES IN THE FIELD OF EYE CARE, NAMELY, ADMINISTRATION OF EMPLOYEE BENEFIT PLANS (U.S. CLS. 100, 101 AND 102).
MARTHA FROMM, EXAMINING ATTORNEY

SN 77-293,293. BROWN BROTHERS HARRIMAN & CO., NEW YORK, NY. FILED 10-1-2007.

EGLOBALCUSTODY

THE MARK CONSISTS OF STANDARD CHARACTERS WITHOUT CLAIM TO ANY PARTICULAR FONT, STYLE, SIZE, OR COLOR.

FOR FINANCIAL ANALYSIS AND CONSULTATION; FINANCIAL AND INVESTMENT SERVICES, NAMELY, MANAGEMENT AND BROKERAGE IN THE FIELDS OF STOCKS, BONDS, OPTIONS, COMMODITIES, FUTURES AND OTHER SECURITIES, AND THE INVESTMENT OF FUNDS OF OTHERS; FINANCIAL CLEARING HOUSES; FINANCIAL EXCHANGE; FINANCIAL INFORMATION IN THE NATURE OF RATES OF EXCHANGE; FINANCIAL INFORMATION PROCESSING; FINANCIAL INFORMATION PROVIDED BY ELECTRONIC MEANS; FINANCIAL PORTFOLIO MANAGEMENT; FINANCIAL RISK MANAGEMENT; FINANCIAL SERVICES, NAMELY, ASSISTING OTHERS WITH THE COMPLETION OF FINANCIAL TRANSACTIONS FOR STOCKS, BONDS, SECURITIES AND EQUITIES; FINANCIAL SERVICES, NAMELY, PROVIDING INFORMATION IN THE FIELDS OF FOREIGN CURRENCY, COMMODITIES, FINANCIAL DERIVATIVES, INTEREST RATE PRODUCTS, AND EQUITIES VIA THE INTERNET AND INTRANET SYSTEMS; FINANCIAL SERVICES, NAMELY, INVESTMENT FUND TRANSFER AND TRANSACTION SERVICES (U.S. CLS. 100, 101 AND 102).
ALICE SUE CARRUTHERS, EXAMINING ATTORNEY

CLASS 36—(Continued).

SN 77-293,358. VENTURE BANK CORPORATION, LACEY, WA. FILED 10-1-2007.

AS INDEPENDENT AS YOU

THE MARK CONSISTS OF STANDARD CHARACTERS WITHOUT CLAIM TO ANY PARTICULAR FONT, STYLE, SIZE, OR COLOR.

FOR BANKING; BILL PAYMENT SERVICES; CASH MANAGEMENT; CHECK CASHING; ESTATE PLANNING; FINANCIAL CONSULTATION; FINANCIAL MANAGEMENT; FINANCIAL SERVICES, NAMELY, MONEY LENDING; FINANCIAL SERVICES, NAMELY, INVESTMENT FUND TRANSFER AND TRANSACTION SERVICES; FUND INVESTMENT CONSULTATION; FUNDS INVESTMENT; INVESTMENT BANKING SERVICES; INVESTMENT MANAGEMENT; INVESTMENT ADVICE; MORTGAGE BANKING; MORTGAGE BROKERAGE; MORTGAGE LENDING; MORTGAGE PROCUREMENT FOR OTHERS; ON-LINE BANKING SERVICES; SAVINGS ACCOUNT SERVICES; SAVINGS BANK SERVICES; FINANCIAL PLANNING (U.S. CLS. 100, 101 AND 102).
FIRST USE 5-27-2003; IN COMMERCE 5-27-2003.
SCOTT BIBB, EXAMINING ATTORNEY

SN 77-293,415. DESARROLLO MARINA VALLARTA, S.A. DE C.V., GUADALAJARA, MEXICO, FILED 10-1-2007.

MAYAN DE CORTES

THE MARK CONSISTS OF STANDARD CHARACTERS WITHOUT CLAIM TO ANY PARTICULAR FONT, STYLE, SIZE, OR COLOR.

FOR REAL ESTATE TIME-SHARING; VACATION REAL ESTATE TIME-SHARING; VACATION REAL ESTATE TIMESHARE SERVICES (U.S. CLS. 100, 101 AND 102).
DAVID TOOLEY, EXAMINING ATTORNEY

SN 77-293,487. KEYCORP, CLEVELAND, OH. FILED 10-2-2007.

KBO

THE MARK CONSISTS OF STANDARD CHARACTERS WITHOUT CLAIM TO ANY PARTICULAR FONT, STYLE, SIZE, OR COLOR.

FOR FINANCIAL SERVICES, NAMELY, BANKING SERVICES ACCESSED VIA A GLOBAL COMPUTER NETWORK (U.S. CLS. 100, 101 AND 102).
ANTHONY RINKER, EXAMINING ATTORNEY

CLASS 36—(Continued).

SN 77-293,575. DEALLIGENCE, LTD, BERGENFIELD, NJ. FILED 10-2-2007.

Dealligence

THE MARK CONSISTS OF STANDARD CHARACTERS WITHOUT CLAIM TO ANY PARTICULAR FONT, STYLE, SIZE, OR COLOR.
FOR FINANCIAL DUE DILIGENCE; FINANCIAL ANALYSIS AND CONSULTATION; FINANCIAL RESEARCH (U.S. CLS. 100, 101 AND 102).
LOURDES AYALA, EXAMINING ATTORNEY

SN 77-293,657. MERCURY VENTURES, LLC, CONCORD, OH. FILED 10-2-2007.

Ratespeed

THE MARK CONSISTS OF STANDARD CHARACTERS WITHOUT CLAIM TO ANY PARTICULAR FONT, STYLE, SIZE, OR COLOR.
FOR FINANCIAL LOAN CONSULTATION (U.S. CLS. 100, 101 AND 102).
RICHARD WHITE, EXAMINING ATTORNEY

SN 77-293,674. POWELL, JANE, CORTE MADERA, CA. FILED 10-2-2007.

Don't just beat the heat -
enjoy it!

THE MARK CONSISTS OF STANDARD CHARACTERS WITHOUT CLAIM TO ANY PARTICULAR FONT, STYLE, SIZE, OR COLOR.
FOR FACILITATING AND ARRANGING FOR THE FINANCING OF SWIMMING POOLS (U.S. CLS. 100, 101 AND 102).
FIRST USE 5-10-2007; IN COMMERCE 5-10-2007.
CORY BOONE, EXAMINING ATTORNEY

CLASS 36—(Continued).

SN 77-293,793. WESBANCO, INC., WHEELING, WV. FILED 10-2-2007.

WESTRAK

THE MARK CONSISTS OF STANDARD CHARACTERS WITHOUT CLAIM TO ANY PARTICULAR FONT, STYLE, SIZE, OR COLOR.
FOR FINANCIAL PLANNING (U.S. CLS. 100, 101 AND 102).
FIRST USE 1-31-2006; IN COMMERCE 1-31-2006.
PATRICIA EVANKO, EXAMINING ATTORNEY

SN 77-293,943. ADVISER INVESTMENT MANAGEMENT, NEWTON, MA. FILED 10-2-2007.

AN INVESTMENT ADVISER YOU
CAN TALK TO

THE MARK CONSISTS OF STANDARD CHARACTERS WITHOUT CLAIM TO ANY PARTICULAR FONT, STYLE, SIZE, OR COLOR.
FOR INVESTMENT SERVICES, NAMELY, INVESTMENT CONSULTATION AND INVESTMENT MANAGEMENT (U.S. CLS. 100, 101 AND 102).
JAY FLOWERS, EXAMINING ATTORNEY

SN 77-294,148. OGNEK, DAVID XAVIER, MYRTLE BEACH, SC. FILED 10-2-2007.

You Talk + We Listen =
SOLUTIONS

THE MARK CONSISTS OF STANDARD CHARACTERS WITHOUT CLAIM TO ANY PARTICULAR FONT, STYLE, SIZE, OR COLOR.
FOR FINANCIAL CONSULTATION (U.S. CLS. 100, 101 AND 102).
LINDA ORNDORFF, EXAMINING ATTORNEY

CLASS 36—(Continued).

SN 77-294,235. FLORIDA BANK GROUP, INC., TAMPA, FL. FILED 10-2-2007.



OWNER OF U.S. REG. NO. 3,205,422.
THE MARK CONSISTS OF A DESIGN OF A BRIDGE.
FOR BANKING SERVICES (U.S. CLS. 100, 101 AND 102).
CAROLINE WOOD, EXAMINING ATTORNEY

SN 77-294,299. KUDZU REALTY, INC., FLOWERY BRANCH, GA. FILED 10-2-2007.



NO CLAIM IS MADE TO THE EXCLUSIVE RIGHT TO USE "REALTY INC", APART FROM THE MARK AS SHOWN.
THE MARK CONSISTS OF OF THE STYLIZED WORDS KUDZU REALTY INC COVERING THE SOUTH. THERE IS A LEAF ON EACH SIDE OF THE WORDS "KUDZU".
FOR REAL ESTATE BROKERAGE (U.S. CLS. 100, 101 AND 102).
FIRST USE 4-21-2004; IN COMMERCE 4-21-2004.
LINDA ORNDORFF, EXAMINING ATTORNEY

SN 77-294,410. NEHRET, L.L.C., ATASCOSITA, TX. FILED 10-2-2007.



FOR REAL ESTATE BROKERAGE, REAL ESTATE LISTING, REAL ESTATE AGENCY SERVICES, REAL ESTATE CONSULTATION, REAL ESTATE ACQUISITION SERVICES (U.S. CLS. 100, 101 AND 102).
FIRST USE 5-21-2007; IN COMMERCE 5-21-2007.
DAVID YONTEF, EXAMINING ATTORNEY

CLASS 36—(Continued).

SN 77-294,582. FEDERAL HILL MORTGAGE COMPANY, LLC, BALTIMORE, MD. FILED 10-2-2007.



THE MARK CONSISTS OF A CURVED LINE REPRESENTING A HORIZON WITH STEEPLY ANGLED TRIANGLES ORGANIZED IN AN ARC REPRESENTING THE SUN. INSIDE THE ARC ARE INTERSECTING LINES FORMING THE OUTLINE OF A HOUSE. SOME OF THESE LINES ALSO DOUBLE AS TWO STICK FIGURES WITH HANDS MEETING AT THE PITCH OF THE ROOF, WITH CIRCLES REPRESENTING THEIR HEADS.
FOR FINANCIAL SERVICES, NAMELY, MORTGAGE PLANNING; MORTGAGE BROKERAGE; MORTGAGE SERVICES, NAMELY, BUYER PRE-QUALIFICATION OF MORTGAGES FOR MORTGAGE BROKERS AND BANKS (U.S. CLS. 100, 101 AND 102).
FIRST USE 10-1-2006; IN COMMERCE 10-1-2006.
ALYSSA PALADINO, EXAMINING ATTORNEY

SN 77-294,621. D/AQ CORPORATION, LOS ANGELES, CA. FILED 10-2-2007.



OWNER OF U.S. REG. NO. 3,284,320.
FOR REAL ESTATE BROKERAGE (U.S. CLS. 100, 101 AND 102).
FIRST USE 12-31-1904; IN COMMERCE 12-31-1912.
MARIAM MAHMOUDI, EXAMINING ATTORNEY

SN 77-294,726. SEQUOIA INSURANCE COMPANY, MONTEREY, CA. FILED 10-3-2007.

ROOTED IN THE WEST

THE MARK CONSISTS OF STANDARD CHARACTERS WITHOUT CLAIM TO ANY PARTICULAR FONT, STYLE, SIZE, OR COLOR.
FOR PROPERTY AND CASUALTY INSURANCE UNDERWRITING SERVICES (U.S. CLS. 100, 101 AND 102).
FIRST USE 7-0-2006; IN COMMERCE 7-0-2006.
LINDA E. BLOHM, EXAMINING ATTORNEY

CLASS 36—(Continued).

SN 77-294,764. ADMIN AMERICA, INC., DBA FLEXIBLE BENEFITS ADMINISTRATORS, INC., ROSWELL, GA. FILED 10-3-2007.



OWNER OF U.S. REG. NO. 2,637,550.
NO CLAIM IS MADE TO THE EXCLUSIVE RIGHT TO USE "ADMIN", APART FROM THE MARK AS SHOWN.

THE MARK CONSISTS OF THE WORD "ADMIN" ON TOP OF THE WORD "AMERICA" WITH THE "A"'S IN EACH WORD JOINED. THE BACKGROUND OF THE MARK CONSISTS OF FOUR WAVY LINES WHICH SPAN THE ENTIRE BACKGROUND. A SOLID STAR SITS ON THE SECOND WAVE FROM THE TOP NEXT TO THE WORD "ADMIN".

SEC. 2(F).

FOR ADMINISTRATION OF EMPLOYEE BENEFIT PLANS CONCERNING INSURANCE AND FINANCE (U.S. CLS. 100, 101 AND 102).

FIRST USE 2-1-2000; IN COMMERCE 2-1-2000.

TARAH HARDY, EXAMINING ATTORNEY

SN 77-294,767. THOMAS J. BRAKKE, LLC, EXCELSIOR, MN. FILED 10-3-2007.

THE RESEARCH PUZZLE

THE MARK CONSISTS OF STANDARD CHARACTERS WITHOUT CLAIM TO ANY PARTICULAR FONT, STYLE, SIZE, OR COLOR.

FOR ADVICE RELATING TO INVESTMENTS (U.S. CLS. 100, 101 AND 102).

FIRST USE 3-6-2006; IN COMMERCE 3-6-2006.

DAVID MURRAY, EXAMINING ATTORNEY

SN 77-295,112. IMS INTEGRATED MARKETING SOLUTIONS, INC., OXNARD, CA. FILED 10-3-2007.

NOTE MOD SQUAD

THE MARK CONSISTS OF STANDARD CHARACTERS WITHOUT CLAIM TO ANY PARTICULAR FONT, STYLE, SIZE, OR COLOR.

NO CLAIM IS MADE TO THE EXCLUSIVE RIGHT TO USE "NOTE", APART FROM THE MARK AS SHOWN.

FOR FINANCIAL CONSULTING IN THE FIELD OF MODIFYING SECURED PROMISSORY NOTES (U.S. CLS. 100, 101 AND 102).

SIMON TENG, EXAMINING ATTORNEY

CLASS 36—(Continued).

SN 77-295,263. THE LOVELACE GROUP, LLC, DULUTH, GA. FILED 10-3-2007.

RENT COUNTS

THE MARK CONSISTS OF STANDARD CHARACTERS WITHOUT CLAIM TO ANY PARTICULAR FONT, STYLE, SIZE, OR COLOR.

NO CLAIM IS MADE TO THE EXCLUSIVE RIGHT TO USE "RENT", APART FROM THE MARK AS SHOWN.

FOR REAL ESTATE MANAGEMENT CONSULTATION (U.S. CLS. 100, 101 AND 102).

TARAH HARDY, EXAMINING ATTORNEY

SN 77-295,510. BRASSE, JOHN, HERNDON, VA. FILED 10-3-2007.

"Think Outside the Pig"

THE MARK CONSISTS OF STANDARD CHARACTERS WITHOUT CLAIM TO ANY PARTICULAR FONT, STYLE, SIZE, OR COLOR.

FOR FINANCIAL PLANNING FOR RETIREMENT; FINANCIAL PLANNING (U.S. CLS. 100, 101 AND 102).

STEVEN PEREZ, EXAMINING ATTORNEY

SN 77-296,058. BLOOMBERG L.P., NEW YORK, NY. FILED 10-4-2007.

TRADEHUB

THE MARK CONSISTS OF STANDARD CHARACTERS WITHOUT CLAIM TO ANY PARTICULAR FONT, STYLE, SIZE, OR COLOR.

FOR FINANCIAL SERVICES IN THE NATURE OF PROVIDING A SECURITIES TRADING SYSTEM; ELECTRONICALLY PROVIDING THE SERVICES OF A SECURITIES TRADING BROKER; OBJECTIVELY RATING SECURITIES; FINANCIAL SERVICES IN THE NATURE OF PROVIDING AN ALGORITHMIC TRADING STRATEGY; INFORMATION SERVICES RELATING TO FINANCE AND FINANCIAL NEWS, NAMELY, PROVIDING ANALYSES OF SECURITIES MARKETS AND MODELS THAT OBJECTIVELY RATE SECURITIES (U.S. CLS. 100, 101 AND 102).

GILBERT SWIFT, EXAMINING ATTORNEY

CLASS 36—(Continued).

SN 77-296,402. BANK OF AMERICA CORPORATION, CHARLOTTE, NC. FILED 10-4-2007.

IT'S OPPORTUNITY SEASON

THE MARK CONSISTS OF STANDARD CHARACTERS WITHOUT CLAIM TO ANY PARTICULAR FONT, STYLE, SIZE, OR COLOR.
FOR BANKING AND RELATED FINANCIAL SERVICES (U.S. CLS. 100, 101 AND 102).
JANET LEE, EXAMINING ATTORNEY

SN 77-296,563. CNBS FINANCIAL GROUP, INC., TAMPA, FL. FILED 10-4-2007.

SOUTHERN REPUBLIC BANCORP

THE MARK CONSISTS OF STANDARD CHARACTERS WITHOUT CLAIM TO ANY PARTICULAR FONT, STYLE, SIZE, OR COLOR.
NO CLAIM IS MADE TO THE EXCLUSIVE RIGHT TO USE "BANCORP", APART FROM THE MARK AS SHOWN.
FOR BANKING; FINANCIAL SERVICES IN THE FIELD OF MONEY LENDING; LOAN FINANCING; SAVINGS BANK SERVICES; TRUST SERVICES, NAMELY, INVESTMENT AND TRUST COMPANY SERVICES (U.S. CLS. 100, 101 AND 102).
SCOTT SISUN, EXAMINING ATTORNEY

SN 77-296,567. CNBS FINANCIAL GROUP, INC., TAMPA, FL. FILED 10-4-2007.

SOUTHERN REPUBLIC BANK

THE MARK CONSISTS OF STANDARD CHARACTERS WITHOUT CLAIM TO ANY PARTICULAR FONT, STYLE, SIZE, OR COLOR.
NO CLAIM IS MADE TO THE EXCLUSIVE RIGHT TO USE "BANK", APART FROM THE MARK AS SHOWN.
FOR BANKING; FINANCIAL SERVICES IN THE FIELD OF MONEY LENDING; LOAN FINANCING; SAVINGS BANK SERVICES; TRUST SERVICES, NAMELY, INVESTMENT AND TRUST COMPANY SERVICES (U.S. CLS. 100, 101 AND 102).
SCOTT SISUN, EXAMINING ATTORNEY

CLASS 36—(Continued).

SN 77-296,669. MARTINHO, MARK M, REDWOOD CITY, CA. FILED 10-4-2007.



THE MARK CONSISTS OF FILLED IN OUTLINE OF A DECORATIVE DOOR KNOCKER.
FOR LEASING OF REAL PROPERTY; PROVIDING INFORMATION IN THE FIELD OF REAL ESTATE VIA THE INTERNET; REAL ESTATE ACQUISITION SERVICES; REAL ESTATE BROKERAGE; REAL ESTATE LISTING (U.S. CLS. 100, 101 AND 102).
FIRST USE 9-10-2007; IN COMMERCE 9-10-2007.
DANIEL CAPSHAW, EXAMINING ATTORNEY

SN 77-297,448. JANUS INTERNATIONAL HOLDING LLC, DENVER, CO. FILED 10-5-2007.

GO FURTHER

THE MARK CONSISTS OF STANDARD CHARACTERS WITHOUT CLAIM TO ANY PARTICULAR FONT, STYLE, SIZE, OR COLOR.
FOR FINANCIAL AND INVESTMENT SERVICES, NAMELY, MANAGEMENT AND BROKERAGE IN THE FIELDS OF STOCKS, BONDS, OPTIONS, COMMODITIES, FUTURES AND OTHER SECURITIES, AND THE INVESTMENT OF FUNDS OF OTHERS (U.S. CLS. 100, 101 AND 102).
DAVID YONTEF, EXAMINING ATTORNEY

SN 77-297,489. BANK OF AMERICA CORPORATION, CHARLOTTE, NC. FILED 10-5-2007.

TOMORROW'S OPPORTUNITY TODAY

THE MARK CONSISTS OF STANDARD CHARACTERS WITHOUT CLAIM TO ANY PARTICULAR FONT, STYLE, SIZE, OR COLOR.
FOR PROVIDING INFORMATION IN THE FIELD OF EMPLOYEE BENEFITS; MANAGING EMPLOYEE BENEFIT PLANS (U.S. CLS. 100, 101 AND 102).
JANET LEE, EXAMINING ATTORNEY

CLASS 36—(Continued).

SN 77-297,494. BANK OF AMERICA CORPORATION, CHARLOTTE, NC. FILED 10-5-2007.

YOUR OPPORTUNITY . . . OUR
COMMITMENT

THE MARK CONSISTS OF STANDARD CHARACTERS WITHOUT CLAIM TO ANY PARTICULAR FONT, STYLE, SIZE, OR COLOR.

FOR PROVIDING INFORMATION IN THE FIELD OF EMPLOYEE BENEFITS; MANAGING EMPLOYEE BENEFIT PLANS (U.S. CLS. 100, 101 AND 102).

JANET LEE, EXAMINING ATTORNEY

SN 77-297,599. ISRAEL CANCER RESEARCH FUND, INC., NEW YORK, NY. FILED 10-5-2007.

ISRAEL CANCER RESEARCH FUND

THE MARK CONSISTS OF STANDARD CHARACTERS WITHOUT CLAIM TO ANY PARTICULAR FONT, STYLE, SIZE, OR COLOR.

NO CLAIM IS MADE TO THE EXCLUSIVE RIGHT TO USE "CANCER RESEARCH FUND", APART FROM THE MARK AS SHOWN.

SEC. 2(F).
FOR CHARITABLE FUND RAISING (U.S. CLS. 100, 101 AND 102).

FIRST USE 5-0-1983; IN COMMERCE 5-0-1983.
STEVEN R. FOSTER, EXAMINING ATTORNEY

SN 77-297,676. STEPHENS INVESTMENT MANAGEMENT GROUP, LLC, LITTLE ROCK, AR. FILED 10-5-2007.

The Power of Growth

THE MARK CONSISTS OF STANDARD CHARACTERS WITHOUT CLAIM TO ANY PARTICULAR FONT, STYLE, SIZE, OR COLOR.

FOR FINANCIAL ANALYSIS AND CONSULTATION; INVESTMENT ADVICE; INVESTMENT MANAGEMENT; MUTUAL FUND DISTRIBUTION AND MUTUAL FUND INVESTMENT (U.S. CLS. 100, 101 AND 102).

RONALD MCMORROW, EXAMINING ATTORNEY

CLASS 36—(Continued).

SN 77-297,802. UNITED COUNTRY REAL ESTATE, INC., KANSAS CITY, MO. FILED 10-5-2007.

UNITED COUNTRY HOME
MORTGAGE

THE MARK CONSISTS OF STANDARD CHARACTERS WITHOUT CLAIM TO ANY PARTICULAR FONT, STYLE, SIZE, OR COLOR.

OWNER OF U.S. REG. NOS. 1,109,683, 2,186,596 AND 2,188,368.

NO CLAIM IS MADE TO THE EXCLUSIVE RIGHT TO USE "HOME MORTGAGE", APART FROM THE MARK AS SHOWN.

FOR HOME EQUITY LOANS AND MORTGAGE LENDING SERVICES (U.S. CLS. 100, 101 AND 102).

JOHN KELLY, EXAMINING ATTORNEY

SN 77-298,478. MCDONALD, MICHAEL, LA QUNITA, CA. FILED 10-8-2007.

GLOBAL WARMING CAPITAL
MANAGEMENT

THE MARK CONSISTS OF STANDARD CHARACTERS WITHOUT CLAIM TO ANY PARTICULAR FONT, STYLE, SIZE, OR COLOR.

NO CLAIM IS MADE TO THE EXCLUSIVE RIGHT TO USE "CAPITAL MANAGEMENT", APART FROM THE MARK AS SHOWN.

FOR ESTABLISHING MUTUAL FUNDS AND HEDGE FUNDS FOR OTHERS; INVESTMENT ADVISORY SERVICES (U.S. CLS. 100, 101 AND 102).

TEJBIR SINGH, EXAMINING ATTORNEY

SN 77-300,108. RANGEL, GUILLERMO, BAKERSFIELD, CA. FILED 10-10-2007.

LEMCO

THE MARK CONSISTS OF STANDARD CHARACTERS WITHOUT CLAIM TO ANY PARTICULAR FONT, STYLE, SIZE, OR COLOR.

THE WORDING "LEMCO" HAS NO MEANING IN A FOREIGN LANGUAGE.

FOR PROVIDING REAL ESTATE LISTINGS AND REAL ESTATE INFORMATION VIA THE INTERNET; REAL ESTATE ACQUISITION SERVICES; REAL ESTATE AGENCIES; REAL ESTATE BROKERAGE; REAL ESTATE CONSULTANCY; REAL ESTATE PROCUREMENT FOR OTHERS; MORTGAGE BANKING SERVICES, NAMELY, ORIGINATION, ACQUISITION, SERVICING, SECURITIZATION AND BROKERAGE OF MORTGAGE LOANS; MORTGAGE BROKERAGE; MORTGAGE LENDING; MORTGAGE PROCUREMENT FOR OTHERS (U.S. CLS. 100, 101 AND 102).

FIRST USE 9-18-2007; IN COMMERCE 9-18-2007.

ANDREW RHIM, EXAMINING ATTORNEY

CLASS 36—(Continued).

SN 77-300,806. BRASSE, JOHN, HERNDON, VA. FILED 10-10-2007.

**Retirement Planning Should
Involve More Than a Hammer**

THE MARK CONSISTS OF STANDARD CHARACTERS WITHOUT CLAIM TO ANY PARTICULAR FONT, STYLE, SIZE, OR COLOR.

FOR FINANCIAL PLANNING; FINANCIAL PLANNING FOR RETIREMENT (U.S. CLS. 100, 101 AND 102). STEVEN PEREZ, EXAMINING ATTORNEY

SN 77-301,411. LINCOLN NATIONAL CORPORATION, RADNOR, PA. FILED 10-11-2007.

FUTURESELF

THE MARK CONSISTS OF STANDARD CHARACTERS WITHOUT CLAIM TO ANY PARTICULAR FONT, STYLE, SIZE, OR COLOR.

FOR FINANCIAL SERVICES, NAMELY, LIFE INSURANCE AND ANNUITY UNDERWRITING SERVICES; FINANCIAL SERVICES IN THE NATURE OF ANNUITY INVESTMENT; ADMINISTRATION AND MANAGEMENT OF ANNUITY CONTRACTS; ADMINISTRATION OF ANNUITY CONTRACTS FOR OTHERS AND CONSULTATION IN THE FIELD OF DEVELOPING ANNUITY PRODUCTS FOR OTHERS; MUTUAL FUND SERVICES, NAMELY, MUTUAL FUND BROKERAGE, MUTUAL FUND DISTRIBUTION AND THE ADMINISTRATION AND MANAGEMENT OF MUTUAL FUNDS; FINANCIAL PLANNING AND INVESTMENT ADVISORY SERVICES; INSTITUTIONAL INVESTMENT MANAGEMENT SERVICES; INVESTMENT PLANNING SERVICES, NAMELY, INVESTMENT CONSULTATION AND ADVICE; ARRANGING DEFERRED COMPENSATION FOR PRIVATE, PUBLIC AND TAX EXEMPT EMPLOYERS AND THEIR EMPLOYEES, AND OFFERING INDIVIDUAL RETIREMENT ACCOUNTS FOR INDIVIDUAL RETIREMENT (U.S. CLS. 100, 101 AND 102). EDWARD NELSON, EXAMINING ATTORNEY

CLASS 36—(Continued).

SN 77-301,418. LINCOLN NATIONAL CORPORATION, RADNOR, PA. FILED 10-11-2007.

GET TO KNOW YOUR FUTURESELF

THE MARK CONSISTS OF STANDARD CHARACTERS WITHOUT CLAIM TO ANY PARTICULAR FONT, STYLE, SIZE, OR COLOR.

FOR FINANCIAL SERVICES, NAMELY, LIFE INSURANCE AND ANNUITY UNDERWRITING SERVICES; FINANCIAL SERVICES IN THE NATURE OF ANNUITY INVESTMENT; ADMINISTRATION AND MANAGEMENT OF ANNUITY CONTRACTS; ADMINISTRATION OF ANNUITY CONTRACTS FOR OTHERS AND CONSULTATION IN THE FIELD OF DEVELOPING ANNUITY PRODUCTS FOR OTHERS; MUTUAL FUND SERVICES, NAMELY, MUTUAL FUND BROKERAGE, MUTUAL FUND DISTRIBUTION AND THE ADMINISTRATION AND MANAGEMENT OF MUTUAL FUNDS; FINANCIAL PLANNING AND INVESTMENT ADVISORY SERVICES; INSTITUTIONAL INVESTMENT MANAGEMENT SERVICES; INVESTMENT PLANNING SERVICES, NAMELY, INVESTMENT CONSULTATION AND ADVICE; ARRANGING DEFERRED COMPENSATION FOR PRIVATE, PUBLIC AND TAX EXEMPT EMPLOYERS AND THEIR EMPLOYEES, AND OFFERING INDIVIDUAL RETIREMENT ACCOUNTS FOR INDIVIDUAL RETIREMENT (U.S. CLS. 100, 101 AND 102). EDWARD NELSON, EXAMINING ATTORNEY

SN 77-301,422. LINCOLN NATIONAL CORPORATION, RADNOR, PA. FILED 10-11-2007.

LISTEN TO YOUR FUTURESELF

THE MARK CONSISTS OF STANDARD CHARACTERS WITHOUT CLAIM TO ANY PARTICULAR FONT, STYLE, SIZE, OR COLOR.

FOR FINANCIAL SERVICES, NAMELY, LIFE INSURANCE AND ANNUITY UNDERWRITING SERVICES; FINANCIAL SERVICES IN THE NATURE OF ANNUITY INVESTMENT; ADMINISTRATION AND MANAGEMENT OF ANNUITY CONTRACTS; ADMINISTRATION OF ANNUITY CONTRACTS FOR OTHERS AND CONSULTATION IN THE FIELD OF DEVELOPING ANNUITY PRODUCTS FOR OTHERS; MUTUAL FUND SERVICES, NAMELY, MUTUAL FUND BROKERAGE, MUTUAL FUND DISTRIBUTION AND THE ADMINISTRATION AND MANAGEMENT OF MUTUAL FUNDS; FINANCIAL PLANNING AND INVESTMENT ADVISORY SERVICES; INSTITUTIONAL INVESTMENT MANAGEMENT SERVICES; INVESTMENT PLANNING SERVICES, NAMELY, INVESTMENT CONSULTATION AND ADVICE; ARRANGING DEFERRED COMPENSATION FOR PRIVATE, PUBLIC AND TAX EXEMPT EMPLOYERS AND THEIR EMPLOYEES, AND OFFERING INDIVIDUAL RETIREMENT ACCOUNTS FOR INDIVIDUAL RETIREMENT (U.S. CLS. 100, 101 AND 102). EDWARD NELSON, EXAMINING ATTORNEY

CLASS 36—(Continued).

SN 77-301,427. LINCOLN NATIONAL CORPORATION, RADNOR, PA. FILED 10-11-2007.

CLASS 36—(Continued).

SN 77-303,197. LINCOLN NATIONAL CORPORATION, RADNOR, PA. FILED 10-12-2007.

YOUR FUTURESELF

NOTES FROM YOUR FUTURESELF

THE MARK CONSISTS OF STANDARD CHARACTERS WITHOUT CLAIM TO ANY PARTICULAR FONT, STYLE, SIZE, OR COLOR.

FOR FINANCIAL SERVICES, NAMELY, LIFE INSURANCE AND ANNUITY UNDERWRITING SERVICES; FINANCIAL SERVICES IN THE NATURE OF ANNUITY INVESTMENT; ADMINISTRATION AND MANAGEMENT OF ANNUITY CONTRACTS; ADMINISTRATION OF ANNUITY CONTRACTS FOR OTHERS AND CONSULTATION IN THE FIELD OF DEVELOPING ANNUITY PRODUCTS FOR OTHERS; MUTUAL FUND SERVICES, NAMELY, MUTUAL FUND BROKERAGE, MUTUAL FUND DISTRIBUTION AND THE ADMINISTRATION AND MANAGEMENT OF MUTUAL FUNDS; FINANCIAL PLANNING AND INVESTMENT ADVISORY SERVICES; INSTITUTIONAL INVESTMENT MANAGEMENT SERVICES; INVESTMENT PLANNING SERVICES, NAMELY, INVESTMENT CONSULTATION AND ADVICE; ARRANGING DEFERRED COMPENSATION FOR PRIVATE, PUBLIC AND TAX EXEMPT EMPLOYERS AND THEIR EMPLOYEES, AND OFFERING INDIVIDUAL RETIREMENT ACCOUNTS FOR INDIVIDUAL RETIREMENT (U.S. CLS. 100, 101 AND 102). EDWARD NELSON, EXAMINING ATTORNEY

THE MARK CONSISTS OF STANDARD CHARACTERS WITHOUT CLAIM TO ANY PARTICULAR FONT, STYLE, SIZE, OR COLOR.

FOR FINANCIAL SERVICES, NAMELY, LIFE INSURANCE AND ANNUITY UNDERWRITING SERVICES; FINANCIAL SERVICES IN THE NATURE OF ANNUITY INVESTMENT; ADMINISTRATION AND MANAGEMENT OF ANNUITY CONTRACTS; ADMINISTRATION OF ANNUITY CONTRACTS FOR OTHERS AND CONSULTATION IN THE FIELD OF DEVELOPING ANNUITY PRODUCTS FOR OTHERS; MUTUAL FUND SERVICES, NAMELY, MUTUAL FUND BROKERAGE, MUTUAL FUND DISTRIBUTION AND THE ADMINISTRATION AND MANAGEMENT OF MUTUAL FUNDS; FINANCIAL PLANNING AND INVESTMENT ADVISORY SERVICES; INSTITUTIONAL INVESTMENT MANAGEMENT SERVICES; INVESTMENT PLANNING SERVICES, NAMELY, INVESTMENT CONSULTATION AND ADVICE; ARRANGING DEFERRED COMPENSATION FOR PRIVATE, PUBLIC AND TAX EXEMPT EMPLOYERS AND THEIR EMPLOYEES, AND OFFERING INDIVIDUAL RETIREMENT ACCOUNTS FOR INDIVIDUAL RETIREMENT (U.S. CLS. 100, 101 AND 102). EDWARD NELSON, EXAMINING ATTORNEY

SN 77-303,208. LINCOLN NATIONAL CORPORATION, RADNOR, PA. FILED 10-12-2007.

SN 77-301,611. NATIONWIDE MUTUAL INSURANCE COMPANY, COLUMBUS, OH. FILED 10-11-2007.

BUILDER'S LINK

THE MARK CONSISTS OF STANDARD CHARACTERS WITHOUT CLAIM TO ANY PARTICULAR FONT, STYLE, SIZE, OR COLOR.

FOR INSURANCE SERVICES, NAMELY, ADMINISTRATION, UNDERWRITING AND BROKERAGE OF PROPERTY AND CASUALTY INSURANCE (U.S. CLS. 100, 101 AND 102). LINDA MICKLEBURGH, EXAMINING ATTORNEY

IF YOUR FUTURESELF COULD TALK TO YOU, WHAT WOULD IT SAY?

THE MARK CONSISTS OF STANDARD CHARACTERS WITHOUT CLAIM TO ANY PARTICULAR FONT, STYLE, SIZE, OR COLOR.

FOR FINANCIAL SERVICES, NAMELY, LIFE INSURANCE AND ANNUITY UNDERWRITING SERVICES; FINANCIAL SERVICES IN THE NATURE OF ANNUITY INVESTMENT; ADMINISTRATION AND MANAGEMENT OF ANNUITY CONTRACTS; ADMINISTRATION OF ANNUITY CONTRACTS FOR OTHERS AND CONSULTATION IN THE FIELD OF DEVELOPING ANNUITY PRODUCTS FOR OTHERS; MUTUAL FUND SERVICES, NAMELY, MUTUAL FUND BROKERAGE, MUTUAL FUND DISTRIBUTION AND THE ADMINISTRATION AND MANAGEMENT OF MUTUAL FUNDS; FINANCIAL PLANNING AND INVESTMENT ADVISORY SERVICES; INSTITUTIONAL INVESTMENT MANAGEMENT SERVICES; INVESTMENT PLANNING SERVICES, NAMELY, INVESTMENT CONSULTATION AND ADVICE; ARRANGING DEFERRED COMPENSATION FOR PRIVATE, PUBLIC AND TAX EXEMPT EMPLOYERS AND THEIR EMPLOYEES, AND OFFERING INDIVIDUAL RETIREMENT ACCOUNTS FOR INDIVIDUAL RETIREMENT (U.S. CLS. 100, 101 AND 102). EDWARD NELSON, EXAMINING ATTORNEY

CLASS 36—(Continued).

SN 77-303,221. LINCOLN NATIONAL CORPORATION, RADNOR, PA. FILED 10-12-2007.

BELIEVE IN YOUR FUTURESELF

THE MARK CONSISTS OF STANDARD CHARACTERS WITHOUT CLAIM TO ANY PARTICULAR FONT, STYLE, SIZE, OR COLOR.

FOR FINANCIAL SERVICES, NAMELY, LIFE INSURANCE AND ANNUITY UNDERWRITING SERVICES; FINANCIAL SERVICES IN THE NATURE OF ANNUITY INVESTMENT; ADMINISTRATION AND MANAGEMENT OF ANNUITY CONTRACTS; ADMINISTRATION OF ANNUITY CONTRACTS FOR OTHERS AND CONSULTATION IN THE FIELD OF DEVELOPING ANNUITY PRODUCTS FOR OTHERS; MUTUAL FUND SERVICES, NAMELY, MUTUAL FUND BROKERAGE, MUTUAL FUND DISTRIBUTION AND THE ADMINISTRATION AND MANAGEMENT OF MUTUAL FUNDS; FINANCIAL PLANNING AND INVESTMENT ADVISORY SERVICES; INSTITUTIONAL INVESTMENT MANAGEMENT SERVICES; INVESTMENT PLANNING SERVICES, NAMELY, INVESTMENT CONSULTATION AND ADVICE; ARRANGING DEFERRED COMPENSATION FOR PRIVATE, PUBLIC AND TAX EXEMPT EMPLOYERS AND THEIR EMPLOYEES, AND OFFERING INDIVIDUAL RETIREMENT ACCOUNTS FOR INDIVIDUAL RETIREMENT (U.S. CLS. 100, 101 AND 102). EDWARD NELSON, EXAMINING ATTORNEY

SN 77-307,916. KRATOS LLC, LAS VEGAS, NV. FILED 10-18-2007.

Trust Independence

THE MARK CONSISTS OF STANDARD CHARACTERS WITHOUT CLAIM TO ANY PARTICULAR FONT, STYLE, SIZE, OR COLOR.

FOR TRUST SERVICES, NAMELY, INVESTMENT AND TRUST COMPANY SERVICES (U.S. CLS. 100, 101 AND 102). FIRST USE 9-1-2007; IN COMMERCE 10-15-2007. REGINA DRUMMOND, EXAMINING ATTORNEY

CLASS 36—(Continued).

SN 77-309,983. OM FINANCIAL LIFE INSURANCE COMPANY, BALTIMORE, MD. FILED 10-22-2007.

OM INCOME ADVANTAGE

THE MARK CONSISTS OF STANDARD CHARACTERS WITHOUT CLAIM TO ANY PARTICULAR FONT, STYLE, SIZE, OR COLOR.

NO CLAIM IS MADE TO THE EXCLUSIVE RIGHT TO USE "INCOME", APART FROM THE MARK AS SHOWN. FOR FIXED ANNUITY UNDERWRITING SERVICES (U.S. CLS. 100, 101 AND 102). RICHARD A. STRASER, EXAMINING ATTORNEY

SN 77-312,318. MERCURY VENTURES, LLC, PAINESVILLE, OH. FILED 10-24-2007.

Shared Success

THE MARK CONSISTS OF STANDARD CHARACTERS WITHOUT CLAIM TO ANY PARTICULAR FONT, STYLE, SIZE, OR COLOR.

FOR PROVIDING WORKING CAPITAL FINANCING TO SMALL BUSINESSES AND SMALL BUSINESS OWNERS (U.S. CLS. 100, 101 AND 102). RICHARD WHITE, EXAMINING ATTORNEY

SN 77-312,339. MERCURY VENTURES, LLC, PAINESVILLE, OH. FILED 10-24-2007.

Success Quotient

THE MARK CONSISTS OF STANDARD CHARACTERS WITHOUT CLAIM TO ANY PARTICULAR FONT, STYLE, SIZE, OR COLOR.

FOR PROVIDING WORKING CAPITAL FINANCING TO SMALL BUSINESSES AND SMALL BUSINESS OWNERS (U.S. CLS. 100, 101 AND 102). RICHARD WHITE, EXAMINING ATTORNEY

CLASS 36—(Continued).

SN 77-319,385. CNBS FINANCIAL GROUP, INC., TAMPA, FL. FILED 11-1-2007.

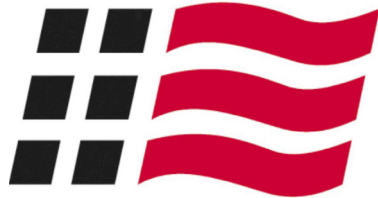

THE COLOR(S) BLACK AND RED IS/ARE CLAIMED AS A FEATURE OF THE MARK.

THE MARK CONSISTS OF TWO ROWS OF THREE BOXES IN BLACK ON THE LEFT OF THREE ROWS OF SLIGHTLY CURVED LINES IN RED.

FOR BANKING; SAVINGS BANK SERVICES; FINANCIAL SERVICES IN THE FIELD OF MONEY LENDING; LOAN FINANCING; TRUST SERVICES, NAMELY, INVESTMENT AND TRUST COMPANY SERVICES (U.S. CLS. 100, 101 AND 102).

SCOTT SISUN, EXAMINING ATTORNEY

CLASS 36—(Continued).

SN 77-321,270. THE GUARDIAN LIFE INSURANCE COMPANY OF AMERICA, NEW YORK, NY. FILED 11-5-2007.

GUARDIAN GUARANTEED INCOME
BENEFIT

THE MARK CONSISTS OF STANDARD CHARACTERS WITHOUT CLAIM TO ANY PARTICULAR FONT, STYLE, SIZE, OR COLOR.

OWNER OF U.S. REG. NOS. 1,641,537, 2,250,212 AND OTHERS.

NO CLAIM IS MADE TO THE EXCLUSIVE RIGHT TO USE "GUARANTEED INCOME BENEFIT", APART FROM THE MARK AS SHOWN.

FOR ANNUITY SERVICES, NAMELY, VARIABLE ANNUITY UNDERWRITING, ADMINISTRATION, BROKERAGE, INVESTMENT MANAGEMENT OF AND DISTRIBUTION OF VARIABLE ANNUITIES (U.S. CLS. 100, 101 AND 102).

SANJEEV VOHRA, EXAMINING ATTORNEY

SN 77-321,202. QPAY, INC., NORTH MIAMI BEACH, FL. FILED 11-5-2007.

QPAY THE RIGHT PARTNER

THE MARK CONSISTS OF STANDARD CHARACTERS WITHOUT CLAIM TO ANY PARTICULAR FONT, STYLE, SIZE, OR COLOR.

OWNER OF U.S. REG. NO. 2,957,746.

FOR PRE-PAID PURCHASE CARD SERVICES NAMELY, PROCESSING ELECTRONIC PAYMENTS MADE THROUGH PREPAID CARDS; BILL PAYMENT SERVICES; ELECTRONIC PAYMENT, NAMELY, ELECTRONIC PROCESSING AND TRANSMISSION OF BILL PAYMENT DATA (U.S. CLS. 100, 101 AND 102).

FIRST USE 8-1-2007; IN COMMERCE 8-1-2007.
CURTIS FRENCH, EXAMINING ATTORNEY

SN 77-322,428. BANK OF AMERICA CORPORATION, CHARLOTTE, NC. FILED 11-6-2007.

THE CREDIT YOU NEED, FROM
A BANK YOU TRUST

THE MARK CONSISTS OF STANDARD CHARACTERS WITHOUT CLAIM TO ANY PARTICULAR FONT, STYLE, SIZE, OR COLOR.

NO CLAIM IS MADE TO THE EXCLUSIVE RIGHT TO USE "CREDIT" AND "BANK", APART FROM THE MARK AS SHOWN.

FOR BANKING AND RELATED FINANCIAL SERVICES (U.S. CLS. 100, 101 AND 102).

JANET LEE, EXAMINING ATTORNEY

CLASS 36—(Continued).

SN 77-323,812. MPC PROPERTIES, LLC, JACKSON HEIGHTS, NY. FILED 11-7-2007.

MEET JACK HEIGHTS

THE MARK CONSISTS OF STANDARD CHARACTERS WITHOUT CLAIM TO ANY PARTICULAR FONT, STYLE, SIZE, OR COLOR.

THE NAME "JACK HEIGHTS" DOES NOT IDENTIFY A LIVING INDIVIDUAL.

FOR ASSESSMENT AND MANAGEMENT OF REAL ESTATE; FINANCIAL INVESTMENT IN THE FIELD OF REAL ESTATE; FINANCIAL VALUATION OF REAL ESTATE; LEASING OF REAL ESTATE; OPERATING MARKETPLACES FOR SELLERS OF GOODS AND/OR SERVICES IN CONNECTION WITH REAL ESTATE; PROVIDING INFORMATION IN THE FIELD OF REAL ESTATE BY MEANS OF LINKING THE WEB SITE TO OTHER WEB SITES FEATURING REAL ESTATE INFORMATION; REAL ESTATE ACQUISITION SERVICES; REAL ESTATE AGENCIES; REAL ESTATE BROKERAGE; REAL ESTATE CONSULTATION; REAL ESTATE EQUITY SHARING, NAMELY, MANAGING AND ARRANGING FOR CO-OWNERSHIP OF REAL ESTATE; REAL ESTATE INVESTMENT; REAL ESTATE LISTING; REAL ESTATE MANAGEMENT; REAL ESTATE MANAGEMENT CONSULTATION; REAL ESTATE PROCUREMENT FOR OTHERS; REAL ESTATE SYNDICATION; REAL ESTATE VALUATION SERVICES (U.S. CLS. 100, 101 AND 102).

GILBERT SWIFT, EXAMINING ATTORNEY

SN 77-323,872. MPC PROPERTIES, LLC, JACKSON HEIGHTS, NY. FILED 11-7-2007.

JACK HEIGHTS

THE MARK CONSISTS OF STANDARD CHARACTERS WITHOUT CLAIM TO ANY PARTICULAR FONT, STYLE, SIZE, OR COLOR.

THE NAME "JACK HEIGHTS" DOES NOT IDENTIFY A LIVING INDIVIDUAL.

FOR ASSESSMENT AND MANAGEMENT OF REAL ESTATE; FINANCIAL INVESTMENT IN THE FIELD OF REAL ESTATE; FINANCIAL VALUATION OF REAL ESTATE; LEASING OF REAL ESTATE; OPERATING MARKETPLACES FOR SELLERS OF GOODS AND/OR SERVICES IN CONNECTION WITH REAL ESTATE; PROVIDING INFORMATION IN THE FIELD OF REAL ESTATE BY MEANS OF LINKING THE WEB SITE TO OTHER WEB SITES FEATURING REAL ESTATE INFORMATION; REAL ESTATE ACQUISITION SERVICES; REAL ESTATE AGENCIES; REAL ESTATE BROKERAGE; REAL ESTATE CONSULTATION; REAL ESTATE EQUITY SHARING, NAMELY, MANAGING AND ARRANGING FOR CO-OWNERSHIP OF REAL ESTATE; REAL ESTATE INVESTMENT; REAL ESTATE LISTING; REAL ESTATE MANAGEMENT; REAL ESTATE MANAGEMENT CONSULTATION; REAL ESTATE PROCUREMENT FOR OTHERS; REAL ESTATE SYNDICATION; REAL ESTATE VALUATION SERVICES (U.S. CLS. 100, 101 AND 102).

GILBERT SWIFT, EXAMINING ATTORNEY

CLASS 36—(Continued).

SN 77-324,384. MPC PROPERTIES, LLC, JACKSON HEIGHTS, NY. FILED 11-8-2007.



THE MARK CONSISTS OF A STICK FIGURE OF A MAN COMPOSED OF THE LETTERS "J" AND "H," WEARING A TOP HAT.

FOR ASSESSMENT AND MANAGEMENT OF REAL ESTATE; FINANCIAL INVESTMENT IN THE FIELD OF REAL ESTATE; FINANCIAL VALUATION OF REAL ESTATE; LEASING OF REAL ESTATE; OPERATING MARKETPLACES FOR SELLERS OF GOODS AND/OR SERVICES IN CONNECTION WITH REAL ESTATE; PROVIDING INFORMATION IN THE FIELD OF REAL ESTATE BY MEANS OF LINKING THE WEB SITE TO OTHER WEB SITES FEATURING REAL ESTATE INFORMATION; REAL ESTATE ACQUISITION SERVICES; REAL ESTATE AGENCIES; REAL ESTATE BROKERAGE; REAL ESTATE CONSULTATION; REAL ESTATE EQUITY SHARING, NAMELY, MANAGING AND ARRANGING FOR CO-OWNERSHIP OF REAL ESTATE; REAL ESTATE INVESTMENT; REAL ESTATE LISTING; REAL ESTATE MANAGEMENT; REAL ESTATE MANAGEMENT CONSULTATION; REAL ESTATE PROCUREMENT FOR OTHERS; REAL ESTATE SYNDICATION; REAL ESTATE VALUATION SERVICES (U.S. CLS. 100, 101 AND 102).

GILBERT SWIFT, EXAMINING ATTORNEY

SN 77-324,956. CALIFORNIA STATE TEACHERS' RETIREMENT SYSTEM, SACRAMENTO, CA. FILED 11-8-2007.

PENSION TWO

THE MARK CONSISTS OF STANDARD CHARACTERS WITHOUT CLAIM TO ANY PARTICULAR FONT, STYLE, SIZE, OR COLOR.

NO CLAIM IS MADE TO THE EXCLUSIVE RIGHT TO USE "PENSION", APART FROM THE MARK AS SHOWN, FOR ADMINISTRATION OF EMPLOYEE PENSION PLANS (U.S. CLS. 100, 101 AND 102).

FIRST USE 8-29-2007; IN COMMERCE 8-29-2007.

MARILYN IZZI, EXAMINING ATTORNEY

CLASS 36—(Continued).

SN 77-325,440. GENZYME CORPORATION, CAMBRIDGE, MA. FILED 11-9-2007.

SYNVISC CONNECTION

THE MARK CONSISTS OF STANDARD CHARACTERS WITHOUT CLAIM TO ANY PARTICULAR FONT, STYLE, SIZE, OR COLOR.

OWNER OF U.S. REG. NO. 1,418,125.

NO CLAIM IS MADE TO THE EXCLUSIVE RIGHT TO USE "CONNECTION", APART FROM THE MARK AS SHOWN.

FOR PROVIDING A DATABASE FOR TRACKING, MONITORING, AND GENERATING REPORTS ON INFORMATION AND STATISTICS ABOUT PATIENT REIMBURSEMENT AND INSURANCE COVERAGE FOR PHARMACEUTICALS AND MEDICAL DEVICES (U.S. CLS. 100, 101 AND 102).

NAKIA HENRY, EXAMINING ATTORNEY

CLASS 36—(Continued).

SN 77-346,193. MONSTER CABLE PRODUCTS, INC., BRISBANE, CA. FILED 12-6-2007.



OWNER OF U.S. REG. NOS. 2,220,851, 2,728,729 AND OTHERS.

NO CLAIM IS MADE TO THE EXCLUSIVE RIGHT TO USE "PERFORMANCE GUARANTEED", APART FROM THE MARK AS SHOWN.

THE MARK CONSISTS OF THE LITERAL ELEMENT ON A STYLIZED DESIGN.

FOR WARRANTY SERVICES (U.S. CLS. 100, 101 AND 102).

JOHN WILKE, EXAMINING ATTORNEY

SN 77-340,527. EBAY INC., SAN JOSE, CA. FILED 11-29-2007.



THE COLOR(S) BLUE, ORANGE AND YELLOW IS/ARE CLAIMED AS A FEATURE OF THE MARK.

THE MARK CONSISTS OF A RIBBON MADE UP OF INTERSECTING BLUE AND YELLOW STRANDS. THE INTERSECTING SECTION OF THE TWO STRANDS IS ORANGE.

FOR CHARITABLE FUNDRAISING SERVICES (U.S. CLS. 100, 101 AND 102).

FIRST USE 11-1-2003; IN COMMERCE 11-1-2003.

LINDA MICKLEBURGH, EXAMINING ATTORNEY

SN 77-346,213. MONSTER CABLE PRODUCTS, INC., BRISBANE, CA. FILED 12-6-2007.



NO CLAIM IS MADE TO THE EXCLUSIVE RIGHT TO USE "FULL LIFETIME WARRANTY", APART FROM THE MARK AS SHOWN.

THE MARK CONSISTS OF THE LITERAL ELEMENT ON A STYLIZED DESIGN.

FOR WARRANTY SERVICES (U.S. CLS. 100, 101 AND 102).

JOHN WILKE, EXAMINING ATTORNEY

CLASS 36—(Continued).

SN 77-346,552. KEYCORP, CLEVELAND, OH. FILED 12-7-2007.

ACHIEVERLOAN DIRECT

THE MARK CONSISTS OF STANDARD CHARACTERS WITHOUT CLAIM TO ANY PARTICULAR FONT, STYLE, SIZE, OR COLOR.

OWNER OF U.S. REG. NOS. 1,916,786, 2,142,784 AND OTHERS.

FOR BANKING SERVICES, NAMELY, EDUCATIONAL LENDING SERVICES (U.S. CLS. 100, 101 AND 102).

ANTHONY RINKER, EXAMINING ATTORNEY

CLASS 36—(Continued).

SN 78-468,075. TSP PILOT, LLC, GERMANTOWN, MD. FILED 8-16-2004.

TSP Pilot

THE MARK CONSISTS OF STANDARD CHARACTERS WITHOUT CLAIM TO ANY PARTICULAR FONT, STYLE, SIZE, OR COLOR.

NO CLAIM IS MADE TO THE EXCLUSIVE RIGHT TO USE "TSP", APART FROM THE MARK AS SHOWN.

FOR MUTUAL FUND TIMING SERVICES FOR UNITED STATES FEDERAL THRIFT SAVINGS PLAN ACCOUNT HOLDERS (U.S. CLS. 100, 101 AND 102).

WARREN L. OLANDRIA, EXAMINING ATTORNEY

SN 78-395,741. WALTON INTERNATIONAL GROUP INC., CALGARY, CANADA, FILED 4-2-2004.



Walton
International Group Inc.

PRIORITY CLAIMED UNDER SEC. 44(D) ON CANADA APPLICATION NO. 1,193,581, FILED 10-3-2003, REG. NO. TMA679,982, DATED 1-22-2007, EXPIRES 1-22-2022.

NO CLAIM IS MADE TO THE EXCLUSIVE RIGHT TO USE "INTERNATIONAL GROUP INC.", APART FROM THE MARK AS SHOWN.

FOR REAL ESTATE INVESTMENT SERVICES; PROPERTY MANAGEMENT SERVICES, NAMELY, BUILDING AND REAL ESTATE MANAGEMENT; CONSULTING SERVICES IN THE AREA OF REAL ESTATE; MORTGAGE INVESTMENT SERVICES, NAMELY, MORTGAGE LENDING SERVICES (U.S. CLS. 100, 101 AND 102).

MARLENE BELL, EXAMINING ATTORNEY

SN 78-516,349. BRIDGER MANAGEMENT, LLC, NEW YORK, NY. FILED 11-12-2004.

BRIDGER CAPITAL

SN 78-417,517. ISURITY, INC., HIGH POINT, NC. FILED 5-12-2004.

ISURITY SPECIAL RISK

THE MARK CONSISTS OF STANDARD CHARACTERS WITHOUT CLAIM TO ANY PARTICULAR FONT, STYLE, SIZE, OR COLOR.

NO CLAIM IS MADE TO THE EXCLUSIVE RIGHT TO USE "SPECIAL RISK", APART FROM THE MARK AS SHOWN.

FOR INSURANCE UNDERWRITING, CLAIMS PROCESSING AND BROKERAGE SERVICES (U.S. CLS. 100, 101 AND 102).

FIRST USE 1-0-2004; IN COMMERCE 1-0-2004.
MARGERY A. TIERNEY, EXAMINING ATTORNEY

THE MARK CONSISTS OF STANDARD CHARACTERS WITHOUT CLAIM TO ANY PARTICULAR FONT, STYLE, SIZE, OR COLOR.

NO CLAIM IS MADE TO THE EXCLUSIVE RIGHT TO USE "CAPITAL", APART FROM THE MARK AS SHOWN.

FOR HEDGE FUND SERVICES OFFERED TO QUALIFIED HIGH-NET-WORTH INDIVIDUALS AND ENTITIES (U.S. CLS. 100, 101 AND 102).

FIRST USE 6-0-2000; IN COMMERCE 6-0-2000.
H. M. FISHER, EXAMINING ATTORNEY

CLASS 36—(Continued).

SN 78-628,605. PACIFIC ALTERNATIVE ASSET MANAGEMENT COMPANY LLC, IRVINE, CA. FILED 5-12-2005.

PAAMCO

THE MARK CONSISTS OF STANDARD CHARACTERS WITHOUT CLAIM TO ANY PARTICULAR FONT, STYLE, SIZE, OR COLOR.

FOR HEDGE FUND INVESTMENT (U.S. CLS. 100, 101 AND 102).

FIRST USE 3-8-2000; IN COMMERCE 3-8-2000.

ARETHA SOMERVILLE, EXAMINING ATTORNEY

SN 78-667,222. DEUTSCHE TELEKOM AG, BONN, FED REP GERMANY, FILED 7-11-2005.



OWNER OF FED REP GERMANY REG. NO. 39722098, DATED 8-6-1997, EXPIRES 5-31-2017.

OWNER OF U.S. REG. NOS. 2,436,053, 2,975,719 AND OTHERS.

NO CLAIM IS MADE TO THE EXCLUSIVE RIGHT TO USE "DEUTSCHE TELEKOM", APART FROM THE MARK AS SHOWN.

THE COLOR(S) MAGENTA AND GREY IS/ARE CLAIMED AS A FEATURE OF THE MARK.

THE COLOR GREY APPEARS IN THE FOUR SMALL SQUARES AND IN THE LANGUAGE "DEUTSCHE TELEKOM" AND THE COLOR MAGENTA APPEARS IN THE LETTER "T".

THE FOREIGN WORDING IN THE MARK TRANSLATES INTO ENGLISH AS "GERMAN TELECOM".

FOR INSURANCE SERVICES, NAMELY, INSURANCE BROKERAGE, INSURANCE CLAIMS PROCESSING; FINANCIAL SERVICES, NAMELY, CLEARING OF SECURE FINANCIAL TRANSACTIONS THROUGH ONLINE SERVICES; FINANCIAL ANALYSIS AND CONSULTATION; FINANCIAL INFORMATION PROVIDED BY ELECTRONIC MEANS; FINANCIAL INFORMATION PROCESSING; FINANCIAL PORTFOLIO MANAGEMENT; FINANCIAL SERVICES, NAMELY, FINANCIAL CONSULTATION IN THE FIELD OF FINANCIAL SECURITIES; SAFE DEPOSIT BOX SERVICES FOR THE SAFEKEEPING OF SECURITIES; FINANCIAL SPONSORSHIP OF SPORTS, EDUCATIONAL AND ENTERTAINMENT PROGRAMS AND EVENTS; COMMERCIAL LENDING SERVICES; MONETARY EXCHANGE; CREDIT CARD SERVICES; TELEPHONE CALLING CARD SERVICES; ELECTRONIC COMMERCE SERVICES, NAMELY, ELECTRONIC DEBIT AND CREDIT CARD TRANSACTION PROCESSING SERVICES, FUNDS

CLASS 36—(Continued).

TRANSFER AND BILL PAYMENT-PROCESSING SERVICES; DISCOUNT BROKERAGE SERVICES; SECURITY BROKERAGE; BROKERAGE IN THE FIELD OF INSURANCE, STOCKS, COMMODITIES; CUSTOM BROKERAGE FOR THIRD PARTIES IN THE FIELD OF INSURANCE, STOCKS, COMMODITIES; BROKERAGE OF SHARES AND VENTURE CAPITAL FUNDING SERVICES TO START-UP COMPANIES; BROKERAGE OF FUND SHARES; BROKERAGE OF PRODUCTIVE INVESTMENT OF FUNDS; REAL ESTATE SERVICES, NAMELY, BROKERAGE, MANAGEMENT, LEASING, AND APPRAISAL OF REAL PROPERTY; CONSULTING SERVICES RELATING TO INSURANCE SERVICES, NAMELY, PROVIDING INFORMATION AND BROKERAGE OF INSURANCES IN THE FIELD OF HOME INSURANCE, ACCIDENT INSURANCE AND HEALTH INSURANCE; CONSULTING SERVICES RELATING TO BANK SERVICES; PROVIDING INFORMATION VIA THE TELEPHONE AND THE GLOBAL COMMUNICATION NETWORKS IN THE FIELD OF FINANCE (U.S. CLS. 100, 101 AND 102).

JAMES GRIFFIN, EXAMINING ATTORNEY

SN 78-748,266. AMERICAN COMMERCE INSURANCE COMPANY, COLUMBUS, OH. FILED 11-7-2005.

GEAR

THE MARK CONSISTS OF STANDARD CHARACTERS WITHOUT CLAIM TO ANY PARTICULAR FONT, STYLE, SIZE, OR COLOR.

FOR INSURANCE SERVICES, NAMELY, A FIVE-TIER PASSENGER AUTOMOBILE INSURANCE PROGRAM (U.S. CLS. 100, 101 AND 102).

WILLIAM ROSSMAN, EXAMINING ATTORNEY

SN 78-839,742. AFRICAN MEDICAL & RESEARCH FOUNDATION, INC., NEW YORK, NY. FILED 3-17-2006.

FLYING DOCTORS

THE MARK CONSISTS OF STANDARD CHARACTERS WITHOUT CLAIM TO ANY PARTICULAR FONT, STYLE, SIZE, OR COLOR.

FOR CHARITABLE FUNDRAISING SERVICES RELATING TO INTERNATIONAL HUMANITARIAN ACTIVITIES (U.S. CLS. 100, 101 AND 102).

FIRST USE 6-1-1957; IN COMMERCE 6-1-1957.

NORA BUCHANAN WILL, EXAMINING ATTORNEY

CLASS 36—(Continued).

SN 78-846,278. BEEMAN, RANDY, RESTON, VA. FILED 3-26-2006.

Wise Investor Group

THE MARK CONSISTS OF STANDARD CHARACTERS WITHOUT CLAIM TO ANY PARTICULAR FONT, STYLE, SIZE, OR COLOR.

NO CLAIM IS MADE TO THE EXCLUSIVE RIGHT TO USE "INVESTOR GROUP", APART FROM THE MARK AS SHOWN.

FOR INVESTMENT MANAGEMENT (U.S. CLS. 100, 101 AND 102).
SKYE YOUNG, EXAMINING ATTORNEY

SN 78-877,795. 1ST GLOBAL, INC., DALLAS, TX. FILED 5-5-2006.



OWNER OF U.S. REG. NO. 2,383,138.
NO CLAIM IS MADE TO THE EXCLUSIVE RIGHT TO USE "GLOBAL", APART FROM THE MARK AS SHOWN.

FOR PERSONAL FINANCIAL PLANNING AND IMPLEMENTATION OF PERSONAL FINANCIAL TRANSACTIONS AND CORPORATE FINANCIAL TRANSACTIONS, NAMELY, INVESTMENTS IN MUTUAL FUNDS, STOCK, BONDS, LIMITED PARTNERSHIPS, ANNUITIES, AND INSURANCE (U.S. CLS. 100, 101 AND 102).

FIRST USE 0-0-2002; IN COMMERCE 0-0-2002.
SIMON TENG, EXAMINING ATTORNEY

SN 78-897,266. UNICORN FINANCIAL SERVICES INC., TALLAHASSEE, FL. FILED 5-31-2006.

Unicorn Online

THE MARK CONSISTS OF STANDARD CHARACTERS WITHOUT CLAIM TO ANY PARTICULAR FONT, STYLE, SIZE, OR COLOR.

OWNER OF U.S. REG. NOS. 2,273,731, 2,329,720 AND 2,355,722.

NO CLAIM IS MADE TO THE EXCLUSIVE RIGHT TO USE "ONLINE", APART FROM THE MARK AS SHOWN.

FOR CONSUMER FINANCING SERVICES, NAMELY, FACILITATING, ARRANGING AND PROVIDING FINANCING FOR MEDICAL AND DENTAL SERVICES (U.S. CLS. 100, 101 AND 102).

FIRST USE 2-15-2003; IN COMMERCE 2-15-2003.
DOMINIC FATHY, EXAMINING ATTORNEY

CLASS 36—(Continued).

SN 78-904,953. AMERICAN NOTE BUYERS, INC., WAYNE, PA. FILED 6-9-2006.



NO CLAIM IS MADE TO THE EXCLUSIVE RIGHT TO USE "AMERICA'S NOTE BUYER", APART FROM THE MARK AS SHOWN.

FOR FINANCIAL SERVICES, NAMELY, PURCHASING OF DEFERRED STREAMS OF PAYMENT, IN THE NATURE OF STRUCTURED SETTLEMENTS, MORTGAGE NOTES, LOTTERY ADVANCES, INHERITANCES, MORTGAGES AND MUNICIPAL CLAIMS (U.S. CLS. 100, 101 AND 102).

LOURDES AYALA, EXAMINING ATTORNEY

SN 78-907,173. STONEBRIDGE FINANCIAL CORP., WEST CHESTER, PA. FILED 6-13-2006.

STONEBRIDGE BANK

THE MARK CONSISTS OF STANDARD CHARACTERS WITHOUT CLAIM TO ANY PARTICULAR FONT, STYLE, SIZE, OR COLOR.

NO CLAIM IS MADE TO THE EXCLUSIVE RIGHT TO USE "BANK", APART FROM THE MARK AS SHOWN.

FOR BANKING AND FINANCIAL SERVICES, NAMELY, BANKING AND CREDIT, NAMELY, CREDIT CARD SERVICES, DEBITING STORED VALUE CARD AND ELECTRONIC TRANSACTION SERVICES, NAMELY, ELECTRONIC CREDIT AND DEBIT TRANSACTIONS; FINANCIAL INFORMATION PROVIDED BY ELECTRONIC MEANS; BROKERAGE SERVICES IN THE FIELDS OF INVESTMENTS, MORTGAGES, MUTUAL FUNDS, SECURITIES AND STOCKS; INVESTMENT ADVICE AND CONSULTATION; FUNDS INVESTMENT; MUTUAL FUNDS INVESTMENT; PERSONAL FINANCIAL MANAGEMENT AND PLANNING; LOAN FINANCING AND FINANCING SERVICES; CASH MANAGEMENT; AND CURRENCY EXCHANGE AND ADVICE, ALL ACCOMPLISHED IN FACE-TO-FACE TRANSACTIONS AND VIA THE GLOBAL COMPUTER INFORMATION NETWORK (U.S. CLS. 100, 101 AND 102).

FIRST USE 2-29-2000; IN COMMERCE 2-29-2000.
LYDIA BELZER, EXAMINING ATTORNEY

CLASS 36—(Continued).

SN 78-907,621. BANK OF AMERICA CORPORATION, CHARLOTTE, NC. FILED 6-14-2006.

CLASSICTRANCHE

THE MARK CONSISTS OF STANDARD CHARACTERS WITHOUT CLAIM TO ANY PARTICULAR FONT, STYLE, SIZE, OR COLOR.

FOR BANKING AND RELATED FINANCIAL SERVICES, NAMELY, BROKERAGE OF FINANCIAL INVESTMENT PRODUCTS IN THE NATURE OF AN INVESTMENT SECURITY (U.S. CLS. 100, 101 AND 102).
JULIE WATSON, EXAMINING ATTORNEY

SN 78-919,393. FIRST TEAM REAL ESTATE - ORANGE COUNTY, COSTA MESA, CA. FILED 6-28-2006.

TEAM ONE

THE MARK CONSISTS OF STANDARD CHARACTERS WITHOUT CLAIM TO ANY PARTICULAR FONT, STYLE, SIZE, OR COLOR.

FOR REAL ESTATE BROKERAGE SERVICES AND REAL ESTATE LISTINGS ALL ALSO OFFERED ONLINE (U.S. CLS. 100, 101 AND 102).
SUE LAWRENCE, EXAMINING ATTORNEY

SN 78-931,685. BIDS HOLDINGS L.P., NEW YORK, NY. FILED 7-18-2006.

BLOCK INTEREST DISCOVERY SERVICE

THE MARK CONSISTS OF STANDARD CHARACTERS WITHOUT CLAIM TO ANY PARTICULAR FONT, STYLE, SIZE, OR COLOR.

NO CLAIM IS MADE TO THE EXCLUSIVE RIGHT TO USE "BLOCK INTEREST" AND "SERVICE", APART FROM THE MARK AS SHOWN.

FOR FINANCIAL SERVICES, NAMELY, PROVIDING A STOCK TRADING SYSTEM FOR TRADING LARGE BLOCKS OF STOCK (U.S. CLS. 100, 101 AND 102).
ANDREA HACK, EXAMINING ATTORNEY

CLASS 36—(Continued).

SN 78-944,141. INNISFREE LIMITED, LONDON, ENGLAND, FILED 8-3-2006.

INNISFREE

THE MARK CONSISTS OF STANDARD CHARACTERS WITHOUT CLAIM TO ANY PARTICULAR FONT, STYLE, SIZE, OR COLOR.

FOR PROJECT FINANCING IN THE FIELDS OF PRIVATE FINANCE PROJECTS AND PUBLIC-PRIVATE PARTNERSHIPS; INVESTMENT OF FUNDS FOR OTHERS IN THE FIELDS OF PRIVATE FINANCE PROJECTS AND PROJECT FINANCE (U.S. CLS. 100, 101 AND 102).

CHARLOTTE CORWIN, EXAMINING ATTORNEY

SN 78-972,595. CLARK, DOUGLAS R, PONTE VEDRA BEACH, FL. FILED 9-12-2006.

Top Sell Real Estate

THE MARK CONSISTS OF STANDARD CHARACTERS WITHOUT CLAIM TO ANY PARTICULAR FONT, STYLE, SIZE, OR COLOR.

NO CLAIM IS MADE TO THE EXCLUSIVE RIGHT TO USE "SELL" OR "REAL ESTATE", APART FROM THE MARK AS SHOWN.

FOR REAL ESTATE MARKETING SERVICES IN THE FIELD OF HOMES (U.S. CLS. 100, 101 AND 102).

FIRST USE 1-1-2006; IN COMMERCE 1-1-2006.

BONNIE LUKEN, EXAMINING ATTORNEY

SN 79-028,075. HELVETIA SCHWEIZERISCHE; VERSICHERUNGSGESELLSCHAFT, SWITZERLAND, FILED 7-13-2006.

helvetia 

PRIORITY DATE OF 4-26-2006 IS CLAIMED.

OWNER OF INTERNATIONAL REGISTRATION 0896408 DATED 7-13-2006, EXPIRES 7-13-2016.

THE COLOR(S) BLACK, RED, PURPLE AND TURQUOISE IS/ARE CLAIMED AS A FEATURE OF THE MARK. THE COLOR BLACK APPEARS IN THE WORD "HELVETIA". THE COLOR RED APPEARS IN THE RIGHT SIDE OF THE TRIANGLE. THE COLOR PURPLE APPEARS ON THE LEFT SIDE OF THE TRIANGLE. THE COLOR TURQUOISE APPEARS ON THE BOTTOM PART OF THE TRIANGLE.

FOR INSURANCE UNDERWRITING IN THE FIELD OF HEALTH, ACCIDENT, FIRE; FINANCIAL SERVICES, NAMELY, REAL ESTATE FINANCING; REAL ESTATE BROKERAGE; FINANCIAL EVALUATION FOR INSURANCE PURPOSES (U.S. CLS. 100, 101 AND 102).

CHARLES L. JENKINS, EXAMINING ATTORNEY

CLASS 36—(Continued).

SN 79-039,172. GRUPPO BANCA LEONARDO S.P.A., ITALY, FILED 4-3-2007.



PRIORITY DATE OF 1-22-2007 IS CLAIMED.
OWNER OF INTERNATIONAL REGISTRATION 0925881 DATED 4-3-2007, EXPIRES 4-3-2017.

THE COLOR(S) BLACK AND YELLOW IS/ARE CLAIMED AS A FEATURE OF THE MARK.

THE MARK CONSISTS OF THE INITIALS GBL, IN SPECIAL SCRIPT; BEFORE THE INITIALS IS A SQUARE IMPRINT OVERLAPPING A ROUND IMPRINT. THE COLOR BLACK APPEARS IN THE INITIALS "GBL," AND THE COLOR YELLOW APPEARS IN THE DESIGN OF A SQUARE IMPRINT OVERLAPPING THE ROUND IMPRINT.

FOR BANKING SERVICES; FINANCING SERVICES; CAPITAL INVESTMENT CONSULTATION; CREDIT AND FINANCIAL CONSULTATION; FINANCIAL ANALYSIS AND CONSULTATION; ON-LINE BANKING SERVICES; PROVIDING FINANCIAL CONSULTATION AND INFORMATION; ISSUING CREDIT AND DEBIT CARDS (U.S. CLS. 100, 101 AND 102).

CARRIE GENOVESE, EXAMINING ATTORNEY

CLASS 36—(Continued).

SN 79-039,174. GRUPPO BANCA LEONARDO S.P.A., ITALY, FILED 4-3-2007.



PRIORITY DATE OF 1-22-2007 IS CLAIMED.
OWNER OF INTERNATIONAL REGISTRATION 0925883 DATED 4-3-2007, EXPIRES 4-3-2017.

NO CLAIM IS MADE TO THE EXCLUSIVE RIGHT TO USE "GRUPPO BANCA", APART FROM THE MARK AS SHOWN.

THE COLOR(S) BLACK AND YELLOW IS/ARE CLAIMED AS A FEATURE OF THE MARK.

THE MARK CONSISTS OF THE WORDS GRUPPO BANCA LEONARDO, IN SPECIAL SCRIPT; BEFORE THE SCRIPT IS A SQUARE IMPRINT OVERLAPPING A ROUND IMPRINT. THE COLOR BLACK APPEARS IN THE WORDING "GRUPPO BANCA LEONARDO," AND THE COLOR YELLOW APPEARS IN THE DESIGN OF A SQUARE IMPRINT OVERLAPPING A ROUND IMPRINT.

THE ENGLISH TRANSLATION OF THE WORDING "GRUPPO BANCA" IS "BANK GROUP".

FOR BANKING SERVICES; FINANCING SERVICES; CAPITAL INVESTMENT CONSULTATION; CREDIT AND FINANCIAL CONSULTATION; FINANCIAL ANALYSIS AND CONSULTATION; ON-LINE BANKING SERVICES; PROVIDING FINANCIAL CONSULTATION AND INFORMATION; ISSUING CREDIT AND DEBIT CARDS (U.S. CLS. 100, 101 AND 102).

CARRIE GENOVESE, EXAMINING ATTORNEY

SN 79-039,173. GRUPPO BANCA LEONARDO S.P.A., ITALY, FILED 4-3-2007.



PRIORITY DATE OF 1-22-2007 IS CLAIMED.
OWNER OF INTERNATIONAL REGISTRATION 0925882 DATED 4-3-2007, EXPIRES 4-3-2017.

THE COLOR(S) BLACK AND YELLOW IS/ARE CLAIMED AS A FEATURE OF THE MARK.

THE MARK CONSISTS OF THE INITIALS G.B.L., IN SPECIAL SCRIPT, EACH LETTER FOLLOWED BY A FULL STOP; BEFORE THE INITIALS IS A SQUARE IMPRINT OVERLAPPING A ROUND IMPRINT. THE COLOR BLACK APPEARS IN THE INITIALS "G.B.L.," AND THE COLOR YELLOW APPEARS IN THE DESIGN OF A SQUARE IMPRINT OVERLAPPING A ROUND IMPRINT.

FOR BANKING SERVICES; FINANCING SERVICES; CAPITAL INVESTMENT CONSULTATION; CREDIT AND FINANCIAL CONSULTATION; FINANCIAL ANALYSIS AND CONSULTATION; ON-LINE BANKING SERVICES; PROVIDING FINANCIAL CONSULTATION AND INFORMATION; ISSUING CREDIT AND DEBIT CARDS (U.S. CLS. 100, 101 AND 102).

CARRIE GENOVESE, EXAMINING ATTORNEY

SN 79-041,613. CEVIAN CAPITAL LTD, UNITED KINGDOM, FILED 6-25-2007.



OWNER OF INTERNATIONAL REGISTRATION 0932102 DATED 6-25-2007, EXPIRES 6-25-2017.

THE MARK CONSISTS OF A SHADED TRIANGLE BISECTED BY A VERTICAL LINE AND ALSO BY TWO INTERSECTING DIAGONAL LINES.

FOR FINANCIAL AFFAIRS, NAMELY, MANAGEMENT OF CAPITAL INVESTMENT FUNDS (U.S. CLS. 100, 101 AND 102).

TOBY BULLOFF, EXAMINING ATTORNEY

CLASS 37—CONSTRUCTION AND REPAIR

SN 76-273,471. VANTAGE FABRICATION, LLC, BIRMINGHAM, AL. FILED 6-19-2001.

VANTAGE FABRICATION

NO CLAIM IS MADE TO THE EXCLUSIVE RIGHT TO USE "FABRICATION", APART FROM THE MARK AS SHOWN.

FOR INSTALLATION AND ERECTION OF STRUCTURAL METAL FABRICATION PRODUCTS, NAMELY, STRUCTURAL STEEL BEAMS, GIRDERS, TRUSSES, BRACING, COLUMNS, CLIP ANGLES, AND CONNECTION AND BASE PLATES; METAL FABRICATION PRODUCTS, NAMELY, INDUSTRIAL WATER TREATMENT SYSTEMS, TANKS, CLARIFIERS, BAFFLES, AGGLOMERATORS, WEIRS, INDUSTRIAL WASHERS, AND SUPPORT PLATFORMS; PLATE METAL FABRICATION PRODUCTS, NAMELY, DUCT, AIR POLLUTION CONTROL EQUIPMENT, PRECIPITATORS, BAGHOUSES, SCRUBBERS, SELECTIVE CATALYTIC REDUCTION SYSTEMS, AGGREGATE HANDLING AND MOVING SYSTEMS, COAL BUNKERS, HOPPERS, BINS, TANKS, AND OTHER PLATE STRUCTURES USED IN INDUSTRIAL AND UTILITY APPLICATIONS; AND MISCELLANEOUS METAL FABRICATION PRODUCTS, NAMELY, HANDRAILS, STAIR STRINGERS, GRATING, TREADS, ORNAMENTAL AND ARCHITECTURAL TRIM PIECES, STOVE HOODS, METAL TABLES AND OTHER CUSTOM METAL FABRICATIONS (U.S. CLS. 100, 103 AND 106).

PAULA MAHONEY, EXAMINING ATTORNEY

SN 76-594,023. TEXAS AIR COMPOSITES, INC., CEDAR HILL, TX. FILED 5-24-2004.

**Texas Air Composites**

NO CLAIM IS MADE TO THE EXCLUSIVE RIGHT TO USE "TEXAS AIR", APART FROM THE MARK AS SHOWN.

FOR REPAIR OF COMMERCIAL AND REGIONAL AIRCRAFTS, NAMELY, REPAIR OF AIRPLANE PRIMARY AND SECONDARY CONTROL PANEL SURFACES AND THEIR COMPONENTS AND GENERAL AIRPLANE STRUCTURES (U.S. CLS. 100, 103 AND 106).

FIRST USE 1-0-2000; IN COMMERCE 1-0-2000.

BRENDAN MCCAULEY, EXAMINING ATTORNEY

CLASS 37—(Continued).

SN 76-664,774. PUTNAM, SAMUEL W., WEST MONROE, LA. FILED 8-18-2006.

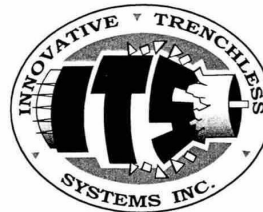
**ACCU-BORE**

NO CLAIM IS MADE TO THE EXCLUSIVE RIGHT TO USE "TRENCHLESS" AND "SYSTEMS INC.", APART FROM THE MARK AS SHOWN.

FOR PIPELINE INSTALLATION AND REPAIR, LAYING AND CONSTRUCTION OF PIPELINES THROUGH THE USE OF A PIPE-PULLING APPARATUS (U.S. CLS. 100, 103 AND 106).

KAREN K. BUSH, EXAMINING ATTORNEY

SN 76-671,857. WEGAT ENTERPRISES INC., DBA NOR CAL PERFORMANCE, SACRAMENTO, CA. FILED 1-26-2007.



NO CLAIM IS MADE TO THE EXCLUSIVE RIGHT TO USE "NOR CAL" OR "PERFORMANCE", APART FROM THE MARK AS SHOWN.

FOR REPAIR AND MAINTENANCE OF VEHICLES (U.S. CLS. 100, 103 AND 106).

FIRST USE 3-1-2004; IN COMMERCE 3-1-2004.

JAMES A. RAUEN, EXAMINING ATTORNEY

SN 77-061,603. MERCURY SOLAR SYSTEMS, LLC, NEW ROCHELLE, NY. FILED 12-11-2006.

Mercury Solar Systems

THE MARK CONSISTS OF STANDARD CHARACTERS WITHOUT CLAIM TO ANY PARTICULAR FONT, STYLE, SIZE, OR COLOR.

NO CLAIM IS MADE TO THE EXCLUSIVE RIGHT TO USE "SOLAR SYSTEMS", APART FROM THE MARK AS SHOWN.

FOR INSTALLATION, MAINTENANCE AND REPAIR OF PHOTOVOLTAIC/SOLAR ELECTRIC SYSTEMS (U.S. CLS. 100, 103 AND 106).

FIRST USE 9-22-2006; IN COMMERCE 9-22-2006.

REBECCA SMITH, EXAMINING ATTORNEY

CLASS 37—(Continued).

SN 77-116,940. A. LEECHMAN HEATING & COOLING, INC.,
DES MOINES, IA. FILED 2-27-2007.

SERVICE LEGENDS

THE MARK CONSISTS OF STANDARD CHARACTERS WITHOUT CLAIM TO ANY PARTICULAR FONT, STYLE, SIZE, OR COLOR.

NO CLAIM IS MADE TO THE EXCLUSIVE RIGHT TO USE "SERVICE", APART FROM THE MARK AS SHOWN.

FOR HEATING AND AIR CONDITIONING CONTRACTOR SERVICES, INCLUDING INSTALLATION, REPAIR, AND MAINTENANCE SERVICES; PLUMBING CONTRACTOR SERVICES, INCLUDING INSTALLATION, REPAIR, AND MAINTENANCE SERVICES; ELECTRICAL CONTRACTOR SERVICES, INCLUDING INSTALLATION, REPAIR, AND MAINTENANCE SERVICES (U.S. CLS. 100, 103 AND 106).

MARK SPARACINO, EXAMINING ATTORNEY

CLASS 37—(Continued).

SN 77-131,162. J.E. DUNN CONSTRUCTION GROUP, INC.,
KANSAS CITY, MO. FILED 3-14-2007.



THE MARK CONSISTS OF BLACK AND WHITE TRAFFIC SIGN.

FOR BUILDING CONSTRUCTION SERVICES (U.S. CLS. 100, 103 AND 106).

JORDAN BAKER, EXAMINING ATTORNEY

SN 77-131,891. FRIENDLY ELECTRIC LLC, EAST BRUNSWICK, NJ. FILED 3-15-2007.



NO CLAIM IS MADE TO THE EXCLUSIVE RIGHT TO USE "ELECTRIC" AND "ELECTRICIAN", APART FROM THE MARK AS SHOWN.

THE COLOR(S) DARK BLUE, LIGHT BLUE, YELLOW, WHITE, GRAY AND BLACK IS/ARE CLAIMED AS A FEATURE OF THE MARK.

THE MARK CONSISTS OF THE COLOR DARK BLUE APPEARS IN THE WORDING "FRIENDLY ELECTRIC". THE WORDS "YOUR NEIGHBORHOOD ELECTRICIAN" ARE BLACK. THE COLOR DARK BLUE IS A SWIRL IN THE DESIGN BELOW THE WORDING "FRIENDLY ELECTRIC". THE COLOR YELLOW APPEARS IN THE BODY OF THE LIGHTBULB CHARACTER AND THE COLOR BLACK IS OUTLINING THE BODY OF THE LIGHTBULB CHARACTER. THE LIGHTBULB CHARACTER IS WEARING A LIGHT BLUE CAP WITH A WHITE VISOR. THE LIGHTBULB CHARACTER HAS LIGHT BLUE EYES ON WHITE WITH BLACK PUPILS, BLACK ARMS WITH GRAY GLOVED HANDS, AND A BLACK SWIRL FOR THE SOCKET.

FOR ELECTRICAL CONTRACTING SERVICES; REPAIR, MAINTENANCE, AND INSTALLATION OF ELECTRICAL DEVICES (U.S. CLS. 100, 103 AND 106).

FIRST USE 10-15-2004; IN COMMERCE 10-15-2004.

G. MAYERSCHOFF, EXAMINING ATTORNEY

SN 77-123,395. STAIRGODDESS, LLC, APPLETON, WI.
FILED 3-6-2007.

STAIRGODDESS

THE MARK CONSISTS OF STANDARD CHARACTERS WITHOUT CLAIM TO ANY PARTICULAR FONT, STYLE, SIZE, OR COLOR.

FOR CONSTRUCTION SERVICES, NAMELY, CUSTOM CONSTRUCTION, INSTALLATION, AND REPAIR OF STAIRCASES AND STAIRCASE PARTS (U.S. CLS. 100, 103 AND 106).

FIRST USE 5-15-2001; IN COMMERCE 6-1-2001.

C. DIONNE CLYBURN, EXAMINING ATTORNEY

CLASS 37—(Continued).

SN 77-132,685. J.E. DUNN CONSTRUCTION GROUP, INC., KANSAS CITY, MO. FILED 3-16-2007.

THE ONLY THINGS WE BUILD
BETTER THAN OUR BUILDINGS
ARE OUR RELATIONSHIPS

THE MARK CONSISTS OF STANDARD CHARACTERS WITHOUT CLAIM TO ANY PARTICULAR FONT, STYLE, SIZE, OR COLOR.

FOR BUILDING CONSTRUCTION SERVICES (U.S. CLS. 100, 103 AND 106).

FIRST USE 12-31-1992; IN COMMERCE 12-31-1992.
JORDAN BAKER, EXAMINING ATTORNEY

SN 77-142,922. J.E. DUNN CONSTRUCTION GROUP, INC., KANSAS CITY, MO. FILED 3-28-2007.



OWNER OF U.S. REG. NOS. 2,600,439 AND 2,721,997.
THE MARK CONSISTS OF THE WORDING "DUNN RIGHT" WITH LARGE CHECK MARK.

FOR BUILDING CONSTRUCTION SERVICES (U.S. CLS. 100, 103 AND 106).

JORDAN BAKER, EXAMINING ATTORNEY

SN 77-143,862. R&M RESTORATION & MAINTENANCE, LLC, ROCKVILLE, MD. FILED 3-29-2007.



THE MARK CONSISTS OF THE LETTERS "RM" IN A GRAY SQUARE.

FOR WOOD REFURBISHING; METAL REFINISHING; STONE MAINTENANCE AND RESTORATION; MAINTENANCE AND RESTORATION OF HARD FLOORING; GARAGE AND PARKING LOT CLEANING (U.S. CLS. 100, 103 AND 106).

FIRST USE 5-0-2002; IN COMMERCE 5-0-2002.
JOHN WILKE, EXAMINING ATTORNEY

CLASS 37—(Continued).

SN 77-157,506. INNOVEI INTERNATIONAL LP, EL PASO, TX. FILED 4-16-2007.



THE COLOR(S) RED, BLACK, GRAY AND WHITE IS/ ARE CLAIMED AS A FEATURE OF THE MARK.

A DESIGN OF A RED CHERRY WITH WHITE SHADING IN THE MIDDLE AND TWO GRAY SPHERE OVALS SURROUNDING THE CHERRY, APPEARS BEFORE THE WORDING "CHERRYFUSION". THE WORD "CHERRY" APPEARS IN RED AND THE WORD "FUSION" APPEARS IN BLACK.

FOR MAINTENANCE AND REPAIR OF CONSUMER ELECTRONICS (U.S. CLS. 100, 103 AND 106).

JESSICA FATHY, EXAMINING ATTORNEY

SN 77-165,827. SAMEDAY TRADEMARK, INC., OLYMPIA, WA. FILED 4-25-2007.

SAMEDAY

THE MARK CONSISTS OF STANDARD CHARACTERS WITHOUT CLAIM TO ANY PARTICULAR FONT, STYLE, SIZE, OR COLOR.

OWNER OF U.S. REG. NO. 2,447,204.
SEC. 2(F).

FOR MOBILE VEHICLE COSMETIC REPAIR AND FINISHING SERVICES (U.S. CLS. 100, 103 AND 106).

FIRST USE 11-1-1997; IN COMMERCE 11-1-1997.
TARAH HARDY, EXAMINING ATTORNEY

SN 77-209,612. HOUSERAISING, INC., CHARLOTTE, NC. FILED 6-19-2007.

HouseRaising...For All The
Right Reasons

THE MARK CONSISTS OF STANDARD CHARACTERS WITHOUT CLAIM TO ANY PARTICULAR FONT, STYLE, SIZE, OR COLOR.

FOR CONSTRUCTION SERVICES, NAMELY, PLANNING, LAYING OUT AND CUSTOM CONSTRUCTION OF RESIDENTIAL AND COMMERCIAL COMMUNITIES; CUSTOM CONSTRUCTION AND BUILDING RENOVATION; CUSTOM CONSTRUCTION OF HOMES (U.S. CLS. 100, 103 AND 106).

FIRST USE 1-1-2004; IN COMMERCE 1-1-2004.
H. M. FISHER, EXAMINING ATTORNEY

CLASS 37—(Continued).

SN 77-209,658. HOUSERAISING, INC., CHARLOTTE, NC. FILED 6-19-2007.

A Builder's Home

THE MARK CONSISTS OF STANDARD CHARACTERS WITHOUT CLAIM TO ANY PARTICULAR FONT, STYLE, SIZE, OR COLOR.

FOR CONSTRUCTION SERVICES, NAMELY, PLANNING, LAYING OUT AND CUSTOM CONSTRUCTION OF RESIDENTIAL AND COMMERCIAL COMMUNITIES; CONSULTING IN THE FIELD OF BUILDING CONSTRUCTION; CUSTOM CONSTRUCTION AND BUILDING RENOVATION (U.S. CLS. 100, 103 AND 106).

FIRST USE 1-1-2006; IN COMMERCE 1-1-2006.
H. M. FISHER, EXAMINING ATTORNEY

SN 77-217,073. DLR ASSOCIATES, L.L.C., COLUMBUS, GA. FILED 6-27-2007.

EVERY WASH GUARANTEED OUR
WAY OF SAYING WE LOVE TO
PLEASE YOU

THE MARK CONSISTS OF STANDARD CHARACTERS WITHOUT CLAIM TO ANY PARTICULAR FONT, STYLE, SIZE, OR COLOR.

NO CLAIM IS MADE TO THE EXCLUSIVE RIGHT TO USE "EVERY WASH GUARANTEED", APART FROM THE MARK AS SHOWN.

FOR AUTOMOBILE CLEANING AND CAR WASHING (U.S. CLS. 100, 103 AND 106).

FIRST USE 12-21-2004; IN COMMERCE 12-21-2004.
HEATHER SAPP, EXAMINING ATTORNEY

SN 77-223,869. MY TIME IS YOUR TIME, INC., SWANSEA, IL. FILED 7-6-2007.



THE MARK CONSISTS OF DOG WITH SMILE SITTING IN DOG HOUSE WITH BOWL OF FOOD ON LEFT. TO LEFT OF DOG HOUSE A STICK MAN CHARACTER IS HOLDING A DUST PAN IN RIGHT HAND AND SCOOPING TOOL IN LEFT HAND. THE STICK MAN IS SCOOPING THE SLANTED LETTER P IN THE WORDS "THE PET BUSTERS" THAT ARE POSITIONED BELOW THE DOG HOUSE AND IN FRONT OF STICK MAN CHARACTER.

FOR PET WASTE REMOVAL SERVICES (U.S. CLS. 100, 103 AND 106).

FIRST USE 6-15-2007; IN COMMERCE 6-15-2007.
BILL DAWE, EXAMINING ATTORNEY

CLASS 37—(Continued).

SN 77-232,851. DISH DIRECT, LLC, GILBERT, AZ. FILED 7-18-2007.

DISH DIRECT

THE MARK CONSISTS OF STANDARD CHARACTERS WITHOUT CLAIM TO ANY PARTICULAR FONT, STYLE, SIZE, OR COLOR.

NO CLAIM IS MADE TO THE EXCLUSIVE RIGHT TO USE "DISH", APART FROM THE MARK AS SHOWN.

FOR INSTALLATION AND MAINTENANCE OF SATELLITE TELEVISION PRODUCTS (U.S. CLS. 100, 103 AND 106).

FIRST USE 3-10-2003; IN COMMERCE 3-10-2003.
JAMES LOVELACE, EXAMINING ATTORNEY

SN 77-238,933. PLATINUM DRY CLEANERS, LLC., PHOENIX, AZ. FILED 7-25-2007.

ORGANIC CLEANERS
mean on stains, green on earth!

NO CLAIM IS MADE TO THE EXCLUSIVE RIGHT TO USE "ORGANIC CLEANERS", APART FROM THE MARK AS SHOWN.

THE COLOR(S) GREEN AND DARK GREY IS/ARE CLAIMED AS A FEATURE OF THE MARK.

"THE COLOR GREEN APPEARS IN THE WORDING "ORGANIC", "GREEN" AND "EARTH". THE COLOR DARK GRAY APPEARS IN THE WORDING "CLEANERS", "MEAN ON STAINS," AND "ON" AND IN THE EXCLAMATION MARK "!"

FOR DRY CLEANING, CLOTHING REPAIR, DRY CLEANING, NAMELY, CLEANING, IRONING, LAUNDERING, PRESSING AND WASHING; WASHING OF CLOTH, FABRIC, LINEN AND TEXTILES; LEATHER CLEANING (U.S. CLS. 100, 103 AND 106).

LEE-ANNE BERNIS, EXAMINING ATTORNEY

SN 77-256,089. ADEVCO CORPORATION, ATLANTA, GA. FILED 8-15-2007.

ADEVCO

THE MARK CONSISTS OF STANDARD CHARACTERS WITHOUT CLAIM TO ANY PARTICULAR FONT, STYLE, SIZE, OR COLOR.

FOR CONSTRUCTION OF BUILDINGS USED BY BUSINESSES FOR CALL CENTERS; CONSTRUCTION CONSULTATION, MANAGEMENT, PLANNING AND SUPERVISION; REFURBISHING, REPAIR AND RENOVATING EXISTING BUILDINGS AND OTHER STRUCTURES (U.S. CLS. 100, 103 AND 106).

FIRST USE 6-15-1990; IN COMMERCE 6-15-1990.
KELLY MCCOY, EXAMINING ATTORNEY

CLASS 37—(Continued).

SN 77-256,620. BLUEWATER HOLDING CORP., PEMBROKE, MA. FILED 8-16-2007.

SMARTER. GREENER. CLEANER.

THE MARK CONSISTS OF STANDARD CHARACTERS WITHOUT CLAIM TO ANY PARTICULAR FONT, STYLE, SIZE, OR COLOR.

FOR SEPTIC SYSTEM INSTALLATION, PUMPING, MAINTENANCE AND REPAIR; VACUUM TRUCK SERVICES, NAMELY, HYDRO EXCAVATING SERVICES; DRAINAGE CLEANING SERVICES (U.S. CLS. 100, 103 AND 106).

JAY FLOWERS, EXAMINING ATTORNEY

SN 77-263,216. THE RICE-TINSLEY CORPORATION, HOUSTON, TX. FILED 8-23-2007.

direct
PLUMBING 
Quality Solutions

NO CLAIM IS MADE TO THE EXCLUSIVE RIGHT TO USE "PLUMBING" AND "QUALITY SOLUTIONS", APART FROM THE MARK AS SHOWN.

THE MARK CONSISTS OF THE LOWER CASE FONT SETTING OF THE WORD "DIRECT" FOLLOWED THEREAFTER BY THE ALL CAPS FONT SETTING OF THE WORD "PLUMBING" PRECEDED BY AN ADJACENT LOGO CONSISTING OF A SQUARE WITH AN IMAGE OF A WRENCH AND SCREW, OVERLAYING THE SQUARE IMAGE. TRADEMARK WILL ALSO CONTAIN THE SLOGAN LINE "QUALITY SOLUTIONS" IN A BOLD, ITALICS STANDARD FONT SETTING.

FOR PLUMBING SERVICES (U.S. CLS. 100, 103 AND 106).

FIRST USE 8-1-2006; IN COMMERCE 8-1-2006.
STEVEN JACKSON, EXAMINING ATTORNEY

SN 77-269,923. BROADWAY 3012 LLC, CHICAGO, IL. FILED 8-31-2007.

BROADWAY 3030

THE MARK CONSISTS OF STANDARD CHARACTERS WITHOUT CLAIM TO ANY PARTICULAR FONT, STYLE, SIZE, OR COLOR.

NO CLAIM IS MADE TO THE EXCLUSIVE RIGHT TO USE "BROADWAY", APART FROM THE MARK AS SHOWN.

FOR REAL ESTATE DEVELOPMENT OF RESIDENTIAL PROPERTY (U.S. CLS. 100, 103 AND 106).

MARILYN IZZI, EXAMINING ATTORNEY

CLASS 37—(Continued).

SN 77-274,162. GEM PLUMBING & HEATING CO., INC., LINCOLN, RI. FILED 9-7-2007.

GEM

THE MARK CONSISTS OF STANDARD CHARACTERS WITHOUT CLAIM TO ANY PARTICULAR FONT, STYLE, SIZE, OR COLOR.

OWNER OF U.S. REG. NO. 2,962,917.

FOR RESIDENTIAL HOME REPAIR AND GENERAL RESIDENTIAL HOME MAINTENANCE SERVICES (U.S. CLS. 100, 103 AND 106).

MARK PILARO, EXAMINING ATTORNEY

SN 77-276,248. EASTERN BUILDING SERVICES, LOWELL, MA. FILED 9-11-2007.

EBS-GREEN

THE MARK CONSISTS OF STANDARD CHARACTERS WITHOUT CLAIM TO ANY PARTICULAR FONT, STYLE, SIZE, OR COLOR.

FOR JANITORIAL SERVICES FEATURING ENVIRONMENTALLY FRIENDLY METHODS (U.S. CLS. 100, 103 AND 106).

MARK RADEMACHER, EXAMINING ATTORNEY

SN 77-278,658. EASTERN BUILDING SERVICES, LOWELL, MA. FILED 9-13-2007.

EBS GREEN

THE MARK CONSISTS OF STANDARD CHARACTERS WITHOUT CLAIM TO ANY PARTICULAR FONT, STYLE, SIZE, OR COLOR.

NO CLAIM IS MADE TO THE EXCLUSIVE RIGHT TO USE "GREEN", APART FROM THE MARK AS SHOWN.

FOR JANITORIAL SERVICES FEATURING ENVIRONMENTALLY FRIENDLY METHODS (U.S. CLS. 100, 103 AND 106).

MARK RADEMACHER, EXAMINING ATTORNEY

CLASS 37—(Continued).

SN 77-278,848. THE SCREEN DOCTOR OF CENTRAL FLORIDA, INC., APOPKA, FL. FILED 9-13-2007.



THE COLOR(S) CYAN, DARK BLUE, GREEN, BEIGE, YELLOW, WHITE, GREY IS/ARE CLAIMED AS A FEATURE OF THE MARK.

THE MARK CONSISTS OF SCREEN PHYSICIAN WEARING SCRUBS, WEARING MEDICAL HEADBAND, HOLDING SCREEN ROLLER, HOLDING DRILL, ON TOP OF THE STAR OF LIFE MEDICAL SYMBOL. CYAN STAR OF LIFE MEDICAL SYMBOL, DARK BLUE "SHADOWED" STAR OF LIFE UNDERNEATH, MAN HAS BEIGE SKIN, YELLOW HAIR, GREEN SCRUBS, GREY SCREEN ROLLER, GREY AND WHITE HEADBAND, AND A WHITE DRILL.

FOR INSTALLATION AND REPAIR SERVICES OF METAL AND NON-METAL SCREENS FOR POOL ENCLOSURES, SCREEN ROOMS, LANAIS, FLORIDA ROOMS, AND SCREEN PORCHES; CLEANING SERVICES FOR METAL AND NON-METAL SCREENS, NAMELY, BY CHEMICAL CLEANING PROCESSES; INSTALLATION OF ALUMINUM STRUCTURES (U.S. CLS. 100, 103 AND 106).

FIRST USE 7-1-2000; IN COMMERCE 7-1-2000.
YAT SYE, LEE, EXAMINING ATTORNEY

CLASS 37—(Continued).

SN 77-281,654. VILLAGE HOMES OF COLORADO, INC., ENGLEWOOD, CO. FILED 9-17-2007.

LÚCE

THE MARK CONSISTS OF STANDARD CHARACTERS WITHOUT CLAIM TO ANY PARTICULAR FONT, STYLE, SIZE, OR COLOR.

"THE FOREIGN WORDING IN THE MARK TRANSLATES INTO ENGLISH AS LIGHT."

FOR CONSTRUCTION SERVICES, NAMELY, PLANNING, LAYING OUT AND CUSTOM CONSTRUCTION OF RESIDENTIAL AND COMMERCIAL COMMUNITIES; REAL ESTATE DEVELOPMENT (U.S. CLS. 100, 103 AND 106).

AHSEN KHAN, EXAMINING ATTORNEY

SN 77-283,753. BREITBURN ENERGY CORPORATION, LOS ANGELES, CA. FILED 9-19-2007.

SN 77-279,948. BUILDING INFRASTRUCTURE GROUP, INC., BROOKLYN, NY. FILED 9-14-2007.



NO CLAIM IS MADE TO THE EXCLUSIVE RIGHT TO USE "BUILDING INFRASTRUCTURE GROUP", APART FROM THE MARK AS SHOWN.

THE MARK CONSISTS OF THE DESIGN OF A SKYLINE OF BUILDINGS WITH AN ORBIT, TWO LINE SEGMENTS, AND WORDING "BUILDING INFRASTRUCTURE GROUP".

FOR CONSULTATION IN THE FIELD OF CONSTRUCTION (U.S. CLS. 100, 103 AND 106).

DAVID C. REIHNER, EXAMINING ATTORNEY



THE MARK CONSISTS OF A DOUBLE IMPOSED LETTER B WITH THE TERM BREITBURN UNDERNEATH.

FOR OIL AND GAS PRODUCTION SERVICES, NAMELY, THE DRILLING, PUMPING AND EXTRACTION OF OIL, THE DRILLING AND EXTRACTION OF GAS, THE LAYING OF PIPELINE, AND THE INSTALLATION AND REPAIR OF OIL AND GAS PRODUCTION FACILITIES (U.S. CLS. 100, 103 AND 106).

FIRST USE 0-0-1996; IN COMMERCE 0-0-1996.
DAWN FELDMAN, EXAMINING ATTORNEY

CLASS 37—(Continued).

SN 77-284,175. A1 BODY AND GLASS, LLC, DEERFIELD BEACH, FL. FILED 9-20-2007.

A1 BODY AND GLASS

THE MARK CONSISTS OF STANDARD CHARACTERS WITHOUT CLAIM TO ANY PARTICULAR FONT, STYLE, SIZE, OR COLOR.

NO CLAIM IS MADE TO THE EXCLUSIVE RIGHT TO USE "BODY AND GLASS", APART FROM THE MARK AS SHOWN.

FOR AUTOMOBILE PAINTING, AND AUTOMOBILE BODY REPAIR (U.S. CLS. 100, 103 AND 106).

FIRST USE 0-0-2003; IN COMMERCE 0-0-2003.

ALEXANDER L. POWERS, EXAMINING ATTORNEY

SN 77-284,222. AIBODY AND GLASS, LLC, DEERFIELD BEACH, FL. FILED 9-20-2007.



NO CLAIM IS MADE TO THE EXCLUSIVE RIGHT TO USE "BODY AND GLASS FAST FLAWLESS FOREVER", APART FROM THE MARK AS SHOWN.

THE MARK CONSISTS OF THE LETTER "A" AND THE NUMBER "1" IN A STYLIZED FORMAT, CONTAINED WITHIN AN ELLIPSE ON THE FIRST LINE; FOLLOWED BY THE WORDS "A1 BODY AND GLASS" ON THE SECOND LINE, FOLLOWED BY THE WORD "FAST", THEN A BULLET SHAPE, THE WORD "FLAWLESS", THEN A BULLET SHAPE, AND THE WORD "FOREVER" ON THE THIRD LINE.

FOR AUTOMOBILE PAINTING, AND AUTOMOBILE BODY REPAIR (U.S. CLS. 100, 103 AND 106).

FIRST USE 0-0-2003; IN COMMERCE 0-0-2003.

ALEXANDER L. POWERS, EXAMINING ATTORNEY

SN 77-286,196. FLOOR CARE PROFESSIONALS, SAN DIEGO, CA. FILED 9-21-2007.



NO CLAIM IS MADE TO THE EXCLUSIVE RIGHT TO USE "FLOOR CARE PROFESSIONALS" AND "YOUR FLOOR CARE PEOPLE", APART FROM THE MARK AS SHOWN.

THE MARK CONSISTS OF A STAR TO THE LEFT OF THE WORDS "FLOOR CARE PROFESSIONALS YOUR FLOOR CARE PEOPLE" IN STYLIZED TEXT

FOR CLEANING OF HARD SURFACES AND CARPETS (U.S. CLS. 100, 103 AND 106).

FIRST USE 12-26-2006; IN COMMERCE 12-26-2006.

PAUL E. FAHRENKOPF, EXAMINING ATTORNEY

CLASS 37—(Continued).

SN 77-287,216. RENT-A-CENTER WEST, INC., PLANO, TX. FILED 9-24-2007.

RAC WORRY FREE GUARANTEE

THE MARK CONSISTS OF STANDARD CHARACTERS WITHOUT CLAIM TO ANY PARTICULAR FONT, STYLE, SIZE, OR COLOR.

OWNER OF U.S. REG. NO. 3,161,654.

NO CLAIM IS MADE TO THE EXCLUSIVE RIGHT TO USE "GUARANTEE", APART FROM THE MARK AS SHOWN.

FOR RENTAL, LEASING, LEASE PURCHASING AND RENTAL-TO-OWN OF HOME APPLIANCES, NAMELY, WASHERS AND DRYERS (U.S. CLS. 100, 103 AND 106).

JILL C. ALT, EXAMINING ATTORNEY

SN 77-287,258. THE ROOF STAIN DOCTOR, LLC, CLARKSVILLE, IN. FILED 9-24-2007.

THE ROOF STAIN DOCTOR

THE MARK CONSISTS OF STANDARD CHARACTERS WITHOUT CLAIM TO ANY PARTICULAR FONT, STYLE, SIZE, OR COLOR.

NO CLAIM IS MADE TO THE EXCLUSIVE RIGHT TO USE "ROOF STAIN", APART FROM THE MARK AS SHOWN.

FOR CLEANING OF HOUSES, ROOFS, SIDEWALKS, DRIVEWAYS, SIDING, BRICK, STUCCO, GUTTERS, DECKS, AND WINDOWS; CLEANING OF BUILDING EXTERIOR SURFACES (U.S. CLS. 100, 103 AND 106).

FIRST USE 9-30-2006; IN COMMERCE 9-30-2006.

AISHA CLARKE, EXAMINING ATTORNEY

CLASS 37—(Continued).

SN 77-287,278. THE ROOF STAIN DOCTOR, LLC, CLARKSVILLE, IN. FILED 9-24-2007.

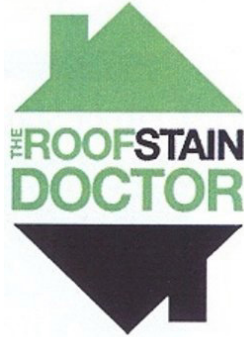

NO CLAIM IS MADE TO THE EXCLUSIVE RIGHT TO USE "ROOF STAIN", APART FROM THE MARK AS SHOWN.

THE COLOR(S) GREEN, WHITE, AND BLACK IS/ARE CLAIMED AS A FEATURE OF THE MARK.

THE MARK CONSISTS OF A GREEN TRIANGULAR ROOF WITH ATTACHED CHIMNEY ABOVE THE WORDS "THE ROOF" IN GREEN AND THE WORD "STAIN" IN BLACK ABOVE THE WORD "DOCTOR" IN GREEN, ALL ON A WHITE BACKGROUND AND ABOVE AN INVERTED BLACK TRIANGULAR ROOF WITH ATTACHED CHIMNEY.

FOR CLEANING OF HOUSES, ROOFS, SIDEWALKS, DRIVEWAYS, SIDING, BRICK, STUCCO, GUTTERS, DECKS, AND WINDOWS; CLEANING OF BUILDING EXTERIOR SURFACES (U.S. CLS. 100, 103 AND 106).

FIRST USE 9-30-2006; IN COMMERCE 9-30-2006.
AISHA CLARKE, EXAMINING ATTORNEY

SN 77-288,850. HERCULES OFFSHORE, INC, HOUSTON, LA. FILED 9-25-2007.

HERCULES DRILLING

THE MARK CONSISTS OF STANDARD CHARACTERS WITHOUT CLAIM TO ANY PARTICULAR FONT, STYLE, SIZE, OR COLOR.

OWNER OF U.S. REG. NOS. 3,176,662, 3,192,479 AND 3,192,480.

NO CLAIM IS MADE TO THE EXCLUSIVE RIGHT TO USE "DRILLING", APART FROM THE MARK AS SHOWN.

FOR OIL AND GAS DRILLING; OIL AND GAS RECOVERY, NAMELY, PUMPING AND EXTRACTION (U.S. CLS. 100, 103 AND 106).

FIRST USE 8-30-2004; IN COMMERCE 8-30-2004.
ESTHER BELENKER, EXAMINING ATTORNEY

CLASS 37—(Continued).

SN 77-289,748. BERGER, LENARD, OAKTON, VA. FILED 9-26-2007.

We make your o y vey go
away!

THE MARK CONSISTS OF STANDARD CHARACTERS WITHOUT CLAIM TO ANY PARTICULAR FONT, STYLE, SIZE, OR COLOR.

FOR HOUSING SERVICES, NAMELY, REPAIR, IMPROVEMENT, AND CONSTRUCTION OF RESIDENTIAL REAL PROPERTY (U.S. CLS. 100, 103 AND 106).

FIRST USE 1-5-2007; IN COMMERCE 1-5-2007.
LESLIE RICHARDS, EXAMINING ATTORNEY

SN 77-290,435. STANDARD PACIFIC CORP., IRVINE, CA. FILED 9-27-2007.

SYNERGY BETWEEN YOUR HOME
AND THE SUN

THE MARK CONSISTS OF STANDARD CHARACTERS WITHOUT CLAIM TO ANY PARTICULAR FONT, STYLE, SIZE, OR COLOR.

FOR RESIDENTIAL AND COMMERCIAL BUILDING CONSTRUCTION AND LAND DEVELOPMENT SERVICES, NAMELY, PLANNING AND LAYING OUT OF RESIDENTIAL AND COMMERCIAL COMMUNITIES BUILT WITH SOLAR/ENERGY EFFICIENT FEATURES (U.S. CLS. 100, 103 AND 106).

FIRST USE 8-24-2007; IN COMMERCE 8-24-2007.
TRACY CROSS, EXAMINING ATTORNEY

SN 77-290,655. THE SOLAR CENTER, INC., DENVER, NJ. FILED 9-27-2007.



THE COLOR(S) GREEN AND YELLOW IS/ARE CLAIMED AS A FEATURE OF THE MARK.

THE MARK CONSISTS OF THE WORDS "THE SOLAR CENTER" IN GREEN WITH THE WORD "THE" RUNNING VERTICALLY AND THE TERM "SOLAR CENTER" RUNNING HORIZONTALLY, AND A YELLOW SEMI-CIRCLE WITH THE CURVE POINTING UPWARDS HOVERING OVER THE MARK BEGINNING AT THE LETTER "A" IN "SOLAR" AND ENDING JUST BEFORE THE "T" IN "CENTER".

FOR INSTALLATION OF SOLAR ELECTRIC SYSTEMS AND SOLAR DOMESTIC HOT WATER SYSTEMS (U.S. CLS. 100, 103 AND 106).

FIRST USE 4-1-2005; IN COMMERCE 4-1-2005.
AISHA CLARKE, EXAMINING ATTORNEY

CLASS 37—(Continued).

SN 77-290,939. FOUTS CONSTRUCTION & ARTISAN FINISHING, PLANO, TX. FILED 9-27-2007.



NO CLAIM IS MADE TO THE EXCLUSIVE RIGHT TO USE "CONSTRUCTION & ARTISAN FINISHING", APART FROM THE MARK AS SHOWN.

THE MARK CONSISTS OF A STYLIZED WINDOW WITH A CURVED TOP. THE ENTIRE SHAPE IS OUTLINED. THERE ARE CURVED VINE LIKE LINES INSIDE WITH A LINE RUNNING DOWN THE CENTER. THE STYLIZED LETTERING "FOUTS CONSTRUCTION & ARTISAN FINISHING" IS BELOW.

FOR BUILDING CONSTRUCTION AND REPAIR; CONSTRUCTION AND RENOVATION OF BUILDINGS & HOMES; PAINTING; CABINET REPAIR; INSTALLATION OF CABINETS (U.S. CLS. 100, 103 AND 106).
MARY MUNSON, EXAMINING ATTORNEY

SN 77-291,090. HUGGINS, SCOT G., BROOKLINE, MA. FILED 9-28-2007.

AUTOSEXUAL

THE MARK CONSISTS OF STANDARD CHARACTERS WITHOUT CLAIM TO ANY PARTICULAR FONT, STYLE, SIZE, OR COLOR.

FOR AUTOMOBILE CUSTOMIZATION SERVICES (U.S. CLS. 100, 103 AND 106).
SIMON TENG, EXAMINING ATTORNEY

CLASS 37—(Continued).

SN 77-291,679. CONSTRUCTION ONE, INC., COLUMBUS, OH. FILED 9-28-2007.



THE MARK CONSISTS OF THE WORD "ONE" WITH THE NUMBER 1 DESIGNED TO INCORPORATE THE "E" FROM THE WORD "ONE" AND TO SERVE AS THE LEFT STEM IN THE "V" IN THE WORD "VISION".

FOR CONSTRUCTION SERVICES, NAMELY, PLANNING, LAYING OUT AND CUSTOM CONSTRUCTION OF RESIDENTIAL AND COMMERCIAL COMMUNITIES (U.S. CLS. 100, 103 AND 106).

MATTHEW MCDOWELL, EXAMINING ATTORNEY

SN 77-293,118. K&M TRUCK REPAIR, INC., DBA K&M TRUCK AND AUTO REPAIR, MOUNT SINAI, NY. FILED 10-1-2007.

Keeping You On The Road

THE MARK CONSISTS OF STANDARD CHARACTERS WITHOUT CLAIM TO ANY PARTICULAR FONT, STYLE, SIZE, OR COLOR.

FOR AUTOMOBILE REPAIR AND MAINTENANCE; AUTOMOTIVE MAINTENANCE AND REPAIR; GARAGE SERVICES, NAMELY, REPAIR OF AUTOMOBILES (U.S. CLS. 100, 103 AND 106).

MORGAN WYNNE, EXAMINING ATTORNEY

SN 77-293,304. NEVADA BARRICADE & SIGN COMPANY, INC., SPARKS, NV. FILED 10-1-2007.

NBSCO

THE MARK CONSISTS OF STANDARD CHARACTERS WITHOUT CLAIM TO ANY PARTICULAR FONT, STYLE, SIZE, OR COLOR.

FOR ROAD CONSTRUCTION; STREET CONSTRUCTION; LEASING OF CONSTRUCTION EQUIPMENT (U.S. CLS. 100, 103 AND 106).

JANET LEE, EXAMINING ATTORNEY

CLASS 37—(Continued).

SN 77-293,391. ANTS ON FIRE, INC., FRONT ROYAL, VA. FILED 10-1-2007.

ANTS ON FIRE

THE MARK CONSISTS OF STANDARD CHARACTERS WITHOUT CLAIM TO ANY PARTICULAR FONT, STYLE, SIZE, OR COLOR.

NO CLAIM IS MADE TO THE EXCLUSIVE RIGHT TO USE "ANTS", APART FROM THE MARK AS SHOWN.

FOR PEST CONTROL; PEST CONTROL AND EXTERMINATION OTHER THAN FOR AGRICULTURAL PURPOSES (U.S. CLS. 100, 103 AND 106).

ANDREA HACK, EXAMINING ATTORNEY

CLASS 37—(Continued).

SN 77-294,212. LITHOCRETE, COSTA MESA, CA. FILED 10-2-2007.

LITHOCRETE QUARRIED STONE

THE MARK CONSISTS OF STANDARD CHARACTERS WITHOUT CLAIM TO ANY PARTICULAR FONT, STYLE, SIZE, OR COLOR.

OWNER OF U.S. REG. NOS. 1,879,329, 2,358,054 AND 2,358,183.

NO CLAIM IS MADE TO THE EXCLUSIVE RIGHT TO USE "QUARRIED STONE", APART FROM THE MARK AS SHOWN.

FOR CONSTRUCTION OF DECORATIVE ARCHITECTURAL CONCRETE, FLOORING AND PAVEMENT SURFACES (U.S. CLS. 100, 103 AND 106).

NATALIE POLZER, EXAMINING ATTORNEY

SN 77-293,700. DERANZ BUILDING SYSTEMS, INC., PEARL, MS. FILED 10-2-2007.



THE MARK CONSISTS OF THE WORDS "DERANZ" IN STYLIZED TEXT. TRIANGLE OUTLINE IN THE BACKGROUND.

FOR COMMERCIAL AND RESIDENTIAL BUILDING CONSTRUCTION SERVICES (U.S. CLS. 100, 103 AND 106).

FIRST USE 8-17-1987; IN COMMERCE 8-17-1987.

JOHN WILKE, EXAMINING ATTORNEY

SN 77-294,754. YOUNG AMERICA CORPORATION, YOUNG AMERICA, MN. FILED 10-3-2007.

MYBONEYARD

GOOD OLE HOUSEKEEPING JANITORIAL AND MAID SERVICE

THE MARK CONSISTS OF STANDARD CHARACTERS WITHOUT CLAIM TO ANY PARTICULAR FONT, STYLE, SIZE, OR COLOR.

NO CLAIM IS MADE TO THE EXCLUSIVE RIGHT TO USE "HOUSEKEEPING JANITORIAL AND MAID SERVICE", APART FROM THE MARK AS SHOWN.

FOR JANITORIAL SERVICES; MAID SERVICES (U.S. CLS. 100, 103 AND 106).

JESSICA A. POWERS, EXAMINING ATTORNEY

THE MARK CONSISTS OF STANDARD CHARACTERS WITHOUT CLAIM TO ANY PARTICULAR FONT, STYLE, SIZE, OR COLOR.

FOR COLLECTION OF COMPUTERS, PHONES, AND ELECTRONIC DEVICES FOR RECYCLING (U.S. CLS. 100, 103 AND 106).

STEVEN PEREZ, EXAMINING ATTORNEY

CLASS 37—(Continued).

SN 77-295,185. WILLMARK COMMUNITIES, INC., SAN DIEGO, CA. FILED 10-3-2007.



THE MARK CONSISTS OF THE WORD "WILLMARK", BELOW WHICH IS THE CAPITAL (OR "HEAD") AND A SMALL PORTION OF THE SHAFT OF AN IONIC PILLAR/COLUMN CONTAINING VOLUTES (SPIRAL SCROLL-LIKE ORNAMENTS), AND THE LETTERS "WM" CONTAINED WITHIN THE SHAFT.

FOR HOUSING SERVICES, NAMELY, DEVELOPMENT OF REAL PROPERTY, NAMELY, REPAIR, IMPROVEMENT, AND NEW CONSTRUCTION (U.S. CLS. 100, 103 AND 106).

FIRST USE 8-1-2007, THE MARK WAS FIRST USED ANYWHERE IN A DIFFERENT FORM OTHER THAN THAT SOUGHT TO BE REGISTERED ON 01/01/2003.; IN COMMERCE 8-1-2007, THE MARK WAS FIRST USED IN COMMERCE IN A DIFFERENT FORM OTHER THAN THAT SOUGHT TO BE REGISTERED ON 01/01/2003..
SALLY SHIH, EXAMINING ATTORNEY

SN 77-295,780. WILLIAMS, LEWIS W, ROCHESTER, IL. FILED 10-4-2007.

Faster, Cleaner, Better!

THE MARK CONSISTS OF STANDARD CHARACTERS WITHOUT CLAIM TO ANY PARTICULAR FONT, STYLE, SIZE, OR COLOR.

FOR HVAC CONTRACTOR SERVICES; PLUMBING CONTRACTOR SERVICES (U.S. CLS. 100, 103 AND 106).
FIRST USE 1-1-2004; IN COMMERCE 1-1-2004.
DANIEL CAPSHAW, EXAMINING ATTORNEY

CLASS 37—(Continued).

SN 77-296,251. CENTEX CORPORATION, DALLAS, TX. FILED 10-4-2007.

AURIA

THE MARK CONSISTS OF STANDARD CHARACTERS WITHOUT CLAIM TO ANY PARTICULAR FONT, STYLE, SIZE, OR COLOR.

FOR CONSTRUCTION SERVICES, NAMELY, PLANNING, LAYING OUT AND CONSTRUCTION OF RESIDENTIAL AND COMMERCIAL COMMUNITIES (U.S. CLS. 100, 103 AND 106).

SAMUEL E. SHARPER JR., EXAMINING ATTORNEY

SN 77-296,356. ARAB PEST MANAGEMENT SERVICES, INC., CRAWFORDSVILLE, IN. FILED 10-4-2007.



OWNER OF U.S. REG. NO. 1,078,086.
NO CLAIM IS MADE TO THE EXCLUSIVE RIGHT TO USE "AMERICAN OWNED AND OPERATED SINCE 1929", APART FROM THE MARK AS SHOWN.

THE MARK CONSISTS OF A TOP LINE CONSISTING OF STYLIZED EYES IN THE UPPER LEFT, A TELEPHONE DESIGN IN THE UPPER RIGHT AND THE WORDS "SEE A BUG...CALL" IN THE CENTER, A CENTER LINE CONSISTING OF THE WORD "ARAB" AND A BOTTOM LINE CONSISTING OF THE WORDS "AMERICAN OWNED AND OPERATED SINCE 1929".

FOR PEST CONTROL SERVICES (U.S. CLS. 100, 103 AND 106).

FIRST USE 5-24-2004; IN COMMERCE 5-24-2004.
MORGAN WYNNE, EXAMINING ATTORNEY

SN 77-297,344. BULLSEYE TELECOM, INC., OAK PARK, MI. FILED 10-5-2007.

SHORTSTOP

THE MARK CONSISTS OF STANDARD CHARACTERS WITHOUT CLAIM TO ANY PARTICULAR FONT, STYLE, SIZE, OR COLOR.

FOR REPAIR AND REPLACEMENT SERVICES IN THE FIELD OF TELECOMMUNICATION WIRING, FEATURING CUSTOMER SERVICE CONTRACTS (U.S. CLS. 100, 103 AND 106).

FIRST USE 7-1-2007; IN COMMERCE 7-1-2007.
JOHN WILKE, EXAMINING ATTORNEY

CLASS 37—(Continued).

SN 77-298,323. JAN-PRO FRANCHISING INTERNATIONAL, INC., ALPHARETTA, GA. FILED 10-8-2007.

**MEASURABLE CLEANING.
GUARANTEED RESULTS.**

THE MARK CONSISTS OF STANDARD CHARACTERS WITHOUT CLAIM TO ANY PARTICULAR FONT, STYLE, SIZE, OR COLOR.

NO CLAIM IS MADE TO THE EXCLUSIVE RIGHT TO USE "CLEANING", APART FROM THE MARK AS SHOWN. FOR JANITORIAL SERVICES (U.S. CLS. 100, 103 AND 106).

FIRST USE 9-24-2007; IN COMMERCE 9-24-2007.
TINA L. SNAPP, EXAMINING ATTORNEY

SN 77-308,293. HALLIBURTON ENERGY SERVICES, INC., CARROLLTON, TX. FILED 10-19-2007.

STRATASTEER

THE MARK CONSISTS OF STANDARD CHARACTERS WITHOUT CLAIM TO ANY PARTICULAR FONT, STYLE, SIZE, OR COLOR.

OWNER OF U.S. REG. NOS. 2,599,825 AND 2,866,752. SEC. 2(F).
FOR OIL AND GAS WELL SERVICES, NAMELY, OIL WELL DRILLING SERVICES USING AT-BIT SENSORS, DOWNHOLE TOOLS AND COMPUTER SOFTWARE, WHICH FACILITATE THE TRAJECTORY AND PLACEMENT OF WELL BORE STEERING (U.S. CLS. 100, 103 AND 106).

FIRST USE 5-5-1999; IN COMMERCE 5-5-1999.
SHAILA SETTLES, EXAMINING ATTORNEY

SN 77-312,652. APONTE, JOHN, MISSION VIEJO, CA. FILED 10-24-2007.

FLOOD ONE

THE MARK CONSISTS OF STANDARD CHARACTERS WITHOUT CLAIM TO ANY PARTICULAR FONT, STYLE, SIZE, OR COLOR.

NO CLAIM IS MADE TO THE EXCLUSIVE RIGHT TO USE "FLOOD", APART FROM THE MARK AS SHOWN.

FOR WATER DAMAGE REPAIR, NAMELY, REPAIR OF BUILDING INTERIORS INCLUDING WATER EXTRACTION, LEAK DETECTION AND CONTAINMENT, SEWAGE CLEANUP, AND REPAIR OF CARPET, DRY-WALL AND PAINT (U.S. CLS. 100, 103 AND 106).

MONIQUE MILLER, EXAMINING ATTORNEY

CLASS 37—(Continued).

SN 77-316,058. LEEDY ELECTRIC CORP., MULBERRY, FL. FILED 10-29-2007.

WE GOT THE POWER ... WHEN YOU DON'T

THE MARK CONSISTS OF STANDARD CHARACTERS WITHOUT CLAIM TO ANY PARTICULAR FONT, STYLE, SIZE, OR COLOR.

FOR ELECTRICAL CONTRACTOR SERVICES (U.S. CLS. 100, 103 AND 106).

FIRST USE 10-26-2007; IN COMMERCE 10-26-2007.
TRACY WHITTAKER-BROWN, EXAMINING ATTORNEY

SN 78-590,399. PANALYTICAL B.V., ALMELO, NETHERLANDS, FILED 3-18-2005.



THE COLOR(S) BLUE AND GREEN IS/ARE CLAIMED AS A FEATURE OF THE MARK.

THE COLOR(S) BLUE APPEARS IN THE LEFT QUADRILATERAL OF THE DESIGN AND IN THE "PAN" PORTION OF THE WORD MARK. THE COLOR GREEN APPEARS IN THE RIGHT QUADRILATERAL OF THE DESIGN AND IN THE "ALYTICAL" PORTION OF THE WORD MARK.

THE WORDING "PAN" HAS NO MEANING IN A FOREIGN LANGUAGE.

FOR REPAIR OF SCIENTIFIC AND MEASURING APPARATUS AND INSTRUMENTS, NAMELY, X-RAY FLUORESCENCE ANALYZERS, SPECTROMETERS AND DIFFRACTOMETERS AND X-RAY TUBES NOT FOR MEDICAL USE; INSTALLATION OF SCIENTIFIC AND MEASURING APPARATUS AND INSTRUMENTS, SPECTROMETERS AND DIFFRACTOMETERS AND X-RAY DIFFRACTOMETERS; INFORMATION AND CONSULTANCY SERVICES IN THE FIELDS OF REPAIR AND INSTALLATION OF SCIENTIFIC AND MEASURING APPARATUS AND INSTRUMENTS (U.S. CLS. 100, 103 AND 106).

JENNIFER VASQUEZ, EXAMINING ATTORNEY

CLASS 37—(Continued).

SN 78-930,968. AMERICLEAN DRY CLEANING CENTERS, INCORPORATED, DEERFIELD BEACH, FL. FILED 7-17-2006.



NO CLAIM IS MADE TO THE EXCLUSIVE RIGHT TO USE "DRY CLEANING CENTERS, INC.", APART FROM THE MARK AS SHOWN.

THE COLOR(S) BLUE AND GOLD IS/ARE CLAIMED AS A FEATURE OF THE MARK.

THE MARK CONSISTS OF THE WORDING "AMERICLEAN" AND "DRY CLEANING CENTERS, INC.," IN THE COLOR BLUE, WITH THE WORDING "DRY CLEANING CENTERS INC." APPEARING BENEATH THE TERM "AMERICLEAN." THE COLORS BLUE AND GOLD APPEAR IN A CURVED BAND STARTING AT THE CROSS FOR THE LETTER "A" IN "AMERICLEAN" AND ENDING AT THE LETTER "I."

FOR DRY CLEANING (U.S. CLS. 100, 103 AND 106).
FIRST USE 1-11-2005; IN COMMERCE 1-11-2005.
NAKIA HENRY, EXAMINING ATTORNEY

CLASS 38—(Continued).

SN 76-681,421. O2 HOLDINGS, LLC, NEW YORK, NY. FILED 9-4-2007.

OH! AIR KARAOKE

THE MARK CONSISTS OF STANDARD CHARACTERS WITHOUT CLAIM TO ANY PARTICULAR FONT, STYLE, SIZE, OR COLOR.

OWNER OF U.S. REG. NOS. 2,818,216, 3,169,929 AND OTHERS.

NO CLAIM IS MADE TO THE EXCLUSIVE RIGHT TO USE "KARAOKE", APART FROM THE MARK AS SHOWN.

FOR TELECOMMUNICATIONS SERVICES, NAMELY, PROVIDING TELEVISION TRANSMISSION VIA CABLE, SATELLITE AND BROADCAST TRANSMISSIONS, INCLUDING VIDEO-ON-DEMAND AND ON-LINE OR OTHER DIGITAL TRANSMISSION OF MUSIC AND KARAOKE SONGS; ELECTRONIC TRANSMISSION OF MUSIC AND KARAOKE SONGS TO MOBILE OR CELLULAR TELEPHONES (U.S. CLS. 100, 101 AND 104).

FIRST USE 10-7-2005; IN COMMERCE 10-7-2005.

SAMUEL E. SHARPER JR., EXAMINING ATTORNEY

SN 77-054,017. ROCOCO SOFTWARE LTD., DUBLIN 2, IRELAND, FILED 11-30-2006.

CLASS 38—COMMUNICATION

SN 76-661,092. VIOX MEDIA CORP, POWDER SPRINGS, GA. FILED 6-5-2006.

THE MARK CONSISTS OF "MYSTATUS".

FOR ELECTRONIC TRANSMISSION OF PRESENCE BASED DATA VIA COMPUTER TERMINALS AND MOBILE DEVICES; MOBILE TEXT MESSAGING TRANSMISSION SERVICES RELATING TO MARKETING DATA; AND WIRELESS ELECTRONIC TRANSMISSION OF ADVERTISING DATA, FACSIMILES, IMAGES AND INFORMATIONS (U.S. CLS. 100, 101 AND 104).

FIRST USE 7-26-2002; IN COMMERCE 5-26-2005.
WILLIAM VERHOSEK, EXAMINING ATTORNEY

MYSAY

THE MARK CONSISTS OF STANDARD CHARACTERS WITHOUT CLAIM TO ANY PARTICULAR FONT, STYLE, SIZE, OR COLOR.

FOR TELECOMMUNICATIONS SERVICES, NAMELY, PROVIDING SERVICES FOR THE SIMULTANEOUS TRANSMISSION OF VOICE MESSAGES OVER THE TELEPHONE AND OVER THE INTERNET AND RELATED ONLINE AND TELEPHONE SERVICES, NAMELY, RECORDING USERS' VOICE MESSAGES OVER THE PHONE AND INTERNET, ALLOWING PLAYBACK OF MESSAGES FROM THE USER OR OTHER USERS ON THE PHONE AND INTERNET, ALLOWING USERS TO ADD TEXT (SMS) COMMENTS ON THEIR PHONES OR ADD TEXT COMMENTS OVER THE INTERNET AND DISPLAY OF THESE COMMENTS OVER THE INTERNET ON THE USER'S PHONE, PROVIDING USERS ACCESS VIA A WEB-BASED SERVICE TO MESSAGES THEY HAVE SENT OR RECEIVED; PROVIDING USERS ACCESS TO AN ONLINE DATABASE FOR STORAGE OF INFORMATION ABOUT THEIR NETWORK OF CONTACTS; TELECOMMUNICATIONS SERVICES, NAMELY, PROVISION OF TELEPHONE CONFERENCING SERVICES OVER THE TELEPHONE AND OVER THE INTERNET (U.S. CLS. 100, 101 AND 104).

KATHY DE JONGE, EXAMINING ATTORNEY

CLASS 38—(Continued).

SN 77-054,020. ROCOCO SOFTWARE LTD., DUBLIN 2, IRELAND, FILED 11-30-2006.

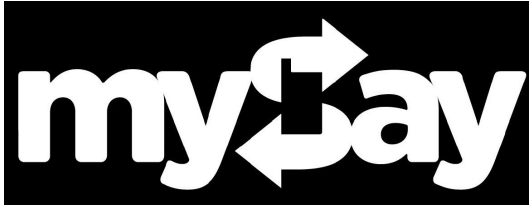

THE MARK CONSISTS OF THE STYLIZED WORD "MYSAY", WITH THE LETTERS "M" AND "Y" IN LOWER CASE, FOLLOWED BY A CAPITAL STYLIZED "S", THEN LOWER-CASE "A" AND "Y". THE TOP AND BOTTOM OF THE STYLIZED CAPITAL "S" INCORPORATE ARROWS, AND A SILHOUETTE OF A PHONE APPEARS OVER THE MIDDLE OF THE "S".

FOR TELECOMMUNICATIONS SERVICES, NAMELY, PROVIDING SERVICES FOR THE SIMULTANEOUS TRANSMISSION OF VOICE MESSAGES OVER THE TELEPHONE AND OVER THE INTERNET AND RELATED ONLINE AND TELEPHONE SERVICES, NAMELY, RECORDING USERS' VOICE MESSAGES OVER THE PHONE AND INTERNET, ALLOWING PLAYBACK OF MESSAGES FROM THE USER OR OTHER USERS ON THE PHONE AND INTERNET, ALLOWING USERS TO ADD TEXT (SMS) COMMENTS ON THEIR PHONES OR ADD TEXT COMMENTS OVER THE INTERNET AND DISPLAY OF THESE COMMENTS OVER THE INTERNET ON THE USER'S PHONE, PROVIDING USERS ACCESS VIA A WEB-BASED SERVICE TO MESSAGES THEY HAVE SENT OR RECEIVED; PROVIDING USERS ACCESS TO AN ONLINE DATABASE FOR STORAGE OF INFORMATION ABOUT THEIR NETWORK OF CONTACTS, TELECOMMUNICATIONS SERVICES, NAMELY, PROVISION OF TELEPHONE CONFERENCING SERVICES OVER THE TELEPHONE AND OVER THE INTERNET (U.S. CLS. 100, 101 AND 104).

KATHY DE JONGE, EXAMINING ATTORNEY

SN 77-115,374. JAZZ PHARMACEUTICALS, INC., PALO ALTO, CA. FILED 2-23-2007.



Jazz Pharmaceuticals

OWNER OF U.S. REG. NO. 3,005,004.

NO CLAIM IS MADE TO THE EXCLUSIVE RIGHT TO USE "PHARMACEUTICALS", APART FROM THE MARK AS SHOWN.

THE COLOR(S) PURPLE, GOLD AND WHITE IS/ARE CLAIMED AS A FEATURE OF THE MARK.

THE MARK CONSISTS OF THE WORDING JAZZ PHARMACEUTICALS IN THE COLOR PURPLE POSITIONED TO THE RIGHT OF A CIRCULAR LOGO WITH CONCENTRIC CIRCLES OF PURPLE AND WHITE CONTAINING A STYLIZED DEPICTION OF THE LETTERS JP IN THE COLOR WHITE WHICH VERTICALLY SPLITS THE CIRCLE SHOWING GOLD ON THE RIGHT PORTION AND PURPLE ON THE LEFT PORTION OF THE CIRCLE.

FOR PROVIDING ON-LINE COMMUNICATIONS LINKS WHICH TRANSFER THE WEBSITE USER TO OTHER LOCAL AND GLOBAL WEB PAGES; AND ON-LINE DOCUMENT DELIVERY VIA A GLOBAL COMPUTER NETWORK (U.S. CLS. 100, 101 AND 104).

FIRST USE 5-19-2004; IN COMMERCE 5-19-2004.

EMILY CHUO, EXAMINING ATTORNEY

CLASS 38—(Continued).

SN 77-115,643. BLUE HERON NETWORK, LLC, WYOMING, MI. FILED 2-25-2007.

Blue Heron Network

THE MARK CONSISTS OF STANDARD CHARACTERS WITHOUT CLAIM TO ANY PARTICULAR FONT, STYLE, SIZE, OR COLOR.

NO CLAIM IS MADE TO THE EXCLUSIVE RIGHT TO USE "NETWORK", APART FROM THE MARK AS SHOWN, FOR TRANSMISSION OF INFORMATION BY DATA COMMUNICATIONS FOR ASSISTING DECISION MAKING (U.S. CLS. 100, 101 AND 104).

AMOS T. MATTHEWS, JR., EXAMINING ATTORNEY

SN 77-118,122. YAPLET, LLC, ATLANTA, GA. FILED 2-28-2007.

YAPLET

THE MARK CONSISTS OF STANDARD CHARACTERS WITHOUT CLAIM TO ANY PARTICULAR FONT, STYLE, SIZE, OR COLOR.

FOR ELECTRONIC TRANSMISSION OF DATA, IMAGES, DOCUMENTS, AND SOUND VIA COMPUTER NETWORKS; PROVIDING ONLINE ELECTRONIC BULLETIN BOARDS AND CHAT ROOMS FOR TRANSMISSION OF MESSAGES AND GRAPHICS OF COMPUTER USERS CONCERNING A WIDE VARIETY OF USER-DIRECTED SUBJECTS; PROVIDING ONLINE COMPUTER NETWORK FACILITIES FOR REAL-TIME INTERACTION AND COMMUNICATION WITH OTHER COMPUTER USERS (U.S. CLS. 100, 101 AND 104).

FIRST USE 2-9-2007; IN COMMERCE 2-9-2007.

TRICIA SONNEBORN, EXAMINING ATTORNEY

SN 77-123,932. M. ILLIES ENTERPRISES, INC., CULVER CITY, CA. FILED 3-6-2007.

MONKEY DO GOOD

THE MARK CONSISTS OF STANDARD CHARACTERS WITHOUT CLAIM TO ANY PARTICULAR FONT, STYLE, SIZE, OR COLOR.

FOR INTERNET CAFE SERVICES, NAMELY, PROVIDING TELECOMMUNICATIONS CONNECTIONS TO THE INTERNET IN A CAFE ENVIRONMENT (U.S. CLS. 100, 101 AND 104).

JENNIFER VASQUEZ, EXAMINING ATTORNEY

CLASS 38—(Continued).

SN 77-124,758. ZONE TELECOM, INC., CHERRY HILL, NJ. FILED 3-7-2007.



NO CLAIM IS MADE TO THE EXCLUSIVE RIGHT TO USE "MOBILE", APART FROM THE MARK AS SHOWN. FOR MOBILE TELEPHONE COMMUNICATION (U.S. CLS. 100, 101 AND 104). FIRST USE 2-6-2007; IN COMMERCE 2-6-2007. MICHELE SWAIN, EXAMINING ATTORNEY

SN 77-127,743. BLUE HERON NETWORK, LLC, GRANDVILLE, MI. FILED 3-10-2007.

Reside@HOME

THE MARK CONSISTS OF STANDARD CHARACTERS WITHOUT CLAIM TO ANY PARTICULAR FONT, STYLE, SIZE, OR COLOR.

FOR PROVIDING MULTIPLE USE ACCESS TO GLOBAL COMPUTER INFORMATION NETWORKS FOR THE TRANSFER AND DISSEMINATION OF A WIDE RANGE OF INFORMATION (U.S. CLS. 100, 101 AND 104).

AMOS T. MATTHEWS, JR., EXAMINING ATTORNEY

SN 77-128,436. THE KNOT, INC., NEW YORK, NY. FILED 3-12-2007.

NESTIE

THE MARK CONSISTS OF STANDARD CHARACTERS WITHOUT CLAIM TO ANY PARTICULAR FONT, STYLE, SIZE, OR COLOR.

FOR PROVIDING ON-LINE CHAT ROOMS, ELECTRONIC BULLETIN BOARDS, AND ELECTRONIC FORUMS FOR THE TRANSMISSION OF MESSAGES AMONG COMPUTER USERS CONCERNING GENERAL INTEREST (U.S. CLS. 100, 101 AND 104).

BRIAN PINO, EXAMINING ATTORNEY

CLASS 38—(Continued).

SN 77-139,570. CONVERGENT MEDIA RESOURCES, LLC, WEST HARTFORD, CT. FILED 3-24-2007.

Splashnet

THE MARK CONSISTS OF STANDARD CHARACTERS WITHOUT CLAIM TO ANY PARTICULAR FONT, STYLE, SIZE, OR COLOR.

FOR BROADCAST OF CABLE TELEVISION PROGRAMMES; BROADCASTING PROGRAMS VIA A GLOBAL COMPUTER NETWORK; BROADCASTING SERVICES AND PROVISION OF TELECOMMUNICATION ACCESS TO VIDEO AND AUDIO CONTENT PROVIDED VIA A VIDEO-ON-DEMAND SERVICE VIA THE INTERNET; CABLE TELEVISION BROADCASTING; SATELLITE TELEVISION BROADCASTING; TELEVISION BROADCASTING; TELEVISION PROGRAMME BROADCASTING VIA CABLE; CELLULAR TELEPHONE COMMUNICATION; CELLULAR TELEPHONE SERVICES; MOBILE MEDIA AND ENTERTAINMENT SERVICES IN THE NATURE OF ELECTRONIC TRANSMISSION OF ENTERTAINMENT MEDIA CONTENT; WIRELESS COMMUNICATIONS SERVICES, NAMELY, TRANSMISSION OF GRAPHICS TO MOBILE TELEPHONES; SATELLITE, CABLE, NETWORK TRANSMISSION OF SOUNDS, IMAGES, SIGNALS AND DATA; SUBSCRIPTION TELEVISION BROADCASTING (U.S. CLS. 100, 101 AND 104).

LAURIE MAYES, EXAMINING ATTORNEY

SN 77-140,951. TIME WARNER ENTERTAINMENT-ADVANCE/NEWHOUSE PARTNERSHIP, ROCHESTER, NY. FILED 3-27-2007.

TWSN

THE MARK CONSISTS OF STANDARD CHARACTERS WITHOUT CLAIM TO ANY PARTICULAR FONT, STYLE, SIZE, OR COLOR.

FOR CABLE TELEVISION BROADCASTING SERVICES (U.S. CLS. 100, 101 AND 104).

FIRST USE 12-8-2006; IN COMMERCE 12-8-2006.

REBECCA EISINGER, EXAMINING ATTORNEY

CLASS 38—(Continued).

SN 77-144,294. LIU, JONATHAN, REDONDO BEACH, CA.
FILED 3-29-2007.

Wallet Pos

THE MARK CONSISTS OF STANDARD CHARACTERS WITHOUT CLAIM TO ANY PARTICULAR FONT, STYLE, SIZE, OR COLOR.

FOR COMMUNICATIONS VIA MULTINATIONAL TELECOMMUNICATION NETWORKS; DATA TRANSMISSION AND RECEPTION SERVICES VIA TELECOMMUNICATION MEANS; PROVIDING ACCESS TO TELECOMMUNICATION NETWORKS; TELECOMMUNICATIONS SERVICES, NAMELY, PERSONAL COMMUNICATION SERVICES (U.S. CLS. 100, 101 AND 104).
YAT SYE, LEE, EXAMINING ATTORNEY

SN 77-163,391. HOME BOX OFFICE, INC., NEW YORK, NY.
FILED 4-23-2007.

RUNAWAYBOX

THE MARK CONSISTS OF STANDARD CHARACTERS WITHOUT CLAIM TO ANY PARTICULAR FONT, STYLE, SIZE, OR COLOR.

FOR AUDIO AND VIDEO BROADCASTING SERVICES OVER THE INTERNET OR OTHER COMMUNICATIONS NETWORK, NAMELY, UPLOADING, POSTING, SHOWING, DISPLAYING, TAGGING AND ELECTRONICALLY TRANSMITTING INFORMATION, AUDIO, AND VIDEO CLIPS; PROVIDING MULTIPLE USE ACCESS TO GLOBAL COMPUTER INFORMATION NETWORKS, NAMELY, WEBSITES, ON-LINE FORUMS, CHAT ROOMS, LISTSERVICES AND BLOGS, FOR THE TRANSFER AND DISSEMINATION OF A WIDE RANGE OF INFORMATION; PROVIDING ON-LINE CHAT ROOMS AND ELECTRONIC BULLETIN BOARDS FOR TRANSMISSION OF MESSAGES AMONG USERS IN THE FIELD OF GENERAL INTEREST (U.S. CLS. 100, 101 AND 104).

LINDA E. BLOHM, EXAMINING ATTORNEY

CLASS 38—(Continued).

SN 77-177,745. KIJJI INTERNATIONAL LIMITED, DUBLIN 15, IRELAND, FILED 5-10-2007.

LOQUO

THE MARK CONSISTS OF STANDARD CHARACTERS WITHOUT CLAIM TO ANY PARTICULAR FONT, STYLE, SIZE, OR COLOR.

OWNER OF ERP N CMNTY TM OFC REG. NO. 004414157, DATED 4-19-2006, EXPIRES 4-29-2015.

THE WORDING "LOQUO" HAS NO MEANING IN ENGLISH.

FOR PROVIDING ONLINE INTERACTIVE BULLETIN BOARDS FOR TRANSMISSION OF MESSAGES AMONG USERS OF GLOBAL COMPUTER AND WIRELESS NETWORKS CONCERNING CLASSIFIED LISTINGS AND LISTINGS FOR ANNOUNCEMENTS, EVENTS, CLASSES, MEETINGS, ACTIVITIES, HOUSING, REAL ESTATE, ROOMMATES, RENTALS, FOR SALE ADVERTISEMENTS, WANT ADS, EMPLOYMENT, RESUMES, VOLUNTEERISM, SERVICES, COMMUNITY, PERSONALS, POLITICS, FAMILY, ARTS AND INFORMATION ON A WIDE VARIETY OF TOPICS OF GENERAL INTEREST TO THE PUBLIC; PROVIDING ON-LINE FORUMS AND DISCUSSION GROUPS FOR TRANSMISSION OF MESSAGES AMONG USERS OF GLOBAL COMPUTER AND WIRELESS NETWORKS CONCERNING HEALTH, FAMILY, ARTS, POLITICS, LEISURE, ROMANCE, WORK, AND INFORMATION ON A WIDE VARIETY OF TOPICS OF GENERAL INTEREST TO THE PUBLIC; AND ELECTRONIC TRANSMISSION OF MESSAGES, DATA AND IMAGES (U.S. CLS. 100, 101 AND 104).

JASON LOTT, EXAMINING ATTORNEY

SN 77-182,577. EBAGS.COM, GREENWOOD VILLAGE, CO.
FILED 5-16-2007.

BAGOPEDIA

THE MARK CONSISTS OF STANDARD CHARACTERS WITHOUT CLAIM TO ANY PARTICULAR FONT, STYLE, SIZE, OR COLOR.

FOR ELECTRONIC DATA TRANSMISSION OF INFORMATION IN THE FIELD OF LUGGAGE, HANDBAGS AND APPAREL VIA A GLOBAL COMPUTER NETWORK; INFORMATION TRANSMISSION IN THE FIELD OF LUGGAGE, HANDBAGS AND APPAREL VIA ELECTRONIC COMMUNICATIONS NETWORKS, PROVIDING ON-LINE FORUMS FOR TRANSMISSION OF MESSAGES AMONG COMPUTER USERS CONCERNING LUGGAGE, HANDBAGS AND APPAREL (U.S. CLS. 100, 101 AND 104).

STEVEN JACKSON, EXAMINING ATTORNEY

CLASS 38—(Continued).

SN 77-183,255. IPTV AMERICAS, LLC, MIAMI, FL. FILED 5-17-2007.



NO CLAIM IS MADE TO THE EXCLUSIVE RIGHT TO USE "IPTV AMERICAS", APART FROM THE MARK AS SHOWN.

THE COLOR(S) BLUE, YELLOW, ORANGE AND WHITE IS/ARE CLAIMED AS A FEATURE OF THE MARK.

THE MARK CONSISTS OF THE PHRASE "IPTV AMERICAS" WRITTEN IN STYLIZED WHITE LETTERING; THE LETTERS "IPTV" ARE ABOVE THE WORD "AMERICAS"; ON THE LEFT HAND SIDE OF THIS PHRASE THERE APPEARS AN ORANGE CURVY LINE AND THREE YELLOW CIRCLES; THE BACKGROUND IS IN BLUE .

FOR TELEVISION TRANSMISSION SERVICES USING INTERNET PROTOCOL TECHNOLOGIES; AND VIDEO ON-DEMAND TRANSMISSION SERVICES USING INTERNET PROTOCOL TECHNOLOGIES (U.S. CLS. 100, 101 AND 104).

FIRST USE 6-1-2006; IN COMMERCE 6-1-2006.
PATRICIA EVANKO, EXAMINING ATTORNEY

SN 77-190,813. SPC DIGITAL, INC., BIRMINGHAM, AL. FILED 5-25-2007.

MY HOME IDEAS

THE MARK CONSISTS OF STANDARD CHARACTERS WITHOUT CLAIM TO ANY PARTICULAR FONT, STYLE, SIZE, OR COLOR.

NO CLAIM IS MADE TO THE EXCLUSIVE RIGHT TO USE "HOME", APART FROM THE MARK AS SHOWN.

FOR STREAMING OF AUDIO AND VIDEO MATERIAL ON THE INTERNET AND THROUGH MOBILE COMMUNICATIONS DEVICES IN THE FIELDS OF HOMES, GARDENS, LANDSCAPING, HOME DESIGN, HOME DECORATING, HOME REMODELING, REAL ESTATE, AND LIFESTYLES (U.S. CLS. 100, 101 AND 104).

LYDIA BELZER, EXAMINING ATTORNEY

SN 77-191,119. YOUNBABBLE, INC., DELMAR, NY. FILED 5-25-2007.



THE COLOR(S) LIGHT BLUE, DARK BLUE, ORANGE, WHITE, GREY, BLACK IS/ARE CLAIMED AS A FEATURE OF THE MARK.

THE MARK CONSISTS OF A WHITE BACKGROUND OVER TO THE LEFT IS A TELEVISION WITH A THICK FRAME OF LIGHT BLUE AND DARK BLUE FADING

CLASS 38—(Continued).

INTO EACH OTHER, AND AN INNER ORANGE FRAME AROUND THE NAME "YOUNBABBLE.COM" WITH A WHITE BACKGROUND. EMANATING FROM THE TELEVISION IS THE PHRASE "EXPAND YOUR VOICE" IN BLACK LETTERS, WITH THE "EXPAND" HEADING DIAGONALLY UP AND TO THE RIGHT AND EMBOLDENED IN ORANGE, EACH LETTER GROWING LARGER AS IT COVERS THE DISTANCE BETWEEN THE TELEVISION AND THE TELEPHONE. THE "EXPAND" ALSO RIDES BLACK, GROWING WAVY LINES HEADING TO THE RIGHT. THE "YOUR VOICE" RUNS ALONG THE BOTTOM ENDING UNDER THE TELEPHONE ON THE FAR RIGHT. THE GRAY TELEPHONE ON THE RIGHT IS FRAMED BY LIGHT BLUE AND DARK BLUE FADING INTO EACH OTHER, HAS BLUE BUTTONS, AND A WHITE SCREEN WITH AN ORANGE SMILEY FACE WITH BLACK EYES AND MOUTH.

FOR TELEPHONE VOICE MESSAGING SERVICES; TRANSMISSION OF MESSAGES OVER ELECTRONIC MEDIA (U.S. CLS. 100, 101 AND 104).

FIRST USE 4-1-2007; IN COMMERCE 4-1-2007.
LAURA KOVALSKY, EXAMINING ATTORNEY

SN 77-193,084. AT&T KNOWLEDGE VENTURES II, L.P., RENO, NV. FILED 5-30-2007.

AT&T WORLDWIDE VALUE CALLING

THE MARK CONSISTS OF STANDARD CHARACTERS WITHOUT CLAIM TO ANY PARTICULAR FONT, STYLE, SIZE, OR COLOR.

OWNER OF U.S. REG. NOS. 1,296,936, 1,970,579 AND OTHERS.

NO CLAIM IS MADE TO THE EXCLUSIVE RIGHT TO USE "WORLDWIDE VALUE CALLING", APART FROM THE MARK AS SHOWN.

FOR LONG DISTANCE TELEPHONE COMMUNICATION SERVICES (U.S. CLS. 100, 101 AND 104).

FIRST USE 4-22-2007; IN COMMERCE 4-22-2007.
STEVEN JACKSON, EXAMINING ATTORNEY

SN 77-193,226. AT&T KNOWLEDGE VENTURES II, L.P., RENO, NV. FILED 5-30-2007.

AT&T WORLDWIDE OCCASIONAL CALLING

THE MARK CONSISTS OF STANDARD CHARACTERS WITHOUT CLAIM TO ANY PARTICULAR FONT, STYLE, SIZE, OR COLOR.

OWNER OF U.S. REG. NOS. 1,296,936, 1,970,579 AND OTHERS.

NO CLAIM IS MADE TO THE EXCLUSIVE RIGHT TO USE "WORLDWIDE OCCASIONAL CALLING", APART FROM THE MARK AS SHOWN.

FOR LONG DISTANCE TELEPHONE COMMUNICATION SERVICES (U.S. CLS. 100, 101 AND 104).

FIRST USE 4-22-2007; IN COMMERCE 4-22-2007.
STEVEN JACKSON, EXAMINING ATTORNEY

CLASS 38—(Continued).

SN 77-193,304. AT&T KNOWLEDGE VENTURES II, L.P., RENO, NV. FILED 5-30-2007.

AT&T INDIA 60 PLUS

THE MARK CONSISTS OF STANDARD CHARACTERS WITHOUT CLAIM TO ANY PARTICULAR FONT, STYLE, SIZE, OR COLOR.

OWNER OF U.S. REG. NOS. 1,296,936, 1,970,579 AND OTHERS.

NO CLAIM IS MADE TO THE EXCLUSIVE RIGHT TO USE "INDIA 60", APART FROM THE MARK AS SHOWN.

FOR LONG DISTANCE TELEPHONE COMMUNICATION SERVICES (U.S. CLS. 100, 101 AND 104).

FIRST USE 4-22-2007; IN COMMERCE 4-22-2007.
STEVEN JACKSON, EXAMINING ATTORNEY

SN 77-193,367. AT&T KNOWLEDGE VENTURES II, L.P., RENO, NV. FILED 5-30-2007.

AT&T ASIASAVER 60 PLUS PHILIPPINES

THE MARK CONSISTS OF STANDARD CHARACTERS WITHOUT CLAIM TO ANY PARTICULAR FONT, STYLE, SIZE, OR COLOR.

OWNER OF U.S. REG. NOS. 1,296,936, 1,970,579 AND OTHERS.

NO CLAIM IS MADE TO THE EXCLUSIVE RIGHT TO USE "60" AND "PHILIPPINES", APART FROM THE MARK AS SHOWN.

FOR LONG DISTANCE TELEPHONE COMMUNICATION SERVICES (U.S. CLS. 100, 101 AND 104).

FIRST USE 4-22-2007; IN COMMERCE 4-22-2007.
STEVEN JACKSON, EXAMINING ATTORNEY

SN 77-195,216. ATLANTA AUTO TRACKER, INC., MABLETON, GA. FILED 6-1-2007.

EliteTrak

THE MARK CONSISTS OF STANDARD CHARACTERS WITHOUT CLAIM TO ANY PARTICULAR FONT, STYLE, SIZE, OR COLOR.

FOR WIRELESS DATA COMMUNICATIONS SERVICES, NAMELY, PROVIDING GLOBAL POSITIONING SERVICES FOR VEHICLES TO A CENTRAL COMPUTER SYSTEM USING WIRELESS NETWORKS (U.S. CLS. 100, 101 AND 104).

LINDA E. BLOHM, EXAMINING ATTORNEY

CLASS 38—(Continued).

SN 77-207,090. TURNER BROADCASTING SYSTEM, INC., ATLANTA, GA. FILED 6-15-2007.

TRUST YOUR BRAND WITH PEOPLE WHO KNOW BRANDS

THE MARK CONSISTS OF STANDARD CHARACTERS WITHOUT CLAIM TO ANY PARTICULAR FONT, STYLE, SIZE, OR COLOR.

FOR TELECOMMUNICATION SERVICES, NAMELY, TELEVISION, CABLE TELEVISION, RADIO AND ON-LINE BROADCASTING SERVICES; INTERNET BROADCASTING SERVICES; DIGITAL TELEVISION BROADCASTING SERVICES; INTERACTIVE TELEVISION BROADCASTING SERVICES (U.S. CLS. 100, 101 AND 104).

FIRST USE 1-0-2006; IN COMMERCE 1-0-2006.
JASON LOTT, EXAMINING ATTORNEY

SN 77-223,633. TELEMUNDO OF LOS ANGELES, INC., BURBANK, CA. FILED 7-6-2007.



THE MARK CONSISTS OF COWGIRL NAMED LANITA, FOR TELEVISION BROADCASTING (U.S. CLS. 100, 101 AND 104).

ROSELLE HERRERA, EXAMINING ATTORNEY

SN 77-224,149. MAURY FRIEDMAN, AGOURA HILLS, CA. FILED 7-7-2007.

Zumbox

THE MARK CONSISTS OF STANDARD CHARACTERS WITHOUT CLAIM TO ANY PARTICULAR FONT, STYLE, SIZE, OR COLOR.

FOR PROVIDING ON-LINE ELECTRONIC BULLETIN BOARDS FOR TRANSMISSION OF MESSAGES AMONG COMPUTER USERS CONCERNING LOCAL NEWS, ACTIVITIES, AND EVENTS; ELECTRONIC MAIL SERVICES; ELECTRONIC TRANSMISSION OF MESSAGES AND DATA (U.S. CLS. 100, 101 AND 104).

JEAN IM, EXAMINING ATTORNEY

CLASS 38—(Continued).

SN 77-224,151. MAURY FRIEDMAN, AGOURA HILLS, CA.
FILED 7-7-2007.

Zumbuzz

THE MARK CONSISTS OF STANDARD CHARACTERS WITHOUT CLAIM TO ANY PARTICULAR FONT, STYLE, SIZE, OR COLOR.

FOR PROVIDING ON-LINE ELECTRONIC BULLETIN BOARDS FOR TRANSMISSION OF MESSAGES AMONG COMPUTER USERS CONCERNING LOCAL NEWS, ACTIVITIES, AND EVENTS; ELECTRONIC MAIL SERVICES; ELECTRONIC TRANSMISSION OF MESSAGES AND DATA (U.S. CLS. 100, 101 AND 104).

JEAN IM, EXAMINING ATTORNEY

SN 77-224,153. MAURY FRIEDMAN, AGOURA HILLS, CA.
FILED 7-7-2007.

Zummarket

THE MARK CONSISTS OF STANDARD CHARACTERS WITHOUT CLAIM TO ANY PARTICULAR FONT, STYLE, SIZE, OR COLOR.

FOR PROVIDING ON-LINE ELECTRONIC BULLETIN BOARDS FOR TRANSMISSION OF MESSAGES AMONG COMPUTER USERS CONCERNING LOCAL NEWS, ACTIVITIES, AND EVENTS; ELECTRONIC MAIL SERVICES; ELECTRONIC TRANSMISSION OF MESSAGES AND DATA (U.S. CLS. 100, 101 AND 104).

JEAN IM, EXAMINING ATTORNEY

SN 77-224,154. MAURY FRIEDMAN, AGOURA HILLS, CA.
FILED 7-7-2007.

ZumID

THE MARK CONSISTS OF STANDARD CHARACTERS WITHOUT CLAIM TO ANY PARTICULAR FONT, STYLE, SIZE, OR COLOR.

FOR PROVIDING ON-LINE ELECTRONIC BULLETIN BOARDS FOR TRANSMISSION OF MESSAGES AMONG COMPUTER USERS CONCERNING LOCAL NEWS, ACTIVITIES, AND EVENTS; ELECTRONIC MAIL SERVICES; ELECTRONIC TRANSMISSION OF MESSAGES AND DATA (U.S. CLS. 100, 101 AND 104).

JEAN IM, EXAMINING ATTORNEY

CLASS 38—(Continued).

SN 77-224,156. MAURY FRIEDMAN, AGOURA HILLS, CA.
FILED 7-7-2007.

Zumkey

THE MARK CONSISTS OF STANDARD CHARACTERS WITHOUT CLAIM TO ANY PARTICULAR FONT, STYLE, SIZE, OR COLOR.

FOR PROVIDING ON-LINE ELECTRONIC BULLETIN BOARDS FOR TRANSMISSION OF MESSAGES AMONG COMPUTER USERS CONCERNING LOCAL NEWS, ACTIVITIES, AND EVENTS; ELECTRONIC MAIL SERVICES; ELECTRONIC TRANSMISSION OF MESSAGES AND DATA (U.S. CLS. 100, 101 AND 104).

JEAN IM, EXAMINING ATTORNEY

SN 77-226,586. ICIM CORPORATION DBA PLANET TELECOM, NEW ALBANY, IN. FILED 7-11-2007.



NO CLAIM IS MADE TO THE EXCLUSIVE RIGHT TO USE CALL, APART FROM THE MARK AS SHOWN.

THE MARK CONSISTS OF A CIRCLE WITHIN A SWOOSH TO THE LEFT OF THE WORD CALL ON TOP OF THE WORD BLASTER.

FOR WEB-BASED TELEPHONE COMMUNICATION SERVICES; ELECTRONIC VOICE AND TEXT MESSAGING, NAMELY, THE RECORDING AND SUBSEQUENT TRANSMISSION OF AUTOMATED AND RECORDED VOICE MESSAGES, SCHEDULES, SURVEYS, AND TEXT MESSAGES BY TELEPHONE (U.S. CLS. 100, 101 AND 104).

FIRST USE 7-0-2006; IN COMMERCE 7-0-2006.

SUSAN STIGLITZ, EXAMINING ATTORNEY

CLASS 38—(Continued).

SN 77-236,621. SATURN TELECOMMUNICATION SERVICES, INC., DBA STS TELECOM, PEMBROKE PINES, FL. FILED 7-23-2007.

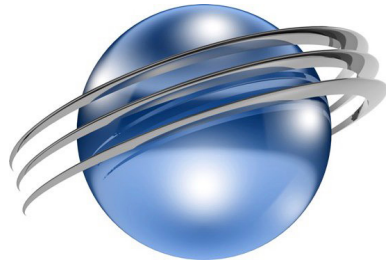

THE COLOR(S) BLUE, GRAY AND WHITE IS/ARE CLAIMED AS A FEATURE OF THE MARK.

THE MARK CONSISTS OF THREE GRAY RINGS CIRCLING A BLUE SPHERE WITH WHITE ACCENTS.

FOR TELECOMMUNICATION SERVICES, NAMELY, PROVIDING THE TRANSMISSION OF INFORMATION VIA ELECTRONIC COMMUNICATION NETWORKS AND CONVERGED NETWORKS, NAMELY, NATIONAL AND INTERNATIONAL NETWORKS; PROVIDING TELECOMMUNICATION SERVICES, NAMELY, PERSONAL COMMUNICATION SERVICES BY LINKING, ACCESSING, DISSEMINATING, COMMUNICATING AND SHARING INFORMATION VIA A GLOBAL COMMUNICATIONS NETWORK; VOICE OVER INTERNET PROTOCOL (VOIP) COMMUNICATION SERVICES, NAMELY, FIXED, WIRELESS AND MOBILE PHONE VOIP SERVICES (U.S. CLS. 100, 101 AND 104).

FIRST USE 4-0-2005; IN COMMERCE 4-0-2005.
MARY MUNSON, EXAMINING ATTORNEY

CLASS 38—(Continued).

SN 77-241,908. AGENCE FRANCE PRESSE, PARIS, FRANCE, FILED 7-30-2007.

NEWZWAG

THE MARK CONSISTS OF STANDARD CHARACTERS WITHOUT CLAIM TO ANY PARTICULAR FONT, STYLE, SIZE, OR COLOR.

FOR NEWS INFORMATION SERVICES, NAMELY, TRANSMISSION OF NEWS (U.S. CLS. 100, 101 AND 104).
MORGAN WYNNE, EXAMINING ATTORNEY

SN 77-256,678. TRIFECTA, INC., BOWIE, MD. FILED 8-16-2007.



SN 77-237,777. GONZALEZ HERNANDEZ RUBEN, GUADAJAJARA, MEXICO, FILED 7-24-2007.

IMMORTALITY BOOK

THE MARK CONSISTS OF STANDARD CHARACTERS WITHOUT CLAIM TO ANY PARTICULAR FONT, STYLE, SIZE, OR COLOR.

FOR COMMUNICATION SERVICES, NAMELY, ELECTRONIC TRANSMISSION OF DATA AND DOCUMENTS AMONG USERS OF COMPUTERS; COMPUTER AIDED TRANSMISSION OF INFORMATION AND IMAGES; ELECTRONIC MESSAGE TRANSMISSION; TRANSMISSION OF SOUND, PICTURE AND DATA SIGNALS; TRANSMISSION OF SOUND, VIDEO AND INFORMATION; VIDEO BROADCASTING (U.S. CLS. 100, 101 AND 104).

JULIE GUTTADAURO, EXAMINING ATTORNEY

THE COLOR(S) ORANGE, BLUE, GRAY AND WHITE IS/ARE CLAIMED AS A FEATURE OF THE MARK.

THE MARK CONSISTS OF THE WORDING "PLAYERSBLOCK"; THE WORD "PLAYERS" APPEARS IN ORANGE WITH AN ORANGE SHADOW EMANATING FROM THE BOTTOM OF EACH LETTER ONTO A WHITE BACKGROUND; THE WORD "BLOCK" APPEARS IN BLUE WITH A BLUE SHADOW EMANATING FROM THE BOTTOM OF EACH LETTER ONTO A WHITE BACKGROUND; TO THE LEFT OF THE TERM "PLAYERSBLOCK" ARE THREE HUMAN SILHOUETTES, THE TWO OUTER SILHOUETTES ARE DEPICTED IN GRAY WITH THEIR HANDS DOWN AND THE MIDDLE SILHOUETTE IS DEPICTED IN ORANGE WITH HANDS UP.

FOR PROVIDING ON-LINE FORUMS FOR TRANSMISSION OF MESSAGES AMONG COMPUTER USERS CONCERNING ALL SPORTS FOR JR. HIGH, HIGH SCHOOL, COLLEGE ATHLETES AND AGENTS THEREFOR (U.S. CLS. 100, 101 AND 104).

SHAILA SETTLES, EXAMINING ATTORNEY

CLASS 38—(Continued).

SN 77-258,014. CLEARWIRE CORPORATION, KIRKLAND, WA. FILED 8-17-2007.

CLASS 38—(Continued).

SN 77-270,566. NATIONAL FOOTBALL LEAGUE, NEW YORK, NY. FILED 9-4-2007.

PERSONAL BROADBAND

THE MARK CONSISTS OF STANDARD CHARACTERS WITHOUT CLAIM TO ANY PARTICULAR FONT, STYLE, SIZE, OR COLOR.

NO CLAIM IS MADE TO THE EXCLUSIVE RIGHT TO USE "BROADBAND", APART FROM THE MARK AS SHOWN.

FOR TELECOMMUNICATIONS SERVICES, NAMELY, PROVIDING HIGH-SPEED ACCESS TO COMPUTER AND COMMUNICATION NETWORKS, AND THE ELECTRONIC TRANSMISSION OF VOICE, VIDEO AND DATA VIA COMPUTER AND COMMUNICATION NETWORKS (U.S. CLS. 100, 101 AND 104).

RICHARD A. STRASER, EXAMINING ATTORNEY



SN 77-268,117. PAXFIRE, INC., HERNDON, VA. FILED 8-30-2007.



NO CLAIM IS MADE TO THE EXCLUSIVE RIGHT TO USE "GENERATING NEW REVENUE FOR NETWORK OPERATORS", APART FROM THE MARK AS SHOWN.

THE MARK CONSISTS OF A GRAPHICAL DEPICTION OF AN ELLIPTICAL SHAPE IMPACTING AND SURROUNDED BY A PORTION OF A WEB-LIKE STRUCTURE. THE WORD "PAXFIRE" APPEARS TO THE RIGHT OF THE DESIGN AND THE WORDING "GENERATING NEW REVENUE FOR NETWORK OPERATORS" APPEARS UNDER THE WORDING "PAXFIRE".

FOR TELECOMMUNICATION SERVICES, NAMELY, ELECTRONIC DATA RECEPTION AND TRANSMISSION VIA TELECOMMUNICATION MEANS; INTERNET COMMUNICATION SERVICES, NAMELY, ELECTRONIC DATA RECEPTION AND TRANSMISSION WITHIN AND AMONG COMPUTERS CONNECTED TO THE INTERNET (U.S. CLS. 100, 101 AND 104).

FIRST USE 4-9-2006; IN COMMERCE 4-9-2006.

JAY BESCH, EXAMINING ATTORNEY

OWNER OF U.S. REG. NOS. 886,055, 2,919,270 AND 3,138,589.

THE MARK CONSISTS OF A SHIELD CONTAINING THE STYLIZED LETTERS "NFL" WITHIN THE BOTTOM PORTION OF THE SHIELD, AND EIGHT STARS AND A FOOTBALL CONTAINED WITHIN THE TOP PORTION OF THE SHIELD.

FOR TELEVISION BROADCASTING SERVICES; TELEVISION TRANSMISSION SERVICES; DISTRIBUTION OF TELEVISION PROGRAMMING TO CABLE AND SATELLITE TELEVISION SYSTEMS; DISTRIBUTION OF TELEVISION PROGRAMS FOR OTHERS; CABLE TELEVISION BROADCASTING; RADIO BROADCASTING; BROADCASTING PROGRAMMING ON THE INTERNET; INFORMATION TRANSMISSION VIA ELECTRONIC COMMUNICATIONS NETWORKS; TRANSMISSION OF INFORMATION THROUGH VIDEO COMMUNICATION SYSTEMS; COMMUNICATION SERVICES, NAMELY, AUDIO AND VIDEO BROADCASTING; BROADCASTING SERVICES AND PROVISION OF TELECOMMUNICATION ACCESS TO VIDEO AND AUDIO CONTENT PROVIDED VIA A VIDEO ON DEMAND SERVICE VIA THE INTERNET AND TELEVISION; STREAMING OF AUDIO MATERIAL ON THE INTERNET; STREAMING OF VIDEO MATERIAL ON THE INTERNET; TELECOMMUNICATION SERVICES, NAMELY, TRANSMISSION OF PODCASTS; ELECTRONIC DELIVERY OF IMAGES AND PHOTOS VIA A GLOBAL COMPUTER NETWORK; PROVIDING MULTIPLE-USER ACCESS TO A GLOBAL COMPUTER INFORMATION NETWORK FOR THE PURPOSE OF PARTICIPATING IN INTERACTIVE POLLING IN THE FIELD OF FOOTBALL; WIRELESS COMMUNICATIONS SERVICES, NAMELY, TRANSMISSION OF TEXT, GRAPHICS, DATA, AND ENTERTAINMENT INFORMATION TO MOBILE PHONES; MOBILE MEDIA SERVICES IN THE NATURE OF ELECTRONIC TRANSMISSION OF ENTERTAINMENT MEDIA CONTENT (U.S. CLS. 100, 101 AND 104).

NAKWAMA ANKRAH, EXAMINING ATTORNEY

CLASS 38—(Continued).

SN 77-273,576. FRIEDMAN, MAURY, AGOURA HILLS, CA.
FILED 9-6-2007.

Be Neighborly

THE MARK CONSISTS OF STANDARD CHARACTERS WITHOUT CLAIM TO ANY PARTICULAR FONT, STYLE, SIZE, OR COLOR.

FOR PROVIDING ON-LINE ELECTRONIC BULLETIN BOARDS FOR TRANSMISSION OF MESSAGES AMONG COMPUTER USERS CONCERNING LOCAL NEWS, ACTIVITIES, AND EVENTS; ELECTRONIC MAIL SERVICES; ELECTRONIC TRANSMISSION OF MESSAGES AND DATA (U.S. CLS. 100, 101 AND 104).

JEAN IM, EXAMINING ATTORNEY

SN 77-278,936. WHATS2WATCH, LLC, EAST DENNIS, MA.
FILED 9-13-2007.

Whats2Watch

THE MARK CONSISTS OF STANDARD CHARACTERS WITHOUT CLAIM TO ANY PARTICULAR FONT, STYLE, SIZE, OR COLOR.

FOR (BASED ON USE IN COMMERCE) TELEVISION BROADCASTING INFORMATION (U.S. CLS. 100, 101 AND 104).

FIRST USE 8-1-2007; IN COMMERCE 9-13-2007.

FRANK LATTUCA, EXAMINING ATTORNEY

SN 77-287,577. ARNELL, MICHAEL, CAMERON PARK, CA.
FILED 9-24-2007.

WEBSYSTEM2

THE MARK CONSISTS OF STANDARD CHARACTERS WITHOUT CLAIM TO ANY PARTICULAR FONT, STYLE, SIZE, OR COLOR.

FOR INTERNET-BASED E-MAIL SERVICES, NAMELY, AUTOMATED FORWARDING VIA E-MAIL OF NEWSLETTERS, THANK-YOU E-MAILS, APPOINTMENT-REMINDER E-MAILS, ADVERTISING EMAILS AND OTHER NOTICES TO PATIENTS (U.S. CLS. 100, 101 AND 104).

FIRST USE 1-15-2001; IN COMMERCE 1-15-2001.

JULIE WATSON, EXAMINING ATTORNEY

CLASS 38—(Continued).

SN 77-289,805. ALIVELOOK HOLDINGS LLC., CENTREVILLE, VA. FILED 9-26-2007.



THE MARK CONSISTS OF THE WORDS "ALIVELOOK" IN STYLIZED TEXT. THERE IS AN EYE UNDERNEATH THE TEXT.

FOR WEB CASTING SERVICES (U.S. CLS. 100, 101 AND 104).

FIRST USE 5-16-2007; IN COMMERCE 7-30-2007.

KIMBERLY FRYE, EXAMINING ATTORNEY

SN 77-290,095. D. ROY ENTERPRISES, LLC, ATLANTA, GA.
FILED 9-27-2007.

SHAREFAM

THE MARK CONSISTS OF STANDARD CHARACTERS WITHOUT CLAIM TO ANY PARTICULAR FONT, STYLE, SIZE, OR COLOR.

FOR PROVIDING ONLINE CHAT ROOMS FOR REGISTERED USERS FOR TRANSMISSION OF MESSAGES CONCERNING FAMILY LIFE, CLASSIFIEDS, VIRTUAL COMMUNITY, AND SOCIAL NETWORKING (U.S. CLS. 100, 101 AND 104).

ESTHER A. BORSUK, EXAMINING ATTORNEY

SN 77-290,106. D. ROY ENTERPRISES, LLC, ATLANTA, GA.
FILED 9-27-2007.

WHERE FAMILIES CONNECT

THE MARK CONSISTS OF STANDARD CHARACTERS WITHOUT CLAIM TO ANY PARTICULAR FONT, STYLE, SIZE, OR COLOR.

FOR PROVIDING ONLINE CHAT ROOMS FOR REGISTERED USERS FOR TRANSMISSION OF MESSAGES CONCERNING FAMILY LIFE, CLASSIFIEDS, VIRTUAL COMMUNITY, AND SOCIAL NETWORKING (U.S. CLS. 100, 101 AND 104).

ESTHER A. BORSUK, EXAMINING ATTORNEY

CLASS 38—(Continued).

SN 77-291,156. HOBNOX, USA INC., WALTHAM, MA. FILED 9-28-2007.

hypershow

THE MARK CONSISTS OF STANDARD CHARACTERS WITHOUT CLAIM TO ANY PARTICULAR FONT, STYLE, SIZE, OR COLOR.

FOR BROADCASTING PROGRAMS VIA A GLOBAL COMPUTER NETWORK, ELECTRONIC DELIVERY OF IMAGES AND PHOTOGRAPHS VIA A GLOBAL COMPUTER NETWORK, TELECOMMUNICATION SERVICES, NAMELY, TRANSMISSION OF WEBCASTS, TRANSMISSION AND RECEPTION OF DATABASE INFORMATION VIA THE TELECOMMUNICATION NETWORK, TRANSMISSION OF DATA, SOUND AND IMAGES BY SATELLITE, TRANSMISSION OF DATABASE INFORMATION VIA TELECOMMUNICATIONS NETWORKS, TRANSMISSION OF INFORMATION BY ELECTRONIC COMMUNICATIONS NETWORKS, TRANSMISSION OF SOUND AND VISION VIA SATELLITE OR INTERACTIVE MULTIMEDIA NETWORKS, TRANSMISSION OF SOUND, PICTURE, DATA SIGNALS, VIDEO AND INFORMATION, WEB CASTING SERVICES, ELECTRONIC EXCHANGE OF DATA STORED IN DATABASES ACCESSIBLE VIA TELECOMMUNICATION NETWORKS, BROADCASTING SERVICES AND PROVISION OF TELECOMMUNICATION ACCESS TO FILMS AND TV PROGRAMMES PROVIDED VIA A VIDEO-ON-DEMAND SERVICE, BROADCASTING SERVICES AND PROVISION OF TELECOMMUNICATION ACCESS TO VIDEO AND AUDIO CONTENT PROVIDED VIA A VIDEO-ON-DEMAND SERVICE VIA A GLOBAL COMPUTER NETWORK, INFORMATION TRANSMISSION VIA ELECTRONIC COMMUNICATIONS NETWORKS, ELECTRONIC TRANSMISSION OF MESSAGES AND DATA, ELECTRONIC TRANSMISSION OF VOICE, DATA AND IMAGES BY TELEVISION AND VIDEO BROADCASTING, ELECTRONIC, ELECTRIC, AND DIGITAL TRANSMISSION OF VOICE, DATA, IMAGES, SIGNALS, AND MESSAGES (U.S. CLS. 100, 101 AND 104).

BRENDAN MCCAULEY, EXAMINING ATTORNEY

SN 77-292,894. TALKPATH LLC, LAS VEGAS, NV. FILED 10-1-2007.

Blast Dial

THE MARK CONSISTS OF STANDARD CHARACTERS WITHOUT CLAIM TO ANY PARTICULAR FONT, STYLE, SIZE, OR COLOR.

FOR NETWORK CONFERENCING SERVICES; PROVIDING TELEPHONE CONFERENCING SERVICES; WEB CONFERENCING SERVICES (U.S. CLS. 100, 101 AND 104).

FIRST USE 2-14-2003; IN COMMERCE 2-14-2003.
ELLEN PERKINS, EXAMINING ATTORNEY

CLASS 38—(Continued).

SN 77-293,155. PLAYBOY ENTERPRISES INTERNATIONAL, INC., CHICAGO, IL. FILED 10-1-2007.

SEE WHAT YOU WANT TO SEE

THE MARK CONSISTS OF STANDARD CHARACTERS WITHOUT CLAIM TO ANY PARTICULAR FONT, STYLE, SIZE, OR COLOR.

FOR SATELLITE TELEVISION BROADCASTING; VIDEO-ON-DEMAND TRANSMISSION SERVICES; TELEVISION TRANSMISSION SERVICES; TELEVISION BROADCASTING; CABLE TELEVISION TRANSMISSION; CABLE TELEVISION BROADCASTING; WIRELESS COMMUNICATIONS SERVICES, NAMELY, TRANSMISSION OF GRAPHICS TO MOBILE TELEPHONES; SUBSCRIPTION TELEVISION BROADCASTING (U.S. CLS. 100, 101 AND 104).

ALEXANDER L. POWERS, EXAMINING ATTORNEY

SN 77-293,251. TOKBOX, INC., STANFORD, CA. FILED 10-1-2007.



THE COLOR(S) BLACK, WHITE, GRAY AND BLUE IS/ARE CLAIMED AS A FEATURE OF THE MARK.

THE MARK CONSISTS OF THE TERM "TOKBOX" IN BLACK LETTERS, WITH THE SECOND LETTER "O" IN THE TERM APPEARING AS THE DESIGN OF THE LENS OR EYE OF A DIGITAL OR WEB CAMERA IN BLACK, WHITE AND GRAY. THE BACKGROUND OF THE MARK IS BLUE.

FOR REAL-TIME ONLINE VIDEO BROADCASTING AND CONFERENCING SERVICES, IN WHICH VIDEO AND AUDIO COMMUNICATIONS, MEDIA AND DATA ARE CAPABLE OF BEING EMBEDDED WITHIN WEB PAGES; TRANSMITTING REAL-TIME AND ASYNCHRONOUS VIDEO AND AUDIO COMMUNICATIONS, MEDIA AND DATA AMONG COMPUTER USERS (U.S. CLS. 100, 101 AND 104).

FIRST USE 4-1-2007; IN COMMERCE 4-1-2007.
KATINA MISTER, EXAMINING ATTORNEY

SN 77-293,774. RADIO ONE, INC., LANHAM, MD. FILED 10-2-2007.

WTLC

THE MARK CONSISTS OF STANDARD CHARACTERS WITHOUT CLAIM TO ANY PARTICULAR FONT, STYLE, SIZE, OR COLOR.

FOR RADIO BROADCASTING SERVICES (U.S. CLS. 100, 101 AND 104).

FIRST USE 12-31-1968; IN COMMERCE 12-31-1968.
TINA BROWN, EXAMINING ATTORNEY

CLASS 38—(Continued).

SN 77-294,177. WEAZ-FM RADIO, INC., BALA CYNWYD, PA. FILED 10-2-2007.

SONG TAGS

THE MARK CONSISTS OF STANDARD CHARACTERS WITHOUT CLAIM TO ANY PARTICULAR FONT, STYLE, SIZE, OR COLOR.
NO CLAIM IS MADE TO THE EXCLUSIVE RIGHT TO USE "SONG", APART FROM THE MARK AS SHOWN.
FOR RADIO BROADCASTING; RADIO BROADCASTING INFORMATION (U.S. CLS. 100, 101 AND 104).
FIRST USE 9-18-2007; IN COMMERCE 9-18-2007.
MARIA-VICTORIA SUAREZ, EXAMINING ATTORNEY

SN 77-294,198. ADVERTISING.COM, INC., BALTIMORE, MD. FILED 10-2-2007.

WE MAKE THE WORLD CLICK

THE MARK CONSISTS OF STANDARD CHARACTERS WITHOUT CLAIM TO ANY PARTICULAR FONT, STYLE, SIZE, OR COLOR.
FOR COMMUNICATIONS SERVICES, NAMELY, PROVIDING CUSTOMIZED E-MAIL MESSAGES FOR OTHERS, AND ISSUING REPORTS ON THE EFFECTIVENESS AND RESPONSE RATES FOR SUCH E-MAIL MESSAGES AS A COMPONENT SERVICE (U.S. CLS. 100, 101 AND 104).
NATALIE POLZER, EXAMINING ATTORNEY

SN 77-295,507. NEUTRON DYNAMIC SYSTEMS INC., CRESTON, CANADA, FILED 10-3-2007.

MISCHIEVIOUS

THE MARK CONSISTS OF STANDARD CHARACTERS WITHOUT CLAIM TO ANY PARTICULAR FONT, STYLE, SIZE, OR COLOR.
FOR PROVIDING STREAMING VIDEO CLIPS FEATURING ADULT ENTERTAINMENT VIA AN ONLINE SUBSCRIPTION SERVICE (U.S. CLS. 100, 101 AND 104).
CYNTHIA SLOAN, EXAMINING ATTORNEY

CLASS 38—(Continued).

SN 77-296,181. COLDSPARK INC., BROOMFIELD, CO. FILED 10-4-2007.

Your Business to the Power of Email

THE MARK CONSISTS OF STANDARD CHARACTERS WITHOUT CLAIM TO ANY PARTICULAR FONT, STYLE, SIZE, OR COLOR.
FOR DELIVERY OF MESSAGES BY ELECTRONIC TRANSMISSION (U.S. CLS. 100, 101 AND 104).
FIRST USE 10-4-2007; IN COMMERCE 10-4-2007.
RUSS HERMAN, EXAMINING ATTORNEY

SN 77-297,388. AT&T INTELLECTUAL PROPERTY II, L.P., RENO, NV. FILED 10-5-2007.

AT&T ALASCOM NATIONWIDE CALLING

THE MARK CONSISTS OF STANDARD CHARACTERS WITHOUT CLAIM TO ANY PARTICULAR FONT, STYLE, SIZE, OR COLOR.
OWNER OF U.S. REG. NOS. 1,298,084, 1,970,579 AND OTHERS.
NO CLAIM IS MADE TO THE EXCLUSIVE RIGHT TO USE "NATIONWIDE CALLING", APART FROM THE MARK AS SHOWN.
FOR LOCAL AND LONG DISTANCE TELEPHONE SERVICES (U.S. CLS. 100, 101 AND 104).
KAREN BRACEY, EXAMINING ATTORNEY

SN 77-297,405. AT&T INTELLECTUAL PROPERTY II, L.P., RENO, NV. FILED 10-5-2007.

AT&T ASIASAVER 60 PLUS PHILLIPPINES

THE MARK CONSISTS OF STANDARD CHARACTERS WITHOUT CLAIM TO ANY PARTICULAR FONT, STYLE, SIZE, OR COLOR.
OWNER OF U.S. REG. NOS. 1,298,084, 1,970,579 AND OTHERS.
NO CLAIM IS MADE TO THE EXCLUSIVE RIGHT TO USE "60 PLUS PHILIPPINES", APART FROM THE MARK AS SHOWN.
FOR LOCAL AND LONG DISTANCE TELEPHONE SERVICES (U.S. CLS. 100, 101 AND 104).
KAREN BRACEY, EXAMINING ATTORNEY

CLASS 38—(Continued).

SN 77-297,428. AT&T INTELLECTUAL PROPERTY II, L.P., RENO, NV. FILED 10-5-2007.

AT&T TOLL FREE 800

THE MARK CONSISTS OF STANDARD CHARACTERS WITHOUT CLAIM TO ANY PARTICULAR FONT, STYLE, SIZE, OR COLOR.

OWNER OF U.S. REG. NOS. 1,298,084, 1,970,579 AND OTHERS.

NO CLAIM IS MADE TO THE EXCLUSIVE RIGHT TO USE "TOLL FREE 800", APART FROM THE MARK AS SHOWN.

FOR LOCAL AND LONG DISTANCE TELEPHONE SERVICES (U.S. CLS. 100, 101 AND 104).

KAREN BRACEY, EXAMINING ATTORNEY

SN 77-297,439. AT&T INTELLECTUAL PROPERTY II, L.P., RENO, NV. FILED 10-5-2007.

AT&T UNIFIED WORLDWIDE CALLING

THE MARK CONSISTS OF STANDARD CHARACTERS WITHOUT CLAIM TO ANY PARTICULAR FONT, STYLE, SIZE, OR COLOR.

OWNER OF U.S. REG. NOS. 1,298,084, 1,970,579 AND OTHERS.

NO CLAIM IS MADE TO THE EXCLUSIVE RIGHT TO USE "UNIFIED WORLDWIDE CALLING", APART FROM THE MARK AS SHOWN.

FOR LOCAL AND LONG DISTANCE TELEPHONE SERVICES (U.S. CLS. 100, 101 AND 104).

KAREN BRACEY, EXAMINING ATTORNEY

SN 77-302,708. TRACFONE WIRELESS, INC., MIAMI, FL. FILED 10-12-2007.

SUPERSIZE THIS PURCHASE

THE MARK CONSISTS OF STANDARD CHARACTERS WITHOUT CLAIM TO ANY PARTICULAR FONT, STYLE, SIZE, OR COLOR.

FOR WIRELESS TELEPHONE TELECOMMUNICATIONS SERVICES PROVIDED VIA PREPAID TELEPHONE CALLING CARDS; PREPAID WIRELESS CELLULAR TELEPHONE SERVICES; WIRELESS TELEPHONE TELECOMMUNICATIONS SERVICES, NAMELY, PROVIDING PREPAID WIRELESS MOBILE TELEPHONE CALLING PLANS (U.S. CLS. 100, 101 AND 104).

MICHAEL GAAFAR, EXAMINING ATTORNEY

CLASS 38—(Continued).

SN 77-307,422. EBAY INC., SAN JOSE, CA. FILED 10-18-2007.

NEIGHBORHOODS

THE MARK CONSISTS OF STANDARD CHARACTERS WITHOUT CLAIM TO ANY PARTICULAR FONT, STYLE, SIZE, OR COLOR.

FOR PROVIDING AN ONLINE, INTERACTIVE BULLETIN BOARD FOR THE TRANSMISSION OF MESSAGES AMONG COMPUTER USERS CONCERNING HOBBIES, COLLECTIBLES, TRADING, AND THE SALE OF ITEMS VIA A GLOBAL COMPUTER NETWORK (U.S. CLS. 100, 101 AND 104).

LINDA MICKLEBURGH, EXAMINING ATTORNEY

SN 77-323,700. ACS MARKETING, L.P., DALLAS, TX. FILED 11-7-2007.

EXPERTISE IN ACTION

THE MARK CONSISTS OF STANDARD CHARACTERS WITHOUT CLAIM TO ANY PARTICULAR FONT, STYLE, SIZE, OR COLOR.

FOR TELECOMMUNICATION CONSULTATION IN THE NATURE OF TECHNICAL CONSULTING IN THE FIELD OF AUDIO, TEXT AND VISUAL DATA TRANSMISSION AND COMMUNICATION; PROVIDING MULTIPLE-USER ACCESS TO A GLOBAL COMPUTER INFORMATION NETWORK; TELECOMMUNICATION SERVICES, NAMELY, LOCAL AND LONG DISTANCE TRANSMISSION OF VOICE, DATA, GRAPHICS AND VIDEO BY MEANS OF BROADBAND, COPPER AND OPTICAL OR WIRELESS NETWORKS; TRANSMISSION OF VOICE, DATA, DOCUMENTS, IMAGES, SIGNALS, AND MESSAGES; ELECTRONIC MAIL SERVICES (U.S. CLS. 100, 101 AND 104).

COLLEEN DOMBROW, EXAMINING ATTORNEY

SN 78-858,304. SIMPSON, JOSEPH, JR., BEVERLY HILLS, CA. FILED 4-10-2006.

U GOT HEAT?

THE MARK CONSISTS OF STANDARD CHARACTERS WITHOUT CLAIM TO ANY PARTICULAR FONT, STYLE, SIZE, OR COLOR.

FOR AUDIO, VIDEO AND IMAGE BROADCASTING SERVICES OVER THE INTERNET; PROVIDING ACCESS TO DATABASES, AUDIO, IMAGES AND VIDEO VIA WEBSITES, ONLINE FORUMS, CHAT ROOMS, LISTSERV AND BLOGS OVER THE INTERNET; PROVIDING ON-LINE CHAT ROOMS AND ELECTRONIC BULLETIN BOARDS FOR TRANSMISSION OF MESSAGES AMONG USERS IN THE FIELD OF GENERAL INTEREST (U.S. CLS. 100, 101 AND 104).

DORITT L. CARROLL, EXAMINING ATTORNEY

CLASS 38—(Continued).

SN 78-956,327. SYNACOR, INC., BUFFALO, NY. FILED 8-21-2006.

Learning Edge

THE MARK CONSISTS OF STANDARD CHARACTERS WITHOUT CLAIM TO ANY PARTICULAR FONT, STYLE, SIZE, OR COLOR.

NO CLAIM IS MADE TO THE EXCLUSIVE RIGHT TO USE "LEARNING", APART FROM THE MARK AS SHOWN.

FOR PROVIDING ACCESS TO SUBSCRIPTION-BASED ELECTRONIC SITES CONTAINING EDUCATION REFERENCE MATERIALS FOR AGES PRE-SCHOOL THROUGH HIGH SCHOOL INCLUDING, ENCYCLOPEDIAS, STUDY GUIDES, LEARNING ACTIVITIES, TEST PREPARATION MATERIALS, AND OTHER REFERENCE MATERIALS (U.S. CLS. 100, 101 AND 104).

ANDREW RHIM, EXAMINING ATTORNEY

SN 79-047,204. PADO METAWARE AB, SE-904 20 UMEÅ, SWEDEN, FILED 8-17-2007.

OMNIPAD

OWNER OF INTERNATIONAL REGISTRATION 0946050 DATED 8-17-2007, EXPIRES 8-17-2017.

FOR PROVIDING ACCESS TO WEBSITES THROUGH PORTALS, NAMELY, PROVIDING MULTIPLE-USER ACCESS TO A GLOBAL COMPUTER INFORMATION NETWORK (U.S. CLS. 100, 101 AND 104).

SETH A. RAPPAPORT, EXAMINING ATTORNEY

CLASS 39—TRANSPORTATION AND STORAGE

SN 76-439,622. OCEAN WORLD LIMITED, HAMILTON HM 12, BERMUDA, FILED 8-9-2002.

POLO CLUB

NO CLAIM IS MADE TO THE EXCLUSIVE RIGHT TO USE "CLUB", APART FROM THE MARK AS SHOWN.

FOR ARRANGING AND CONDUCTING OCEAN CRUISE SERVICES FEATURING A MEMBERSHIP AND INCENTIVE REWARD PROGRAM FOR FREQUENT TRAVELERS (U.S. CLS. 100 AND 105).

FIRST USE 11-0-1993; IN COMMERCE 11-0-1993.

MARY ROSSMAN, EXAMINING ATTORNEY

CLASS 39—(Continued).

SN 76-599,868. TEAM AIR EXPRESS, INC., WINNSBORO, TX. FILED 6-28-2004.

TEAM INTERNATIONAL GLOBAL ALLIANCE

THE MARK CONSISTS OF STANDARD CHARACTERS WITHOUT CLAIM TO ANY PARTICULAR FONT, STYLE, SIZE, OR COLOR.

OWNER OF U.S. REG. NOS. 1,170,590, 2,581,666 AND OTHERS.

NO CLAIM IS MADE TO THE EXCLUSIVE RIGHT TO USE "INTERNATIONAL", "GLOBAL", AND "ALLIANCE", APART FROM THE MARK AS SHOWN.

FOR FREIGHT TRANSPORTATION BY LAND AND AIR (U.S. CLS. 100 AND 105).

STEVEN JACKSON, EXAMINING ATTORNEY

SN 76-678,382. DISTRIBUTED APPLICATIONS TECHNOLOGY, LLC., CLIFTON PARK, NY. FILED 6-18-2007.

SKYSPHERE

THE MARK CONSISTS OF STANDARD CHARACTERS WITHOUT CLAIM TO ANY PARTICULAR FONT, STYLE, SIZE, OR COLOR.

FOR COMPUTER DATA ARCHIVING AND STORAGE SERVICES, NAMELY, SECURE DATA STORAGE AND ARCHIVING SERVICES (U.S. CLS. 100 AND 105).

FIRST USE 5-1-2005; IN COMMERCE 5-1-2005.

PATRICIA EVANKO, EXAMINING ATTORNEY

SN 76-679,496. TRIPS2ITALY, LLC, HOUSTON, TX. FILED 7-13-2007.



FOR ARRANGING GUIDED, PACKAGED, AND PERSONALIZED TRAVEL TOURS; TRAVEL AGENCY, NAMELY, MAKING RESERVATIONS AND BOOKINGS FOR TRANSPORTATION; TRAVEL BOOKING AGENCIES (U.S. CLS. 100 AND 105).

FIRST USE 4-1-2004; IN COMMERCE 4-1-2004.

CHARLES L. JENKINS, EXAMINING ATTORNEY

CLASS 39—(Continued).

SN 77-039,062. GOOD NEWS GARAGE, BURLINGTON, VT. FILED 11-7-2006.



THE MARK CONSISTS OF A REPRESENTATION OF A CAR WITH AN ANIMATED FACE, WITH A STAR ON THE WINDSHIELD, AND THE LETTERS "GNG" WITHIN A RECTANGULAR BORDER ON THE FRONT OF THE CAR. FOR CHARITABLE SERVICES, NAMELY, PROVIDING REPAIRED AND RECONDITIONED CARS, TRUCKS AND VANS TO LOW INCOME FAMILIES (U.S. CLS. 100 AND 105).

KATHLEEN LORENZO, EXAMINING ATTORNEY

SN 77-100,011. GRAND CIRCLE LLC, BOSTON, MA. FILED 2-6-2007.

**GRAND CIRCLE SMALL SHIP
CRUISES**

THE MARK CONSISTS OF STANDARD CHARACTERS WITHOUT CLAIM TO ANY PARTICULAR FONT, STYLE, SIZE, OR COLOR.

OWNER OF U.S. REG. NO. 2,616,634.

NO CLAIM IS MADE TO THE EXCLUSIVE RIGHT TO USE "SMALL SHIP CRUISES", APART FROM THE MARK AS SHOWN.

FOR TRAVEL CLUBS, TRAVEL GUIDE SERVICES, TRAVEL INFORMATION SERVICES, ARRANGING TRAVEL TOURS, AND TRAVEL AGENCY SERVICES, NAMELY, MAKING RESERVATIONS AND BOOKINGS FOR TRANSPORTATION (U.S. CLS. 100 AND 105).

SETH A. RAPPAPORT, EXAMINING ATTORNEY

SN 77-125,373. CAROL'S TRAVEL SERVICE & CRUISE CENTER, INC., ORLAND PARK, IL. FILED 3-8-2007.

**CHICAGOLAND'S PREMIER
VACATION PLANNERS**

THE MARK CONSISTS OF STANDARD CHARACTERS WITHOUT CLAIM TO ANY PARTICULAR FONT, STYLE, SIZE, OR COLOR.

SEC. 2(F).

FOR COORDINATING TRAVEL ARRANGEMENTS FOR INDIVIDUALS AND FOR GROUPS; TRAVEL BOOKING AGENCIES (U.S. CLS. 100 AND 105).

FIRST USE 2-1-2000; IN COMMERCE 2-1-2000.

BRENDAN MCCAULEY, EXAMINING ATTORNEY

CLASS 39—(Continued).

SN 77-129,864. 1-800-JACKPOT, INC., KANSAS CITY, MO. FILED 3-13-2007.

1800JACKPOT

THE MARK CONSISTS OF STANDARD CHARACTERS WITHOUT CLAIM TO ANY PARTICULAR FONT, STYLE, SIZE, OR COLOR.

FOR PROVIDING TRAVEL INFORMATION; PROVIDING INFORMATION IN THE FIELDS OF MOTOR VEHICLE, BOATS AND PLANES LEASING AND SHARING SERVICES; PROVIDING LINKS TO THE WEBSITES OF OTHERS FEATURING TRAVEL, TRAVEL SERVICES, TRAVEL ACCOMMODATIONS, AND LEASING AND SHARING SERVICES OF MOTOR VEHICLE, BOATS AND PLANES (U.S. CLS. 100 AND 105).

LESLEY LAMOTHE, EXAMINING ATTORNEY

SN 77-130,872. 4REFUEL CANADA LTD, LANGLEY, CANADA, FILED 3-14-2007.

4Refuel

THE LEADER IN FUEL MANAGEMENT

NO CLAIM IS MADE TO THE EXCLUSIVE RIGHT TO USE "FOR REFUEL" AND "THE LEADER IN FUEL MANAGEMENT", APART FROM THE MARK AS SHOWN.

THE MARK CONSISTS OF THE MARK "4REFUEL" APPEARS ABOVE THE SLOGAN "THE LEADER IN FUEL MANAGEMENT" IN STYLIZED FONT.

FOR DELIVERY OF GOODS BY TRUCK; TRANSPORTATION AND STORAGE OF FUELS; TANKER TRANSPORT (U.S. CLS. 100 AND 105).

ELISSA GARBER KON, EXAMINING ATTORNEY

SN 77-136,593. PERRY-DALE, NANCY, GRESHAM, OR. FILED 3-21-2007.

OPERATION SAFE DOG

THE MARK CONSISTS OF STANDARD CHARACTERS WITHOUT CLAIM TO ANY PARTICULAR FONT, STYLE, SIZE, OR COLOR.

NO CLAIM IS MADE TO THE EXCLUSIVE RIGHT TO USE "DOG", APART FROM THE MARK AS SHOWN.

FOR LOANING AND RENTAL OF LIFE JACKETS FOR ANIMALS (U.S. CLS. 100 AND 105).

FIRST USE 6-30-2007; IN COMMERCE 6-30-2007.

DEZMONA MIZELLE, EXAMINING ATTORNEY

CLASS 39—(Continued).

SN 77-137,232. ALL GUESTS WELCOME, LLC, CHICAGO, IL. FILED 3-21-2007.

All Guests Welcome

THE MARK CONSISTS OF STANDARD CHARACTERS WITHOUT CLAIM TO ANY PARTICULAR FONT, STYLE, SIZE, OR COLOR.

FOR PROVIDING AN ON-LINE COMPUTER DATABASE IN THE FIELD OF TRAVEL INFORMATION SERVICES; PROVIDING LINKS TO WEB SITES OF OTHERS FEATURING TRAVEL; PROVIDING REVIEWS OF TRAVEL SERVICE PROVIDERS; TRAVEL INFORMATION SERVICES; TRAVEL AND TOUR INFORMATION SERVICE; TRAVEL GUIDE SERVICES (U.S. CLS. 100 AND 105).

FIRST USE 11-17-2006; IN COMMERCE 1-21-2007.
PAULA MAYS, EXAMINING ATTORNEY

SN 77-142,557. UNITED PARCEL SERVICE OF AMERICA, INC., ATLANTA, GA. FILED 3-28-2007.

UPS FTZ FACILITATOR

THE MARK CONSISTS OF STANDARD CHARACTERS WITHOUT CLAIM TO ANY PARTICULAR FONT, STYLE, SIZE, OR COLOR.

OWNER OF U.S. REG. NOS. 2,867,999, 2,868,000 AND 3,188,289.

NO CLAIM IS MADE TO THE EXCLUSIVE RIGHT TO USE "FTZ FACILITATOR", APART FROM THE MARK AS SHOWN.

FOR FREIGHT FORWARDING; TRANSPORTATION OF PASSENGERS AND/OR GOODS BY AIR, RAIL, BOAT, AND MOTOR VEHICLE; SHIPPING AND DELIVERY SERVICES, NAMELY, PICKUP, TRANSPORTATION, AND DELIVERY OF PACKAGES AND LETTERS BY VARIOUS MODES OF TRANSPORTATION; WAREHOUSING SERVICES, NAMELY, STORAGE, DISTRIBUTION, PICK-UP, PACKING, AND SHIPPING OF PERSONAL PROPERTY; SUPPLY CHAIN, LOGISTICS AND REVERSE LOGISTICS SERVICES, NAMELY, STORAGE, TRANSPORTATION AND DELIVERY OF DOCUMENTS, PACKAGES, RAW MATERIALS, AND OTHER FREIGHT FOR OTHERS BY AIR, RAIL, SHIP OR TRUCK (U.S. CLS. 100 AND 105).

LINDA E. BLOHM, EXAMINING ATTORNEY

CLASS 39—(Continued).

SN 77-149,318. GLOBUS-GATEWAY LTD. INC., TERCER PISO, PANAMA, FILED 4-5-2007.

GET MORE VACATION FROM YOUR VACATION

THE MARK CONSISTS OF STANDARD CHARACTERS WITHOUT CLAIM TO ANY PARTICULAR FONT, STYLE, SIZE, OR COLOR.

FOR TRAVEL SERVICES, NAMELY, TRAVEL AGENCY AND TRAVEL RESERVATION SERVICES, NAMELY, ARRANGING FOR TRAVEL VISAS, PASSPORTS AND TRAVEL DOCUMENTS FOR TRAVELERS, ARRANGING TRAVEL TOURS AND COORDINATING TRAVEL ARRANGEMENTS FOR INDIVIDUALS AND FOR GROUPS, ARRANGING, CONDUCTING, AND ESCORTING OF EXCURSIONS, SIGHTSEEING TOURS, HOLIDAYS, BOAT, CAR, AND BUS TRIPS, TOURS AND TRAVEL, MAKING RESERVATIONS AND BOOKINGS FOR TRANSPORTATION AND TOURS; PROVIDING INFORMATION ON TRAVEL AND TOURS; TRAVEL GUIDE SERVICES; CRUISE SHIP SERVICES; MAKING RESERVATIONS AND BOOKINGS FOR CRUISES; RIVER CRUISES; SEA CRUISES; BOOKING OF CABINS ON BOATS AND SHIPS; VEHICLE RENTALS; WATERCRAFT RENTALS; TRANSPORTATION OF TRAVELERS, FREIGHT, AND BAGGAGE BY AIR, BOAT, RAIL, AND BUS (U.S. CLS. 100 AND 105).

AISHA SALEM, EXAMINING ATTORNEY

SN 77-165,311. UNITED PARCEL SERVICE OF AMERICA, INC., ATLANTA, GA. FILED 4-25-2007.

UPS PAPERLESS

THE MARK CONSISTS OF STANDARD CHARACTERS WITHOUT CLAIM TO ANY PARTICULAR FONT, STYLE, SIZE, OR COLOR.

OWNER OF U.S. REG. NOS. 966,774, 2,520,558 AND OTHERS.

NO CLAIM IS MADE TO THE EXCLUSIVE RIGHT TO USE "PAPERLESS", APART FROM THE MARK AS SHOWN.

FOR FREIGHT FORWARDING; SHIPPING AND DELIVERY SERVICES, NAMELY, PICKUP, TRANSPORTATION, AND DELIVERY OF PACKAGES AND LETTERS BY VARIOUS MODES OF TRANSPORTATION; SUPPLY CHAIN, LOGISTICS AND REVERSE LOGISTICS SERVICES, NAMELY, STORAGE, TRANSPORTATION AND DELIVERY OF DOCUMENTS, PACKAGES, RAW MATERIALS, AND OTHER FREIGHT FOR OTHERS BY AIR, RAIL, SHIP OR TRUCK; TRANSPORTATION OF PASSENGERS AND/OR GOODS BY AIR, RAIL, BOAT, AND MOTOR VEHICLE; WAREHOUSING SERVICES, NAMELY, STORAGE, DISTRIBUTION, PICK-UP, AND PACKING FOR SHIPMENT OF DOCUMENTS, PACKAGES, RAW MATERIALS, AND OTHER FREIGHT FOR OTHERS (U.S. CLS. 100 AND 105).

LINDA E. BLOHM, EXAMINING ATTORNEY

CLASS 39—(Continued).

SN 77-176,342. COSMOS EUROPEAN TRAVELS AKTIENGESELLSCHAFT, VADUZ FUSTENTUM, LIECHTENSTEIN, FILED 5-9-2007.

TURNING TRAVEL DREAMS INTO
REALITY

THE MARK CONSISTS OF STANDARD CHARACTERS WITHOUT CLAIM TO ANY PARTICULAR FONT, STYLE, SIZE, OR COLOR.

FOR TRAVEL SERVICES, NAMELY, TRAVEL AGENCY AND TRAVEL RESERVATION SERVICES, NAMELY, ARRANGING FOR TRAVEL VISAS, PASSPORTS AND TRAVEL DOCUMENTS FOR TRAVELERS, ARRANGING TRAVEL TOURS AND COORDINATING TRAVEL ARRANGEMENTS FOR INDIVIDUALS AND FOR GROUPS, ARRANGING, CONDUCTING, AND ESCORTING OF EXCURSIONS, SIGHTSEEING TOURS, HOLIDAYS, BOAT, CAR, AND BUS TRIPS, TOURS AND TRAVEL, MAKING RESERVATIONS AND BOOKINGS FOR TRANSPORTATION AND TOURS; PROVIDING INFORMATION ON TRAVEL AND TOURS; TRAVEL GUIDE SERVICES; CRUISE SHIP SERVICES; MAKING RESERVATIONS AND BOOKINGS FOR CRUISES; RIVER CRUISES; SEA CRUISES; BOOKING OF CABINS ON BOATS AND SHIPS; VEHICLE RENTALS; WATERCRAFT RENTALS; TRANSPORTATION OF TRAVELERS, FREIGHT, AND BAGGAGE BY AIR, BOAT, RAIL, AND BUS (U.S. CLS. 100 AND 105).

DORITT L. CARROLL, EXAMINING ATTORNEY

CLASS 39—(Continued).

SN 77-203,501. NEW WAY GROUP, LTD. D/B/A IMPERIAL RIVER CRUISES, EAST NORWICH, NY. FILED 6-12-2007.



NO CLAIM IS MADE TO THE EXCLUSIVE RIGHT TO USE "RIVER CRUISES", APART FROM THE MARK AS SHOWN.

THE COLOR(S) GOLD AND BLUE IS/ARE CLAIMED AS A FEATURE OF THE MARK.

THE MARK CONSISTS OF THE GOLD LETTERS IR INTERSECTED BY THE STYLIZED BLUE LETTER C. THE TERM IMPERIAL RIVER IS IN BLUE WITH THE TERM CRUISES IN GOLD AND BELOW THE LETTERS IR.

FOR TRAVEL AGENCY SERVICES, NAMELY, ARRANGING RIVER CRUISES TO TOUR OPERATORS, WHOLESALE COMPANY TOUR AGENTS, AND PRIVATE CLIENTS (U.S. CLS. 100 AND 105).

FIRST USE 1-26-2006; IN COMMERCE 1-26-2006.
BENJAMIN ALLEN, EXAMINING ATTORNEY

SN 77-183,120. ECO-EDGE, LLC, CHANDLER, AZ. FILED 5-16-2007.

IMPROVING PROFITS -
REDUCING ENVIRONMENTAL
IMPACT

THE MARK CONSISTS OF STANDARD CHARACTERS WITHOUT CLAIM TO ANY PARTICULAR FONT, STYLE, SIZE, OR COLOR.

FOR DISTRIBUTION SERVICES, NAMELY, DELIVERY OF ENVIRONMENTAL AND EFFICIENCY PRODUCTS, NAMELY, COMBUSTION CATALYST SYSTEMS, DIESEL POWER KITS, AND FUEL AND OIL FILTRATION SYSTEMS, BY TRUCK, AIR AND SHIP (U.S. CLS. 100 AND 105).

RICHARD A. STRASER, EXAMINING ATTORNEY

SN 77-208,867. CROWN MELBOURNE LIMITED, SOUTH-BANK, MELBOURNE, AUSTRALIA, FILED 6-18-2007.

CROWN

THE MARK CONSISTS OF STANDARD CHARACTERS WITHOUT CLAIM TO ANY PARTICULAR FONT, STYLE, SIZE, OR COLOR.

FOR TRAVEL AND TOUR TICKET RESERVATION SERVICES; ARRANGING TRAVEL TOURS; TRAVEL AND TOUR INFORMATION SERVICES (U.S. CLS. 100 AND 105).

FIRST USE 1-31-1994; IN COMMERCE 7-31-2002.
CYNTHIA SLOAN, EXAMINING ATTORNEY

CLASS 39—(Continued).

SN 77-237,138. MCFADYEN, GRAHAM, GLASGOW, UNITED KINGDOM, FILED 7-24-2007.



NO CLAIM IS MADE TO THE EXCLUSIVE RIGHT TO USE "24 EXPRESS WORLD DELIVERY", APART FROM THE MARK AS SHOWN.

THE COLOR(S) PURPLE, ORANGE AND GRAY IS/ARE CLAIMED AS A FEATURE OF THE MARK.

THE MARK CONSISTS OF THE NUMBER "24" IN PURPLE, ABOVE THE WORD "XPRESS" IN ORANGE ABOVE THE WORDING "WORLD DELIVERY" AND "THE WORLD IN 24 HOURS" ALL IN GRAY.

FOR GLOBAL TRANSPORTATION OF FREIGHT FOR OTHERS BY ALL AVAILABLE MEANS (U.S. CLS. 100 AND 105).

JAMES LOVELACE, EXAMINING ATTORNEY

CLASS 39—(Continued).

SN 77-246,545. COLLETTE TRAVEL SERVICE, INC., PAW-TUCKET, RI. FILED 8-3-2007.

COLLETTE VACATIONS. OUR PEOPLE. YOUR WORLD.

THE MARK CONSISTS OF STANDARD CHARACTERS WITHOUT CLAIM TO ANY PARTICULAR FONT, STYLE, SIZE, OR COLOR.

OWNER OF U.S. REG. NOS. 2,112,973, 2,696,164 AND OTHERS.

NO CLAIM IS MADE TO THE EXCLUSIVE RIGHT TO USE "VACATIONS", APART FROM THE MARK AS SHOWN.

FOR ARRANGING TRAVEL TOURS; COORDINATING TRAVEL ARRANGEMENTS FOR INDIVIDUALS AND FOR GROUPS; ORGANIZATION OF EXCURSIONS, SIGHTSEEING TOURS, HOLIDAYS, TOURS AND TRAVEL; TRAVEL AGENCY SERVICES, NAMELY, MAKING RESERVATIONS AND BOOKINGS FOR TRANSPORTATION; TRAVEL BOOKING AGENCIES (U.S. CLS. 100 AND 105).

FIRST USE 8-1-2007; IN COMMERCE 8-1-2007.

NELSON SNYDER, EXAMINING ATTORNEY

SN 77-271,652. IMPACT LOGISTICS, INC., FORMERLY D & D LOADING SERVICE, INC., CORDOVA, TN. FILED 9-5-2007.

IMPACT LOGISTICS

THE MARK CONSISTS OF STANDARD CHARACTERS WITHOUT CLAIM TO ANY PARTICULAR FONT, STYLE, SIZE, OR COLOR.

NO CLAIM IS MADE TO THE EXCLUSIVE RIGHT TO USE "LOGISTICS", APART FROM THE MARK AS SHOWN.

FOR TRANSPORT OF GOODS, NAMELY, LOADING AND UNLOADING CONTAINERS, TRAILERS AND RAILCARS (U.S. CLS. 100 AND 105).

FIRST USE 1-1-2002; IN COMMERCE 1-1-2002.

MICHELE SWAIN, EXAMINING ATTORNEY

SN 77-239,509. KRANA ENTERPRISES INC., DBA TRAVEL DYNAMICS INTERNATIONAL, NEW YORK, NY. FILED 7-26-2007.

TRAVEL DYNAMICS INTERNATIONAL

THE MARK CONSISTS OF STANDARD CHARACTERS WITHOUT CLAIM TO ANY PARTICULAR FONT, STYLE, SIZE, OR COLOR.

OWNER OF U.S. REG. NO. 2,448,904.

NO CLAIM IS MADE TO THE EXCLUSIVE RIGHT TO USE "TRAVEL" AND "INTERNATIONAL", APART FROM THE MARK AS SHOWN.

FOR TRAVEL BOOKING SERVICES; ARRANGING AND CONDUCTING CRUISES, TOURS AND VACATIONS (U.S. CLS. 100 AND 105).

FIRST USE 6-0-2002; IN COMMERCE 6-0-2002.

ANN E. SAPPENFIELD, EXAMINING ATTORNEY

SN 77-280,668. GEMINI ORGANICS INC., DENVER, CO. FILED 9-16-2007.

Gemini Organics

THE MARK CONSISTS OF STANDARD CHARACTERS WITHOUT CLAIM TO ANY PARTICULAR FONT, STYLE, SIZE, OR COLOR.

NO CLAIM IS MADE TO THE EXCLUSIVE RIGHT TO USE "ORGANICS", APART FROM THE MARK AS SHOWN.

FOR FLOWER DELIVERY; FOOD DELIVERY (U.S. CLS. 100 AND 105).

KAPIL BHANOT, EXAMINING ATTORNEY

CLASS 39—(Continued).

SN 77-285,659. LAND SPAN, INC., ATLANTA, GA. FILED 9-21-2007.



OWNER OF U.S. REG. NOS. 1,474,526 AND 2,604,244.
NO CLAIM IS MADE TO THE EXCLUSIVE RIGHT TO USE "INC.", APART FROM THE MARK AS SHOWN.
THE COLOR(S) RED, BLUE AND WHITE IS/ARE CLAIMED AS A FEATURE OF THE MARK.

THE MARK CONSISTS OF THE WORDS "LAND SPAN INC" IN A STYLIZED FORMAT IN COMBINATION WITH A DESIGN OF TWO PARALLEL LINES. "LAND SPAN" IS IN RED. "INC" IS IN WHITE AND THE PARALLEL LINE DESIGN IS IN BLUE.

FOR TRUCK FREIGHT TRANSPORTATION SERVICES (U.S. CLS. 100 AND 105).

FIRST USE 0-0-2002; IN COMMERCE 0-0-2002.
CURTIS FRENCH, EXAMINING ATTORNEY

SN 77-287,249. RENT-A-CENTER WEST, INC., PLANO, TX. FILED 9-24-2007.

RAC WORRY FREE GUARANTEE

THE MARK CONSISTS OF STANDARD CHARACTERS WITHOUT CLAIM TO ANY PARTICULAR FONT, STYLE, SIZE, OR COLOR.

OWNER OF U.S. REG. NO. 3,161,654.

NO CLAIM IS MADE TO THE EXCLUSIVE RIGHT TO USE "GUARANTEE", APART FROM THE MARK AS SHOWN.

FOR RENTAL, LEASING, LEASE PURCHASING AND RENTAL-TO-OWN OF HOME APPLIANCES, NAMELY, FREEZERS AND REFRIGERATORS (U.S. CLS. 100 AND 105).

JILL C. ALT, EXAMINING ATTORNEY

SN 77-288,267. WORLD MARKET CENTER VENTURE, LLC, LAS VEGAS, NV. FILED 9-25-2007.

WMC

THE MARK CONSISTS OF STANDARD CHARACTERS WITHOUT CLAIM TO ANY PARTICULAR FONT, STYLE, SIZE, OR COLOR.

FOR TRAVEL AGENCY SERVICES, NAMELY, MAKING RESERVATIONS AND BOOKING FOR TRANSPORTATION (U.S. CLS. 100 AND 105).

FIRST USE 4-1-2001; IN COMMERCE 4-1-2001.

ARETHA SOMERVILLE, EXAMINING ATTORNEY

CLASS 39—(Continued).

SN 77-288,688. KESHISHYAN, HAKOP, LOS ANGELES, CA. FILED 9-25-2007.



OWNER OF U.S. REG. NO. 3,255,415.

NO CLAIM IS MADE TO THE EXCLUSIVE RIGHT TO USE "RENT-A-CAR" AND "EXOTIC & LUXURY COLLECTION", APART FROM THE MARK AS SHOWN.

THE COLOR(S) BLACK, WHITE AND RED IS/ARE CLAIMED AS A FEATURE OF THE MARK.

THE MARK CONSISTS OF THE LETTERS "PM" IN BLACK WITHIN A BLACK CIRCLE FOLLOWED BY THE WORD "PLATINUM" WITH THE WORDS "RENT-A-CAR" IN BLACK UNDERNEATH THE WORD "PLATINUM"; THE WORDS "EXOTIC & LUXURY COLLECTION" ARE IN RED UNDERNEATH THE WORDS "RENT-A-CAR".

FOR VEHICLE RENTAL AND LEASING SERVICES (U.S. CLS. 100 AND 105).

KEVIN DINALLO, EXAMINING ATTORNEY

SN 77-293,837. JLINE, INC., DBA JLINE TRANSPORTATION, RIVERSIDE, RI. FILED 10-2-2007.

The logo for Jline TRANSPORTATION features the word "Jline" in a large, bold, red, sans-serif font. The letter "J" is significantly larger and extends downwards. Below "Jline", the word "TRANSPORTATION" is written in a smaller, bold, red, sans-serif font.

NO CLAIM IS MADE TO THE EXCLUSIVE RIGHT TO USE "TRANSPORTATION", APART FROM THE MARK AS SHOWN.

THE COLOR(S) RED IS/ARE CLAIMED AS A FEATURE OF THE MARK.

THE MARK CONSISTS OF COMPANY NAME, "JLINE TRANSPORTATION", IN RED LETTERS WITH THE "JLINE" IN LARGE LETTERS, THE "L" EXTENDING UNDER THE "INE". THE WORD "TRANSPORTATION" APPEARS UNDER "JLINE" IN SMALLER LETTERS.

FOR FREIGHT TRANSPORTATION BY TRACTOR TRAILER (U.S. CLS. 100 AND 105).

FIRST USE 1-15-1985; IN COMMERCE 1-15-1985.

DAWN FELDMAN, EXAMINING ATTORNEY

CLASS 39—(Continued).

SN 77-302,473. CARGILL, INCORPORATED, WAYZATA, MN. FILED 10-12-2007.



OWNER OF U.S. REG. NOS. 798,187, 808,227 AND OTHERS.

THE COLOR(S) RED, WHITE, BLACK IS/ARE CLAIMED AS A FEATURE OF THE MARK.

THE MARK CONSISTS OF RED OUTLINED CIRCULAR PATTERN COMING TO A POINT AT THE TOP AND BOTTOM WITH A WHITE COLOR INSIDE THE CIRCULAR PATTERN AND "AGWAY" WRITTEN IN BLACK IN THE MIDDLE OF THE CIRCULAR PATTERN.

FOR FARM DELIVERY SERVICE OF FEED, FERTILIZER, SEED, PESTICIDES, AND MISCELLANEOUS FARM SUPPLIES (U.S. CLS. 100 AND 105).

FIRST USE 3-5-1964; IN COMMERCE 3-5-1964.
BRENDAN REGAN, EXAMINING ATTORNEY

SN 77-310,671. OILTANKING HOUSTON, L.P., HOUSTON, TX. FILED 10-23-2007.

OILTANKING

THE MARK CONSISTS OF STANDARD CHARACTERS WITHOUT CLAIM TO ANY PARTICULAR FONT, STYLE, SIZE, OR COLOR.

OWNER OF U.S. REG. NO. 2,195,977.

SEC. 2(F).

FOR STORING REFINED FUELS, PETROLEUM, AND PETROCHEMICALS IN TANK FACILITIES; TRANSPORTING REFINED FUELS, PETROLEUM, AND PETROCHEMICALS BY PIPELINE (U.S. CLS. 100 AND 105).

FIRST USE 7-26-1976; IN COMMERCE 12-16-1977.
STEVEN JACKSON, EXAMINING ATTORNEY

SN 77-323,707. ACS MARKETING, L.P., DALLAS, TX. FILED 11-7-2007.

EXPERTISE IN ACTION

THE MARK CONSISTS OF STANDARD CHARACTERS WITHOUT CLAIM TO ANY PARTICULAR FONT, STYLE, SIZE, OR COLOR.

FOR ELECTRONIC, ELECTRIC, AND DIGITAL STORAGE OF VOICE MESSAGES, DATA, DOCUMENTS, IMAGES, SIGNALS, AND MESSAGES (U.S. CLS. 100 AND 105).

COLLEEN DOMBROW, EXAMINING ATTORNEY

CLASS 39—(Continued).

SN 77-975,134. NATIONAL AIR CARGO, INC., ORCHARD PARK, NY. FILED 6-20-2007.



OWNER OF U.S. REG. NOS. 2,285,270 AND 2,852,727.
NO CLAIM IS MADE TO THE EXCLUSIVE RIGHT TO USE "AIR CARGO", APART FROM THE MARK AS SHOWN.

THE MARK CONSISTS OF THE LITERAL ELEMENT "NATIONAL AIR CARGO" WITH A SOLID PARALLELOGRAM.

SEC. 2(F) AS TO "NATIONAL".

FOR DOMESTIC AND INTERNATIONAL CARGO AIR TRANSPORTATION SERVICES; CARGO AIR TRANSPORTATION SERVICES; FREIGHT FORWARDING SERVICES; TRANSPORTATION LOGISTICS SERVICES, NAMELY, ARRANGING FOR THE DOMESTIC AND INTERNATIONAL PICK-UP, STORAGE, TRANSPORTATION AND DELIVERY OF CARGO FOR OTHERS (U.S. CLS. 100 AND 105).

FIRST USE 6-0-2004; IN COMMERCE 6-0-2004.
ZHALEH DELANEY, EXAMINING ATTORNEY

SN 78-906,649. GENERAL AVIATION FLYING SERVICE, INC., DBA MERIDIAN AIR CHARTER, TETERBORO, NJ. FILED 6-13-2006.



NO CLAIM IS MADE TO THE EXCLUSIVE RIGHT TO USE "AIR CHARTER", APART FROM THE MARK AS SHOWN.

THE MARK CONSISTS OF GLOBE CONTAINING CONTINENTS, MERIDIANS AND PARALLELS WITH AN AIRPLANE WHICH APPEARS TO FLY FROM OUT OF THE GLOBE.

FOR PRIVATE PASSENGER AIRPLANE CHARTERING (U.S. CLS. 100 AND 105).

FIRST USE 1-11-2004; IN COMMERCE 1-11-2004.
CHARLES L. JENKINS, EXAMINING ATTORNEY

CLASS 39—(Continued).

SN 78-943,408. EELLS, JEFF, LINCOLN, NE. AND EELLS, DEREK, LINCOLN, NE. FILED 8-2-2006.



NO CLAIM IS MADE TO THE EXCLUSIVE RIGHT TO USE "CORPORATE TRAVEL", APART FROM THE MARK AS SHOWN.

FOR CONSULTING IN THE FIELD OF TRAVEL PLANNING; ARRANGING FOR TRAVEL VISAS, PASSPORTS AND TRAVEL DOCUMENTS FOR PERSONS TRAVELING ABROAD; ARRANGING TRAVEL TOURS; ARRANGING TRAVEL TOURS AS A BONUS PROGRAM FOR CREDIT CARDS CUSTOMERS; COORDINATING TRAVEL ARRANGEMENTS FOR INDIVIDUALS AND FOR GROUPS; ORGANIZATION OF TRAVEL; ORGANIZATION OF EXCURSIONS, SIGHTSEEING TOURS, HOLIDAYS, TOURS AND TRAVEL; ORGANIZATION OF TRAVEL AND BOAT TRIPS; TRAVEL AGENCY SERVICES, NAMELY, MAKING RESERVATIONS AND BOOKINGS FOR TRANSPORTATION; TRAVEL AND TOUR TICKET RESERVATION SERVICE; TRAVEL BOOKING AGENCIES; TRAVEL DEMAND MANAGEMENT SERVICE, NAMELY, PROVIDING CUSTOMIZED DRIVING INSTRUCTIONS THROUGH USE OF AN ON-LINE PARKING RESERVATION SYSTEM; TRAVEL, EXCURSION AND CRUISE ARRANGEMENT (U.S. CLS. 100 AND 105).

FIRST USE 1-1-2005; IN COMMERCE 1-9-2005.
MARY MUNSON, EXAMINING ATTORNEY

CLASS 40—(Continued).

SN 77-068,996. CAST-RITE CORPORATION, GARDENA, CA. FILED 12-20-2006.



NO CLAIM IS MADE TO THE EXCLUSIVE RIGHT TO USE "INTERNATIONAL DIE CASTING, INC.", APART FROM THE MARK AS SHOWN.

THE COLOR(S) RED AND BLUE IS/ARE CLAIMED AS A FEATURE OF THE MARK.

THE MARK CONSISTS OF A RED GLOBE AND BLUE LETTERING.

FOR DIE CASTING (U.S. CLS. 100, 103 AND 106).
FIRST USE 8-1-2006; IN COMMERCE 8-1-2006.
TASNEEM HUSSAIN, EXAMINING ATTORNEY

SN 77-088,002. BLUE CROSS AND BLUE SHIELD OF KANSAS CITY, KANSAS CITY, MO. FILED 1-22-2007.

HEARTLAND CARD SERVICES

THE MARK CONSISTS OF STANDARD CHARACTERS WITHOUT CLAIM TO ANY PARTICULAR FONT, STYLE, SIZE, OR COLOR.

NO CLAIM IS MADE TO THE EXCLUSIVE RIGHT TO USE "CARD SERVICES", APART FROM THE MARK AS SHOWN.

FOR PRINTING SERVICES, NAMELY, PRINTING ON PLASTIC CARDS (U.S. CLS. 100, 103 AND 106).
ANDREA BUTLER, EXAMINING ATTORNEY

CLASS 40—MATERIAL TREATMENT

SN 76-676,942. TRIPLE A CONTAINERS, INC., CERRITOS, CA. FILED 5-16-2007.

WE PACKAGE YOUR SUCCESS

THE MARK CONSISTS OF STANDARD CHARACTERS WITHOUT CLAIM TO ANY PARTICULAR FONT, STYLE, SIZE, OR COLOR.

FOR MANUFACTURE OF CORRUGATED CARDBOARD, WOOD, FOAM PACKAGING AND CORRUGATED CARDBOARD PALLETS TO THE ORDER AND/OR SPECIFICATION OF OTHERS (U.S. CLS. 100, 103 AND 106).

MIDGE BUTLER, EXAMINING ATTORNEY

SN 77-095,986. OFFICE PAPER SYSTEMS, INC., GAITHERSBURG, MD. FILED 1-31-2007.

OFFICE PAPER SYSTEMS

THE MARK CONSISTS OF STANDARD CHARACTERS WITHOUT CLAIM TO ANY PARTICULAR FONT, STYLE, SIZE, OR COLOR.

SEC. 2(F).
FOR DOCUMENT DESTRUCTION SERVICES AND RECYCLING SERVICES (U.S. CLS. 100, 103 AND 106).
FIRST USE 6-0-1990; IN COMMERCE 6-0-1990.
TEJBIR SINGH, EXAMINING ATTORNEY

CLASS 40—(Continued).

SN 77-118,162. INDUSTRIA PROCESADORA DE ALIMENTOS DE MAIZ, S.A. DE C.V., TIJUANA, MEXICO, FILED 2-28-2007.



OWNER OF MEXICO REG. NO. 921705, DATED 2-27-2006, EXPIRES 1-7-2015.

NO CLAIM IS MADE TO THE EXCLUSIVE RIGHT TO USE "ELABORADAS CON EL PROCESO TRADICIONAL" AND "TORTILLAS DE MAIZ", APART FROM THE MARK AS SHOWN.

THE MARK CONSISTS OF THE PHRASE "ELABORADAS CON EL PROCESO TRADICIONAL" IN THE UPPER PART OF THE DESIGN, AND UNDER THIS AN OVAL WITH A FIELD AS BACKGROUND, ON THE FRONT A BARN, UNDER THIS OVAL A BANNER THAT READS "LOS PINOS" AND UNDER THIS BANNER THE WORDS "TORTILLAS DE MAIZ".

THE FOREIGN WORDING IN THE MARK TRANSLATES INTO ENGLISH AS "ELABORATED WITH THE TRADITIONAL PROCESS CORN TORTILLAS".

FOR FOOD PROCESSING, NAMELY, MAKING OF CORN TORTILLAS (U.S. CLS. 100, 103 AND 106).
MORGAN WYNNE, EXAMINING ATTORNEY

CLASS 40—(Continued).

SN 77-160,932. NHK OF AMERICA SUSPENSION COMPONENTS INC., BOWLING GREEN, KY. FILED 4-19-2007.



OWNER OF U.S. REG. NOS. 1,585,517 AND 2,514,471. NO CLAIM IS MADE TO THE EXCLUSIVE RIGHT TO USE "AMERICA SUSPENSION COMPONENTS INC.", APART FROM THE MARK AS SHOWN.

THE MARK CONSISTS OF A STYLIZED LETTER "N" IN A RECTANGLE WITH THE WORDING "NASCO NHK OF AMERICA SUSPENSION COMPONENTS INC.".

FOR MANUFACTURING SERVICES FOR OTHERS IN THE FIELD OF AUTOMOTIVE SUSPENSION COMPONENTS (U.S. CLS. 100, 103 AND 106).

FIRST USE 6-30-2005; IN COMMERCE 6-30-2005.
JAMES A. RAUEN, EXAMINING ATTORNEY

SN 77-120,861. 6356036 CANADA INC., MONTREAL, CANADA, FILED 3-2-2007.



NO CLAIM IS MADE TO THE EXCLUSIVE RIGHT TO USE "TWELVE OUNCE", APART FROM THE MARK AS SHOWN.

THE COLOR(S) BLUE, WHITE, AND BLACK IS/ARE CLAIMED AS A FEATURE OF THE MARK.

THE MARK CONSISTS OF A BLUE STYLIZED LETTER "T" WITH A SMALL WHITE STYLIZED LETTER "T" CROSSING OVER THE BOTTOM OF THE BLUE "T" WITH THE WORDS TWELVE OUNCE IN WHITE HORIZONTALLY ACROSS THE MIDDLE OF THE TWO "T"'S AND THE COLOR BLACK APPEARING IN THE RECTANGLE AND BACKGROUND.

FOR CUSTOM MANUFACTURE OF CLOTHING AND TEXTILES (U.S. CLS. 100, 103 AND 106).
FIRST USE 6-30-2005; IN COMMERCE 6-30-2005.
SALLY SHIH, EXAMINING ATTORNEY

SN 77-180,847. CHINOOK SCIENCE GROUP CORPORATION, CRANFORD, NJ. FILED 5-14-2007.

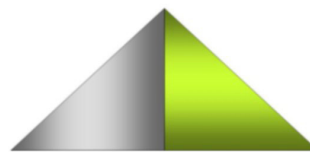

THE COLOR(S) GREY AND GREEN IS/ARE CLAIMED AS A FEATURE OF THE MARK.

THE MARK CONSISTS OF AN ISOSCELES TRIANGLE. THE RIGHT HALF OF THE DESIGN IS IN GRADIENT SHADES OF GREEN. THE LEFT SIDE OF THE DESIGN IS IN GRADIENT SHADES OF GREY.

FOR METAL RECLAMATION SERVICES; WASTE-TO-ENERGY GENERATION SERVICES (U.S. CLS. 100, 103 AND 106).
FIRST USE 4-27-2007; IN COMMERCE 4-27-2007.
PAULA MAHONEY, EXAMINING ATTORNEY

CLASS 40—(Continued).

SN 77-220,886. RIVERWOODS MILL, INC., ST. GEORGE, UT.
FILED 7-2-2007.

RIVERWOODS MILL

THE MARK CONSISTS OF STANDARD CHARACTERS WITHOUT CLAIM TO ANY PARTICULAR FONT, STYLE, SIZE, OR COLOR.

NO CLAIM IS MADE TO THE EXCLUSIVE RIGHT TO USE "MILL", APART FROM THE MARK AS SHOWN.

FOR CUSTOM WOODWORKING AND MILLWORKING SERVICES, NAMELY, MANUFACTURE OF CUSTOM MADE WOOD CABINETS, MOLDINGS, DOORS, WINDOW FRAMES AND OTHER WOOD PRODUCTS FOR HOME DÉCOR (U.S. CLS. 100, 103 AND 106).

FIRST USE 12-31-1997; IN COMMERCE 12-31-1997.
RICHARD WHITE, EXAMINING ATTORNEY

SN 77-223,495. L'AVANT GARDE, INC., SIMI VALLEY, CA.
FILED 7-6-2007.

TECHNOLOGY EMBRACING NATURE

THE MARK CONSISTS OF STANDARD CHARACTERS WITHOUT CLAIM TO ANY PARTICULAR FONT, STYLE, SIZE, OR COLOR.

FOR CONTRACT MANUFACTURING IN THE FIELD OF HAIR CARE PRODUCTS (U.S. CLS. 100, 103 AND 106).

FIRST USE 6-3-2007; IN COMMERCE 6-3-2007.
PRISCILLA MILTON, EXAMINING ATTORNEY

SN 77-223,973. RIVERWOODS MILL, INC., ST. GEORGE, UT.
FILED 7-6-2007.

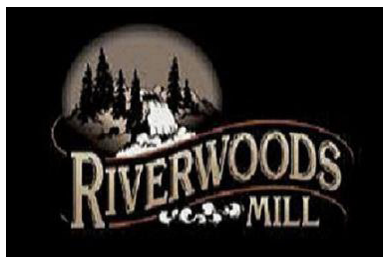

NO CLAIM IS MADE TO THE EXCLUSIVE RIGHT TO USE "MILL", APART FROM THE MARK AS SHOWN.

THE COLOR(S) BLACK, WHITE, BROWN AND TAN IS/ARE CLAIMED AS A FEATURE OF THE MARK.

"THE COLOR BLACK APPEARS IN THE TREES, ACCENTS ON THE HILL DESIGN, OUTLINING ON THE

CLASS 40—(Continued).

WATERFALL DESIGN AND THE OVERALL BACKGROUND: THE COLOR WHITE APPEARS IN THE WATERFALL DESIGN AND THE FLORAL DESIGN UNDER THE TERM RIVERWOODS AND TO THE LEFT OF THE TERM MILL; THE COLOR BROWN APPEARS AS THE BACKGROUND DIRECTLY BEHIND THE TREES, WATERFALL AND HILL DESIGN AND IN THE HILL DESIGN ITSELF AND THE UNDERLINING AND OVERLINING SURROUNDING THE TERM RIVERWOODS; THE COLOR TAN APPEARS IN THE TERMS RIVERWOODS AND MILL."

FOR CUSTOM WOODWORKING AND MILLWORKING SERVICES, NAMELY, MANUFACTURE OF CUSTOM MADE WOOD CABINETS, MOLDINGS, DOORS, WINDOW FRAMES AND OTHER WOOD PRODUCTS FOR HOME DÉCOR (U.S. CLS. 100, 103 AND 106).

FIRST USE 12-31-1997; IN COMMERCE 12-31-1997.
RICHARD WHITE, EXAMINING ATTORNEY

SN 77-234,640. CATHERINE M. MASI AND LAURA M. TURNER PARTNERSHIP, THE, DBA VENUS LOVES JUPITER, SANTA BARBARA, CA. FILED 7-20-2007.



THE MARK CONSISTS OF STYLIZED USE OF LETTERING FOR "VENUS LOVES JUPITER" WITH A LOTUS FLOWER DESIGN TO REPRESENT THE "O" IN THE WORD "LOVE" IN "VENUS LOVES JUPITER".

FOR IMPRINTING MESSAGES ON T-SHIRTS (U.S. CLS. 100, 103 AND 106).

ALICIA COLLINS, EXAMINING ATTORNEY

SN 77-238,683. CASELLA WASTE SYSTEMS, INC., RUTLAND, VT. FILED 7-25-2007.

CASELLA

THE MARK CONSISTS OF STANDARD CHARACTERS WITHOUT CLAIM TO ANY PARTICULAR FONT, STYLE, SIZE, OR COLOR.

SEC. 2(F).

FOR WASTE MANAGEMENT SERVICES, WASTE TREATMENT SERVICES, WASTE PROCESSING, COMPOSTING AND RECYCLING; GREEN POWER GENERATION SERVICES; CONSULTING SERVICES IN THE FIELD OF WASTE RECYCLING AND MANAGEMENT (U.S. CLS. 100, 103 AND 106).

FIRST USE 6-1-1983; IN COMMERCE 6-1-1983.

FLORENTINA BLANDU, EXAMINING ATTORNEY

CLASS 40—(Continued).

SN 77-256,451. SOUTHERN CALIFORNIA GRAPHICS, CULVER CITY, CA. FILED 8-15-2007.

Service Without Boundaries

THE MARK CONSISTS OF STANDARD CHARACTERS WITHOUT CLAIM TO ANY PARTICULAR FONT, STYLE, SIZE, OR COLOR.
FOR LITHOGRAPHIC PRINTING (U.S. CLS. 100, 103 AND 106).
FIRST USE 1-5-2007; IN COMMERCE 3-2-2007.
KIMBERLY FRYE, EXAMINING ATTORNEY

SN 77-266,550. EBS CARBON, INC., BOULDER, CO. FILED 8-28-2007.



NO CLAIM IS MADE TO THE EXCLUSIVE RIGHT TO USE "CARBON INC", APART FROM THE MARK AS SHOWN.
THE MARK CONSISTS OF THE CHARACTERS "EBS" ENCLOSED BY AN OVAL FOLLOWED BY THE TERMS "CARBON INC" IN STYLIZED CHARACTERS.
FOR CUSTOM MANUFACTURE OF COMPOSITE MOLDED PARTS FOR USE IN INDUSTRY (U.S. CLS. 100, 103 AND 106).
FIRST USE 4-1-2005; IN COMMERCE 4-1-2005.
SAMUEL E. SHARPER JR., EXAMINING ATTORNEY

SN 77-266,768. SABIN, JOHN, PATERSON, NJ. FILED 8-29-2007.



THE COLOR(S) GRAY, RED AND BLACK IS/ARE CLAIMED AS A FEATURE OF THE MARK.
THE COLOR BLACK APPEARS IN THE WORDING "END PEDOPHILIA NOW! PEDOPHILIACS NOT WELCOME". THE COLOR RED APPEARS IN LETTER "R" THAT APPEARS BETWEEN THE "P" AND "E" IN THE WORDING "PEDOPHILIA" AND THE LETTER "R" APPEARING BETWEEN "P" AND "E" IN "PEDOPHILIACS". THE COLOR GRAY APPEARS ON THE SWAN DESIGN. NO COLOR CLAIMED FOR THE BACKGROUND.
FOR IMPRINTING MESSAGES ON WEARING APPAREL, ACCESSORIES AND MUGS (U.S. CLS. 100, 103 AND 106).
LINDA ESTRADA, EXAMINING ATTORNEY

CLASS 40—(Continued).

SN 77-282,815. TRADEWIND ENERGY, LLC, LENEXA, KS. FILED 9-18-2007.

HARVESTING THE POWER OF THE WIND

THE MARK CONSISTS OF STANDARD CHARACTERS WITHOUT CLAIM TO ANY PARTICULAR FONT, STYLE, SIZE, OR COLOR.
FOR UTILITY SERVICES, NAMELY, PRODUCTION AND GENERATION OF RENEWABLE ENERGY (U.S. CLS. 100, 103 AND 106).
MICHAEL LITZAU, EXAMINING ATTORNEY

SN 77-286,780. DLA INDUSTRIES INC., NUTLEY, NJ. FILED 9-24-2007.

Sourcing the World Made Simple

THE MARK CONSISTS OF STANDARD CHARACTERS WITHOUT CLAIM TO ANY PARTICULAR FONT, STYLE, SIZE, OR COLOR.
NO CLAIM IS MADE TO THE EXCLUSIVE RIGHT TO USE "SOURCING", APART FROM THE MARK AS SHOWN.
FOR MANUFACTURE OF PLASTICS, METALS AND ELECTRONIC SUB-ASSEMBLIES TO ORDER AND/OR SPECIFICATION OF OTHERS (U.S. CLS. 100, 103 AND 106).
FIRST USE 9-21-2007; IN COMMERCE 9-21-2007.
CURTIS FRENCH, EXAMINING ATTORNEY

SN 77-287,277. RENT-A-CENTER WEST, INC., PLANO, TX. FILED 9-24-2007.

RAC WORRY FREE GUARANTEE

THE MARK CONSISTS OF STANDARD CHARACTERS WITHOUT CLAIM TO ANY PARTICULAR FONT, STYLE, SIZE, OR COLOR.
OWNER OF U.S. REG. NO. 3,161,654.
NO CLAIM IS MADE TO THE EXCLUSIVE RIGHT TO USE "GUARANTEE", APART FROM THE MARK AS SHOWN.
FOR RENTAL, LEASING, LEASE PURCHASING AND RENTAL-TO-OWN OF HOME APPLIANCES, NAMELY, AIR CONDITIONERS (U.S. CLS. 100, 103 AND 106).
JILL C. ALT, EXAMINING ATTORNEY

CLASS 40—(Continued).

SN 77-287,518. HUNTER CONSULTING, INC., ANAHEIM HILLS, CA. FILED 9-24-2007.



NO CLAIM IS MADE TO THE EXCLUSIVE RIGHT TO USE "ENVIRONMENTAL & ENGINEERING", APART FROM THE MARK AS SHOWN.

THE MARK CONSISTS OF A LOGO IN A RECTANGULAR SHAPE FOR; SOLID BAR ON TOP WITH THE WORD "ENVIRONMENTAL" IN STYLIZED TEXT INSIDE THE BOX, CAPITAL LETTER "H", CAPITAL LETTER "C" AND LOWER CASE "I" IN BETWEEN THE SOLID BOXES. A LOWER SOLID BAR WITH THE WORD "& ENGINEERING" IN STYLIZED TEXT INSIDE THE BOX.

FOR DECONTAMINATION OF HAZARDOUS MATERIALS; ENVIRONMENTAL REMEDIATION SERVICES, NAMELY, SOIL, WASTE AND/OR WATER TREATMENT SERVICES; HAZARDOUS WASTE MANAGEMENT (U.S. CLS. 100, 103 AND 106).

FIRST USE 4-1-2000; IN COMMERCE 4-1-2000.
CURTIS FRENCH, EXAMINING ATTORNEY

SN 77-291,487. NATIONAL IMAGE COMPANY, LLC, PORTLAND, ME. FILED 9-28-2007.



THE MARK CONSISTS OF FANCIFUL DEPICTION OF PAPER WITH CORNER PEELED BACK.

FOR PHOTOGRAPHIC AND PHOTOGRAPHIC IMAGE PROCESSING SERVICES, NAMELY, DEVELOPING, REPRINTING AND MODIFYING IMAGES; PRINTING SERVICES, NAMELY, TRANSFERRING PHOTOGRAPHIC AND DIGITAL PHOTOGRAPHIC IMAGES TO IMPRINTABLE SURFACES (U.S. CLS. 100, 103 AND 106).

DANIEL CAPSHAW, EXAMINING ATTORNEY

CLASS 40—(Continued).

SN 77-291,963. SOUND CITY INC., VAN NUYS, CA. FILED 9-28-2007.



FOR IMPRINTING MESSAGES ON WEARING APPAREL, ACCESSORIES AND MUGS (U.S. CLS. 100, 103 AND 106).

DAVID YONTEF, EXAMINING ATTORNEY

SN 77-292,191. MASTELLA, DEBORAH, DBA MASTELLASERSHON, DEBORAH, EDEN PRAIRIE, MN. FILED 9-28-2007.

BUZZ THE VOTE

THE MARK CONSISTS OF STANDARD CHARACTERS WITHOUT CLAIM TO ANY PARTICULAR FONT, STYLE, SIZE, OR COLOR.

FOR (BASED ON INTENT TO USE) IMPRINTING MESSAGES ON WEARING APPAREL, ACCESSORIES AND MUGS (U.S. CLS. 100, 103 AND 106).

ANNE MADDEN, EXAMINING ATTORNEY

SN 77-292,193. MASTELLA, DEBORAH, DBA MASTELLASERSHON, DEBORAH, EDEN PRAIRIE, MN. FILED 9-28-2007.

RETRO NEXT

THE MARK CONSISTS OF STANDARD CHARACTERS WITHOUT CLAIM TO ANY PARTICULAR FONT, STYLE, SIZE, OR COLOR.

FOR (BASED ON INTENT TO USE) IMPRINTING MESSAGES ON WEARING APPAREL, ACCESSORIES AND MUGS (U.S. CLS. 100, 103 AND 106).

ANNE MADDEN, EXAMINING ATTORNEY

CLASS 40—(Continued).

SN 77-292,630. HURST, WILLIAM R, DBA REGGAETSHIRT-COM, MCDONOUGH, GA. FILED 10-1-2007.



THE COLOR(S) BLACK, WHITE, GREEN IS/ARE CLAIMED AS A FEATURE OF THE MARK.
 THE MARK CONSISTS OF A MAN SINGING INTO A MICROPHONE PHYSICALLY PRODUCING A MUSICAL EXPRESSION. BLACK GLOVES AND HAT, WHITE T-SHIRT, GREEN PANTS, BLACK AND WHITE SHOES, NOTES AND MICROPHONE.
 FOR CUSTOMIZED PRINTING OF COMPANY NAMES AND LOGOS FOR PROMOTIONAL AND ADVERTISING PURPOSES ON THE GOODS OF OTHERS (U.S. CLS. 100, 103 AND 106).
 LINDA MICKLEBURGH, EXAMINING ATTORNEY

SN 77-292,768. HUMMINGBIRD RECYCLING SERVICES, LLC, ERIE, CO. FILED 10-1-2007.

EFFICIENCY IN MOTION

THE MARK CONSISTS OF STANDARD CHARACTERS WITHOUT CLAIM TO ANY PARTICULAR FONT, STYLE, SIZE, OR COLOR.
 FOR ON SITE WASTE RECYCLING (U.S. CLS. 100, 103 AND 106).
 JASON BLAIR, EXAMINING ATTORNEY

SN 77-292,771. HUMMINGBIRD RECYCLING SERVICES, LLC, ERIE, CO. FILED 10-1-2007.

HUMMINGBIRD

THE MARK CONSISTS OF STANDARD CHARACTERS WITHOUT CLAIM TO ANY PARTICULAR FONT, STYLE, SIZE, OR COLOR.
 FOR ON SITE WASTE RECYCLING (U.S. CLS. 100, 103 AND 106).
 JASON BLAIR, EXAMINING ATTORNEY

CLASS 40—(Continued).

SN 77-292,776. KNOWASTE INTERNATIONAL, L.L.C., MISSISSAUGA, ONTARIO, CANADA, FILED 10-1-2007.



OWNER OF U.S. REG. NO. 2,165,682.
 THE MARK CONSISTS OF A THICK ARROW IN THE SHAPE OF A CIRCLE WITH THE ARROW POINTING IN A CLOCKWISE DIRECTION. IN THE CENTER OF THE CIRCULAR-SHAPED ARROW IS THE WORD "KNOWASTE" IN STYLIZED PRINT, WITH THE "O" IN "KNOWASTE" REPRESENTING THE EARTH.
 FOR RECYCLING SERVICES; PROCESSING, TREATING AND RECYCLING OF DIAPERS AND OTHER WASTE PRODUCTS AND RELATED CONSULTING SERVICES; PROVIDING INFORMATION ON THE FOREGOING SUBJECT MATTERS (U.S. CLS. 100, 103 AND 106).
 JANICE L. MCMORROW, EXAMINING ATTORNEY

SN 77-293,046. BHATT GAURAV K, LOS ANGELES, CA. FILED 10-1-2007.

**Reality is an illusion
 caused by deficiency of
 Spirituality**

THE MARK CONSISTS OF STANDARD CHARACTERS WITHOUT CLAIM TO ANY PARTICULAR FONT, STYLE, SIZE, OR COLOR.
 FOR IMPRINTING MESSAGES ON WEARING APPAREL, ACCESSORIES AND MUGS (U.S. CLS. 100, 103 AND 106).
 C. DIONNE CLYBURN, EXAMINING ATTORNEY

SN 77-293,345. CEDAR CONCEPTS CORPORATION, CHICAGO, IL. FILED 10-1-2007.

**We Do Your Chemistry
 Homework!**

THE MARK CONSISTS OF STANDARD CHARACTERS WITHOUT CLAIM TO ANY PARTICULAR FONT, STYLE, SIZE, OR COLOR.
 FOR MANUFACTURING SERVICES FOR OTHERS IN THE FIELD OF SURFACTANTS, LUBRICANTS, CHEMICAL INTERMEDIATES (U.S. CLS. 100, 103 AND 106).
 FIRST USE 9-4-2007; IN COMMERCE 9-4-2007.
 ANDREA K. NADELMAN, EXAMINING ATTORNEY

CLASS 40—(Continued).

SN 77-293,904. DAWSON, ELSIE NICOLE, CLEVELAND HEIGHTS, OH. FILED 10-2-2007.

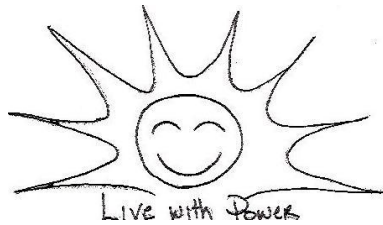

THE MARK CONSISTS OF A SUN WITH 8 RAYS AND A FACE WITH EYES AND A SMILE.

FOR IMPRINTING MESSAGES ON T-SHIRTS (U.S. CLS. 100, 103 AND 106).

JAMES A. RAUEN, EXAMINING ATTORNEY

CLASS 40—(Continued).

SN 77-296,387. FONTAINE, PETER, PORT ORANGE, FL. FILED 10-4-2007.

SCANNERMAN

THE MARK CONSISTS OF STANDARD CHARACTERS WITHOUT CLAIM TO ANY PARTICULAR FONT, STYLE, SIZE, OR COLOR.

FOR ELECTRONIC IMAGING, SCANNING, DIGITIZING, ALTERATION AND/OR RETOUCHING OF PHOTOGRAPHIC MATERIALS, IMAGES AND DOCUMENTS (U.S. CLS. 100, 103 AND 106).

FIRST USE 7-30-2007; IN COMMERCE 10-1-2007.

NAKWAMA ANKRAH, EXAMINING ATTORNEY

SN 77-295,103. SIMON CHRISTOPHER, TRACY, CA. FILED 10-3-2007.



FOR WINERY SERVICES (U.S. CLS. 100, 103 AND 106).
GRETTA YAO, EXAMINING ATTORNEY

SN 77-297,188. D.R.OUTDOORS INC., HICKSVILLE, NY. FILED 10-5-2007.



THE MARK CONSISTS OF CHECK MARK WITH MOUNTAIN ON IT AND PALM TREE AT THE BASE OF THE MOUNTAIN.

FOR MANUFACTURING OF APPAREL TO THE ORDER AND/OR SPECIFICATION OF OTHERS (U.S. CLS. 100, 103 AND 106).

FIRST USE 11-9-2006; IN COMMERCE 3-15-2007.

KATHY DE JONGE, EXAMINING ATTORNEY

SN 77-295,718. JAPOC INDUSTRIES INC., ORLANDO, FL. FILED 10-4-2007.

Just Another Piece Of Clay

THE MARK CONSISTS OF STANDARD CHARACTERS WITHOUT CLAIM TO ANY PARTICULAR FONT, STYLE, SIZE, OR COLOR.

FOR IMPRINTING MESSAGES ON WEARING APPAREL, ACCESSORIES AND MUGS (U.S. CLS. 100, 103 AND 106).

SCOTT SISUN, EXAMINING ATTORNEY

SN 77-306,136. GEORGIA-PACIFIC CONSUMER PRODUCTS LP, ATLANTA, GA. FILED 10-17-2007.

GREEN BY DESIGN

THE MARK CONSISTS OF STANDARD CHARACTERS WITHOUT CLAIM TO ANY PARTICULAR FONT, STYLE, SIZE, OR COLOR.

NO CLAIM IS MADE TO THE EXCLUSIVE RIGHT TO USE "GREEN", APART FROM THE MARK AS SHOWN.

FOR CUSTOM MANUFACTURE OF TISSUES, TOWELS, NAPKINS, WIPERS AND DISPENSERS (U.S. CLS. 100, 103 AND 106).

BRIAN CALLAGHAN, EXAMINING ATTORNEY

CLASS 40—(Continued).

SN 77-306,246. INNOVATIER, INC., LAKELAND, FL. FILED 10-17-2007.



THE COLOR(S) BLACK, WHITE, YELLOW AND RED IS/ ARE CLAIMED AS A FEATURE OF THE MARK.

THE MARK CONSISTS OF THE WORDING "PROTECUT" IN BLACK, PRECEDED BY A THREE-SIDED SHIELD DESIGN WITH A CURVED TOP AND TWO CURVED SIDES DISPLAYING THE COLORS WHITE AND VARYING SHADES OF YELLOW AND RED. A WHITE V DESIGN POINTING TO THE RIGHT APPEARS WITHIN THE SHIELD DESIGN, WITH THE RIGHT END ADJOINING THE RIGHT SIDE OF THE SHIELD DESIGN AND THE OTHER ENDS TOUCHING THE TOP AND LEFT SIDE OF THE SHIELD DESIGN. A BRIGHT SUN DESIGN IN WHITE, BLENDING INTO SHADES OF YELLOW AND THEN RED, APPEARS WITHIN THE WHITE V DESIGN AND FILLS IN THE REMAINDER OF THE SHIELD DESIGN. THE AREAS OF THE SHIELD ABOVE AND BELOW THE WHITE V DESIGN ARE SHADES OF YELLOW BLENDING INTO RED TO COMPLETE THE SYMMETRICAL LOOK OF THE SUN DESIGN, WITH THE YELLOW PORTIONS BEING CLOSEST TO THE CENTER OF THE SUN DESIGN.

FOR ASSEMBLY AND FABRICATION OF CUT RESISTANT CREDIT CARDS, IDENTIFICATION CARDS AND OTHER CARDS, TAGS, WRIST BANDS AND FOBS TO THE ORDER AND SPECIFICATION OF OTHERS; ASSEMBLY AND LIQUID POLYMER ENCAPSULATION OF CUT RESISTANT ELECTRONIC CREDIT CARDS, IDENTIFICATION CARDS AND OTHER SMART CARDS, TAGS, WRIST BANDS AND FOBS, NAMELY, ASSEMBLY AND LIQUID THERMOSET POLYMER ENCAPSULATION OF BATTERY POWERED CREDIT CARDS, IDENTIFICATION CARDS, TAGS, WRIST BANDS AND FOBS AND OTHER ELECTRONIC SMART CARDS, TAGS, WRIST BANDS AND FOBS WITH A CUT RESISTANT SPRING STEEL OR OTHER METALLIC FRAME OR BAND INSTALLED AROUND THE BATTERY, THE ELECTRONIC COMPONENTS OR ALL OR OTHER PORTIONS OF THE SMART CARD, ALL TO THE ORDER AND SPECIFICATION OF OTHERS (U.S. CLS. 100, 103 AND 106).

KAREN K. BUSH, EXAMINING ATTORNEY

CLASS 40—(Continued).

SHADES OF YELLOW AND RED. A WHITE V DESIGN POINTING TO THE RIGHT APPEARS WITHIN THE SHIELD DESIGN, WITH THE RIGHT END ADJOINING THE RIGHT SIDE OF THE SHIELD DESIGN AND THE OTHER ENDS TOUCHING THE TOP AND LEFT SIDE OF THE SHIELD DESIGN. A BRIGHT SUN DESIGN IN WHITE, BLENDING INTO SHADES OF YELLOW AND THEN RED, APPEARS WITHIN THE WHITE V DESIGN AND FILLS IN THE REMAINDER OF THE SHIELD DESIGN. THE AREAS OF THE SHIELD ABOVE AND BELOW THE WHITE V DESIGN ARE SHADES OF YELLOW BLENDING INTO RED TO COMPLETE THE SYMMETRICAL LOOK OF THE SUN DESIGN, WITH THE YELLOW PORTIONS BEING CLOSEST TO THE CENTER OF THE SUN DESIGN.

FOR ASSEMBLY AND FABRICATION OF CUT RESISTANT CREDIT CARDS, IDENTIFICATION CARDS AND OTHER CARDS, TAGS, WRIST BANDS AND FOBS TO THE ORDER AND SPECIFICATION OF OTHERS; ASSEMBLY AND LIQUID POLYMER ENCAPSULATION OF CUT RESISTANT ELECTRONIC CREDIT CARDS, IDENTIFICATION CARDS AND OTHER SMART CARDS, TAGS, WRIST BANDS AND FOBS, NAMELY, ASSEMBLY AND LIQUID THERMOSET POLYMER ENCAPSULATION OF BATTERY POWERED CREDIT CARDS, IDENTIFICATION CARDS, TAGS, WRIST BANDS AND FOBS AND OTHER ELECTRONIC SMART CARDS, TAGS, WRIST BANDS AND FOBS WITH A CUT RESISTANT SPRING STEEL OR OTHER METALLIC FRAME OR BAND INSTALLED AROUND THE BATTERY, THE ELECTRONIC COMPONENTS OR ALL OR OTHER PORTIONS OF THE SMART CARD, ALL TO THE ORDER AND SPECIFICATION OF OTHERS (U.S. CLS. 100, 103 AND 106).

KAREN K. BUSH, EXAMINING ATTORNEY

SN 77-323,709. ACS MARKETING, L.P., DALLAS, TX. FILED 11-7-2007.

SN 77-306,275. INNOVATIER, INC., LAKELAND, FL. FILED 10-17-2007.



THE COLOR(S) WHITE, YELLOW AND RED IS/ARE CLAIMED AS A FEATURE OF THE MARK.

THE MARK CONSISTS OF A THREE-SIDED SHIELD DESIGN WITH A CURVED TOP AND TWO CURVED SIDES DISPLAYING THE COLORS WHITE AND VARYING

EXPERTISE IN ACTION

THE MARK CONSISTS OF STANDARD CHARACTERS WITHOUT CLAIM TO ANY PARTICULAR FONT, STYLE, SIZE, OR COLOR.

FOR ELECTRONIC IMAGING, SCANNING, AND DIGITIZING OF DOCUMENTS AND OTHER PRINTED MATERIALS FOR STORAGE, RETRIEVAL, USE OR DISTRIBUTION (U.S. CLS. 100, 103 AND 106).

COLLEEN DOMBROW, EXAMINING ATTORNEY

CLASS 40—(Continued).

SN 77-975,170. AVALIGN TECHNOLOGIES, INC., LAKE FOREST, IL. FILED 3-1-2007.

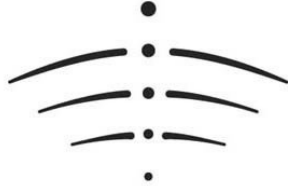

FOR CONTRACT MANUFACTURING IN THE FIELD OF MEDICAL DEVICES AND MEDICAL TECHNOLOGY; PRODUCT ASSEMBLY SERVICES FOR OTHERS IN THE FIELD OF MEDICAL DEVICES AND MEDICAL TECHNOLOGY (U.S. CLS. 100, 103 AND 106).
FIRST USE 5-0-2007; IN COMMERCE 5-0-2007.
MARIAM MAHMOUDI, EXAMINING ATTORNEY

SN 77-975,196. AVALIGN TECHNOLOGIES, INC., LAKE FOREST, IL. FILED 3-1-2007.

AVALIGN

THE MARK CONSISTS OF STANDARD CHARACTERS WITHOUT CLAIM TO ANY PARTICULAR FONT, STYLE, SIZE, OR COLOR.
FOR CONTRACT MANUFACTURING IN THE FIELD OF MEDICAL DEVICES AND MEDICAL TECHNOLOGY; PRODUCT ASSEMBLY SERVICES FOR OTHERS IN THE FIELD OF MEDICAL DEVICES AND MEDICAL TECHNOLOGY (U.S. CLS. 100, 103 AND 106).
FIRST USE 5-0-2007; IN COMMERCE 5-0-2007.
MARIAM MAHMOUDI, EXAMINING ATTORNEY

CLASS 41—EDUCATION AND ENTERTAINMENT

SN 75-696,424. GIFTS OF LEARNING FOUNDATION, INC. DBA KIDS GOLF, PALM BEACH GARDENS, FL. FILED 5-3-1999.



NO CLAIM IS MADE TO THE EXCLUSIVE RIGHT TO USE "WORLDWIDE COMPETITION", APART FROM THE MARK AS SHOWN.
SEC. 2(F) AS TO "KIDS GOLF" AND "DRIVE PITCH PUTT".
FOR EDUCATIONAL AND ENTERTAINMENT SERVICES, NAMELY, SPONSORING GOLF TOURNAMENTS FOR CHILDREN (U.S. CLS. 100, 101 AND 107).
FIRST USE 3-0-1999; IN COMMERCE 3-0-1999.
JOSETTE BEVERLY, EXAMINING ATTORNEY

SN 76-372,366. AF2 ENTERPRISES LLC, CHICAGO, IL. FILED 2-19-2002.

BAKERSFIELD BLITZ

THE MARK CONSISTS OF STANDARD CHARACTERS WITHOUT CLAIM TO ANY PARTICULAR FONT, STYLE, SIZE, OR COLOR.
OWNER OF U.S. REG. NO. 2,595,924.
NO CLAIM IS MADE TO THE EXCLUSIVE RIGHT TO USE "BAKERSFIELD", APART FROM THE MARK AS SHOWN.
FOR ENTERTAINMENT SERVICES, NAMELY, ORGANIZING AND PRESENTING FOOTBALL GAMES BEFORE LIVE AUDIENCES AND ON TELEVISION, RADIO, FOR GLOBAL COMPUTER NETWORK DISPLAY AND OTHER MEDIA (U.S. CLS. 100, 101 AND 107).
FIRST USE 4-4-2001; IN COMMERCE 4-4-2001.
DAVID MURRAY, EXAMINING ATTORNEY

CLASS 41—(Continued).

SN 76-587,279. USA FOOTBALL, VIENNA, VA. FILED 4-19-2004.

HUDDLE

THE MARK CONSISTS OF STANDARD CHARACTERS WITHOUT CLAIM TO ANY PARTICULAR FONT, STYLE, SIZE, OR COLOR.

FOR EDUCATIONAL SERVICES, NAMELY, CONDUCTING PROGRAMS, CLASSES, SEMINARS, CONFERENCES, WORKSHOPS AND EXHIBITIONS, DISPLAYS, AND INTERACTIVE EXHIBITS ON SPORTING AND OUTDOOR ATHLETIC ACTIVITIES (U.S. CLS. 100, 101 AND 107).

CHARLOTTE CORWIN, EXAMINING ATTORNEY

CLASS 41—(Continued).

SN 76-661,820. NYC - PARENTS IN ACTION, INC., NEW YORK, NY. FILED 6-19-2006.



NO CLAIM IS MADE TO THE EXCLUSIVE RIGHT TO USE "NYC", APART FROM THE MARK AS SHOWN.

FOR EDUCATIONAL SERVICES, NAMELY, PROVIDING PARENTS WITH SEMINARS, SEMINARS VIA COMMUNICATION NETWORKS, AND IN PERSON DISCUSSION GROUPS IN THE FIELD OF SUBSTANCE ABUSE PREVENTION FOR THEIR CHILDREN AND TEENAGERS (U.S. CLS. 100, 101 AND 107).

FIRST USE 12-1-2001; IN COMMERCE 12-1-2001.
KAPIL BHANOT, EXAMINING ATTORNEY

SN 76-649,009. ARMAND, AKILAH, CHICAGO, IL. AND PENN, YAVONNE, CHICAGO, IL. AND PARKER, KORI, CHICAGO, IL. AND WOODS, CRYSTAL, CHICAGO, IL. FILED 10-24-2005.

ANEW

THE MARK CONSISTS OF STANDARD CHARACTERS WITHOUT CLAIM TO ANY PARTICULAR FONT, STYLE, SIZE, OR COLOR.

FOR ENTERTAINMENT SERVICES, NAMELY LIVE PERFORMANCES BY A SINGING GROUP (U.S. CLS. 100, 101 AND 107).

FIRST USE 1-1-1999; IN COMMERCE 1-1-1999.
MATTHEW EINSTEIN, EXAMINING ATTORNEY

SN 76-672,369. GREATER MIAMI CHAMBER OF COMMERCE, INC., MIAMI, FL. FILED 2-7-2007.



NO CLAIM IS MADE TO THE EXCLUSIVE RIGHT TO USE "PROGRAM", APART FROM THE MARK AS SHOWN. THE COLOR(S) BROWN AND BLUE IS/ARE CLAIMED AS A FEATURE OF THE MARK.

THE MARK IS COMPOSED OF THE WORD, LEADERSHIP, IN BROWN, THREE WAVE LINES IN BLUE, THE WORD, MIAMI, IN BLUE, AND A BROWN SUN ABOVE "I" IN MIAMI.

SEC. 2(F).
FOR EDUCATIONAL SERVICES, NAMELY, PERSONAL AND PROFESSIONAL DEVELOPMENT PROGRAMS FOR FUTURE BUSINESS LEADERS (U.S. CLS. 100, 101 AND 107).

FIRST USE 5-1-1979; IN COMMERCE 5-1-1979.
MICHELE SWAIN, EXAMINING ATTORNEY

CLASS 41—(Continued).

SN 76-672,542. RHYTEC, INC., WALTHAM, MA. FILED 2-12-2007.

Portrait^{EXPRESS}
*TRUE RESULTS
 No DOWNTIME*

OWNER OF U.S. REG. NO. 3,096,845.
 NO CLAIM IS MADE TO THE EXCLUSIVE RIGHT TO USE "NO DOWNTIME", APART FROM THE MARK AS SHOWN.

FOR EDUCATIONAL SERVICES, NAMELY, CONDUCTING ON-SITE INSTRUCTIONS AND TRAINING SESSIONS IN THE FIELD OF PROTOCOLS FOR THE OPERATION OF PLASMA ENERGY DELIVERY DEVICES FOR SKIN TREATMENT (U.S. CLS. 100, 101 AND 107).

LINDA M. KING, EXAMINING ATTORNEY

SN 76-672,543. RHYTEC, INC., WALTHAM, MA. FILED 2-12-2007.

PORTRAIT EXPRESS

OWNER OF U.S. REG. NO. 3,096,845.
 FOR EDUCATIONAL SERVICES, NAMELY, CONDUCTING ON-SITE INSTRUCTIONS AND TRAINING SESSIONS IN THE FIELD OF PROTOCOLS FOR THE OPERATION OF PLASMA ENERGY DELIVERY DEVICES FOR SKIN TREATMENT (U.S. CLS. 100, 101 AND 107).

LINDA M. KING, EXAMINING ATTORNEY

SN 76-672,582. ADVANCE INTERNET INC., JERSEY CITY, NJ. FILED 2-12-2007.

LIFE HERE. STARTS HERE.

THE MARK CONSISTS OF STANDARD CHARACTERS WITHOUT CLAIM TO ANY PARTICULAR FONT, STYLE, SIZE, OR COLOR.

FOR PROVIDING INFORMATION, NEWS AND COMMENTARY IN THE FIELD OF ENTERTAINMENT, PROVIDING NEWS AND INFORMATION IN THE FIELD OF SPORTS, PROVIDING NEWS IN THE NATURE OF CURRENT EVENTS, INTERNATIONAL AND NATIONAL EVENT REPORTING, NEWS SYNDICATION REPORTING, NEWS REPORTING SERVICES (U.S. CLS. 100, 101 AND 107).

DORITT L. CARROLL, EXAMINING ATTORNEY

CLASS 41—(Continued).

SN 76-672,861. THOMAS, STEPHEN, TOMS RIVER, NJ. FILED 2-20-2007.

JUPITER JONES

THE NAME "JUPITER JONES" DOES NOT IDENTIFY A LIVING INDIVIDUAL.

FOR ENTERTAINMENT, NAMELY LIVE PERFORMANCES BY A MUSICAL BAND (U.S. CLS. 100, 101 AND 107).

JANICE KIM, EXAMINING ATTORNEY

SN 76-673,020. ANIBOOM LTD, TEL AVIV 61297, ISRAEL, FILED 2-22-2007.

ANIBOOM EYEDOLL

THE MARK CONSISTS OF STANDARD CHARACTERS WITHOUT CLAIM TO ANY PARTICULAR FONT, STYLE, SIZE, OR COLOR.

FOR ANIMATED MOTION PICTURE PRODUCTION; PRODUCTION OF ON-LINE ANIMATED MOTION PICTURES; INTERNET SITES, NAMELY, PROVIDING ON-LINE REVIEWS OF MOTION PICTURES (U.S. CLS. 100, 101 AND 107).

ERNEST SHOSHO, EXAMINING ATTORNEY

SN 76-673,021. ANIBOOM LTD, TEL AVIV 61297, ISRAEL, FILED 2-22-2007.

ANIBOOM

THE MARK CONSISTS OF STANDARD CHARACTERS WITHOUT CLAIM TO ANY PARTICULAR FONT, STYLE, SIZE, OR COLOR.

FOR ANIMATED MOTION PICTURE PRODUCTION; PRODUCTION OF ON-LINE ANIMATED MOTION PICTURES; INTERNET SITES, NAMELY, PROVIDING ON-LINE REVIEWS OF MOTION PICTURES (U.S. CLS. 100, 101 AND 107).

ERNEST SHOSHO, EXAMINING ATTORNEY

CLASS 41—(Continued).

SN 76-674,810. BROWN, JACOB P., NASHVILLE, TN. AND VOLK, SHANE, NASHVILLE, TN. FILED 3-29-2007.

ONE BAD SON

THE MARK CONSISTS OF STANDARD CHARACTERS WITHOUT CLAIM TO ANY PARTICULAR FONT, STYLE, SIZE, OR COLOR.

FOR ENTERTAINMENT IN THE NATURE OF VISUAL AND AUDIO PERFORMANCES, NAMELY, MUSIC BANDS, ROCK GROUP, GYMNASTIC, DANCE, AND BALLET PERFORMANCE (U.S. CLS. 100, 101 AND 107).
FIRST USE 4-29-2003; IN COMMERCE 4-25-2006.

JAMES A. RAUEN, EXAMINING ATTORNEY

SN 76-675,301. ANIBOOM LTD, TEL AVIV 61297, ISRAEL, FILED 4-10-2007.

SHAPESHIFTER

THE MARK CONSISTS OF STANDARD CHARACTERS WITHOUT CLAIM TO ANY PARTICULAR FONT, STYLE, SIZE, OR COLOR.

FOR INTERNET SITES, NAMELY, PROVIDING ONLINE REVIEWS OF MOTION PICTURES (U.S. CLS. 100, 101 AND 107).

ERNEST SHOSHO, EXAMINING ATTORNEY

SN 76-679,668. EDWORKS, LLC, CINCINNATI, OH. FILED 7-19-2007.



THE MARK CONSISTS OF A HOLLOW OUTLINE SHAPED LIKE A PIECE OF FRUIT, SUCH AS AN APPLE, WITH SMALL LEAVES PROTRUDING ALONG ITS UPPER SURFACE, WITH A LEFT ARCULATE TAPERED LINE EXTENDING OUTWARD FROM NEAR THE BOTTOM OF THE FRUIT SHAPE, AND WITH A RIGHT ARCULATE TAPERED LINE EXTENDING OUTWARD FROM NEAR THE BOTTOM OF THE FRUIT SHAPE.

FOR CONSULTING SERVICES FOR SCHOOLS FOR IMPROVING CLASSROOM INSTRUCTION; PROVIDING TRAINING SERVICES FOR EDUCATIONAL PROFESSIONALS, NAMELY, WORKSHOPS AND ONE TO ONE COACHING IN THE FIELD OF REDESIGNING AND STARTING UP HIGH SCHOOLS, IMPLEMENTING A RIGOROUS CURRICULUM, USING ASSESSMENT AND DATA TO IMPROVE STUDENT PERFORMANCE, AND LEADERSHIP DEVELOPMENT FOR ADMINISTRATORS AND TEACHERS; AND PROVIDING TRAINING RESOURCES FOR EDUCATION PROFESSIONALS, NAMELY, ARRANGING AND CONDUCTING WORKSHOPS FOR THE ON-GOING IMPLEMENTATION OF NEW SCHOOL CURRICULUM AND PHYSICAL LAYOUT DESIGN (U.S. CLS. 100, 101 AND 107).

FIRST USE 5-23-2007; IN COMMERCE 5-23-2007.

SHAILA SETTLES, EXAMINING ATTORNEY

CLASS 41—(Continued).

SN 76-681,816. MAGIC ANIMATION, WILMINGTON, DE. FILED 9-13-2007.



NO CLAIM IS MADE TO THE EXCLUSIVE RIGHT TO USE "ANIMATION", APART FROM THE MARK AS SHOWN.

THE LITERAL ELEMENT OF THE MARK CONSISTS OF "MAGIC ANIMATION". THE MARK CONSISTS OF A STYLIZED "M" OVER A CIRCLE WITH THE WORDING "MAGIC ANIMATION" WRITTEN UNDERNEATH.

FOR ANIMATION PRODUCTION SERVICES (U.S. CLS. 100, 101 AND 107).

FIRST USE 12-1-1998; IN COMMERCE 12-1-1998.

ZACHARY BELLO, EXAMINING ATTORNEY

SN 76-682,010. HOPE FOR THE HEART, INC., DALLAS, TX. FILED 9-18-2007.

RIDE FOR LIFE

THE MARK CONSISTS OF STANDARD CHARACTERS WITHOUT CLAIM TO ANY PARTICULAR FONT, STYLE, SIZE, OR COLOR.

NO CLAIM IS MADE TO THE EXCLUSIVE RIGHT TO USE "RIDE", APART FROM THE MARK AS SHOWN.

FOR ORGANIZING, ARRANGING AND CONDUCTING MOTORCYCLE RIDES (U.S. CLS. 100, 101 AND 107).

FIRST USE 6-30-2006; IN COMMERCE 6-30-2006.

TINA L. SNAPP, EXAMINING ATTORNEY

SN 76-682,382. THE TORCH LOUNGE & CAFE, CORP, BOISE, ID. FILED 9-27-2007.

MISS RACKTOBER

THE MARK CONSISTS OF STANDARD CHARACTERS WITHOUT CLAIM TO ANY PARTICULAR FONT, STYLE, SIZE, OR COLOR.

FOR NIGHTCLUB SERVICES (U.S. CLS. 100, 101 AND 107).

FIRST USE 0-0-2003; IN COMMERCE 0-0-2003.

STEVEN R. FINE, EXAMINING ATTORNEY

CLASS 41—(Continued).

SN 76-682,393. THE ORGAN WISE GUYS, INCORPORATED, DULUTH, GA. FILED 9-28-2007.

Pirates of the Carrot and Bean

THE MARK CONSISTS OF STANDARD CHARACTERS WITHOUT CLAIM TO ANY PARTICULAR FONT, STYLE, SIZE, OR COLOR.

FOR EDUCATIONAL SERVICES, NAMELY, PROVIDING CLASSES, WORKSHOPS, TRAININGS, AND VIDEO-BASED TRAININGS IN THE FIELD OF HEALTH AND NUTRITION (U.S. CLS. 100, 101 AND 107).

ANDREA HACK, EXAMINING ATTORNEY

SN 76-682,394. THE ORGAN WISE GUYS INCORPORATED, DULUTH, GA. FILED 9-28-2007.

Health Trek

THE MARK CONSISTS OF STANDARD CHARACTERS WITHOUT CLAIM TO ANY PARTICULAR FONT, STYLE, SIZE, OR COLOR.

NO CLAIM IS MADE TO THE EXCLUSIVE RIGHT TO USE "HEALTH", APART FROM THE MARK AS SHOWN.

FOR EDUCATIONAL SERVICES, NAMELY, PROVIDING CLASSES, WORKSHOPS, TRAININGS, AND VIDEO-BASED TRAININGS IN THE FIELD OF HEALTH AND NUTRITION (U.S. CLS. 100, 101 AND 107).

TOBY BULLOFF, EXAMINING ATTORNEY

SN 76-682,399. BRUCK, CHRISTIAN, NEW YORK, NY. FILED 9-28-2007.

METASPHERES

THE MARK CONSISTS OF STANDARD CHARACTERS WITHOUT CLAIM TO ANY PARTICULAR FONT, STYLE, SIZE, OR COLOR.

FOR PROVIDING A COMPUTER GAME THAT MAY BE ACCESSED NETWORK-WIDE BY NETWORK USERS; DIGITAL VIDEO, AUDIO, AND MULTIMEDIA PUBLISHING SERVICES; ELECTRONIC PUBLISHING SERVICES, NAMELY, PUBLICATION OF TEXT AND GRAPHIC WORKS OF OTHERS ON-LINE FEATURING RICH MEDIA TREATMENT OF USER-SELECTED THEMES AND TOPICS; MULTIMEDIA PUBLISHING OF BOOKS, MAGAZINES, JOURNALS, SOFTWARE, GAMES, MUSIC, AND ELECTRONIC PUBLICATIONS (U.S. CLS. 100, 101 AND 107).

ANDREW RHIM, EXAMINING ATTORNEY

CLASS 41—(Continued).

SN 76-682,416. DREAMMAKER KIDS, INC., MEMPHIS, TN. FILED 9-28-2007.

DREAMMAKER KIDS

THE MARK CONSISTS OF STANDARD CHARACTERS WITHOUT CLAIM TO ANY PARTICULAR FONT, STYLE, SIZE, OR COLOR.

NO CLAIM IS MADE TO THE EXCLUSIVE RIGHT TO USE "KIDS", APART FROM THE MARK AS SHOWN.

FOR EDUCATIONAL SERVICES, NAMELY, PROVIDING MOTIVATIONAL AND EDUCATIONAL SPEAKERS AND CONDUCTING PROGRAMS FOR CHILDREN IN THE FIELD OF CAREER AWARENESS, CAREER SELECTION, AND CAREER PLANNING (U.S. CLS. 100, 101 AND 107).

FIRST USE 9-1-2005; IN COMMERCE 10-16-2005.

REBECCA SMITH, EXAMINING ATTORNEY

SN 76-682,482. PERFORMANCE LEARNING SYSTEMS, INC., ALLENTOWN, PA. FILED 10-1-2007.



THE MARK CONSISTS OF 3 STICK FIGURES WITH UPWARD OUTSTRETCHED ARMS PARTIALLY CIRCUMSCRIBED BY A CRESCENT SHAPED ARC WITH THE POINTS FACING DOWNWARD.

FOR EDUCATIONAL SERVICES, NAMELY, CONDUCTING CLASSES, SEMINARS, AND WORKSHOPS IN THE FIELD OF GRADUATE-LEVEL TEACHER TRAINING (U.S. CLS. 100, 101 AND 107).

FIRST USE 3-4-2003; IN COMMERCE 3-4-2003.

DORITT L. CARROLL, EXAMINING ATTORNEY

CLASS 41—(Continued).

SN 77-003,685. GOLF D'ALLIE AT THE FARM, LAFAYETTE, LA. FILED 9-20-2006.



NO CLAIM IS MADE TO THE EXCLUSIVE RIGHT TO USE "GOLF CLUB", APART FROM THE MARK AS SHOWN.

THE COLOR(S) RED, GREEN, AND WHITE IS/ARE CLAIMED AS A FEATURE OF THE MARK.

THE CENTER PORTION OF THE MARK CONSISTS OF THE WORDS "FARM D'ALLIE" IN RED. THE UPPER PORTION OF THE MARK CONSISTS OF A GOLF FLAG AND GOLF GREEN DESIGN PRESENTED IN RED AND GREEN LINES. THE BOTTOM PORTION OF THE MARK CONSISTS OF A FILLED GREEN RECTANGLE, WITHIN WHICH THE WORDING "GOLF CLUB" APPEARS IN THE COLOR WHITE.

THE ENGLISH TRANSLATION OF "D'ALLIÉ" IS "OF AN ALLY".

FOR GOLF COURSES (U.S. CLS. 100, 101 AND 107).
FIRST USE 9-1-2006; IN COMMERCE 9-1-2006.
KEVIN CORWIN, EXAMINING ATTORNEY

CLASS 41—(Continued).

SN 77-034,518. MATT STREITEL, REDONDO BEACH, CA. FILED 11-1-2006.

International Club Union

THE MARK CONSISTS OF STANDARD CHARACTERS WITHOUT CLAIM TO ANY PARTICULAR FONT, STYLE, SIZE, OR COLOR.

NO CLAIM IS MADE TO THE EXCLUSIVE RIGHT TO USE "INTERNATIONAL", APART FROM THE MARK AS SHOWN.

FOR ARRANGING FOR TICKET RESERVATIONS FOR SHOWS AND OTHER ENTERTAINMENT EVENTS; BOOKING OF ENTERTAINMENT HALLS; ENTERTAINMENT IN THE NATURE OF DANCE PERFORMANCES; ENTERTAINMENT IN THE NATURE OF FASHION SHOWS; ENTERTAINMENT IN THE NATURE OF LIGHT SHOWS; ENTERTAINMENT IN THE NATURE OF LIVE PERFORMANCES BY VARIOUS LIVE MUSIC ACTS INCLUDING DJS; ENTERTAINMENT IN THE NATURE OF THEATER PRODUCTIONS; ENTERTAINMENT, NAMELY, PRODUCTION OF TELEVISION SHOWS; ENTERTAINMENT SERVICES, NAMELY, LIVE, TELEVISED AND MOVIE APPEARANCES BY A PROFESSIONAL ENTERTAINER; ENTERTAINMENT SERVICES, NAMELY, PROVIDING A WEBSITE FEATURING, PHOTOGRAPHIC, AUDIO, VIDEO AND PROSE PRESENTATIONS FEATURING MUSICAL ARTISTS; ENTERTAINMENT SERVICES, NAMELY, PERFORMING AND COMPETING IN MOTOR SPORTS EVENTS; ENTERTAINMENT SERVICES, NAMELY, PRODUCTION AND DISTRIBUTION OF A GAME SHOW; ENTERTAINMENT SERVICES, NAMELY, PROVIDING A RADIO PROGRAM IN THE FIELD OF ELECTRONIC DANCE MUSIC VIA A GLOBAL COMPUTER NETWORK; ENTERTAINMENT SERVICES, NAMELY, PROVIDING A TELEVISION PROGRAM IN THE FIELD OF ELECTRONIC DANCE MUSIC VIA A GLOBAL COMPUTER NETWORK; ENTERTAINMENT SERVICES, NAMELY, PROVIDING A WEB SITE FEATURING MUSICAL PERFORMANCES, MUSICAL VIDEOS, RELATED FILM CLIPS, PHOTOGRAPHS, AND OTHER MULTIMEDIA MATERIALS; ENTERTAINMENT SERVICES, NAMELY, PROVIDING AN ON-LINE COMPUTER GAME; ENTERTAINMENT SERVICES, NAMELY, PROVIDING ON-LINE COMPUTER GAMES; ENTERTAINMENT SERVICES, NAMELY, PROVIDING PRERECORDED MUSIC, INFORMATION IN THE FIELD OF MUSIC, AND COMMENTARY AND ARTICLES ABOUT MUSIC, ALL ON-LINE VIA A GLOBAL COMPUTER NETWORK; ENTERTAINMENT, NAMELY, A CONTINUING MUSIC SHOW BROADCAST OVER TELEVISION, SATELLITE, AUDIO, AND VIDEO MEDIA; ENTERTAINMENT, NAMELY, LIVE MUSIC CONCERTS; ENTERTAINMENT, NAMELY, TELEVISION NEWS SHOWS; MOBILE MEDIA AND ENTERTAINMENT SERVICES IN THE NATURE OF CONTENT PREPARATION, POST-PRODUCTION; MULTIMEDIA ENTERTAINMENT SOFTWARE PRODUCTION SERVICES; PRODUCTION OF VISUAL EFFECTS FOR VIDEOS, DVDS, TELEVISION AND FOR INTERNET WEBSITES (U.S. CLS. 100, 101 AND 107).

FIRST USE 1-5-1993; IN COMMERCE 1-5-1993.
AMY HELLA, EXAMINING ATTORNEY

SN 77-031,632. JAMES O' PHARROW, BROOKLYN, NY. FILED 10-28-2006.

STARRETT CITY BOXING CLUB

THE MARK CONSISTS OF STANDARD CHARACTERS WITHOUT CLAIM TO ANY PARTICULAR FONT, STYLE, SIZE, OR COLOR.

NO CLAIM IS MADE TO THE EXCLUSIVE RIGHT TO USE "BOXING CLUB", APART FROM THE MARK AS SHOWN.

SEC. 2(F) STARRETT CITY.
FOR GYMNASIUMS (U.S. CLS. 100, 101 AND 107).
FIRST USE 3-8-1994; IN COMMERCE 3-8-1994.
CHERYL CLAYTON, EXAMINING ATTORNEY

CLASS 41—(Continued).

SN 77-035,635. GUILLERMO HORACIO PINO, BUENOS AIRES, ARGENTINA, FILED 11-2-2006.

EL PAYASO PLIM PLIM

THE MARK CONSISTS OF STANDARD CHARACTERS WITHOUT CLAIM TO ANY PARTICULAR FONT, STYLE, SIZE, OR COLOR.

NO CLAIM IS MADE TO THE EXCLUSIVE RIGHT TO USE "PAYASO", APART FROM THE MARK AS SHOWN.

THE FOREIGN WORDING "EL PAYASO" IN THE MARK TRANSLATES INTO ENGLISH AS THE CLOWN.

FOR ENTERTAINMENT SERVICES IN THE NATURE OF ORGANIZING SPORTS AND CULTURAL EXHIBITIONS, AND ORGANIZING SPORTING EXHIBITIONS IN THE FIELD OF SOCCER, FOOTBALL, BASKET BALL, AND TENNIS; CONDUCTING CONTESTS, EDUCATIONAL AND CULTURAL EVENTS, NAMELY, EXHIBITIONS, EDUCATIONAL DEMONSTRATIONS; ENTERTAINMENT THROUGH ON-GOING TELEVISION PROGRAMS IN THE FIELD OF VARIETY (U.S. CLS. 100, 101 AND 107).

ALLISON SCHRODY, EXAMINING ATTORNEY

SN 77-047,432. MUNDIAL DE LA SALSA INC, MIAMI, FL. FILED 11-19-2006.



NO CLAIM IS MADE TO THE EXCLUSIVE RIGHT TO USE "EL MUNDIAL DE LA SALSA 2007", APART FROM THE MARK AS SHOWN.

THE COLOR(S) ORANGE, BLACK, WHITE, TAN, GRAY, YELLOW, AND RED IS/ARE CLAIMED AS A FEATURE OF THE MARK.

THE COLOR GREY APPEARS IN THE OUTLINE OF THE OUTER CIRCLE, AS BACKGROUND TO THE WORDS "EL MUNDIAL DE LA SALSA", AND AS PALM TREES AND PEOPLE; ORANGE APPEARS IN LINES INSIDE THE CIRCLE IN THE SHAPE OF LINES ON A SOCCER BALL; BLACK APPEARS INSIDE FOUR PARTIAL PENTAGONS CONNECTING TO THE ORANGE LINES; THE NUMBER

CLASS 41—(Continued).

2007 APPEARS IN BLACK; WHITE APPEARS IN THE BACKGROUND AND IN THE FORM OF A COUPLE DANCING NEAR THE CENTER OF THE CIRCLE; WHITE APPEARS IN SECTIONS OF THE SOCCER BALL AND THE TERM "MUNDIAL"; THE COLOR TAN APPEARS IN RAYS FANNING OUT FROM THE CENTER OF THE CIRCLE LIKE LIGHT; RED APPEARS IN THE WORDING "EL", "DE LA", AND THE TOP OF THE WORD "SALSA"; AND YELLOW APPEARS AS THE OUTLINE OF "EL MUNDIAL DE LA SALSA" AND THE BOTTOM OF THE WORD SALSA.

THE FOREIGN WORDING IN THE MARK TRANSLATES INTO ENGLISH AS "THE WORLD CUP OF SALSA".

FOR ENTERTAINMENT IN THE NATURE OF DANCE PERFORMANCES; ENTERTAINMENT, NAMELY, LIVE MUSIC CONCERTS; ENTERTAINMENT, NAMELY, LIVE PERFORMANCES BY MUSICAL BANDS; PRESENTATION OF LIVE SHOW PERFORMANCES; PRESENTATION OF MUSICAL PERFORMANCE (U.S. CLS. 100, 101 AND 107).

FIRST USE 11-1-2006; IN COMMERCE 11-1-2006.

PETER B. BROMAGHIM, EXAMINING ATTORNEY

SN 77-051,766. SUCCESS DESIGN INTERNATIONAL LLC, LOS ANGELES, CA. FILED 11-28-2006.

**Cognitive-Emotional
Realignment**

THE MARK CONSISTS OF STANDARD CHARACTERS WITHOUT CLAIM TO ANY PARTICULAR FONT, STYLE, SIZE, OR COLOR.

FOR EDUCATIONAL SERVICES, NAMELY, PROVIDING A TRAINING COURSE IN THE FIELD OF SELF-IMPROVEMENT (U.S. CLS. 100, 101 AND 107).

FIRST USE 3-15-1998; IN COMMERCE 3-15-1998.

TAMARA FRAZIER, EXAMINING ATTORNEY

SN 77-054,031. KABUSHIKI KAISHA BANDAI, (AKA BANDAI CO., LTD.), TAITO-KU, JAPAN, FILED 11-30-2006.

GUNPEY EX

THE MARK CONSISTS OF STANDARD CHARACTERS WITHOUT CLAIM TO ANY PARTICULAR FONT, STYLE, SIZE, OR COLOR.

FOR PROVIDING GAMES, INFORMATION ABOUT GAMES AND GAMING AND UPDATES OF GAMES THAT USERS MAY DOWNLOAD FROM APPLICANT'S WEBSITE TO THEIR MOBILE PHONES (U.S. CLS. 100, 101 AND 107).

FIRST USE 2-18-2004; IN COMMERCE 6-2-2006.

LINDA MICKLEBURGH, EXAMINING ATTORNEY

CLASS 41—(Continued).

SN 77-055,493. MUSIC MAKERS, LLC, BETHESDA, MD.
FILED 12-1-2006.

CLASS 41—(Continued).

SN 77-060,989. HANLEY-WOOD, LLC, WASHINGTON, DC.
FILED 12-11-2006.

REMODELING ONLINE



THE MARK CONSISTS OF STANDARD CHARACTERS WITHOUT CLAIM TO ANY PARTICULAR FONT, STYLE, SIZE, OR COLOR.

OWNER OF U.S. REG. NO. 1,731,008.

NO CLAIM IS MADE TO THE EXCLUSIVE RIGHT TO USE "ONLINE", APART FROM THE MARK AS SHOWN. SEC. 2(F).

FOR ON-LINE PUBLICATION OF MAGAZINES FOR THE PROFESSIONAL HOME IMPROVEMENT INDUSTRY (U.S. CLS. 100, 101 AND 107).

FIRST USE 1-1-1997; IN COMMERCE 1-1-1997.

DAVID MURRAY, EXAMINING ATTORNEY

THE COLOR(S) RED, PURPLE, BLUE, AND BLACK IS/ ARE CLAIMED AS A FEATURE OF THE MARK.

THE MARK CONSISTS OF A STYLIZED LETTER "B" IN RED, A STYLIZED NUMBER "2" IN PURPLE, A STYLIZED LETTER "R" IN BLUE, AND A STYLIZED HUMAN FIGURE HOLDING A GUITAR IN BLACK.

FOR EDUCATION AND ENTERTAINMENT SERVICES, NAMELY, PROVIDING TRAINING AND INSTRUCTION IN THE FIELDS OF POP AND ROCK MUSIC AND PERFORMANCE ARTS; OPERATING SCHOOLS IN THE FIELDS OF POP AND ROCK MUSIC AND PERFORMANCE ARTS; PROVIDING PHYSICAL FACILITIES FOR THE REHEARSAL AND RECORDING OF PERFORMANCES IN POP AND ROCK MUSIC; PROVIDING INSTRUCTOR TRAINING SERVICES IN THE FIELDS OF POP AND ROCK MUSIC AND PERFORMANCE ARTS; ORGANIZING AND CONDUCTING CONCERTS AND COMPETITIONS IN THE FIELDS OF POP AND ROCK MUSIC AND PERFORMANCE ARTS; PROVIDING RECOGNITION AND INCENTIVES TO INDIVIDUALS WHO DEMONSTRATE EXCELLENCE IN THE FIELDS OF POP AND ROCK MUSIC AND PERFORMANCE ARTS; ENTERTAINMENT IN THE NATURE OF ONGOING TELEVISION, CABLE TELEVISION, AND RADIO PROGRAMS IN THE FIELDS OF POP AND ROCK MUSIC AND PERFORMANCE ARTS; PRODUCTION AND DISTRIBUTION OF AUDIO AND AUDIO-VISUAL RADIO PROGRAMS AND TELEVISION SHOWS FOR BROADCAST TELEVISION, BROADCAST RADIO, CABLE NETWORKS, SATELLITE NETWORKS, AND GLOBAL COMPUTER NETWORKS; PROVIDING WEB SITES IN THE FIELDS OF POP AND ROCK MUSIC AND PERFORMANCE ARTS (U.S. CLS. 100, 101 AND 107).

H. M. FISHER, EXAMINING ATTORNEY

SN 77-063,389. BOYD GAMING CORPORATION, LAS VEGAS, NV. FILED 12-13-2006.

JADE

THE MARK CONSISTS OF STANDARD CHARACTERS WITHOUT CLAIM TO ANY PARTICULAR FONT, STYLE, SIZE, OR COLOR.

FOR CASINOS (U.S. CLS. 100, 101 AND 107).

FIRST USE 5-24-2006; IN COMMERCE 5-24-2006.

JENNIFER DIXON, EXAMINING ATTORNEY

CLASS 41—(Continued).

SN 77-067,403. WYNN RESORTS HOLDINGS, LLC, LAS VEGAS, NV. FILED 12-19-2006.

WYNN TOWER SUITES

THE MARK CONSISTS OF STANDARD CHARACTERS WITHOUT CLAIM TO ANY PARTICULAR FONT, STYLE, SIZE, OR COLOR.

OWNER OF U.S. REG. NOS. 2,977,861, 3,195,978 AND OTHERS.

FOR CASINOS AND CASINO SERVICES; ENTERTAINMENT IN THE NATURE OF THEATER PRODUCTIONS, LIVE MUSIC CONCERTS, BOXING CONTESTS, VISUAL AND AUDIO PERFORMANCES, VARIETY, AND COMEDY SHOWS; ENTERTAINMENT SERVICES NAMELY PROVIDING COMMUNITY EVENTS, ART FESTIVALS, PARADES, LIVE MUSIC CONCERTS AND FESTIVALS, PRODUCTION OF TELEVISION SPECIALS IN THE NATURE OF VARIETY SHOWS, AWARDS SHOWS AND CELEBRATION SPECIALS; ARRANGING FOR TICKET RESERVATIONS FOR SHOWS AND OTHER ENTERTAINMENT EVENTS; AMUSEMENT PARKS AND ARCADES; ANIMAL EXHIBITIONS; ARRANGING AND CONDUCTING ATHLETIC COMPETITIONS; AUDIO RECORDING AND PRODUCTION; MOVIE THEATERS; CABARETS; NIGHT CLUB SERVICES; FIGURE SALONS; ARRANGING AND CONDUCTING GOLF COMPETITIONS, ENTERTAINMENT IN THE NATURE OF GOLF TOURNAMENTS, GOLF COURSES, GOLF CLUB SERVICES; GYMNASIUMS; HEALTH CLUB SERVICES, NAMELY PROVIDING INSTRUCTION AND EQUIPMENT IN THE FIELD OF PHYSICAL EXERCISE; MUSEUMS; PROVIDING FACILITIES FOR RECREATION ACTIVITIES; PROVIDING FACILITIES FOR SPORTS TOURNAMENTS AND GAMING TOURNAMENTS; SPECIAL EVENT PLANNING; PROVIDING TRAVEL AGENCY SERVICES, NAMELY MAKING RESERVATIONS AND BOOKINGS FOR ENTERTAINMENT IN THE NATURE OF LIVE SHOWS AND NIGHTCLUB ADMISSION; PROVIDING ENTERTAINMENT INFORMATION CONCERNING MUSIC, THEATER PRODUCTIONS, ATHLETIC COMPETITIONS, SPORTS TOURNAMENTS, GAMING TOURNAMENTS AND LIVE SHOWS VIA THE INTERNET; PHOTOGRAPHY SERVICES (U.S. CLS. 100, 101 AND 107).

YONG KIM, EXAMINING ATTORNEY

CLASS 41—(Continued).

SN 77-071,123. COTHRAN, DENNIS W., DBA LAZARUS WOLF, TURNER, OR. FILED 12-25-2006.

Lazarus Wolf

THE MARK CONSISTS OF STANDARD CHARACTERS WITHOUT CLAIM TO ANY PARTICULAR FONT, STYLE, SIZE, OR COLOR.

THE NAME "LAZARUS WOLF" IDENTIFIES A LIVING INDIVIDUAL WHOSE CONSENT IS OF RECORD.

FOR ENTERTAINMENT IN THE NATURE OF VISUAL AND AUDIO PERFORMANCES, NAMELY, MUSICAL BAND, ROCK GROUP, GYMNASTIC, DANCE, AND BALLET PERFORMANCES; ENTERTAINMENT, NAMELY, LIVE PERFORMANCES BY A MUSICAL BAND; ENTERTAINMENT SERVICES, NAMELY, PROVIDING A WEB SITE FEATURING MUSICAL PERFORMANCES, MUSICAL VIDEOS, RELATED FILM CLIPS, PHOTOGRAPHS, AND OTHER MULTIMEDIA MATERIALS; PRESENTATION OF LIVE SHOW PERFORMANCES; PRESENTATION OF MUSICAL PERFORMANCE; RADIO ENTERTAINMENT SERVICES, NAMELY, RADIO PROGRAMS FEATURING PERFORMANCES BY A PERSON OR INDIVIDUAL (U.S. CLS. 100, 101 AND 107).

FIRST USE 9-15-2006; IN COMMERCE 12-15-2006.

RONALD MCMORROW, EXAMINING ATTORNEY

SN 77-073,818. BECKER, JAMES F., JR., CHICAGO, IL. FILED 12-30-2006.

XDANCE

THE MARK CONSISTS OF STANDARD CHARACTERS WITHOUT CLAIM TO ANY PARTICULAR FONT, STYLE, SIZE, OR COLOR.

FOR ENTERTAINMENT IN THE NATURE OF VISUAL AND AUDIO PERFORMANCES, NAMELY, MUSICAL BAND, ROCK GROUP, GYMNASTIC, DANCE, AND BALLET PERFORMANCES (U.S. CLS. 100, 101 AND 107).

FIRST USE 2-1-2001; IN COMMERCE 2-1-2001.

DANNEAN HETZEL, EXAMINING ATTORNEY

CLASS 41—(Continued).

SN 77-074,842. RUTGERS, THE STATE UNIVERSITY OF NEW JERSEY, NEW BRUNSWICK, NJ. FILED 1-3-2007.

RUTGERS UNIVERSITY

THE MARK CONSISTS OF STANDARD CHARACTERS WITHOUT CLAIM TO ANY PARTICULAR FONT, STYLE, SIZE, OR COLOR.

OWNER OF U.S. REG. NOS. 1,110,675 AND 1,598,541.

NO CLAIM IS MADE TO THE EXCLUSIVE RIGHT TO USE "UNIVERSITY", APART FROM THE MARK AS SHOWN.

FOR EDUCATIONAL SERVICES IN THE FIELDS OF POST-SECONDARY AND CONTINUING EDUCATION IN THE FIELDS OF LAW, HEALTH, SOCIAL SCIENCE, LIBERAL ARTS, VOCATIONAL TRAINING, FINE ARTS, ENGINEERING AND SCIENCE (U.S. CLS. 100, 101 AND 107).

YONG KIM, EXAMINING ATTORNEY

CLASS 41—(Continued).

SN 77-075,018. FORNI, DREW, LOS ANGELES, CA. FILED 1-3-2007.



NO CLAIM IS MADE TO THE EXCLUSIVE RIGHT TO USE "DJS", APART FROM THE MARK AS SHOWN.

THE MARK CONSISTS OF THE STYLIZED WORDING "ONE SHOT DJs", HAVING THE LETTER "O" WITH AN OVERLAPPING DESIGN OF CROSSHAIRS. ABOVE THE STYLIZED WORDING IS THE DESIGN OF A SKYLINE FORMED BY THE SILHOUETTE OF A BUILDING ON THE FAR LEFT AND THE FAR RIGHT OF THE SKYLINE AND HAVING THE REPRESENTATION OF AN EQUALIZER DISPLAY FORMING THE REMAINDER OF THE SKYLINE BETWEEN THE BUILDINGS.

FOR DISC JOCKEYS FOR PARTIES AND SPECIAL EVENTS (U.S. CLS. 100, 101 AND 107).

FIRST USE 7-1-2006; IN COMMERCE 7-1-2006.

JAY BESCH, EXAMINING ATTORNEY

SN 77-081,836. AZUSA PACIFIC UNIVERSITY, AZUSA, CA. FILED 1-12-2007.

SN 77-074,882. VERSUS, L.P., STAMFORD, CT. FILED 1-3-2007.

WHITETAIL NATION



THE MARK CONSISTS OF STANDARD CHARACTERS WITHOUT CLAIM TO ANY PARTICULAR FONT, STYLE, SIZE, OR COLOR.

NO CLAIM IS MADE TO THE EXCLUSIVE RIGHT TO USE "WHITETAIL", APART FROM THE MARK AS SHOWN.

FOR ENTERTAINMENT SERVICES IN THE NATURE OF TELEVISION PROGRAMMING; PRODUCTION OF TELEVISION PROGRAMS AND DISTRIBUTION OF TELEVISION PROGRAMMING TO CABLE TELEVISION SYSTEMS; PROVIDING INFORMATION RELATING TO TELEVISION PROGRAMMING VIA A GLOBAL COMPUTER NETWORK (U.S. CLS. 100, 101 AND 107).

BRENDAN REGAN, EXAMINING ATTORNEY

THE MARK CONSISTS OF A FLATTENED TRIANGLE CONTAINING A CROSS.

FOR EDUCATIONAL SERVICES, NAMELY, PROVIDING COURSES OF INSTRUCTION AT THE COLLEGE LEVEL AND DISTRIBUTION OF COURSE MATERIALS RELATED THERETO; ENTERTAINMENT SERVICES IN THE NATURE OF CONDUCTING AND HOSTING SPORTING EVENTS AT THE COLLEGE AND UNIVERSITY LEVEL, NAMELY, BASKETBALL, FOOTBALL, BASEBALL, SOCCER, TENNIS, TRACK AND FIELD, CROSS-COUNTRY, SOFTBALL, VOLLEYBALL AND CHEERLEADING (U.S. CLS. 100, 101 AND 107).

FIRST USE 12-31-1998; IN COMMERCE 12-31-1998.

WANDA KAY PRICE, EXAMINING ATTORNEY

CLASS 41—(Continued).

SN 77-083,058. MURDOCK, BRENDA MARIE, BLOOMFIELD, NJ. FILED 1-15-2007.

The Angry Dieter

THE MARK CONSISTS OF STANDARD CHARACTERS WITHOUT CLAIM TO ANY PARTICULAR FONT, STYLE, SIZE, OR COLOR.

FOR PUBLICATION OF BOOKS; PUBLICATION OF BOOKS, MAGAZINES, ALMANACS AND JOURNALS; PUBLICATION OF BOOKS, OF MAGAZINES, OF JOURNALS, OF NEWSPAPERS, OF PERIODICALS, OF CATALOGS, OF BROCHURES; PUBLICATION OF BOOKS, REVIEWS; PUBLICATION OF BOOKS ON DIETING AND/OR NUTRITION; PUBLISHING OF BOOKS AND REVIEWS; PUBLISHING OF BOOKS, MAGAZINES (U.S. CLS. 100, 101 AND 107).

APRIL ROACH, EXAMINING ATTORNEY

SN 77-087,910. DENNIS PESCIPELLI, SPRINGFIELD, IL. AND ROBERT L. NEWBOLD, SPRINGFIELD, IL. FILED 1-22-2007.

InspireNET

THE MARK CONSISTS OF STANDARD CHARACTERS WITHOUT CLAIM TO ANY PARTICULAR FONT, STYLE, SIZE, OR COLOR.

FOR EDUCATIONAL SERVICES, NAMELY, PROVIDING MEETINGS, SEMINARS AND WORKSHOPS IN THE FIELDS OF VALUES AND INSPIRATION; PROVIDING EDUCATIONAL MENTORING SERVICES AND PROGRAMS FOR BUSINESS AND COMMUNITY LEADERS IN THE FIELDS OF VALUES AND INSPIRATION (U.S. CLS. 100, 101 AND 107).

FIRST USE 10-0-2005; IN COMMERCE 10-0-2005.
JIM RINGLE, EXAMINING ATTORNEY

SN 77-088,982. WIRTH, JOHN E., HUNTLEY, IL. FILED 1-23-2007.

DOUBLE WIN POKER

THE MARK CONSISTS OF STANDARD CHARACTERS WITHOUT CLAIM TO ANY PARTICULAR FONT, STYLE, SIZE, OR COLOR.

NO CLAIM IS MADE TO THE EXCLUSIVE RIGHT TO USE "POKER", APART FROM THE MARK AS SHOWN.

FOR ENTERTAINMENT SERVICES, NAMELY, CONDUCTING GAMES OF CHANCE IN GAMING ESTABLISHMENTS (U.S. CLS. 100, 101 AND 107).

MARK SPARACINO, EXAMINING ATTORNEY

CLASS 41—(Continued).

SN 77-090,757. AMGEN INC., THOUSAND OAKS, CA. FILED 1-25-2007.

PMI PSORIASIS MANAGEMENT INSTITUTE

THE MARK CONSISTS OF STANDARD CHARACTERS WITHOUT CLAIM TO ANY PARTICULAR FONT, STYLE, SIZE, OR COLOR.

NO CLAIM IS MADE TO THE EXCLUSIVE RIGHT TO USE "PSORIASIS MANAGEMENT INSTITUTE", APART FROM THE MARK AS SHOWN.

FOR EDUCATIONAL SERVICES, NAMELY, DEVELOPMENT AND DISSEMINATION OF EDUCATIONAL MATERIALS OF OTHERS IN THE FIELD OF PSORIASIS AND THE TREATMENT THEREOF (U.S. CLS. 100, 101 AND 107).

JASON BLAIR, EXAMINING ATTORNEY

SN 77-092,259. HOLLYWOOD MOVIEOKE STUDIOS, INC., SARASOTA, FL. FILED 1-26-2007.

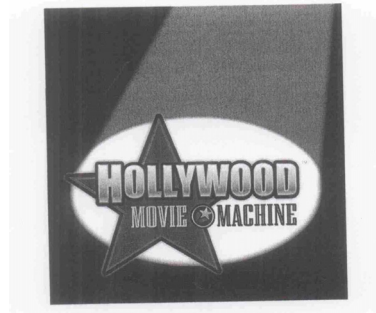

NO CLAIM IS MADE TO THE EXCLUSIVE RIGHT TO USE "HOLLYWOOD MOVIE", APART FROM THE MARK AS SHOWN.

THE MARK CONSISTS OF A STAR BEHIND THE WORDS "HOLLYWOOD MOVIE MACHINE" AND A SPOT LIGHT SHINING ON THEM, ALL ENCOMPASSED WITHIN A RECTANGLE.

FOR VIDEO EDITING, NAMELY, INSERTING PARTICIPANTS' FACES FOR THOSE OF ACTORS OR OTHER CHARACTERS IN HOLLYWOOD MOVIE CLIPS (U.S. CLS. 100, 101 AND 107).

TEJBIR SINGH, EXAMINING ATTORNEY

CLASS 41—(Continued).

SN 77-096,968. VIACOM INTERNATIONAL INC., NEW YORK, NY. FILED 2-1-2007.

TIPSTER

THE MARK CONSISTS OF STANDARD CHARACTERS WITHOUT CLAIM TO ANY PARTICULAR FONT, STYLE, SIZE, OR COLOR.

FOR ENTERTAINMENT SERVICES, NAMELY, PROVIDING ONGOING TELEVISION PROGRAMS, FEATURING LIVE ACTION, DRAMA, COMEDY, ANIMATION, MUSIC, NEWS, AND FASHION; ENTERTAINMENT SERVICES, NAMELY, PROVIDING ONGOING TELEVISION PROGRAMS, FEATURING LIVE ACTION, DRAMA, COMEDY, ANIMATION, MUSIC, NEWS, AND FASHION VIA A GLOBAL COMPUTER NETWORK; ENTERTAINMENT SERVICES, NAMELY, PROVIDING A WEB SITE FEATURING MUSICAL PERFORMANCES, MUSICAL VIDEOS, RELATED FILM CLIPS, PHOTOGRAPHS, ANIMATED FILM CLIPS, COMPUTER GAMES, ENTERTAINMENT INFORMATION, AND OTHER MULTIMEDIA MATERIALS FOR ENTERTAINMENT (U.S. CLS. 100, 101 AND 107).

LESLEY LAMOTHE, EXAMINING ATTORNEY

CLASS 41—(Continued).

SN 77-097,476. HERNANDEZ, ZEPHYR I., EL PASO, TX. FILED 2-2-2007.

7pm

THE MARK CONSISTS OF STANDARD CHARACTERS WITHOUT CLAIM TO ANY PARTICULAR FONT, STYLE, SIZE, OR COLOR.

FOR COMPOSITION OF MUSIC FOR OTHERS; ENTERTAINMENT IN THE NATURE OF VISUAL AND AUDIO PERFORMANCES, AND MUSICAL, VARIETY, NEWS AND COMEDY SHOWS; ENTERTAINMENT IN THE NATURE OF VISUAL AND AUDIO PERFORMANCES, NAMELY, MUSICAL BAND, ROCK GROUP, GYMNASTIC, DANCE, AND BALLET PERFORMANCES; ENTERTAINMENT IN THE NATURE OF MUSICAL GROUP; ENTERTAINMENT NAMELY, LIVE PERFORMANCES BY A MUSICAL BAND; ENTERTAINMENT SERVICES, NAMELY, PROVIDING A WEB SITE FEATURING MUSICAL PERFORMANCES, MUSICAL VIDEOS, RELATED FILM CLIPS, PHOTOGRAPHS, AND OTHER MULTIMEDIA MATERIALS; ENTERTAINMENT SERVICES, NAMELY, PROVIDING ON-LINE REVIEWS OF MUSIC; ENTERTAINMENT SERVICES, NAMELY, PROVIDING PRERECORDED MUSIC, INFORMATION IN THE FIELD OF MUSIC, AND COMMENTARY AND ARTICLES ABOUT MUSIC, ALL ONLINE VIA A GLOBAL COMPUTER NETWORK; ENTERTAINMENT, NAMELY LIVE MUSIC CONCERTS; ENTERTAINMENT, NAMELY LIVE PERFORMANCES BY MUSICAL BANDS; MUSIC COMPOSITION AND TRANSCRIPTION FOR OTHERS; MUSIC COMPOSITION FOR OTHERS; MUSIC PRODUCTION SERVICES; MUSIC PUBLISHING SERVICES; MUSIC TRANSCRIPTION FOR OTHERS; PLANNING ARRANGEMENT OF SHOWING MOVIES, SHOWS, PLAYS OR MUSICAL PERFORMANCES; PRESENTATION OF MUSICAL PERFORMANCE; PRODUCTION OF SOUND AND MUSICAL VIDEO RECORDINGS; THEATRICAL AND MUSICAL FLOOR SHOWS PROVIDED AT DISCOTHEQUES AND NIGHTCLUBS (U.S. CLS. 100, 101 AND 107).

FIRST USE 5-11-2006; IN COMMERCE 11-10-2006.
ROBIN MITTLER, EXAMINING ATTORNEY

SN 77-099,744. TOPLINE FEDERAL CREDIT UNION, MAPLE GROVE, MN. FILED 2-5-2007.

**Get Smart
With Your
Money**

FOR EDUCATION SERVICES, NAMELY, SEMINARS AND WORKSHOPS EDUCATING KIDS ON SPENDING, SAVING AND SHARING MONEY (U.S. CLS. 100, 101 AND 107).

FIRST USE 12-26-2006; IN COMMERCE 12-26-2006.
PAUL E. FAHRENKOPF, EXAMINING ATTORNEY

CLASS 41—(Continued).

SN 77-099,931. FERNANDES, EDYLLENNE MICHELLE LEMOS, ALLSTON, MA. FILED 2-6-2007.



NO CLAIM IS MADE TO THE EXCLUSIVE RIGHT TO USE "INTERNATIONAL STUDENT CENTER", APART FROM THE MARK AS SHOWN.

THE COLOR(S) BLUE AND WHITE IS/ARE CLAIMED AS A FEATURE OF THE MARK.

THE COLOR BLUE APPEARS IN THE WORDING OF THE MARK AND THE GLOBE DESIGN; THE COLOR WHITE APPEARS IN THE GLOBE DESIGN.

FOR LANGUAGE INSTRUCTION; LANGUAGE INTERPRETATION; LANGUAGE INTERPRETING; LANGUAGE SCHOOLS FEATURING ENGLISH, FRENCH, ITALIAN, SPANISH, PORTUGUESE, CHINESE, JAPANESE AND RUSSIAN; LANGUAGE TRANSLATION (U.S. CLS. 100, 101 AND 107).

FIRST USE 1-1-1994; IN COMMERCE 1-1-1994.
BONNIE LUKEN, EXAMINING ATTORNEY

CLASS 41—(Continued).

SN 77-102,778. THE KLUB, INC., LOS ANGELES, CA. FILED 2-8-2007.



NO CLAIM IS MADE TO THE EXCLUSIVE RIGHT TO USE "CLUB", APART FROM THE MARK AS SHOWN.

THE MARK CONSISTS OF "THE KLUB" AND STYLIZED "K" LOGO.

FOR HEALTH AND FITNESS CLUBS FOR CHILDREN; PROVIDING FITNESS AND EXERCISE FACILITIES FOR CHILDREN; GYMNASICS INSTRUCTION FOR CHILDREN; ORGANIZING AND CONDUCTING BIRTHDAY PARTIES FOR CHILDREN; ORGANIZING AND CONDUCTING CHILDREN'S ENTERTAINMENT EVENTS (U.S. CLS. 100, 101 AND 107).

MARGARET POWER, EXAMINING ATTORNEY

SN 77-104,331. LOVE SCIENCES, LLC, NAPLES, FL. FILED 2-10-2007.

SN 77-101,256. ZUKAV, GARY, ASHLAND, OR. FILED 2-7-2007.

Authentic Power



THE COLOR(S) RED, BLACK, WHITE, AND GRAY IS/ARE CLAIMED AS A FEATURE OF THE MARK.

THE MARK CONSISTS OF A RED HEART WITH A BLACK OUTLINE. A SILHOUETTE OF A MAN AND A WOMAN HOLDING HANDS ARE IN BLACK. BELOW THE MAN AND WOMAN IS A BEAKER WITH A GRAY LIQUID WITH A BLACK OUTLINE.

FOR ENTERTAINMENT SERVICES, NAMELY, CONDUCTING PARTIES FOR THE PURPOSE OF DATING AND SOCIAL INTRODUCTION FOR ADULTS (U.S. CLS. 100, 101 AND 107).

KAPIL BHANOT, EXAMINING ATTORNEY

THE MARK CONSISTS OF STANDARD CHARACTERS WITHOUT CLAIM TO ANY PARTICULAR FONT, STYLE, SIZE, OR COLOR.

FOR EDUCATION SERVICES, NAMELY, PROVIDING CLASSES, CONFERENCES, RETREATS, SEMINARS, AND WORKSHOPS IN THE FIELD OF SPIRITUALITY, SELF-EMPOWERMENT, AND SELF-IMPROVEMENT (U.S. CLS. 100, 101 AND 107).

FIRST USE 3-24-1990; IN COMMERCE 3-24-1990.
ZACHARY BELLO, EXAMINING ATTORNEY

CLASS 41—(Continued).

SN 77-106,337. TABLE MOUNTAIN ANIMAL CENTER FOUNDATION, GOLDEN, CO. FILED 2-13-2007.



FOR ENTERTAINMENT SERVICES, NAMELY, ORGANIZING GOLF TOURNAMENTS FOR THE PURPOSE OF RAISING FUNDS FOR CHARITIES (U.S. CLS. 100, 101 AND 107).

DAYNA BROWNE, EXAMINING ATTORNEY

SN 77-110,639. MARTIN, LATASHA S., COLUMBIA, SC. FILED 2-19-2007.



NO CLAIM IS MADE TO THE EXCLUSIVE RIGHT TO USE "BOOK CLUB", APART FROM THE MARK AS SHOWN.

THE MARK CONSISTS OF DEPICTS THE OUTLINES OF TWO CURVACEOUS WOMEN, CONNECTED AT ONE ARM. ONE WOMAN'S HAIR IS IN BRAIDS AND THE OTHER WOMAN'S HAIR IS IN CURLS. THE WORDS NEXT TO SYMBOL ARE "SISTAHFRIEND BOOK CLUB". UNDERNEATH "SISTAHFRIEND BOOK CLUB" IS THE DESCRIPTION: "A SISTERHOOD OF READERS".

FOR ENTERTAINMENT SERVICES, NAMELY, PROVIDING ON-LINE REVIEWS OF BOOKS (U.S. CLS. 100, 101 AND 107).

FIRST USE 11-1-2004; IN COMMERCE 1-1-2007.

TRACY WHITTAKER-BROWN, EXAMINING ATTORNEY

SN 77-115,234. STAND YOUR GROUND FOUNDATION, HERMOSA BEACH, CA. FILED 2-23-2007.

STAND YOUR GROUND

THE MARK CONSISTS OF STANDARD CHARACTERS WITHOUT CLAIM TO ANY PARTICULAR FONT, STYLE, SIZE, OR COLOR.

OWNER OF U.S. REG. NOS. 2,120,291 AND 2,858,681.

FOR ENTERTAINMENT IN THE NATURE OF AN ONGOING TELEVISION PUBLIC SERVICE ANNOUNCEMENT PROGRAMS IN THE FIELD OF SOCIAL ISSUES (U.S. CLS. 100, 101 AND 107).

FIRST USE 12-2-2006; IN COMMERCE 12-2-2006.

LAURA HAMMEL, EXAMINING ATTORNEY

CLASS 41—(Continued).

SN 77-115,633. BOOKS ALL AROUND, INC., BERKELEY, CA. FILED 2-25-2007.

Books All Around

THE MARK CONSISTS OF STANDARD CHARACTERS WITHOUT CLAIM TO ANY PARTICULAR FONT, STYLE, SIZE, OR COLOR.

NO CLAIM IS MADE TO THE EXCLUSIVE RIGHT TO USE "BOOKS", APART FROM THE MARK AS SHOWN.

FOR CHARITABLE SERVICES, NAMELY, PROVIDING BOOKS TO CHILDREN (U.S. CLS. 100, 101 AND 107).

FIRST USE 5-4-2005; IN COMMERCE 5-4-2005.

ANDREA HACK, EXAMINING ATTORNEY

SN 77-117,060. AMERICAN BOARD OF ANTI-AGING & REGENERATIVE MEDICINE, INC., CHICAGO, IL. FILED 2-27-2007.



NO CLAIM IS MADE TO THE EXCLUSIVE RIGHT TO USE "AMERICAN BOARD OF ANTI-AGING REGENERATIVE MEDICINE" AND THE DESIGN OF THE ROD OF ASCLEPIUS, APART FROM THE MARK AS SHOWN.

THE MARK CONSISTS OF A STYLIZED SNAKE WRAPPED AROUND A STAFF THAT APPEARS TO THE LEFT OF THE LITERAL ELEMENT "AMERICAN BOARD OF ANTI-AGING REGENERATIVE MEDICINE", AND A SERIES OF SMALL BOXES APPEAR IN THE RIGHT LOWER PORTION OF THE MARK.

FOR EDUCATIONAL SERVICES, NAMELY, CONDUCTING CLASSES, SEMINARS, CONFERENCES, AND WORKSHOPS IN THE FIELD OF ANTI-AGING REGENERATIVE MEDICINE FOR PURPOSES OF CERTIFYING, CREDENTIALING AND ACCREDITING PHYSICIANS IN THESE FIELDS; PREPARING, ADMINISTERING AND SCORING TESTS FOR THE PURPOSE OF CERTIFYING, CREDENTIALING AND ACCREDITATION OF PHYSICIANS IN THE FIELD OF ANTI-AGING REGENERATIVE MEDICINE (U.S. CLS. 100, 101 AND 107).

FIRST USE 11-0-2006; IN COMMERCE 11-0-2006.

LAURIE MAYES, EXAMINING ATTORNEY

CLASS 41—(Continued).

SN 77-117,099. AMERICAN BOARD OF ANTI-AGING & REGENERATIVE MEDICINE, INC., CHICAGO, IL. FILED 2-27-2007.



NO CLAIM IS MADE TO THE EXCLUSIVE RIGHT TO USE "FELLOWSHIP IN ANTI-AGING & REGENERATIVE MEDICINE", APART FROM THE MARK AS SHOWN.

FOR EDUCATIONAL SERVICES, NAMELY, CONDUCTING CLASSES, SEMINARS, CONFERENCES, AND WORKSHOPS IN THE FIELD OF ANTI-AGING REGENERATIVE MEDICINE FOR PURPOSES OF CERTIFYING, CREDENTIALING AND ACCREDITING PHYSICIANS IN THESE FIELDS; PREPARING, ADMINISTERING AND SCORING TESTS FOR THE PURPOSE OF CERTIFYING, CREDENTIALING AND ACCREDITATION OF PHYSICIANS IN THE FIELD OF ANTI-AGING REGENERATIVE MEDICINE (U.S. CLS. 100, 101 AND 107).

FIRST USE 11-0-2006; IN COMMERCE 11-0-2006.
LAURIE MAYES, EXAMINING ATTORNEY

SN 77-117,202. LIFE SKILLS AUTHORITIES LLC, CHICAGO, IL. FILED 2-27-2007.

Project Rejection

THE MARK CONSISTS OF STANDARD CHARACTERS WITHOUT CLAIM TO ANY PARTICULAR FONT, STYLE, SIZE, OR COLOR.

FOR PERSONAL COACHING SERVICES IN THE FIELDS OF DATING, COMPATIBILITY, SOCIAL RELATIONSHIPS, PERSONAL IMPROVEMENT, SELF-DEVELOPMENT AND SELF AWARENESS; EDUCATIONAL SERVICES, NAMELY, CONDUCTING CLASSES, SEMINARS, CONFERENCES AND WORKSHOPS IN THE FIELDS OF DATING, COMPATIBILITY, SOCIAL RELATIONSHIPS, AND EFFECTIVE COMMUNICATIONS; AND COURSE MATERIALS DISTRIBUTED IN CONNECTION WITH ALL OF THE FOREGOING SERVICES (U.S. CLS. 100, 101 AND 107).

JAY BESCH, EXAMINING ATTORNEY

CLASS 41—(Continued).

SN 77-118,617. SCRIPPS NETWORKS, LLC., KNOXVILLE, TN. FILED 2-28-2007.

LULU'S HOUSE

THE MARK CONSISTS OF STANDARD CHARACTERS WITHOUT CLAIM TO ANY PARTICULAR FONT, STYLE, SIZE, OR COLOR.

FOR ENTERTAINMENT SERVICES IN THE NATURE OF AN ON-GOING PROGRAM IN THE FIELDS OF COOKING, ENTERTAINING, DECORATING, AND FITNESS, BROADCAST OVER TELEVISION, VIA SATELLITE, AND THROUGH OTHER AUDIOVISUAL MEDIA (U.S. CLS. 100, 101 AND 107).

LYDIA BELZER, EXAMINING ATTORNEY

SN 77-120,042. COX ENTERPRISES, INC., ATLANTA, GA. FILED 3-1-2007.

COX EXCELLENCE IN LEADERSHIP TAKING LEADERSHIP TO THE NEXT LEVEL

THE MARK CONSISTS OF STANDARD CHARACTERS WITHOUT CLAIM TO ANY PARTICULAR FONT, STYLE, SIZE, OR COLOR.

OWNER OF U.S. REG. NOS. 1,716,534 AND 1,720,928.

NO CLAIM IS MADE TO THE EXCLUSIVE RIGHT TO USE "EXCELLENCE IN LEADERSHIP", APART FROM THE MARK AS SHOWN.

FOR EDUCATIONAL SERVICES, NAMELY, PROVIDING CLASSES, SEMINARS AND WORKSHOPS IN THE FIELD OF EXECUTIVE TRAINING FOR EMPLOYEES OF FOR-PROFIT COMPANIES (U.S. CLS. 100, 101 AND 107).

FIRST USE 8-0-2005; IN COMMERCE 8-0-2005.

DANIEL BRODY, EXAMINING ATTORNEY

SN 77-120,842. MARRIER, CHAUNCEY ANTHONY, WITHEE, WI. AND MARRIER, DARRELL WARREN, WITHEE, WI. FILED 3-2-2007.

Fragile

THE MARK CONSISTS OF STANDARD CHARACTERS WITHOUT CLAIM TO ANY PARTICULAR FONT, STYLE, SIZE, OR COLOR.

FOR ENTERTAINMENT, NAMELY, LIVE PERFORMANCES BY A MUSICAL BAND (U.S. CLS. 100, 101 AND 107).

FIRST USE 5-11-2000; IN COMMERCE 9-17-2002.

BERNICE MIDDLETON, EXAMINING ATTORNEY

CLASS 41—(Continued).

SN 77-121,495. PLAN AHEAD EVENTS, INC., WEST PALM BEACH, FL. FILED 3-2-2007.

PLAN AHEAD EVENTS

THE MARK CONSISTS OF STANDARD CHARACTERS WITHOUT CLAIM TO ANY PARTICULAR FONT, STYLE, SIZE, OR COLOR.

NO CLAIM IS MADE TO THE EXCLUSIVE RIGHT TO USE "EVENTS", APART FROM THE MARK AS SHOWN.

FOR PROVIDING EVENT PLANNING AND MANAGEMENT SERVICES, NAMELY, PROVIDING SUPPORT, ORGANIZATION AND MANAGEMENT AND ARRANGING AND SCHEDULING CORPORATE MEETINGS, CONVENTIONS, TRADESHOWS, SPECIAL EVENTS, CULTURAL EVENTS (U.S. CLS. 100, 101 AND 107).

WILLIAM BRECKENFELD, EXAMINING ATTORNEY

SN 77-121,751. FATS, INC., SUWANEE, GA. FILED 3-4-2007.

FATS VIRTUAL TRAINING SOLUTIONS COMPANY

THE MARK CONSISTS OF STANDARD CHARACTERS WITHOUT CLAIM TO ANY PARTICULAR FONT, STYLE, SIZE, OR COLOR.

OWNER OF U.S. REG. NOS. 2,077,153, 2,088,866 AND 2,967,753.

NO CLAIM IS MADE TO THE EXCLUSIVE RIGHT TO USE "VIRTUAL TRAINING SOLUTIONS COMPANY", APART FROM THE MARK AS SHOWN.

FOR VIRTUAL TRAINING AND EDUCATIONAL SERVICE, NAMELY, PROVIDING TRAINING, CLASSES, SEMINARS AND PROGRAMS USING FULLY-INTEGRATED, SIMULATED, INTERACTIVE TRAINING SCENARIOS TO FACILITATE THE MASTERING JUDGMENTAL, TACTICAL AND COMBINED ARMS EXPERIENCES AND CRITICAL TASKS REQUIRED BY ADVANCED MILITARY AND LAW ENFORCEMENT OPERATIONS; PROVIDING TRAINING IN THE USE OF FIREARMS AND WEAPONS COMPRISED OF ACTUAL OR MODIFIED RIFLES, SHOTGUNS, PISTOLS, MACHINE GUNS, HEAVY MACHINE ANTI-ARMOR ROCKET LAUNCHERS, LASERS, GRENADES, AS WELL AS WEAPONS TRAINING ON MOTION INTEGRATED PLATFORMS, GROUND ATTACK AIR CONTROL SYSTEMS, AND COLLECTIVE TACTICAL SYSTEMS (U.S. CLS. 100, 101 AND 107).

FIRST USE 12-0-2004; IN COMMERCE 12-0-2004.

KELLY BOULTON, EXAMINING ATTORNEY

CLASS 41—(Continued).

SN 77-121,855. ELDER WISDOM CIRCLE, WALNUT CREEK, CA. FILED 3-4-2007.

ELDER WISDOM CIRCLE

THE MARK CONSISTS OF STANDARD CHARACTERS WITHOUT CLAIM TO ANY PARTICULAR FONT, STYLE, SIZE, OR COLOR.

FOR PRODUCTION OF RADIO AND TELEVISION PROGRAMS AND MOTION PICTURES; AND, ON-LINE PUBLICATIONS, NAMELY, ARTICLES, COLUMNS, NEWSLETTERS, AND BOOKS; ALL FEATURING PRACTICAL ADVICE ON A BROAD RANGE OF TOPICS INCLUDING SELF IMPROVEMENT AND PERSONAL EMPOWERMENT THAT IS PROVIDED BY VOLUNTEER SENIORS (U.S. CLS. 100, 101 AND 107).

PAUL E. FAHRENKOPF, EXAMINING ATTORNEY

SN 77-123,687. BYRNES & ANDERSON LLC, GRAND RAPIDS, MI. FILED 3-6-2007.

QUALITY BOOT CAMP

THE MARK CONSISTS OF STANDARD CHARACTERS WITHOUT CLAIM TO ANY PARTICULAR FONT, STYLE, SIZE, OR COLOR.

NO CLAIM IS MADE TO THE EXCLUSIVE RIGHT TO USE "QUALITY", APART FROM THE MARK AS SHOWN.

FOR EDUCATIONAL SERVICES, NAMELY, CONDUCTING LIVE AND WEB CONFERENCES AND SEMINARS IN THE FIELD OF HEALTH CARE, AND DISTRIBUTION OF COURSE MATERIAL IN CONNECTION THEREWITH (U.S. CLS. 100, 101 AND 107).

RICHARD A. STRASER, EXAMINING ATTORNEY

SN 77-124,589. PARAMOUNT PICTURES CORPORATION, HOLLYWOOD, CA. FILED 3-7-2007.

PARAMOUNT FAMOUS PRODUCTIONS

THE MARK CONSISTS OF STANDARD CHARACTERS WITHOUT CLAIM TO ANY PARTICULAR FONT, STYLE, SIZE, OR COLOR.

OWNER OF U.S. REG. NOS. 1,695,847, 2,683,224 AND OTHERS.

NO CLAIM IS MADE TO THE EXCLUSIVE RIGHT TO USE "FAMOUS PRODUCTIONS", APART FROM THE MARK AS SHOWN.

FOR ENTERTAINMENT SERVICES IN THE NATURE OF PRODUCTION AND DISTRIBUTION OF DIRECT-TO-VIDEO LIVE-ACTION, COMEDY, DRAMA AND ANIMATED MOTION PICTURE THEATRICAL FILMS (U.S. CLS. 100, 101 AND 107).

ERIN FALK, EXAMINING ATTORNEY

CLASS 41—(Continued).

SN 77-124,834. AMERICAN BROADCASTING COMPANIES, INC., NEW YORK, NY. FILED 3-7-2007.

WIDE WORLD OF POLITICS

THE MARK CONSISTS OF STANDARD CHARACTERS WITHOUT CLAIM TO ANY PARTICULAR FONT, STYLE, SIZE, OR COLOR.

NO CLAIM IS MADE TO THE EXCLUSIVE RIGHT TO USE POLITICS, APART FROM THE MARK AS SHOWN.

FOR ENTERTAINMENT SERVICES IN THE NATURE OF ONGOING TELEVISION PROGRAMS IN THE FIELD OF POLITICS, CURRENT NEWS EVENTS, CULTURE, AND HISTORY (U.S. CLS. 100, 101 AND 107).

ELISSA GARBER KON, EXAMINING ATTORNEY

SN 77-125,500. APEX MERCHANDISE GROUP, LLC, SCOTTSDALE, AZ. FILED 3-8-2007.

PH ION

THE MARK CONSISTS OF STANDARD CHARACTERS WITHOUT CLAIM TO ANY PARTICULAR FONT, STYLE, SIZE, OR COLOR.

NO CLAIM IS MADE TO THE EXCLUSIVE RIGHT TO USE "PH", APART FROM THE MARK AS SHOWN.

FOR EDUCATION SERVICES, NAMELY, PROVIDING CLASSES, SEMINARS, WORKSHOPS IN THE FIELD OF NUTRITION; DEVELOPMENT AND DISSEMINATION OF EDUCATIONAL MATERIALS OF OTHERS IN THE FIELD OF NUTRITION; PROGRAMMING ON A GLOBAL COMPUTER NETWORK; ELECTRONIC PUBLISHING SERVICES, NAMELY, PUBLICATION OF TEXT AND GRAPHIC WORKS OF OTHERS ON DVD AND ON-LINE FEATURING EDUCATIONAL MATERIAL IN THE FIELD OF NUTRITION; ON-LINE LIBRARY SERVICES, NAMELY, PROVIDING ELECTRONIC LIBRARY SERVICES WHICH FEATURE NEWSPAPERS, MAGAZINES, PHOTOGRAPHS AND PICTURES VIA AN ON-LINE COMPUTER NETWORK (U.S. CLS. 100, 101 AND 107).

FIRST USE 1-0-2003; IN COMMERCE 1-0-2003.
DAVID ELTON, EXAMINING ATTORNEY

CLASS 41—(Continued).

SN 77-125,542. GAME ONE SAS, PARIS, FRANCE, FILED 3-8-2007.

GAME ONE

OWNER OF U.S. REG. NOS. 2,682,102 AND 2,863,917.
NO CLAIM IS MADE TO THE EXCLUSIVE RIGHT TO USE "GAME", APART FROM THE MARK AS SHOWN.

FOR ENTERTAINMENT SERVICES, NAMELY, PROVIDING AN ON-LINE COMPUTER GAME; AMUSEMENT SERVICES, NAMELY, AMUSEMENT ARCADES; PUBLICATION OF BOOKS AND MAGAZINES; MOTION PICTURE AND AUDIOVISUAL FILM PRODUCTION; ELECTRONIC PUBLISHING SERVICES, NAMELY, PUBLICATION OF TEXT AND GRAPHIC WORKS OF OTHERS ON CD-ROMS AND DVD-ROMS FEATURING GAMES, VIDEO GAMES, TOYS AND DATABASES; TRAINING IN THE FIELD OF DATA PROCESSING; EDUCATIONAL SERVICES, NAMELY, ON-LINE CLASSES IN THE FIELD OF GAMES AND VIDEO GAMES; ENTERTAINMENT, NAMELY, PRODUCTION OF TELEVISION SHOWS; ENTERTAINMENT IN THE NATURE OF ONGOING TELEVISION PROGRAMS IN THE FIELDS OF NEWS AND COMEDY; VARIETY ENTERTAINMENT, NAMELY, PRODUCTION OF MOTION PICTURE FILMS; ENTERTAINMENT SERVICES THROUGH PROVIDING OF INFORMATION NEWS REGARDING VIDEO GAMES, GAME STRATEGIES OR PLAY STRATEGIES FOR VIDEO GAME SOFTWARE BY TELEVISION OR BY A GLOBAL COMMUNICATION NETWORK; ONLINE GAMES THROUGH COMPUTERS OR GAME CONSOLES USED WITH TELEVISION; RENTAL OF COMPUTER GAME SOFTWARE; NEWS AGENCIES, NAMELY, GATHERING AND DISSEMINATION OF NEWS AND NEWS SYNDICATION REPORTING; PHOTOGRAPHIC NEWS REPORTING SERVICES; PHOTOGRAPHIC DOCUMENTARY PRODUCTION (U.S. CLS. 100, 101 AND 107).

REBECCA POVARCHUK, EXAMINING ATTORNEY

SN 77-125,797. NATIONAL BALLROOM DANCE PRODUCTIONS, INC., BOSTON, MA. FILED 3-8-2007.



NO CLAIM IS MADE TO THE EXCLUSIVE RIGHT TO USE "NEW ENGLAND BALLROOM & LATIN DANCE CENTER", APART FROM THE MARK AS SHOWN.

FOR EDUCATIONAL AND ENTERTAINMENT SERVICES, NAMELY, PROVIDING DANCE INSTRUCTION AND DANCE PERFORMANCES, DANCE SCHOOL SERVICES, DANCE STUDIO SERVICES, DANCE CLUB SERVICES, AND DANCE PARTY SERVICES; ONLINE PROVISION OF INSTRUCTIONAL AND PERFORMANCE MATERIALS RELATED TO DANCE (U.S. CLS. 100, 101 AND 107).

MICHELE SWAIN, EXAMINING ATTORNEY

CLASS 41—(Continued).

SN 77-125,802. NATIONAL BALLROOM DANCE PRODUCTIONS, INC., BOSTON, MA. FILED 3-8-2007.



NO CLAIM IS MADE TO THE EXCLUSIVE RIGHT TO USE CAPE COD BALLROOM & LATIN DANCE CENTER, APART FROM THE MARK AS SHOWN.

FOR EDUCATIONAL AND ENTERTAINMENT SERVICES, NAMELY, PROVIDING DANCE INSTRUCTION AND DANCE PERFORMANCES, DANCE SCHOOL SERVICES, DANCE STUDIO SERVICES, DANCE CLUB SERVICES, AND DANCE PARTY SERVICES; ONLINE PROVISION OF INSTRUCTIONAL AND PERFORMANCE MATERIALS RELATED TO DANCE (U.S. CLS. 100, 101 AND 107).
MICHELE SWAIN, EXAMINING ATTORNEY

CLASS 41—(Continued).

SN 77-125,813. NATIONAL BALLROOM DANCE PRODUCTIONS, INC., BOSTON, MA. FILED 3-8-2007.



NO CLAIM IS MADE TO THE EXCLUSIVE RIGHT TO USE "SOUTH FLORIDA BALLROOM & LATIN DANCE CENTER", APART FROM THE MARK AS SHOWN.

FOR EDUCATIONAL AND ENTERTAINMENT SERVICES, NAMELY, PROVIDING DANCE INSTRUCTION AND DANCE PERFORMANCES, DANCE SCHOOL SERVICES, DANCE STUDIO SERVICES, DANCE CLUB SERVICES, AND DANCE PARTY SERVICES; ONLINE PROVISION OF INSTRUCTIONAL AND PERFORMANCE MATERIALS RELATED TO DANCE (U.S. CLS. 100, 101 AND 107).
MICHELE SWAIN, EXAMINING ATTORNEY

SN 77-125,809. NATIONAL BALLROOM DANCE PRODUCTIONS, INC., BOSTON, MA. FILED 3-8-2007.



NO CLAIM IS MADE TO THE EXCLUSIVE RIGHT TO USE "WEDDING DANCE CENTER", APART FROM THE MARK AS SHOWN.

FOR EDUCATIONAL AND ENTERTAINMENT SERVICES, NAMELY, PROVIDING DANCE INSTRUCTION AND DANCE PERFORMANCES, DANCE SCHOOL SERVICES, DANCE STUDIO SERVICES, DANCE CLUB SERVICES, AND DANCE PARTY SERVICES; ONLINE PROVISION OF INSTRUCTIONAL AND PERFORMANCE MATERIALS RELATED TO DANCE (U.S. CLS. 100, 101 AND 107).
MICHELE SWAIN, EXAMINING ATTORNEY

SN 77-125,817. NATIONAL BALLROOM DANCE PRODUCTIONS, INC., BOSTON, MA. FILED 3-8-2007.



NO CLAIM IS MADE TO THE EXCLUSIVE RIGHT TO USE NATIONAL BALLROOM DANCE PRODUCTIONS, INC., APART FROM THE MARK AS SHOWN.

FOR EDUCATIONAL AND ENTERTAINMENT SERVICES, NAMELY, PROVIDING DANCE INSTRUCTION AND DANCE PERFORMANCES, DANCE SCHOOL SERVICES, DANCE STUDIO SERVICES, DANCE CLUB SERVICES, AND DANCE PARTY SERVICES; ONLINE PROVISION OF INSTRUCTIONAL AND PERFORMANCE MATERIALS RELATED TO DANCE (U.S. CLS. 100, 101 AND 107).
MICHELE SWAIN, EXAMINING ATTORNEY

CLASS 41—(Continued).

SN 77-125,822. NATIONAL BALLROOM DANCE PRODUCTIONS, INC., BOSTON, MA. FILED 3-8-2007.



NO CLAIM IS MADE TO THE EXCLUSIVE RIGHT TO USE "FLORIDA BALLROOM & LATIN DANCE CENTER", APART FROM THE MARK AS SHOWN.

FOR EDUCATIONAL AND ENTERTAINMENT SERVICES, NAMELY, PROVIDING DANCE INSTRUCTION AND DANCE PERFORMANCES, DANCE SCHOOL SERVICES, DANCE STUDIO SERVICES, DANCE CLUB SERVICES, AND DANCE PARTY SERVICES; ONLINE PROVISION OF INSTRUCTIONAL AND PERFORMANCE MATERIALS RELATED TO DANCE (U.S. CLS. 100, 101 AND 107).

MICHELE SWAIN, EXAMINING ATTORNEY

SN 77-126,501. MURPHY, RICHARD C., III, HOMESTEAD, FL. FILED 3-9-2007.

RICK MURPHY

THE MARK CONSISTS OF STANDARD CHARACTERS WITHOUT CLAIM TO ANY PARTICULAR FONT, STYLE, SIZE, OR COLOR.

THE NAME "RICK MURPHY" IDENTIFIES A LIVING INDIVIDUAL WHOSE CONSENT IS OF RECORD.

FOR ENTERTAINMENT SERVICES IN THE NATURE OF AN ONGOING TELEVISION PROGRAM IN THE FIELD OF SALTWATER FISHING AND FISHING TECHNIQUES (U.S. CLS. 100, 101 AND 107).

FIRST USE 6-1-1992; IN COMMERCE 6-1-1992.
ALICIA COLLINS, EXAMINING ATTORNEY

CLASS 41—(Continued).

SN 77-126,908. OCEAN WAY RECORDING, INC., HOLLYWOOD, CA. FILED 3-9-2007.

OCEAN WAY

THE MARK CONSISTS OF STANDARD CHARACTERS WITHOUT CLAIM TO ANY PARTICULAR FONT, STYLE, SIZE, OR COLOR.

FOR ENTERTAINMENT SERVICES, NAMELY, PRODUCTION OF AUDIO AND AUDIO RECORDINGS; MUSIC PRODUCTION; PRODUCTION OF COMPACT DISCS; PRODUCTION OF INSTRUCTIONAL DVDS FEATURING AUDIO SYSTEMS AND SOUND LIBRARIES, PROVIDING AUDIO STUDIOS; PROVIDING RECORDING STUDIOS; PROVIDING SOUND RECORDING STUDIOS; RECORD MASTER PRODUCTION; AUDIO RECORDING AND PRODUCTION; RENTAL OF AUDIO EQUIPMENT; PROVIDING AUDIO STUDIOS FOR MASTERING AND SCORING; AUDIO PRODUCTION SERVICES IN THE NATURE OF REMOTE RECORDING, LOCATION RECORDING AND MOBILE RECORDING (U.S. CLS. 100, 101 AND 107).

FIRST USE 0-0-1974; IN COMMERCE 0-0-1974.

ALLISON HOLTZ, EXAMINING ATTORNEY

SN 77-127,461. DELUCABIZ, LLC, LONG BEACH, CA. FILED 3-9-2007.

THE BURDEN

THE MARK CONSISTS OF STANDARD CHARACTERS WITHOUT CLAIM TO ANY PARTICULAR FONT, STYLE, SIZE, OR COLOR.

FOR ENTERTAINMENT IN THE NATURE OF LIVE PERFORMANCES BY A MUSICAL GROUP (U.S. CLS. 100, 101 AND 107).

FIRST USE 4-16-2005; IN COMMERCE 4-16-2005.

JEFF DEFORD, EXAMINING ATTORNEY

SN 77-127,930. WHAT ARE WE FIGHTING FOR?, INC., SEYMOUR, MO. FILED 3-12-2007.

WHAT ARE WE FIGHTING FOR?

THE MARK CONSISTS OF STANDARD CHARACTERS WITHOUT CLAIM TO ANY PARTICULAR FONT, STYLE, SIZE, OR COLOR.

FOR ELECTRONIC BOOKS AND MAGAZINES FEATURING INFORMATION IN THE FIELD OF SOCIAL, POLITICAL AND PATRIOTIC COMMENTARY; SEMINARS ABOUT THE FIELD OF SOCIAL, POLITICAL AND PATRIOTIC COMMENTARY; TELEVISION AND RADIO ENTERTAINMENT PRODUCTION; PRODUCTION OF VIDEO AND AUDIO MEDIA, MULTIMEDIA (U.S. CLS. 100, 101 AND 107).

ARETHA SOMERVILLE, EXAMINING ATTORNEY

CLASS 41—(Continued).

SN 77-128,469. WWE LIBRARIES, INC., STAMFORD, CT. FILED 3-12-2007.

ALL STAR WRESTLING

THE MARK CONSISTS OF STANDARD CHARACTERS WITHOUT CLAIM TO ANY PARTICULAR FONT, STYLE, SIZE, OR COLOR.

OWNER OF U.S. REG. NO. 1,432,377.

NO CLAIM IS MADE TO THE EXCLUSIVE RIGHT TO USE "WRESTLING", APART FROM THE MARK AS SHOWN.

SEC. 2(F).

FOR ENTERTAINMENT SERVICES, NAMELY, THE PRODUCTION AND EXHIBITION OF PROFESSIONAL WRESTLING EVENTS RENDERED LIVE AND THROUGH THE MEDIA OF TELEVISION; PROVIDING WRESTLING NEWS AND INFORMATION VIA A GLOBAL COMPUTER NETWORK (U.S. CLS. 100, 101 AND 107).

JENNIFER HETU, EXAMINING ATTORNEY

SN 77-128,604. NOAH'S ARK ANIMAL WORKSHOP, CRESTWOOD, IL. FILED 3-12-2007.



NO CLAIM IS MADE TO THE EXCLUSIVE RIGHT TO USE "ANIMAL WORKSHOP", APART FROM THE MARK AS SHOWN.

THE MARK CONSISTS OF AN ARK THAT CONTAINS TWO HIPPOS, TWO BEARS, AND TWO GIRAFFES. THE ARK WITH THE ANIMALS ARE WITHIN A STAR. THE WORDS "NOAH'S ARK" APPEAR ABOVE THE ARK AND THE WORDS "ANIMAL WORKSHOP" APPEAR BELOW THE ARK.

FOR ORGANIZING AND CONDUCTING WORKSHOP PARTIES AT WHICH PARTICIPANTS MAKE STUFFED TOY ANIMALS, PLUSH TOY ANIMALS, STUFFED TOY DOLLS, PLUSH TOY DOLLS, AND STUFFED PLUSH ANIMAL PILLOWS; AND DRESS AND ACCESSORIZE THESE TOYS IN AND WITH TOY BANDANAS, T-SHIRTS, CLOTHING, SUNGLASSES, JEWELRY, SHOES, BACKPACKS, HAND BAGS, TOTE BAGS, PURSES, AND TOY BIRTH CERTIFICATES (U.S. CLS. 100, 101 AND 107).

FIRST USE 0-0-2004; IN COMMERCE 0-0-2004.

MARK RADEMACHER, EXAMINING ATTORNEY

CLASS 41—(Continued).

SN 77-128,878. ADVANCED ENERGY INDUSTRIES, INC., FORT COLLINS, CO. FILED 3-12-2007.

Sputter Spotlight

THE MARK CONSISTS OF STANDARD CHARACTERS WITHOUT CLAIM TO ANY PARTICULAR FONT, STYLE, SIZE, OR COLOR.

NO CLAIM IS MADE TO THE EXCLUSIVE RIGHT TO USE "SPUTTER", APART FROM THE MARK AS SHOWN.

FOR PROVIDING A NEWSLETTER IN THE FIELD OF POWER SUPPLIES VIA E-MAIL (U.S. CLS. 100, 101 AND 107).

FIRST USE 2-20-2007; IN COMMERCE 2-20-2007.

EMILY CARLSEN, EXAMINING ATTORNEY

SN 77-129,062. CHEYENNE MOUNTAIN ENTERTAINMENT, INC., MESA, AZ. FILED 3-12-2007.

SUPERSTITION STUDIOS

THE MARK CONSISTS OF STANDARD CHARACTERS WITHOUT CLAIM TO ANY PARTICULAR FONT, STYLE, SIZE, OR COLOR.

FOR ENTERTAINMENT SERVICES, NAMELY, PROVIDING AN ON-LINE COMPUTER GAME FOR OTHERS OVER GLOBAL AND LOCAL AREA COMPUTER NETWORKS; PROVIDING AND HOSTING ONLINE COMPUTER GAME COMPETITIONS FOR OTHERS OVER GLOBAL AND LOCAL AREA COMPUTER NETWORKS (U.S. CLS. 100, 101 AND 107).

JAMES A. RAUEN, EXAMINING ATTORNEY

SN 77-129,385. DYNAMIC FITNESS HIGH PERFORMANCE KINESIOLOGY, MURRIETA, CA. FILED 3-13-2007.



NO CLAIM IS MADE TO THE EXCLUSIVE RIGHT TO USE "KINESIOLOGY", APART FROM THE MARK AS SHOWN.

THE STIPPLING IS FOR SHADING PURPOSES ONLY.

THE MARK CONSISTS OF A LOGO THAT ENTAILS HUMAN MOVEMENT FIGURE ABOVE WORDING. THE BUSINESS NAME IN BOLD ITALIC FONT LIES BELOW THE LOGO W/ THE TAG (HIGH PERFORMANCE KINESIOLOGY) BELOW IT.

FOR PERSONAL TRAINING SERVICES, NAMELY, STRENGTH AND CONDITIONING TRAINING; PHYSICAL FITNESS CONSULTATION; PHYSICAL FITNESS INSTRUCTION (U.S. CLS. 100, 101 AND 107).

FIRST USE 6-1-2005; IN COMMERCE 6-1-2005.

ALLISON HOLTZ, EXAMINING ATTORNEY

CLASS 41—(Continued).

SN 77-130,486. NATIONAL BALLROOM DANCE PRODUCTIONS, INC., BOSTON, MA. FILED 3-14-2007.



NO CLAIM IS MADE TO THE EXCLUSIVE RIGHT TO USE "PALM BEACH BALLROOM & LATIN DANCE CENTER", APART FROM THE MARK AS SHOWN.

FOR EDUCATIONAL AND ENTERTAINMENT SERVICES, NAMELY, PROVIDING DANCE INSTRUCTION AND DANCE PERFORMANCES, DANCE SCHOOL SERVICES, DANCE STUDIO SERVICES, DANCE CLUB SERVICES, AND DANCE PARTY SERVICES; ONLINE PROVISION OF INSTRUCTIONAL AND PERFORMANCE MATERIALS RELATED TO DANCE (U.S. CLS. 100, 101 AND 107).

MICHELE SWAIN, EXAMINING ATTORNEY

SN 77-132,130. THE FRATELLIS, LONDON, UNITED KINGDOM, FILED 3-15-2007.

THE FRATELLIS

THE MARK CONSISTS OF STANDARD CHARACTERS WITHOUT CLAIM TO ANY PARTICULAR FONT, STYLE, SIZE, OR COLOR.

PRIORITY CLAIMED UNDER SEC. 44(D) ON ERP CMNTY TM OFC APPLICATION NO. 5326251, FILED 9-20-2006, REG. NO. 005326251, DATED 10-31-2007, EXPIRES 9-20-2016.

THE ENGLISH TRANSLATION OF THE WORD "FRATELLIS" IN THE MARK IS "BROTHERS".

FOR ENTERTAINMENT, NAMELY, LIVE PERFORMANCES BY A MUSICAL BAND (U.S. CLS. 100, 101 AND 107).

LEIGH CAROLINE CASE, EXAMINING ATTORNEY

CLASS 41—(Continued).

SN 77-132,715. ATLANTA SLEEP INSTITUTE, ATLANTA, GA. FILED 3-16-2007.

**THE ATLANTA SCHOOL OF SLEEP MEDICINE & TECHNOLOGY**

NO CLAIM IS MADE TO THE EXCLUSIVE RIGHT TO USE "SCHOOL OF SLEEP MEDICINE & TECHNOLOGY", APART FROM THE MARK AS SHOWN.

THE NAME(S), PORTRAIT(S), AND/OR SIGNATURE(S) SHOWN IN THE MARK DOES NOT IDENTIFY A PARTICULAR LIVING INDIVIDUAL.

SEC. 2(F).

FOR EDUCATIONAL SERVICES, NAMELY, CONDUCTING CLINICAL TRAINING FOR MEDICAL PHYSICIANS, TECHNICIANS AND INDUSTRY PROFESSIONALS IN THE FIELD OF SLEEP MEDICINE, SLEEP DISORDERS AND THE TREATMENT OPTIONS RELATED THERETO (U.S. CLS. 100, 101 AND 107).

FIRST USE 8-1-1992; IN COMMERCE 8-1-1992.

PAUL F. GAST, EXAMINING ATTORNEY

SN 77-132,746. SOCCERTOTS INCORPORATED, SPOKANE, WA. FILED 3-16-2007.



NO CLAIM IS MADE TO THE EXCLUSIVE RIGHT TO USE "SUMMER CAMPS", APART FROM THE MARK AS SHOWN.

THE COLOR(S) ORANGE, PURPLE AND WHITE IS/ARE CLAIMED AS A FEATURE OF THE MARK.

THE MARK CONSISTS OF A STYLIZED DESIGN OF A PERSON RUNNING WITH SHORTS AND A SHIRT AND SUNGLASSES, WITH AN OVAL BENEATH THE PERSON, LINES REPRESENTING MOTION ABOVE AND ADJACENT TO THE PERSON, A STYLIZED DESIGN OF A SOCCER BALL AT THE END OF THE MOTION LINE, A STYLIZED DESIGN OF THE SUN, AND THE WORDING, "SOCCER-

CLASS 41—(Continued).

TOUCH" "SUMMER CAMPS" ADJACENT TO THE PERSON. THE COLOR ORANGE APPEARS IN THE PERSON AND IN THE SUN; THE COLOR PURPLE APPEARS IN THE PERSON'S SHORTS, SHIRT, SUNGLASSES, IN THE OVAL, IN THE MOTION LINES, IN THE SOCCER BALL, AND IN THE WORDING, "SOCCERTOUC" AND "SUMMER CAMPS"; THE COLOR WHITE APPEARS IN THE PERSON'S MOUTH, IN THE EDGES OF THE SHORTS AND SHIRT, IN A RING INSIDE THE SUN DESIGN AND IN THE SOCCER BALL.

FOR PHYSICAL FITNESS TRAINING FOR CHILDREN, NAMELY, PROVIDING PHYSICAL FITNESS INSTRUCTION FEATURING INSTRUCTION IN SKILL-BASED GAMES DESIGNED TO DEVELOP MOTOR SKILLS, COORDINATION, AND PHYSICAL FITNESS (U.S. CLS. 100, 101 AND 107).

FIRST USE 2-1-2005; IN COMMERCE 2-1-2005.
PAUL CROWLEY, EXAMINING ATTORNEY

CLASS 41—(Continued).

SN 77-136,441. ZOO TOO LLC, SECAUCUS, NJ. FILED 3-21-2007.



THE MARK CONSISTS OF SILHOUETTES OF A BIRD, HORSE, DOG, CAT, FISH AND REPTILE POSITIONED TO THE LEFT OF THE WORDS "ZOO TOO". THE WORDS "ZOO TOO" ARE ENCLOSED IN LINES REPRESENTING A HOUSE. THE WORD "HOUSE" IS POSITIONED BENEATH THE WORDS "ZOO TOO".

FOR ENTERTAINMENT SERVICES IN THE NATURE OF AN ON-GOING TELEVISION SHOW ABOUT ANIMALS AND PETS; ENTERTAINMENT SERVICES IN THE NATURE OF A TELEVISION SERIES DOCUMENTING MAKEOVERS OF ANIMAL SHELTERS (U.S. CLS. 100, 101 AND 107).

SKYE YOUNG, EXAMINING ATTORNEY

SN 77-134,065. MORPHOSES LIMITED, THE WHEELDON COMPANY, NEW YORK, NY. FILED 3-19-2007.

MORPHOSES

THE MARK CONSISTS OF STANDARD CHARACTERS WITHOUT CLAIM TO ANY PARTICULAR FONT, STYLE, SIZE, OR COLOR.

FOR ENTERTAINMENT IN THE NATURE OF DANCE PERFORMANCES; EDUCATIONAL SERVICES, NAMELY, CONDUCTING PROGRAMS IN THE FIELD OF DANCE (U.S. CLS. 100, 101 AND 107).

FIRST USE 8-8-2007; IN COMMERCE 8-8-2007.
SEAN CROWLEY, EXAMINING ATTORNEY

SN 77-136,481. ANNETTE M. CHARRON, BAKERSFIELD, CA. FILED 3-21-2007.

English Rx

SN 77-135,291. NATIONAL CONSULTANTS FOR EDUCATION, INC., THORNWOOD, NY. FILED 3-20-2007.

Integral Formation

THE MARK CONSISTS OF STANDARD CHARACTERS WITHOUT CLAIM TO ANY PARTICULAR FONT, STYLE, SIZE, OR COLOR.

NO CLAIM IS MADE TO THE EXCLUSIVE RIGHT TO USE "ENGLISH", APART FROM THE MARK AS SHOWN.

FOR EDUCATION SERVICES, NAMELY, PROVIDING CLASSES SEMINARS WORKSHOPS AND TESTS IN THE FIELD OF LANGUAGE ARTS (U.S. CLS. 100, 101 AND 107).

FIRST USE 7-1-2006; IN COMMERCE 7-1-2006.
GEORGIA CARTY, EXAMINING ATTORNEY

THE MARK CONSISTS OF STANDARD CHARACTERS WITHOUT CLAIM TO ANY PARTICULAR FONT, STYLE, SIZE, OR COLOR.

FOR EDUCATIONAL SERVICES, NAMELY, CONDUCTING PROGRAMS IN THE FIELDS OF PERSONAL ACADEMICS, HUMAN SPIRITUALITY, AND APOSTOLIC ENHANCEMENT (U.S. CLS. 100, 101 AND 107).

TINA L. SNAPP, EXAMINING ATTORNEY

CLASS 41—(Continued).

SN 77-137,956. KEYCORP, CLEVELAND, OH. FILED 3-22-2007.



NO CLAIM IS MADE TO THE EXCLUSIVE RIGHT TO USE "REWARDS", APART FROM THE MARK AS SHOWN. THE MARK CONSISTS OF THE NUMBER "44" AND THE WORD "REWARDS", WITH A SUNBURST PATTERN SURROUNDING THE NUMBER "44", AND THE WORD "REWARDS" EMBLAZONED ACROSS A BANNER UNDER THE NUMBER "44".

FOR SWEEPSTAKE SERVICES FEATURING A MULTI-TIERED PARTNERSHIP PROGRAM THAT OFFERS CUSTOMER REWARD GIVEAWAYS, CHARITABLE CONTRIBUTIONS, STUDENT INTERNSHIPS, AND COLLEGE SCHOLARSHIPS (U.S. CLS. 100, 101 AND 107). FIRST USE 11-15-2006; IN COMMERCE 11-15-2006. SOPHIA S. KIM, EXAMINING ATTORNEY

SN 77-138,833. ACXIOM CORPORATION, LITTLE ROCK, AR. FILED 3-23-2007.

OUTSIDETHEBOX AN ACXIOM WEBINAR SERIES

THE MARK CONSISTS OF STANDARD CHARACTERS WITHOUT CLAIM TO ANY PARTICULAR FONT, STYLE, SIZE, OR COLOR.

OWNER OF U.S. REG. NOS. 1,907,571, 2,444,453 AND 3,108,579.

NO CLAIM IS MADE TO THE EXCLUSIVE RIGHT TO USE WEBINAR SERIES, APART FROM THE MARK AS SHOWN.

FOR CONDUCTING ON-LINE SEMINARS IN THE FIELDS OF CUSTOMER RELATIONSHIP MANAGEMENT AND INFORMATION MANAGEMENT (U.S. CLS. 100, 101 AND 107).

MORGAN WYNNE, EXAMINING ATTORNEY

CLASS 41—(Continued).

SN 77-138,912. ACXIOM CORPORATION, LITTLE ROCK, AR. FILED 3-23-2007.



OWNER OF U.S. REG. NOS. 1,907,571, 3,108,579 AND OTHERS.

NO CLAIM IS MADE TO THE EXCLUSIVE RIGHT TO USE "WEBINAR SERIES", APART FROM THE MARK AS SHOWN.

FOR CONDUCTING ON-LINE SEMINARS IN THE FIELDS OF CUSTOMER RELATIONSHIP MANAGEMENT AND INFORMATION MANAGEMENT (U.S. CLS. 100, 101 AND 107).

MORGAN WYNNE, EXAMINING ATTORNEY

SN 77-139,433. DEPALMA'S ACTION KARATE, LLC, MESA, AZ. FILED 3-23-2007.

DEPALMA'S TEAM USA MARTIAL ARTS

THE MARK CONSISTS OF STANDARD CHARACTERS WITHOUT CLAIM TO ANY PARTICULAR FONT, STYLE, SIZE, OR COLOR.

NO CLAIM IS MADE TO THE EXCLUSIVE RIGHT TO USE "TEAM USA MARTIAL ARTS", APART FROM THE MARK AS SHOWN.

FOR KARATE INSTRUCTION; MARTIAL ARTS INSTRUCTION; OPERATING OF MARTIAL ARTS SCHOOLS (U.S. CLS. 100, 101 AND 107).

FIRST USE 2-1-1997; IN COMMERCE 2-1-1997.

KAREN K. BUSH, EXAMINING ATTORNEY

SN 77-139,452. DEPALMA'S ACTION KARATE, LLC, MESA, AZ. FILED 3-23-2007.



THE MARK CONSISTS OF KICKER WITH BALL. FOR KARATE INSTRUCTION; MARTIAL ARTS INSTRUCTION; OPERATING OF MARTIAL ARTS SCHOOLS (U.S. CLS. 100, 101 AND 107).

FIRST USE 12-31-1991; IN COMMERCE 12-31-1991.

KAREN K. BUSH, EXAMINING ATTORNEY

CLASS 41—(Continued).

SN 77-141,631. HOBEY BAKER MEMORIAL AWARD FOUNDATION, ST. PAUL, MN. FILED 3-27-2007.

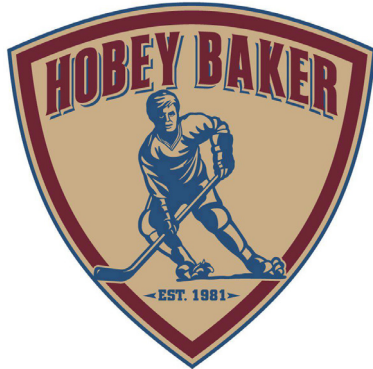

OWNER OF U.S. REG. NOS. 1,759,999, 1,761,790 AND 1,763,392.

NO CLAIM IS MADE TO THE EXCLUSIVE RIGHT TO USE "EST. 1981", APART FROM THE MARK AS SHOWN.

THE NAME "HOBEY BAKER" DOES NOT IDENTIFY A LIVING INDIVIDUAL.

THE COLOR(S) RED, BLUE, AND TAN IS/ARE CLAIMED AS A FEATURE OF THE MARK.

THE COLOR RED APPEARS IN THE OUTLINE OF THE SHIELD DESIGN AND IN THE WORDING "HOBEY BAKER". THE COLOR BLUE APPEARS IN THE HOCKEY PLAYER DESIGN AND IN THE SHADOWS FOR THE WORDING "HOBEY BAKER" AND IN THE WORDING "EST. 1981" AND IN THE OUTLINE OF THE SHIELD DESIGN. THE COLOR TAN APPEARS IN THE BACKGROUND OF THE SHIELD AND HOCKEY PLAYER DESIGN AND IN THE OUTLINE OF THE SHIELD DESIGN.

FOR EDUCATIONAL SERVICES, NAMELY, PROVIDING INCENTIVES TO COLLEGE STUDENTS TO DEMONSTRATE EXCELLENCE IN THE FIELD OF HOCKEY THROUGH THE ISSUANCE OF AWARDS (U.S. CLS. 100, 101 AND 107).

FIRST USE 9-1-2002; IN COMMERCE 9-1-2002.
LINDA ORNDORFF, EXAMINING ATTORNEY

SN 77-142,744. WORLD WRESTLING ENTERTAINMENT, INC., STAMFORD, CT. FILED 3-28-2007.

MARCUS COR VON

THE MARK CONSISTS OF STANDARD CHARACTERS WITHOUT CLAIM TO ANY PARTICULAR FONT, STYLE, SIZE, OR COLOR.

THE NAME(S), PORTRAIT(S), AND/OR SIGNATURE(S) SHOWN IN THE MARK DOES NOT IDENTIFY A PARTICULAR LIVING INDIVIDUAL.

FOR ENTERTAINMENT SERVICES, NAMELY, LIVE WRESTLING EXHIBITIONS AND PERFORMANCES BY A PROFESSIONAL WRESTLER AND ENTERTAINER; PROVIDING WRESTLING NEWS AND INFORMATION VIA A GLOBAL COMPUTER NETWORK (U.S. CLS. 100, 101 AND 107).

WILLIAM VERHOSEK, EXAMINING ATTORNEY

CLASS 41—(Continued).

SN 77-143,424. HOBEY BAKER MEMORIAL AWARD FOUNDATION, ST. PAUL, MN. FILED 3-29-2007.

HOBEY BAKER HIGH SCHOOL CHARACTER AWARD

THE MARK CONSISTS OF STANDARD CHARACTERS WITHOUT CLAIM TO ANY PARTICULAR FONT, STYLE, SIZE, OR COLOR.

OWNER OF U.S. REG. NOS. 1,759,999, 1,761,790 AND 1,763,392.

NO CLAIM IS MADE TO THE EXCLUSIVE RIGHT TO USE "HIGH SCHOOL CHARACTER AWARD", APART FROM THE MARK AS SHOWN.

THE NAME "HOBEY BAKER" DOES NOT IDENTIFY A LIVING INDIVIDUAL.

FOR EDUCATIONAL SERVICES, NAMELY, PROVIDING INCENTIVES TO HIGH SCHOOL STUDENTS TO DEMONSTRATE EXCELLENCE IN THE FIELD OF HOCKEY THROUGH THE ISSUANCE OF AWARDS (U.S. CLS. 100, 101 AND 107).

FIRST USE 3-27-2007; IN COMMERCE 3-27-2007.
LINDA ORNDORFF, EXAMINING ATTORNEY

SN 77-146,677. DELTA FUNDING CORPORATION, WOODBURY, NY. FILED 4-2-2007.

DRINKER OR DRIVER? YOU CAN'T BE BOTH

THE MARK CONSISTS OF STANDARD CHARACTERS WITHOUT CLAIM TO ANY PARTICULAR FONT, STYLE, SIZE, OR COLOR.

FOR EDUCATIONAL SERVICES, NAMELY, CLASSES, SEMINARS AND WORKSHOPS IN THE FIELDS OF DRIVER EDUCATION AND THE PREVENTION OF ALCOHOL ABUSE (U.S. CLS. 100, 101 AND 107).

FIRST USE 5-11-2006; IN COMMERCE 5-11-2006.
DAVID MURRAY, EXAMINING ATTORNEY

SN 77-146,700. DELTA FUNDING CORPORATION, WOODBURY, NY. FILED 4-2-2007.

¿TOMADOR OR CONDUCTOR? NO PUEDES SER AMBOS

THE MARK CONSISTS OF STANDARD CHARACTERS WITHOUT CLAIM TO ANY PARTICULAR FONT, STYLE, SIZE, OR COLOR.

THE FOREIGN WORDING IN THE MARK TRANSLATES INTO ENGLISH AS "DRINKER OR DRIVER? YOU CAN'T BE BOTH".

FOR EDUCATIONAL SERVICES, NAMELY, CLASSES, SEMINARS AND WORKSHOPS IN THE FIELDS OF DRIVER EDUCATION AND THE PREVENTION OF ALCOHOL ABUSE (U.S. CLS. 100, 101 AND 107).

DAVID MURRAY, EXAMINING ATTORNEY

CLASS 41—(Continued).

SN 77-147,295. SCHOLASTIC INC., NEW YORK, NY. FILED 4-3-2007.

GOOSEBUMPS

THE MARK CONSISTS OF STANDARD CHARACTERS WITHOUT CLAIM TO ANY PARTICULAR FONT, STYLE, SIZE, OR COLOR.

OWNER OF U.S. REG. NOS. 1,871,292 AND 2,019,991. FOR ENTERTAINMENT SERVICES, NAMELY, A TELEVISION SERIES AND FAN CLUBS BASED ON A FICTIONAL SERIES OF BOOKS FOR CHILDREN; ON-LINE ACTIVITIES, NAMELY, PROVIDING ONLINE EDUCATIONAL AND ENTERTAINMENT SERVICES, NAMELY, A WEBSITE FEATURING INFORMATION ABOUT CHILDREN'S BOOKS, CHILDREN'S TELEVISION SHOWS, INTERACTIVE GAMES, QUIZZES AND LEARNING ACTIVITIES; ENTERTAINMENT SERVICES IN THE NATURE OF THEATER PRODUCTIONS FOR CHILDREN (U.S. CLS. 100, 101 AND 107).

KATHLEEN M. VANSTON, EXAMINING ATTORNEY

SN 77-147,399. SCHOLASTIC INC., NEW YORK, NY. FILED 4-3-2007.

SCHOLASTIC READSEARCH

THE MARK CONSISTS OF STANDARD CHARACTERS WITHOUT CLAIM TO ANY PARTICULAR FONT, STYLE, SIZE, OR COLOR.

OWNER OF U.S. REG. NOS. 1,677,988, 2,711,978 AND OTHERS.

FOR PROVIDING ON-LINE NON-DOWNLOADABLE PUBLICATIONS IN THE NATURE OF GENERAL TOPIC ENCYCLOPEDIAS, CHILDREN'S BOOKS, JOURNALS ON CURRENT EVENTS, A SERIES OF FICTION BOOKS AND REFERENCE BOOKS ON A VARIETY OF SUBJECTS (U.S. CLS. 100, 101 AND 107).

KATHLEEN M. VANSTON, EXAMINING ATTORNEY

SN 77-147,429. SCHOLASTIC INC., NEW YORK, NY. FILED 4-3-2007.

KNOWLEDGE SPACE

THE MARK CONSISTS OF STANDARD CHARACTERS WITHOUT CLAIM TO ANY PARTICULAR FONT, STYLE, SIZE, OR COLOR.

FOR PROVIDING ON-LINE NON-DOWNLOADABLE PUBLICATIONS IN THE NATURE OF GENERAL TOPIC ENCYCLOPEDIAS, CHILDREN'S BOOKS, JOURNALS ON CURRENT EVENTS, A SERIES OF FICTION BOOKS AND REFERENCE BOOKS ON A VARIETY OF SUBJECTS (U.S. CLS. 100, 101 AND 107).

KATHLEEN M. VANSTON, EXAMINING ATTORNEY

CLASS 41—(Continued).

SN 77-147,912. THE SILKEN TENT, LLC, EVANSTON, IL. FILED 4-3-2007.

SILKEN TENT

THE MARK CONSISTS OF STANDARD CHARACTERS WITHOUT CLAIM TO ANY PARTICULAR FONT, STYLE, SIZE, OR COLOR.

FOR YOGA AND PILATES INSTRUCTION (U.S. CLS. 100, 101 AND 107).

SANI KHOURI, EXAMINING ATTORNEY

SN 77-148,852. GEORGE & COMPANY, LLC, NAPLES, FL. FILED 4-4-2007.

LCR

THE MARK CONSISTS OF STANDARD CHARACTERS WITHOUT CLAIM TO ANY PARTICULAR FONT, STYLE, SIZE, OR COLOR.

OWNER OF U.S. REG. NOS. 2,802,321 AND 2,989,658.

FOR ENTERTAINMENT SERVICES, NAMELY, PROVIDING ON-LINE COMPUTER GAMES; PROVIDING INFORMATION ON-LINE RELATING TO COMPUTER GAMES AND COMPUTER ENHANCEMENTS FOR GAMES; PROVIDING A COMPUTER GAME THAT MAY BE ACCESSED NETWORK-WIDE BY NETWORK USERS; ORGANIZING COMPUTER AND VIDEO GAME COMPETITIONS; MOBILE MEDIA AND ENTERTAINMENT SERVICES IN THE NATURE OF CONTENT PREPARATION; PROVIDING ON-LINE COMPUTER AND VIDEO GAMES; ENTERTAINMENT INFORMATION SERVICES, NAMELY, PROVIDING ON-LINE INFORMATION WITH REGARD TO ENTERTAINMENT TIME FOR MOVIES, GAMES, SHOWS, LIVE PERFORMANCES, EXHIBITIONS, SPORTS AND MUSICAL EVENTS THROUGH WORLD WIDE WEB AND MOBILE PHONES; ON-LINE PUBLICATION OF COMPUTER AND VIDEO GAMES, MOTION PICTURES, ANIMATION AND TELEVISION FILMS; MOTION PICTURE AND ANIMATION FILM PRODUCTION AND DISTRIBUTION SERVICES; TELEVISION PROGRAM PRODUCTION AND DISTRIBUTION SERVICES; PROVIDING INFORMATION IN THE FIELDS OF ENTERTAINMENT, MOTION PICTURES AND MUSIC OVER COMPUTER NETWORKS AND GLOBAL COMMUNICATION NETWORKS; PROVIDING ONLINE COMPUTER GAMES; ENTERTAINMENT SERVICES, NAMELY, PROVIDING VIDEO GAMES FOR PLAY ONLINE, ON WIRELESS DEVICES, ON COMPUTERS, OR ON GAME CONSOLES; ENTERTAINMENT SERVICES IN THE FORM OF PRODUCTION AND DISTRIBUTION OF ANIMATION, VISUAL EFFECTS, AND COMPUTER GRAPHICS FOR MOTION PICTURES AND TELEVISION (U.S. CLS. 100, 101 AND 107).

TEJBIR SINGH, EXAMINING ATTORNEY

CLASS 41—(Continued).

SN 77-150,772. HERO SOLUTION, INC., LAS VEGAS, NV. FILED 4-6-2007.

STOP SITTING ON YOUR ASSETS

THE MARK CONSISTS OF STANDARD CHARACTERS WITHOUT CLAIM TO ANY PARTICULAR FONT, STYLE, SIZE, OR COLOR.

FOR ON-LINE JOURNALS, NAMELY, BLOGS FEATURING INFORMATION REGARDING FINANCE, ASSET MANAGEMENT, REAL ESTATE, INVESTMENTS, FINANCIAL PLANNING, MUTUAL FUNDS, LEVERAGING, TAXATION, RETIREMENT, ASSETS, INHERITANCE, WEALTH, INSURANCE, MORTGAGE, PLANNING, REAL ESTATE INVESTMENT, FINANCIAL EDUCATION, REAL ESTATE EQUITY MANAGEMENT AND MORTGAGE PLANNING; AND ELECTRONIC PUBLISHING SERVICES, NAMELY, PUBLICATION OF TEXT, DOCUMENTS, ARTICLES, COMMENTARY, EDITORIALS, VIDEO, GRAPHIC WORKS AND PHOTOGRAPHY OF OTHERS IN THE FIELDS OF INFORMATION REGARDING FINANCE, ASSET MANAGEMENT, REAL ESTATE, INVESTMENTS, FINANCIAL PLANNING, MUTUAL FUNDS, LEVERAGING, TAXATION, RETIREMENT, ASSETS, INHERITANCE, WEALTH, INSURANCE, MORTGAGE, PLANNING, REAL ESTATE INVESTMENT, FINANCIAL EDUCATION, REAL ESTATE EQUITY MANAGEMENT AND MORTGAGE PLANNING (U.S. CLS. 100, 101 AND 107).

FIRST USE 10-20-2006; IN COMMERCE 10-20-2006.
BILL DAWE, EXAMINING ATTORNEY

SN 77-152,388. WILSON-CLARKE, MILLICENT LORRI, TRAPPE, MD. FILED 4-9-2007.



THE MARK CONSISTS OF A SILHOUETTE OF A WOMAN IN A POSITION OF EXERCISE.

FOR HEALTH CLUB SERVICES, NAMELY, PROVIDING INSTRUCTION AND EQUIPMENT IN THE FIELD OF PHYSICAL EXERCISE (U.S. CLS. 100, 101 AND 107).
FIRST USE 1-7-2007; IN COMMERCE 1-7-2007.
ZHALEH DELANEY, EXAMINING ATTORNEY

CLASS 41—(Continued).

SN 77-157,117. VERNON, STEPHEN, CHICAGO, IL. FILED 4-15-2007.

PHATLAW

THE MARK CONSISTS OF STANDARD CHARACTERS WITHOUT CLAIM TO ANY PARTICULAR FONT, STYLE, SIZE, OR COLOR.

FOR ON-LINE INFORMATION SERVICES, NAMELY, PROVIDING NEWS, COMMENTARY, DOCUMENTS, GRAPHIC IMAGES AND PHOTOGRAPHS IN THE FIELD OF CURRENT EVENTS RELATED TO NEWS-WORTHY TOPICS, EVENTS AND PEOPLE (U.S. CLS. 100, 101 AND 107).

BRIDGETT SMITH, EXAMINING ATTORNEY

SN 77-157,770. CREATIVE ASSOCIATES INTERNATIONAL, INC., WASHINGTON, DC. FILED 4-16-2007.

THE CREATIVE WAY

OWNER OF U.S. REG. NOS. 3,165,750 AND 3,177,536.
THE COLOR(S) BLUE AND GREEN IS/ARE CLAIMED AS A FEATURE OF THE MARK.

THE WORDS "THE" AND "WAY" ARE GREEN, AND THE WORD "CREATIVE" IS BLUE.

FOR EDUCATION AND TRAINING SERVICES, NAMELY, PROVIDING COURSES OF ACCELERATED LEARNING INSTRUCTION IN THE AREA OF ELEMENTARY, MIDDLE AND HIGH SCHOOL SUBJECTS FOR STUDENTS IN GRADES 1 THROUGH 12 AND DISTRIBUTING COURSE MATERIAL IN CONNECTION THEREWITH; DESIGN AND DEVELOPMENT FOR OTHERS OF EDUCATIONAL CURRICULUM, TEACHING GUIDES, MANUALS, LESSON PLANS, STUDENT BOOKS, STUDY GUIDES, COURSE WORKBOOKS AND COURSE MATERIALS, TEXTBOOKS AND TESTS FOR USE IN CONNECTION WITH A PROGRAM OF ACCELERATED LEARNING INSTRUCTION IN THE AREA OF ELEMENTARY, MIDDLE AND HIGH SCHOOL SUBJECTS FOR STUDENTS IN GRADES 1 THROUGH 12 (U.S. CLS. 100, 101 AND 107).

BRIAN PINO, EXAMINING ATTORNEY

CLASS 41—(Continued).

SN 77-159,267. VIACOM INTERNATIONAL INC., NEW YORK, NY. FILED 4-18-2007.

TV LAND RANDOM ACTS OF
TELEVISION

THE MARK CONSISTS OF STANDARD CHARACTERS WITHOUT CLAIM TO ANY PARTICULAR FONT, STYLE, SIZE, OR COLOR.

OWNER OF U.S. REG. NOS. 2,084,672, 2,715,871 AND OTHERS.

NO CLAIM IS MADE TO THE EXCLUSIVE RIGHT TO USE "TV" AND "TELEVISION", APART FROM THE MARK AS SHOWN.

FOR ENTERTAINMENT SERVICES IN THE NATURE OF AN ON-GOING SERIES OF INTERSTITIALS, FEATURING ANIMATION, COMEDY AND DRAMA; PROVIDING ONLINE INFORMATION IN THE FIELD OF ENTERTAINMENT CONCERNING TELEVISION PROGRAMS (U.S. CLS. 100, 101 AND 107).

ELISSA GARBER KON, EXAMINING ATTORNEY

CLASS 41—(Continued).

SN 77-159,586. WORLD WRESTLING ENTERTAINMENT, INC., STAMFORD, CT. FILED 4-18-2007.

DAN RODMAN

THE MARK CONSISTS OF STANDARD CHARACTERS WITHOUT CLAIM TO ANY PARTICULAR FONT, STYLE, SIZE, OR COLOR.

THE NAME(S), PORTRAIT(S), AND/OR SIGNATURE(S) SHOWN IN THE MARK DOES NOT IDENTIFY A PARTICULAR LIVING INDIVIDUAL.

FOR ENTERTAINMENT SERVICES, NAMELY, LIVE WRESTLING EXHIBITIONS AND PERFORMANCES BY A PROFESSIONAL WRESTLER AND ENTERTAINER; PROVIDING WRESTLING NEWS AND INFORMATION VIA A GLOBAL COMPUTER NETWORK (U.S. CLS. 100, 101 AND 107).

WILLIAM VERHOSEK, EXAMINING ATTORNEY

SN 77-159,572. WORLD WRESTLING ENTERTAINMENT, INC., STAMFORD, CT. FILED 4-18-2007.

SANTINO MARELLA

THE MARK CONSISTS OF STANDARD CHARACTERS WITHOUT CLAIM TO ANY PARTICULAR FONT, STYLE, SIZE, OR COLOR.

THE NAME(S), PORTRAIT(S), AND/OR SIGNATURE(S) SHOWN IN THE MARK DOES NOT IDENTIFY A PARTICULAR LIVING INDIVIDUAL.

FOR ENTERTAINMENT SERVICES, NAMELY, LIVE WRESTLING EXHIBITIONS AND PERFORMANCES BY A PROFESSIONAL WRESTLER AND ENTERTAINER; PROVIDING WRESTLING NEWS AND INFORMATION VIA A GLOBAL COMPUTER NETWORK (U.S. CLS. 100, 101 AND 107).

WILLIAM VERHOSEK, EXAMINING ATTORNEY

SN 77-159,826. ECHELON RESORTS CORPORATION, LAS VEGAS, NV. FILED 4-18-2007.

TOURBILLON

THE MARK CONSISTS OF STANDARD CHARACTERS WITHOUT CLAIM TO ANY PARTICULAR FONT, STYLE, SIZE, OR COLOR.

THE FOREIGN WORDING IN THE MARK TRANSLATES INTO ENGLISH AS WHIRLWIND.

FOR ENTERTAINMENT IN THE NATURE OF CASINO SERVICES, LIVE MUSIC, SINGING, DANCING, ACTORS, ACROBATS, LIVE BANDS, BOXING MATCHES, MAGICIANS, COMEDIANS, CONCERTS AND PANTOMIMES (U.S. CLS. 100, 101 AND 107).

KATHLEEN M. VANSTON, EXAMINING ATTORNEY

CLASS 41—(Continued).

SN 77-159,936. A SCHOOL FOR THE MIND AND BODY, LLC, CLARKSTON, MI. FILED 4-18-2007.



THE COLOR(S) NAVY, GREEN, PURPLE AND BLACK IS/ARE CLAIMED AS A FEATURE OF THE MARK.

THE MARK CONSISTS OF A BOY, A BEAN BAG CHAIR AND THE WORDING "A SCHOOL FOR THE" AND "AND" IN NAVY, THE WORDING "MIND" IN GREEN AND THE WORDING "BODY" IN PURPLE. THE BOY'S NOSE AND PORTIONS OF THE BOY'S EAR AND HAIR ARE IN BLACK.

FOR EDUCATIONAL PROGRAMS, NAMELY, PRE-SCHOOLS (U.S. CLS. 100, 101 AND 107).
FIRST USE 4-25-2002; IN COMMERCE 5-1-2002.
MELISSA VALLILLO, EXAMINING ATTORNEY

SN 77-160,973. COMEDY PARTNERS, NEW YORK, NY. FILED 4-19-2007.

COMEDY CENTRAL'S OPEN MIC FIGHT

THE MARK CONSISTS OF STANDARD CHARACTERS WITHOUT CLAIM TO ANY PARTICULAR FONT, STYLE, SIZE, OR COLOR.

OWNER OF U.S. REG. NOS. 1,741,737 AND 1,745,015.
NO CLAIM IS MADE TO THE EXCLUSIVE RIGHT TO USE "COMEDY" AND "OPEN MIC", APART FROM THE MARK AS SHOWN.

FOR ENTERTAINMENT SERVICES IN THE NATURE OF TELEVISION SERIES, FEATURING LIVE ACTION, COMEDY AND DRAMA; PROVIDING ONLINE INFORMATION IN THE FIELD OF ENTERTAINMENT CONCERNING TELEVISION PROGRAMS (U.S. CLS. 100, 101 AND 107).

BRIAN CALLAGHAN, EXAMINING ATTORNEY

CLASS 41—(Continued).

SN 77-163,979. OH BABY! FITNESS LLC, DECATUR, GA. FILED 4-24-2007.



NO CLAIM IS MADE TO THE EXCLUSIVE RIGHT TO USE "FITNESS", APART FROM THE MARK AS SHOWN.

THE COLOR(S) GREEN, WHITE AND GRAY IS/ARE CLAIMED AS A FEATURE OF THE MARK.

THE MARK CONSISTS OF THE WORD "OH" IN WHITE, SUPERIMPOSED UPON A DEPICTION OF A GREEN CIRCLE WITH THE WORDS "BABY" AND AN EXCLAMATION POINT IN GREEN NEXT TO THE CIRCLE. THE WORD "FITNESS" IS BELOW IN GRAY.

FOR PRENATAL AND POSTNATAL PHYSICAL FITNESS INSTRUCTION (U.S. CLS. 100, 101 AND 107).

FIRST USE 6-1-2005; IN COMMERCE 6-1-2005.
SETH A. RAPPAPORT, EXAMINING ATTORNEY

SN 77-165,832. FUEL TV, INC., LOS ANGELES, CA. FILED 4-25-2007.

THE 808

THE MARK CONSISTS OF STANDARD CHARACTERS WITHOUT CLAIM TO ANY PARTICULAR FONT, STYLE, SIZE, OR COLOR.

FOR ENTERTAINMENT SERVICES IN THE NATURE OF AN UNSCRIPTED REALITY TELEVISION SERIES (U.S. CLS. 100, 101 AND 107).

AMY MCMENAMIN, EXAMINING ATTORNEY

SN 77-166,661. SOUTHERN COMFORT PROPERTIES, INC., SAN RAFAEL, CA. FILED 4-26-2007.

SOCO NIGHT INSTITUTE

THE MARK CONSISTS OF STANDARD CHARACTERS WITHOUT CLAIM TO ANY PARTICULAR FONT, STYLE, SIZE, OR COLOR.

OWNER OF U.S. REG. NO. 2,254,264.
FOR ENTERTAINMENT, NAMELY, PROVIDING AN INTERACTIVE WEBSITE FOR ADULTS DEDICATED TO SPOOFING NIGHTLIFE AND THE BAR SCENE (U.S. CLS. 100, 101 AND 107).

BILL DAWE, EXAMINING ATTORNEY

CLASS 41—(Continued).

SN 77-167,330. DOBISH, LOUISE M., WARREN, MI. FILED 4-27-2007.

Do You Love Your Life

THE MARK CONSISTS OF STANDARD CHARACTERS WITHOUT CLAIM TO ANY PARTICULAR FONT, STYLE, SIZE, OR COLOR.

FOR CONDUCTING WORKSHOPS AND SEMINARS IN PERSONAL AWARENESS (U.S. CLS. 100, 101 AND 107).

FIRST USE 2-1-2007; IN COMMERCE 2-1-2007.
MONIQUE MILLER, EXAMINING ATTORNEY

SN 77-167,540. SIX FLAGS THEME PARKS, INC., GRAND PRAIRIE, TX. FILED 4-27-2007.

SIX FLAGS: LIVE AND LOCAL

THE MARK CONSISTS OF STANDARD CHARACTERS WITHOUT CLAIM TO ANY PARTICULAR FONT, STYLE, SIZE, OR COLOR.

OWNER OF U.S. REG. NOS. 853,408, 2,161,566 AND OTHERS.

FOR ENTERTAINMENT IN THE NATURE OF AMUSEMENT PARKS AND THEME PARKS; ENTERTAINMENT IN THE NATURE OF PERFORMANCES, NAMELY, LIVE MUSICAL AND THEATRICAL PERFORMANCES (U.S. CLS. 100, 101 AND 107).

KAREN K. BUSH, EXAMINING ATTORNEY

CLASS 41—(Continued).

SN 77-169,134. BABY ABUELITA PRODUCTIONS, LLC, MIAMI, FL. FILED 4-30-2007.

BABY ABUELITA

THE MARK CONSISTS OF STANDARD CHARACTERS WITHOUT CLAIM TO ANY PARTICULAR FONT, STYLE, SIZE, OR COLOR.

OWNER OF U.S. REG. NO. 3,025,890.

THE ENGLISH TRANSLATION OF THE WORD "BABY ABUELITA" IN THE MARK IS "LITTLE GRANDMOTHER".

FOR ENTERTAINMENT AND EDUCATIONS SERVICES IN THE NATURE OF ON-GOING TELEVISION PROGRAMS, ON-GOING RADIO PROGRAMS AND THEATRICAL STAGE PROGRAMS, ALL DIRECTED TOWARD CHILDREN, PARENTS AND FAMILIES; PRODUCTION OF MOTION PICTURES DIRECTED TOWARD CHILDREN, PARENTS AND FAMILIES; PROVIDING A WEB SITE DIRECTED TO THE PRESERVATION OF HISPANIC CULTURE AND LANGUAGE, FEATURING, COMMUNICATION WITH ANIMATED CHARACTERS, COLORING, SPANISH FOOD COOKING DEMONSTRATIONS, ANIMATED FLASH CARDS FOR PRACTICING SPANISH AND ENGLISH, AND VIEWING OF LIVE ACTION EDUCATIONAL SEGMENTS WITH CHILDREN SPEAKING AND SINGING SONGS IN SPANISH AND ENGLISH; PROVIDING ON-LINE COMPUTER GAMES DIRECTED TO THE PRESERVATION OF HISPANIC CULTURE AND LANGUAGE (U.S. CLS. 100, 101 AND 107).

MARK SPARACINO, EXAMINING ATTORNEY

SN 77-169,928. VIACOM INTERNATIONAL INC., NEW YORK, NY. FILED 5-1-2007.

BUBBLE GUPPIES

THE MARK CONSISTS OF STANDARD CHARACTERS WITHOUT CLAIM TO ANY PARTICULAR FONT, STYLE, SIZE, OR COLOR.

FOR ENTERTAINMENT SERVICES IN THE NATURE OF TELEVISION SERIES, FEATURING ANIMATION, COMEDY AND DRAMA; PROVIDING ONLINE INFORMATION IN THE FIELD OF ENTERTAINMENT CONCERNING TELEVISION PROGRAMS (U.S. CLS. 100, 101 AND 107).

KAREN K. BUSH, EXAMINING ATTORNEY

CLASS 41—(Continued).

SN 77-173,346. STEREOTAXIS, INC., ST. LOUIS, MO. FILED 5-4-2007.

CLASS 41—(Continued).

SN 77-177,338. NATIONAL BALLROOM DANCE PRODUCTIONS, INC., BOSTON, MA. FILED 5-10-2007.

ODYSSEY



THE MARK CONSISTS OF STANDARD CHARACTERS WITHOUT CLAIM TO ANY PARTICULAR FONT, STYLE, SIZE, OR COLOR.

FOR TRAINING RELATING TO MONITORING AND CONDUCTING REMOTE MEDICAL PROCEDURES AND MEDICAL INFORMATION SEARCHING (U.S. CLS. 100, 101 AND 107).

CHARLOTTE CORWIN, EXAMINING ATTORNEY

NO CLAIM IS MADE TO THE EXCLUSIVE RIGHT TO USE "NATIONAL BALLROOM & LATIN DANCE CENTER", APART FROM THE MARK AS SHOWN.

FOR EDUCATIONAL AND ENTERTAINMENT SERVICES, NAMELY, PROVIDING DANCE INSTRUCTION AND DANCE PERFORMANCES, DANCE SCHOOL SERVICES, DANCE STUDIO SERVICES, DANCE CLUB SERVICES, AND DANCE PARTY SERVICES; ONLINE PROVISION OF INSTRUCTIONAL AND PERFORMANCE MATERIALS RELATED TO DANCE (U.S. CLS. 100, 101 AND 107).

MICHELE SWAIN, EXAMINING ATTORNEY

SN 77-176.007. HEALEY, CHERYL K. DBA THE GIFT OF YOU COACHING, OLDSMAR, FL. FILED 5-8-2007.



NO CLAIM IS MADE TO THE EXCLUSIVE RIGHT TO USE "COACHING", APART FROM THE MARK AS SHOWN. THE COLOR(S) PURPLE, BLUE AND WHITE IS/ARE CLAIMED AS A FEATURE OF THE MARK.

THE MARK CONSISTS OF A PURPLE AND BLUE CIRCLE SURROUNDING A WHITE BODY REACHING UP AND OUTSIDE THE CIRCLE TO THE UPPER RIGHT. THE HAND AND A PORTION OF THE ARM ON THE BODY IS A PURPLE STAR. THE COMPANY NAME IS IN TWO COLORS AS FOLLOWS: "THE GIFT OF YOU" IS PURPLE AND "COACHING" IS IN BLUE. THE LINE UNDERNEATH THE WORDS IN THE MARK IS IN PURPLE AND BLUE.

FOR PERSONAL COACHING SERVICES IN THE FIELD OF PERSONAL DEVELOPMENT AND BUSINESS; EDUCATION SERVICES, NAMELY, PROVIDING WORKSHOPS IN THE FIELD OF PERSONAL DEVELOPMENT (U.S. CLS. 100, 101 AND 107).

FIRST USE 9-12-2006; IN COMMERCE 9-12-2006.
ERNEST SHOSHO, EXAMINING ATTORNEY

SN 77-177,343. NATIONAL BALLROOM DANCE PRODUCTIONS, INC., BOSTON, MA. FILED 5-10-2007.



NO CLAIM IS MADE TO THE EXCLUSIVE RIGHT TO USE "NATIONAL DANCESPORT CENTER", APART FROM THE MARK AS SHOWN.

FOR EDUCATIONAL AND ENTERTAINMENT SERVICES, NAMELY, PROVIDING DANCE INSTRUCTION AND DANCE PERFORMANCES, DANCE SCHOOL SERVICES, DANCE STUDIO SERVICES, DANCE CLUB SERVICES, AND DANCE PARTY SERVICES; ONLINE PROVISION OF INSTRUCTIONAL AND PERFORMANCE MATERIALS RELATED TO DANCE (U.S. CLS. 100, 101 AND 107).

MICHELE SWAIN, EXAMINING ATTORNEY

CLASS 41—(Continued).

SN 77-177,347. NATIONAL BALLROOM DANCE PRODUCTIONS, INC., BOSTON, MA. FILED 5-10-2007.



NO CLAIM IS MADE TO THE EXCLUSIVE RIGHT TO USE "NATIONAL BALLROOM CENTER", APART FROM THE MARK AS SHOWN.

FOR EDUCATIONAL AND ENTERTAINMENT SERVICES, NAMELY, PROVIDING DANCE INSTRUCTION AND DANCE PERFORMANCES, DANCE SCHOOL SERVICES, DANCE STUDIO SERVICES, DANCE CLUB SERVICES, AND DANCE PARTY SERVICES; ONLINE PROVISION OF INSTRUCTIONAL AND PERFORMANCE MATERIALS RELATED TO DANCE (U.S. CLS. 100, 101 AND 107).

MICHELE SWAIN, EXAMINING ATTORNEY

SN 77-178,797. CBS BROADCASTING INC., NEW YORK, NY. FILED 5-11-2007.

YOURTAKE

THE MARK CONSISTS OF STANDARD CHARACTERS WITHOUT CLAIM TO ANY PARTICULAR FONT, STYLE, SIZE, OR COLOR.

FOR ENTERTAINMENT SERVICES, NAMELY, PROVIDING A WEB SITE FEATURING USER GENERATED MUSICAL PERFORMANCES, MUSICAL VIDEOS, RELATED FILM CLIPS, PHOTOGRAPHS, AND OTHER MULTIMEDIA MATERIALS; ON-LINE JOURNALS, NAMELY, BLOGS FEATURING INFORMATION AND USER GENERATED CONTENT (U.S. CLS. 100, 101 AND 107).

CHRIS WELLS, EXAMINING ATTORNEY

CLASS 41—(Continued).

SN 77-180,096. GRACY, SONJA D., BRONX, NY. FILED 5-14-2007.

The Gospel Music Moment

NO CLAIM IS MADE TO THE EXCLUSIVE RIGHT TO USE "GOSPEL MUSIC", APART FROM THE MARK AS SHOWN.

THE COLOR(S) BLACK, BROWN AND YELLOW-GOLD IS/ARE CLAIMED AS A FEATURE OF THE MARK.

THE MARK CONSISTS OF ALL BLACK LETTERING FOR THE STYLIZED RENDERING OF "THE GOSPEL MUSIC MOMENT" EXCEPT FOR THE FINAL CHARACTER IN THE DESCRIPTION WHICH IS A CROSS SUFFICING FOR THE LETTER "T". THE CROSS IS BROWN INSIDE OF A HORIZONTAL YELLOW-GOLD BOX.

FOR ENTERTAINMENT IN THE NATURE OF AN ONGOING SPECIAL VARIETY, NEWS, MUSIC OR COMEDY SHOW FEATURING ENTERTAINING AND INFORMATIVE 60 SECOND VIGNETTES PROFILING FAMOUS GOSPEL MUSIC ARTISTS/COLLABORATORS FROM THE 1920'S TO THE PRESENT FOR BROADCAST OVER TELEVISION, SATELLITE, AUDIO, AND VIDEO MEDIA; RADIO ENTERTAINMENT SERVICES, NAMELY, RADIO PROGRAMS FEATURING PERFORMANCES BY A WRITER AND GOSPEL MUSIC ENTHUSIAST-RESEARCHER SONJA D. GRACY (U.S. CLS. 100, 101 AND 107).

LINDA ORNDORFF, EXAMINING ATTORNEY

SN 77-181,418. ACADEMIC LADDER LLC, MC LEAN, VA. FILED 5-15-2007.

ACADEMIC LADDER

THE MARK CONSISTS OF STANDARD CHARACTERS WITHOUT CLAIM TO ANY PARTICULAR FONT, STYLE, SIZE, OR COLOR.

NO CLAIM IS MADE TO THE EXCLUSIVE RIGHT TO USE "ACADEMIC", APART FROM THE MARK AS SHOWN.

FOR PERSONAL COACHING SERVICES IN THE FIELD OF ACADEMIA AND WRITING; EDUCATION SERVICES, NAMELY, MENTORING IN THE FIELD OF ACADEMIA AND WRITING; EDUCATION SERVICES, NAMELY, ONE-ON-ONE MENTORING IN THE FIELD OF ACADEMIA AND WRITING; EDUCATIONAL SERVICES, NAMELY, CONDUCTING PROGRAMS IN THE FIELD OF ACADEMIA AND WRITING; EDUCATIONAL SERVICES, NAMELY, CONDUCTING DISTANCE LEARNING INSTRUCTION AT THE SECONDARY, COLLEGE AND GRADUATE LEVELS; EDUCATIONAL SERVICES, NAMELY, CONDUCTING ON-LINE EXHIBITIONS AND DISPLAYS AND INTERACTIVE EXHIBITS IN THE FIELD OF ACADEMIA AND WRITING (U.S. CLS. 100, 101 AND 107).

FIRST USE 11-0-2004; IN COMMERCE 11-0-2004.

JULIE WATSON, EXAMINING ATTORNEY

CLASS 41—(Continued).

SN 77-181,499. BACKLAND OUTDOORS, LLC, HUTCHINSON, MN. FILED 5-15-2007.



THE MARK CONSISTS OF "BACKLAND EXPERIENCES" AND DESIGN.

FOR ENTERTAINMENT, NAMELY, A CONTINUING HUNTING SHOW BROADCAST OVER TELEVISION, CABLE, AND SATELLITE FEATURING PROGRAMS ON HUNTING TOPICS (U.S. CLS. 100, 101 AND 107).

FIRST USE 1-5-2003; IN COMMERCE 1-5-2003.
REBECCA GILBERT, EXAMINING ATTORNEY

SN 77-181,503. BACKLAND OUTDOORS, LLC, HUTCHINSON, MN. FILED 5-15-2007.



THE MARK CONSISTS OF "BACKLAND COUNTRY" & DESIGN.

FOR ENTERTAINMENT, NAMELY, A CONTINUING HUNTING SHOW BROADCAST OVER TELEVISION, CABLE, AND SATELLITE FEATURING PROGRAMS ON HUNTING TOPICS (U.S. CLS. 100, 101 AND 107).

FIRST USE 1-7-2007; IN COMMERCE 1-7-2007.
REBECCA GILBERT, EXAMINING ATTORNEY

SN 77-181,517. BACKLAND OUTDOORS, LLC, HUTCHINSON, MN. FILED 5-15-2007.



NO CLAIM IS MADE TO THE EXCLUSIVE RIGHT TO USE "CLASSICS", APART FROM THE MARK AS SHOWN. THE MARK CONSISTS OF "BACKLAND CLASSICS" AND DESIGN.

FOR ENTERTAINMENT, NAMELY, A CONTINUING HUNTING SHOW BROADCAST OVER TELEVISION, CABLE, AND SATELLITE FEATURING PROGRAMS ON HUNTING TOPICS (U.S. CLS. 100, 101 AND 107).

FIRST USE 1-2-2007; IN COMMERCE 1-2-2007.
REBECCA GILBERT, EXAMINING ATTORNEY

CLASS 41—(Continued).

SN 77-183,433. THRESHOLD DIGITAL RESEARCH LABS, INC., SANTA MONICA, CA. FILED 5-17-2007.

SUNDAY COMICS CAPER

THE MARK CONSISTS OF STANDARD CHARACTERS WITHOUT CLAIM TO ANY PARTICULAR FONT, STYLE, SIZE, OR COLOR.

NO CLAIM IS MADE TO THE EXCLUSIVE RIGHT TO USE "SUNDAY COMICS", APART FROM THE MARK AS SHOWN.

FOR ENTERTAINMENT IN THE NATURE OF A SERIES OF ANIMATED MOTION PICTURES AND ONGOING ANIMATED TELEVISION PROGRAMS (U.S. CLS. 100, 101 AND 107).

JOHN SCHUYLER YARD, EXAMINING ATTORNEY

SN 77-185,513. PATRICK G MCAVENA, GAHANNA, OH. FILED 5-20-2007.

Pale Blue Films

THE MARK CONSISTS OF STANDARD CHARACTERS WITHOUT CLAIM TO ANY PARTICULAR FONT, STYLE, SIZE, OR COLOR.

NO CLAIM IS MADE TO THE EXCLUSIVE RIGHT TO USE "FILMS", APART FROM THE MARK AS SHOWN.

FOR MOVIE STUDIOS; PRODUCTION AND DISTRIBUTION OF TELEVISION SHOWS AND MOVIES (U.S. CLS. 100, 101 AND 107).

SOPHIA S. KIM, EXAMINING ATTORNEY

SN 77-188,492. JOSEPH N. ABRAHAM, III, UNIVERSITY HEIGHTS, OH. FILED 5-23-2007.

BELMEZ

THE MARK CONSISTS OF STANDARD CHARACTERS WITHOUT CLAIM TO ANY PARTICULAR FONT, STYLE, SIZE, OR COLOR.

THE WORDING "BELMEZ" HAS NO MEANING IN A FOREIGN LANGUAGE.

FOR LIVE PERFORMANCES BY A MUSICAL BAND (U.S. CLS. 100, 101 AND 107).

FIRST USE 10-0-2005; IN COMMERCE 10-0-2005.
LAURA HAMMEL, EXAMINING ATTORNEY

CLASS 41—(Continued).

SN 77-189,349. RENEGADE NATION, INC., NEW YORK, NY.
FILED 5-24-2007.

Rock and Roll 911

THE MARK CONSISTS OF STANDARD CHARACTERS WITHOUT CLAIM TO ANY PARTICULAR FONT, STYLE, SIZE, OR COLOR.

NO CLAIM IS MADE TO THE EXCLUSIVE RIGHT TO USE ROCK AND ROLL, APART FROM THE MARK AS SHOWN.

FOR ENTERTAINMENT SERVICES, NAMELY, RECORD PRODUCTION; RECORD MASTER PRODUCTION; MUSIC PRODUCTION; AUDIO RECORDING AND PRODUCTION; VIDEOTAPE PRODUCTION; MOTION PICTURE PRODUCTION; PRODUCTION OF VIDEO DISCS FOR OTHERS; RECORDING STUDIOS; ENTERTAINMENT SERVICES, NAMELY, PRODUCING AND DISTRIBUTING MUSICAL AUDIO AND VIDEO RECORDINGS; MUSIC COMPOSITION; SONG WRITING SERVICES; MUSIC PUBLISHING SERVICES; ENTERTAINMENT IN THE NATURE OF A LIVE MUSICAL PERFORMER, MUSICAL BAND OR MUSICAL GROUP; ENTERTAINMENT IN THE NATURE OF LIVE PERFORMANCES BY A MUSICAL ARTIST, MUSICAL GROUP OR MUSICAL BAND; ENTERTAINMENT IN THE NATURE OF VISUAL AND AUDIO PERFORMANCES BY A MUSICAL ARTIST, MUSICAL GROUP AND MUSICAL BAND; ENTERTAINMENT, NAMELY, LIVE MUSIC CONCERTS; ENTERTAINMENT, NAMELY, PERSONAL APPEARANCES BY A MUSICIAN, MUSICAL GROUP OR MUSICAL BAND; ENTERTAINMENT, NAMELY, PROVIDING A WEB SITE FEATURING MUSICAL PERFORMANCES, MUSICAL VIDEOS, RELATED FILM CLIPS, PHOTOGRAPHS, AND OTHER MULTIMEDIA MATERIALS; ENTERTAINMENT SERVICES, NAMELY, PROVIDING PRERECORDED MUSIC, INFORMATION IN THE FIELD OF MUSIC, COMMENTARY AND ARTICLES ABOUT MUSIC, ALL ONLINE VIA THE INTERNET; TELEVISION PRODUCTION; TELEVISION SHOW PRODUCTION; CABLE TELEVISION SHOW PRODUCTION; RADIO ENTERTAINMENT PRODUCTION; MOTION PICTURE FILM PRODUCTION AND DISTRIBUTION; ENTERTAINMENT IN THE NATURE OF ON-GOING TELEVISION, PROGRAMS FEATURING MUSICAL, DANCE, COMEDIC AND DRAMATIC ACTS; TELEVISION PROGRAMS FEATURING A WIDE VARIETY OF SUBJECT MATTERS INCLUDING BUT NOT LIMITED TO MUSIC, DANCE, DRAMA AND COMEDY; PROVIDING A VARIETY SHOW DISTRIBUTED OVER TELEVISION, RADIO, SATELLITE, AUDIO AND VIDEO MEDIA; THEATRE PRODUCTIONS; ENTERTAINMENT IN THE NATURE OF TRAVELING TOURS FEATURING A WIDE VARIETY OF SUBJECT MATTERS, NAMELY, MUSIC, DANCE, DRAMA AND COMEDY (U.S. CLS. 100, 101 AND 107).

ALLISON HOLTZ, EXAMINING ATTORNEY

CLASS 41—(Continued).

SN 77-192,739. OJUNGA, DAVID, ARLINGTON, TX. FILED 5-30-2007.

Dezyne

THE MARK CONSISTS OF STANDARD CHARACTERS WITHOUT CLAIM TO ANY PARTICULAR FONT, STYLE, SIZE, OR COLOR.

FOR ENTERTAINMENT SERVICES, NAMELY, LIVE PERFORMANCES BY A MUSICAL ARTIST (U.S. CLS. 100, 101 AND 107).

FIRST USE 12-1-2005; IN COMMERCE 12-1-2005.

PAULA MAHONEY, EXAMINING ATTORNEY

SN 77-193,704. INSTITUTE FOR SYSTEMS BIOLOGY, SEATTLE, WA. FILED 5-30-2007.

ISB

THE MARK CONSISTS OF STANDARD CHARACTERS WITHOUT CLAIM TO ANY PARTICULAR FONT, STYLE, SIZE, OR COLOR.

FOR EDUCATIONAL SERVICES, NAMELY, CONDUCTING CONFERENCES, CLASSES, WORKSHOPS, PROGRAMS, AND SEMINARS IN THE FIELD OF SYSTEMS BIOLOGY, AND DISTRIBUTING COURSE MATERIALS IN CONNECTION THEREWITH; PROVIDING ONLINE EDUCATIONAL MATERIALS OF OTHERS IN THE FIELD OF SYSTEMS BIOLOGY; DEVELOPMENT AND DISSEMINATION OF EDUCATIONAL MATERIALS OF OTHERS IN THE FIELD OF SYSTEMS BIOLOGY; AND FELLOWSHIP PROGRAMS (U.S. CLS. 100, 101 AND 107).

PAULA MAYS, EXAMINING ATTORNEY

SN 77-194,858. CORE MEDIA, LLC, WESTMINSTER, CO. FILED 5-31-2007.

CORE

THE MARK CONSISTS OF STANDARD CHARACTERS WITHOUT CLAIM TO ANY PARTICULAR FONT, STYLE, SIZE, OR COLOR.

OWNER OF U.S. REG. NO. 3,235,900.

FOR PUBLISHING OF WEB MAGAZINES; ENTERTAINMENT SERVICES, NAMELY, PROVIDING A WEBSITE FEATURING, PHOTOGRAPHIC, AUDIO, VIDEO AND PROSE PRESENTATIONS FEATURING MUSIC, THEATRE, CONCERTS, THE ARTS, EXERCISE AND FITNESS INFORMATION (U.S. CLS. 100, 101 AND 107).

FIRST USE 10-1-2004; IN COMMERCE 10-1-2004.

MICHELE SWAIN, EXAMINING ATTORNEY

CLASS 41—(Continued).

SN 77-195,430. SAN DIEGO BAY PARADE OF LIGHTS, A PUBLIC BENEFIT CORPORATION, SAN DIEGO, CA. FILED 6-1-2007.



NO CLAIM IS MADE TO THE EXCLUSIVE RIGHT TO USE "PARADE OF LIGHTS", APART FROM THE MARK AS SHOWN.

THE COLOR(S) BLUE, GOLD, BLACK, AND WHITE IS/ ARE CLAIMED AS A FEATURE OF THE MARK.

THE MARK CONSISTS OF A SAILBOAT IN GOLD, RINGED WITH ALTERNATING GOLD AND WHITE LIGHTS, SUPERIMPOSED OVER A STYLIZED REPRESENTATION IN BLUE TRIMED IN WHITE OF THE CITY OF "SAN DIEGO", CA, WITH A STYLIZED REPRESENTATION OF THE CORONADO BRIDGE IN BLUE TRIMED IN WHITE, WITH A BLACK OVAL BACKGROUND.

SEC. 2(F) AS TO "SAN DIEGO BAY PARADE OF LIGHTS". FOR ENTERTAINMENT, NAMELY, PRODUCTION OF A PARADE; ENTERTAINMENT SERVICES, NAMELY, FIREWORKS DISPLAYS; ENTERTAINMENT IN THE NATURE OF A PARADE (U.S. CLS. 100, 101 AND 107).

FIRST USE 10-1-1999; IN COMMERCE 10-1-1999.
KEVIN DINALLO, EXAMINING ATTORNEY

CLASS 41—(Continued).

SN 77-195,668. TEKAVEC, VALERIE, HIGH FALLS, NY. FILED 6-1-2007.



NO CLAIM IS MADE TO THE EXCLUSIVE RIGHT TO USE "INTEGRATED SELF ADVOCACY", APART FROM THE MARK AS SHOWN.

THE COLOR(S) TURQUOISE, BROWN AND WHITE IS/ ARE CLAIMED AS A FEATURE OF THE MARK.

THE MARK CONSISTS OF STYLIZED IMAGES OF A HAND AND A STAR CONTAINED WITHIN A CIRCLE, AND THE WORDS INTEGRATED SELF ADVOCACY AND THE LETTERS ISA. THE WORDS INTEGRATED SELF ADVOCACY, STAR AND OUTLINE OF THE CIRCLE APPEAR IN TURQUOISE. THE OUTLINE OF THE HAND AND THE LETTERS ISA APPEAR IN BROWN. THE INSIDE OF THE HAND AND THE CIRCLE ARE IN WHITE.

FOR TRAINING SERVICES, NAMELY CONDUCTING PRESENTATIONS, SEMINARS AND INDIVIDUAL SESSIONS IN THE FIELD OF SELF ADVOCACY FOR INDIVIDUALS WITH DISABILITIES, AND DISTRIBUTING COURSE MATERIALS IN CONNECTION THEREWITH; EDUCATIONAL SERVICES, NAMELY DEVELOPING CURRICULUM FOR OTHERS IN THE FIELD OF SELF ADVOCACY FOR INDIVIDUALS WITH DISABILITIES (U.S. CLS. 100, 101 AND 107).

FIRST USE 5-25-2007; IN COMMERCE 5-25-2007.
BARBARA BROWN, EXAMINING ATTORNEY

SN 77-196,727. DARIN DOUGHERTY, PORTLAND, OR. FILED 6-4-2007.

seedmodern

THE MARK CONSISTS OF STANDARD CHARACTERS WITHOUT CLAIM TO ANY PARTICULAR FONT, STYLE, SIZE, OR COLOR.

FOR PROVIDING ON-LINE PUBLICATIONS IN THE NATURE OF BLOGS FEATURING MODERN AND SUSTAINABLE DESIGN IN THE FIELD OF ARCHITECTURE AND CONSTRUCTION (U.S. CLS. 100, 101 AND 107).

ALICE BENMAMAN, EXAMINING ATTORNEY

CLASS 41—(Continued).

SN 77-198,330. ARCHITECTURE 2030, SANTA FE, NM. FILED 6-5-2007.

Architecture 2030

THE MARK CONSISTS OF STANDARD CHARACTERS WITHOUT CLAIM TO ANY PARTICULAR FONT, STYLE, SIZE, OR COLOR.

NO CLAIM IS MADE TO THE EXCLUSIVE RIGHT TO USE "ARCHITECTURE", APART FROM THE MARK AS SHOWN.

FOR EDUCATION SERVICES, NAMELY, CONDUCTING LECTURES, SEMINARS, AND WORKSHOPS IN THE FIELDS OF GLOBAL WARMING, NAMELY, PROVIDING SOLUTIONS THAT DRAMATICALLY REDUCE AND EVENTUALLY ELIMINATE GREENHOUSE GAS EMISSIONS PRODUCED BY CONSTRUCTION INDUSTRIES AND THE BUILDING SECTOR (U.S. CLS. 100, 101 AND 107).

FIRST USE 1-1-2005; IN COMMERCE 1-1-2005.
GEORGIA CARTY, EXAMINING ATTORNEY

SN 77-204,400. BUSINESS TO BUSINESS MARKETING, SAN DIEGO, CA. FILED 6-12-2007.

Outbound Calling by Design

THE MARK CONSISTS OF STANDARD CHARACTERS WITHOUT CLAIM TO ANY PARTICULAR FONT, STYLE, SIZE, OR COLOR.

NO CLAIM IS MADE TO THE EXCLUSIVE RIGHT TO USE "OUTBOUND CALLING", APART FROM THE MARK AS SHOWN.

FOR CONDUCTING WORKSHOPS AND SEMINARS IN SALES AND MARKETING (U.S. CLS. 100, 101 AND 107).

FIRST USE 1-1-2007; IN COMMERCE 4-19-2007.
SUSAN LESLIE DUBOIS, EXAMINING ATTORNEY

CLASS 41—(Continued).

SN 77-205,811. KAGYU MONLAM LIMITED, ROAD TOWN, TORTOLA, BR. VIRGIN ISLANDS, FILED 6-14-2007.



THE COLOR(S) RED, YELLOW, GREEN, BLACK AND GRAY IS/ARE CLAIMED AS A FEATURE OF THE MARK.

THE MARK CONSISTS OF A SERIES OF FOUR SWIRL DESIGNS WITH ONE RED SWIRL, ONE YELLOW SWIRL, ONE GREEN SWIRL AND ONE GRAY SWIRL. THERE IS A BLACK CIRCLE IN THE CENTER OF THE FOUR SWIRL DESIGNS.

THE DESIGN COMPRISING THE MARK HAS NO MEANING IN A FOREIGN LANGUAGE.

FOR RELIGION EDUCATIONAL DEMONSTRATIONS; PUBLICATION OF BOOKS AND MAGAZINES IN THE FIELD OF RELIGION; ARRANGING AND CONDUCTING RELIGION CONFERENCES; PROVIDING INFORMATION IN THE FIELD OF RELIGIOUS EDUCATION; EDUCATIONAL SERVICES, NAMELY, CONDUCTING SEMINARS IN THE FIELD OF RELIGION (U.S. CLS. 100, 101 AND 107).

KEVIN CORWIN, EXAMINING ATTORNEY

SN 77-207,237. MAYOR, RUSSELL ROBERT, JIM THORPE, PA. FILED 6-15-2007.

BLITHER

THE MARK CONSISTS OF STANDARD CHARACTERS WITHOUT CLAIM TO ANY PARTICULAR FONT, STYLE, SIZE, OR COLOR.

FOR ENTERTAINMENT, NAMELY LIVE PERFORMANCES BY A MUSICAL BAND (U.S. CLS. 100, 101 AND 107).

FIRST USE 3-25-2005; IN COMMERCE 3-25-2005.
ROBERT C. CLARK JR., EXAMINING ATTORNEY

CLASS 41—(Continued).

SN 77-210,659. CHURCHILL DOWNS TECHNOLOGY INITIATIVES COMPANY, LOUISVILLE, KY. FILED 6-20-2007.

HEADS UP HORSERACING

THE MARK CONSISTS OF STANDARD CHARACTERS WITHOUT CLAIM TO ANY PARTICULAR FONT, STYLE, SIZE, OR COLOR.

NO CLAIM IS MADE TO THE EXCLUSIVE RIGHT TO USE HORSERACING, APART FROM THE MARK AS SHOWN.

FOR HANDICAPPING OF SPORTING EVENTS, HANDICAPPING OF HORSERACING, WAGERING SERVICES, CONDUCTING CONTESTS, CONDUCTING ONLINE CONTESTS, PROVIDING INFORMATION IN THE FIELD OF ENTERTAINMENT FEATURING HORSE RACES AND HORSERACING (U.S. CLS. 100, 101 AND 107).

LAURIE MAYES, EXAMINING ATTORNEY

CLASS 41—(Continued).

SN 77-214,555. METAL, A MUTUAL BENEFIT NOT FOR PROFIT CORPORATION, MARINA DEL REY, CA. FILED 6-25-2007.

METaL

THE MARK CONSISTS OF STANDARD CHARACTERS WITHOUT CLAIM TO ANY PARTICULAR FONT, STYLE, SIZE, OR COLOR.

FOR EDUCATIONAL SERVICES, NAMELY, CONDUCTING INFORMAL PROGRAMS IN THE FIELDS OF MEDIA, ENTERTAINMENT AND TECHNOLOGY, USING ON-LINE ACTIVITIES AND INTERACTIVE EXHIBITS, AND PRINTABLE MATERIALS DISTRIBUTED THEREWITH; EDUCATION SERVICES, NAMELY, PROVIDING MEETINGS, PANELS AND DISCUSSION GROUPS IN THE FIELD OF MEDIA ENTERTAINMENT AND TECHNOLOGY; EDUCATION SERVICES, NAMELY, PROVIDING LIVE AND ON-LINE DISCUSSIONS AND INTERACTION IN THE FIELD OF MEDIA ENTERTAINMENT AND TECHNOLOGY (U.S. CLS. 100, 101 AND 107).

FIRST USE 10-1-2006; IN COMMERCE 12-31-2006.
ANN E. SAPPENFIELD, EXAMINING ATTORNEY

SN 77-211,222. ABIOMED, INC., DANVERS, MA. FILED 6-20-2007.

ABIOMED

OWNER OF U.S. REG. NOS. 1,332,596, 1,650,057 AND OTHERS.

FOR MEDICAL TRAINING AND EDUCATIONAL SERVICES, NAMELY, PROVIDING CLASSES, SEMINARS AND WORKSHOPS, IN THE FIELD OF CIRCULATORY SUPPORT AND CARDIOVASCULAR CARE (U.S. CLS. 100, 101 AND 107).

FIRST USE 9-15-2006; IN COMMERCE 9-15-2006.
ALICIA COLLINS, EXAMINING ATTORNEY

SN 77-215,474. AOL LLC, DULLES, VA. FILED 6-26-2007.

INNERVIEW

THE MARK CONSISTS OF STANDARD CHARACTERS WITHOUT CLAIM TO ANY PARTICULAR FONT, STYLE, SIZE, OR COLOR.

FOR ONLINE JOURNALS, NAMELY, BLOGS AND VIDEO BLOGS FEATURING CONSUMER TECHNOLOGY (U.S. CLS. 100, 101 AND 107).

KATHERINE M. DUBRAY, EXAMINING ATTORNEY

CLASS 41—(Continued).

SN 77-221,247. FEED THE BEAT, LLC., MONTPELIER, VT.
FILED 7-3-2007.



THE MARK CONSISTS OF A STYLIZED FORK AND MUSICAL SYMBOL INSIDE A SQUARE WITH THE STYLIZED WORDS "FEED THE BEAT" BELOW, ALL SURROUNDED BY A SMALL RECTANGULAR BORDER.

FOR ENTERTAINMENT SERVICES, NAMELY, A CONTINUING TELEVISION PROGRAM IN THE FIELDS OF COOKING, MUSIC, HEALTH, DIET AND LIFESTYLE ACCESSIBLE BY TELEVISION, SATELLITE AND GLOBAL COMPUTER NETWORKS; PROVIDING ENTERTAINMENT INFORMATION VIA A WEBSITE IN THE FIELDS OF COOKING, MUSIC AND LIFESTYLE (U.S. CLS. 100, 101 AND 107).

B. PARADEWELAI, EXAMINING ATTORNEY

SN 77-221,785. FOOTBALL TALK, LLC, CLARKSBURG, WV.
FILED 7-3-2007.

PROFOOTBALLTALK

THE MARK CONSISTS OF STANDARD CHARACTERS WITHOUT CLAIM TO ANY PARTICULAR FONT, STYLE, SIZE, OR COLOR.

FOR PROVIDING PROFESSIONAL FOOTBALL INFORMATION VIA A GLOBAL COMPUTER INFORMATION NETWORK (U.S. CLS. 100, 101 AND 107).

FIRST USE 11-1-2001; IN COMMERCE 11-1-2001.
JOHN DWYER, EXAMINING ATTORNEY

CLASS 41—(Continued).

SN 77-232,375. FAMILY DYNAMICS INSTITUTE, INC.,
FRANKLIN, TN. FILED 7-18-2007.



OWNER OF U.S. REG. NO. 3,067,754.

NO CLAIM IS MADE TO THE EXCLUSIVE RIGHT TO USE "FAMILY DYNAMICS INSTITUTE", APART FROM THE MARK AS SHOWN.

THE COLOR(S) DARK BLUE, BLUE, AND SILVER IS/ARE CLAIMED AS A FEATURE OF THE MARK.

THE MARK CONSISTS OF "FAMILY DYNAMICS INSTITUTE" STYLIZED AND TWO STYLIZED FIGURES ON A SOLID COLORED BACKGROUND. THE WORDING "FAMILY DYNAMICS INSTITUTE" AND ONE STYLIZED FIGURE ARE SILVER. THE SECOND STYLIZED FIGURE IS LIGHT BLUE. THE BACKGROUND IS DARK BLUE.

FOR EDUCATIONAL SERVICES, NAMELY, PROVIDING TRAINING WORKSHOPS, CLASSES, AND SEMINARS ALL RELATING TO MARRIAGE AND FAMILY INTERACTIVE SOCIAL SKILLS (U.S. CLS. 100, 101 AND 107).

FIRST USE 4-28-2007; IN COMMERCE 4-28-2007.
BERYL GARDNER, EXAMINING ATTORNEY

SN 77-233,930. THE ENGINEERING SOCIETY OF DETROIT,
SOUTHFIELD, MI. FILED 7-19-2007.

SCIENGIMATHEPLORATION

THE MARK CONSISTS OF STANDARD CHARACTERS WITHOUT CLAIM TO ANY PARTICULAR FONT, STYLE, SIZE, OR COLOR.

FOR EDUCATION SERVICES, NAMELY, PROVIDING LIVE AND ON-LINE CLASSES, SEMINARS AND WORKSHOPS IN THE FIELDS OF SCIENCE, ENGINEERING AND MATHEMATICS AND THE PRACTICAL APPLICATION THEREOF, AND THE DISTRIBUTION OF COURSE MATERIALS IN CONNECTION THEREWITH; ENTERTAINMENT AND EDUCATIONAL SERVICES IN THE NATURE OF ONGOING TELEVISION PROGRAMS IN THE FIELD OF SCIENCE, ENGINEERING AND MATHEMATICS AND THE PRACTICAL APPLICATION THEREOF (U.S. CLS. 100, 101 AND 107).

FIRST USE 2-14-2007; IN COMMERCE 2-14-2007.
TEJBIR SINGH, EXAMINING ATTORNEY

CLASS 41—(Continued).

SN 77-236,997. KNOXVILLE NEWS-SENTINEL COMPANY, KNOXVILLE, TN. FILED 7-24-2007.

GOSMOKIES

THE MARK CONSISTS OF STANDARD CHARACTERS WITHOUT CLAIM TO ANY PARTICULAR FONT, STYLE, SIZE, OR COLOR.

OWNER OF U.S. REG. NO. 2,499,496.
 FOR PROVIDING AN ON-LINE INTERACTIVE NEWS-PAPER FEATURING INFORMATION ABOUT THE SMOKY MOUNTAINS INCLUDING TOURIST INFORMATION REGARDING AREA ATTRACTIONS, RESORTS, ACTIVITIES, RESTAURANTS AND BUSINESSES (U.S. CLS. 100, 101 AND 107).
 FIRST USE 6-30-2001; IN COMMERCE 6-30-2001.
 KIMBERLY PERRY, EXAMINING ATTORNEY

CLASS 41—(Continued).

SN 77-237,661. SALSA BABIES INC., TORONTO, CANADA, FILED 7-24-2007.



NO CLAIM IS MADE TO THE EXCLUSIVE RIGHT TO USE "SALSA BABIES", APART FROM THE MARK AS SHOWN.

THE COLOR(S) YELLOW, GREEN, ORANGE, AND BLACK IS/ARE CLAIMED AS A FEATURE OF THE MARK.
 THE COLOR BLACK APPEARS IN THE WORDING "SALSA BABIES LATIN BEAT FOR TINY FEET!", AND IN THE OUTLINE OF THE MARACA. THE MARACA IS COLORED YELLOW, ORANGE, YELLOW, AND GREEN FROM TOP TO BOTTOM. THE CIRCLES ARE COLORED ORANGE, YELLOW, GREEN, ORANGE, GREEN, YELLOW, GREEN, YELLOW, ORANGE, ORANGE, AND GREEN FROM LEFT TO RIGHT.
 FOR PHYSICAL FITNESS CONDITIONING CLASSES (U.S. CLS. 100, 101 AND 107).
 FIRST USE 6-1-2002; IN COMMERCE 6-1-2002.
 JASON BLAIR, EXAMINING ATTORNEY

SN 77-237,481. DISNEY ENTERPRISES, INC., BURBANK, CA. FILED 7-24-2007.

**ECO-ACTION THROUGH ACTION
SPORTS**

THE MARK CONSISTS OF STANDARD CHARACTERS WITHOUT CLAIM TO ANY PARTICULAR FONT, STYLE, SIZE, OR COLOR.

FOR EDUCATION SERVICES, NAMELY, CONDUCTING PROGRAMS IN THE FIELD OF ENVIRONMENTAL PRESERVATION, RESOURCE CONSERVATION, WASTE MANAGEMENT, WASTE MINIMIZATION, RECYCLING, COMPOSTING, AND USE OF RENEWABLE RESOURCES (U.S. CLS. 100, 101 AND 107).
 FIRST USE 7-0-2006; IN COMMERCE 7-0-2006.
 STEPHEN AQUILA, EXAMINING ATTORNEY

SN 77-238,831. GRANITE MOUNTAIN CONSULTING AND PUBLISHING, INC., PRESCOTT, AZ. FILED 7-25-2007.

Crown King Books

THE MARK CONSISTS OF STANDARD CHARACTERS WITHOUT CLAIM TO ANY PARTICULAR FONT, STYLE, SIZE, OR COLOR.

NO CLAIM IS MADE TO THE EXCLUSIVE RIGHT TO USE "BOOKS", APART FROM THE MARK AS SHOWN.
 FOR MULTIMEDIA PUBLISHING OF BOOKS, MAGAZINES, JOURNALS, SOFTWARE, GAMES, MUSIC, AND ELECTRONIC PUBLICATIONS (U.S. CLS. 100, 101 AND 107).
 FIRST USE 5-31-2007; IN COMMERCE 5-31-2007.
 BRENDAN REGAN, EXAMINING ATTORNEY

CLASS 41—(Continued).

SN 77-238,944. THE FALL COLLECTION, INC., NEW YORK, NY. FILED 7-25-2007.



NO CLAIM IS MADE TO THE EXCLUSIVE RIGHT TO USE "FESTIVAL", APART FROM THE MARK AS SHOWN.

THE MARK CONSISTS OF A COAT OF ARMS CREST IN BLACK AND WHITE, SURROUNDED BY FLOR DE LIS DESIGN AND TOPPED WITH A CROWN, WITH THE WORDS "CROWN POINT" IN ALL CAPITAL LETTERS WITH THE WORD "FESTIVAL" IN A SCROLL INSIDE THE CREST.

FOR ENTERTAINMENT SERVICES, NAMELY, PLANNING AND CONDUCTING A SERIES OF FILM, THEATER AND MUSIC FESTIVALS (U.S. CLS. 100, 101 AND 107).

MICHAEL KEATING, EXAMINING ATTORNEY

SN 77-240,310. MEN OF CHRIST CATHOLIC CONFERENCE, INC., DBA MEN OF CHRIST, PEWAUKEE, WI. FILED 7-27-2007.

MEN OF CHRIST

THE MARK CONSISTS OF STANDARD CHARACTERS WITHOUT CLAIM TO ANY PARTICULAR FONT, STYLE, SIZE, OR COLOR.

NO CLAIM IS MADE TO THE EXCLUSIVE RIGHT TO USE "CHRIST", APART FROM THE MARK AS SHOWN.

FOR ARRANGING AND CONDUCTING EDUCATIONAL CONFERENCES; CONDUCTING SEMINARS AND WORKSHOPS IN THE FIELD OF SPIRITUALITY (U.S. CLS. 100, 101 AND 107).

FIRST USE 8-1-2006; IN COMMERCE 12-1-2006.
ROBERT LAVACHE, EXAMINING ATTORNEY

CLASS 41—(Continued).

SN 77-240,973. POLYGON ENTERTAINMENT, SAN RAFAEL, CA. FILED 7-27-2007.

Young Santa

THE MARK CONSISTS OF STANDARD CHARACTERS WITHOUT CLAIM TO ANY PARTICULAR FONT, STYLE, SIZE, OR COLOR.

FOR PRODUCTION OF MOTION PICTURES, MOTION PICTURE FILM SERIES, AND TELEVISION AND RADIO PROGRAMS (U.S. CLS. 100, 101 AND 107).

SETH A. RAPPAPORT, EXAMINING ATTORNEY

SN 77-241,960. KINGSDOWN, INC., MEBANE, NC. FILED 7-30-2007.

KINGSDOWN SOCIETY OF SLEEP SCIENCE

THE MARK CONSISTS OF STANDARD CHARACTERS WITHOUT CLAIM TO ANY PARTICULAR FONT, STYLE, SIZE, OR COLOR.

OWNER OF U.S. REG. NOS. 520,839, 2,362,378 AND OTHERS.

NO CLAIM IS MADE TO THE EXCLUSIVE RIGHT TO USE "SLEEP SCIENCE", APART FROM THE MARK AS SHOWN.

FOR EDUCATIONAL SERVICES, NAMELY, PROVIDING TRAINING SEMINARS AND WORKSHOPS IN THE FIELD OF THE EFFECT OF BEDDING TECHNOLOGY ON THE QUALITY OF SLEEP (U.S. CLS. 100, 101 AND 107).

ZACHARY BELLO, EXAMINING ATTORNEY

SN 77-242,931. ANDRES, BENJAMIN, P., TRACY, CA. FILED 7-31-2007.

MethadoneBābē

THE MARK CONSISTS OF NAME IN STANDARD CHARACTER PLUS 2 LINES DRAWN ABOVE THE "A" AND "E" OF "BABE" TO ASSIST WITH PROPER PRONUNCIATION OF NAME.

FOR (BASED ON USE IN COMMERCE) ENTERTAINMENT IN THE NATURE OF AN ON-GOING SPECIAL VARIETY, NEWS, MUSIC OR COMEDY SHOW FEATURING MUSIC BROADCAST OVER TELEVISION, SATELLITE, AUDIO, AND VIDEO MEDIA; ENTERTAINMENT IN THE NATURE OF VISUAL AND AUDIO PERFORMANCES, AND MUSICAL, VARIETY, NEWS AND COMEDY SHOWS; ENTERTAINMENT IN THE NATURE OF VISUAL AND AUDIO PERFORMANCES, NAMELY, MUSICAL BAND, ROCK GROUP, GYMNAS-TIC, DANCE, AND BALLET PERFORMANCES; ENTERTAINMENT IN THE NATURE OF MUSICAL PERFORMANCE; ENTERTAINMENT NAMELY, LIVE PERFORMANCES BY A MUSICAL BAND; ENTERTAINMENT SERVICES, NAMELY, AN ONLINE ACTIVITY WHERE YOU CREATE YOUR OWN MUSIC VIDEOS; ENTERTAINMENT SERVICES, NAMELY, NON-DOWNLOADABLE RINGTONES, PRE-RECORDED MUSIC, VI-

CLASS 41—(Continued).

DEO AND GRAPHICS PRESENTED TO MOBILE COMMUNICATIONS DEVICES VIA A GLOBAL COMPUTER NETWORK AND WIRELESS NETWORKS; ENTERTAINMENT SERVICES, NAMELY, PROVIDING A WEB SITE FEATURING MUSICAL PERFORMANCES, MUSICAL VIDEOS, RELATED FILM CLIPS, PHOTOGRAPHS, AND OTHER MULTIMEDIA MATERIALS; ENTERTAINMENT SERVICES, NAMELY, PROVIDING PRERECORDED MUSIC, INFORMATION IN THE FIELD OF MUSIC, AND COMMENTARY AND ARTICLES ABOUT MUSIC, ALL ON-LINE VIA A GLOBAL COMPUTER NETWORK; ENTERTAINMENT, NAMELY LIVE MUSIC CONCERTS; ENTERTAINMENT, NAMELY, LIVE PERFORMANCES BY MUSICAL BANDS; MULTIMEDIA ENTERTAINMENT SERVICES IN THE NATURE OF RECORDING, PRODUCTION AND POST-PRODUCTION SERVICES IN THE FIELDS OF MUSIC, VIDEO, AND FILMS; MULTIMEDIA PUBLISHING OF BOOKS, MAGAZINES, JOURNALS, SOFTWARE, GAMES, MUSIC, AND ELECTRONIC PUBLICATIONS (U.S. CLS. 100, 101 AND 107).

FIRST USE 7-28-2007; IN COMMERCE 7-28-2007.
DOMINIC J. FERRAIUOLO, EXAMINING ATTORNEY

SN 77-243,250. COURTROOM TELEVISION NETWORK LLC, NEW YORK, NY. FILED 7-31-2007.

24/24 RULE

THE MARK CONSISTS OF STANDARD CHARACTERS WITHOUT CLAIM TO ANY PARTICULAR FONT, STYLE, SIZE, OR COLOR.

FOR ENTERTAINMENT SERVICES, NAMELY, A CONTINUING TELEVISION PROGRAM SERIES PROVIDED THROUGH CABLE TELEVISION, BROADCAST TELEVISION, INTERNET, VIDEO-ON-DEMAND, AND THROUGH OTHER DISTRIBUTION PLATFORMS IN THE FIELD OF COMEDY, DRAMA, ACTION AND/OR ADVENTURE; PROVIDING INFORMATION, NAMELY, ENTERTAINMENT INFORMATION, OVER THE INTERNET (U.S. CLS. 100, 101 AND 107).

MICHELLE DUBOIS, EXAMINING ATTORNEY

SN 77-243,287. OMEGA LEGAL SYSTEMS, INC., PHOENIX, AZ. FILED 7-31-2007.

OMEGA UNIVERSITY

THE MARK CONSISTS OF STANDARD CHARACTERS WITHOUT CLAIM TO ANY PARTICULAR FONT, STYLE, SIZE, OR COLOR.

NO CLAIM IS MADE TO THE EXCLUSIVE RIGHT TO USE "UNIVERSITY", APART FROM THE MARK AS SHOWN.

FOR EDUCATION SERVICES, NAMELY, CONDUCTING CLASSES IN THE USE OF COMPUTER SOFTWARE; TRAINING IN THE USE OF COMPUTER SOFTWARE; AND PROVIDING ON-LINE TRAINING COURSES IN THE USE OF COMPUTER SOFTWARE (U.S. CLS. 100, 101 AND 107).

AMEETA JORDAN, EXAMINING ATTORNEY

CLASS 41—(Continued).

SN 77-246,295. 3RD EYE FILMS, INC., AVONDALE ESTATES, GA. FILED 8-3-2007.



THE NAME(S), PORTRAIT(S), AND/OR SIGNATURE(S) SHOWN IN THE MARK DOES NOT IDENTIFY A PARTICULAR LIVING INDIVIDUAL.

THE COLOR(S) RED, BLACK, WHITE, PINK, AND BROWN IS/ARE CLAIMED AS A FEATURE OF THE MARK.

THE COLOR BROWN APPEARS IN THE SKIN OF THE FACE AND THE EYES, THE COLOR WHITE APPEARS IN THE EYES, THE COLOR PINK APPEARS IN THE LIPS, THE COLOR BLACK APPEARS IN THE OUTLINE OF ALL THE FEATURES OF THE FACE, AND THE COLOR RED APPEARS IN THE RIBBON THAT CROSSES UNDER THE CHIN OF THE FACE.

FOR EDUCATIONAL SERVICES, NAMELY, PROVIDING WORKSHOPS AND SEMINARS ABOUT THE SPREAD OF HIV/AIDS (U.S. CLS. 100, 101 AND 107).

FIRST USE 10-25-2006; IN COMMERCE 10-25-2006.
DANIEL BRODY, EXAMINING ATTORNEY

SN 77-248,258. FAMILY DYNAMICS INSTITUTE, FRANKLIN, TN. FILED 8-6-2007.

LovePath Institute

THE MARK CONSISTS OF STANDARD CHARACTERS WITHOUT CLAIM TO ANY PARTICULAR FONT, STYLE, SIZE, OR COLOR.

NO CLAIM IS MADE TO THE EXCLUSIVE RIGHT TO USE "INSTITUTE", APART FROM THE MARK AS SHOWN.

FOR TRAINING SERVICES IN THE FIELD OF SEMINARS, CLASSES, AND WORKSHOPS FOR MARRIAGE AND FAMILY INTERACTIVE SOCIAL SKILLS (U.S. CLS. 100, 101 AND 107).

FRANK LATTUCA, EXAMINING ATTORNEY

CLASS 41—(Continued).

SN 77-248,842. THE LITTLE BLACK APRON, LLC, DIX HILLS, NY. FILED 8-7-2007.



THE MARK CONSISTS OF A STYLIZED APRON DESIGN ON THE LEFT OF THE STYLIZED WORDS "THE LITTLE BLACK APRON".

FOR ENTERTAINMENT SERVICES IN THE NATURE OF TELEVISION COOKING PROGRAMS (U.S. CLS. 100, 101 AND 107).

RON FAIRBANKS, EXAMINING ATTORNEY

SN 77-249,249. GREAT WHITE ENTERTAINMENT, LLC, LAS VEGAS, NV. FILED 8-7-2007.

METAMORPHOSIS

THE MARK CONSISTS OF STANDARD CHARACTERS WITHOUT CLAIM TO ANY PARTICULAR FONT, STYLE, SIZE, OR COLOR.

FOR PLANNING AND CONDUCTING PARTIES FOR ADULTS WITH A FANTASY AND FETISH THEME (U.S. CLS. 100, 101 AND 107).

JANICE L. MCMORROW, EXAMINING ATTORNEY

SN 77-250,832. WHITE, TIMOTHY D., NANUET, NY. FILED 8-9-2007.



THE COLOR(S) WHITE, SILVER, BLACK IS/ARE CLAIMED AS A FEATURE OF THE MARK.

THE MARK CONSISTS OF THE WORD, "SISPILLI", WHERE EACH LETTER "S," "L," AND "P" ARE WHITE WITH A SILVER BORDER, EACH LETTER "I" IS BLACK AND IN THE SHAPE OF A HUMAN FIGURE AND THE ENTIRE MARK IS ENCLOSED IN A SILVER BORDER.

THE WORDING "SISPILLI" HAS NO MEANING OTHER THAN TRADEMARK SIGNIFICANCE.

FOR MOTION PICTURE FILM PRODUCTION (U.S. CLS. 100, 101 AND 107).

ELLEN PERKINS, EXAMINING ATTORNEY

CLASS 41—(Continued).

SN 77-250,866. KWAIT BROTHERS BAND, LLC, DBA CABIN DOGS, PHILADELPHIA, PA. FILED 8-9-2007.

CABIN DOGS

THE MARK CONSISTS OF STANDARD CHARACTERS WITHOUT CLAIM TO ANY PARTICULAR FONT, STYLE, SIZE, OR COLOR.

FOR ENTERTAINMENT IN THE NATURE OF VISUAL AND AUDIO PERFORMANCES, NAMELY, MUSICAL BAND, ROCK GROUP, GYMNASTIC, DANCE, AND BALLET PERFORMANCES; ENTERTAINMENT, NAMELY, LIVE PERFORMANCES BY A MUSICAL BAND (U.S. CLS. 100, 101 AND 107).

FIRST USE 10-1-2005; IN COMMERCE 2-1-2006.

CAROLINE WOOD, EXAMINING ATTORNEY

SN 77-251,032. UNITED STATES POLO ASSOCIATION, LEXINGTON, KY. FILED 8-9-2007.

SILVER CUP

THE MARK CONSISTS OF STANDARD CHARACTERS WITHOUT CLAIM TO ANY PARTICULAR FONT, STYLE, SIZE, OR COLOR.

SEC. 2(F).

FOR ENTERTAINMENT SERVICES, NAMELY, ORGANIZING AND CONDUCTING POLO EVENTS AND TOURNAMENTS (U.S. CLS. 100, 101 AND 107).

FIRST USE 0-0-1974; IN COMMERCE 0-0-1974.

ALICE BENMAMAN, EXAMINING ATTORNEY

SN 77-251,311. STERLING, WILLIAM T., NORWALK, CT. FILED 8-9-2007.

LAUGH RIOT RADIO

THE MARK CONSISTS OF STANDARD CHARACTERS WITHOUT CLAIM TO ANY PARTICULAR FONT, STYLE, SIZE, OR COLOR.

NO CLAIM IS MADE TO THE EXCLUSIVE RIGHT TO USE "RADIO", APART FROM THE MARK AS SHOWN.

FOR ENTERTAINMENT SERVICES, NAMELY, AN ON-GOING SERIES FEATURING COMEDY PROVIDING THROUGH RADIO AND WEBCASTS; ENTERTAINMENT SERVICES, NAMELY, PROVIDING A RADIO PROGRAM IN THE FIELD OF COMEDY VIA A GLOBAL COMPUTER NETWORK; PRODUCTION OF RADIO OR TELEVISION PROGRAMS; RADIO ENTERTAINMENT PRODUCTION (U.S. CLS. 100, 101 AND 107).

ALEXANDER L. POWERS, EXAMINING ATTORNEY

CLASS 41—(Continued).

SN 77-252,671. SALSA BABIES INC., TORONTO, CANADA, FILED 8-10-2007.



NO CLAIM IS MADE TO THE EXCLUSIVE RIGHT TO USE "SALSA TOTS", APART FROM THE MARK AS SHOWN.

THE COLOR(S) YELLOW, GREEN, ORANGE, AND BLACK IS/ARE CLAIMED AS A FEATURE OF THE MARK.

THE COLOR BLACK APPEARS IN THE WORDING "SALSA" AND "LATIN GROOVE FOR KIDS ON THE MOVE!," AND IN THE OUTLINE OF THE MARACA. THE COLOR ORANGE APPEARS IN THE WORDING "TOTS." THE MARACA IS COLORED YELLOW, ORANGE, YELLOW, AND GREEN FROM TOP TO BOTTOM. THE CIRCLES ARE COLORED YELLOW, ORANGE, GREEN, YELLOW, AND GREEN FROM LEFT TO RIGHT.

FOR PHYSICAL FITNESS CONDITIONING CLASSES (U.S. CLS. 100, 101 AND 107).

FIRST USE 6-1-2003; IN COMMERCE 6-1-2003.

JASON BLAIR, EXAMINING ATTORNEY

CLASS 41—(Continued).

SN 77-255,227. LEFT NOODLE RIGHT NOODLE, LLC., ARLINGTON, VA. FILED 8-14-2007.



THE MARK CONSISTS OF KOOKY NOODLE GUY HAPPY FACE WITH WORDS "LEFT NOODLE - RIGHT NOODLE" IN ARCH SHAPE OVER FACE AS HAIR.

FOR EDUCATIONAL SERVICES, NAMELY, PROVIDING COURSES OF INSTRUCTION FOR THE ENRICHMENT OF CHILDREN AT THE PRESCHOOL, PRIMARY AND SECONDARY LEVELS (U.S. CLS. 100, 101 AND 107).

FIRST USE 9-1-2006; IN COMMERCE 9-1-2006.

JENNIFER DIXON, EXAMINING ATTORNEY

SN 77-253,205. GARZA, RAYNALDO, MONARCH BEACH, CA. FILED 8-12-2007.

RANGER RAY

THE MARK CONSISTS OF STANDARD CHARACTERS WITHOUT CLAIM TO ANY PARTICULAR FONT, STYLE, SIZE, OR COLOR.

FOR ENTERTAINMENT SERVICES, NAMELY, LIVE STAGE PERFORMANCES AND EVENTS BY A FICTIONAL CHARACTER; ENTERTAINMENT IN THE NATURE OF AN ONGOING TELEVISION PROGRAM FEATURING A FICTIONAL CHARACTER; ENTERTAINMENT SERVICES, NAMELY, ONGOING TELEVISION, SATELLITE, RADIO AND INTERNET PROGRAMS FEATURING CHILDREN'S ENTERTAINMENT; PRODUCTION AND DISTRIBUTION OF TELEVISION, RADIO AND INTERNET PROGRAMS FOR OTHERS (U.S. CLS. 100, 101 AND 107).

FIRST USE 7-17-2004; IN COMMERCE 7-28-2006.

PATRICIA EVANKO, EXAMINING ATTORNEY

SN 77-256,039. NEW UNDERSTANDINGS AWAKEN WORLDWIDE, LLC, WILMINGTON, DE. FILED 8-15-2007.

NUAW NEW UNDERSTANDINGS AWAKEN WITHIN

THE MARK CONSISTS OF STANDARD CHARACTERS WITHOUT CLAIM TO ANY PARTICULAR FONT, STYLE, SIZE, OR COLOR.

FOR ARRANGING OF SEMINARS AND CONFERENCES; EDUCATION SERVICES, NAMELY, PROVIDING CLASSES, SEMINARS, AND WORKSHOPS IN SELF AWARENESS, SPIRITUALITY, SELF-HELP AND PERSONAL EMPOWERMENT SUBJECT MATTERS AND DISTRIBUTING COURSE MATERIALS IN CONNECTION THEREWITH (U.S. CLS. 100, 101 AND 107).

KYLE PEETE, EXAMINING ATTORNEY

CLASS 41—(Continued).

SN 77-256,226. NEW UNDERSTANDINGS AWAKEN WORLDWIDE, LLC, WILMINGTON, DE. FILED 8-15-2007.

NUAW NEW UNDERSTANDINGS
AWAKEN WORLDWIDE

THE MARK CONSISTS OF STANDARD CHARACTERS WITHOUT CLAIM TO ANY PARTICULAR FONT, STYLE, SIZE, OR COLOR.

FOR ARRANGING OF SEMINARS AND CONFERENCES; EDUCATION SERVICES, NAMELY, PROVIDING CLASSES, SEMINARS, AND WORKSHOPS IN SELF AWARENESS, SPIRITUALITY, SELF-HELP AND PERSONAL EMPOWERMENT SUBJECT MATTERS AND DISTRIBUTING COURSE MATERIALS IN CONNECTION THEREWITH (U.S. CLS. 100, 101 AND 107).

KYLE PEETE, EXAMINING ATTORNEY

CLASS 41—(Continued).

SN 77-257,888. DEVOTTO, JORGE, SANTA MONICA, CA. FILED 8-17-2007.



THE MARK CONSISTS OF A ROUND SHAPE CIRCLE INTERSECTED BY ANOTHER WITH TWO SPOTS INSIDE. FOR MOTION PICTURE FILM PRODUCTION; PRODUCTION OF VIDEO DISCS AND TAPES (U.S. CLS. 100, 101 AND 107).

JOHN GARTNER, EXAMINING ATTORNEY

SN 77-258,243. CHRISTOPHER MCHUGH, DBA DBA, NORWOOD, MA. FILED 8-17-2007.

SN 77-257,176. STEPHEN EPSTEIN, SAN FRANCISCO, CA. FILED 8-16-2007.

APT Assessment Personal
Training

DOLLAR CAMP

THE MARK CONSISTS OF STANDARD CHARACTERS WITHOUT CLAIM TO ANY PARTICULAR FONT, STYLE, SIZE, OR COLOR.

NO CLAIM IS MADE TO THE EXCLUSIVE RIGHT TO USE "CAMP", APART FROM THE MARK AS SHOWN.

FOR EDUCATION SERVICES, NAMELY, PROVIDING A CRASH COURSE ON ENTERING THE "REAL WORLD" AS A YOUNG ADULT BY CONDUCTING A SERIES OF INTERACTIVE SEMINARS AND COURSES GEARED TOWARD YOUNG ADULTS IN THE FIELD OF PERSONAL FINANCE, SUSTAINABLE LIFE CHOICES, AND THE BASICS OF ACCOUNTING, HEALTH CARE, INVESTMENTS AND ENTERING THE WORKFORCE (U.S. CLS. 100, 101 AND 107).

KRISTIN DAHLING, EXAMINING ATTORNEY

THE MARK CONSISTS OF STANDARD CHARACTERS WITHOUT CLAIM TO ANY PARTICULAR FONT, STYLE, SIZE, OR COLOR.

NO CLAIM IS MADE TO THE EXCLUSIVE RIGHT TO USE "ASSESSMENT PERSONAL TRAINING", APART FROM THE MARK AS SHOWN.

FOR PERSONAL TRAINING SERVICES, NAMELY, STRENGTH AND CONDITIONING TRAINING; PROVIDING ASSISTANCE, PERSONAL TRAINING AND PHYSICAL FITNESS CONSULTATION TO CORPORATE CLIENTS TO HELP THEIR EMPLOYEES MAKE PHYSICAL FITNESS, STRENGTH, CONDITIONING, AND EXERCISE ALTERATIONS IN THEIR DAILY LIVING; PROVIDING ASSISTANCE, PERSONAL TRAINING AND PHYSICAL FITNESS CONSULTATION TO INDIVIDUALS TO HELP THEM MAKE PHYSICAL FITNESS, STRENGTH, CONDITIONING, AND EXERCISE IMPROVEMENT IN THEIR DAILY LIVING (U.S. CLS. 100, 101 AND 107).

FIRST USE 5-5-2007; IN COMMERCE 5-7-2007.

AMY MCMENAMIN, EXAMINING ATTORNEY

CLASS 41—(Continued).

SN 77-258,815. GARZA, RAYNALDO, MONARCH BEACH, CA. FILED 8-19-2007.

VIPERSONS

THE MARK CONSISTS OF STANDARD CHARACTERS WITHOUT CLAIM TO ANY PARTICULAR FONT, STYLE, SIZE, OR COLOR.

FOR PERSONAL STRENGTH TRAINING SERVICES, NAMELY, STRENGTH AND CONDITIONING TRAINING; PRODUCTION SERVICES, NAMELY, RADIO ENTERTAINMENT PRODUCTION; PRODUCTION OF RADIO AND TELEVISION PROGRAMS FEATURING EDUCATIONAL TOPICS, SPORTS, ENTERTAINMENT AND CULTURAL ACTIVITIES; ENTERTAINMENT SERVICES, IN THE NATURE OF ONGOING TELEVISION PROGRAMS FEATURING EDITORIALS, PICTURES AND BEHIND-THE-SCENES INTERVIEWS IN THE FIELDS OF POLITICS, GOVERNMENT, PUBLIC POLICY, TECHNOLOGY, ENTERTAINMENT, DANCE, MUSIC, CONCERTS, SPORTING EVENTS, CONVENTIONS, PERFORMING ARTS, LEISURE, TRAVEL, GAMES, MEDICINE, LAW, BUSINESS, PEOPLE, HEALTH, EDUCATION, SPORTS, PHOTOGRAPHY, CONTESTS, FASHION, ART, FOOD, MOVIES, TELEVISION PROGRAMS, RADIO PROGRAMS, THE INTERNET, REAL ESTATE, FINANCE, INVESTMENTS, COMPUTERS, TRAVEL, CLASSIFIED ADVERTISING AND CULTURAL ACTIVITIES; ON-LINE LIBRARY SERVICES, NAMELY, PROVIDING ELECTRONIC LIBRARY SERVICES WHICH FEATURE NEWSPAPERS, MAGAZINES, PHOTOGRAPHS AND PICTURES VIA AN ONLINE COMPUTER NETWORK FEATURING EDUCATIONAL TOPICS, SPORTS, ENTERTAINMENT AND CULTURAL ACTIVITIES; ON-LINE LIBRARY SERVICES, NAMELY, PROVIDING ELECTRONIC LIBRARY SERVICES WHICH FEATURE NEWSPAPERS, MAGAZINES, PHOTOGRAPHS AND PICTURES VIA AN ONLINE COMPUTER NETWORK FEATURING POLITICS, GOVERNMENT, POLICY, TECHNOLOGY, ENTERTAINMENT, DANCE, MUSIC, CONCERTS, EVENTS, CONVENTIONS, PERFORMING ARTS, LEISURE, TRAVEL, GAMES, MEDICAL, LEGAL, BUSINESS, PEOPLE, HEALTH, EDUCATION, SPORTS, PHOTOGRAPHY, CONTESTS, FASHION, ART, FOOD, MOVIES, TELEVISION, RADIO, THE INTERNET, REAL ESTATE, FINANCE, INVESTMENTS, COMPUTERS, TRAVEL, CLASSIFIED ADVERTISING AND CULTURAL ACTIVITIES; PROVIDING A WEBSITE FEATURING INFORMATION ON MUSICAL PERFORMANCES, MUSICAL VIDEOS, AUDIO CLIPS, RELATED FILM CLIPS, PHOTOGRAPHS, AND OTHER MULTIMEDIA MATERIAL; ON-LINE JOURNALS, NAMELY, BLOGS FEATURING INFORMATION IN THE FIELDS OF PRODUCTION OF AUDIO CLIPS, RADIO CLIPS, INTERNET CLIPS, VIDEO CLIPS, MUSICAL PERFORMANCES, MUSICAL VIDEOS, FILM CLIPS, TELEVISION CLIPS, SPORTS CLIPS, INTERNET CLIPS AND PHOTOGRAPHS; EDUCATIONAL SERVICES, NAMELY, DEVELOPING, ARRANGING, AND CONDUCTING EDUCATIONAL CONFERENCES AND PROGRAMS AND PROVIDING COURSES OF INSTRUCTION IN THE FIELD OF BUSINESS; DISTRIBUTION OF RADIO PROGRAMS FOR OTHERS; DISTRIBUTION OF TELEVISION PROGRAMS FOR OTHERS (U.S. CLS. 100, 101 AND 107).

DAVID MURRAY, EXAMINING ATTORNEY

CLASS 41—(Continued).

SN 77-259,252. HONIG, AVROM, WORCESTER, MA. FILED 8-20-2007.

FEED ME BUBBE

THE MARK CONSISTS OF STANDARD CHARACTERS WITHOUT CLAIM TO ANY PARTICULAR FONT, STYLE, SIZE, OR COLOR.

THE ENGLISH TRANSLATION OF "BUBBE" IS "GRANDMOTHER."

FOR ENTERTAINMENT SERVICES, NAMELY, PROVIDING A WEBSITE FEATURING PHOTOGRAPHIC, AUDIO, VIDEO AND PROSE PRESENTATIONS FEATURING COOKING (U.S. CLS. 100, 101 AND 107).

FIRST USE 6-16-2006; IN COMMERCE 6-16-2006.
MELISSA VALLILLO, EXAMINING ATTORNEY

SN 77-260,493. 24 HOUR FITNESS USA, INC., SAN RAMON, CA. FILED 8-21-2007.

Fitness Done Right

THE MARK CONSISTS OF STANDARD CHARACTERS WITHOUT CLAIM TO ANY PARTICULAR FONT, STYLE, SIZE, OR COLOR.

NO CLAIM IS MADE TO THE EXCLUSIVE RIGHT TO USE "FITNESS", APART FROM THE MARK AS SHOWN.

FOR HEALTH CLUB SERVICES, NAMELY, PROVIDING INSTRUCTION AND EQUIPMENT IN THE FIELD OF PHYSICAL EXERCISE (U.S. CLS. 100, 101 AND 107).
SOPHIA S. KIM, EXAMINING ATTORNEY

SN 77-261,232. LO, CINDY Y., DBA RED VELVET EVENTS, INC., AUSTIN, TX. FILED 8-22-2007.



The logo for Red Velvet Events features the words "Red Velvet" in a stylized, cursive red font. Below "Red Velvet" is the word "EVENTS" in a smaller, black, sans-serif font.

THE COLOR(S) RED, LIGHT GREY, AND BLACK IS/ARE CLAIMED AS A FEATURE OF THE MARK.

THE MARK CONSISTS OF "RED VELVET" IN THE COLOR RED WITH A SHADOW EFFECT IN LIGHT GREY AND THE WORD "EVENTS" IN BLACK. "EVENTS" IS DEFINITELY BELOW THE WORD "RED VELVET", OFF-CENTERED TO THE RIGHT.

FOR PARTY PLANNING CONSULTATION; SPECIAL EVENT PLANNING CONSULTATION (U.S. CLS. 100, 101 AND 107).

FIRST USE 10-1-2002; IN COMMERCE 10-1-2002.
ALEX KEAM, EXAMINING ATTORNEY

CLASS 41—(Continued).

SN 77-261,543. GARZA, RAYNALDO, MONARCH BEACH, CA. FILED 8-22-2007.

SENIOROBICS

THE MARK CONSISTS OF STANDARD CHARACTERS WITHOUT CLAIM TO ANY PARTICULAR FONT, STYLE, SIZE, OR COLOR.

FOR ENTERTAINMENT SERVICES, NAMELY, LIVE THEATER STAGE PERFORMANCES AND EVENTS, NAMELY, A LIVE PERFORMANCE BY A MUSICAL BAND; ENTERTAINMENT IN THE NATURE OF A CONTINUING HEALTH, SINGING, DANCING, HUMOR, MAGIC, FASHION AND VARIETY SHOW FEATURING HEALTH AND EXERCISE INSTRUCTION BROADCAST OVER TELEVISION, SATELLITE, AUDIO AND VIDEO MEDIA (U.S. CLS. 100, 101 AND 107).

DAVID MURRAY, EXAMINING ATTORNEY

SN 77-261,610. GLIMCHER, SUMNER, NEW YORK, NY. FILED 8-22-2007.

MEET THE FILMMAKERS

THE MARK CONSISTS OF STANDARD CHARACTERS WITHOUT CLAIM TO ANY PARTICULAR FONT, STYLE, SIZE, OR COLOR.

NO CLAIM IS MADE TO THE EXCLUSIVE RIGHT TO USE "FILMMAKERS", APART FROM THE MARK AS SHOWN.

FOR ENTERTAINMENT IN THE NATURE OF LIVE, TELEVISED, VIDEOTAPED OR FILMED PERSONAL APPEARANCES BY MEMBERS OF THE FILM, TELEVISION AND ENTERTAINMENT INDUSTRIES; EDUCATIONAL SERVICES, NAMELY, CONDUCTING INTERVIEWS IN THE FIELD OF FILM, VIDEO AND TELEVISION (U.S. CLS. 100, 101 AND 107).

FIRST USE 10-24-2005; IN COMMERCE 10-24-2005.
CHRIS WELLS, EXAMINING ATTORNEY

SN 77-263,180. VALLEY BACK IN CONTROL, PASADENA, CA. FILED 8-23-2007.

BACK IN CONTROL

THE MARK CONSISTS OF STANDARD CHARACTERS WITHOUT CLAIM TO ANY PARTICULAR FONT, STYLE, SIZE, OR COLOR.

FOR EDUCATIONAL SERVICES, NAMELY, CONDUCTING SEMINARS AND OTHER MEETINGS IN THE FIELD OF PARENT-CHILD RELATIONSHIPS AND CHILD BEHAVIOR MODIFICATION (U.S. CLS. 100, 101 AND 107).

FIRST USE 7-31-1986; IN COMMERCE 7-31-1986.
JENNY PARK, EXAMINING ATTORNEY

CLASS 41—(Continued).

SN 77-263,419. BORN TO RIDE, INC., BRANDON, FL. FILED 8-24-2007.

BORN TO RIDE

THE MARK CONSISTS OF STANDARD CHARACTERS WITHOUT CLAIM TO ANY PARTICULAR FONT, STYLE, SIZE, OR COLOR.

OWNER OF U.S. REG. NOS. 2,482,316, 3,213,461 AND OTHERS.

FOR MOTION PICTURE FILM PRODUCTION; PRODUCTION AND DISTRIBUTION OF MOTION PICTURES (U.S. CLS. 100, 101 AND 107).

FIRST USE 1-1-1995; IN COMMERCE 1-1-1995.
ANGELA GAW, EXAMINING ATTORNEY

SN 77-264,753. CITIZENEWS, INC., NEW YORK, NY. FILED 8-27-2007.

CTZN.TV

THE MARK CONSISTS OF STANDARD CHARACTERS WITHOUT CLAIM TO ANY PARTICULAR FONT, STYLE, SIZE, OR COLOR.

FOR NEWS AGENCIES, NAMELY, GATHERING AND DISSEMINATION OF NEWS (U.S. CLS. 100, 101 AND 107).

SETH A. RAPPAPORT, EXAMINING ATTORNEY

CLASS 41—(Continued).

SN 77-265,965. RECTOR, REGINA, GALAX, VA. FILED 8-28-2007.



THE NAME "REGINA RECTOR" IDENTIFIES A LIVING INDIVIDUAL WHOSE CONSENT IS OF RECORD.

THE COLOR(S) BROWN, PINK, YELLOW AND WHITE IS/ARE CLAIMED AS A FEATURE OF THE MARK.

THE TERM "REGINA" IS BROWN. THE TERM "RECTOR" IS PINK, WITH A BROWN ".COM" IN BROWN OVER THE LETTERS "O" AND "R" IN "RECTOR". THE TERMS "FIND YOUR CONFIDENCE IN GOD" ARE BROWN. THE CLIFF DESIGN IS BROWN AND WHITE, WITH A YELLOW LINE SEPARATING THE CLIFFS. THE SUN RISING OVER THE CLIFFS IS PINK. THE STYLIZED BIRD OVER THE SUN IS BROWN.

FOR EDUCATION SERVICES, NAMELY, PROVIDING WORKSHOPS IN THE FIELD OF RELIGION; EDUCATIONAL AND ENTERTAINMENT SERVICES, NAMELY, PROVIDING MOTIVATIONAL AND EDUCATIONAL SPEAKERS (U.S. CLS. 100, 101 AND 107).

MICHAEL KEATING, EXAMINING ATTORNEY

SN 77-266,288. THE LEARNING INTERNET, INC., PORTLAND, OR. FILED 8-28-2007.



NO CLAIM IS MADE TO THE EXCLUSIVE RIGHT TO USE "ASSESSMENT", APART FROM THE MARK AS SHOWN.

THE COLOR(S) BLUE AND BLACK IS/ARE CLAIMED AS A FEATURE OF THE MARK.

THE MARK CONSISTS OF THE WORD "TECH" IN THE COLOR BLUE FOLLOWED BY THE WORD "LITERACY" IN THE COLOR BLACK, WITH THE WORD "ASSESSMENT" IN THE COLOR BLACK APPEARING BENEATH.

FOR EDUCATION SERVICES, NAMELY, PROVIDING AN ON-LINE ASSESSMENT WHICH MEASURES AND REPORTS TECHNOLOGY LITERACY FOR K-12 SCHOOL STUDENTS (U.S. CLS. 100, 101 AND 107).

FIRST USE 6-0-2005; IN COMMERCE 6-0-2005.
CAROLYN GRAY, EXAMINING ATTORNEY

CLASS 41—(Continued).

SN 77-267,037. WILLIAMS, LAMAR, LAKEWOOD, CA. FILED 8-29-2007.



THE MARK CONSISTS OF THE WORD "CRE'O" BUT WITH A BOX AROUND THE R.

FOR ENTERTAINMENT IN THE NATURE OF LIVE PERFORMANCES BY A MUSIC AND RAP MUSIC ARTIST (U.S. CLS. 100, 101 AND 107).

FIRST USE 11-20-2003; IN COMMERCE 11-20-2003.
KELLEY WELLS, EXAMINING ATTORNEY

SN 77-267,085. SNI/SI NETWORKS LLC, NEW YORK, NY. FILED 8-29-2007.

HIDDEN ARMOR, FOUND TREASURES

THE MARK CONSISTS OF STANDARD CHARACTERS WITHOUT CLAIM TO ANY PARTICULAR FONT, STYLE, SIZE, OR COLOR.

FOR ENTERTAINMENT SERVICES, NAMELY AN ONGOING TELEVISION SERIES IN THE FIELD OF EVALUATING AND APPRAISING WEAPONRY (U.S. CLS. 100, 101 AND 107).

FRANK LATTUCA, EXAMINING ATTORNEY

SN 77-267,514. AMERICAN PSYCHOTHERAPY ASSOCIATION, INC., SPRINGFIELD, MO. FILED 8-29-2007.

BOARD CERTIFIED IN INTEGRATIVE MEDICINE, BCIM

THE MARK CONSISTS OF STANDARD CHARACTERS WITHOUT CLAIM TO ANY PARTICULAR FONT, STYLE, SIZE, OR COLOR.

NO CLAIM IS MADE TO THE EXCLUSIVE RIGHT TO USE "BOARD CERTIFIED IN INTEGRATIVE MEDICINE", APART FROM THE MARK AS SHOWN.

FOR EDUCATIONAL SERVICES, NAMELY, ADMINISTERING ON-SITE CLASSES, ON-SITE EXAMS, ON-LINE COURSES, AND ONLINE EXAMS IN THE FIELD OF INTEGRATIVE MEDICINE (U.S. CLS. 100, 101 AND 107).

ANN E. SAPPENFIELD, EXAMINING ATTORNEY

CLASS 41—(Continued).

SN 77-267,551. A-MARK ENTERTAINMENT, LLC, BOISE, ID. FILED 8-29-2007.

A-MARK ENTERTAINMENT

THE MARK CONSISTS OF STANDARD CHARACTERS WITHOUT CLAIM TO ANY PARTICULAR FONT, STYLE, SIZE, OR COLOR.

NO CLAIM IS MADE TO THE EXCLUSIVE RIGHT TO USE "ENTERTAINMENT", APART FROM THE MARK AS SHOWN.

FOR MOTION PICTURE FILM PRODUCTION (U.S. CLS. 100, 101 AND 107).

REBECCA EISINGER, EXAMINING ATTORNEY

SN 77-267,674. GIFFORD, LEE STODDARD, LOMPOC, CA. FILED 8-29-2007.

PHOTOCRYPTIC

THE MARK CONSISTS OF STANDARD CHARACTERS WITHOUT CLAIM TO ANY PARTICULAR FONT, STYLE, SIZE, OR COLOR.

FOR PHOTOGRAPHY SERVICES; PORTRAIT PHOTOGRAPHY; ON-LINE LIBRARY SERVICES, NAMELY, PROVIDING ELECTRONIC LIBRARY SERVICES WHICH FEATURE NEWSPAPERS, MAGAZINES, PHOTOGRAPHS AND PICTURES VIA AN ON-LINE COMPUTER NETWORK; PHOTOGRAPHIC AND VIDEO SERVICES, NAMELY, PHOTOGRAPHIC AND VIDEO CAPTURE (U.S. CLS. 100, 101 AND 107).

RAMONA ORTIGA, EXAMINING ATTORNEY

SN 77-268,747. VUGO, LUNO, JOAO, SANTA MONICA, CA. FILED 8-30-2007.

Luno Vugo

THE MARK CONSISTS OF STANDARD CHARACTERS WITHOUT CLAIM TO ANY PARTICULAR FONT, STYLE, SIZE, OR COLOR.

THE NAME "LUNO VUGO" IDENTIFIES A LIVING INDIVIDUAL WHOSE CONSENT IS OF RECORD.

FOR ENTERTAINMENT SERVICES IN THE NATURE OF LIVE PERFORMANCES BY A MUSICIAN (U.S. CLS. 100, 101 AND 107).

MARGERY A. TIERNEY, EXAMINING ATTORNEY

CLASS 41—(Continued).

SN 77-269,859. TRAYLOR, DAVID KIRK, ROME, ITALY, FILED 8-31-2007.

ZED

THE MARK CONSISTS OF STANDARD CHARACTERS WITHOUT CLAIM TO ANY PARTICULAR FONT, STYLE, SIZE, OR COLOR.

THE NAME "ZED" IDENTIFIES A LIVING INDIVIDUAL WHOSE CONSENT IS OF RECORD.

FOR ENTERTAINMENT SERVICES, NAMELY, LIVE, TELEVISED AND MOVIE APPEARANCES BY A PROFESSIONAL ENTERTAINER (U.S. CLS. 100, 101 AND 107).

FIRST USE 6-7-1984; IN COMMERCE 6-7-1984.

BARBARA RUTLAND, EXAMINING ATTORNEY

SN 77-271,062. GGWTV, LLC, WEST HOLLYWOOD, CA. FILED 9-4-2007.

All You Can Eat Comedy

THE MARK CONSISTS OF STANDARD CHARACTERS WITHOUT CLAIM TO ANY PARTICULAR FONT, STYLE, SIZE, OR COLOR.

NO CLAIM IS MADE TO THE EXCLUSIVE RIGHT TO USE "COMEDY", APART FROM THE MARK AS SHOWN.

FOR ENTERTAINMENT IN THE NATURE OF LIVE PERFORMANCES BY COMEDIANS (U.S. CLS. 100, 101 AND 107).

FIRST USE 4-1-1997; IN COMMERCE 5-1-1997.

CHRISTINE COOPER, EXAMINING ATTORNEY

CLASS 41—(Continued).

SN 77-271,446. COUNTY OF LOS ANGELES SHERIFF'S DEPARTMENT, MONTEREY PARK, CA. FILED 9-4-2007.



OWNER OF U.S. REG. NOS. 2,627,597, 2,972,035 AND OTHERS.

NO CLAIM IS MADE TO THE EXCLUSIVE RIGHT TO USE "LOS ANGELES COUNTY", APART FROM THE MARK AS SHOWN.

THE MARK CONSISTS OF A STAR DESIGN CONSISTING OF THE TERMS "LOS ANGELES COUNTY SHERIFF" AND A BEAR WITHIN A CIRCLE DESIGN.

FOR ENTERTAINMENT SERVICES, NAMELY, PRODUCTION AND DISTRIBUTION OF MOTION PICTURE FILMS AND TELEVISION SHOWS; ENTERTAINMENT SERVICES, NAMELY, A CONTINUING DRAMATIC VARIETY SHOW BROADCAST OVER GLOBAL COMPUTER NETWORKS, CABLE AND TELEVISION; PROVIDING A WEB SITE ON GLOBAL COMPUTER NETWORKS FEATURING INFORMATION IN THE FIELD OF ENTERTAINMENT; EDUCATIONAL SERVICES, NAMELY, CONDUCTING CLASSES, SEMINARS, CONFERENCES AND WORKSHOPS IN THE FIELDS OF LAW ENFORCEMENT, COMMUNITY SAFETY AND YOUTH DEVELOPMENT (U.S. CLS. 100, 101 AND 107).

CAROLINE WOOD, EXAMINING ATTORNEY



SN 77-271,909. AMERICAN INTERNATIONAL RADIO, INC., ROLLING MEADOWS, IL. FILED 9-5-2007.



THE MARK CONSISTS OF YING-YANG WITH FISH TAILS.

FOR FISHING GUIDE SERVICES (U.S. CLS. 100, 101 AND 107).

MATTHEW PAPPAS, EXAMINING ATTORNEY

CLASS 41—(Continued).

SN 77-271,949. GALEN, CORINA ANGELES, LOS ANGELES, CA. FILED 9-5-2007.

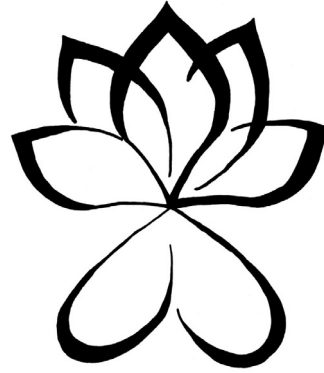

THE MARK CONSISTS OF LOTUS AND HEART REFLECTING EACH OTHER.

FOR YOGA INSTRUCTION (U.S. CLS. 100, 101 AND 107).

FIRST USE 9-5-2007; IN COMMERCE 9-5-2007.

JASON LOTT, EXAMINING ATTORNEY



SN 77-272,409. GARTH REDWOOD, VENICE, CA. FILED 9-5-2007.

Redwood Athletic

THE MARK CONSISTS OF STANDARD CHARACTERS WITHOUT CLAIM TO ANY PARTICULAR FONT, STYLE, SIZE, OR COLOR.

NO CLAIM IS MADE TO THE EXCLUSIVE RIGHT TO USE ATHLETIC, APART FROM THE MARK AS SHOWN.

FOR PROVIDING ASSISTANCE, PERSONAL TRAINING AND PHYSICAL FITNESS CONSULTATION TO INDIVIDUALS TO HELP THEM MAKE PHYSICAL FITNESS, STRENGTH, CONDITIONING, AND EXERCISE IMPROVEMENT IN THEIR DAILY LIVING (U.S. CLS. 100, 101 AND 107).

ALICE BENMAMAN, EXAMINING ATTORNEY

CLASS 41—(Continued).

SN 77-272,901. RE-CREATE YOURSELF NOW, LLC, SCOTTSDALE, AZ. FILED 9-6-2007.

Achievement IQ Moment

THE MARK CONSISTS OF STANDARD CHARACTERS WITHOUT CLAIM TO ANY PARTICULAR FONT, STYLE, SIZE, OR COLOR.

OWNER OF U.S. REG. NOS. 3,339,119 AND 3,339,189.
FOR ARRANGING OF SEMINARS; ARRANGING AND CONDUCTING EDUCATIONAL CONFERENCES; BUSINESS TRAINING; CONDUCTING WORKSHOPS AND SEMINARS IN PERSONAL AWARENESS; CONDUCTING WORKSHOPS AND SEMINARS IN SELF AWARENESS; CONDUCTING WORKSHOPS AND SEMINARS IN PERSONAL IMPROVEMENT AND PERSONAL GROWTH; EDUCATION SERVICES, NAMELY, PROVIDING LIVE AND ON-LINE SEMINARS AND COURSES IN THE FIELD OF PERSONAL IMPROVEMENT AND PERSONAL GROWTH; EDUCATION SERVICES, NAMELY, PROVIDING SEMINARS AND COURSES IN THE FIELD OF BUSINESS GROWTH AND TEAMWORK BUILDING; EDUCATIONAL SERVICES, NAMELY, CONDUCTING SEMINARS AND COURSES IN THE FIELD OF PERSONAL IMPROVEMENT AND PERSONAL GROWTH AND DISTRIBUTION OF COURSE MATERIAL IN CONNECTION THEREWITH; EDUCATIONAL SERVICES, NAMELY, CONDUCTING SEMINARS AND COURSES IN THE FIELD OF BUSINESS GROWTH AND TEAMWORKING BUILDING AND DISTRIBUTION OF COURSE MATERIAL IN CONNECTION THEREWITH; MEETING AND SEMINAR ARRANGING; PROVIDING ON-LINE TRAINING COURSES AND SEMINARS IN THE FIELD OF PERSONAL IMPROVEMENT, PERSONAL GROWTH, BUSINESS GROWTH AND TEAMWORK BUILDING; TRAINING COURSES IN STRATEGIC PLANNING RELATING TO ADVERTISING, PROMOTION, MARKETING AND BUSINESS; WORKSHOPS AND SEMINARS IN THE FIELD OF PERSONAL IMPROVEMENT, PERSONAL GROWTH, BUSINESS GROWTH AND TEAMWORK BUILDING (U.S. CLS. 100, 101 AND 107).

FIRST USE 8-4-2007; IN COMMERCE 8-4-2007.
MARY CRAWFORD, EXAMINING ATTORNEY

SN 77-273,664. HULA MOON PRESS, LLC, HONOLULU, HI. FILED 9-6-2007.

HULA MOON PRESS

THE MARK CONSISTS OF STANDARD CHARACTERS WITHOUT CLAIM TO ANY PARTICULAR FONT, STYLE, SIZE, OR COLOR.

NO CLAIM IS MADE TO THE EXCLUSIVE RIGHT TO USE "PRESS", APART FROM THE MARK AS SHOWN.

FOR (BASED ON USE IN COMMERCE) PUBLISHING OF BOOKS AND REVIEWS; PUBLISHING OF BOOKS, MAGAZINES (U.S. CLS. 100, 101 AND 107).

FIRST USE 8-8-2007; IN COMMERCE 8-8-2007.
LINDA M. KING, EXAMINING ATTORNEY

CLASS 41—(Continued).

SN 77-273,804. CNSG, INC., VERO BEACH, FL. FILED 9-7-2007.

THE JIM CAMP GROUP

THE MARK CONSISTS OF STANDARD CHARACTERS WITHOUT CLAIM TO ANY PARTICULAR FONT, STYLE, SIZE, OR COLOR.

NO CLAIM IS MADE TO THE EXCLUSIVE RIGHT TO USE "GROUP", APART FROM THE MARK AS SHOWN.

THE NAME(S), PORTRAIT(S), AND/OR SIGNATURE(S) SHOWN IN THE MARK IDENTIFIES JAMES R. CAMP, WHOSE CONSENT(S) TO REGISTER IS MADE OF RECORD.

FOR TRAINING SERVICES IN THE FIELD OF NEGOTIATION (U.S. CLS. 100, 101 AND 107).

FIRST USE 7-30-2007; IN COMMERCE 7-30-2007.
PAM WILLIS, EXAMINING ATTORNEY

SN 77-275,880. RONALD J. TUTSKY, GREENWICH, CT. FILED 9-10-2007.



The GPS For Your Mind's Eye!

THE MARK CONSISTS OF THE WORDS GVII THE GPS FOR YOUR MIND'S EYE! AND THE DEPICTION OF A GLOBE.

FOR EDUCATIONAL SERVICES, NAMELY, TEACHING AND INSTRUCTION IN THE FIELD OF COGNITIVE/SPATIAL PROCESSING AND IMAGING SYSTEMS WHEREBY A SET OF SYMBOLIC IMAGES AND ASSOCIATED CONCEPTUAL ILLUSTRATIONS ARE CREATED THAT ACT AS A MENTAL REPRESENTATION OF A PROBLEM TO FACILITATE THE SEARCH FOR SOLUTIONS TO SAID PROBLEM (U.S. CLS. 100, 101 AND 107).

FIRST USE 1-20-2005; IN COMMERCE 8-29-2007.
TAMARA FRAZIER, EXAMINING ATTORNEY

CLASS 41—(Continued).

SN 77-276,632. DSMMG, INC., ROCHESTER, NY. FILED 9-11-2007.

U.N.H. M.B.A. UNITED NETWORK OF HELP WITH (ONLINE, CAMPUS, & EXECUTIVE!) MASTERS OF BUSINESS ADMINISTRATION (MBA) PROGRAMS

THE MARK CONSISTS OF STANDARD CHARACTERS WITHOUT CLAIM TO ANY PARTICULAR FONT, STYLE, SIZE, OR COLOR.

NO CLAIM IS MADE TO THE EXCLUSIVE RIGHT TO USE "M.B.A." OR "MASTERS OF BUSINESS ADMINISTRATION (MBA) PROGRAMS", APART FROM THE MARK AS SHOWN.

FOR PROVIDING A WEBSITE FEATURING INFORMATION ABOUT MASTERS OF BUSINESS ADMINISTRATION SCHOOLS AND PROGRAMS (U.S. CLS. 100, 101 AND 107).

FIRST USE 10-20-2005; IN COMMERCE 10-20-2005. ANNE MADDEN, EXAMINING ATTORNEY

CLASS 41—(Continued).

SN 77-278,828. BUSHMAN MUSIC WORKS, LLC, NASHVILLE, IN. FILED 9-13-2007.

BEAN BLOSSOM BLUES FEST

THE MARK CONSISTS OF STANDARD CHARACTERS WITHOUT CLAIM TO ANY PARTICULAR FONT, STYLE, SIZE, OR COLOR.

NO CLAIM IS MADE TO THE EXCLUSIVE RIGHT TO USE "BLUES FEST", APART FROM THE MARK AS SHOWN.

SEC. 2(F). FOR ENTERTAINMENT SERVICES IN THE NATURE OF A MUSIC FESTIVAL (U.S. CLS. 100, 101 AND 107).

FIRST USE 6-12-1999; IN COMMERCE 6-12-1999. LINDA POWELL, EXAMINING ATTORNEY

SN 77-276,736. CHAT WITH WOMEN LLC, BELLEVUE, WA. FILED 9-11-2007.

CHAT PARTY

THE MARK CONSISTS OF STANDARD CHARACTERS WITHOUT CLAIM TO ANY PARTICULAR FONT, STYLE, SIZE, OR COLOR.

NO CLAIM IS MADE TO THE EXCLUSIVE RIGHT TO USE "PARTY", APART FROM THE MARK AS SHOWN.

FOR SPECIAL EVENT PLANNING; ARRANGING AND CONDUCTING PARTIES AND SPECIAL EVENTS (U.S. CLS. 100, 101 AND 107).

FIRST USE 4-20-2006; IN COMMERCE 4-20-2006. AMEETA JORDAN, EXAMINING ATTORNEY

SN 77-278,875. OK GO, INC., PALISADES, NY. FILED 9-13-2007.

OK GO

THE MARK CONSISTS OF STANDARD CHARACTERS WITHOUT CLAIM TO ANY PARTICULAR FONT, STYLE, SIZE, OR COLOR.

FOR ENTERTAINMENT SERVICES, NAMELY, LIVE MUSICAL PERFORMANCES BY A BAND (U.S. CLS. 100, 101 AND 107).

FIRST USE 5-25-1999; IN COMMERCE 5-25-1999. FRANK LATTUCA, EXAMINING ATTORNEY

SN 77-278,772. COURTROOM TELEVISION NETWORK LLC, NEW YORK, NY. FILED 9-13-2007.

LOVE DECOY

THE MARK CONSISTS OF STANDARD CHARACTERS WITHOUT CLAIM TO ANY PARTICULAR FONT, STYLE, SIZE, OR COLOR.

FOR ENTERTAINMENT SERVICES, NAMELY, A CONTINUING TELEVISION PROGRAM SERIES IN THE FIELD OF COMEDY, DRAMA, ACTION AND/OR ADVENTURE PROVIDED THROUGH CABLE TELEVISION, BROADCAST TELEVISION, INTERNET, VIDEO-ON-DEMAND, AND THROUGH OTHER DISTRIBUTION PLATFORMS; PROVIDING INFORMATION, NAMELY, ENTERTAINMENT INFORMATION, OVER THE INTERNET (U.S. CLS. 100, 101 AND 107).

ALLISON SCHRODY, EXAMINING ATTORNEY

SN 77-278,876. DARETOLOOKIN, LLC, ATLANTA, GA. FILED 9-13-2007.

Dare to look in

THE MARK CONSISTS OF THE WORDS " DARE TO LOOK IN" WITH THE TWO LETTERS "O" IN THE WORD "LOOK" DESIGNED TO LOOK LIKE A PAIR OF EYES.

FOR PUBLICATION OF BOOKS; PUBLISHING OF BOOKS AND REVIEWS; PUBLISHING OF BOOKS, MAGAZINES (U.S. CLS. 100, 101 AND 107).

FRANK LATTUCA, EXAMINING ATTORNEY

CLASS 41—(Continued).

SN 77-279,090. NORTH, KAREN, ATHENS, GA. FILED 9-13-2007.

CARRY ON LANGUAGE

THE MARK CONSISTS OF STANDARD CHARACTERS WITHOUT CLAIM TO ANY PARTICULAR FONT, STYLE, SIZE, OR COLOR.

NO CLAIM IS MADE TO THE EXCLUSIVE RIGHT TO USE "LANGUAGE", APART FROM THE MARK AS SHOWN.

FOR EDUCATION SERVICES, NAMELY, FOREIGN LANGUAGE, CULTURAL AND TRAVEL SKILLS INSTRUCTION, TUTORING AND TRAINING; TRANSLATION AND LANGUAGE INTERPRETATION SERVICES (U.S. CLS. 100, 101 AND 107).

LINDA M. KING, EXAMINING ATTORNEY

SN 77-279,296. MIRROR IMAGE MUSIC GROUP, LAS VEGAS, NV. FILED 9-13-2007.



NO CLAIM IS MADE TO THE EXCLUSIVE RIGHT TO USE "MUSIC GROUP", APART FROM THE MARK AS SHOWN.

FOR MUSIC PRODUCTION SERVICES; MUSIC PRODUCTION AND POST PRODUCTION EDITING SERVICES, NAMELY, MIXING AND MASTERING OF MUSIC; POST-PRODUCTION EDITING SERVICES IN THE FIELD OF MUSIC; AND MUSIC DISTRIBUTION, NAMELY, DISTRIBUTION OF TELEVISION SHOWS AND RADIO PROGRAMS FEATURING MUSIC (U.S. CLS. 100, 101 AND 107).

ELI HELLMAN, EXAMINING ATTORNEY

CLASS 41—(Continued).

SN 77-279,750. GLWL, INC., DBA BIKRAM YOGA IN THE CITY, CHICAGO, IL. FILED 9-14-2007.



THE MARK CONSISTS OF A SILHOUETTE OF SKYSCRAPERS ABOVE THE WORDS "MEET OTHER HOT PEOPLE".

FOR YOGA INSTRUCTION (U.S. CLS. 100, 101 AND 107).

FIRST USE 7-0-2007; IN COMMERCE 8-2-2007.

WILLIAM ROSSMAN, EXAMINING ATTORNEY

SN 77-280,932. ALABAMA ASSOCIATION OF ORTHOPAEDIC EXECUTIVES, ROSEMONT, IL. FILED 9-17-2007.

AAOE AMERICAN ASSOCIATION OF ORTHOPAEDIC EXECUTIVES

THE MARK CONSISTS OF STANDARD CHARACTERS WITHOUT CLAIM TO ANY PARTICULAR FONT, STYLE, SIZE, OR COLOR.

NO CLAIM IS MADE TO THE EXCLUSIVE RIGHT TO USE "AMERICAN ASSOCIATION OF ORTHOPAEDIC EXECUTIVES", APART FROM THE MARK AS SHOWN.

FOR EDUCATION SERVICES, NAMELY, PROVIDING SEMINARS IN THE FIELD OF ORTHOPAEDIC PRACTICE MANAGEMENT (U.S. CLS. 100, 101 AND 107).

ANDREA K. NADELMAN, EXAMINING ATTORNEY

SN 77-281,102. 800-JR CIGAR, INC., WHIPPANY, NJ. FILED 9-17-2007.

National Cigar Museum

THE MARK CONSISTS OF STANDARD CHARACTERS WITHOUT CLAIM TO ANY PARTICULAR FONT, STYLE, SIZE, OR COLOR.

NO CLAIM IS MADE TO THE EXCLUSIVE RIGHT TO USE "CIGAR MUSEUM", APART FROM THE MARK AS SHOWN.

SEC. 2(F).

FOR MUSEUMS (U.S. CLS. 100, 101 AND 107).

FIRST USE 12-31-1993; IN COMMERCE 12-31-1993.

KATHLEEN M. VANSTON, EXAMINING ATTORNEY

CLASS 41—(Continued).

SN 77-281,268. 944 MEDIA, LLC, SCOTTSDALE, AZ. FILED 9-17-2007.

944 MEDIA

THE MARK CONSISTS OF STANDARD CHARACTERS WITHOUT CLAIM TO ANY PARTICULAR FONT, STYLE, SIZE, OR COLOR.

OWNER OF U.S. REG. NO. 3,273,648.
NO CLAIM IS MADE TO THE EXCLUSIVE RIGHT TO USE "MEDIA", APART FROM THE MARK AS SHOWN.
FOR (BASED ON INTENT TO USE) MAGAZINE PUBLISHING; PUBLICATION OF ELECTRONIC MAGAZINES; PUBLICATION OF MAGAZINES; PUBLISHING OF WEB MAGAZINES (U.S. CLS. 100, 101 AND 107).
ELI HELLMAN, EXAMINING ATTORNEY

CLASS 41—(Continued).

SN 77-282,381. POWERSURGE PRODUCTIONS, INC., STOCKBRIDGE, GA. FILED 9-18-2007.

POWERSURGE

THE MARK CONSISTS OF STANDARD CHARACTERS WITHOUT CLAIM TO ANY PARTICULAR FONT, STYLE, SIZE, OR COLOR.

FOR EDUCATIONAL SERVICES, NAMELY, CONDUCTING PROGRAMS IN THE FIELD OF ENTREPRENEURSHIP (U.S. CLS. 100, 101 AND 107).
BRIAN NEVILLE, EXAMINING ATTORNEY

SN 77-281,340. TRI-CITY SURVIVOR BOOTCAMP INC., PT. MOODY, CANADA, FILED 9-17-2007.

SURVIVOR BOOTCAMP

THE MARK CONSISTS OF STANDARD CHARACTERS WITHOUT CLAIM TO ANY PARTICULAR FONT, STYLE, SIZE, OR COLOR.

NO CLAIM IS MADE TO THE EXCLUSIVE RIGHT TO USE BOOTCAMP, APART FROM THE MARK AS SHOWN.
FOR PHYSICAL FITNESS INSTRUCTION (U.S. CLS. 100, 101 AND 107).
SHARON MEIER, EXAMINING ATTORNEY

SN 77-282,667. LENNON, YOKO ONO, NEW YORK, NY. FILED 9-18-2007.

IMAGINE PEACE

THE MARK CONSISTS OF STANDARD CHARACTERS WITHOUT CLAIM TO ANY PARTICULAR FONT, STYLE, SIZE, OR COLOR.

FOR CONDUCTING ENTERTAINMENT AND EDUCATIONAL EXHIBITIONS IN THE NATURE OF MONUMENT DEDICATIONS (U.S. CLS. 100, 101 AND 107).
TIMOTHY FINNEGAN, EXAMINING ATTORNEY

SN 77-281,862. DISCOVERLINK, INC., HENDERSONVILLE, TN. FILED 9-18-2007.

MULTI U

THE MARK CONSISTS OF STANDARD CHARACTERS WITHOUT CLAIM TO ANY PARTICULAR FONT, STYLE, SIZE, OR COLOR.

NO CLAIM IS MADE TO THE EXCLUSIVE RIGHT TO USE "U", APART FROM THE MARK AS SHOWN.
FOR EDUCATIONAL SERVICES, NAMELY, PROVIDING ONLINE COURSES IN THE FIELD OF LEADERSHIP TRAINING FEATURING INTERACTIVE MULTIMEDIA TRAINING, COURSE ENROLLMENT, EDUCATIONAL CONTENT, TESTING, EVALUATION, CREATING AND ADMINISTERING LEARNING CONTENT AND TRACKING LEARNING PROGRESS AND RESULTS AND DISTRIBUTION OF COURSE MATERIAL IN CONNECTION THEREWITH, NAMELY, USER MANUALS (U.S. CLS. 100, 101 AND 107).
GEORGIA CARTY, EXAMINING ATTORNEY

SN 77-283,455. CONCERT SERVICES, INC., CHICAGO, IL. FILED 9-19-2007.

KINGS FEST

THE MARK CONSISTS OF STANDARD CHARACTERS WITHOUT CLAIM TO ANY PARTICULAR FONT, STYLE, SIZE, OR COLOR.

NO CLAIM IS MADE TO THE EXCLUSIVE RIGHT TO USE "FEST", APART FROM THE MARK AS SHOWN.
FOR ARRANGING AND CONDUCTING MUSICAL CONCERTS FEATURING MULTIPLE MUSICAL GROUPS AND BANDS; ARRANGING AND CONDUCTING FESTIVALS FEATURING MUSICAL GROUPS, AND CHRISTIAN MUSIC (U.S. CLS. 100, 101 AND 107).
FIRST USE 6-0-1997; IN COMMERCE 6-0-1997.
SONYA STEPHENS, EXAMINING ATTORNEY

CLASS 41—(Continued).

SN 77-283,587. BRYANT ENTERTAINMENT, ALLEN, TX. FILED 9-19-2007.

SHUT UP AND WORK

THE MARK CONSISTS OF STANDARD CHARACTERS WITHOUT CLAIM TO ANY PARTICULAR FONT, STYLE, SIZE, OR COLOR.

FOR MOTION PICTURE FILM PRODUCTION (U.S. CLS. 100, 101 AND 107).

NAPOLEON SHARMA, EXAMINING ATTORNEY

CLASS 41—(Continued).

SN 77-283,848. EYEGLOO LLC, PROVIDENCE, RI. FILED 9-19-2007.

**Who Said Money Doesn't
Grow on Trees?**

THE MARK CONSISTS OF STANDARD CHARACTERS WITHOUT CLAIM TO ANY PARTICULAR FONT, STYLE, SIZE, OR COLOR.

FOR CASINOS; CONDUCTING AND PROVIDING FACILITIES FOR SPECIAL EVENTS FEATURING CASINO AND GAMING CONTESTS AND TOURNAMENTS; LEASING OF CASINO GAMES; PROVIDING CASINO FACILITIES (U.S. CLS. 100, 101 AND 107).

KATHLEEN LORENZO, EXAMINING ATTORNEY

SN 77-283,966. PRUDDEN, SUZY, BEVERLY HILLS, CA. FILED 9-19-2007.

SN 77-283,767. AMALGAMATED WORLDWIDE ENTERPRISES LLC, DBA HUDSON & HOUSATONIC, ALEXANDRIA, VA. FILED 9-19-2007.

METAFITNESS

NO CLAIM IS MADE TO THE EXCLUSIVE RIGHT TO USE "HUDSON & HOUSATONIC", APART FROM THE MARK AS SHOWN.

THE MARK CONSISTS OF TWO ALLEGORICAL HISTORICAL FIGURES – A DUTCH-AMERICAN FEMALE AND A NATIVE-AMERICAN MALE – FLANK A COAT OF ARMS DEPICTING TWO RIVERS FLOWING FROM A HIGHLAND PLATEAU INSCRIBED WITH THE WORDS "HUDSON & HOUSATONIC".

FOR CUSTOM WRITING SERVICES; POEM AND LYRIC WRITING; SCRIPT WRITING SERVICES; SONG WRITING SERVICES; WRITING OF ARTICLES FOR JOURNALS OTHER THAN FOR ADVERTISING OR PUBLICITY; WRITING OF ARTICLES FOR PERIODICALS OTHER THAN FOR ADVERTISING OR PUBLICITY; WRITING OF ARTICLES FOR PROFESSIONAL JOURNALS OTHER THAN FOR ADVERTISING OR PUBLICITY; WRITING OF TEXTS (U.S. CLS. 100, 101 AND 107).

CHRISIE B. KING, EXAMINING ATTORNEY

THE MARK CONSISTS OF STANDARD CHARACTERS WITHOUT CLAIM TO ANY PARTICULAR FONT, STYLE, SIZE, OR COLOR.

FOR HEALTH CLUB SERVICES, NAMELY, PROVIDING INSTRUCTION AND EQUIPMENT IN THE FIELD OF PHYSICAL EXERCISE; ARRANGING AND CONDUCTING EDUCATIONAL CONFERENCES; CONDUCTING EDUCATIONAL EXHIBITIONS IN THE NATURE OF COURSES, WORKSHOPS, AND SEMINARS FEATURING EDUCATIONAL INFORMATION IN THE FIELD OF HEALTH, PHYSICAL FITNESS, NUTRITION, SELF-CONTROL AND SELF-AWARENESS; EDUCATION SERVICES, NAMELY, PROVIDING LIVE AND ON-LINE COURSES, WORKSHOPS, AND SEMINARS FEATURING EDUCATIONAL INFORMATION IN THE FIELD OF HEALTH, PHYSICAL FITNESS, NUTRITION, SELF-CONTROL AND SELF-AWARENESS; EDUCATIONAL AND ENTERTAINMENT SERVICES, NAMELY, PROVIDING MOTIVATIONAL AND EDUCATIONAL SPEAKERS; EDUCATIONAL AND ENTERTAINMENT SERVICES, NAMELY, A CONTINUING PROGRAM ABOUT HEALTH, NUTRITION AND SELF-IMPROVEMENT ACCESSIBLE BY RADIO, TELEVISION, SATELLITE, AUDIO, VIDEO AND COMPUTER NETWORKS; EDUCATIONAL SERVICES, NAMELY, CONDUCTING LECTURES, COURSES, WORKSHOPS, AND SEMINARS FEATURING EDUCATIONAL INFORMATION IN THE FIELD OF HEALTH, PHYSICAL FITNESS, NUTRITION, SELF-CONTROL AND SELF-AWARENESS; EDUCATIONAL SERVICES, NAMELY, CONDUCTING INFORMAL ON-LINE PROGRAMS IN THE FIELDS OF HEALTH, PHYSICAL FITNESS, NUTRITION, SELF-CONTROL AND SELF-AWARENESS, AND PRINTABLE MATERIALS DISTRIBUTED THEREWITH (U.S. CLS. 100, 101 AND 107).

PAUL MORENO, EXAMINING ATTORNEY

CLASS 41—(Continued).

SN 77-284,513. MASTER AMY REED'S BLACK BELT ACADEMY, STUART, FL. FILED 9-20-2007.



NO CLAIM IS MADE TO THE EXCLUSIVE RIGHT TO USE "MASTER," "ORH," "TKD," AND "BLACK BELT ACADEMY", APART FROM THE MARK AS SHOWN.

THE NAME "AMY REED" IDENTIFIES A LIVING INDIVIDUAL WHOSE CONSENT IS OF RECORD.

THE MARKS CONSISTS OF THE WORDING "MASTER AMY REED'S BLACK BELT ACADEMY ORH TKD" SPREAD AROUND A CIRCULAR FRAME WITH SMALL CIRCLES SEPARATING OUT "MASTER AMY REED'S" FROM "TKD" FROM "BLACK BELT ACADEMY" FROM "ORH". THE MIDDLE OF THE CIRCLE CONTAINS TWO STYLIZED DRAGONS FORMING A CIRCULAR YIN YANG DESIGN

FOR MARTIAL ARTS INSTRUCTION (U.S. CLS. 100, 101 AND 107).

TOBY BULLOFF, EXAMINING ATTORNEY

CLASS 41—(Continued).

SN 77-284,553. ROCKIT WAVE 8, LLC, BAYSIDE, NY. FILED 9-20-2007.

THE FITNESS DJ

THE MARK CONSISTS OF STANDARD CHARACTERS WITHOUT CLAIM TO ANY PARTICULAR FONT, STYLE, SIZE, OR COLOR.

NO CLAIM IS MADE TO THE EXCLUSIVE RIGHT TO USE "DJ", APART FROM THE MARK AS SHOWN.

FOR ENTERTAINMENT SERVICES IN THE NATURE OF MUSICAL PERFORMANCES BY AN INDIVIDUAL DISC JOCKEY OF MUSIC FOR EXERCISE AND FITNESS PURPOSES (U.S. CLS. 100, 101 AND 107).

FIRST USE 8-1-2007; IN COMMERCE 8-1-2007.
MARY CRAWFORD, EXAMINING ATTORNEY

SN 77-284,906. NATIONAL WOMEN'S HEALTH RESOURCE CENTER, INC., DBA NWHRC, RED BANK, NJ. FILED 9-20-2007.

HEALTHYWOMEN.ORG

THE MARK CONSISTS OF STANDARD CHARACTERS WITHOUT CLAIM TO ANY PARTICULAR FONT, STYLE, SIZE, OR COLOR.

FOR PROVIDING A WEBSITE FEATURING EDUCATIONAL INFORMATION ON WOMEN'S HEALTH, NAMELY, ONLINE ARTICLES, NEWSLETTERS, BULLETINS, COLUMNS, PAMPHLETS, AND INTERACTIVE TOOLS AND DEVICES, NAMELY, QUIZZES, GUIDES, POLLS, AND ASSESSMENT QUESTIONNAIRES (U.S. CLS. 100, 101 AND 107).

FIRST USE 11-0-1999; IN COMMERCE 11-0-1999.
DEIRDRE ROBERTSON, EXAMINING ATTORNEY

SN 77-284,542. HAWKINS, SHAWN S., BEVERLY HILLS, CA. FILED 9-20-2007.



NO CLAIM IS MADE TO THE EXCLUSIVE RIGHT TO USE "INTERNET", APART FROM THE MARK AS SHOWN.

THE MARK CONSISTS OF THE PHRASE: "INTERNET SINGERS ACTORS ARTISTS GUILD" WRITTEN IN THE OUTER CIRCLE OF THE LOGO ATTACHED BY A COMPUTER 'MOUSE' CORD TO THE LETTER 'I' IN "INTERNET". EACH WORD IS SEPARATED BY A FIVE-POINT STAR. THE CENTER OF THE LOGO IS A LARGE FIVE-POINT STAR WITH THE COMPUTER 'MOUSE' IN THE MIDDLE OF THE LARGE STAR.

FOR ENTERTAINMENT SERVICES, NAMELY, NON-DOWNLOADABLE RINGTONES, PRE-RECORDED MUSIC, VIDEO AND GRAPHICS PRESENTED TO MOBILE COMMUNICATIONS DEVICES VIA A GLOBAL COMPUTER NETWORK AND WIRELESS NETWORKS (U.S. CLS. 100, 101 AND 107).

DAWN FELDMAN, EXAMINING ATTORNEY

SN 77-285,776. AWAD, JAMIE, DBA CLUB PAPI PRODUCTIONS, SAN FRANCISCO, CA. FILED 9-21-2007.

¿QUE PASA PAPI?

THE MARK CONSISTS OF STANDARD CHARACTERS WITHOUT CLAIM TO ANY PARTICULAR FONT, STYLE, SIZE, OR COLOR.

OWNER OF U.S. REG. NO. 2,535,869.
THE FOREIGN WORDING IN THE MARK TRANSLATES INTO ENGLISH AS "WHAT'S HAPPENING FATHER?".

FOR ENTERTAINMENT SERVICES, NAMELY, ORGANIZING FESTIVALS, FAIRS, AND DANCES FEATURING MUSIC AND OTHER LIVE ENTERTAINMENT, FOOD AND DRINK (U.S. CLS. 100, 101 AND 107).

SUNG IN, EXAMINING ATTORNEY

CLASS 41—(Continued).

SN 77-285,806. THE WASHINGTON AND LEE UNIVERSITY, LEXINGTON, VA. FILED 9-21-2007.

W & L LAW

THE MARK CONSISTS OF STANDARD CHARACTERS WITHOUT CLAIM TO ANY PARTICULAR FONT, STYLE, SIZE, OR COLOR.

OWNER OF U.S. REG. NOS. 2,020,926, 2,026,969 AND OTHERS.

NO CLAIM IS MADE TO THE EXCLUSIVE RIGHT TO USE "LAW", APART FROM THE MARK AS SHOWN.

FOR EDUCATIONAL SERVICES, NAMELY, PROVIDING COURSES OF INSTRUCTION IN THE FIELD OF LAW (U.S. CLS. 100, 101 AND 107).

FIRST USE 8-31-2001; IN COMMERCE 8-31-2001.
ROBIN MITTLER, EXAMINING ATTORNEY

SN 77-286,214. CITY OF KANSAS CITY, MISSOURI, KANSAS CITY, MO. FILED 9-21-2007.

KANSAS CITY MUSEUM OF HISTORY AND SCIENCE

THE MARK CONSISTS OF STANDARD CHARACTERS WITHOUT CLAIM TO ANY PARTICULAR FONT, STYLE, SIZE, OR COLOR.

NO CLAIM IS MADE TO THE EXCLUSIVE RIGHT TO USE "MUSEUM OF HISTORY AND SCIENCE", APART FROM THE MARK AS SHOWN.

SEC. 2(F).
FOR MUSEUMS (U.S. CLS. 100, 101 AND 107).
FIRST USE 0-0-1962; IN COMMERCE 0-0-1962.
PAUL E. FAHRENKOPF, EXAMINING ATTORNEY

SN 77-286,581. BRAMAN, MYRON K, PENROSE, NC. FILED 9-23-2007.

Blue Volcano Productions

THE MARK CONSISTS OF STANDARD CHARACTERS WITHOUT CLAIM TO ANY PARTICULAR FONT, STYLE, SIZE, OR COLOR.

NO CLAIM IS MADE TO THE EXCLUSIVE RIGHT TO USE "PRODUCTIONS", APART FROM THE MARK AS SHOWN.

FOR PRODUCTION AND DISTRIBUTION OF TELEVISION SHOWS AND MOVIES (U.S. CLS. 100, 101 AND 107).

FIRST USE 5-0-2006; IN COMMERCE 9-11-2007.
ANTHONY RINKER, EXAMINING ATTORNEY

CLASS 41—(Continued).

SN 77-286,642. THE PALIWODA GROUP, INC., NEW YORK, NY. FILED 9-23-2007.

Brainiac TV

THE MARK CONSISTS OF STANDARD CHARACTERS WITHOUT CLAIM TO ANY PARTICULAR FONT, STYLE, SIZE, OR COLOR.

NO CLAIM IS MADE TO THE EXCLUSIVE RIGHT TO USE "TV", APART FROM THE MARK AS SHOWN.

FOR ENTERTAINMENT SERVICES, NAMELY, PROVIDING A WEBSITE FEATURING PHOTOGRAPHIC, AUDIO, VIDEO AND PROSE PRESENTATIONS FEATURING ACADEMIC, VOCATIONAL AND PROFESSIONAL COURSES AND INSTRUCTION; EDUCATIONAL SERVICES, NAMELY, PROVIDING A WEBSITE FEATURING AUDIO CLIPS, VIDEO CLIPS, MUSICAL PERFORMANCES, MUSICAL VIDEOS, FILM CLIPS, PHOTOGRAPHS AND OTHER MULTIMEDIA MATERIALS, FOR USE BY EDUCATORS IN TEST PREPARATION, ACADEMIC PREPARATION, AND CAREER DEVELOPMENT; EDUCATIONAL SERVICES, NAMELY, CONDUCTING DISTANCE LEARNING INSTRUCTION AT THE SECONDARY, COLLEGE AND GRADUATE LEVELS; EDUCATIONAL SERVICES, NAMELY, CONDUCTING INFORMAL PROGRAMS IN THE FIELDS OF EDUCATIONAL PRODUCTS, DEVELOPMENTAL PRODUCTS, TEST PREPARATION, ACADEMIC PREPARATION, AND CAREER DEVELOPMENT, USING ON-LINE ACTIVITIES AND INTERACTIVE EXHIBITS, AND PRINTABLE MATERIALS DISTRIBUTED THEREWITH; ON-LINE JOURNALS, NAMELY, BLOGS FEATURING MULTIMEDIA MATERIALS AND INFORMATION IN THE FIELDS OF EDUCATIONAL PRODUCTS, DEVELOPMENTAL PRODUCTS, TEST PREPARATION, ACADEMIC PREPARATION, AND CAREER DEVELOPMENT (U.S. CLS. 100, 101 AND 107).

MELVIN AXILBUND, EXAMINING ATTORNEY

SN 77-286,849. SINGING TELEGRAMS BY JEFF INC., CANADENSIS, PA. FILED 9-24-2007.

THE BRAIN SHOW

THE MARK CONSISTS OF STANDARD CHARACTERS WITHOUT CLAIM TO ANY PARTICULAR FONT, STYLE, SIZE, OR COLOR.

NO CLAIM IS MADE TO THE EXCLUSIVE RIGHT TO USE "SHOW", APART FROM THE MARK AS SHOWN.

FOR ENTERTAINMENT SERVICES, NAMELY, PRODUCTION AND DISTRIBUTION OF A GAME SHOW; ENTERTAINMENT IN THE NATURE OF GAME SHOW (U.S. CLS. 100, 101 AND 107).

FIRST USE 6-27-2007; IN COMMERCE 6-27-2007.
AMY MCMENAMIN, EXAMINING ATTORNEY

CLASS 41—(Continued).

SN 77-286,906. HIGH ENERGY ENTERTAINMENT, LLC, PISCATAWAY, NJ. FILED 9-24-2007.

BRET AMAZZEING

THE MARK CONSISTS OF STANDARD CHARACTERS WITHOUT CLAIM TO ANY PARTICULAR FONT, STYLE, SIZE, OR COLOR.

THE NAME "BRET AMAZZEING" IDENTIFIES A LIVING INDIVIDUAL WHOSE CONSENT IS OF RECORD.

FOR ENTERTAINMENT IN THE NATURE OF MAGIC SHOWS, PUPPET SHOWS AND LIVE COMEDY SHOWS (U.S. CLS. 100, 101 AND 107).

FIRST USE 6-1-1999; IN COMMERCE 6-1-1999.
KEVIN DINALLO, EXAMINING ATTORNEY

CLASS 41—(Continued).

SN 77-287,308. RENT-A-CENTER WEST, INC., PLANO, TX. FILED 9-24-2007.

RAC WORRY FREE GUARANTEE

THE MARK CONSISTS OF STANDARD CHARACTERS WITHOUT CLAIM TO ANY PARTICULAR FONT, STYLE, SIZE, OR COLOR.

OWNER OF U.S. REG. NO. 3,161,654.

NO CLAIM IS MADE TO THE EXCLUSIVE RIGHT TO USE "GUARANTEE", APART FROM THE MARK AS SHOWN.

FOR RENTAL, LEASING, LEASE PURCHASING AND RENTAL TO OWN OF HOME ENTERTAINMENT PRODUCTS AND CONSUMER ELECTRONICS, NAMELY, TELEVISIONS, STEREOS, CAMERAS, CAMCORDERS, DVD PLAYERS AND VIDEO GAME CONSOLES (U.S. CLS. 100, 101 AND 107).

JILL C. ALT, EXAMINING ATTORNEY

SN 77-287,435. NATIONAL STUDENT NURSES' ASSOCIATION, INC., BROOKLYN, NY. FILED 9-24-2007.

NSNA LEADERSHIP U

THE MARK CONSISTS OF STANDARD CHARACTERS WITHOUT CLAIM TO ANY PARTICULAR FONT, STYLE, SIZE, OR COLOR.

FOR PROVIDING EDUCATIONAL MENTORING SERVICES AND PROGRAMS IN THE FIELD OF NURSING; PROVIDING RECOGNITION AND INCENTIVES BY THE WAY OF AWARDS TO DEMONSTRATE EXCELLENCE IN THE FIELD OF NURSING AND NURSING STUDIES (U.S. CLS. 100, 101 AND 107).

FIRST USE 0-0-2002; IN COMMERCE 0-0-2002.

LEIGH CAROLINE CASE, EXAMINING ATTORNEY

SN 77-287,004. CHEYENNE MOUNTAIN ENTERTAINMENT, INC., MESA, AZ. FILED 9-24-2007.

SOCIAL NETWORKS AT PLAY

THE MARK CONSISTS OF STANDARD CHARACTERS WITHOUT CLAIM TO ANY PARTICULAR FONT, STYLE, SIZE, OR COLOR.

NO CLAIM IS MADE TO THE EXCLUSIVE RIGHT TO USE "NETWORKS", APART FROM THE MARK AS SHOWN.

FOR ENTERTAINMENT SERVICES, NAMELY, PROVIDING AN ON-LINE COMPUTER GAME FOR OTHERS OVER GLOBAL AND LOCAL AREA COMPUTER NETWORKS; PROVIDING AND HOSTING ONLINE COMPUTER GAME COMPETITIONS FOR OTHERS OVER GLOBAL AND LOCAL AREA COMPUTER NETWORKS; PROVIDING NEWS AND INFORMATION ONLINE RELATING TO COMPUTER GAMES, VIDEO GAMES AND COMPUTER AND VIDEO GAME RELATED PRODUCTS (U.S. CLS. 100, 101 AND 107).

KATHERINE STOIDES, EXAMINING ATTORNEY

SN 77-287,629. SHANNON, WHITNEY, LOS ANGELES, CA. AND KELLY, MINDY, LOS ANGELES, CA. FILED 9-24-2007.

BALETE'

THE MARK CONSISTS OF STANDARD CHARACTERS WITHOUT CLAIM TO ANY PARTICULAR FONT, STYLE, SIZE, OR COLOR.

THE WORDING "BALETE" HAS NO MEANING IN A FOREIGN LANGUAGE.

FOR PROVIDING ASSISTANCE, PERSONAL TRAINING AND PHYSICAL FITNESS CONSULTATION TO INDIVIDUALS TO HELP THEM MAKE PHYSICAL FITNESS, STRENGTH, CONDITIONING, AND EXERCISE IMPROVEMENT IN THEIR DAILY LIVING (U.S. CLS. 100, 101 AND 107).

WARREN L. OLANDRIA, EXAMINING ATTORNEY

CLASS 41—(Continued).

SN 77-287,673. STELLAR PRODUCTIONS, AGOURA HILLS, CA. FILED 9-24-2007.

Movie Smackdown

THE MARK CONSISTS OF STANDARD CHARACTERS WITHOUT CLAIM TO ANY PARTICULAR FONT, STYLE, SIZE, OR COLOR.

NO CLAIM IS MADE TO THE EXCLUSIVE RIGHT TO USE "MOVIE", APART FROM THE MARK AS SHOWN.

FOR ENTERTAINMENT SERVICES, NAMELY, PROVIDING ON-LINE REVIEWS OF MOVIE COMPARISONS FROM CURRENT MOVIES TO ONES PREVIOUSLY RELEASED (U.S. CLS. 100, 101 AND 107).

FIRST USE 7-2-2004; IN COMMERCE 3-8-2006.

WENDY JUN, EXAMINING ATTORNEY

CLASS 41—(Continued).

SN 77-288,716. BAI HSING ENTERPRISES INC., SANTA ANA, CA. FILED 9-25-2007.

IVY INSTITUTE IRVINE

THE MARK CONSISTS OF STANDARD CHARACTERS WITHOUT CLAIM TO ANY PARTICULAR FONT, STYLE, SIZE, OR COLOR.

NO CLAIM IS MADE TO THE EXCLUSIVE RIGHT TO USE "INSTITUTE IRVINE", APART FROM THE MARK AS SHOWN.

FOR EDUCATIONAL SERVICES, NAMELY, CONDUCTING ADVANCED PLACEMENT CLASSES AND TUTORING IN THE FIELD OF MATH, ENGLISH, PHYSICS, CHEMISTRY AND CHINESE FOR COLLEGE ENTRANCE EXAMINATIONS WITH DISTRIBUTION OF COURSE MATERIAL IN CONNECTION THEREWITH (U.S. CLS. 100, 101 AND 107).

FIRST USE 3-0-1986; IN COMMERCE 3-0-1986.

TOBY BULLOFF, EXAMINING ATTORNEY

SN 77-287,974. MOORE, ROBERT C., MARIETTA, GA. FILED 9-25-2007.

Helping People to Know, Love and Follow Jesus Christ

THE MARK CONSISTS OF STANDARD CHARACTERS WITHOUT CLAIM TO ANY PARTICULAR FONT, STYLE, SIZE, OR COLOR.

FOR RELIGIOUS INSTRUCTION SERVICES (U.S. CLS. 100, 101 AND 107).

FIRST USE 9-2-2001; IN COMMERCE 9-2-2001.

ALLISON HOLTZ, EXAMINING ATTORNEY

SN 77-288,939. J JR., SHANNON JOSEPH, HONOLULU, HI. FILED 9-26-2007.

STRAIGHT-FORWARD GOLF

THE MARK CONSISTS OF STANDARD CHARACTERS WITHOUT CLAIM TO ANY PARTICULAR FONT, STYLE, SIZE, OR COLOR.

NO CLAIM IS MADE TO THE EXCLUSIVE RIGHT TO USE "GOLF", APART FROM THE MARK AS SHOWN.

FOR GOLF INSTRUCTION (U.S. CLS. 100, 101 AND 107).

MICHAEL TANNER, EXAMINING ATTORNEY

SN 77-288,181. CHICAGO HORTICULTURAL SOCIETY, GLENCOE, IL. FILED 9-25-2007.

REALM OF THE ROSE

THE MARK CONSISTS OF STANDARD CHARACTERS WITHOUT CLAIM TO ANY PARTICULAR FONT, STYLE, SIZE, OR COLOR.

FOR ORGANIZING AND CONDUCTING EXHIBITIONS IN THE FIELD OF BOTANY AND HORTICULTURE; EDUCATIONAL SERVICES, NAMELY, PROVIDING CLASSES IN THE FIELD OF BOTANY AND HORTICULTURE (U.S. CLS. 100, 101 AND 107).

SUZANNE BLANE, EXAMINING ATTORNEY

SN 77-289,086. THE BRONFMAN YOUTH FELLOWSHIPS IN ISRAEL, INC., DELMAR, NY. FILED 9-26-2007.

THE BRONFMAN YOUTH FELLOWSHIPS IN ISRAEL

THE MARK CONSISTS OF STANDARD CHARACTERS WITHOUT CLAIM TO ANY PARTICULAR FONT, STYLE, SIZE, OR COLOR.

NO CLAIM IS MADE TO THE EXCLUSIVE RIGHT TO USE YOUTH FELLOWSHIPS IN ISRAEL, APART FROM THE MARK AS SHOWN.

THE NAME(S), PORTRAIT(S), AND/OR SIGNATURE(S) SHOWN IN THE MARK IDENTIFIES BRONFMAN, WHOSE CONSENT(S) TO REGISTER IS MADE OF RECORD.

FOR EDUCATIONAL SERVICES, NAMELY, PROVIDING FELLOWSHIP PROGRAMS AND CONDUCTING PROGRAMS FOR THE STUDY OF JEWISH TEXTS, TRADITIONS, HISTORY AND CULTURE (U.S. CLS. 100, 101 AND 107).

FIRST USE 1-1-1993; IN COMMERCE 1-1-1993.

WANDA KAY PRICE, EXAMINING ATTORNEY

CLASS 41—(Continued).

SN 77-289,508. BAIRD, ROBERT P, CHICAGO, IL. FILED 9-26-2007.

Digital Emunction

THE MARK CONSISTS OF STANDARD CHARACTERS WITHOUT CLAIM TO ANY PARTICULAR FONT, STYLE, SIZE, OR COLOR.

NO CLAIM IS MADE TO THE EXCLUSIVE RIGHT TO USE "DIGITAL", APART FROM THE MARK AS SHOWN.

FOR BOOK AND REVIEW PUBLISHING; PUBLISHING OF BOOKS AND REVIEWS; PUBLISHING OF ELECTRONIC PUBLICATIONS; PUBLISHING OF WEB MAGAZINES (U.S. CLS. 100, 101 AND 107).

FIRST USE 11-1-2006; IN COMMERCE 11-1-2006.
PAM WILLIS, EXAMINING ATTORNEY

SN 77-289,643. REGAL ENTERTAINMENT GROUP, KNOXVILLE, TN. FILED 9-26-2007.

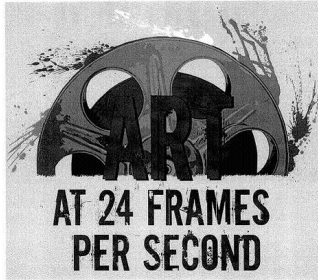

THE MARK CONSISTS OF MOTION PICTURE FILM REEL.

FOR ENTERTAINMENT SERVICES, NAMELY, EXHIBITION OF FILMED ENTERTAINMENT (U.S. CLS. 100, 101 AND 107).

FIRST USE 10-1-2006; IN COMMERCE 10-1-2006.
GINA HAYES, EXAMINING ATTORNEY

SN 77-289,646. REGAL ENTERTAINMENT GROUP, KNOXVILLE, TN. FILED 9-26-2007.

ART AT 24 FRAMES PER SECOND

THE MARK CONSISTS OF STANDARD CHARACTERS WITHOUT CLAIM TO ANY PARTICULAR FONT, STYLE, SIZE, OR COLOR.

FOR ENTERTAINMENT SERVICES, NAMELY, EXHIBITION OF FILMED ENTERTAINMENT (U.S. CLS. 100, 101 AND 107).

FIRST USE 10-1-2006; IN COMMERCE 10-1-2006.
GINA HAYES, EXAMINING ATTORNEY

CLASS 41—(Continued).

SN 77-289,823. GIRLS ROCK RIDE AND RULE LLC, CARLSBAD, CA. FILED 9-26-2007.

GIRLS ROCK RIDE AND RULE

THE MARK CONSISTS OF STANDARD CHARACTERS WITHOUT CLAIM TO ANY PARTICULAR FONT, STYLE, SIZE, OR COLOR.

FOR ENTERTAINMENT AND ENTERTAINMENT SERVICES, NAMELY, ORGANIZING AND CONDUCTING MUSICAL FESTIVALS, MUSICAL COMPETITIONS AND BAND CONCERTS; ORGANIZING AND CONDUCTING EXHIBITIONS, CONTESTS AND COMPETITIONS IN THE NATURE OF MOTOR SPORTS, ACTION SPORTS AND EXTREME SPORTS; ORGANIZING AND CONDUCTING EXHIBITIONS, CONTESTS AND COMPETITIONS IN THE NATURE OF DANCE; ORGANIZING AND CONDUCTING EXHIBITIONS, CONTESTS AND COMPETITIONS IN THE NATURE OF ART AND CREATION OF ART; ORGANIZING AND CONDUCTING FASHION SHOWS; EXHIBITION OF STILL PHOTOGRAPHS, FILM, VIDEOTAPES AND OTHER MULTIMEDIA MATERIALS; PRODUCTION AND DISTRIBUTION OF TELEVISION PROGRAMS, CABLE TELEVISION PROGRAMS, MUSICAL AND AUDIO PROGRAMS; AND MULTIMEDIA ENTERTAINMENT SERVICES IN THE NATURE OF RECORDING, PRODUCTION AND POST-PRODUCTION SERVICES IN THE FIELDS OF MUSIC, VIDEO, AND FILMS" (U.S. CLS. 100, 101 AND 107).

NAKIA HENRY, EXAMINING ATTORNEY

SN 77-290,070. OH, BESSY, LAS VEGAS, NV. FILED 9-27-2007.

The Big A

THE MARK CONSISTS OF STANDARD CHARACTERS WITHOUT CLAIM TO ANY PARTICULAR FONT, STYLE, SIZE, OR COLOR.

FOR PUBLICATION OF MAGAZINES (U.S. CLS. 100, 101 AND 107).

BRENDAN REGAN, EXAMINING ATTORNEY

SN 77-290,076. BANYAN PUBLISHING COMPANY, INC., HOUSTON, TX. FILED 9-27-2007.

All Roads Lead To Branson

THE MARK CONSISTS OF STANDARD CHARACTERS WITHOUT CLAIM TO ANY PARTICULAR FONT, STYLE, SIZE, OR COLOR.

FOR MAGAZINE PUBLISHING (U.S. CLS. 100, 101 AND 107).

SARA THOMAS, EXAMINING ATTORNEY

CLASS 41—(Continued).

SN 77-290,224. AMERICAN COLLEGE OF ENDOCRINOLOGY, INC., JACKSONVILLE, FL. FILED 9-27-2007.

POWER OF PREVENTION

THE MARK CONSISTS OF STANDARD CHARACTERS WITHOUT CLAIM TO ANY PARTICULAR FONT, STYLE, SIZE, OR COLOR.

FOR EDUCATION SERVICES, NAMELY, PROVIDING LIVE AND ON-LINE SEMINARS AND COURSES IN THE FIELD OF HEALTHY AND ACTIVE LIFESTYLES (U.S. CLS. 100, 101 AND 107).

FIRST USE 8-30-2007; IN COMMERCE 8-30-2007.
SUNG IN, EXAMINING ATTORNEY

CLASS 41—(Continued).

SN 77-290,837. OPTIMUS ADVERTISING INC, MIAMI LAKES, FL. FILED 9-27-2007.



NO CLAIM IS MADE TO THE EXCLUSIVE RIGHT TO USE "COLLEGE AID AWARD", APART FROM THE MARK AS SHOWN.

THE MARK CONSISTS OF A SHAPE FEATURING A GRADUATE OVER AN OVAL SHAPE AND THE STYLIZED WORDS "COLLEGE AID AWARD" NEXT TO IT.

FOR INFORMATION ABOUT EDUCATION (U.S. CLS. 100, 101 AND 107).
FIRST USE 4-19-2005; IN COMMERCE 4-19-2005.
CAROLYN GRAY, EXAMINING ATTORNEY

SN 77-290,482. DAVID ALLEN & CO., OJAI, CA. FILED 9-27-2007.

THE SHORTEST DISTANCE BETWEEN YOU & SUCCESS

THE MARK CONSISTS OF STANDARD CHARACTERS WITHOUT CLAIM TO ANY PARTICULAR FONT, STYLE, SIZE, OR COLOR.

FOR EDUCATIONAL AND TRAINING SERVICES, NAMELY, CONDUCTING TRAINING CLASSES AND COURSES FEATURING METHODS FOR IMPROVING INDIVIDUAL AND ORGANIZATIONAL PRODUCTIVITY, COMMUNICATIONS, WRITING, MARKETING SKILLS AND TIME MANAGEMENT SKILLS; CONDUCTING AND ORGANIZING SEMINARS AND WORKSHOPS TO HELP OTHERS DEVELOP MANAGEMENT AND BUSINESS SKILLS, EFFICIENT WORK HABITS, PLANNING AND ORGANIZATIONAL TECHNIQUES, AND PERSONAL PRODUCTIVITY AND GROWTH AND DISTRIBUTING COURSE MATERIALS IN CONNECTION THEREWITH; AND PROVIDING ONLINE EDUCATIONAL PROGRAMS, COACHING AND TRAINING SERVICES TO SUBSCRIBING MEMBERS IN THE FIELDS OF INDIVIDUAL AND BUSINESS PRODUCTIVITY, SELF IMPROVEMENT AND TIME MANAGEMENT (U.S. CLS. 100, 101 AND 107).

FIRST USE 5-15-2006; IN COMMERCE 5-15-2006.
KATHRYN COWARD, EXAMINING ATTORNEY

SN 77-290,891. DAVID ALLEN & CO., OJAI, CA. FILED 9-27-2007.

WINNING AT THE GAME OF WORK & BUSINESS OF LIFE

THE MARK CONSISTS OF STANDARD CHARACTERS WITHOUT CLAIM TO ANY PARTICULAR FONT, STYLE, SIZE, OR COLOR.

FOR EDUCATIONAL AND TRAINING SERVICES, NAMELY, CONDUCTING TRAINING CLASSES AND COURSES FEATURING METHODS FOR IMPROVING INDIVIDUAL AND ORGANIZATIONAL PRODUCTIVITY, COMMUNICATIONS, WRITING, MARKETING SKILLS AND TIME MANAGEMENT SKILLS; CONDUCTING AND ORGANIZING SEMINARS AND WORKSHOPS TO HELP OTHERS DEVELOP MANAGEMENT AND BUSINESS SKILLS, EFFICIENT WORK HABITS, PLANNING AND ORGANIZATIONAL TECHNIQUES, AND PERSONAL PRODUCTIVITY AND GROWTH AND DISTRIBUTING COURSE MATERIALS IN CONNECTION THEREWITH; AND PROVIDING ONLINE EDUCATIONAL PROGRAMS, COACHING AND TRAINING SERVICES TO SUBSCRIBING MEMBERS IN THE FIELDS OF INDIVIDUAL AND BUSINESS PRODUCTIVITY, SELF IMPROVEMENT AND TIME MANAGEMENT (U.S. CLS. 100, 101 AND 107).

FIRST USE 1-15-2004; IN COMMERCE 1-15-2004.
KATHRYN COWARD, EXAMINING ATTORNEY

CLASS 41—(Continued).

SN 77-291,103. THE WASHINGTON UNIVERSITY, DBA WSHU 2130, ST. LOUIS, MO. FILED 9-28-2007.

PEMRAP

THE MARK CONSISTS OF STANDARD CHARACTERS WITHOUT CLAIM TO ANY PARTICULAR FONT, STYLE, SIZE, OR COLOR.
FOR EDUCATIONAL SERVICES, NAMELY, PROVIDING INTERNSHIPS AND APPRENTICESHIPS IN THE FIELD OF MEDICINE (U.S. CLS. 100, 101 AND 107).
FIRST USE 0-0-2002; IN COMMERCE 0-0-2002.
AMY GEARIN, EXAMINING ATTORNEY

SN 77-291,148. MCELLIGOTT, THOMAS J., CHICAGO, IL. FILED 9-28-2007.

OUT & Authentic

THE MARK CONSISTS OF STANDARD CHARACTERS WITHOUT CLAIM TO ANY PARTICULAR FONT, STYLE, SIZE, OR COLOR.
FOR LIFE COACHING SERVICES IN THE FIELD OF SPIRITUAL DIRECTION AND AWARENESS (U.S. CLS. 100, 101 AND 107).
FIRST USE 9-19-2007; IN COMMERCE 9-19-2007.
DOMINICK J. SALEMI, EXAMINING ATTORNEY

SN 77-291,208. BARBER PRODUCTIONS, INC., ORANGE, CT. FILED 9-28-2007.

THE REAL LIFE SURVIVAL GUIDE

THE MARK CONSISTS OF STANDARD CHARACTERS WITHOUT CLAIM TO ANY PARTICULAR FONT, STYLE, SIZE, OR COLOR.
NO CLAIM IS MADE TO THE EXCLUSIVE RIGHT TO USE "GUIDE", APART FROM THE MARK AS SHOWN.
FOR ON-LINE JOURNALS, NAMELY, PROVIDING A WEBSITE FEATURING BLOGS AND INFORMATION OF INTEREST TO FAMILIES AND FAMILY MEMBERS (U.S. CLS. 100, 101 AND 107).
FIRST USE 2-14-2006; IN COMMERCE 2-14-2006.
MATTHEW MCDOWELL, EXAMINING ATTORNEY

CLASS 41—(Continued).

SN 77-291,291. MCMAHON, MARGOT N., ST. LOUIS, MO. FILED 9-28-2007.

SPORTRAIN

THE MARK CONSISTS OF STANDARD CHARACTERS WITHOUT CLAIM TO ANY PARTICULAR FONT, STYLE, SIZE, OR COLOR.
FOR PERSONAL TRAINING SERVICES, NAMELY, STRENGTH AND CONDITIONING TRAINING; TRAINING SERVICES IN THE FIELD OF SPORTS (U.S. CLS. 100, 101 AND 107).
FIRST USE 6-22-2007; IN COMMERCE 9-27-2007.
ADA HAN, EXAMINING ATTORNEY

SN 77-291,298. SILENT VICTORY PRODUCTIONS, INC., SALISBURY, NC. FILED 9-28-2007.

SILENT VICTORY

THE MARK CONSISTS OF STANDARD CHARACTERS WITHOUT CLAIM TO ANY PARTICULAR FONT, STYLE, SIZE, OR COLOR.
FOR MOTION PICTURE FILM PRODUCTION (U.S. CLS. 100, 101 AND 107).
MIDGE BUTLER, EXAMINING ATTORNEY

SN 77-291,304. REBEL ROUSER ENTERTAINMENT, HOLLYWOOD, CA. FILED 9-28-2007.

REBEL ROUSER ENTERTAINMENT

THE MARK CONSISTS OF STANDARD CHARACTERS WITHOUT CLAIM TO ANY PARTICULAR FONT, STYLE, SIZE, OR COLOR.
NO CLAIM IS MADE TO THE EXCLUSIVE RIGHT TO USE "ENTERTAINMENT", APART FROM THE MARK AS SHOWN.
FOR PRODUCTION OF TELEVISION SHOWS AND MOVIES (U.S. CLS. 100, 101 AND 107).
JILL PRATER, EXAMINING ATTORNEY

CLASS 41—(Continued).

SN 77-291,374. CHENIERE PRESS INC., WILMINGTON, DE. FILED 9-28-2007.

Cheniere Press

THE MARK CONSISTS OF STANDARD CHARACTERS WITHOUT CLAIM TO ANY PARTICULAR FONT, STYLE, SIZE, OR COLOR.

NO CLAIM IS MADE TO THE EXCLUSIVE RIGHT TO USE "PRESS", APART FROM THE MARK AS SHOWN.

FOR BOOK AND REVIEW PUBLISHING; ELECTRONIC PUBLISHING SERVICES, NAMELY, PUBLICATION OF TEXT AND GRAPHIC WORKS OF OTHERS ONLINE FEATURING SCIENTIFIC WORKS; MULTIMEDIA PUBLISHING OF BOOKS, MAGAZINES, JOURNALS, SOFTWARE, GAMES, MUSIC, AND ELECTRONIC PUBLICATIONS; PUBLISHING OF BOOKS AND REVIEWS; PUBLISHING OF ELECTRONIC PUBLICATIONS (U.S. CLS. 100, 101 AND 107).

MARILYN IZZI, EXAMINING ATTORNEY

SN 77-291,645. SEMPEREX, LLC, HOUSTON, TX. FILED 9-28-2007.

PRESSING TRUTH

THE MARK CONSISTS OF STANDARD CHARACTERS WITHOUT CLAIM TO ANY PARTICULAR FONT, STYLE, SIZE, OR COLOR.

FOR PROVIDING ONLINE ENTERTAINMENT AND EDUCATIONAL INFORMATION IN THE FIELD OF NEWS, SPORTS, CELEBRITIES, POLITICS, CURRENT EVENT NEWS, SCIENCE, TECHNOLOGY, ACADEMIC AND TOPICS OF GENERAL INTEREST; ENTERTAINMENT SERVICES IN THE NATURE OF AN INTERACTIVE WEBSITE IN THE FIELD OF NEWS, SCIENCE, TECHNOLOGY, ACADEMIC AND ENCYCLOPEDIA INFORMATION; ONLINE JOURNALS, NAMELY, BLOGS FEATURING OPINIONS, ANALYSIS AND EVIDENCE RELATING TO BLOG TOPICS (U.S. CLS. 100, 101 AND 107).

ALLISON SCHRODY, EXAMINING ATTORNEY

CLASS 41—(Continued).

SN 77-291,891. SCOTTSDALE CENTER FOR DENTISTRY, LLC, SCOTTSDALE, AZ. FILED 9-28-2007.



NO CLAIM IS MADE TO THE EXCLUSIVE RIGHT TO USE "THE SCOTTSDALE CENTER FOR DENTISTRY", APART FROM THE MARK AS SHOWN.

THE COLOR(S) BROWN IS/ARE CLAIMED AS A FEATURE OF THE MARK.

THE MARK CONSISTS OF THE WORDING THE SCOTTSDALE CENTER FOR DENTISTRY IN STYLIZED LETTERING WITH FOR DENTISTRY UNDERNEATH THE SCOTTSDALE CENTER. THIS WORDING APPEARS NEXT TO A "C" SHAPED DESIGN WITH ADDITIONAL CURVED AND STRAIGHT LINES COMING OUT OF IT. THE ENTIRE MARK IS BROWN IN COLOR.

FOR EDUCATIONAL SERVICES, NAMELY, DEVELOPING, ARRANGING, AND CONDUCTING EDUCATIONAL CONFERENCES AND PROGRAMS AND PROVIDING COURSES OF INSTRUCTION IN THE FIELD OF DENTISTRY (U.S. CLS. 100, 101 AND 107).

FIRST USE 7-18-2007; IN COMMERCE 7-18-2007.

RONALD MCMORROW, EXAMINING ATTORNEY

SN 77-291,917. ECT NEWS NETWORK, INC., ENCINO, CA. FILED 9-28-2007.

E-COMMERCE TIMES

THE MARK CONSISTS OF STANDARD CHARACTERS WITHOUT CLAIM TO ANY PARTICULAR FONT, STYLE, SIZE, OR COLOR.

NO CLAIM IS MADE TO THE EXCLUSIVE RIGHT TO USE "E-COMMERCE", APART FROM THE MARK AS SHOWN.

FOR PROVIDING ONLINE PUBLICATIONS, NAMELY, ONLINE NEWSPAPERS AND ONLINE MAGAZINES IN THE FIELD OF ELECTRONIC COMMERCE AND ONLINE COMPUTER RELATED BUSINESS (U.S. CLS. 100, 101 AND 107).

FIRST USE 8-15-1998; IN COMMERCE 8-15-1998.

ELLEN BURNS, EXAMINING ATTORNEY

CLASS 41—(Continued).

SN 77-291,932. TOURS BAYOU, LLC, NEW ORLEANS, LA. FILED 9-28-2007.

Tours BaYou

THE MARK CONSISTS OF STANDARD CHARACTERS WITHOUT CLAIM TO ANY PARTICULAR FONT, STYLE, SIZE, OR COLOR.

NO CLAIM IS MADE TO THE EXCLUSIVE RIGHT TO USE "TOURS", APART FROM THE MARK AS SHOWN.

FOR PROVIDING INFORMATION REGARDING THE HISTORICAL, ENTERTAINMENT AND CULTURAL ASPECTS OF CITIES AND FAMOUS AND HISTORICAL SITES; PROVIDING SELF-GUIDED TOURS OF CITIES AND FAMOUS AND HISTORICAL SIGHTS (U.S. CLS. 100, 101 AND 107).

FIRST USE 8-16-2007; IN COMMERCE 8-16-2007.
BENJAMIN ALLEN, EXAMINING ATTORNEY



SN 77-291,949. ALEMBIX ENGINEERING, LLC, LAFAYETTE, CA. FILED 9-28-2007.

Four and out!

THE MARK CONSISTS OF STANDARD CHARACTERS WITHOUT CLAIM TO ANY PARTICULAR FONT, STYLE, SIZE, OR COLOR.

FOR EDUCATIONAL CONSULTING SERVICES, NAMELY, UNDERGRADUATE DEGREE PLANNING THAT ASSISTS THE STUDENT AND/OR COUNSELOR IN DETERMINING THE OPTIMAL COURSE/CURRICULUM SCHEDULE FOR GRADUATING WITH A DESIRED DEGREE IN FOUR YEARS OR LESS (U.S. CLS. 100, 101 AND 107).

JAMES A. RAUEN, EXAMINING ATTORNEY



SN 77-292,025. CYPROOF LLC, PORTLAND, OR. FILED 9-28-2007.

ERRNET

THE MARK CONSISTS OF STANDARD CHARACTERS WITHOUT CLAIM TO ANY PARTICULAR FONT, STYLE, SIZE, OR COLOR.

FOR COMPUTERIZED ON-LINE PROOF-READING SERVICES (U.S. CLS. 100, 101 AND 107).

FIRST USE 6-19-2007; IN COMMERCE 6-19-2007.
G. MAYERSCHOFF, EXAMINING ATTORNEY

CLASS 41—(Continued).

SN 77-292,082. JONES, LAURIE BETH, PHOENIX, AZ. FILED 9-28-2007.

SPIRITRENEUR

THE MARK CONSISTS OF STANDARD CHARACTERS WITHOUT CLAIM TO ANY PARTICULAR FONT, STYLE, SIZE, OR COLOR.

FOR EDUCATION SERVICES NAMELY, CONDUCTING WORKSHOPS AND COURSES OF INSTRUCTION IN THE FIELD OF BUSINESS AND SPIRITUALITY AND DISTRIBUTING COURSE MATERIALS THEREWITH (U.S. CLS. 100, 101 AND 107).

JOHN WILKE, EXAMINING ATTORNEY



SN 77-292,088. HARKINS REEL DEALS, LLC, SCOTTSDALE, AZ. FILED 9-28-2007.

MOVIE MONKEY

THE MARK CONSISTS OF STANDARD CHARACTERS WITHOUT CLAIM TO ANY PARTICULAR FONT, STYLE, SIZE, OR COLOR.

NO CLAIM IS MADE TO THE EXCLUSIVE RIGHT TO USE "MOVIE", APART FROM THE MARK AS SHOWN.

FOR MOTION PICTURE THEATERS (U.S. CLS. 100, 101 AND 107).

EVELYN BRADLEY, EXAMINING ATTORNEY

CLASS 41—(Continued).

SN 77-292,195. KIMURA, KRIS H., WHITTIER, CA. FILED 9-28-2007.



THE MARK CONSISTS OF A STAMP-LIKE DESIGN IN WHICH THE JAPANESE KANJI CHARACTER "RIKI" APPEARS IN A CALLIGRAPHY STYLE AND IS ENCASED IN A RECTANGLE-SHAPED BOX. THE CHARACTER IN THE DESIGN ALSO CAN BE TRANSLITERATED IN JAPANESE AS "RYOKU" OR "CHIKARA".

THE ENGLISH TRANSLATION OF THE CHARACTER IS "STRENGTH" OR "POWER".

THE NON-LATIN CHARACTER(S) IN THE MARK TRANSLITERATE INTO "RIKI," "RYOKU" OR "CHIKARA" IN JAPANESE, AND THIS MEANS STRENGTH OR POWER IN ENGLISH.

FOR SPORTS PERFORMANCE ENHANCEMENT TRAINING SERVICES, NAMELY, PROVIDING FITNESS TRAINING, INSTRUCTION AND CONSULTATION TO ATHLETES TO ENHANCE THEIR SPORTS AND ATHLETIC PERFORMANCES, AND PROVIDING FACILITIES FOR CONDUCTING SUCH TRAINING, INSTRUCTION AND CONSULTATION (U.S. CLS. 100, 101 AND 107).

LINDA E. BLOHM, EXAMINING ATTORNEY

SN 77-292,303. QWIZZY'S WORLD, L.L.C., CUMMING, GA. FILED 9-29-2007.

Where Studying Comes Easy

THE MARK CONSISTS OF STANDARD CHARACTERS WITHOUT CLAIM TO ANY PARTICULAR FONT, STYLE, SIZE, OR COLOR.

FOR PROVIDING AN INTERACTIVE WEBSITE ALLOWING USERS TO CREATE, TAKE AND SCORE QUIZZES (U.S. CLS. 100, 101 AND 107).

ESTHER A. BORSUK, EXAMINING ATTORNEY

CLASS 41—(Continued).

SN 77-292,305. QWIZZY'S WORLD, L.L.C., CUMMING, GA. FILED 9-29-2007.



THE MARK CONSISTS OF A STYLIZED DRAWING OF A WIZARD.

FOR PROVIDING AN INTERACTIVE WEBSITE ALLOWING USERS TO CREATE, TAKE AND SCORE QUIZZES (U.S. CLS. 100, 101 AND 107).

ESTHER A. BORSUK, EXAMINING ATTORNEY

SN 77-292,310. MARCELA DI SANTO, MIAMI BEACH, FL. FILED 9-29-2007.

DOLCE

THE MARK CONSISTS OF STANDARD CHARACTERS WITHOUT CLAIM TO ANY PARTICULAR FONT, STYLE, SIZE, OR COLOR.

FOR ENTERTAINMENT SERVICES, NAMELY, CONDUCTING PARTIES (U.S. CLS. 100, 101 AND 107).

FIRST USE 3-15-2004; IN COMMERCE 3-15-2004.

JOHN WILKE, EXAMINING ATTORNEY

SN 77-292,380. CLIFTON, A. MICHELLE, FALLS CHURCH, VA. FILED 9-30-2007.

Ms. Organization

THE MARK CONSISTS OF STANDARD CHARACTERS WITHOUT CLAIM TO ANY PARTICULAR FONT, STYLE, SIZE, OR COLOR.

FOR PRODUCTION AND DISTRIBUTION OF TELEVISION SHOWS AND MOVIES; TELEVISION SHOW PRODUCTION (U.S. CLS. 100, 101 AND 107).

KAREN K. BUSH, EXAMINING ATTORNEY

CLASS 41—(Continued).

SN 77-292,388. SO, ANDY, NEW YORK, NY. FILED 9-30-2007.

BALL OR DIE

THE MARK CONSISTS OF STANDARD CHARACTERS WITHOUT CLAIM TO ANY PARTICULAR FONT, STYLE, SIZE, OR COLOR.

FOR MULTIMEDIA PUBLISHING OF BOOKS, MAGAZINES, JOURNALS, SOFTWARE, GAMES, MUSIC, AND ELECTRONIC PUBLICATIONS; PUBLICATION OF BOOKS, MAGAZINES, ALMANACS AND JOURNALS; PUBLICATION OF BOOKS, OF MAGAZINES, OF JOURNALS, OF NEWSPAPERS, OF PERIODICALS, OF CATALOGS, OF BROCHURES; PUBLICATION OF ELECTRONIC MAGAZINES; PUBLICATION OF MAGAZINES; PUBLICATION OF TEXTS, BOOKS, MAGAZINES AND OTHER PRINTED MATTER; PUBLICATION OF BOOKS, OF MAGAZINE, OF JOURNALS, OF NEWSPAPERS, OF PERIODICALS, OF CATALOGS, OF BROCHURES; PUBLISHING OF BOOKS, MAGAZINES; PUBLISHING OF WEB MAGAZINES; RENTAL OF MAGAZINES; ELECTRONIC PUBLISHING SERVICES, NAMELY, PUBLICATION OF TEXT AND GRAPHIC WORKS OF OTHERS ON WEB SITES, CDS, DVDS AND OTHER DIGITAL MEDIA CURRENTLY IN EXISTENCE OR DEVELOPED IN THE FUTURE FEATURING BASKETBALL RELATED CONCEPTS AND MATERIALS; PRODUCTION OF DVDS, VIDEOTAPES AND TELEVISION PROGRAMS FEATURING BASKETBALL RELATED CONCEPTS AND MATERIALS; PRODUCTION OF VIDEO AND CREATION OF VISUAL EFFECTS FOR OTHERS FOR USE IN DVDS, TELEVISION PROGRAMS AND ON WEB SITES (U.S. CLS. 100, 101 AND 107).

RAUL CORDOVA, EXAMINING ATTORNEY

CLASS 41—(Continued).

SN 77-292,414. DALLEMAND, KERVENS L., ST. ALBANS, NY, AND PERRY, GREGORY S., ROSEDALE, NY. FILED 9-30-2007.

Amillyan Soundz Music Group

THE MARK CONSISTS OF STANDARD CHARACTERS WITHOUT CLAIM TO ANY PARTICULAR FONT, STYLE, SIZE, OR COLOR.

NO CLAIM IS MADE TO THE EXCLUSIVE RIGHT TO USE "MUSIC GROUP", APART FROM THE MARK AS SHOWN.

FOR ENTERTAINMENT SERVICES, NAMELY, MUSIC PRODUCTION, MUSIC PUBLISHING (U.S. CLS. 100, 101 AND 107).

FIRST USE 1-1-2005; IN COMMERCE 7-1-2007.

BRENDAN REGAN, EXAMINING ATTORNEY

SN 77-292,500. SANGREAL MUSIC, INC., NORTH HOLLYWOOD, CA. FILED 10-1-2007.

DIVINE HERESY

THE MARK CONSISTS OF STANDARD CHARACTERS WITHOUT CLAIM TO ANY PARTICULAR FONT, STYLE, SIZE, OR COLOR.

FOR ENTERTAINMENT IN THE NATURE OF LIVE PERFORMANCES BY A MUSICAL BAND (U.S. CLS. 100, 101 AND 107).

MICHAEL ENGEL, EXAMINING ATTORNEY

SN 77-292,411. BEASLEY, PHILLIP, E, MAPLE HEIGHTS, OH. FILED 9-30-2007.

PHILLEY PHRESH

THE MARK CONSISTS OF STANDARD CHARACTERS WITHOUT CLAIM TO ANY PARTICULAR FONT, STYLE, SIZE, OR COLOR.

FOR ENTERTAINMENT IN THE NATURE OF VISUAL AND AUDIO PERFORMANCES, AND MUSICAL, VARIETY, NEWS AND COMEDY SHOWS (U.S. CLS. 100, 101 AND 107).

BRENDAN REGAN, EXAMINING ATTORNEY

SN 77-292,556. ELIZABETH A. REHFELD, DBA BOUND 4 COLLEGE, NOVATO, CA. FILED 10-1-2007.

BOUND4COLLEGE

THE MARK CONSISTS OF STANDARD CHARACTERS WITHOUT CLAIM TO ANY PARTICULAR FONT, STYLE, SIZE, OR COLOR.

FOR COLLEGE COUNSELING SERVICES, NAMELY, ASSISTING STUDENTS WHO STRUGGLE ACADEMICALLY DUE TO LEARNING DISABILITIES IN FINDING COLLEGES AND UNIVERSITIES AND COMPLETING THE APPLICATION PROCESS AND ASSISTING IN APPLYING FOR SCHOLARSHIPS AND FINANCIAL AID (U.S. CLS. 100, 101 AND 107).

FIRST USE 5-31-2005; IN COMMERCE 7-31-2005.

DOMINIC FATHY, EXAMINING ATTORNEY

CLASS 41—(Continued).

SN 77-292,639. TOTAL SYSTEM SERVICES, INC., COLUMBUS, GA. FILED 10-1-2007.

TSTutor

THE MARK CONSISTS OF STANDARD CHARACTERS WITHOUT CLAIM TO ANY PARTICULAR FONT, STYLE, SIZE, OR COLOR.

OWNER OF U.S. REG. NOS. 1,834,023 AND 2,329,547. FOR EDUCATIONAL SERVICES, NAMELY, ON-LINE INTERACTIVE TRAINING PROGRAM IN THE FIELDS OF FINANCIAL DATA, BANKCARD, DEBIT CARD AND CREDIT CARD PROCESSING, CONSUMER FRAUD AND CREDIT CARD SECURITY, AND THE DISTRIBUTION OF COURSE MATERIALS IN CONNECTION THEREWITH (U.S. CLS. 100, 101 AND 107).

FIRST USE 1-1-1998; IN COMMERCE 10-1-2001. SANI KHOURI, EXAMINING ATTORNEY

CLASS 41—(Continued).

SN 77-292,674. THE BOARD OF REDENTS OF THE UNIVERSITY OF WISCONSIN SYSTEM, MADISON, WI. FILED 10-1-2007.

BE OUT IN FRONT

THE MARK CONSISTS OF STANDARD CHARACTERS WITHOUT CLAIM TO ANY PARTICULAR FONT, STYLE, SIZE, OR COLOR.

FOR EDUCATING AT UNIVERSITY OR COLLEGES; PROVIDING COURSES OF INSTRUCTION AT THE COLLEGE, GRADUATE AND POST-GRADUATE LEVEL; EDUCATION SERVICES IN THE NATURE OF COURSES AT THE UNIVERSITY LEVEL; BUSINESS TRAINING; EDUCATIONAL SERVICES IN THE NATURE OF BUSINESS SCHOOLS (U.S. CLS. 100, 101 AND 107).

FIRST USE 7-10-2007; IN COMMERCE 8-15-2007. MIDGE BUTLER, EXAMINING ATTORNEY

SN 77-292,654. LOTOWORLD, INC., MINEOLA, NY. FILED 10-1-2007.

LotoWorld

THE MARK CONSISTS OF STANDARD CHARACTERS WITHOUT CLAIM TO ANY PARTICULAR FONT, STYLE, SIZE, OR COLOR.

NO CLAIM IS MADE TO THE EXCLUSIVE RIGHT TO USE "LOTO", APART FROM THE MARK AS SHOWN.

FOR LOTTERY AND GAMING SERVICES FOR OTHERS (U.S. CLS. 100, 101 AND 107).

FIRST USE 3-16-2005; IN COMMERCE 3-16-2005. MELISSA VALLILLO, EXAMINING ATTORNEY

SN 77-292,688. INTEGRITY NEWS MEDIA, INC., LA JOLLA, CA. FILED 10-1-2007.

Fashion Anarchy

THE MARK CONSISTS OF STANDARD CHARACTERS WITHOUT CLAIM TO ANY PARTICULAR FONT, STYLE, SIZE, OR COLOR.

NO CLAIM IS MADE TO THE EXCLUSIVE RIGHT TO USE "FASHION", APART FROM THE MARK AS SHOWN.

FOR NEWS REPORTING SERVICES (U.S. CLS. 100, 101 AND 107).

FIRST USE 10-1-2007; IN COMMERCE 10-1-2007. REBECCA GILBERT, EXAMINING ATTORNEY

SN 77-292,670. GREATER PHILADELPHIA TOURISM MARKETING CORPORATION, PHILADELPHIA, PA. FILED 10-1-2007.

ILLADATES

THE MARK CONSISTS OF STANDARD CHARACTERS WITHOUT CLAIM TO ANY PARTICULAR FONT, STYLE, SIZE, OR COLOR.

FOR PROVIDING AN ONLINE PUBLICATION IN THE NATURE OF A GUIDE IN THE FIELD OF ENTERTAINMENT IN THE PHILADELPHIA REGION (U.S. CLS. 100, 101 AND 107).

CHRISTINA SOBRAL, EXAMINING ATTORNEY

SN 77-292,808. METROPOLITAN DETROIT LANDSCAPE ASSOCIATION, DBA MICHIGAN GREEN INDUSTRY ASSOCIATION, BINGHAM FARMS, MI. FILED 10-1-2007.

Test-N-Tune

THE MARK CONSISTS OF STANDARD CHARACTERS WITHOUT CLAIM TO ANY PARTICULAR FONT, STYLE, SIZE, OR COLOR.

FOR EDUCATION SERVICES, NAMELY, PROVIDING SEMINARS IN THE FIELD OF SNOW PLOWING AND SNOW PLOWING EQUIPMENT (U.S. CLS. 100, 101 AND 107).

ALICE BENMAMAN, EXAMINING ATTORNEY

CLASS 41—(Continued).

SN 77-292,855. MIL MUSIC, LLC, PITTSBURGH, PA. FILED 10-1-2007.

28 North

THE MARK CONSISTS OF STANDARD CHARACTERS WITHOUT CLAIM TO ANY PARTICULAR FONT, STYLE, SIZE, OR COLOR.

FOR ENTERTAINMENT SERVICES, NAMELY, LIVE PERFORMANCES BY A MUSICAL GROUP (U.S. CLS. 100, 101 AND 107).

FIRST USE 8-5-2006; IN COMMERCE 8-5-2006.
RONALD MCMORROW, EXAMINING ATTORNEY

SN 77-292,858. BLUE HEART TOURS, INC., DBA CLASSICAL MOVEMENTS, ALEXANDRIA, VA. FILED 10-1-2007.

IHLOMBE

THE MARK CONSISTS OF STANDARD CHARACTERS WITHOUT CLAIM TO ANY PARTICULAR FONT, STYLE, SIZE, OR COLOR.

FOR EDUCATION SERVICES, NAMELY, ORGANIZING AND CONDUCTING MUSICAL WORKSHOPS FOR CHILDREN AND ADULTS; ENTERTAINMENT SERVICES, NAMELY, ORGANIZING LIVE PERFORMANCES AND MUSICAL CONCERTS BY CHOIRS OF ADULTS AND CHILDREN (U.S. CLS. 100, 101 AND 107).

FIRST USE 9-18-2007; IN COMMERCE 9-18-2007.
KIMBERLY PERRY, EXAMINING ATTORNEY

SN 77-292,911. KIDD, DEVON R., DBA JENKIN, HUGHES, SAN DIEGO, CA. FILED 10-1-2007.

Airflix

THE MARK CONSISTS OF STANDARD CHARACTERS WITHOUT CLAIM TO ANY PARTICULAR FONT, STYLE, SIZE, OR COLOR.

FOR MULTIMEDIA ENTERTAINMENT SERVICES IN THE NATURE OF RECORDING, PRODUCTION AND POST-PRODUCTION SERVICES IN THE FIELDS OF MUSIC, VIDEO, AND FILMS (U.S. CLS. 100, 101 AND 107).

KIMBERLY PERRY, EXAMINING ATTORNEY

CLASS 41—(Continued).

SN 77-292,954. EYSENBACH, GUNTHER, TORONTO, CANADA, FILED 10-1-2007.

Medicine 2.0

THE MARK CONSISTS OF STANDARD CHARACTERS WITHOUT CLAIM TO ANY PARTICULAR FONT, STYLE, SIZE, OR COLOR.

NO CLAIM IS MADE TO THE EXCLUSIVE RIGHT TO USE "MEDICINE", APART FROM THE MARK AS SHOWN.

FOR ARRANGING OF EXHIBITIONS, SEMINARS AND CONFERENCES; EDUCATIONAL SERVICES, NAMELY, CONDUCTING CONFERENCES, WORKSHOPS, SEMINARS, EXHIBITIONS, COURSES IN THE FIELD OF MEDICINE AND ICT (INFORMATION AND COMMUNICATION TECHNOLOGY) AND DISTRIBUTION OF COURSE MATERIAL IN CONNECTION THEREWITH; ORGANISATION OF CONFERENCES AND SYMPOSIA IN THE FIELD OF MEDICAL SCIENCE; ELECTRONIC PUBLISHING SERVICES, NAMELY, PUBLICATION OF TEXT AND GRAPHIC WORKS OF OTHERS ON CD, DVD, ON-LINE FEATURING MATERIAL RELEVANT TO HEALTH AND HEALTH CARE; ON-LINE PUBLICATION OF BOOKS, OF MAGAZINES, OF JOURNALS, OF CONFERENCE PROCEEDINGS, OF NEWSPAPERS, OF PERIODICALS, OF CATALOGS, OF BROCHURES; PUBLICATION OF BOOKS, OF MAGAZINES, OF JOURNALS, OF NEWSPAPERS, OF PERIODICALS, OF CATALOGS, OF BROCHURES (U.S. CLS. 100, 101 AND 107).

DAWN HAN, EXAMINING ATTORNEY

SN 77-293,001. PLANET VENTURES, INC., PORTAND, ME. FILED 10-1-2007.



THE MARK CONSISTS OF A CIRCLE CONTAINING AN IMAGE OF A CHILD WITH A PUPPY ON A LEASH, WITH THE WORD "ADOPT" BELOW THEIR FEET AND THE WORDS "GIVE A HOME A DOG" ABOVE.

FOR EDUCATIONAL SERVICES, NAMELY, CLASSES AND WORKSHOPS RELATED TO THE ADOPTION OF DOGS (U.S. CLS. 100, 101 AND 107).

LAURA KOVALSKY, EXAMINING ATTORNEY

CLASS 41—(Continued).

SN 77-293,080. ARIZONA PUBLIC SERVICE COMPANY, PHOENIX, AZ. FILED 10-1-2007.



THE MARK CONSISTS OF A MALE CLOWN DRESSED IN COLONIAL PERIOD ATTIRE.

FOR EDUCATIONAL SERVICES, NAMELY, PROVIDING INFORMATION TO ELEMENTARY SCHOOL-AGE CHILDREN IN THE FIELDS OF ENERGY CONSERVATION EDUCATION, ENVIRONMENTAL EDUCATION, AND ELECTRICAL SAFETY EDUCATION (U.S. CLS. 100, 101 AND 107).

JIM RINGLE, EXAMINING ATTORNEY

SN 77-293,213. PLAYBOY ENTERPRISES INTERNATIONAL, INC., CHICAGO, IL. FILED 10-1-2007.

SEE WHAT YOU WANT TO SEE

THE MARK CONSISTS OF STANDARD CHARACTERS WITHOUT CLAIM TO ANY PARTICULAR FONT, STYLE, SIZE, OR COLOR.

FOR PROGRAMMING ON A GLOBAL COMPUTER NETWORK; TELEVISION PROGRAMMING; TELEVISION SCHEDULING; PROVISION OF NON-DOWNLOADABLE FILMS AND TV PROGRAMMES VIA A VIDEO-ON-DEMAND SERVICE (U.S. CLS. 100, 101 AND 107).

ALEXANDER L. POWERS, EXAMINING ATTORNEY

SN 77-293,373. FARRIS, ROY W., GILBERT, AZ. FILED 10-1-2007.

Honky Tonk Man

THE MARK CONSISTS OF STANDARD CHARACTERS WITHOUT CLAIM TO ANY PARTICULAR FONT, STYLE, SIZE, OR COLOR.

FOR ENTERTAINMENT IN THE NATURE OF WRESTLING CONTESTS (U.S. CLS. 100, 101 AND 107).

INGA ERVIN, EXAMINING ATTORNEY

CLASS 41—(Continued).

SN 77-293,451. FARRIS, ROY W., GILBERT, AZ. FILED 10-2-2007.

The Honky Tonk Man

THE MARK CONSISTS OF STANDARD CHARACTERS WITHOUT CLAIM TO ANY PARTICULAR FONT, STYLE, SIZE, OR COLOR.

FOR ENTERTAINMENT IN THE NATURE OF WRESTLING CONTESTS (U.S. CLS. 100, 101 AND 107).

INGA ERVIN, EXAMINING ATTORNEY

SN 77-293,671. LOUGHLIN, WILLIAM JOHN, SACRAMENTO, CA. FILED 10-2-2007.

GigRight

Gigged wrong? Now GigRight!

THE MARK CONSISTS OF THE STYLIZED WORDS GIGRIGHT GIGGED WRONG? NOW GIGRIGHT!.

FOR ENTERTAINMENT SERVICES NAMELY PROVIDING A WEBSITE FEATURING PHOTOGRAPHIC, AUDIO, VIDEO AND PROSE PRESENTATIONS FEATURING ENTERTAINMENT TALENT, INCLUDING MUSIC, MODELING, VISUAL AND PERFORMING ARTS (U.S. CLS. 100, 101 AND 107).

CORY BOONE, EXAMINING ATTORNEY

SN 77-293,735. HOPELAB FOUNDATION, INC., REDWOOD CITY, CA. FILED 10-2-2007.

RUCKUS NATION

THE MARK CONSISTS OF STANDARD CHARACTERS WITHOUT CLAIM TO ANY PARTICULAR FONT, STYLE, SIZE, OR COLOR.

FOR EDUCATIONAL SERVICES, NAMELY, CONDUCTING PROGRAMS IN THE FIELDS OF CONCEPT DEVELOPMENT, PRODUCT INNOVATION, AND NEW PRODUCT DEVELOPMENT DIRECTED TOWARDS YOUNG PEOPLE TO ENCOURAGE THE ADOPTION OF HEALTHY, FIT AND ENERGETIC LIFESTYLES AND TO REDUCE OBESITY (U.S. CLS. 100, 101 AND 107).

FIRST USE 6-28-2007; IN COMMERCE 6-28-2007.
CHRISTINA SOBRAL, EXAMINING ATTORNEY

CLASS 41—(Continued).

SN 77-293,954. HOPELAB FOUNDATION, INC., REDWOOD CITY, CA. FILED 10-2-2007.



THE COLOR(S) GOLD, GREEN, BLACK, RED AND WHITE IS/ARE CLAIMED AS A FEATURE OF THE MARK. THE MARK CONSISTS OF THE WORD "RUCKUS" WHICH APPEARS IN WHITE, OUTLINED IN BLACK AND IS SHADOWED BY THE COLORS GREEN, BLACK AND GOLD, A DRAWING OF A WHITE LIGHT BULB OUTLINED IN BLACK AND IS SHADOWED BY GOLD WITH RED LINES IN VARYING PLACES INSIDE AND OUTSIDE OF THE LIGHT BULB, AND THE WORD "NATION" APPEARS IN WHITE LETTERING IS INSIDE A BLACK RECTANGULAR SHAPED BOX.

FOR EDUCATIONAL SERVICES, NAMELY, CONDUCTING PROGRAMS IN THE FIELDS OF CONCEPT DEVELOPMENT, PRODUCT INNOVATION, AND NEW PRODUCT DEVELOPMENT DIRECTED TOWARDS YOUNG PEOPLE TO ENCOURAGE THE ADOPTION OF HEALTHY, FIT AND ENERGETIC LIFESTYLES AND TO REDUCE OBESITY (U.S. CLS. 100, 101 AND 107).

FIRST USE 6-28-2007; IN COMMERCE 6-28-2007. CHRISTINA SOBRAL, EXAMINING ATTORNEY

SN 77-293,965. DRB LIT, LTD., IRVING, TX. FILED 10-2-2007.

Triple R

THE MARK CONSISTS OF STANDARD CHARACTERS WITHOUT CLAIM TO ANY PARTICULAR FONT, STYLE, SIZE, OR COLOR. FOR EDUCATION SERVICES, NAMELY, PROVIDING INSTRUCTION IN THE FIELD OF INFORMATION RETENTION (U.S. CLS. 100, 101 AND 107). TASNEEM HUSSAIN, EXAMINING ATTORNEY

CLASS 41—(Continued).

SN 77-293,972. GRACE SCHOOLS, INC., WINONA LAKE, IN. FILED 10-2-2007.



NO CLAIM IS MADE TO THE EXCLUSIVE RIGHT TO USE "ONLINE", APART FROM THE MARK AS SHOWN. THE MARK CONSISTS OF STYLIZED LETTERING OF THE WORDS "GRACE ONLINE A WORLD OF LEARNING".

FOR EDUCATION SERVICES IN THE NATURE OF COURSES AT THE UNIVERSITY LEVEL (U.S. CLS. 100, 101 AND 107).

SHANNON TWOHIG, EXAMINING ATTORNEY

SN 77-293,974. DRB LIT, LTD., IRVING, TX. FILED 10-2-2007.

3-RRR

THE MARK CONSISTS OF STANDARD CHARACTERS WITHOUT CLAIM TO ANY PARTICULAR FONT, STYLE, SIZE, OR COLOR.

FOR EDUCATION SERVICES, NAMELY, PROVIDING INSTRUCTION IN THE FIELD OF INFORMATION RETENTION (U.S. CLS. 100, 101 AND 107).

TASNEEM HUSSAIN, EXAMINING ATTORNEY

SN 77-293,992. DRB LIT, LTD., IRVING, TX. FILED 10-2-2007.

Real Results from Retention

THE MARK CONSISTS OF STANDARD CHARACTERS WITHOUT CLAIM TO ANY PARTICULAR FONT, STYLE, SIZE, OR COLOR. FOR EDUCATION SERVICES, NAMELY, PROVIDING INSTRUCTION IN THE FIELD OF INFORMATION RETENTION (U.S. CLS. 100, 101 AND 107). TASNEEM HUSSAIN, EXAMINING ATTORNEY

CLASS 41—(Continued).

SN 77-294,027. BIG NIGHT IN TENT, LLC, NEW YORK, NY. FILED 10-2-2007.

BIG NIGHT IN TENT

THE MARK CONSISTS OF STANDARD CHARACTERS WITHOUT CLAIM TO ANY PARTICULAR FONT, STYLE, SIZE, OR COLOR.

FOR ENTERTAINMENT SERVICES, NAMELY, LIVE PERFORMANCES BY TRAVELING SPEAKERS, COMEDIANS, MUSICIANS, AUTHORS, STORYTELLERS, ACADEMICS AND CELEBRITIES (U.S. CLS. 100, 101 AND 107).

MICHAEL KEATING, EXAMINING ATTORNEY

SN 77-294,032. MODEL A FITNESS, INC., BOONTON, NJ. FILED 10-2-2007.

GET IN GEAR

THE MARK CONSISTS OF STANDARD CHARACTERS WITHOUT CLAIM TO ANY PARTICULAR FONT, STYLE, SIZE, OR COLOR.

FOR HEALTH CLUB SERVICES, NAMELY, PROVIDING INSTRUCTION AND EQUIPMENT IN THE FIELD OF PHYSICAL EXERCISE; PROVIDING FITNESS AND EXERCISE FACILITIES (U.S. CLS. 100, 101 AND 107).

HENRY S. ZAK, EXAMINING ATTORNEY

SN 77-294,131. BIG NIGHT IN TENT, LLC, NEW YORK, NY. FILED 10-2-2007.

BNIT

THE MARK CONSISTS OF STANDARD CHARACTERS WITHOUT CLAIM TO ANY PARTICULAR FONT, STYLE, SIZE, OR COLOR.

FOR ENTERTAINMENT SERVICES, NAMELY, LIVE PERFORMANCES BY TRAVELING SPEAKERS, COMEDIANS, MUSICIANS, AUTHORS, STORYTELLERS, ACADEMICS AND CELEBRITIES (U.S. CLS. 100, 101 AND 107).

MICHAEL KEATING, EXAMINING ATTORNEY

CLASS 41—(Continued).

SN 77-294,204. JENNIFER FORMAN WEINSTEIN, PARADISE VALLEY, AZ. FILED 10-2-2007.

FACE TOLERANCE

THE MARK CONSISTS OF THE WORDS FACE TOLERANCE IN BLOCK LETTERING. THE LETTERS "C" AND "E" OF THE WORD FACE APPEAR IN BACKWARDS LETTERING.

FOR EDUCATIONAL SERVICES, NAMELY, CONDUCTING COURSES OF INSTRUCTION ABOUT GLOBAL DIVERSITY AND DEMONSTRATING GLOBAL DIVERSITY THROUGH WORKS OF ART (U.S. CLS. 100, 101 AND 107).

DAWN FELDMAN, EXAMINING ATTORNEY

SN 77-294,207. ADVERTISING.COM, INC., BALTIMORE, MD. FILED 10-2-2007.

WE MAKE THE WORLD CLICK

THE MARK CONSISTS OF STANDARD CHARACTERS WITHOUT CLAIM TO ANY PARTICULAR FONT, STYLE, SIZE, OR COLOR.

FOR PROVIDING CUSTOMIZED ELECTRONIC NEWSLETTERS FOR OTHERS IN THE FIELD OF ADVERTISING AND ISSUING REPORTS ON THE EFFECTIVENESS AND RESPONSE RATES FOR SUCH NEWSLETTERS AS A COMPONENT SERVICE (U.S. CLS. 100, 101 AND 107).

NATALIE POLZER, EXAMINING ATTORNEY

SN 77-294,412. BRENDA WINFREE, DESTIN, FL. FILED 10-2-2007.

TABU REVEAL THE INNER YOU

THE MARK CONSISTS OF STANDARD CHARACTERS WITHOUT CLAIM TO ANY PARTICULAR FONT, STYLE, SIZE, OR COLOR.

FOR PHYSICAL FITNESS INSTRUCTION; DANCE INSTRUCTION (U.S. CLS. 100, 101 AND 107).

FIRST USE 12-15-2006; IN COMMERCE 1-25-2007.

SIMON TENG, EXAMINING ATTORNEY

CLASS 41—(Continued).

SN 77-294,588. DREAMBOX LEARNING, INC., BELLEVUE, WA. FILED 10-2-2007.



NO CLAIM IS MADE TO THE EXCLUSIVE RIGHT TO USE "LEARNING", APART FROM THE MARK AS SHOWN. THE MARK CONSISTS OF THE LITERAL ELEMENT "DREAMBOX LEARNING" IN STYLIZED FORM BELOW A HURDLER IN SILHOUETTE.

FOR EDUCATIONAL SERVICES, NAMELY, PROVIDING COURSES OF INSTRUCTION AT THE PRE-SCHOOL, PRIMARY, SECONDARY, COLLEGE, GRADUATE, AND POST-GRADUATE LEVELS, AND DISTRIBUTION OF COURSE MATERIAL IN CONNECTION THEREWITH (U.S. CLS. 100, 101 AND 107).

SALLY SHIH, EXAMINING ATTORNEY

SN 77-294,593. DREAMBOX LEARNING, INC., BELLEVUE, WA. FILED 10-2-2007.



THE MARK CONSISTS OF A HURDLER IN SILHOUETTE.

FOR EDUCATIONAL SERVICES, NAMELY, PROVIDING COURSES OF INSTRUCTION AT THE PRE-SCHOOL, PRIMARY, SECONDARY, COLLEGE, GRADUATE, AND POST-GRADUATE LEVELS AND DISTRIBUTION OF COURSE MATERIAL IN CONNECTION THEREWITH (U.S. CLS. 100, 101 AND 107).

SALLY SHIH, EXAMINING ATTORNEY

CLASS 41—(Continued).

SN 77-294,594. THE DIMES PARTNERSHIP, DBA THE DIMES, PORTLAND, OR. FILED 10-2-2007.

The Dimes

THE MARK CONSISTS OF STANDARD CHARACTERS WITHOUT CLAIM TO ANY PARTICULAR FONT, STYLE, SIZE, OR COLOR.

FOR ENTERTAINMENT, NAMELY, LIVE PERFORMANCES BY A MUSICAL BAND (U.S. CLS. 100, 101 AND 107).

FIRST USE 2-1-2003; IN COMMERCE 3-1-2003.

SALLY SHIH, EXAMINING ATTORNEY

SN 77-294,824. THE VANDERBILT UNIVERSITY, NASHVILLE, TN. FILED 10-3-2007.

WHERE HEART IS HEADED

THE MARK CONSISTS OF STANDARD CHARACTERS WITHOUT CLAIM TO ANY PARTICULAR FONT, STYLE, SIZE, OR COLOR.

FOR EDUCATIONAL SERVICES, NAMELY, CONDUCTING CLASSES, CONFERENCES, COURSES, LECTURES, MEETINGS, SEMINARS, SYMPOSIUMS, TRAINING PROGRAMS AND WORKSHOPS, IN THE FIELDS OF DISEASES, DISEASE PREVENTION, HEALTH CARE, MEDICINE, MEDICAL RESEARCH AND MEDICAL SERVICES, AND DISTRIBUTING COURSE MATERIALS IN CONNECTION THEREWITH (U.S. CLS. 100, 101 AND 107).

SAMUEL E. SHARPER JR., EXAMINING ATTORNEY

SN 77-294,882. ANDREW WOMMACK MINISTRIES, INC., COLORADO SPRINGS, CO. FILED 10-3-2007.

THE GOSPEL TRUTH

THE MARK CONSISTS OF STANDARD CHARACTERS WITHOUT CLAIM TO ANY PARTICULAR FONT, STYLE, SIZE, OR COLOR.

FOR ENTERTAINMENT AND EDUCATION SERVICES, NAMELY, ON-GOING SERIES FEATURING THE BIBLE AND CHRISTIAN MINISTRY PROVIDED THROUGH TELEVISION, RADIO AND INTERNET BROADCASTS (U.S. CLS. 100, 101 AND 107).

FIRST USE 7-1-1976; IN COMMERCE 7-1-1976.

JOHN WILKE, EXAMINING ATTORNEY

CLASS 41—(Continued).

SN 77-294,919. KOMORI CONNECTIONS, INC., PALMDALE, CA. FILED 10-3-2007.

THE BROAD PERSPECTIVE

THE MARK CONSISTS OF STANDARD CHARACTERS WITHOUT CLAIM TO ANY PARTICULAR FONT, STYLE, SIZE, OR COLOR.

FOR EDUCATION SERVICES, NAMELY, PROVIDING CLASSES, SEMINARS, CONFERENCES IN THE FIELD OF WOMEN'S ISSUES; ENTERTAINMENT SERVICES, NAMELY, PROVIDING PODCASTS IN THE FIELD OF WOMEN'S ISSUES; ON-LINE JOURNALS, NAMELY, BLOGS FEATURING WOMEN'S ISSUES (U.S. CLS. 100, 101 AND 107).

FIRST USE 9-22-2002; IN COMMERCE 9-22-2002.
VIVIAN MICZNIK FIRST, EXAMINING ATTORNEY

SN 77-295,052. ALBRIGHT, MICHAEL, RENO, NV. FILED 10-3-2007.



THE MARK CONSISTS OF THE STYLIZED LETTER P BEING FILLED IN WITH BLACK IN THE CIRCLE PART OF THE P WITH A WHITE SPACE THAT DEPICTS A QUARTER MOON.

FOR FILM EDITING; FILM MASTERING SERVICES; FILM STUDIOS; MOTION PICTURE FILM PRODUCTION; MULTIMEDIA ENTERTAINMENT SERVICES IN THE NATURE OF RECORDING, PRODUCTION AND POST-PRODUCTION SERVICES IN THE FIELDS OF MUSIC, VIDEO, AND FILMS; OPERATING OF FILM STUDIOS; POST-PRODUCTION EDITING SERVICES IN THE FIELD OF MUSIC, VIDEOS AND FILMS (U.S. CLS. 100, 101 AND 107).

ESTHER A. BORSUK, EXAMINING ATTORNEY

CLASS 41—(Continued).

SN 77-295,068. ELLIS, KELLI, HOUSTON, TX. AND TATUM, PAUL, HOUSTON, TX. FILED 10-3-2007.



NO CLAIM IS MADE TO THE EXCLUSIVE RIGHT TO USE "BUSINESS" AND "RECORDS", APART FROM THE MARK AS SHOWN.

FOR AUDIO RECORDING AND PRODUCTION; MUSIC PRODUCTION SERVICES; RECORD MASTER PRODUCTION; RECORDING STUDIOS (U.S. CLS. 100, 101 AND 107).

ALICE SUE CARRUTHERS, EXAMINING ATTORNEY

SN 77-295,081. FRANK, ALLAN D., LAS VEGAS, NV. FILED 10-3-2007.

PARENTING TODAY

THE MARK CONSISTS OF STANDARD CHARACTERS WITHOUT CLAIM TO ANY PARTICULAR FONT, STYLE, SIZE, OR COLOR.

NO CLAIM IS MADE TO THE EXCLUSIVE RIGHT TO USE "PARENTING", APART FROM THE MARK AS SHOWN.

FOR NEWSPAPER PUBLISHING; PUBLISHING OF ELECTRONIC PUBLICATIONS (U.S. CLS. 100, 101 AND 107).

ROBIN CHOSID, EXAMINING ATTORNEY

CLASS 41—(Continued).

SN 77-295,253. HALLIBURTON ENERGY SERVICES, INC., CARROLLTON, TX. FILED 10-3-2007.



FOR EDUCATIONAL AND TRAINING SERVICES, NAMELY, PROVIDING CAREER PLANNING OPPORTUNITIES AND OBJECTIVES BY CONDUCTING ONLINE VIA THE INTERNET CLASSES, SEMINARS, CONFERENCES, WORKSHOPS, AND EDUCATIONAL TESTING, COMPETENCIES, AND EVALUATION CONCERNING INDIVIDUAL CAREER AND PROFESSIONAL DEVELOPMENT IN VARIOUS DISCIPLINES USED PRIMARILY IN THE OIL AND GAS INDUSTRY, AND THE DISTRIBUTION OF PRINTED MATERIALS IN CONNECTION THEREWITH (U.S. CLS. 100, 101 AND 107).

FIRST USE 5-10-2005; IN COMMERCE 5-10-2005.
SHAILA SETTLES, EXAMINING ATTORNEY

SN 77-295,358. VEROPEDIA, INC., ST. PETERSBURG, FL. FILED 10-3-2007.

VEROPEDIA

THE MARK CONSISTS OF STANDARD CHARACTERS WITHOUT CLAIM TO ANY PARTICULAR FONT, STYLE, SIZE, OR COLOR.

FOR PROVIDING INFORMATION IN THE FIELD OF GENERAL ENCYCLOPEDIA KNOWLEDGE VIA THE INTERNET (U.S. CLS. 100, 101 AND 107).

MARK T. MULLEN, EXAMINING ATTORNEY

SN 77-295,406. GOODWILL COMMUNITY FOUNDATION, INC., DURHAM, NC. FILED 10-3-2007.



OWNER OF U.S. REG. NOS. 2,560,391, 2,890,969 AND OTHERS.

NO CLAIM IS MADE TO THE EXCLUSIVE RIGHT TO USE THE REPRESENTATIVE DRAWING OF THE STATE OF NORTH CAROLINA, APART FROM THE MARK AS SHOWN.

THE COLOR(S) BLUE, WHITE, BROWN, GRAY AND ORANGE IS/ARE CLAIMED AS A FEATURE OF THE MARK.

THE MARK CONSISTS OF A LIGHT BLUE CIRCLE ON WHICH ARE SUPERIMPOSED TWO CIRCULAR PARALLEL WHITE LINES, AND ACROSS THE BOTTOM OF WHICH IS SUPERIMPOSED A DARK BLUE SILHOUETTE OF THE STATE OF NORTH CAROLINA, BEHIND THE TOP

CLASS 41—(Continued).

OF WHICH IS A WHITE BORDER; SUPERIMPOSED ON THE SILHOUETTE OF THE STATE OF NORTH CAROLINA IS A MALE PAPER DOLL FIGURE IN THE COLOR BROWN, WITH A DARK BROWN BORDER; ABOVE THAT FIGURE'S RIGHT HAND APPEARS A SMALL FIVE-POINTED WHITE STAR, ABOVE WHICH APPEARS A LARGER FIVE-POINTED WHITE STAR, AND ABOVE THAT APPEARS A LARGE FIVE-POINTED STAR, THE BOTTOM PORTION OF WHICH IS IN THE COLOR WHITE AND THE TOP PORTION OF WHICH IS IN THE COLOR ORANGE; TO THE RIGHT OF THESE FIGURES APPEAR THE LETTERS GCF IN THE COLOR GRAY, ABOVE THE WORDS LEARNFREE.ORG IN THE COLOR LIGHT BLUE WITH A GRAY BORDER.

FOR EDUCATIONAL SERVICES, NAMELY, PROVIDING INTERNET-BASED TRAINING PROGRAMS IN THE FIELD OF COMPUTER USE AND OPERATIONS; VOCATIONAL TRAINING IN THE FIELD OF COMPUTERS; TRAINING IN THE DEVELOPMENT AND ACQUISITION OF COMPUTER SKILLS AND RELATED CAREER AND WORKPLACE DEVELOPMENT SKILLS (U.S. CLS. 100, 101 AND 107).

FIRST USE 9-30-2007; IN COMMERCE 9-30-2007.
TEJBIR SINGH, EXAMINING ATTORNEY

SN 77-295,584. STEELE HAVIN' FUN, INC., AGOURA HILLS, CA. FILED 10-3-2007.

dianasteele.net

THE MARK CONSISTS OF STANDARD CHARACTERS WITHOUT CLAIM TO ANY PARTICULAR FONT, STYLE, SIZE, OR COLOR.

THE NAME "DIANA STEELE" IN THE MARK DOES NOT IDENTIFY A LIVING INDIVIDUAL.

FOR ENTERTAINMENT SERVICES, NAMELY, PROVIDING A WEB SITE FEATURING PHOTOGRAPHIC, AUDIO, VIDEO AND PROSE PRESENTATIONS FEATURING A RADIO PERSONALITY; ENTERTAINMENT SERVICES, NAMELY, PERSONAL APPEARANCES BY A RADIO PERSONALITY; PROVIDING VOICE OVERS FOR TAPES, RECORDS AND OTHER RECORDED MEDIA (U.S. CLS. 100, 101 AND 107).

IRA J. GOODSID, EXAMINING ATTORNEY

SN 77-295,591. UNIVERSAL CITY STUDIOS LLLP, UNIVERSAL CITY, CA. FILED 10-3-2007.

MASTER OF MAYHEM

THE MARK CONSISTS OF STANDARD CHARACTERS WITHOUT CLAIM TO ANY PARTICULAR FONT, STYLE, SIZE, OR COLOR.

FOR AMUSEMENT PARK SERVICES (U.S. CLS. 100, 101 AND 107).

JEAN IM, EXAMINING ATTORNEY

CLASS 41—(Continued).

SN 77-295,616. YOGA WORKS, INC., SANTA MONICA, CA.
FILED 10-3-2007.

BARWORKS

THE MARK CONSISTS OF STANDARD CHARACTERS WITHOUT CLAIM TO ANY PARTICULAR FONT, STYLE, SIZE, OR COLOR.

OWNER OF U.S. REG. NOS. 2,066,984, 2,075,873 AND 2,991,794.

FOR YOGA INSTRUCTION; PHYSICAL FITNESS CONDITIONING CLASSES (U.S. CLS. 100, 101 AND 107).

ANNE E. GUSTASON, EXAMINING ATTORNEY

SN 77-295,633. TIED TO THE TRACKS FILMS, INC., CAMBRIDGE, MA. FILED 10-3-2007.

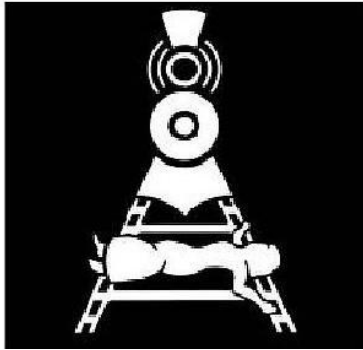

THE MARK CONSISTS OF A GRAPHIC REPRESENTATION OF A PRONE WOMAN TIED TO TRAIN TRACKS IN FRONT OF AN ONCOMING TRAIN.

FOR MOTION PICTURE FILM PRODUCTION (U.S. CLS. 100, 101 AND 107).

FIRST USE 12-30-1991; IN COMMERCE 12-30-1991.

MELVIN AXILBUND, EXAMINING ATTORNEY

SN 77-295,698. JENSEN, JEFFREY W, NEW PORT RICHEY, FL. FILED 10-3-2007.

SIDEARMS

THE MARK CONSISTS OF STANDARD CHARACTERS WITHOUT CLAIM TO ANY PARTICULAR FONT, STYLE, SIZE, OR COLOR.

FOR ENTERTAINMENT IN THE NATURE OF A MUSICAL GROUP (U.S. CLS. 100, 101 AND 107).

FIRST USE 9-8-1995; IN COMMERCE 7-11-1998.

CHARLES L. JENKINS, EXAMINING ATTORNEY

CLASS 41—(Continued).

SN 77-296,121. MAKE WORKSHOP INC., NEW YORK, NY.
FILED 10-4-2007.

make

THE MARK CONSISTS OF STANDARD CHARACTERS WITHOUT CLAIM TO ANY PARTICULAR FONT, STYLE, SIZE, OR COLOR.

FOR EDUCATION SERVICES, NAMELY, PROVIDING CLASSES AND WORKSHOPS IN THE FIELD OF KNITTING, CROCHETING, EMBROIDERY, JEWELRY DESIGN, QUILTING, AND SEWING (U.S. CLS. 100, 101 AND 107).

FIRST USE 3-1-2002; IN COMMERCE 3-1-2002.

LOURDES AYALA, EXAMINING ATTORNEY

SN 77-296,188. 3 BAR H PRODUCTIONS, LLC, ANAHEIM HILLS, CA. FILED 10-4-2007.

FAUX ROYALTY

THE MARK CONSISTS OF STANDARD CHARACTERS WITHOUT CLAIM TO ANY PARTICULAR FONT, STYLE, SIZE, OR COLOR.

FOR ENTERTAINMENT IN THE NATURE OF ONGOING TELEVISION PROGRAMS IN THE FIELD OF SITCOMS (U.S. CLS. 100, 101 AND 107).

LOURDES AYALA, EXAMINING ATTORNEY

SN 77-296,200. 3 BAR H PRODUCTIONS, LLC, ANAHEIM HILLS, CA. FILED 10-4-2007.

HOLLYWOOD ROYALTY

THE MARK CONSISTS OF STANDARD CHARACTERS WITHOUT CLAIM TO ANY PARTICULAR FONT, STYLE, SIZE, OR COLOR.

FOR ENTERTAINMENT IN THE NATURE OF ONGOING TELEVISION PROGRAMS IN THE FIELD OF SITCOMS (U.S. CLS. 100, 101 AND 107).

LOURDES AYALA, EXAMINING ATTORNEY

CLASS 41—(Continued).

SN 77-296,208. 3 BAR H PRODUCTIONS, LLC, ANAHEIM HILLS, CA. FILED 10-4-2007.

THE COUNTRY CLUB

THE MARK CONSISTS OF STANDARD CHARACTERS WITHOUT CLAIM TO ANY PARTICULAR FONT, STYLE, SIZE, OR COLOR.
FOR ENTERTAINMENT IN THE NATURE OF ONGOING TELEVISION PROGRAMS IN THE FIELD OF SITCOMS (U.S. CLS. 100, 101 AND 107).
LOURDES AYALA, EXAMINING ATTORNEY

SN 77-296,213. 3 BAR H PRODUCTIONS, LLC, ANAHEIM HILLS, CA. FILED 10-4-2007.

SEB

THE MARK CONSISTS OF STANDARD CHARACTERS WITHOUT CLAIM TO ANY PARTICULAR FONT, STYLE, SIZE, OR COLOR.
FOR ENTERTAINMENT IN THE NATURE OF ONGOING TELEVISION PROGRAMS IN THE FIELD OF SITCOMS (U.S. CLS. 100, 101 AND 107).
LOURDES AYALA, EXAMINING ATTORNEY

SN 77-296,298. YOGA WORKS, INC., SANTA MONICA, CA. FILED 10-4-2007.

DANCEWORKS

THE MARK CONSISTS OF STANDARD CHARACTERS WITHOUT CLAIM TO ANY PARTICULAR FONT, STYLE, SIZE, OR COLOR.
OWNER OF U.S. REG. NOS. 2,022,243, 2,066,984 AND 2,991,794.
FOR YOGA INSTRUCTION (U.S. CLS. 100, 101 AND 107).
FIRST USE 8-25-2007; IN COMMERCE 8-25-2007.
ANNE E. GUSTASON, EXAMINING ATTORNEY

CLASS 41—(Continued).

SN 77-296,319. YOGA WORKS, INC., SANTA MONICA, CA. FILED 10-4-2007.

CARDIOWORKS

THE MARK CONSISTS OF STANDARD CHARACTERS WITHOUT CLAIM TO ANY PARTICULAR FONT, STYLE, SIZE, OR COLOR.
OWNER OF U.S. REG. NOS. 2,022,243, 2,066,984 AND 2,991,794.
FOR YOGA INSTRUCTION (U.S. CLS. 100, 101 AND 107).
FIRST USE 8-25-2007; IN COMMERCE 8-25-2007.
ANNE E. GUSTASON, EXAMINING ATTORNEY

SN 77-296,340. LATINO TODAY PUBLISHING, DBA LATINO TODAY FOUNDATION, SANTA MARIA, CA. FILED 10-4-2007.



THE COLOR(S) LIGHT BLUE, WITH DARK BLUE DROP SHADOWS AND GLOSSY WHITE HIGHLIGHTS IS/ARE CLAIMED AS A FEATURE OF THE MARK.
THE MARK CONSISTS OF STYLIZED LIGHT BLUE LETTERS "Y", "E", "L", "L" WHICH IS ACRONYM FOR YOUNG EDUCATED LATINO LEADERS, WITH DARK BLUE DROP SHADOWS AND GLOSSY WHITE HIGHLIGHTS.
FOR EDUCATION SERVICES, NAMELY, PROVIDING WORKSHOPS, CONFERENCES AND SEMINARS IN THE FIELD OF LATINO EDUCATIONAL OPPORTUNITIES (U.S. CLS. 100, 101 AND 107).
SALLY SHIH, EXAMINING ATTORNEY

SN 77-296,351. CRISP, TONY, COSTA MESA, CA. FILED 10-4-2007.

VELICIOUS

THE MARK CONSISTS OF STANDARD CHARACTERS WITHOUT CLAIM TO ANY PARTICULAR FONT, STYLE, SIZE, OR COLOR.
FOR ENTERTAINMENT, NAMELY, LIVE PERFORMANCE BY A MUSICAL BAND (U.S. CLS. 100, 101 AND 107).
FIRST USE 0-0-2002; IN COMMERCE 0-0-2002.
JENNIFER MARTIN, EXAMINING ATTORNEY

CLASS 41—(Continued).

SN 77-296,427. YOGA WORKS, INC., SANTA MONICA, CA.
FILED 10-4-2007.

SCULPTWORKS

THE MARK CONSISTS OF STANDARD CHARACTERS WITHOUT CLAIM TO ANY PARTICULAR FONT, STYLE, SIZE, OR COLOR.

OWNER OF U.S. REG. NOS. 2,022,243, 2,066,984 AND 2,991,794.

FOR YOGA INSTRUCTION (U.S. CLS. 100, 101 AND 107).

FIRST USE 8-25-2007; IN COMMERCE 8-25-2007.
ANNE E. GUSTASON, EXAMINING ATTORNEY

CLASS 41—(Continued).

SN 77-296,684. SINGER LEARNING, INC., CINCINNATI, OH. FILED 10-4-2007.

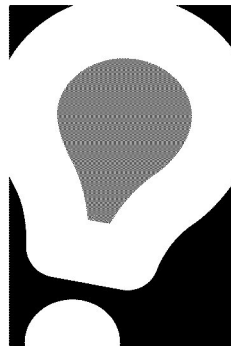

THE MARK CONSISTS OF A LIGHT BULB. FOR EDUCATION SERVICES, NAMELY, PROVIDING CLASSES, SEMINARS, WORKSHOPS, TUTORING, COACHING, AND MENTORING IN THE FIELD OF LEADERSHIP, TRAINING, PRESENTING, AND TEACHING (U.S. CLS. 100, 101 AND 107).

FIRST USE 7-0-2004; IN COMMERCE 7-0-2004.
MARK PILARO, EXAMINING ATTORNEY

SN 77-297,279. MARIANO PASTOR, INC., BROOKLYN, NY.
FILED 10-5-2007.

Via U!

THE MARK CONSISTS OF STANDARD CHARACTERS WITHOUT CLAIM TO ANY PARTICULAR FONT, STYLE, SIZE, OR COLOR.

FOR PHOTOGRAPHY SERVICES (U.S. CLS. 100, 101 AND 107).

FLORENTINA BLANDU, EXAMINING ATTORNEY

SN 77-297,702. INTERNATIONAL FEDERATION OF DENTAL EDUCATORS AND ASSOCIATIONS, WASHINGTON, DC. FILED 10-5-2007.

IFDEA

THE MARK CONSISTS OF STANDARD CHARACTERS WITHOUT CLAIM TO ANY PARTICULAR FONT, STYLE, SIZE, OR COLOR.

FOR EDUCATIONAL SERVICES, NAMELY, CONDUCTING PROGRAMS IN THE FIELD OF PUBLIC HEALTH, DENTAL EDUCATION AND ORAL HEALTH CARE (U.S. CLS. 100, 101 AND 107).

FIRST USE 7-11-2007; IN COMMERCE 7-11-2007.
AISHA CLARKE, EXAMINING ATTORNEY

SN 77-296,675. LAURENCE, TIM, CHATSWORTH, CA.
FILED 10-4-2007.



THE MARK CONSISTS OF SKULL AND CROSS BONES AND PORTION OF FIVE PLAYING CARDS.

FOR SOCIAL CLUB SERVICES, NAMELY, ARRANGING, ORGANIZING, AND HOSTING SOCIAL EVENTS, GET-TOGETHERS, AND PARTIES FOR CLUB MEMBERS (U.S. CLS. 100, 101 AND 107).

DANIEL CAPSHAW, EXAMINING ATTORNEY

CLASS 41—(Continued).

SN 77-297,813. SILVA, SINFORIANO R., NORWALK, CA. FILED 10-5-2007.

LA LUZ ROJA DE SAN MARCOS

THE MARK CONSISTS OF STANDARD CHARACTERS WITHOUT CLAIM TO ANY PARTICULAR FONT, STYLE, SIZE, OR COLOR.

THE FOREIGN WORDING IN THE MARK TRANSLATES INTO ENGLISH AS "THE RED LIGHT OF SAN MARCOS". FOR ENTERTAINMENT IN THE NATURE OF LIVE PERFORMANCES BY A MUSICAL GROUP (U.S. CLS. 100, 101 AND 107).

FIRST USE 1-1-1997; IN COMMERCE 1-1-1997.
FLORENTINA BLANDU, EXAMINING ATTORNEY

SN 77-297,820. NEW WEALTH PUBLISHING, INC., BELLEVUE, WA. FILED 10-5-2007.

MULTIFAMILY MILLIONAIRE

THE MARK CONSISTS OF STANDARD CHARACTERS WITHOUT CLAIM TO ANY PARTICULAR FONT, STYLE, SIZE, OR COLOR.

FOR EDUCATIONAL SERVICES, NAMELY, PROVIDING ONLINE TRAINING IN THE FIELD OF REAL ESTATE (U.S. CLS. 100, 101 AND 107).

FIRST USE 8-3-2007; IN COMMERCE 8-3-2007.
FLORENTINA BLANDU, EXAMINING ATTORNEY

SN 77-297,931. EYES ON THE WEB, PARKLAND, FL. FILED 10-6-2007.

Because life and business are
about Human Connections

THE MARK CONSISTS OF STANDARD CHARACTERS WITHOUT CLAIM TO ANY PARTICULAR FONT, STYLE, SIZE, OR COLOR.

FOR PRODUCTION OF VIDEO AND CREATION OF VISUAL EFFECTS FOR OTHERS FOR USE IN DVDS, TELEVISION PROGRAMS AND ON WEBSITES (U.S. CLS. 100, 101 AND 107).

FIRST USE 8-1-2007; IN COMMERCE 8-1-2007.
KAREN BRACEY, EXAMINING ATTORNEY

CLASS 41—(Continued).

SN 77-297,964. KEHINDE, YVONNE, ROMEOVILLE, IL. FILED 10-6-2007.



NO CLAIM IS MADE TO THE EXCLUSIVE RIGHT TO USE "MAGAZINE", APART FROM THE MARK AS SHOWN. THE COLOR(S) RED IS/ARE CLAIMED AS A FEATURE OF THE MARK.

THE MARK CONSISTS OF A RIBBON, A ZERO AND THE WORDS "RED RIBBON OPEN MAGAZINE" ALL IN THE COLOR RED.

FOR MULTIMEDIA PUBLISHING OF BOOKS, MAGAZINES, JOURNALS, SOFTWARE, GAMES, MUSIC, AND ELECTRONIC PUBLICATIONS (U.S. CLS. 100, 101 AND 107).

FIRST USE 8-30-2007; IN COMMERCE 8-30-2007.
JOHN WILKE, EXAMINING ATTORNEY

SN 77-298,236. TIME INC., NEW YORK, NY. FILED 10-8-2007.

REAL SIMPLE SOLUTIONS

THE MARK CONSISTS OF STANDARD CHARACTERS WITHOUT CLAIM TO ANY PARTICULAR FONT, STYLE, SIZE, OR COLOR.

OWNER OF U.S. REG. NOS. 2,470,211, 3,098,845 AND OTHERS.

FOR ENTERTAINMENT IN THE NATURE OF ONGOING TELEVISION PROGRAMS IN THE FIELD OF ORGANIZING OR SAVING TIME, MONEY, FOOD, COOKING, ENTERTAINING, CLEANING, TRAVEL, FITNESS, AND STORAGE (U.S. CLS. 100, 101 AND 107).

DOMINIC FATHY, EXAMINING ATTORNEY

CLASS 41—(Continued).

SN 77-300,306. LIVING PROOF MINISTRIES, HOUSTON, TX. FILED 10-10-2007.

A QUICK WORD

THE MARK CONSISTS OF STANDARD CHARACTERS WITHOUT CLAIM TO ANY PARTICULAR FONT, STYLE, SIZE, OR COLOR.

FOR ENTERTAINMENT SERVICES, NAMELY, AN ONGOING COMMENTARY SERIES FEATURING INSPIRATIONAL CHRISTIAN CONTENT PROVIDED THROUGH RADIO, TELEVISION AND THE INTERNET (U.S. CLS. 100, 101 AND 107).

FIRST USE 5-30-2007; IN COMMERCE 5-30-2007.
EDWARD NELSON, EXAMINING ATTORNEY

SN 77-302,001. RE-CREATE YOURSELF NOW, LLC, SCOTTSDALE, AZ. FILED 10-11-2007.

Laws Of Positioning

THE MARK CONSISTS OF STANDARD CHARACTERS WITHOUT CLAIM TO ANY PARTICULAR FONT, STYLE, SIZE, OR COLOR.

FOR ARRANGING OF SEMINARS; ARRANGING AND CONDUCTING EDUCATIONAL CONFERENCES; BUSINESS TRAINING; CONDUCTING WORKSHOPS AND SEMINARS IN PERSONAL AWARENESS; CONDUCTING WORKSHOPS AND SEMINARS IN SELF AWARENESS; CONDUCTING WORKSHOPS AND SEMINARS IN PERSONAL IMPROVEMENT AND PERSONAL GROWTH; EDUCATION SERVICES, NAMELY, PROVIDING LIVE AND ON-LINE SEMINARS AND COURSES IN THE FIELD OF PERSONAL IMPROVEMENT AND PERSONAL GROWTH; EDUCATION SERVICES, NAMELY, PROVIDING SEMINARS AND COURSES IN THE FIELD OF PERSONAL IMPROVEMENT AND PERSONAL GROWTH; EDUCATION SERVICES, NAMELY, PROVIDING SEMINARS AND COURSES IN THE FIELDS OF PERSONAL IMPROVEMENT AND PERSONAL GROWTH; EDUCATIONAL SERVICES, NAMELY, PROVIDING SEMINARS AND COURSES IN THE FIELDS OF PERSONAL IMPROVEMENT AND PERSONAL GROWTH; EDUCATIONAL SERVICES, NAMELY, CONDUCTING SEMINARS AND COURSES IN THE FIELD OF PERSONAL IMPROVEMENT AND PERSONAL GROWTH AND THE DISTRIBUTION OF COURSE MATERIALS IN CONNECTION THEREWITH AND DISTRIBUTION OF COURSE MATERIAL IN CONNECTION THEREWITH; EDUCATIONAL SERVICES, NAMELY, CONDUCTING SEMINARS AND COURSES IN THE FIELD OF PERSONAL IMPROVEMENT AND PERSONAL GROWTH AND THE DISTRIBUTION OF COURSE MATERIALS IN CONNECTION THEREWITH; MEETING AND SEMINAR ARRANGING; PROVIDING CONTINUING BUSINESS EDUCATION COURSES; PROVIDING ON-LINE TRAINING SEMINARS AND COURSES IN THE FIELD OF PERSONAL IMPROVEMENT AND PERSONAL GROWTH; TRAINING COURSES IN STRATEGIC PLANNING RELATING TO ADVERTISING, PROMOTION, MARKETING AND BUSINESS; WORKSHOPS AND SEMINARS IN THE FIELD OF PERSONAL IMPROVEMENT AND PERSONAL GROWTH (U.S. CLS. 100, 101 AND 107).

FIRST USE 10-11-2007; IN COMMERCE 10-11-2007.
MARY CRAWFORD, EXAMINING ATTORNEY

CLASS 41—(Continued).

SN 77-303,310. NEW WEALTH PUBLISHING, INC., BELLEVUE, WA. FILED 10-12-2007.

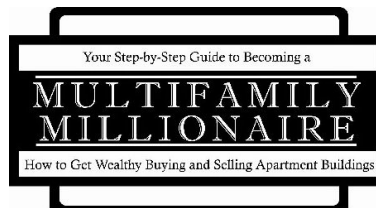

THE MARK CONSISTS OF A PARALLELOGRAM OVER ANOTHER PARALLELOGRAM. THE FRONT PARALLELOGRAM CONTAINING THE WORDS "YOUR STEP-BY-STEP GUIDE TO BECOMING A MULTIFAMILY MILLIONAIRE HOW TO GET WEALTHY BUYING AND SELLING APARTMENT BUILDINGS".

FOR EDUCATIONAL SERVICES, NAMELY, PROVIDING ONLINE TRAINING IN THE FIELD OF REAL ESTATE (U.S. CLS. 100, 101 AND 107).

FIRST USE 9-12-2007; IN COMMERCE 9-12-2007.
FLORENTINA BLANDU, EXAMINING ATTORNEY

SN 77-304,095. EBSCO INDUSTRIES, INC., BIRMINGHAM, AL. FILED 10-15-2007.

BIG WATER ADVENTURES

THE MARK CONSISTS OF STANDARD CHARACTERS WITHOUT CLAIM TO ANY PARTICULAR FONT, STYLE, SIZE, OR COLOR.

FOR ENTERTAINMENT IN THE NATURE OF ONGOING TELEVISION PROGRAMS IN THE FIELD OF FISHING; ENTERTAINMENT, NAMELY, A CONTINUING FISHING SHOW BROADCAST OVER TELEVISION, SATELLITE, AUDIO, AND VIDEO MEDIA (U.S. CLS. 100, 101 AND 107).

MICHAEL KEATING, EXAMINING ATTORNEY

SN 77-304,697. SAFER SKIES INC., DBA SAFER SKIES, NEW YORK, NY. FILED 10-15-2007.

SAFER SKIES

THE MARK CONSISTS OF STANDARD CHARACTERS WITHOUT CLAIM TO ANY PARTICULAR FONT, STYLE, SIZE, OR COLOR.

FOR EDUCATIONAL SERVICES, NAMELY, CONDUCTING CLASSES, SEMINARS, CONFERENCES, AND WORKSHOPS IN THE FIELD OF AVIATION TRAINING AND AVIATION SAFETY AND DISTRIBUTION OF COURSE MATERIAL IN CONNECTION THEREWITH (U.S. CLS. 100, 101 AND 107).

FIRST USE 9-30-2006; IN COMMERCE 9-30-2006.
BILL DAWE, EXAMINING ATTORNEY

CLASS 41—(Continued).

SN 77-305,371. CARNIVAL CORPORATION, MIAMI, FL. FILED 10-16-2007.

A-B-SEAS

THE MARK CONSISTS OF STANDARD CHARACTERS WITHOUT CLAIM TO ANY PARTICULAR FONT, STYLE, SIZE, OR COLOR.

FOR TODDLERS' ENTERTAINMENT PROGRAM PROVIDED ABOARD A CRUISE SHIP, NAMELY, READING STORIES, PUPPET SHOWS, SKITS AND GROUP THEATRICAL ACTIVITIES (U.S. CLS. 100, 101 AND 107).

FIRST USE 3-31-2004; IN COMMERCE 3-31-2004.
KATHERINE E. HALMEN, EXAMINING ATTORNEY



SN 77-305,388. CARNIVAL CORPORATION, MIAMI, FL. FILED 10-16-2007.

EDU-CRUISE

THE MARK CONSISTS OF STANDARD CHARACTERS WITHOUT CLAIM TO ANY PARTICULAR FONT, STYLE, SIZE, OR COLOR.

FOR EDUCATIONAL SERVICES FOR CHILDREN, NAMELY, CLASSES IN THE FIELDS OF CULTURE, LANDMARKS, HISTORY AND GEOGRAPHY OF SELECT COUNTRIES, ARTWORK AND ARTS AND CRAFTS (U.S. CLS. 100, 101 AND 107).

FIRST USE 6-30-2002; IN COMMERCE 6-30-2002.
KATHERINE E. HALMEN, EXAMINING ATTORNEY



SN 77-305,404. CARNIVAL CORPORATION, MIAMI, FL. FILED 10-16-2007.

EXERSEAS

THE MARK CONSISTS OF STANDARD CHARACTERS WITHOUT CLAIM TO ANY PARTICULAR FONT, STYLE, SIZE, OR COLOR.

FOR CHILDREN'S RECREATION AND FITNESS ACTIVITIES, NAMELY, AEROBICS, RECREATIONAL AND FITNESS CONTESTS, INDOOR AND OUTDOOR RECREATIONAL AND FITNESS GAMES (U.S. CLS. 100, 101 AND 107).

FIRST USE 4-30-2003; IN COMMERCE 4-30-2003.
KATHERINE E. HALMEN, EXAMINING ATTORNEY

CLASS 41—(Continued).

SN 77-305,421. CARNIVAL CORPORATION, MIAMI, FL. FILED 10-16-2007.

H2OCEAN

THE MARK CONSISTS OF STANDARD CHARACTERS WITHOUT CLAIM TO ANY PARTICULAR FONT, STYLE, SIZE, OR COLOR.

FOR CHILDREN'S EDUCATIONAL AND DEVELOPMENTAL PROGRAMS, NAMELY, SCIENCE CLASSES AND SEMINARS, ARTS AND CRAFTS CLASSES AND COOKING CLASSES (U.S. CLS. 100, 101 AND 107).

FIRST USE 6-30-2004; IN COMMERCE 6-30-2004.
KATHERINE E. HALMEN, EXAMINING ATTORNEY

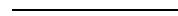

SN 77-305,495. 944 MEDIA, LLC, SCOTTSDALE, AZ. FILED 10-16-2007.

THE MOST POWERFUL ENTERTAINMENT MAGAZINE

THE MARK CONSISTS OF STANDARD CHARACTERS WITHOUT CLAIM TO ANY PARTICULAR FONT, STYLE, SIZE, OR COLOR.

NO CLAIM IS MADE TO THE EXCLUSIVE RIGHT TO USE "ENTERTAINMENT MAGAZINE", APART FROM THE MARK AS SHOWN.

FOR PROVIDING INFORMATION, NEWS AND COMMENTARY IN THE FIELD OF ENTERTAINMENT; ENTERTAINMENT SERVICES, NAMELY, PROVIDING PRERECORDED MUSIC, INFORMATION IN THE FIELD OF MUSIC, AND COMMENTARY AND ARTICLES ABOUT MUSIC, ALL ON-LINE VIA A GLOBAL COMPUTER NETWORK; ENTERTAINMENT SERVICES, NAMELY, PROVIDING ON-LINE REVIEWS OF NIGHT-LIFE VENUES, CONCERTS, ENTERTAINMENT ACTIVITIES IN SPECIFIC GEOGRAPHIC LOCALS (U.S. CLS. 100, 101 AND 107).

ELI HELLMAN, EXAMINING ATTORNEY

CLASS 41—(Continued).

SN 77-305,851. VERSUS, L.P., STAMFORD, CT. FILED 10-17-2007.

THE HUNTLEY WAY

THE MARK CONSISTS OF STANDARD CHARACTERS WITHOUT CLAIM TO ANY PARTICULAR FONT, STYLE, SIZE, OR COLOR.

FOR ENTERTAINMENT IN THE NATURE OF ON-GOING TELEVISION PROGRAMS IN THE FIELD OF OUTDOOR SPORTS; ENTERTAINMENT SERVICES, NAMELY, AN ON-GOING SERIES FEATURING OUTDOOR SPORTS PROVIDED THROUGH, CABLE TELEVISION, SATELLITE TELEVISION, MOBILE TELEVISION, WEBCASTS, PODCASTS; ENTERTAINMENT, NAMELY, A CONTINUING OUTDOOR SPORTS SHOW BROADCAST OVER TELEVISION, SATELLITE, AUDIO, AND VIDEO MEDIA (U.S. CLS. 100, 101 AND 107).

FIRST USE 9-29-2006; IN COMMERCE 9-29-2006.
BARNEY CHARLON, EXAMINING ATTORNEY

SN 77-307,713. HALL, KATHLEEN A., CLARKESVILLE, GA. FILED 10-18-2007.

MINDFUL LIVING EVERYDAY

THE MARK CONSISTS OF STANDARD CHARACTERS WITHOUT CLAIM TO ANY PARTICULAR FONT, STYLE, SIZE, OR COLOR.

FOR EDUCATIONAL SERVICES AND TRAINING, NAMELY, CONDUCTING SEMINARS, WEB SEMINARS, WORKSHOPS AND CONFERENCES FEATURING PERSONAL SPIRITUAL GROWTH, HEALING AND WELLNESS, AND IDENTIFYING, OVERCOMING AND AVOIDING STRESS AND DESTRUCTIVE BEHAVIOR (U.S. CLS. 100, 101 AND 107).

FIRST USE 3-20-2007; IN COMMERCE 3-20-2007.
JASON BLAIR, EXAMINING ATTORNEY

CLASS 41—(Continued).

SN 77-308,978. PASATIEMPO, INC., SANTA CRUZ, CA. FILED 10-19-2007.



NO CLAIM IS MADE TO THE EXCLUSIVE RIGHT TO USE "GOLF CLUB", APART FROM THE MARK AS SHOWN.

THE MARK CONSISTS OF A MAN SITTING UNDER PALM TREE WEARING SOMBRERO WITH THE STYLIZED WORDS "PASATIEMPO GOLF CLUB" UNDERNEATH.

THE ENGLISH TRANSLATION OF "PASATIEMPO" IS "PASSING OF TIME" OR "PASTIME".

FOR GOLF CLUB SERVICES (U.S. CLS. 100, 101 AND 107).

FIRST USE 9-9-1929; IN COMMERCE 9-9-1929.
NATALIE POLZER, EXAMINING ATTORNEY

SN 77-309,033. VERSUS, L.P., STAMFORD, CT. FILED 10-19-2007.

CITY LIMITS FISHING

THE MARK CONSISTS OF STANDARD CHARACTERS WITHOUT CLAIM TO ANY PARTICULAR FONT, STYLE, SIZE, OR COLOR.

NO CLAIM IS MADE TO THE EXCLUSIVE RIGHT TO USE "FISHING", APART FROM THE MARK AS SHOWN.

FOR ENTERTAINMENT IN THE NATURE OF ON-GOING TELEVISION PROGRAMS IN THE FIELD OF FISHING AND OUTDOOR RECREATION; ENTERTAINMENT SERVICES, NAMELY, AN ON-GOING SERIES FEATURING FISHING AND OUTDOOR RECREATION PROVIDED THROUGH SATELLITE AND CABLE TELEVISION; PRODUCTION OF CABLE TELEVISION PROGRAMS; TELEVISION SHOW PRODUCTION; DISTRIBUTION OF TELEVISION PROGRAMMING TO CABLE TELEVISION SYSTEMS (U.S. CLS. 100, 101 AND 107).

BARNEY CHARLON, EXAMINING ATTORNEY

CLASS 41—(Continued).

SN 77-309,630. PAUL FERRARA, MANALAPAN, NJ. FILED 10-22-2007.

Robert Fiance

THE MARK CONSISTS OF STANDARD CHARACTERS WITHOUT CLAIM TO ANY PARTICULAR FONT, STYLE, SIZE, OR COLOR.

THE NAME "ROBERT FIANCE" DOES NOT IDENTIFY A LIVING INDIVIDUAL.

FOR EDUCATIONAL SERVICES IN THE NATURE OF BEAUTY SCHOOLS, SPECIFICALLY, TEACHING HAIR STYLING, CUTTING, BEAUTY TREATMENTS, AND USE OF COSMETICS; TEACHING OF BEAUTY SKILLS (U.S. CLS. 100, 101 AND 107).

FIRST USE 10-12-2007; IN COMMERCE 10-12-2007.
DAVID COLLIER, EXAMINING ATTORNEY

SN 77-310,345. JESSICA DITTMER, MILO, IA. FILED 10-22-2007.

Develop Your Positives

THE MARK CONSISTS OF STANDARD CHARACTERS WITHOUT CLAIM TO ANY PARTICULAR FONT, STYLE, SIZE, OR COLOR.

FOR PHOTOGRAPHY SERVICES; PORTRAIT PHOTOGRAPHY (U.S. CLS. 100, 101 AND 107).

JORDAN BAKER, EXAMINING ATTORNEY

SN 77-314,247. NOBER, LEE, OLD BETHPAGE, NY. FILED 10-26-2007.

"The Nation Loves Lacrosse!"

THE MARK CONSISTS OF THE WORDS "THE NATION LOVE LACROSSE," WITH THE FIRST LETTERS N, L, AND L OF "NATION LOVES LACROSSE" IN BOLDER FONT, ALL OF WHICH IS FOLLOWED BY AN EXCLAMATION POINT.

FOR ARRANGING OF LACROSSE EXHIBITIONS; ENTERTAINMENT IN THE NATURE OF LACROSSE GAMES; ORGANIZATION OF LEAGUE SPORTS EVENTS IN THE FIELD OF LACROSSE; MAINTAINING A LACROSSE LEAGUE, NAMELY, ENTERTAINMENT IN THE NATURE OF LEAGUE LACROSSE GAMES (U.S. CLS. 100, 101 AND 107).

JOHN DALIER, EXAMINING ATTORNEY

CLASS 41—(Continued).

SN 77-315,773. UNIVERSAL CITY STUDIOS LLLP, UNIVERSAL CITY, CA. FILED 10-29-2007.

VOODOOWEEN

THE MARK CONSISTS OF STANDARD CHARACTERS WITHOUT CLAIM TO ANY PARTICULAR FONT, STYLE, SIZE, OR COLOR.

FOR ENTERTAINMENT SERVICES, NAMELY, AN ANNUAL HALLOWEEN-THEMED EVENT (U.S. CLS. 100, 101 AND 107).

FIRST USE 10-27-2007; IN COMMERCE 10-27-2007.
JEAN IM, EXAMINING ATTORNEY

SN 77-316,855. HARKINS REEL DEALS, LLC, SCOTTSDALE, AZ. FILED 10-30-2007.

STUDIO 1 CINEMAS

THE MARK CONSISTS OF STANDARD CHARACTERS WITHOUT CLAIM TO ANY PARTICULAR FONT, STYLE, SIZE, OR COLOR.

NO CLAIM IS MADE TO THE EXCLUSIVE RIGHT TO USE "STUDIO" AND "CINEMAS", APART FROM THE MARK AS SHOWN.

FOR MOVIE THEATRE SERVICES (U.S. CLS. 100, 101 AND 107).

EVELYN BRADLEY, EXAMINING ATTORNEY

SN 77-317,352. ALEGENT HEALTH, OMAHA, NE. FILED 10-30-2007.

THE ART OF BALANCE

THE MARK CONSISTS OF STANDARD CHARACTERS WITHOUT CLAIM TO ANY PARTICULAR FONT, STYLE, SIZE, OR COLOR.

FOR EDUCATION SERVICES, NAMELY, PROVIDING CLASSES AND SEMINARS IN THE FIELD OF LIFE COACHING (U.S. CLS. 100, 101 AND 107).

JENNIFER VASQUEZ, EXAMINING ATTORNEY

CLASS 41—(Continued).

SN 77-317,362. ALENT HEALTH, OMAHA, NE. FILED 10-30-2007.

THE ART OF SUPPORT

THE MARK CONSISTS OF STANDARD CHARACTERS WITHOUT CLAIM TO ANY PARTICULAR FONT, STYLE, SIZE, OR COLOR.

FOR EDUCATION SERVICES, NAMELY, PROVIDING CLASSES AND SEMINARS IN THE FIELD OF LIFE COACHING (U.S. CLS. 100, 101 AND 107).

JENNIFER VASQUEZ, EXAMINING ATTORNEY

SN 77-317,961. GAYLORD ENTERTAINMENT COMPANY, NASHVILLE, TN. FILED 10-31-2007.



NO CLAIM IS MADE TO THE EXCLUSIVE RIGHT TO USE "BLUEGRASS", APART FROM THE MARK AS SHOWN.

THE MARK CONSISTS OF THE WORD "BLUEGRASS" UNDERLINED WITH A CURVY LINE AND A BANJO. THE BODY OF THE BANJO IS PLACED UNDERNEATH THE "G" AND THE NECK OF THE BANJO IS SHOOTING UP BETWEEN THE "G" AND THE "R".

FOR ENTERTAINMENT, NAMELY, LIVE MUSIC CONCERTS (U.S. CLS. 100, 101 AND 107).

FIRST USE 6-0-1994; IN COMMERCE 6-0-1994.
MATTHEW PAPPAS, EXAMINING ATTORNEY

SN 77-318,260. BAXA CORPORATION, ENGLEWOOD, CO. FILED 10-31-2007.

STAR Center

THE MARK CONSISTS OF STANDARD CHARACTERS WITHOUT CLAIM TO ANY PARTICULAR FONT, STYLE, SIZE, OR COLOR.

NO CLAIM IS MADE TO THE EXCLUSIVE RIGHT TO USE "CENTER", APART FROM THE MARK AS SHOWN.

FOR EDUCATION SERVICES, NAMELY, PROVIDING CLASSES, SEMINARS, CONFERENCES AND WORKSHOPS IN THE FIELDS OF PHARMACY AND MANAGED HEALTH CARE (U.S. CLS. 100, 101 AND 107).

FIRST USE 7-1-2006; IN COMMERCE 9-1-2006.
WENDY GOODMAN, EXAMINING ATTORNEY

CLASS 41—(Continued).

SN 77-318,316. BAXA CORPORATION, ENGLEWOOD, CO. FILED 10-31-2007.



NO CLAIM IS MADE TO THE EXCLUSIVE RIGHT TO USE "CENTER", APART FROM THE MARK AS SHOWN.

THE MARK CONSISTS OF DESIGN MARK CONTAINING THE "STAR CENTER" NAME WITH AN ABSTRACT IMAGE OF A MOUNTAIN ABOVE THE NAME.

FOR EDUCATION SERVICES, NAMELY, PROVIDING CLASSES, SEMINARS, CONFERENCES AND WORKSHOPS IN THE FIELDS OF PHARMACY AND MANAGED HEALTH CARE (U.S. CLS. 100, 101 AND 107).

FIRST USE 7-1-2006; IN COMMERCE 9-1-2006.

WENDY GOODMAN, EXAMINING ATTORNEY

SN 77-319,274. VERSUS, L.P., STAMFORD, CT. FILED 11-1-2007.



OWNER OF U.S. REG. NOS. 3,270,348, 3,346,266 AND OTHERS.

THE COLOR(S) RED AND BLACK IS/ARE CLAIMED AS A FEATURE OF THE MARK.

THE MARK CONSISTS OF THE STYLIZED WORDS "VERSUS COUNTRY" IN THE COLOR RED BELOW THE STYLIZED LETTERS "VS." IN THE COLOR RED WHICH LETTERS ARE ON A BLACK CIRCULAR BACKGROUND AND OUTLINED WITH AN INCOMPLETE CIRCLE IN THE COLOR RED.

FOR ENTERTAINMENT IN THE NATURE OF AN ONGOING BLOCK OF TELEVISION PROGRAMMING FEATURING HUNTING AND FISHING PROGRAMS; PROVIDING INFORMATION ON-LINE IN THE FIELD OF ENTERTAINMENT CONCERNING TELEVISION PROGRAMS (U.S. CLS. 100, 101 AND 107).

FIRST USE 9-15-2007; IN COMMERCE 9-15-2007.

BARNEY CHARLON, EXAMINING ATTORNEY

CLASS 41—(Continued).

SN 77-319,318. VERSUS, L.P., STAMFORD, CT. FILED 11-1-2007.

CLASS 41—(Continued).

SN 77-319,822. APM VENTURES, INC., THE WOODLANDS, TX. FILED 11-2-2007.



ONE 30 FITNESS

OWNER OF U.S. REG. NOS. 3,270,348, 3,346,266 AND OTHERS.

THE COLOR(S) RED AND BLACK IS/ARE CLAIMED AS A FEATURE OF THE MARK.

THE MARK CONSISTS OF THE WORDS "VERSUS" AND "COUNTRY" IN THE COLOR RED ON THE RIGHT AND LEFT SIDE OF THE STYLIZED LETTERS "VS." IN THE COLOR RED WHICH LETTERS ARE ON A BLACK CIRCULAR BACKGROUND AND OUTLINED WITH AN INCOMPLETE CIRCLE IN THE COLOR RED.

FOR ENTERTAINMENT IN THE NATURE OF AN ONGOING BLOCK OF TELEVISION PROGRAMMING FEATURING HUNTING AND FISHING PROGRAMS; PROVIDING INFORMATION ON-LINE IN THE FIELD OF ENTERTAINMENT CONCERNING TELEVISION PROGRAMS (U.S. CLS. 100, 101 AND 107).

FIRST USE 9-15-2007; IN COMMERCE 9-15-2007.
BARNEY CHARLON, EXAMINING ATTORNEY

THE MARK CONSISTS OF STANDARD CHARACTERS WITHOUT CLAIM TO ANY PARTICULAR FONT, STYLE, SIZE, OR COLOR.

NO CLAIM IS MADE TO THE EXCLUSIVE RIGHT TO USE "FITNESS", APART FROM THE MARK AS SHOWN.

FOR PERSONAL TRAINING SERVICES, NAMELY, STRENGTH AND CONDITIONING TRAINING (U.S. CLS. 100, 101 AND 107).

FIRST USE 12-26-2007; IN COMMERCE 12-26-2007.
KIMBERLY PERRY, EXAMINING ATTORNEY

SN 77-319,565. THE VANDERBILT UNIVERSITY, NASHVILLE, TN. FILED 11-1-2007.

SN 77-322,204. BARBER PRODUCTIONS, INC., ORANGE, CT. FILED 11-6-2007.

VANDERBILT HEALTH

THE REAL LIFE SURVIVAL GUIDE

THE MARK CONSISTS OF STANDARD CHARACTERS WITHOUT CLAIM TO ANY PARTICULAR FONT, STYLE, SIZE, OR COLOR.

OWNER OF U.S. REG. NOS. 1,642,042, 2,778,959 AND OTHERS.

NO CLAIM IS MADE TO THE EXCLUSIVE RIGHT TO USE "HEALTH", APART FROM THE MARK AS SHOWN.

FOR EDUCATIONAL SERVICES, NAMELY, CONDUCTING CLASSES, CONFERENCES, COURSES, LECTURES, MEETINGS, SEMINARS, SYMPOSIUMS, TRAINING PROGRAMS AND WORKSHOPS, IN THE FIELDS OF DISEASES, DISEASE PREVENTION, HEALTH CARE, MEDICINE, MEDICAL RESEARCH AND MEDICAL SERVICES, AND DISTRIBUTING COURSE MATERIALS IN CONNECTION THEREWITH (U.S. CLS. 100, 101 AND 107).

SAMUEL E. SHARPER JR., EXAMINING ATTORNEY

THE MARK CONSISTS OF STANDARD CHARACTERS WITHOUT CLAIM TO ANY PARTICULAR FONT, STYLE, SIZE, OR COLOR.

NO CLAIM IS MADE TO THE EXCLUSIVE RIGHT TO USE "GUIDE", APART FROM THE MARK AS SHOWN.

FOR ENTERTAINMENT SERVICES, NAMELY, AN ON-GOING SERIES FEATURING INFORMATION OF INTEREST TO FAMILIES AND FAMILY MEMBERS PROVIDED THROUGH RADIO BROADCASTS, WEBCASTS AND PODCASTS (U.S. CLS. 100, 101 AND 107).

FIRST USE 11-4-2007; IN COMMERCE 11-4-2007.
MATTHEW MCDOWELL, EXAMINING ATTORNEY

CLASS 41—(Continued).

SN 77-324,772. ERICKSON-ROBINSON, ASHLEY, CANYON COUNTRY, CA. FILED 11-8-2007.

TEAGAN RAW

THE MARK CONSISTS OF STANDARD CHARACTERS WITHOUT CLAIM TO ANY PARTICULAR FONT, STYLE, SIZE, OR COLOR.

THE NAME SHOWN IN THE MARK IDENTIFIES "ASHLEY ERICKSON-ROBINSON" WHOSE CONSENT IS OF RECORD.

FOR ENTERTAINMENT SERVICES, NAMELY, PROVIDING VISUAL IMAGES, VIDEO CLIPS, AUDIO CLIPS, FILM CLIPS, PHOTOGRAPHS, AND OTHER MULTIMEDIA MATERIALS IN THE FIELD OF ADULT ENTERTAINMENT VIA THE INTERNET; ENTERTAINMENT SERVICES, NAMELY, PROVIDING A WEBSITE FEATURING INFORMATION IN THE FIELD OF ADULT ENTERTAINMENT AND BLOGS IN THE FIELD OF ADULT ENTERTAINMENT (U.S. CLS. 100, 101 AND 107).

FIRST USE 10-30-2007; IN COMMERCE 10-30-2007.
WON TEAK OH, EXAMINING ATTORNEY

CLASS 41—(Continued).

SN 77-331,334. MPOWER VENTURES, LP, AUSTIN, TX. FILED 11-16-2007.



NO CLAIM IS MADE TO THE EXCLUSIVE RIGHT TO USE "RELATIONSHIP & INFORMATION SERIES FOR ENTREPRENEURS", APART FROM THE MARK AS SHOWN.

FOR EDUCATIONAL SERVICES, NAMELY, ORGANIZING AND CONDUCTING EDUCATIONAL SEMINARS, CONFERENCES, TRAINING PROGRAMS AND CLASSES TO ASSIST ENTREPRENEURS WITH DEVELOPING, STARTING, MANAGING, PROMOTING, AND OPERATING BUSINESSES AND ENTREPRENEURIAL VENTURES (U.S. CLS. 100, 101 AND 107).

FIRST USE 11-0-2006; IN COMMERCE 11-0-2006.
AMY GEARIN, EXAMINING ATTORNEY

SN 77-324,893. TWENTIETH CENTURY FOX FILM CORPORATION, LOS ANGELES, CA. FILED 11-8-2007.

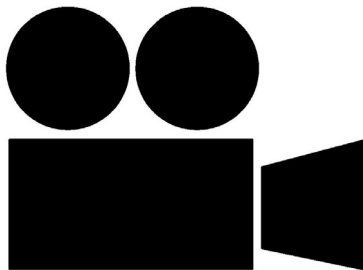

FOR ENTERTAINMENT SERVICES IN THE NATURE OF ON-GOING TELEVISION SEGMENTS FEATURING SPORTS; PROVIDING ON-LINE INFORMATION IN THE FIELD OF SPORTS, NEWS AND ENTERTAINMENT (U.S. CLS. 100, 101 AND 107).

MICHAEL GAFFAR, EXAMINING ATTORNEY

SN 77-349,134. CHEYENNE MOUNTAIN ENTERTAINMENT, INC., MESA, AZ. FILED 12-11-2007.

CLIQPLA.NET

THE MARK CONSISTS OF STANDARD CHARACTERS WITHOUT CLAIM TO ANY PARTICULAR FONT, STYLE, SIZE, OR COLOR.

FOR ENTERTAINMENT SERVICES, NAMELY, PROVIDING AN ON-LINE COMPUTER GAME FOR OTHERS OVER GLOBAL AND LOCAL AREA COMPUTER NETWORKS; PROVIDING AND HOSTING ONLINE COMPUTER GAME COMPETITIONS FOR OTHERS OVER GLOBAL AND LOCAL AREA COMPUTER NETWORKS; PROVIDING NEWS AND INFORMATION ONLINE RELATING TO COMPUTER GAMES, VIDEO GAMES AND COMPUTER AND VIDEO GAME RELATED PRODUCTS (U.S. CLS. 100, 101 AND 107).

KATHERINE STOIDES, EXAMINING ATTORNEY

CLASS 41—(Continued).

SN 77-349,496. CHEYENNE MOUNTAIN ENTERTAINMENT, INC., MESA, AZ. FILED 12-11-2007.

PROVOQ

THE MARK CONSISTS OF STANDARD CHARACTERS WITHOUT CLAIM TO ANY PARTICULAR FONT, STYLE, SIZE, OR COLOR.

FOR ENTERTAINMENT SERVICES, NAMELY, PROVIDING AN ON-LINE COMPUTER GAME FOR OTHERS OVER GLOBAL AND LOCAL AREA COMPUTER NETWORKS; PROVIDING AND HOSTING ONLINE COMPUTER GAME COMPETITIONS FOR OTHERS OVER GLOBAL AND LOCAL AREA COMPUTER NETWORKS (U.S. CLS. 100, 101 AND 107).

KATHERINE STOIDES, EXAMINING ATTORNEY

CLASS 41—(Continued).

SN 78-230,027. WOOF'S! DOG TRAINING CENTER, LLC, ARLINGTON, VA. FILED 3-26-2003.

WOOF'S! DOG TRAINING CENTER

NO CLAIM IS MADE TO THE EXCLUSIVE RIGHT TO USE "DOG TRAINING CENTER", APART FROM THE MARK AS SHOWN.

FOR OBEDIENCE SCHOOL TRAINING FOR DOGS (U.S. CLS. 100, 101 AND 107).
MONIQUE MILLER, EXAMINING ATTORNEY

SN 77-354,285. KEYCORP, CLEVELAND, OH. FILED 12-18-2007.

KEY4KIDS

THE MARK CONSISTS OF STANDARD CHARACTERS WITHOUT CLAIM TO ANY PARTICULAR FONT, STYLE, SIZE, OR COLOR.

OWNER OF U.S. REG. NOS. 2,093,723, 3,210,576 AND OTHERS.

FOR EDUCATIONAL SERVICES, NAMELY, CONDUCTING CLASSES, SEMINARS, CONFERENCES, WORKSHOPS AND ONLINE SERVICES IN THE FIELD OF FINANCIAL LITERACY PROGRAMS FOR CHILDREN AND DISTRIBUTION OF COURSE MATERIAL IN CONNECTION THEREWITH (U.S. CLS. 100, 101 AND 107).

ANTHONY RINKER, EXAMINING ATTORNEY

SN 78-429,268. COUNCIL ON EDUCATION IN MANAGEMENT, CHARLOTTE, NC. FILED 6-3-2004.

FOCUS

SN 77-975,203. SAMARRA, KENNETH, ROCHESTER, NY. FILED 5-23-2007.

SPACELOTTO

THE MARK CONSISTS OF STANDARD CHARACTERS WITHOUT CLAIM TO ANY PARTICULAR FONT, STYLE, SIZE, OR COLOR.

FOR ORGANIZING AND CONDUCTING LOTTERIES, FOR OTHERS, IN THE FIELD OF SPACE TRIPS AND TRIPS TO SPACE-RELATED DESTINATIONS (U.S. CLS. 100, 101 AND 107).

FIRST USE 5-30-2002; IN COMMERCE 5-30-2002.
KIMBERLY FRYE, EXAMINING ATTORNEY

THE MARK CONSISTS OF STANDARD CHARACTERS WITHOUT CLAIM TO ANY PARTICULAR FONT, STYLE, SIZE, OR COLOR.

FOR EDUCATIONAL SERVICES, NAMELY, CONDUCTING TRAINING SESSIONS, SEMINARS AND CONFERENCE IN THE FIELD OF HEALTH CARE AND BENEFITS AND DISTRIBUTING COURSE MATERIALS IN CONNECTION THEREWITH (U.S. CLS. 100, 101 AND 107).

BARBARA GAYNOR, EXAMINING ATTORNEY

CLASS 41—(Continued).

SN 78-566,019. FORCE OF NATURE, INC., LOS ALTOS, CA. FILED 2-11-2005.



THE COLOR(S) ORANGE AND WHITE IS/ARE CLAIMED AS A FEATURE OF THE MARK.

THE MARK CONSISTS OF A DEPICTION OF A HAND PRINT IN ORANGE; THE TERM "I AM A FORCE OF NATURE" IS WHITE, AS IS THE ENTIRE BACKGROUND OF THE MARK.

FOR ENTERTAINMENT SERVICES, NAMELY, LIVE MUSIC CONCERTS; TELEVISION PRODUCTION SERVICES (U.S. CLS. 100, 101 AND 107).

JIM RINGLE, EXAMINING ATTORNEY

SN 78-567,195. BROWN, TEDRIC R., DALLAS, TX. FILED 2-14-2005.

Hip-Hop Nonstop T. V. SHOW

THE MARK CONSISTS OF STANDARD CHARACTERS WITHOUT CLAIM TO ANY PARTICULAR FONT, STYLE, SIZE, OR COLOR.

NO CLAIM IS MADE TO THE EXCLUSIVE RIGHT TO USE T.V. SHOW, APART FROM THE MARK AS SHOWN. SEC. 2(F).

FOR ENTERTAINMENT IN THE NATURE OF AN ONGOING TELEVISION SHOW FEATURING HIP HOP ARTISTS, SPORTS CELEBRITIES, AND MOVIE STARS (U.S. CLS. 100, 101 AND 107).

DORITT L. CARROLL, EXAMINING ATTORNEY

CLASS 41—(Continued).

SN 78-632,650. MARKETING CONTENT PARTNERS LLC, SANTA MONICA, CA. FILED 5-18-2005.

MOJO MASTER

THE MARK CONSISTS OF STANDARD CHARACTERS WITHOUT CLAIM TO ANY PARTICULAR FONT, STYLE, SIZE, OR COLOR.

FOR ENTERTAINMENT SERVICES, NAMELY, PROVIDING ON-LINE COMPUTER GAMES (U.S. CLS. 100, 101 AND 107).

PAUL E. FAHRENKOPF, EXAMINING ATTORNEY

SN 78-633,263. MARKETING CONTENT PARTNERS LLC, SANTA MONICA, CA. FILED 5-19-2005.



THE NAME(S), PORTRAIT(S), AND/OR SIGNATURE(S) SHOWN IN THE MARK DOES NOT IDENTIFY A PARTICULAR LIVING INDIVIDUAL.

THE COLOR(S) RED, BLACK AND TAN IS/ARE CLAIMED AS A FEATURE OF THE MARK.

THE MARK CONSISTS OF "MOJO MASTER" IN RED, THE WOMEN'S OUTFIT IN RED, HER SHOES WHICH ARE BLACK, HER SKIN WHICH IS TAN, HER HAIR WHICH IS BLACK, ALL ON A BLACK BACKGROUND.

FOR ENTERTAINMENT SERVICES, NAMELY, PROVIDING ON-LINE COMPUTER GAMES (U.S. CLS. 100, 101 AND 107).

PAUL E. FAHRENKOPF, EXAMINING ATTORNEY

SN 78-640,533. BUILDING CHAMPIONS, INC., LAKE OSWEGO, OR. FILED 5-31-2005.

THE CHAMPION'S CHOICE

THE MARK CONSISTS OF STANDARD CHARACTERS WITHOUT CLAIM TO ANY PARTICULAR FONT, STYLE, SIZE, OR COLOR.

OWNER OF U.S. REG. NOS. 2,622,915, 2,856,198 AND OTHERS.

FOR CONDUCTING MONTHLY EDUCATIONAL CONFERENCES VIA TELEPHONE IN THE FIELD OF MORTGAGE BANKING AND MORTGAGE LENDING FOR CLIENTS, MORTGAGE PROFESSIONALS, INDUSTRY PARTNERS WHO PROVIDE SERVICES TO THE MORTGAGE INDUSTRY, COLLEAGUES AND GUESTS (U.S. CLS. 100, 101 AND 107).

NELSON SNYDER, EXAMINING ATTORNEY

CLASS 41—(Continued).

SN 78-656,482. REID, GRAHAM C. M., TORONTO, CANADA, FILED 6-22-2005.

Jazz by Genre

THE MARK CONSISTS OF STANDARD CHARACTERS WITHOUT CLAIM TO ANY PARTICULAR FONT, STYLE, SIZE, OR COLOR.

PRIORITY CLAIMED UNDER SEC. 44(D) ON CANADA APPLICATION NO. 1261659, FILED 6-17-2005, REG. NO. TMA695565, DATED 9-4-2007, EXPIRES 9-4-2022.

NO CLAIM IS MADE TO THE EXCLUSIVE RIGHT TO USE "JAZZ", APART FROM THE MARK AS SHOWN.

FOR CONDUCTING ENTERTAINMENT EXHIBITIONS IN THE NATURE OF MUSIC FESTIVALS AND PARADES; CONDUCTING WORKSHOPS IN THE FIELD OF MUSIC (U.S. CLS. 100, 101 AND 107).

ROBERT C. CLARK JR., EXAMINING ATTORNEY

CLASS 41—(Continued).

SN 78-769,525. CERTAINTED CORPORATION, VALLEY FORGE, PA. FILED 12-8-2005.



SEC. 2(F) AS TO "SHINGLE ROOFER".
FOR PROVIDING RECOGNITION BY WAY OF CERTIFICATE AND AWARDS TO DEMONSTRATE EXCELLENCE IN THE FIELD OF ROOFING (U.S. CLS. 100, 101 AND 107).

FIRST USE 1-0-1998; IN COMMERCE 1-0-1998.
KELLY MCCOY, EXAMINING ATTORNEY

SN 78-746,845. WALNUT CREEK TECHNOLOGY GROUP, WALNUT CREEK, CA. FILED 11-3-2005.

NEWSETA

THE MARK CONSISTS OF STANDARD CHARACTERS WITHOUT CLAIM TO ANY PARTICULAR FONT, STYLE, SIZE, OR COLOR.

FOR PROVIDING A WEBSITE FOR OTHERS FEATURING NEWS ARTICLES IN THE FIELD OF CURRENT EVENTS (U.S. CLS. 100, 101 AND 107).

TEJBIR SINGH, EXAMINING ATTORNEY

SN 78-769,603. CERTAINTED CORPORATION, VALLEY FORGE, PA. FILED 12-8-2005.

ROOFER'S REWARDS

THE MARK CONSISTS OF STANDARD CHARACTERS WITHOUT CLAIM TO ANY PARTICULAR FONT, STYLE, SIZE, OR COLOR.

NO CLAIM IS MADE TO THE EXCLUSIVE RIGHT TO USE "ROOFER'S", APART FROM THE MARK AS SHOWN.

SEC. 2(F).
FOR EDUCATIONAL SERVICES, NAMELY, PROVIDING INCENTIVES TO ROOFING CONTRACTORS TO DEMONSTRATE EXCELLENCE IN THE FIELD OF ROOFING THROUGH THE ISSUANCE OF AWARDS (U.S. CLS. 100, 101 AND 107).

FIRST USE 1-0-2001; IN COMMERCE 1-0-2001.
KELLY MCCOY, EXAMINING ATTORNEY

SN 78-769,439. CERTAINTED CORPORATION, VALLEY FORGE, PA. FILED 12-8-2005.



SEC. 2(F) AS TO "MASTER SHINGLE APPLICATOR".
FOR EDUCATIONAL TESTING IN THE FIELD OF ROOFING (U.S. CLS. 100, 101 AND 107).
FIRST USE 1-0-1993; IN COMMERCE 1-0-1993.
KELLY MCCOY, EXAMINING ATTORNEY

SN 78-820,483. THOMAS, PHILLIP, KEW GARDENS, NY. FILED 2-22-2006.

Friday

THE MARK CONSISTS OF STANDARD CHARACTERS WITHOUT CLAIM TO ANY PARTICULAR FONT, STYLE, SIZE, OR COLOR.

FOR LIVE PERFORMANCES BY A MUSICAL ARTIST (U.S. CLS. 100, 101 AND 107).

WILLIAM VERHOSEK, EXAMINING ATTORNEY

CLASS 41—(Continued).

SN 78-853,153. SOIRÉE PRODUCTIONS, L.L.C., PARK CITY, UT. FILED 4-4-2006.

SOIRÉE PRODUCTIONS

THE MARK CONSISTS OF STANDARD CHARACTERS WITHOUT CLAIM TO ANY PARTICULAR FONT, STYLE, SIZE, OR COLOR.

SEC. 2(F).

FOR SPECIAL EVENT AND PARTY PLANNING AND CONSULTATIONS SERVICES (U.S. CLS. 100, 101 AND 107).

FIRST USE 7-1-2000; IN COMMERCE 7-1-2000.

AISHA CLARKE, EXAMINING ATTORNEY

SN 78-855,363. ANATOMY MEDIA, INC., NEW YORK, NY. FILED 4-6-2006.

ANATOMY

THE MARK CONSISTS OF STANDARD CHARACTERS WITHOUT CLAIM TO ANY PARTICULAR FONT, STYLE, SIZE, OR COLOR.

FOR SCRIPT WRITING FOR TELEVISION NETWORK PROMOTION; EDITORIAL SERVICES, NAMELY, EDITORIAL CONSULTATION, WRITTEN TEXT EDITING; MOTION PICTURE FILM PRODUCTION; VIDEOTAPE PRODUCTION (U.S. CLS. 100, 101 AND 107).

GILBERT SWIFT, EXAMINING ATTORNEY

SN 78-855,403. ANATOMY MEDIA, INC., NEW YORK, NY. FILED 4-6-2006.

anatomy media, inc.

THE MARK CONSISTS OF STANDARD CHARACTERS WITHOUT CLAIM TO ANY PARTICULAR FONT, STYLE, SIZE, OR COLOR.

NO CLAIM IS MADE TO THE EXCLUSIVE RIGHT TO USE "MEDIA, INC.", APART FROM THE MARK AS SHOWN.

FOR SCRIPT WRITING FOR TELEVISION NETWORK PROMOTION; EDITORIAL SERVICES, NAMELY, EDITORIAL CONSULTATION, WRITTEN TEXT EDITING; MOTION PICTURE FILM PRODUCTION; VIDEOTAPE PRODUCTION (U.S. CLS. 100, 101 AND 107).

FIRST USE 12-18-2001; IN COMMERCE 12-18-2001.

GILBERT SWIFT, EXAMINING ATTORNEY

CLASS 41—(Continued).

SN 78-861,915. KIDTRIBE, INC., SANTA MONICA, CA. FILED 4-14-2006.

KidTribe

THE MARK CONSISTS OF STANDARD CHARACTERS WITHOUT CLAIM TO ANY PARTICULAR FONT, STYLE, SIZE, OR COLOR.

FOR EDUCATION SERVICES, NAMELY, PROVIDING CLASSES, SEMINARS, AND WORKSHOPS IN THE FIELD OF CHILD EDUCATION, HEALTH, FITNESS AND MOTIVATION; ENTERTAINMENT IN THE NATURE OF LIVE MUSIC CONCERTS, CONDUCTING ASSEMBLIES IN THE FIELD OF HEALTH AND FITNESS FOR CHILDREN, CONDUCTING PARTIES FOR CHILDREN, AND LIVE SHOW PERFORMANCES FEATURING MUSIC, SONGS AND DIALOGUE; ALL OF THE FOREGOING SPECIFICALLY EXCLUDING THE SPORT OF BASEBALL (U.S. CLS. 100, 101 AND 107).

FIRST USE 3-30-2002; IN COMMERCE 3-30-2002.

ANDREA K. NADELMAN, EXAMINING ATTORNEY

SN 78-885,837. LA TOURAINÉ, INC., SAN DIEGO, CA. FILED 5-17-2006.

DIARY OF A MILF

THE MARK CONSISTS OF STANDARD CHARACTERS WITHOUT CLAIM TO ANY PARTICULAR FONT, STYLE, SIZE, OR COLOR.

FOR PROVIDING AN ONLINE INTERACTIVE WEB SITE FEATURING ADULT ENTERTAINMENT SUBJECT MATTER (U.S. CLS. 100, 101 AND 107).

FIRST USE 2-20-2006; IN COMMERCE 2-20-2006.

CHRISTINE COOPER, EXAMINING ATTORNEY

SN 78-895,675. GREEN SPLATT PUBLISHERS, INC., LAS VEGAS, NV. FILED 5-30-2006.

GREEN SPLATT

THE MARK CONSISTS OF STANDARD CHARACTERS WITHOUT CLAIM TO ANY PARTICULAR FONT, STYLE, SIZE, OR COLOR.

FOR PUBLISHING SERVICES, NAMELY, PUBLISHING OF PRINTED AND ELECTRONIC EDUCATIONAL MATERIALS FOR OTHERS IN THE NATURE OF LECTURE NOTES, LAB MANUALS, TRAINING MANUALS, EXAM MATERIALS, JOURNALS, WORKBOOKS, FICTION AND NON-FICTION BOOKS, PERIODICALS AND MAGAZINES IN ALL FIELDS OF EDUCATIONAL ACTIVITY (U.S. CLS. 100, 101 AND 107).

KAREN BRACEY, EXAMINING ATTORNEY

CLASS 41—(Continued).

SN 78-898,199. IMPELSYS, NEW YORK, NY. FILED 6-1-2006.



THE COLOR(S) RED, BLACK AND DARK ORANGE IS/ ARE CLAIMED AS A FEATURE OF THE MARK.

THE MARK CONSISTS OF IPLATFORM WHICH CONSISTS OF THE LETTER "I" IN RED, THE WORD "PLATFORM" IN BLACK AND AT THE END OF THE WORD IS A RED COMPUTER SCREEN WITH A DARK ORANGE BASE.

FOR ELECTRONIC PUBLISHING SERVICES, NAMELY, PUBLICATION OF TEXT AND GRAPHIC WORKS OF OTHERS ON ON-LINE PORTALS FEATURING BOOKS, JOURNALS, MAGAZINES, AND NEWSPAPERS (U.S. CLS. 100, 101 AND 107).

JASON BLAIR, EXAMINING ATTORNEY

SN 78-918,058. OPEN SPACE INSTITUTE, INC., NEW YORK, NY. FILED 6-27-2006.



WORLD OCEAN OBSERVATORY

NO CLAIM IS MADE TO THE EXCLUSIVE RIGHT TO USE "WORLD OCEAN OBSERVATORY", APART FROM THE MARK AS SHOWN.

THE COLOR(S) DARK BLUE AND WHITE IS/ARE CLAIMED AS A FEATURE OF THE MARK.

THE MARK CONSISTS OF A WHITE FIELD, WITH THE WORDS "WORLD OCEAN OBSERVATORY" IN DARK BLUE AND ABOVE THE WORDS IS AN OBLONG-SHAPED DARK BLUE AND WHITE DEPICTION OF THE WORLD.

FOR EDUCATIONAL SERVICES, NAMELY, CLASSES, SEMINARS AND WORKSHOPS ABOUT THE OCEAN AND ITS GLOBAL IMPACT ON HUMAN HEALTH, WEALTH AND SURVIVAL (U.S. CLS. 100, 101 AND 107).

FIRST USE 12-31-2004; IN COMMERCE 12-13-2005.

JENNY PARK, EXAMINING ATTORNEY

SN 78-919,171. THE NEW YORK RACING ASSOCIATION INC., JAMAICA, NY. FILED 6-28-2006.

NASSAU COUNTY

THE MARK CONSISTS OF STANDARD CHARACTERS WITHOUT CLAIM TO ANY PARTICULAR FONT, STYLE, SIZE, OR COLOR.

SEC. 2(F).

FOR ENTERTAINMENT IN THE NATURE OF HORSE-RACES (U.S. CLS. 100, 101 AND 107).

FIRST USE 0-0-1996; IN COMMERCE 0-0-1996.

CORY BOONE, EXAMINING ATTORNEY

CLASS 41—(Continued).

SN 78-919,946. THE INSTITUTE FOR GLOBAL ENVIRONMENTAL STRATEGIES, ARLINGTON, VA. FILED 6-29-2006.



NO CLAIM IS MADE TO THE EXCLUSIVE RIGHT TO USE "THE ALLIANCE FOR EARTH OBSERVATIONS", APART FROM THE MARK AS SHOWN.

THE MARK CONSISTS OF A CIRCLE WITH TOPICAL GRAPHICS AND THE WORDS "THE ALLIANCE FOR EARTH OBSERVATIONS".

FOR EDUCATION SERVICES, NAMELY, PROVIDING SEMINARS, WORKSHOPS AND CONFERENCES FOR PROMOTING THE UNDERSTANDING OF INFORMATION FROM GOVERNMENT AND COMMERCIAL SOURCES IN THE FIELD OF EARTH OBSERVATIONS (U.S. CLS. 100, 101 AND 107).

FIRST USE 9-25-2007; IN COMMERCE 9-25-2007.

NAKIA HENRY, EXAMINING ATTORNEY

SN 78-928,551. TIME WARNER CABLE INC., STAMFORD, CT. FILED 7-13-2006.

CABLE 6

THE MARK CONSISTS OF STANDARD CHARACTERS WITHOUT CLAIM TO ANY PARTICULAR FONT, STYLE, SIZE, OR COLOR.

NO CLAIM IS MADE TO THE EXCLUSIVE RIGHT TO USE "CABLE", APART FROM THE MARK AS SHOWN.

SEC. 2(F).

FOR ENTERTAINMENT SERVICES IN THE NATURE OF A CONTINUOUS RUNNING CABLE TELEVISION PROGRAM SPECIALIZING IN NEWS, WEATHER, CURRENT EVENTS AND INFORMATION ON TOPICS OF GENERAL INTEREST; PROVIDING INFORMATION ONLINE RELATING TO NEWS, WEATHER, CURRENT EVENTS AND INFORMATION ON TOPICS OF GENERAL INTEREST (U.S. CLS. 100, 101 AND 107).

FIRST USE 8-1-1982; IN COMMERCE 8-1-1982.

GEOFFREY FOSDICK, EXAMINING ATTORNEY

CLASS 41—(Continued).

SN 78-930,603. HEBRON SOFT LIMITED, TAIPEI, TAIWAN, FILED 7-17-2006.

THE MARK CONSISTS OF THE WORD "LIVEABC" WITH DIAMOND CONTOURS POSITIONED ABOVE AND ARCUATELY EXTENDING FROM THE LETTER "I" TO THE LETTER "E".

FOR ANALYZING EDUCATIONAL TEST SCORES AND DATA FOR OTHERS; BOOK AND REVIEW PUBLISHING; DEVELOPING EDUCATIONAL MANUALS FOR OTHERS IN THE FIELD OF LANGUAGE LEARNING; EDITING OR RECORDING OF SOUNDS AND IMAGES; EDUCATING AT SENIOR HIGH SCHOOLS; EDUCATING AT UNIVERSITY OR COLLEGES; EDUCATION IN THE FIELD OF LANGUAGE LEARNING RENDERED THROUGH CORRESPONDENCE COURSE; EDUCATION SERVICES IN THE NATURE OF COURSES AT THE UNIVERSITY LEVEL; EDUCATION SERVICES, NAMELY, MENTORING IN THE FIELD OF LANGUAGE LEARNING; EDUCATION SERVICES, NAMELY, PROVIDING TUTORIAL SESSIONS IN THE FIELD OF LANGUAGE LEARNING; EDUCATIONAL DEMONSTRATIONS; EDUCATIONAL EXAMINATION SERVICES; EDUCATION SERVICES IN THE NATURE OF CORRESPONDENCE SCHOOLS; EDUCATION SERVICES, NAMELY, CONDUCTING ON-LINE EXHIBITIONS AND DISPLAYS AND INTERACTIVE EXHIBITS IN THE FIELD OF LANGUAGE LEARNING; LANGUAGE INSTRUCTION; MAGAZINE PUBLISHING; MOBILE MEDIA AND ENTERTAINMENT SERVICES IN THE NATURE OF CONTENT PREPARATION, POST-PRODUCTION; ON-LINE LIBRARY SERVICES, NAMELY, PROVIDING ELECTRONIC LIBRARY SERVICES WHICH FEATURE NEWSPAPERS, MAGAZINES, PHOTOGRAPHS AND PICTURES VIA AN ON-LINE COMPUTER NETWORK; ON-LINE PUBLICATION OF BOOKS AND MAGAZINES FEATURING LANGUAGE LEARNING MATERIALS; PREPARING, ADMINISTERING, AND SCORING STANDARDIZED TESTS; PROVIDING COURSES OF INSTRUCTION AT THE JUNIOR AND SENIOR HIGH SCHOOL, COLLEGE AND POST-GRADUATE LEVEL; CONDUCTING ON-LINE CLASSES IN THE FIELD OF LANGUAGE LEARNING; PUBLICATION AND EDITING OF PRINTED MATTER; PUBLICATION OF BOOKS; PUBLICATION OF ELECTRONIC MAGAZINES; PUBLICATION OF TEXT BOOKS; PUBLICATION OF TEXTS, BOOKS, MAGAZINES AND OTHER PRINTED MATTER; PUBLISHING OF BOOKS, REVIEWS AND OTHER PRINTED MATTER; PUBLISHING OF WEB MAGAZINES (U.S. CLS. 100, 101 AND 107).
LINDA LAVACHE, EXAMINING ATTORNEY

SN 78-938,772. GOODMAN, GORDON, SOMIS, CA. FILED 7-27-2006.

HypnoCast

THE MARK CONSISTS OF STANDARD CHARACTERS WITHOUT CLAIM TO ANY PARTICULAR FONT, STYLE, SIZE, OR COLOR.

FOR EDUCATION SERVICES, NAMELY, PROVIDING CLASSES, SEMINARS, LECTURES, AND WORKSHOPS IN THE FIELD OF BEHAVIORAL IMPROVEMENT (U.S. CLS. 100, 101 AND 107).

FIRST USE 5-9-2006; IN COMMERCE 6-7-2006.

TIMOTHY FINNEGAN, EXAMINING ATTORNEY

CLASS 41—(Continued).

SN 78-955,690. KENNYWOOD ENTERTAINMENT PARTNERS, L.P., WEST MIFFLIN, PA. FILED 8-18-2006.

KENNYWOOD

THE MARK CONSISTS OF STANDARD CHARACTERS WITHOUT CLAIM TO ANY PARTICULAR FONT, STYLE, SIZE, OR COLOR.

FOR AMUSEMENT PARK SERVICES (U.S. CLS. 100, 101 AND 107).

FIRST USE 4-0-1898; IN COMMERCE 4-0-1898.

CHARISMA HAMPTON, EXAMINING ATTORNEY

SN 78-960,783. NUERNBERGER, EDWIN P., HONESDALE, PA. FILED 8-25-2006.

SIS◇TIM

FOR WORKSHOPS AND SEMINARS IN THE FIELD OF IMPROVING FOCUSING AND CONCENTRATION ABILITIES, EMOTIONAL SELF-CONTROL AND WELL-BEING, EFFECTIVE VISIONING, PROBLEM SOLVING SKILLS, AND SELF-MANAGEMENT, NAMELY, TEACHING AND IMPROVING THESE SKILLS AND ABILITIES THROUGH A SPECIFIC SERIES OF EXERCISES AND TEACHING TECHNIQUES (U.S. CLS. 100, 101 AND 107).

FIRST USE 12-0-2004; IN COMMERCE 12-0-2004.

BERNICE MIDDLETON, EXAMINING ATTORNEY

SN 78-964,403. FLIGHT 333, SAN DIEGO, CA. FILED 8-30-2006.

The Good, The Bad, and The Money

THE MARK CONSISTS OF STANDARD CHARACTERS WITHOUT CLAIM TO ANY PARTICULAR FONT, STYLE, SIZE, OR COLOR.

FOR ENTERTAINMENT NAMELY, LIVE PERFORMANCES BY A MUSICAL BAND (U.S. CLS. 100, 101 AND 107).

JAY BESCH, EXAMINING ATTORNEY

CLASS 41—(Continued).

SN 79-026,512. SIGA SERVICES AG, SWITZERLAND, FILED 7-10-2006.

SIGA. Stick with us.

THE MARK CONSISTS OF STANDARD CHARACTERS WITHOUT CLAIM TO ANY PARTICULAR FONT, STYLE, SIZE, OR COLOR.

PRIORITY DATE OF 4-3-2006 IS CLAIMED. OWNER OF INTERNATIONAL REGISTRATION 0892235 DATED 7-10-2006, EXPIRES 7-10-2016.

OWNER OF U.S. REG. NO. 3,057,121. FOR EDUCATION AND TRAINING SERVICES, NAMELY, ARRANGING AND CONDUCTING TRAINING WORKSHOPS FOR APPLYING ADHESIVES (U.S. CLS. 100, 101 AND 107).

KATHRYN COWARD, EXAMINING ATTORNEY

CLASS 42—SCIENTIFIC AND COMPUTER SERVICES

SN 76-675,203. SAFEWAY INC., PLEASANTON, CA. FILED 4-6-2007.

foodflex

THE COLOR(S) GREEN IS/ARE CLAIMED AS A FEATURE OF THE MARK.

THE TERM "FOOD" APPEARS IN LIGHT GREEN WITH THE LETTERS 'OO' IN "FOOD" FORMED BY AN ARROW SHAPED INTO AN INFINITY SYMBOL IN VARYING SHADES OF GREEN FROM LIGHT TO MEDIUM GREEN. THE TERM "FLEX" APPEARS IN MEDIUM GREEN.

FOR PROVIDING ON-LINE NON-DOWNLOADABLE WEB-BASED INTERACTIVE SOFTWARE ALLOWING CUSTOMERS TO VIEW AND TRACK NUTRITIONAL INFORMATION AND OPTIONS BY COMPARING PERSONAL FOOD SHOPPING DATA WITH INDUSTRY-ACCEPTED NUTRITION GUIDELINES, AND TO VIEW NUTRITIONAL REPORTING DATA, FOOD PRODUCT ALTERNATIVES, AND MEAL PLANNING AND HEALTH AND WELLNESS LIFESTYLE INFORMATION (U.S. CLS. 100 AND 101).

FIRST USE 3-29-2007; IN COMMERCE 3-29-2007. ZHALEH DELANEY, EXAMINING ATTORNEY

SN 79-035,414. SALLY RAMAGE, STAFFORD, GREAT BRITAIN, FILED 2-13-2007.



OWNER OF INTERNATIONAL REGISTRATION 0900614 DATED 7-17-2006, EXPIRES 7-17-2016.

THE NAME(S), PORTRAIT(S), AND/OR SIGNATURE(S) SHOWN IN THE MARK IDENTIFIES A PARTICULAR LIVING INDIVIDUAL, WHOSE CONSENT(S) TO REGISTER IS SUBMITTED.

THE COLOR(S) BROWN, RED, PINK AND TAN IS/ARE CLAIMED AS A FEATURE OF THE MARK.

THE MARK CONSISTS OF THE COLOR BROWN APPEARS IN THE WOMAN'S EYES AND PORTIONS OF HER HAIR, THE COLOR RED APPEARS IN PORTIONS OF HER HAIR, THE COLOR PINK APPEARS IN HER LIPS, AND THE COLOR TAN APPEARS IN THE WOMAN'S FACE AND NECK.

FOR EDUCATIONAL SERVICES, NAMELY, PUBLISHING ELECTRONIC JOURNALS AND NEWSLETTERS WITH QUESTION AND ANSWER PORTIONS FOR THE TRAINING AND CONTINUING PROFESSIONAL DEVELOPMENT OF LAWYERS, ACCOUNTANTS AND BUSINESS PROFESSIONALS IN THE FIELDS OF FINANCIAL FRAUD, MONEY LAUNDERING, ANTI-TRUST, ON-LINE THEFT AND CRIMINAL LAW TOPICS (U.S. CLS. 100, 101 AND 107).

CURTIS FRENCH, EXAMINING ATTORNEY

SN 76-677,341. AFFINISENSE LABS, LLC, PHOENIX, AZ. FILED 5-24-2007.

FuelTrace

THE STIPPLING IS FOR SHADING PURPOSES.

THE MARK CONSISTS OF THE STYLIZED WORD "FUELTRACE" ACCOMPANIED BY SHADOWED TRACE SIGNAL HAVING A HORIZONTAL LINE PEAKING VERTICALLY AND HORIZONTALLY.

FOR INSTALLATION OF COMPUTER SOFTWARE FOR MONITORING AND CONTROLLING THE DISPENSING OF FUEL TO FLEET VEHICLES (U.S. CLS. 100 AND 101).

GIANCARLO CASTRO, EXAMINING ATTORNEY

CLASS 42—(Continued).

SN 76-681,975. CELERITY IT, MCLEAN, VA. FILED 9-17-2007.

CELERITY

THE MARK CONSISTS OF STANDARD CHARACTERS WITHOUT CLAIM TO ANY PARTICULAR FONT, STYLE, SIZE, OR COLOR.

OWNER OF U.S. REG. NO. 2,977,596.
 FOR COMPUTER CONSULTING SERVICES IN THE FIELD OF PROGRAMMING, ANALYSIS, DESIGN AND IMPLEMENTATION; RESEARCH AND DEVELOPMENT FOR NEW INFORMATION TECHNOLOGY PRODUCTS FOR OTHERS (U.S. CLS. 100 AND 101).
 KARANENDRA S. CHHINA, EXAMINING ATTORNEY

SN 76-682,721. BIOFUELS AUTOMATION, INC., PLYMOUTH, MN. FILED 10-9-2007.

TECHtrak

THE MARK CONSISTS OF STANDARD CHARACTERS WITHOUT CLAIM TO ANY PARTICULAR FONT, STYLE, SIZE, OR COLOR.

FOR SERVICES FOR TRACKING AND MONITORING THE CONFIGURATION AND STATUS OF VARIOUS EQUIPMENTS IN A BIOFUEL MANUFACTURING PLANT; NAMELY, CONTROL VALVES, METERS, PUMPS, MEASURING INSTRUMENTS, TEMPERATURE PROBES, TEMPERATURE TRANSMITTERS, PRESSURE TRANSMITTERS, PRESSURE MEASURING DEVICES AND ANALYTICAL EQUIPMENT (U.S. CLS. 100 AND 101).
 FIRST USE 12-0-2005; IN COMMERCE 12-0-2005.
 GRETTA YAO, EXAMINING ATTORNEY

SN 77-014,535. ZEAL MEDIA GROUP LLC, SISTERS, OR. FILED 10-5-2006.

ZEAL MEDIA GROUP

THE MARK CONSISTS OF STANDARD CHARACTERS WITHOUT CLAIM TO ANY PARTICULAR FONT, STYLE, SIZE, OR COLOR.

OWNER OF U.S. REG. NO. 2,607,987.
 NO CLAIM IS MADE TO THE EXCLUSIVE RIGHT TO USE "MEDIA GROUP", APART FROM THE MARK AS SHOWN.
 FOR WEB SITE DESIGN SERVICES; DESIGN AND DEVELOPMENT OF MULTIMEDIA PRODUCTS, NAMELY, INTERNET SERVICES, NAMELY, DEVELOPING AND DISTRIBUTING PODCASTS AND FLASH CONTENT FOR OTHERS AND SEARCH ENGINE OPTIMIZATION SERVICES; PRODUCT RESEARCH AND PRODUCT DEVELOPMENT FOR OTHERS; GRAPHIC DESIGN SERVICES (U.S. CLS. 100 AND 101).
 TASNEM HUSSAIN, EXAMINING ATTORNEY

CLASS 42—(Continued).

SN 77-028,113. ENERTECH WIRELINE SERVICES, L.P., MIDLAND, TX. FILED 10-24-2006.

ENERTECH
Wireline Services 

NO CLAIM IS MADE TO THE EXCLUSIVE RIGHT TO USE "WIRELINE SERVICES", APART FROM THE MARK AS SHOWN.

THE STIPPLING IS FOR SHADING PURPOSES ONLY. COLOR IS NOT CLAIMED AS A FEATURE OF THE MARK.
 FOR WELL LOGGING AND WIRELINING OIL WELLS SERVICES (U.S. CLS. 100 AND 101).
 FIRST USE 7-1-2006; IN COMMERCE 7-1-2006.
 TAMARA FRAZIER, EXAMINING ATTORNEY

SN 77-087,883. U.S. DATA SECURITY CORPORATION, RENO, NV. FILED 1-22-2007.

U.S. DataTrust 

NO CLAIM IS MADE TO THE EXCLUSIVE RIGHT TO USE "U.S.", APART FROM THE MARK AS SHOWN.

FOR TECHNICAL SUPPORT, NAMELY, PROVIDING BACK-UP COMPUTER PROGRAMS AND FACILITIES FOR DATA STORAGE, DATA ARCHIVING AND DATA RECOVERY; MONITORING THE COMPUTER SYSTEMS OF OTHERS FOR TECHNICAL PURPOSES; COMPUTER SERVICES, NAMELY, DATA RECOVERY SERVICES; AND RECOVERY OF COMPUTER DATA (U.S. CLS. 100 AND 101).
 FIRST USE 8-20-2002; IN COMMERCE 9-9-2002.
 MORGAN WYNNE, EXAMINING ATTORNEY

SN 77-089,828. GEOMONKEY, LLC, BATTLE GROUND, WA. FILED 1-24-2007.

Geomonkey

THE MARK CONSISTS OF STANDARD CHARACTERS WITHOUT CLAIM TO ANY PARTICULAR FONT, STYLE, SIZE, OR COLOR.

FOR HOSTING OF DIGITAL CONTENT ON THE INTERNET (U.S. CLS. 100 AND 101).
 FIRST USE 8-1-2006; IN COMMERCE 1-1-2007.
 SEAN CROWLEY, EXAMINING ATTORNEY

CLASS 42—(Continued).

SN 77-102,418. AD.IQ LIMITED, LONDON, UNITED KINGDOM, FILED 2-8-2007.

AD INTELLIGENCE

THE MARK CONSISTS OF STANDARD CHARACTERS WITHOUT CLAIM TO ANY PARTICULAR FONT, STYLE, SIZE, OR COLOR.

NO CLAIM IS MADE TO THE EXCLUSIVE RIGHT TO USE "AD", APART FROM THE MARK AS SHOWN.

FOR SCIENTIFIC RESEARCH AND DEVELOPMENT IN THE FIELDS OF WIRELESS COMMUNICATION METHODS AND MULTIMEDIA TELECOMMUNICATION SYSTEMS; TECHNOLOGICAL CONSULTATION AND RESEARCH IN THE FIELDS OF WIRELESS COMMUNICATION METHODS AND MULTIMEDIA TELECOMMUNICATION SYSTEMS; DESIGN AND DEVELOPMENT OF COMPUTER SOFTWARE RELATING TO THE COLLECTION AND TRANSMISSION OF DATA THROUGH MULTIMEDIA TELECOMMUNICATIONS OR WIRELESS COMMUNICATION SERVICES; COMPUTER DATABASE DESIGN SERVICES; HOSTING WEBSITES; PROVIDING ADVICE, INFORMATION AND CONSULTATION SERVICES IN RELATION TO ALL OF THE ABOVE (U.S. CLS. 100 AND 101).

JEFFERY COWARD, EXAMINING ATTORNEY

CLASS 42—(Continued).

SN 77-109,838. THE ACTIVE NETWORK, INC., SAN DIEGO, CA. FILED 2-16-2007.

LeadAdvance

THE MARK CONSISTS OF STANDARD CHARACTERS WITHOUT CLAIM TO ANY PARTICULAR FONT, STYLE, SIZE, OR COLOR.

FOR PROVIDING WEB-BASED NON-DOWNLOADABLE CORPORATE EVENT MANAGEMENT SOFTWARE USED TO CAPTURE AND MANAGE SALES LEADS (U.S. CLS. 100 AND 101).

FIRST USE 9-19-2006; IN COMMERCE 9-19-2006.

HEATHER THOMPSON, EXAMINING ATTORNEY

SN 77-106,616. THE ACTIVE NETWORK, INC., SAN DIEGO, CA. FILED 2-13-2007.

WingateWeb

THE MARK CONSISTS OF STANDARD CHARACTERS WITHOUT CLAIM TO ANY PARTICULAR FONT, STYLE, SIZE, OR COLOR.

FOR PROVIDING WEB-BASED NON-DOWNLOADABLE CORPORATE EVENT MANAGEMENT SOFTWARE (U.S. CLS. 100 AND 101).

FIRST USE 1-15-1998; IN COMMERCE 1-15-1998.

HEATHER THOMPSON, EXAMINING ATTORNEY

SN 77-111,205. HYDROLOGIC WATER MANAGEMENT, INC., PLYMOUTH, MN. FILED 2-20-2007.



SN 77-107,744. AMERICAN CULINARY CHEFSBEST, INC., SAN FRANCISCO, CA. FILED 2-14-2007.

SAQA

THE MARK CONSISTS OF STANDARD CHARACTERS WITHOUT CLAIM TO ANY PARTICULAR FONT, STYLE, SIZE, OR COLOR.

FOR TESTING, ANALYSIS AND EVALUATION SERVICES FOR THE FOOD AND BEVERAGE PRODUCTS OF OTHERS (U.S. CLS. 100 AND 101).

ERNEST SHOSHO, EXAMINING ATTORNEY

OWNER OF U.S. REG. NOS. 2,397,050 AND 2,399,194.

NO CLAIM IS MADE TO THE EXCLUSIVE RIGHT TO USE "SMART SYSTEMS", APART FROM THE MARK AS SHOWN.

THE COLOR(S) GREEN AND BLUE IS/ARE CLAIMED AS A FEATURE OF THE MARK.

THE MARK CONSISTS OF THE WORDING "HYDRO", "3" AND "SMART SYSTEM" IN BLUE AND THE WORDING "LOGIC" AND "HC" IN GREEN IN FRONT OF A PICTURE OF THE GLOBE IN VARIOUS SHADES OF BLUE.

FOR TESTING, ANALYSIS AND EVALUATION OF THE GOODS AND SERVICES OF OTHERS FOR THE PURPOSE OF CERTIFICATION (U.S. CLS. 100 AND 101).

JOHN DALIER, EXAMINING ATTORNEY

CLASS 42—(Continued).

SN 77-111,669. WILLIAM LILLY AND ASSOCIATES INC., CERES, CA. FILED 2-20-2007.



NO CLAIM IS MADE TO THE EXCLUSIVE RIGHT TO USE "HOMES OF AMERICA" AND THE MAP OUTLINE OF THE UNITED STATES, APART FROM THE MARK AS SHOWN.

THE MARK CONSISTS OF THE WORDS "GREEN BUILT", WITH EACH WORD ENCLOSED IN A RECTANGLE AND STACKED ON TOP OF ONE ANOTHER WITH A ROOF ON TOP, GIVING THE APPEARANCE OF THE OUTLINE OF A HOUSE, WITH THE WORDS "HOMES OF AMERICA" TO THE RIGHT, AND WITH A MAP OUTLINE OF THE UNITED STATES BEHIND THE LETTERS "OF" AND "RICA".

FOR ENVIRONMENTAL TESTING AND INSPECTION SERVICES; INSPECTIONS OF HOME INSULATION, AIR CONDITIONING FOR WINDOW VALVES, RECYCLING, NATIVE PLANTS IN BUILDING AREA; WATER QUALITY CONTROL SERVICES (U.S. CLS. 100 AND 101).

FIRST USE 6-17-2004; IN COMMERCE 6-17-2004.
LAURA KOVALSKY, EXAMINING ATTORNEY

CLASS 42—(Continued).

SN 77-113,634. HCPRO, INC., MARBLEHEAD, MA. FILED 2-22-2007.

EPHARMACEUTICALS

THE MARK CONSISTS OF STANDARD CHARACTERS WITHOUT CLAIM TO ANY PARTICULAR FONT, STYLE, SIZE, OR COLOR.

OWNER OF U.S. REG. NOS. 2,533,105, 2,540,130 AND 2,914,823.

SEC. 2(F).

FOR PROVIDING AN ON-LINE COMPUTER DATABASE IN THE FIELD OF PHARMACEUTICAL RESEARCH; PROVIDING INFORMATION CONCERNING THE PHARMACEUTICAL INDUSTRY RESEARCH AND DEVELOPMENT OVER A GLOBAL COMPUTER NETWORK (U.S. CLS. 100 AND 101).

FIRST USE 10-0-1999; IN COMMERCE 10-0-1999.

ANNE E. GUSTASON, EXAMINING ATTORNEY

SN 77-115,381. JAZZ PHARMACEUTICALS, INC., PALO ALTO, CA. FILED 2-23-2007.

JAZZ PHARMACEUTICALS

SN 77-112,409. ARES TRADING S.A., AUBONNE, SWITZERLAND, FILED 2-21-2007.

REBIQOL

THE MARK CONSISTS OF STANDARD CHARACTERS WITHOUT CLAIM TO ANY PARTICULAR FONT, STYLE, SIZE, OR COLOR.

FOR SCIENTIFIC AND TECHNOLOGICAL SERVICES, NAMELY, SCIENTIFIC AND TECHNOLOGICAL RESEARCH IN THE FIELD OF NEUROLOGY; INDUSTRIAL ANALYSIS AND RESEARCH SERVICES IN THE FIELD OF NEUROLOGY (U.S. CLS. 100 AND 101).

KIMBERLY FRYE, EXAMINING ATTORNEY

THE MARK CONSISTS OF STANDARD CHARACTERS WITHOUT CLAIM TO ANY PARTICULAR FONT, STYLE, SIZE, OR COLOR.

NO CLAIM IS MADE TO THE EXCLUSIVE RIGHT TO USE "PHARMACEUTICALS", APART FROM THE MARK AS SHOWN.

FOR PROVIDING CUSTOMIZED ON-LINE WEB PAGES FEATURING USER-DEFINED INFORMATION, WHICH INCLUDES ON-LINE WEB LINKS TO OTHER WEB SITES; PROVIDING INFORMATION AT THE SPECIFIC REQUEST OF END-USERS BY MEANS OF TELEPHONE OR GLOBAL COMPUTER NETWORKS; SCIENTIFIC RESEARCH AND DEVELOPMENT; PHARMACEUTICAL DRUG DEVELOPMENT SERVICES; PHARMACEUTICAL RESEARCH AND DEVELOPMENT; RESEARCH AND DEVELOPMENT FOR NEW PRODUCTS FOR OTHERS (U.S. CLS. 100 AND 101).

FIRST USE 5-19-2004; IN COMMERCE 5-19-2004.

JOHN DWYER, EXAMINING ATTORNEY

CLASS 42—(Continued).

SN 77-115,558. REPUTATIONDEFENDER, INC., LOUISVILLE, KY. FILED 2-25-2007.



FOR COMPUTER SERVICES, NAMELY, CREATING INDEXES OF INFORMATION, SITES AND OTHER RESOURCES AVAILABLE ON COMPUTER NETWORKS (U.S. CLS. 100 AND 101).

DAVID YONTEF, EXAMINING ATTORNEY

CLASS 42—(Continued).

SN 77-123,702. BYRNES & ANDERSON LLC, GRAND RAPIDS, MI. FILED 3-6-2007.

QUALITY BOOT CAMP

THE MARK CONSISTS OF STANDARD CHARACTERS WITHOUT CLAIM TO ANY PARTICULAR FONT, STYLE, SIZE, OR COLOR.

NO CLAIM IS MADE TO THE EXCLUSIVE RIGHT TO USE "QUALITY", APART FROM THE MARK AS SHOWN.

FOR QUALITY IMPROVEMENT PROGRAMS, NAMELY, QUALITY CONTROL FOR OTHERS, NAMELY, MEDICAL CENTERS AND HEALTH CARE PROVIDERS (U.S. CLS. 100 AND 101).

RICHARD A. STRASER, EXAMINING ATTORNEY

SN 77-115,820. SYNFUELS INTERNATIONAL, INC., DALLAS, TX. FILED 2-26-2007.

SYNFUELS INTERNATIONAL

THE MARK CONSISTS OF STANDARD CHARACTERS WITHOUT CLAIM TO ANY PARTICULAR FONT, STYLE, SIZE, OR COLOR.

SEC. 2(F).

FOR SCIENTIFIC RESEARCH AND DEVELOPMENT AND CONSULTATION RELATED THERETO IN THE FIELD OF GAS-TO-LIQUIDS TECHNOLOGY (U.S. CLS. 100 AND 101).

FIRST USE 5-24-1999; IN COMMERCE 5-24-1999.
JENNIFER MARTIN, EXAMINING ATTORNEY

SN 77-124,475. WESTSIDE BEHAVIORAL CARE, INC., DENVER, CO. FILED 3-7-2007.

AVALON SCHEDULING

THE MARK CONSISTS OF STANDARD CHARACTERS WITHOUT CLAIM TO ANY PARTICULAR FONT, STYLE, SIZE, OR COLOR.

NO CLAIM IS MADE TO THE EXCLUSIVE RIGHT TO USE "SCHEDULING", APART FROM THE MARK AS SHOWN.

FOR PROVIDING TEMPORARY USE OF ON-LINE NON-DOWNLOADABLE SOFTWARE FOR SCHEDULING APPOINTMENTS AND MAKING MEDICAL REFERRALS (U.S. CLS. 100 AND 101).

FIRST USE 11-21-2006; IN COMMERCE 11-21-2006.
BRIAN PINO, EXAMINING ATTORNEY

SN 77-123,204. WACHOVIA CORPORATION, CHARLOTTE, NC. FILED 3-6-2007.

VERTICE I-QUE

THE MARK CONSISTS OF STANDARD CHARACTERS WITHOUT CLAIM TO ANY PARTICULAR FONT, STYLE, SIZE, OR COLOR.

FOR PROVIDING TEMPORARY USE OF ON-LINE NON-DOWNLOADABLE PROPRIETARY COMPUTER SOFTWARE FOR USE IN COMPARING, EVALUATING, SELECTING, QUALIFYING, PROCESSING, UNDERWRITING, PRICING AND ORIGINATING LOAN PROGRAMS IN THE FIELD OF MORTGAGE LENDING (U.S. CLS. 100 AND 101).

SIMON TENG, EXAMINING ATTORNEY

SN 77-125,376. HERBALSCIENCE SINGAPORE PTE LTD, SINGAPORE, SINGAPORE, FILED 3-8-2007.

ACCUDART

THE MARK CONSISTS OF STANDARD CHARACTERS WITHOUT CLAIM TO ANY PARTICULAR FONT, STYLE, SIZE, OR COLOR.

FOR CHEMICAL ANALYSIS AND RESEARCH SERVICES REGARDING THE IDENTIFICATION OF CHEMICAL COMPONENTS OF VARIOUS MATERIALS (U.S. CLS. 100 AND 101).

DAVID YONTEF, EXAMINING ATTORNEY

CLASS 42—(Continued).

SN 77-125,389. HERBALSCIENCE SINGAPORE PTE LTD, SINGAPORE, SINGAPORE, FILED 3-8-2007.

DARTVISION

THE MARK CONSISTS OF STANDARD CHARACTERS WITHOUT CLAIM TO ANY PARTICULAR FONT, STYLE, SIZE, OR COLOR.

FOR CHEMICAL ANALYSIS AND RESEARCH SERVICES REGARDING THE IDENTIFICATION OF CHEMICAL COMPONENTS OF VARIOUS MATERIALS (U.S. CLS. 100 AND 101).

DAVID YONTEF, EXAMINING ATTORNEY

SN 77-126,895. JAZZ PHARMACEUTICALS, INC., PALO ALTO, CA. FILED 3-9-2007.



OWNER OF U.S. REG. NO. 3,005,004.

THE COLOR(S) PURPLE, GOLD AND WHITE IS/ARE CLAIMED AS A FEATURE OF THE MARK.

THE MARK CONSISTS OF CONCENTRIC CIRCLES OF PURPLE AND WHITE CONTAINING A STYLIZED DEPICTION OF THE LETTERS JP IN THE COLOR WHITE WHICH VERTICALLY SPLITS THE CIRCLE SHOWING GOLD ON THE RIGHT PORTION AND PURPLE ON THE LEFT PORTION OF THE CIRCLE.

FOR PROVIDING CUSTOMIZED ON-LINE WEB PAGES FEATURING USER-DEFINED INFORMATION, WHICH INCLUDES ON-LINE WEB LINKS TO OTHER WEB SITES; PROVIDING INFORMATION AT THE SPECIFIC REQUEST OF END-USERS BY MEANS OF TELEPHONE OR GLOBAL COMPUTER NETWORKS; SCIENTIFIC RESEARCH AND DEVELOPMENT; PHARMACEUTICAL DRUG DEVELOPMENT SERVICES; PHARMACEUTICAL RESEARCH AND DEVELOPMENT; RESEARCH AND DEVELOPMENT FOR NEW PRODUCTS FOR OTHERS (U.S. CLS. 100 AND 101).

FIRST USE 5-19-2004; IN COMMERCE 5-19-2004.

JOHN DWYER, EXAMINING ATTORNEY

CLASS 42—(Continued).

SN 77-127,112. SHIRE HUMAN GENETIC THERAPIES, INC., CAMBRIDGE, MA. FILED 3-9-2007.

FOS
FABRY OUTCOME SURVEY

NO CLAIM IS MADE TO THE EXCLUSIVE RIGHT TO USE "FABRY OUTCOME SURVEY", APART FROM THE MARK AS SHOWN.

THE MARK CONSISTS OF THE LETTERS "FOS" WITH AN ARROW DESIGN FORMING THE LETTER "O", AND THE WORDS "FABRY OUTCOME SURVEY" IN SMALLER LETTERS BENEATH.

FOR PROVIDING MEDICAL AND SCIENTIFIC RESEARCH INFORMATION IN THE FIELD OF PHARMACEUTICALS AND THE TREATMENT OF MEDICAL CONDITIONS (U.S. CLS. 100 AND 101).

TASNEEM HUSSAIN, EXAMINING ATTORNEY

SN 77-130,453. KRUGER ENERGY INC., MONTREAL, CANADA, FILED 3-14-2007.

POWERING YOUR WORLD WITH
RENEWABLE RESOURCES

THE MARK CONSISTS OF STANDARD CHARACTERS WITHOUT CLAIM TO ANY PARTICULAR FONT, STYLE, SIZE, OR COLOR.

PRIORITY CLAIMED UNDER SEC. 44(D) ON CANADA APPLICATION NO. 1316425, FILED 9-14-2006, REG. NO. TMA698614, DATED 10-16-2007, EXPIRES 10-16-2022.

FOR DESIGN OF ELECTRICAL POWER-GENERATING AND TRANSMISSION FACILITIES (U.S. CLS. 100 AND 101).

PETER B. BROMAGHIM, EXAMINING ATTORNEY

CLASS 42—(Continued).

SN 77-130,459. KRUGER ENERGY INC., MONTREAL, CANADA, FILED 3-14-2007.



PRIORITY CLAIMED UNDER SEC. 44(D) ON CANADA APPLICATION NO. 1316424, FILED 9-14-2006, REG. NO. TMA692944, DATED 7-30-2007, EXPIRES 7-30-2022.
FOR DESIGN OF ELECTRICAL POWER-GENERATING AND TRANSMISSION FACILITIES (U.S. CLS. 100 AND 101).
PETER B. BROMAGHIM, EXAMINING ATTORNEY

SN 77-140,088. AIR GAMES WIRELESS INC., VANCOUVER, CANADA, FILED 3-26-2007.

AIRGAMES

THE MARK CONSISTS OF STANDARD CHARACTERS WITHOUT CLAIM TO ANY PARTICULAR FONT, STYLE, SIZE, OR COLOR.
FOR DEVELOPMENT OF WIRELESS GAME AND ENTERTAINMENT SOFTWARE FOR USE ACROSS MULTIPLE MOBILE HANDSETS, CARRIERS AND GATEWAYS; PROVIDING DATA MINING INFORMATION AND SERVICES REGARDING WIRELESS GAME AND ENTERTAINMENT USAGE FOR MULTIPLE CARRIERS; HOSTING WIRELESS GAME AND ENTERTAINMENT APPLICATIONS FOR MULTIPLE CARRIERS; PROVIDING TESTING VIA A GLOBAL COMMUNICATIONS NETWORK TO DETERMINE THE INTEROPERABILITY OF MULTIPLE HANDSETS, CARRIERS AND GATEWAYS (U.S. CLS. 100 AND 101).
WOODROW HARTZOG, EXAMINING ATTORNEY

CLASS 42—(Continued).

SN 77-140,410. LARSEN, JOANNE, CHICAGO, IL. FILED 3-26-2007.

HEALTHY BODY CALCULATOR

THE MARK CONSISTS OF STANDARD CHARACTERS WITHOUT CLAIM TO ANY PARTICULAR FONT, STYLE, SIZE, OR COLOR.
SEC. 2(F).
FOR PROVIDING TEMPORARY USE OF NON-DOWNLOADABLE SOFTWARE FOR PROVIDING PERSONALIZED NUTRITIONAL PROFILES AND ASSESSMENTS (U.S. CLS. 100 AND 101).
FIRST USE 11-27-1996; IN COMMERCE 11-27-1996.
DAWN FELDMAN, EXAMINING ATTORNEY

SN 77-141,017. DIGITAL STEAMWORKS, LLC, HUNT VALLEY, MD. FILED 3-27-2007.

Digital Steamworks

THE MARK CONSISTS OF STANDARD CHARACTERS WITHOUT CLAIM TO ANY PARTICULAR FONT, STYLE, SIZE, OR COLOR.
NO CLAIM IS MADE TO THE EXCLUSIVE RIGHT TO USE "DIGITAL", APART FROM THE MARK AS SHOWN.
FOR COMPUTER SOFTWARE DEVELOPMENT (U.S. CLS. 100 AND 101).
FIRST USE 4-2-2004; IN COMMERCE 4-2-2004.
BRENDAN REGAN, EXAMINING ATTORNEY

SN 77-142,782. VERTAFORE, INC., BOTHELL, WA. FILED 3-28-2007.

AMS FINANCEPRO

THE MARK CONSISTS OF STANDARD CHARACTERS WITHOUT CLAIM TO ANY PARTICULAR FONT, STYLE, SIZE, OR COLOR.
OWNER OF U.S. REG. NOS. 3,054,904, 3,137,845 AND OTHERS.
FOR TEMPORARY USE OF ONLINE NON-DOWNLOADABLE COMPUTER SOFTWARE FOR MANAGING INSURANCE PREMIUM FINANCING AND FOR INSURANCE PREMIUM FINANCING QUOTES (U.S. CLS. 100 AND 101).
FIRST USE 3-0-2006; IN COMMERCE 3-0-2006.
TEJBIR SINGH, EXAMINING ATTORNEY

CLASS 42—(Continued).

SN 77-142,876. VERTAFORE, INC., BOTHELL, WA. FILED 3-28-2007.

FINANCEPRO

THE MARK CONSISTS OF STANDARD CHARACTERS WITHOUT CLAIM TO ANY PARTICULAR FONT, STYLE, SIZE, OR COLOR.

FOR TEMPORARY USE OF ONLINE NON-DOWNLOADABLE COMPUTER SOFTWARE FOR MANAGING INSURANCE PREMIUM FINANCING AND FOR INSURANCE PREMIUM FINANCING QUOTES (U.S. CLS. 100 AND 101).

FIRST USE 9-23-1998; IN COMMERCE 9-23-1998.
TEJBIR SINGH, EXAMINING ATTORNEY

CLASS 42—(Continued).

SN 77-145,921. PERESYS (PROPRIETARY) LIMITED, BRYANSTON, GAUTENG, SOUTH AFRICA, FILED 4-2-2007.

PERFIX

THE MARK CONSISTS OF STANDARD CHARACTERS WITHOUT CLAIM TO ANY PARTICULAR FONT, STYLE, SIZE, OR COLOR.

FOR DESIGN, DEVELOPMENT, AND MAINTENANCE OF COMPUTER SOFTWARE IN THE FIELD OF FINANCE AND INVESTMENT; TECHNICAL SUPPORT SERVICES, NAMELY, TROUBLESHOOTING OF COMPUTER SOFTWARE PROBLEMS IN THE FIELD OF FINANCE AND INVESTMENT; PROVIDING TECHNICAL INFORMATION TO THE FINANCIAL SERVICES INDUSTRY OVER COMPUTER NETWORKS AND GLOBAL COMMUNICATION NETWORKS IN THE FIELDS OF COMPUTER SYSTEMS, NETWORKS AND SOFTWARE (U.S. CLS. 100 AND 101).

FIRST USE 2-2-2007; IN COMMERCE 2-2-2007.
REBECCA EISINGER, EXAMINING ATTORNEY

SN 77-143,699. BLUE MARBLE ENVIRONMENTAL, INC., WILMINGTON, DE. FILED 3-29-2007.

BLUE MARBLE ENVIRONMENTAL

THE MARK CONSISTS OF STANDARD CHARACTERS WITHOUT CLAIM TO ANY PARTICULAR FONT, STYLE, SIZE, OR COLOR.

NO CLAIM IS MADE TO THE EXCLUSIVE RIGHT TO USE "ENVIRONMENTAL", APART FROM THE MARK AS SHOWN.

FOR ENVIRONMENTAL SERVICES, NAMELY, TECHNICAL CONSULTATION IN THE FIELD OF ENVIRONMENTAL SCIENCE, ENGINEERING SERVICES, DESIGN FOR OTHERS IN THE FIELD OF ENVIRONMENTAL ENGINEERING, DESIGNING AND TESTING OF NEW ENVIRONMENTALLY FRIENDLY PRODUCTS FOR OTHERS (U.S. CLS. 100 AND 101).

FIRST USE 1-1-2006; IN COMMERCE 1-1-2006.
ALICE BENMAMAN, EXAMINING ATTORNEY

SN 77-146,602. COMODO CA, INC., MANCHESTER, UNITED KINGDOM, FILED 4-2-2007.

EV AUTO-Enhancer

THE MARK CONSISTS OF STANDARD CHARACTERS WITHOUT CLAIM TO ANY PARTICULAR FONT, STYLE, SIZE, OR COLOR.

NO CLAIM IS MADE TO THE EXCLUSIVE RIGHT TO USE "EV", APART FROM THE MARK AS SHOWN.

FOR COMPUTER SECURITY SERVICE, NAMELY, RESTRICTING ACCESS TO AND BY COMPUTER NETWORKS TO AND OF UNDESIRED WEB SITES, MEDIA AND INDIVIDUALS AND FACILITIES; DEVELOPMENT OF SOFTWARE FOR SECURE NETWORK OPERATIONS; ON-LINE SECURITY SERVICES, NAMELY, PROVIDING SECURITY AND ANONYMITY FOR ELECTRONICALLY TRANSMITTED CREDIT CARD TRANSACTIONS; PROVIDING ELECTRONIC VERIFICATION OF ON-LINE ORDERS OF DIGITAL CONTENT AND GENERATING ELECTRONIC PERMISSION CODES WHICH THEN ALLOW USERS TO ACCESS SAID DIGITAL CONTENT (U.S. CLS. 100 AND 101).

SCOTT BIBB, EXAMINING ATTORNEY

CLASS 42—(Continued).

SN 77-148,308. LARSEN, JOANNE, CHICAGO, IL. FILED 4-4-2007.

HEALTHY KID CALCULATOR

THE MARK CONSISTS OF STANDARD CHARACTERS WITHOUT CLAIM TO ANY PARTICULAR FONT, STYLE, SIZE, OR COLOR.

SEC. 2(F).
FOR PROVIDING TEMPORARY USE OF NON-DOWNLOADABLE SOFTWARE FOR PROVIDING PERSONALIZED NUTRITIONAL PROFILES AND ASSESSMENTS FOR CHILDREN FROM BIRTH TO AGE 18 (U.S. CLS. 100 AND 101).

FIRST USE 7-17-1997; IN COMMERCE 7-17-1997.
DAWN FELDMAN, EXAMINING ATTORNEY

SN 77-148,311. LARSEN, JOANNE, CHICAGO, IL. FILED 4-4-2007.

ASK THE DIETITIAN

THE MARK CONSISTS OF STANDARD CHARACTERS WITHOUT CLAIM TO ANY PARTICULAR FONT, STYLE, SIZE, OR COLOR.

FOR PROVIDING TEMPORARY USE OF NON-DOWNLOADABLE SOFTWARE FOR PROVIDING PERSONALIZED NUTRITIONAL PROFILES AND ASSESSMENTS (U.S. CLS. 100 AND 101).

FIRST USE 7-22-1995; IN COMMERCE 7-22-1995.
DAWN FELDMAN, EXAMINING ATTORNEY

CLASS 42—(Continued).

SN 77-156,112. CTG ENTERPRISES, INC., IRVINE, CA. FILED 4-13-2007.

CLIMATE READY

THE MARK CONSISTS OF STANDARD CHARACTERS WITHOUT CLAIM TO ANY PARTICULAR FONT, STYLE, SIZE, OR COLOR.

NO CLAIM IS MADE TO THE EXCLUSIVE RIGHT TO USE "CLIMATE", APART FROM THE MARK AS SHOWN.

FOR ENVIRONMENTAL CONSULTING AND TECHNOLOGY SERVICES, NAMELY, TECHNICAL CONSULTATION IN THE FIELD OF ENVIRONMENTAL SCIENCE, ENGINEERING SERVICES, AND DESIGN FOR OTHERS IN THE FIELD OF ENVIRONMENTAL ENGINEERING, NAMELY, PROVIDING CUSTOMIZED GREENHOUSE GAS INVENTORY REPORTS, EMISSIONS REDUCTION STRATEGIES, DESIGN AND EVALUATION OF STRATEGIES FOR THE CREATION OF POTENTIALLY MARKETABLE GREENHOUSE GAS REDUCTIONS, ENERGY MANAGEMENT PLANS PROVIDING GUIDANCE FOR ACHIEVING ENERGY CONSERVATION AND GREENHOUSE GAS EMISSIONS REDUCTIONS THROUGH THE DESIGN AND OPERATION OF BUILT ENVIRONMENTS AND ASSOCIATED INFRASTRUCTURE, PERFORMANCE MONITORING OF ENERGY, TRANSPORTATION, SOLID WASTE, WATER USE, MATERIALS USE, LAND-COVER, AND OTHER FACTORS RELEVANT TO THE DETERMINATION OF GREENHOUSE GAS EMISSIONS IN THE NATURE OF ENVIRONMENTAL TESTING AND INSPECTION SERVICES, ASSISTANCE WITH THE DESIGN AND OPERATION OF BUILT ENVIRONMENTS FOR THE PURPOSE OF ACHIEVING SUSTAINABILITY UNDER CHANGING CLIMATIC CONDITIONS THROUGH ENVIRONMENTAL COMPLIANCE CONSULTING AND PLANNING AND LAYOUT DESIGN SERVICES, ALL OF THE FOREGOING SERVICES BEING PROVIDED TO BUSINESSES, NON-GOVERNMENTAL ORGANIZATIONS, OR PUBLIC ENTITIES ENGAGED IN ANALYZING, DESIGNING, CREATING AND OPERATING BUILT ENVIRONMENTS, BUILDING SYSTEMS, RESIDENTIAL AND COMMERCIAL STRUCTURES, ENERGY PRODUCTION AND DISTRIBUTION SYSTEMS, TRANSPORTATION SYSTEMS, SEWER AND STORM WATER INFRASTRUCTURES, GREEN INFRASTRUCTURES, NEIGHBORHOODS, COMMUNITIES, CAMPUSES, FACILITIES, METROPOLITAN AREAS AND LARGER CIVIL DIVISIONS INCLUDING COUNTIES, REGIONS, COUNTRIES, ALL FOR PURPOSE OF MITIGATING THE DRIVERS OF CLIMATE CHANGE AND HELPING TO MAINTAIN PERFORMANCE UNDER CHANGING CLIMATIC CONDITIONS (U.S. CLS. 100 AND 101).

SHAILA SETTLES, EXAMINING ATTORNEY

CLASS 42—(Continued).

SN 77-158,909. CAMPUSEAI, CLEVELAND, OH. FILED 4-17-2007.



THE PORTRAIT SHOWN IN THE MARK DOES NOT IDENTIFY A PARTICULAR LIVING INDIVIDUAL.

THE MARK CONSISTS OF A FEMALE FORM WITH HEAD IN PROFILE, HOLDING A NOTEBOOK COMPUTER.

FOR INFORMATION TECHNOLOGY CONSULTING SERVICES, NAMELY, CONSULTING SERVICES IN THE FIELD OF RESEARCH, DESIGN, DEVELOPMENT, IMPLEMENTATION, AND USE OF COMPUTER HARDWARE AND SOFTWARE SYSTEMS FOR OTHERS; CONSULTING IN THE FIELD OF INSTALLATION OF COMPUTER SOFTWARE; COMPUTER PROGRAMMING FOR OTHERS; COMPUTER DIAGNOSTIC SERVICES; CONSULTING IN THE FIELD OF TECHNICAL SUPPORT SERVICES, NAMELY, TROUBLESHOOTING OF COMPUTER HARDWARE AND SOFTWARE PROBLEMS (U.S. CLS. 100 AND 101).

FIRST USE 10-31-2002; IN COMMERCE 10-31-2002.
STEVEN R. FOSTER, EXAMINING ATTORNEY

SN 77-159,946. DYCOM IDENTITY, LLC, PALM BEACH, FL. FILED 4-18-2007.

PREFERRED EXCAVATOR

THE MARK CONSISTS OF STANDARD CHARACTERS WITHOUT CLAIM TO ANY PARTICULAR FONT, STYLE, SIZE, OR COLOR.

NO CLAIM IS MADE TO THE EXCLUSIVE RIGHT TO USE "EXCAVATOR", APART FROM THE MARK AS SHOWN.

FOR LOCATING AND MARKING PLACEMENT OF UNDERGROUND UTILITY PIPES, CABLE OR WIRES; PROVIDING ON-LINE NON-DOWNLOADABLE SOFTWARE FOR ELECTRONICALLY LOCATING AND DISPLAYING UNDERGROUND UTILITIES (U.S. CLS. 100 AND 101).

KATHERINE E. HALMEN, EXAMINING ATTORNEY

CLASS 42—(Continued).

SN 77-162,509. DN LEASING LLC, LAS VEGAS, NV. FILED 4-21-2007.

Got Spread

THE MARK CONSISTS OF STANDARD CHARACTERS WITHOUT CLAIM TO ANY PARTICULAR FONT, STYLE, SIZE, OR COLOR.

FOR PROVIDING CUSTOMIZED ONLINE WEB PAGES FEATURING USER-DEFINED INFORMATION, WHICH INCLUDES ONLINE WEB LINKS TO OTHER WEB SITES (U.S. CLS. 100 AND 101).

PATRICIA EVANKO, EXAMINING ATTORNEY

SN 77-162,943. SECURUS TECHNOLOGIES, INC., DALLAS, TX. FILED 4-23-2007.

SECURUS

THE MARK CONSISTS OF STANDARD CHARACTERS WITHOUT CLAIM TO ANY PARTICULAR FONT, STYLE, SIZE, OR COLOR.

OWNER OF U.S. REG. NO. 3,169,198.

FOR PROVIDING TEMPORARY USE OF ONLINE NON-DOWNLOADABLE SOFTWARE FOR FACILITATING JOB PLACEMENT OF INMATES OF CORRECTIONAL INSTITUTIONS; AND PROVIDING TEMPORARY USE OF ONLINE NON-DOWNLOADABLE SOFTWARE FOR PREPARATION, CALCULATION AND RECORD KEEPING OF TAX CREDITS FOR HIRING INMATES OF CORRECTIONAL INSTITUTIONS (U.S. CLS. 100 AND 101).

JOHN SCHUYLER YARD, EXAMINING ATTORNEY

SN 77-173,321. SHIRE HUMAN GENETIC THERAPIES, INC., CAMBRIDGE, MA. FILED 5-4-2007.

hos
hunter outcome survey

NO CLAIM IS MADE TO THE EXCLUSIVE RIGHT TO USE "HUNTER OUTCOME SURVEY", APART FROM THE MARK AS SHOWN.

FOR PROVIDING MEDICAL AND SCIENTIFIC RESEARCH INFORMATION IN THE FIELD OF PHARMACEUTICALS AND THE TREATMENT OF MEDICAL CONDITIONS (U.S. CLS. 100 AND 101).

TASNEEM HUSSAIN, EXAMINING ATTORNEY

CLASS 42—(Continued).

SN 77-175,141. BACKOFFICE ASSOCIATES, LLC, SOUTH HARWICH, MA. FILED 5-8-2007.

BACKOFFICE ASSOCIATES

THE MARK CONSISTS OF STANDARD CHARACTERS WITHOUT CLAIM TO ANY PARTICULAR FONT, STYLE, SIZE, OR COLOR.

SEC. 2(F).
FOR PROVIDING TECHNICAL SERVICES IN THE AREA OF DATA QUALITY ASSESSMENT AND MANAGEMENT, NAMELY, CONSULTING IN THE FIELD OF SOFTWARE SOLUTIONS FOR DATA QUALITY ASSESSMENT AND DATA MANAGEMENT (U.S. CLS. 100 AND 101).

FIRST USE 9-0-2000; IN COMMERCE 9-0-2000.
KRISTIN DAHLING, EXAMINING ATTORNEY

SN 77-180,022. MILLER ENGINEERING INC., MILWAUKEE, WI. FILED 5-14-2007.

RACC

THE MARK CONSISTS OF STANDARD CHARACTERS WITHOUT CLAIM TO ANY PARTICULAR FONT, STYLE, SIZE, OR COLOR.

FOR REMOTE MONITORING SERVICES OF HEATING, VENTILATING AND AIR CONDITIONING APPARATUS IN THE NATURE OF PROVIDING MONITORING OF CRITICAL COMPUTING ENVIRONMENT ELECTRICAL BRANCH LOAD DISTRIBUTION, ROOM HEAT LOAD DISTRIBUTION (BTU OUTPUT), ROOM TEMPERATURE DISTRIBUTION, HUMIDITY LEVEL MONITORING, UNDERFLOOR WATER LEAK DETECTION, UNDERFLOOR PRESSURE DISTRIBUTION, AND HVAC COMPONENT PERFORMANCE MONITORING (U.S. CLS. 100 AND 101).

FIRST USE 10-21-2005; IN COMMERCE 12-1-2005.
MARK T. MULLEN, EXAMINING ATTORNEY

SN 77-183,121. ECO-EDGE, LLC, CHANDLER, AZ. FILED 5-16-2007.

**IMPROVING PROFITS -
REDUCING ENVIRONMENTAL
IMPACT**

THE MARK CONSISTS OF STANDARD CHARACTERS WITHOUT CLAIM TO ANY PARTICULAR FONT, STYLE, SIZE, OR COLOR.

FOR CONSULTING SERVICES, NAMELY, TECHNOLOGY CONSULTATION SERVICES IN THE FIELD OF FUEL EFFICIENCY, EMISSION CONTROL, AND AUTOMOTIVE TECHNOLOGY FOR DIESEL FREIGHT TRUCK FLEET OPERATIONS (U.S. CLS. 100 AND 101).

RICHARD A. STRASER, EXAMINING ATTORNEY

CLASS 42—(Continued).

SN 77-183,949. NAVISITE, INC., ANDOVER, MA. FILED 5-17-2007.

**NAVISITE ISV ON-DEMAND
SANDBOX**

THE MARK CONSISTS OF STANDARD CHARACTERS WITHOUT CLAIM TO ANY PARTICULAR FONT, STYLE, SIZE, OR COLOR.

NO CLAIM IS MADE TO THE EXCLUSIVE RIGHT TO USE "ISV ON-DEMAND", APART FROM THE MARK AS SHOWN.

FOR APPLICATION SERVICE PROVIDER (ASP), NAMELY, HOSTING AND MANAGING COMPUTER SOFTWARE APPLICATIONS OF INDEPENDENT SOFTWARE VENDORS IN AN EFFORT TO ENABLE THEM TO PORT THEIR APPLICATIONS TO A SOFTWARE-AS-A-SERVICE ENVIRONMENT (U.S. CLS. 100 AND 101).
RAUL CORDOVA, EXAMINING ATTORNEY

SN 77-185,978. NOVARTIS AG, BASEL, SWITZERLAND, FILED 5-21-2007.

VALUE

THE MARK CONSISTS OF STANDARD CHARACTERS WITHOUT CLAIM TO ANY PARTICULAR FONT, STYLE, SIZE, OR COLOR.

FOR MEDICAL AND SCIENTIFIC RESEARCH, NAMELY, CONDUCTING CLINICAL TRIALS (U.S. CLS. 100 AND 101).

JANICE KIM, EXAMINING ATTORNEY

SN 77-190,338. VISIBLE MEASURES CORP., CAMBRIDGE, MA. FILED 5-25-2007.

INTERNET VIDEO AUTHORITY

THE MARK CONSISTS OF STANDARD CHARACTERS WITHOUT CLAIM TO ANY PARTICULAR FONT, STYLE, SIZE, OR COLOR.

NO CLAIM IS MADE TO THE EXCLUSIVE RIGHT TO USE "INTERNET VIDEO", APART FROM THE MARK AS SHOWN.

FOR PROVIDING ON-LINE NON-DOWNLOADABLE SOFTWARE FOR ENABLING USERS TO QUANTIFY AND ANALYZE AUDIENCE ENGAGEMENT AND EXPERIENCE WITH INTERNET VIDEO AND INTERACTIVE ADVERTISING (U.S. CLS. 100 AND 101).

TIMOTHY FINNEGAN, EXAMINING ATTORNEY

CLASS 42—(Continued).

SN 77-190,949. FIREPOND, INC., NEWTON, MA. FILED 5-25-2007.

FIREPOND CPQ

THE MARK CONSISTS OF STANDARD CHARACTERS WITHOUT CLAIM TO ANY PARTICULAR FONT, STYLE, SIZE, OR COLOR.

OWNER OF U.S. REG. NO. 2,968,557.

NO CLAIM IS MADE TO THE EXCLUSIVE RIGHT TO USE "CPQ", APART FROM THE MARK AS SHOWN.

FOR PROVIDING ONLINE NON-DOWNLOADABLE SOFTWARE, NAMELY PROVIDING AN ONLINE NON-DOWNLOADABLE SUITE OF COMPUTER SOFTWARE THAT ENABLES A COMPANY'S SALES FORCE AND SUPPORTING ORGANIZATIONS TO CONFIGURE COMPLEX PRODUCTS AND SERVICES, ACCURATELY PRICE PRODUCTS AND SERVICES, DEVELOP PRICE QUOTES, GENERATE HIGH QUALITY PROPOSALS, AUTOMATE AND SIMPLIFY PRODUCT PRICING AND CONFIGURATION, IMPROVE ORDER ACCURACY AND REDUCE THE COST OF SALES, OPTIMIZE SALES PROCESSES, CREATE PRODUCT CATALOGS, AND PROVIDE AN INTERACTIVE SELLING SYSTEM (U.S. CLS. 100 AND 101).

FIRST USE 8-0-2005; IN COMMERCE 8-0-2005.

PAUL F. GAST, EXAMINING ATTORNEY

SN 77-193,705. INSTITUTE FOR SYSTEMS BIOLOGY, SEATTLE, WA. FILED 5-30-2007.

ISB

THE MARK CONSISTS OF STANDARD CHARACTERS WITHOUT CLAIM TO ANY PARTICULAR FONT, STYLE, SIZE, OR COLOR.

FOR RESEARCH IN THE FIELD OF SYSTEMS BIOLOGY (U.S. CLS. 100 AND 101).

PAULA MAYS, EXAMINING ATTORNEY

SN 77-196,069. ROYAL BANK OF CANADA, MONTREAL, CANADA, FILED 6-1-2007.

CAM CONNECT

THE MARK CONSISTS OF STANDARD CHARACTERS WITHOUT CLAIM TO ANY PARTICULAR FONT, STYLE, SIZE, OR COLOR.

FOR APPLICATION SERVICE PROVIDER (ASP), UTILIZING A SECURE WEB PORTAL, FOR USE IN COMMISSION MANAGEMENT FOR CLIENTS TO EFFECTIVELY AND SECURELY MANAGE TRADING COMMISSION ALLOCATIONS AND OTHER BROKER AND VENDOR DISBURSEMENTS AND ACCOUNT ACTIVITY (U.S. CLS. 100 AND 101).

ERIN FALK, EXAMINING ATTORNEY

CLASS 42—(Continued).

SN 77-200,924. 4 WALL ENTERPRISES, INC., LAS VEGAS, NV. FILED 6-7-2007.



NO CLAIM IS MADE TO THE EXCLUSIVE RIGHT TO USE WALL LIGHTING, APART FROM THE MARK AS SHOWN.

THE MARK CONSISTS OF A STYLIZED 4 WALL LIGHTING ENTERTAINMENT.

FOR DESIGN FOR OTHERS IN THE FIELD OF LIGHTING, LIGHTING ENGINEERING INSTALLATIONS, PLANNING OF LIGHTING INSTALLATIONS, CUSTOM LIGHTING DESIGN, LIGHTING DESIGN FOR ARCHITECTURE, OUTDOOR LIGHTING DESIGN, INDOOR LIGHTING DESIGN, CONTROL SYSTEMS DESIGN, LANDSCAPE LIGHTING DESIGN, THEATRICAL LIGHTING DESIGN; DESIGN, DEVELOPMENT AND IMPLEMENTATION OF SOFTWARE FOR LIGHTING SERVICES (U.S. CLS. 100 AND 101).

FIRST USE 1-25-1999; IN COMMERCE 1-25-1999.

JACQUELINE A. LAVINE, EXAMINING ATTORNEY

SN 77-213,983. SPORTRONIX LLC, MARIETTA, GA. FILED 6-24-2007.

sportronix

THE MARK CONSISTS OF STANDARD CHARACTERS WITHOUT CLAIM TO ANY PARTICULAR FONT, STYLE, SIZE, OR COLOR.

FOR TECHNOLOGY CONSULTATION IN THE FIELD OF COMPETITIVE SPORTS TECHNOLOGY (U.S. CLS. 100 AND 101).

FIRST USE 4-1-2007; IN COMMERCE 4-1-2007.

LOURDES AYALA, EXAMINING ATTORNEY

CLASS 42—(Continued).

SN 77-214,556. REMEDIATION TECHNOLOGIES, LTD., NORTHFIELD, IL. FILED 6-25-2007.



NO CLAIM IS MADE TO THE EXCLUSIVE RIGHT TO USE "REMEDIATION TECHNOLOGIES, LTD.", APART FROM THE MARK AS SHOWN.

THE COLOR(S) DARK BLUE, LIGHT BLUE, AND BLACK IS/ARE CLAIMED AS A FEATURE OF THE MARK.

THE MARK CONSISTS OF THE WORD REMTECH IN DARK BLUE WITH LIGHT BLUE ARROWS FORMING AN ALMOST COMPLETE CIRCLE, AND THE WORDS REMEDIATION TECHNOLOGIES, LTD. IN BLACK.

FOR ENGINEERING EVALUATION, NAMELY CONDUCTING ENGINEERING SURVEYS; PREPARING ENVIRONMENTAL COMPLIANCE REPORTS; ENVIRONMENTAL SITE ASSESSMENT, NAMELY, ENGINEERING SERVICES FOR BUILDING AND PROPERTY CONDITION ASSESSMENT, FACILITY MANAGEMENT, REPAIR AND RESTORATION, BUILDING INSTRUMENTATION AND MONITORING, AND MONITORING, AND ENVIRONMENTAL CONSULTING; FACILITY DECOMMISSIONING, NAMELY BUILDING INSPECTION; REMEDIAL DESIGN, NAMELY DESIGN FOR OTHERS IN THE FIELD OF ENVIRONMENTAL ENGINEERING OF FACTORY AND COMMERCIAL BUILDINGS FOR THE PURPOSE OF REMOVING CONTAMINATED SOIL AND/OR GROUNDWATER; ENVIRONMENTAL TESTING AND INSPECTION SERVICES, NAMELY, SOIL AND GROUNDWATER INVESTIGATION (U.S. CLS. 100 AND 101).

FIRST USE 2-1-2002; IN COMMERCE 2-1-2002.
LEIGH CAROLINE CASE, EXAMINING ATTORNEY

SN 77-216,136. EVERYTRAIL, INC., PALO ALTO, CA. FILED 6-26-2007.

GLOBALMOTION

THE MARK CONSISTS OF STANDARD CHARACTERS WITHOUT CLAIM TO ANY PARTICULAR FONT, STYLE, SIZE, OR COLOR.

FOR ASP-HOSTED SOFTWARE SERVICES, NAMELY, HOSTING COMPUTER SOFTWARE APPLICATIONS FOR OTHERS; PROVIDING TEMPORARY USE OF ON-LINE NON-DOWNLOADABLE SOFTWARE FOR REAL-TIME ONLINE TRACKING OF PEOPLE AND THEIR LOCATIONS THROUGH GPS DEVICES, CELL PHONES AND OTHER LOCATION TECHNOLOGY; COMPUTER SERVICES, NAMELY, PROVIDING CUSTOMIZED ON-LINE WEB PAGES FEATURING USER-DEFINED INFORMATION RELATING TO MAPPING AND TRACKING OF PEOPLE AND THEIR LOCATIONS WHICH INCLUDES SEARCH ENGINES AND ONLINE WEB LINKS TO OTHER WEB SITES (U.S. CLS. 100 AND 101).

JAY BESCH, EXAMINING ATTORNEY

CLASS 42—(Continued).

SN 77-216,572. VICTOR, MELISSA, WILLIAMSPORT, OH. FILED 6-27-2007.

HORSEHOUSEDESIGN

THE MARK CONSISTS OF STANDARD CHARACTERS WITHOUT CLAIM TO ANY PARTICULAR FONT, STYLE, SIZE, OR COLOR.

FOR GRAPHIC DESIGN SERVICES, NAMELY, WEB SITE DESIGN (U.S. CLS. 100 AND 101).

FIRST USE 10-1-2005; IN COMMERCE 10-1-2005.
COLLEEN DOMBROW, EXAMINING ATTORNEY

SN 77-228,994. SOLUTIONARY, INC., OMAHA, NE. FILED 7-13-2007.



THE MARK CONSISTS OF DESIGN IN THE SHAPE OF AN ARCHED EMBLEM COMING TO A POINT IN THE CENTER WITH AN WHITE OVAL ABOVE THE CENTER POINT.

FOR COMPUTER CONSULTATION SERVICES IN THE FIELD OF INTERNET SECURITY, MANAGED INTERNET SECURITY AND COMPUTER SECURITY PROGRAMS (U.S. CLS. 100 AND 101).

FIRST USE 0-0-2004; IN COMMERCE 0-0-2004.
CHERYL CLAYTON, EXAMINING ATTORNEY

SN 77-230,843. PEPCO HOLDINGS, INC., WASHINGTON, DC. FILED 7-16-2007.



FOR PROVIDING METEOROLOGICAL INFORMATION AND WEATHER INFORMATION; WEATHER REPORTING (U.S. CLS. 100 AND 101).

KATHERINE CHANG, EXAMINING ATTORNEY

CLASS 42—(Continued).

SN 77-232,918. ENOVASYS, L.L.C., DBA INFUSION SOFTWARE, GILBERT, AZ. FILED 7-18-2007.



FOR CONSULTATION SERVICES IN THE FIELDS OF IMPLEMENTATION AND USE OF COMPUTER SOFTWARE SYSTEMS FOR WEB-BASED CUSTOMER RELATIONSHIP MANAGEMENT SOFTWARE FOR SMALL BUSINESSES; COMPUTER SOFTWARE DIAGNOSTIC SERVICES FOR WEB-BASED CUSTOMER RELATIONSHIP MANAGEMENT SOFTWARE SYSTEMS FOR SMALL BUSINESSES; AND TECHNICAL SUPPORT SERVICES, NAMELY, TROUBLESHOOTING OF COMPUTER SOFTWARE PROBLEMS FOR WEB-BASED CUSTOMER RELATIONSHIP MANAGEMENT SOFTWARE FOR SMALL BUSINESSES (U.S. CLS. 100 AND 101).

FIRST USE 2-1-2003; IN COMMERCE 2-1-2003.
MORGAN WYNNE, EXAMINING ATTORNEY

SN 77-232,926. ENOVASYS, L.L.C., DBA INFUSION SOFTWARE, GILBERT, AZ. FILED 7-18-2007.



FOR PROVIDING ON-LINE NON-DOWNLOADABLE SOFTWARE FOR CUSTOMER RELATIONSHIP MANAGEMENT SOFTWARE SYSTEMS FOR SMALL BUSINESSES (U.S. CLS. 100 AND 101).

FIRST USE 2-1-2003; IN COMMERCE 2-1-2003.
MORGAN WYNNE, EXAMINING ATTORNEY

SN 77-235,910. WOJNO, CHRISTOPHER R, HUNTINGTON BEACH, CA. FILED 7-23-2007.

AdTracker

THE MARK CONSISTS OF STANDARD CHARACTERS WITHOUT CLAIM TO ANY PARTICULAR FONT, STYLE, SIZE, OR COLOR.

FOR PROVIDING ON-LINE NON-DOWNLOADABLE SOFTWARE FOR SIGNING AFFIDAVITS; PROVIDING TEMPORARY USE OF ON-LINE NON-DOWNLOADABLE SOFTWARE FOR SIGNING AFFIDAVITS (U.S. CLS. 100 AND 101).

FIRST USE 9-25-2007; IN COMMERCE 10-1-2007.
BILL DAWE, EXAMINING ATTORNEY

CLASS 42—(Continued).

SN 77-236,397. ORIGIN DIGITAL, INC., WEEHAWKEN, NJ. FILED 7-23-2007.

ODAPTOR

THE MARK CONSISTS OF STANDARD CHARACTERS WITHOUT CLAIM TO ANY PARTICULAR FONT, STYLE, SIZE, OR COLOR.

THE WORDING "ODAPTOR" HAS NO SIGNIFICANCE IN RELATION TO THE GOODS AND IN THE RELEVANT TRADE OR ANY MEANING IN A LANGUAGE OTHER THAN ENGLISH.

FOR APPLICATION SERVICE PROVIDER FEATURING SOFTWARE FOR USE IN FILE BASED CAPTURE, MANAGEMENT, TRANSFORMATION AND DISTRIBUTION OF DIGITAL VIDEO, AUDIO AND IMAGE CONTENT (U.S. CLS. 100 AND 101).

FIRST USE 4-19-2007; IN COMMERCE 4-19-2007.
DANIEL CAPSHAW, EXAMINING ATTORNEY

SN 77-236,460. CRAYHON RESEARCH, INC., RENO, NV. FILED 7-23-2007.

LABASSIST

THE MARK CONSISTS OF STANDARD CHARACTERS WITHOUT CLAIM TO ANY PARTICULAR FONT, STYLE, SIZE, OR COLOR.

FOR LABORATORY SERVICES, NAMELY, ANALYSIS OF BLOOD SAMPLES AND BLOOD SAMPLE RESULTS (U.S. CLS. 100 AND 101).

FIRST USE 10-1-2006; IN COMMERCE 10-1-2006.
MICHAEL KAZAZIAN, EXAMINING ATTORNEY

SN 77-250,075. WASHINGTONPOST.NEWSWEEK INTERACTIVE COMPANY, LLC, ARLINGTON, VA. FILED 8-8-2007.

RIGHT MATTERS

THE MARK CONSISTS OF STANDARD CHARACTERS WITHOUT CLAIM TO ANY PARTICULAR FONT, STYLE, SIZE, OR COLOR.

FOR COMPUTER SERVICES, NAMELY, HOSTING ON-LINE WEB FACILITIES FOR OTHERS FOR ORGANIZING AND CONDUCTING INTERACTIVE DISCUSSION GROUPS FEATURING TOPICS IN THE FIELDS OF POLITICS AND CULTURE (U.S. CLS. 100 AND 101).

FIRST USE 7-21-2007; IN COMMERCE 7-21-2007.
DOMINIC FATHY, EXAMINING ATTORNEY

CLASS 42—(Continued).

SN 77-252,330. BLCPRO, LLC, NEW LONDON, CT. FILED 8-10-2007.



NO CLAIM IS MADE TO THE EXCLUSIVE RIGHT TO USE "THE GREEN CRO", APART FROM THE MARK AS SHOWN.

THE COLOR(S) DARK GRAY, GOLD, AND GREEN IS/ ARE CLAIMED AS A FEATURE OF THE MARK.

THE MARK CONSISTS OF SEVEN SCALPEL BLADE SHAPES ARRAYED IN AN OVERLAPPING CIRCULAR FORM, THE LOWEST BLADE IS GOLD IN COLOR, THE OTHER BLADES ARE DARK GRAY; THE DESIGN IS FOLLOWED BY THE WORDS "BLCPRO THE GREEN CRO", THE LETTERS "BLC", "THE" AND "CRO" ARE IN GRAY, THE WORD "PRO" IS IN GOLD AND THE WORD "GREEN" IS IN THE COLOR GREEN.

FOR APPLICATION SERVICE PROVIDER, NAMELY, PROVIDING, HOSTING, MANAGING, DEVELOPING, AND MAINTAINING APPLICATIONS, SOFTWARE, WEBSITES, AND DATABASES IN THE FIELDS OF PERSONAL PRODUCTIVITY, WIRELESS COMMUNICATION, MOBILE INFORMATION ACCESS, AND REMOTE DATA MANAGEMENT FOR WIRELESS DELIVERY OF CONTENT TO HANDHELD COMPUTERS, LAPTOPS AND MOBILE ELECTRONIC DEVICES; PHARMACEUTICAL DRUG DEVELOPMENT SERVICES; PHARMACEUTICAL RESEARCH AND DEVELOPMENT; RESEARCH AND DEVELOPMENT AND CONSULTATION RELATED THERETO IN THE FIELD OF PHARMACEUTICALS; MEDICAL AND SCIENTIFIC RESEARCH, NAMELY, CONDUCTING CLINICAL TRIALS; PROVIDING MEDICAL AND SCIENTIFIC RESEARCH INFORMATION IN THE FIELD OF PHARMACEUTICALS AND CLINICAL TRIALS (U.S. CLS. 100 AND 101).

FIRST USE 8-8-2007; IN COMMERCE 8-8-2007.
KAREN K. BUSH, EXAMINING ATTORNEY

SN 77-252,867. 1031 OPERATIONS CORP., LOS GATOS, CA. FILED 8-10-2007.

EXCHANGEWARE

THE MARK CONSISTS OF STANDARD CHARACTERS WITHOUT CLAIM TO ANY PARTICULAR FONT, STYLE, SIZE, OR COLOR.

FOR PROVIDING ON-LINE NON-DOWNLOADABLE SOFTWARE FOR AUTO-GENERATING AND CREATING DOCUMENTS FOR TAX DEFERRED EXCHANGES PURSUANT TO SECTION 1031 OF THE INTERNAL REVENUE CODE (U.S. CLS. 100 AND 101).

SHAILA SETTLES, EXAMINING ATTORNEY

CLASS 42—(Continued).

SN 77-253,386. THE FRAYMAN GROUP, INC., SUNNY ISLES, FL. FILED 8-13-2007.



NO CLAIM IS MADE TO THE EXCLUSIVE RIGHT TO USE "GROUP", APART FROM THE MARK AS SHOWN.

THE MARK CONSISTS OF AN "F" ON TOP OF A "G" LAYING ON ITS SIDE, AND UNDERNEATH THAT THE WORDS "THE FRAYMAN GROUP".

FOR APPLICATION SERVICE PROVIDER (ASP) FEATURING SOFTWARE FOR USE IN LEGAL RECORDS MANAGEMENT USED TO MANAGED CLIENTS' RECORDS (U.S. CLS. 100 AND 101).

FIRST USE 3-1-2007; IN COMMERCE 4-1-2007.
SUSAN STIGLITZ, EXAMINING ATTORNEY

SN 77-253,388. THE FRAYMAN GROUP, INC., SUNNY ISLES, FL. FILED 8-13-2007.



THE MARK CONSISTS OF THE WORD "COMPLIFLOW" WITH A CAPITAL F.

FOR APPLICATION SERVICE PROVIDER (ASP) FEATURING SOFTWARE FOR USE IN LEGAL RECORDS MANAGEMENT USED TO MANAGED CLIENTS' RECORDS (U.S. CLS. 100 AND 101).

FIRST USE 3-6-2007; IN COMMERCE 4-6-2007.
SUSAN STIGLITZ, EXAMINING ATTORNEY

CLASS 42—(Continued).

SN 77-258,397. GOODCIRCLE LLC, NEW YORK, NY. FILED 8-17-2007.

goodcircle

THE MARK CONSISTS OF THE TERM "GOODCIRCLE" IN STYLIZED LETTERS WITH THE SECOND "O" IN A DIFFERENT SHADE THAN THE OTHER LETTERS.

FOR COMPUTER SERVICES, NAMELY, HOSTING ONLINE WEB FACILITIES FOR INDIVIDUALS AND NON-PROFIT ORGANIZATIONS FOR ORGANIZING AND CONDUCTING ONLINE MEETINGS, GATHERINGS, AND INTERACTIVE DISCUSSIONS; AND COMPUTER SERVICES IN THE NATURE OF CUSTOMIZED WEB PAGES FEATURING USER-DEFINED INFORMATION, PERSONAL PROFILES AND INFORMATION (U.S. CLS. 100 AND 101).

CHRIS WELLS, EXAMINING ATTORNEY

CLASS 42—(Continued).

SN 77-259,993. KUATRO, LLC, SAN DIEGO, CA. FILED 8-20-2007.

KUATRO DESIGN

THE MARK CONSISTS OF STANDARD CHARACTERS WITHOUT CLAIM TO ANY PARTICULAR FONT, STYLE, SIZE, OR COLOR.

NO CLAIM IS MADE TO THE EXCLUSIVE RIGHT TO USE "DESIGN", APART FROM THE MARK AS SHOWN.

THE WORD "KUATRO" HAS NO MEANING IN A FOREIGN LANGUAGE.

FOR INTERIOR DESIGN SERVICES; PLANNING AND LAYOUT DESIGN FOR THE INTERIOR SPACE OF HOSPITALITY ESTABLISHMENTS; PLANNING AND LAYOUT DESIGN FOR THE INTERIOR SPACE OF COMMERCIAL ESTABLISHMENTS; PLANNING AND LAYOUT DESIGN FOR THE INTERIOR SPACE OF RESIDENCES; PLANNING AND LAYOUT DESIGN FOR THE INTERIOR PUBLIC SPACES OF COMMERCIAL ESTABLISHMENTS; PLANNING AND LAYOUT DESIGN FOR THE INTERIOR SPACE OF MODEL HOMES (U.S. CLS. 100 AND 101).

FIRST USE 1-1-2000; IN COMMERCE 1-1-2000.
WENDY GOODMAN, EXAMINING ATTORNEY

SN 77-259,976. KUATRO, LLC, SAN DIEGO, CA. FILED 8-20-2007.

KUATRO

THE MARK CONSISTS OF STANDARD CHARACTERS WITHOUT CLAIM TO ANY PARTICULAR FONT, STYLE, SIZE, OR COLOR.

THE WORDING "KUATRO" HAS NO MEANING IN A FOREIGN LANGUAGE.

FOR INTERIOR DESIGN SERVICES; PLANNING AND LAYOUT DESIGN FOR THE INTERIOR SPACE OF HOSPITALITY ESTABLISHMENTS; PLANNING AND LAYOUT DESIGN FOR THE INTERIOR SPACE OF COMMERCIAL ESTABLISHMENTS; PLANNING AND LAYOUT DESIGN FOR THE INTERIOR SPACE OF RESIDENCES; PLANNING AND LAYOUT DESIGN FOR THE INTERIOR PUBLIC SPACES OF COMMERCIAL ESTABLISHMENTS; PLANNING AND LAYOUT DESIGN FOR THE INTERIOR SPACE OF MODEL HOMES (U.S. CLS. 100 AND 101).

FIRST USE 1-1-2000; IN COMMERCE 1-1-2000.
WENDY GOODMAN, EXAMINING ATTORNEY

SN 77-263,351. BOUTIQUE ONE, LAND O LAKES, FL. FILED 8-24-2007.



THE COLOR(S) BLACK AND GOLD IS/ARE CLAIMED AS A FEATURE OF THE MARK.

THE COLOR GOLD APPEARS IN "BJ4J" AND IN THE WORDING "BE JEWELLED FOR JESUS". THE COLOR BLACK APPEARS AS THE BACKGROUND FOR THE MARK.

FOR (BASED ON INTENT TO USE) CUSTOM DESIGN OF WEARING APPAREL BASED ON PERSONAL SELECTIONS MADE BY THE CUSTOMER (U.S. CLS. 100 AND 101).

ELI HELLMAN, EXAMINING ATTORNEY

CLASS 42—(Continued).

SN 77-267,595. ETHIC LIVING, LLP, AUSTIN, TX. FILED 8-29-2007.

ARCHITECTURE FOR A GREEN
PLANET

THE MARK CONSISTS OF STANDARD CHARACTERS WITHOUT CLAIM TO ANY PARTICULAR FONT, STYLE, SIZE, OR COLOR.

NO CLAIM IS MADE TO THE EXCLUSIVE RIGHT TO USE "ARCHITECTURE", APART FROM THE MARK AS SHOWN.

FOR ARCHITECTURAL DESIGN; CONSULTING IN THE FIELDS OF ENGINEERING AND ARCHITECTURE; CONSULTING SERVICES IN THE FIELD OF ARCHITECTURAL DESIGN (U.S. CLS. 100 AND 101).

FIRST USE 7-16-2007; IN COMMERCE 7-16-2007.
CHERYL CLAYTON, EXAMINING ATTORNEY

CLASS 42—(Continued).

SN 77-278,854. MICNELF USA INC, HILLSBORO, OR. FILED 9-13-2007.

Balanced Plant Nutrition
(BPN)

THE MARK CONSISTS OF STANDARD CHARACTERS WITHOUT CLAIM TO ANY PARTICULAR FONT, STYLE, SIZE, OR COLOR.

NO CLAIM IS MADE TO THE EXCLUSIVE RIGHT TO USE "BALANCED PLANT NUTRITION", APART FROM THE MARK AS SHOWN.

FOR (BASED ON USE IN COMMERCE) AGRICULTURAL RESEARCH (BASED ON INTENT TO USE) PROFESSIONAL CONSULTING SERVICES AND ADVICE ABOUT AGRICULTURAL CHEMISTRY; TESTING, INSPECTION OR RESEARCH ON AGRICULTURE, LIVESTOCK BREEDING OR FISHERIES (U.S. CLS. 100 AND 101).

FIRST USE 6-1-2002; IN COMMERCE 6-1-2004.
SANI KHOURI, EXAMINING ATTORNEY

SN 77-278,226. FORGENT NETWORKS, INC., AUSTIN, TX. FILED 9-12-2007.

ASURE SOFTWARE

THE MARK CONSISTS OF STANDARD CHARACTERS WITHOUT CLAIM TO ANY PARTICULAR FONT, STYLE, SIZE, OR COLOR.

NO CLAIM IS MADE TO THE EXCLUSIVE RIGHT TO USE SOFTWARE, APART FROM THE MARK AS SHOWN.

FOR PROVIDING TEMPORARY USE OF ON-LINE NON-DOWNLOADABLE SOFTWARE DESIGNED TO ALLOW EMPLOYEES ACCESS AND UPDATE INFORMATION REGARDING HUMAN RESOURCES, PAYROLL, TIMESHEETS, EXPENSE STATEMENTS AND ADMINISTRATION; PROVIDING TEMPORARY USE OF ON-LINE NON-DOWNLOADABLE SOFTWARE DESIGNED TO BE USED FOR MANAGING AND SCHEDULING MEETINGS AND SOFTWARE USED FOR THE MANAGEMENT AND TRACKING OF INFORMATION TECHNOLOGY AND FIXED ASSETS (U.S. CLS. 100 AND 101).

RENEE MCCRAY, EXAMINING ATTORNEY

SN 77-280,627. KUATRO, LLC, SAN DIEGO, CA. FILED 9-16-2007.

KUATRO LIVING

THE MARK CONSISTS OF STANDARD CHARACTERS WITHOUT CLAIM TO ANY PARTICULAR FONT, STYLE, SIZE, OR COLOR.

THE MARK HAS NO MEANING IN ENGLISH, FOR FURNITURE DESIGN SERVICES; INTERIOR DESIGN SERVICES (U.S. CLS. 100 AND 101).

FIRST USE 3-31-2007; IN COMMERCE 3-31-2007.
WENDY GOODMAN, EXAMINING ATTORNEY

CLASS 42—(Continued).

SN 77-281,216. RHINO MANUFACTURING GROUP, INC., SAN DIEGO, CA. FILED 9-17-2007.



NO CLAIM IS MADE TO THE EXCLUSIVE RIGHT TO USE "MANUFACTURING GROUP", APART FROM THE MARK AS SHOWN.

THE MARK CONSISTS OF A FORWARD-FACING RHINOCEROS WITH A DUST CLOUD BY HIS FEET, WITH THE WORDS "RHINO MANUFACTURING GROUP" BELOW THE RHINOCEROS.

FOR PRODUCT DEVELOPMENT FOR OTHERS (U.S. CLS. 100 AND 101).

FIRST USE 1-0-2006; IN COMMERCE 1-0-2006.
CURTIS FRENCH, EXAMINING ATTORNEY

SN 77-282,724. VIZSOURCE, LLC, SAN DIEGO, CA. FILED 9-18-2007.

See it before you build it

THE MARK CONSISTS OF STANDARD CHARACTERS WITHOUT CLAIM TO ANY PARTICULAR FONT, STYLE, SIZE, OR COLOR.

FOR COMPUTER GRAPHICS SERVICES (U.S. CLS. 100 AND 101).

FIRST USE 3-1-2007; IN COMMERCE 3-1-2007.
AISHA CLARKE, EXAMINING ATTORNEY

SN 77-283,293. OMNIUPDATE, INC., CAMARILLO, CA. FILED 9-19-2007.

OMNIUPDATE

THE MARK CONSISTS OF STANDARD CHARACTERS WITHOUT CLAIM TO ANY PARTICULAR FONT, STYLE, SIZE, OR COLOR.

FOR APPLICATION SERVICE PROVIDER (ASP) FEATURING SOFTWARE FOR USE IN UPDATING AND MANAGING CONTENT, NAMELY, TEXT, GRAPHICS AND MEDIA, ON THE WEBSITES OF OTHERS (U.S. CLS. 100 AND 101).

FIRST USE 5-22-2000; IN COMMERCE 5-22-2000.
ANNE FARRELL, EXAMINING ATTORNEY

CLASS 42—(Continued).

SN 77-283,410. RYERO CORPORATION, POWELL'S POINT, NC. FILED 9-19-2007.

SLAB SEARCH

THE MARK CONSISTS OF STANDARD CHARACTERS WITHOUT CLAIM TO ANY PARTICULAR FONT, STYLE, SIZE, OR COLOR.

NO CLAIM IS MADE TO THE EXCLUSIVE RIGHT TO USE "SEARCH", APART FROM THE MARK AS SHOWN.

FOR PROVIDING CUSTOMIZED, ONLINE WEB PAGES FEATURING USER-DEFINED INFORMATION WHICH INCLUDES SEARCH ENGINES AND ONLINE WEB LINKS TO OTHER WEB SITES IN THE COUNTER TOP INDUSTRY (U.S. CLS. 100 AND 101).

ROBIN MITTLER, EXAMINING ATTORNEY

SN 77-285,156. PUMPKINFISH, LLC, FORT LAUDERDALE, FL. FILED 9-20-2007.

PUMPKINFISH

THE MARK CONSISTS OF STANDARD CHARACTERS WITHOUT CLAIM TO ANY PARTICULAR FONT, STYLE, SIZE, OR COLOR.

FOR GRAPHIC DESIGN SERVICES; COMPUTER SERVICES, NAMELY, DESIGNING AND IMPLEMENTING WEBSITES FOR OTHERS (U.S. CLS. 100 AND 101).

FIRST USE 3-1-2007; IN COMMERCE 3-1-2007.
BARBARA A. GOLD, EXAMINING ATTORNEY

SN 77-285,178. PUMPKINFISH, LLC, FORT LAUDERDALE, FL. FILED 9-20-2007.



THE MARK CONSISTS OF THE TERM, "PUMPKINFISH", TO THE RIGHT OF THE FANCIFUL DESIGN OF A PARTIALLY CARVED PUMPKIN, WITH THE SHAPE OF A JACK-O'-LANTERN ABOVE TWO CRISS-CROSSED FISH, IN THE CENTER OF THE CIRCULAR PUMPKIN DESIGN.

FOR GRAPHIC DESIGN SERVICES; COMPUTER SERVICES, NAMELY, DESIGNING AND IMPLEMENTING WEBSITES FOR OTHERS (U.S. CLS. 100 AND 101).

FIRST USE 3-1-2007; IN COMMERCE 3-1-2007.
BARBARA A. GOLD, EXAMINING ATTORNEY

CLASS 42—(Continued).

SN 77-285,699. COURSOURCE TECHNOLOGY GROUP, INC., BEAVERTON, OR. FILED 9-21-2007.



CORSOURCE
TECHNOLOGY GROUP

NO CLAIM IS MADE TO THE EXCLUSIVE RIGHT TO USE TECHNOLOGY GROUP, APART FROM THE MARK AS SHOWN.

THE COLOR(S) RED AND BLACK IS/ARE CLAIMED AS A FEATURE OF THE MARK.

THE COLOR RED APPEARS IN THE OPPOSITELY DIRECTED INTERLEAVED OVALOID CRESCENTS ADJACENT THE LITERAL ELEMENT OF THE MARK COURSOURCE TECHNOLOGY GROUP, WHICH APPEARS IN BLACK.

FOR SOFTWARE DEVELOPMENT, CONSULTING SERVICES IN THE FIELD OF DESIGN, SELECTION, IMPLEMENTATION AND USE OF COMPUTER HARDWARE AND SOFTWARE SYSTEMS FOR OTHERS AND COMPUTER PROGRAMMING FOR OTHERS (U.S. CLS. 100 AND 101).

FIRST USE 9-17-2007; IN COMMERCE 9-17-2007.
GINA HAYES, EXAMINING ATTORNEY

SN 77-286,313. SLIDE, INC., SAN FRANCISCO, CA. FILED 9-21-2007.

Top Friends

THE MARK CONSISTS OF STANDARD CHARACTERS WITHOUT CLAIM TO ANY PARTICULAR FONT, STYLE, SIZE, OR COLOR.

FOR PROVIDING ON-LINE NON-DOWNLOADABLE SOFTWARE FOR THE ENHANCEMENT OF THE EXPERIENCE OF ONLINE BROWSING OF PRODUCTS AND SERVICES AND SHOPPING BY ALLOWING USERS TO DELIVER AND RECEIVE RECOMMENDATIONS, REVIEWS AND ADVICE ON SOCIAL NETWORKING SITES; PROVIDING ON-LINE NON-DOWNLOADABLE COMPUTER PROGRAMS FOR SENDING, CREATING, RECEIVING, CUSTOMIZING AND PERSONALIZING DIGITAL IMAGES, COMPUTER GRAPHICS, TEXT, METADATA, VIDEO AND PHOTOGRAPHS, AND HYPERLINKS AND HYPERLINKED FILES, VIA A COMPUTER AND COMMUNICATIONS NETWORK (U.S. CLS. 100 AND 101).

FIRST USE 6-15-2007; IN COMMERCE 6-15-2007.
TOBY BULLOFF, EXAMINING ATTORNEY

CLASS 42—(Continued).

SN 77-286,511. TGW CONSULTING, LLC, DBA CONCERAS, FAIRFAX, VA. FILED 9-22-2007.



THE COLOR(S) ORANGE AND BLUE IS/ARE CLAIMED AS A FEATURE OF THE MARK.

THE MARK CONSISTS OF THE STYLIZED WORDING "CONCERAS" WITH AN OVAL SHAPED DESIGN CONTAINING THREE SQUARES AT SEPARATE POINTS ON THE OVAL. THE COLOR BLUE APPEARS IN THE STYLIZED WORDING "CONCERAS" AND IN THE FILL OF THE THREE SQUARE DESIGNS. THE COLOR ORANGE APPEARS IN THE OUTLINE OF AN OVAL AND IN THE OUTLINE OF THE THREE SQUARES.

FOR INFORMATION TECHNOLOGY CONSULTATION (U.S. CLS. 100 AND 101).
JAY BESCH, EXAMINING ATTORNEY

SN 77-287,023. THE PBS&J CORPORATION, TAMPA, FL. FILED 9-24-2007.

COMPLIMENT

THE MARK CONSISTS OF STANDARD CHARACTERS WITHOUT CLAIM TO ANY PARTICULAR FONT, STYLE, SIZE, OR COLOR.

FOR PROVIDING TEMPORARY USE OF ON-LINE NON-DOWNLOADABLE SOFTWARE FOR MONITORING ENVIRONMENTAL COMPLIANCE (U.S. CLS. 100 AND 101).

FIRST USE 5-17-2007; IN COMMERCE 6-24-2007.
JAY BESCH, EXAMINING ATTORNEY

SN 77-287,323. RENT-A-CENTER WEST, INC., PLANO, TX. FILED 9-24-2007.

RAC WORRY FREE GUARANTEE

THE MARK CONSISTS OF STANDARD CHARACTERS WITHOUT CLAIM TO ANY PARTICULAR FONT, STYLE, SIZE, OR COLOR.

OWNER OF U.S. REG. NO. 3,161,654.
NO CLAIM IS MADE TO THE EXCLUSIVE RIGHT TO USE "GUARANTEE", APART FROM THE MARK AS SHOWN.

FOR RENTAL, LEASING, LEASE PURCHASING AND RENTAL-TO-OWN OF COMPUTERS AND COMPUTER EQUIPMENT (U.S. CLS. 100 AND 101).

JILL C. ALT, EXAMINING ATTORNEY

CLASS 42—(Continued).

SN 77-287,324. TREND INTEGRATION, LLC, CHERRY HILL, NJ. FILED 9-24-2007.

POINT, CLICK, AND LISTEN

THE MARK CONSISTS OF STANDARD CHARACTERS WITHOUT CLAIM TO ANY PARTICULAR FONT, STYLE, SIZE, OR COLOR.

FOR DATA COLLECTION SERVICES, NAMELY, COLLECTING DATA THROUGH USE OF AUTOMATED TELEPHONE INTERVIEWS SELECTED BY CUSTOMERS WHICH ALLOWS CUSTOMERS TO REVIEW THE RESULTS OF INTERVIEWS TAKEN UPON THEIR COMPLETION THROUGH USE OF A COMPUTER BASED GRAPHICAL INTERFACE ACCESSIBLE VIA THE INTERNET (U.S. CLS. 100 AND 101).

FIRST USE 5-8-2006; IN COMMERCE 5-8-2006.
ASMAT KHAN, EXAMINING ATTORNEY

SN 77-287,667. STEVENSON, LINDA, ROCHESTER, NY. FILED 9-24-2007.

DISCOVER THE WORKS!

THE MARK CONSISTS OF STANDARD CHARACTERS WITHOUT CLAIM TO ANY PARTICULAR FONT, STYLE, SIZE, OR COLOR.

FOR PROVIDING TEMPORARY USE OF ON-LINE NON-DOWNLOADABLE SOFTWARE USED TO CREATE A PERSONALIZED ON-LINE INFORMATION SERVICE, NAMELY, SOFTWARE USED IN CONNECTION WITH SEARCHING, EXTRACTING, RETRIEVING, CATEGORIZING AND DISPLAYING INFORMATION AND OTHER CONTENT INCLUDING TEXT, ELECTRONIC DOCUMENTS, DATABASES, AUDIO VISUAL INFORMATION AND GRAPHICS; PROVIDING SUBSCRIPTION-BASED USE OF NON-DOWNLOADABLE COMPUTER SOFTWARE USED TO CREATE A PERSONALIZED ON-LINE INFORMATION SERVICE, NAMELY, SOFTWARE USED IN CONNECTION WITH SEARCHING, EXTRACTING, RETRIEVING, CATEGORIZING AND DISPLAYING INFORMATION AND OTHER CONTENT INCLUDING TEXT, ELECTRONIC DOCUMENTS, DATABASES, AUDIO VISUAL INFORMATION AND GRAPHICS; PROVIDING INFORMATION AT THE SPECIFIC REQUEST OF END-USERS BY MEANS OF TELEPHONE OR GLOBAL COMPUTER NETWORKS; COMPUTER SERVICES, NAMELY, CREATING INDEXES OF INFORMATION, SITES AND OTHER RESOURCES AVAILABLE ON COMPUTER NETWORKS (U.S. CLS. 100 AND 101).

MICHAEL LITZAU, EXAMINING ATTORNEY

CLASS 42—(Continued).

SN 77-288,603. OLIVERA-SILVERA, JUAN-MANUEL, BROOKLYN, NY. FILED 9-25-2007.

ugo luxury

THE MARK CONSISTS OF STANDARD CHARACTERS WITHOUT CLAIM TO ANY PARTICULAR FONT, STYLE, SIZE, OR COLOR.

FOR CUSTOM DESIGN OF WEARABLE APPAREL BASED ON PERSONAL SELECTIONS MADE BY THE CUSTOMER (U.S. CLS. 100 AND 101).

NAPOLEON SHARMA, EXAMINING ATTORNEY

SN 77-288,612. PLANSOURCE, LLC, LOUISVILLE, CO. FILED 9-25-2007.

PLANSOURCE

THE MARK CONSISTS OF STANDARD CHARACTERS WITHOUT CLAIM TO ANY PARTICULAR FONT, STYLE, SIZE, OR COLOR.

FOR PROVIDING TEMPORARY USE OF ON-LINE NON-DOWNLOADABLE SOFTWARE FOR STORING, MANAGING, TRACKING AND ANALYZING DATA IN THE FIELD OF EMPLOYEE BENEFITS, NAMELY, HEALTH INSURANCE, DENTAL INSURANCE, LIFE AND DISABILITY INSURANCE, MEDICARE, RETIREMENT, SOCIAL SECURITY AND TUITION REIMBURSEMENT; COMPUTER SERVICES, NAMELY, DESIGNING, IMPLEMENTING, AND MAINTAINING COMPUTER SOFTWARE FOR THE BENEFIT OF OTHERS (U.S. CLS. 100 AND 101).

SIMON TENG, EXAMINING ATTORNEY

SN 77-290,020. TOMATIC GMBH, LINZ, AUSTRIA, FILED 9-27-2007.

tomatic

THE MARK CONSISTS OF STANDARD CHARACTERS WITHOUT CLAIM TO ANY PARTICULAR FONT, STYLE, SIZE, OR COLOR.

THE WORDING "TOMATIC" HAS NO MEANING IN A FOREIGN LANGUAGE.

FOR DESIGN, CREATION, HOSTING, MAINTENANCE OF WEBSITES FOR OTHERS; PROVIDING A WEBSITE THAT FEATURES INFORMATION ON COMPUTER TECHNOLOGY AND PROGRAMMING (U.S. CLS. 100 AND 101).

FIRST USE 11-4-2006; IN COMMERCE 9-22-2007.
REBECCA SMITH, EXAMINING ATTORNEY

CLASS 42—(Continued).

SN 77-290,043. THE TIPSTONE GROUP, LLC, ARLINGTON, VA. FILED 9-27-2007.



NO CLAIM IS MADE TO THE EXCLUSIVE RIGHT TO USE "GROUP", APART FROM THE MARK AS SHOWN. THE COLOR(S) BLUE AND GREEN IS/ARE CLAIMED AS A FEATURE OF THE MARK.

THE COLOR BLUE APPEARS IN THE WORDS "THE TIPSTONE GROUP" AND IN THE SPHERE. THE COLOR GREEN APPEARS IN THE CURVE UNDERNEATH THE WORD "TIPSTONE" AND IN THE SPHERE.

FOR INFORMATION TECHNOLOGY CONSULTATION; COMPUTER CONSULTATION IN THE FIELD OF COMPUTER SECURITY; TECHNOLOGY CONSULTATION AND RESEARCH IN THE FIELD OF INFORMATION TECHNOLOGY AND SECURITY (U.S. CLS. 100 AND 101).

FIRST USE 9-4-2007; IN COMMERCE 9-4-2007. EVELYN BRADLEY, EXAMINING ATTORNEY

SN 77-290,055. CELL THERAPEUTICS, INC., SEATTLE, WA. FILED 9-27-2007.

CONTEXT OF VULNERABILITY

THE MARK CONSISTS OF STANDARD CHARACTERS WITHOUT CLAIM TO ANY PARTICULAR FONT, STYLE, SIZE, OR COLOR.

FOR RESEARCH AND DEVELOPMENT OF PHARMACEUTICAL PREPARATIONS; PRODUCT RESEARCH AND DEVELOPMENT FOR OTHERS IN THE FIELD OF PHARMACEUTICAL PREPARATIONS; PRODUCT RESEARCH AND DEVELOPMENT SERVICES, NAMELY, ASSESSING INTENDED TARGET RECIPIENTS OF PHARMACEUTICAL PREPARATIONS AND POSITIONING PHARMACEUTICAL PREPARATIONS FOR SUCCESS IN CLINICAL DEVELOPMENT AND COMMERCIAL USE; AND PROVIDING TECHNICAL CONSULTATION IN THE FIELD OF PHARMACEUTICAL PRODUCT RESEARCH AND DEVELOPMENT (U.S. CLS. 100 AND 101).

LINDA ORNDORFF, EXAMINING ATTORNEY

CLASS 42—(Continued).

SN 77-290,089. MIAN, MICHAEL, LIVERMORE, CA. FILED 9-27-2007.

taggerang

THE MARK CONSISTS OF STANDARD CHARACTERS WITHOUT CLAIM TO ANY PARTICULAR FONT, STYLE, SIZE, OR COLOR.

FOR HOSTING AN ONLINE COMMUNITY WEBSITE FEATURING INFORMATION IN THE FIELD OF PERSONAL AND BUSINESS ASSETS ACCESSED BY USERS VIA UNIVERSAL UNIQUE IDENTIFIERS (U.S. CLS. 100 AND 101).

BRENDAN REGAN, EXAMINING ATTORNEY

SN 77-290,631. SOUTH RIVER CONSULTING, LLC, BALTIMORE, MD. FILED 9-27-2007.

GSDS

THE MARK CONSISTS OF STANDARD CHARACTERS WITHOUT CLAIM TO ANY PARTICULAR FONT, STYLE, SIZE, OR COLOR.

FOR PROVIDING TEMPORARY ACCESS TO NON-DOWNLOADABLE COMPUTER SOFTWARE FOR SCHEDULING AND DISPATCHING GENERATORS OVER COMPUTER NETWORKS, INTRANETS AND THE INTERNET (U.S. CLS. 100 AND 101).

KRISTINA MORRIS, EXAMINING ATTORNEY

SN 77-290,650. MONK DEVELOPMENT, SAN DIEGO, CA. FILED 9-27-2007.



THE COLOR(S) BLUE, WHITE, AND GRAY IS/ARE CLAIMED AS A FEATURE OF THE MARK.

THE COLOR BLUE APPEARS IN THE LETTER "E" WITH A CIRCLE AROUND IT, THE WORD "EKKLESIA" IS WHITE, AND THE NUMBER "360" IS GRAY.

THE ENGLISH TRANSLATION OF THE WORD "EKKLESIA" IN THE MARK IS "CHURCH".

FOR COMPUTER SOFTWARE DESIGN, COMPUTER PROGRAMMING, OR MAINTENANCE OF COMPUTER SOFTWARE (U.S. CLS. 100 AND 101).

FIRST USE 6-1-2005; IN COMMERCE 1-27-2006. AISHA CLARKE, EXAMINING ATTORNEY

CLASS 42—(Continued).

SN 77-290,833. LITIGATION MANAGEMENT, INC., MAYFIELD HEIGHTS, OH. FILED 9-27-2007.

SmartCase

THE MARK CONSISTS OF STANDARD CHARACTERS WITHOUT CLAIM TO ANY PARTICULAR FONT, STYLE, SIZE, OR COLOR.

NO CLAIM IS MADE TO THE EXCLUSIVE RIGHT TO USE "CASE", APART FROM THE MARK AS SHOWN.

FOR COMPUTER SERVICES, NAMELY, ACTING AS AN APPLICATION SERVICE PROVIDER IN THE FIELD OF MEDICAL LITIGATION TO HOST COMPUTER APPLICATION SOFTWARE FOR WEB-ENABLED ELECTRONIC DATA COLLECTION TO CREATE SEARCHABLE DATABASES OF MEDICAL AND LEGAL INFORMATION AND DATA FOR CENTRALIZED DATA MANAGEMENT OF MEDICAL LITIGATION MATTERS (U.S. CLS. 100 AND 101).

FIRST USE 2-5-2007; IN COMMERCE 2-5-2007.
CAROLYN GRAY, EXAMINING ATTORNEY

SN 77-291,262. RELIABLE HOME INSPECTION INC., NEW PROVIDENCE, NJ. FILED 9-28-2007.

RELIABLE HOME INSPECTION

THE MARK CONSISTS OF STANDARD CHARACTERS WITHOUT CLAIM TO ANY PARTICULAR FONT, STYLE, SIZE, OR COLOR.

NO CLAIM IS MADE TO THE EXCLUSIVE RIGHT TO USE "HOME INSPECTION", APART FROM THE MARK AS SHOWN.

FOR INSPECTIONS OF HOMES, INSPECTIONS OF HOMES FOR TERMITES, AND RADON TESTING (U.S. CLS. 100 AND 101).

ANDREW RHIM, EXAMINING ATTORNEY

SN 77-291,319. BLUE PRINCE GROUP, L.L.C., HOUSTON, TX. FILED 9-28-2007.

SYLAS

THE MARK CONSISTS OF STANDARD CHARACTERS WITHOUT CLAIM TO ANY PARTICULAR FONT, STYLE, SIZE, OR COLOR.

FOR COMPUTER SERVICES, NAMELY, HOSTING AN ONLINE COMMUNITY WEBSITE FEATURING INFORMATION FOR LOCAL MUSICIANS WHO WISH TO DISCOVER, INTERACT, AND PARTICIPATE WITHIN THEIR LOCAL MUSIC COMMUNITY (U.S. CLS. 100 AND 101).

TOBY BULLOFF, EXAMINING ATTORNEY

CLASS 42—(Continued).

SN 77-291,498. NATIONAL IMAGE COMPANY, LLC, PORTLAND, ME. FILED 9-28-2007.



THE MARK CONSISTS OF FANCIFUL DEPICTION OF PAPER WITH CORNER PEELED BACK.

FOR COMPUTER SERVICES, NAMELY, DISPLAYING THE PHOTOGRAPHIC DIGITAL IMAGES OF OTHERS ON THE INTERNET (U.S. CLS. 100 AND 101).

FIRST USE 9-6-2007; IN COMMERCE 9-6-2007.
DANIEL CAPSHAW, EXAMINING ATTORNEY

SN 77-291,613. HEALTH IT SERVICES GROUP, LLC, NASHVILLE, TN. FILED 9-28-2007.

ACUMEN Clinical Software

THE MARK CONSISTS OF STANDARD CHARACTERS WITHOUT CLAIM TO ANY PARTICULAR FONT, STYLE, SIZE, OR COLOR.

NO CLAIM IS MADE TO THE EXCLUSIVE RIGHT TO USE "CLINICAL SOFTWARE", APART FROM THE MARK AS SHOWN.

FOR APPLICATION SERVICE PROVIDER (ASP) FEATURING SOFTWARE FOR USE IN MAINTAINING WEB-BASED CLINICAL ELECTRONIC HEALTH RECORDS (U.S. CLS. 100 AND 101).

LEE-ANNE BERNS, EXAMINING ATTORNEY

SN 77-291,624. HEALTH IT SERVICES GROUP, LLC, NASHVILLE, TN. FILED 9-28-2007.

ACUMEN nEHR

THE MARK CONSISTS OF STANDARD CHARACTERS WITHOUT CLAIM TO ANY PARTICULAR FONT, STYLE, SIZE, OR COLOR.

FOR APPLICATION SERVICE PROVIDER (ASP) FEATURING SOFTWARE FOR USE IN MAINTAINING WEB-BASED CLINICAL ELECTRONIC HEALTH RECORDS (U.S. CLS. 100 AND 101).

LEE-ANNE BERNS, EXAMINING ATTORNEY

CLASS 42—(Continued).

SN 77-291,638. HEALTH IT SERVICES GROUP, LLC, NASHVILLE, TN. FILED 9-28-2007.

CLASS 42—(Continued).

SN 77-291,693. RESERVOIR VISUALIZATION, INC., HUMBLE, TX. FILED 9-28-2007.

ACUMEN

THE MARK CONSISTS OF STANDARD CHARACTERS WITHOUT CLAIM TO ANY PARTICULAR FONT, STYLE, SIZE, OR COLOR.

FOR APPLICATION SERVICE PROVIDER (ASP) FEATURING SOFTWARE FOR USE IN MAINTAINING WEB-BASED CLINICAL ELECTRONIC HEALTH RECORDS (U.S. CLS. 100 AND 101).

LEE-ANNE BERNIS, EXAMINING ATTORNEY

EARTHWORM

THE MARK CONSISTS OF STANDARD CHARACTERS WITHOUT CLAIM TO ANY PARTICULAR FONT, STYLE, SIZE, OR COLOR.

FOR OIL AND GAS PROSPECTING; EXPLORATION AND SEARCHING OF OIL AND GAS; COMPUTER AIDED DESIGN SERVICES FOR OTHERS IN THE NATURE OF RESERVOIR VISUALIZATION SERVICES; CONVERSION OF WELL LOGGING DATA TO A DIGITIZED FORMAT; WELL LOGGING DATABASE SERVICES; MANAGING THE EXPLORATION AND PRODUCTION OF NATURAL GAS AND OIL PROPERTIES FOR OTHERS; PROVIDING TECHNOLOGY INFORMATION IN THE OIL AND GAS INDUSTRY; COMPUTER PROGRAMMING AND COMPUTER CONSULTING SERVICES FOR THE ABOVE (U.S. CLS. 100 AND 101).

BARBARA BROWN, EXAMINING ATTORNEY

SN 77-291,677. KRUEGER, JEFFREY N, SEDALIA, CO. FILED 9-28-2007.

SN 77-291,899. CYBREZE ENTERPRISES, LLC, VERO BEACH, FL. FILED 9-28-2007.

By Example

THE MARK CONSISTS OF STANDARD CHARACTERS WITHOUT CLAIM TO ANY PARTICULAR FONT, STYLE, SIZE, OR COLOR.

FOR COMPUTER PROGRAMMING; COMPUTER SITE DESIGN; COMPUTER SOFTWARE DESIGN FOR OTHERS; COMPUTER SOFTWARE DESIGN, COMPUTER PROGRAMMING, OR MAINTENANCE OF COMPUTER SOFTWARE; COMPUTER SOFTWARE DEVELOPMENT; COMPUTER SYSTEMS ANALYSIS; CUSTOMIZATION OF COMPUTER HARDWARE AND SOFTWARE; DESIGN AND DEVELOPMENT OF COMPUTER HARDWARE AND SOFTWARE; DESIGN OF HOME PAGES, COMPUTER SOFTWARE AND WEB SITES; MAINTENANCE OF COMPUTER SOFTWARE (U.S. CLS. 100 AND 101).

LINDA MICKLEBURGH, EXAMINING ATTORNEY

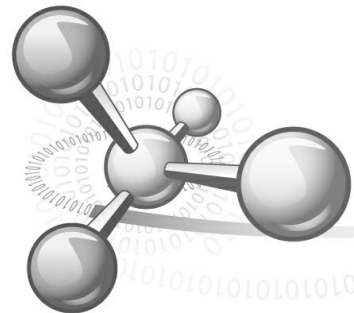

THE STIPPLING IS FOR SHADING PURPOSES ONLY. THE MARK CONSISTS OF A SPHERE WITH FOUR RODS PROJECTING FROM IT AND A SPHERE ATTACHED TO THE END OF EACH ROD.

FOR COMPUTER PROGRAMMING (U.S. CLS. 100 AND 101).

FIRST USE 8-1-2007; IN COMMERCE 8-1-2007.

AMY GEARIN, EXAMINING ATTORNEY

CLASS 42—(Continued).

SN 77-292,157. SERBIN STUDIO, INC., PHOENIX, AZ. FILED 9-28-2007.



NO CLAIM IS MADE TO THE EXCLUSIVE RIGHT TO USE "STUDIO", APART FROM THE MARK AS SHOWN.

THE MARK CONSISTS OF A SQUARE THAT HAS A HALF OF A LOTUS FLOWER ON THE LEFT HAND SIDE OF THE BOX. THE NAME "SERBIN STUDIO" IS WRITTEN ON THE BOTTOM INSIDE THE SQUARE. "SERBIN" IS ON TOP OF "STUDIO". THE 'O' IN "STUDIO" IS A LOTUS INSTEAD OF THE LETTER 'O'.

FOR ARCHITECTURAL DESIGN (U.S. CLS. 100 AND 101).

FIRST USE 1-1-2000; IN COMMERCE 1-1-2000.
DANIEL CAPSHAW, EXAMINING ATTORNEY

CLASS 42—(Continued).

SN 77-292,353. CLEARY STEPHEN B, DBA UNIVERSAL TOOL COMPANY, CALIMESA, CA. AND MERRILL MATTHEW M, DBA UNIVERSAL TOOL COMPANY, DESERT HOT SPRINGS, CA. FILED 9-30-2007.

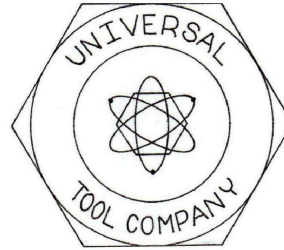

NO CLAIM IS MADE TO THE EXCLUSIVE RIGHT TO USE "TOOL COMPANY", APART FROM THE MARK AS SHOWN.

THE MARK CONSISTS OF A HEX SHAPED FASTNER HEAD DESIGN, WITH "UNIVERSAL TOOL COMPANY" SPELLED IN A CIRCULAR PATTERN AROUND THE THE OUTER PORTION OF THE INSIDE OF THE DESIGN, AND A SPINNING ATOM PATTERN SURROUNDING A SMALLER HEX PATTERN IN THE MIDDLE OF THE DESIGN.

FOR (BASED ON INTENT TO USE) TOOL DESIGN (U.S. CLS. 100 AND 101).

JESSICA A. POWERS, EXAMINING ATTORNEY

SN 77-292,158. SINGLETON, TERESA, DUBLIN, CA. FILED 9-28-2007.



THE MARK CONSISTS OF THE TEXT V G, A GLOBE, A DONUT CIRCLE, AND THE TEXT VIRTUAL GLOBE ...IT JUST MAKES SENSE!

FOR DESIGN OF HOMEPAGES AND WEBSITES (U.S. CLS. 100 AND 101).

BILL DAWE, EXAMINING ATTORNEY

SN 77-292,410. ABLE GRAPE LLC, SAN FRANCISCO, CA. FILED 9-30-2007.

Able Grape

THE MARK CONSISTS OF STANDARD CHARACTERS WITHOUT CLAIM TO ANY PARTICULAR FONT, STYLE, SIZE, OR COLOR.

FOR COMPUTER SERVICES, NAMELY, PROVIDING SEARCH ENGINES FOR OBTAINING DATA ON A GLOBAL COMPUTER NETWORK; PROVIDING CUSTOMIZED ON-LINE WEB PAGES FEATURING USER-DEFINED INFORMATION, WHICH INCLUDES SEARCH ENGINES AND ON-LINE WEB LINKS TO OTHER WEB SITES (U.S. CLS. 100 AND 101).

BRENDAN REGAN, EXAMINING ATTORNEY

CLASS 42—(Continued).

SN 77-292,538. MICHAEL B. LUND, POUGHKEEPSIE, NY. FILED 10-1-2007.

MEMURME

THE MARK CONSISTS OF STANDARD CHARACTERS WITHOUT CLAIM TO ANY PARTICULAR FONT, STYLE, SIZE, OR COLOR.

FOR COMPUTER SERVICES, NAMELY, HOSTING ON-LINE WEB FACILITIES FOR OTHERS FOR ORGANIZING AND CONDUCTING ONLINE MEETINGS, GATHERINGS, AND INTERACTIVE DISCUSSIONS; COMPUTER SERVICES, NAMELY, HOSTING AND MAINTAINING AN ONLINE WEBSITE FOR OTHERS TO INPUT INFORMATION ABOUT THEMSELVES TO CREATE PERSONAL PROFILES; COMPUTER SERVICES, NAMELY CREATING INDEXES OF INFORMATION, SITES AND OTHER RESOURCES AVAILABLE ON COMPUTER NETWORKS (U.S. CLS. 100 AND 101).
JAY BESCH, EXAMINING ATTORNEY

CLASS 42—(Continued).

SN 77-292,550. CIVITAN SERVICES, INC., BENTON, AR. FILED 10-1-2007.

Koine' IMS

THE MARK CONSISTS OF STANDARD CHARACTERS WITHOUT CLAIM TO ANY PARTICULAR FONT, STYLE, SIZE, OR COLOR.

NO CLAIM IS MADE TO THE EXCLUSIVE RIGHT TO USE "IMS", APART FROM THE MARK AS SHOWN.

FOR APPLICATION SERVICE PROVIDER (ASP) FEATURING SOFTWARE FOR USE IN PATIENT CASE MANAGEMENT AND REPORTING; COMPUTER SERVICE, NAMELY, ACTING AS AN APPLICATION SERVICE PROVIDER IN THE FIELD OF KNOWLEDGE MANAGEMENT TO HOST COMPUTER APPLICATION SOFTWARE FOR THE COLLECTION, EDITING, ORGANIZING, MODIFYING, BOOK MARKING, TRANSMISSION, STORAGE AND SHARING OF DATA AND INFORMATION (U.S. CLS. 100 AND 101).

JAY BESCH, EXAMINING ATTORNEY

SN 77-292,571. INFOVISA, INC., CORNELIUS, NC. FILED 10-1-2007.

INNOVATION BY DESIGN

THE MARK CONSISTS OF STANDARD CHARACTERS WITHOUT CLAIM TO ANY PARTICULAR FONT, STYLE, SIZE, OR COLOR.

NO CLAIM IS MADE TO THE EXCLUSIVE RIGHT TO USE "DESIGN", APART FROM THE MARK AS SHOWN.

FOR DESIGN AND DEVELOPMENT FOR OTHERS OF COMPUTER SOFTWARE FOR USE IN TRUST ACCOUNTING (U.S. CLS. 100 AND 101).

PAUL F. GAST, EXAMINING ATTORNEY

SN 77-292,541. MICHAEL B. LUND, POUGHKEEPSIE, NY. FILED 10-1-2007.

MANY YOUS. ONE ME.

THE MARK CONSISTS OF STANDARD CHARACTERS WITHOUT CLAIM TO ANY PARTICULAR FONT, STYLE, SIZE, OR COLOR.

FOR COMPUTER SERVICES, NAMELY, HOSTING ON-LINE WEB FACILITIES FOR OTHERS FOR ORGANIZING AND CONDUCTING ONLINE MEETINGS, GATHERINGS, AND INTERACTIVE DISCUSSIONS; COMPUTER SERVICES, NAMELY, CREATING INDEXES OF INFORMATION, SITES AND OTHER RESOURCES AVAILABLE ON COMPUTER NETWORKS; COMPUTER SERVICES, NAMELY, HOSTING AND MAINTAINING AN ONLINE WEBSITE FOR OTHERS TO INPUT INFORMATION ABOUT THEMSELVES TO CREATE PERSONAL PROFILES (U.S. CLS. 100 AND 101).

JAY BESCH, EXAMINING ATTORNEY

SN 77-292,645. INFOVISA, INC., CORNELIUS, NC. FILED 10-1-2007.

MAUIWEB

THE MARK CONSISTS OF STANDARD CHARACTERS WITHOUT CLAIM TO ANY PARTICULAR FONT, STYLE, SIZE, OR COLOR.

FOR COMPUTER SERVICE, NAMELY, ACTING AS AN APPLICATION SERVICE PROVIDER FEATURING INTERNET BASED CLIENT ACCESS COMPUTER SOFTWARE TO REPORT TRUST ACCOUNTING DATA (U.S. CLS. 100 AND 101).

FIRST USE 9-1-2001; IN COMMERCE 9-1-2001.

PAUL F. GAST, EXAMINING ATTORNEY

CLASS 42—(Continued).

SN 77-292,919. FOURTHLINK, INC., NEWTON, MA. FILED 10-1-2007.

FOURTHLINK

THE MARK CONSISTS OF STANDARD CHARACTERS WITHOUT CLAIM TO ANY PARTICULAR FONT, STYLE, SIZE, OR COLOR.

FOR APPLICATION SERVICE PROVIDER (ASP) FEATURING SOFTWARE FOR USE IN PROJECT MANAGEMENT, SCHEDULING AND RESOURCE MANAGEMENT (U.S. CLS. 100 AND 101).
KIMBERLY PERRY, EXAMINING ATTORNEY

SN 77-293,054. REBECCA DOLAN, DBA CLEAN LINE DESIGN, MILL VALLEY, CA. FILED 10-1-2007.

CLEAN LINE DESIGN

THE MARK CONSISTS OF STANDARD CHARACTERS WITHOUT CLAIM TO ANY PARTICULAR FONT, STYLE, SIZE, OR COLOR.

NO CLAIM IS MADE TO THE EXCLUSIVE RIGHT TO USE "DESIGN", APART FROM THE MARK AS SHOWN.

FOR COMPUTER SERVICES IN THE NATURE OF CUSTOMIZED WEB PAGES FEATURING USER-DEFINED INFORMATION, PERSONAL PROFILES AND INFORMATION; COMPUTER SERVICES, NAMELY, CREATING AND MAINTAINING WEB SITES FOR OTHERS; COMPUTER SERVICES, NAMELY, DESIGNING AND IMPLEMENTING WEB SITES FOR OTHERS; COMPUTER SITE DESIGN; CREATING OR MAINTAINING WEB SITES FOR OTHERS; CREATION AND MAINTENANCE OF WEB SITES FOR OTHERS; CREATION AND PROVISION OF WEB PAGES TO AND FOR THIRD PARTIES; DESIGN OF HOME PAGES; DESIGN OF HOME PAGES, COMPUTER SOFTWARE AND WEB SITES; DESIGN OF HOMEPAGES AND WEB-SITES; DESIGN OF HOMEPAGES AND WEBSITES; DESIGN, CREATION, HOSTING AND MAINTENANCE OF INTERNET SITES FOR THIRD PARTIES; DESIGN, CREATION, HOSTING, MAINTENANCE OF WEBSITES FOR OTHERS; DESIGNING WEBSITES FOR ADVERTISING PURPOSES; DEVELOPMENT, DESIGN AND UPDATING OF HOME PAGES; GRAPHIC ART DESIGN; GRAPHIC DESIGN SERVICES; PROVIDING CUSTOMIZED ON-LINE WEB PAGES FEATURING USER-DEFINED INFORMATION, WHICH INCLUDES SEARCH ENGINES AND ON-LINE WEB LINKS TO OTHER WEB SITES (U.S. CLS. 100 AND 101).

FIRST USE 5-1-2004; IN COMMERCE 5-1-2004.
DORITT L. CARROLL, EXAMINING ATTORNEY

CLASS 42—(Continued).

SN 77-293,499. PLANET PARTNERSHIP, LLC, TAMPA, FL. FILED 10-2-2007.

PLANET PARTNERSHIP

THE MARK CONSISTS OF STANDARD CHARACTERS WITHOUT CLAIM TO ANY PARTICULAR FONT, STYLE, SIZE, OR COLOR.

FOR ENVIRONMENTAL SERVICES, NAMELY, CONSULTATION IN THE FIELD OF REDUCING CARBON DIOXIDE EMISSIONS PRODUCED BY BUSINESS ACTIVITY (U.S. CLS. 100 AND 101).

CURTIS FRENCH, EXAMINING ATTORNEY

SN 77-293,504. ESTECH, LLC, COLUMBUS, OH. FILED 10-2-2007.

ESTECH

THE MARK CONSISTS OF STANDARD CHARACTERS WITHOUT CLAIM TO ANY PARTICULAR FONT, STYLE, SIZE, OR COLOR.

FOR ENGINEERING SERVICES FOR THE CONSTRUCTION OF WATER TREATMENT AND PURIFICATION PLANTS, SOLID WASTE TREATMENT PLANTS AND OTHER MUNICIPAL INFRASTRUCTURE FACILITIES (U.S. CLS. 100 AND 101).

RUSS HERMAN, EXAMINING ATTORNEY

SN 77-293,699. PIVOT POINT INTERNATIONAL, INC., EVANSTON, IL. FILED 10-2-2007.

A DESIGNER'S APPROACH

THE MARK CONSISTS OF STANDARD CHARACTERS WITHOUT CLAIM TO ANY PARTICULAR FONT, STYLE, SIZE, OR COLOR.

NO CLAIM IS MADE TO THE EXCLUSIVE RIGHT TO USE "DESIGNER'S", APART FROM THE MARK AS SHOWN.

FOR PROVIDING ON-LINE NON-DOWNLOADABLE SOFTWARE FOR TRAINING COSMETOLOGISTS IN A VARIETY OF TECHNIQUES RELATING TO HAIR SCULPTURE, HAIR DESIGN, HAIR COLORING, PERMANENTS AND TEXTURIZING OF HAIR, AND HAIRSTYLING FOR LONG HAIR (U.S. CLS. 100 AND 101).

JOHN WILKE, EXAMINING ATTORNEY

CLASS 42—(Continued).

SN 77-293,702. CLARICODE, INC., WALTHAM, MA. FILED 10-2-2007.



THE MARK CONSISTS OF THE STYLIZED WORD "CLARICODE". THERE ARE LINES GOING THROUGH THE FIRST HALF OF THE WORD.
FOR COMPUTER SOFTWARE DEVELOPMENT CONSULTING (U.S. CLS. 100 AND 101).
FIRST USE 11-0-2004; IN COMMERCE 11-0-2004.
JOHN WILKE, EXAMINING ATTORNEY

CLASS 42—(Continued).

SN 77-294,184. HOPELAB FOUNDATION, INC., REDWOOD CITY, CA. FILED 10-2-2007.



OWNER OF U.S. REG. NOS. 2,816,601 AND 2,820,940.
THE COLOR(S) BLUE AND GREEN IS/ARE CLAIMED AS A FEATURE OF THE MARK.
THE MARK CONSISTS OF THE WORD "HOPELAB" WITH THE LETTERS "HOPE" CONSISTING OF THE COLOR GREEN AND THE LETTERS "LAB" CONSISTING OF THE COLOR BLUE; INSIDE THE LETTER "B" IS A GREEN CIRCLE/MOLECULE AND PASSING THROUGH THE LETTER "B" ARE GREEN LINES CONNECTING THE CIRCLE/MOLECULE INSIDE THE LETTER "B" TO FIVE (5) GREEN CIRCLES/MOLECULES OUTSIDE THE LETTER "B".
FOR PRODUCT RESEARCH AND PRODUCT DEVELOPMENT (U.S. CLS. 100 AND 101).
FIRST USE 8-23-2007; IN COMMERCE 8-23-2007.
CHRISTINA SOBRAL, EXAMINING ATTORNEY

SN 77-294,049. DESIGN GROUP, INC. ARCHITECTS AND PLANNERS, COLUMBUS, OH. FILED 10-2-2007.

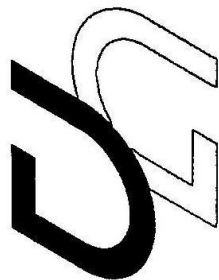

SN 77-294,400. CLICKSTREAM TECHNOLOGIES LLC, DBA CLICKSTREAM TECHNOLOGIES CORPORATION, BERKELEY, CA. FILED 10-2-2007.



THE MARK CONSISTS OF THE LETTERS "D" AND "G" CONNECTED ALONG THE TOP OF THE "D" AND BOTTOM OF THE "G."
FOR ARCHITECTURAL DESIGN; GRAPHIC DESIGN SERVICES; INTERIOR DESIGN SERVICES (U.S. CLS. 100 AND 101).
FIRST USE 10-0-2000; IN COMMERCE 10-0-2000.
ELLEN PERKINS, EXAMINING ATTORNEY

THE MARK CONSISTS OF STANDARD CHARACTERS WITHOUT CLAIM TO ANY PARTICULAR FONT, STYLE, SIZE, OR COLOR.
OWNER OF U.S. REG. NO. 3,251,700.
FOR COMPUTER MONITORING SERVICE WHICH TRACKS HARDWARE PERFORMANCE AND PROCESSES AND SENDS OUT HISTORICAL REPORTS AND ALERTS (U.S. CLS. 100 AND 101).
FIRST USE 7-11-2006; IN COMMERCE 8-7-2006.
JUDITH HELFMAN, EXAMINING ATTORNEY

CLASS 42—(Continued).

SN 77-294,562. USTACKS.COM, LLC, JAMISON, PA. FILED 10-2-2007.

Ustacks.com

THE MARK CONSISTS OF STANDARD CHARACTERS WITHOUT CLAIM TO ANY PARTICULAR FONT, STYLE, SIZE, OR COLOR.

FOR HOSTING AN ONLINE COMMUNITY WEBSITE FEATURING ACADEMIC INFORMATION AND STUDY MATERIALS PROVIDED BY UNDERGRADUATE, GRADUATE, PROFESSIONAL STUDENTS, AND/OR PROFESSORS (U.S. CLS. 100 AND 101).

FIRST USE 4-1-2007; IN COMMERCE 10-1-2007.
TOBY BULLOFF, EXAMINING ATTORNEY

SN 77-294,858. THE VANDERBILT UNIVERSITY, NASHVILLE, TN. FILED 10-3-2007.

WHERE HEART IS HEADED

THE MARK CONSISTS OF STANDARD CHARACTERS WITHOUT CLAIM TO ANY PARTICULAR FONT, STYLE, SIZE, OR COLOR.

FOR MEDICAL RESEARCH (U.S. CLS. 100 AND 101).
SAMUEL E. SHARPER JR., EXAMINING ATTORNEY

SN 77-295,071. S.P. CRAMER & ASSOCIATES, INC., GRESHAM, OR. FILED 10-3-2007.

CRAMER FISH SCIENCES

THE MARK CONSISTS OF STANDARD CHARACTERS WITHOUT CLAIM TO ANY PARTICULAR FONT, STYLE, SIZE, OR COLOR.

NO CLAIM IS MADE TO THE EXCLUSIVE RIGHT TO USE "FISH SCIENCES", APART FROM THE MARK AS SHOWN.

FOR ENVIRONMENTAL CONSULTING SERVICES (U.S. CLS. 100 AND 101).

FIRST USE 4-1-2006; IN COMMERCE 4-1-2006.
LINDA E. BLOHM, EXAMINING ATTORNEY

CLASS 42—(Continued).

SN 77-295,090. JAZEL, LLC, LAKE FOREST, CA. FILED 10-3-2007.

JAZEL

THE MARK CONSISTS OF STANDARD CHARACTERS WITHOUT CLAIM TO ANY PARTICULAR FONT, STYLE, SIZE, OR COLOR.

FOR PROVIDING NON-DOWNLOADABLE WEB BASED SOFTWARE APPLICATION FOR WEBSITE MANAGEMENT, DATABASE MANAGEMENT, PROCESS AUTOMATION, CUSTOMER SERVICE, SALES FORCE AUTOMATION, EMAIL PROGRAMS, EMAIL MARKETING, EMAIL SCHEDULING, EMAIL CAMPAIGN MANAGEMENT, LEAD CAPTURING, LEAD DELEGATION, CUSTOMER RELATIONSHIP MANAGEMENT, AND ADVERTISEMENT TRACKING; WEBSITE DESIGN SERVICES (U.S. CLS. 100 AND 101).

FIRST USE 7-23-2003; IN COMMERCE 7-23-2003.
DOMINIC FATHY, EXAMINING ATTORNEY

SN 77-295,294. IMIKIMI, LLC, LAKEWOOD, CO. FILED 10-3-2007.

KIMI

THE MARK CONSISTS OF STANDARD CHARACTERS WITHOUT CLAIM TO ANY PARTICULAR FONT, STYLE, SIZE, OR COLOR.

FOR APPLICATION SERVICE PROVIDER (ASP) FEATURING SOFTWARE FOR PROVIDING, HOSTING, MANAGING, DEVELOPING, AND MAINTAINING APPLICATIONS, SOFTWARE, WEBSITES, CONTENT TEMPLATES, GRAPHICS, AUDIO, VIDEO, AND DATABASES; COMPUTER SERVICES, NAMELY, HOSTING ONLINE CONTENT FOR CUSTOMIZED WEB PAGES FEATURING USER-DEFINED INFORMATION, PERSONAL PROFILES AND INFORMATION (U.S. CLS. 100 AND 101).

DANIEL BRODY, EXAMINING ATTORNEY

SN 77-295,558. ASTIN REDEVELOPMENT, LP, DBA FIBERTOWN, BRYAN, TX. FILED 10-3-2007.

FIBERTOWN

THE MARK CONSISTS OF STANDARD CHARACTERS WITHOUT CLAIM TO ANY PARTICULAR FONT, STYLE, SIZE, OR COLOR.

FOR DATA WAREHOUSING (U.S. CLS. 100 AND 101).
FIRST USE 1-1-2005; IN COMMERCE 1-1-2005.

ALEX KEAM, EXAMINING ATTORNEY

CLASS 42—(Continued).

SN 77-295,677. SCOTT CARR, SAN DIEGO, CA. FILED 10-3-2007.

SCARRGO

THE MARK CONSISTS OF STANDARD CHARACTERS WITHOUT CLAIM TO ANY PARTICULAR FONT, STYLE, SIZE, OR COLOR.

FOR CHARITABLE SERVICES, NAMELY, PROVIDING WEB SITE DESIGN FOR OTHERS; COMPUTER SERVICES IN THE NATURE OF CUSTOMIZED WEB PAGES FEATURING USER-DEFINED INFORMATION, PERSONAL PROFILES AND INFORMATION; COMPUTER SERVICES, NAMELY, CREATING AND MAINTAINING WEB SITES FOR OTHERS; COMPUTER SERVICES, NAMELY, DESIGNING AND IMPLEMENTING NETWORK WEB PAGES FOR OTHERS; COMPUTER SERVICES, NAMELY, DESIGNING AND IMPLEMENTING WEB SITES FOR OTHERS; COMPUTER SERVICES, NAMELY, HOSTING ON-LINE WEB FACILITIES FOR OTHERS FOR ORGANIZING AND CONDUCTING ONLINE MEETINGS, GATHERINGS, AND INTERACTIVE DISCUSSIONS; COMPUTER SERVICES, NAMELY, MANAGING WEB SITES FOR OTHERS; CREATION AND MAINTENANCE OF WEB SITES FOR OTHERS; CREATION AND PROVISION OF WEB PAGES TO AND FOR THIRD PARTIES; DESIGN OF HOME PAGES, COMPUTER SOFTWARE AND WEB SITES; DESIGN OF HOMEPAGES AND WEB-SITES; DISPLAYING THE WEB SITES AND IMAGES OF OTHERS ON A COMPUTER SERVER; ELABORATION AND MAINTENANCE OF WEB SITES FOR THIRD PARTIES; HOSTING THE WEB SITES OF OTHERS ON A COMPUTER SERVER FOR A GLOBAL COMPUTER NETWORK; PROVIDING CUSTOMIZED ON-LINE WEB PAGES FEATURING USER-DEFINED INFORMATION, WHICH INCLUDES SEARCH ENGINES AND ON-LINE WEB LINKS TO OTHER WEB SITES; RENTAL OF WEB SERVERS; WEB SITE HOSTING SERVICES (U.S. CLS. 100 AND 101).

FIRST USE 12-17-1998; IN COMMERCE 12-17-1998.
ALLISON SCHRODY, EXAMINING ATTORNEY

CLASS 42—(Continued).

SN 77-296,246. WHITE RHINO, INC., SAN JUAN, PUERTO RICO, FILED 10-4-2007.



NO CLAIM IS MADE TO THE EXCLUSIVE RIGHT TO USE "INC.", APART FROM THE MARK AS SHOWN.

THE MARK CONSISTS OF THE CAPITAL LETTERS "W" AND "R" TOGETHER SIDE BY SIDE "WR" AND A WHITE RHINO HEAD DESIGN COMING OUT FROM THE RIGHT SIDE OF THE LETTER "R".

FOR TECHNICAL SUPPORT SERVICES, NAMELY, TROUBLESHOOTING OF COMPUTER HARDWARE AND SOFTWARE PROBLEMS; INTEGRATION OF COMPUTER SYSTEMS AND NETWORKS; MAINTENANCE OF COMPUTER SOFTWARE; MONITORING THE COMPUTER SYSTEMS OF OTHERS FOR TECHNICAL PURPOSES AND PROVIDING BACK-UP COMPUTER PROGRAMS AND FACILITIES; DATABASE DEVELOPMENT SERVICES; CONSULTATION SERVICES IN THE FIELDS OF SELECTION, IMPLEMENTATION AND USE OF COMPUTER HARDWARE AND SOFTWARE SYSTEMS FOR OTHERS (U.S. CLS. 100 AND 101).

FIRST USE 6-30-2006; IN COMMERCE 6-30-2006.
VERNA BETH RIRIE, EXAMINING ATTORNEY

SN 77-296,529. AMERICA INVENTS, LLC, SAN FRANCISCO, CA. FILED 10-4-2007.

AMERICA INVENTS

THE MARK CONSISTS OF STANDARD CHARACTERS WITHOUT CLAIM TO ANY PARTICULAR FONT, STYLE, SIZE, OR COLOR.

FOR PRODUCT DESIGN SERVICES, NAMELY, PRODUCT RESEARCH AND DEVELOPMENT CONSULTATION AND DESIGN FOR OTHERS (U.S. CLS. 100 AND 101).

FIRST USE 7-1-1998; IN COMMERCE 11-1-1998.
SHANNON TWOHIG, EXAMINING ATTORNEY

SN 77-296,535. CENTIV SERVICES, INC., CHICAGO, IL. FILED 10-4-2007.

THE MARK CONSISTS OF THE WORDS DESIGN AND TRACKER.

FOR PROVIDING AN ON-LINE COMPUTER DATABASE IN THE FIELD OF WORKFLOW AUTOMATION FOR THE ALCOHOL AND SPIRITS INDUSTRY (U.S. CLS. 100 AND 101).

FIRST USE 12-1-2006; IN COMMERCE 12-1-2006.
RICHARD A. STRASER, EXAMINING ATTORNEY

CLASS 42—(Continued).

SN 77-296,539. CENTIV SERVICES, INC., CHICAGO, IL.
FILED 10-4-2007.

DESIGNTRACKER

THE MARK CONSISTS OF STANDARD CHARACTERS WITHOUT CLAIM TO ANY PARTICULAR FONT, STYLE, SIZE, OR COLOR.

FOR PROVIDING AN ON-LINE COMPUTER DATABASE IN THE FIELD OF WORKFLOW AUTOMATION FOR THE ALCOHOL AND SPIRITS INDUSTRY (U.S. CLS. 100 AND 101).

FIRST USE 12-1-2006; IN COMMERCE 12-1-2006.
RICHARD A. STRASER, EXAMINING ATTORNEY

SN 77-296,543. PORTLAND BIOSCIENCE, INC., PORTLAND, OR. FILED 10-4-2007.

PDXBIO

THE MARK CONSISTS OF STANDARD CHARACTERS WITHOUT CLAIM TO ANY PARTICULAR FONT, STYLE, SIZE, OR COLOR.

FOR RESEARCH AND DEVELOPMENT SERVICES AND DATA ANALYSIS SERVICES FOR OTHERS IN THE FIELD OF GENETICS; SCIENTIFIC RESEARCH AND TECHNOLOGICAL CONSULTATION AND RESEARCH IN THE FIELD OF GENETICS (U.S. CLS. 100 AND 101).

FIRST USE 10-15-2003; IN COMMERCE 1-31-2007.
G. MAYERSCHOFF, EXAMINING ATTORNEY

SN 77-296,621. SKY ROAD LLC, DOWNERS GROVE, IL.
FILED 10-4-2007.

SKY ROAD

THE MARK CONSISTS OF STANDARD CHARACTERS WITHOUT CLAIM TO ANY PARTICULAR FONT, STYLE, SIZE, OR COLOR.

FOR APPLICATION SERVICE PROVIDER (ASP) FEATURING SOFTWARE FOR USE IN MANAGING ASSETS AND DERIVATIVES IN THE FIELDS OF FINANCE AND COMMODITIES EXCHANGE (U.S. CLS. 100 AND 101).

FIRST USE 5-4-2006; IN COMMERCE 5-4-2006.
MORGAN WYNNE, EXAMINING ATTORNEY

CLASS 42—(Continued).

SN 77-296,983. MASTERCARD INTERNATIONAL INCORPORATED, PURCHASE, NY. FILED 10-5-2007.

MASTERCARD PURCHASE OPTIMIZER

THE MARK CONSISTS OF STANDARD CHARACTERS WITHOUT CLAIM TO ANY PARTICULAR FONT, STYLE, SIZE, OR COLOR.

OWNER OF U.S. REG. NOS. 1,186,117, 1,292,519 AND OTHERS.

NO CLAIM IS MADE TO THE EXCLUSIVE RIGHT TO USE "PURCHASE OPTIMIZER", APART FROM THE MARK AS SHOWN.

FOR PROVIDING TEMPORARY USE OF NON-DOWNLOADABLE SOFTWARE PROGRAM TO EVALUATE AND COMPARE PURCHASING, TRAVEL, FLEET, AND MULTI-APPLICATION CARD PROGRAM (U.S. CLS. 100 AND 101).

FIRST USE 5-0-2006; IN COMMERCE 5-0-2006.
JANET LEE, EXAMINING ATTORNEY

SN 77-297,217. MOFFATT & NICHOL, LONG BEACH, CA.
FILED 10-5-2007.

Creative people, practical solutions.

THE MARK CONSISTS OF STANDARD CHARACTERS WITHOUT CLAIM TO ANY PARTICULAR FONT, STYLE, SIZE, OR COLOR.

FOR ENGINEERING (U.S. CLS. 100 AND 101).
FIRST USE 4-1-2003; IN COMMERCE 4-1-2003.
KIMBERLY FRYE, EXAMINING ATTORNEY

SN 77-297,278. ALPHAGEN CO., LTD., CHIYODA-KU, TOKYO, JAPAN, FILED 10-5-2007.

alphaGEN

THE MARK CONSISTS OF THE STYLIZED TERM "ALPHAGEN" WITH NO CLAIM TO COLOR.

FOR PHARMACEUTICAL RESEARCH AND DEVELOPMENT (U.S. CLS. 100 AND 101).

FIRST USE 7-4-2006; IN COMMERCE 1-25-2007.
FLORENTINA BLANDU, EXAMINING ATTORNEY

CLASS 42—(Continued).

SN 77-297,557. AIROHA TECHNOLOGY CORP., HSINCHU, TAIWAN, FILED 10-5-2007.



The logo for AIROHA features the word "AIROHA" in a bold, black, sans-serif font. The letter "H" is unique, with its crossbar extending to the left and right, overlapping the vertical stems of the "A" and "I" respectively.

THE MARK CONSISTS OF THE WORDING "AIROHA" WHERE THE CROSSBAR FOR THE LETTER "H" CONTINUES AND FUNCTIONS ALSO AS THE CROSSBAR FOR THE LETTER "A".

FOR SEMICONDUCTOR DESIGN; TECHNICAL CONSULTANCY IN RELATION TO THE PRODUCTION OF SEMICONDUCTORS; RESEARCH IN THE AREA OF SEMICONDUCTOR PROCESSING TECHNOLOGY; DESIGN OF COMPUTER HARDWARE, INTEGRATED CIRCUITS, COMMUNICATIONS HARDWARE AND SOFTWARE AND COMPUTER NETWORKS FOR OTHERS; DESIGN FOR OTHERS OF INTEGRATED CIRCUITS AND INTEGRATED CIRCUIT CORES FOR USE IN WIRELESS COMMUNICATIONS AND WIRELESS COMMUNICATION EQUIPMENT AND APPARATI AND DIGITAL SIGNAL PROCESSORS (DSP); INDUSTRIAL DESIGN; INTEGRATED CIRCUIT DESIGN AND ENGINEERING SERVICES, NAMELY, THE DESIGN OF RADIO FREQUENCY (RF), ANALOG AND DIGITAL INTEGRATED CIRCUIT PRODUCTS FOR OTHERS; DEVELOPMENT OF TECHNOLOGIES FOR THE FABRICATION OF CIRCUITS FOR WIRELESS COMMUNICATION, ELECTRONIC DATA PROCESSING, CONSUMER ELECTRONIC, AUTOMOTIVE ELECTRONICS (U.S. CLS. 100 AND 101).

FIRST USE 8-31-2001; IN COMMERCE 9-30-2004.
KYLE PEETE, EXAMINING ATTORNEY

SN 77-297,774. ASIERUS, INC., SOUTH JORDAN, UT. FILED 10-5-2007.



The logo for ASIERUS features the word "ASIERUS" in a bold, black, serif font.

THE MARK CONSISTS OF STANDARD CHARACTERS WITHOUT CLAIM TO ANY PARTICULAR FONT, STYLE, SIZE, OR COLOR.

FOR CONSULTING SERVICES IN THE FIELD OF DESIGN, DEVELOPMENT, SELECTION, IMPLEMENTATION, AND USE OF COMPUTER HARDWARE AND SOFTWARE SYSTEMS FOR OTHERS (U.S. CLS. 100 AND 101).

FIRST USE 8-0-2005; IN COMMERCE 12-0-2005.
BARBARA RUTLAND, EXAMINING ATTORNEY

CLASS 42—(Continued).

SN 77-297,794. MICROSOFT CORPORATION, REDMOND, WA. FILED 10-5-2007.



The logo for XRANK features the word "XRANK" in a bold, black, serif font.

THE MARK CONSISTS OF STANDARD CHARACTERS WITHOUT CLAIM TO ANY PARTICULAR FONT, STYLE, SIZE, OR COLOR.

FOR COMPUTER SERVICES, NAMELY, PROVIDING SEARCH ENGINES FOR OBTAINING DATA ON A GLOBAL COMPUTER NETWORK; AND COMPUTER SERVICES, NAMELY, SEARCH ENGINE SERVICES FOR ASSESSING THE FREQUENCY OF SEARCH TERMS ON THE INTERNET AND THE POPULARITY OF SEARCH TOPICS AMONG INTERNET USERS (U.S. CLS. 100 AND 101).

KEVIN CORWIN, EXAMINING ATTORNEY

SN 77-298,787. SIGNATURE GENOMIC LABORATORIES, LLC, SPOKANE, WA. FILED 10-8-2007.



The logo for OLIGOGLYPHIX features the word "OLIGOGLYPHIX" in a bold, black, serif font.

THE MARK CONSISTS OF STANDARD CHARACTERS WITHOUT CLAIM TO ANY PARTICULAR FONT, STYLE, SIZE, OR COLOR.

FOR MEDICAL LABORATORIES; MEDICAL RESEARCH; PROVIDING INFORMATION AT THE SPECIFIC REQUEST OF END-USERS BY MEANS OF TELEPHONE OR GLOBAL COMPUTER NETWORKS (U.S. CLS. 100 AND 101).

TRACY WHITTAKER-BROWN, EXAMINING ATTORNEY

SN 77-298,924. ALPHAGEEK WEB DESIGN, INC., PETOSKEY, MI. FILED 10-8-2007.



The logo for ALPHAGEEK features the word "ALPHAGEEK" in a bold, black, serif font.

THE MARK CONSISTS OF STANDARD CHARACTERS WITHOUT CLAIM TO ANY PARTICULAR FONT, STYLE, SIZE, OR COLOR.

FOR DESIGN OF HOMEPAGES AND WEB-SITES; WEBSITE DEVELOPMENT FOR OTHERS (U.S. CLS. 100 AND 101).

FIRST USE 9-6-2005; IN COMMERCE 9-28-2005.
GIANCARLO CASTRO, EXAMINING ATTORNEY

CLASS 42—(Continued).

SN 77-300,437. GSA HOME ENERGY SOLUTIONS, LLC, CEDAR PARK, TX. FILED 10-10-2007.



NO CLAIM IS MADE TO THE EXCLUSIVE RIGHT TO USE "GET RATED", APART FROM THE MARK AS SHOWN.

THE MARK CONSISTS OF A HOUSE IN THE BACKGROUND AND THE WORDS "GET RATED BE HOME ENERGY WISE, CLIMATIZE!" IN STYLIZED TEXT IN THE FOREFRONT.

FOR HOME ENERGY INSPECTIONS, AND TESTING, ANALYSIS AND EVALUATION OF THE GOODS AND SERVICES OF OTHERS FOR THE PURPOSE OF CERTIFICATION (U.S. CLS. 100 AND 101).

FIRST USE 11-1-2006; IN COMMERCE 1-19-2007.
MICHAEL LITZAU, EXAMINING ATTORNEY

SN 77-307,529. HALLIBURTON ENERGY SERVICES, INC., CARROLLTON, TX. FILED 10-18-2007.

MRILAB

THE MARK CONSISTS OF STANDARD CHARACTERS WITHOUT CLAIM TO ANY PARTICULAR FONT, STYLE, SIZE, OR COLOR.

OWNER OF U.S. REG. NO. 2,576,872.
SEC. 2(F).

FOR TESTING AND ANALYTICAL SERVICES TO DETERMINE DOWNHOLE MEASUREMENTS, COMPOSITIONS, AND PROPERTIES OF FLUID IN OIL AND GAS WELLS (U.S. CLS. 100 AND 101).

FIRST USE 7-25-2001; IN COMMERCE 7-25-2001.
SHAILA SETTLES, EXAMINING ATTORNEY

CLASS 42—(Continued).

SN 77-314,288. INETU, INC., ALLENTOWN, PA. FILED 10-26-2007.

Think Outside The Server

THE MARK CONSISTS OF STANDARD CHARACTERS WITHOUT CLAIM TO ANY PARTICULAR FONT, STYLE, SIZE, OR COLOR.

FOR APPLICATION SERVICE PROVIDER (ASP), NAMELY, HOSTING COMPUTER SOFTWARE APPLICATIONS OF OTHERS; APPLICATION SERVICE PROVIDER, NAMELY, PROVIDING, HOSTING, MANAGING, DEVELOPING, AND MAINTAINING APPLICATIONS, SOFTWARE, WEBSITES, AND DATABASES IN THE FIELDS OF PERSONAL PRODUCTIVITY, WIRELESS COMMUNICATION, MOBILE INFORMATION ACCESS, AND REMOTE DATA MANAGEMENT FOR WIRELESS DELIVERY OF CONTENT TO HANDHELD COMPUTERS, LAPTOPS AND MOBILE ELECTRONIC DEVICES; COMPUTER SERVICE, ACTING AS AN APPLICATION SERVICE PROVIDER IN THE FIELD OF KNOWLEDGE MANAGEMENT TO HOST COMPUTER APPLICATION SOFTWARE FOR CREATING SEARCHABLE DATABASES OF INFORMATION AND DATA TO ALLOW USERS TO PERFORM, ON-LINE, THE COLLECTING AND ANALYZING OF DIFFERENT TYPES OF OPINION SURVEYS; COMPUTER SERVICE, NAMELY, ACTING AS AN APPLICATION SERVICE PROVIDER IN THE FIELD OF KNOWLEDGE MANAGEMENT TO HOST COMPUTER APPLICATION SOFTWARE FOR CREATING SEARCHABLE DATABASES OF INFORMATION AND DATA; COMPUTER SERVICE, NAMELY, ACTING AS AN APPLICATION SERVICE PROVIDER IN THE FIELD OF KNOWLEDGE MANAGEMENT TO HOST COMPUTER APPLICATION SOFTWARE FOR SEARCHING AND RETRIEVING INFORMATION FROM DATABASES AND COMPUTER NETWORKS; COMPUTER SERVICE, NAMELY, ACTING AS AN APPLICATION SERVICE PROVIDER IN THE FIELD OF KNOWLEDGE MANAGEMENT TO HOST COMPUTER APPLICATION SOFTWARE FOR THE COLLECTION, EDITING, ORGANIZING, MODIFYING, BOOK MARKING, TRANSMISSION, STORAGE AND SHARING OF DATA AND INFORMATION; COMPUTER SERVICES, NAMELY, HOSTING ON-LINE INTERACTIVE PUBLIC CALENDARS THAT ALLOW MULTIPLE PARTICIPANTS TO SHARE EVENT SCHEDULES, FACILITY RESERVATIONS, AND TRANSPORTATION REQUESTS; COMPUTER SERVICES, NAMELY, HOSTING ON-LINE WEB FACILITIES FOR OTHERS FOR ORGANIZING AND CONDUCTING ONLINE MEETINGS, GATHERINGS, AND INTERACTIVE DISCUSSIONS; DESIGN, CREATION, HOSTING AND MAINTENANCE OF INTERNET SITES FOR THIRD PARTIES; DESIGN, CREATION, HOSTING, MAINTENANCE OF WEBSITES FOR OTHERS; HOSTING OF DIGITAL CONTENT ON THE INTERNET; HOSTING THE DIGITAL AUDIO AND VIDEO CONTENT OF OTHERS FOR THE PURPOSE OF ENABLING HOTEL, INN, AND OTHER LODGING ESTABLISHMENT GUESTS TO DOWNLOAD THE CONTENT ON A PAY PER VIEW BASIS; HOSTING THE WEB SITES OF OTHERS ON A COMPUTER SERVER FOR A GLOBAL COMPUTER NETWORK; WEB SITE HOSTING SERVICES (U.S. CLS. 100 AND 101).

FIRST USE 10-26-2007; IN COMMERCE 10-26-2007.
BONNIE LUKEN, EXAMINING ATTORNEY

CLASS 42—(Continued).

SN 77-316,001. MEADWESTVACO CORPORATION, GLEN ALLEN, VA. FILED 10-29-2007.



OWNER OF U.S. REG. NOS. 1,675,828, 3,113,881 AND OTHERS.

THE MARK CONSISTS OF A RECTANGLE CONTAINING THE WORDS "FIVE STAR" ABOVE A DESIGN OF FIVE STARS IN A ROW.

FOR PROVIDING ON-LINE NON-DOWNLOADABLE SOFTWARE FOR THE COLLECTION, EDITING, ORGANIZING, MODIFYING, BOOK MARKING, TRANSMISSION, STORAGE AND SHARING OF DATA, IMAGES AND INFORMATION; PROVIDING ON-LINE NON-DOWNLOADABLE SOFTWARE FOR PROJECT PLANNING, PROJECT ORGANIZATION, PROJECT MANAGEMENT, EVENT PLANNING, EVENT ORGANIZATION, EVENT MANAGEMENT, PERSONAL PLANNING, PERSONAL ORGANIZATION, REPORT PLANNING, REPORT ORGANIZATION, REPORT MANAGEMENT, TIME MANAGEMENT, WORD PROCESSING (U.S. CLS. 100 AND 101).

MONIQUE MILLER, EXAMINING ATTORNEY

SN 77-319,572. THE VANDERBILT UNIVERSITY, NASHVILLE, TN. FILED 11-1-2007.

VANDERBILT HEALTH

THE MARK CONSISTS OF STANDARD CHARACTERS WITHOUT CLAIM TO ANY PARTICULAR FONT, STYLE, SIZE, OR COLOR.

OWNER OF U.S. REG. NOS. 1,642,042, 2,778,959 AND OTHERS.

NO CLAIM IS MADE TO THE EXCLUSIVE RIGHT TO USE "HEALTH", APART FROM THE MARK AS SHOWN.

FOR MEDICAL RESEARCH (U.S. CLS. 100 AND 101). SAMUEL E. SHARPER JR., EXAMINING ATTORNEY

CLASS 42—(Continued).

SN 77-323,715. FOURTHLINK, INC., NEWTON, MA. FILED 11-7-2007.



THE MARK CONSISTS OF THE WORDS "FOURTH" AND "LINK" SEPARATED BY THE NUMBER "4" WITHIN A SMALL CIRCLE, WITH A SMALLER BLACK OVAL BENEATH THE NUMBER "4", WITH A CURVED LINE CONNECTING THE LETTER "H" AT THE END OF THE WORD "FOURTH" WITH THE LETTER "L" AT THE BEGINNING OF THE WORD "LINK".

FOR APPLICATION SERVICE PROVIDER (ASP) FEATURING SOFTWARE FOR USE IN PROJECT MANAGEMENT, SCHEDULING AND RESOURCE MANAGEMENT (U.S. CLS. 100 AND 101).

KIMBERLY PERRY, EXAMINING ATTORNEY

SN 77-324,404. TRIAD ISOTOPES, INC., ORLANDO, FL. FILED 11-8-2007.

ICL

THE MARK CONSISTS OF STANDARD CHARACTERS WITHOUT CLAIM TO ANY PARTICULAR FONT, STYLE, SIZE, OR COLOR.

FOR PROVIDING MEDICAL AND SCIENTIFIC RESEARCH INFORMATION IN THE FIELD OF NUCLEAR PHARMACEUTICALS (U.S. CLS. 100 AND 101).

MARK SPARACINO, EXAMINING ATTORNEY

SN 78-246,036. HEALTHCARE ADVOCATES INC., PHILADELPHIA, PA. FILED 5-6-2003.

HEALTHCARE ADVOCATES

SEC. 2(F).

FOR PROVIDING INFORMATION AT THE SPECIFIC REQUEST OF END-USERS BY MEANS OF TELEPHONE OR A COMPUTER NETWORK, INCLUDING THE USE OF EMAIL AND WEB PAGES, FOR THE PURPOSE OF SCIENTIFIC RESEARCH SERVICES FOR MEDICAL PURPOSES, AND FOR THE PURPOSE OF QUALITY ASSURANCE IN THE FIELD OF MEDICINE (U.S. CLS. 100 AND 101).

FIRST USE 8-30-1998; IN COMMERCE 8-30-1998.

REBECCA SMITH, EXAMINING ATTORNEY

CLASS 42—(Continued).

SN 78-526,157. RAMBUS INC., LOS ALTOS, CA. FILED 12-2-2004.

RASER

THE MARK CONSISTS OF STANDARD CHARACTERS WITHOUT CLAIM TO ANY PARTICULAR FONT, STYLE, SIZE, OR COLOR.

FOR DESIGN, ENGINEERING AND TESTING OF COMPUTERS, COMPUTER SYSTEMS, AND COMMUNICATION SYSTEMS; DESIGN, ENGINEERING AND TESTING OF COMPUTER CHIP INTERFACES, I/O INTERFACES AND CHANNELS; DESIGN, ENGINEERING AND TESTING OF COMPUTER COMPONENTS, NAMELY, CIRCUITS, CELLS, INTEGRATED CIRCUITS, CONTROLLERS, GRAPHIC CHIPS, GRAPHIC CONTROLLERS, PERIPHERAL CONTROLLERS, DISK CONTROLLERS, COMMUNICATION CONTROLLERS, CONNECTORS, LOGIC CHIPS, MICROPROCESSORS, CLOCK GENERATOR CHIPS, TRANSCEIVERS, SERDES CHIPS, PRINTED CIRCUIT BOARDS, AND SOCKETS; CONSULTING SERVICES IN THE FIELD OF COMPUTER DESIGN, ENGINEERING AND TESTING (U.S. CLS. 100 AND 101).

ELI HELLMAN, EXAMINING ATTORNEY

SN 78-613,261. COMBINED L.A./WESTSIDE MLS, INC., LOS ANGELES, CA. FILED 4-20-2005.



NO CLAIM IS MADE TO THE EXCLUSIVE RIGHT TO USE "MLS" AND "YOUR ONLINE TRANSACTION MANAGER", APART FROM THE MARK AS SHOWN.

THE STIPPLING IS FOR SHADING PURPOSES ONLY. THE MARK CONSISTS OF THE TERM "THE MLS TRANSACT YOUR ONLINE TRANSACTION MANAGER" IN A STYLIZED FORM. "MLS" APPEARS IN LARGE CAPITAL LETTERS WITH "THE" IN THE UPPER LEFT HAND CORNER AND "TRANSACT" AT THE BASE OF "MLS" IN CAPITAL BLOCK LETTERS WITH SHADING IN EACH OF THE LETTERS. "YOUR ONLINE TRANSACTION MANAGER" APPEARS BELOW "THE MLS TRANSACT."

FOR PROVIDING ONLINE NON-DOWNLOADABLE SOFTWARE FOR USE AS AN ONLINE PAPERLESS DOCUMENT MANAGEMENT SYSTEM (U.S. CLS. 100 AND 101).

FIRST USE 4-25-2005; IN COMMERCE 4-25-2005.
SCOTT SISUN, EXAMINING ATTORNEY

CLASS 42—(Continued).

SN 78-823,373. NETWORK SAVANTS, LLC, LAS VEGAS, NV. FILED 2-25-2006.



NO CLAIM IS MADE TO THE EXCLUSIVE RIGHT TO USE "NETWORK", APART FROM THE MARK AS SHOWN. THE COLOR(S) BLACK, WHITE, AND ORANGE IS/ARE CLAIMED AS A FEATURE OF THE MARK.

THE COLOR BLACK APPEARS IN THE WORDING "NETWORK," THE COLOR ORANGE APPEARS IN THE WORDING "SAVANTS," AND THE COLORS BLACK, WHITE, AND ORANGE APPEAR IN THE HOODED FIGURE AND RINGS DESIGN.

FOR CONSULTING SERVICES IN THE FIELD OF DESIGN, SELECTION, IMPLEMENTATION AND USE OF COMPUTER HARDWARE AND SOFTWARE SYSTEMS FOR OTHERS (U.S. CLS. 100 AND 101).

FIRST USE 6-1-2002; IN COMMERCE 9-26-2002.
TEJBIR SINGH, EXAMINING ATTORNEY

SN 78-886,330. INSTANT SOFTWARE, INC., KISSIMMEE, FL. FILED 5-17-2006.

Instant Software

THE MARK CONSISTS OF STANDARD CHARACTERS WITHOUT CLAIM TO ANY PARTICULAR FONT, STYLE, SIZE, OR COLOR.

NO CLAIM IS MADE TO THE EXCLUSIVE RIGHT TO USE "SOFTWARE", APART FROM THE MARK AS SHOWN.

FOR DEVELOPMENT OF NEW TECHNOLOGY FOR OTHERS IN THE FIELD OF VACATION RENTAL RESERVATIONS AND MANAGEMENT (U.S. CLS. 100 AND 101).

FIRST USE 3-18-1995; IN COMMERCE 3-18-1995.
TOBY BULLOFF, EXAMINING ATTORNEY

SN 78-948,688. MEDTRONIC, INC., MINNEAPOLIS, MN. FILED 8-9-2006.

CONNECT

THE MARK CONSISTS OF STANDARD CHARACTERS WITHOUT CLAIM TO ANY PARTICULAR FONT, STYLE, SIZE, OR COLOR.

FOR PRODUCT TESTING, NAMELY, CONDUCTING MEDICAL AND MEDICAL DATA ANALYSIS OF APPROVED MEDICAL DEVICES AND PREPARING STATISTICAL REPORTS RESULTING FROM SUCH STUDIES (U.S. CLS. 100 AND 101).

CYNTHIA SLOAN, EXAMINING ATTORNEY

CLASS 42—(Continued).

SN 78-957,947. WONN, DENNIS EDWIN, SARASOTA, FL. FILED 8-22-2006.



THE COLOR(S) RED, GOLD, BLACK, AND WHITE IS/ ARE CLAIMED AS A FEATURE OF THE MARK.

THE COLOR RED APPEARS IN THE WORD "VOD." THE COLOR GOLD APPEARS IN THE WORD "SQUAD." THE COLOR BLACK APPEARS IN THE BACKGROUND OF THE WORD MARK AND IN THE DESIGN OF THE HIGH DEFINITION CAMERA. THE COLOR WHITE ALSO APPEARS IN THE DESIGN OF THE HIGH DEFINITION CAMERA."

FOR DESIGN AND DEVELOPMENT OF MULTIMEDIA PRODUCTS (U.S. CLS. 100 AND 101).

DAVID COLLIER, EXAMINING ATTORNEY

CLASS 42—(Continued).

SN 78-964,250. RAY QUINNEY & NEBEKER, P.C., SALT LAKE CITY, UT. FILED 8-30-2006.

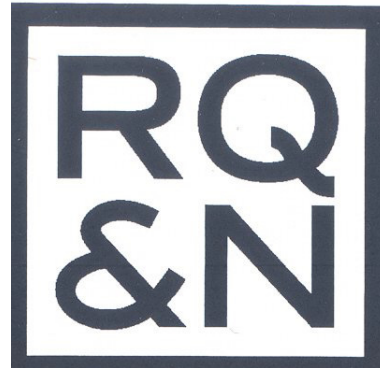

THE MARK CONSISTS OF THE LETTERS "RQ" ABOVE THE LETTERS "&N", SURROUNDED BY A BOX.

FOR LEGAL SERVICES, NAMELY, LEGAL REPRESENTATION SERVICES; LEGAL CONSULTATION SERVICES; LEGAL RESEARCH SERVICES; LEGAL DOCUMENT REVIEW SERVICES; LEGAL DOCUMENT DRAFTING SERVICES; DISPUTE RESOLUTION SERVICES; LITIGATION SERVICES; ARBITRATION SERVICES; AND MEDIATION SERVICES (U.S. CLS. 100 AND 101).

FIRST USE 1-2-2002; IN COMMERCE 1-2-2002.

MICHAEL LEWIS, EXAMINING ATTORNEY

SN 78-962,155. BAKER, DONALD BRUCE, HILTON HEAD ISLAND, SC. FILED 8-28-2006.

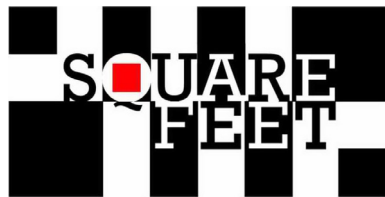

THE COLOR(S) BLACK, WHITE, AND RED IS/ARE CLAIMED AS A FEATURE OF THE MARK.

THE MARK CONSISTS OF BLACK AND WHITE BLOCK AND SERIF TEXT ON A CHECKERED WHITE AND BLACK BACKGROUND WITH ONE RED SQUARE INSIDE THE LETTER "Q".

FOR ARCHITECTURAL DESIGN (U.S. CLS. 100 AND 101).

FIRST USE 3-15-2004; IN COMMERCE 3-15-2004. MICHAEL WEBSTER, EXAMINING ATTORNEY

SN 78-970,546. TRINDERA ENGINEERING, INC., COEUR D'ALENE, ID. FILED 9-8-2006.



THE WORDING "TRINDERA" HAS NO MEANING IN A FOREIGN LANGUAGE.

FOR ENGINEERING (U.S. CLS. 100 AND 101).

FIRST USE 7-1-2004; IN COMMERCE 7-1-2004.

STEPHEN AQUILA, EXAMINING ATTORNEY

CLASS 42—(Continued).

SN 78-972,307. NATIONAL CYBER FORENSICS AND TRAINING ALLIANCE LIMITED, PITTSBURGH, PA. FILED 9-12-2006.



NO CLAIM IS MADE TO THE EXCLUSIVE RIGHT TO USE "NATIONAL CYBER-FORENSICS & TRAINING ALLIANCE", APART FROM THE MARK AS SHOWN.

THE COLOR(S) BLUE AND GOLD IS/ARE CLAIMED AS A FEATURE OF THE MARK.

THE MARK CONSISTS OF A CIRCULAR SHAPE WITH MULTIPLE RINGS IN BLUE, GOLD THEN A WIDE BLUE RING CONTAINING THE WORD ELEMENTS "NATIONAL CYBER-FORENSICS & TRAINING ALLIANCE" IN GOLD LETTERS AND THEN A THIN GOLD RING SURROUNDING THE INNER CIRCLE'S EDGE, THE BACKGROUND OF THE INSIDE CIRCLE PRESENTS A COMPUTER CHIP OR CIRCUIT IN SHADES OF LIGHT AND DARK BLUE WITH COMPUTER CODING SEQUENCES MADE UP OF DIGITS 0 AND 1 IN GOLD AND SET FORTH NUMEROUS TIMES IN THE FOREGROUND, AT THE BASE OF THE CIRCLE APPEARS A GOLD WAVING BANNER WITH THE LETTERS "NCFTA" SET OUT IN BLUE.

FOR COMPUTER SERVICES, NAMELY, MONITORING, TESTING, ANALYZING, AND REPORTING ON THE INTERNET TRAFFIC CONTROL AND CONTENT CONTROL OF THE WEBSITES OF OTHERS (U.S. CLS. 100 AND 101).

FIRST USE 10-15-2002; IN COMMERCE 10-15-2002.
JEFF DEFORD, EXAMINING ATTORNEY

SN 78-979,840. ARM LIMITED, CAMBRIDGE, ENGLAND, FILED 3-1-2005.

TRUSTZONE

THE MARK CONSISTS OF STANDARD CHARACTERS WITHOUT CLAIM TO ANY PARTICULAR FONT, STYLE, SIZE, OR COLOR.

FOR RESEARCH, DEVELOPMENT, DESIGN AND LICENSING OF INTELLECTUAL PROPERTY RELATING TO SECURE INTEGRATED CIRCUITS, SECURE MICROPROCESSORS, AND SECURE MICROPROCESSOR CORES (U.S. CLS. 100 AND 101).

FIRST USE 5-27-2003; IN COMMERCE 5-27-2003.
DAVID C. REIHNER, EXAMINING ATTORNEY

CLASS 43—HOTEL AND RESTAURANT SERVICES

SN 75-373,279. PRAIRIE ISLAND INDIAN COMMUNITY IN THE STATE OF MINNESOTA, RED WING, MN. FILED 10-15-1997.

TREASURE ISLAND

FOR RESTAURANT SERVICES (U.S. CLS. 100 AND 101).

FIRST USE 1-19-1990; IN COMMERCE 1-19-1990.
SHANNON TWOHIG, EXAMINING ATTORNEY

SN 76-673,059. SALEVA'A, ATISANOE, WAIANAE, HI. FILED 2-23-2007.

KONISHIKI

THE MARK CONSISTS OF STANDARD CHARACTERS WITHOUT CLAIM TO ANY PARTICULAR FONT, STYLE, SIZE, OR COLOR.

THE WORDING "KONISHIKI" HAS NO MEANING IN A FOREIGN LANGUAGE.

FOR RESTAURANT SERVICES (U.S. CLS. 100 AND 101).

FIRST USE 1-15-1982; IN COMMERCE 1-15-1982.
DAYNA BROWNE, EXAMINING ATTORNEY

SN 76-682,302. THE RED ELEPHANT, LLC, TALLAHASSEE, FL. FILED 9-24-2007.

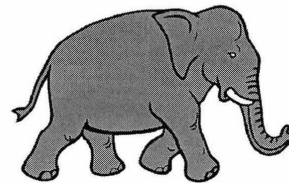

The
Red Elephant
Pizza and Grill

OWNER OF U.S. REG. NO. 3,310,396.

NO CLAIM IS MADE TO THE EXCLUSIVE RIGHT TO USE "PIZZA AND GRILL", APART FROM THE MARK AS SHOWN.

THE GREY TONES IN THE DRAWING ARE TO INDICATE SHADING NOT COLOR.

FOR RESTAURANT SERVICES (U.S. CLS. 100 AND 101).

FIRST USE 11-22-2006; IN COMMERCE 11-22-2006.
LEIGH CAROLINE CASE, EXAMINING ATTORNEY

CLASS 43—(Continued).

SN 77-003,752. THE BRAMBLES RESTAURANT, INC., CAMBRIA, CA. FILED 9-20-2006.



FOR FOOD PREPARATION; PREPARATION OF FOOD AND BEVERAGES; PROVIDING A DATABASE IN THE FIELD OF RECIPES AND COOKING INFORMATION; RESTAURANT AND BAR SERVICES; RESTAURANT SERVICES; RESTAURANTS; SERVING FOOD AND DRINKS; SERVING OF FOOD AND DRINK/ BEVERAGES (U.S. CLS. 100 AND 101).
 FIRST USE 10-12-1982; IN COMMERCE 10-12-1982.
 WENDY GOODMAN, EXAMINING ATTORNEY

CLASS 43—(Continued).

SN 77-055,060. GDP ENTERPRISES, INC., NEW YORK, NY. FILED 12-1-2006.



THE COLOR(S) RED, GREEN, BLUE, YELLOW, BLACK AND WHITE IS/ARE CLAIMED AS A FEATURE OF THE MARK.
 THE MARK CONSISTS OF A STYLIZED LOWERCASE "A" WHICH IS RED, FOLLOWED BY A GREEN LOWERCASE "G", FOLLOWED BY A BLUE LOWERCASE "O", FOLLOWED BY A RED LOWERCASE "Z", FOLLOWED BY A YELLOW LOWERCASE "A", FOLLOWED BY A BLUE LOWERCASE "R", FOLLOWED BY A STYLIZED EXCLAMATION POINT WHICH HAS A BLACK AND WHITE CHECKERED PATTERN.
 THE FOREIGN WORDING IN THE MARK TRANSLATES INTO ENGLISH AS "TO HAVE FUN AND TO ENJOY".
 FOR RESTAURANT AND BAR SERVICES; SERVING FOOD AND DRINKS (U.S. CLS. 100 AND 101).
 FIRST USE 11-27-2002; IN COMMERCE 11-27-2002.
 DANIEL CAPSHAW, EXAMINING ATTORNEY

SN 77-055,701. WYNN RESORTS HOLDINGS, LLC, LAS VEGAS, NV. FILED 12-1-2006.

SN 77-033,169. HOV BRANDS LLC, NEW YORK, NY. FILED 10-31-2006.

SIMPLY ZEN

THE MARK CONSISTS OF STANDARD CHARACTERS WITHOUT CLAIM TO ANY PARTICULAR FONT, STYLE, SIZE, OR COLOR.
 FOR FAST-FOOD RESTAURANTS; CATERING AND PREPARATION OF FOOD AND BEVERAGES; RESTAURANTS (U.S. CLS. 100 AND 101).
 FIRST USE 4-15-2004; IN COMMERCE 4-15-2004.
 KEVON CHISOLM, EXAMINING ATTORNEY

THE WYNN DIAMOND HOTEL

THE MARK CONSISTS OF STANDARD CHARACTERS WITHOUT CLAIM TO ANY PARTICULAR FONT, STYLE, SIZE, OR COLOR.
 OWNER OF U.S. REG. NOS. 2,977,862, 2,983,696 AND 3,195,978.
 NO CLAIM IS MADE TO THE EXCLUSIVE RIGHT TO USE "HOTEL", APART FROM THE MARK AS SHOWN.
 FOR RESORT HOTELS, RESORT LODGING SERVICES, HOTELS, RESTAURANT, BAR AND COCKTAIL LOUNGE SERVICES; HOTEL, RESTAURANT AND BAR SERVICES FEATURING A CUSTOMER LOYALTY PROGRAM TO REWARD REPEAT CUSTOMERS; ARENA SERVICES, NAMELY PROVIDING FACILITIES FOR SPORTS, CONCERTS, CONVENTIONS AND EXHIBITIONS; CAFETERIAS; SNACK BARS; CATERING; DAY CARE CENTERS; PROVIDING BANQUET AND SOCIAL FUNCTION FACILITIES FOR SPECIAL OCCASIONS; PROVIDING CONVENTION FACILITIES; PROVIDING FACILITIES FOR EXHIBITIONS; PROVIDING TRAVEL AGENCY SERVICES, NAMELY MAKING RESERVATIONS AND BOOKINGS FOR TEMPORARY LODGING AND ENTERTAINMENT IN THE NATURE OF RESTAURANTS AND MEALS; PROVIDING HOTEL AND DINING INFORMATION VIA THE INTERNET (U.S. CLS. 100 AND 101).
 YONG KIM, EXAMINING ATTORNEY

CLASS 43—(Continued).

SN 77-061,643. WYNN RESORTS HOLDINGS, LLC, LAS VEGAS, NV. FILED 12-11-2006.

WYNN DIAMOND SUITES

THE MARK CONSISTS OF STANDARD CHARACTERS WITHOUT CLAIM TO ANY PARTICULAR FONT, STYLE, SIZE, OR COLOR.

OWNER OF U.S. REG. NOS. 2,977,862, 3,195,978 AND OTHERS.

NO CLAIM IS MADE TO THE EXCLUSIVE RIGHT TO USE "SUITES", APART FROM THE MARK AS SHOWN.

FOR RESORT HOTELS, RESORT LODGING SERVICES, HOTELS, RESTAURANT, BAR AND COCKTAIL LOUNGE SERVICES; HOTEL, RESTAURANT AND BAR SERVICES FEATURING A CUSTOMER LOYALTY PROGRAM TO REWARD REPEAT CUSTOMERS; ARENA SERVICES, NAMELY PROVIDING FACILITIES FOR SPORTS, CONCERTS, CONVENTIONS AND EXHIBITIONS; CAFETERIAS; SNACK BARS; CATERING; DAY CARE CENTERS; PROVIDING BANQUET AND SOCIAL FUNCTION FACILITIES FOR SPECIAL OCCASIONS; PROVIDING CONVENTION FACILITIES; PROVIDING FACILITIES FOR EXHIBITIONS; PROVIDING TRAVEL AGENCY SERVICES, NAMELY MAKING RESERVATIONS AND BOOKINGS FOR TEMPORARY LODGING AND ENTERTAINMENT IN THE NATURE OF RESTAURANTS AND MEALS; PROVIDING HOTEL AND DINING INFORMATION VIA THE INTERNET (U.S. CLS. 100 AND 101).

YONG KIM, EXAMINING ATTORNEY

CLASS 43—(Continued).

SN 77-067,407. WYNN RESORTS HOLDINGS, LLC, LAS VEGAS, NV. FILED 12-19-2006.

WYNN TOWER SUITES

THE MARK CONSISTS OF STANDARD CHARACTERS WITHOUT CLAIM TO ANY PARTICULAR FONT, STYLE, SIZE, OR COLOR.

OWNER OF U.S. REG. NOS. 2,977,862, 3,195,978 AND OTHERS.

NO CLAIM IS MADE TO THE EXCLUSIVE RIGHT TO USE "TOWER SUITES", APART FROM THE MARK AS SHOWN.

FOR RESORT HOTELS, RESORT LODGING SERVICES, HOTELS, RESTAURANT, BAR AND COCKTAIL LOUNGE SERVICES; HOTEL, RESTAURANT AND BAR SERVICES FEATURING A CUSTOMER LOYALTY PROGRAM TO REWARD REPEAT CUSTOMERS; ARENA SERVICES, NAMELY PROVIDING FACILITIES FOR SPORTS, CONCERTS, CONVENTIONS AND EXHIBITIONS; CAFETERIAS; SNACK BARS; CATERING; DAY CARE CENTERS; PROVIDING BANQUET AND SOCIAL FUNCTION FACILITIES FOR SPECIAL OCCASIONS; PROVIDING CONVENTION FACILITIES; PROVIDING FACILITIES FOR EXHIBITIONS; PROVIDING TRAVEL AGENCY SERVICES, NAMELY MAKING RESERVATIONS AND BOOKINGS FOR TEMPORARY LODGING AND ENTERTAINMENT IN THE NATURE OF RESTAURANTS AND MEALS; PROVIDING HOTEL AND DINING INFORMATION VIA THE INTERNET (U.S. CLS. 100 AND 101).

YONG KIM, EXAMINING ATTORNEY

SN 77-064,187. KATHERINE'S CATERING, INC., ANN ARBOR, MI. FILED 12-14-2006.



THE NAME(S), PORTRAIT(S), AND/OR SIGNATURE(S) SHOWN IN THE MARK DOES NOT IDENTIFY A PARTICULAR LIVING INDIVIDUAL.

THE MARK CONSISTS OF A LITTLE GIRL IN OLD FASHIONED DRESS PULLING AN OLD FASHIONED WAGON WITH A BASKET INSIDE.

FOR CATERING OF FOOD AND DRINKS (U.S. CLS. 100 AND 101).

FIRST USE 12-15-1985; IN COMMERCE 12-15-1985.
STEVEN JACKSON, EXAMINING ATTORNEY

SN 77-086,282. THYEN, PHIL, BOULDER, CO. FILED 1-19-2007.

ORGANIC EXPRESS

THE MARK CONSISTS OF STANDARD CHARACTERS WITHOUT CLAIM TO ANY PARTICULAR FONT, STYLE, SIZE, OR COLOR.

OWNER OF U.S. REG. NOS. 2,257,848 AND 2,261,483.
NO CLAIM IS MADE TO THE EXCLUSIVE RIGHT TO USE "ORGANIC", APART FROM THE MARK AS SHOWN.
SEC. 2(F).

FOR RESTAURANT AND BAR SERVICES (U.S. CLS. 100 AND 101).

FIRST USE 11-24-1998; IN COMMERCE 11-24-1998.
BARBARA GAYNOR, EXAMINING ATTORNEY

CLASS 43—(Continued).

SN 77-089,271. CFR AND ASSOCIATES, LLC, LAS VEGAS, NV. FILED 1-23-2007.



NO CLAIM IS MADE TO THE EXCLUSIVE RIGHT TO USE "OKLAHOMA" AND "BBQ", APART FROM THE MARK AS SHOWN.
FOR RESTAURANT SERVICES (U.S. CLS. 100 AND 101).
FIRST USE 3-0-1992; IN COMMERCE 3-0-1992.
YONG KIM, EXAMINING ATTORNEY

SN 77-091,239. BUFFALO'S FRANCHISE CONCEPTS, INC., MARIETTA, GA. FILED 1-25-2007.

BUFFALO'S SOUTHWEST GRILLE

THE MARK CONSISTS OF STANDARD CHARACTERS WITHOUT CLAIM TO ANY PARTICULAR FONT, STYLE, SIZE, OR COLOR.
OWNER OF U.S. REG. NOS. 1,992,472, 2,859,289 AND OTHERS.
NO CLAIM IS MADE TO THE EXCLUSIVE RIGHT TO USE "SOUTHWEST GRILLE", APART FROM THE MARK AS SHOWN.
FOR RESTAURANT SERVICES (U.S. CLS. 100 AND 101).
STEPHANIE ALI, EXAMINING ATTORNEY

CLASS 43—(Continued).

SN 77-117,129. CANAD CORPORATION OF MANITOBA LTD., WINNIPEG, MANITOBA, CANADA, FILED 2-27-2007.

BEACONS OF HOSPITALITY

THE MARK CONSISTS OF STANDARD CHARACTERS WITHOUT CLAIM TO ANY PARTICULAR FONT, STYLE, SIZE, OR COLOR.
OWNER OF CANADA REG. NO. 554948, DATED 12-4-2001, EXPIRES 12-4-2016.
NO CLAIM IS MADE TO THE EXCLUSIVE RIGHT TO USE "HOSPITALITY", APART FROM THE MARK AS SHOWN.
FOR PROVISION OF HOTEL, MOTEL AND COCKTAIL LOUNGE SERVICES; PROVISION OF BEVERAGE ROOM SERVICES, NAMELY, BAR SERVICES; PROVISION OF BANQUET FACILITIES FOR SPECIAL OCCASIONS (U.S. CLS. 100 AND 101).
STEPHEN AQUILA, EXAMINING ATTORNEY

SN 77-118,389. MONTELUCCIA HOLDINGS, LLC, IRVINE, CA. FILED 2-28-2007.

PRADO

THE MARK CONSISTS OF STANDARD CHARACTERS WITHOUT CLAIM TO ANY PARTICULAR FONT, STYLE, SIZE, OR COLOR.
THE ENGLISH TRANSLATION OF THE WORD "PRADO" IS "FIELD" OR "MEADOW".
FOR RESTAURANT SERVICES (U.S. CLS. 100 AND 101).
JOHN KELLY, EXAMINING ATTORNEY

SN 77-127,477. ZUPELY S.A., PISO 17, MONTEVIDEO, URUGUAY, FILED 3-9-2007.

LA MAR CEBICHERIA PERUANA

THE MARK CONSISTS OF STANDARD CHARACTERS WITHOUT CLAIM TO ANY PARTICULAR FONT, STYLE, SIZE, OR COLOR.
NO CLAIM IS MADE TO THE EXCLUSIVE RIGHT TO USE "CEBICHERIA PERUANA", APART FROM THE MARK AS SHOWN.
THE ENGLISH TRANSLATION OF "LA MAR CEBICHERIA PERUANA" IS THE SEA PERUVIAN CEBICHERIA. THE WORDING "CEBICHERIA" REFERS TO A TRADITIONAL PERUVIAN DISH MADE FROM FISH OR SEAFOOD.
FOR RESTAURANT SERVICES (U.S. CLS. 100 AND 101).
ALICIA COLLINS, EXAMINING ATTORNEY

CLASS 43—(Continued).

SN 77-130,818. MISSION DESIGN AND DEVELOPMENT, L.L.C., ANN ARBOR, MI. FILED 3-14-2007.

BLUE TRACTOR

THE MARK CONSISTS OF STANDARD CHARACTERS WITHOUT CLAIM TO ANY PARTICULAR FONT, STYLE, SIZE, OR COLOR.

FOR RESTAURANT SERVICES (U.S. CLS. 100 AND 101).

DOMINICK J. SALEMI, EXAMINING ATTORNEY

SN 77-132,395. IRON MOUNTAIN TRADING COMPANY, LLC, MINNEAPOLIS, MN. FILED 3-15-2007.

IRON MOUNTAIN TRADING COMPANY

THE MARK CONSISTS OF STANDARD CHARACTERS WITHOUT CLAIM TO ANY PARTICULAR FONT, STYLE, SIZE, OR COLOR.

NO CLAIM IS MADE TO THE EXCLUSIVE RIGHT TO USE "TRADING COMPANY", APART FROM THE MARK AS SHOWN.

FOR SERVICES OF PROVIDING FOOD AND DRINK, NAMELY, COFFEE HOUSE SERVICES AND CAFE SERVICES (U.S. CLS. 100 AND 101).

CARYN GLASSER, EXAMINING ATTORNEY

SN 77-134,700. ROSTIPOLLOS INTERNATIONAL RISA, S.A., SAN JOSE, COSTA RICA, FILED 3-19-2007.



OWNER OF U.S. REG. NO. 2,437,754.
THE MARK CONSISTS OF THE WORD "ROSTIPOLLOS" WITH SEVEN BARS BEHIND RESEMBLING AN AWNING. FOR RESTAURANT SERVICES, NAMELY, FAST FOOD SERVICES SPECIALIZING IN CHICKEN GRILLED OVER A WOOD FIRE (U.S. CLS. 100 AND 101).
WARREN L. OLANDRIA, EXAMINING ATTORNEY

CLASS 43—(Continued).

SN 77-136,291. PERKINS & MARIE CALLENDER'S INC., MEMPHIS, TN. FILED 3-21-2007.



NO CLAIM IS MADE TO THE EXCLUSIVE RIGHT TO USE "HOUSE BLEND", APART FROM THE MARK AS SHOWN.

THE COLOR(S) YELLOW, BROWN, AND BURGUNDY IS/ARE CLAIMED AS A FEATURE OF THE MARK.

THE MARK CONSISTS OF THE WORDING "MARIE'S HOUSE BLEND" APPEARING IN YELLOW INSIDE A BURGUNDY RECTANGLE SURROUNDED BY A BROWN INNER BORDER AND A YELLOW OUTER BORDER.

FOR RESTAURANT SERVICES FEATURING COFFEE (U.S. CLS. 100 AND 101).

JASON ROTH, EXAMINING ATTORNEY

SN 77-137,081. CALAMOS REAL ESTATE LLC, NAPERVILLE, IL. FILED 3-21-2007.

NONA GRAND

THE MARK CONSISTS OF STANDARD CHARACTERS WITHOUT CLAIM TO ANY PARTICULAR FONT, STYLE, SIZE, OR COLOR.

THE NAME "NONA GRAND" DOES NOT IDENTIFY A LIVING INDIVIDUAL.

FOR BAR SERVICES; COCKTAIL LOUNGES; HOTEL SERVICES; RESTAURANT SERVICES (U.S. CLS. 100 AND 101).

JENNIFER VASQUEZ, EXAMINING ATTORNEY

SN 77-137,093. CALAMOS REAL ESTATE LLC, NAPERVILLE, IL. FILED 3-21-2007.



THE NAME "NONA GRAND" DOES NOT IDENTIFY A LIVING INDIVIDUAL.

THE MARK CONSISTS OF THE WORD "NONA" ABOVE THE WORD "GRAND".

FOR BAR SERVICES; COCKTAIL LOUNGES; HOTEL SERVICES; RESTAURANT SERVICES (U.S. CLS. 100 AND 101).

JENNIFER VASQUEZ, EXAMINING ATTORNEY

CLASS 43—(Continued).

SN 77-138,752. CHICK, DONALD E., DALLAS, TX. FILED 3-23-2007.

HOT BUNS

THE MARK CONSISTS OF STANDARD CHARACTERS WITHOUT CLAIM TO ANY PARTICULAR FONT, STYLE, SIZE, OR COLOR.

FOR RESTAURANT SERVICES; RESTAURANTS (U.S. CLS. 100 AND 101).

MELVIN AXILBUND, EXAMINING ATTORNEY

SN 77-139,044. VILLA NETWORK, INC., COLLINSVILLE, TX. FILED 3-23-2007.

Villa Network

THE MARK CONSISTS OF STANDARD CHARACTERS WITHOUT CLAIM TO ANY PARTICULAR FONT, STYLE, SIZE, OR COLOR.

NO CLAIM IS MADE TO THE EXCLUSIVE RIGHT TO USE "VILLA", APART FROM THE MARK AS SHOWN.

SEC. 2(F).

FOR TRAVEL AGENCY SERVICES, NAMELY, MAKING RESERVATIONS AND BOOKING FOR TEMPORARY LODGING (U.S. CLS. 100 AND 101).

FIRST USE 5-1-1996; IN COMMERCE 7-1-1996.

SHANNON TWOHIG, EXAMINING ATTORNEY

SN 77-141,595. FIELD, JOEL A., MARION, OH. FILED 3-27-2007.

CADILLAC RANCH ROCK -N- COUNTRY BAR & GRILL

THE MARK CONSISTS OF STANDARD CHARACTERS WITHOUT CLAIM TO ANY PARTICULAR FONT, STYLE, SIZE, OR COLOR.

NO CLAIM IS MADE TO THE EXCLUSIVE RIGHT TO USE "ROCK -N- COUNTRY BAR & GRILL", APART FROM THE MARK AS SHOWN.

FOR RESTAURANT AND BAR SERVICES (U.S. CLS. 100 AND 101).

FIRST USE 3-1-2007; IN COMMERCE 3-1-2007.

C. DIONNE CLYBURN, EXAMINING ATTORNEY

CLASS 43—(Continued).

SN 77-143,228. THE SHERATON LLC, WHITE PLAINS, NY. FILED 3-28-2007.

ST. REGIS ADOUR

THE MARK CONSISTS OF STANDARD CHARACTERS WITHOUT CLAIM TO ANY PARTICULAR FONT, STYLE, SIZE, OR COLOR.

OWNER OF U.S. REG. NOS. 1,897,870, 2,893,705 AND OTHERS.

FOR HOTEL, MOTEL, INN AND RESORT LODGING SERVICES, NAMELY, PROVIDING FOOD AND BEVERAGE; RESTAURANT, COCKTAIL LOUNGE, AND BAR SERVICES (U.S. CLS. 100 AND 101).

HANNO RITTNER, EXAMINING ATTORNEY

SN 77-143,230. THE SHERATON LLC, WHITE PLAINS, NY. FILED 3-28-2007.

ADOUR

THE MARK CONSISTS OF STANDARD CHARACTERS WITHOUT CLAIM TO ANY PARTICULAR FONT, STYLE, SIZE, OR COLOR.

FOR HOTEL, MOTEL, INN AND RESORT LODGING SERVICES, NAMELY, PROVIDING FOOD AND BEVERAGE; RESTAURANT, COCKTAIL LOUNGE, AND BAR SERVICES (U.S. CLS. 100 AND 101).

HANNO RITTNER, EXAMINING ATTORNEY

SN 77-144,660. TAZA FRESH, LLC, LAKEWOOD, OH. FILED 3-30-2007.

TAZA

THE MARK CONSISTS OF STANDARD CHARACTERS WITHOUT CLAIM TO ANY PARTICULAR FONT, STYLE, SIZE, OR COLOR.

OWNER OF U.S. REG. NOS. 3,213,261 AND 3,213,262. THE ENGLISH TRANSLATION OF "TAZA" IS "FRESH". FOR RESTAURANT AND BAR SERVICES (U.S. CLS. 100 AND 101).

FIRST USE 11-22-2005; IN COMMERCE 11-22-2005.

LINDA ESTRADA, EXAMINING ATTORNEY

CLASS 43—(Continued).

SN 77-159,868. ECHELON RESORTS CORPORATION, LAS VEGAS, NV. FILED 4-18-2007.

TOURBILLON

THE MARK CONSISTS OF STANDARD CHARACTERS WITHOUT CLAIM TO ANY PARTICULAR FONT, STYLE, SIZE, OR COLOR.

THE FOREIGN WORDING IN THE MARK TRANSLATES INTO ENGLISH AS WHIRLWIND.

FOR RESERVATION OF RESTAURANTS; RESTAURANT AND BAR SERVICES (U.S. CLS. 100 AND 101).
KATHLEEN M. VANSTON, EXAMINING ATTORNEY

SN 77-161,889. GOURMET KITCHENS, INC., CHICAGO, IL. FILED 4-20-2007.

GOURMET KITCHENS, INC.

THE MARK CONSISTS OF STANDARD CHARACTERS WITHOUT CLAIM TO ANY PARTICULAR FONT, STYLE, SIZE, OR COLOR.

NO CLAIM IS MADE TO THE EXCLUSIVE RIGHT TO USE INC., APART FROM THE MARK AS SHOWN.
SEC. 2(F).

FOR SERVICES OF PREPARING FRESH PERISHABLE FOODS (U.S. CLS. 100 AND 101).

FIRST USE 4-10-1989; IN COMMERCE 4-10-1989.
MARGERY A. TIERNEY, EXAMINING ATTORNEY

SN 77-165,155. CORDUA RESTAURANTS, LP, HOUSTON, TX. FILED 4-25-2007.

CHURRASCOS

THE MARK CONSISTS OF STANDARD CHARACTERS WITHOUT CLAIM TO ANY PARTICULAR FONT, STYLE, SIZE, OR COLOR.

THE FOREIGN WORDING IN THE MARK TRANSLATES INTO ENGLISH AS "BARBECUE".

SEC. 2(F).
FOR RESTAURANT AND BAR SERVICES; CATERING (U.S. CLS. 100 AND 101).

FIRST USE 8-8-1998; IN COMMERCE 8-8-1998.
AMOS T. MATTHEWS, JR., EXAMINING ATTORNEY

CLASS 43—(Continued).

SN 77-165,855. 7713 RESTAURANT GROUP, LTD., PLANO, TX. FILED 4-25-2007.



THE MARK CONSISTS OF THE NAME "SHINSEI" WRAPPED AROUND A BOX.

THE FOREIGN WORDING IN THE MARK TRANSLATES INTO ENGLISH AS REBIRTH.

THE NON-LATIN CHARACTER(S) IN THE MARK TRANSLITERATES INTO "SHIN", AND THIS MEANS "TO APPLY" IN ENGLISH.

FOR RESTAURANT, BAR AND CATERING SERVICES (U.S. CLS. 100 AND 101).

FIRST USE 6-15-2006; IN COMMERCE 6-15-2006.
RUSS HERMAN, EXAMINING ATTORNEY

SN 77-165,926. 7713 RESTAURANT GROUP, LTD., PLANO, TX. FILED 4-25-2007.

SHINSEI

THE MARK CONSISTS OF STANDARD CHARACTERS WITHOUT CLAIM TO ANY PARTICULAR FONT, STYLE, SIZE, OR COLOR.

THE FOREIGN WORDING IN THE MARK TRANSLATES INTO ENGLISH AS REBIRTH.

FOR RESTAURANT, BAR AND CATERING SERVICES (U.S. CLS. 100 AND 101).

FIRST USE 6-15-2006; IN COMMERCE 6-15-2006.
RUSS HERMAN, EXAMINING ATTORNEY

SN 77-174,853. PROMECASA, S.A. DE C.V., DELEGACIOBENITO-JAUREZ, MEXICO, FILED 5-7-2007.



THE COLOR(S) PINK, BLUE, ORANGE, YELLOW, BROWN, RED, WHITE AND GREEN IS/ARE CLAIMED AS A FEATURE OF THE MARK.

THE MARK CONSISTS OF NINETY-SIX CIRCLES IN A RECTANGULAR PATTERN SHOWN IN SOLID PINK, BLUE, ORANGE AND YELLOW AND VARIOUS DESIGNS OF CORN, BEVERAGES, FRUITS, VEGETABLES AND TAMALES APPEARING IN BROWN, RED, YELLOW, WHITE AND GREEN.

FOR SERVING FOOD AND DRINK; PROVIDING TEMPORARY ACCOMMODATION (U.S. CLS. 100 AND 101).

DAVID YONTEF, EXAMINING ATTORNEY

CLASS 43—(Continued).

SN 77-175,771. ECHELON RESORTS CORPORATION, LAS VEGAS, NV. FILED 5-8-2007.

CLASS 43—(Continued).

SN 77-188,027. THE SHERATON LLC, WHITE PLAINS, NY. FILED 5-23-2007.

TOURBILLON

THE MARK CONSISTS OF STANDARD CHARACTERS WITHOUT CLAIM TO ANY PARTICULAR FONT, STYLE, SIZE, OR COLOR.

THE FOREIGN WORDING IN THE MARK TRANSLATES INTO ENGLISH AS WHIRLWIND.

FOR COCKTAIL LOUNGES; HOTEL SERVICES (U.S. CLS. 100 AND 101).

KATHLEEN M. VANSTON, EXAMINING ATTORNEY

KING COLE

THE MARK CONSISTS OF STANDARD CHARACTERS WITHOUT CLAIM TO ANY PARTICULAR FONT, STYLE, SIZE, OR COLOR.

OWNER OF U.S. REG. NO. 1,952,305.

FOR HOTEL SERVICES; RESORT HOTELS; RESTAURANT SERVICES; PREPARATION OF FOOD AND BEVERAGES (U.S. CLS. 100 AND 101).

HANNO RITTNER, EXAMINING ATTORNEY

SN 77-176,919. PREFERRED HOTEL GROUP, INC., CHICAGO, IL. FILED 5-9-2007.

PREFERRED BOUTIQUE

THE MARK CONSISTS OF STANDARD CHARACTERS WITHOUT CLAIM TO ANY PARTICULAR FONT, STYLE, SIZE, OR COLOR.

OWNER OF U.S. REG. NOS. 1,227,080, 2,409,197 AND OTHERS.

NO CLAIM IS MADE TO THE EXCLUSIVE RIGHT TO USE "BOUTIQUE", APART FROM THE MARK AS SHOWN. SEC. 2(F) AS TO "PREFERRED".

FOR HOTEL SERVICES (U.S. CLS. 100 AND 101).

FIRST USE 2-0-2006; IN COMMERCE 2-0-2006.

LINDA LAVACHE, EXAMINING ATTORNEY

SN 77-193,722. ECHELON RESORTS CORPORATION, LAS VEGAS, NV. FILED 5-30-2007.

THE MEETING CENTER AT ECHELON

SN 77-176,938. PREFERRED HOTEL GROUP, INC., CHICAGO, IL. FILED 5-9-2007.



OWNER OF U.S. REG. NOS. 1,227,080, 2,409,197 AND OTHERS.

NO CLAIM IS MADE TO THE EXCLUSIVE RIGHT TO USE "BOUTIQUE", APART FROM THE MARK AS SHOWN. THE MARK CONSISTS OF THE WORDS "PREFERRED" AND "BOUTIQUE" STACKED IN STYLIZED LETTERS WITH A PINEAPPLE/PINECONE/LOTUS FLOWER DESIGN AT THE RIGHT.

SEC. 2(F) AS TO "PREFERRED".
FOR HOTEL SERVICES (U.S. CLS. 100 AND 101).

FIRST USE 2-0-2006; IN COMMERCE 2-0-2006.

LINDA LAVACHE, EXAMINING ATTORNEY

THE MARK CONSISTS OF STANDARD CHARACTERS WITHOUT CLAIM TO ANY PARTICULAR FONT, STYLE, SIZE, OR COLOR.

NO CLAIM IS MADE TO THE EXCLUSIVE RIGHT TO USE "MEETING CENTER", APART FROM THE MARK AS SHOWN.

FOR ARENA SERVICES, NAMELY, PROVIDING FACILITIES FOR SPORTS, CONCERTS, CONVENTIONS AND EXHIBITIONS; PROVIDING CONFERENCE ROOMS; PROVIDING CONVENTION FACILITIES; PROVIDING FACILITIES FOR EXHIBITIONS; PROVISION OF CONFERENCE, EXHIBITION AND MEETING FACILITIES (U.S. CLS. 100 AND 101).

KATHLEEN M. VANSTON, EXAMINING ATTORNEY

CLASS 43—(Continued).

SN 77-198,079. MINNER, RODNEY LOUIS, EUREKA SPRINGS, AR. AND MINNER, SHARON VERONICA, EUREKA SPRINGS, AR. FILED 6-5-2007.



NO CLAIM IS MADE TO THE EXCLUSIVE RIGHT TO USE "RESTAURANT & TAVERN", APART FROM THE MARK AS SHOWN.

THE COLOR(S) BLACK, WHITE, BROWN AND GREEN IS/ARE CLAIMED AS A FEATURE OF THE MARK.

THE MARK CONSISTS OF BROWN BEAVER WEARING SUNGLASSES AND VEST AGAINST A GREEN BACKGROUND, SURROUNDED BY A BLACK RING WITH THE WORDS "ROWDY BEAVER RESTAURANT & TAVERN" IN WHITE LETTERS, WITH TWO GREEN DIAMONDS BETWEEN "ROWDY BEAVER" AND "RESTAURANT & TAVERN", SURROUNDED BY A NARROW BROWN BORDER.

FOR PREPARATION OF FOOD AND BEVERAGES (U.S. CLS. 100 AND 101).

FIRST USE 1-1-2007; IN COMMERCE 1-1-2007.
JANICE KIM, EXAMINING ATTORNEY

SN 77-206,739. COLONY RESORTS LVH ACQUISITIONS, LLC, LAS VEGAS, NV. FILED 6-14-2007.

Zen Lounge

THE MARK CONSISTS OF STANDARD CHARACTERS WITHOUT CLAIM TO ANY PARTICULAR FONT, STYLE, SIZE, OR COLOR.

NO CLAIM IS MADE TO THE EXCLUSIVE RIGHT TO USE "LOUNGE", APART FROM THE MARK AS SHOWN.

FOR RESTAURANT AND BAR SERVICES (U.S. CLS. 100 AND 101).

FIRST USE 6-29-2007; IN COMMERCE 6-29-2007.
PATRICIA EVANKO, EXAMINING ATTORNEY

CLASS 43—(Continued).

SN 77-213,732. SPIRITZ ENTERTAINMENT LLC, UPPER MARLBORO, MD. FILED 6-22-2007.



NO CLAIM IS MADE TO THE EXCLUSIVE RIGHT TO USE "MIXOLOGY BARTENDING SERVICES", APART FROM THE MARK AS SHOWN.

THE MARK CONSISTS OF THE STYLIZED TEXT "MIXOLOGY BARTENDING SERVICES"; (THE "I" IN "MIXOLOGY" IS A FILLED MARTINI GLASS WITH AN OLIVE IN THE MIDDLE.

FOR CATERING (U.S. CLS. 100 AND 101).
FIRST USE 2-1-2005; IN COMMERCE 2-1-2005.
AISHA SALEM, EXAMINING ATTORNEY

SN 77-220,979. YANG CHOW RESTAURANT, INC., LOS ANGELES, CA. FILED 7-2-2007.

Yang Chow

FOR RESTAURANT SERVICES (U.S. CLS. 100 AND 101).

FIRST USE 9-1-1985; IN COMMERCE 9-1-1985.
TOBY BULLOFF, EXAMINING ATTORNEY

SN 77-223,793. SCHLOTZSKY'S FRANCHISE LLC, ATLANTA, GA. FILED 7-6-2007.

LOTZ BETTER

THE MARK CONSISTS OF STANDARD CHARACTERS WITHOUT CLAIM TO ANY PARTICULAR FONT, STYLE, SIZE, OR COLOR.

FOR RESTAURANT, CARRYOUT RESTAURANT AND CATERING SERVICES (U.S. CLS. 100 AND 101).

BILL DAWE, EXAMINING ATTORNEY

CLASS 43—(Continued).

SN 77-249,744. RAVA GROUP, LLC, KITTY HAWK, NC. FILED 8-8-2007.

RAVA

THE MARK CONSISTS OF STANDARD CHARACTERS WITHOUT CLAIM TO ANY PARTICULAR FONT, STYLE, SIZE, OR COLOR.

OWNER OF U.S. REG. NOS. 3,186,281 AND 3,212,551. FOR CONSULTING SERVICES IN THE FIELD OF HOSPITALITY, NAMELY, HOTELS AND RESORT PROPERTIES (U.S. CLS. 100 AND 101).

FIRST USE 11-15-2005; IN COMMERCE 11-15-2005. JULIE GUTTADAURO, EXAMINING ATTORNEY

SN 77-260,990. SAMUELS, KIRK M., RALEIGH, NC. FILED 8-21-2007.

THE COMFORT TABLE

THE MARK CONSISTS OF STANDARD CHARACTERS WITHOUT CLAIM TO ANY PARTICULAR FONT, STYLE, SIZE, OR COLOR.

FOR PROVIDING A WEBSITE THAT FEATURES INFORMATION ON FOOD AND COOKING (U.S. CLS. 100 AND 101).

FIRST USE 2-1-2005; IN COMMERCE 2-1-2005. KEVON CHISOLM, EXAMINING ATTORNEY

SN 77-265,426. AMERICAN PROPERTY MANAGEMENT CORPORATION, SAN DIEGO, CA. FILED 8-27-2007.

Aqua Bloom

THE MARK CONSISTS OF STANDARD CHARACTERS WITHOUT CLAIM TO ANY PARTICULAR FONT, STYLE, SIZE, OR COLOR.

FOR HOTEL, BAR AND RESTAURANT SERVICES (U.S. CLS. 100 AND 101).

CHRIS WELLS, EXAMINING ATTORNEY

CLASS 43—(Continued).

SN 77-267,496. BRIVO LLC, DBA VILLA DESTI LLC, EAST HILLS, NY. FILED 8-29-2007.



THE COLOR(S) BLACK, MAROON AND YELLOW IS/ ARE CLAIMED AS A FEATURE OF THE MARK.

THE WORDING IS IN THE COLOR BLACK, THE INCOMPLETE OVAL AND DOT OVER THE LETTER "I" ARE IN THE COLOR DARK MAROON, AND THE BACKGROUND IS IN THE COLOR YELLOW.

FOR RESTAURANT SERVICES (U.S. CLS. 100 AND 101).

FIRST USE 6-10-2007; IN COMMERCE 6-10-2007. JOHN GARTNER, EXAMINING ATTORNEY

SN 77-268,022. CIRCA 33RD STREET LLC, NEW YORK, NY. FILED 8-30-2007.

CIRCANY

THE MARK CONSISTS OF STANDARD CHARACTERS WITHOUT CLAIM TO ANY PARTICULAR FONT, STYLE, SIZE, OR COLOR.

FOR RESTAURANT SERVICES, CONTRACT FOOD SERVICES AND CATERING (U.S. CLS. 100 AND 101).

FIRST USE 3-0-2006; IN COMMERCE 3-0-2006. STEVEN PEREZ, EXAMINING ATTORNEY

SN 77-268,026. CIRCA 33RD STREET LLC, NEW YORK, NY. FILED 8-30-2007.

CIRCA-NY

THE MARK CONSISTS OF STANDARD CHARACTERS WITHOUT CLAIM TO ANY PARTICULAR FONT, STYLE, SIZE, OR COLOR.

FOR RESTAURANT SERVICES, CONTRACT FOOD SERVICES AND CATERING (U.S. CLS. 100 AND 101).

FIRST USE 8-0-2000; IN COMMERCE 8-0-2000. STEVEN PEREZ, EXAMINING ATTORNEY

CLASS 43—(Continued).

SN 77-268,318. COOPER REALTY COMPANY, MEMPHIS, TN. FILED 8-30-2007.

GARDEN PLAZA

THE MARK CONSISTS OF STANDARD CHARACTERS WITHOUT CLAIM TO ANY PARTICULAR FONT, STYLE, SIZE, OR COLOR.

OWNER OF U.S. REG. NO. 1,339,737.
FOR HOTEL SERVICES (U.S. CLS. 100 AND 101).
FIRST USE 9-17-2007; IN COMMERCE 9-17-2007.
ALICE BENMAMAN, EXAMINING ATTORNEY

SN 77-272,355. CROWN MELBOURNE LIMITED, SOUTH-BANK, MELBOURNE, AUSTRALIA, FILED 9-5-2007.



NO CLAIM IS MADE TO THE EXCLUSIVE RIGHT TO USE LAS VEGAS, APART FROM THE MARK AS SHOWN.

THE MARK CONSISTS OF THE IMAGE OF A CROWN, CONSISTING OF A BASE AND NINE VERTICAL, BROKEN LINES AT VARIOUS ANGLES, BELOW WHICH APPEAR THE WORDS "CROWN LAS VEGAS" IN STYLIZED TEXT.

FOR HOTEL SERVICES; HOTEL, BAR AND RESTAURANT SERVICES; HOTELS; RESORT HOTELS (U.S. CLS. 100 AND 101).

STEVEN JACKSON, EXAMINING ATTORNEY

SN 77-272,985. DESMARAIS, MARC, LAS VEGAS, NV. FILED 9-6-2007.



FOR HOSTELS; PROVIDING TEMPORARY ACCOMMODATION (U.S. CLS. 100 AND 101).

FIRST USE 8-15-2007; IN COMMERCE 10-1-2007.
KATHERINE CONNOLLY, EXAMINING ATTORNEY

CLASS 43—(Continued).

SN 77-277,768. CHOU SHIH SHRIMP ROLL, TAINAN, TAIWAN, FILED 9-12-2007.

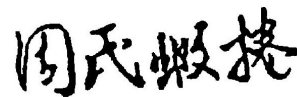

OWNER OF U.S. REG. NO. 2,847,195.

NO CLAIM IS MADE TO THE EXCLUSIVE RIGHT TO USE THE NON-LATIN CHARACTERS THAT MEAN "SHRIMP ROLL", APART FROM THE MARK AS SHOWN.

THE NAME SHOWN IN THE MARK IDENTIFIES CHIH-FENG CHOU, WHOSE CONSENT TO REGISTER IS MADE OF RECORD.

THE FOREIGN WORDING IN THE MARK TRANSLATES INTO ENGLISH AS "MR. CHOU'S SHRIMP ROLL."

THE NON-LATIN CHARACTERS IN THE MARK TRANSLITERATE INTO "CHOU SHIH HSIA JUAN," AND THIS MEANS "CHOU SHIH (IN CHINESE SHOWS RESPECT FOR AN INDIVIDUAL) SHRIMP ROLL" IN ENGLISH.

FOR RESTAURANTS; FAST-FOOD RESTAURANTS; RESERVATION OF RESTAURANTS; CARRY-OUT RESTAURANTS; FAST-FOOD RESTAURANTS AND SNACKBARS; DELICATESSENS; PUBS; SNACK BARS; WINE BARS; RESERVATION OF HOTEL ROOMS FOR TRAVELLERS; TEA ROOMS; COFFEE SHOPS; COFFEE-HOUSE AND SNACK-BAR SERVICES; CAFES; BAR SERVICES; CANTEEN SERVICES; TRAVEL AGENCY SERVICES, NAMELY, MAKING RESERVATIONS AND BOOKING FOR TEMPORARY LODGING; TAVERN SERVICES; CAFETERIAS; CATERING; CATERING FOR THE PROVISION OF FOOD AND BEVERAGES; RENTAL OF FOOD SERVICE EQUIPMENT; RENTAL OF PORTABLE BUILDINGS; RENTAL OF TENTS; PREPARATION OF FOOD AND BEVERAGES; HOTELS; MAKING HOTEL RESERVATIONS FOR OTHERS; TOURIST INNS; MOTELS; PROVIDING TEMPORARY HOUSING ACCOMMODATIONS; PROVIDING COMMUNITY CENTERS FOR SOCIAL GATHERINGS AND MEETINGS; PROVIDING CONFERENCE ROOMS; PROVIDING FACILITIES FOR EXHIBITIONS; PROVIDING HALFWAY HOUSES; PROVIDING IN-FLIGHT MEAL SERVICES IN AN AIRPLANE; GUESTHOUSE; ARRANGING TEMPORARY HOUSING ACCOMMODATIONS; BOARDING HOUSES; HOSTELS; PROVIDING CAMPGROUND FACILITIES; LEASING OF KITCHEN APPLIANCES (U.S. CLS. 100 AND 101).

JASON BLAIR, EXAMINING ATTORNEY

CLASS 43—(Continued).

SN 77-280,970. HIRALES, JOSE CARLOS, LAS VEGAS, NV. FILED 9-17-2007.



NO CLAIM IS MADE TO THE EXCLUSIVE RIGHT TO USE "GORDITAS" AND "MEXICO", APART FROM THE MARK AS SHOWN.

THE COLOR(S) GREEN, RED, BLACK, WHITE, BROWN AND YELLOW IS/ARE CLAIMED AS A FEATURE OF THE MARK.

THE MARK CONSISTS OF THE WORDING "LAS GORDITAS" IN YELLOW, RED AND GREEN IN THE FOREGROUND OF A RED, WHITE AND GREEN BACKGROUND. THE DESIGN OF A WOMAN WITH BLACK HAIR AND EYES, A YELLOW FACE, WITH A RED MOUTH, HAIR BOWS AND COLLAR APPEARS NEXT TO THE WORDING. UNDERNEATH THE MAIN WORDING ARE THE WORDS "EL SABOR DE MEXICO...!" IN WHITE. ALSO NEXT TO THE WORDING IS THE DESIGN OF BROWN AND YELLOW FOOD COOKING ON A BLACK AND WHITE GRILL WITH RED AND GREEN STEAM RISING FROM THE FOOD. NEXT TO THE GRILL IS A BLACK AND WHITE BOWL WITH GREEN RED AND WHITE VEGETABLES INSIDE AND A WEAVED BLACK AND YELLOW SPATULA OFF TO THE SIDE.

THE FOREIGN WORDING IN THE MARK TRANSLATES INTO ENGLISH AS "THE" AND "THE FLAVOR OF".

FOR RESTAURANT SERVICES (U.S. CLS. 100 AND 101).

FIRST USE 2-14-2007; IN COMMERCE 2-14-2007. ANTHONY RINKER, EXAMINING ATTORNEY

SN 77-281,716. STRESS FREE RELOCATION, INC., PEMBROKE PINES, FL. FILED 9-17-2007.

STRESS FREE RELOCATION

THE MARK CONSISTS OF STANDARD CHARACTERS WITHOUT CLAIM TO ANY PARTICULAR FONT, STYLE, SIZE, OR COLOR.

NO CLAIM IS MADE TO THE EXCLUSIVE RIGHT TO USE "RELOCATION", APART FROM THE MARK AS SHOWN.

FOR ARRANGING TEMPORARY HOUSING ACCOMMODATIONS; PROVIDING TEMPORARY HOUSING ACCOMMODATIONS; RENTAL OF FURNITURE AND HOUSEHOLD FURNISHINGS IN THE NATURE OF APPLIANCES AND ELECTRONIC EQUIPMENT FOR USE IN TEMPORARY HOUSING ACCOMMODATIONS (U.S. CLS. 100 AND 101).

YAT SYE, LEE, EXAMINING ATTORNEY

CLASS 43—(Continued).

SN 77-281,893. COLD FUZION INC, NAPLES, FL. FILED 9-18-2007.



NO CLAIM IS MADE TO THE EXCLUSIVE RIGHT TO USE "NATURAL INGREDIENTS FLASH FROZEN", APART FROM THE MARK AS SHOWN.

THE MARK CONSISTS OF A STYLIZED LETTER "R" AND A STYLIZED LETTER "O" A CYCLONE SHAPE COMING FROM THE LETTER "U".

FOR RESTAURANT SERVICES (U.S. CLS. 100 AND 101).

WENDY GOODMAN, EXAMINING ATTORNEY

SN 77-281,951. KIMPTON HOTEL & RESTAURANT GROUP, LLC, SAN FRANCISCO, CA. FILED 9-18-2007.

M. BELLE

THE MARK CONSISTS OF STANDARD CHARACTERS WITHOUT CLAIM TO ANY PARTICULAR FONT, STYLE, SIZE, OR COLOR.

THE NAME "M. BELLE" DOES NOT IDENTIFY A LIVING INDIVIDUAL.

FOR RESTAURANT AND BAR SERVICES (U.S. CLS. 100 AND 101).

CURTIS FRENCH, EXAMINING ATTORNEY

SN 77-283,499. LING & LOUIE'S RESTAURANTS, LLC, SCOTTSDALE, AZ. FILED 9-19-2007.

NOT FOR BORING PEOPLE

THE MARK CONSISTS OF STANDARD CHARACTERS WITHOUT CLAIM TO ANY PARTICULAR FONT, STYLE, SIZE, OR COLOR.

FOR RESTAURANT SERVICES (U.S. CLS. 100 AND 101).

YAT SYE, LEE, EXAMINING ATTORNEY

CLASS 43—(Continued).

SN 77-283,600. FONSECA, FLAVIO, MILWAUKEE, WI. AND FONSECA, IVAN, MILWAUKEE, WI. FILED 9-19-2007.

EL NOVILLERO RESTAURANT

THE MARK CONSISTS OF STANDARD CHARACTERS WITHOUT CLAIM TO ANY PARTICULAR FONT, STYLE, SIZE, OR COLOR.

NO CLAIM IS MADE TO THE EXCLUSIVE RIGHT TO USE "RESTAURANT", APART FROM THE MARK AS SHOWN.

FOR RESTAURANT AND BAR SERVICES (U.S. CLS. 100 AND 101).

PAUL E. FAHRENKOPF, EXAMINING ATTORNEY

SN 77-285,442. DUROVSIK, MICHAEL, LAS VEGAS, NV. FILED 9-21-2007.

Grade Restaurant

THE MARK CONSISTS OF STANDARD CHARACTERS WITHOUT CLAIM TO ANY PARTICULAR FONT, STYLE, SIZE, OR COLOR.

NO CLAIM IS MADE TO THE EXCLUSIVE RIGHT TO USE "RESTAURANT", APART FROM THE MARK AS SHOWN.

FOR RESTAURANT AND BAR SERVICES (U.S. CLS. 100 AND 101).

MICHAEL GAAFAR, EXAMINING ATTORNEY

SN 77-287,045. TOMMY BAHAMA GROUP, INC., ATLANTA, GA. FILED 9-24-2007.

Tommy Bahama's Island Grille

THE MARK CONSISTS OF STANDARD CHARACTERS WITHOUT CLAIM TO ANY PARTICULAR FONT, STYLE, SIZE, OR COLOR.

OWNER OF U.S. REG. NOS. 2,112,530 AND 2,284,151. NO CLAIM IS MADE TO THE EXCLUSIVE RIGHT TO USE "GRILLE", APART FROM THE MARK AS SHOWN.

THE NAME(S), PORTRAIT(S), AND/OR SIGNATURE(S) SHOWN IN THE MARK DOES NOT IDENTIFY A PARTICULAR LIVING INDIVIDUAL.

FOR RESTAURANTS (U.S. CLS. 100 AND 101).
CIMMERIAN COLEMAN, EXAMINING ATTORNEY

CLASS 43—(Continued).

SN 77-287,341. RENT-A-CENTER WEST, INC., PLANO, TX. FILED 9-24-2007.

RAC WORRY FREE GUARANTEE

THE MARK CONSISTS OF STANDARD CHARACTERS WITHOUT CLAIM TO ANY PARTICULAR FONT, STYLE, SIZE, OR COLOR.

OWNER OF U.S. REG. NO. 3,161,654.

NO CLAIM IS MADE TO THE EXCLUSIVE RIGHT TO USE "GUARANTEE", APART FROM THE MARK AS SHOWN.

FOR RENTAL, LEASING, LEASE PURCHASING AND RENTAL-TO-OWN OF FURNITURE; RENTAL, LEASING, LEASE PURCHASING AND RENTAL-TO-OWN OF HOME FURNISHINGS, NAMELY, HOME ENTERTAINMENT CENTERS AND DECORATIVE ACCESSORIES; RENTAL, LEASING, LEASE PURCHASING AND RENTAL-TO-OWN OF HOME APPLIANCES, NAMELY, OVENS AND RANGES (U.S. CLS. 100 AND 101).

JILL C. ALT, EXAMINING ATTORNEY

SN 77-287,493. GARCIA, FERMIN CAMARENA, GUADALAJARA, MEXICO, FILED 9-24-2007.

KAMILOS 333

THE MARK CONSISTS OF STANDARD CHARACTERS WITHOUT CLAIM TO ANY PARTICULAR FONT, STYLE, SIZE, OR COLOR.

THE WORDING "KAMILOS" HAS NO MEANING IN A FOREIGN LANGUAGE.

FOR PREPARATION OF FOOD AND BEVERAGES; RESTAURANT SERVICES (U.S. CLS. 100 AND 101).

MICHAEL ENGEL, EXAMINING ATTORNEY

SN 77-288,301. RICHARD W. MOSS, KILMARNOCK, VA. FILED 9-25-2007.

BIG HAT BAR-B-QUE

THE MARK CONSISTS OF STANDARD CHARACTERS WITHOUT CLAIM TO ANY PARTICULAR FONT, STYLE, SIZE, OR COLOR.

NO CLAIM IS MADE TO THE EXCLUSIVE RIGHT TO USE "BARBECUE", APART FROM THE MARK AS SHOWN. FOR RESTAURANT SERVICES; RESTAURANTS (U.S. CLS. 100 AND 101).

MARK RADEMACHER, EXAMINING ATTORNEY

CLASS 43—(Continued).

SN 77-289,452. MANERO'S RESTAURANT OF PALM BEACH COUNTY INC., DBA MANERO'S, PALM CITY, FL. FILED 9-26-2007.

Manero's

THE MARK CONSISTS OF STANDARD CHARACTERS WITHOUT CLAIM TO ANY PARTICULAR FONT, STYLE, SIZE, OR COLOR.

SEC. 2(F).
FOR RESTAURANT AND BAR SERVICES; RESTAURANTS (U.S. CLS. 100 AND 101).
FIRST USE 0-0-1960; IN COMMERCE 0-0-1970.
ALEXANDER L. POWERS, EXAMINING ATTORNEY

SN 77-289,749. BRITISH AMERICAN PUB COMPANY, INC., BOCA RATON, FL. FILED 9-26-2007.

Aspen Jack's

THE MARK CONSISTS OF STANDARD CHARACTERS WITHOUT CLAIM TO ANY PARTICULAR FONT, STYLE, SIZE, OR COLOR.

FOR RESTAURANT AND BAR SERVICES (U.S. CLS. 100 AND 101).
DARRYL SPRUILL, EXAMINING ATTORNEY

SN 77-289,942. FONSECA ENTERPRISES, L.L.C., YUMA, AZ. FILED S.R. 9-26-2007; AM. P.R. 1-8-2007.



NO CLAIM IS MADE TO THE EXCLUSIVE RIGHT TO USE "BURRITO GRILL" AND "MEXICAN CUISINE", APART FROM THE MARK AS SHOWN.

FOR RESTAURANTS (U.S. CLS. 100 AND 101).
FIRST USE 8-1-2007; IN COMMERCE 8-1-2007.
MICHAEL KAZAZIAN, EXAMINING ATTORNEY

CLASS 43—(Continued).

SN 77-290,099. KMB DEVELOPMENT LTD., MAUMEE, OH. FILED 9-27-2007.

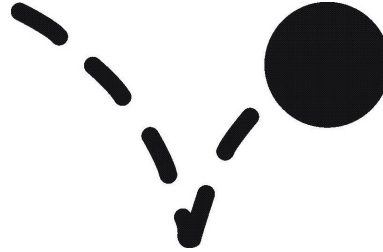

THE MARK CONSISTS OF A BOUNCING BALL FOR DAY CARE CENTERS (U.S. CLS. 100 AND 101).
FIRST USE 3-0-2007; IN COMMERCE 3-0-2007.
LINDA E. BLOHM, EXAMINING ATTORNEY

SN 77-290,369. SHARP, ROGER, PASO ROBLES, CA. FILED 9-27-2007.

GOOD OL' BURGERS

THE MARK CONSISTS OF STANDARD CHARACTERS WITHOUT CLAIM TO ANY PARTICULAR FONT, STYLE, SIZE, OR COLOR.

NO CLAIM IS MADE TO THE EXCLUSIVE RIGHT TO USE "BURGERS", APART FROM THE MARK AS SHOWN. FOR RESTAURANT SERVICES (U.S. CLS. 100 AND 101).

FIRST USE 11-15-1983; IN COMMERCE 2-1-1984.
LYDIA BELZER, EXAMINING ATTORNEY

SN 77-290,995. BPM SENIOR LIVING COMPANY, PORTLAND, OR. FILED 9-27-2007.

PERSONAL PREFERENCES

THE MARK CONSISTS OF STANDARD CHARACTERS WITHOUT CLAIM TO ANY PARTICULAR FONT, STYLE, SIZE, OR COLOR.

FOR PROVIDING ASSISTED LIVING FACILITIES AND SENIOR LIVING FACILITIES (U.S. CLS. 100 AND 101).

FIRST USE 1-0-2006; IN COMMERCE 1-0-2006.
MATTHEW MCDOWELL, EXAMINING ATTORNEY

CLASS 43—(Continued).

SN 77-291,101. SKY RESORT MANAGEMENT, LLC, ORLANDO, FL. FILED 9-28-2007.

Specializing in the art of vacations

THE MARK CONSISTS OF STANDARD CHARACTERS WITHOUT CLAIM TO ANY PARTICULAR FONT, STYLE, SIZE, OR COLOR.

FOR PROVIDING TEMPORARY LODGING SERVICES IN THE NATURE OF A CONDOMINIUM HOTEL (U.S. CLS. 100 AND 101).

FIRST USE 9-15-2007; IN COMMERCE 9-15-2007.
AMY GEARIN, EXAMINING ATTORNEY

SN 77-291,349. YBL RESTAURANT GROUP, SAN FRANCISCO, CA. FILED 9-28-2007.

Tropisueño

THE MARK CONSISTS OF STANDARD CHARACTERS WITHOUT CLAIM TO ANY PARTICULAR FONT, STYLE, SIZE, OR COLOR.

FOR RESTAURANTS (U.S. CLS. 100 AND 101).
RICHARD A. STRASER, EXAMINING ATTORNEY

SN 77-291,502. YONG JIN LEE, FULLERTON, CA. FILED 9-28-2007.



THE COLOR(S) BLACK, ORANGE, YELLOW, DARK GREEN, LIGHT GREEN, AND GRAY IS/ARE CLAIMED AS A FEATURE OF THE MARK.

THE MARK CONSISTS OF THE TEXT "IYOGURT" WHERE THE "I" IS BLACK, THE "Y" IS ORANGE, THE "O" IS YELLOW, THE "G" AND THE "R" ARE LIGHT GREEN, THE "U" IS DARK GREEN, AND THE "T" IS GRAY.

FOR RESTAURANT SERVICES FOR SMOOTHIES, FROZEN YOGURT AND FROZEN YOGURT BASED DESSERTS COMBINED WITH FRUITS, NUTS, CEREAL AND SHAVED ICE AND RICE CAKES (U.S. CLS. 100 AND 101).

ANDREA HACK, EXAMINING ATTORNEY

CLASS 43—(Continued).

SN 77-291,592. ARBY'S IP HOLDER TRUST, ATLANTA, GA. FILED 9-28-2007.

A FRESH LOOK AT ARBY'S

THE MARK CONSISTS OF STANDARD CHARACTERS WITHOUT CLAIM TO ANY PARTICULAR FONT, STYLE, SIZE, OR COLOR.

OWNER OF U.S. REG. NOS. 890,631, 3,146,765 AND OTHERS.

FOR RESTAURANT SERVICES (U.S. CLS. 100 AND 101).

RICHARD A. STRASER, EXAMINING ATTORNEY

SN 77-292,367. CLEARWEST VII SEATTLE OWNER, LLC, NEWPORT BEACH, CA. FILED 9-30-2007.

TULIO

THE MARK CONSISTS OF STANDARD CHARACTERS WITHOUT CLAIM TO ANY PARTICULAR FONT, STYLE, SIZE, OR COLOR.

FOR RESTAURANT AND BAR SERVICES (U.S. CLS. 100 AND 101).

FIRST USE 8-14-1992; IN COMMERCE 8-14-1992.
LAURIE KAUFMAN, EXAMINING ATTORNEY

SN 77-292,369. CLEARWEST VII SEATTLE OWNER, LLC, NEWPORT BEACH, CA. FILED 9-30-2007.

VINTAGE PARK

THE MARK CONSISTS OF STANDARD CHARACTERS WITHOUT CLAIM TO ANY PARTICULAR FONT, STYLE, SIZE, OR COLOR.

FOR HOTELS (U.S. CLS. 100 AND 101).

FIRST USE 8-14-1992; IN COMMERCE 8-14-1992.
LAURIE KAUFMAN, EXAMINING ATTORNEY

CLASS 43—(Continued).

SN 77-292,371. CLEARWEST VII PORTLAND OWNER, LLC, NEWPORT BEACH, CA. FILED 9-30-2007.

VINTAGE PLAZA

THE MARK CONSISTS OF STANDARD CHARACTERS WITHOUT CLAIM TO ANY PARTICULAR FONT, STYLE, SIZE, OR COLOR.
FOR HOTELS (U.S. CLS. 100 AND 101).
FIRST USE 5-15-1991; IN COMMERCE 5-15-1991.
KAREN K. BUSH, EXAMINING ATTORNEY

SN 77-292,732. TINY BITES, INC., GREENLAWN, NY. FILED 10-1-2007.

TINY BITES

THE MARK CONSISTS OF STANDARD CHARACTERS WITHOUT CLAIM TO ANY PARTICULAR FONT, STYLE, SIZE, OR COLOR.
FOR PREPARATION OF FOOD AND BEVERAGES (U.S. CLS. 100 AND 101).
BRIAN CALLAGHAN, EXAMINING ATTORNEY

SN 77-292,819. PONTE, KENNETH A., DBA THE DONUT STATION, TORRINGTON, CT. FILED 10-1-2007.

The Donut Station

THE MARK CONSISTS OF STANDARD CHARACTERS WITHOUT CLAIM TO ANY PARTICULAR FONT, STYLE, SIZE, OR COLOR.
NO CLAIM IS MADE TO THE EXCLUSIVE RIGHT TO USE "DONUT", APART FROM THE MARK AS SHOWN.
SEC. 2(F).
FOR COFFEE SHOPS (U.S. CLS. 100 AND 101).
FIRST USE 8-1-1995; IN COMMERCE 3-1-1996.
ALYSSA PALADINO, EXAMINING ATTORNEY

CLASS 43—(Continued).

SN 77-292,832. PONTE, KENNETH A., DBA TASTE IT! FOR YOURSELF, TORRINGTON, CT. FILED 10-1-2007.

Taste It! For Yourself

THE MARK CONSISTS OF STANDARD CHARACTERS WITHOUT CLAIM TO ANY PARTICULAR FONT, STYLE, SIZE, OR COLOR.
FOR COFFEE SHOPS (U.S. CLS. 100 AND 101).
FIRST USE 8-1-1995; IN COMMERCE 3-1-1996.
ALYSSA PALADINO, EXAMINING ATTORNEY

SN 77-292,879. DIFFERENT CONCEPTS, INC., COCONUT CREEK, FL. FILED 10-1-2007.



OWNER OF U.S. REG. NO. 2,157,603.
NO CLAIM IS MADE TO THE EXCLUSIVE RIGHT TO USE "ITALIAN RISTORANTE", APART FROM THE MARK AS SHOWN.
THE COLOR(S) RED, WHITE, GRAY, AND GREEN IS/ ARE CLAIMED AS A FEATURE OF THE MARK.
THE MARK CONSISTS OF A CHEF DEPICTED IN WHITE AND GRAY, WITH A RED, WHITE, AND GREEN COLLAR ON THE LEFT SIDE, AND HOLDING A RED SIGN WITH A GRAY AND WHITE BORDER AND WITH WHITE LETTERING SET AGAINST A RED BACKGROUND.
THE FOREIGN WORDING IN THE MARK TRANSLATES INTO ENGLISH AS RESTAURANT.
FOR RESTAURANT SERVICES (U.S. CLS. 100 AND 101).
FIRST USE 10-0-2006; IN COMMERCE 10-0-2006.
KIMBERLY PERRY, EXAMINING ATTORNEY

CLASS 43—(Continued).

SN 77-292,898. DIFFERENT CONCEPTS, INC., COCONUT CREEK, FL. FILED 10-1-2007.

SAL'S ITALIAN RISTORANTE

THE MARK CONSISTS OF STANDARD CHARACTERS WITHOUT CLAIM TO ANY PARTICULAR FONT, STYLE, SIZE, OR COLOR.

OWNER OF U.S. REG. NO. 2,157,603.

NO CLAIM IS MADE TO THE EXCLUSIVE RIGHT TO USE "ITALIAN RISTORANTE", APART FROM THE MARK AS SHOWN.

THE ENGLISH TRANSLATION OF THE WORD "RISTORANTE" IN THE MARK IS RESTAURANT.

FOR RESTAURANT SERVICES (U.S. CLS. 100 AND 101).

FIRST USE 2-1-1997; IN COMMERCE 2-1-1997.

KIMBERLY PERRY, EXAMINING ATTORNEY

SN 77-292,990. WHITE, JAMES ABNER, OXFORD, MS. FILED 10-1-2007.

ABNER'S

THE MARK CONSISTS OF STANDARD CHARACTERS WITHOUT CLAIM TO ANY PARTICULAR FONT, STYLE, SIZE, OR COLOR.

FOR RESTAURANT SERVICES (U.S. CLS. 100 AND 101).

FIRST USE 1-25-1993; IN COMMERCE 1-25-1993.

KATHY DE JONGE, EXAMINING ATTORNEY

CLASS 43—(Continued).

SN 77-293,120. ACORN ASSET MANAGEMENT, INC., SACRAMENTO, CA. FILED 10-1-2007.



THE MARK CONSISTS OF A TREE LOGO WITH THE WORDS "TEMPLE ORANGE" UNDERNEATH.

FOR BAR SERVICES; CAFE-RESTAURANTS; CAFES; COCKTAIL LOUNGE BUFFETS; COCKTAIL LOUNGES; COFFEE SHOPS; HOTEL, BAR AND RESTAURANT SERVICES; PROVIDING BANQUET AND SOCIAL FUNCTION FACILITIES FOR SPECIAL OCCASIONS; PROVIDING OF FOOD AND DRINK; PUBS; RESTAURANT AND BAR SERVICES; RESTAURANT SERVICES; RESTAURANTS; SERVING FOOD AND DRINKS; SERVING OF FOOD AND DRINK/BEVERAGES; SNACK BARS; TAVERN SERVICES (U.S. CLS. 100 AND 101).

CARYN GLASSER, EXAMINING ATTORNEY

SN 77-293,412. MAALOUF, GABY, MARINA DEL REY, CA. FILED 10-2-2007.

Creating a healthy habit
every day

THE MARK CONSISTS OF STANDARD CHARACTERS WITHOUT CLAIM TO ANY PARTICULAR FONT, STYLE, SIZE, OR COLOR.

FOR CAFE-RESTAURANTS; CARRY-OUT RESTAURANTS; FAST FOOD AND NON-STOP RESTAURANT SERVICES; FAST-FOOD RESTAURANTS; RESTAURANT SERVICES; RESTAURANT SERVICES FEATURING SANDWICHES; TAKE-OUT RESTAURANT SERVICES (U.S. CLS. 100 AND 101).

FIRST USE 1-5-2000; IN COMMERCE 1-5-2000.

TEJBIR SINGH, EXAMINING ATTORNEY

CLASS 43—(Continued).

SN 77-293,440. DESARROLLO MARINA VALLARTA, S.A. DE C.V., GUADALAJARA, MEXICO, FILED 10-2-2007.

BALCHE POOL SNACK BAR

THE MARK CONSISTS OF STANDARD CHARACTERS WITHOUT CLAIM TO ANY PARTICULAR FONT, STYLE, SIZE, OR COLOR.

NO CLAIM IS MADE TO THE EXCLUSIVE RIGHT TO USE "POOL SNACK BAR", APART FROM THE MARK AS SHOWN.

FOR RESTAURANT AND BAR SERVICES; RESTAURANTS; CAFE-RESTAURANTS; FAST-FOOD RESTAURANTS AND SNACKBARS (U.S. CLS. 100 AND 101).

RONALD MCMORROW, EXAMINING ATTORNEY

SN 77-293,443. DESARROLLO MARINA VALLARTA, S.A. DE C.V., GUADALAJARA, MEXICO, FILED 10-2-2007.

HAVANA MOON

THE MARK CONSISTS OF STANDARD CHARACTERS WITHOUT CLAIM TO ANY PARTICULAR FONT, STYLE, SIZE, OR COLOR.

FOR RESTAURANT AND BAR SERVICES; RESTAURANTS (U.S. CLS. 100 AND 101).

RONALD MCMORROW, EXAMINING ATTORNEY

SN 77-294,086. CALMEX, INC., MODESTO, CA. FILED 10-2-2007.

FUZIO UNIVERSAL BISTRO

THE MARK CONSISTS OF STANDARD CHARACTERS WITHOUT CLAIM TO ANY PARTICULAR FONT, STYLE, SIZE, OR COLOR.

OWNER OF U.S. REG. NOS. 2,248,206, 2,926,320 AND OTHERS.

NO CLAIM IS MADE TO THE EXCLUSIVE RIGHT TO USE "BISTRO", APART FROM THE MARK AS SHOWN.

FOR RESTAURANT SERVICES (U.S. CLS. 100 AND 101).

BENJAMIN ALLEN, EXAMINING ATTORNEY

CLASS 43—(Continued).

SN 77-294,120. CALMEX, INC., MODESTO, CA. FILED 10-2-2007.

BAR FUZIO

THE MARK CONSISTS OF STANDARD CHARACTERS WITHOUT CLAIM TO ANY PARTICULAR FONT, STYLE, SIZE, OR COLOR.

OWNER OF U.S. REG. NOS. 2,248,206, 2,926,320 AND OTHERS.

NO CLAIM IS MADE TO THE EXCLUSIVE RIGHT TO USE "BAR", APART FROM THE MARK AS SHOWN.

FOR RESTAURANT SERVICES; BAR SERVICES (U.S. CLS. 100 AND 101).

BENJAMIN ALLEN, EXAMINING ATTORNEY

SN 77-294,886. ANGEL'S FRANCHISING INC., GUAYNABO, PUERTO RICO, FILED 10-3-2007.



OWNER OF U.S. REG. NO. 3,194,971.

NO CLAIM IS MADE TO THE EXCLUSIVE RIGHT TO USE "GREAT FOOD & ICE CREAM", APART FROM THE MARK AS SHOWN.

FOR RESTAURANT SERVICES (U.S. CLS. 100 AND 101).

SHANNON TWOHIG, EXAMINING ATTORNEY

SN 77-295,617. YOHANA GROUP, INC., LOS ANGELES, CA. FILED 10-3-2007.

ASAKUMA

THE MARK CONSISTS OF STANDARD CHARACTERS WITHOUT CLAIM TO ANY PARTICULAR FONT, STYLE, SIZE, OR COLOR.

FOR RESTAURANTS (U.S. CLS. 100 AND 101).

FIRST USE 7-1-1985; IN COMMERCE 7-1-1985.

LINDA ORNDORFF, EXAMINING ATTORNEY

CLASS 43—(Continued).

SN 77-296,759. YOHANA GROUP, INC., LOS ANGELES, CA.
FILED 10-4-2007.

ASAKUMA RICE

THE MARK CONSISTS OF STANDARD CHARACTERS WITHOUT CLAIM TO ANY PARTICULAR FONT, STYLE, SIZE, OR COLOR.
NO CLAIM IS MADE TO THE EXCLUSIVE RIGHT TO USE "RICE", APART FROM THE MARK AS SHOWN.
FOR RESTAURANTS (U.S. CLS. 100 AND 101).
FIRST USE 9-1-2006; IN COMMERCE 9-1-2006.
LINDA ORNDORFF, EXAMINING ATTORNEY

SN 77-297,744. THE EDWARD THOMAS HOSPITALITY CORP., BEVERLY HILLS, CA. FILED 10-5-2007.

GOTELS

THE MARK CONSISTS OF STANDARD CHARACTERS WITHOUT CLAIM TO ANY PARTICULAR FONT, STYLE, SIZE, OR COLOR.
FOR HOTEL, BAR AND RESTAURANT SERVICES (U.S. CLS. 100 AND 101).
WON TEAK OH, EXAMINING ATTORNEY

SN 77-317,132. ERICKSON RETIREMENT COMMUNITIES, LLC, BALTIMORE, MD. FILED 10-30-2007.

TANGLEWOOD CREEK

THE MARK CONSISTS OF STANDARD CHARACTERS WITHOUT CLAIM TO ANY PARTICULAR FONT, STYLE, SIZE, OR COLOR.
FOR LIFE CARE RETIREMENT HOME SERVICES (U.S. CLS. 100 AND 101).
ROBIN MITTLER, EXAMINING ATTORNEY

CLASS 43—(Continued).

SN 77-321,830. HMSHOST CORPORATION, BETHESDA, MD.
FILED 11-5-2007.

CARRY OUT & CARRY ON!

THE MARK CONSISTS OF STANDARD CHARACTERS WITHOUT CLAIM TO ANY PARTICULAR FONT, STYLE, SIZE, OR COLOR.
FOR RESTAURANT SERVICES (U.S. CLS. 100 AND 101).
FIRST USE 11-0-2003; IN COMMERCE 11-0-2003.
SUSAN RICHARDS, EXAMINING ATTORNEY

SN 77-325,870. CALMEX, INC., MODESTO, CA. FILED 11-9-2007.

FUZIO UNIVERSAL CAFE

THE MARK CONSISTS OF STANDARD CHARACTERS WITHOUT CLAIM TO ANY PARTICULAR FONT, STYLE, SIZE, OR COLOR.
OWNER OF U.S. REG. NOS. 2,248,206, 2,926,320 AND OTHERS.
NO CLAIM IS MADE TO THE EXCLUSIVE RIGHT TO USE "CAFE", APART FROM THE MARK AS SHOWN.
FOR RESTAURANT SERVICES (U.S. CLS. 100 AND 101).
BENJAMIN ALLEN, EXAMINING ATTORNEY

SN 77-343,429. PMA CONSULTANTS LLC, ANN ARBOR, MI.
FILED 12-4-2007.

EarthandTable

THE MARK CONSISTS OF STANDARD CHARACTERS WITHOUT CLAIM TO ANY PARTICULAR FONT, STYLE, SIZE, OR COLOR.
FOR BAR AND RESTAURANT SERVICES (U.S. CLS. 100 AND 101).
TANYA AMOS, EXAMINING ATTORNEY

CLASS 43—(Continued).

SN 78-879,757. ISLAND GLOBAL YACHTING LTD., NEW YORK, NY. FILED 5-9-2006.

WIKKED

THE MARK CONSISTS OF STANDARD CHARACTERS WITHOUT CLAIM TO ANY PARTICULAR FONT, STYLE, SIZE, OR COLOR.

FOR RESTAURANT SERVICES (U.S. CLS. 100 AND 101).

MARTHA FROMM, EXAMINING ATTORNEY



SN 78-915,404. TOKYO 21, LLC, CHICAGO, IL. FILED 6-23-2006.

TOKYO 21

THE MARK CONSISTS OF STANDARD CHARACTERS WITHOUT CLAIM TO ANY PARTICULAR FONT, STYLE, SIZE, OR COLOR.

FOR CATERING; RESTAURANT AND BAR SERVICES; TAKE-OUT RESTAURANT SERVICES (U.S. CLS. 100 AND 101).

FIRST USE 6-7-2006; IN COMMERCE 6-7-2006.
BILL DAWE, EXAMINING ATTORNEY



SN 78-915,840. NAGATA, WATARU, ALPHARETTA, GA. FILED 6-23-2006.

RU SAN'S

THE MARK CONSISTS OF STANDARD CHARACTERS WITHOUT CLAIM TO ANY PARTICULAR FONT, STYLE, SIZE, OR COLOR.

"RU SAN'S" HAS NO MEANING IN A FOREIGN LANGUAGE.

FOR RESTAURANT AND COCKTAIL LOUNGE SERVICES (U.S. CLS. 100 AND 101).

FIRST USE 1-0-1993; IN COMMERCE 1-0-1998.
INGA ERVIN, EXAMINING ATTORNEY

CLASS 43—(Continued).

SN 78-924,336. STAATLICHES HOFBRÄUHAUS IN MÜNCHEN, 81829 MÜNCHEN, FED REP GERMANY, FILED 7-7-2006.

HOFBRÄU BEER HALL

THE MARK CONSISTS OF STANDARD CHARACTERS WITHOUT CLAIM TO ANY PARTICULAR FONT, STYLE, SIZE, OR COLOR.

OWNER OF U.S. REG. NOS. 305,898, 3,053,225 AND OTHERS.

NO CLAIM IS MADE TO THE EXCLUSIVE RIGHT TO USE "BEER HALL", APART FROM THE MARK AS SHOWN.

THE FOREIGN WORDING IN THE MARK TRANSLATES INTO ENGLISH AS "ROYAL BREWERY" OR "COURT BREWERY".

SEC. 2(F).
FOR RESTAURANT AND BREW PUB SERVICES (U.S. CLS. 100 AND 101).

DOMINIC FATHY, EXAMINING ATTORNEY



SN 78-942,976. LIVING SPACE PROPERTIES LIMITED, CHRISTCHURCH, NEW ZEALAND, FILED 8-2-2006.

HOTEL SO

THE MARK CONSISTS OF STANDARD CHARACTERS WITHOUT CLAIM TO ANY PARTICULAR FONT, STYLE, SIZE, OR COLOR.

PRIORITY CLAIMED UNDER SEC. 44(D) ON NEW ZEALAND APPLICATION NO. 742501, FILED 2-7-2006, REG. NO. 733421, DATED 2-7-2006, EXPIRES 2-7-2016.

NO CLAIM IS MADE TO THE EXCLUSIVE RIGHT TO USE "HOTEL", APART FROM THE MARK AS SHOWN.

FOR PROVIDING TEMPORARY ACCOMMODATION; HOTEL SERVICES; MAKING HOTEL RESERVATIONS FOR OTHERS; SERVICES FOR THE RESERVATION OF ROOMS; RESTAURANT, CAFE, AND BAR SERVICES (U.S. CLS. 100 AND 101).

MICHAEL GAFFAR, EXAMINING ATTORNEY

CLASS 43—(Continued).

SN 78-956,261. KYMA 69, LLC, ANNAPOLIS, MD. FILED 8-21-2006.



tapas • mezzes • bar

NO CLAIM IS MADE TO THE EXCLUSIVE RIGHT TO USE "TAPAS MEZZES BAR", APART FROM THE MARK AS SHOWN.

THE ENGLISH TRANSLATION OF THE WORD "KYMA" IN THE MARK IS "WAVE".

FOR RESTAURANT, BAR AND LOUNGE SERVICES (U.S. CLS. 100 AND 101).

FIRST USE 6-6-2005; IN COMMERCE 6-6-2005.

KATHERINE CHANG, EXAMINING ATTORNEY

SN 78-956,274. KYMA 69, LLC, ANNAPOLIS, MD. FILED 8-21-2006.



tapas • mezzes • bar

NO CLAIM IS MADE TO THE EXCLUSIVE RIGHT TO USE "TAPAS MEZZES BAR", APART FROM THE MARK AS SHOWN.

THE ENGLISH TRANSLATION OF THE WORD "KYMA" IN THE MARK IS "WAVE".

FOR RESTAURANT, BAR AND LOUNGE SERVICES (U.S. CLS. 100 AND 101).

FIRST USE 6-6-2005; IN COMMERCE 6-6-2005.

KATHERINE CHANG, EXAMINING ATTORNEY

SN 78-974,048. ULTIMATE FRANCHISE SYSTEMS, INC., HEATHROW, FL. FILED 9-14-2006.



NO CLAIM IS MADE TO THE EXCLUSIVE RIGHT TO USE "WINGS, BURGERS & FRIES", APART FROM THE MARK AS SHOWN.

THE MARK CONSISTS OF THE WORDS "WING WAY WINGS, BURGERS & FRIES" IN A STYLIZED FORMAT WITHIN A RECTANGULAR DESIGN.

FOR RESTAURANT SERVICES (U.S. CLS. 100 AND 101).

DAVID MURRAY, EXAMINING ATTORNEY

CLASS 44—MEDICAL, BEAUTY AND AGRICULTURAL SERVICES

SN 76-647,486. RAPSEIK, SHARON, NEW YORK, NY. FILED 9-26-2005.

SPA HOLISTICA

THE MARK CONSISTS OF STANDARD CHARACTERS WITHOUT CLAIM TO ANY PARTICULAR FONT, STYLE, SIZE, OR COLOR.

NO CLAIM IS MADE TO THE EXCLUSIVE RIGHT TO USE "SPA", APART FROM THE MARK AS SHOWN.

THE WORDING "HOLETICA" HAS NO MEANING IN A FOREIGN LANGUAGE.

FOR HEALTH SPA SERVICES FEATURING FACIALS, PEDICURES, MANICURES, BODY TREATMENTS AND MASSAGES (U.S. CLS. 100 AND 101).

FIRST USE 1-0-2003; IN COMMERCE 2-2-2003.

JEFFERY COWARD, EXAMINING ATTORNEY

SN 76-668,031. ALTERNATIVE MEDICAL SOLUTIONS, ERIE, PA. FILED 10-25-2006.

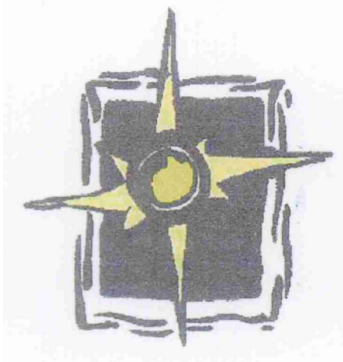

THE COLOR(S) BLACK, WHITE, AND YELLOW IS/ARE CLAIMED AS A FEATURE OF THE MARK.

THE COLORS BLACK AND YELLOW APPEAR IN THE STAR DESIGN, AND THE COLORS BLACK AND WHITE APPEAR IN THE RECTANGLE DESIGN.

FOR MEDICAL SERVICES, NAMELY, PSYCHOLOGICAL COUNSELING (U.S. CLS. 100 AND 101).

TEJBIR SINGH, EXAMINING ATTORNEY

SN 76-672,897. ATOMIC TATTOOS, LLC, LARGO, FL. FILED 2-20-2007.

ATOMIC TATTOOS

THE MARK CONSISTS OF STANDARD CHARACTERS WITHOUT CLAIM TO ANY PARTICULAR FONT, STYLE, SIZE, OR COLOR.

NO CLAIM IS MADE TO THE EXCLUSIVE RIGHT TO USE "TATTOOS", APART FROM THE MARK AS SHOWN.

FOR TATTOOING, PIERCING AND BODY PIERCING SERVICES (U.S. CLS. 100 AND 101).

FIRST USE 10-0-2001; IN COMMERCE 10-0-2001.

INGA ERVIN, EXAMINING ATTORNEY

CLASS 44—(Continued).

SN 76-680,537. MARYLAND HEART, P.C., BETHESDA, MD.
FILED 8-9-2007.



NO CLAIM IS MADE TO THE EXCLUSIVE RIGHT TO USE "MARYLAND HEART P.C.", APART FROM THE MARK AS SHOWN.

FOR MEDICAL SERVICES, NAMELY, CARDIAC CARE (U.S. CLS. 100 AND 101).

FIRST USE 9-1-2004; IN COMMERCE 9-1-2004.
LINDA LAVACHE, EXAMINING ATTORNEY

SN 76-680,704. LOVEBUGS, LLC, LAFAYETTE, CA. FILED 8-15-2007.



THE COLOR(S) PINK AND BLACK IS/ARE CLAIMED AS A FEATURE OF THE MARK.

THE MARK CONSISTS OF THE TERM, "LOVEBUGS", WITH THE LETTER "O" REPRESENTED BY THE FANCIFUL DESIGN OF A BUG. THE TERM, "LOVEBUGS" AND THE DESIGN OF THE BUG APPEAR IN BLACK, AND THE COLOR PINK APPEARS ON THE HORIZONTAL LINE DESIGN ON THE BUG.

FOR NON-TOXIC HEAD LICE REMOVAL SALON (U.S. CLS. 100 AND 101).

FIRST USE 3-1-2007; IN COMMERCE 3-1-2007.
BARBARA A. GOLD, EXAMINING ATTORNEY

SN 77-067,410. WYNN RESORTS HOLDINGS, LLC, LAS VEGAS, NV. FILED 12-19-2006.

WYNN TOWER SUITES

THE MARK CONSISTS OF STANDARD CHARACTERS WITHOUT CLAIM TO ANY PARTICULAR FONT, STYLE, SIZE, OR COLOR.

OWNER OF U.S. REG. NOS. 2,992,949, 3,195,978 AND OTHERS.

FOR BEAUTY SALON, BARBERSHOP AND HEALTH SPA SERVICES, NAMELY, COSMETIC BODY CARE SERVICES (U.S. CLS. 100 AND 101).

YONG KIM, EXAMINING ATTORNEY

CLASS 44—(Continued).

SN 77-075,262. MIRACLE-EAR, INC., PLYMOUTH, MN.
FILED 1-3-2007.

THE MOST THOROUGH AND COMPLETE HEARING TEST

THE MARK CONSISTS OF STANDARD CHARACTERS WITHOUT CLAIM TO ANY PARTICULAR FONT, STYLE, SIZE, OR COLOR.

NO CLAIM IS MADE TO THE EXCLUSIVE RIGHT TO USE "HEARING TEST", APART FROM THE MARK AS SHOWN.

FOR MEDICAL SERVICES IN THE NATURE OF HEARING EVALUATION (U.S. CLS. 100 AND 101).

ODESSA BIBBINS, EXAMINING ATTORNEY

SN 77-075,358. HEALTH DIALOG SERVICES CORPORATION, BOSTON, MA. FILED 1-3-2007.

Layered Language

THE MARK CONSISTS OF STANDARD CHARACTERS WITHOUT CLAIM TO ANY PARTICULAR FONT, STYLE, SIZE, OR COLOR.

FOR PROVIDING HEALTHCARE INFORMATION; PROVIDING MEDICAL INFORMATION REGARDING DISEASE AND CARE MANAGEMENT; PROVIDING HEALTHCARE DATA EVALUATION AND ANALYTICAL SERVICES, NAMELY, DATA COLLECTION, ANALYSIS AND REPORTING FOR HEALTHCARE DATA, CLINICAL INFORMATION, TREATMENT OPTIONS AND TREATMENT SUCCESS (U.S. CLS. 100 AND 101).

MARTHA FROMM, EXAMINING ATTORNEY

SN 77-086,467. MEDMARK, INC., CARNEGIE, PA. FILED 1-19-2007.

RXRESULTS

THE MARK CONSISTS OF STANDARD CHARACTERS WITHOUT CLAIM TO ANY PARTICULAR FONT, STYLE, SIZE, OR COLOR.

OWNER OF U.S. REG. NO. 3,108,419.

FOR HEALTH CARE SERVICES, NAMELY, REPORTING OF RESULTS RELATING TO CLINICAL PROGRAMS, THERAPY MANAGEMENT PROGRAMS, AND DISEASE MANAGEMENT PROGRAMS; INTERACTIVE MEDICAL MONITORING AND ALERT SERVICES FOR REMINDING CLIENTS OF MEDICAL INFORMATION, NAMELY, MEDICINAL DOSAGES, ALLERGIC SENSITIVITY AND PRESCRIPTION REFILLS (U.S. CLS. 100 AND 101).

FIRST USE 2-0-2004; IN COMMERCE 2-0-2004.

ELI HELLMAN, EXAMINING ATTORNEY

CLASS 44—(Continued).

SN 77-095,389. JOHN C. JEPPESEN, DMD, INC., VENTURA, CA. FILED 1-31-2007.

SNOROMETER

THE MARK CONSISTS OF STANDARD CHARACTERS WITHOUT CLAIM TO ANY PARTICULAR FONT, STYLE, SIZE, OR COLOR.

FOR PROVIDING ONLINE MEDICAL EVALUATION SERVICES IN THE FIELD OF SNORING AND RELATED SLEEPING DYSFUNCTIONS, NAMELY, AN EVALUATION SERVICE WHERE A CUSTOMER TRANSMITS THE SOUND OF SNORING EITHER REAL-TIME OR BY AN AUDIO OR AUDIO/VISUAL FILE, THE SOUND IS THEREAFTER EVALUATED AGAINST OTHER SOUND FILES IN APPLICANT'S DATABASE AND THE CUSTOMER IS PROVIDED A RESPONSE RANKING THE SOUND PROVIDED BASED ON FACTORS SUCH AS SEVERITY OF LOUDNESS (U.S. CLS. 100 AND 101).
SCOTT BIBB, EXAMINING ATTORNEY

SN 77-099,690. ARLINE HERRERA, CHULA VISTA, CA. FILED 2-5-2007.



NO CLAIM IS MADE TO THE EXCLUSIVE RIGHT TO USE "DENTAL CHECK-UP", APART FROM THE MARK AS SHOWN.

THE COLOR(S) RED, BLUE, AND BLACK IS/ARE CLAIMED AS A FEATURE OF THE MARK.

THE WORD "DENTAL" APPEARS IN BLUE AND IS UNDERLINED IN RED; THE WORD "CHECK - UP" APPEARS IN BLACK; THE CHECK MARK APPEARS IN RED; AND THE BLACK OUTLINED RECTANGULAR SHAPE FRAMES ALL OF THE ABOVE.

FOR DENTISTRY (U.S. CLS. 100 AND 101).
FIRST USE 11-15-1999; IN COMMERCE 11-15-1999.
LEIGH CAROLINE CASE, EXAMINING ATTORNEY

CLASS 44—(Continued).

SN 77-108,775. NOVUS MEDICAL DETOX CENTER, LLC, NEW PORT RICHEY, FL. FILED 2-15-2007.



NO CLAIM IS MADE TO THE EXCLUSIVE RIGHT TO USE "MEDICAL DETOX CENTERS, LLC", APART FROM THE MARK AS SHOWN.

THE MARK CONSISTS OF A HUMMINGBIRD ABOVE THE WORD NOVUS AND BELOW NOVUS IS MEDICAL DETOX CENTER, LLC.

FOR MEDICAL DETOXIFICATION SERVICES IN THE NATURE OF ADDICTION TREATMENT SERVICES (U.S. CLS. 100 AND 101).

FIRST USE 7-15-2006; IN COMMERCE 7-30-2006.
LAURIE MAYES, EXAMINING ATTORNEY

SN 77-109,758. THE 519 CORPORATION, SAN FRANCISCO, CA. FILED 2-16-2007.

Janet Moyer Landscaping

THE MARK CONSISTS OF STANDARD CHARACTERS WITHOUT CLAIM TO ANY PARTICULAR FONT, STYLE, SIZE, OR COLOR.

OWNER OF U.S. REG. NO. 3,272,470.

NO CLAIM IS MADE TO THE EXCLUSIVE RIGHT TO USE "LANDSCAPING", APART FROM THE MARK AS SHOWN.

"JANET MOYER" IDENTIFIES A LIVING INDIVIDUAL WHOSE CONSENT IS OF RECORD.

FOR LANDSCAPE GARDENING (U.S. CLS. 100 AND 101).

FIRST USE 7-1-1994; IN COMMERCE 7-1-1994.
APRIL ROACH, EXAMINING ATTORNEY

SN 77-119,297. BLOOD DIAGNOSTICS, INC., IRMO, SC. FILED 3-1-2007.



THE COLOR(S) BLUE, RED AND GREY IS/ARE CLAIMED AS A FEATURE OF THE MARK.

THE MARK CONSISTS OF THE LITERAL ELEMENT AND THE DESIGN ELEMENT WHERE THE TERM "CON-SIGN" APPEARS IN THE COLOR GREY, THE TERM "ADVANTAGE" APPEARS IN BLUE AND THE DESIGN ELEMENT APPEARS IN RED.

FOR BLOOD BANKS; COLLECTION AND PRESERVA-TION OF HUMAN BLOOD (U.S. CLS. 100 AND 101).
GINA HAYES, EXAMINING ATTORNEY

CLASS 44—(Continued).

SN 77-122,568. NORTSHORE REGIONAL MEDICAL CENTER, LLC, DALLAS, TX. FILED 3-5-2007.

CLASS 44—(Continued).

SN 77-130,762. POLA CHEMICAL INDUSTRIES INC., SHI-ZUOKA-KEN, JAPAN, FILED 3-14-2007.



The Neuroscience Institute
at NorthShore Regional Medical Center

POLA KIREI

NO CLAIM IS MADE TO THE EXCLUSIVE RIGHT TO USE "THE NEUROSCIENCE INSTITUTE" AND "REGIONAL MEDICAL CENTER", APART FROM THE MARK AS SHOWN.

THE COLOR(S) BLUE, WHITE AND BLACK IS/ARE CLAIMED AS A FEATURE OF THE MARK.

THE MARK CONSISTS OF A BLUE LETTER "N" OUTLINED IN WHITE, INSIDE A BLUE SQUARE BOX AT THE BEGINNING OF THE MARK, FOLLOWED BY THE WORDS, ALL IN BLACK LETTERING, "THE NEUROSCIENCE INSTITUTE" TO THE RIGHT OF THE BLUE SQUARE, AND THE WORDS "AT NORTSHORE REGIONAL MEDICAL CENTER" DIRECTLY UNDERNEATH THE FIRST LINE OF WORDS.

FOR MEDICAL SERVICES (U.S. CLS. 100 AND 101).
FIRST USE 3-19-2007; IN COMMERCE 3-19-2007.
PAUL E. FAHRENKOPF, EXAMINING ATTORNEY

THE MARK CONSISTS OF STANDARD CHARACTERS WITHOUT CLAIM TO ANY PARTICULAR FONT, STYLE, SIZE, OR COLOR.

OWNER OF U.S. REG. NOS. 755,665, 1,955,770 AND OTHERS.

THE ENGLISH TRANSLATION OF THE JAPANESE WORD "KIREI" IS "PRETTY", "CLEAN", "FAIR", "BEAUTIFUL", "NICE", "TIDY", "REFINED" OR "POLISHED".

FOR BEAUTY SALON SERVICES; HAIR DRESSING SALON SERVICES; SKIN CARE SALON SERVICES; COSMETOLOGY AND ESTHETIC TREATMENT SERVICES, NAMELY, MICRODERMABRASION COMPRISING A TOPICAL SKIN TREATMENT INVOLVING ABRASION OF THE SKIN WITH A HIGH-PRESSURE FLOW OF CRYSTALS, AND, INJECTION OF DERMAL FILLERS TO REDUCE THE APPEARANCE OF FACIAL FINE LINES; PROVIDING INFORMATION AND CONSULTING SERVICES IN THE FIELDS OF THE ABOVE-MENTIONED SERVICES, NAMELY, BEAUTY CONSULTATIONS AND PROVIDING INFORMATION ABOUT BEAUTY, HAIR DRESSING AND SKIN CARE (U.S. CLS. 100 AND 101).

FIRST USE 9-5-2006; IN COMMERCE 9-5-2006.
HANNO RITTNER, EXAMINING ATTORNEY

SN 77-125,503. APEX MERCHANDISE GROUP, LLC, SCOTTSDALE, AZ. FILED 3-8-2007.

SN 77-137,189. KOVED CARE LLC, PALO ALTO, CA. FILED 3-21-2007.

PH ION



KOVED CARE LLC

Care with Honor

THE MARK CONSISTS OF STANDARD CHARACTERS WITHOUT CLAIM TO ANY PARTICULAR FONT, STYLE, SIZE, OR COLOR.

NO CLAIM IS MADE TO THE EXCLUSIVE RIGHT TO USE "PH", APART FROM THE MARK AS SHOWN.

FOR PROVIDING INFORMATION ABOUT DIETARY SUPPLEMENTS AND NUTRITION; VITAMIN THERAPY (U.S. CLS. 100 AND 101).

FIRST USE 1-0-2003; IN COMMERCE 1-0-2003.
DAVID ELTON, EXAMINING ATTORNEY

NO CLAIM IS MADE TO THE EXCLUSIVE RIGHT TO USE "CARE LLC", APART FROM THE MARK AS SHOWN. THE MARK CONSISTS OF STYLIZED TEXT.

THE ENGLISH TRANSLATION OF THE WORD "KOVED" IN THE MARK IS "HONOR."

FOR HOME CARE HEALTH SERVICES (U.S. CLS. 100 AND 101).

FIRST USE 5-1-2005; IN COMMERCE 5-1-2005.
STEVEN JACKSON, EXAMINING ATTORNEY

CLASS 44—(Continued).

SN 77-138,593. JOHNSON & JOHNSON, NEW BRUNSWICK, NJ. FILED 3-23-2007.

MEDVERSATION

THE MARK CONSISTS OF STANDARD CHARACTERS WITHOUT CLAIM TO ANY PARTICULAR FONT, STYLE, SIZE, OR COLOR.

FOR PROVIDING INFORMATION CONCERNING AUTO-IMMUNE DISEASES, CROHN'S DISEASE, ARTHRITIS, AND PSORIASIS TO HEALTHCARE PROFESSIONALS AND PATIENTS VIA THE INTERNET (U.S. CLS. 100 AND 101).

STEVEN JACKSON, EXAMINING ATTORNEY

SN 77-139,019. TRI-STATE BREEDERS COOPERATIVE, BARABOO, WI. FILED 3-23-2007.



OWNER OF U.S. REG. NO. 1,812,499.
NO CLAIM IS MADE TO THE EXCLUSIVE RIGHT TO USE "GENETICS", APART FROM THE MARK AS SHOWN.

THE MARK CONSISTS OF THE WORD "ACCELERATED GENETICS" ABOVE AN IMAGE CONSISTING OF AN INVERTED TRIANGLE WITH SEVEN NARROW EVENLY-SPACED HORIZONTAL LINES BELOW THE END OF THE WORD "ACCELERATED" AND THE BEGINNING OF THE WORD "GENETICS," AND EIGHT EVENLY-SPACED HORIZONTAL LINES BELOW THE BEGINNING OF THE WORD "ACCELERATED" AND THE END OF THE WORD "GENETICS".

FOR ANIMAL BREEDING (U.S. CLS. 100 AND 101).
FIRST USE 10-0-1994; IN COMMERCE 10-0-1994.
JAY BESCH, EXAMINING ATTORNEY

CLASS 44—(Continued).

SN 77-143,914. ISS A/S, 1260 KOBENHAVN K, DENMARK, FILED 3-29-2007.

ISS GROUNDS CONTROL

THE MARK CONSISTS OF STANDARD CHARACTERS WITHOUT CLAIM TO ANY PARTICULAR FONT, STYLE, SIZE, OR COLOR.

NO CLAIM IS MADE TO THE EXCLUSIVE RIGHT TO USE "GROUNDS CONTROL", APART FROM THE MARK AS SHOWN.

FOR TREE SURGERY SERVICES, GARDENER AND GARDENING SERVICES; CARE TAKING OF GREEN AREAS, GOLF COURSES, INDOOR GREEN AREAS, LAWNS, AND PARKS; LANDSCAPE GARDENING DESIGN FOR OTHERS, NAMELY, CONSTRUCTION AND LAYOUT OF GREEN AREAS, GOLF COURSES, INDOOR GREEN AREAS, LAWNS, AND PARKS; PEST CONTROL SERVICES FOR AGRICULTURE (U.S. CLS. 100 AND 101).

RICHARD A. STRASER, EXAMINING ATTORNEY

SN 77-155,283. NGUYEN, DOMINIC N., SACRAMENTO, CA. FILED 4-12-2007.

THE SUPER ULTIMATE MEGA CLINIC

THE MARK CONSISTS OF STANDARD CHARACTERS WITHOUT CLAIM TO ANY PARTICULAR FONT, STYLE, SIZE, OR COLOR.

NO CLAIM IS MADE TO THE EXCLUSIVE RIGHT TO USE "CLINIC", APART FROM THE MARK AS SHOWN.

FOR MEDICAL CLINICS FEATURING MEDICAL SERVICES (U.S. CLS. 100 AND 101).
JEAN IM, EXAMINING ATTORNEY

CLASS 44—(Continued).

SN 77-155,560. MYRIAD GENETICS, INC., SALT LAKE CITY, UT. FILED 4-12-2007.

THERAGUIDE

THE MARK CONSISTS OF STANDARD CHARACTERS WITHOUT CLAIM TO ANY PARTICULAR FONT, STYLE, SIZE, OR COLOR.

FOR MEDICAL DIAGNOSTIC AND PROGNOSTIC TESTING SERVICES, NAMELY, CONDUCTING REFERENCE AND CLINICAL LABORATORY TESTING FOR USE IN DRUG SELECTION, PREDICTION OF DISEASE PROGNOSIS, OR THERAPEUTIC RESPONSE, INCLUDING SAFETY AND TOXICITY RESPONSE, TO MEDICAL CONDITIONS SUCH AS CANCER, NEURODEGENERATIVE DISEASES, INCLUDING ALZHEIMER'S DISEASE, METABOLIC DISEASES, INCLUDING DIABETES, AUTOIMMUNE DISEASES, INFECTIOUS DISEASES AND OTHER COMMON DISEASES, ALL OF THE AFORESAID TESTING SERVICES BEING FOR MEDICAL TREATMENT PURPOSES (U.S. CLS. 100 AND 101).

MARTHA FROMM, EXAMINING ATTORNEY

CLASS 44—(Continued).

SN 77-168,303. MANICURE ROOM, LLC, MIAMI BEACH, FL. FILED 4-28-2007.



NO CLAIM IS MADE TO THE EXCLUSIVE RIGHT TO USE "MANICURE ROOM", APART FROM THE MARK AS SHOWN.

THE COLOR(S) BLACK, WHITE, ORANGE, AND BLUE IS/ARE CLAIMED AS A FEATURE OF THE MARK.

THE MARK CONSISTS OF BLACK BACKGROUND; THE CHAIR, LAMP, TABLE, DOOR, FLOOR TILES, AND MIRROR FRAME ARE TRIMMED IN THE COLOR WHITE; A TEXTURE BLUE COLOR APPEARS INSIDE THE MIRROR; THE TILE FLOOR AND DOOR KNOB APPEARS IN TEXTURED ORANGE COLOR, A TEXTURED BLUE PANEL WITH MANICURE ROOM WRITTEN IN BLACK APPEARS ON THE FLOORING SIMILAR TO A CARPET OR RUG.

FOR HEALTH SPA SERVICES FOR HEALTH AND WELLNESS OF THE MIND, BODY AND SPIRIT OFFERED IN OR FROM A REMOTE, MOBILE OR TEMPORARY ON-SITE LOCATION (U.S. CLS. 100 AND 101).
MICHELLE DUBOIS, EXAMINING ATTORNEY

SN 77-162,657. STRATTON-PHELPS, MERI, WEST SACRAMENTO, CA. FILED 4-22-2007.



FOR VETERINARY SERVICES; PROVIDING ON-LINE INFORMATION VIA THE INTERNET IN THE FIELDS OF ANIMALS AND PETS, RELATING TO BREEDING, SELECTION OF THE ANIMALS AND PETS, CARE, GROOMING, FEEDING AND NUTRITION (U.S. CLS. 100 AND 101).

FIRST USE 10-1-2006; IN COMMERCE 10-1-2006.
JASON BLAIR, EXAMINING ATTORNEY

SN 77-168,748. PROSTHODONTICS INTERMEDICA, P.C., FORT WASHINGTON, PA. FILED 4-30-2007.

PROSTHODONTICS INTERMEDICA

THE MARK CONSISTS OF STANDARD CHARACTERS WITHOUT CLAIM TO ANY PARTICULAR FONT, STYLE, SIZE, OR COLOR.

NO CLAIM IS MADE TO THE EXCLUSIVE RIGHT TO USE "PROSTHODONTICS", APART FROM THE MARK AS SHOWN.

FOR DENTISTRY SERVICES, NAMELY, PROVIDING DENTAL EXAMINATIONS, IMPLANTING DENTAL IMPLANTS, AND DENTAL IMPLANT TREATMENTS (U.S. CLS. 100 AND 101).

FIRST USE 10-23-1986; IN COMMERCE 12-31-1986.
CARYN GLASSER, EXAMINING ATTORNEY

CLASS 44—(Continued).

SN 77-175,719. LYNX, LLC, ROSEVILLE, MN. FILED 5-8-2007.



THE MARK CONSISTS OF THE WORD "TEAM" POSITIONED OVER THE PHRASE "PROVIDING REAL LIFE SOLUTIONS", OF WHICH ARE TO THE LEFT OF A CARICATURE OF A PERSON HELPING ANOTHER PERSON UP A HILL SUPERIMPOSED OVER THE RAYS OF THE SUN.

FOR EMPLOYEE ASSISTANCE PROGRAMS IN THE NATURE OF PSYCHOLOGICAL COUNSELING, MEDICAL COUNSELING, MENTAL HEALTH SERVICES, DRUG TESTING FOR SUBSTANCE ABUSE, ADDICTION TREATMENT SERVICES AND PERFORMANCE-BASED ASSESSMENTS (U.S. CLS. 100 AND 101).

FIRST USE 4-0-2006; IN COMMERCE 4-0-2006.

FLORENTINA BLANDU, EXAMINING ATTORNEY

SN 77-182,228. LIFESTYLE LIFT HOLDING, INC., TROY, MI. FILED 5-16-2007.

LIFESTYLE COSMETIC

THE MARK CONSISTS OF STANDARD CHARACTERS WITHOUT CLAIM TO ANY PARTICULAR FONT, STYLE, SIZE, OR COLOR.

NO CLAIM IS MADE TO THE EXCLUSIVE RIGHT TO USE "COSMETIC", APART FROM THE MARK AS SHOWN.

FOR COSMETIC AND PLASTIC SURGERY (U.S. CLS. 100 AND 101).

JAY BESCH, EXAMINING ATTORNEY

SN 77-196,769. TOLLIN, CRAIG J., HARTSDALE, NY. FILED 6-4-2007.

Just Play NYC

THE MARK CONSISTS OF STANDARD CHARACTERS WITHOUT CLAIM TO ANY PARTICULAR FONT, STYLE, SIZE, OR COLOR.

NO CLAIM IS MADE TO THE EXCLUSIVE RIGHT TO USE "NYC", APART FROM THE MARK AS SHOWN.

FOR OCCUPATIONAL THERAPY SERVICES (U.S. CLS. 100 AND 101).

FIRST USE 1-1-2007; IN COMMERCE 1-1-2007.

KAREN BRACEY, EXAMINING ATTORNEY

CLASS 44—(Continued).

SN 77-202,600. LISBETH ENTERPRISES LIMITED, CHAI-WAN, HONG KONG, FILED 6-11-2007.

PHILLIP WAIN

THE MARK CONSISTS OF STANDARD CHARACTERS WITHOUT CLAIM TO ANY PARTICULAR FONT, STYLE, SIZE, OR COLOR.

PRIORITY CLAIMED UNDER SEC. 44(D) ON HONG KONG APPLICATION NO. 300887626, FILED 6-7-2007, REG. NO. 300887626, DATED 6-7-2007, EXPIRES 6-7-2014.

"PHILLIP WAIN" DOES NOT IDENTIFY A KNOWN LIVING INDIVIDUAL.

FOR PHYSICAL THERAPY SERVICES; BEAUTY SALON SERVICES; SKIN CARE AND BEAUTY TREATMENT, NAMELY, FACIALS; MASSAGE SERVICES; OPERATING OF PUBLIC BATHS FOR HYGIENE PURPOSES; SERVICES OF BEAUTY PARLORS, NAMELY, HAIRDRESSING SERVICES, SELECTION OF COSMETICS ON BEHALF OF INDIVIDUALS, NAMELY, COSMETIC ANALYSIS; PROVISION OF INFORMATION AND ADVISORY AND CONSULTANCY SERVICES RELATING TO THE USE OF SKIN CARE, BEAUTY TREATMENT, COSMETIC PRODUCTS, PHARMACEUTICAL AND MEDICAL SERVICES VIA THE INTERNET, BY TELECOMMUNICATIONS DEVICES OR OTHER ELECTRONIC MEANS; PROVISION OF SAUNA FACILITIES; PROVISION OF SOLARIUM AND SKIN TANNING SERVICE FOR HUMANS FOR COSMETIC PURPOSE; FITNESS EVALUATION; FAT ERADICATION SERVICES, NAMELY, WEIGHT REDUCTION SERVICES; HAIR TREATMENT SERVICES, NAMELY, HAIR CUTTING, HAIR COLORING; MANAGED HEALTH CARE SERVICES; SERVICES OF A MAKE-UP ARTIST (U.S. CLS. 100 AND 101).

ELIZABETH KAJUBI, EXAMINING ATTORNEY

SN 77-217,934. REGENCY CORPORATION, DBA REGENCY BEAUTY INSTITUTE, BLAINE, MN. FILED 6-28-2007.

Regency Guest Rewards

THE MARK CONSISTS OF STANDARD CHARACTERS WITHOUT CLAIM TO ANY PARTICULAR FONT, STYLE, SIZE, OR COLOR.

OWNER OF U.S. REG. NO. 2,838,140.

NO CLAIM IS MADE TO THE EXCLUSIVE RIGHT TO USE "GUEST REWARDS", APART FROM THE MARK AS SHOWN.

FOR BEAUTY SALON SERVICES FEATURING A CUSTOMER LOYALTY REWARDS PROGRAM FOR FREQUENT USERS OF SALON SERVICES (U.S. CLS. 100 AND 101).

FIRST USE 11-0-2005; IN COMMERCE 8-0-2006.

MICHELE SWAIN, EXAMINING ATTORNEY

CLASS 44—(Continued).

SN 77-242,724. NORTHEAST WISCONSIN HEALTH VALUE NETWORK, INC., GREEN BAY, WI. FILED 7-31-2007.



THE MARK CONSISTS OF THE LETTERS "NEWHVN", WITH THE "V" BEING STACKED IN FOUR "V'S" ON TOP OF EACH OTHER.

FOR MEDICAL SERVICES IN THE NATURE OF PHYSICIANS PROVIDING HEALTH CARE SERVICES THROUGH A CLINICAL INTEGRATION PROGRAM (U.S. CLS. 100 AND 101).

AMY MCMENAMIN, EXAMINING ATTORNEY

CLASS 44—(Continued).

SN 77-254,114. INTOUCH SOLUTIONS, INC., OVERLAND PARK, KS. FILED 8-13-2007.

PARTNERS IN CARE

THE MARK CONSISTS OF STANDARD CHARACTERS WITHOUT CLAIM TO ANY PARTICULAR FONT, STYLE, SIZE, OR COLOR.

FOR PROVIDING MEDICAL INFORMATION VIA EMAIL AND A WEB SITE ON A GLOBAL COMPUTER NETWORK TO THE PHARMACEUTICAL INDUSTRY RELATING TO EPILEPSY MEDICATIONS (U.S. CLS. 100 AND 101).

PATRICIA EVANKO, EXAMINING ATTORNEY

SN 77-242,725. NORTHEAST WISCONSIN HEALTH VALUE NETWORK, INC., GREEN BAY, WI. FILED 7-31-2007.



THE MARK CONSISTS OF STANDARD CHARACTERS WITHOUT CLAIM TO ANY PARTICULAR FONT, STYLE, SIZE, OR COLOR.

FOR MEDICAL SERVICES IN THE NATURE OF PHYSICIANS PROVIDING HEALTH CARE SERVICES THROUGH A CLINICAL INTEGRATION PROGRAM (U.S. CLS. 100 AND 101).

AMY MCMENAMIN, EXAMINING ATTORNEY

SN 77-254,129. INTOUCH SOLUTIONS, INC., OVERLAND PARK, KS. FILED 8-13-2007.



THE MARK CONSISTS OF, IN PART, A PERSON. FOR PROVIDING MEDICAL INFORMATION VIA EMAIL AND A WEB SITE ON A GLOBAL COMPUTER NETWORK TO THE PHARMACEUTICAL INDUSTRY RELATING TO EPILEPSY MEDICATIONS (U.S. CLS. 100 AND 101).

PATRICIA EVANKO, EXAMINING ATTORNEY

SN 77-251,794. HOWLAND, VAUGHN J, SILVER SPRING, MD. FILED 8-9-2007.



Intervention Center

Helping People Accept Help

NO CLAIM IS MADE TO THE EXCLUSIVE RIGHT TO USE "INTERVENTION CENTER", APART FROM THE MARK AS SHOWN.

FOR BEHAVIORAL AND MENTAL HEALTH COUNSELING SERVICES IN THE FIELD OF ADDICTION THERAPY (U.S. CLS. 100 AND 101).

FIRST USE 7-1-1992; IN COMMERCE 7-1-1992.
BILL DAWE, EXAMINING ATTORNEY

SN 77-254,135. INTOUCH SOLUTIONS, INC., OVERLAND PARK, KS. FILED 8-13-2007.

PARTNERS IN CARE A TREATMENT SUPPORT PROGRAM

THE MARK CONSISTS OF STANDARD CHARACTERS WITHOUT CLAIM TO ANY PARTICULAR FONT, STYLE, SIZE, OR COLOR.

NO CLAIM IS MADE TO THE EXCLUSIVE RIGHT TO USE "A TREATMENT SUPPORT PROGRAM", APART FROM THE MARK AS SHOWN.

FOR PROVIDING MEDICAL INFORMATION VIA EMAIL AND A WEB SITE ON A GLOBAL COMPUTER NETWORK TO THE PHARMACEUTICAL INDUSTRY RELATING TO EPILEPSY MEDICATIONS (U.S. CLS. 100 AND 101).

PATRICIA EVANKO, EXAMINING ATTORNEY

CLASS 44—(Continued).

SN 77-254,147. INTOUCH SOLUTIONS, INC., OVERLAND PARK, KS. FILED 8-13-2007.



NO CLAIM IS MADE TO THE EXCLUSIVE RIGHT TO USE "A TREATMENT SUPPORT PROGRAM", APART FROM THE MARK AS SHOWN.

THE MARK CONSISTS OF, IN PART, A PERSON. FOR PROVIDING MEDICAL INFORMATION VIA EMAIL AND A WEB SITE ON A GLOBAL COMPUTER NETWORK TO THE PHARMACEUTICAL INDUSTRY RELATING TO EPILEPSY MEDICATIONS (U.S. CLS. 100 AND 101).

PATRICIA EVANKO, EXAMINING ATTORNEY

SN 77-263,355. YOUR MEDICAL HOME, LLC, EXETER, NH. FILED 8-24-2007.

YOUR MEDICAL HOME

THE MARK CONSISTS OF STANDARD CHARACTERS WITHOUT CLAIM TO ANY PARTICULAR FONT, STYLE, SIZE, OR COLOR.

NO CLAIM IS MADE TO THE EXCLUSIVE RIGHT TO USE "MEDICAL", APART FROM THE MARK AS SHOWN. FOR MEDICAL SERVICES (U.S. CLS. 100 AND 101).

FIRST USE 9-17-2007; IN COMMERCE 9-17-2007. KATHERINE CHANG, EXAMINING ATTORNEY

SN 77-269,274. DISABOOM, INC., GREENWOOD VILLAGE, CO. FILED 8-31-2007.

Live Forward

THE MARK CONSISTS OF STANDARD CHARACTERS WITHOUT CLAIM TO ANY PARTICULAR FONT, STYLE, SIZE, OR COLOR.

FOR PROVIDING MEDICAL INFORMATION; PROVIDING HEALTH INFORMATION; PROVIDING MEDICAL AND HEALTH INFORMATION RELATED TO DISABILITIES (U.S. CLS. 100 AND 101).

FIRST USE 8-15-2007; IN COMMERCE 8-15-2007. CHARLES L. JENKINS, EXAMINING ATTORNEY

CLASS 44—(Continued).

SN 77-269,553. SOUTH TEXAS BLOOD & TISSUE CENTER, SAN ANTONIO, TX. FILED 8-31-2007.



OWNER OF U.S. REG. NO. 2,937,273. THE COLOR(S) RED IS/ARE CLAIMED AS A FEATURE OF THE MARK.

THE MARK CONSISTS OF TWO INTERSECTING HEARTS WHICH BOTH APPEAR IN RED BELOW A HALF GLOBE WITH MERIDIAN AND PARALLEL LINES, ALSO IN RED.

FOR MEDICAL TESTING; MEDICAL TESTING SERVICES IN THE NATURE OF INFECTIOUS DISEASE TESTING AND GENETIC TESTING (U.S. CLS. 100 AND 101).

FIRST USE 8-31-2007; IN COMMERCE 8-31-2007. CARYN GLASSER, EXAMINING ATTORNEY

SN 77-269,893. RADIOLOGY ASSOCIATES OF SAN ANTONIO, P.A., SAN ANTONIO, TX. FILED 8-31-2007.



THE COLOR(S) GREEN AND GOLD IS/ARE CLAIMED AS A FEATURE OF THE MARK.

THE MARK CONSISTS OF THE STYLIZED WORD "FLEXRAD". THE LETTER "X" IS GOLD WHILE THE REST OF THE LETTERS ARE GREEN.

FOR MEDICAL RADIOLOGY SERVICES (U.S. CLS. 100 AND 101).

FIRST USE 8-23-2007; IN COMMERCE 8-23-2007. ANNE MADDEN, EXAMINING ATTORNEY

CLASS 44—(Continued).

SN 77-271,312. HOUSTON NORTHWEST PARTNERS, LTD., DALLAS, TX. FILED 9-4-2007.



NO CLAIM IS MADE TO THE EXCLUSIVE RIGHT TO USE "HOUSTON NORTHWEST MEDICAL CENTER", APART FROM THE MARK AS SHOWN.
 "THE COLOR(S) WHITE, PANTONE PMS 208 MAROON AND PANTONE PMS 9 COOL GRAY IS/ARE CLAIMED AS A FEATURE OF THE MARK."
 "THE MARK CONSISTS OF A CROSS IN MAROON WITH THREE WAVY DIAGONAL LINES IN WHITE PRECEEDING THE WORDS "HOUSTON NORTHWEST MEDICAL CENTER" IN COOL GRAY."
 FOR (BASED ON USE IN COMMERCE) HEALTH CARE (U.S. CLS. 100 AND 101).
 FIRST USE 6-20-2007; IN COMMERCE 6-20-2007.
 CAROLYN GRAY, EXAMINING ATTORNEY

CLASS 44—(Continued).

SN 77-274,015. RED OAK IMAGING, SALT LAKE CITY, UT. FILED 9-7-2007.

PATHWAY IMAGING CENTERS

THE MARK CONSISTS OF STANDARD CHARACTERS WITHOUT CLAIM TO ANY PARTICULAR FONT, STYLE, SIZE, OR COLOR.
 NO CLAIM IS MADE TO THE EXCLUSIVE RIGHT TO USE "IMAGING" AND "CENTERS", APART FROM THE MARK AS SHOWN.
 FOR MEDICAL IMAGING SERVICES; MEDICAL IMAGING SERVICES, NAMELY, CONSULTING SERVICES IN THE FIELD OF USING AND OPERATING MEDICAL IMAGING APPARATUS INCLUDING CONE BEAM COMPUTED TOMOGRAPHY AND DIGITAL X-RAY APPARATUS (U.S. CLS. 100 AND 101).
 ANDREW RHIM, EXAMINING ATTORNEY

SN 77-272,011. TENET HEALTHSYSTEM SPALDING, INC., DALLAS, TX. FILED 9-5-2007.



NO CLAIM IS MADE TO THE EXCLUSIVE RIGHT TO USE "URGENT CARE AND SPALDING REGIONAL MEDICAL CENTER", APART FROM THE MARK AS SHOWN.
 THE MARK CONSISTS OF THE WORDS "URGENT CARE AT HERON BAY" WITH THE LETTER "G" IN THE WORD "URGENT" AND THE LETTER "R" IN THE WORD "CARE" CONNECTED ABOVE A LINE AND DIRECTLY BELOW THE LINE THE WORDS "SPALDING REGIONAL MEDICAL CENTER".
 FOR HEALTH CARE (U.S. CLS. 100 AND 101).
 KAREN BRACEY, EXAMINING ATTORNEY

SN 77-274,910. ROBERT G. ROY, DVM, MS, P.A., WEST PALM BEACH, FL. FILED 9-8-2007.



NO CLAIM IS MADE TO THE EXCLUSIVE RIGHT TO USE PALM BEACH AND VETERINARY SPECIALISTS, APART FROM THE MARK AS SHOWN.
 THE COLOR(S) GRAY AND BLUE IS/ARE CLAIMED AS A FEATURE OF THE MARK.
 THE MARK CONSISTS OF THE LETTERS PBVS IN BLUE WITH A STYLIZED LETTER V FEATURING THREE GRAY CURVED BANDS, THE WORDS PALM BEACH VETERINARY SPECIALISTS IN BLUE WITH A GRAY LINE ABOVE "PALM BEACH" AND A LINE BELOW "VETERINARY SPECIALISTS," AND A GRAY IBIS STANDING IN BLADES OF GRASS IN GRAY TO THE LEFT OF THE WORD "VETERINARY."
 FOR (BASED ON INTENT TO USE) VETERINARY SERVICES; VETERINARY SURGERY (U.S. CLS. 100 AND 101).
 RICHARD A. STRASER, EXAMINING ATTORNEY

CLASS 44—(Continued).

SN 77-277,237. SABINA ENTERPRISES INC., DUBLIN, OH.
FILED 9-12-2007.

Style India

THE MARK CONSISTS OF STANDARD CHARACTERS WITHOUT CLAIM TO ANY PARTICULAR FONT, STYLE, SIZE, OR COLOR.

FOR BEAUTY SALONS; HAIR SALON SERVICES; HAIR SALON SERVICES, NAMELY, HAIR CUTTING, STYLING, COLORING, AND HAIR EXTENSION SERVICES; HAIR SALON SERVICES, NAMELY, TREATMENTS TO PROTECT HAIR FROM AFFECTS OF EXPOSURE TO SUNLIGHT, HEAT, HUMIDITY AND CHLORINATED WATER; HAIRDRESSING SALONS; NAIL CARE SALONS; SALON SERVICES, NAMELY, FACIALS, MANICURES AND MESSAGES THAT ARE PROVIDED IN A TRAILER OUTFITTED WITH CHAIR, TABLE AND SINK ACCESSORIES; SKIN CARE SALONS; TANNING SALONS (U.S. CLS. 100 AND 101).

FIRST USE 3-1-2006; IN COMMERCE 3-1-2006.

ANGELA M. MICHELI, EXAMINING ATTORNEY

CLASS 44—(Continued).

SN 77-281,825. SOUTH BEACH TANNING FACTORY, INC.,
ALTAMONTE SPRINGS, FL. FILED 9-18-2007.



OWNER OF U.S. REG. NO. 3,309,357.
NO CLAIM IS MADE TO THE EXCLUSIVE RIGHT TO USE "TANNING COMPANY", APART FROM THE MARK AS SHOWN.

THE MARK CONSISTS OF A STYLIZED IMAGE OF THE SUN WITH THE STYLIZED WORDS "SOUTH BEACH TANNING COMPANY" RUNNING THROUGH THE CENTER.

FOR TANNING SALONS (U.S. CLS. 100 AND 101).

FIRST USE 4-4-2007; IN COMMERCE 4-4-2007.

SHAUNIA CARLYLE, EXAMINING ATTORNEY

SN 77-286,216. JEFFREY S. HOROWITZ, DBA RIO LAGO RANCH & VINEYARD, BERKELEY, CA. AND LYNN R. HOROWITZ, DBA RIO LAGO RANCH & VINEYARD, BERKELEY, CA. FILED 9-21-2007.



SN 77-281,217. METROPOLITAN DENVER DENTAL FOUNDATION, INC., DENVER, CO. FILED 9-17-2007.

THE SMILE AGAIN PROGRAM

THE MARK CONSISTS OF STANDARD CHARACTERS WITHOUT CLAIM TO ANY PARTICULAR FONT, STYLE, SIZE, OR COLOR.

NO CLAIM IS MADE TO THE EXCLUSIVE RIGHT TO USE "PROGRAM", APART FROM THE MARK AS SHOWN.

FOR CHARITABLE SERVICES, NAMELY, ORGANIZING AND ADMINISTERING A PROGRAM TO PROVIDE DENTAL CARE TO SURVIVORS OF DOMESTIC VIOLENCE (U.S. CLS. 100 AND 101).

CURTIS FRENCH, EXAMINING ATTORNEY

NO CLAIM IS MADE TO THE EXCLUSIVE RIGHT TO USE "RANCH & VINEYARD", APART FROM THE MARK AS SHOWN.

THE MARK CONSISTS OF A RECTANGULAR CUTOUT WITH THE WORDS "RIO LAGO" IN CAPITAL LETTERS AT THE TOP BETWEEN TWO LINES CURVING DOWNWARDS FROM THE CENTER; UNDERNEATH IS A LINE CURVING UP FROM THE CENTER ON WHICH ARE SILHOUETTES OF A ROOSTER, PIG, HORSE AND GOAT; ON THE BOTTOM LINE OF THE RECTANGLE SITS A CANOE WITH AN OAR EXTENDING BELOW THE BOTTOM LINE; BELOW THE BOTTOM LINE APPEAR THE WORDS RANCH & VINEYARD.

THE ENGLISH TRANSLATION OF "RIO LAGO" IS RIVER LAKE.

FOR VITICULTURE SERVICES, NAMELY, WINE GRAPE GROWING AND CULTIVATION OF WINE GRAPES FOR OTHERS (U.S. CLS. 100 AND 101).

SANJEEV VOHRA, EXAMINING ATTORNEY

CLASS 44—(Continued).

SN 77-286,226. JEFFREY S. HOROWITZ, DBA RIO LAGO RANCH & VINEYARD, BERKELEY, CA. AND LYNN R. HOROWITZ, DBA RIO LAGO RANCH & VINEYARD, BERKELEY, CA. FILED 9-21-2007.

RIO LAGO RANCH & VINEYARD

THE MARK CONSISTS OF STANDARD CHARACTERS WITHOUT CLAIM TO ANY PARTICULAR FONT, STYLE, SIZE, OR COLOR.

NO CLAIM IS MADE TO THE EXCLUSIVE RIGHT TO USE "RANCH & VINEYARD", APART FROM THE MARK AS SHOWN.

THE ENGLISH TRANSLATION OF "RIO LAGO" IS RIVER LAKE.

FOR VITICULTURE SERVICES, NAMELY, WINE GRAPE GROWING AND CULTIVATION OF WINE GRAPES FOR OTHERS (U.S. CLS. 100 AND 101).

SANJEEV VOHRA, EXAMINING ATTORNEY

SN 77-286,763. ADVANCED AESTHETIC CONCEPTS, INC., MANSFIELD, TX. FILED 9-24-2007.

RESTORE A MEDICAL DAY SPA

THE MARK CONSISTS OF STANDARD CHARACTERS WITHOUT CLAIM TO ANY PARTICULAR FONT, STYLE, SIZE, OR COLOR.

OWNER OF U.S. REG. NO. 3,303,502.

NO CLAIM IS MADE TO THE EXCLUSIVE RIGHT TO USE "A MEDICAL DAY SPA", APART FROM THE MARK AS SHOWN.

FOR HEALTH SPA SERVICES, NAMELY MEDICAL COSMETIC BODY CARE SERVICES (U.S. CLS. 100 AND 101).

FIRST USE 11-1-2004; IN COMMERCE 11-1-2004.

WOODROW HARTZOG, EXAMINING ATTORNEY

CLASS 44—(Continued).

SN 77-287,261. JERMAINE JONES, TEMPE, AZ. FILED 9-24-2007.



THE COLOR(S) BLACK, RED, WHITE, AND BLUE IS/ARE CLAIMED AS A FEATURE OF THE MARK.

THE MARK CONSISTS OF A DESIGN COMPRISING A WHITE CADUCEUS, A RED CROSS, A WHITE CROSS AND A BLUE SHIELD NEXT TO THE WORDING "WWW.ERIDCARD.COM, EMERGENCY RESPONSE ID." BENEATH THIS WORDING ARE THE WORDS "HAVE IT WHEN SECONDS COUNT," WITH RED PULSE LINES ON BOTH SIDES OF THE WORDS. THE WORDING "ER" AND "SECONDS" ARE IN RED AND ALL OTHER WORDING IS IN BLACK.

FOR 24-HOUR RESPONSE CENTER WHICH PROVIDES MEDICAL INFORMATION TO EMERGENCY MEDICAL PERSONNEL AND ALLOWS MEMBERS TO UPDATE THEIR MEDICAL/PERSONAL FILES (U.S. CLS. 100 AND 101).

AISHA CLARKE, EXAMINING ATTORNEY

SN 77-288,021. RESTORING ESSENCE, LLC, CHICAGO, IL. FILED 9-25-2007.



THE MARK CONSISTS OF A DESIGN OF A LOTUS FLOWER ABOVE FOUR STACKED ROCKS ABOVE THE WORDING "RESTORING ESSENCE". THE WORD "RESTORING" APPEARS ABOVE THE WORD "ESSENCE".

FOR CONSULTING SERVICES RELATING TO NUTRITION, HEALTH, AND WELLNESS (U.S. CLS. 100 AND 101).

DAVID ELTON, EXAMINING ATTORNEY

CLASS 44—(Continued).

SN 77-290,121. LWB IME OFFICE SOFTWARE, L.L.C., ANDES, NY. FILED 9-27-2007.

EMPIRE STAT

THE MARK CONSISTS OF STANDARD CHARACTERS WITHOUT CLAIM TO ANY PARTICULAR FONT, STYLE, SIZE, OR COLOR.

FOR ARRANGING FOR INDEPENDENT MEDICAL EXAMINATIONS AND REPORTS BY OTHERS; ARRANGING FOR REVIEWS OF MEDICAL TREATMENT NECESSITY, NEED AND APPROPRIATENESS AND REPORTS BY OTHERS (U.S. CLS. 100 AND 101).

FIRST USE 12-31-1983; IN COMMERCE 8-13-1998.
ESTHER A. BORSUK, EXAMINING ATTORNEY

SN 77-290,967. APOLLO DEVELOPMENTS LTD., PROVIDENCIALES, TURKS/CAICOS IS., FILED 9-27-2007.

WYMARA

THE MARK CONSISTS OF STANDARD CHARACTERS WITHOUT CLAIM TO ANY PARTICULAR FONT, STYLE, SIZE, OR COLOR.

FOR HEALTH SPA SERVICES FOR HEALTH AND WELLNESS OF THE BODY AND SPIRIT OFFERED AT A CONDOMINIUM, CONDOMINIUM HOTEL, OR RESORT (U.S. CLS. 100 AND 101).

CAROLYN GRAY, EXAMINING ATTORNEY

SN 77-291,151. KATHAMINE LLC, KANSAS CITY, MO. FILED 9-28-2007.

Vital Synergies

THE MARK CONSISTS OF STANDARD CHARACTERS WITHOUT CLAIM TO ANY PARTICULAR FONT, STYLE, SIZE, OR COLOR.

FOR PROVIDING WELLNESS SERVICES, NAMELY, PERSONAL ASSESSMENTS, PERSONALIZED ROUTINES, MAINTENANCE SCHEDULES, AND COUNSELING (U.S. CLS. 100 AND 101).

FIRST USE 9-27-2007; IN COMMERCE 9-27-2007.
DOMINICK J. SALEMI, EXAMINING ATTORNEY

CLASS 44—(Continued).

SN 77-291,547. ADVENTIST HEALTH SYSTEM/SUNBELT, INC., WINTER PARK, FL. FILED 9-28-2007.



THE MARK CONSISTS OF AN OVERALL HEXAGONAL SHAPE FORMED BY THREE INTERLOCKED LETTER "FS"

FOR MEDICAL SERVICES (U.S. CLS. 100 AND 101).
FIRST USE 12-15-1985; IN COMMERCE 12-15-1985.
BARBARA BROWN, EXAMINING ATTORNEY

SN 77-291,920. PREFERRED FAMILY HEALTHCARE, INCORPORATED, KIRKSVILLE, MO. FILED 9-28-2007.

A.R.T.C.

THE MARK CONSISTS OF STANDARD CHARACTERS WITHOUT CLAIM TO ANY PARTICULAR FONT, STYLE, SIZE, OR COLOR.

FOR PSYCHOLOGICAL COUNSELING SERVICES USING CREATIVE ARTS (U.S. CLS. 100 AND 101).

FIRST USE 12-0-2005; IN COMMERCE 12-0-2005.
ELLEN BURNS, EXAMINING ATTORNEY

SN 77-292,052. PARVATI HARI IYER, D.D.S., P.C., SCOTTSDALE, AZ. FILED 9-28-2007.

SMILE CONCEPTS

THE MARK CONSISTS OF STANDARD CHARACTERS WITHOUT CLAIM TO ANY PARTICULAR FONT, STYLE, SIZE, OR COLOR.

FOR DENTIST SERVICES (U.S. CLS. 100 AND 101).
FIRST USE 5-5-2003; IN COMMERCE 5-5-2003.
MICHAEL GAAFAR, EXAMINING ATTORNEY

CLASS 44—(Continued).

SN 77-292,155. TLC LAWCARE L.L.C., WINCHESTER, KY. FILED 9-28-2007.

**EVERY LAWN DESERVES A
LITTLE TLC**

THE MARK CONSISTS OF STANDARD CHARACTERS WITHOUT CLAIM TO ANY PARTICULAR FONT, STYLE, SIZE, OR COLOR.

FOR LAWN CARE AND LAWN MOWING SERVICES, LANDSCAPE DESIGN AND LANDSCAPE GARDENING SERVICES, AND GARDENING SERVICES (U.S. CLS. 100 AND 101).

FIRST USE 10-1-2007; IN COMMERCE 10-1-2007.
ADA HAN, EXAMINING ATTORNEY

CLASS 44—(Continued).

SN 77-292,360. PATEL, KAMLESH G, BROOKEVILLE, MD. FILED 9-30-2007.

MAPLE LAWN ORTHODONTICS

THE MARK CONSISTS OF STANDARD CHARACTERS WITHOUT CLAIM TO ANY PARTICULAR FONT, STYLE, SIZE, OR COLOR.

NO CLAIM IS MADE TO THE EXCLUSIVE RIGHT TO USE "ORTHODONTICS", APART FROM THE MARK AS SHOWN.

FOR DENTISTRY; ORTHODONTIC SERVICES; PROVIDING NEWS AND INFORMATION IN THE FIELD OF DENTISTRY; COSMETIC DENTISTRY (U.S. CLS. 100 AND 101).

JESSICA A. POWERS, EXAMINING ATTORNEY

SN 77-292,318. BRADLEY, STACY J., DBA MASSAGE & HOLISTIC WELLNESS SERVICES, MONTEREY, CA. FILED 9-29-2007.



THE COLOR(S) BLACK, BLUE, GREEN, WHITE, ORANGE, YELLOW, PURPLE AND RED IS/ARE CLAIMED AS A FEATURE OF THE MARK.

THE COLOR PURPLE APPEARS IN THE DESIGN OF THE TREE SHAPED IN A FEMALE FIGURE WITH CURLY BRANCHES, THE COLOR WHITE APPEARS IN THE GLOW LIGHT LOCATED ABOVE THE FEMALE'S HEAD AND IN THE LOWER PORTION OF THE TRUNK. THE COLOR BLACK APPEARS AS THE OUTLINE OF THE CIRCLE AND THE LARGER OVAL, THE COLOR PURPLE APPEARS IN THE SMALLER OVAL IN THE CENTER OF THE CIRCLE, THE COLORS BLUE, GREEN, YELLOW, ORANGE AND RED APPEAR IN THE INTERIOR OF THE CIRCLE AND THE LARGER OVAL.

FOR MASSAGE; PROVIDING IN-PERSON ENERGY HEALING SERVICES (U.S. CLS. 100 AND 101).

FIRST USE 5-20-2007; IN COMMERCE 5-20-2007.
DEIRDRE ROBERTSON, EXAMINING ATTORNEY

SN 77-292,647. LPG SYSTEMS, 26000 VALENCE, FRANCE, FILED 10-1-2007.

CELLU M6

THE MARK CONSISTS OF STANDARD CHARACTERS WITHOUT CLAIM TO ANY PARTICULAR FONT, STYLE, SIZE, OR COLOR.

FOR MASSAGE SERVICES (U.S. CLS. 100 AND 101).
MELISSA VALLILLO, EXAMINING ATTORNEY

SN 77-292,659. HUMANE SOCIETY OF MISSOURI, ST. LOUIS, MO. FILED 10-1-2007.



THE MARK CONSISTS OF A BLACK BAR OVER WHICH ARE POSITIONED THE HEADS AND PAWS OF THREE DOGS AND A CAT AND THE HEAD OF A HORSE.

FOR VETERINARY SERVICES; VETERINARY SURGERY (U.S. CLS. 100 AND 101).

FIRST USE 6-1-1992; IN COMMERCE 6-1-1992.
GEORGE LORENZO, EXAMINING ATTORNEY

CLASS 44—(Continued).

SN 77-292,680. KUSHNER, RICK A., LAKEWOOD, CO. FILED 10-1-2007.

WE'LL BE THERE WHEN YOU
NEED US!

THE MARK CONSISTS OF STANDARD CHARACTERS WITHOUT CLAIM TO ANY PARTICULAR FONT, STYLE, SIZE, OR COLOR.

FOR DENTIST SERVICES; DENTISTRY; ORTHODONTIC SERVICES (U.S. CLS. 100 AND 101).

FIRST USE 2-0-2005; IN COMMERCE 2-0-2005.

JENNIFER MARTIN, EXAMINING ATTORNEY

SN 77-293,134. NEW MEDICAL HORIZONS II, LTD., DALLAS, TX. FILED 10-1-2007.

Cypress Fairbanks
Sleep Medicine Center



NO CLAIM IS MADE TO THE EXCLUSIVE RIGHT TO USE "CYPRESS FAIRBANKS SLEEP MEDICINE CENTER" AND "A PART OF CY-FAIR REGIONAL HEALTH NETWORK", APART FROM THE MARK AS SHOWN.

THE COLOR(S) WHITE, LIME GREEN, LIGHT TURQUOISE BLUE, AND DARK TURQUOISE BLUE IS/ARE CLAIMED AS A FEATURE OF THE MARK.

THE MARK CONSISTS OF THE WORDS "CYPRESS FAIRBANKS" IN DARK TURQUOISE BLUE ON ONE LINE, THE UNDERLINED WORDS "SLEEP MEDICINE CENTER" IN DARK TURQUOISE BLUE ON THE NEXT LINE, UNDER THE LINE ARE OVERLAPPING BOXES IN WHITE, LIGHT TURQUOISE BLUE, DARK TURQUOISE BLUE AND LIME GREEN BESIDE THE WORDS "A PART OF CY-FAIR REGIONAL HEALTH NETWORK" IN DARK TURQUOISE BLUE

FOR HEALTH CARE (U.S. CLS. 100 AND 101).

FIRST USE 9-1-2007; IN COMMERCE 9-1-2007.

JENNIFER VASQUEZ, EXAMINING ATTORNEY

SN 77-293,150. PM PEDIATRICS LLC, SYOSSET, NY. FILED 10-1-2007.

CARE WHEN YOU NEED US

THE MARK CONSISTS OF STANDARD CHARACTERS WITHOUT CLAIM TO ANY PARTICULAR FONT, STYLE, SIZE, OR COLOR.

FOR PEDIATRIC URGENT MEDICAL SERVICES (U.S. CLS. 100 AND 101).

FIRST USE 8-30-2007; IN COMMERCE 8-30-2007.

DAVID HOFFMAN, EXAMINING ATTORNEY

CLASS 44—(Continued).

SN 77-293,288. PROVENA HOSPITALS, DBA PROVENA ST. MARY'S HOSPITAL, MOKENA, IL. FILED 10-1-2007.

IT'S A PROMISE

THE MARK CONSISTS OF STANDARD CHARACTERS WITHOUT CLAIM TO ANY PARTICULAR FONT, STYLE, SIZE, OR COLOR.

FOR HEALTH CARE SERVICES, HOSPITALS, MEDICAL CLINICS, NURSING HOMES; HOME HEALTHCARE SERVICES; HOSPICES; MANAGED HEALTHCARE SERVICES, NAMELY, HEALTH MAINTENANCE ORGANIZATIONS AND PREFERRED PROVIDER ORGANIZATIONS (U.S. CLS. 100 AND 101).

KRISTINA MORRIS, EXAMINING ATTORNEY

SN 77-293,521. MACHINERYLINK, INC., KANSAS CITY, MO. FILED 10-2-2007.

MACHINERYLINK THE SMARTER
HARVEST

THE MARK CONSISTS OF STANDARD CHARACTERS WITHOUT CLAIM TO ANY PARTICULAR FONT, STYLE, SIZE, OR COLOR.

OWNER OF U.S. REG. NOS. 2,554,960, 3,306,385 AND OTHERS.

FOR LEASING AND RENTAL OF AGRICULTURAL AND FARM EQUIPMENT (U.S. CLS. 100 AND 101).

ALEXANDER L. POWERS, EXAMINING ATTORNEY

SN 77-293,716. NEW MEDICAL HORIZONS II, LTD., DALLAS, TX. FILED 10-2-2007.

Cypress Fairbanks
Occupational Medicine



NO CLAIM IS MADE TO THE EXCLUSIVE RIGHT TO USE "CYPRESS FAIRBANKS OCCUPATIONAL MEDICINE" AND "A PART OF CY-FAIR REGIONAL HEALTH NETWORK", APART FROM THE MARK AS SHOWN.

THE COLOR(S) WHITE, LIME GREEN, LIGHT TURQUOISE BLUE, AND DARK TURQUOISE BLUE IS/ARE CLAIMED AS A FEATURE OF THE MARK.

THE MARK CONSISTS OF THE WORDS "CYPRESS FAIRBANKS" IN DARK TURQUOISE BLUE ON ONE LINE, THE UNDERLINED WORDS "OCCUPATIONAL MEDICINE" IN DARK TURQUOISE BLUE ON THE NEXT LINE, UNDER THE LINE ARE OVERLAPPING BOXES IN WHITE, LIGHT TURQUOISE BLUE, DARK TURQUOISE BLUE AND LIME GREEN BESIDE THE WORDS "A PART OF CY-FAIR REGIONAL HEALTH NETWORK" IN DARK TURQUOISE BLUE

FOR HEALTH CARE (U.S. CLS. 100 AND 101).

FIRST USE 7-9-2007; IN COMMERCE 7-9-2007.

JENNIFER VASQUEZ, EXAMINING ATTORNEY

CLASS 44—(Continued).

SN 77-293,845. ACCREDITED THERAPIES, LLC, MILFORD CENTER, OH. FILED 10-2-2007.

CLASS 44—(Continued).

SN 77-294,513. ESSPA, INC., PITTSBURGH, PA. FILED 10-2-2007.

RAYSSAGE

THE MARK CONSISTS OF STANDARD CHARACTERS WITHOUT CLAIM TO ANY PARTICULAR FONT, STYLE, SIZE, OR COLOR.
FOR PROVIDING HOLISTIC THERAPIES, NAMELY, MASSAGE THERAPY AND ENERGY MEDICINE (U.S. CLS. 100 AND 101).
FIRST USE 6-27-2005; IN COMMERCE 6-27-2005.
DAWN FELDMAN, EXAMINING ATTORNEY

SPA 101

SN 77-294,135. THE DERMATOLOGY CLINIC, PLLC, GULFPORT, MS. FILED 10-2-2007.

Vivify

THE MARK CONSISTS OF STANDARD CHARACTERS WITHOUT CLAIM TO ANY PARTICULAR FONT, STYLE, SIZE, OR COLOR.
FOR HEALTH SPA SERVICES FOR HEALTH AND WELLNESS OF THE BODY AND SPIRIT OFFERED AT A HEALTH RESORT (U.S. CLS. 100 AND 101).
CHRISTINA SOBRAL, EXAMINING ATTORNEY

THE MARK CONSISTS OF STANDARD CHARACTERS WITHOUT CLAIM TO ANY PARTICULAR FONT, STYLE, SIZE, OR COLOR.
NO CLAIM IS MADE TO THE EXCLUSIVE RIGHT TO USE "SPA", APART FROM THE MARK AS SHOWN.

FOR BEAUTY SALONS; HEALTH SPA SERVICES, NAMELY, COSMETIC BODY CARE SERVICES; FACIAL TREATMENT SERVICES, NAMELY, COSMETIC PEELS; MASSAGE; NAIL CARE SALONS; SERVICES OF A MAKE-UP ARTIST; SALON SERVICES, NAMELY, FACIALS, MANICURES AND MESSAGES THAT ARE PROVIDED IN A TRAILER OUTFITTED WITH CHAIR, TABLE AND SINK ACCESSORIES; HEALTH SPA SERVICES FOR HEALTH AND WELLNESS OF THE BODY AND SPIRIT OFFERED AT A HEALTH RESORT; HEALTH SPA SERVICES FOR HEALTH AND WELLNESS OF THE MIND, BODY AND SPIRIT OFFERED IN OR FROM A REMOTE, MOBILE OR TEMPORARY ON-SITE LOCATION; CONSULTING SERVICES IN THE FIELD OF MENTAL HEALTH AND WELLNESS; BODY WAXING SERVICES; MASSAGE AND THERAPEUTIC SHIATSU MASSAGE; PERMANENT HAIR REMOVAL AND REDUCTION; MICRODERMABRASION, NAMELY, A TOPICAL SKIN TREATMENT INVOLVING ABRASION OF THE SKIN WITH A HIGH-PRESSURE FLOW OF CRYSTALS; PROVIDING ASSISTANCE, FITNESS EVALUATION AND CONSULTATION TO CORPORATE CLIENTS TO HELP THEIR EMPLOYEES MAKE HEALTH, WELLNESS AND NUTRITIONAL CHANGES IN THEIR DAILY LIVING TO IMPROVE HEALTH; PROVIDING A WEBSITE FEATURING INFORMATION IN THE FIELD OF MENTAL HEALTH AND WELLNESS ; BARBERSHOP; BARBERING SERVICES; AROMATHERAPY SERVICES; BODYWORK THERAPY; ACUPUNCTURE; COLOR ANALYSIS FOR COSMETIC PURPOSES; CONSULTATION SERVICES IN THE FIELD OF MAKEUP, NAMELY ON-LINE MAKEUP CONSULTATION SERVICES AND IN-PERSON MAKEUP CONSULTATION AND APPLICATION SERVICES; CONSULTATION SERVICES IN THE FIELD OF BEAUTY AND COSMETICS, NAMELY ON-LINE BEAUTY AND COSMETIC CONSULTATION SERVICES AND IN-PERSON BEAUTY AND COSMETIC CONSULTATION AND APPLICATION SERVICES; COSMETICIAN SERVICES; COSMETOLOGY SERVICES; COSMETIC AND PLASTIC SURGERY SERVICES; HAIR SALON SERVICES; HAIR REPLACEMENT, HAIR ADDITION, AND HAIR EXTENSION SERVICES; BODY PIERCING SERVICES (U.S. CLS. 100 AND 101).
FIRST USE 2-1-2002; IN COMMERCE 5-12-2003.
G. MAYERSCHOFF, EXAMINING ATTORNEY

SN 77-294,294. JAG PHYSICAL THERAPY, L.L.C., WEST ORANGE, NJ. FILED 10-2-2007.

JAG PHYSICAL THERAPY

THE MARK CONSISTS OF STANDARD CHARACTERS WITHOUT CLAIM TO ANY PARTICULAR FONT, STYLE, SIZE, OR COLOR.
NO CLAIM IS MADE TO THE EXCLUSIVE RIGHT TO USE "PHYSICAL THERAPY", APART FROM THE MARK AS SHOWN.
FOR PHYSICAL THERAPY; PHYSICAL REHABILITATION; HEALTH CARE SERVICES, NAMELY, PROVIDING SPORTS PHYSICAL THERAPY, SPORTS MEDICINE AND ATHLETIC TRAINING TO TREAT AND PREVENT SPORTS-RELATED INJURIES (U.S. CLS. 100 AND 101).
FIRST USE 4-12-2005; IN COMMERCE 4-12-2005.
JORDAN BAKER, EXAMINING ATTORNEY

CLASS 44—(Continued).

SN 77-294,558. ESTHETICS + WAX LLC, AUSTIN, TX. FILED 10-2-2007.

Relax & Wax

THE MARK CONSISTS OF STANDARD CHARACTERS WITHOUT CLAIM TO ANY PARTICULAR FONT, STYLE, SIZE, OR COLOR.

NO CLAIM IS MADE TO THE EXCLUSIVE RIGHT TO USE "WAX", APART FROM THE MARK AS SHOWN.

FOR FACIAL TREATMENT SERVICES, NAMELY, COSMETIC PEELS; SALON SERVICES, NAMELY, FACIALS, MANICURES AND MESSAGES THAT ARE PROVIDED IN A TRAILER OUTFITTED WITH CHAIR, TABLE AND SINK ACCESSORIES; PERMANENT HAIR REMOVAL AND REDUCTION; DEPILATORY HAIR REMOVAL SERVICES (U.S. CLS. 100 AND 101).
SIMON TENG, EXAMINING ATTORNEY

SN 77-294,733. SPRING-GREEN LAWN CARE CORP., PLAINFIELD, IL. FILED 10-3-2007.

Your Neighborhood Lawn Care Professional

THE MARK CONSISTS OF STANDARD CHARACTERS WITHOUT CLAIM TO ANY PARTICULAR FONT, STYLE, SIZE, OR COLOR.

OWNER OF U.S. REG. NO. 2,812,235.

NO CLAIM IS MADE TO THE EXCLUSIVE RIGHT TO USE "LAWN CARE PROFESSIONAL", APART FROM THE MARK AS SHOWN.

FOR LANDSCAPING, LAWN CARE AND TREE CARE SERVICES, NAMELY, LAWN MAINTENANCE, LAWN FERTILIZATION, TREE FERTILIZATION, WEED CONTROL, AND SPREADING AGRICULTURAL CHEMICALS FOR CONTROL OF INSECTS (U.S. CLS. 100 AND 101).
SHARON MEIER, EXAMINING ATTORNEY

CLASS 44—(Continued).

SN 77-294,878. THE VANDERBILT UNIVERSITY, NASHVILLE, TN. FILED 10-3-2007.

WHERE HEART IS HEADED

THE MARK CONSISTS OF STANDARD CHARACTERS WITHOUT CLAIM TO ANY PARTICULAR FONT, STYLE, SIZE, OR COLOR.

FOR HEALTH CARE SERVICES; HOSPITAL SERVICES; MEDICAL CLINICS; MEDICAL COUNSELING; MEDICAL EVALUATION SERVICES, NAMELY, FUNCTIONAL ASSESSMENT PROGRAM FOR PATIENTS RECEIVING MEDICAL SERVICES FOR PURPOSES OF GUIDING TREATMENT AND ASSESSING PROGRAM EFFECTIVENESS; MEDICAL SERVICES; NUTRITION COUNSELING; PHYSICAL REHABILITATION SERVICES; PROVIDING INFORMATION IN THE FIELDS OF DISEASES, DISEASE PREVENTION, HEALTH CARE, MEDICINE AND MEDICAL SERVICES; AND PROVIDING INFORMATION VIA A GLOBAL COMMUNICATIONS NETWORK IN THE FIELDS OF DISEASES, DISEASE PREVENTION, HEALTH CARE, MEDICINE AND MEDICAL SERVICES (U.S. CLS. 100 AND 101).
SAMUEL E. SHARPER JR., EXAMINING ATTORNEY

SN 77-295,403. DAPPER DENTISTRY INC., SAN CLEMENTE, CA. FILED 10-3-2007.

Blending Art, Science and Technology into Beautiful Smiles

THE MARK CONSISTS OF STANDARD CHARACTERS WITHOUT CLAIM TO ANY PARTICULAR FONT, STYLE, SIZE, OR COLOR.

FOR DENTISTRY (U.S. CLS. 100 AND 101).

FIRST USE 7-1-2007; IN COMMERCE 7-1-2007.

GEOFFREY FOSDICK, EXAMINING ATTORNEY

SN 77-295,425. DAPPER DENTISTRY INC., SAN CLEMENTE, CA. FILED 10-3-2007.

Dapper Dentistry

THE MARK CONSISTS OF STANDARD CHARACTERS WITHOUT CLAIM TO ANY PARTICULAR FONT, STYLE, SIZE, OR COLOR.

NO CLAIM IS MADE TO THE EXCLUSIVE RIGHT TO USE "DENTISTRY", APART FROM THE MARK AS SHOWN.

FOR DENTISTRY (U.S. CLS. 100 AND 101).

FIRST USE 7-1-2007; IN COMMERCE 7-1-2007.

GEOFFREY FOSDICK, EXAMINING ATTORNEY

CLASS 44—(Continued).

SN 77-295,429. FORBA HOLDINGS, LLC, NASHVILLE, TN.
FILED 10-3-2007.

SMALL SMILES

THE MARK CONSISTS OF STANDARD CHARACTERS WITHOUT CLAIM TO ANY PARTICULAR FONT, STYLE, SIZE, OR COLOR.

FOR DENTIST SERVICES (U.S. CLS. 100 AND 101).
FIRST USE 5-11-2001; IN COMMERCE 5-11-2001.
ALEX KEAM, EXAMINING ATTORNEY

CLASS 44—(Continued).

SN 77-295,488. FORBA HOLDINGS, LLC, NASHVILLE, TN.
FILED 10-3-2007.



SN 77-295,446. CENTER FOR VETERINARY DENTISTRY AND ORAL SURGERY, GAITHERSBURG, MD. FILED 10-3-2007.

SPECIALIZATION BEYOND EXPECTATION

THE MARK CONSISTS OF STANDARD CHARACTERS WITHOUT CLAIM TO ANY PARTICULAR FONT, STYLE, SIZE, OR COLOR.

FOR SPECIALTY VETERINARY DENTISTRY AND SURGICAL SERVICES (U.S. CLS. 100 AND 101).
FIRST USE 9-15-2007; IN COMMERCE 9-15-2007.
HANNO RITTNER, EXAMINING ATTORNEY

NO CLAIM IS MADE TO THE EXCLUSIVE RIGHT TO USE "TEXAS", APART FROM THE MARK AS SHOWN.

THE MARK CONSISTS OF THREE SMILING ANIMALS PLACED DIRECTLY ABOVE THE WORDS "TEXAS SMILES." THE ANIMAL ON THE RIGHT IS HOLDING A LASSO.

FOR DENTIST SERVICES (U.S. CLS. 100 AND 101).
ALEX KEAM, EXAMINING ATTORNEY

SN 77-295,476. FORBA HOLDINGS, LLC, NASHVILLE, TN.
FILED 10-3-2007.



SN 77-295,503. FORBA HOLDINGS, LLC, NASHVILLE, TN.
FILED 10-3-2007.

TEXAS SMILES

THE MARK CONSISTS OF THREE SMILING ANIMALS PLACED DIRECTLY ABOVE THE WORDS "SMALL SMILES". THE ANIMAL ON THE RIGHT IS HOLDING A LASSO.

FOR DENTIST SERVICES (U.S. CLS. 100 AND 101).
FIRST USE 9-17-2007; IN COMMERCE 9-17-2007.
ALEX KEAM, EXAMINING ATTORNEY

THE MARK CONSISTS OF STANDARD CHARACTERS WITHOUT CLAIM TO ANY PARTICULAR FONT, STYLE, SIZE, OR COLOR.

NO CLAIM IS MADE TO THE EXCLUSIVE RIGHT TO USE "TEXAS", APART FROM THE MARK AS SHOWN.

FOR DENTIST SERVICES (U.S. CLS. 100 AND 101).
FIRST USE 11-17-2007; IN COMMERCE 11-17-2007.
ALEX KEAM, EXAMINING ATTORNEY

CLASS 44—(Continued).

SN 77-295,666. CAPLAN, ANDREA CLAIRE, CABIN JOHN, MD. FILED 10-3-2007.



NO CLAIM IS MADE TO THE EXCLUSIVE RIGHT TO USE "THAI", APART FROM THE MARK AS SHOWN. THE MARK CONSISTS OF AN ABSTRACT IMAGE OF A THAI MASSAGE PRACTITIONER LEANING OVER A SEATED THAI MASSAGE CLIENT, WITH THE WORDS "MY THAI" BELOW THE IMAGE. FOR BODYWORK THERAPY (U.S. CLS. 100 AND 101). EMILY CARLSEN, EXAMINING ATTORNEY

SN 77-295,807. TELEMEDICINE MANAGEMENT, INC., FLEMINGTON, NJ. FILED 10-4-2007.

SWIFTCLINIC

THE MARK CONSISTS OF STANDARD CHARACTERS WITHOUT CLAIM TO ANY PARTICULAR FONT, STYLE, SIZE, OR COLOR. FOR HEALTH CARE; TELEMEDICINE SERVICES (U.S. CLS. 100 AND 101). EDWARD FENNESSY, EXAMINING ATTORNEY

SN 77-295,808. TELEMEDICINE MANAGEMENT, INC., FLEMINGTON, NJ. FILED 10-4-2007.

SWIFTCARE

THE MARK CONSISTS OF STANDARD CHARACTERS WITHOUT CLAIM TO ANY PARTICULAR FONT, STYLE, SIZE, OR COLOR. FOR HEALTH CARE; TELEMEDICINE SERVICES (U.S. CLS. 100 AND 101). EDWARD FENNESSY, EXAMINING ATTORNEY

CLASS 44—(Continued).

SN 77-295,953. PARTNERS HEALTHCARE SYSTEM, INC., BOSTON, MA. FILED 10-4-2007.



OWNER OF U.S. REG. NOS. 2,375,555, 3,183,484 AND OTHERS. NO CLAIM IS MADE TO THE EXCLUSIVE RIGHT TO USE "HEALTHCARE", APART FROM THE MARK AS SHOWN. THE MARK CONSISTS OF THE WORDS PARTNERS HEALTHCARE WITH THREE CURVED LINES. FOR HOSPITALS; HEALTH CARE; PROVIDING HEALTH INFORMATION (U.S. CLS. 100 AND 101). FIRST USE 6-0-2007; IN COMMERCE 6-0-2007. HEATHER BIDDULPH, EXAMINING ATTORNEY

SN 77-296,385. EVERYDAY SYSTEMS, LLC, CAMBRIDGE, MA. FILED 10-4-2007.

No S Diet

THE MARK CONSISTS OF STANDARD CHARACTERS WITHOUT CLAIM TO ANY PARTICULAR FONT, STYLE, SIZE, OR COLOR. NO CLAIM IS MADE TO THE EXCLUSIVE RIGHT TO USE "DIET", APART FROM THE MARK AS SHOWN. FOR WEIGHT REDUCTION DIET PLANNING, AND PROVIDING A WEBSITE FEATURING EDUCATIONAL WEIGHT REDUCTION DIET PLANNING (U.S. CLS. 100 AND 101). FIRST USE 10-4-2001; IN COMMERCE 10-4-2001. NAAKWAMA ANKRAH, EXAMINING ATTORNEY

SN 77-296,554. ICONOPSYCH CARE LLC, COLUMBIA, MO. FILED 10-4-2007.

HomePsych

THE MARK CONSISTS OF STANDARD CHARACTERS WITHOUT CLAIM TO ANY PARTICULAR FONT, STYLE, SIZE, OR COLOR. FOR PSYCHOLOGICAL AND PSYCHIATRY COUNSELING (U.S. CLS. 100 AND 101). ROBIN CHOSID, EXAMINING ATTORNEY

CLASS 44—(Continued).

SN 77-296,847. PARTNERS HEALTHCARE SYSTEM, INC., BOSTON, MA. FILED 10-5-2007.



OWNER OF U.S. REG. NOS. 2,375,555, 3,183,484 AND OTHERS.
THE MARK CONSISTS OF THE WORD "PARTNERS" WITH THREE CURVED LINES.
FOR HOSPITALS (U.S. CLS. 100 AND 101).
FIRST USE 2-1-1996; IN COMMERCE 2-1-1996.
HEATHER BIDDULPH, EXAMINING ATTORNEY

SN 77-298,051. BAREZ, BRAD, DBA BACKTOHEALTHCARE.COM, LAWDALE, CA. FILED 10-7-2007.

Making Healthy Lifestyles

THE MARK CONSISTS OF STANDARD CHARACTERS WITHOUT CLAIM TO ANY PARTICULAR FONT, STYLE, SIZE, OR COLOR.
FOR CONSULTING SERVICES IN THE FIELD OF MENTAL HEALTH AND WELLNESS; HEALTH CARE; HEALTH SPA SERVICES, NAMELY, COSMETIC BODY CARE SERVICES (U.S. CLS. 100 AND 101).
PAUL F. GAST, EXAMINING ATTORNEY

SN 77-298,091. BAZILIAN, INC., ESCONDIDO, CA. FILED 10-7-2007.

Eat well. Move daily. Be Healthy.

THE MARK CONSISTS OF STANDARD CHARACTERS WITHOUT CLAIM TO ANY PARTICULAR FONT, STYLE, SIZE, OR COLOR.
FOR HEALTH CARE (U.S. CLS. 100 AND 101).
FIRST USE 8-1-2002; IN COMMERCE 8-1-2002.
CHRISTOPHER BUONGIORNO, EXAMINING ATTORNEY

CLASS 44—(Continued).

SN 77-298,795. SIGNATURE GENOMIC LABORATORIES, LLC, SPOKANE, WA. FILED 10-8-2007.

OLIGOGLYPHIX

THE MARK CONSISTS OF STANDARD CHARACTERS WITHOUT CLAIM TO ANY PARTICULAR FONT, STYLE, SIZE, OR COLOR.
FOR MEDICAL SERVICES; MEDICAL TESTING; MEDICAL IMAGING SERVICES (U.S. CLS. 100 AND 101).
TRACY WHITTAKER-BROWN, EXAMINING ATTORNEY

SN 77-302,467. CARGILL, INCORPORATED, WAYZATA, MN. FILED 10-12-2007.



OWNER OF U.S. REG. NOS. 798,187, 808,227 AND OTHERS.
THE COLOR(S) RED, WHITE, BLACK IS/ARE CLAIMED AS A FEATURE OF THE MARK.
THE MARK CONSISTS OF RED OUTLINED CIRCULAR PATTERN COMING TO A POINT AT THE TOP AND BOTTOM WITH A WHITE COLOR INSIDE THE CIRCULAR PATTERN AND "AGWAY" WRITTEN IN BLACK IN THE MIDDLE OF THE CIRCULAR PATTERN.
FOR PROVIDING ANIMAL FEEDING AND NUTRITIONAL INFORMATION TO OTHERS (U.S. CLS. 100 AND 101).
FIRST USE 3-5-1964; IN COMMERCE 3-5-1964.
BRENDAN REGAN, EXAMINING ATTORNEY

SN 77-319,890. SPRING-GREEN LAWN CARE CORP., PLAINFIELD, IL. FILED 11-2-2007.

Organic Alternative

THE MARK CONSISTS OF STANDARD CHARACTERS WITHOUT CLAIM TO ANY PARTICULAR FONT, STYLE, SIZE, OR COLOR.
NO CLAIM IS MADE TO THE EXCLUSIVE RIGHT TO USE "ORGANIC", APART FROM THE MARK AS SHOWN.
FOR LANDSCAPING, LAWN CARE AND TREE CARE SERVICES - NAMELY, LAWN MAINTENANCE, LAWN FERTILIZATION, TREE FERTILIZATION, WEED CONTROL, AND SPREADING AGRICULTURAL CHEMICALS FOR CONTROL OF INSECTS (U.S. CLS. 100 AND 101).
SHARON MEIER, EXAMINING ATTORNEY

CLASS 44—(Continued).

SN 77-323,576. NEUROTEXAS, PLLC, AUSTIN, TX. FILED 11-7-2007.



NO CLAIM IS MADE TO THE EXCLUSIVE RIGHT TO USE "PLLC", APART FROM THE MARK AS SHOWN.

THE MARK CONSISTS OF OVERLAPPING ELONGATED TRIANGLES NEXT TO THE WORD "NEUROTEXAS" IN LOWER CASE, AND THE LETTERS "PLLC" IN UPPER CASE NEXT TO "NEUROTEXAS." THE "T" IN "NEUROTEXAS" IS STYLIZED.

FOR NEUROLOGICAL AND NEUROSURGICAL MEDICAL SERVICES; PROVIDING TREATMENTS FOR MEDICAL CONDITIONS RELATING TO THE SPINE AND NERVOUS SYSTEM (U.S. CLS. 100 AND 101).

PAM WILLIS, EXAMINING ATTORNEY

SN 78-879,654. BALDUZZI, MARK G., FAYETTEVILLE, NY. FILED 5-9-2006.



NO CLAIM IS MADE TO THE EXCLUSIVE RIGHT TO USE "ICE", APART FROM THE MARK AS SHOWN.

THE COLOR(S) BLUE (PROCESS BLUE), ORANGE (PMS 165) AND WHITE IS/ARE CLAIMED AS A FEATURE OF THE MARK.

THE MARK CONSISTS OF A SIX BARRED CROSS IN BLUE (PROCESS BLUE) WITH THE LETTERS "ICE" IN THE CENTER OF THE CROSS IN WHITE OVERLYING AN ORANGE SQUARE (PMS 165) BACKGROUND.

FOR EMERGENCY MEDICAL ASSISTANCE (U.S. CLS. 100 AND 101).

JAMES MACFARLANE, EXAMINING ATTORNEY

CLASS 44—(Continued).

SN 78-948,483. MCBRIDE CLINIC, INCORPORATED, OKLAHOMA CITY, OK. FILED 8-9-2006.

McBRIDE ORTHOPEDIC HOSPITAL

THE MARK CONSISTS OF STANDARD CHARACTERS WITHOUT CLAIM TO ANY PARTICULAR FONT, STYLE, SIZE, OR COLOR.

NO CLAIM IS MADE TO THE EXCLUSIVE RIGHT TO USE "ORTHOPEDIC HOSPITAL", APART FROM THE MARK AS SHOWN.

SEC. 2(F) AS TO "MCBRIDE".

FOR HOSPITAL SERVICES (U.S. CLS. 100 AND 101).

FIRST USE 9-0-2005; IN COMMERCE 9-0-2005.

SCOTT BIBB, EXAMINING ATTORNEY

SN 78-965,353. SAINT JOSEPH REGIONAL MEDICAL CENTER, INC., SOUTH BEND, IN. FILED 8-31-2006.

FOR CERVICAL CANCER SCREENINGS PROVIDED AS PART OF A PROGRAM DESIGNED TO SERVE WOMEN AND PROMOTE THE EARLY DETECTION OF CERVICAL CANCER (U.S. CLS. 100 AND 101).

FIRST USE 4-0-2006; IN COMMERCE 4-0-2006.

HEATHER BIDDULPH, EXAMINING ATTORNEY

SN 79-037,747. PUECH MICHEL, FRANCE, FILED 3-26-2007.

EXPLORE VISION

PRIORITY DATE OF 9-27-2006 IS CLAIMED. OWNER OF INTERNATIONAL REGISTRATION 0922122 DATED 3-26-2007, EXPIRES 3-26-2017.

FOR MEDICAL SERVICES, NAMELY, MEDICAL IMAGING IN THE FIELD OF OPHTHALMOLOGY (U.S. CLS. 100 AND 101).

RENEE MCCRAY, EXAMINING ATTORNEY

CLASS 45—PERSONAL AND LEGAL SERVICES

SN 76-674,753. UNITED STATES DEPARTMENT OF ENERGY, WASHINGTON, DC. FILED 3-29-2007.



NO CLAIM IS MADE TO THE EXCLUSIVE RIGHT TO USE "NATIONAL LABORATORIES", APART FROM THE MARK AS SHOWN.

STYLIZED THUNDERBIRD WITH "SANDIA NATIONAL LABORATORIES" A VERTICAL FORMAT.

FOR SECURITY SERVICES, NAMELY ENSURING NUCLEAR WEAPON STOCKPILE IS SECURE; CIVIL PROTECTION, NAMELY ENHANCING THE SURETY OF ENERGY AND OTHER CRITICAL INFRASTRUCTURE; SECURITY SERVICES, NAMELY PLANNING STRATEGIZING, AND SUPERVISING THE NONPROLIFERATION OF WEAPONS OF MASS DESTRUCTION, THE THREAT OF NUCLEAR ACCIDENTS, AND DAMAGE TO THE ENVIRONMENT; SECURITY SERVICES, NAMELY ASSESSMENT OF THREATS TO NATIONAL SECURITY; SECURITY SERVICES, NAMELY HOMELAND SECURITY (U.S. CLS. 100 AND 101).

FIRST USE 12-20-1979; IN COMMERCE 12-20-1979.
CHRISTINA SOBRAL, EXAMINING ATTORNEY

SN 76-674,755. UNITED STATES DEPARTMENT OF ENERGY, WASHINGTON, DC. FILED 3-29-2007.

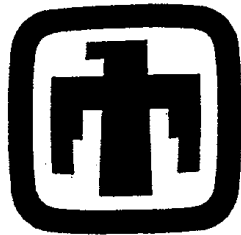

THE MARK CONSIST OF STYLIZED THUNDERBIRD WITH A VERTICAL FORMAT.

FOR SECURITY SERVICES, NAMELY, ENSURING NUCLEAR WEAPON STOCKPILE IS SECURE; CIVIL PROTECTION, NAMELY, ENHANCING THE SURETY OF ENERGY AND OTHER CRITICAL INFRASTRUCTURE; SECURITY SERVICES, NAMELY, PLANNING STRATEGIZING, AND SUPERVISING THE NONPROLIFERATION OF WEAPONS OF MASS DESTRUCTION, THE THREAT OF NUCLEAR ACCIDENTS, AND DAMAGE TO THE ENVIRONMENT; SECURITY SERVICES, NAMELY, ASSESSMENT OF THREATS TO NATIONAL SECURITY; SECURITY SERVICES, NAMELY, HOMELAND SECURITY (U.S. CLS. 100 AND 101).

FIRST USE 12-20-1979; IN COMMERCE 12-20-1979.
CHRISTINA SOBRAL, EXAMINING ATTORNEY

CLASS 45—(Continued).

SN 76-676,345. PALLADIUM LEGAL SERVICES, LLC, ATLANTA, GA. FILED 5-2-2007.



NO CLAIM IS MADE TO THE EXCLUSIVE RIGHT TO USE "LEGAL SERVICES", APART FROM THE MARK AS SHOWN.

FOR LEGAL SERVICES (U.S. CLS. 100 AND 101).
FIRST USE 3-1-2007; IN COMMERCE 3-1-2007.
TASNEEM HUSSAIN, EXAMINING ATTORNEY

SN 77-058,982. MCPHERSON, BASIL, LAURELTON, NY. FILED 12-7-2006.

Praise Fest

THE MARK CONSISTS OF STANDARD CHARACTERS WITHOUT CLAIM TO ANY PARTICULAR FONT, STYLE, SIZE, OR COLOR.

NO CLAIM IS MADE TO THE EXCLUSIVE RIGHT TO USE "FEST", APART FROM THE MARK AS SHOWN.

FOR MINISTERIAL SERVICES, NAMELY, HOLDING SPIRITUAL RETREATS TO ASSIST RELIGIOUS LEADERS, BOTH CLERGY AND LAY, TO DEVELOP AND ENHANCE THEIR SPIRITUAL LIVES (U.S. CLS. 100 AND 101).

FIRST USE 6-1-2005; IN COMMERCE 6-1-2005.
DOMINICK J. SALEMI, EXAMINING ATTORNEY

SN 77-067,411. WYNN RESORTS HOLDINGS, LLC, LAS VEGAS, NV. FILED 12-19-2006.

WYNN TOWER SUITES

THE MARK CONSISTS OF STANDARD CHARACTERS WITHOUT CLAIM TO ANY PARTICULAR FONT, STYLE, SIZE, OR COLOR.

OWNER OF U.S. REG. NOS. 3,088,707, 3,195,978 AND OTHERS.

FOR WEDDING CHAPEL SERVICES (U.S. CLS. 100 AND 101).

YONG KIM, EXAMINING ATTORNEY

CLASS 45—(Continued).

SN 77-120,589. RUDNITSKY & HACKMAN, LLP, SELINS-GROVE, PA. FILED 3-2-2007.

YOUR BUSINESS ADVANTAGE

THE MARK CONSISTS OF STANDARD CHARACTERS WITHOUT CLAIM TO ANY PARTICULAR FONT, STYLE, SIZE, OR COLOR.

NO CLAIM IS MADE TO THE EXCLUSIVE RIGHT TO USE BUSINESS, APART FROM THE MARK AS SHOWN.

FOR LEGAL SERVICES (U.S. CLS. 100 AND 101).

JORDAN BAKER, EXAMINING ATTORNEY

SN 77-133,776. CONTROLTHINK LC, OREM, UT. FILED 3-17-2007.

ThinkSecure

THE MARK CONSISTS OF STANDARD CHARACTERS WITHOUT CLAIM TO ANY PARTICULAR FONT, STYLE, SIZE, OR COLOR.

FOR MONITORING OF BURGLAR AND SECURITY ALARMS AND SECURITY SYSTEMS; AND VIDEO SURVEILLANCE SERVICES, NAMELY, VIDEO MONITORING OF FACILITIES, HOMES, AND OUTDOOR AREAS (U.S. CLS. 100 AND 101).

BILL DAWE, EXAMINING ATTORNEY

SN 77-137,129. OLKIM ENTERPRISES, INC., AURORA, OH. FILED 3-21-2007.

Catch Your Dreams

THE MARK CONSISTS OF STANDARD CHARACTERS WITHOUT CLAIM TO ANY PARTICULAR FONT, STYLE, SIZE, OR COLOR.

FOR PERSONAL GROWTH AND MOTIVATION CONSULTING SERVICES (U.S. CLS. 100 AND 101).

FIRST USE 3-15-2007; IN COMMERCE 3-15-2007.

SAIMA MAKHDOOM, EXAMINING ATTORNEY

CLASS 45—(Continued).

SN 77-137,541. BAPTIST CHILD & FAMILY SERVICES, SAN ANTONIO, TX. FILED 3-22-2007.

BCFS

THE MARK CONSISTS OF STANDARD CHARACTERS WITHOUT CLAIM TO ANY PARTICULAR FONT, STYLE, SIZE, OR COLOR.

FOR SOCIAL AND CHARITABLE SERVICES, NAMELY, PROVIDING FOSTER CARE; SOCIAL AND CHARITABLE SERVICES, NAMELY, PERSONAL CARE ASSISTANCE OF ACTIVITIES OF DAILY LIVING, SUCH AS BATHING, GROOMING AND PERSONAL MOBILITY FOR MENTALLY OR PHYSICALLY CHALLENGED PEOPLE (U.S. CLS. 100 AND 101).

FIRST USE 1-2-1998; IN COMMERCE 1-2-1998.

DAVID TOOLEY, EXAMINING ATTORNEY

SN 77-150,730. CONTROL SECURITY SERVICES, INC., SECAUCUS, NJ. FILED 4-6-2007.

The logo for Control Security features a stylized human figure with arms raised, positioned to the left of the word "Control" in a bold, sans-serif font. Below "Control" is the word "security" in a smaller, lowercase, sans-serif font.

NO CLAIM IS MADE TO THE EXCLUSIVE RIGHT TO USE "SECURITY", APART FROM THE MARK AS SHOWN.

THE MARK CONSISTS OF THE WORDS CONTROL SECURITY AND A STYLIZED "T".

FOR SECURITY SERVICES FOR THE PROTECTION OF PROPERTY AND INDIVIDUALS, NAMELY, SECURITY GUARD SERVICES, MONITORING BURGLAR AND SECURITY ALARMS, MONITORING SECURITY SYSTEMS, INVESTIGATION OR SURVEILLANCE ON BACKGROUND PROFILES (U.S. CLS. 100 AND 101).

FIRST USE 11-0-1999; IN COMMERCE 11-0-1999.

JANICE KIM, EXAMINING ATTORNEY

SN 77-153,268. PALLADIUM LEGAL SERVICES, LLC, ATLANTA, GA. FILED 4-10-2007.

PALLADIUM

THE MARK CONSISTS OF STANDARD CHARACTERS WITHOUT CLAIM TO ANY PARTICULAR FONT, STYLE, SIZE, OR COLOR.

FOR LEGAL SERVICES (U.S. CLS. 100 AND 101).

FIRST USE 2-0-2005; IN COMMERCE 2-0-2005.

TASNEEM HUSSAIN, EXAMINING ATTORNEY

CLASS 45—(Continued).

SN 77-154,418. PALLADIUM LEGAL SERVICES, LLC, ATLANTA, GA. FILED 4-11-2007.

CLASS 45—(Continued).

SN 77-184,446. ALL SPACED OUT, INC., PELHAM, AL. FILED 5-18-2007.

YOUR ATTORNEY. YOUR WORLD.

ALL spaced out

THE MARK CONSISTS OF STANDARD CHARACTERS WITHOUT CLAIM TO ANY PARTICULAR FONT, STYLE, SIZE, OR COLOR.

FOR LEGAL SERVICES (U.S. CLS. 100 AND 101).
FIRST USE 3-0-2007; IN COMMERCE 3-0-2007.
TASNEEM HUSSAIN, EXAMINING ATTORNEY

SN 77-175,845. CLASSY COZY CREATIONS LLC, ELLICOTT CITY, MD. FILED 5-8-2007.



NO CLAIM IS MADE TO THE EXCLUSIVE RIGHT TO USE "CREATIONS", APART FROM THE MARK AS SHOWN.

THE COLOR(S) BEIGE, BROWN, YELLOW, ORANGE, BLUE, SILVER, BLACK AND WHITE IS/ARE CLAIMED AS A FEATURE OF THE MARK.

THE MARK CONSISTS OF A BLACK-BORDERED TRIANGLE THAT IS FURTHER BORDERED BY A WHITE STYLIZED WAVE-FORM DESIGN WITH COLORS OF SILVER AND LIGHT BLUE ON THE EDGE. THE TRIANGLE IS FULLY FILLED WITH COLOR, BEGINNING WITH A YELLOW-ORANGE TINT AT THE APEX AND GETTING PROGRESSIVELY DARKER AS IT MOVES TO THE BOTTOM, WHERE IT BECOMES FULLY BROWN. IN THE CENTER OF THE TRIANGLE IS A BROWN SUITCASE, WITH HANDLE UPRIGHT, POSSESSING TWO BROWN STRAPS, WITH SILVER BUCKLES. ON THE SUITCASE ARE REPRESENTATIONS OF FOUR STYLIZED STICKERS: ONE OF THE STATUE OF LIBERTY IN SILVER, WHITE AND BLACK, ONE OF A SILVER FIVE-POINTED MILITARY STAR, ONE IN BLUE AND WHITE OF A BI-PLANE, AND ONE (PARTIALLY OBSTRUCTED BY THE LEFT STRAP) OF AN ORANGE AND BLACK COLORED CITY SKYLINE. ABOVE THE SUITCASE ARE THE WORDS "CLASSY COZY", WRITTEN IN BLUE AND IN ALL CAPS, PLACED INSIDE OF A BEIGE BANNER THAT OVERLAPS EACH SIDE OF THE TRIANGLE. BELOW THE SUITCASE IS THE WORD "CREATIONS", WRITTEN IN BEIGE AND IN ALL CAPS, THAT SITS ALONG THE BOTTOM BORDER OF THE TRIANGLE.

FOR PREPARATION OF CUSTOMIZED SUITCASES CONTAINING SELECTED ITEMS FOR EVENTS AND CUSTOMERS (U.S. CLS. 100 AND 101).

FIRST USE 1-1-2007; IN COMMERCE 1-1-2007.
KATHERINE CONNOLLY, EXAMINING ATTORNEY

THE MARK CONSISTS OF STANDARD CHARACTERS WITHOUT CLAIM TO ANY PARTICULAR FONT, STYLE, SIZE, OR COLOR.

FOR ORGANIZATIONAL SERVICES FOR HOME OR PERSONAL PURPOSES, NAMELY, ORGANIZING SPACES OF CLOSETS, KITCHENS, GARAGE, LAUNDRY ROOM, PLAYROOM, HOME OFFICES, AND ORGANIZING PERSONAL SCHEDULES; CONSULTING IN THE FIELD OF STORAGE SPACE ORGANIZING SERVICES FOR HOME OR PERSONAL PURPOSES (U.S. CLS. 100 AND 101).

FIRST USE 1-1-2002; IN COMMERCE 1-1-2002.
JASON BLAIR, EXAMINING ATTORNEY

SN 77-224,373. ANDERSON GROVE BAPTIST CHURCH OF GREENSBORO, INC., GREENSBORO, NC. FILED 7-9-2007.

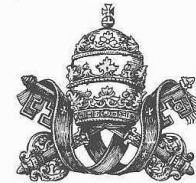

FOR RELIGIOUS SERVICES, NAMELY EVANGELISTIC AND MINISTERIAL SERVICES, AND DISTRIBUTION OF MATERIALS IN THE FIELD OF RELIGION FOR USE IN CONNECTION THEREWITH (U.S. CLS. 100 AND 101).

FIRST USE 1-1-2003; IN COMMERCE 1-1-2003.
ELLEN PERKINS, EXAMINING ATTORNEY

CLASS 45—(Continued).

SN 77-234,181. U.S.A. CENTRAL STATION ALARM CORP., PORT CHESTER, NY. FILED 7-19-2007.



NO CLAIM IS MADE TO THE EXCLUSIVE RIGHT TO USE "USA CENTRAL STATION ALARM", APART FROM THE MARK AS SHOWN.

THE MARK CONSISTS OF A STAR LOGO AND STYLIZED LETTERS.

FOR ELECTRONIC MONITORING SERVICES FOR SECURITY ALARM SYSTEMS (U.S. CLS. 100 AND 101).

FIRST USE 6-10-2007; IN COMMERCE 6-10-2007.
CHRISIE B. KING, EXAMINING ATTORNEY

SN 77-241,667. CHEERWAY CARE, INC., CENTREVILLE, VA. FILED 7-30-2007.

CHEERWAY CARE

THE MARK CONSISTS OF STANDARD CHARACTERS WITHOUT CLAIM TO ANY PARTICULAR FONT, STYLE, SIZE, OR COLOR.

NO CLAIM IS MADE TO THE EXCLUSIVE RIGHT TO USE "CARE", APART FROM THE MARK AS SHOWN.

FOR PROVIDING INDIVIDUALS WITH IN-HOME, COMPANION CARE AND ASSISTANCE SERVICES, NAMELY, ACTIVITIES OF DAILY LIVING, BATHING, WALKING, RUNNING ERRANDS FOR OTHERS; AND SOCIAL WORKER CONSULTATIONS (U.S. CLS. 100 AND 101).

FIRST USE 5-1-2004; IN COMMERCE 5-1-2004.
KAREN K. BUSH, EXAMINING ATTORNEY

CLASS 45—(Continued).

SN 77-244,449. ASSOCIATIONS, INC., DALLAS, TX. FILED 8-1-2007.

ASSOCIERGE

THE MARK CONSISTS OF STANDARD CHARACTERS WITHOUT CLAIM TO ANY PARTICULAR FONT, STYLE, SIZE, OR COLOR.

FOR PERSONAL CONCIERGE SERVICES FOR OTHERS COMPRISING MAKING REQUESTED PERSONAL ARRANGEMENTS AND RESERVATIONS, RUNNING ERRANDS AND PROVIDING CUSTOMER SPECIFIC INFORMATION TO MEET INDIVIDUAL NEEDS, ALL RENDERED IN MASTER PLANNED COMMUNITIES, CONDOMINIUMS, LOFTS, CONDO HOTELS AND MIXED USE DEVELOPMENTS (U.S. CLS. 100 AND 101).

DEZMONA MIZELLE, EXAMINING ATTORNEY

SN 77-247,453. TAILLEEN ARIAS, DORAL, FL. FILED 8-5-2007.



THE MARK CONSISTS OF THE NUMBER THREE (3) AND ROMAN NUMBER THREE (III) WITH THE UPPER CASE LETTER "Q" AND APOSTROPHE LOWER CASE LETTERS AND LOGO.

FOR LICENSING OF ADVERTISING SLOGANS AND CARTOON CHARACTERS (U.S. CLS. 100 AND 101).

DOMINIC J. FERRAIUOLO, EXAMINING ATTORNEY

SN 77-253,996. FLEETINGLOOK, INC., WASHINGTON, DC. FILED S.R. 8-13-2007; AM. P.R. 12-28-2007.

FleetingLook

THE COLOR(S) PURPLE IS/ARE CLAIMED AS A FEATURE OF THE MARK.

THE MARK CONSISTS OF THE MARK "FLEETINGLOOK" IS ONE WORD WRITTEN IN ALL PURPLE COLOR AND THE TWO "O'S IN THE WORD HAVE TWO EYES LOOKING OUTWARD TO THE RIGHT.

FOR PROVIDING A WEBSITE FEATURING INFORMATION AND CONTENT IN THE FIELDS OF PERSONAL RELATIONSHIPS, DATING AND FASHION (U.S. CLS. 100 AND 101).

DAVID I, EXAMINING ATTORNEY

CLASS 45—(Continued).

SN 77-263,155. QUIEROLATINO.COM LLC, FREMONT, CA. FILED 8-23-2007.

QuieroLatino.com

THE MARK CONSISTS OF STANDARD CHARACTERS WITHOUT CLAIM TO ANY PARTICULAR FONT, STYLE, SIZE, OR COLOR.

THE FOREIGN WORDING IN THE MARK TRANSLATES INTO ENGLISH AS I LIKE OR I LOVE LATINOS OR I LIKE OR I LOVE LATINO CULTURE.

FOR INTERNET BASED SOCIAL NETWORKING, INTRODUCTION, AND DATING SERVICES (U.S. CLS. 100 AND 101).

LINDA MICKLEBURGH, EXAMINING ATTORNEY

SN 77-263,455. RTW, INC., BLOOMINGTON, MN. FILED 8-24-2007.

RTW SELECTRITE

THE MARK CONSISTS OF STANDARD CHARACTERS WITHOUT CLAIM TO ANY PARTICULAR FONT, STYLE, SIZE, OR COLOR.

FOR PRE-EMPLOYMENT BACKGROUND SCREENING TO DETERMINE BEHAVIORAL TENDENCIES OF POTENTIAL EMPLOYEES (U.S. CLS. 100 AND 101).

FIRST USE 8-16-2007; IN COMMERCE 8-16-2007.
CHARLES L. JENKINS, EXAMINING ATTORNEY

SN 77-267,003. CONCEPTS OF TRUTH, INC., WYNNE, AR. FILED 8-29-2007.



NO CLAIM IS MADE TO THE EXCLUSIVE RIGHT TO USE "NATIONAL HELPLINE FOR ABORTION RECOVERY" AND THE PICTORIAL REPRESENTATION OF THE CONTINENTAL UNITED STATES OF AMERICA, APART FROM THE MARK AS SHOWN.

THE MARK CONSISTS OF THESE WORDS INCLUDED INSIDE AN OUTLINE OF THE UNITED STATES OF AMERICA.

FOR TELEPHONE HELPLINE COUNSELING, NAMELY, OFFERING RELIGIOUS AND SPIRITUAL COUNSELING REGARDING ABORTION RECOVERY (U.S. CLS. 100 AND 101).

FIRST USE 5-0-2003; IN COMMERCE 6-0-2003.
CIMMERIAN COLEMAN, EXAMINING ATTORNEY

CLASS 45—(Continued).

SN 77-268,530. WINSTEAD PC, DBA WINSTEAD SECHREST & MINICK P.C., DALLAS, TX. FILED 8-30-2007.



NO CLAIM IS MADE TO THE EXCLUSIVE RIGHT TO USE "ATTORNEYS", APART FROM THE MARK AS SHOWN.

THE COLOR(S) YELLOW, WHITE, BLACK IS/ARE CLAIMED AS A FEATURE OF THE MARK.

THE MARK CONSISTS OF RECTANGULAR LOGO FORMED FROM A FIRST, YELLOW, RECTANGLE IN THE UPPER LEFT QUADRANT OF A SECOND, LARGER, WHITE, RECTANGLE, WITH THE WORD "WINSTEAD" IN BLACK PRINT, "WIN" IN THE BOTTOM RIGHT QUADRANT OF THE YELLOW RECTANGLE YELLOW RECTANGLE, "STEAD" CONTINUING INTO THE WHITE RECTANGLE, AND "ATTORNEYS" IN BLACK PRINT IN THE BOTTOM RIGHT CORNER OF THE WHITE RECTANGLE.

FOR LEGAL SERVICES (U.S. CLS. 100 AND 101).
VIVIAN MICZNIK FIRST, EXAMINING ATTORNEY

SN 77-274,231. JOHNSON, LARRY, PALM SPRINGS, CA. FILED 9-7-2007.

DESERT DOVE

THE MARK CONSISTS OF STANDARD CHARACTERS WITHOUT CLAIM TO ANY PARTICULAR FONT, STYLE, SIZE, OR COLOR.

FOR PET CREMATION AND RELATED FUNERAL ARRANGEMENT SERVICES (U.S. CLS. 100 AND 101).

CYNTHIA SLOAN, EXAMINING ATTORNEY

SN 77-274,753. KAZAN, MCCLAIN, ABRAMS, LYONS, FARRISE & GREENWOOD, PLC, OAKLAND, CA. FILED 9-7-2007.



NO CLAIM IS MADE TO THE EXCLUSIVE RIGHT TO USE "PLC", APART FROM THE MARK AS SHOWN.

THE MARK CONSISTS OF A STYLIZED BIRD TO THE LEFT OF THE WORDS "KAZAN, MCCLAIN, ABRAMS, LYONS, FARRISE & GREENWOOD, PLC".

FOR LEGAL SERVICES (U.S. CLS. 100 AND 101).
FIRST USE 8-23-2007; IN COMMERCE 8-23-2007.
LYDIA BELZER, EXAMINING ATTORNEY

CLASS 45—(Continued).

SN 77-277,392. MYFREEIMPLANTS.COM LLC, LOS ANGELES, CA. FILED 9-12-2007.



NO CLAIM IS MADE TO THE EXCLUSIVE RIGHT TO USE "MYFREEIMPLANTS.COM", APART FROM THE MARK AS SHOWN.

THE MARK CONSISTS OF ALL UPPERCASE LETTERS THAT SPELL THE WORDS "MYFREEIMPLANTS.COM." THE FIRST LETTER OF EACH WORD IS LARGER IN SIZE AND THE LETTER "P" IN "IMPLANTS" IS REPLACED BY AN IMAGE OF A WOMAN WITH LEGS EXTENDED AROUND THE LETTER "L" IN "IMPLANTS".

FOR ONLINE SOCIAL NETWORKING SERVICES (U.S. CLS. 100 AND 101).

FIRST USE 6-1-2005; IN COMMERCE 6-1-2005.
MICHAEL LITZAU, EXAMINING ATTORNEY

SN 77-278,617. RICHARDS, RALPH & SCHWAB, CHARTERED, VERNON HILLS, IL. FILED 9-13-2007.

PRACTICAL PROBLEM SOLVERS

THE MARK CONSISTS OF STANDARD CHARACTERS WITHOUT CLAIM TO ANY PARTICULAR FONT, STYLE, SIZE, OR COLOR.

FOR LEGAL SERVICES (U.S. CLS. 100 AND 101).

FIRST USE 8-30-2007; IN COMMERCE 8-30-2007.
NORA BUCHANAN WILL, EXAMINING ATTORNEY

SN 77-281,717. LUNCEFORD, SHANE TROY, SAN JOSE, CA. FILED 9-17-2007.



THE MARK CONSISTS OF STANDARD CHARACTERS WITHOUT CLAIM TO ANY PARTICULAR FONT, STYLE, SIZE, OR COLOR.

FOR COMPUTER DATING SERVICES; INTERNET BASED SOCIAL NETWORKING, INTRODUCTION, AND DATING SERVICES; PROVIDING A WEBSITE FEATURING INFORMATION AND CONTENT IN THE FIELDS OF PERSONAL RELATIONSHIPS, DATING AND FASHION (U.S. CLS. 100 AND 101).

YAT SYE, LEE, EXAMINING ATTORNEY

CLASS 45—(Continued).

SN 77-287,498. AMERICAN CASE MANAGEMENT ASSOCIATION, LITTLE ROCK, AR. FILED 9-24-2007.

COMPARE-AD

THE MARK CONSISTS OF STANDARD CHARACTERS WITHOUT CLAIM TO ANY PARTICULAR FONT, STYLE, SIZE, OR COLOR.

FOR HOSPITAL AND HEALTHCARE CASE MANAGEMENT SERVICES IN THE NATURE OF PROVIDING STANDARDIZED CATEGORIES, DEFINITIONS, CODING, AND BENCHMARKING FOR PATIENT CARE EVALUATION (U.S. CLS. 100 AND 101).

CURTIS FRENCH, EXAMINING ATTORNEY

SN 77-287,505. AMERICAN CASE MANAGEMENT ASSOCIATION, LITTLE ROCK, AR. FILED 9-24-2007.

COMPARE-DA

THE MARK CONSISTS OF STANDARD CHARACTERS WITHOUT CLAIM TO ANY PARTICULAR FONT, STYLE, SIZE, OR COLOR.

FOR HOSPITAL AND HEALTHCARE CASE MANAGEMENT SERVICES IN THE NATURE OF PROVIDING STANDARDIZED CATEGORIES, DEFINITIONS, CODING, AND BENCHMARKING FOR PATIENT CARE EVALUATION (U.S. CLS. 100 AND 101).

CURTIS FRENCH, EXAMINING ATTORNEY

SN 77-287,510. AMERICAN CASE MANAGEMENT ASSOCIATION, LITTLE ROCK, AR. FILED 9-24-2007.

ACMA'S COMPARE-AD

THE MARK CONSISTS OF STANDARD CHARACTERS WITHOUT CLAIM TO ANY PARTICULAR FONT, STYLE, SIZE, OR COLOR.

OWNER OF U.S. REG. NOS. 2,497,012 AND 2,557,744.
FOR HOSPITAL AND HEALTHCARE CASE MANAGEMENT SERVICES IN THE NATURE OF PROVIDING STANDARDIZED CATEGORIES, DEFINITIONS, CODING, AND BENCHMARKING FOR PATIENT CARE EVALUATION (U.S. CLS. 100 AND 101).

CURTIS FRENCH, EXAMINING ATTORNEY

CLASS 45—(Continued).

SN 77-287,516. AMERICAN CASE MANAGEMENT ASSOCIATION, LITTLE ROCK, AR. FILED 9-24-2007.

ACMA'S COMPARE-DA

THE MARK CONSISTS OF STANDARD CHARACTERS WITHOUT CLAIM TO ANY PARTICULAR FONT, STYLE, SIZE, OR COLOR.

OWNER OF U.S. REG. NOS. 2,497,012 AND 2,557,744.
FOR HOSPITAL AND HEALTHCARE CASE MANAGEMENT SERVICES IN THE NATURE OF PROVIDING STANDARDIZED CATEGORIES, DEFINITIONS, CODING, AND BENCHMARKING FOR PATIENT CARE EVALUATION (U.S. CLS. 100 AND 101).
CURTIS FRENCH, EXAMINING ATTORNEY

SN 77-288,691. WORLD SINGLES, LLC, IRVINE, CA. FILED 9-25-2007.

IRANIANPERSONALS.COM

THE MARK CONSISTS OF STANDARD CHARACTERS WITHOUT CLAIM TO ANY PARTICULAR FONT, STYLE, SIZE, OR COLOR.

SEC. 2(F).
FOR INTERNET BASED SOCIAL NETWORKING, INTRODUCTION, AND DATING SERVICES (U.S. CLS. 100 AND 101).
FIRST USE 5-31-2001; IN COMMERCE 5-31-2001.
WOODROW HARTZOG, EXAMINING ATTORNEY

SN 77-288,711. WORLD SINGLES, LLC, IRVINE, CA. FILED 9-25-2007.

ELIGIBLEGREEKS.COM

THE MARK CONSISTS OF STANDARD CHARACTERS WITHOUT CLAIM TO ANY PARTICULAR FONT, STYLE, SIZE, OR COLOR.

SEC. 2(F).
FOR INTERNET BASED SOCIAL NETWORKING, INTRODUCTION, AND DATING SERVICES (U.S. CLS. 100 AND 101).
FIRST USE 1-31-2002; IN COMMERCE 1-31-2002.
WOODROW HARTZOG, EXAMINING ATTORNEY

CLASS 45—(Continued).

SN 77-291,110. CAESAR, RIVISE, BERNSTEIN, COHEN & POKOTILOW, LTD., PHILADELPHIA, PA. FILED 9-28-2007.

IP LAW IS IN OUR DNA

THE MARK CONSISTS OF STANDARD CHARACTERS WITHOUT CLAIM TO ANY PARTICULAR FONT, STYLE, SIZE, OR COLOR.

FOR LEGAL SERVICES (U.S. CLS. 100 AND 101).
FIRST USE 4-9-2006; IN COMMERCE 4-9-2006.
DOMINICK J. SALEMI, EXAMINING ATTORNEY

SN 77-291,937. CONCIERGE ON THE GO, MANHATTEN BEACH, CA. FILED 9-28-2007.

CONCIERGE ON THE GO

THE MARK CONSISTS OF STANDARD CHARACTERS WITHOUT CLAIM TO ANY PARTICULAR FONT, STYLE, SIZE, OR COLOR.

NO CLAIM IS MADE TO THE EXCLUSIVE RIGHT TO USE "CONCIERGE", APART FROM THE MARK AS SHOWN.

FOR PERSONAL CONCIERGE SERVICES FOR OTHERS COMPRISING MAKING REQUESTED PERSONAL ARRANGEMENTS AND RESERVATIONS, RUNNING ERRANDS AND PROVIDING CUSTOMER SPECIFIC INFORMATION TO MEET INDIVIDUAL NEEDS, ALL RENDERED IN BUSINESS ESTABLISHMENTS, OFFICE BUILDINGS, HOTELS, RESIDENTIAL COMPLEXES AND HOMES (U.S. CLS. 100 AND 101).
FIRST USE 2-22-2007; IN COMMERCE 2-22-2007.
BENJAMIN ALLEN, EXAMINING ATTORNEY

SN 77-292,178. CIRELLO & VESSICCHIO, LLC, NEW HAVEN, CT. FILED 9-28-2007.

LawyerYou

THE MARK CONSISTS OF STANDARD CHARACTERS WITHOUT CLAIM TO ANY PARTICULAR FONT, STYLE, SIZE, OR COLOR.

FOR LEGAL SERVICES AND LEGAL CONSULTATION (U.S. CLS. 100 AND 101).
FIRST USE 9-15-2007; IN COMMERCE 9-15-2007.
EMILY CARLSEN, EXAMINING ATTORNEY

CLASS 45—(Continued).

SN 77-292,502. SECUREWORKS, INC., ATLANTA, GA. FILED 10-1-2007.

SHERLOCK

THE MARK CONSISTS OF STANDARD CHARACTERS WITHOUT CLAIM TO ANY PARTICULAR FONT, STYLE, SIZE, OR COLOR.

FOR COMPUTER SECURITY SERVICES, NAMELY, AGGREGATING, MANAGING AND DISPLAYING SECURITY INFORMATION, MONITORING THE SECURITY STATUS OF COMPUTER NETWORKS AND GENERATING SECURITY RESPONSES BASED ON NETWORK ALERTS ON SELECTED METRICS OR DISPLAYS (U.S. CLS. 100 AND 101).

FIRST USE 6-0-2001; IN COMMERCE 6-0-2001.
MICHAEL ENGEL, EXAMINING ATTORNEY

SN 77-292,772. HOWARD, VICTORIA, BOCA RATON, FL. FILED 10-1-2007.

KICK HIM TO THE CURB

THE MARK CONSISTS OF STANDARD CHARACTERS WITHOUT CLAIM TO ANY PARTICULAR FONT, STYLE, SIZE, OR COLOR.

FOR ORGANIZING AND CONDUCTING SUPPORT GROUPS FOR WOMEN WHO MEET ONCE A MONTH AND TALK ABOUT THEIR TOXIC RELATIONSHIPS (U.S. CLS. 100 AND 101).

JANICE L. MCMORROW, EXAMINING ATTORNEY

SN 77-293,271. CAVIAR 23 LLC, LAKE FOREST, CA. FILED 10-1-2007.

CAVIAR 23

THE MARK CONSISTS OF STANDARD CHARACTERS WITHOUT CLAIM TO ANY PARTICULAR FONT, STYLE, SIZE, OR COLOR.

FOR LICENSING OF REGISTERED TRADEMARKS, SCREENPLAYS, WEB ADDRESSES, DESIGN WORK, ART, FILM AND TELEVISION CONCEPTS, CHARACTERS (U.S. CLS. 100 AND 101).

GRETTA YAO, EXAMINING ATTORNEY

CLASS 45—(Continued).

SN 77-293,944. DISABILITY RIGHTS ADVOCATES, BERKELEY, CA. FILED 10-2-2007.



NO CLAIM IS MADE TO THE EXCLUSIVE RIGHT TO USE "DISABILITY RIGHTS ADVOCATES" AND "A NON-PROFIT CORPORATION", APART FROM THE MARK AS SHOWN.

THE COLOR(S) RED AND BLACK IS/ARE CLAIMED AS A FEATURE OF THE MARK.

THE MARK CONSISTS OF A RED, TAPERING ARCH (NARROW END ON THE LEFT AND WIDE END ON THE RIGHT), UNDERNEATH WHICH ARE RED, STYLIZED, CAPITALIZED LETTERS "DRA," UNDERNEATH WHICH ARE BLACK, CAPITALIZED, AND UNDERLINED WORDS "DISABILITY RIGHTS ADVOCATES, UNDERNEATH WHICH ARE BLACK WORDS THAT READ "A NON-PROFIT CORPORATION".

FOR LEGAL SERVICES (U.S. CLS. 100 AND 101).
FIRST USE 12-1-2005; IN COMMERCE 12-1-2005.
PATRICIA EVANKO, EXAMINING ATTORNEY

SN 77-294,375. WALSH LAW PLLC, OKEMOS, MI. FILED 10-2-2007.

www.lawrefs.com

THE MARK CONSISTS OF STANDARD CHARACTERS WITHOUT CLAIM TO ANY PARTICULAR FONT, STYLE, SIZE, OR COLOR.

FOR LEGAL SERVICES (U.S. CLS. 100 AND 101).
FIRST USE 3-1-2007; IN COMMERCE 3-1-2007.
GIANCARLO CASTRO, EXAMINING ATTORNEY

SN 77-294,511. HYAQ, INC., MERCER ISLAND, WA. FILED 10-2-2007.

PAYPHRASE

THE MARK CONSISTS OF STANDARD CHARACTERS WITHOUT CLAIM TO ANY PARTICULAR FONT, STYLE, SIZE, OR COLOR.

FOR PROVIDING USER AUTHENTICATION OF ELECTRONIC FUNDS TRANSFER, CREDIT AND DEBIT CARD AND ELECTRONIC CHECK TRANSACTIONS VIA A GLOBAL COMPUTER NETWORK; PROVIDING USER AUTHENTICATION SERVICES IN E-COMMERCE TRANSACTIONS (U.S. CLS. 100 AND 101).

SIMON TENG, EXAMINING ATTORNEY

CLASS 45—(Continued).

SN 77-294,522. QUARLES, ANTHONY K., NEW YORK, NY. FILED 10-2-2007.

"GORILLA FORCE"

THE MARK CONSISTS OF STANDARD CHARACTERS WITHOUT CLAIM TO ANY PARTICULAR FONT, STYLE, SIZE, OR COLOR.

NO CLAIM IS MADE TO THE EXCLUSIVE RIGHT TO USE "GORILLA", APART FROM THE MARK AS SHOWN.

FOR BODYGUARD SERVICES; CONSULTATION SERVICES IN THE FIELD OF THE SAFETY NEEDS OF COMMERCIAL AND INDUSTRIAL COMPANIES; GUARD SERVICES; SECURITY GUARD SERVICES; SECURITY SERVICES, NAMELY, PROVIDING EXECUTIVE PROTECTION; SECURITY SERVICES, NAMELY, PROVIDING SECURITY ASSESSMENTS OF PHYSICAL LOCATIONS, INFORMATION SYSTEMS, AND WORKING ENVIRONMENTS (U.S. CLS. 100 AND 101).

FIRST USE 9-18-1993; IN COMMERCE 9-18-1993.
BRENDAN MCCAULEY, EXAMINING ATTORNEY

SN 77-294,535. ADRENALINE STUDENT MINISTRIES, WINTER GARDEN, FL. FILED 10-2-2007.

Adrenaline Youth Ministries

THE MARK CONSISTS OF STANDARD CHARACTERS WITHOUT CLAIM TO ANY PARTICULAR FONT, STYLE, SIZE, OR COLOR.

NO CLAIM IS MADE TO THE EXCLUSIVE RIGHT TO USE "YOUTH MINISTRIES", APART FROM THE MARK AS SHOWN.

FOR MINISTERIAL SERVICES (U.S. CLS. 100 AND 101).

FIRST USE 5-1-2007; IN COMMERCE 5-1-2007.
ADA HAN, EXAMINING ATTORNEY

SN 77-294,688. GROUP9, INC., LANGHORNE, PA. FILED 10-3-2007.

CLOSENOW!

THE MARK CONSISTS OF STANDARD CHARACTERS WITHOUT CLAIM TO ANY PARTICULAR FONT, STYLE, SIZE, OR COLOR.

FOR REAL ESTATE CLOSING SERVICES; LOAN CLOSING SERVICES; CLOSING SERVICES FOR MORTGAGE LOANS (U.S. CLS. 100 AND 101).

FIRST USE 7-9-2007; IN COMMERCE 7-9-2007.
TASNEEM HUSSAIN, EXAMINING ATTORNEY

CLASS 45—(Continued).

SN 77-295,226. GRAY, EDWARD W., JR., WASHINGTON, DC. FILED 10-3-2007.

MASTER OF THE GRAY AREA

THE MARK CONSISTS OF STANDARD CHARACTERS WITHOUT CLAIM TO ANY PARTICULAR FONT, STYLE, SIZE, OR COLOR.

FOR LEGAL SERVICES (U.S. CLS. 100 AND 101).
TARAH HARDY, EXAMINING ATTORNEY

SN 77-295,472. FINAL GIFT PET CREMATION SERVICES, INC, CRANSTON, RI. FILED 10-3-2007.



THE MARK CONSISTS OF AN IMAGE OF A STANDING BROAD SIDE DOG STANDING IN BACK OF A STANDING BROAD SIDE CAT. THE CAT FORMS THE UNDERSIDE IMAGE OF THE DOG. THE STYLIZED WORDS "FINAL GIFT" ARE IN THE FOREFRONT. THERE IS AN OVAL DRAWN WITH TWO LINES WHICH CIRCLE THE CAT AND THE WORD FINAL ENTIRELY AND A PORTION OF THE DOG AND THE WORD GIFT.

FOR CREMATION AND BURIAL SERVICES OF PETS (U.S. CLS. 100 AND 101).

FIRST USE 8-11-2004; IN COMMERCE 11-19-2004.
MARIA-VICTORIA SUAREZ, EXAMINING ATTORNEY

SN 77-295,778. GRAFFITI TRACKER, INC., OMAHA, NE. FILED 10-4-2007.

GT

THE MARK CONSISTS OF STANDARD CHARACTERS WITHOUT CLAIM TO ANY PARTICULAR FONT, STYLE, SIZE, OR COLOR.

FOR PROVIDING PRIVATE ENTITIES, AND LOCAL, STATE AND FEDERAL LAW ENFORCEMENT AGENCIES WITH INTELLIGENCE AND INFORMATION GATHERED FROM THE ANALYSIS AND TRACKING OF INCIDENCES OF GRAFFITI (U.S. CLS. 100 AND 101).

FIRST USE 12-5-2006; IN COMMERCE 12-5-2006.
HEATHER THOMPSON, EXAMINING ATTORNEY

CLASS 45—(Continued).

SN 77-296,305. ERELATING, LLC, ALPHARETTA, GA.
FILED 10-4-2007.

ERELATING

THE MARK CONSISTS OF STANDARD CHARACTERS WITHOUT CLAIM TO ANY PARTICULAR FONT, STYLE, SIZE, OR COLOR.

FOR ONLINE SOCIAL NETWORKING SERVICES (U.S. CLS. 100 AND 101).

FIRST USE 9-30-2006; IN COMMERCE 9-30-2006.
SALLY SHIH, EXAMINING ATTORNEY

SN 77-296,428. CIVILITYROCKS, CHICAGO, IL. FILED 10-4-2007.



THE MARK CONSISTS OF THE WORDS "CIVILITY ROCKS!" WITHOUT A SPACE BETWEEN THEM SUPERIMPOSED OVER SIX INDIVIDUALS SHOWN IN SILHOUETTE EXCITEDLY JUMPING UP.

FOR COUNSELING IN ETIQUETTE AND PROTOCOL (U.S. CLS. 100 AND 101).

FIRST USE 6-30-2007; IN COMMERCE 7-31-2007.
LINDA M. KING, EXAMINING ATTORNEY

SN 77-296,841. IDENTITY PADLOCK LLC, DBA IDENTITY-PADLOCK, WESTPORT, CT. FILED 10-5-2007.

IdentityPadlock

THE MARK CONSISTS OF STANDARD CHARACTERS WITHOUT CLAIM TO ANY PARTICULAR FONT, STYLE, SIZE, OR COLOR.

FOR CONSULTATION IN THE FIELD OF DATA THEFT AND IDENTITY THEFT; FINANCIAL IDENTITY MONITORING SERVICE (U.S. CLS. 100 AND 101).

FIRST USE 9-20-2007; IN COMMERCE 10-2-2007.
WILLIAM VERHOSEK, EXAMINING ATTORNEY

CLASS 45—(Continued).

SN 77-307,433. EBAY INC., SAN JOSE, CA. FILED 10-18-2007.

NEIGHBORHOODS

THE MARK CONSISTS OF STANDARD CHARACTERS WITHOUT CLAIM TO ANY PARTICULAR FONT, STYLE, SIZE, OR COLOR.

FOR ONLINE SOCIAL NETWORKING SERVICES (U.S. CLS. 100 AND 101).

LINDA MICKLEBURGH, EXAMINING ATTORNEY

SN 77-328,841. LUNCEFORD, SHANE TROY, SAN JOSE, CA. FILED 11-14-2007.



FOR COMPUTER DATING SERVICES; DATING SERVICES; INTERNET BASED SOCIAL NETWORKING, INTRODUCTION, AND DATING SERVICES; MARRIAGE PARTNER INTRODUCTION OR DATING SERVICES; PROVIDING A WEBSITE FEATURING INFORMATION AND CONTENT IN THE FIELDS OF PERSONAL RELATIONSHIPS, DATING AND FASHION; MATCHMAKING SERVICES; ONLINE SOCIAL NETWORKING SERVICES; SOCIAL INTRODUCTION AGENCIES (U.S. CLS. 100 AND 101).

YAT SYE, LEE, EXAMINING ATTORNEY

SN 77-341,015. HYAQ, INC., MERCER ISLAND, WA. FILED 11-30-2007.

BUYPHRASE

THE MARK CONSISTS OF STANDARD CHARACTERS WITHOUT CLAIM TO ANY PARTICULAR FONT, STYLE, SIZE, OR COLOR.

FOR PROVIDING USER AUTHENTICATION OF ELECTRONIC FUNDS TRANSFER, CREDIT AND DEBIT CARD AND ELECTRONIC CHECK TRANSACTIONS VIA A GLOBAL COMPUTER NETWORK; PROVIDING USER AUTHENTICATION SERVICES IN E-COMMERCE TRANSACTIONS (U.S. CLS. 100 AND 101).

SIMON TENG, EXAMINING ATTORNEY

CLASS 45—(Continued).

SN 78-915,686. UNITED STATES DEPARTMENT OF HOMELAND SECURITY, WASHINGTON, DC. FILED 6-23-2006.



THE COLOR(S) GREEN, RED, TAN, WHITE, BLACK, YELLOW, AND PINK IS/ARE CLAIMED AS A FEATURE OF THE MARK.

THE MARK CONSISTS OF A MALE MOUNTAIN LION. THE ENTIRE MOUNTAIN LION IS OUTLINED IN BLACK. THE LION'S FACE, ARMS, LEGS, AND TAIL ARE TAN AND WHITE; THE TIP OF THE TAIL IS BLACK; HIS HAT IS TAN WITH GREEN TRIM AND A BLACK PAW PRINT; THE LION HAS GREEN EYES AND A PINK NOSE; HE WEARS A RED BANDANA, A YELLOW AND WHITE WATCH, GREEN OVERALLS WITH YELLOW AND BLACK DETAILING, A TAN AND YELLOW TOOL BELT, WHICH INCLUDES A BLACK AND WHITE CANTEEN AND A RED, BLACK, AND YELLOW FLASHLIGHT.

FOR PROVIDING INFORMATION TO HELP PREPARE FAMILIES WITH CHILDREN FOR RESPONDING TO EMERGENCIES, INCLUDING NATURAL DISASTERS AND MAN-MADE EMERGENCIES; PROVIDING CONSULTATION AND INFORMATION TO PARENTS AND TEACHERS IN THE FIELD OF EMERGENCY RESPONSE FOR COMMUNITIES (U.S. CLS. 100 AND 101).

FIRST USE 2-6-2006; IN COMMERCE 2-6-2006.
TOBY BULLOFF, EXAMINING ATTORNEY

CLASS 45—(Continued).

SN 78-915,704. UNITED STATES DEPARTMENT OF HOMELAND SECURITY, WASHINGTON, DC. FILED 6-23-2006.



THE COLOR(S) TAN, WHITE, BLACK, GREEN, YELLOW, PINK, PURPLE, BLUE AND RED IS/ARE CLAIMED AS A FEATURE OF THE MARK.

THE MARK CONSISTS OF A FEMALE MOUNTAIN LION. THE ENTIRE FEMALE LION IS OUTLINED IN BLACK. THE LION'S FACE, ARMS, LEGS AND TAIL ARE TAN AND WHITE; THE TIP OF THE TAIL IS BLACK; THE LION HAS GREEN EYES AND A PINK NOSE; SHE WEARS A PURPLE AND YELLOW DRESS AND JEWELRY THAT IS WHITE, BLUE, RED, YELLOW, GREEN, AND PURPLE.

FOR PROVIDING INFORMATION TO HELP PREPARE FAMILIES WITH CHILDREN FOR RESPONDING TO EMERGENCIES, INCLUDING NATURAL DISASTERS AND MAN-MADE EMERGENCIES; PROVIDING CONSULTATION AND INFORMATION TO PARENTS AND TEACHERS IN THE FIELD OF EMERGENCY RESPONSE FOR COMMUNITIES (U.S. CLS. 100 AND 101).

FIRST USE 2-6-2006; IN COMMERCE 2-6-2006.
TOBY BULLOFF, EXAMINING ATTORNEY

SN 78-915,718. UNITED STATES DEPARTMENT OF HOMELAND SECURITY, WASHINGTON, DC. FILED 6-23-2006.



THE COLOR(S) TAN, WHITE, BLACK, BLUE, RED, YELLOW, ORANGE, BROWN AND PINK IS/ARE CLAIMED AS A FEATURE OF THE MARK.

THE MARK CONSISTS OF A FEMALE MOUNTAIN

CLASS 45—(Continued).

LION. THE ENTIRE MOUNTAIN LION IS OUTLINED IN BLACK. THE LION'S FACE, ARMS, LEGS AND TAIL ARE TAN AND WHITE; THE TIP OF THE TAIL IS BLACK; THE LION HAS BLUE EYES AND A PINK NOSE. SHE IS WEARING BLUE JEANS, A BROWN AND YELLOW BELT, AN ORANGE AND BLACK SHIRT, BRACELETS THAT ARE RED, YELLOW, BLUE, GREEN, A BROWN ANKLET, AND A WHITE PENDANT ON A BLACK NECKLACE. HER PORTABLE AUDIO PLAYER WITH HEADPHONES IS BLACK.

FOR PROVIDING INFORMATION TO HELP PREPARE FAMILIES WITH CHILDREN FOR RESPONDING TO EMERGENCIES, INCLUDING NATURAL DISASTERS AND MAN-MADE EMERGENCIES; PROVIDING CONSULTATION AND INFORMATION TO PARENTS AND TEACHERS IN THE FIELD OF EMERGENCY RESPONSE FOR COMMUNITIES (U.S. CLS. 100 AND 101).

FIRST USE 2-6-2006; IN COMMERCE 2-6-2006.
TOBY BULLOFF, EXAMINING ATTORNEY

CLASS 45—(Continued).

SN 78-951,397. SCHAFFER, ROBIN, EAST BRUNSWICK, NJ. FILED 8-14-2006.

MASTERFUL KIDS

THE MARK CONSISTS OF STANDARD CHARACTERS WITHOUT CLAIM TO ANY PARTICULAR FONT, STYLE, SIZE, OR COLOR.

NO CLAIM IS MADE TO THE EXCLUSIVE RIGHT TO USE "KIDS", APART FROM THE MARK AS SHOWN.

FOR PROVIDING ON-LINE INFORMATION, INCLUDING VIDEO CONTENT, IN THE FIELD OF SELF-HELP AND PERSONAL EMPOWERMENT SUBJECT MATTERS (U.S. CLS. 100 AND 101).

BRENDAN REGAN, EXAMINING ATTORNEY

SN 78-942,080. BIKINIS AND BIFOCALS, LLC, LAGRANGE, KY. FILED 8-1-2006.

BIKINIS AND BIFOCALS

THE MARK CONSISTS OF STANDARD CHARACTERS WITHOUT CLAIM TO ANY PARTICULAR FONT, STYLE, SIZE, OR COLOR.

FOR PROVIDING ONLINE INFORMATION SERVICES RELATING TO MIDDLE-AGED WOMEN, NAMELY, TOPICS RELATING TO ONLINE SOCIAL NETWORKING (U.S. CLS. 100 AND 101).

LOURDES AYALA, EXAMINING ATTORNEY

SN 78-971,957. WHISPERINGTREE.NET, BOULDER, CO. FILED 9-12-2006.



THE COLOR(S) GREEN, REDDISH ORANGE, AND DARK GREY IS/ARE CLAIMED AS A FEATURE OF THE MARK.

THE MARK CONSISTS OF A GREEN TREE WITH REDDISH ORANGE BERRIES ON TOP OF THE WORDS "WHISPERINGTREE.NET." THE TERM "WHISPERING" APPEARS IN GREEN, THE TERMS "TREE" AND "NET" APPEAR IN DARK GREY, AND THE DOT APPEARS IN REDDISH ORANGE.

FOR PROVIDING ON-LINE INFORMATION IN THE FIELD OF SPIRITUALITY, SELF-HELP, AND PERSONAL EMPOWERMENT SUBJECT MATTERS (U.S. CLS. 100 AND 101).

FIRST USE 9-6-2006; IN COMMERCE 9-10-2006.
FRANK LATTUCA, EXAMINING ATTORNEY

* * * * *

SECTION 4.—PRIOR UNITED STATES CLASSIFICATION

APPLICATION IN ONE CLASS

COLLECTIVE MEMBERSHIP MARKS

CLASS 200—COLLECTIVE MEMBERSHIP
SN 77-216,965. GREEN SPA NETWORK, INC., FREESTONE,
CA. FILED 6-27-2007.



NO CLAIM IS MADE TO THE EXCLUSIVE RIGHT TO USE "GREEN SPA NETWORK", APART FROM THE MARK AS SHOWN.

FOR INDICATING MEMBERSHIP IN AN ASSOCIATION OF HEALTH AND BEAUTY SPA BUSINESSES THAT ARE COMMITTED TO UTILIZING ENVIRONMENTALLY RESPONSIBLE PRACTICES AND PROMOTING THE PRESERVATION AND SAFEGUARDING OF THE ENVIRONMENT.

FIRST USE 3-1-2006; IN COMMERCE 3-1-2006.
LEIGH CAROLINE CASE, EXAMINING ATTORNEY

SN 77-253,054. BROTHERS IN ARMS MOTORCYCLE CLUB,
TACOMA, WA. FILED 8-11-2007.



NO CLAIM IS MADE TO THE EXCLUSIVE RIGHT TO USE "ARMY", APART FROM THE MARK AS SHOWN.

THE COLOR(S) BLUE, RED, WHITE, GOLD, SILVER, GREEN AND BLACK IS/ARE CLAIMED AS A FEATURE OF THE MARK.

THE COLOR BLUE APPEARS IN THE BACKGROUND OF THE MARK AND THE COLOR GREEN APPEARS IN THE EYE OF THE EAGLE, THE COLOR GOLD APPEARS IN THE WORDING "BROTHERS-IN-ARMS", "MC" AND "ARMY", THE OUTLINE OF THE SHIELD DESIGN AND THE OUT-

LINE OF THE STRIPES APPEARING INSIDE THE SHIELD AND THE BEAK OF THE EAGLE, THE COLOR RED APPEARS ON THE HANDLE OF THE SWORD AND THE THREE STRIPES APPEARING INSIDE THE SHIELD, THE COLOR SILVER APPEARS IN THE OVERALL OUTLINE OF THE SWORD AND THE BLADES OF THE SWORD, THE COLOR WHITE APPEARS ON THE STARS, THE TWO OF THE STRIPES APPEARING INSIDE SHIELD, AND THE EAGLES HEAD, AND THE COLOR BLACK OUTLINES THE EAGLE DESIGN.

FOR INDICATING MEMBERSHIP IN A MOTORCYCLE CLUB .

FIRST USE 10-1-2002; IN COMMERCE 10-1-2002.
JENNY PARK, EXAMINING ATTORNEY

SN 77-280,935. AMERICAN ASSOCIATION OF ORTHOPAEDIC EXECUTIVES, ROSEMONT, IL. FILED 9-17-2007.

AAOE AMERICAN ASSOCIATION OF ORTHOPAEDIC EXECUTIVES

THE MARK CONSISTS OF STANDARD CHARACTERS WITHOUT CLAIM TO ANY PARTICULAR FONT, STYLE, SIZE, OR COLOR.

NO CLAIM IS MADE TO THE EXCLUSIVE RIGHT TO USE "AMERICAN ASSOCIATION OF ORTHOPAEDIC EXECUTIVES", APART FROM THE MARK AS SHOWN.

FOR INDICATING MEMBERSHIP IN A(N) ORGANIZATION OF ORTHOPAEDIC ADMINISTRATORS.
ELISSA GARBER KON, EXAMINING ATTORNEY

CERTIFICATION MARKS

CLASS A—GOODS

SN 75-516,529. CONSORZIO DEL FORMAGGIO PARMIGIANO-REGGIANO, 42100 REGGIO EMILIA, ITALY, FILED 7-10-1998.

REGGIANO

OWNER OF U.S. REG. NOS. 1,753,059, 1,896,683 AND OTHERS.

THE ENGLISH TRANSLATION OF THE MARK 'REGGIANO' IS "OF REGGIO".

THE CERTIFICATION MARK, AS USED BY PERSONS AUTHORIZED BY CERTIFIER, CERTIFIES THAT THE GOODS ORIGINATE IN THE PARMA-REGGIO REGION OF ITALY, SPECIFICALLY THE ZONE COMPRISING THE TERRITORY OF THE PROVINCES OF PARMA, REGGIO EMILIA, MODENA AND MANTUA ON THE RIGHT BANK OF THE RIVER PO AND BOLOGNA ON THE LEFT BANK OF THE RIVER RENO.

FOR CHEESE.
FIRST USE 4-10-1954; IN COMMERCE 5-25-1965.
FLORENTINA BLANDU, EXAMINING ATTORNEY

CLASS B—SERVICES

SN 77-082,170. PRAXIS INVESTMENTS, LLC, BOISE, ID. FILED 1-12-2007.

SN 77-122,773. STEVE & EDI ENTERPRISES INC. DBA MENTOR PLUS, CARMEL VALLEY, CA. FILED 3-5-2007.

CSSS - CERTIFIED SHORT SALES SPECIALIST



THE MARK CONSISTS OF STANDARD CHARACTERS WITHOUT CLAIM TO ANY PARTICULAR FONT, STYLE, SIZE, OR COLOR.

NO CLAIM IS MADE TO THE EXCLUSIVE RIGHT TO USE CERTIFIED SHORT SALES SPECIALIST, APART FROM THE MARK AS SHOWN.

THE CERTIFICATION MARK AS USED BY PERSONS AUTHORIZED BY THE CERTIFIER CERTIFIES THAT THE PERSON DISPLAYING THE MARK MEETS OR EXCEEDS THE CERTIFIER'S MINIMUM ESTABLISHED EXPERIENCE AND EDUCATION STANDARDS FOR KNOWLEDGE AND COMPETENCY IN THE FIELD OF GENERAL DISTRESSED REAL ESTATE PRINCIPLES AND PRACTICES

FOR REAL ESTATE/FINANCIAL BROKERAGE.
FIRST USE 1-7-2007; IN COMMERCE 1-7-2007.
DORITT L. CARROLL, EXAMINING ATTORNEY

NO CLAIM IS MADE TO THE EXCLUSIVE RIGHT TO USE "CERTIFIED IN STRATEGIC PERFORMANCE MANAGEMENT", APART FROM THE MARK AS SHOWN.

THE CERTIFICATION MARK, AS USED BY PERSONS AUTHORIZED BY THE CERTIFIER, CERTIFIES THAT THE SERVICE PROVIDERS HAVE MET MINIMUM STANDARDS OF EXPERIENCE, KNOWLEDGE, AND SKILLS AS ESTABLISHED BY THE CERTIFIER IN THE FIELD OF BUSINESS CONSULTING..

FOR BUSINESS AND MANAGEMENT CONSULTING.
MICHELE SWAIN, EXAMINING ATTORNEY

SN 77-100,042. ASSOCIATION OF CLINICAL RESEARCH PROFESSIONALS, INC., ALEXANDRIA, VA. FILED 2-6-2007.

SN 78-707,657. INSTITUTE OF CORPORATE DIRECTORS, TORONTO, CANADA, FILED 9-6-2005.

ICD CERTIFIED DIRECTOR

CPI

THE MARK CONSISTS OF STANDARD CHARACTERS WITHOUT CLAIM TO ANY PARTICULAR FONT, STYLE, SIZE, OR COLOR.

PRIORITY CLAIMED UNDER SEC. 44(D) ON CANADA APPLICATION NO. 1250205, FILED 3-10-2005, REG. NO. TMA667377, DATED 7-12-2006, EXPIRES 7-12-2021.

OWNER OF U.S. REG. NOS. 3,049,350 AND 3,058,717.

NO CLAIM IS MADE TO THE EXCLUSIVE RIGHT TO USE "CERTIFIED DIRECTOR", APART FROM THE MARK AS SHOWN.

THE CERTIFICATION MARK, AS INTENDED TO BE USED BY AUTHORIZED PERSONS, IS INTENDED TO CERTIFY THAT SUCH PERSONS HAVE SUCCESSFULLY COMPLETED A PARTICULAR SERIES OF DIRECTOR EDUCATION COURSES, PASSED ACCREDITATION EXAMS, AND SUCCESSFULLY COMPLETED AN ORAL INTERVIEW PROCESS.

FOR BUSINESS MANAGEMENT CONSULTATION SERVICES FOR ACCREDITING CORPORATE DIRECTORS OF PUBLIC AND PRIVATE CORPORATIONS, AND NOT-FOR-PROFIT COMPANIES.

PAULA MAHONEY, EXAMINING ATTORNEY

THE MARK CONSISTS OF STANDARD CHARACTERS WITHOUT CLAIM TO ANY PARTICULAR FONT, STYLE, SIZE, OR COLOR.

THE CERTIFICATION MARK IS INTENDED TO BE USED BY AUTHORIZED PERSONS TO CERTIFY THAT THEY MEET THE STANDARDS OF PROFICIENCY AND EXPERIENCE AND HAVE ATTAINED A LEVEL OF EDUCATION AS SET BY THE CERTIFIER.

FOR CLINICAL RESEARCH AND DEVELOPMENT.
FIRST USE 0-0-2002; IN COMMERCE 0-0-2002.
ELIZABETH KAJUBI, EXAMINING ATTORNEY

TRADEMARK REGISTRATIONS ISSUED

PRINCIPAL REGISTER

SECTION 1.— INTERNATIONAL CLASSIFICATION

The short titles associated below with the international class numbers are terms designed merely for quick identification and are not an official part of the international classification. The full names of international classes are given in section 6.1 of the trademark rules of practice.

The designation "U.S. Cl." appearing in this section refers to the U.S. class in effect prior to Sep. 1, 1973 rather than the international class which applies to applications filed on or after that date. For adoption of international classification see notice in the OFFICIAL GAZETTE of Jun. 26, 1973 (911 O.G. TM 210).

CLASS 1—CHEMICALS

- 3,396,914. **CONVALEX (BLOCK FORM)**. INLAND VACUUM INDUSTRIES, INC., (U.S. CLS. 1, 5, 6, 10, 26 AND 46). SN 76-675,457. PUB. 1-1-2008. FILED 4-13-2007.
- 3,396,934. **LEBANON (BLOCK FORM)**. LEBANON SEABOARD CORPORATION, MULTIPLE CLASS, (INT. CLS. 1, 5 AND 31), (U.S. CLS. 1, 5, 6, 10, 18, 26, 44, 46, 51 AND 52). SN 76-678,784. PUB. 1-1-2008. FILED 6-27-2007.
- 3,397,049. **APLICARE (BLOCK FORM)**. APLICARE, INC., MULTIPLE CLASS, (INT. CLS. 1, 3, 5 AND 21), (U.S. CLS. 1, 2, 4, 5, 6, 10, 13, 18, 23, 26, 29, 30, 33, 40, 44, 46, 50, 51 AND 52). SN 77-039,201. PUB. 1-1-2008. FILED 11-8-2006.
- 3,397,208. **PROSTAR (BLOCK FORM)**. PRAXAIR TECHNOLOGY, INC., MULTIPLE CLASS, (INT. CLS. 1 AND 6), (U.S. CLS. 1, 2, 5, 6, 10, 12, 13, 14, 23, 25, 26, 46 AND 50). SN 77-070,781. PUB. 1-1-2008. FILED 12-22-2006.
- 3,397,291. **BIOLEND (BLOCK FORM)**. MOTOR OIL, INC., MULTIPLE CLASS, (INT. CLS. 1, 2, 4 AND 17), (U.S. CLS. 1, 5, 6, 10, 11, 12, 13, 15, 16, 26, 35, 46 AND 50). SN 77-091,871. PUB. 1-1-2008. FILED 1-26-2007.
- 3,397,375. **I-SABI WASABI JAPONICA AND DESIGN**. BIOCELL TECHNOLOGY, LLC, (U.S. CLS. 1, 5, 6, 10, 26 AND 46). SN 77-116,377. PUB. 1-1-2008. FILED 2-26-2007.
- 3,397,476. **BIOIONE (BLOCK FORM)**. A.L.E.G., INC., (U.S. CLS. 1, 5, 6, 10, 26 AND 46). SN 77-159,424. PUB. 1-1-2008. FILED 4-18-2007.
- 3,397,751. **EXTREME GREEN (BLOCK FORM)**. J.R. SIMPLOT COMPANY, (U.S. CLS. 1, 5, 6, 10, 26 AND 46). SN 77-222,774. PUB. 1-1-2008. FILED 7-5-2007.
- 3,397,828. **TRIPLE EIGHT (BLOCK FORM)**. GLOBAL ORGANICS, LLC, (U.S. CLS. 1, 5, 6, 10, 26 AND 46). SN 77-227,142. PUB. 1-1-2008. FILED 7-11-2007.
- 3,397,830. **CHICKEN NUGGETS (BLOCK FORM)**. GLOBAL ORGANICS, LLC, (U.S. CLS. 1, 5, 6, 10, 26 AND 46). SN 77-227,171. PUB. 1-1-2008. FILED 7-11-2007.
- 3,397,831. **MEGATURF (BLOCK FORM)**. GLOBAL ORGANICS, LLC, (U.S. CLS. 1, 5, 6, 10, 26 AND 46). SN 77-227,214. PUB. 1-1-2008. FILED 7-11-2007.
- 3,397,834. **MEGACAL (BLOCK FORM)**. GLOBAL ORGANICS, LLC, (U.S. CLS. 1, 5, 6, 10, 26 AND 46). SN 77-227,242. PUB. 1-1-2008. FILED 7-11-2007.
- 3,397,837. **MEGA-K (BLOCK FORM)**. GLOBAL ORGANICS, LLC, (U.S. CLS. 1, 5, 6, 10, 26 AND 46). SN 77-227,260. PUB. 1-1-2008. FILED 7-11-2007.
- 3,397,840. **FULVEX (BLOCK FORM)**. GLOBAL ORGANICS, LLC, (U.S. CLS. 1, 5, 6, 10, 26 AND 46). SN 77-227,292. PUB. 1-1-2008. FILED 7-11-2007.
- 3,397,842. **DYNAMEGA (BLOCK FORM)**. GLOBAL ORGANICS, LLC, (U.S. CLS. 1, 5, 6, 10, 26 AND 46). SN 77-227,315. PUB. 1-1-2008. FILED 7-11-2007.
- 3,397,844. **CRUMBLES (BLOCK FORM)**. GLOBAL ORGANICS, LLC, (U.S. CLS. 1, 5, 6, 10, 26 AND 46). SN 77-227,336. PUB. 1-1-2008. FILED 7-11-2007.
- 3,398,010. **HAFNIUM OXIMET (BLOCK FORM)**. GENERAL SCIENCES, INC., (U.S. CLS. 1, 5, 6, 10, 26 AND 46). SN 77-230,473. PUB. 1-1-2008. FILED 7-16-2007.
- 3,398,098. **BIO PURE AND DESIGN**. BIO-PURE PRODUCTS, INC., (U.S. CLS. 1, 5, 6, 10, 26 AND 46). SN 77-231,854. PUB. 1-1-2008. FILED 7-17-2007.
- 3,398,312. **BIO FRESH-END (BLOCK FORM)**. ADVANCED BIOLOGICAL MARKETING, (U.S. CLS. 1, 5, 6, 10, 26 AND 46). SN 77-254,384. PUB. 1-1-2008. FILED 8-14-2007.
- 3,398,313. **SEPTIC-EEZE (BLOCK FORM)**. ADVANCED BIOLOGICAL MARKETING, (U.S. CLS. 1, 5, 6, 10, 26 AND 46). SN 77-254,410. PUB. 1-1-2008. FILED 8-14-2007.
- 3,398,704. **SINOCEM AND DESIGN**. SINOCEM CORPORATION, (U.S. CLS. 1, 5, 6, 10, 26 AND 46). SN 79-032,883. PUB. 1-1-2008. FILED 12-11-2006.
- 3,398,710. **SINOCEM (STYLIZED)**. SINOCEM CORPORATION, (U.S. CLS. 1, 5, 6, 10, 26 AND 46). SN 79-033,162. PUB. 1-1-2008. FILED 12-11-2006.
- 3,398,712. **DAIRYGOX (BLOCK FORM)**. DANISCO A/S, (U.S. CLS. 1, 5, 6, 10, 26 AND 46). SN 79-033,610. PUB. 1-1-2008. FILED 12-9-2006.
- 3,398,713. **DAIRYCAT (BLOCK FORM)**. DANISCO A/S, (U.S. CLS. 1, 5, 6, 10, 26 AND 46). SN 79-033,626. PUB. 1-1-2008. FILED 12-8-2006.
- 3,398,724. **LINEALENE (BLOCK FORM)**. IDEMITSU KOSAN CO., LTD., (U.S. CLS. 1, 5, 6, 10, 26 AND 46). SN 79-034,484. PUB. 1-1-2008. FILED 1-9-2007.
- 3,398,729. **MISCELLANEOUS DESIGN**. SINOCEM CORPORATION, (U.S. CLS. 1, 5, 6, 10, 26 AND 46). SN 79-034,703. PUB. 1-1-2008. FILED 12-15-2006.
- 3,398,753. **BEKAERT (BLOCK FORM)**. N.V. BEKAERT S.A., MULTIPLE CLASS, (INT. CLS. 1, 6, 17 AND 40), (U.S. CLS. 1, 2, 5, 6, 10, 12, 13, 14, 23, 25, 26, 35, 46, 50, 100, 103 AND 106). SN 79-035,355. PUB. 1-1-2008. FILED 8-25-2006.
- 3,398,757. **BASONETIC (BLOCK FORM)**. BASF AKTIENGESELLSCHAFT, MULTIPLE CLASS, (INT. CLS. 1 AND 4), (U.S. CLS. 1, 5, 6, 10, 15, 26 AND 46). SN 79-035,661. PUB. 1-1-2008. FILED 1-5-2007.
- 3,398,768. **SOLACOR (BLOCK FORM)**. OXONICA MATERIALS LIMITED, (U.S. CLS. 1, 5, 6, 10, 26 AND 46). SN 79-036,374. PUB. 1-1-2008. FILED 11-13-2006.
- 3,398,792. **GUOGUANG AND DESIGN**. SICHUAN GUOGUANG; AGROCHEMICAL CO., LTD, (U.S. CLS. 1, 5, 6, 10, 26 AND 46). SN 79-038,531. PUB. 1-1-2008. FILED 4-3-2007.
- 3,398,799. **EMCOL (STYLIZED)**. EMSLAND-STÄRKE GMBH, (U.S. CLS. 1, 5, 6, 10, 26 AND 46). SN 79-039,866. PUB. 1-1-2008. FILED 5-24-2007.
- 3,398,814. **EMGRANULE (STYLIZED)**. EMSLAND-STÄRKE GMBH, MULTIPLE CLASS, (INT. CLS. 1, 2, 5 AND 30), (U.S. CLS. 1, 5, 6, 10, 11, 16, 18, 26, 44, 46, 51 AND 52). SN 79-041,095. PUB. 1-1-2008. FILED 5-16-2007.
- 3,398,815. **EMFLAKE (STYLIZED)**. EMSLAND-STÄRKE GMBH, MULTIPLE CLASS, (INT. CLS. 1, 2, 5 AND 30), (U.S. CLS. 1, 5, 6, 10, 11, 16, 18, 26, 44, 46, 51 AND 52). SN 79-041,096. PUB. 1-1-2008. FILED 5-16-2007.

CLASS 2—PAINTS

- 3,397,083. **SNOW SEAL (BLOCK FORM)**. AMES RESEARCH LABORATORIES, INC., (U.S. CLS. 6, 11 AND 16). SN 77-049,022. PUB. 1-1-2008. FILED 11-21-2006.
- 3,397,291 (See Class 1 for this trademark).

- 3,397,299. **PANASONIC (BLOCK FORM)**. MATSUSHITA ELECTRIC INDUSTRIAL CO., LTD., (U.S. CLS. 6, 11 AND 16). SN 77-095,866. PUB. 1-1-2008. FILED 1-31-2007.
- 3,397,498. **AUDITIONS AND DESIGN**. LF. LLC, MULTIPLE CLASS, (INT. CLS. 2 AND 37), (U.S. CLS. 6, 11, 16, 100, 103 AND 106). SN 77-166,505. PUB. 1-1-2008. FILED 4-26-2007.
- 3,397,671. **DYH DESIGNING YOUR HOME AND DESIGN**. JOMAX INTERNATIONAL, CORP., (U.S. CLS. 6, 11 AND 16). SN 77-213,386. PUB. 1-1-2008. FILED 6-22-2007.
- 3,398,814 (*See Class 1 for this trademark*).
- 3,398,815 (*See Class 1 for this trademark*).

CLASS 3—COSMETICS AND CLEANING PREPARATIONS

- 3,396,822. **ARMSTRONG (BLOCK FORM)**. AWI LICENSING COMPANY, MULTIPLE CLASS, (INT. CLS. 3, 6, 19 AND 27), (U.S. CLS. 1, 2, 4, 6, 12, 13, 14, 19, 20, 23, 25, 33, 37, 42, 50, 51 AND 52). SN 76-512,500. PUB. 1-1-2008. FILED 5-8-2003.
- 3,396,836. **INKOMFE (BLOCK FORM)**. JOY LIMITED, (U.S. CLS. 1, 4, 6, 50, 51 AND 52). SN 76-619,118. PUB. 1-1-2008. FILED 11-3-2004.
- 3,396,847. **PRANA EVOLUTIONS AND DESIGN**. PRANA EVOLUTIONS, (U.S. CLS. 1, 4, 6, 50, 51 AND 52). SN 76-646,767. PUB. 1-1-2008. FILED 9-14-2005.
- 3,396,932. **RA AND DESIGN**. ROCCO ALTOBELLI, INC., (U.S. CLS. 1, 4, 6, 50, 51 AND 52). SN 76-678,353. PUB. 1-1-2008. FILED 6-18-2007.
- 3,396,933. **ROCCO ALTOBELLI (BLOCK FORM)**. ROCCO ALTOBELLI, INC., (U.S. CLS. 1, 4, 6, 50, 51 AND 52). SN 76-678,397. PUB. 1-1-2008. FILED 6-18-2007.
- 3,396,991. **OLIVEOLOGY (BLOCK FORM)**. BELLO, ANDREW, JR., (U.S. CLS. 1, 4, 6, 50, 51 AND 52). SN 77-018,510. PUB. 1-1-2008. FILED 10-11-2006.
- 3,397,035. **TOKYO BY KENZO (BLOCK FORM)**. KENZO S.A., (U.S. CLS. 1, 4, 6, 50, 51 AND 52). SN 77-033,364. PUB. 1-1-2008. FILED 10-31-2006.
- 3,397,038. **H HOPE AESTHETICS SKINCARE AND DESIGN**. HOPE AESTHETICS COSMECEUTICAL, INC., (U.S. CLS. 1, 4, 6, 50, 51 AND 52). SN 77-034,157. PUB. 1-1-2008. FILED 11-1-2006.
- 3,397,049 (*See Class 1 for this trademark*).
- 3,397,094. **REDI-GLASS (BLOCK FORM)**. U.S. NONWOVENS CORPORATION, (U.S. CLS. 1, 4, 6, 50, 51 AND 52). SN 77-051,958. PUB. 1-1-2008. FILED 11-28-2006.
- 3,397,117. **STEELMAGIC (BLOCK FORM)**. U.S. TECHNOLOGY CORPORATION, (U.S. CLS. 1, 4, 6, 50, 51 AND 52). SN 77-057,422. PUB. 1-1-2008. FILED 12-5-2006.
- 3,397,164. **DESIGNED FOR REAL LIFE (BLOCK FORM)**. REITMANS (CANADA) LIMITED, MULTIPLE CLASS, (INT. CLS. 3, 9, 18 AND 25), (U.S. CLS. 1, 2, 3, 4, 6, 21, 22, 23, 26, 36, 38, 39, 41, 50, 51 AND 52). SN 77-065,580. PUB. 1-1-2008. FILED 12-15-2006.
- 3,397,313. **CARBOREX (BLOCK FORM)**. WASHINGTON MILLS COMPANY, (U.S. CLS. 1, 4, 6, 50, 51 AND 52). SN 77-097,598. PUB. 1-1-2008. FILED 2-2-2007.
- 3,397,323. **PANASONIC (BLOCK FORM)**. MATSUSHITA ELECTRIC INDUSTRIAL CO., LTD., MULTIPLE CLASS, (INT. CLS. 3, 17, 28 AND 36), (U.S. CLS. 1, 4, 5, 6, 12, 13, 22, 23, 35, 38, 50, 51, 52, 100, 101 AND 102). SN 77-099,043. PUB. 1-1-2008. FILED 2-5-2007.
- 3,397,327. **RR LINE AND DESIGN**. RR Y ASOCIADOS,S.A., (U.S. CLS. 1, 4, 6, 50, 51 AND 52). SN 77-100,311. PUB. 1-1-2008. FILED 2-6-2007.
- 3,397,373. **EXLINEA (BLOCK FORM)**. PHYSICIAN'S CARE ALLIANCE, LLC, (U.S. CLS. 1, 4, 6, 50, 51 AND 52). SN 77-115,544. PUB. 1-1-2008. FILED 2-24-2007.
- 3,397,411. **MAKE UP STORE (BLOCK FORM)**. MAKE UP STORE AB, MULTIPLE CLASS, (INT. CLS. 3 AND 44), (U.S. CLS. 1, 4, 6, 50, 51, 52, 100 AND 101). SN 77-131,909. PUB. 1-1-2008. FILED 3-15-2007.
- 3,397,422. **URINE TROUBLE! (BLOCK FORM)**. INNIVATION, LLC, (U.S. CLS. 1, 4, 6, 50, 51 AND 52). SN 77-136,330. PUB. 9-25-2007. FILED 3-21-2007.
- 3,397,445. **HAPPY MAMA ESSENTIALS AND DESIGN**. RILEYCORUM, LEYEA R, AND CORUM, BENJAMIN M, (U.S. CLS. 1, 4, 6, 50, 51 AND 52). SN 77-144,403. PUB. 1-1-2008. FILED 3-30-2007.
- 3,397,610. **SWISSCLINICAL AND DESIGN**. SWISSCLINICAL S.A., (U.S. CLS. 1, 4, 6, 50, 51 AND 52). SN 77-201,170. PUB. 1-1-2008. FILED 6-8-2007.
- 3,397,624. **1 2 3 (BLOCK FORM)**. HENKEL CAPITAL, S.A. DE C.V., (U.S. CLS. 1, 4, 6, 50, 51 AND 52). SN 77-203,925. PUB. 11-27-2007. FILED 6-12-2007.
- 3,397,691. **VIM VIM ESSENTIALS (STYLIZED)**. KATAI, NOELLE C., (U.S. CLS. 1, 4, 6, 50, 51 AND 52). SN 77-215,960. PUB. 1-1-2008. FILED 6-26-2007.
- 3,397,825. **WIPEKINS (BLOCK FORM)**. CYNTHIA S FER-RARO, (U.S. CLS. 1, 4, 6, 50, 51 AND 52). SN 77-226,916. PUB. 1-1-2008. FILED 7-11-2007.
- 3,397,848. **RECYCLED PRINCESS (STYLIZED)**. SARA ELIZABETH WALTHER, (U.S. CLS. 1, 4, 6, 50, 51 AND 52). SN 77-227,434. PUB. 1-1-2008. FILED 7-11-2007.
- 3,397,860. **FRAGRANCE STUDIO (BLOCK FORM)**. COUSIN CORPORATION OF AMERICA, (U.S. CLS. 1, 4, 6, 50, 51 AND 52). SN 77-227,784. PUB. 1-1-2008. FILED 7-12-2007.
- 3,397,882. **THE STAIN REMEDY (BLOCK FORM)**. FOREVER NEW INTERNATIONAL, INC., (U.S. CLS. 1, 4, 6, 50, 51 AND 52). SN 77-228,089. PUB. 1-1-2008. FILED 7-12-2007.
- 3,397,932. **ALLGONE (BLOCK FORM)**. EARTH FRIENDLY CHEMICALS, INC., (U.S. CLS. 1, 4, 6, 50, 51 AND 52). SN 77-229,105. PUB. 1-1-2008. FILED 7-13-2007.
- 3,397,942. **ERMINIA ESSENCE (BLOCK FORM)**. CASTANEDA, ERMINIA, (U.S. CLS. 1, 4, 6, 50, 51 AND 52). SN 77-229,292. PUB. 1-1-2008. FILED 7-13-2007.
- 3,397,992. **HAIR FOUNDATION (BLOCK FORM)**. MARK ADAMS, (U.S. CLS. 1, 4, 6, 50, 51 AND 52). SN 77-230,276. PUB. 1-1-2008. FILED 7-16-2007.
- 3,398,001. **ZIM'S (BLOCK FORM)**. PERFECTA PRODUCTS, INC., (U.S. CLS. 1, 4, 6, 50, 51 AND 52). SN 77-230,391. PUB. 1-1-2008. FILED 7-16-2007.
- 3,398,003. **PROLIPOSOME (BLOCK FORM)**. PROSTRONG, INC., (U.S. CLS. 1, 4, 6, 50, 51 AND 52). SN 77-230,405. PUB. 1-1-2008. FILED 7-16-2007.
- 3,398,071. **PROCOAT (BLOCK FORM)**. PROSTRONG, INC., (U.S. CLS. 1, 4, 6, 50, 51 AND 52). SN 77-231,396. PUB. 1-1-2008. FILED 7-17-2007.
- 3,398,073. **PROACCELERATOR (BLOCK FORM)**. PROSTRONG, INC., (U.S. CLS. 1, 4, 6, 50, 51 AND 52). SN 77-231,428. PUB. 1-1-2008. FILED 7-17-2007.
- 3,398,106. **LABORIORE REMEDE AND DESIGN**. BLISS WORLD LLC, (U.S. CLS. 1, 4, 6, 50, 51 AND 52). SN 77-231,981. PUB. 1-1-2008. FILED 7-17-2007.
- 3,398,130. **DKNY RED DELICIOUS (BLOCK FORM)**. GABRIELLE STUDIO, INC., (U.S. CLS. 1, 4, 6, 50, 51 AND 52). SN 77-232,327. PUB. 1-1-2008. FILED 7-18-2007.
- 3,398,148. **SWAGAT (BLOCK FORM)**. R. EXPO, (U.S. CLS. 1, 4, 6, 50, 51 AND 52). SN 77-232,631. PUB. 1-1-2008. FILED 7-18-2007.
- 3,398,158. **ZODIAC (BLOCK FORM)**. R. EXPO, (U.S. CLS. 1, 4, 6, 50, 51 AND 52). SN 77-232,755. PUB. 1-1-2008. FILED 7-18-2007.
- 3,398,159. **IFRENEL (BLOCK FORM)**. MATIAS, JONATHAN R., (U.S. CLS. 1, 4, 6, 50, 51 AND 52). SN 77-232,759. PUB. 1-1-2008. FILED 7-18-2007.
- 3,398,173. **POOF! (BLOCK FORM)**. POOF, LLC, (U.S. CLS. 1, 4, 6, 50, 51 AND 52). SN 77-233,143. PUB. 1-1-2008. FILED 7-18-2007.
- 3,398,178. **SUKICOLOR (BLOCK FORM)**. SUKI, INC., (U.S. CLS. 1, 4, 6, 50, 51 AND 52). SN 77-233,312. PUB. 1-1-2008. FILED 7-19-2007.
- 3,398,194. **SEPTICON (BLOCK FORM)**. ALOPECIL CORPORATION, C X A., (U.S. CLS. 1, 4, 6, 50, 51 AND 52). SN 77-233,617. PUB. 1-1-2008. FILED 7-19-2007.
- 3,398,208. **ECO-PH (BLOCK FORM)**. GORS, DON, (U.S. CLS. 1, 4, 6, 50, 51 AND 52). SN 77-233,972. PUB. 1-1-2008. FILED 7-19-2007.
- 3,398,229. **SCENTPAK (BLOCK FORM)**. INTELLISCENTS, LLC, (U.S. CLS. 1, 4, 6, 50, 51 AND 52). SN 77-234,585. PUB. 1-1-2008. FILED 7-20-2007.
- 3,398,230. **DEMOSCENTER (BLOCK FORM)**. INTELLISCENTS, LLC, (U.S. CLS. 1, 4, 6, 50, 51 AND 52). SN 77-234,587. PUB. 1-1-2008. FILED 7-20-2007.
- 3,398,245. **BEAUTIFUL FLOORS MADE EASY (BLOCK**

FORM). RECKITT BENCKISER INC., (U.S. CLS. 1, 4, 6, 50, 51 AND 52). SN 77-237,048. PUB. 1-1-2008. FILED 7-24-2007.

3,398,256. **VOCI DELLA MORA (BLOCK FORM)**. BLOOMWORKS SOAP COMPANY, LC, (U.S. CLS. 1, 4, 6, 50, 51 AND 52). SN 77-241,471. PUB. 1-1-2008. FILED 7-29-2007.

3,398,262. **PERFECT-IT (BLOCK FORM)**. 3M COMPANY, (U.S. CLS. 1, 4, 6, 50, 51 AND 52). SN 77-241,751. PUB. 1-1-2008. FILED 7-30-2007.

3,398,269. **GUINEFYR'S TRYST (BLOCK FORM)**. BLOOMWORKS SOAP COMPANY, LC, (U.S. CLS. 1, 4, 6, 50, 51 AND 52). SN 77-244,299. PUB. 1-1-2008. FILED 8-1-2007.

3,398,270. **CADEBERRY MOSS (BLOCK FORM)**. BLOOMWORKS SOAP COMPANY, LC, (U.S. CLS. 1, 4, 6, 50, 51 AND 52). SN 77-244,314. PUB. 1-1-2008. FILED 8-1-2007.

3,398,272. **MIDNIGHT (BLOCK FORM)**. R. EXPO (USA) LTD., INC., (U.S. CLS. 1, 4, 6, 50, 51 AND 52). SN 77-244,754. PUB. 1-1-2008. FILED 8-1-2007.

3,398,332. **BODYTIQUE (BLOCK FORM)**. BLOOMWORKS SOAP COMPANY, LC, DBA BLOOMWORKS SOAP COMPANY, LC, (U.S. CLS. 1, 4, 6, 50, 51 AND 52). SN 77-258,566. PUB. 1-1-2008. FILED 8-17-2007.

3,398,338. **IDENTOIL (BLOCK FORM)**. SYMRISE GMBH & CO. KG, (U.S. CLS. 1, 4, 6, 50, 51 AND 52). SN 77-269,302. PUB. 1-1-2008. FILED 8-31-2007.

3,398,342. **BODACIOUS (BLOCK FORM)**. BLOOMWORKS SOAP COMPANY, LC, (U.S. CLS. 1, 4, 6, 50, 51 AND 52). SN 77-274,849. PUB. 1-1-2008. FILED 9-7-2007.

3,398,346. **FACETIOUS (BLOCK FORM)**. BLOOMWORKS SOAP COMPANY, LC, (U.S. CLS. 1, 4, 6, 50, 51 AND 52). SN 77-280,394. PUB. 1-1-2008. FILED 9-14-2007.

3,398,363. **TRIBAL INK (BLOCK FORM)**. DIXON, MARK A, (U.S. CLS. 1, 4, 6, 50, 51 AND 52). SN 78-349,120. PUB. 1-1-2008. FILED 1-7-2004.

3,398,402. **SPAZZSTICK (BLOCK FORM)**. HOLSCHEN, RICHARD, (U.S. CLS. 1, 4, 6, 50, 51 AND 52). SN 78-591,347. PUB. 10-10-2006. FILED 3-21-2005.

3,398,426. **DERMASWIM (BLOCK FORM)**. PRO LOTIONS, LLC, (U.S. CLS. 1, 4, 6, 50, 51 AND 52). SN 78-696,171. PUB. 1-1-2008. FILED 8-19-2005.

3,398,452. **SM SHADES OF MONET (STYLIZED)**. COLBERT, MONIQUE, (U.S. CLS. 1, 4, 6, 50, 51 AND 52). SN 78-755,062. PUB. 1-1-2008. FILED 11-16-2005.

3,398,483. **LA POUFRE C'EST MOI (BLOCK FORM)**. GUERLAIN S.A., (U.S. CLS. 1, 4, 6, 50, 51 AND 52). SN 78-821,920. PUB. 1-1-2008. FILED 2-23-2006.

3,398,567. **ORIBE (BLOCK FORM)**. ORIBE LLC, (U.S. CLS. 1, 4, 6, 50, 51 AND 52). SN 78-923,798. PUB. 1-1-2008. FILED 7-6-2006.

3,398,600. **AMMA AND DESIGN**. MATA AMRITANANDAMAYI CENTER, MULTIPLE CLASS, (INT. CLS. 3, 9, 14, 16, 20, 25, 35, 36, 37, 43 AND 45), (U.S. CLS. 1, 2, 4, 5, 6, 13, 21, 22, 23, 25, 26, 27, 28, 29, 32, 36, 37, 38, 39, 50, 51, 52, 100, 101, 102, 103 AND 106). SN 78-964,245. PUB. 9-25-2007. FILED 8-30-2006.

3,398,613. **SASSY LASH AND DESIGN**. NGUYEN, JULIE MONG, MULTIPLE CLASS, (INT. CLS. 3, 35 AND 41), (U.S. CLS. 1, 4, 6, 50, 51, 52, 100, 101, 102 AND 107). SN 78-973,318. PUB. 1-1-2008. FILED 9-13-2006.

3,398,638. **PULSONIC (BLOCK FORM)**. BRAUN GMBH, MULTIPLE CLASS, (INT. CLS. 3 AND 8), (U.S. CLS. 1, 4, 6, 23, 28, 44, 50, 51 AND 52). SN 79-023,419. PUB. 1-1-2008. FILED 12-19-2005.

3,398,703. **A.D.A.D.ITIONAL.JAPAN (BLOCK FORM)**. MACK DADDY CO., LTD., MULTIPLE CLASS, (INT. CLS. 3, 14, 18, 25 AND 26), (U.S. CLS. 1, 2, 3, 4, 6, 22, 27, 28, 37, 39, 40, 41, 42, 50, 51 AND 52). SN 79-032,826. PUB. 1-1-2008. FILED 7-5-2006.

3,398,705. **COSMETIC CHOICE.COM.AU. AND DESIGN**. INSTANT HAIR REMOVAL CLINIC PTY LTD; ACN 095 241 884, MULTIPLE CLASS, (INT. CLS. 3, 5, 35 AND 44), (U.S. CLS. 1, 4, 6, 18, 44, 46, 50, 51, 52, 100, 101 AND 102). SN 79-032,885. PUB. 1-1-2008. FILED 7-5-2006.

3,398,718. **VIVASAN AND DESIGN**. GECCO IMPORT-EXPORT; HANDELSGESELLSCHAFT MBH, MULTIPLE CLASS, (INT. CLS. 3, 5, 29, 30 AND 31), (U.S. CLS. 1, 4, 6, 18, 44, 46, 50, 51 AND 52). SN 79-034,002. PUB. 1-1-2008. FILED 11-29-2006.

3,398,749. **BODY BY UNIQLO (BLOCK FORM)**. KABUSHIKI

KAISHA FAST RETAILING, MULTIPLE CLASS, (INT. CLS. 3, 9, 18, 24 AND 25), (U.S. CLS. 1, 2, 3, 4, 6, 21, 22, 23, 26, 36, 38, 39, 41, 42, 50, 51 AND 52). SN 79-035,205. PUB. 1-1-2008. FILED 6-30-2006.

3,398,755. **NO NAME NAILS (BLOCK FORM)**. PETER TROSKA, MULTIPLE CLASS, (INT. CLS. 3, 35 AND 44), (U.S. CLS. 1, 4, 6, 50, 51, 52, 100, 101 AND 102). SN 79-035,579. PUB. 1-1-2008. FILED 11-27-2006.

3,398,789. **CAROLINA BUCCI AND DESIGN**. FERDINANDO BUCCI S.R.L., MULTIPLE CLASS, (INT. CLS. 3 AND 14), (U.S. CLS. 1, 2, 4, 6, 27, 28, 50, 51 AND 52). SN 79-038,455. PUB. 1-1-2008. FILED 10-25-2006.

3,398,817. **INCANTO HEAVEN (BLOCK FORM)**. SALVATORE FERRAGAMO ITALIA S.P.A., (U.S. CLS. 1, 4, 6, 50, 51 AND 52). SN 79-041,187. PUB. 1-1-2008. FILED 6-8-2007.

CLASS 4—LUBRICANTS AND FUELS

3,397,291 (*See Class 1 for this trademark*).

3,397,641. **MANSFIELD (BLOCK FORM)**. MANSFIELD OIL COMPANY OF GAINESVILLE, INC., MULTIPLE CLASS, (INT. CLS. 4, 35, 39 AND 42), (U.S. CLS. 1, 6, 15, 100, 101, 102 AND 105). SN 77-207,336. PUB. 1-1-2008. FILED 6-15-2007.

3,398,375. **SWIFT-LITE (BLOCK FORM)**. SWIFT-LITE CHARCOAL COMPANY LTD., MULTIPLE CLASS, (INT. CLS. 4 AND 34), (U.S. CLS. 1, 2, 6, 8, 9, 15 AND 17). SN 78-458,355. PUB. 1-1-2008. FILED 7-28-2004.

3,398,757 (*See Class 1 for this trademark*).

3,398,764. **MISCELLANEOUS DESIGN**. OTKRYTOE AKTIONERNOE OBCHTCHESTVO; "NEFTYANAYA KOMPANIYA "LUKOIL", MULTIPLE CLASS, (INT. CLS. 4, 6, 12, 14, 16, 20, 24, 25, 28, 34, 35, 37 AND 39), (U.S. CLS. 1, 2, 5, 6, 8, 9, 12, 13, 14, 15, 17, 19, 21, 22, 23, 25, 27, 28, 29, 31, 32, 35, 37, 38, 39, 42, 44, 50, 100, 101, 102, 103, 105 AND 106). SN 79-036,010. PUB. 1-1-2008. FILED 11-21-2006.

CLASS 5—PHARMACEUTICALS

3,396,827. **WELLNESS ESSENTIALS**. METAGENICS, INC., (U.S. CLS. 6, 18, 44, 46, 51 AND 52). SN 76-553,169. PUB. 1-1-2008. FILED 10-1-2003.

3,396,871. **DIOXYCHLOR (BLOCK FORM)**. CRB INC., DBA AMERICAN BIOLOGICS, (U.S. CLS. 6, 18, 44, 46, 51 AND 52). SN 76-666,798. PUB. 1-1-2008. FILED 9-29-2006.

3,396,900. **DUAL HEALTH PACK (BLOCK FORM)**. GREAT AMERICAN PRODUCTS, INC., (U.S. CLS. 6, 18, 44, 46, 51 AND 52). SN 76-672,591. PUB. 1-1-2008. FILED 2-12-2007.

3,396,915. **NATUZYME (BLOCK FORM)**. BIOPROTON PTY LTD, (U.S. CLS. 6, 18, 44, 46, 51 AND 52). SN 76-675,866. PUB. 1-1-2008. FILED 4-23-2007.

3,396,916. **BIOPROTON (BLOCK FORM)**. BIOPROTON PTY LTD, (U.S. CLS. 6, 18, 44, 46, 51 AND 52). SN 76-675,867. PUB. 1-1-2008. FILED 4-23-2007.

3,396,919. **B. E. TURMERIC 7X (BLOCK FORM)**. ORCAS INTERNATIONAL, INC., (U.S. CLS. 6, 18, 44, 46, 51 AND 52). SN 76-676,026. PUB. 1-1-2008. FILED 4-26-2007.

3,396,924. **MUSCLE & JOINT A-MAX GOLD (BLOCK FORM)**. PEBLE CORP., (U.S. CLS. 6, 18, 44, 46, 51 AND 52). SN 76-677,084. PUB. 1-1-2008. FILED 5-18-2007.

3,396,934 (*See Class 1 for this trademark*).

3,396,942. **SEROLITE (BLOCK FORM)**. RENEWAL FOR LIFE, LLC, (U.S. CLS. 6, 18, 44, 46, 51 AND 52). SN 76-679,536. PUB. 1-1-2008. FILED 7-16-2007.

3,396,943. **SEROBOOST (BLOCK FORM)**. RENEWAL FOR LIFE, LLC, (U.S. CLS. 6, 18, 44, 46, 51 AND 52). SN 76-679,545. PUB. 1-1-2008. FILED 7-16-2007.

3,396,961. **JOINT LOTION RELIEF AND DESIGN**. JOSEPH A. ZAMBITO, (U.S. CLS. 6, 18, 44, 46, 51 AND 52). SN 77-002,837. PUB. 1-1-2008. FILED 9-19-2006.

3,396,978. **CENFLEX HA+ (BLOCK FORM)**. CENTURION SYSTEMS USA INC., (U.S. CLS. 6, 18, 44, 46, 51 AND 52). SN 77-012,686. PUB. 1-1-2008. FILED 10-3-2006.

3,396,986. **ADVANCED HOLISTICS (BLOCK FORM)**. PURE

- ESSENCE LABS, (U.S. CLS. 6, 18, 44, 46, 51 AND 52). SN 77-015,800. PUB. 1-1-2008. FILED 10-6-2006.
- 3,397,002. **MULTI+ DAILY GLOW (BLOCK FORM)**, GENUINE HEALTH INC., (U.S. CLS. 6, 18, 44, 46, 51 AND 52). SN 77-024,093. PUB. 1-1-2008. FILED 10-18-2006.
- 3,397,049 (See Class 1 for this trademark).
- 3,397,051. **BODY IMAGE SOLUTIONS (BLOCK FORM)**, BODY IMAGE SOLUTIONS, LLC, MULTIPLE CLASS, (INT. CLS. 5, 41 AND 44), (U.S. CLS. 6, 18, 44, 46, 51, 52, 100, 101 AND 107). SN 77-039,758. PUB. 1-1-2008. FILED 11-8-2006.
- 3,397,085. **ALOE ADVANTAGE (BLOCK FORM)**, RARE VALLEY RESOURCES, INC, (U.S. CLS. 6, 18, 44, 46, 51 AND 52). SN 77-049,525. PUB. 1-1-2008. FILED 11-22-2006.
- 3,397,162. **SKIN SMOOTHIE (BLOCK FORM)**, GOLDSMITH, IVAN, (U.S. CLS. 6, 18, 44, 46, 51 AND 52). SN 77-065,287. PUB. 1-1-2008. FILED 12-15-2006.
- 3,397,177. **BITE BLOCKER XTREME (BLOCK FORM)**, HOMS, LLC, (U.S. CLS. 6, 18, 44, 46, 51 AND 52). SN 77-068,337. PUB. 1-1-2008. FILED 12-20-2006.
- 3,397,203. **CYTOSPORT AND DESIGN**, CYTOSPORT, INC., MULTIPLE CLASS, (INT. CLS. 5 AND 32), (U.S. CLS. 6, 18, 44, 45, 46, 48, 51 AND 52). SN 77-070,437. PUB. 1-1-2008. FILED 12-22-2006.
- 3,397,260. **LONGIVAL (BLOCK FORM)**, BIOFARMA, (U.S. CLS. 6, 18, 44, 46, 51 AND 52). SN 77-084,100. PUB. 1-1-2008. FILED 1-16-2007.
- 3,397,270. **ENHANCE750 (BLOCK FORM)**, LA WEIGHT LOSS FRANCHISE COMPANY, (U.S. CLS. 6, 18, 44, 46, 51 AND 52). SN 77-086,848. PUB. 1-1-2008. FILED 1-19-2007.
- 3,397,381. **TRANSFORMING LIVES CHANGING PERCEPTIONS AND DESIGN**, ARES TRADING S.A., MULTIPLE CLASS, (INT. CLS. 5 AND 44), (U.S. CLS. 6, 18, 44, 46, 51, 52, 100 AND 101). SN 77-117,488. PUB. 1-1-2008. FILED 2-27-2007.
- 3,397,394. **RELIMATIC (BLOCK FORM)**, GLAXO GROUP LIMITED, (U.S. CLS. 6, 18, 44, 46, 51 AND 52). SN 77-123,483. PUB. 1-1-2008. FILED 3-6-2007.
- 3,397,413. **NUTRILINA (BLOCK FORM)**, VASQUEZ, CARLOS, (U.S. CLS. 6, 18, 44, 46, 51 AND 52). SN 77-133,762. PUB. 1-1-2008. FILED 3-17-2007.
- 3,397,432. **AMPM FLEX (BLOCK FORM)**, H&N HERBS, (U.S. CLS. 6, 18, 44, 46, 51 AND 52). SN 77-139,756. PUB. 9-25-2007. FILED 3-25-2007.
- 3,397,437. **PAVAZEN (BLOCK FORM)**, TAKEDA PHARMACEUTICAL COMPANY LIMITED, (U.S. CLS. 6, 18, 44, 46, 51 AND 52). SN 77-141,418. PUB. 11-27-2007. FILED 3-27-2007.
- 3,397,453. **ESSIX (BLOCK FORM)**, RAIN TREE ESSIX INC., (U.S. CLS. 6, 18, 44, 46, 51 AND 52). SN 77-149,736. PUB. 1-1-2008. FILED 4-5-2007.
- 3,397,471. **ANTERCONLINS AND DESIGN**, SUPERMED HEALTH INC., (U.S. CLS. 6, 18, 44, 46, 51 AND 52). SN 77-157,064. PUB. 1-1-2008. FILED 4-15-2007.
- 3,397,490. **SIS (BLOCK FORM)**, N CORE LIMITED, (U.S. CLS. 6, 18, 44, 46, 51 AND 52). SN 77-164,214. PUB. 1-1-2008. FILED 4-24-2007.
- 3,397,505. **THE BEAUTY SCOOP (BLOCK FORM)**, YAGODA, M.D., MICHELLE R., AND GANS, PH.D., EUGENE H., (U.S. CLS. 6, 18, 44, 46, 51 AND 52). SN 77-168,260. PUB. 1-1-2008. FILED 4-27-2007.
- 3,397,604. **CUTTER (BLOCK FORM)**, UNITED INDUSTRIES CORPORATION, (U.S. CLS. 6, 18, 44, 46, 51 AND 52). SN 77-200,458. PUB. 1-1-2008. FILED 6-7-2007.
- 3,397,609. **POWDERS PLUS (BLOCK FORM)**, BETTY MITCHELL, (U.S. CLS. 6, 18, 44, 46, 51 AND 52). SN 77-201,070. PUB. 1-1-2008. FILED 6-8-2007.
- 3,397,700. **ONE VISIT. ONE TEST. ONE TIME. (BLOCK FORM)**, QUIDEL CORPORATION, (U.S. CLS. 6, 18, 44, 46, 51 AND 52). SN 77-216,826. PUB. 1-1-2008. FILED 6-27-2007.
- 3,397,754. **SEAGATE AND DESIGN**, FIRST FISHERY DEVELOPMENT SERVICES INC., (U.S. CLS. 6, 18, 44, 46, 51 AND 52). SN 77-223,087. PUB. 1-1-2008. FILED 7-5-2007.
- 3,397,772. **SILOSPHERES (BLOCK FORM)**, MCGRAW, THOMAS L., (U.S. CLS. 6, 18, 44, 46, 51 AND 52). SN 77-224,704. PUB. 1-1-2008. FILED 7-9-2007.
- 3,397,863. **CARTIAXT (BLOCK FORM)**, ANDRX PHARMACEUTICALS, INC., DBA WATSON LABORATORIES - FLORIDA, (U.S. CLS. 6, 18, 44, 46, 51 AND 52). SN 77-227,830. PUB. 1-1-2008. FILED 7-12-2007.
- 3,397,911. **HONGOCHAN (BLOCK FORM)**, CACERES, AUGUSTO B., DBA ABC BEAUTY WHOLESALE, (U.S. CLS. 6, 18, 44, 46, 51 AND 52). SN 77-228,883. PUB. 1-1-2008. FILED 7-13-2007.
- 3,397,965. **QH-ABSORB (BLOCK FORM)**, JARROW FORMULAS, INC., (U.S. CLS. 6, 18, 44, 46, 51 AND 52). SN 77-229,648. PUB. 1-1-2008. FILED 7-13-2007.
- 3,397,968. **Q-ABSORB (BLOCK FORM)**, JARROW FORMULAS, INC., (U.S. CLS. 6, 18, 44, 46, 51 AND 52). SN 77-229,657. PUB. 1-1-2008. FILED 7-13-2007.
- 3,397,984. **VIRX (BLOCK FORM)**, FILO AMERICA, (U.S. CLS. 6, 18, 44, 46, 51 AND 52). SN 77-230,009. PUB. 1-1-2008. FILED 7-15-2007.
- 3,398,045. **FLORAJEN (BLOCK FORM)**, AMERICAN LIFE-LINE, INC, (U.S. CLS. 6, 18, 44, 46, 51 AND 52). SN 77-230,946. PUB. 1-1-2008. FILED 7-16-2007.
- 3,398,046. **FLORAJEN3 (BLOCK FORM)**, AMERICAN LIFE-LINE, INC, (U.S. CLS. 6, 18, 44, 46, 51 AND 52). SN 77-230,963. PUB. 1-1-2008. FILED 7-16-2007.
- 3,398,086. **3V (BLOCK FORM)**, IVX ANIMAL HEALTH, INC., (U.S. CLS. 6, 18, 44, 46, 51 AND 52). SN 77-231,675. PUB. 1-1-2008. FILED 7-17-2007.
- 3,398,088. **URIXIN (BLOCK FORM)**, BIOADVANTEX PHARMA INC., (U.S. CLS. 6, 18, 44, 46, 51 AND 52). SN 77-231,711. PUB. 1-1-2008. FILED 7-17-2007.
- 3,398,090. **PROVANTEX (BLOCK FORM)**, BIOADVANTEX PHARMA INC., (U.S. CLS. 6, 18, 44, 46, 51 AND 52). SN 77-231,717. PUB. 1-1-2008. FILED 7-17-2007.
- 3,398,167. **TODAY (STYLIZED)**, TODAYS WOMENCARE COMPANY, (U.S. CLS. 6, 18, 44, 46, 51 AND 52). SN 77-232,969. PUB. 1-1-2008. FILED 7-18-2007.
- 3,398,224. **CHIGGER-TOX (BLOCK FORM)**, SCHERER LABORATORIES, INC., (U.S. CLS. 6, 18, 44, 46, 51 AND 52). SN 77-234,521. PUB. 1-1-2008. FILED 7-20-2007.
- 3,398,227. **4JOINT HEALTH PLUS (BLOCK FORM)**, GENESIS TODAY, INC., (U.S. CLS. 6, 18, 44, 46, 51 AND 52). SN 77-234,577. PUB. 1-1-2008. FILED 7-20-2007.
- 3,398,231. **DBC (STYLIZED)**, HEALING POWER INC., (U.S. CLS. 6, 18, 44, 46, 51 AND 52). SN 77-234,614. PUB. 1-1-2008. FILED 7-20-2007.
- 3,398,277. **SMARTFLEX (BLOCK FORM)**, SMARTPAK EQUINE, LLC., (U.S. CLS. 6, 18, 44, 46, 51 AND 52). SN 77-245,674. PUB. 1-1-2008. FILED 8-2-2007.
- 3,398,289. **STICK TOGETHER (BLOCK FORM)**, T-MOBILE USA, INC., (U.S. CLS. 6, 18, 44, 46, 51 AND 52). SN 77-249,917. PUB. 1-1-2008. FILED 8-8-2007.
- 3,398,362. **ALLER 24**, CONFIDENCE INC., (U.S. CLS. 6, 18, 44, 46, 51 AND 52). SN 78-310,193. PUB. 1-1-2008. FILED 10-7-2003.
- 3,398,430. **XAWEX (BLOCK FORM)**, WIELAND DENTAL + TECHNIK GMBH & CO. KG, MULTIPLE CLASS, (INT. CLS. 5 AND 10), (U.S. CLS. 6, 18, 26, 39, 44, 46, 51 AND 52). SN 78-710,830. PUB. 11-14-2006. FILED 9-12-2005.
- 3,398,518. **CREOMED (BLOCK FORM)**, CREOMED, INC., MULTIPLE CLASS, (INT. CLS. 5 AND 35), (U.S. CLS. 6, 18, 44, 46, 51, 52, 100, 101 AND 102). SN 78-863,623. PUB. 1-1-2008. FILED 4-18-2006.
- 3,398,536. **READYCHEM (BLOCK FORM)**, READYCHEM INC., (U.S. CLS. 6, 18, 44, 46, 51 AND 52). SN 78-881,351. PUB. 1-1-2008. FILED 5-11-2006.
- 3,398,542. **RHUMATOL (BLOCK FORM)**, VANG, TONG BRUCE, (U.S. CLS. 6, 18, 44, 46, 51 AND 52). SN 78-899,057. PUB. 1-1-2008. FILED 6-2-2006.
- 3,398,616. **VETCAP (STYLIZED)**, VETERINARY ENCAPSULATION BIOSCIENCES PTY LTD, MULTIPLE CLASS, (INT. CLS. 5 AND 13), (U.S. CLS. 2, 6, 9, 18, 44, 46, 51 AND 52). SN 78-974,949. PUB. 1-1-2008. FILED 9-14-2006.
- 3,398,623. **BENEFIBER FIBER SUPPLEMENT AND DESIGN**, NOVARTIS AG, (U.S. CLS. 6, 18, 44, 46, 51 AND 52). SN 79-015,742. PUB. 1-1-2008. FILED 8-4-2005.
- 3,398,650. **LUXAPOST (BLOCK FORM)**, ERNST MÜHLBAUER GMBH & CO. KG, (U.S. CLS. 6, 18, 44, 46, 51 AND 52). SN 79-025,823. PUB. 1-1-2008. FILED 5-5-2006.
- 3,398,668. **ZOLVIX AND DESIGN**, NOVARTIS AG, (U.S. CLS. 6, 18, 44, 46, 51 AND 52). SN 79-029,469. PUB. 1-1-2008. FILED 9-14-2006.

- 3,398,673. **BIOGAIA (BLOCK FORM)**. BIOGAIA AB, MULTIPLE CLASS, (INT. CLS. 5 AND 29), (U.S. CLS. 6, 18, 44, 46, 51 AND 52). SN 79-030,227. PUB. 1-1-2008. FILED 8-11-2006.
- 3,398,681. **MISCELLANEOUS DESIGN**. NOVARTIS AG, (U.S. CLS. 6, 18, 44, 46, 51 AND 52). SN 79-031,344. PUB. 1-1-2008. FILED 10-11-2006.
- 3,398,694. **XYLICYST (BLOCK FORM)**. BIOHIT OYJ, MULTIPLE CLASS, (INT. CLS. 5 AND 30), (U.S. CLS. 6, 18, 44, 46, 51 AND 52). SN 79-032,108. PUB. 1-1-2008. FILED 11-8-2006.
- 3,398,705 (*See Class 3 for this trademark*).
- 3,398,718 (*See Class 3 for this trademark*).
- 3,398,720. **ANI MARINE (STYLIZED)**. LABORATOIRE MOUTIERS MARINE, S.A.R.L., (U.S. CLS. 6, 18, 44, 46, 51 AND 52). SN 79-034,139. PUB. 1-1-2008. FILED 12-7-2006.
- 3,398,740. **TERGANZO (BLOCK FORM)**. ASTRAZENECA AB, (U.S. CLS. 6, 18, 44, 46, 51 AND 52). SN 79-035,045. PUB. 1-1-2008. FILED 12-19-2006.
- 3,398,741. **IGZURO (BLOCK FORM)**. ASTRAZENECA AB, (U.S. CLS. 6, 18, 44, 46, 51 AND 52). SN 79-035,047. PUB. 1-1-2008. FILED 12-19-2006.
- 3,398,742. **FETRUSCO (BLOCK FORM)**. ASTRAZENECA AB, (U.S. CLS. 6, 18, 44, 46, 51 AND 52). SN 79-035,049. PUB. 1-1-2008. FILED 12-19-2006.
- 3,398,743. **FORGRELIS (BLOCK FORM)**. ASTRAZENECA AB, (U.S. CLS. 6, 18, 44, 46, 51 AND 52). SN 79-035,051. PUB. 1-1-2008. FILED 12-19-2006.
- 3,398,774. **TWOCELLS (BLOCK FORM)**. TWO CELLS CO. LTD., MULTIPLE CLASS, (INT. CLS. 5 AND 9), (U.S. CLS. 6, 18, 21, 23, 26, 36, 38, 44, 46, 51 AND 52). SN 79-036,651. PUB. 1-1-2008. FILED 2-8-2007.
- 3,398,786. **RIKKELTA (BLOCK FORM)**. UCB, SOCIÉTÉ ANONYME, (U.S. CLS. 6, 18, 44, 46, 51 AND 52). SN 79-038,210. PUB. 1-1-2008. FILED 4-10-2007.
- 3,398,814 (*See Class 1 for this trademark*).
- 3,398,815 (*See Class 1 for this trademark*).
- 3,398,834. **BRAMITOB (BLOCK FORM)**. CHIESI FARMACEUTICI S.P.A., (U.S. CLS. 6, 18, 44, 46, 51 AND 52). SN 79-043,807. PUB. 1-1-2008. FILED 11-9-2006.
- PUB. 1-1-2008. FILED 6-20-2007.
- 3,397,720. **RMI (BLOCK FORM)**. RMI TITANIUM COMPANY, (U.S. CLS. 2, 12, 13, 14, 23, 25 AND 50). SN 77-219,194. PUB. 1-1-2008. FILED 6-29-2007.
- 3,398,005. **SERVAFRAC (BLOCK FORM)**. SERVA CORPORATION, (U.S. CLS. 2, 12, 13, 14, 23, 25 AND 50). SN 77-230,435. PUB. 1-1-2008. FILED 7-16-2007.
- 3,398,016. **APPLEGATE AND DESIGN**. R.G. APPLEGATE STEEL COMPANY, INC., (U.S. CLS. 2, 12, 13, 14, 23, 25 AND 50). SN 77-230,543. PUB. 1-1-2008. FILED 7-16-2007.
- 3,398,019. **APPLEGATE AND DESIGN**. R.G. APPLEGATE STEEL COMPANY, INC., (U.S. CLS. 2, 12, 13, 14, 23, 25 AND 50). SN 77-230,589. PUB. 1-1-2008. FILED 7-16-2007.
- 3,398,197. **EAGLE SHIELD (BLOCK FORM)**. VICTORY BOLT & SPECIALTY, INC., (U.S. CLS. 2, 12, 13, 14, 23, 25 AND 50). SN 77-233,804. PUB. 1-1-2008. FILED 7-19-2007.
- 3,398,280. **QWEST (BLOCK FORM)**. QWEST COMMUNICATIONS INTERNATIONAL INC., (U.S. CLS. 2, 12, 13, 14, 23, 25 AND 50). SN 77-246,747. PUB. 1-1-2008. FILED 8-3-2007.
- 3,398,296. **STICK TOGETHER (BLOCK FORM)**. T-MOBILE USA, INC., (U.S. CLS. 2, 12, 13, 14, 23, 25 AND 50). SN 77-250,610. PUB. 1-1-2008. FILED 8-8-2007.
- 3,398,486. **TUBULAR USA (BLOCK FORM)**. TUBULAR USA, INC., (U.S. CLS. 2, 12, 13, 14, 23, 25 AND 50). SN 78-823,802. PUB. 1-1-2008. FILED 2-27-2006.
- 3,398,523. **P PACIFIC LOCK AND DESIGN**. PACIFIC LOCK COMPANY, (U.S. CLS. 2, 12, 13, 14, 23, 25 AND 50). SN 78-868,574. PUB. 1-1-2008. FILED 4-24-2006.
- 3,398,526. **QUEST MANUFACTURING CO. AND DESIGN**. QUEST MANUFACTURING CORP, MULTIPLE CLASS, (INT. CLS. 6, 9 AND 20), (U.S. CLS. 2, 12, 13, 14, 21, 22, 23, 25, 26, 32, 36, 38 AND 50). SN 78-870,953. PUB. 1-1-2008. FILED 4-27-2006.
- 3,398,630. **BENZING AND DESIGN**. HUGO BENZING GMBH & CO. KG, MULTIPLE CLASS, (INT. CLS. 6, 7 AND 8), (U.S. CLS. 2, 12, 13, 14, 19, 21, 23, 25, 28, 31, 34, 35, 44 AND 50). SN 79-020,342. PUB. 1-1-2008. FILED 11-25-2005.
- 3,398,644. **XYLX (STYLIZED)**. NINGBO ZHENHAI XINGYI FASTENERS CO., LTD; (NINGBOSHI ZHENHAI XINGYI JINGUJIAN; ZHIZAO YOUXIAN GONGSI), (U.S. CLS. 2, 12, 13, 14, 23, 25 AND 50). SN 79-024,914. PUB. 1-1-2008. FILED 3-27-2006.
- 3,398,645. **NORDPLAN (BLOCK FORM)**. NORD-PLAN A/S, MULTIPLE CLASS, (INT. CLS. 6 AND 20), (U.S. CLS. 2, 12, 13, 14, 22, 23, 25, 32 AND 50). SN 79-025,173. PUB. 1-1-2008. FILED 2-17-2006.
- 3,398,674. **VACONO (BLOCK FORM)**. VACONO ALUMINIUM COVERS GMBH, MULTIPLE CLASS, (INT. CLS. 6, 11, 17, 19 AND 42), (U.S. CLS. 1, 2, 5, 12, 13, 14, 21, 23, 25, 31, 33, 34, 35, 50, 100 AND 101). SN 79-030,270. PUB. 1-1-2008. FILED 5-26-2006.
- 3,398,688. **ARS SONORA AND DESIGN**. PACCARD FONDERIE, MULTIPLE CLASS, (INT. CLS. 6 AND 15), (U.S. CLS. 2, 12, 13, 14, 21, 23, 25, 36 AND 50). SN 79-031,654. PUB. 1-1-2008. FILED 10-30-2006.
- 3,398,706. **MIROSOL PROTECT AND DESIGN**. ALANOD; ALUMINIUM-VEREDLUNG GMBH & CO. KG, MULTIPLE CLASS, (INT. CLS. 6, 11 AND 17), (U.S. CLS. 1, 2, 5, 12, 13, 14, 21, 23, 25, 31, 34, 35 AND 50). SN 79-032,910. PUB. 1-1-2008. FILED 11-14-2006.
- 3,398,753 (*See Class 1 for this trademark*).
- 3,398,764 (*See Class 4 for this trademark*).
- 3,398,779. **WG AND DESIGN**. WUHAN IRON AND STEEL (GROUP) CO., (U.S. CLS. 2, 12, 13, 14, 23, 25 AND 50). SN 79-036,987. PUB. 1-1-2008. FILED 2-21-2007.
- 3,398,812. **POLY CHAIN (BLOCK FORM)**. THE GATES CORPORATION, MULTIPLE CLASS, (INT. CLS. 6, 7 AND 12), (U.S. CLS. 2, 12, 13, 14, 19, 21, 23, 25, 31, 34, 35, 44 AND 50). SN 79-040,932. PUB. 1-1-2008. FILED 4-16-2007.
- 3,398,820. **CABIN (STYLIZED)**. ZHEJIANG PUJIANG PLUMBLOSSOM; LOCK INDUSTRY GROUP CO., LTD, (U.S. CLS. 2, 12, 13, 14, 23, 25 AND 50). SN 79-041,586. PUB. 1-1-2008. FILED 5-9-2007.

CLASS 6—METAL GOODS

- 3,396,822 (*See Class 3 for this trademark*).
- 3,397,121. **LOYAL AND DESIGN**. LOYAL WROUGHT IRON CO., LTD., (U.S. CLS. 2, 12, 13, 14, 23, 25 AND 50). SN 77-057,909. PUB. 1-1-2008. FILED 12-6-2006.
- 3,397,208 (*See Class 1 for this trademark*).
- 3,397,244. **METASPACE (BLOCK FORM)**. SERENUS JOHNSON PORTABLES, LLC, (U.S. CLS. 2, 12, 13, 14, 23, 25 AND 50). SN 77-078,473. PUB. 1-1-2008. FILED 1-8-2007.
- 3,397,269. **BOARDWALK (BLOCK FORM)**. LAGASSE, INC., MULTIPLE CLASS, (INT. CLS. 6, 8, 16 AND 21), (U.S. CLS. 2, 5, 12, 13, 14, 22, 23, 25, 28, 29, 30, 33, 37, 38, 40, 44 AND 50). SN 77-086,775. PUB. 1-1-2008. FILED 1-19-2007.
- 3,397,277. **SS 15 (BLOCK FORM)**. ALLIED TUBE AND CONDUIT CORPORATION, (U.S. CLS. 2, 12, 13, 14, 23, 25 AND 50). SN 77-088,141. PUB. 1-1-2008. FILED 1-22-2007.
- 3,397,350. **WATER WARDEN (BLOCK FORM)**. ESSE TRADING, INC., MULTIPLE CLASS, (INT. CLS. 6 AND 19), (U.S. CLS. 1, 2, 12, 13, 14, 23, 25, 33 AND 50). SN 77-107,562. PUB. 1-1-2008. FILED 2-14-2007.
- 3,397,407. **PPOC AND DESIGN**. PUSH PULL OPEN CLOSE INCORPORATED, (U.S. CLS. 2, 12, 13, 14, 23, 25 AND 50). SN 77-129,269. PUB. 1-1-2008. FILED 3-13-2007.
- 3,397,483. **GEERPRES (BLOCK FORM)**. GEERPRES, INC., MULTIPLE CLASS, (INT. CLS. 6, 20 AND 21), (U.S. CLS. 2, 12, 13, 14, 22, 23, 25, 29, 30, 32, 33, 40 AND 50). SN 77-161,470. PUB. 1-1-2008. FILED 4-20-2007.
- 3,397,530. **QUITE POSSIBLY THE WORLD'S EASIEST MOUNTS TO INSTALL! (BLOCK FORM)**. BELL'O INTERNATIONAL CORP., (U.S. CLS. 2, 12, 13, 14, 23, 25 AND 50). SN 77-177,756. PUB. 1-1-2008. FILED 5-10-2007.
- 3,397,546. **VALMICRO (BLOCK FORM)**. LUPATECH S/A, (U.S. CLS. 2, 12, 13, 14, 23, 25 AND 50). SN 77-185,080. PUB. 1-1-2008. FILED 5-18-2007.
- 3,397,656. **DOPAR (BLOCK FORM)**. UNIROPE LIMITED, (U.S. CLS. 2, 12, 13, 14, 23, 25 AND 50). SN 77-210,755.

CLASS 7—MACHINERY

- 3,396,850. **CW AUTOMOTIVE AND DESIGN**. CW AUTOMOTIVE, INC., (U.S. CLS. 13, 19, 21, 23, 31, 34 AND 35). SN 76-653,029. PUB. 1-1-2008. FILED 1-6-2006.
- 3,396,851. **POWER PAN AND DESIGN**. THE SCOTT FETZER COMPANY, (U.S. CLS. 13, 19, 21, 23, 31, 34 AND 35). SN 76-653,701. PUB. 1-1-2008. FILED 1-20-2006.
- 3,396,874. **AIR 2 GO (BLOCK FORM)**. JENNY PRODUCTS, INCORPORATED, (U.S. CLS. 13, 19, 21, 23, 31, 34 AND 35). SN 76-668,447. PUB. 1-1-2008. FILED 11-2-2006.
- 3,396,925. **IDC SELECT (STYLIZED)**. INDEPENDENT DISTRIBUTORS COOPERATIVE - USA, (U.S. CLS. 13, 19, 21, 23, 31, 34 AND 35). SN 76-677,454. PUB. 1-1-2008. FILED 5-29-2007.
- 3,396,976. **ROBOMOUNT (BLOCK FORM)**. SCHENCK ROTEC GMBH, MULTIPLE CLASS, (INT. CLS. 7, 9 AND 37), (U.S. CLS. 13, 19, 21, 23, 26, 31, 34, 35, 36, 38, 100, 103 AND 106). SN 77-012,543. PUB. 1-1-2008. FILED 10-3-2006.
- 3,396,977. **ROBMOUNT (BLOCK FORM)**. SCHENCK ROTEC GMBH, MULTIPLE CLASS, (INT. CLS. 7, 9 AND 37), (U.S. CLS. 13, 19, 21, 23, 26, 31, 34, 35, 36, 38, 100, 103 AND 106). SN 77-012,619. PUB. 1-1-2008. FILED 10-3-2006.
- 3,397,029. **GENSMART (BLOCK FORM)**. LIGHT ENGINEERING, (U.S. CLS. 13, 19, 21, 23, 31, 34 AND 35). SN 77-031,837. PUB. 1-1-2008. FILED 10-30-2006.
- 3,397,030. **SMARTTORQ (BLOCK FORM)**. LIGHT ENGINEERING, (U.S. CLS. 13, 19, 21, 23, 31, 34 AND 35). SN 77-031,838. PUB. 1-1-2008. FILED 10-30-2006.
- 3,397,037. **MISCELLANEOUS DESIGN**. GUARDAIR CORPORATION, (U.S. CLS. 13, 19, 21, 23, 31, 34 AND 35). SN 77-033,940. PUB. 1-1-2008. FILED 11-1-2006.
- 3,397,095. **ARMORTEC (BLOCK FORM)**. ASTENJOHNSON, INC., (U.S. CLS. 13, 19, 21, 23, 31, 34 AND 35). SN 77-052,155. PUB. 1-1-2008. FILED 11-28-2006.
- 3,397,132. **K1 TECHNOLOGIES AND DESIGN**. DELAWARE CAPITAL FORMATION, INC., (U.S. CLS. 13, 19, 21, 23, 31, 34 AND 35). SN 77-060,379. PUB. 1-1-2008. FILED 12-8-2006.
- 3,397,135. **HIPPO MULTIPOWER SYSTEMS AND DESIGN**. MOBILE HYDRAULICS EQUIPMENT COMPANY, LLC, (U.S. CLS. 13, 19, 21, 23, 31, 34 AND 35). SN 77-061,358. PUB. 1-1-2008. FILED 12-11-2006.
- 3,397,170. **EASYCHANGE (BLOCK FORM)**. CUTSFORTH PRODUCTS, INC., (U.S. CLS. 13, 19, 21, 23, 31, 34 AND 35). SN 77-066,737. PUB. 1-1-2008. FILED 12-18-2006.
- 3,397,294. **CANYON CAPACITY (BLOCK FORM)**. SEARS BRANDS, LLC, MULTIPLE CLASS, (INT. CLS. 7 AND 11), (U.S. CLS. 13, 19, 21, 23, 31, 34 AND 35). SN 77-094,295. PUB. 1-1-2008. FILED 1-30-2007.
- 3,397,300. **PANASONIC (BLOCK FORM)**. MATSUSHITA ELECTRIC INDUSTRIAL CO., LTD., MULTIPLE CLASS, (INT. CLS. 7, 9 AND 11), (U.S. CLS. 13, 19, 21, 23, 26, 31, 34, 35, 36 AND 38). SN 77-095,886. PUB. 1-1-2008. FILED 1-31-2007.
- 3,397,359. **UTS ULTRA-DEX TOOLING SYSTEMS AND DESIGN**. ULTRA-DEX TOOLING SYSTEMS, (U.S. CLS. 13, 19, 21, 23, 31, 34 AND 35). SN 77-109,615. PUB. 1-1-2008. FILED 2-16-2007.
- 3,397,374. **TITAN (BLOCK FORM)**. STEVE CHANDLER, (U.S. CLS. 13, 19, 21, 23, 31, 34 AND 35). SN 77-115,926. PUB. 9-25-2007. FILED 2-26-2007.
- 3,397,455. **SCORPION PERFORMANCE (BLOCK FORM)**. SCORPION PERFORMANCE, INC., (U.S. CLS. 13, 19, 21, 23, 31, 34 AND 35). SN 77-150,396. PUB. 1-1-2008. FILED 4-6-2007.
- 3,397,514. **DEDUSTER (BLOCK FORM)**. PELLETRON CORPORATION, (U.S. CLS. 13, 19, 21, 23, 31, 34 AND 35). SN 77-173,221. PUB. 1-1-2008. FILED 5-4-2007.
- 3,397,528. **HOONVED (STYLIZED)**. HOONVED S.R.L., (U.S. CLS. 13, 19, 21, 23, 31, 34 AND 35). SN 77-177,281. PUB. 1-1-2008. FILED 5-10-2007.
- 3,397,849. **SIMPLE. RELIABLE. SECURE. (BLOCK FORM)**. HY-SECURITY GATE, INC., MULTIPLE CLASS, (INT. CLS. 7 AND 9), (U.S. CLS. 13, 19, 21, 23, 26, 31, 34, 35, 36 AND 38). SN 77-227,462. PUB. 1-1-2008. FILED 7-11-2007.
- 3,397,999. **SERVAPUMP (BLOCK FORM)**. SERVA CORPORATION, (U.S. CLS. 13, 19, 21, 23, 31, 34 AND 35). SN 77-230,372. PUB. 1-1-2008. FILED 7-16-2007.
- 3,398,028. **MULTIPRO (BLOCK FORM)**. CREDO TECHNOLOGY CORPORATION, (U.S. CLS. 13, 19, 21, 23, 31, 34 AND 35). SN 77-230,752. PUB. 1-1-2008. FILED 7-16-2007.
- 3,398,170. **STRETCH-O-MATIC (BLOCK FORM)**. A.M. MACHINERY INC., (U.S. CLS. 13, 19, 21, 23, 31, 34 AND 35). SN 77-233,004. PUB. 1-1-2008. FILED 7-18-2007.
- 3,398,193. **FPT AND DESIGN**. FPT HOLDING S.A., (U.S. CLS. 13, 19, 21, 23, 31, 34 AND 35). SN 77-233,551. PUB. 1-1-2008. FILED 7-19-2007.
- 3,398,351. **STAIREASY AND DESIGN**. ACCESS INTERNATIONAL, INC., DBA ACCESS-ABILITY, INC., (U.S. CLS. 13, 19, 21, 23, 31, 34 AND 35). SN 78-110,907. PUB. 1-1-2008. FILED 2-25-2002.
- 3,398,360. **AJAY**. AJAY EQUIPMENT CORPORATION, MULTIPLE CLASS, (INT. CLS. 7 AND 37), (U.S. CLS. 13, 19, 21, 23, 31, 34, 35, 100, 103 AND 106). SN 78-286,704. PUB. 1-1-2008. FILED 8-13-2003.
- 3,398,382. **WHISPER TECH (BLOCK FORM)**. WHISPER TECH LTD., (U.S. CLS. 13, 19, 21, 23, 31, 34 AND 35). SN 78-512,280. PUB. 5-8-2007. FILED 11-5-2004.
- 3,398,429. **UNIVEX (BLOCK FORM)**. UNIVEX CORPORATION, MULTIPLE CLASS, (INT. CLS. 7 AND 9), (U.S. CLS. 13, 19, 21, 23, 26, 31, 34, 35, 36 AND 38). SN 78-703,237. PUB. 1-1-2008. FILED 8-30-2005.
- 3,398,436. **SNM AND DESIGN**. SHIN NIPPON MACHINERY CO., LTD., (U.S. CLS. 13, 19, 21, 23, 31, 34 AND 35). SN 78-717,812. PUB. 10-31-2006. FILED 9-21-2005.
- 3,398,525. **WHITE HYDRAULICS (BLOCK FORM)**. WHITE DRIVE PRODUCTS, INC., MULTIPLE CLASS, (INT. CLS. 7, 9 AND 12), (U.S. CLS. 13, 19, 21, 23, 26, 31, 34, 35, 36, 38 AND 44). SN 78-869,682. PUB. 1-1-2008. FILED 4-26-2006.
- 3,398,534. **NEXUS (BLOCK FORM)**. BROWN, JOHNNIE W., (U.S. CLS. 13, 19, 21, 23, 31, 34 AND 35). SN 78-879,112. PUB. 1-1-2008. FILED 5-8-2006.
- 3,398,619. **TWINSTAR (BLOCK FORM)**. CFS GERMANY GMBH, MULTIPLE CLASS, (INT. CLS. 7, 16 AND 39), (U.S. CLS. 2, 5, 13, 19, 21, 22, 23, 29, 31, 34, 35, 37, 38, 50, 100 AND 105). SN 79-007,898. PUB. 1-1-2008. FILED 9-9-2004.
- 3,398,630 (See Class 6 for this trademark).
- 3,398,655. **WOLVERINE PROCTOR (BLOCK FORM)**. WOLVERINE PROCTOR & SCHWARTZ LTD, MULTIPLE CLASS, (INT. CLS. 7 AND 11), (U.S. CLS. 13, 19, 21, 23, 31, 34 AND 35). SN 79-026,710. PUB. 1-1-2008. FILED 2-8-2006.
- 3,398,656. **PROCTOR & SCHWARTZ (BLOCK FORM)**. WOLVERINE PROCTOR & SCHWARTZ LTD, MULTIPLE CLASS, (INT. CLS. 7 AND 11), (U.S. CLS. 13, 19, 21, 23, 31, 34 AND 35). SN 79-026,711. PUB. 1-1-2008. FILED 2-8-2006.
- 3,398,684. **CHAIN AND DESIGN**. CONSEIL EUROPEEN DE LA CONSTRUCTION; D'APPAREILS DOMESTIQUES; AISBL EN ABRÉGÉ CECED, MULTIPLE CLASS, (INT. CLS. 7, 9, 11, 35, 37 AND 42), (U.S. CLS. 13, 19, 21, 23, 26, 31, 34, 35, 36, 38, 100, 101, 102, 103 AND 106). SN 79-031,466. PUB. 1-1-2008. FILED 6-8-2006.
- 3,398,696. **VSF (BLOCK FORM)**. OUTOTEC OYJ, MULTIPLE CLASS, (INT. CLS. 7, 40 AND 42), (U.S. CLS. 13, 19, 21, 23, 31, 34, 35, 100, 101, 103 AND 106). SN 79-032,287. PUB. 1-1-2008. FILED 6-28-2006.
- 3,398,716. **ROTER (STYLIZED)**. ROTER HUNGARY LIMITED, MULTIPLE CLASS, (INT. CLS. 7, 12 AND 35), (U.S. CLS. 13, 19, 21, 23, 31, 34, 35, 44, 100, 101 AND 102). SN 79-033,916. PUB. 1-1-2008. FILED 9-6-2006.
- 3,398,730. **AIR THRU AND DESIGN**. DEMAIN TECHNOLOGY PTY LTD, (U.S. CLS. 13, 19, 21, 23, 31, 34 AND 35). SN 79-034,708. PUB. 1-1-2008. FILED 1-9-2007.
- 3,398,732. **ROTOTYPE AND DESIGN**. ROTOTYPE S.P.A., MULTIPLE CLASS, (INT. CLS. 7, 9 AND 16), (U.S. CLS. 2, 5, 13, 19, 21, 22, 23, 26, 29, 31, 34, 35, 36, 37, 38 AND 50). SN 79-034,747. PUB. 1-1-2008. FILED 10-6-2006.
- 3,398,733. **BLUE MAURITIUS LABEL BY DORNIER (BLOCK FORM)**. LINDAUER DORNIER GESELLSCHAFT; MIT BESCHRÄNKTER HAFTUNG., MULTIPLE CLASS, (INT. CLS. 7, 17, 24 AND 25), (U.S. CLS. 1, 5, 12, 13, 19, 21, 22, 23, 31, 34, 35, 39, 42 AND 50). SN 79-034,755. PUB. 1-1-2008. FILED 9-8-2006.
- 3,398,734. **ARCOM AND DESIGN**. CEMDAG MAKINA; SANAYI VE TICARET LIMITED SIRMETI, MULTIPLE CLASS, (INT. CLS. 7 AND 37), (U.S. CLS. 13, 19, 21, 23, 31, 34, 35, 100, 103 AND 106). SN 79-034,798. PUB. 1-1-2008. FILED 12-28-2006.

- 3,398,735. **WOLFFCRANE (BLOCK FORM)**. WOLFFKRAN GMBH, MULTIPLE CLASS, (INT. CLS. 7, 36, 37, 38 AND 42), (U.S. CLS. 13, 19, 21, 23, 31, 34, 35, 100, 101, 102, 103, 104 AND 106). SN 79-034,811. PUB. 1-1-2008. FILED 7-11-2006.
- 3,398,744. **TMB (BLOCK FORM)**. ZHEJIANG TIANMA BEARING CO., LTD, (U.S. CLS. 13, 19, 21, 23, 31, 34 AND 35). SN 79-035,100. PUB. 1-1-2008. FILED 1-19-2007.
- 3,398,748. **TIMBERLINK (STYLIZED)**. DEERE & COMPANY, MULTIPLE CLASS, (INT. CLS. 7, 9, 12 AND 41), (U.S. CLS. 13, 19, 21, 23, 26, 31, 34, 35, 36, 38, 44, 100, 101 AND 107). SN 79-035,201. PUB. 1-1-2008. FILED 8-3-2006.
- 3,398,750. **JUROUND (BLOCK FORM)**. ERWIN JUNKER.; BROUSÍČI TECHNIKA MELNÍK A.S., (U.S. CLS. 13, 19, 21, 23, 31, 34 AND 35). SN 79-035,250. PUB. 1-1-2008. FILED 12-21-2006.
- 3,398,763. **CONDOR (BLOCK FORM)**. AMAZONEN-WERKE H. DREYER GMBH & CO. KG, MULTIPLE CLASS, (INT. CLS. 7 AND 42), (U.S. CLS. 13, 19, 21, 23, 31, 34, 35, 100 AND 101). SN 79-035,936. PUB. 1-1-2008. FILED 9-27-2006.
- 3,398,782. **HOSEKI (STYLIZED)**. ZHEJIANG GEMSY; SEWING MACHINE CO., LTD., (U.S. CLS. 13, 19, 21, 23, 31, 34 AND 35). SN 79-037,233. PUB. 1-1-2008. FILED 3-22-2007.
- 3,398,800. **MISCELLANEOUS DESIGN**. BUCCHI S.R.L., MULTIPLE CLASS, (INT. CLS. 7, 17 AND 20), (U.S. CLS. 1, 2, 5, 12, 13, 19, 21, 22, 23, 25, 31, 32, 34, 35 AND 50). SN 79-039,895. PUB. 1-1-2008. FILED 4-6-2007.
- 3,398,806. **AUTO ADAPT (STYLIZED)**. GRUNDFOS MANAGEMENT A/S, (U.S. CLS. 13, 19, 21, 23, 31, 34 AND 35). SN 79-040,479. PUB. 1-1-2008. FILED 6-6-2007.
- 3,398,812 (*See Class 6 for this trademark*).
- 3,398,816. **AUTO ADAPT (BLOCK FORM)**. GRUNDFOS MANAGEMENT A/S, (U.S. CLS. 13, 19, 21, 23, 31, 34 AND 35). SN 79-041,171. PUB. 1-1-2008. FILED 6-6-2007.
- 3,398,818. **STS SUGIYAMA AND DESIGN**. SUGIYAMA SAW MFG. CO., LTD., (U.S. CLS. 13, 19, 21, 23, 31, 34 AND 35). SN 79-041,409. PUB. 1-1-2008. FILED 7-10-2007.
- 3,398,827. **LM 3000 (BLOCK FORM)**. SATA GMBH & CO. KG, (U.S. CLS. 13, 19, 21, 23, 31, 34 AND 35). SN 79-042,909. PUB. 1-1-2008. FILED 7-13-2007.
- 3,398,833. **FLOATFORCE (BLOCK FORM)**. OUTOTEC OYJ, (U.S. CLS. 13, 19, 21, 23, 31, 34 AND 35). SN 79-043,737. PUB. 1-1-2008. FILED 7-10-2007.

CLASS 8—HAND TOOLS

- 3,397,269 (*See Class 6 for this trademark*).
- 3,397,355. **MULTI-CUT (BLOCK FORM)**. WAHL CLIPPER CORPORATION, (U.S. CLS. 23, 28 AND 44). SN 77-109,008. PUB. 1-1-2008. FILED 2-16-2007.
- 3,397,612. **SPREAD THE LOVE (BLOCK FORM)**. KATE ASPEN, INC., (U.S. CLS. 23, 28 AND 44). SN 77-201,575. PUB. 1-1-2008. FILED 6-8-2007.
- 3,397,983. **PACIFIC (BLOCK FORM)**. FILO AMERICA, (U.S. CLS. 23, 28 AND 44). SN 77-230,004. PUB. 1-1-2008. FILED 7-15-2007.
- 3,398,273. **THE RIGHT TOOL FOR YOUR GOATEE (BLOCK FORM)**. WAHL CLIPPER CORPORATION, (U.S. CLS. 23, 28 AND 44). SN 77-245,174. PUB. 1-1-2008. FILED 8-2-2007.
- 3,398,274. **THE RIGHT TOOL FOR YOUR MUSTACHE (BLOCK FORM)**. WAHL CLIPPER CORPORATION, (U.S. CLS. 23, 28 AND 44). SN 77-245,201. PUB. 1-1-2008. FILED 8-2-2007.
- 3,398,283. **THE RIGHT TOOL FOR YOUR BEARD (BLOCK FORM)**. WAHL CLIPPER CORPORATION, (U.S. CLS. 23, 28 AND 44). SN 77-247,761. PUB. 1-1-2008. FILED 8-6-2007.
- 3,398,519. **MISCELLANEOUS DESIGN**. ODEGARD, INC., MULTIPLE CLASS, (INT. CLS. 8, 11, 19, 20, 21, 24 AND 27), (U.S. CLS. 1, 2, 12, 13, 19, 20, 21, 22, 23, 25, 28, 29, 30, 31, 32, 33, 34, 37, 40, 42, 44 AND 50). SN 78-864,752. PUB. 1-1-2008. FILED 4-19-2006.
- 3,398,584. **HANDOZER (BLOCK FORM)**. GROSBERG MIKE THOMAS, (U.S. CLS. 23, 28 AND 44). SN 78-952,926. PUB. 1-1-2008. FILED 8-15-2006.
- 3,398,604. **XTREME TOOLS AND DESIGN**. XTREME TOOLS INTERNATIONAL, INC., MULTIPLE CLASS, (INT. CLS. 8, 9 AND 11), (U.S. CLS. 13, 21, 23, 26, 28, 31, 34, 36, 38 AND 44).

- SN 78-967,390. PUB. 9-18-2007. FILED 9-5-2006.
- 3,398,630 (*See Class 6 for this trademark*).
- 3,398,638 (*See Class 3 for this trademark*).
- 3,398,675. **KAY BOJESEN AND DESIGN**. SUSANNE BOJESEN ROSENQVIST, MULTIPLE CLASS, (INT. CLS. 8, 14, 20, 21, 28 AND 35), (U.S. CLS. 2, 13, 22, 23, 25, 27, 28, 29, 30, 32, 33, 38, 40, 44, 50, 100, 101 AND 102). SN 79-030,313. PUB. 1-1-2008. FILED 10-11-2006.

CLASS 9—ELECTRICAL AND SCIENTIFIC APPARATUS

- 3,396,835. **UBIQUITY BANK (BLOCK FORM)**. UBIQUITY BANK OF CANADA, MULTIPLE CLASS, (INT. CLS. 9, 35, 36 AND 42), (U.S. CLS. 21, 23, 26, 36, 38, 100, 101 AND 102). SN 76-614,495. PUB. 5-16-2006. FILED 10-1-2004.
- 3,396,841. **SONOPLATFORM (BLOCK FORM)**. SONOMAX HEARING HEALTHCARE INC., MULTIPLE CLASS, (INT. CLS. 9, 10, 42 AND 44), (U.S. CLS. 21, 23, 26, 36, 38, 39, 44, 100 AND 101). SN 76-640,061. PUB. 1-1-2008. FILED 6-3-2005.
- 3,396,845. **MISCELLANEOUS DESIGN**. KABUSHIKI KAISHA SATO, (U.S. CLS. 21, 23, 26, 36 AND 38). SN 76-643,779. PUB. 1-1-2008. FILED 7-28-2005.
- 3,396,848. **V4 AND DESIGN**. VISION 4 MUSIC, INC., MULTIPLE CLASS, (INT. CLS. 9, 35 AND 41), (U.S. CLS. 21, 23, 26, 36, 38, 100, 101, 102 AND 107). SN 76-648,942. PUB. 1-1-2008. FILED 10-21-2005.
- 3,396,859. **AQUA LUNG AND DESIGN**. LA SPIROTECHNIQUE INDUSTRIELLE ET COMMERCIALE, MULTIPLE CLASS, (INT. CLS. 9, 18, 25, 28 AND 41), (U.S. CLS. 1, 2, 3, 21, 22, 23, 26, 36, 38, 39, 41, 50, 100, 101 AND 107). SN 76-660,740. PUB. 1-1-2008. FILED 5-30-2006.
- 3,396,869. **GUIDING LIGHT FOR SECURITY (BLOCK FORM)**. SECURE VANTAGE TECHNOLOGIES, INC., (U.S. CLS. 21, 23, 26, 36 AND 38). SN 76-665,635. PUB. 1-1-2008. FILED 9-5-2006.
- 3,396,876. **ECOCHIP (BLOCK FORM)**. KABUSHIKI KAISHA TOSHIBA, (U.S. CLS. 21, 23, 26, 36 AND 38). SN 76-668,683. PUB. 1-1-2008. FILED 11-7-2006.
- 3,396,880. **WOODY'S (BLOCK FORM)**. INTERNATIONAL ENGINEERING & MANUFACTURING INC., DBA INTERNATIONAL ENGINEERING AND INTERNATIONAL ENGINEERING CO., MULTIPLE CLASS, (INT. CLS. 9, 16, 20, 24 AND 26), (U.S. CLS. 2, 5, 13, 21, 22, 23, 25, 26, 29, 32, 36, 37, 38, 39, 40, 42 AND 50). SN 76-669,296. PUB. 1-1-2008. FILED 11-20-2006.
- 3,396,882. **BILLY DA KID (BLOCK FORM)**. REGULATOR RECORDS, INC., (U.S. CLS. 21, 23, 26, 36 AND 38). SN 76-669,519. PUB. 1-1-2008. FILED 11-27-2006.
- 3,396,901. **MIDDLE CLASS MILLIONAIRES (BLOCK FORM)**. BEATTIE, ROGER L., MULTIPLE CLASS, (INT. CLS. 9 AND 41), (U.S. CLS. 21, 23, 26, 36, 38, 100, 101 AND 107). SN 76-672,942. PUB. 1-1-2008. FILED 2-21-2007.
- 3,396,918. **HEART OF THE MATTER SERIES (BLOCK FORM)**. HOPE FOR THE HEART, INC., MULTIPLE CLASS, (INT. CLS. 9 AND 16), (U.S. CLS. 2, 5, 21, 22, 23, 26, 29, 36, 37, 38 AND 50). SN 76-676,018. PUB. 1-1-2008. FILED 4-26-2007.
- 3,396,920. **MICROLITE (BLOCK FORM)**. STYLE EYES, INC., (U.S. CLS. 21, 23, 26, 36 AND 38). SN 76-676,103. PUB. 1-1-2008. FILED 4-27-2007.
- 3,396,953. **PIOLET NETWORKS AND DESIGN**. BRAVO, PABLO SOTO, (U.S. CLS. 21, 23, 26, 36 AND 38). SN 76-680,584. PUB. 1-1-2008. FILED 8-13-2007.
- 3,396,966. **FLOWING CONTENT (BLOCK FORM)**. FLOWING CONTENT, S.A., MULTIPLE CLASS, (INT. CLS. 9, 35 AND 38), (U.S. CLS. 21, 23, 26, 36, 38, 100, 101, 102 AND 104). SN 77-005,823. PUB. 1-1-2008. FILED 9-22-2006.
- 3,396,967. **TUTORSYSTEMS (BLOCK FORM)**. BLS, INC., (U.S. CLS. 21, 23, 26, 36 AND 38). SN 77-006,114. PUB. 1-1-2008. FILED 9-24-2006.
- 3,396,975. **ONE SIMPLE MOVE (BLOCK FORM)**. ONE SIMPLE MOVE, LLC, MULTIPLE CLASS, (INT. CLS. 9, 35 AND 42), (U.S. CLS. 21, 23, 26, 36, 38, 100, 101 AND 102). SN 77-011,938. PUB. 1-1-2008. FILED 10-2-2006.
- 3,396,976 (*See Class 7 for this trademark*).

- 3,396,977 (*See Class 7 for this trademark*).
- 3,396,992. **THE FINANCIAL INTELLIGENCE EXPERIENCE AND DESIGN**. MCDOWELL, CHARLES W., III, MULTIPLE CLASS, (INT. CLS. 9, 36 AND 41), (U.S. CLS. 21, 23, 26, 36, 38, 100, 101, 102 AND 107). SN 77-018,597. PUB. 1-1-2008. FILED 10-11-2006.
- 3,396,996. **WED'ZE (STYLIZED)**. PROJETCLUB, MULTIPLE CLASS, (INT. CLS. 9 AND 18), (U.S. CLS. 1, 2, 3, 21, 22, 23, 26, 36, 38 AND 41). SN 77-021,231. PUB. 1-1-2008. FILED 10-13-2006.
- 3,397,004. **TAP TAP (BLOCK FORM)**. ROYAL SOUNDS ANCA PRODUCTIONS, (U.S. CLS. 21, 23, 26, 36 AND 38). SN 77-024,456. PUB. 1-1-2008. FILED 10-18-2006.
- 3,397,006. **MOBILITYPASS (BLOCK FORM)**. SHARP ROCK TECHNOLOGIES LLC, (U.S. CLS. 21, 23, 26, 36 AND 38). SN 77-024,775. PUB. 1-1-2008. FILED 10-19-2006.
- 3,397,012. **SIMUCAD (BLOCK FORM)**. SIMUCAD DESIGN AUTOMATION, INC., (U.S. CLS. 21, 23, 26, 36 AND 38). SN 77-026,109. PUB. 1-1-2008. FILED 10-20-2006.
- 3,397,018. **PARISH DATA SYSTEM AND DESIGN**. ACS TECHNOLOGIES GROUP, INC., (U.S. CLS. 21, 23, 26, 36 AND 38). SN 77-027,777. PUB. 1-1-2008. FILED 10-24-2006.
- 3,397,021. **APTIXIA (BLOCK FORM)**. IXIA, (U.S. CLS. 21, 23, 26, 36 AND 38). SN 77-028,295. PUB. 1-1-2008. FILED 10-24-2006.
- 3,397,040. **DUB. B (STYLIZED)**. SEAREAL PRODUCTIONS, LLC, MULTIPLE CLASS, (INT. CLS. 9 AND 41), (U.S. CLS. 21, 23, 26, 36, 38, 100, 101 AND 107). SN 77-034,955. PUB. 1-1-2008. FILED 11-2-2006.
- 3,397,043. **V! AND DESIGN**. VIVA VISION, INC., (U.S. CLS. 21, 23, 26, 36 AND 38). SN 77-036,771. PUB. 1-1-2008. FILED 11-3-2006.
- 3,397,045. **LOTPRO (BLOCK FORM)**. ACE TECH INCORPORATED. MULTIPLE CLASS, (INT. CLS. 9, 35 AND 36), (U.S. CLS. 21, 23, 26, 36, 38, 100, 101 AND 102). SN 77-037,288. PUB. 1-1-2008. FILED 11-6-2006.
- 3,397,050. **MISCELLANEOUS DESIGN**. DWYER INSTRUMENTS, INC., (U.S. CLS. 21, 23, 26, 36 AND 38). SN 77-039,625. PUB. 1-1-2008. FILED 11-8-2006.
- 3,397,053. **RTD TANGO (BLOCK FORM)**. RTS REALTIME SYSTEMS, INC., (U.S. CLS. 21, 23, 26, 36 AND 38). SN 77-040,373. PUB. 1-1-2008. FILED 11-9-2006.
- 3,397,054. **VERY WELL CONNECTED (BLOCK FORM)**. GAMBER-JOHNSON LLC, MULTIPLE CLASS, (INT. CLS. 9 AND 12), (U.S. CLS. 19, 21, 23, 26, 31, 35, 36, 38 AND 44). SN 77-040,462. PUB. 1-1-2008. FILED 11-9-2006.
- 3,397,064. **SETTING THE NEW STANDARD (BLOCK FORM)**. COMPLETECAMPAIGNS.COM, LLC, (U.S. CLS. 21, 23, 26, 36 AND 38). SN 77-043,493. PUB. 1-1-2008. FILED 11-14-2006.
- 3,397,070. **MUSICMAP SERIES (STYLIZED)**. KOOMZAAL CO., LTD., MULTIPLE CLASS, (INT. CLS. 9, 16 AND 41), (U.S. CLS. 2, 5, 21, 22, 23, 26, 29, 36, 37, 38, 50, 100, 101 AND 107). SN 77-045,957. PUB. 1-1-2008. FILED 11-16-2006.
- 3,397,077. **MALWAREBOT (BLOCK FORM)**. C-NETMEDIA INC., (U.S. CLS. 21, 23, 26, 36 AND 38). SN 77-047,470. PUB. 1-1-2008. FILED 11-20-2006.
- 3,397,107. **TTE AND DESIGN**. TUNG THIH ENTERPRISE CO., LTD., (U.S. CLS. 21, 23, 26, 36 AND 38). SN 77-055,587. PUB. 1-1-2008. FILED 12-1-2006.
- 3,397,109. **EXSHIELD (BLOCK FORM)**. SAMSUNG NETWORKS, INC., (U.S. CLS. 21, 23, 26, 36 AND 38). SN 77-056,566. PUB. 1-1-2008. FILED 12-4-2006.
- 3,397,110. **PARTICLE MEASURING SYSTEMS (BLOCK FORM)**. PARTICLE MEASURING SYSTEMS, INC., MULTIPLE CLASS, (INT. CLS. 9, 37, 41 AND 42), (U.S. CLS. 21, 23, 26, 36, 38, 100, 101, 103, 106 AND 107). SN 77-056,660. PUB. 1-1-2008. FILED 12-4-2006.
- 3,397,111. **TTE (BLOCK FORM)**. TUNG THIH ENTERPRISE CO., LTD., (U.S. CLS. 21, 23, 26, 36 AND 38). SN 77-056,788. PUB. 1-1-2008. FILED 12-4-2006.
- 3,397,116. **MURF (BLOCK FORM)**. WADING RIVER HOLDINGS, LLC, (U.S. CLS. 21, 23, 26, 36 AND 38). SN 77-057,241. PUB. 1-1-2008. FILED 12-5-2006.
- 3,397,122. **MYSQL (BLOCK FORM)**. MYSQL AB, MULTIPLE CLASS, (INT. CLS. 9, 16, 41 AND 42), (U.S. CLS. 2, 5, 21, 22, 23, 26, 29, 36, 37, 38, 50, 100, 101 AND 107). SN 77-058,039. PUB. 1-1-2008. FILED 12-6-2006.
- 3,397,146. **SHEPHERD MEDICAL SOLUTIONS (BLOCK FORM)**. SHEPHERD MEDICAL SOLUTIONS LLC, (U.S. CLS. 21, 23, 26, 36 AND 38). SN 77-063,159. PUB. 1-1-2008. FILED 12-13-2006.
- 3,397,152. **MISCELLANEOUS DESIGN**. COM DEV LTD., (U.S. CLS. 21, 23, 26, 36 AND 38). SN 77-064,025. PUB. 1-1-2008. FILED 12-14-2006.
- 3,397,153. **BROKER WEBSTATION (BLOCK FORM)**. BWS HOLDING COMPANY, (U.S. CLS. 21, 23, 26, 36 AND 38). SN 77-064,113. PUB. 1-1-2008. FILED 12-14-2006.
- 3,397,164 (*See Class 3 for this trademark*).
- 3,397,166. **KOKUA FESTIVAL (BLOCK FORM)**. KOKUA HAWAII FOUNDATION, (U.S. CLS. 21, 23, 26, 36 AND 38). SN 77-065,715. PUB. 1-1-2008. FILED 12-15-2006.
- 3,397,188. **SIRIS AND DESIGN**. MALEY, MICHAEL, MULTIPLE CLASS, (INT. CLS. 9 AND 41), (U.S. CLS. 21, 23, 26, 36, 38, 100, 101 AND 107). SN 77-068,885. PUB. 1-1-2008. FILED 12-20-2006.
- 3,397,195. **PROTECTA WRAP (BLOCK FORM)**. PLUM ENTERPRISES, INC., (U.S. CLS. 21, 23, 26, 36 AND 38). SN 77-069,200. PUB. 1-1-2008. FILED 12-21-2006.
- 3,397,209. **GIZMOMAX (BLOCK FORM)**. MAINLINE, INC., (U.S. CLS. 21, 23, 26, 36 AND 38). SN 77-071,307. PUB. 1-1-2008. FILED 12-26-2006.
- 3,397,212. **JBL ON STAGE (BLOCK FORM)**. HARMAN INTERNATIONAL INDUSTRIES, INCORPORATED, (U.S. CLS. 21, 23, 26, 36 AND 38). SN 77-072,181. PUB. 9-25-2007. FILED 12-27-2006.
- 3,397,213. **P&H CENTURION AND DESIGN**. HARNISCHFEGGER TECHNOLOGIES, INC., (U.S. CLS. 21, 23, 26, 36 AND 38). SN 77-072,426. PUB. 1-1-2008. FILED 12-28-2006.
- 3,397,215. **CHOCOBO TALES AND DESIGN**. KABUSHIKI KAISHA SQUARE ENIX (ALSO TRADING AS SQUARE ENIX CO., LTD.), (U.S. CLS. 21, 23, 26, 36 AND 38). SN 77-072,468. PUB. 1-1-2008. FILED 12-28-2006.
- 3,397,225. **INSIGHT (BLOCK FORM)**. PERSYST DEVELOPMENT CORPORATION, INC., (U.S. CLS. 21, 23, 26, 36 AND 38). SN 77-074,022. PUB. 7-31-2007. FILED 1-1-2007.
- 3,397,242. **CURRENT REPORTS (BLOCK FORM)**. CURRENT MEDICINE GROUP, LLC, (U.S. CLS. 21, 23, 26, 36 AND 38). SN 77-078,216. PUB. 1-1-2008. FILED 1-8-2007.
- 3,397,243. **CURRENT TREATMENT OPTIONS (BLOCK FORM)**. CURRENT MEDICINE GROUP, LLC, (U.S. CLS. 21, 23, 26, 36 AND 38). SN 77-078,345. PUB. 1-1-2008. FILED 1-8-2007.
- 3,397,251. **TAHITI MAGIC (BLOCK FORM)**. ARISTOCRAT TECHNOLOGIES AUSTRALIA PTY LTD, (U.S. CLS. 21, 23, 26, 36 AND 38). SN 77-080,413. PUB. 1-1-2008. FILED 1-10-2007.
- 3,397,263. **COHERENCE (BLOCK FORM)**. PARALLELS SOFTWARE INTERNATIONAL, INC., (U.S. CLS. 21, 23, 26, 36 AND 38). SN 77-084,572. PUB. 1-1-2008. FILED 1-17-2007.
- 3,397,283. **EVERFINE (BLOCK FORM)**. EVERFINE PHOTO-INFO CO., LTD., (U.S. CLS. 21, 23, 26, 36 AND 38). SN 77-089,027. PUB. 1-1-2008. FILED 1-23-2007.
- 3,397,300 (*See Class 7 for this trademark*).
- 3,397,310. **DB BLOCKER (BLOCK FORM)**. CUSTOM PROTECT EAR INC., (U.S. CLS. 21, 23, 26, 36 AND 38). SN 77-097,299. PUB. 1-1-2008. FILED 2-1-2007.
- 3,397,316. **EYETV (BLOCK FORM)**. ELGATO SYSTEMS GMBH, MULTIPLE CLASS, (INT. CLS. 9, 16 AND 42), (U.S. CLS. 2, 5, 21, 22, 23, 26, 29, 36, 37, 38, 50, 100 AND 101). SN 77-097,821. PUB. 1-1-2008. FILED 2-2-2007.
- 3,397,332. **DESERT BLOOM (BLOCK FORM)**. ARISTOCRAT TECHNOLOGIES AUSTRALIA PTY LTD, (U.S. CLS. 21, 23, 26, 36 AND 38). SN 77-101,639. PUB. 1-1-2008. FILED 2-7-2007.
- 3,397,336. **KING OF ASIA (BLOCK FORM)**. ARISTOCRAT TECHNOLOGIES AUSTRALIA PTY LTD, (U.S. CLS. 21, 23, 26, 36 AND 38). SN 77-102,065. PUB. 1-1-2008. FILED 2-7-2007.
- 3,397,337. **PRECISIONWEB (BLOCK FORM)**. ABBOTT LABORATORIES, (U.S. CLS. 21, 23, 26, 36 AND 38). SN 77-102,690. PUB. 1-1-2008. FILED 2-8-2007.
- 3,397,351. **SLAMLOCK (BLOCK FORM)**. DIVERSIFIED CONTROL, INC., (U.S. CLS. 21, 23, 26, 36 AND 38). SN 77-108,002. PUB. 1-1-2008. FILED 2-15-2007.
- 3,397,353. **DSIR AND DESIGN**. MULLIN, GREGORY, (U.S.

- CLS. 21, 23, 26, 36 AND 38). SN 77-108,763. PUB. 1-1-2008. FILED 2-15-2007.
- 3,397,364. **SPEEDALITE (BLOCK FORM)**. FIBER CABLES DIRECT, LLC, (U.S. CLS. 21, 23, 26, 36 AND 38). SN 77-111,438. PUB. 1-1-2008. FILED 2-20-2007.
- 3,397,369. **PAGE TALKERS (BLOCK FORM)**. GRANT, STEPHEN, (U.S. CLS. 21, 23, 26, 36 AND 38). SN 77-112,589. PUB. 1-1-2008. FILED 2-21-2007.
- 3,397,377. **MAGNUM (STYLIZED)**. PETRA INDUSTRIES, INC., (U.S. CLS. 21, 23, 26, 36 AND 38). SN 77-116,440. PUB. 1-1-2008. FILED 2-26-2007.
- 3,397,386. **VGA SNIFFER (BLOCK FORM)**. ALTINEX, INC., (U.S. CLS. 21, 23, 26, 36 AND 38). SN 77-120,224. PUB. 1-1-2008. FILED 3-1-2007.
- 3,397,387. **HEART OF VEGAS (BLOCK FORM)**. ARISTOCRAT TECHNOLOGIES AUSTRALIA PTY LTD, (U.S. CLS. 21, 23, 26, 36 AND 38). SN 77-120,746. PUB. 1-1-2008. FILED 3-2-2007.
- 3,397,396. **EASYSYEN (BLOCK FORM)**. EASYSYEN, (U.S. CLS. 21, 23, 26, 36 AND 38). SN 77-124,299. PUB. 1-1-2008. FILED 3-7-2007.
- 3,397,399. **DB BLOCKER AND DESIGN**. CUSTOM PROTECT EAR INC., (U.S. CLS. 21, 23, 26, 36 AND 38). SN 77-125,496. PUB. 1-1-2008. FILED 3-8-2007.
- 3,397,409. **RESTOREREX DON'T LET YOUR DATA BECOME EXTINCT AND DESIGN**. DIGITAL INFO SECURITY CO, INC, (U.S. CLS. 21, 23, 26, 36 AND 38). SN 77-130,095. PUB. 1-1-2008. FILED 3-13-2007.
- 3,397,412. **NCFC (BLOCK FORM)**. NORTH COUNTY FIGHT CLUB, LLC, MULTIPLE CLASS, (INT. CLS. 9, 25 AND 41), (U.S. CLS. 21, 22, 23, 26, 36, 38, 39, 100, 101 AND 107). SN 77-132,123. PUB. 1-1-2008. FILED 3-15-2007.
- 3,397,419. **SITEVISTA (BLOCK FORM)**. PLACEVISION, INC., (U.S. CLS. 21, 23, 26, 36 AND 38). SN 77-135,976. PUB. 1-1-2008. FILED 3-20-2007.
- 3,397,431. **ANGELIC ABUNDANCE (BLOCK FORM)**. KASPER, CATHERINE M., MULTIPLE CLASS, (INT. CLS. 9 AND 41), (U.S. CLS. 21, 23, 26, 36, 38, 100, 101 AND 107). SN 77-139,596. PUB. 1-1-2008. FILED 3-24-2007.
- 3,397,440. **VIETNAM (BLOCK FORM)**. GERNER, MICHAEL, AND GRUBB, JOSH, AND FOSS, MICHAEL, AND BERKO, IVAN, (U.S. CLS. 21, 23, 26, 36 AND 38). SN 77-142,728. PUB. 1-1-2008. FILED 3-28-2007.
- 3,397,442. **X-CAL (BLOCK FORM)**. DOUBLE BLACK IMAGING CORPORATION, (U.S. CLS. 21, 23, 26, 36 AND 38). SN 77-143,187. PUB. 1-1-2008. FILED 3-28-2007.
- 3,397,456. **TRADING ALCHEMY (BLOCK FORM)**. ALCHEMY TRADING TECHNOLOGIES, INC., (U.S. CLS. 21, 23, 26, 36 AND 38). SN 77-151,409. PUB. 1-1-2008. FILED 4-8-2007.
- 3,397,475. **PADDS (BLOCK FORM)**. ZENTECH, INC., (U.S. CLS. 21, 23, 26, 36 AND 38). SN 77-159,400. PUB. 1-1-2008. FILED 4-18-2007.
- 3,397,488. **DDG - DI LEMME DEVELOPMENT GROUP, INC. - WWW.FINDYOURWHY.COM AND DESIGN**. JOHN DI LEMME, MULTIPLE CLASS, (INT. CLS. 9 AND 16), (U.S. CLS. 2, 5, 21, 22, 23, 26, 29, 36, 37, 38 AND 50). SN 77-163,721. PUB. 1-1-2008. FILED 4-23-2007.
- 3,397,495. **T-3 FIBS PROTRADER (BLOCK FORM)**. NEXGEN SOFTWARE SERVICES, INC., (U.S. CLS. 21, 23, 26, 36 AND 38). SN 77-165,474. PUB. 1-1-2008. FILED 4-25-2007.
- 3,397,534. **A AND DESIGN**. AVEPOINT, INC., MULTIPLE CLASS, (INT. CLS. 9, 41 AND 42), (U.S. CLS. 21, 23, 26, 36, 38, 100, 101 AND 107). SN 77-180,972. PUB. 1-1-2008. FILED 5-15-2007.
- 3,397,537. **FOCUS ON GEOLOGY (BLOCK FORM)**. AUSTIN GEOMODELING, INC., MULTIPLE CLASS, (INT. CLS. 9, 40 AND 42), (U.S. CLS. 21, 23, 26, 36, 38, 100, 101, 103 AND 106). SN 77-181,097. PUB. 1-1-2008. FILED 5-15-2007.
- 3,397,544. **SNAPSHHELL (BLOCK FORM)**. CSSN, INC., DBA CARD SCANNING SOLUTIONS, (U.S. CLS. 21, 23, 26, 36 AND 38). SN 77-184,711. PUB. 1-1-2008. FILED 5-18-2007.
- 3,397,547. **US AMPS (BLOCK FORM)**. KIM, EUNJUNG, (U.S. CLS. 21, 23, 26, 36 AND 38). SN 77-185,535. PUB. 1-1-2008. FILED 5-20-2007.
- 3,397,561. **A7X (STYLIZED)**. AVENGED SEVENFOLD PARTNERSHIP, MULTIPLE CLASS, (INT. CLS. 9, 25 AND 41), (U.S. CLS. 21, 22, 23, 26, 36, 38, 39, 100, 101 AND 107). SN 77-192,446. PUB. 1-1-2008. FILED 5-29-2007.
- 3,397,581. **REGISCELL (BLOCK FORM)**. REGIS TECHNOLOGIES, INC., (U.S. CLS. 21, 23, 26, 36 AND 38). SN 77-195,431. PUB. 1-1-2008. FILED 6-1-2007.
- 3,397,593. **MELISSA KAYE AND DESIGN**. LEIGHTON, JOHN T, (U.S. CLS. 21, 23, 26, 36 AND 38). SN 77-198,527. PUB. 1-1-2008. FILED 6-5-2007.
- 3,397,615. **HINEYNU (BLOCK FORM)**. SOLEL SOFTWARE CORPORATION, (U.S. CLS. 21, 23, 26, 36 AND 38). SN 77-202,261. PUB. 1-1-2008. FILED 6-10-2007.
- 3,397,629. **BLUEGRASS UNLIMITED (BLOCK FORM)**. BLUEGRASS UNLIMITED, INC., (U.S. CLS. 21, 23, 26, 36 AND 38). SN 77-204,702. PUB. 1-1-2008. FILED 6-13-2007.
- 3,397,653. **SONOSOFT AND DESIGN**. STAGL, JOHN, (U.S. CLS. 21, 23, 26, 36 AND 38). SN 77-210,398. PUB. 1-1-2008. FILED 6-20-2007.
- 3,397,655. **STRATEGIC PLANNING ONLINE AND DESIGN**. THINK HOLDINGS LLC, (U.S. CLS. 21, 23, 26, 36 AND 38). SN 77-210,557. PUB. 1-1-2008. FILED 6-20-2007.
- 3,397,657. **WINGGARD (BLOCK FORM)**. ACTUANT CORPORATION, (U.S. CLS. 21, 23, 26, 36 AND 38). SN 77-210,802. PUB. 11-27-2007. FILED 6-20-2007.
- 3,397,658. **WI-TRAC (BLOCK FORM)**. CYBER ANGEL SECURITY SOLUTIONS, INC., (U.S. CLS. 21, 23, 26, 36 AND 38). SN 77-210,954. PUB. 1-1-2008. FILED 6-20-2007.
- 3,397,660. **LIVEWATCH AND DESIGN**. OCUSAFE, (U.S. CLS. 21, 23, 26, 36 AND 38). SN 77-211,323. PUB. 1-1-2008. FILED 6-20-2007.
- 3,397,684. **Q QUIKCHEK (STYLIZED)**. AVENTURINE INC., (U.S. CLS. 21, 23, 26, 36 AND 38). SN 77-215,469. PUB. 1-1-2008. FILED 6-26-2007.
- 3,397,706. **ORIGINAL DIXIELAND JAZZ BAND AND DESIGN**. LAROCCA, JAMES C., MULTIPLE CLASS, (INT. CLS. 9 AND 41), (U.S. CLS. 21, 23, 26, 36, 38, 100, 101 AND 107). SN 77-217,305. PUB. 1-1-2008. FILED 6-27-2007.
- 3,397,715. **ADVANCED INSTRUMENTS DIVISION AND DESIGN**. AGS ADVANCED INSTRUMENTS DIVISION, MULTIPLE CLASS, (INT. CLS. 9 AND 35), (U.S. CLS. 21, 23, 26, 36, 38, 100, 101 AND 102). SN 77-218,857. PUB. 1-1-2008. FILED 6-29-2007.
- 3,397,724. **SALONTEC (BLOCK FORM)**. SALONTEC, INC., (U.S. CLS. 21, 23, 26, 36 AND 38). SN 77-219,545. PUB. 1-1-2008. FILED 6-29-2007.
- 3,397,743. **TABLATURE (BLOCK FORM)**. AZTEC SYSTEMS, INC., (U.S. CLS. 21, 23, 26, 36 AND 38). SN 77-222,277. PUB. 1-1-2008. FILED 7-5-2007.
- 3,397,750. **GGI INTERNATIONAL AND DESIGN**. GRAHAM GROUP INTERNATIONAL, INC., MULTIPLE CLASS, (INT. CLS. 9, 40 AND 42), (U.S. CLS. 21, 23, 26, 36, 38, 100, 101, 103 AND 106). SN 77-222,677. PUB. 1-1-2008. FILED 7-5-2007.
- 3,397,767. **ACUITÉ (BLOCK FORM)**. VERO SYSTEMS INC., (U.S. CLS. 21, 23, 26, 36 AND 38). SN 77-224,453. PUB. 1-1-2008. FILED 7-9-2007.
- 3,397,774. **SAFFRON ATLAS (BLOCK FORM)**. SAFFRON TECHNOLOGY, INC., (U.S. CLS. 21, 23, 26, 36 AND 38). SN 77-224,768. PUB. 1-1-2008. FILED 7-9-2007.
- 3,397,780. **THE VERMILLION PARTNERSHIP SYSTEM (BLOCK FORM)**. VERMILLION CONSULTING, INC., (U.S. CLS. 21, 23, 26, 36 AND 38). SN 77-225,124. PUB. 1-1-2008. FILED 7-9-2007.
- 3,397,792. **MODERN TIMES (BLOCK FORM)**. MODERN OPTICAL INTERNATIONAL, LTD., (U.S. CLS. 21, 23, 26, 36 AND 38). SN 77-225,712. PUB. 1-1-2008. FILED 7-10-2007.
- 3,397,793. **GOSTEREO (BLOCK FORM)**. PRICE POINT ACCESSORIES LLC, (U.S. CLS. 21, 23, 26, 36 AND 38). SN 77-225,807. PUB. 1-1-2008. FILED 7-10-2007.
- 3,397,803. **VS PRO (BLOCK FORM)**. VIEWTECH INCORPORATED, (U.S. CLS. 21, 23, 26, 36 AND 38). SN 77-226,248. PUB. 1-1-2008. FILED 7-10-2007.
- 3,397,812. **ICOMMENT (BLOCK FORM)**. QUALITY PROGRAMMING CORPORATION, MULTIPLE CLASS, (INT. CLS. 9 AND 38), (U.S. CLS. 21, 23, 26, 36, 38, 100, 101 AND 104). SN 77-226,506. PUB. 1-1-2008. FILED 7-11-2007.
- 3,397,816. **SIECLEAR (BLOCK FORM)**. SIEMENS MEDICAL SOLUTIONS USA, INC., (U.S. CLS. 21, 23, 26, 36 AND 38). SN 77-226,658. PUB. 1-1-2008. FILED 7-11-2007.
- 3,397,818. **MEGARAD (BLOCK FORM)**. THERMO CIDTEC, (U.S. CLS. 21, 23, 26, 36 AND 38). SN 77-226,781. PUB. 1-1-

2008. FILED 7-11-2007.
- 3,397,821. **REKON (STYLIZED)**. REKON TECHNOLOGIES, MULTIPLE CLASS, (INT. CLS. 9 AND 42), (U.S. CLS. 21, 23, 26, 36, 38, 100 AND 101). SN 77-226,820. PUB. 1-1-2008. FILED 7-11-2007.
- 3,397,826. **ROBOT MONSTER RECORDS (BLOCK FORM)**. BERGERON, ANTHONY. (U.S. CLS. 21, 23, 26, 36 AND 38). SN 77-226,944. PUB. 1-1-2008. FILED 7-11-2007.
- 3,397,832. **BELLYSONIC (BLOCK FORM)**. SLEEPSONIC, LLC. (U.S. CLS. 21, 23, 26, 36 AND 38). SN 77-227,218. PUB. 1-1-2008. FILED 7-11-2007.
- 3,397,849 (*See Class 7 for this trademark*).
- 3,397,851. **WELLS FARGO BUSINESS BANKING ROUNDUP (BLOCK FORM)**. WELLS FARGO & COMPANY, (U.S. CLS. 21, 23, 26, 36 AND 38). SN 77-227,489. PUB. 1-1-2008. FILED 7-11-2007.
- 3,397,877. **SIONEX (BLOCK FORM)**. SIONEX CORPORATION, (U.S. CLS. 21, 23, 26, 36 AND 38). SN 77-228,024. PUB. 1-1-2008. FILED 7-12-2007.
- 3,397,878. **EVERTECH (BLOCK FORM)**. DUMANOGULARI, SEMIH, MULTIPLE CLASS, (INT. CLS. 9 AND 45), (U.S. CLS. 21, 23, 26, 36, 38, 100 AND 101). SN 77-228,028. PUB. 1-1-2008. FILED 7-12-2007.
- 3,397,900. **3 BAD BROTHAZ (BLOCK FORM)**. PAYES, AARON T. (U.S. CLS. 21, 23, 26, 36 AND 38). SN 77-228,756. PUB. 1-1-2008. FILED 7-12-2007.
- 3,397,904. **TOILET TUNES (BLOCK FORM)**. GREEN, LEWIS A. (U.S. CLS. 21, 23, 26, 36 AND 38). SN 77-228,778. PUB. 1-1-2008. FILED 7-13-2007.
- 3,397,917. **CHANGE GEAR (BLOCK FORM)**. SUNVIEW SOFTWARE, INC., (U.S. CLS. 21, 23, 26, 36 AND 38). SN 77-228,949. PUB. 1-1-2008. FILED 7-13-2007.
- 3,397,922. **QOVISION (BLOCK FORM)**. QOMO HITEVISION, (U.S. CLS. 21, 23, 26, 36 AND 38). SN 77-228,999. PUB. 1-1-2008. FILED 7-13-2007.
- 3,397,924. **BED READY (BLOCK FORM)**. NEW AGE SYSTEMS, INC., (U.S. CLS. 21, 23, 26, 36 AND 38). SN 77-229,022. PUB. 1-1-2008. FILED 7-13-2007.
- 3,397,928. **ULTRALITE ALS (BLOCK FORM)**. CAO GROUP, INC., (U.S. CLS. 21, 23, 26, 36 AND 38). SN 77-229,051. PUB. 1-1-2008. FILED 7-13-2007.
- 3,397,933. **DYNASTY (BLOCK FORM)**. CAO GROUP, INC., (U.S. CLS. 21, 23, 26, 36 AND 38). SN 77-229,113. PUB. 1-1-2008. FILED 7-13-2007.
- 3,397,936. **MEDIAVISTA (BLOCK FORM)**. CAO GROUP, INC., (U.S. CLS. 21, 23, 26, 36 AND 38). SN 77-229,146. PUB. 1-1-2008. FILED 7-13-2007.
- 3,397,938. **MVADS (BLOCK FORM)**. BILLY AZBELL ELECTRONICS, INC., (U.S. CLS. 21, 23, 26, 36 AND 38). SN 77-229,180. PUB. 1-1-2008. FILED 7-13-2007.
- 3,397,952. **JIMM-ENEWS (BLOCK FORM)**. JIMMY JOHN ENTERPRISES, LLC, (U.S. CLS. 21, 23, 26, 36 AND 38). SN 77-229,477. PUB. 1-1-2008. FILED 7-13-2007.
- 3,397,976. **SMOKE FREE WISDOM (BLOCK FORM)**. ROBERT J. REINA. (U.S. CLS. 21, 23, 26, 36 AND 38). SN 77-229,878. PUB. 1-1-2008. FILED 7-14-2007.
- 3,397,981. **STUDIO DEVIL (BLOCK FORM)**. GALLO, MARC N., DBA GALLO ENGINEERING, PLLC, (U.S. CLS. 21, 23, 26, 36 AND 38). SN 77-229,934. PUB. 1-1-2008. FILED 7-15-2007.
- 3,398,004. **NEWSMAKERS IN MEDICINE WHERE BREAKING RESEARCH SPEAKS TO THE CLINICIAN AND DESIGN**. PROJECTS IN KNOWLEDGE, INC., (U.S. CLS. 21, 23, 26, 36 AND 38). SN 77-230,433. PUB. 1-1-2008. FILED 7-16-2007.
- 3,398,009. **WEIGH SHARK (BLOCK FORM)**. MCR TECHNOLOGIES GROUP, INC., (U.S. CLS. 21, 23, 26, 36 AND 38). SN 77-230,472. PUB. 1-1-2008. FILED 7-16-2007.
- 3,398,025. **JFT (BLOCK FORM)**. CDM TECHNOLOGIES, INC., (U.S. CLS. 21, 23, 26, 36 AND 38). SN 77-230,710. PUB. 1-1-2008. FILED 7-16-2007.
- 3,398,040. **IMT (BLOCK FORM)**. CDM TECHNOLOGIES, INC., (U.S. CLS. 21, 23, 26, 36 AND 38). SN 77-230,865. PUB. 1-1-2008. FILED 7-16-2007.
- 3,398,048. **RFGEN SOFTWARE (STYLIZED)**. THE DATAMAX SOFTWARE GROUP, INC., (U.S. CLS. 21, 23, 26, 36 AND 38). SN 77-230,974. PUB. 1-1-2008. FILED 7-16-2007.
- 3,398,066. **ICONS OF ROCK AND DESIGN**. MUSIC STAR PRODUCTIONS, (U.S. CLS. 21, 23, 26, 36 AND 38). SN 77-231,303. PUB. 1-1-2008. FILED 7-17-2007.
- 3,398,076. **HANDI-LENS (BLOCK FORM)**. ULTRA-OPTIX, INC., (U.S. CLS. 21, 23, 26, 36 AND 38). SN 77-231,501. PUB. 1-1-2008. FILED 7-17-2007.
- 3,398,089. **TPI INDUSTRIAL AND DESIGN**. TPI CORPORATION, MULTIPLE CLASS, (INT. CLS. 9 AND 11), (U.S. CLS. 13, 21, 23, 26, 31, 34, 36 AND 38). SN 77-231,712. PUB. 1-1-2008. FILED 7-17-2007.
- 3,398,209. **POWER MOS 8 (BLOCK FORM)**. MICROSEMI CORPORATION, (U.S. CLS. 21, 23, 26, 36 AND 38). SN 77-233,976. PUB. 1-1-2008. FILED 7-19-2007.
- 3,398,211. **PIPENET VISION (BLOCK FORM)**. SUNRISE SYSTEMS LIMITED, (U.S. CLS. 21, 23, 26, 36 AND 38). SN 77-234,120. PUB. 1-1-2008. FILED 7-19-2007.
- 3,398,213. **REALITY ENGLISH AND DESIGN**. LINGOLYNX, LLC, MULTIPLE CLASS, (INT. CLS. 9, 16 AND 41), (U.S. CLS. 2, 5, 21, 22, 23, 26, 29, 36, 37, 38, 50, 100, 101 AND 107). SN 77-234,142. PUB. 1-1-2008. FILED 7-19-2007.
- 3,398,219. **BOCK AUDIO (BLOCK FORM)**. BOCK, DAVID, (U.S. CLS. 21, 23, 26, 36 AND 38). SN 77-234,244. PUB. 1-1-2008. FILED 7-19-2007.
- 3,398,233. **HYPERFEA (BLOCK FORM)**. COLLIER RESEARCH & DEVELOPMENT CORP., (U.S. CLS. 21, 23, 26, 36 AND 38). SN 77-234,622. PUB. 1-1-2008. FILED 7-20-2007.
- 3,398,235. **SECURITYTITAN (BLOCK FORM)**. TITAN SAFETY PRODUCTS, INC., DBA TAG INVENTIONS, INC., (U.S. CLS. 21, 23, 26, 36 AND 38). SN 77-234,712. PUB. 1-1-2008. FILED 7-20-2007.
- 3,398,236. **MISCELLANEOUS DESIGN**. STEC, INC., (U.S. CLS. 21, 23, 26, 36 AND 38). SN 77-234,894. PUB. 1-1-2008. FILED 7-20-2007.
- 3,398,242. **ITUNES (BLOCK FORM)**. APPLE INC., (U.S. CLS. 21, 23, 26, 36 AND 38). SN 77-236,568. PUB. 1-1-2008. FILED 7-23-2007.
- 3,398,255. **PROJECTS IN KNOWLEDGE (BLOCK FORM)**. PROJECTS IN KNOWLEDGE, INC., (U.S. CLS. 21, 23, 26, 36 AND 38). SN 77-241,001. PUB. 1-1-2008. FILED 7-27-2007.
- 3,398,265. **ACS SCIENCE ELEMENTS (BLOCK FORM)**. AMERICAN CHEMICAL SOCIETY, (U.S. CLS. 21, 23, 26, 36 AND 38). SN 77-243,067. PUB. 1-1-2008. FILED 7-31-2007.
- 3,398,267. **E-HOP (BLOCK FORM)**. PAYES, AARON T, DBA LIVE WIRE EMPIRE, AND MONICA, STEPHEN M, DBA LIVE WIRE EMPIRE, (U.S. CLS. 21, 23, 26, 36 AND 38). SN 77-243,806. PUB. 1-1-2008. FILED 8-1-2007.
- 3,398,282. **PROJECTS IN KNOWLEDGE MEDICAL EDUCATION ACTIVITIES FOR CLINICIANS SINCE 1980 AND DESIGN**. PROJECTS IN KNOWLEDGE, INC., (U.S. CLS. 21, 23, 26, 36 AND 38). SN 77-247,755. PUB. 1-1-2008. FILED 8-6-2007.
- 3,398,298. **LOST ONES AND DESIGN**. NICHOLSON, HAL L, AKA KING PAPS, AND NICHOLSON, STEVIE O., AKA STEVIE PRIEST, (U.S. CLS. 21, 23, 26, 36 AND 38). SN 77-250,703. PUB. 1-1-2008. FILED 8-8-2007.
- 3,398,311. **ACTIVISION (BLOCK FORM)**. ACTIVISION PUBLISHING, INC., MULTIPLE CLASS, (INT. CLS. 9, 16 AND 25), (U.S. CLS. 2, 5, 21, 22, 23, 26, 29, 36, 37, 38, 39 AND 50). SN 77-254,263. PUB. 1-1-2008. FILED 8-13-2007.
- 3,398,314. **CEDAR (BLOCK FORM)**. CEDAR AUDIO, LTD., (U.S. CLS. 21, 23, 26, 36 AND 38). SN 77-254,523. PUB. 1-1-2008. FILED 8-14-2007.
- 3,398,329. **3M (BLOCK FORM)**. 3M COMPANY, MULTIPLE CLASS, (INT. CLS. 9 AND 10), (U.S. CLS. 21, 23, 26, 36, 38, 39 AND 44). SN 77-257,496. PUB. 1-1-2008. FILED 8-16-2007.
- 3,398,337. **BARON (BLOCK FORM)**. COLEMAN CABLE, INC., (U.S. CLS. 21, 23, 26, 36 AND 38). SN 77-267,015. PUB. 1-1-2008. FILED 8-29-2007.
- 3,398,340. **SOUNDSATIONAL (BLOCK FORM)**. COLEMAN CABLE, INC., (U.S. CLS. 21, 23, 26, 36 AND 38). SN 77-270,877. PUB. 1-1-2008. FILED 9-4-2007.
- 3,398,348. **JAMES TYLER ELECTRIC (BLOCK FORM)**. TYLER, JAMES, (U.S. CLS. 21, 23, 26, 36 AND 38). SN 77-297,325. PUB. 1-1-2008. FILED 10-5-2007.
- 3,398,349. **DVD KIDS AND DESIGN**. 3-PLUS HF., MULTIPLE CLASS, (INT. CLS. 9, 35, 38, 41 AND 42), (U.S. CLS. 21, 23, 26, 36, 38, 100, 101, 102, 104 AND 107). SN 78-073,784. PUB. 7-15-2003. FILED 7-13-2001.
- 3,398,354. **CONNECTA AND DESIGN**. BIOMNI LIMITED,

- MULTIPLE CLASS, (INT. CLS. 9, 35, 38 AND 42), (U.S. CLS. 21, 23, 26, 36, 38, 100, 101, 102 AND 104). SN 78-145,988. PUB. 11-14-2006. FILED 7-21-2002.
- 3,398,356. **SC3D. BRAINTECH CANADA, INC., MULTIPLE CLASS**, (INT. CLS. 9 AND 42), (U.S. CLS. 21, 23, 26, 36, 38, 100 AND 101). SN 78-164,494. PUB. 5-18-2004. FILED 9-16-2002.
- 3,398,361. **QUIZMAS. GORDON PAPE ENTERPRISES LTD., MULTIPLE CLASS**, (INT. CLS. 9 AND 16), (U.S. CLS. 2, 5, 21, 22, 23, 26, 29, 36, 37, 38 AND 50). SN 78-308,356. PUB. 5-29-2007. FILED 10-2-2003.
- 3,398,368. **SPAM CUBE AND DESIGN. SPAM CUBE, INC, DBA SPAM CUBE**, (U.S. CLS. 21, 23, 26, 36 AND 38). SN 78-411,511. PUB. 11-15-2005. FILED 4-30-2004.
- 3,398,374. **MARK TODD (BLOCK FORM). WESTGATE EFI LIMITED, MULTIPLE CLASS**, (INT. CLS. 9, 18, 25 AND 28), (U.S. CLS. 1, 2, 3, 21, 22, 23, 26, 36, 38, 39, 41 AND 50). SN 78-436,922. PUB. 6-5-2007. FILED 6-17-2004.
- 3,398,378. **S SU-KAM AND DESIGN. SU-KAM COMMUNICATION SYSTEMS LTD.**, (U.S. CLS. 21, 23, 26, 36 AND 38). SN 78-499,014. PUB. 1-1-2008. FILED 10-13-2004.
- 3,398,387. **K2 (BLOCK FORM). SOURCECODE TECHNOLOGY HOLDINGS, INC., MULTIPLE CLASS**, (INT. CLS. 9 AND 42), (U.S. CLS. 21, 23, 26, 36, 38, 100 AND 101). SN 78-537,896. PUB. 1-1-2008. FILED 12-23-2004.
- 3,398,389. **TIGER AND DRAGON (BLOCK FORM). ATRONIC INTERNATIONAL GMBH, MULTIPLE CLASS**, (INT. CLS. 9 AND 28), (U.S. CLS. 21, 22, 23, 26, 36, 38 AND 50). SN 78-546,914. PUB. 11-7-2006. FILED 1-13-2005.
- 3,398,396. **QUOTATION LIFECYCLE MANAGEMENT (BLOCK FORM). QSTRAT INC., MULTIPLE CLASS**, (INT. CLS. 9, 35, 41 AND 42), (U.S. CLS. 21, 23, 26, 36, 38, 100, 101, 102 AND 107). SN 78-578,303. PUB. 4-10-2007. FILED 3-2-2005.
- 3,398,397. **CRYSTAL LAKE (BLOCK FORM). ATRONIC INTERNATIONAL GMBH, MULTIPLE CLASS**, (INT. CLS. 9 AND 28), (U.S. CLS. 21, 22, 23, 26, 36, 38 AND 50). SN 78-579,424. PUB. 11-21-2006. FILED 3-3-2005.
- 3,398,403. **CLMEI (BLOCK FORM). CYBERLINK CORPORATION**, (U.S. CLS. 21, 23, 26, 36 AND 38). SN 78-596,705. PUB. 1-1-2008. FILED 3-29-2005.
- 3,398,405. **WARMUP AND DESIGN. WARMUP PLC, MULTIPLE CLASS**, (INT. CLS. 9, 11 AND 17), (U.S. CLS. 1, 5, 12, 13, 21, 23, 26, 31, 34, 35, 36, 38 AND 50). SN 78-613,507. PUB. 1-1-2008. FILED 4-21-2005.
- 3,398,407. **OUT SYSTEMS AND DESIGN. OUTSYSTEMS, SOFTWARE EM REDE, S.A., MULTIPLE CLASS**, (INT. CLS. 9, 35, 41 AND 42), (U.S. CLS. 21, 23, 26, 36, 38, 100, 101, 102 AND 107). SN 78-628,416. PUB. 1-1-2008. FILED 5-12-2005.
- 3,398,423. **SPAMFIGHTER (BLOCK FORM). SPAMFIGHTER APS**, (U.S. CLS. 21, 23, 26, 36 AND 38). SN 78-691,344. PUB. 5-2-2006. FILED 8-12-2005.
- 3,398,429 (*See Class 7 for this trademark*).
- 3,398,438. **SURFCONTROL RISKFILTER (BLOCK FORM). SURFCONTROL PLC, MULTIPLE CLASS**, (INT. CLS. 9 AND 42), (U.S. CLS. 21, 23, 26, 36, 38, 100 AND 101). SN 78-720,532. PUB. 1-1-2008. FILED 9-26-2005.
- 3,398,444. **WARMUP (BLOCK FORM). WARMUP PLC, MULTIPLE CLASS**, (INT. CLS. 9, 11 AND 17), (U.S. CLS. 1, 5, 12, 13, 21, 23, 26, 31, 34, 35, 36, 38 AND 50). SN 78-735,264. PUB. 1-1-2008. FILED 10-18-2005.
- 3,398,456. **VANGONOTES (BLOCK FORM). PEARSON EDUCATION, INC.**, (U.S. CLS. 21, 23, 26, 36 AND 38). SN 78-765,309. PUB. 1-1-2008. FILED 12-2-2005.
- 3,398,459. **SINGLE COPY DELIVERY SYSTEM (BLOCK FORM). AUTOMATED SOLUTIONS CORPORATION**, (U.S. CLS. 21, 23, 26, 36 AND 38). SN 78-770,396. PUB. 1-1-2008. FILED 12-9-2005.
- 3,398,466. **GRASS VALLEY (BLOCK FORM). THOMSON, MULTIPLE CLASS**, (INT. CLS. 9, 38 AND 41), (U.S. CLS. 21, 23, 26, 36, 38, 100, 101, 104 AND 107). SN 78-794,194. PUB. 10-9-2007. FILED 1-18-2006.
- 3,398,467. **CLIO (BLOCK FORM). ENDOWMENT CAPITAL GROUP, L.P.**, (U.S. CLS. 21, 23, 26, 36 AND 38). SN 78-795,463. PUB. 1-1-2008. FILED 1-20-2006.
- 3,398,471. **U&U (BLOCK FORM). NIHON UNISYS, LTD., MULTIPLE CLASS**, (INT. CLS. 9, 35 AND 42), (U.S. CLS. 21, 23, 26, 36, 38, 100, 101 AND 102). SN 78-804,148. PUB. 10-9-2007. FILED 2-1-2006.
- 3,398,478. **SOUL KITCHEN (BLOCK FORM). MALNIK, SHAREEF, MULTIPLE CLASS**, (INT. CLS. 9, 41 AND 43), (U.S. CLS. 21, 23, 26, 36, 38, 100, 101 AND 107). SN 78-815,159. PUB. 1-1-2008. FILED 2-15-2006.
- 3,398,492. **CRITERION (BLOCK FORM). CRI SYSTEMS, INC.**, (U.S. CLS. 21, 23, 26, 36 AND 38). SN 78-838,857. PUB. 1-1-2008. FILED 3-16-2006.
- 3,398,494. **OMOX (BLOCK FORM). SEMICONDUCTOR ENERGY LABORATORY CO., LTD.**, (U.S. CLS. 21, 23, 26, 36 AND 38). SN 78-842,068. PUB. 1-1-2008. FILED 3-21-2006.
- 3,398,495. **I-LIGHTING (BLOCK FORM). SUNPLUS TECHNOLOGY CO., LTD.**, (U.S. CLS. 21, 23, 26, 36 AND 38). SN 78-843,045. PUB. 1-1-2008. FILED 3-22-2006.
- 3,398,499. **DOUBLE BASS (BLOCK FORM). DOUBLE BASS PRODUCTIONS, MULTIPLE CLASS**, (INT. CLS. 9 AND 41), (U.S. CLS. 21, 23, 26, 36, 38, 100, 101 AND 107). SN 78-844,907. PUB. 1-1-2008. FILED 3-23-2006.
- 3,398,504. **SG (BLOCK FORM). INFRARED FIBER SYSTEMS, INC.**, (U.S. CLS. 21, 23, 26, 36 AND 38). SN 78-848,589. PUB. 7-31-2007. FILED 3-29-2006.
- 3,398,521. **GLOBAL COMMUNICATOR (BLOCK FORM). GLOBAL LANGUAGE SOLUTIONS, INC., MULTIPLE CLASS**, (INT. CLS. 9 AND 41), (U.S. CLS. 21, 23, 26, 36, 38, 100, 101 AND 107). SN 78-866,999. PUB. 1-1-2008. FILED 4-21-2006.
- 3,398,524. **OEMV (BLOCK FORM). NOVATEL INC.**, (U.S. CLS. 21, 23, 26, 36 AND 38). SN 78-869,042. PUB. 1-1-2008. FILED 4-25-2006.
- 3,398,525 (*See Class 7 for this trademark*).
- 3,398,526 (*See Class 6 for this trademark*).
- 3,398,530. **MOBILITY BUSINESS SOLUTIONS AND DESIGN. MOBILITY BUSINESS SOLUTIONS, INC.**, (U.S. CLS. 21, 23, 26, 36 AND 38). SN 78-875,956. PUB. 1-1-2008. FILED 5-3-2006.
- 3,398,535. **VENTZONE SYSTEMS (BLOCK FORM). AMERICAN ALDES VENTILATION CORPORATION, MULTIPLE CLASS**, (INT. CLS. 9 AND 11), (U.S. CLS. 13, 21, 23, 26, 31, 34, 36 AND 38). SN 78-879,433. PUB. 1-1-2008. FILED 5-9-2006.
- 3,398,545. **DYNAKIT (STYLIZED). AUTOMATED FLEXIBLE CONVEYOR, INC.**, (U.S. CLS. 21, 23, 26, 36 AND 38). SN 78-900,882. PUB. 1-1-2008. FILED 6-6-2006.
- 3,398,548. **THE FASTEST WAY TO LEARN A LANGUAGE. GUARANTEED. (BLOCK FORM). ROSETTA STONE LTD.**, (U.S. CLS. 21, 23, 26, 36 AND 38). SN 78-902,748. PUB. 1-1-2008. FILED 6-7-2006.
- 3,398,560. **SILVERTECH (BLOCK FORM). ICS TRIPLEX TECHNOLOGY LTD., MULTIPLE CLASS**, (INT. CLS. 9 AND 37), (U.S. CLS. 21, 23, 26, 36, 38, 100, 103 AND 106). SN 78-916,679. PUB. 9-4-2007. FILED 6-26-2006.
- 3,398,576. **ROCKERS (BLOCK FORM). BLUE SUN FILM COMPANY**, (U.S. CLS. 21, 23, 26, 36 AND 38). SN 78-935,991. PUB. 1-1-2008. FILED 7-24-2006.
- 3,398,592. **MISCELLANEOUS DESIGN. OBJECTWORLD COMMUNICATIONS CORP.**, (U.S. CLS. 21, 23, 26, 36 AND 38). SN 78-957,683. PUB. 1-1-2008. FILED 8-22-2006.
- 3,398,593. **AWIS (BLOCK FORM). ADE CORPORATION**, (U.S. CLS. 21, 23, 26, 36 AND 38). SN 78-958,139. PUB. 1-1-2008. FILED 8-22-2006.
- 3,398,596. **XMES (BLOCK FORM). PERFORMIX INC.**, (U.S. CLS. 21, 23, 26, 36 AND 38). SN 78-960,173. PUB. 1-1-2008. FILED 8-24-2006.
- 3,398,599. **IITPORTF (BLOCK FORM). INFANGER INVESTMENT TECHNOLOGY, LLC**, (U.S. CLS. 21, 23, 26, 36 AND 38). SN 78-964,141. PUB. 1-1-2008. FILED 8-30-2006.
- 3,398,600 (*See Class 3 for this trademark*).
- 3,398,604 (*See Class 8 for this trademark*).
- 3,398,605. **COMMUNICAID (BLOCK FORM). COMMUNICAID GROUP LIMITED, MULTIPLE CLASS**, (INT. CLS. 9, 16, 35 AND 41), (U.S. CLS. 2, 5, 21, 22, 23, 26, 29, 36, 37, 38, 50, 100, 101, 102 AND 107). SN 78-967,858. PUB. 1-1-2008. FILED 9-6-2006.
- 3,398,606. **MISCELLANEOUS DESIGN. SABRE VISION PTY LTD, MULTIPLE CLASS**, (INT. CLS. 9, 16 AND 25), (U.S. CLS. 2, 5, 21, 22, 23, 26, 29, 36, 37, 38, 39 AND 50). SN 78-968,060. PUB. 8-7-2007. FILED 9-6-2006.

- 3,398,612. **EXPEED (BLOCK FORM)**. NIKON CORPORATION, (U.S. CLS. 21, 23, 26, 36 AND 38). SN 78-973,219. PUB. 9-18-2007. FILED 9-13-2006.
- 3,398,614. **DISSENT (BLOCK FORM)**. TONY HAWK, INC., MULTIPLE CLASS, (INT. CLS. 9, 35, 38, 41 AND 42), (U.S. CLS. 21, 23, 26, 36, 38, 100, 101, 102, 104 AND 107). SN 78-974,419. PUB. 1-1-2008. FILED 9-14-2006.
- 3,398,615. **PTXCONNECT AND DESIGN**. PSION TEKLOGIX INC., (U.S. CLS. 21, 23, 26, 36 AND 38). SN 78-974,501. PUB. 1-1-2008. FILED 9-14-2006.
- 3,398,620. **ITEX (BLOCK FORM)**. TEN CATE ADVANCED TEXTILES B.V., MULTIPLE CLASS, (INT. CLS. 9, 10, 22, 24 AND 25), (U.S. CLS. 1, 2, 7, 19, 21, 22, 23, 26, 36, 38, 39, 42, 44 AND 50). SN 79-010,775. PUB. 10-31-2006. FILED 3-1-2005.
- 3,398,621. **FEEDINFO NEWS SERVICE AND DESIGN**. DAVID FEELEY, MULTIPLE CLASS, (INT. CLS. 9, 16 AND 38), (U.S. CLS. 2, 5, 21, 22, 23, 26, 29, 36, 37, 38, 50, 100, 101 AND 104). SN 79-012,587. PUB. 1-1-2008. FILED 1-4-2005.
- 3,398,624. **ÇANAKKALE SERAMİK (STYLIZED)**. KALESERAMİK ÇANAKKALE KALEBODUR SERAMİK SANAYİ ANONİM ŞİRKETİ, (U.S. CLS. 21, 23, 26, 36 AND 38). SN 79-016,488. PUB. 1-1-2008. FILED 5-27-2005.
- 3,398,626. **KARPOS (BLOCK FORM)**. MICRONTEL S.P.A., (U.S. CLS. 21, 23, 26, 36 AND 38). SN 79-018,134. PUB. 1-1-2008. FILED 9-28-2005.
- 3,398,628. **KSR KUEBLER AND DESIGN**. KSR KUEBLER NIVEAU-MESSTECHNIK AKTIENGESELLSCHAFT, (U.S. CLS. 21, 23, 26, 36 AND 38). SN 79-018,538. PUB. 1-1-2008. FILED 10-18-2005.
- 3,398,633. **KLEIN + HUMMEL (BLOCK FORM)**. SENNHESER ELECTRONIC GMBH & CO. KG, (U.S. CLS. 21, 23, 26, 36 AND 38). SN 79-021,423. PUB. 1-1-2008. FILED 11-15-2005.
- 3,398,634. **3IVX (BLOCK FORM)**. 3IVX TECHNOLOGIES PTY LTD, (U.S. CLS. 21, 23, 26, 36 AND 38). SN 79-022,418. PUB. 1-1-2008. FILED 2-23-2006.
- 3,398,636. **LIFE IS NOTHING WITHOUT CONNECTIONS (BLOCK FORM)**. PIRELLI & C. S.P.A., MULTIPLE CLASS, (INT. CLS. 9, 16 AND 35), (U.S. CLS. 2, 5, 21, 22, 23, 26, 29, 36, 37, 38, 50, 100, 101 AND 102). SN 79-022,643. PUB. 1-1-2008. FILED 10-3-2005.
- 3,398,637. **PROSIEBENSAT.1 WELT AND DESIGN**. PROSIEBENSAT.1 MEDIA AG, MULTIPLE CLASS, (INT. CLS. 9, 16, 35, 38, 41 AND 42), (U.S. CLS. 2, 5, 21, 22, 23, 26, 29, 36, 37, 38, 50, 100, 101, 102, 104 AND 107). SN 79-023,186. PUB. 1-1-2008. FILED 2-3-2005.
- 3,398,642. **CHEMI-CON (STYLIZED)**. NIPPON CHEMI-CON CORPORATION, (U.S. CLS. 21, 23, 26, 36 AND 38). SN 79-024,862. PUB. 1-1-2008. FILED 5-19-2006.
- 3,398,647. **FISCHER LUC (BLOCK FORM)**. FISCHER CONNECTORS HOLDING S.A., (U.S. CLS. 21, 23, 26, 36 AND 38). SN 79-025,318. PUB. 1-1-2008. FILED 5-31-2006.
- 3,398,648. **ECO-SET AND DESIGN**. ECO-SOLUTION, MULTIPLE CLASS, (INT. CLS. 9 AND 42), (U.S. CLS. 21, 23, 26, 36, 38, 100 AND 101). SN 79-025,678. PUB. 1-1-2008. FILED 2-24-2006.
- 3,398,649. **R AND DESIGN**. ORIGINIZE IP AG; C/O INCO CONSULTING AG, MULTIPLE CLASS, (INT. CLS. 9, 16 AND 35), (U.S. CLS. 2, 5, 21, 22, 23, 26, 29, 36, 37, 38, 50, 100, 101 AND 102). SN 79-025,803. PUB. 1-1-2008. FILED 4-27-2006.
- 3,398,651. **QUANTAX (BLOCK FORM)**. BRUKER AXS MICROANALYSIS GMBH, (U.S. CLS. 21, 23, 26, 36 AND 38). SN 79-026,161. PUB. 1-1-2008. FILED 5-16-2006.
- 3,398,652. **LUC (BLOCK FORM)**. FISCHER CONNECTORS HOLDING S.A., (U.S. CLS. 21, 23, 26, 36 AND 38). SN 79-026,259. PUB. 1-1-2008. FILED 6-14-2006.
- 3,398,653. **B K AND DESIGN**. BRÜEL & KJÆR SOUND & VIBRATION; MEASUREMENT A/S, MULTIPLE CLASS, (INT. CLS. 9, 37 AND 42), (U.S. CLS. 21, 23, 26, 36, 38, 100, 101, 103 AND 106). SN 79-026,589. PUB. 1-1-2008. FILED 3-28-2006.
- 3,398,654. **LASERTEC (STYLIZED)**. LASERTEC CORPORATION, (U.S. CLS. 21, 23, 26, 36 AND 38). SN 79-026,660. PUB. 1-1-2008. FILED 2-8-2006.
- 3,398,657. **CERTESS (BLOCK FORM)**. CERTESS S.A., MULTIPLE CLASS, (INT. CLS. 9, 16 AND 42), (U.S. CLS. 2, 5, 21, 22, 23, 26, 29, 36, 37, 38, 50, 100 AND 101). SN 79-026,923. PUB. 1-1-2008. FILED 5-17-2006.
- 3,398,659. **NUTRAINGREDIENTS (BLOCK FORM)**. DECISION NEWS MEDIA SAS, MULTIPLE CLASS, (INT. CLS. 9, 35, 38, 41 AND 42), (U.S. CLS. 21, 23, 26, 36, 38, 100, 101, 102, 104 AND 107). SN 79-028,461. PUB. 1-1-2008. FILED 3-24-2006.
- 3,398,660. **DECISION NEWS (BLOCK FORM)**. DECISION NEWS MEDIA SAS, MULTIPLE CLASS, (INT. CLS. 9, 35, 38, 41 AND 42), (U.S. CLS. 21, 23, 26, 36, 38, 100, 101, 102, 104 AND 107). SN 79-028,462. PUB. 1-1-2008. FILED 3-24-2006.
- 3,398,663. **RECIVA AND DESIGN**. RECIVA LIMITED, MULTIPLE CLASS, (INT. CLS. 9 AND 42), (U.S. CLS. 21, 23, 26, 36, 38, 100 AND 101). SN 79-028,774. PUB. 1-1-2008. FILED 2-7-2006.
- 3,398,664. **SMARTSPARK (BLOCK FORM)**. HAMWORTHY COMBUSTION ENGINEERING; LIMITED, MULTIPLE CLASS, (INT. CLS. 9 AND 11), (U.S. CLS. 13, 21, 23, 26, 31, 34, 36 AND 38). SN 79-028,829. PUB. 1-1-2008. FILED 5-6-2006.
- 3,398,666. **OPTIARC (BLOCK FORM)**. SONY NEC OPTIARC INC., (U.S. CLS. 21, 23, 26, 36 AND 38). SN 79-029,125. PUB. 1-1-2008. FILED 7-24-2006.
- 3,398,679. **FAR EAST CABLE AND DESIGN**. FAR EAST CABLE FACTORY, (U.S. CLS. 21, 23, 26, 36 AND 38). SN 79-030,872. PUB. 1-1-2008. FILED 8-7-2006.
- 3,398,684 (*See Class 7 for this trademark*).
- 3,398,686. **MISCELLANEOUS DESIGN**. TOMTOM INTERNATIONAL B.V., MULTIPLE CLASS, (INT. CLS. 9, 38, 39, 41, 42 AND 45), (U.S. CLS. 21, 23, 26, 36, 38, 100, 101, 104, 105 AND 107). SN 79-031,569. PUB. 1-1-2008. FILED 5-4-2006.
- 3,398,690. **FAR EAST CABLE AND DESIGN**. FAR EAST CABLE FACTORY, (U.S. CLS. 21, 23, 26, 36 AND 38). SN 79-031,706. PUB. 1-1-2008. FILED 8-7-2006.
- 3,398,695. **VOXTER (BLOCK FORM)**. TOPSYSTEM SYSTEMHAUS GMBH, (U.S. CLS. 21, 23, 26, 36 AND 38). SN 79-032,241. PUB. 1-1-2008. FILED 10-23-2006.
- 3,398,697. **ESSENSIUM (BLOCK FORM)**. SENSIVUM NV, MULTIPLE CLASS, (INT. CLS. 9, 35 AND 42), (U.S. CLS. 21, 23, 26, 36, 38, 100, 101 AND 102). SN 79-032,321. PUB. 1-1-2008. FILED 5-3-2006.
- 3,398,699. **DE-SCENT (BLOCK FORM)**. BLÜCHER GMBH, MULTIPLE CLASS, (INT. CLS. 9, 11 AND 24), (U.S. CLS. 13, 21, 23, 26, 31, 34, 36, 38, 42 AND 50). SN 79-032,532. PUB. 1-1-2008. FILED 11-13-2006.
- 3,398,701. **METNEXT (BLOCK FORM)**. METEO FRANCE, MULTIPLE CLASS, (INT. CLS. 9, 35, 38 AND 42), (U.S. CLS. 21, 23, 26, 36, 38, 100, 101, 102 AND 104). SN 79-032,708. PUB. 1-1-2008. FILED 11-10-2006.
- 3,398,702. **IDNA AND DESIGN**. CHEN JIAN QING, (U.S. CLS. 21, 23, 26, 36 AND 38). SN 79-032,772. PUB. 1-1-2008. FILED 11-28-2006.
- 3,398,709. **BLIGHTER (STYLIZED)**. PLEKTEK LIMITED, MULTIPLE CLASS, (INT. CLS. 9, 38 AND 45), (U.S. CLS. 21, 23, 26, 36, 38, 100, 101 AND 104). SN 79-033,033. PUB. 1-1-2008. FILED 3-30-2006.
- 3,398,711. **CERTIFY ID AND DESIGN**. WISEKEY SA, MULTIPLE CLASS, (INT. CLS. 9, 35, 36, 38, 42 AND 45), (U.S. CLS. 21, 23, 26, 36, 38, 100, 101, 102 AND 104). SN 79-033,564. PUB. 1-1-2008. FILED 11-24-2006.
- 3,398,717. **SUPPLYCHAIN HEALTHCHECK (BLOCK FORM)**. A.P. MØLLER A/S - MÆRSK A/S, MULTIPLE CLASS, (INT. CLS. 9, 16, 35, 38, 39 AND 42), (U.S. CLS. 2, 5, 21, 22, 23, 26, 29, 36, 37, 38, 50, 100, 101, 102, 104 AND 105). SN 79-033,956. PUB. 1-1-2008. FILED 9-5-2006.
- 3,398,732 (*See Class 7 for this trademark*).
- 3,398,738. **SHORAR (BLOCK FORM)**. OERLIKON CONTRAVES AG, (U.S. CLS. 21, 23, 26, 36 AND 38). SN 79-034,940. PUB. 1-1-2008. FILED 12-11-2006.
- 3,398,746. **PUZZLECOMMERCE (BLOCK FORM)**. TOBIAS RÜCKERT, (U.S. CLS. 21, 23, 26, 36 AND 38). SN 79-035,143. PUB. 1-1-2008. FILED 12-20-2006.
- 3,398,747. **DSS DIGITAL SPEECH STANDARD AND DESIGN**. KONINKLIJKE PHILIPS ELECTRONICS N.V., (U.S. CLS. 21, 23, 26, 36 AND 38). SN 79-035,195. PUB. 1-1-2008. FILED 1-22-2007.
- 3,398,748 (*See Class 7 for this trademark*).
- 3,398,749 (*See Class 3 for this trademark*).
- 3,398,751. **ER PRODUCTIONS EVANGELISTIC RESOURCES AND DESIGN**. FULL FLAME GMBH, MULTIPLE CLASS,

- (INT. CLS. 9, 16, 41 AND 45), (U.S. CLS. 2, 5, 21, 22, 23, 26, 29, 36, 37, 38, 50, 100, 101 AND 107). SN 79-035,255. PUB. 1-1-2008. FILED 1-11-2007.
- 3,398,760. **VECTRON (BLOCK FORM)**. VECTRON SYSTEMS AG, MULTIPLE CLASS, (INT. CLS. 9, 37 AND 42), (U.S. CLS. 21, 23, 26, 36, 38, 100, 101, 103 AND 106). SN 79-035,789. PUB. 1-1-2008. FILED 11-23-2006.
- 3,398,770. **CAREZZA (BLOCK FORM)**. OTTO BOCK HEALTHCARE GMBH, MULTIPLE CLASS, (INT. CLS. 9 AND 10), (U.S. CLS. 21, 23, 26, 36, 38, 39 AND 44). SN 79-036,481. PUB. 1-1-2008. FILED 2-15-2007.
- 3,398,771. **LENIA (BLOCK FORM)**. OTTO BOCK HEALTHCARE GMBH, MULTIPLE CLASS, (INT. CLS. 9 AND 10), (U.S. CLS. 21, 23, 26, 36, 38, 39 AND 44). SN 79-036,483. PUB. 1-1-2008. FILED 2-15-2007.
- 3,398,772. **AREXA (BLOCK FORM)**. OTTO BOCK HEALTHCARE GMBH, MULTIPLE CLASS, (INT. CLS. 9 AND 10), (U.S. CLS. 21, 23, 26, 36, 38, 39 AND 44). SN 79-036,485. PUB. 1-1-2008. FILED 2-15-2007.
- 3,398,774 (*See Class 5 for this trademark*).
- 3,398,775. **MISCELLANEOUS DESIGN**. BSE HOLDINGS CO., LTD., MULTIPLE CLASS, (INT. CLS. 9, 10, 35 AND 36), (U.S. CLS. 21, 23, 26, 36, 38, 39, 44, 100, 101 AND 102). SN 79-036,664. PUB. 1-1-2008. FILED 11-10-2006.
- 3,398,780. **CELLAVISTA (BLOCK FORM)**. INNOVATIS AG, MULTIPLE CLASS, (INT. CLS. 9 AND 10), (U.S. CLS. 21, 23, 26, 36, 38, 39 AND 44). SN 79-037,107. PUB. 1-1-2008. FILED 2-22-2007.
- 3,398,781. **TS (STYLIZED)**. TECNICAS DE ELECTRONICA; Y AUTOMATISMOS, S.A., (U.S. CLS. 21, 23, 26, 36 AND 38). SN 79-037,124. PUB. 1-1-2008. FILED 1-30-2007.
- 3,398,784. **WANTOK (BLOCK FORM)**. CORINNE DAMAS-SANDIFORD, MULTIPLE CLASS, (INT. CLS. 9, 35 AND 41), (U.S. CLS. 21, 23, 26, 36, 38, 100, 101, 102 AND 107). SN 79-037,578. PUB. 1-1-2008. FILED 2-12-2007.
- 3,398,787. **ANDELI (STYLIZED)**. ANDELI GROUP CO., LTD., (U.S. CLS. 21, 23, 26, 36 AND 38). SN 79-038,225. PUB. 1-1-2008. FILED 4-10-2007.
- 3,398,810. **UBS TRADER (BLOCK FORM)**. UBS AG, MULTIPLE CLASS, (INT. CLS. 9, 35 AND 36), (U.S. CLS. 21, 23, 26, 36, 38, 100, 101 AND 102). SN 79-040,819. PUB. 1-1-2008. FILED 5-23-2007.
- 3,398,813. **ADITON (STYLIZED)**. ADITON LIMITED, MULTIPLE CLASS, (INT. CLS. 9, 35 AND 38), (U.S. CLS. 21, 23, 26, 36, 38, 100, 101, 102 AND 104). SN 79-041,082. PUB. 1-1-2008. FILED 4-10-2007.
- 3,398,821. **LUXIS (BLOCK FORM)**. SOMFY SAS, (U.S. CLS. 21, 23, 26, 36 AND 38). SN 79-041,907. PUB. 1-1-2008. FILED 5-24-2007.
- 3,398,822. **AUDIOSCROBBLER (BLOCK FORM)**. AUDIO-SCROBBLER LIMITED, MULTIPLE CLASS, (INT. CLS. 9, 35, 38 AND 41), (U.S. CLS. 21, 23, 26, 36, 38, 100, 101, 102, 104 AND 107). SN 79-041,971. PUB. 1-1-2008. FILED 6-18-2007.
- 3,398,828. **SIWO-SCREEN (BLOCK FORM)**. NEXANS, (U.S. CLS. 21, 23, 26, 36 AND 38). SN 79-043,141. PUB. 1-1-2008. FILED 7-27-2007.
- 3,398,829. **SIWO-CUL (BLOCK FORM)**. NEXANS, (U.S. CLS. 21, 23, 26, 36 AND 38). SN 79-043,142. PUB. 1-1-2008. FILED 7-27-2007.
- INC., (U.S. CLS. 26, 39 AND 44). SN 77-136,239. PUB. 1-1-2008. FILED 3-21-2007.
- 3,397,452. **RENOVO SPINE SYSTEM AND DESIGN**. SPECIALTY SPINE PRODUCTS, LLC, (U.S. CLS. 26, 39 AND 44). SN 77-148,972. PUB. 1-1-2008. FILED 4-4-2007.
- 3,397,762. **A LITTLE EASIER RECOVERY (BLOCK FORM)**. MCGRATH, CATHERINE E., (U.S. CLS. 26, 39 AND 44). SN 77-223,887. PUB. 1-1-2008. FILED 7-6-2007.
- 3,397,855. **TANTRA (BLOCK FORM)**. FORERUNNERS TECHNOLOGY, INC., (U.S. CLS. 26, 39 AND 44). SN 77-227,597. PUB. 1-1-2008. FILED 7-12-2007.
- 3,397,949. **RAMP (BLOCK FORM)**. ST. JUDE MEDICAL ATRIAL FIBRILLATION DIVISION, INC., (U.S. CLS. 26, 39 AND 44). SN 77-229,409. PUB. 1-1-2008. FILED 7-13-2007.
- 3,397,950. **RAMP-1 (BLOCK FORM)**. ST. JUDE MEDICAL ATRIAL FIBRILLATION DIVISION, INC., (U.S. CLS. 26, 39 AND 44). SN 77-229,415. PUB. 1-1-2008. FILED 7-13-2007.
- 3,398,096. **WHITE SILK (BLOCK FORM)**. SENTRY MEDICAL PRODUCTS, INC., (U.S. CLS. 26, 39 AND 44). SN 77-231,815. PUB. 1-1-2008. FILED 7-17-2007.
- 3,398,100. **SUPER FLEX (BLOCK FORM)**. SENTRY MEDICAL PRODUCTS, INC., (U.S. CLS. 26, 39 AND 44). SN 77-231,859. PUB. 1-1-2008. FILED 7-17-2007.
- 3,398,179. **PINNACLE (BLOCK FORM)**. B. BRAUN MEDICAL INC., (U.S. CLS. 26, 39 AND 44). SN 77-233,314. PUB. 1-1-2008. FILED 7-19-2007.
- 3,398,201. **PLUM A+ AND DESIGN**. HOSPIRA, INC., (U.S. CLS. 26, 39 AND 44). SN 77-233,838. PUB. 1-1-2008. FILED 7-19-2007.
- 3,398,329 (*See Class 9 for this trademark*).
- 3,398,358. **ULTRAFLEX**. MEDTRONIC, INC., (U.S. CLS. 26, 39 AND 44). SN 78-218,268. PUB. 1-1-2008. FILED 2-24-2003.
- 3,398,359. **STRIDER**. DAYS HEALTHCARE U.K. LIMITED, MULTIPLE CLASS, (INT. CLS. 10 AND 12), (U.S. CLS. 19, 21, 23, 26, 31, 35, 39 AND 44). SN 78-278,121. PUB. 9-25-2007. FILED 7-24-2003.
- 3,398,411. **NANODYNAMICS AND DESIGN**. NANODYNAMICS, INC., MULTIPLE CLASS, (INT. CLS. 10 AND 42), (U.S. CLS. 26, 39, 44, 100 AND 101). SN 78-642,575. PUB. 1-1-2008. FILED 6-2-2005.
- 3,398,430 (*See Class 5 for this trademark*).
- 3,398,431. **BD VISITEC AND DESIGN**. BECTON, DICKINSON AND COMPANY, (U.S. CLS. 26, 39 AND 44). SN 78-711,172. PUB. 1-1-2008. FILED 9-12-2005.
- 3,398,476. **LIFE CARE (BLOCK FORM)**. MUELLER SPORTS MEDICINE, INC., MULTIPLE CLASS, (INT. CLS. 10 AND 28), (U.S. CLS. 22, 23, 26, 38, 39, 44 AND 50). SN 78-810,590. PUB. 1-1-2008. FILED 2-8-2006.
- 3,398,482. **EAR-TRONICS (BLOCK FORM)**. EAR-TRONICS, INC., MULTIPLE CLASS, (INT. CLS. 10 AND 44), (U.S. CLS. 26, 39, 44, 100 AND 101). SN 78-821,669. PUB. 1-1-2008. FILED 2-23-2006.
- 3,398,598. **BRIGHT STARTS AND DESIGN**. KIDS II, INC., MULTIPLE CLASS, (INT. CLS. 10, 20, 21 AND 28), (U.S. CLS. 2, 13, 22, 23, 25, 26, 29, 30, 32, 33, 38, 39, 40, 44 AND 50). SN 78-963,662. PUB. 1-1-2008. FILED 8-30-2006.
- 3,398,620 (*See Class 9 for this trademark*).
- 3,398,671. **FA AND DESIGN**. HANGZHOU SHI TONGLU YILIAO; GUANGXUEYI QI ZONGCHANG, (U.S. CLS. 26, 39 AND 44). SN 79-030,106. PUB. 1-1-2008. FILED 5-15-2006.
- 3,398,700. **EXPLORENT (BLOCK FORM)**. GYRUS MEDICAL GMBH, (U.S. CLS. 26, 39 AND 44). SN 79-032,673. PUB. 1-1-2008. FILED 11-28-2006.
- 3,398,715. **GERMITEC AND DESIGN**. GERMITEC, MULTIPLE CLASS, (INT. CLS. 10, 11 AND 37), (U.S. CLS. 13, 21, 23, 26, 31, 34, 39, 44, 100, 103 AND 106). SN 79-033,865. PUB. 1-1-2008. FILED 12-8-2006.
- 3,398,719. **G AND DESIGN**. GERMITEC, MULTIPLE CLASS, (INT. CLS. 10, 11 AND 37), (U.S. CLS. 13, 21, 23, 26, 31, 34, 39, 44, 100, 103 AND 106). SN 79-034,035. PUB. 1-1-2008. FILED 12-8-2006.
- 3,398,737. **REVOLNERV (STYLIZED)**. ORTHOMED, (U.S. CLS. 26, 39 AND 44). SN 79-034,914. PUB. 1-1-2008. FILED 12-14-2006.
- 3,398,770 (*See Class 9 for this trademark*).
- 3,398,771 (*See Class 9 for this trademark*).
- 3,398,772 (*See Class 9 for this trademark*).
- 3,398,775 (*See Class 9 for this trademark*).

CLASS 10—MEDICAL APPARATUS

- 3,396,841 (*See Class 9 for this trademark*).
- 3,396,941. **GRADIENT-3 (BLOCK FORM)**. ULTIMATE WIRE-FORMS, INC., (U.S. CLS. 26, 39 AND 44). SN 76-679,533. PUB. 1-1-2008. FILED 7-16-2007.
- 3,396,970. **POTEC (BLOCK FORM)**. POTEC CO., LTD., (U.S. CLS. 26, 39 AND 44). SN 77-007,269. PUB. 1-1-2008. FILED 9-26-2006.
- 3,396,972. **DRYVU (BLOCK FORM)**. CANNUFLOW, INC., (U.S. CLS. 26, 39 AND 44). SN 77-009,784. PUB. 1-1-2008. FILED 9-28-2006.
- 3,397,358. **RADSPPEED (STYLIZED)**. SHIMADZU CORPORATION, (U.S. CLS. 26, 39 AND 44). SN 77-109,562. PUB. 1-1-2008. FILED 2-16-2007.
- 3,397,421. **VITYAZ (BLOCK FORM)**. MEDICAL QUANT USA,

- 3,398,780 (*See Class 9 for this trademark*).
 3,398,788. **NOSEVOLE (BLOCK FORM)**. KEITH STEWART, (U.S. CLS. 26, 39 AND 44). SN 79-038,389. PUB. 1-1-2008. FILED 1-10-2007.
 3,398,811. **ECHIDNA PIN (BLOCK FORM)**. IAN GRIGGS, (U.S. CLS. 26, 39 AND 44). SN 79-040,846. PUB. 1-1-2008. FILED 7-2-2007.
 3,398,819. **POWER TX AND DESIGN**. LANAFORM LANA ALLPEAK S.A., EN ABRÉGÉ LANA S.A., (U.S. CLS. 26, 39 AND 44). SN 79-041,465. PUB. 1-1-2008. FILED 5-15-2007.

CLASS 11—ENVIRONMENTAL CONTROL APPARATUS

- 3,396,816. **POET**. MUNRO CONCRETE PRODUCTS LTD., (U.S. CLS. 13, 21, 23, 31 AND 34). SN 76-266,534. PUB. 9-14-2004. FILED 6-4-2001.
 3,396,864. **JSD HOME START (STYLIZED)**. JIALE GLASSWARE MANUFACTORY CO., LTD., (U.S. CLS. 13, 21, 23, 31 AND 34). SN 76-663,358. PUB. 1-1-2008. FILED 7-19-2006.
 3,396,905. **SIMPLE-SEPTIC (BLOCK FORM)**. PRESBY ENVIRONMENTAL, INC., MULTIPLE CLASS, (INT. CLS. 11, 17 AND 19), (U.S. CLS. 1, 5, 12, 13, 21, 23, 31, 33, 34, 35 AND 50). SN 76-673,717. PUB. 1-1-2008. FILED 3-7-2007.
 3,396,968. **CALIFORNIA OUTDOOR PIZZA OVENS AND DESIGN**. SHALOM ZANZURI, (U.S. CLS. 13, 21, 23, 31 AND 34). SN 77-006,598. PUB. 1-1-2008. FILED 9-25-2006.
 3,397,131. **MIDWEST FILTRATION COMPANY AND DESIGN**. MIDWEST FILTRATION COMPANY, (U.S. CLS. 13, 21, 23, 31 AND 34). SN 77-060,339. PUB. 1-1-2008. FILED 12-8-2006.
 3,397,186. **LOV (BLOCK FORM)**. FRYMASTER LLC, (U.S. CLS. 13, 21, 23, 31 AND 34). SN 77-068,793. PUB. 1-1-2008. FILED 12-20-2006.
 3,397,255. **H2OCOOL (BLOCK FORM)**. 417394 ALBERTA LTD., MULTIPLE CLASS, (INT. CLS. 11 AND 37), (U.S. CLS. 13, 21, 23, 31, 34, 100, 103 AND 106). SN 77-081,747. PUB. 1-1-2008. FILED 1-12-2007.
 3,397,293. **HYDROPOOL SELF-CLEANING HOT TUBS AND DESIGN**. HYDROPOOL INDUSTRIES INC., MULTIPLE CLASS, (INT. CLS. 11 AND 19), (U.S. CLS. 1, 12, 13, 21, 23, 31, 33, 34 AND 50). SN 77-094,143. PUB. 1-1-2008. FILED 1-30-2007.
 3,397,294 (*See Class 7 for this trademark*).
 3,397,300 (*See Class 7 for this trademark*).
 3,397,434. **EVERLAST (BLOCK FORM)**. FULL SPECTRUM SOLUTIONS, INC., (U.S. CLS. 13, 21, 23, 31 AND 34). SN 77-140,001. PUB. 9-25-2007. FILED 3-26-2007.
 3,397,451. **ANTILIA (BLOCK FORM)**. KOHLER CO., (U.S. CLS. 13, 21, 23, 31 AND 34). SN 77-147,699. PUB. 1-1-2008. FILED 4-3-2007.
 3,397,569. **JUMP START MANIFOLDS (BLOCK FORM)**. JUMP START MANIFOLDS, LLC, (U.S. CLS. 13, 21, 23, 31 AND 34). SN 77-193,893. PUB. 1-1-2008. FILED 5-31-2007.
 3,397,613. **HYDRONIKA (BLOCK FORM)**. HYDRONIKA, INC, (U.S. CLS. 13, 21, 23, 31 AND 34). SN 77-201,980. PUB. 1-1-2008. FILED 6-8-2007.
 3,397,622. **INTELLI-CHECK (BLOCK FORM)**. KAZ, INCORPORATED, (U.S. CLS. 13, 21, 23, 31 AND 34). SN 77-202,663. PUB. 1-1-2008. FILED 6-11-2007.
 3,397,675. **OPTILED AND DESIGN**. OPTILED HOLDINGS COMPANY LIMITED, (U.S. CLS. 13, 21, 23, 31 AND 34). SN 77-213,800. PUB. 1-1-2008. FILED 6-23-2007.
 3,397,695. **H2O AND DESIGN**. H2O INTERNATIONAL, INC., (U.S. CLS. 13, 21, 23, 31 AND 34). SN 77-216,538. PUB. 1-1-2008. FILED 6-27-2007.
 3,397,761. **GRUPO T DIFFUSION (BLOCK FORM)**. VIBIA, INC., MULTIPLE CLASS, (INT. CLS. 11 AND 20), (U.S. CLS. 2, 13, 21, 22, 23, 25, 31, 32, 34 AND 50). SN 77-223,332. PUB. 1-1-2008. FILED 7-6-2007.
 3,397,776. **RAIL-LOCK (BLOCK FORM)**. SUREFIRE, LLC, (U.S. CLS. 13, 21, 23, 31 AND 34). SN 77-224,993. PUB. 1-1-2008. FILED 7-9-2007.
 3,397,867. **TRULY-MAGIC (BLOCK FORM)**. PINEDA, MANUEL, (U.S. CLS. 13, 21, 23, 31 AND 34). SN 77-227,892. PUB. 1-1-2008. FILED 7-12-2007.
 3,397,943. **PRESIDENTIAL II (BLOCK FORM)**. CRAFTMADE INTERNATIONAL, INC., (U.S. CLS. 13, 21, 23, 31 AND 34). SN 77-229,295. PUB. 1-1-2008. FILED 7-13-2007.
 3,397,947. **AMERICAIRE AND DESIGN**. COOL AIR INTERNATIONAL, INC., (U.S. CLS. 13, 21, 23, 31 AND 34). SN 77-229,385. PUB. 1-1-2008. FILED 7-13-2007.
 3,397,962. **LUXEMBRIGHT (BLOCK FORM)**. CAO GROUP, INC., (U.S. CLS. 13, 21, 23, 31 AND 34). SN 77-229,633. PUB. 1-1-2008. FILED 7-13-2007.
 3,398,089 (*See Class 9 for this trademark*).
 3,398,294. **STICK TOGETHER (BLOCK FORM)**. T-MOBILE USA, INC., (U.S. CLS. 13, 21, 23, 31 AND 34). SN 77-250,373. PUB. 1-1-2008. FILED 8-8-2007.
 3,398,367. **PLUGG (BLOCK FORM)**. PLUGG LTD, (U.S. CLS. 13, 21, 23, 31 AND 34). SN 78-397,685. PUB. 10-16-2007. FILED 4-7-2004.
 3,398,388. **FORCE (BLOCK FORM)**. KOOTENAY GROWER'S SUPPLY LTD., (U.S. CLS. 13, 21, 23, 31 AND 34). SN 78-544,252. PUB. 1-1-2008. FILED 1-7-2005.
 3,398,398. **EQUINOX (BLOCK FORM)**. EQUINOX PRODUCTS, L.L.C., (U.S. CLS. 13, 21, 23, 31 AND 34). SN 78-585,616. PUB. 1-1-2008. FILED 3-11-2005.
 3,398,399. **EQ-300 (BLOCK FORM)**. EQUINOX PRODUCTS L.L.C., (U.S. CLS. 13, 21, 23, 31 AND 34). SN 78-585,751. PUB. 1-1-2008. FILED 3-11-2005.
 3,398,405 (*See Class 9 for this trademark*).
 3,398,444 (*See Class 9 for this trademark*).
 3,398,465. **SMART INVERTER AND DESIGN**. SAMSUNG ELECTRONICS CO., LTD., (U.S. CLS. 13, 21, 23, 31 AND 34). SN 78-791,543. PUB. 1-1-2008. FILED 1-13-2006.
 3,398,519 (*See Class 8 for this trademark*).
 3,398,535 (*See Class 9 for this trademark*).
 3,398,594. **ENERHEAT (BLOCK FORM)**. NU-AIR VENTILATION SYSTEMS INC., (U.S. CLS. 13, 21, 23, 31 AND 34). SN 78-958,329. PUB. 1-1-2008. FILED 8-23-2006.
 3,398,604 (*See Class 8 for this trademark*).
 3,398,655 (*See Class 7 for this trademark*).
 3,398,656 (*See Class 7 for this trademark*).
 3,398,664 (*See Class 9 for this trademark*).
 3,398,672. **RESTINGWELL (BLOCK FORM)**. STEFAN GERLEMAN, (U.S. CLS. 13, 21, 23, 31 AND 34). SN 79-030,160. PUB. 1-1-2008. FILED 2-13-2006.
 3,398,674 (*See Class 6 for this trademark*).
 3,398,678. **GEMDRYER (BLOCK FORM)**. N.V. BEKAERT S.A., (U.S. CLS. 13, 21, 23, 31 AND 34). SN 79-030,564. PUB. 1-1-2008. FILED 9-8-2006.
 3,398,684 (*See Class 7 for this trademark*).
 3,398,699 (*See Class 9 for this trademark*).
 3,398,706 (*See Class 6 for this trademark*).
 3,398,715 (*See Class 10 for this trademark*).
 3,398,719 (*See Class 10 for this trademark*).
 3,398,739. **I-CHILLING (BLOCK FORM)**. FRIGINOX, (U.S. CLS. 13, 21, 23, 31 AND 34). SN 79-035,014. PUB. 1-1-2008. FILED 1-25-2007.
 3,398,758. **HORTILED (BLOCK FORM)**. HORTILUX SCHRÉDER B.V., MULTIPLE CLASS, (INT. CLS. 11, 35, 42 AND 44), (U.S. CLS. 13, 21, 23, 31, 34, 100, 101 AND 102). SN 79-035,749. PUB. 1-1-2008. FILED 12-7-2006.
 3,398,759. **AGRILED (BLOCK FORM)**. HORTILUX SCHRÉDER B.V., MULTIPLE CLASS, (INT. CLS. 11, 35, 42 AND 44), (U.S. CLS. 13, 21, 23, 31, 34, 100, 101 AND 102). SN 79-035,750. PUB. 1-1-2008. FILED 12-7-2006.
 3,398,825. **MISCELLANEOUS DESIGN**. ZHEJIANG HEART & HEART; ELECTRIC CO., LTD, (U.S. CLS. 13, 21, 23, 31 AND 34). SN 79-042,684. PUB. 1-1-2008. FILED 7-13-2007.

CLASS 12—VEHICLES

- 3,397,054 (*See Class 9 for this trademark*).
 3,397,081. **SOLID AND DESIGN**. SOLID AXLE INDUSTRIES LLC, (U.S. CLS. 19, 21, 23, 31, 35 AND 44). SN 77-048,206. PUB. 1-1-2008. FILED 11-20-2006.
 3,397,182. **AIRGUIDE (BLOCK FORM)**. DAIMLERCHRYSLER AG, (U.S. CLS. 19, 21, 23, 31, 35 AND 44). SN 77-068,522. PUB. 1-1-2008. FILED 12-20-2006.
 3,397,192. **AIRSTREAK (BLOCK FORM)**. ALASKAN BUSH-

- WHEEL INC., (U.S. CLS. 19, 21, 23, 31, 35 AND 44). SN 77-069,061. PUB. 1-1-2008. FILED 12-21-2006.
- 3,397,363. **MISCELLANEOUS DESIGN**. MOBILE CONCEPTS BY SCOTTY, (U.S. CLS. 19, 21, 23, 31, 35 AND 44). SN 77-111,203. PUB. 1-1-2008. FILED 2-20-2007.
- 3,397,560. **CART-RITE AND DESIGN**. CART-RITE, LLC, (U.S. CLS. 19, 21, 23, 31, 35 AND 44). SN 77-191,689. PUB. 1-1-2008. FILED 5-29-2007.
- 3,397,568. **HOODLIFT (BLOCK FORM)**. HOODLIFT LTD, (U.S. CLS. 19, 21, 23, 31, 35 AND 44). SN 77-193,511. PUB. 1-1-2008. FILED 5-30-2007.
- 3,397,807. **HAPM (STYLIZED)**. HUBEI AVIATION PRECISION MACHINERY TECHNOLOGY CO., LTD., (U.S. CLS. 19, 21, 23, 31, 35 AND 44). SN 77-226,288. PUB. 1-1-2008. FILED 7-10-2007.
- 3,397,850. **IS (BLOCK FORM)**. TOYOTA JIDOSHA KABUSHIKI KAISHA, T/A TOYOTA MOTOR CORPORATION, (U.S. CLS. 19, 21, 23, 31, 35 AND 44). SN 77-227,484. PUB. 10-30-2007. FILED 7-11-2007.
- 3,397,916. **RISK RACING (BLOCK FORM)**. BISS PRODUCT DEVELOPMENT LLC, (U.S. CLS. 19, 21, 23, 31, 35 AND 44). SN 77-228,931. PUB. 1-1-2008. FILED 7-13-2007.
- 3,398,017. **ALLSET (BLOCK FORM)**. ALLSET RV SYSTEMS, LLC, (U.S. CLS. 19, 21, 23, 31, 35 AND 44). SN 77-230,549. PUB. 1-1-2008. FILED 7-16-2007.
- 3,398,112. **AK AND DESIGN**. ANHUI JIANGHUAI AUTOMOBILE GROUP CO., LTD., (U.S. CLS. 19, 21, 23, 31, 35 AND 44). SN 77-232,053. PUB. 1-1-2008. FILED 7-17-2007.
- 3,398,330. **CERTIFIED PRE-OWNED BY BMW AND DESIGN**. BAYERISCHE MOTOREN WERKE AKTIENGESELLSCHAFT, MULTIPLE CLASS, (INT. CLS. 12, 35, 36, 37, 39 AND 42). (U.S. CLS. 19, 21, 23, 31, 35, 44, 100, 101, 102, 103, 105 AND 106). SN 77-257,728. PUB. 1-1-2008. FILED 8-17-2007.
- 3,398,359 (*See Class 10 for this trademark*).
- 3,398,439. **GLO-HOLES AND DESIGN**. SW CREATIONS, (U.S. CLS. 19, 21, 23, 31, 35 AND 44). SN 78-722,043. PUB. 1-1-2008. FILED 9-28-2005.
- 3,398,447. **CORONADO (BLOCK FORM)**. CORONADO RUNABOUTS INC., (U.S. CLS. 19, 21, 23, 31, 35 AND 44). SN 78-748,271. PUB. 1-1-2008. FILED 11-7-2005.
- 3,398,525 (*See Class 7 for this trademark*).
- 3,398,627. **KTM (BLOCK FORM)**. KTM-SPORTMOTORCYCLE AG, (U.S. CLS. 19, 21, 23, 31, 35 AND 44). SN 79-018,370. PUB. 1-1-2008. FILED 7-27-2005.
- 3,398,631. **EMPORIO GA ARMANI AND DESIGN**. GA MODERNE S.A., MULTIPLE CLASS, (INT. CLS. 12 AND 26). (U.S. CLS. 19, 21, 23, 31, 35, 37, 39, 40, 42, 44 AND 50). SN 79-020,511. PUB. 1-1-2008. FILED 1-24-2006.
- 3,398,677. **BRITPART (BLOCK FORM)**. BORDER HOLDINGS (UK) LIMITED, (U.S. CLS. 19, 21, 23, 31, 35 AND 44). SN 79-030,382. PUB. 1-1-2008. FILED 10-17-2006.
- 3,398,716 (*See Class 7 for this trademark*).
- 3,398,748 (*See Class 7 for this trademark*).
- 3,398,764 (*See Class 4 for this trademark*).
- 3,398,795. **AQUAMARINE (STYLIZED)**. WILLI KUSSBERGER, MULTIPLE CLASS, (INT. CLS. 12, 37 AND 39). (U.S. CLS. 19, 21, 23, 31, 35, 44, 100, 103, 105 AND 106). SN 79-039,189. PUB. 1-1-2008. FILED 12-8-2006.
- 3,398,812 (*See Class 6 for this trademark*).

CLASS 13—FIREARMS

- 3,397,174. **MANGONEL (BLOCK FORM)**. DEFENSE PROCUREMENT MANUFACTURING SERVICES, INC., (U.S. CLS. 2 AND 9). SN 77-067,305. PUB. 1-1-2008. FILED 12-19-2006.
- 3,397,420. **NICE SHOT NON-TOXIC SHOT AND DESIGN**. NICE SHOT INC., (U.S. CLS. 2 AND 9). SN 77-136,215. PUB. 1-1-2008. FILED 3-21-2007.
- 3,397,579. **NITRO TURKEY (BLOCK FORM)**. RA BRANDS, L.L.C., (U.S. CLS. 2 AND 9). SN 77-195,123. PUB. 1-1-2008. FILED 6-1-2007.
- 3,397,580. **NITRO PHEASANT (BLOCK FORM)**. RA BRANDS, L.L.C., (U.S. CLS. 2 AND 9). SN 77-195,129. PUB. 1-1-2008. FILED 6-1-2007.

- 3,398,428. **POLY TECHNOLOGIES, INC. (BLOCK FORM)**. KENG'S FIREARMS SPECIALTY, INC., (U.S. CLS. 2 AND 9). SN 78-698,813. PUB. 1-1-2008. FILED 8-23-2005.
- 3,398,586. **TEXAS BRUSH POPPER (BLOCK FORM)**. CIMARON FIREARMS COMPANY, INC., (U.S. CLS. 2 AND 9). SN 78-953,859. PUB. 1-1-2008. FILED 8-16-2006.
- 3,398,616 (*See Class 5 for this trademark*).
- 3,398,762. **MILLENNIUM (BLOCK FORM)**. OERLIKON CONTRAVES AG, (U.S. CLS. 2 AND 9). SN 79-035,837. PUB. 1-1-2008. FILED 12-11-2006.
- 3,398,835. **BLACK MAMBA AND DESIGN**. FIOCCHI MUNIZIONI S.P.A., (U.S. CLS. 2 AND 9). SN 79-043,843. PUB. 1-1-2008. FILED 7-16-2007.

CLASS 14—JEWELRY

- 3,396,896. **STEPHEN DWECK AND DESIGN**. DWECK INDUSTRIES, INC., (U.S. CLS. 2, 27, 28 AND 50). SN 76-670,994. PUB. 1-1-2008. FILED 1-3-2007.
- 3,396,902. **CP FUSAO (BLOCK FORM)**. PHILIP, CHRISTINE, MULTIPLE CLASS, (INT. CLS. 14 AND 25). (U.S. CLS. 2, 22, 27, 28, 39 AND 50). SN 76-673,086. PUB. 1-1-2008. FILED 2-23-2007.
- 3,396,907. **TRACEY MAYER (BLOCK FORM)**. TRACEY MAYER, INC., (U.S. CLS. 2, 27, 28 AND 50). SN 76-674,258. PUB. 1-1-2008. FILED 3-19-2007.
- 3,397,009. **CA (STYLIZED)**. WINSTON STUART ASSOCIATES, LTD., (U.S. CLS. 2, 27, 28 AND 50). SN 77-025,539. PUB. 1-1-2008. FILED 10-20-2006.
- 3,397,120. **MISCELLANEOUS DESIGN**. CITIZEN CBM KABUSHIKI KAISHA, ALSO TRADING AS JAPAN CBM CORPORATION, (U.S. CLS. 2, 27, 28 AND 50). SN 77-057,818. PUB. 1-1-2008. FILED 12-6-2006.
- 3,397,257. **BUNS & GUPIES AND DESIGN**. HARRIS, BERNADETTE M., (U.S. CLS. 2, 27, 28 AND 50). SN 77-082,088. PUB. 1-1-2008. FILED 1-12-2007.
- 3,397,326. **POSHROCKS (BLOCK FORM)**. BROWN, ERIC M, (U.S. CLS. 2, 27, 28 AND 50). SN 77-100,241. PUB. 1-1-2008. FILED 2-6-2007.
- 3,397,365. **NY (STYLIZED)**. NEW YORK FOOTBALL GIANTS, INC., (U.S. CLS. 2, 27, 28 AND 50). SN 77-111,487. PUB. 1-1-2008. FILED 2-20-2007.
- 3,397,389. **GIANNA (BLOCK FORM)**. WORLD WIDE IMPORTS, INC., (U.S. CLS. 2, 27, 28 AND 50). SN 77-120,951. PUB. 1-1-2008. FILED 3-2-2007.
- 3,397,559. **AANRAKU (BLOCK FORM)**. CASTALINE, JEFFREY, (U.S. CLS. 2, 27, 28 AND 50). SN 77-191,514. PUB. 1-1-2008. FILED 5-28-2007.
- 3,397,664. **MITALI (BLOCK FORM)**. B.H.D. INC, (U.S. CLS. 2, 27, 28 AND 50). SN 77-212,445. PUB. 1-1-2008. FILED 6-21-2007.
- 3,397,755. **JOOWELS AND DESIGN**. IMAGES APPLIED LLC, (U.S. CLS. 2, 27, 28 AND 50). SN 77-223,215. PUB. 1-1-2008. FILED 7-6-2007.
- 3,397,813. **QCHARM (BLOCK FORM)**. QCHARM, LLC, (U.S. CLS. 2, 27, 28 AND 50). SN 77-226,555. PUB. 1-1-2008. FILED 7-11-2007.
- 3,397,856. **RGM (STYLIZED)**. MURPHY, ROLAND, (U.S. CLS. 2, 27, 28 AND 50). SN 77-227,671. PUB. 1-1-2008. FILED 7-12-2007.
- 3,398,145. **LANDMARK (BLOCK FORM)**. WATCH WINDER STORE, (U.S. CLS. 2, 27, 28 AND 50). SN 77-232,576. PUB. 1-1-2008. FILED 7-18-2007.
- 3,398,151. **MISCELLANEOUS DESIGN**. SIGMA CHI CORPORATION, (U.S. CLS. 2, 27, 28 AND 50). SN 77-232,699. PUB. 1-1-2008. FILED 7-18-2007.
- 3,398,371. **WATCH BANK (BLOCK FORM)**. YAFIRO INTERNATIONAL PTE LTD, MULTIPLE CLASS, (INT. CLS. 14, 35, 36 AND 37). (U.S. CLS. 2, 27, 28, 50, 100, 101, 102, 103 AND 106). SN 78-426,284. PUB. 12-5-2006. FILED 5-27-2004.
- 3,398,384. **NATURE'S ORIGINALS (BLOCK FORM)**. NATURAL DIAMOND COMPANY LIMITED, MULTIPLE CLASS, (INT. CLS. 14, 35, 37, 40 AND 42). (U.S. CLS. 2, 27, 28, 50, 100, 101, 102, 103 AND 106). SN 78-536,537. PUB. 10-30-2007. FILED 12-21-2004.
- 3,398,401. **DAC AND DESIGN**. CASELLA, DAVID ADAM,

- (U.S. CLS. 2, 27, 28 AND 50). SN 78-590,900. PUB. 1-1-2008. FILED 3-18-2005.
- 3,398,453. **SIMMS (BLOCK FORM)**. SIMMS FISHING PRODUCTS LLC, MULTIPLE CLASS, (INT. CLS. 14, 18, 21, 24, 25 AND 28), (U.S. CLS. 1, 2, 3, 13, 22, 23, 27, 28, 29, 30, 33, 38, 39, 40, 41, 42 AND 50). SN 78-758,814. PUB. 1-1-2008. FILED 11-21-2005.
- 3,398,463. **LUCKY LEAF (BLOCK FORM)**. GERSHI, YEHUDA, (U.S. CLS. 2, 27, 28 AND 50). SN 78-785,056. PUB. 1-1-2008. FILED 1-4-2006.
- 3,398,497. **LUCCELLO (BLOCK FORM)**. LUCCELLO, INC., (U.S. CLS. 2, 27, 28 AND 50). SN 78-844,434. PUB. 1-1-2008. FILED 3-23-2006.
- 3,398,553. **CHARMED ATTITUDES (BLOCK FORM)**. CHARMED ATTITUDES, (U.S. CLS. 2, 27, 28 AND 50). SN 78-906,162. PUB. 1-1-2008. FILED 6-12-2006.
- 3,398,588. **GEMFIRE DIAMONDS (BLOCK FORM)**. SUTHERLAND, STEVE S., AND SUTHERLAND, CHRISTINA, (U.S. CLS. 2, 27, 28 AND 50). SN 78-955,711. PUB. 6-5-2007. FILED 8-18-2006.
- 3,398,600 (*See Class 3 for this trademark*).
- 3,398,632. **EIGHT SIN AND DESIGN**. VITA BELLA TRADING COMPANY SAS, MULTIPLE CLASS, (INT. CLS. 14, 18 AND 25), (U.S. CLS. 1, 2, 3, 22, 27, 28, 39, 41 AND 50). SN 79-020,811. PUB. 1-1-2008. FILED 7-22-2005.
- 3,398,675 (*See Class 8 for this trademark*).
- 3,398,703 (*See Class 3 for this trademark*).
- 3,398,728. **SELVAFONTE (STYLIZED)**. KIKUCHI, YOICHI, MULTIPLE CLASS, (INT. CLS. 14, 18, 25 AND 26), (U.S. CLS. 1, 2, 3, 22, 27, 28, 37, 39, 40, 41, 42 AND 50). SN 79-034,682. PUB. 1-1-2008. FILED 9-29-2006.
- 3,398,764 (*See Class 4 for this trademark*).
- 3,398,789 (*See Class 3 for this trademark*).
- 3,398,793. **LI ANTRA ST AILE AND DESIGN**. VALBEX SA, (U.S. CLS. 2, 27, 28 AND 50). SN 79-038,866. PUB. 1-1-2008. FILED 3-19-2007.
- 3,398,796. **MOVEBEST AND DESIGN**. ZHANG ZHOU SHI HENG LI DIAN; ZI YOU XIAN GONG SI, (U.S. CLS. 2, 27, 28 AND 50). SN 79-039,634. PUB. 1-1-2008. FILED 3-21-2007.

CLASS 15—MUSICAL INSTRUMENTS

- 3,396,823. **MISCELLANEOUS DESIGN**. FENDER MUSICAL INSTRUMENTS CORPORATION, (U.S. CLS. 2, 21 AND 36). SN 76-515,928. PUB. 3-16-2004. FILED 4-25-2003.
- 3,396,824. **MISCELLANEOUS DESIGN**. FENDER MUSICAL INSTRUMENTS CORPORATION, (U.S. CLS. 2, 21 AND 36). SN 76-516,126. PUB. 3-16-2004. FILED 4-25-2003.
- 3,396,825. **MISCELLANEOUS DESIGN**. FENDER MUSICAL INSTRUMENTS CORPORATION, (U.S. CLS. 2, 21 AND 36). SN 76-516,127. PUB. 3-16-2004. FILED 4-25-2003.
- 3,397,341. **DARLING DIVAS AND DESIGN**. LPD MUSIC INTERNATIONAL, (U.S. CLS. 2, 21 AND 36). SN 77-104,112. PUB. 1-1-2008. FILED 2-9-2007.
- 3,397,506. **MIKO (BLOCK FORM)**. OPEN LABS, INC., (U.S. CLS. 2, 21 AND 36). SN 77-168,358. PUB. 1-1-2008. FILED 4-28-2007.
- 3,397,972. **VENGEANCE GUITARS & GRAPHIX AND DESIGN**. STEWART, RICK, DBA VENGEANCE GUITARS AND GRAPHIX, (U.S. CLS. 2, 21 AND 36). SN 77-229,814. PUB. 1-1-2008. FILED 7-14-2007.
- 3,398,011. **JAMES TYLER (BLOCK FORM)**. TYLER, JAMES, (U.S. CLS. 2, 21 AND 36). SN 77-230,482. PUB. 1-1-2008. FILED 7-16-2007.
- 3,398,688 (*See Class 6 for this trademark*).

CLASS 16—PAPER GOODS AND PRINTED MATTER

- 3,396,834. **DCS DAYLIGHT CLEANING SYSTEMS AND DESIGN**. DCS DAYLIGHT CLEANING SYSTEMS INC., (U.S. CLS. 2, 5, 22, 23, 29, 37, 38 AND 50). SN 76-608,661. PUB. 1-1-2008. FILED 8-23-2004.

- 3,396,880 (*See Class 9 for this trademark*).
- 3,396,884. **CAPTAIN OUTRAGEOUS (STYLIZED)**. CAPTAIN OUTRAGEOUS OF KEY WEST, CORP., (U.S. CLS. 2, 5, 22, 23, 29, 37, 38 AND 50). SN 76-669,863. PUB. 1-1-2008. FILED 12-4-2006.
- 3,396,885. **VERSABOARD (BLOCK FORM)**. ELWOOD PACKAGING, INC., (U.S. CLS. 2, 5, 22, 23, 29, 37, 38 AND 50). SN 76-669,965. PUB. 1-1-2008. FILED 12-5-2006.
- 3,396,889. **RACE ARE WE SO DIFFERENT? AND DESIGN**. AMERICAN ANTHROPOLOGICAL ASSOCIATION, (U.S. CLS. 2, 5, 22, 23, 29, 37, 38 AND 50). SN 76-670,291. PUB. 1-1-2008. FILED 12-13-2006.
- 3,396,918 (*See Class 9 for this trademark*).
- 3,396,921. **GALILEO PRESS AND DESIGN**. GALILEO PRESS GMBH, (U.S. CLS. 2, 5, 22, 23, 29, 37, 38 AND 50). SN 76-676,134. PUB. 1-1-2008. FILED 4-27-2007.
- 3,396,937. **RE-FIRE, DON'T RETIRE (BLOCK FORM)**. BARNETT, CYNTHIA, (U.S. CLS. 2, 5, 22, 23, 29, 37, 38 AND 50). SN 76-679,107. PUB. 1-1-2008. FILED 7-5-2007.
- 3,396,981. **GIRLS AND BOYS TOWN HELP HEALING HOPE AND DESIGN**. FATHER FLANAGAN'S BOYS' HOME, MULTIPLE CLASS, (INT. CLS. 16, 41, 42, 43, 44 AND 45), (U.S. CLS. 2, 5, 22, 23, 29, 37, 38, 50, 100, 101 AND 107). SN 77-014,448. PUB. 1-1-2008. FILED 10-5-2006.
- 3,396,989. **ENP (BLOCK FORM)**. ENPAPER MFG. CO., LTD., (U.S. CLS. 2, 5, 22, 23, 29, 37, 38 AND 50). SN 77-016,830. PUB. 1-1-2008. FILED 10-9-2006.
- 3,397,019. **DIALOGUES IN CLINICAL PRACTICE (BLOCK FORM)**. MESG LLC, (U.S. CLS. 2, 5, 22, 23, 29, 37, 38 AND 50). SN 77-027,823. PUB. 1-1-2008. FILED 10-24-2006.
- 3,397,070 (*See Class 9 for this trademark*).
- 3,397,074. **ALO HAYATI (BLOCK FORM)**. KENAAN, WAFAA, (U.S. CLS. 2, 5, 22, 23, 29, 37, 38 AND 50). SN 77-047,001. PUB. 1-1-2008. FILED 11-17-2006.
- 3,397,089. **GIFTS FOR MEDICAL PROFESSIONALS MEDICALLY INSPIRED GIFTS AND COLLECTIBLES AND DESIGN**. HEALTH CARE LOGISTICS, INC., (U.S. CLS. 2, 5, 22, 23, 29, 37, 38 AND 50). SN 77-050,844. PUB. 1-1-2008. FILED S.R. 11-27-2006; AM. P.R. 9-28-2007.
- 3,397,115. **SCRAP BOOK BOARD THINK OUTSIDE THE BOOK AND DESIGN**. DIANE THOMAS, (U.S. CLS. 2, 5, 22, 23, 29, 37, 38 AND 50). SN 77-057,202. PUB. 1-1-2008. FILED S.R. 12-5-2006; AM. P.R. 10-19-2007.
- 3,397,118. **BURLYMAN ENTERTAINMENT AND DESIGN**. BURLYMAN ENTERTAINMENT, INC., (U.S. CLS. 2, 5, 22, 23, 29, 37, 38 AND 50). SN 77-057,541. PUB. 1-1-2008. FILED 12-5-2006.
- 3,397,122 (*See Class 9 for this trademark*).
- 3,397,147. **PC PROCREATE AND DESIGN**. THE KRAFT-MARK COMPANY, (U.S. CLS. 2, 5, 22, 23, 29, 37, 38 AND 50). SN 77-063,292. PUB. 1-1-2008. FILED 12-13-2006.
- 3,397,173. **STORY NATURE AND DESIGN**. CHENG, JOHNNY T., (U.S. CLS. 2, 5, 22, 23, 29, 37, 38 AND 50). SN 77-067,170. PUB. 1-1-2008. FILED 12-19-2006.
- 3,397,193. **NATIONAL CATHOLIC REGISTER (BLOCK FORM)**. CIRCLE MEDIA, INC., (U.S. CLS. 2, 5, 22, 23, 29, 37, 38 AND 50). SN 77-069,120. PUB. 1-1-2008. FILED 12-21-2006.
- 3,397,198. **RISC MANAGEMENT PROGRAM (BLOCK FORM)**. PSP CORPORATION, (U.S. CLS. 2, 5, 22, 23, 29, 37, 38 AND 50). SN 77-069,582. PUB. 1-1-2008. FILED 12-21-2006.
- 3,397,201. **FAITH & FAMILY (BLOCK FORM)**. CIRCLE MEDIA, INC., (U.S. CLS. 2, 5, 22, 23, 29, 37, 38 AND 50). SN 77-070,168. PUB. 1-1-2008. FILED 12-22-2006.
- 3,397,219. **MISCELLANEOUS DESIGN**. PLANET GRAPE LLC, MULTIPLE CLASS, (INT. CLS. 16, 41 AND 43), (U.S. CLS. 2, 5, 22, 23, 29, 37, 38, 50, 100, 101 AND 107). SN 77-073,687. PUB. 1-1-2008. FILED 12-29-2006.
- 3,397,227. **DBLCI (BLOCK FORM)**. DEUTSCHE BANK AG, MULTIPLE CLASS, (INT. CLS. 16, 35 AND 36), (U.S. CLS. 2, 5, 22, 23, 29, 37, 38, 50, 100, 101 AND 102). SN 77-074,942. PUB. 1-1-2008. FILED 1-3-2007.
- 3,397,228. **DBLCI-MR (BLOCK FORM)**. DEUTSCHE BANK AG, MULTIPLE CLASS, (INT. CLS. 16, 35 AND 36), (U.S. CLS. 2, 5, 22, 23, 29, 37, 38, 50, 100, 101 AND 102). SN 77-074,947. PUB. 1-1-2008. FILED 1-3-2007.
- 3,397,236. **RIVERWORKS DISCOVERY (STYLIZED)**. AEP MEMCO LLC, (U.S. CLS. 2, 5, 22, 23, 29, 37, 38 AND 50).

- SN 77-076,636. PUB. 1-1-2008. FILED 1-5-2007.
- 3,397,267. **SAVE WATER NOTHING CAN REPLACE IT AND DESIGN.** CITY OF DALLAS, (U.S. CLS. 2, 5, 22, 23, 29, 37, 38 AND 50). SN 77-085,880. PUB. 1-1-2008. FILED 1-18-2007.
- 3,397,269 (*See Class 6 for this trademark.*).
- 3,397,273. **PHONETICS FIRST- FOCUS ON SOUNDS (BLOCK FORM).** KENNELLY, KIM, (U.S. CLS. 2, 5, 22, 23, 29, 37, 38 AND 50). SN 77-087,316. PUB. 1-1-2008. FILED 1-20-2007.
- 3,397,289. **HELPING KIDS GET SMART ABOUT MONEY (BLOCK FORM).** MONEY SAVVY GENERATION, LLC, (U.S. CLS. 2, 5, 22, 23, 29, 37, 38 AND 50). SN 77-091,299. PUB. 1-1-2008. FILED 1-25-2007.
- 3,397,316 (*See Class 9 for this trademark.*).
- 3,397,329. **JUST DIVE (BLOCK FORM).** NAUI SERVICES GROUP, INC., (U.S. CLS. 2, 5, 22, 23, 29, 37, 38 AND 50). SN 77-101,100. PUB. 1-1-2008. FILED 2-7-2007.
- 3,397,330. **THE UNION (BLOCK FORM).** NEVADA COUNTY PUBLISHING CO., MULTIPLE CLASS, (INT. CLS. 16 AND 41), (U.S. CLS. 2, 5, 22, 23, 29, 37, 38, 50, 100, 101 AND 107). SN 77-101,370. PUB. 1-1-2008. FILED 2-7-2007.
- 3,397,338. **I PLEDGE ALLEGIANCE TO THE FLAG (BLOCK FORM).** ALL TALK CORPORATION, (U.S. CLS. 2, 5, 22, 23, 29, 37, 38 AND 50). SN 77-103,295. PUB. 1-1-2008. FILED 2-9-2007.
- 3,397,348. **BLOOMBERG LAWNOTES (BLOCK FORM).** BLOOMBERG L.P., MULTIPLE CLASS, (INT. CLS. 16, 41 AND 42), (U.S. CLS. 2, 5, 22, 23, 29, 37, 38, 50, 100, 101 AND 107). SN 77-106,685. PUB. 1-1-2008. FILED 2-13-2007.
- 3,397,378. **APLA AIDS PROJECT LOS ANGELES AND DESIGN.** AIDS PROJECT LOS ANGELES, (U.S. CLS. 2, 5, 22, 23, 29, 37, 38 AND 50). SN 77-116,457. PUB. 1-1-2008. FILED 2-26-2007.
- 3,397,397. **SHUTTERFLY (BLOCK FORM).** SHUTTERFLY, INC., MULTIPLE CLASS, (INT. CLS. 16 AND 40), (U.S. CLS. 2, 5, 22, 23, 29, 37, 38, 50, 100, 103 AND 106). SN 77-124,316. PUB. 1-1-2008. FILED 3-7-2007.
- 3,397,400. **LIVING WITH PANACHE (BLOCK FORM).** KR U.S.A., INC., (U.S. CLS. 2, 5, 22, 23, 29, 37, 38 AND 50). SN 77-126,128. PUB. 1-1-2008. FILED 3-8-2007.
- 3,397,457. **MORTGAGE U (BLOCK FORM).** MORTGAGE U, INC., MULTIPLE CLASS, (INT. CLS. 16, 36 AND 41), (U.S. CLS. 2, 5, 22, 23, 29, 37, 38, 50, 100, 101, 102 AND 107). SN 77-151,564. PUB. 1-1-2008. FILED 4-9-2007.
- 3,397,481. **HAUTE HANDBAGS (BLOCK FORM).** STAMPINGTON & COMPANY, LLC, (U.S. CLS. 2, 5, 22, 23, 29, 37, 38 AND 50). SN 77-160,654. PUB. 1-1-2008. FILED 4-19-2007.
- 3,397,488 (*See Class 9 for this trademark.*).
- 3,397,499. **PAGE PAW (BLOCK FORM).** COPERNICUS EDUCATIONAL PRODUCTS INC., (U.S. CLS. 2, 5, 22, 23, 29, 37, 38 AND 50). SN 77-166,616. PUB. 1-1-2008. FILED 4-26-2007.
- 3,397,510. **FLEXEFFECT (BLOCK FORM).** CROWLEY DEBORAH E, (U.S. CLS. 2, 5, 22, 23, 29, 37, 38 AND 50). SN 77-170,142. PUB. 1-1-2008. FILED 5-1-2007.
- 3,397,518. **OPENBANK (STYLIZED).** OPEN BANK SANTANDER CONSUMER, S.A., MULTIPLE CLASS, (INT. CLS. 16, 35, 36 AND 38), (U.S. CLS. 2, 5, 22, 23, 29, 37, 38, 50, 100, 101, 102 AND 104). SN 77-174,212. PUB. 1-1-2008. FILED 5-7-2007.
- 3,397,542. **WAY (BLOCK FORM).** JSONG INTERNATIONAL INC., MULTIPLE CLASS, (INT. CLS. 16 AND 25), (U.S. CLS. 2, 5, 22, 23, 29, 37, 38, 39 AND 50). SN 77-182,602. PUB. 1-1-2008. FILED 5-16-2007.
- 3,397,558. **TRÉ AND DESIGN.** SANCHEZ, MARIA TRESA, (U.S. CLS. 2, 5, 22, 23, 29, 37, 38 AND 50). SN 77-191,390. PUB. 1-1-2008. FILED 5-28-2007.
- 3,397,563. **FORTUNE SMALL BUSINESS (BLOCK FORM).** TIME INC., (U.S. CLS. 2, 5, 22, 23, 29, 37, 38 AND 50). SN 77-192,875. PUB. 1-1-2008. FILED 5-30-2007.
- 3,397,566. **ENDURA TEX AND DESIGN.** SIGNWAREHOUSE, INC., (U.S. CLS. 2, 5, 22, 23, 29, 37, 38 AND 50). SN 77-193,431. PUB. 1-1-2008. FILED 5-30-2007.
- 3,397,673. **MAQ MEN'S ATHLETIC QUARTERLY (STYLIZED).** FRANK J. SEPE, INC., (U.S. CLS. 2, 5, 22, 23, 29, 37, 38 AND 50). SN 77-213,578. PUB. 1-1-2008. FILED 6-22-2007.
- 3,397,679. **MANAGE MORE CALENDAR (BLOCK FORM).** HANNUM, SANDRA RAE, (U.S. CLS. 2, 5, 22, 23, 29, 37, 38 AND 50). SN 77-215,210. PUB. 1-1-2008. FILED 6-26-2007.
- 3,397,731. **STAR KEY ASTROLOGY CARD SYSTEM (BLOCK FORM).** JANIS E WHITE, (U.S. CLS. 2, 5, 22, 23, 29, 37, 38 AND 50). SN 77-220,367. PUB. 1-1-2008. FILED 7-2-2007.
- 3,397,764. **FANCY CUTS (BLOCK FORM).** CABIN CREEK, LLC, (U.S. CLS. 2, 5, 22, 23, 29, 37, 38 AND 50). SN 77-223,905. PUB. 1-1-2008. FILED 7-6-2007.
- 3,397,787. **CREATE A PLATE (BLOCK FORM).** MAKIT PRODUCTS, INC., (U.S. CLS. 2, 5, 22, 23, 29, 37, 38 AND 50). SN 77-225,515. PUB. 1-1-2008. FILED 7-10-2007.
- 3,397,788. **AUTOGRAPH PARTY PLATE! (BLOCK FORM).** MAKIT PRODUCTS, INC., (U.S. CLS. 2, 5, 22, 23, 29, 37, 38 AND 50). SN 77-225,518. PUB. 1-1-2008. FILED 7-10-2007.
- 3,397,843. **AMERICAN HOUSE (BLOCK FORM).** AMERICAN HOUSE LICENSING LLC, MULTIPLE CLASS, (INT. CLS. 16 AND 43), (U.S. CLS. 2, 5, 22, 23, 29, 37, 38, 50, 100 AND 101). SN 77-227,333. PUB. 1-1-2008. FILED 7-11-2007.
- 3,397,846. **THE SENIOR BANNER (BLOCK FORM).** AMERICAN HOUSE LICENSING LLC, (U.S. CLS. 2, 5, 22, 23, 29, 37, 38 AND 50). SN 77-227,348. PUB. 1-1-2008. FILED 7-11-2007.
- 3,397,885. **WILDCAT OPAQUE (BLOCK FORM).** FRASER PAPERS LIMITED, (U.S. CLS. 2, 5, 22, 23, 29, 37, 38 AND 50). SN 77-228,161. PUB. 1-1-2008. FILED 7-12-2007.
- 3,398,099. **LANWORTH (BLOCK FORM).** LANWORTH, INC., (U.S. CLS. 2, 5, 22, 23, 29, 37, 38 AND 50). SN 77-231,857. PUB. 1-1-2008. FILED 7-17-2007.
- 3,398,103. **THE PIC THAT STICKS (BLOCK FORM).** 3M COMPANY, (U.S. CLS. 2, 5, 22, 23, 29, 37, 38 AND 50). SN 77-231,896. PUB. 1-1-2008. FILED 7-17-2007.
- 3,398,213 (*See Class 9 for this trademark.*).
- 3,398,223. **HEAD OF THE CLASS (BLOCK FORM).** LAND O'LAKES, INC., (U.S. CLS. 2, 5, 22, 23, 29, 37, 38 AND 50). SN 77-234,408. PUB. 1-1-2008. FILED 7-20-2007.
- 3,398,243. **CORE CLINICAL OUTCOME RESOURCE ESSENTIALS (BLOCK FORM).** PSS WORLD MEDICAL, INC., (U.S. CLS. 2, 5, 22, 23, 29, 37, 38 AND 50). SN 77-236,885. PUB. 1-1-2008. FILED 7-24-2007.
- 3,398,244. **INSTYLE AND DESIGN.** TIME INC., (U.S. CLS. 2, 5, 22, 23, 29, 37, 38 AND 50). SN 77-236,993. PUB. 1-1-2008. FILED 7-24-2007.
- 3,398,251. **DOWN EAST (STYLIZED).** DOWN EAST ENTERPRISE, INC., (U.S. CLS. 2, 5, 22, 23, 29, 37, 38 AND 50). SN 77-238,121. PUB. 1-1-2008. FILED 7-25-2007.
- 3,398,257. **GO DIEGO GO! (BLOCK FORM).** VIACOM INTERNATIONAL INC., (U.S. CLS. 2, 5, 22, 23, 29, 37, 38 AND 50). SN 77-241,705. PUB. 1-1-2008. FILED 7-30-2007.
- 3,398,311 (*See Class 9 for this trademark.*).
- 3,398,334. **YIELDMAKER (BLOCK FORM).** MONSANTO TECHNOLOGY LLC, (U.S. CLS. 2, 5, 22, 23, 29, 37, 38 AND 50). SN 77-261,775. PUB. 1-1-2008. FILED 8-22-2007.
- 3,398,361 (*See Class 9 for this trademark.*).
- 3,398,380. **CARTE BLANCHE GREETINGS LTD. AND DESIGN.** CARTE BLANCHE GREETINGS LIMITED, MULTIPLE CLASS, (INT. CLS. 16 AND 21), (U.S. CLS. 2, 5, 13, 22, 23, 29, 30, 33, 37, 38, 40 AND 50). SN 78-507,187. PUB. 9-25-2007. FILED 10-28-2004.
- 3,398,427. **SMART PAK (BLOCK FORM).** SMART PAPERS HOLDINGS LLC, (U.S. CLS. 2, 5, 22, 23, 29, 37, 38 AND 50). SN 78-697,341. PUB. 1-1-2008. FILED 8-22-2005.
- 3,398,435. **FLYING FINGERS YARN SHOP AND DESIGN.** FLYING FINGERS, INC., MULTIPLE CLASS, (INT. CLS. 16, 35 AND 41), (U.S. CLS. 2, 5, 22, 23, 29, 37, 38, 50, 100, 101, 102 AND 107). SN 78-715,372. PUB. 1-1-2008. FILED 9-19-2005.
- 3,398,437. **IT'S A JUNGLE UP THERE (BLOCK FORM).** ZULUWORKS, LLC, MULTIPLE CLASS, (INT. CLS. 16 AND 35), (U.S. CLS. 2, 5, 22, 23, 29, 37, 38, 50, 100, 101 AND 102). SN 78-717,838. PUB. 12-26-2006. FILED 9-21-2005.
- 3,398,449. **YTC YOUR TRAVELING COMPANION AND DESIGN.** MORRIS VISITOR PUBLICATIONS, LLC, (U.S. CLS. 2, 5, 22, 23, 29, 37, 38 AND 50). SN 78-751,780. PUB. 1-1-2008. FILED 11-10-2005.
- 3,398,454. **MISCELLANEOUS DESIGN.** GRAPHICS 2000, INC., MULTIPLE CLASS, (INT. CLS. 16 AND 19), (U.S. CLS. 1, 2, 5, 12, 22, 23, 29, 33, 37, 38 AND 50). SN 78-760,539. PUB. 1-1-2008. FILED 11-23-2005.
- 3,398,462. **CELEBRATE LIFE (BLOCK FORM).** KI MEMORIES, INC., (U.S. CLS. 2, 5, 22, 23, 29, 37, 38 AND 50). SN 78-781,665. PUB. 1-1-2008. FILED 12-28-2005.

- 3,398,464. **THE GREAT GAME TRAVEL COMPANY (BLOCK FORM)**. THE GREAT GAME TRAVEL COMPANY LIMITED, MULTIPLE CLASS, (INT. CLS. 16, 39 AND 43), (U.S. CLS. 2, 5, 22, 23, 29, 37, 38, 50, 100, 101 AND 105). SN 78-789,434. PUB. 1-1-2008. FILED 1-11-2006.
- 3,398,549. **MOKA (BLOCK FORM)**. CASCADES CANADA INC., (U.S. CLS. 2, 5, 22, 23, 29, 37, 38 AND 50). SN 78-903,032. PUB. 10-23-2007. FILED 6-7-2006.
- 3,398,574. **COMPETITIVE INTELLIGENCE FOUNDATION (BLOCK FORM)**. SOCIETY OF COMPETITIVE INTELLIGENCE PROFESSIONALS, (U.S. CLS. 2, 5, 22, 23, 29, 37, 38 AND 50). SN 78-931,559. PUB. 1-1-2008. FILED 7-18-2006.
- 3,398,600 (*See Class 3 for this trademark*).
- 3,398,605 (*See Class 9 for this trademark*).
- 3,398,606 (*See Class 9 for this trademark*).
- 3,398,609. **RE: PORTER (BLOCK FORM)**. PORTER AVIATION HOLDINGS INC., (U.S. CLS. 2, 5, 22, 23, 29, 37, 38 AND 50). SN 78-971,372. PUB. 1-1-2008. FILED 9-11-2006.
- 3,398,617. **ON THE WRONG END OF THE PENIS (BLOCK FORM)**. JANICE WALKER, (U.S. CLS. 2, 5, 22, 23, 29, 37, 38 AND 50). SN 79-006,209. PUB. 1-1-2008. FILED 8-25-2004.
- 3,398,619 (*See Class 7 for this trademark*).
- 3,398,621 (*See Class 9 for this trademark*).
- 3,398,635. **GROSS OUT AND DESIGN**. KRYPTYX ENTERTAINMENT PTY LTD, MULTIPLE CLASS, (INT. CLS. 16, 28 AND 30), (U.S. CLS. 2, 5, 22, 23, 29, 37, 38, 46 AND 50). SN 79-022,476. PUB. 1-1-2008. FILED 8-31-2005.
- 3,398,636 (*See Class 9 for this trademark*).
- 3,398,637 (*See Class 9 for this trademark*).
- 3,398,646. **SSP - CREATING A BETTER EXPERIENCE AND DESIGN**. SSP FINANCING UK LIMITED, MULTIPLE CLASS, (INT. CLS. 16, 35 AND 43), (U.S. CLS. 2, 5, 22, 23, 29, 37, 38, 50, 100, 101 AND 102). SN 79-025,218. PUB. 1-1-2008. FILED 6-22-2005.
- 3,398,649 (*See Class 9 for this trademark*).
- 3,398,657 (*See Class 9 for this trademark*).
- 3,398,662. **COMMONPURPOSE AND DESIGN**. THE COMMON PURPOSE CHARITABLE TRUST, MULTIPLE CLASS, (INT. CLS. 16 AND 41), (U.S. CLS. 2, 5, 22, 23, 29, 37, 38, 50, 100, 101 AND 107). SN 79-028,643. PUB. 1-1-2008. FILED 8-21-2006.
- 3,398,680. **DAFENGCHE AND DESIGN**. NINGBO BIG WINDMILL; EDUCATIONAL MATERIALS CO., LTD., (U.S. CLS. 2, 5, 22, 23, 29, 37, 38 AND 50). SN 79-031,252. PUB. 1-1-2008. FILED 11-6-2006.
- 3,398,717 (*See Class 9 for this trademark*).
- 3,398,732 (*See Class 7 for this trademark*).
- 3,398,751 (*See Class 9 for this trademark*).
- 3,398,764 (*See Class 4 for this trademark*).
- 3,398,791. **MISCELLANEOUS DESIGN**. INTERNATIONAL DIABETES FEDERATION; OU FÉDÉRATION INTERNATIONALE DU DIABÈTE; ÉGALEMENT DÉNOMMÉE IDF OU FID.; ASSOCIATION INTERNATIONALE SANS BUT LUCRATIF, MULTIPLE CLASS, (INT. CLS. 16, 35 AND 45), (U.S. CLS. 2, 5, 22, 23, 29, 37, 38, 50, 100, 101 AND 102). SN 79-038,498. PUB. 1-1-2008. FILED 2-27-2007.

CLASS 17—RUBBER GOODS

- 3,396,905 (*See Class 11 for this trademark*).
- 3,397,066. **HAWG STALKER (BLOCK FORM)**. SUPREME CORPORATION, (U.S. CLS. 1, 5, 12, 13, 35 AND 50). SN 77-043,984. PUB. 1-1-2008. FILED 11-14-2006.
- 3,397,291 (*See Class 1 for this trademark*).
- 3,397,323 (*See Class 3 for this trademark*).
- 3,397,955. **FIBER BRITE (BLOCK FORM)**. U.S. HIGHWAY PRODUCTS, INC., (U.S. CLS. 1, 5, 12, 13, 35 AND 50). SN 77-229,510. PUB. 1-1-2008. FILED 7-13-2007.
- 3,398,171. **ACCUFLEX (BLOCK FORM)**. KURIYAMA OF AMERICA, INC., (U.S. CLS. 1, 5, 12, 13, 35 AND 50). SN 77-233,015. PUB. 1-1-2008. FILED 7-18-2007.
- 3,398,405 (*See Class 9 for this trademark*).
- 3,398,444 (*See Class 9 for this trademark*).
- 3,398,537. **GRIPTOUCH (BLOCK FORM)**. PYN, S.A. DE C.V., (U.S. CLS. 1, 5, 12, 13, 35 AND 50). SN 78-881,752. PUB. 1-1-2008. FILED 5-11-2006.

- 3,398,674 (*See Class 6 for this trademark*).
- 3,398,706 (*See Class 6 for this trademark*).
- 3,398,733 (*See Class 7 for this trademark*).
- 3,398,753 (*See Class 1 for this trademark*).
- 3,398,800 (*See Class 7 for this trademark*).
- 3,398,803. **SARNATHERM (STYLIZED)**. SIKA AG, (U.S. CLS. 1, 5, 12, 13, 35 AND 50). SN 79-040,068. PUB. 1-1-2008. FILED 6-4-2007.

CLASS 18—LEATHER GOODS

- 3,396,859 (*See Class 9 for this trademark*).
- 3,396,996 (*See Class 9 for this trademark*).
- 3,397,044. **HANK BUNDLE AND DESIGN**. DEWIED INTERNATIONAL, INC., (U.S. CLS. 1, 2, 3, 22 AND 41). SN 77-037,181. PUB. 1-1-2008. FILED 11-6-2006.
- 3,397,102. **COURIER BAG SPECIALIST (BLOCK FORM)**. NORCO DELIVERY SERVICE, INC., (U.S. CLS. 1, 2, 3, 22 AND 41). SN 77-053,538. PUB. 1-1-2008. FILED 11-29-2006.
- 3,397,128. **WINGPOCKETS (BLOCK FORM)**. SCOTT P. GIBSON, (U.S. CLS. 1, 2, 3, 22 AND 41). SN 77-059,285. PUB. 1-1-2008. FILED 12-7-2006.
- 3,397,164 (*See Class 3 for this trademark*).
- 3,397,321. **SARAYE (BLOCK FORM)**. YESBERGER, THOMAS, (U.S. CLS. 1, 2, 3, 22 AND 41). SN 77-098,827. PUB. 1-1-2008. FILED 2-4-2007.
- 3,397,477. **ZAC POSEN (BLOCK FORM)**. Z SPOKE, LLC, (U.S. CLS. 1, 2, 3, 22 AND 41). SN 77-159,640. PUB. 1-1-2008. FILED 4-18-2007.
- 3,397,531. **SUPER GRABBER AND DESIGN**. LOOK! MARKETING INC., (U.S. CLS. 1, 2, 3, 22 AND 41). SN 77-177,788. PUB. 1-1-2008. FILED 5-10-2007.
- 3,397,614. **G-BAGS (BLOCK FORM)**. GRIFFIN, MARK A., (U.S. CLS. 1, 2, 3, 22 AND 41). SN 77-202,060. PUB. 1-1-2008. FILED 6-8-2007.
- 3,397,621. **TRI ALL 3 SPORTS (BLOCK FORM)**. TRI ALL 3 SPORTS, (U.S. CLS. 1, 2, 3, 22 AND 41). SN 77-202,642. PUB. 1-1-2008. FILED 6-11-2007.
- 3,397,649. **TOUR MASTER (BLOCK FORM)**. HELMET HOUSE, INC., (U.S. CLS. 1, 2, 3, 22 AND 41). SN 77-209,411. PUB. 1-1-2008. FILED 6-19-2007.
- 3,398,107. **310 MOTORING (BLOCK FORM)**. 310 GLOBAL BRANDS, INC., (U.S. CLS. 1, 2, 3, 22 AND 41). SN 77-231,992. PUB. 1-1-2008. FILED 7-17-2007.
- 3,398,258. **GO DIEGO GO! (BLOCK FORM)**. VIACOM INTERNATIONAL INC., (U.S. CLS. 1, 2, 3, 22 AND 41). SN 77-241,715. PUB. 1-1-2008. FILED 7-30-2007.
- 3,398,374 (*See Class 9 for this trademark*).
- 3,398,385. **MCARTHUR GLEN (BLOCK FORM)**. MCARTHUR/GLEN EUROPE HOLDINGS LIMITED, LLC, MULTIPLE CLASS, (INT. CLS. 18, 21, 25, 36, 43, 44 AND 45), (U.S. CLS. 1, 2, 3, 13, 22, 23, 29, 30, 33, 39, 40, 41, 50, 100, 101 AND 102). SN 78-537,627. PUB. 1-2-2007. FILED 12-23-2004.
- 3,398,386. **MCARTHUR GLEN DESIGNER OUTLET AND DESIGN**. MCARTHUR/GLEN EUROPE HOLDINGS LIMITED, LLC, MULTIPLE CLASS, (INT. CLS. 18, 21, 25, 36, 43, 44 AND 45), (U.S. CLS. 1, 2, 3, 13, 22, 23, 29, 30, 33, 39, 40, 41, 50, 100, 101 AND 102). SN 78-537,696. PUB. 1-2-2007. FILED 12-23-2004.
- 3,398,453 (*See Class 14 for this trademark*).
- 3,398,517. **PADDINGTON (BLOCK FORM)**. CHLOE S.A.S., (U.S. CLS. 1, 2, 3, 22 AND 41). SN 78-863,562. PUB. 1-1-2008. FILED 4-18-2006.
- 3,398,575. **14' X 48' DESIGN AND DESIGN**. 14 X 48 DESIGN, INC., (U.S. CLS. 1, 2, 3, 22 AND 41). SN 78-935,819. PUB. 1-1-2008. FILED 7-24-2006.
- 3,398,632 (*See Class 14 for this trademark*).
- 3,398,640. **RICHTER (BLOCK FORM)**. FERDINAND RICHTER GMBH, (U.S. CLS. 1, 2, 3, 22 AND 41). SN 79-023,864. PUB. 1-1-2008. FILED 3-13-2006.
- 3,398,658. **MISCELLANEOUS DESIGN**. BACK TEE TRADITION A/S, MULTIPLE CLASS, (INT. CLS. 18, 25 AND 28), (U.S. CLS. 1, 2, 3, 22, 23, 38, 39, 41 AND 50). SN 79-027,911. PUB. 1-1-2008. FILED 6-20-2006.
- 3,398,703 (*See Class 3 for this trademark*).

3,398,728 (*See Class 14 for this trademark*).
 3,398,749 (*See Class 3 for this trademark*).
 3,398,754. **PERTTI PALMROTH (STYLIZED)**. PALMROTH INTERNATIONAL B.V., MULTIPLE CLASS, (INT. CLS. 18, 25 AND 35), (U.S. CLS. 1, 2, 3, 22, 39, 41, 100, 101 AND 102). SN 79-035,511. PUB. 1-1-2008. FILED 11-27-2006.
 3,398,809. **DICO AND DESIGN**. COR.MAR S.A.S; DI CORVARI MARINO & C., MULTIPLE CLASS, (INT. CLS. 18 AND 25), (U.S. CLS. 1, 2, 3, 22, 39 AND 41). SN 79-040,670. PUB. 1-1-2008. FILED 4-6-2007.

CLASS 19—NON-METALLIC BUILDING MATERIALS

3,396,822 (*See Class 3 for this trademark*).
 3,396,844. **KEEPERS OF THE AMERICAN SPIRIT (BLOCK FORM)**. LINCOLN LOGS, LTD., MULTIPLE CLASS, (INT. CLS. 19 AND 42), (U.S. CLS. 1, 12, 33, 50, 100 AND 101). SN 76-643,752. PUB. 1-1-2008. FILED 7-27-2005.
 3,396,905 (*See Class 11 for this trademark*).
 3,396,917. **FLEXIX BLOCK INSULATED CONCRETE FORM BY LITE-FORM TECHNOLOGIES AND DESIGN**. LITE-FORM TECHNOLOGIES LLC, (U.S. CLS. 1, 12, 33 AND 50). SN 76-675,882. PUB. 1-1-2008. FILED 4-23-2007.
 3,397,033. **TEMGUARD F.R.A. (BLOCK FORM)**. TEMO, INC., MULTIPLE CLASS, (INT. CLS. 19 AND 37), (U.S. CLS. 1, 12, 33, 50, 100, 103 AND 106). SN 77-033,258. PUB. 1-1-2008. FILED 10-31-2006.
 3,397,101. **AFRICAN SAFARI WOODFLOORS AND DESIGN**. FLOORAGE PRODUCTS CORP., (U.S. CLS. 1, 12, 33 AND 50). SN 77-052,945. PUB. 1-1-2008. FILED 11-29-2006.
 3,397,148. **GAGE (BLOCK FORM)**. SWEETMAN CONST. CO., (U.S. CLS. 1, 12, 33 AND 50). SN 77-063,384. PUB. 1-1-2008. FILED 12-13-2006.
 3,397,293 (*See Class 11 for this trademark*).
 3,397,350 (*See Class 6 for this trademark*).
 3,397,384. **KING'S (BLOCK FORM)**. KING'S MATERIAL, INC., (U.S. CLS. 1, 12, 33 AND 50). SN 77-119,334. PUB. 1-1-2008. FILED 3-1-2007.
 3,397,527. **THE NEXT GENERATION OF POOL PEBBLE (BLOCK FORM)**. WET EDGE TECHNOLOGIES, (U.S. CLS. 1, 12, 33 AND 50). SN 77-176,793. PUB. 1-1-2008. FILED 5-9-2007.
 3,397,576. **PANOMUR WALL (BLOCK FORM)**. BORGERT PRODUCTS, INC., (U.S. CLS. 1, 12, 33 AND 50). SN 77-194,352. PUB. 1-1-2008. FILED 5-31-2007.
 3,397,650. **PANEL CHANNELS (BLOCK FORM)**. EVERITT, THOMAS J., (U.S. CLS. 1, 12, 33 AND 50). SN 77-209,687. PUB. 1-1-2008. FILED 6-19-2007.
 3,397,771. **AP AND DESIGN**. ARCHITECTURAL POLYMERS, INC., MULTIPLE CLASS, (INT. CLS. 19 AND 40), (U.S. CLS. 1, 12, 33, 50, 100, 103 AND 106). SN 77-224,643. PUB. 1-1-2008. FILED 7-9-2007.
 3,397,777. **PROCELL (BLOCK FORM)**. AZEK BUILDING PRODUCTS, INC., (U.S. CLS. 1, 12, 33 AND 50). SN 77-225,010. PUB. 1-1-2008. FILED 7-9-2007.
 3,397,887. **MACTUBE (STYLIZED)**. MACCAFERRI, INC., (U.S. CLS. 1, 12, 33 AND 50). SN 77-228,249. PUB. 1-1-2008. FILED 7-12-2007.
 3,397,907. **MACBAG (STYLIZED)**. MACCAFERRI, INC., (U.S. CLS. 1, 12, 33 AND 50). SN 77-228,830. PUB. 1-1-2008. FILED 7-13-2007.
 3,398,409. **EASYTEAR (BLOCK FORM)**. HBP ACQUISITION LLC, (U.S. CLS. 1, 12, 33 AND 50). SN 78-637,224. PUB. 1-1-2008. FILED 5-25-2005.
 3,398,454 (*See Class 16 for this trademark*).
 3,398,489. **GORILLAGRID (BLOCK FORM)**. CHECKMATE GEOSYNTHETICS INC., (U.S. CLS. 1, 12, 33 AND 50). SN 78-830,388. PUB. 11-27-2007. FILED 3-6-2006.
 3,398,498. **CAPRIZI (BLOCK FORM)**. SAROYAN LUMBER CO., (U.S. CLS. 1, 12, 33 AND 50). SN 78-844,461. PUB. 1-1-2008. FILED 3-23-2006.
 3,398,519 (*See Class 8 for this trademark*).
 3,398,674 (*See Class 6 for this trademark*).
 3,398,687. **SAIME AND DESIGN**. RI-WAL CERAMICHE S.P.A., (U.S. CLS. 1, 12, 33 AND 50). SN 79-031,633. PUB. 1-

1-2008. FILED 9-6-2006.
 3,398,723. **VEGECOL (BLOCK FORM)**. COLAS, MULTIPLE CLASS, (INT. CLS. 19 AND 37), (U.S. CLS. 1, 12, 33, 50, 100, 103 AND 106). SN 79-034,457. PUB. 1-1-2008. FILED 12-1-2006.

CLASS 20—FURNITURE AND ARTICLES NOT OTHERWISE CLASSIFIED

3,396,875. **ROADRUNER AND DESIGN**. STEEL CITY CORPORATION, THE, (U.S. CLS. 2, 13, 22, 25, 32 AND 50). SN 76-668,496. PUB. 11-27-2007. FILED 11-6-2006.
 3,396,880 (*See Class 9 for this trademark*).
 3,396,979. **BATWING (BLOCK FORM)**. TRADE GUYS INTERNATIONAL PTY LTD, (U.S. CLS. 2, 13, 22, 25, 32 AND 50). SN 77-012,775. PUB. 9-25-2007. FILED 10-3-2006.
 3,397,100. **EASIKIT (BLOCK FORM)**. HANNECKE DISPLAY SYSTEMS, INC., (U.S. CLS. 2, 13, 22, 25, 32 AND 50). SN 77-052,885. PUB. 1-1-2008. FILED 11-29-2006.
 3,397,194. **IRPINIA (BLOCK FORM)**. IRPINIA, MULTIPLE CLASS, (INT. CLS. 20 AND 42), (U.S. CLS. 2, 13, 22, 25, 32, 50, 100 AND 101). SN 77-069,143. PUB. 1-1-2008. FILED 12-21-2006.
 3,397,301. **PANASONIC (BLOCK FORM)**. MATSUSHITA ELECTRIC INDUSTRIAL CO., LTD., (U.S. CLS. 2, 13, 22, 25, 32 AND 50). SN 77-096,135. PUB. 1-1-2008. FILED 1-31-2007.
 3,397,305. **XPANDX (BLOCK FORM)**. MANNA MARKETING & DEVELOPMENT GROUP, INC., (U.S. CLS. 2, 13, 22, 25, 32 AND 50). SN 77-096,491. PUB. 1-1-2008. FILED 2-1-2007.
 3,397,370. **PLAYNIX (STYLIZED)**. BACKYARD ADVENTURES OF COLORADO, (U.S. CLS. 2, 13, 22, 25, 32 AND 50). SN 77-112,732. PUB. 1-1-2008. FILED 2-21-2007.
 3,397,483 (*See Class 6 for this trademark*).
 3,397,574. **ENDURABANNER AND DESIGN**. SIGNWARE-HOUSE, INC., (U.S. CLS. 2, 13, 22, 25, 32 AND 50). SN 77-194,314. PUB. 1-1-2008. FILED 5-31-2007.
 3,397,729. **KALEIDOSKOP AND DESIGN**. PES INC., (U.S. CLS. 2, 13, 22, 25, 32 AND 50). SN 77-220,122. PUB. 1-1-2008. FILED 7-2-2007.
 3,397,761 (*See Class 11 for this trademark*).
 3,397,786. **DG DIMCOGRAY SOLUTIONS AT HAND (STYLIZED)**. DIMCOGRAY CORPORATION, (U.S. CLS. 2, 13, 22, 25, 32 AND 50). SN 77-225,490. PUB. 1-1-2008. FILED 7-10-2007.
 3,397,894. **NIM AND DESIGN**. NATURE INSPIRES MANUFACTURE, INC., (U.S. CLS. 2, 13, 22, 25, 32 AND 50). SN 77-228,546. PUB. 1-1-2008. FILED 7-12-2007.
 3,398,127. **CHROMALUXE (BLOCK FORM)**. UNIVERSAL WOODS, INCORPORATED, (U.S. CLS. 2, 13, 22, 25, 32 AND 50). SN 77-232,284. PUB. 1-1-2008. FILED 7-18-2007.
 3,398,147. **SUMMER LEGENDS (BLOCK FORM)**. PATIO ENCLOSURES, INC., (U.S. CLS. 2, 13, 22, 25, 32 AND 50). SN 77-232,623. PUB. 1-1-2008. FILED 7-18-2007.
 3,398,175. **THE INCREDIBEDS (BLOCK FORM)**. THE INCREDIBEDS CORPORATION, (U.S. CLS. 2, 13, 22, 25, 32 AND 50). SN 77-233,168. PUB. 1-1-2008. FILED 7-18-2007.
 3,398,189. **BUDDIES (STYLIZED)**. FRANKENSTEIN, GRETCHEN E, AND KESSNER, THOMAS D, (U.S. CLS. 2, 13, 22, 25, 32 AND 50). SN 77-233,522. PUB. 1-1-2008. FILED 7-19-2007.
 3,398,195. **INNER SOULS (BLOCK FORM)**. HIDE 'N SEEK CHILDREN'S FOUNDATION, (U.S. CLS. 2, 13, 22, 25, 32 AND 50). SN 77-233,624. PUB. 1-1-2008. FILED 7-19-2007.
 3,398,318. **KK KATHLEEN KOSZYK AND DESIGN**. ART DREAMS HOME, INC., (U.S. CLS. 2, 13, 22, 25, 32 AND 50). SN 77-255,303. PUB. 1-1-2008. FILED 8-14-2007.
 3,398,510. **A ACORN AND DESIGN**. ACORN KITCHENS, (U.S. CLS. 2, 13, 22, 25, 32 AND 50). SN 78-851,697. PUB. 1-1-2008. FILED 3-31-2006.
 3,398,519 (*See Class 8 for this trademark*).
 3,398,526 (*See Class 6 for this trademark*).
 3,398,538. **STORE IN STYLE THINKING INSIDE THE BOX AND DESIGN**. WESTRIM, INC., (U.S. CLS. 2, 13, 22, 25, 32 AND 50). SN 78-882,860. PUB. 1-1-2008. FILED 5-12-2006.
 3,398,598 (*See Class 10 for this trademark*).

- 3,398,600 (*See Class 3 for this trademark.*)
 3,398,625. **MALERBA (STYLIZED)**. MOBILI MALERBA SNC DI MALERBA NUNZIO & C., (U.S. CLS. 2, 13, 22, 25, 32 AND 50). SN 79-016,580. PUB. 1-1-2008. FILED 5-26-2005.
 3,398,645 (*See Class 6 for this trademark.*)
 3,398,675 (*See Class 8 for this trademark.*)
 3,398,764 (*See Class 4 for this trademark.*)
 3,398,800 (*See Class 7 for this trademark.*)
 3,398,808. **USMDISPLAY (STYLIZED)**. USM HOLDING AG, (U.S. CLS. 2, 13, 22, 25, 32 AND 50). SN 79-040,596. PUB. 1-1-2008. FILED 2-1-2007.
 3,398,830. **TOLIX (STYLIZED)**. TOLIX STEEL DESIGN, (U.S. CLS. 2, 13, 22, 25, 32 AND 50). SN 79-043,161. PUB. 1-1-2008. FILED 7-13-2007.
 3,398,832. **3DPILLOW (BLOCK FORM)**. PATRICK DUDERSTADT, MULTIPLE CLASS, (INT. CLS. 20 AND 37), (U.S. CLS. 2, 13, 22, 25, 32, 50, 100, 103 AND 106). SN 79-043,518. PUB. 1-1-2008. FILED 4-5-2007.

CLASS 21—HOUSEWARES AND GLASS

- 3,397,017. **EGG BAKER (BLOCK FORM)**. FULTON-MORALES, JULIA A, (U.S. CLS. 2, 13, 23, 29, 30, 33, 40 AND 50). SN 77-027,594. PUB. 1-1-2008. FILED 10-23-2006.
 3,397,049 (*See Class 1 for this trademark.*)
 3,397,269 (*See Class 6 for this trademark.*)
 3,397,302. **PANASONIC (BLOCK FORM)**. MATSUSHITA ELECTRIC INDUSTRIAL CO., LTD., (U.S. CLS. 2, 13, 23, 29, 30, 33, 40 AND 50). SN 77-096,138. PUB. 1-1-2008. FILED 1-31-2007.
 3,397,340. **DIELECTRIC SOLUTIONS AND DESIGN**. DIELECTRIC SOLUTIONS, LLC, (U.S. CLS. 2, 13, 23, 29, 30, 33, 40 AND 50). SN 77-103,868. PUB. 1-1-2008. FILED 2-9-2007.
 3,397,483 (*See Class 6 for this trademark.*)
 3,397,631. **KRONIK CHILL (BLOCK FORM)**. KRONIK LLC, (U.S. CLS. 2, 13, 23, 29, 30, 33, 40 AND 50). SN 77-205,667. PUB. 1-1-2008. FILED 6-13-2007.
 3,398,380 (*See Class 16 for this trademark.*)
 3,398,385 (*See Class 18 for this trademark.*)
 3,398,386 (*See Class 18 for this trademark.*)
 3,398,453 (*See Class 14 for this trademark.*)
 3,398,519 (*See Class 8 for this trademark.*)
 3,398,563. **MISCELLANEOUS DESIGN**. THE VOLLRATH COMPANY, L.L.C., (U.S. CLS. 2, 13, 23, 29, 30, 33, 40 AND 50). SN 78-921,153. PUB. 1-1-2008. FILED 6-30-2006.
 3,398,598 (*See Class 10 for this trademark.*)
 3,398,665. **POWCAN AND DESIGN**. ZHEJIANG BAOKANG; HOUSEHOLD APPLIANCE., LTD., (U.S. CLS. 2, 13, 23, 29, 30, 33, 40 AND 50). SN 79-028,891. PUB. 1-1-2008. FILED 9-5-2006.
 3,398,675 (*See Class 8 for this trademark.*)

CLASS 22—CORDAGE AND FIBERS

- 3,398,034. **ANCHOR BUDDY (BLOCK FORM)**. TUGGY PRODUCTS INC., (U.S. CLS. 1, 2, 7, 19, 22, 42 AND 50). SN 77-230,809. PUB. 1-1-2008. FILED 7-16-2007.
 3,398,511. **ALL AMERICAN (BLOCK FORM)**. PLYMKRAFT, INC., (U.S. CLS. 1, 2, 7, 19, 22, 42 AND 50). SN 78-853,437. PUB. 1-1-2008. FILED 4-4-2006.
 3,398,620 (*See Class 9 for this trademark.*)

CLASS 23—YARNS AND THREADS

- 3,396,945. **FARMHOUSE YARNS (BLOCK FORM)**. FARMHOUSE YARNS, LLC, (U.S. CL. 43). SN 76-679,597. PUB. 1-1-2008. FILED 7-16-2007.
 3,397,265. **AUSTRALIAN MERINO AND DESIGN**. AUSTRALIAN WOOL INNOVATION LIMITED, MULTIPLE CLASS, (INT. CLS. 23, 24 AND 25), (U.S. CLS. 22, 39, 42,

43 AND 50). SN 77-085,498. PUB. 1-1-2008. FILED 1-18-2007.

CLASS 24—FABRICS

- 3,396,865. **JINDA (BLOCK FORM)**. ZHEJIANG JINDA NEW MATERIALS CO., LTD., DBA HAINING JINDA COATING CO., LTD., (U.S. CLS. 42 AND 50). SN 76-664,229. PUB. 1-1-2008. FILED 8-7-2006.
 3,396,880 (*See Class 9 for this trademark.*)
 3,397,265 (*See Class 23 for this trademark.*)
 3,397,438. **TORAYAGE (BLOCK FORM)**. TORAY KABUSHIKI KAISHA (TORAY INDUSTRIES, INC.), MULTIPLE CLASS, (INT. CLS. 24 AND 25), (U.S. CLS. 22, 39, 42 AND 50). SN 77-141,518. PUB. 1-1-2008. FILED 3-27-2007.
 3,397,686. **SELECTION NATURELLE AND DESIGN**. OTTO LESQUE LLC, MULTIPLE CLASS, (INT. CLS. 24 AND 25), (U.S. CLS. 22, 39, 42 AND 50). SN 77-215,482. PUB. 1-1-2008. FILED 6-26-2007.
 3,397,692. **TOWTAB (BLOCK FORM)**. 2608961 CANADA INC., (U.S. CLS. 42 AND 50). SN 77-215,994. PUB. 1-1-2008. FILED 6-26-2007.
 3,397,810. **REST MY CASE AND DESIGN**. REST MY CASE INCORPORATED, (U.S. CLS. 42 AND 50). SN 77-226,359. PUB. 1-1-2008. FILED 7-10-2007.
 3,398,336. **FAN SOCKS (BLOCK FORM)**. WESTINGHOUSE LIGHTING CORPORATION, (U.S. CLS. 42 AND 50). SN 77-263,460. PUB. 1-1-2008. FILED 8-24-2007.
 3,398,453 (*See Class 14 for this trademark.*)
 3,398,519 (*See Class 8 for this trademark.*)
 3,398,620 (*See Class 9 for this trademark.*)
 3,398,699 (*See Class 9 for this trademark.*)
 3,398,727. **LORIN AND DESIGN**. LUCZAK JERZY; PRZEDSIEBIORSTWO; PRODUKCYJNO-HANDLOWO-USLUGOWE; LORIN, MULTIPLE CLASS, (INT. CLS. 24 AND 25), (U.S. CLS. 22, 39, 42 AND 50). SN 79-034,645. PUB. 1-1-2008. FILED 12-29-2006.
 3,398,733 (*See Class 7 for this trademark.*)
 3,398,749 (*See Class 3 for this trademark.*)
 3,398,764 (*See Class 4 for this trademark.*)
 3,398,776. **ECOLACE (BLOCK FORM)**. SUOMINEN KUITUKANKAAT OY, (U.S. CLS. 42 AND 50). SN 79-036,775. PUB. 1-1-2008. FILED 3-23-2007.
 3,398,777. **BIOLACE (BLOCK FORM)**. SUOMINEN KUITUKANKAAT OY, (U.S. CLS. 42 AND 50). SN 79-036,776. PUB. 1-1-2008. FILED 3-23-2007.
 3,398,798. **MOONDREAM (BLOCK FORM)**. BRUNSWICK ET FILS SA, (U.S. CLS. 42 AND 50). SN 79-039,718. PUB. 1-1-2008. FILED 5-7-2007.
 3,398,831. **ÇALIK DENIM AND DESIGN**. GAP GÜNEYDOGU TEKSTİL; SANAYI VE TICARET ANONİM ŞİRKETİ, (U.S. CLS. 42 AND 50). SN 79-043,500. PUB. 1-1-2008. FILED 3-2-2007.

CLASS 25—CLOTHING

- 3,396,818. **TACO BLUE JEANS (STYLIZED)**. TCO FRANQUIA LTDA., (U.S. CLS. 22 AND 39). SN 76-325,159. PUB. 1-1-2008. FILED 10-4-2001.
 3,396,820. **SA RUGBY AND DESIGN**. SOUTH AFRICAN RUGBY UNION, (U.S. CLS. 22 AND 39). SN 76-465,996. PUB. 1-1-2008. FILED 11-4-2002.
 3,396,821. **MISCELLANEOUS DESIGN**. SOFTSPIKES, LLC, (U.S. CLS. 22 AND 39). SN 76-506,671. PUB. 8-31-2004. FILED 4-14-2003.
 3,396,832. **[OMEGA-SYMBOL][PSI-SYMBOL][PHI-SYMBOL] 1911 AND DESIGN**. OMEGA PSI PHI FRATERNITY, INC., (U.S. CLS. 22 AND 39). SN 76-593,849. PUB. 1-1-2008. FILED 5-24-2004.
 3,396,840. **KI-KORPO BEACH FITNESS AND DESIGN**. KI KORPO - COMERCIO DE CONFECÇÕES LTDA, (U.S. CLS. 22 AND 39). SN 76-631,516. PUB. 1-1-2008. FILED 2-17-2005.
 3,396,854. **MISCELLANEOUS DESIGN**. RANCHO MIRAGE

- GOLF, INC., MULTIPLE CLASS, (INT. CLS. 25, 28 AND 35), (U.S. CLS. 22, 23, 38, 39, 50, 100, 101 AND 102). SN 76-658,556. PUB. 1-1-2008. FILED 4-17-2006.
- 3,396,856. **PIMA TOUCH (BLOCK FORM)**. MARCOS, PEDRO, (U.S. CLS. 22 AND 39). SN 76-659,138. PUB. 1-1-2008. FILED 4-27-2006.
- 3,396,859 (*See Class 9 for this trademark*).
- 3,396,870. **HIPS AND CURVES (BLOCK FORM)**. CMI ENTERPRISES, LLC, (U.S. CLS. 22 AND 39). SN 76-666,478. PUB. 9-25-2007. FILED 9-22-2006.
- 3,396,887. **FIGHT GRAVITY (BLOCK FORM)**. AADLAND, CHIP, (U.S. CLS. 22 AND 39). SN 76-670,101. PUB. 1-1-2008. FILED 12-8-2006.
- 3,396,894. **AC AND DESIGN**. ACTIVE CREATIONS, (U.S. CLS. 22 AND 39). SN 76-670,580. PUB. 1-1-2008. FILED 12-20-2006.
- 3,396,895. **AC (STYLIZED)**. ACTIVE CREATIONS, (U.S. CLS. 22 AND 39). SN 76-670,581. PUB. 1-1-2008. FILED 12-20-2006.
- 3,396,902 (*See Class 14 for this trademark*).
- 3,396,944. **NIC NAK (BLOCK FORM)**. NICNAK, LLC, (U.S. CLS. 22 AND 39). SN 76-679,592. PUB. 1-1-2008. FILED 7-16-2007.
- 3,396,947. **CRYSTAL MONGKEY (BLOCK FORM)**. JO, EUN JU, (U.S. CLS. 22 AND 39). SN 76-679,632. PUB. 1-1-2008. FILED 7-18-2007.
- 3,396,980. **[EL EI EKS] (BLOCK FORM)**. SHIZUKA MATSUMORI, (U.S. CLS. 22 AND 39). SN 77-013,032. PUB. 5-15-2007. FILED 10-3-2006.
- 3,397,013. **JOHNNY'S \$ AND DESIGN**. JOHNNY'S SPORTSWEAR, INC., (U.S. CLS. 22 AND 39). SN 77-026,719. PUB. 1-1-2008. FILED 10-23-2006.
- 3,397,014. **JOHNNY'S AND DESIGN**. JOHNNY'S SPORTSWEAR, INC., (U.S. CLS. 22 AND 39). SN 77-026,744. PUB. 1-1-2008. FILED 10-23-2006.
- 3,397,052. **HARD 8 (BLOCK FORM)**. MIZRAHI DESIGN GROUP, INC., (U.S. CLS. 22 AND 39). SN 77-040,005. PUB. 1-1-2008. FILED 11-8-2006.
- 3,397,067. **U (STYLIZED)**. GURU DENIM INC., (U.S. CLS. 22 AND 39). SN 77-044,078. PUB. 1-1-2008. FILED 11-14-2006.
- 3,397,133. **MAZZONI (BLOCK FORM)**. VALUE CITY OF MICHIGAN, INC., (U.S. CLS. 22 AND 39). SN 77-061,036. PUB. 9-25-2007. FILED 12-11-2006.
- 3,397,163. **REENIE BEENIE (BLOCK FORM)**. SILLY ME, INC., (U.S. CLS. 22 AND 39). SN 77-065,545. PUB. 1-1-2008. FILED 12-15-2006.
- 3,397,164 (*See Class 3 for this trademark*).
- 3,397,172. **TOTS BOTS AND DESIGN**. TOTSBOTS LIMITED, (U.S. CLS. 22 AND 39). SN 77-067,033. PUB. 1-1-2008. FILED 12-19-2006.
- 3,397,183. **DRIVE18 AND DESIGN**. RAMSEY MEDIWORKS LLC, (U.S. CLS. 22 AND 39). SN 77-068,601. PUB. 1-1-2008. FILED 12-20-2006.
- 3,397,191. **DOLORES CORTÉS (STYLIZED)**. DOLORES FONT CORTES, (U.S. CLS. 22 AND 39). SN 77-069,026. PUB. 1-1-2008. FILED 12-21-2006.
- 3,397,199. **APPRENTICE (BLOCK FORM)**. THE SUFFOLK POINTE SHOE CO.LTD, (U.S. CLS. 22 AND 39). SN 77-069,750. PUB. 1-1-2008. FILED 12-21-2006.
- 3,397,233. **THIRTEEN TWENTYFOUR CLOTHING 13 24 AND DESIGN**. SOLORIO, ANTHONY, AND CUMMINGS, JARED, (U.S. CLS. 22 AND 39). SN 77-076,260. PUB. 1-1-2008. FILED 1-4-2007.
- 3,397,238. **CALL A ROSE (BLOCK FORM)**. CHRISTINA ZELJEZNAK, (U.S. CLS. 22 AND 39). SN 77-077,643. PUB. 8-21-2007. FILED 1-7-2007.
- 3,397,247. **AIRPORT BOOTIES AND DESIGN**. TRIAD OF NORTH ATLANTA, LLC, (U.S. CLS. 22 AND 39). SN 77-079,457. PUB. 1-1-2008. FILED 1-9-2007.
- 3,397,265 (*See Class 23 for this trademark*).
- 3,397,278. **GRAMPY'S (BLOCK FORM)**. CALLAHAN REALTY COMPANY, MULTIPLE CLASS, (INT. CLS. 25, 35 AND 43), (U.S. CLS. 22, 39, 100, 101 AND 102). SN 77-088,330. PUB. 1-1-2008. FILED 1-22-2007.
- 3,397,279. **GRAMPY'S (STYLIZED)**. CALLAHAN REALTY COMPANY, MULTIPLE CLASS, (INT. CLS. 25, 35 AND 43), (U.S. CLS. 22, 39, 100, 101 AND 102). SN 77-088,340. PUB. 1-1-2008. FILED 1-22-2007.
- 3,397,287. **RABIA YALCIN (BLOCK FORM)**. YALCIN, RABIA, (U.S. CLS. 22 AND 39). SN 77-090,991. PUB. 1-1-2008. FILED 1-25-2007.
- 3,397,296. **MISCELLANEOUS DESIGN**. THE BOARD OF REGENTS OF THE UNIVERSITY OF TEXAS SYSTEM, (U.S. CLS. 22 AND 39). SN 77-094,659. PUB. 1-1-2008. FILED 1-30-2007.
- 3,397,308. **SKINSULATES (BLOCK FORM)**. DAVID & YOUNG CO, (U.S. CLS. 22 AND 39). SN 77-096,854. PUB. 1-1-2008. FILED 2-1-2007.
- 3,397,324. **MISCELLANEOUS DESIGN**. TWINS ENTERPRISE, INC., (U.S. CLS. 22 AND 39). SN 77-099,981. PUB. 1-1-2008. FILED 2-6-2007.
- 3,397,328. **YOU'VE ALWAYS HAD THE POWER (BLOCK FORM)**. BRINSON, CYNTHIA L., (U.S. CLS. 22 AND 39). SN 77-100,924. PUB. 1-1-2008. FILED 2-6-2007.
- 3,397,360. **LOCALLY GROWN (BLOCK FORM)**. SCOTT, FRED M., (U.S. CLS. 22 AND 39). SN 77-109,632. PUB. 1-1-2008. FILED 2-16-2007.
- 3,397,367. **CONART AND DESIGN**. HUDSON, ALBION, (U.S. CLS. 22 AND 39). SN 77-112,037. PUB. 1-1-2008. FILED 2-21-2007.
- 3,397,376. **MISCELLANEOUS DESIGN**. NASHVILLE SOUNDS BASEBALL CLUB LIMITED PARTNERSHIP, (U.S. CLS. 22 AND 39). SN 77-116,427. PUB. 1-1-2008. FILED 2-26-2007.
- 3,397,391. **AMALIALAD (BLOCK FORM)**. ACORN CONCEPTS LLC, (U.S. CLS. 22 AND 39). SN 77-122,061. PUB. 1-1-2008. FILED 3-5-2007.
- 3,397,412 (*See Class 9 for this trademark*).
- 3,397,415. **757 APPAREL AND DESIGN**. SAVINO, DAVID A., (U.S. CLS. 22 AND 39). SN 77-135,376. PUB. 1-1-2008. FILED S.R. 3-20-2007; AM. P.R. 8-20-2007.
- 3,397,416. **EST. 1978 CHAPS DENIM TRUE AMERICAN BRAND AND DESIGN**. PRL USA HOLDINGS, INC., (U.S. CLS. 22 AND 39). SN 77-135,703. PUB. 1-1-2008. FILED 3-20-2007.
- 3,397,424. **DIRTY ROYALTY (BLOCK FORM)**. DIRTY ROYALTY, LLC, (U.S. CLS. 22 AND 39). SN 77-137,145. PUB. 1-1-2008. FILED 3-21-2007.
- 3,397,438 (*See Class 24 for this trademark*).
- 3,397,441. **POTTERY BARN KIDS (BLOCK FORM)**. WILLIAMS-SONOMA, INC., (U.S. CLS. 22 AND 39). SN 77-142,801. PUB. 1-1-2008. FILED 3-28-2007.
- 3,397,447. **NYLON PUNK (BLOCK FORM)**. NYLON PUNK, LTD., (U.S. CLS. 22 AND 39). SN 77-146,121. PUB. 1-1-2008. FILED 4-2-2007.
- 3,397,460. **TIAGO'S CABO GRILLE AND DESIGN**. DISCOVER RESTAURANTS, LTD., MULTIPLE CLASS, (INT. CLS. 25 AND 43), (U.S. CLS. 22, 39, 100 AND 101). SN 77-152,075. PUB. 1-1-2008. FILED 4-9-2007.
- 3,397,462. **A VIKING'S JOY (BLOCK FORM)**. RANG, ULLA CAMILLA, (U.S. CLS. 22 AND 39). SN 77-152,377. PUB. 11-27-2007. FILED 4-9-2007.
- 3,397,485. **ERIKA LYNN (BLOCK FORM)**. ERIKA LYNN DESIGNS INC., (U.S. CLS. 22 AND 39). SN 77-161,657. PUB. 1-1-2008. FILED 4-20-2007.
- 3,397,492. **CORNERSPEED (BLOCK FORM)**. CORNERSPEED INC., MULTIPLE CLASS, (INT. CLS. 25 AND 41), (U.S. CLS. 22, 39, 100, 101 AND 107). SN 77-165,200. PUB. 1-1-2008. FILED 4-25-2007.
- 3,397,539. **ETHNICITEE CELEBRATE RESPECT AUG 1 2006 AND DESIGN**. ETHNICITEE, (U.S. CLS. 22 AND 39). SN 77-182,360. PUB. 1-1-2008. FILED 5-16-2007.
- 3,397,542 (*See Class 16 for this trademark*).
- 3,397,561 (*See Class 9 for this trademark*).
- 3,397,608. **M THE MOMENT AND DESIGN**. MICHAEL SEILER, (U.S. CLS. 22 AND 39). SN 77-200,978. PUB. 1-1-2008. FILED 6-8-2007.
- 3,397,619. **BRA TENDERS (BLOCK FORM)**. BRA*TENDERS, INC., (U.S. CLS. 22 AND 39). SN 77-202,532. PUB. 1-1-2008. FILED 6-11-2007.
- 3,397,625. **DOGWOOD CANYON (BLOCK FORM)**. BASS PRO TRADEMARKS, L.L.C., MULTIPLE CLASS, (INT. CLS. 25 AND 28), (U.S. CLS. 22, 23, 38, 39 AND 50). SN 77-203,941. PUB. 1-1-2008. FILED 6-12-2007.
- 3,397,686 (*See Class 24 for this trademark*).
- 3,397,726. **NOVEMBER RAIN AND DESIGN**. GUARINO, JERRY C, MULTIPLE CLASS, (INT. CLS. 25 AND 41), (U.S. CLS. 22, 39, 100, 101 AND 107). SN 77-219,822. PUB. 1-1-

2008. FILED 6-30-2007.
- 3,397,734. **BENECCI (BLOCK FORM)**. BENECCI CORPORATION, (U.S. CLS. 22 AND 39). SN 77-221,155. PUB. 1-1-2008. FILED 7-3-2007.
- 3,397,736. **NANTUCKET BRAND (BLOCK FORM)**. NANTUCKET BRAND, LLC, (U.S. CLS. 22 AND 39). SN 77-221,238. PUB. 1-1-2008. FILED 7-3-2007.
- 3,397,737. **ILLINOIS TECH (BLOCK FORM)**. ILLINOIS INSTITUTE OF TECHNOLOGY, (U.S. CLS. 22 AND 39). SN 77-221,455. PUB. 1-1-2008. FILED 7-3-2007.
- 3,397,742. **HOPE FOR YOU! AND DESIGN**. HOPE FOR YOU! CORPORATION, (U.S. CLS. 22 AND 39). SN 77-222,124. PUB. 1-1-2008. FILED 7-5-2007.
- 3,397,749. **DOWN TO THE BONZ (BLOCK FORM)**. SILVA, CHRISTINE LEONORA, (U.S. CLS. 22 AND 39). SN 77-222,665. PUB. 1-1-2008. FILED 7-5-2007.
- 3,397,866. **MAGICAL CHILD (BLOCK FORM)**. BRICE, MERI, AND BRICE, DAVID, MULTIPLE CLASS, (INT. CLS. 25 AND 35), (U.S. CLS. 22, 39, 100, 101 AND 102). SN 77-227,890. PUB. 1-1-2008. FILED 7-12-2007.
- 3,397,898. **S AND DESIGN**. MEREDITH GARRETT, (U.S. CLS. 22 AND 39). SN 77-228,670. PUB. 1-1-2008. FILED 7-12-2007.
- 3,397,945. **RUDE MANEUVERS AND DESIGN**. RUDE MANEUVERS INDUSTRIES, L.L.C., (U.S. CLS. 22 AND 39). SN 77-229,335. PUB. 1-1-2008. FILED 7-13-2007.
- 3,397,957. **MISCELLANEOUS DESIGN**. VALIANT GROUP, INC., (U.S. CLS. 22 AND 39). SN 77-229,522. PUB. 1-1-2008. FILED 7-13-2007.
- 3,398,014. **ISCUBA AND DESIGN**. COLLEEN QUIGLEY, DBA ISCUBA, (U.S. CLS. 22 AND 39). SN 77-230,524. PUB. 1-1-2008. FILED 7-16-2007.
- 3,398,093. **SIGMA CHI (BLOCK FORM)**. SIGMA CHI CORPORATION, (U.S. CLS. 22 AND 39). SN 77-231,771. PUB. 1-1-2008. FILED 7-17-2007.
- 3,398,104. **ERIN FETHERSTON (BLOCK FORM)**. FETHERSTON DESIGN GROUP, (U.S. CLS. 22 AND 39). SN 77-231,900. PUB. 1-1-2008. FILED 7-17-2007.
- 3,398,125. **MISCELLANEOUS DESIGN**. SIGMA CHI CORPORATION, (U.S. CLS. 22 AND 39). SN 77-232,224. PUB. 1-1-2008. FILED 7-18-2007.
- 3,398,133. **MISCELLANEOUS DESIGN**. BRICE, MERI, AND BRICE, DAVID, (U.S. CLS. 22 AND 39). SN 77-232,408. PUB. 1-1-2008. FILED 7-18-2007.
- 3,398,143. **COLDPRUF (BLOCK FORM)**. INDERA MILLS COMPANY, (U.S. CLS. 22 AND 39). SN 77-232,514. PUB. 1-1-2008. FILED 7-18-2007.
- 3,398,216. **STPL (BLOCK FORM)**. STAPLE DESIGN STUDIO INC., (U.S. CLS. 22 AND 39). SN 77-234,209. PUB. 1-1-2008. FILED 7-19-2007.
- 3,398,226. **MISCELLANEOUS DESIGN**. LIQUID MILITIA, LLC, (U.S. CLS. 22 AND 39). SN 77-234,563. PUB. 1-1-2008. FILED 7-20-2007.
- 3,398,238. **ZENRUNNER AND DESIGN**. TRUEBLOOD, SAMUEL E., (U.S. CLS. 22 AND 39). SN 77-235,553. PUB. 1-1-2008. FILED 7-22-2007.
- 3,398,249. **MISCELLANEOUS DESIGN**. INDERA MILLS COMPANY, (U.S. CLS. 22 AND 39). SN 77-237,981. PUB. 1-1-2008. FILED 7-25-2007.
- 3,398,259. **GO DIEGO GO! (BLOCK FORM)**. VIACOM INTERNATIONAL INC., (U.S. CLS. 22 AND 39). SN 77-241,717. PUB. 1-1-2008. FILED 7-30-2007.
- 3,398,281. **EZYWALKER (BLOCK FORM)**. ARORA GULSHAN, AND ARORA RAJINDER, (U.S. CLS. 22 AND 39). SN 77-247,377. PUB. 1-1-2008. FILED 8-5-2007.
- 3,398,295. **STICK TOGETHER (BLOCK FORM)**. T-MOBILE USA, INC., (U.S. CLS. 22 AND 39). SN 77-250,419. PUB. 1-1-2008. FILED 8-8-2007.
- 3,398,302. **CM AND DESIGN**. CONDIMENTMAN, LLC, MULTIPLE CLASS, (INT. CLS. 25 AND 30), (U.S. CLS. 22, 39 AND 46). SN 77-251,829. PUB. 1-1-2008. FILED 8-9-2007.
- 3,398,304. **MISCELLANEOUS DESIGN**. YACABUCCI, ANTHONY, (U.S. CLS. 22 AND 39). SN 77-251,971. PUB. 1-1-2008. FILED 8-10-2007.
- 3,398,311 (*See Class 9 for this trademark*).
- 3,398,321. **LN LIV NEKED (BLOCK FORM)**. SAINI, KIRPAL, (U.S. CLS. 22 AND 39). SN 77-255,892. PUB. 1-1-2008. FILED 8-15-2007.
- 3,398,374 (*See Class 9 for this trademark*).
- 3,398,376. **SHROOMERY (BLOCK FORM)**. MIND MEDIA, INC., (U.S. CLS. 22 AND 39). SN 78-467,507. PUB. 1-1-2008. FILED 8-13-2004.
- 3,398,385 (*See Class 18 for this trademark*).
- 3,398,386 (*See Class 18 for this trademark*).
- 3,398,424. **GROOVY GODDESS (BLOCK FORM)**. WAYSHAK, CORINNE, (U.S. CLS. 22 AND 39). SN 78-693,168. PUB. 6-27-2006. FILED 8-16-2005.
- 3,398,453 (*See Class 14 for this trademark*).
- 3,398,461. **TUSCAN (BLOCK FORM)**. MWM CREATIONS, INC., (U.S. CLS. 22 AND 39). SN 78-779,309. PUB. 1-1-2008. FILED 12-22-2005.
- 3,398,507. **THRASHER AND DESIGN**. HIGH SPEED PRODUCTIONS, INC., (U.S. CLS. 22 AND 39). SN 78-849,568. PUB. 1-1-2008. FILED 3-29-2006.
- 3,398,551. **CENTURY LINK (STYLIZED)**. WU, BOJIAN, AND LIU, YANLING, (U.S. CLS. 22 AND 39). SN 78-905,668. PUB. 1-1-2008. FILED 6-12-2006.
- 3,398,561. **PERSEVERE AND DESIGN**. SEVERE, EMANUEL J., (U.S. CLS. 22 AND 39). SN 78-917,447. PUB. 1-1-2008. FILED 6-27-2006.
- 3,398,589. **PEELER (BLOCK FORM)**. PEELER, LLC, (U.S. CLS. 22 AND 39). SN 78-955,949. PUB. 1-1-2008. FILED 8-19-2006.
- 3,398,600 (*See Class 3 for this trademark*).
- 3,398,602. **TRELISE (BLOCK FORM)**. TRELISE COOPER LIMITED, (U.S. CLS. 22 AND 39). SN 78-965,466. PUB. 1-1-2008. FILED 8-31-2006.
- 3,398,606 (*See Class 9 for this trademark*).
- 3,398,620 (*See Class 9 for this trademark*).
- 3,398,629. **RACING GREEN (STYLIZED)**. RACING GREEN LIMITED, (U.S. CLS. 22 AND 39). SN 79-020,282. PUB. 1-1-2008. FILED 7-25-2005.
- 3,398,632 (*See Class 14 for this trademark*).
- 3,398,658 (*See Class 18 for this trademark*).
- 3,398,676. **MISCELLANEOUS DESIGN**. UEMORI SABURO, (U.S. CLS. 22 AND 39). SN 79-030,316. PUB. 1-1-2008. FILED 9-26-2006.
- 3,398,682. **YAK AND DESIGN**. ECCO SKO A/S, (U.S. CLS. 22 AND 39). SN 79-031,347. PUB. 1-1-2008. FILED 10-30-2006.
- 3,398,685. **RENO AND DESIGN**. RENO SCHUHCENTRUM GMBH, (U.S. CLS. 22 AND 39). SN 79-031,535. PUB. 1-1-2008. FILED 4-19-2006.
- 3,398,703 (*See Class 3 for this trademark*).
- 3,398,707. **NATURAL NINE AND DESIGN**. WUXI NATURAL TEXTILE INDUSTRIAL; COMPANY LTD., (U.S. CLS. 22 AND 39). SN 79-032,964. PUB. 1-1-2008. FILED 12-11-2006.
- 3,398,708. **NATURE NINE AND DESIGN**. WUXI NATURAL TEXTILE INDUSTRIAL; COMPANY LTD., (U.S. CLS. 22 AND 39). SN 79-032,965. PUB. 1-1-2008. FILED 12-11-2006.
- 3,398,714. **GAGGOHAAS AND DESIGN**. GAGGOHAAS GMBH, MULTIPLE CLASS, (INT. CLS. 25, 30 AND 43), (U.S. CLS. 22, 39, 46, 100 AND 101). SN 79-033,834. PUB. 1-1-2008. FILED 12-15-2006.
- 3,398,727 (*See Class 24 for this trademark*).
- 3,398,728 (*See Class 14 for this trademark*).
- 3,398,731. **FRANCIS MONTESINOS (STYLIZED)**. MADE IN MONTESINOS, S.L., (U.S. CLS. 22 AND 39). SN 79-034,742. PUB. 1-1-2008. FILED 7-31-2006.
- 3,398,733 (*See Class 7 for this trademark*).
- 3,398,749 (*See Class 3 for this trademark*).
- 3,398,754 (*See Class 18 for this trademark*).
- 3,398,764 (*See Class 4 for this trademark*).
- 3,398,809 (*See Class 18 for this trademark*).

CLASS 26—FANCY GOODS

- 3,396,880 (*See Class 9 for this trademark*).
- 3,398,377. **HAIRXTEND (STYLIZED)**. HAIRXTEND INC., (U.S. CLS. 37, 39, 40, 42 AND 50). SN 78-491,483. PUB. 1-1-2008. FILED 9-29-2004.
- 3,398,631 (*See Class 12 for this trademark*).
- 3,398,703 (*See Class 3 for this trademark*).
- 3,398,728 (*See Class 14 for this trademark*).

CLASS 27—FLOOR COVERINGS

- 3,396,822 (*See Class 3 for this trademark.*)
 3,398,015. **SISKIYOU (BLOCK FORM)**. FIBREWORKS CORPORATION, (U.S. CLS. 19, 20, 37, 42 AND 50). SN 77-230,535. PUB. 1-1-2008. FILED 7-16-2007.
 3,398,204. **HEXOMAT (BLOCK FORM)**. INTRO-TECH AUTOMOTIVE, INC., (U.S. CLS. 19, 20, 37, 42 AND 50). SN 77-233,926. PUB. 1-1-2008. FILED 7-19-2007.
 3,398,206. **PROTECT-A-MAT (BLOCK FORM)**. INTRO-TECH AUTOMOTIVE, INC., (U.S. CLS. 19, 20, 37, 42 AND 50). SN 77-233,939. PUB. 1-1-2008. FILED 7-19-2007.
 3,398,323. **EVERYTHING YOU KNOW ABOUT ASTROTURF IS HISTORY (BLOCK FORM)**. TEXTILE MANAGEMENT ASSOCIATES, INC., (U.S. CLS. 19, 20, 37, 42 AND 50). SN 77-256,169. PUB. 1-1-2008. FILED 8-15-2007.
 3,398,324. **PUREGRASS PORTABLE (BLOCK FORM)**. TEXTILE MANAGEMENT ASSOCIATES, INC., (U.S. CLS. 19, 20, 37, 42 AND 50). SN 77-256,198. PUB. 1-1-2008. FILED 8-15-2007.
 3,398,519 (*See Class 8 for this trademark.*)
 3,398,565. **FIBERESSENCE (BLOCK FORM)**. BEAULIEU GROUP, LLC, (U.S. CLS. 19, 20, 37, 42 AND 50). SN 78-922,915. PUB. 1-1-2008. FILED 7-5-2006.

CLASS 28—TOYS AND SPORTING GOODS

- 3,396,815. **PIGGY SAYS**. RICK GOODWIN ENTERPRISES, INC., (U.S. CLS. 22, 23, 38 AND 50). SN 76-033,080. PUB. 12-26-2000. FILED 4-25-2000.
 3,396,854 (*See Class 25 for this trademark.*)
 3,396,859 (*See Class 9 for this trademark.*)
 3,397,235. **SNEEKS (STYLIZED)**. DAVIS, SR. ANTONIO M., (U.S. CLS. 22, 23, 38 AND 50). SN 77-076,430. PUB. 1-1-2008. FILED 1-4-2007.
 3,397,281. **ALPHA MIXER (BLOCK FORM)**. TECHNO SOURCE, (U.S. CLS. 22, 23, 38 AND 50). SN 77-088,717. PUB. 1-1-2008. FILED 1-23-2007.
 3,397,284. **TEXT TUMBLER (BLOCK FORM)**. TECHNO SOURCE, (U.S. CLS. 22, 23, 38 AND 50). SN 77-089,105. PUB. 1-1-2008. FILED 1-23-2007.
 3,397,323 (*See Class 3 for this trademark.*)
 3,397,325. **CHERRY BLAST (BLOCK FORM)**. MATTEL, INC., (U.S. CLS. 22, 23, 38 AND 50). SN 77-100,146. PUB. 1-1-2008. FILED 2-6-2007.
 3,397,406. **STRIKE SQUAD (BLOCK FORM)**. MATTEL, INC., (U.S. CLS. 22, 23, 38 AND 50). SN 77-128,673. PUB. 1-1-2008. FILED 3-12-2007.
 3,397,472. **FIDDLIN' BAGS AND DESIGN**. L-DOT DESIGNS, LLC, (U.S. CLS. 22, 23, 38 AND 50). SN 77-157,451. PUB. 1-1-2008. FILED 4-16-2007.
 3,397,480. **CLUB DISCO (BLOCK FORM)**. MATTEL, INC., (U.S. CLS. 22, 23, 38 AND 50). SN 77-160,368. PUB. 1-1-2008. FILED 4-19-2007.
 3,397,512. **JAZZ DIVA (BLOCK FORM)**. MATTEL, INC., (U.S. CLS. 22, 23, 38 AND 50). SN 77-170,395. PUB. 1-1-2008. FILED 5-1-2007.
 3,397,525. **MOVIE DOUBLES (BLOCK FORM)**. MATTEL, INC., (U.S. CLS. 22, 23, 38 AND 50). SN 77-176,202. PUB. 1-1-2008. FILED 5-9-2007.
 3,397,587. **WOOT! (BLOCK FORM)**. WOOT, INC., MULTIPLE CLASS, (INT. CLS. 28, 35 AND 38), (U.S. CLS. 22, 23, 38, 50, 100, 101, 102 AND 104). SN 77-196,788. PUB. 1-1-2008. FILED 6-4-2007.
 3,397,625 (*See Class 25 for this trademark.*)
 3,397,733. **RIP BAT (BLOCK FORM)**. ENOR CORPORATION, (U.S. CLS. 22, 23, 38 AND 50). SN 77-221,108. PUB. 1-1-2008. FILED 7-3-2007.
 3,397,782. **CQBBS (BLOCK FORM)**. PYRAMYD AIR, (U.S. CLS. 22, 23, 38 AND 50). SN 77-225,319. PUB. 1-1-2008. FILED 7-9-2007.
 3,397,903. **BRICKARMS (BLOCK FORM)**. BRICKARMS LLC, (U.S. CLS. 22, 23, 38 AND 50). SN 77-228,775. PUB. 1-1-2008. FILED 7-13-2007.
 3,397,966. **MAD RATS (BLOCK FORM)**. WOLF, MARSHALL JON, (U.S. CLS. 22, 23, 38 AND 50). SN 77-229,652. PUB. 1-1-

2008. FILED 7-13-2007.
 3,397,970. **HAMPTON AND DESIGN**. U.S. CHINA TRADING CORP., (U.S. CLS. 22, 23, 38 AND 50). SN 77-229,756. PUB. 1-1-2008. FILED 7-13-2007.
 3,398,038. **STINGER (BLOCK FORM)**. GOLFSMITH INTERNATIONAL, INC., (U.S. CLS. 22, 23, 38 AND 50). SN 77-230,845. PUB. 1-1-2008. FILED 7-16-2007.
 3,398,150. **ROAD CANNIBAL (BLOCK FORM)**. MATTEL, INC., (U.S. CLS. 22, 23, 38 AND 50). SN 77-232,653. PUB. 1-1-2008. FILED 7-18-2007.
 3,398,169. **WHO'S TALKING (BLOCK FORM)**. BROQUEVILLE, PAULETTE RENEE, (U.S. CLS. 22, 23, 38 AND 50). SN 77-232,994. PUB. 1-1-2008. FILED 7-18-2007.
 3,398,260. **GO DIEGO GO! (BLOCK FORM)**. VIACOM INTERNATIONAL INC., (U.S. CLS. 22, 23, 38 AND 50). SN 77-241,720. PUB. 1-1-2008. FILED 7-30-2007.
 3,398,292. **STICK TOGETHER (BLOCK FORM)**. T-MOBILE USA, INC., (U.S. CLS. 22, 23, 38 AND 50). SN 77-250,320. PUB. 1-1-2008. FILED 8-8-2007.
 3,398,308. **BANAPUP (BLOCK FORM)**. DOLE FOOD COMPANY, INC., (U.S. CLS. 22, 23, 38 AND 50). SN 77-252,968. PUB. 1-1-2008. FILED 8-10-2007.
 3,398,309. **PINEANIMAL (BLOCK FORM)**. DOLE FOOD COMPANY, INC., (U.S. CLS. 22, 23, 38 AND 50). SN 77-252,972. PUB. 1-1-2008. FILED 8-10-2007.
 3,398,310. **PINEOSAURUS (BLOCK FORM)**. DOLE FOOD COMPANY, INC., (U.S. CLS. 22, 23, 38 AND 50). SN 77-252,974. PUB. 1-1-2008. FILED 8-10-2007.
 3,398,343. **SQ AND DESIGN**. NIKE, INC., (U.S. CLS. 22, 23, 38 AND 50). SN 77-277,161. PUB. 1-1-2008. FILED 9-11-2007.
 3,398,374 (*See Class 9 for this trademark.*)
 3,398,389 (*See Class 9 for this trademark.*)
 3,398,390. **MISCELLANEOUS DESIGN**. MILLER, ANGELES A., (U.S. CLS. 22, 23, 38 AND 50). SN 78-547,304. PUB. 12-12-2006. FILED 1-13-2005.
 3,398,397 (*See Class 9 for this trademark.*)
 3,398,408. **METRO (BLOCK FORM)**. BRUNSWICK BOWLING & BILLIARDS CORPORATION, (U.S. CLS. 22, 23, 38 AND 50). SN 78-629,496. PUB. 1-1-2008. FILED 5-13-2005.
 3,398,412. **APOS (BLOCK FORM)**. APOS - SPORTS AND MEDICAL TECHNOLOGIES LTD., (U.S. CLS. 22, 23, 38 AND 50). SN 78-645,536. PUB. 1-1-2008. FILED 6-7-2005.
 3,398,453 (*See Class 14 for this trademark.*)
 3,398,476 (*See Class 10 for this trademark.*)
 3,398,598 (*See Class 10 for this trademark.*)
 3,398,635 (*See Class 16 for this trademark.*)
 3,398,658 (*See Class 18 for this trademark.*)
 3,398,675 (*See Class 8 for this trademark.*)
 3,398,721. **TUONO (BLOCK FORM)**. PIAGGIO & C. S.P.A., (U.S. CLS. 22, 23, 38 AND 50). SN 79-034,172. PUB. 1-1-2008. FILED 11-23-2006.
 3,398,764 (*See Class 4 for this trademark.*)

CLASS 29—MEATS AND PROCESSED FOODS

- 3,396,931. **MORGAN RANCH (BLOCK FORM)**. MORGAN RANCH BEEF, INC., (U.S. CL. 46). SN 76-678,143. PUB. 1-1-2008. FILED 6-12-2007.
 3,397,027. **COLUCCIO (BLOCK FORM)**. D. COLUCCIO & SONS, INC., (U.S. CL. 46). SN 77-030,605. PUB. 1-1-2008. FILED 10-26-2006.
 3,397,031. **VEGGIE GROWN (BLOCK FORM)**. PLAINVILLE FARMS, LLC, (U.S. CL. 46). SN 77-031,935. PUB. 1-1-2008. FILED 10-30-2006.
 3,397,061. **HIMALANIA (BLOCK FORM)**. SELECTPRO SALES, INC., MULTIPLE CLASS, (INT. CLS. 29, 31 AND 32), (U.S. CLS. 1, 45, 46 AND 48). SN 77-042,705. PUB. 1-1-2008. FILED 11-13-2006.
 3,397,062. **TERRAMAZON (BLOCK FORM)**. SELECTPRO SALES, INC., MULTIPLE CLASS, (INT. CLS. 29, 31 AND 32), (U.S. CLS. 1, 45, 46 AND 48). SN 77-042,738. PUB. 1-1-2008. FILED 11-13-2006.
 3,397,098. **YOCOOL (STYLIZED)**. WIN SOON, INC., DBA EPOCA, (U.S. CL. 46). SN 77-052,579. PUB. 1-1-2008. FILED 11-29-2006.
 3,397,105. **NOMU AND DESIGN**. THE TRACY FOULKES

- AND PAUL RAPHAELY PARTNERSHIP, MULTIPLE CLASS, (INT. CLS. 29 AND 30), (U.S. CL. 46). SN 77-054,925. PUB. 1-1-2008. FILED 12-1-2006.
- 3,397,382. **HONGAR FARMS (BLOCK FORM)**. GOLD STAR BRANDS LLC DBA HONGAR FARMS GOURMET FOODS, (U.S. CL. 46). SN 77-118,339. PUB. 1-1-2008. FILED 2-28-2007.
- 3,397,466. **KI DELICIA AND DESIGN**. BRAZILIAN SPECIALTY FOODS, INC., (U.S. CL. 46). SN 77-154,353. PUB. 1-1-2008. FILED 4-11-2007.
- 3,397,500. **QUICKERT'S DAIRY & FROZEN FOOD AND DESIGN**. REID'S MILKY-WAY DAIRY STORES INC., MULTIPLE CLASS, (INT. CLS. 29, 30 AND 35), (U.S. CLS. 46, 100, 101 AND 102). SN 77-166,671. PUB. 1-1-2008. FILED 4-26-2007.
- 3,397,517. **REBEKAH GRACE (BLOCK FORM)**. REBEKAH GRACE FOOD & SUPPLEMENTS FOR LIFE, LLC, MULTIPLE CLASS, (INT. CLS. 29, 30 AND 31), (U.S. CLS. 1 AND 46). SN 77-174,100. PUB. 1-1-2008. FILED 5-7-2007.
- 3,397,548. **TRUFRESH UNIQUE FRESH FREEZING METHOD (BLOCK FORM)**. WINTERLAB LIMITED, (U.S. CL. 46). SN 77-185,832. PUB. 1-1-2008. FILED 5-21-2007.
- 3,397,617. **ELEGANZA (BLOCK FORM)**. EDIBLE FOOD GROUP, LLC., (U.S. CL. 46). SN 77-202,449. PUB. 1-1-2008. FILED 6-11-2007.
- 3,397,659. **LEONCINI (BLOCK FORM)**. LEONCINI S.R.L., (U.S. CL. 46). SN 77-211,025. PUB. 1-1-2008. FILED 6-20-2007.
- 3,397,702. **HEIDI'S OMELET CREATIONS (BLOCK FORM)**. W3 PARTNERS, LLC, (U.S. CL. 46). SN 77-216,947. PUB. 1-1-2008. FILED 6-27-2007.
- 3,397,703. **MISCELLANEOUS DESIGN**. W3 PARTNERS, LLC, (U.S. CL. 46). SN 77-216,990. PUB. 1-1-2008. FILED 6-27-2007.
- 3,397,719. **MISCELLANEOUS DESIGN**. SANDRIDGE FOOD CORPORATION, (U.S. CL. 46). SN 77-219,111. PUB. 1-1-2008. FILED 6-29-2007.
- 3,397,998. **OTTER CREEK ORGANIC FARM (BLOCK FORM)**. LOCAL CHOICE MARKETING, LLC, (U.S. CL. 46). SN 77-230,333. PUB. 1-1-2008. FILED 7-16-2007.
- 3,398,237. **P PIERCE CHICKEN MASTER PIECES AND DESIGN**. PPC MARKETING, LTD., (U.S. CL. 46). SN 77-235,028. PUB. 1-1-2008. FILED 7-20-2007.
- 3,398,252. **BEST'S KOSHER (BLOCK FORM)**. SARA LEE FOODS, LLC, (U.S. CL. 46). SN 77-238,618. PUB. 1-1-2008. FILED 7-25-2007.
- 3,398,303. **1876 MONTE CUDINE AND DESIGN**. LUIS G. BONOMI Y CIA. S.A., (U.S. CL. 46). SN 77-251,928. PUB. 1-1-2008. FILED 8-10-2007.
- 3,398,328. **COUPOLE (BLOCK FORM)**. VERMONT BUTTER AND CHEESE COMPANY, INC., (U.S. CL. 46). SN 77-257,297. PUB. 1-1-2008. FILED 8-16-2007.
- 3,398,352. **OCEANIC AND DESIGN**. OCEANIC BEVERAGES CO., LTD., (U.S. CL. 46). SN 78-116,616. PUB. 6-17-2003. FILED 3-21-2002.
- 3,398,369. **BASMA GREEN MOLOKHIA 400 G AND DESIGN**. UNITED FOOD IMPORT, (U.S. CL. 46). SN 78-421,214. PUB. 7-18-2006. FILED 5-19-2004.
- 3,398,372. **COLEMAN AND DESIGN**. COLEMAN NATURAL PRODUCTS, INC., (U.S. CL. 46). SN 78-429,021. PUB. 9-20-2005. FILED 6-2-2004.
- 3,398,373. **HIGH SCHOOL SPECIAL (BLOCK FORM)**. MARINI, GIUSEPPE, (U.S. CL. 46). SN 78-429,850. PUB. 1-1-2008. FILED 6-4-2004.
- 3,398,445. **EL PORTEZUELO DE LOLOL (BLOCK FORM)**. BUDGE, CRISTIAN VIAL, (U.S. CL. 46). SN 78-740,835. PUB. 5-15-2007. FILED 10-26-2005.
- 3,398,457. **CAROLINA (BLOCK FORM)**. EXCELLENT, LESLIE F., AND EXCELLENT, ROBERT, MULTIPLE CLASS, (INT. CLS. 29 AND 30), (U.S. CL. 46). SN 78-768,453. PUB. 5-15-2007. FILED 12-7-2005.
- 3,398,546. **ECOLIVE (BLOCK FORM)**. VALLE DE OLIVOS S.A., (U.S. CL. 46). SN 78-901,565. PUB. 1-1-2008. FILED 6-6-2006.
- 3,398,562. **AT HOME IN AMERICA'S KITCHENS SINCE 1914 AND DESIGN**. AZAR NUT COMPANY, LLC, (U.S. CL. 46). SN 78-920,859. PUB. 7-31-2007. FILED 6-30-2006.
- 3,398,597. **BLUEWAVE SEAFOOD COMPANY AND DESIGN**. J&B WHOLESALE DISTRIBUTING, INC., (U.S. CL. 46). SN 78-961,902. PUB. 9-25-2007. FILED 8-28-2006.
- 3,398,673 (*See Class 5 for this trademark*).
- 3,398,718 (*See Class 3 for this trademark*).
- 3,398,752. **ALFESCA (STYLIZED)**. ALFESCA HF., MULTIPLE CLASS, (INT. CLS. 29, 30 AND 35), (U.S. CLS. 46, 100, 101 AND 102). SN 79-035,346. PUB. 1-1-2008. FILED 6-2-2006.

CLASS 30—STAPLE FOODS

- 3,396,846. **DONG SUH (BLOCK FORM)**. DONG SUH FOODS CORPORATION, (U.S. CL. 46). SN 76-644,868. PUB. 11-14-2006. FILED 8-15-2005.
- 3,396,858. **CORN CRUNCH (BLOCK FORM)**. PRAIRIE FOODS, INC., (U.S. CL. 46). SN 76-660,153. PUB. 1-1-2008. FILED 5-17-2006.
- 3,396,893. **MARIMBA (BLOCK FORM)**. VILLASANA, CARLOS, MULTIPLE CLASS, (INT. CLS. 30 AND 32), (U.S. CLS. 45, 46 AND 48). SN 76-670,568. PUB. 1-1-2008. FILED 12-20-2006.
- 3,396,899. **LINDT & SPRÜNGLI (BLOCK FORM)**. CHOCOLATE-FABRIKEN LINDT & SPRÜNGLI AG, (U.S. CL. 46). SN 76-672,507. PUB. 1-1-2008. FILED 2-9-2007.
- 3,396,903. **SURF SWEETS (BLOCK FORM)**. GSH HOLDINGS, INC, (U.S. CL. 46). SN 76-673,157. PUB. 1-1-2008. FILED 2-26-2007.
- 3,396,964. **BAKERY WAGON AND DESIGN**. MOTHER'S CAKE & COOKIE CO., (U.S. CL. 46). SN 77-005,477. PUB. 1-1-2008. FILED 9-22-2006.
- 3,397,105 (*See Class 29 for this trademark*).
- 3,397,160. **TOP SECRET RECIPES AND DESIGN**. TOP SECRET RECIPES, INC., (U.S. CL. 46). SN 77-064,641. PUB. 1-1-2008. FILED 12-14-2006.
- 3,397,181. **PLUSH PIPPIN AND DESIGN**. PLUSH PIPPIN COMPANY, LLC, (U.S. CL. 46). SN 77-068,504. PUB. 1-1-2008. FILED 12-20-2006.
- 3,397,230. **SNO-BAL (BLOCK FORM)**. TONE PRODUCTS, INC., (U.S. CL. 46). SN 77-075,975. PUB. 1-1-2008. FILED 1-4-2007.
- 3,397,253. **ROCKET DONUTS AND DESIGN**. ROCKET FOODS, LLC, MULTIPLE CLASS, (INT. CLS. 30 AND 43), (U.S. CLS. 46, 100 AND 101). SN 77-081,148. PUB. 1-1-2008. FILED 1-11-2007.
- 3,397,254. **ROCKET DONUTS AND DESIGN**. ROCKET FOODS, LLC, MULTIPLE CLASS, (INT. CLS. 30 AND 43), (U.S. CLS. 46, 100 AND 101). SN 77-081,356. PUB. 1-1-2008. FILED 1-11-2007.
- 3,397,311. **SCONEHENGE AND DESIGN**. SCONEHENGE, (U.S. CL. 46). SN 77-097,372. PUB. 1-1-2008. FILED 2-1-2007.
- 3,397,317. **CINNABON (BLOCK FORM)**. CINNABON, INC., (U.S. CL. 46). SN 77-098,015. PUB. 1-1-2008. FILED 2-2-2007.
- 3,397,334. **SMILING MOOSE DELI AND DESIGN**. PINNACLE RESTAURANT GROUP, INC., (U.S. CL. 46). SN 77-101,898. PUB. 9-25-2007. FILED 2-7-2007.
- 3,397,404. **TRUFFLE PIG (BLOCK FORM)**. HAGENSBORG CHOCOLATES LTD., (U.S. CL. 46). SN 77-127,586. PUB. 1-1-2008. FILED 3-9-2007.
- 3,397,436. **MISCELLANEOUS DESIGN**. SPANGLER CANDY COMPANY, (U.S. CL. 46). SN 77-141,094. PUB. 1-1-2008. FILED 3-27-2007.
- 3,397,500 (*See Class 29 for this trademark*).
- 3,397,503. **SUSTAINABLE SOURCING S AND DESIGN**. SUSTAINABLE SOURCING, LLC, (U.S. CL. 46). SN 77-167,754. PUB. 1-1-2008. FILED 4-27-2007.
- 3,397,513. **BELLA MARIA (BLOCK FORM)**. WICKED JOE, LLC, (U.S. CL. 46). SN 77-170,849. PUB. 1-1-2008. FILED 5-2-2007.
- 3,397,517 (*See Class 29 for this trademark*).
- 3,397,597. **COOL BLUE LI'L OATY AND DESIGN**. MALT-O-MEAL COMPANY, (U.S. CL. 46). SN 77-199,177. PUB. 1-1-2008. FILED 6-6-2007.
- 3,397,630. **VALDIVIA'S SALSA (BLOCK FORM)**. VALDIVIA'S SALSA, LLC, (U.S. CL. 46). SN 77-205,453. PUB. 1-1-2008. FILED 6-13-2007.
- 3,397,665. **MONTEREY GOURMET FOODS FINEST QUALITY ONE STEP GOURMET (BLOCK FORM)**. MONTEREY GOURMET FOODS, INC., (U.S. CL. 46). SN 77-212,528. PUB. 11-27-2007. FILED 6-21-2007.

- 3,397,718. **SCHOOLHOUSE PIZZA THE EDUCATED CHOICE AND DESIGN**. SHASTA UNION HIGH SCHOOL DISTRICT, (U.S. CL. 46). SN 77-219,092. PUB. 1-1-2008. FILED 6-29-2007.
- 3,397,741. **B&G CREPES AND DESIGN**. B&G CREPE LLC, MULTIPLE CLASS, (INT. CLS. 30 AND 43), (U.S. CLS. 46, 100 AND 101). SN 77-221,944. PUB. 1-1-2008. FILED 7-3-2007.
- 3,397,773. **PIZZAROLI (BLOCK FORM)**. FUNK FOODS, INC., (U.S. CL. 46). SN 77-224,720. PUB. 1-1-2008. FILED 7-9-2007.
- 3,397,861. **BELLASELVA "BEAUTIFUL JUNGLE" AND DESIGN**. KITTRIDGE & FREDRICKSON, LTD., (U.S. CL. 46). SN 77-227,796. PUB. 1-1-2008. FILED 7-12-2007.
- 3,397,862. **GOOD FOR OUR PLANET SINCE 1983 (BLOCK FORM)**. KITTRIDGE & FREDRICKSON, LTD., (U.S. CL. 46). SN 77-227,799. PUB. 1-1-2008. FILED 7-12-2007.
- 3,397,879. **MRS. APPLETREE (BLOCK FORM)**. DISTINCT INDULGENCE, INC., (U.S. CL. 46). SN 77-228,029. PUB. 1-1-2008. FILED 7-12-2007.
- 3,397,881. **MRS. APPLETREE AND DESIGN**. DISTINCT INDULGENCE, INC., (U.S. CL. 46). SN 77-228,087. PUB. 1-1-2008. FILED 7-12-2007.
- 3,397,913. **CIN-A-MOLLY'S (BLOCK FORM)**. TAMOLLY'S MEXICAN RESTAURANT OF AMERICA, LTD., (U.S. CL. 46). SN 77-228,897. PUB. 1-1-2008. FILED 7-13-2007.
- 3,397,925. **NOI CAFFE (BLOCK FORM)**. WAKE UP AMERICA GROUP, (U.S. CL. 46). SN 77-229,024. PUB. 1-1-2008. FILED 7-13-2007.
- 3,397,941. **TRULY SUGAR FREE (BLOCK FORM)**. LANDIES CANDIES CO., INC., (U.S. CL. 46). SN 77-229,246. PUB. 1-1-2008. FILED 7-13-2007.
- 3,397,953. **THE ORIGINAL SOUTHAMPTON PRINCESS AND DESIGN**. HAMPTON BAKE CO. INC., (U.S. CL. 46). SN 77-229,501. PUB. 1-1-2008. FILED 7-13-2007.
- 3,397,977. **CREATED BY HAND, INSPIRED BY ART (BLOCK FORM)**. MY FAVORITE COMPANY, INC., (U.S. CL. 46). SN 77-229,879. PUB. 1-1-2008. FILED 7-14-2007.
- 3,398,047. **PASTRIES WITH A PURPOSE! (BLOCK FORM)**. EMILY'S EDIBLES, LLC, (U.S. CL. 46). SN 77-230,965. PUB. 1-1-2008. FILED 7-16-2007.
- 3,398,049. **REX'S OUTRAGEOUS (BLOCK FORM)**. REX'S OUTRAGEOUS, LLC, (U.S. CL. 46). SN 77-231,005. PUB. 1-1-2008. FILED 7-16-2007.
- 3,398,050. **PRECIOUS WHITE PEACH (BLOCK FORM)**. TEAVANA CORPORATION, (U.S. CL. 46). SN 77-231,051. PUB. 1-1-2008. FILED 7-17-2007.
- 3,398,051. **SIX SUMMITS OOLONG (BLOCK FORM)**. TEAVANA CORPORATION, (U.S. CL. 46). SN 77-231,057. PUB. 1-1-2008. FILED 7-17-2007.
- 3,398,052. **BANANA CALYPSO (BLOCK FORM)**. TEAVANA CORPORATION, (U.S. CL. 46). SN 77-231,067. PUB. 1-1-2008. FILED 7-17-2007.
- 3,398,054. **AZTECA FIRE (BLOCK FORM)**. TEAVANA CORPORATION, (U.S. CL. 46). SN 77-231,100. PUB. 1-1-2008. FILED 7-17-2007.
- 3,398,077. **EPILOGUE (BLOCK FORM)**. DC3 ENTERTAINMENT, LLC, (U.S. CL. 46). SN 77-231,512. PUB. 1-1-2008. FILED 7-17-2007.
- 3,398,080. **PROLOGUE (BLOCK FORM)**. DC3 ENTERTAINMENT, LLC, (U.S. CL. 46). SN 77-231,528. PUB. 1-1-2008. FILED 7-17-2007.
- 3,398,124. **PLUM HARVEST (BLOCK FORM)**. TEAVANA CORPORATION, (U.S. CL. 46). SN 77-232,188. PUB. 1-1-2008. FILED 7-18-2007.
- 3,398,129. **SWEETWISTS (BLOCK FORM)**. FARLEY'S AND SATHERS CANDY COMPANY, INC., (U.S. CL. 46). SN 77-232,297. PUB. 1-1-2008. FILED 7-18-2007.
- 3,398,138. **PEERLESS COFFEE & TEA (BLOCK FORM)**. PEERLESS COFFEE & TEA, DBA PEERLESS COFFEE COMPANY, (U.S. CL. 46). SN 77-232,465. PUB. 1-1-2008. FILED 7-18-2007.
- 3,398,177. **MATE'VANA (BLOCK FORM)**. TEAVANA CORPORATION, (U.S. CL. 46). SN 77-233,250. PUB. 1-1-2008. FILED 7-19-2007.
- 3,398,250. **GOLD-N-RAISE (BLOCK FORM)**. THE PILLSBURY COMPANY, (U.S. CL. 46). SN 77-238,079. PUB. 1-1-2008. FILED 7-25-2007.
- 3,398,276. **DOLLY (BLOCK FORM)**. INTERSTATE BAKERIES CORPORATION, (U.S. CL. 46). SN 77-245,657. PUB. 1-1-2008. FILED 8-2-2007.
- 3,398,278. **GIVE 'EM WHAT THEY LOVE... WONDER! (BLOCK FORM)**. INTERSTATE BAKERIES CORPORATION, (U.S. CL. 46). SN 77-245,840. PUB. 1-1-2008. FILED 8-2-2007.
- 3,398,293. **STICK TOGETHER (BLOCK FORM)**. T-MOBILE USA, INC., (U.S. CL. 46). SN 77-250,354. PUB. 1-1-2008. FILED 8-8-2007.
- 3,398,299. **FLATTBOY (BLOCK FORM)**. ROR COMPANY, LLC, (U.S. CL. 46). SN 77-251,154. PUB. 1-1-2008. FILED 8-9-2007.
- 3,398,302 (*See Class 25 for this trademark*).
- 3,398,335. **KEEBLER AND DESIGN**. KELLOGG NORTH AMERICA COMPANY, (U.S. CL. 46). SN 77-262,717. PUB. 1-1-2008. FILED 8-23-2007.
- 3,398,366. **ARVID NORDQUIST CLASSIC AND DESIGN**. ARVID NORDQUIST HAB, (U.S. CL. 46). SN 78-395,762. PUB. 1-1-2008. FILED 4-2-2004.
- 3,398,419. **WHEATIES AND DESIGN**. GENERAL MILLS IP HOLDINGS II, LLC, (U.S. CL. 46). SN 78-675,500. PUB. 1-1-2008. FILED 7-21-2005.
- 3,398,432. **WING'S AND DESIGN**. WING HING LUNG LTD., (U.S. CL. 46). SN 78-711,361. PUB. 1-1-2008. FILED 9-12-2005.
- 3,398,433. **WING'S AND DESIGN**. WING HING LUNG LTD., (U.S. CL. 46). SN 78-711,370. PUB. 1-1-2008. FILED 9-12-2005.
- 3,398,446. **WINE GLACE' (STYLIZED)**. WINE.A.RITA LLC, (U.S. CL. 46). SN 78-747,921. PUB. 1-1-2008. FILED 11-5-2005.
- 3,398,448. **HEART'S DELIGHT BAKERY AND DESIGN**. HEART'S DELIGHT BAKERY, INC., (U.S. CL. 46). SN 78-749,765. PUB. 1-1-2008. FILED 11-8-2005.
- 3,398,457 (*See Class 29 for this trademark*).
- 3,398,515. **EL REY AND DESIGN**. FABRICA DE ESPECIAS Y PRODUCTOS EL REY S.A., (U.S. CL. 46). SN 78-860,672. PUB. 1-1-2008. FILED 4-13-2006.
- 3,398,544. **EQUICAFE (BLOCK FORM)**. ALTERNATIVA 3, SOCIEDAD COOPERATIVA CATALANA LIMITADA, MULTIPLE CLASS, (INT. CLS. 30 AND 35), (U.S. CLS. 46, 100, 101 AND 102). SN 78-900,284. PUB. 1-1-2008. FILED 6-5-2006.
- 3,398,556. **DAVINCI GOURMET (STYLIZED)**. KERRY GROUP SERVICES INTERNATIONAL, LTD., (U.S. CL. 46). SN 78-910,492. PUB. 1-1-2008. FILED 6-16-2006.
- 3,398,635 (*See Class 16 for this trademark*).
- 3,398,667. **EXCELLENCE 70% CACAO AND DESIGN**. CHOCOLADEFABRIKEN; LINDT & SPRÜNGLI AG, (U.S. CL. 46). SN 79-029,466. PUB. 1-1-2008. FILED 9-12-2006.
- 3,398,669. **CHOPIN FRÉDÉRIC AND DESIGN**. JUTRZENKA S.A., (U.S. CL. 46). SN 79-029,751. PUB. 1-1-2008. FILED 9-20-2006.
- 3,398,683. **HUIKANG AND DESIGN**. FUJIAN HUIKANG FOODS; INDUSTRY CO., LTD, (U.S. CL. 46). SN 79-031,442. PUB. 1-1-2008. FILED 11-6-2006.
- 3,398,694 (*See Class 5 for this trademark*).
- 3,398,714 (*See Class 25 for this trademark*).
- 3,398,718 (*See Class 3 for this trademark*).
- 3,398,752 (*See Class 29 for this trademark*).
- 3,398,801. **GREENFIELD JASMINE DREAM AND DESIGN**. COMPANY "KARAVAN" LTD., (U.S. CL. 46). SN 79-039,978. PUB. 1-1-2008. FILED 5-8-2007.
- 3,398,802. **MISCELLANEOUS DESIGN**. GUANGDONG MEIWEIXIAN FLAVORING; FOODS CO., LTD., (U.S. CL. 46). SN 79-040,003. PUB. 1-1-2008. FILED 12-7-2006.
- 3,398,814 (*See Class 1 for this trademark*).
- 3,398,815 (*See Class 1 for this trademark*).
- 3,398,823. **CELLINI AND DESIGN**. EKAF INDUSTRIA NAZIONALE; DEL CAFFÈ SPA, (U.S. CL. 46). SN 79-042,507. PUB. 1-1-2008. FILED 4-3-2007.
-
- CLASS 31—NATURAL AGRICULTURAL PRODUCTS**
- 3,396,934 (*See Class 1 for this trademark*).
- 3,397,042. **REFUGE PARTNER (BLOCK FORM)**. COOMER, MICHAEL LEE, (U.S. CLS. 1 AND 46). SN 77-035,228. PUB. 1-1-2008. FILED 11-2-2006.
- 3,397,061 (*See Class 29 for this trademark*).

- 3,397,062 (*See Class 29 for this trademark*).
- 3,397,248. **DIRT AND DESIGN**. ROBERTSON, ANN K., (U.S. CLS. 1 AND 46). SN 77-080,159. PUB. 1-1-2008. FILED 1-10-2007.
- 3,397,345. **SCOPIA (BLOCK FORM)**. DANZIGER - DAN FLOWER FARM, (U.S. CLS. 1 AND 46). SN 77-106,218. PUB. 1-1-2008. FILED 2-13-2007.
- 3,397,517 (*See Class 29 for this trademark*).
- 3,397,836. **CHICKEN SOUP FOR THE CAT LOVER'S SOUL (BLOCK FORM)**. CANFIELD, JOHN T., AND HANSEN & HANSEN LLC, (U.S. CLS. 1 AND 46). SN 77-227,256. PUB. 1-1-2008. FILED 7-11-2007.
- 3,397,839. **CHICKEN SOUP FOR THE DOG LOVER'S SOUL (BLOCK FORM)**. CANFIELD, JOHN T., AND HANSEN & HANSEN, LLC, (U.S. CLS. 1 AND 46). SN 77-227,291. PUB. 1-1-2008. FILED 7-11-2007.
- 3,397,841. **CHICKEN SOUP FOR THE KITTEN LOVER'S SOUL (BLOCK FORM)**. CANFIELD, JOHN T., AND HANSEN & HANSEN, LLC, (U.S. CLS. 1 AND 46). SN 77-227,314. PUB. 1-1-2008. FILED 7-11-2007.
- 3,397,845. **CHICKEN SOUP FOR THE PUPPY LOVER'S SOUL (BLOCK FORM)**. CANFIELD, JOHN T., AND HANSEN & HANSEN, LLC, (U.S. CLS. 1 AND 46). SN 77-227,339. PUB. 1-1-2008. FILED 7-11-2007.
- 3,397,865. **HI-GEST (BLOCK FORM)**. CAL/WEST SEEDS, (U.S. CLS. 1 AND 46). SN 77-227,862. PUB. 1-1-2008. FILED 7-12-2007.
- 3,397,874. **HI-GEST AND DESIGN**. CAL/WEST SEEDS, (U.S. CLS. 1 AND 46). SN 77-227,984. PUB. 1-1-2008. FILED 7-12-2007.
- 3,397,886. **PRODUCING LIFETIME LAWNS (BLOCK FORM)**. PATTEN SEED COMPANY, MULTIPLE CLASS, (INT. CLS. 31 AND 35), (U.S. CLS. 1, 46, 100, 101 AND 102). SN 77-228,170. PUB. 1-1-2008. FILED 7-12-2007.
- 3,397,963. **WORKING WITH YOU TO ACHIEVE PROFITABLE NUTRITION (BLOCK FORM)**. POET, LLC, (U.S. CLS. 1 AND 46). SN 77-229,636. PUB. 1-1-2008. FILED 7-13-2007.
- 3,398,198. **MISCELLANEOUS DESIGN**. BRANCH PROPERTIES, INC., DBA SEMINOLE STORES, (U.S. CLS. 1 AND 46). SN 77-233,810. PUB. 1-1-2008. FILED 7-19-2007.
- 3,398,200. **THE FARM INC. A TREE COMPANY AND DESIGN**. THE FARM, INC., MULTIPLE CLASS, (INT. CLS. 31 AND 44), (U.S. CLS. 1, 46, 100 AND 101). SN 77-233,830. PUB. 1-1-2008. FILED 7-19-2007.
- 3,398,266. **PET H2O AND DESIGN**. DEVONE LAWSON, INCORPORATED, (U.S. CLS. 1 AND 46). SN 77-243,277. PUB. 1-1-2008. FILED 7-31-2007.
- 3,398,487. **AXO-MAMA (BLOCK FORM)**. THE LITTLE POTATO COMPANY LTD, (U.S. CLS. 1 AND 46). SN 78-826,447. PUB. 1-1-2008. FILED 3-1-2006.
- 3,398,718 (*See Class 3 for this trademark*).
- PUB. 1-1-2008. FILED 5-30-2007.
- 3,397,939. **BOLT (BLOCK FORM)**. 206 MACOPIN CORP, (U.S. CLS. 45, 46 AND 48). SN 77-229,215. PUB. 1-1-2008. FILED 7-13-2007.
- 3,397,954. **ROLYIER (BLOCK FORM)**. SUPERIOR BRANDS, INC., (U.S. CLS. 45, 46 AND 48). SN 77-229,503. PUB. 1-1-2008. FILED 7-13-2007.
- 3,398,081. **ARBOR BREWING COMPANY SINCE 1995 ESPRESSO LOVE BREAKFAST STOUT AND DESIGN**. ARBOR BREWING COMPANY, LLC, (U.S. CLS. 45, 46 AND 48). SN 77-231,558. PUB. 1-1-2008. FILED 7-17-2007.
- 3,398,180. **ARBOR BREWING COMPANY SINCE 1995 RED SNAPPER AMBER ALE AND DESIGN**. ARBOR BREWING COMPANY, LLC, (U.S. CLS. 45, 46 AND 48). SN 77-233,372. PUB. 1-1-2008. FILED 7-19-2007.
- 3,398,192. **DARK CORNER ALE (BLOCK FORM)**. ARBOR BREWING COMPANY, LLC, (U.S. CLS. 45, 46 AND 48). SN 77-233,537. PUB. 1-1-2008. FILED 7-19-2007.
- 3,398,220. **LITE MY FIRE VERY PALE LOW CAL ALE AND DESIGN**. KEEP ROCKIN', LLC, (U.S. CLS. 45, 46 AND 48). SN 77-234,275. PUB. 1-1-2008. FILED 7-19-2007.
- 3,398,221. **ROCK STEADY RED AND DESIGN**. KEEP ROCKIN', LLC, (U.S. CLS. 45, 46 AND 48). SN 77-234,282. PUB. 1-1-2008. FILED 7-19-2007.
- 3,398,316. **PANGEA AND DESIGN**. SAPOREITALIANO IMPORTING CO., INC., (U.S. CLS. 45, 46 AND 48). SN 77-254,875. PUB. 1-1-2008. FILED 8-14-2007.
- 3,398,325. **GAGE ROADS AND DESIGN**. GAGE ROADS BREWING CO. LTD, (U.S. CLS. 45, 46 AND 48). SN 77-256,563. PUB. 1-1-2008. FILED 8-16-2007.
- 3,398,331. **JESUS ENERGY DRINK AND DESIGN**. ZARNEKEE, JERRY, (U.S. CLS. 45, 46 AND 48). SN 77-258,547. PUB. 1-1-2008. FILED 8-17-2007.
- 3,398,353. **OCEANIC AND DESIGN**. OCEANIC BEVERAGES CO., LTD., (U.S. CLS. 45, 46 AND 48). SN 78-116,814. PUB. 7-29-2003. FILED 3-22-2002.
- 3,398,516. **ROCKSTAR (BLOCK FORM)**. WEINER, RUSSELL G., (U.S. CLS. 45, 46 AND 48). SN 78-862,808. PUB. 1-1-2008. FILED 4-17-2006.
- 3,398,692. **WEYERMANN AND DESIGN**. HEINZ WEYERMANN; RÖSTMALZBIERBRAUEREI BAMBERG GMBH, (U.S. CLS. 45, 46 AND 48). SN 79-031,816. PUB. 1-1-2008. FILED 10-26-2006.
- 3,398,745. **DOLOMIA (BLOCK FORM)**. SORGENTE VALCIMOLIANA S.R.L., (U.S. CLS. 45, 46 AND 48). SN 79-035,130. PUB. 1-1-2008. FILED 12-6-2006.
- 3,398,807. **GLAMOUR (STYLIZED)**. OTKRYTOYE AKTSIONERNOYE OBCHTCHESTVO; "SYNERGIYA KAPITAL", MULTIPLE CLASS, (INT. CLS. 32 AND 33), (U.S. CLS. 45, 46, 47, 48 AND 49). SN 79-040,509. PUB. 1-1-2008. FILED 5-17-2007.
- 3,398,824. **JANA AND DESIGN**. JAMNICA D.D., (U.S. CLS. 45, 46 AND 48). SN 79-042,516. PUB. 1-1-2008. FILED 2-7-2007.

CLASS 32—LIGHT BEVERAGES

- 3,396,817. **MISCELLANEOUS DESIGN**. OCEANIC BEVERAGES CO., INC., (U.S. CLS. 45, 46 AND 48). SN 76-304,857. PUB. 8-27-2002. FILED 8-24-2001.
- 3,396,878. **PEOPLE WILL LIKE YOU LESS (BLOCK FORM)**. GRUBBS, ROGER STEVEN, (U.S. CLS. 45, 46 AND 48). SN 76-668,950. PUB. 1-1-2008. FILED 11-13-2006.
- 3,396,893 (*See Class 30 for this trademark*).
- 3,397,061 (*See Class 29 for this trademark*).
- 3,397,062 (*See Class 29 for this trademark*).
- 3,397,203 (*See Class 5 for this trademark*).
- 3,397,501. **COFE (BLOCK FORM)**. COFE CO., LTD, (U.S. CLS. 45, 46 AND 48). SN 77-166,903. PUB. 1-1-2008. FILED 4-26-2007.
- 3,397,562. **SUPPLICATION 23 AND DESIGN**. 23 BOTTLES OF BEER LLC, (U.S. CLS. 45, 46 AND 48). SN 77-192,579. PUB. 1-1-2008. FILED 5-29-2007.
- 3,397,565. **PERDITION BIÈRE DE SONOMA 23 AND DESIGN**. 23 BOTTLES OF BEER LLC, (U.S. CLS. 45, 46 AND 48). SN 77-193,402. PUB. 1-1-2008. FILED 5-30-2007.
- 3,397,567. **BEATIFICATION 23 AND DESIGN**. 23 BOTTLES OF BEER LLC, (U.S. CLS. 45, 46 AND 48). SN 77-193,441.

CLASS 33—WINES AND SPIRITS

- 3,396,813. **ZUBROWKA BISON BRAND AND DESIGN**. AGROS HOLDING S.A., (U.S. CLS. 47 AND 49). SN 75-127,541. PUB. 1-1-2008. FILED 7-1-1996.
- 3,396,938. **STANDING TALL WITH CRISTALL (BLOCK FORM)**. CRISTALL U.S.A., INC., (U.S. CLS. 47 AND 49). SN 76-679,221. PUB. 1-1-2008. FILED 7-9-2007.
- 3,396,963. **ELIZABETH ROSE (BLOCK FORM)**. NAPA WINE COMPANY, LLC, (U.S. CLS. 47 AND 49). SN 77-004,036. PUB. 1-1-2008. FILED 9-21-2006.
- 3,396,988. **CAVINO DEL SOL AND DESIGN**. RIO VISTA WINE & SPIRITS, LLC, (U.S. CLS. 47 AND 49). SN 77-016,020. PUB. 1-1-2008. FILED 10-6-2006.
- 3,397,090. **VOLADOR (BLOCK FORM)**. JAGO USA, INC., (U.S. CLS. 47 AND 49). SN 77-050,948. PUB. 1-1-2008. FILED 11-27-2006.
- 3,397,139. **ZINRAH (BLOCK FORM)**. PARMELEE-HILL WINES, (U.S. CLS. 47 AND 49). SN 77-062,275. PUB. 1-1-2008. FILED 12-12-2006.
- 3,397,197. **SILVER SPUR (BLOCK FORM)**. SILVER SPUR PARTNERS, INC., (U.S. CLS. 47 AND 49). SN 77-069,433.

PUB. 1-1-2008. FILED 12-21-2006.

3,397,211. **ORANGELA (BLOCK FORM)**. EMPIRE WINERIES, LLC, DBA EMPIRE WINERY AND DISTILLERY, (U.S. CLS. 47 AND 49). SN 77-071,990. PUB. 1-1-2008. FILED 12-27-2006.

3,397,286. **WORLD CLASS COCKTAILS AND DESIGN**. DIAGEO NORTH AMERICA, INC., (U.S. CLS. 47 AND 49). SN 77-089,868. PUB. 1-1-2008. FILED 1-24-2007.

3,397,366. **SIMPLY RED (BLOCK FORM)**. FRANCIS S. MILLIER, AND ELIZABETH J. MILLIER, (U.S. CLS. 47 AND 49). SN 77-111,876. PUB. 1-1-2008. FILED 2-20-2007.

3,397,683. **CHATEAU DE RAYNE VIGNEAU (BLOCK FORM)**. SOCIETE CIVILE DU CHATEAU RAYNE VIGNEAU, (U.S. CLS. 47 AND 49). SN 77-215,420. PUB. 1-1-2008. FILED 6-26-2007.

3,397,721. **GILBEY'S (BLOCK FORM)**. DIAGEO BRANDS B.V., (U.S. CLS. 47 AND 49). SN 77-219,247. PUB. 1-1-2008. FILED 6-29-2007.

3,397,723. **MISCELLANEOUS DESIGN**. DIAGEO BRANDS B.V., (U.S. CLS. 47 AND 49). SN 77-219,328. PUB. 1-1-2008. FILED 6-29-2007.

3,397,835. **PARAJAXX (BLOCK FORM)**. DUCKHORN WINE COMPANY, (U.S. CLS. 47 AND 49). SN 77-227,246. PUB. 1-1-2008. FILED 7-11-2007.

3,397,908. **MOOSE VALLEY VINEYARD (BLOCK FORM)**. STEPHENS & COMPANY, DBA D.R. STEPHENS ESTATE, (U.S. CLS. 47 AND 49). SN 77-228,836. PUB. 1-1-2008. FILED 7-13-2007.

3,397,990. **HATS OFF (BLOCK FORM)**. WENTE BROS., (U.S. CLS. 47 AND 49). SN 77-230,261. PUB. 1-1-2008. FILED 7-16-2007.

3,397,991. **IN THE SADDLE (BLOCK FORM)**. WENTE BROS., (U.S. CLS. 47 AND 49). SN 77-230,275. PUB. 1-1-2008. FILED 7-16-2007.

3,397,993. **BEST FOOT FORWARD (BLOCK FORM)**. WENTE BROS., (U.S. CLS. 47 AND 49). SN 77-230,289. PUB. 1-1-2008. FILED 7-16-2007.

3,397,994. **LUCKY HORSESHOE (BLOCK FORM)**. WENTE BROS., (U.S. CLS. 47 AND 49). SN 77-230,298. PUB. 1-1-2008. FILED 7-16-2007.

3,398,008. **GOLD STRIPE (BLOCK FORM)**. VENTANA VINTNERS, LLC, (U.S. CLS. 47 AND 49). SN 77-230,468. PUB. 1-1-2008. FILED 7-16-2007.

3,398,084. **V 5 AND DESIGN**. FAST FORWARD BRANDS, LLC, (U.S. CLS. 47 AND 49). SN 77-231,630. PUB. 1-1-2008. FILED 7-17-2007.

3,398,113. **HEALDSBURG RANCHES (BLOCK FORM)**. HAMBRECHT WINE GROUP, LP, (U.S. CLS. 47 AND 49). SN 77-232,076. PUB. 1-1-2008. FILED 7-17-2007.

3,398,116. **LE POUSSEUR (BLOCK FORM)**. BONNY DOON WINERY, INC., (U.S. CLS. 47 AND 49). SN 77-232,129. PUB. 1-1-2008. FILED 7-17-2007.

3,398,160. **VAMPIRE AND DESIGN**. MACHAT, MICHAEL, (U.S. CLS. 47 AND 49). SN 77-232,783. PUB. 1-1-2008. FILED 7-18-2007.

3,398,172. **MOLECA AND DESIGN**. MOLECA, LLC, (U.S. CLS. 47 AND 49). SN 77-233,039. PUB. 1-1-2008. FILED 7-18-2007.

3,398,188. **ZINFANODDLE (BLOCK FORM)**. SCHERRER, FRED C., A CITIZEN OF THE UNITED STATES, DBA SCHERRER WINERY, (U.S. CLS. 47 AND 49). SN 77-233,518. PUB. 1-1-2008. FILED 7-19-2007.

3,398,199. **MCWILLIAM'S (BLOCK FORM)**. M & G BRANDS, LIMITED, (U.S. CLS. 47 AND 49). SN 77-233,824. PUB. 1-1-2008. FILED 7-19-2007.

3,398,212. **TOROSOL (BLOCK FORM)**. SOMO, INC., (U.S. CLS. 47 AND 49). SN 77-234,139. PUB. 1-1-2008. FILED 7-19-2007.

3,398,357. **CAPITAN**. BARTON BRANDS, LTD., (U.S. CLS. 47 AND 49). SN 78-206,145. PUB. 6-6-2006. FILED 1-22-2003.

3,398,400. **CASA RITA (BLOCK FORM)**. EL CHICO RESTAURANTS, INC., (U.S. CLS. 47 AND 49). SN 78-587,727. PUB. 1-1-2008. FILED 3-15-2005.

3,398,406. **SATOMI (BLOCK FORM)**. ANTOGNOLLI, ANTONIO S., (U.S. CLS. 47 AND 49). SN 78-622,737. PUB. 1-1-2008. FILED 5-4-2005.

3,398,591. **BULLE DE BLANQUETTE (BLOCK FORM)**. LES VIGNERONS DU SIEUR D'ARQUES SOCIETE COOPERATIVE AGRICOLE, (U.S. CLS. 47 AND 49). SN 78-956,916.

PUB. 6-26-2007. FILED 8-21-2006.

3,398,689. **CHATEAU LAROSE-TRINTAUDON AND DESIGN**. CHATEAU LAROSE TRINTAUDON, (U.S. CLS. 47 AND 49). SN 79-031,704. PUB. 1-1-2008. FILED 9-15-2006.

3,398,691. **VERPOORTEN VERPOORTEN AND DESIGN**. VERPOORTEN GMBH & CO. KG, (U.S. CLS. 47 AND 49). SN 79-031,765. PUB. 1-1-2008. FILED 11-3-2006.

3,398,722. **PASTOR FRITZ (BLOCK FORM)**. HAHN BAROSSA VINEYARDS (SA) PTY LTD, (U.S. CLS. 47 AND 49). SN 79-034,364. PUB. 1-1-2008. FILED 1-3-2007.

3,398,725. **MARQUES DE TOSOS (STYLIZED)**. BODEGAS SAN VALERO, S. COOP., (U.S. CLS. 47 AND 49). SN 79-034,625. PUB. 1-1-2008. FILED 12-1-2006.

3,398,726. **PONTAC AND DESIGN**. BODEGAS LUIS ALEGRE, S.A., (U.S. CLS. 47 AND 49). SN 79-034,630. PUB. 1-1-2008. FILED 12-20-2006.

3,398,756. **ISTITUTO DEL VINO ITALIANO DI QUALITÀ AND DESIGN**. ISTITUTO DEL VINO ITALIANO; DI QUALITÀ - GRANDI MARCHI S.R.L.; CONSORTILE, (U.S. CLS. 47 AND 49). SN 79-035,649. PUB. 1-1-2008. FILED 1-8-2007.

3,398,766. **CAPENÈ MALVOLI AND DESIGN**. CARPENE' MALVOLI S.P.A., (U.S. CLS. 47 AND 49). SN 79-036,141. PUB. 1-1-2008. FILED 9-19-2006.

3,398,773. **ADRIANO ADAMI AND DESIGN**. ADAMI S.R.L., (U.S. CLS. 47 AND 49). SN 79-036,486. PUB. 1-1-2008. FILED 3-29-2007.

3,398,794. **MONTSECONDO AND DESIGN**. SILVIO MESSANA, (U.S. CLS. 47 AND 49). SN 79-039,175. PUB. 11-27-2007. FILED 4-3-2007.

3,398,797. **WHISPERING ANGEL (BLOCK FORM)**. CHATEAU D'ESCLANS; DOMAINES SACHA LICHINE, (U.S. CLS. 47 AND 49). SN 79-039,705. PUB. 1-1-2008. FILED 4-23-2007.

3,398,805. **RENÉ LALOU (STYLIZED)**. G.H. MUMM & CIE, SOCIÉTÉ VINICOLE; DE CHAMPAGNE, SUCCESEUR.; SOCIÉTÉ ANONYME, (U.S. CLS. 47 AND 49). SN 79-040,295. PUB. 1-1-2008. FILED 1-19-2007.

3,398,807 (*See Class 32 for this trademark*).

3,398,826. **MISCELLANEOUS DESIGN**. FAZI BATTAGLIA S.P.A. O CON SIGLA; "F & B S.P.A.", (U.S. CLS. 47 AND 49). SN 79-042,799. PUB. 1-1-2008. FILED 7-10-2007.

CLASS 34—SMOKERS' ARTICLES

3,398,375 (*See Class 4 for this trademark*).

3,398,547. **JET CIGARETTES GOLD BLEND FILTER KINGS AND DESIGN**. N.V. SUMATRA TOBACCO TRADING COMPANY, (U.S. CLS. 2, 8, 9 AND 17). SN 78-901,913. PUB. 1-1-2008. FILED 6-6-2006.

3,398,639. **WAVE W AND DESIGN**. JAPAN TOBACCO INC., (U.S. CLS. 2, 8, 9 AND 17). SN 79-023,863. PUB. 1-1-2008. FILED 5-4-2006.

3,398,643. **XAXO (BLOCK FORM)**. REINDL, GERHARD., (U.S. CLS. 2, 8, 9 AND 17). SN 79-024,879. PUB. 1-1-2008. FILED 4-13-2006.

3,398,764 (*See Class 4 for this trademark*).

SERVICE MARKS

CLASS 35—ADVERTISING AND BUSINESS

3,396,829. **YOUR BACK OFFICE IS OUR FRONT OFFICE (STYLIZED)**. CONTINUSERVE, LLC, (U.S. CLS. 100, 101 AND 102). SN 76-571,047. PUB. 1-1-2008. FILED 1-20-2004.

3,396,831. **AV DEALS (BLOCK FORM)**. NETBORED INC., (U.S. CLS. 100, 101 AND 102). SN 76-583,506. PUB. 1-1-2008. FILED 3-26-2004.

3,396,835 (*See Class 9 for this trademark*).

3,396,839. **IENTV (BLOCK FORM)**. THOMAS PUBLISHING COMPANY, MULTIPLE CLASS, (INT. CLS. 35 AND 38), (U.S. CLS. 100, 101, 102 AND 104). SN 76-631,223. PUB. 1-1-

2008. FILED 2-14-2005.
- 3,396,842. **DENNY HECKER (STYLIZED)**. DENNY HECKER'S AUTOMOTIVE GROUP, INC., MULTIPLE CLASS, (INT. CLS. 35, 36, 37 AND 39), (U.S. CLS. 100, 101, 102, 103, 105 AND 106). SN 76-642,805. PUB. 1-1-2008. FILED S.R. 7-14-2005; AM. P.R. 10-19-2007.
- 3,396,848 (*See Class 9 for this trademark*).
- 3,396,852. **ATLANTA INTERNATIONAL BRIDAL & SPECIAL OCCASION MARKET (BLOCK FORM)**. AMC, INC., (U.S. CLS. 100, 101 AND 102). SN 76-656,962. PUB. 1-1-2008. FILED 3-20-2006.
- 3,396,854 (*See Class 25 for this trademark*).
- 3,396,855. **SNB AND DESIGN**. SNBT DIAMONDS & JEWELRY, LTD., (U.S. CLS. 100, 101 AND 102). SN 76-659,137. PUB. 1-1-2008. FILED 4-27-2006.
- 3,396,867. **THINK ABOUT TOMORROW (BLOCK FORM)**. MASSACHUSETTS HIGHER EDUCATION ASSISTANCE CORPORATION, DBA AMERICAN STUDENT ASSISTANCE, (U.S. CLS. 100, 101 AND 102). SN 76-664,489. PUB. 1-1-2008. FILED 8-11-2006.
- 3,396,872. **ZIPSCENE AND DESIGN**. TXTBUZZ INC., MULTIPLE CLASS, (INT. CLS. 35 AND 45), (U.S. CLS. 100, 101 AND 102). SN 76-666,911. PUB. 1-1-2008. FILED 10-3-2006.
- 3,396,881. **MISCELLANEOUS DESIGN**. BRISTOW GROUP INC., MULTIPLE CLASS, (INT. CLS. 35, 37, 39, 41, 42, 44 AND 45), (U.S. CLS. 100, 101, 102, 103, 105, 106 AND 107). SN 76-669,397. PUB. 1-1-2008. FILED 11-22-2006.
- 3,396,886. **FOCALPOINT COACHING EXCELLENCE POWERED BY BRIAN TRACY AND DESIGN**. BRIAN TRACY INTERNATIONAL, INC., (U.S. CLS. 100, 101 AND 102). SN 76-669,995. PUB. 1-1-2008. FILED 12-6-2006.
- 3,396,897. **SUPERIOR SERVICE. NATIONAL COVERAGE. (BLOCK FORM)**. ROOFLINK, DBA NATIONAL ROOFING PARTNERS, (U.S. CLS. 100, 101 AND 102). SN 76-671,173. PUB. 1-1-2008. FILED 1-9-2007.
- 3,396,906. **DIVERSITY AFFLUENCE HELPING CLIENTS REACH THE AFFLUENT ETHNIC CONSUMER WWW.DIVERSITYAFFLUENCE.COM AND DESIGN**. HOFFMAN, ANDREA, (U.S. CLS. 100, 101 AND 102). SN 76-674,089. PUB. 1-1-2008. FILED 3-15-2007.
- 3,396,908. **WEIRDWARE (BLOCK FORM)**. TRUSTIN TECHNOLOGY, LLC, (U.S. CLS. 100, 101 AND 102). SN 76-674,500. PUB. 9-25-2007. FILED 3-23-2007.
- 3,396,913. **OAK CREEK AND DESIGN**. AMERICAN HOMESTAR CORPORATION, MULTIPLE CLASS, (INT. CLS. 35 AND 40), (U.S. CLS. 100, 101, 102, 103 AND 106). SN 76-675,400. PUB. 1-1-2008. FILED 4-12-2007.
- 3,396,922. **CYF (BLOCK FORM)**. AMERICAN PSYCHOLOGICAL ASSOCIATION, MULTIPLE CLASS, (INT. CLS. 35, 41 AND 44), (U.S. CLS. 100, 101, 102 AND 107). SN 76-676,210. PUB. 1-1-2008. FILED 4-30-2007.
- 3,396,923. **FREIGHT SALES (BLOCK FORM)**. FREIGHT SALES CARPET AND TILE OF POLK COUNTY, L.L.C., (U.S. CLS. 100, 101 AND 102). SN 76-676,275. PUB. 1-1-2008. FILED 5-1-2007.
- 3,396,926. **EVOLUTIONARY IT (BLOCK FORM)**. EVOLUTIONARY IT, MULTIPLE CLASS, (INT. CLS. 35, 41 AND 42), (U.S. CLS. 100, 101, 102 AND 107). SN 76-677,472. PUB. 1-1-2008. FILED 5-29-2007.
- 3,396,928. **ART JURIS (BLOCK FORM)**. ART JURIS GALLERIES, (U.S. CLS. 100, 101 AND 102). SN 76-677,888. PUB. 1-1-2008. FILED 6-6-2007.
- 3,396,929. **E WORD OF MOUTH EXPONENTIALLY...THE MOST POWERFUL ADVERTISING AND DESIGN**. ANTON PUBLISHING INC., (U.S. CLS. 100, 101 AND 102). SN 76-678,098. PUB. 1-1-2008. FILED 6-11-2007.
- 3,396,930. **EW (STYLIZED)**. ANTON PUBLISHING INC., (U.S. CLS. 100, 101 AND 102). SN 76-678,099. PUB. 1-1-2008. FILED 6-11-2007.
- 3,396,935. **ONEPIN (BLOCK FORM)**. ONEPIN, INC., (U.S. CLS. 100, 101 AND 102). SN 76-678,938. PUB. 1-1-2008. FILED 6-28-2007.
- 3,396,940. **I'M CHOICE (BLOCK FORM)**. INDEPENDENCE-MUSIC.NET, INC., (U.S. CLS. 100, 101 AND 102). SN 76-679,512. PUB. 1-1-2008. FILED 7-13-2007.
- 3,396,948. **TO FIX IT! HOME . OFFICE . LIFE AND DESIGN**. TOFIXIT!, INC., (U.S. CLS. 100, 101 AND 102). SN 76-679,677. PUB. 1-1-2008. FILED 7-19-2007.
- 3,396,949. **SOLSTICE SUNGLASS BOUTIQUE (BLOCK FORM)**. SOLSTICE MARKETING CORPORATION, (U.S. CLS. 100, 101 AND 102). SN 76-679,740. PUB. 1-1-2008. FILED 7-20-2007.
- 3,396,950. **WE RECOMMEND THE BEST ..., AND TOSS THE REST! (BLOCK FORM)**. TOFIXIT!, INC., (U.S. CLS. 100, 101 AND 102). SN 76-679,745. PUB. 1-1-2008. FILED 7-20-2007.
- 3,396,960. **WANDRIAN (BLOCK FORM)**. WANDRIAN, INC., MULTIPLE CLASS, (INT. CLS. 35, 39 AND 42), (U.S. CLS. 100, 101, 102 AND 105). SN 77-002,035. PUB. 1-1-2008. FILED 9-19-2006.
- 3,396,965. **CAPTIVE CHANNEL (BLOCK FORM)**. CAPTIVE CHANNEL CORPORATION, MULTIPLE CLASS, (INT. CLS. 35 AND 37), (U.S. CLS. 100, 101, 102, 103 AND 106). SN 77-005,581. PUB. 1-1-2008. FILED 9-22-2006.
- 3,396,966 (*See Class 9 for this trademark*).
- 3,396,969. **THE SCIENCE OF DIGITAL MARKETING (BLOCK FORM)**. 24/7 REAL MEDIA, INC., MULTIPLE CLASS, (INT. CLS. 35 AND 42), (U.S. CLS. 100, 101 AND 102). SN 77-006,687. PUB. 1-1-2008. FILED 9-25-2006.
- 3,396,975 (*See Class 9 for this trademark*).
- 3,396,985. **CONSUMERS UNION ACTION FUND, INC. AND DESIGN**. CONSUMERS UNION OF UNITED STATES, INC., (U.S. CLS. 100, 101 AND 102). SN 77-015,557. PUB. 1-1-2008. FILED 10-6-2006.
- 3,396,990. **BLUE LINE MARKETING AND DESIGN**. BLUE LINE MEDIA, INC., (U.S. CLS. 100, 101 AND 102). SN 77-017,813. PUB. 1-1-2008. FILED 10-10-2006.
- 3,396,994. **MULTIPARTNER AND DESIGN**. MULTIPARTNER S.P.A., (U.S. CLS. 100, 101 AND 102). SN 77-020,054. PUB. 10-30-2007. FILED 10-12-2006.
- 3,396,995. **ONECART (BLOCK FORM)**. SHOP.COM, (U.S. CLS. 100, 101 AND 102). SN 77-020,811. PUB. 1-1-2008. FILED 10-13-2006.
- 3,396,998. **MASCO (BLOCK FORM)**. MEDICAL ACADEMIC AND SCIENTIFIC COMMUNITY ORGANIZATION, INC., MULTIPLE CLASS, (INT. CLS. 35 AND 45), (U.S. CLS. 100, 101 AND 102). SN 77-022,432. PUB. 1-1-2008. FILED 10-17-2006.
- 3,397,005. **GIMMEGRUB (BLOCK FORM)**. GIMMEGRUB, (U.S. CLS. 100, 101 AND 102). SN 77-024,506. PUB. 1-1-2008. FILED 10-19-2006.
- 3,397,036. **STRICTLY ACCOUNTING (BLOCK FORM)**. DAVID DEVIN, (U.S. CLS. 100, 101 AND 102). SN 77-033,698. PUB. 1-1-2008. FILED 10-31-2006.
- 3,397,039. **BABYSTYLE (BLOCK FORM)**. ESTYLE, INC., (U.S. CLS. 100, 101 AND 102). SN 77-034,899. PUB. 1-1-2008. FILED 11-2-2006.
- 3,397,045 (*See Class 9 for this trademark*).
- 3,397,071. **FRANCHISE SERVICES AND DESIGN**. FRANCHISE SERVICES, INC., (U.S. CLS. 100, 101 AND 102). SN 77-046,118. PUB. 1-1-2008. FILED 11-16-2006.
- 3,397,080. **GETQUIK (BLOCK FORM)**. GETQUIK, INC., (U.S. CLS. 100, 101 AND 102). SN 77-048,127. PUB. 1-1-2008. FILED 11-20-2006.
- 3,397,092. **FNA AND DESIGN**. FARMS AND FAMILIES OF NORTH AMERICA INCORPORATED, (U.S. CLS. 100, 101 AND 102). SN 77-051,114. PUB. 1-1-2008. FILED 11-27-2006.
- 3,397,096. **VALHALLA PARTNERS (BLOCK FORM)**. WEDNESDAY MANAGEMENT LLC, MULTIPLE CLASS, (INT. CLS. 35 AND 36), (U.S. CLS. 100, 101 AND 102). SN 77-052,216. PUB. 1-1-2008. FILED 11-28-2006.
- 3,397,099. **GHSMA A MODEL FOR HIRING (BLOCK FORM)**. G.H. SMART & COMPANY INC., (U.S. CLS. 100, 101 AND 102). SN 77-052,740. PUB. 1-1-2008. FILED 11-29-2006.
- 3,397,106. **CAMPAIGN TO ELIMINATE DRUNK DRIVING (BLOCK FORM)**. MOTHERS AGAINST DRUNK DRIVING, (U.S. CLS. 100, 101 AND 102). SN 77-055,021. PUB. 1-1-2008. FILED 12-1-2006.
- 3,397,113. **"A NEW BREED OF CPA" AND DESIGN**. CHARLES TUNE, (U.S. CLS. 100, 101 AND 102). SN 77-057,149. PUB. 1-1-2008. FILED 12-5-2006.
- 3,397,114. **SUNSTREET MORTGAGE AND DESIGN**. SUNSTREET MORTGAGE, LLC, MULTIPLE CLASS, (INT. CLS. 35 AND 36), (U.S. CLS. 100, 101 AND 102). SN 77-057,176. PUB. 1-1-2008. FILED 12-5-2006.
- 3,397,125. **JJ AND DESIGN**. JACK AND JILL OF AMERICA

- INCORPORATED, MULTIPLE CLASS, (INT. CLS. 35 AND 41), (U.S. CLS. 100, 101, 102 AND 107). SN 77-058,518. PUB. 1-1-2008. FILED 12-6-2006.
- 3,397,126. **STAKEHOLDER 100 (BLOCK FORM)**, STAKEHOLDER, INC. (U.S. CLS. 100, 101 AND 102). SN 77-058,560. PUB. 1-1-2008. FILED 12-6-2006.
- 3,397,127. **T P D TOTAL PLANT DEACTIVATION AND DESIGN**, WATSON ROAD HOLDING CORPORATION, DBA STUART B. MILLNER & ASSOCIATES, (U.S. CLS. 100, 101 AND 102). SN 77-059,204. PUB. 1-1-2008. FILED 12-7-2006.
- 3,397,129. **TOTAL PLANT DEACTIVATION (BLOCK FORM)**, WATSON ROAD HOLDING CORPORATION, DBA STUART B. MILLNER & ASSOCIATES, (U.S. CLS. 100, 101 AND 102). SN 77-059,736. PUB. 1-1-2008. FILED 12-8-2006.
- 3,397,130. **COMPANY C - CREATE CONNECT COMPEL AND DESIGN**, CHINNICI DIRECT, INC., (U.S. CLS. 100, 101 AND 102). SN 77-060,042. PUB. 1-1-2008. FILED 12-8-2006.
- 3,397,137. **UNITED STATES MASTERS SWIMMING (BLOCK FORM)**, UNITED STATES MASTERS SWIMMING, INC., (U.S. CLS. 100, 101 AND 102). SN 77-061,828. PUB. 1-1-2008. FILED 12-11-2006.
- 3,397,154. **POWRE (BLOCK FORM)**, ESCH, ARTHUR G., (U.S. CLS. 100, 101 AND 102). SN 77-064,168. PUB. 1-1-2008. FILED 12-14-2006.
- 3,397,167. **NEXTCAT (BLOCK FORM)**, NEXTCAT, INC., MULTIPLE CLASS, (INT. CLS. 35, 38 AND 42), (U.S. CLS. 100, 101, 102 AND 104). SN 77-065,762. PUB. 1-1-2008. FILED 12-15-2006.
- 3,397,168. **POPNOGGINS (BLOCK FORM)**, POPNOGGINS, LLC, MULTIPLE CLASS, (INT. CLS. 35, 42 AND 45), (U.S. CLS. 100, 101 AND 102). SN 77-066,364. PUB. 1-1-2008. FILED 12-18-2006.
- 3,397,169. **MISCELLANEOUS DESIGN**, THE BLOOD AND TISSUE CENTER OF CENTRAL TEXAS., MULTIPLE CLASS, (INT. CLS. 35 AND 44), (U.S. CLS. 100, 101 AND 102). SN 77-066,721. PUB. 1-1-2008. FILED 12-18-2006.
- 3,397,185. **PROJECTQA (BLOCK FORM)**, PROJECT QUALITY ASSURANCE, LLC, MULTIPLE CLASS, (INT. CLS. 35, 36 AND 37), (U.S. CLS. 100, 101, 102, 103 AND 106). SN 77-068,787. PUB. 1-1-2008. FILED 12-20-2006.
- 3,397,187. **COMMITTED TO PROJECT SUCCESS (BLOCK FORM)**, PROJECT QUALITY ASSURANCE, LLC, MULTIPLE CLASS, (INT. CLS. 35, 36 AND 37), (U.S. CLS. 100, 101, 102, 103 AND 106). SN 77-068,798. PUB. 1-1-2008. FILED 12-20-2006.
- 3,397,204. **MISCELLANEOUS DESIGN**, THE SAMUEL WAXMAN CANCER RESEARCH FOUNDATION, MULTIPLE CLASS, (INT. CLS. 35, 36 AND 42), (U.S. CLS. 100, 101 AND 102). SN 77-070,498. PUB. 1-1-2008. FILED 12-22-2006.
- 3,397,205. **COLLABORATING FOR A CURE (BLOCK FORM)**, THE SAMUEL WAXMAN CANCER RESEARCH FOUNDATION, MULTIPLE CLASS, (INT. CLS. 35, 36 AND 42), (U.S. CLS. 100, 101 AND 102). SN 77-070,527. PUB. 1-1-2008. FILED 12-22-2006.
- 3,397,206. **AN INSTITUTE WITHOUT WALLS (BLOCK FORM)**, THE SAMUEL WAXMAN CANCER RESEARCH FOUNDATION, MULTIPLE CLASS, (INT. CLS. 35, 36 AND 42), (U.S. CLS. 100, 101 AND 102). SN 77-070,539. PUB. 1-1-2008. FILED 12-22-2006.
- 3,397,207. **SAMUEL WAXMAN CANCER RESEARCH FOUNDATION (BLOCK FORM)**, THE SAMUEL WAXMAN CANCER RESEARCH FOUNDATION, MULTIPLE CLASS, (INT. CLS. 35, 36 AND 42), (U.S. CLS. 100, 101 AND 102). SN 77-070,565. PUB. 1-1-2008. FILED 12-22-2006.
- 3,397,210. **ESSENTIAL (BLOCK FORM)**, QUADRATEC, INC., (U.S. CLS. 100, 101 AND 102). SN 77-071,983. PUB. 1-1-2008. FILED 12-27-2006.
- 3,397,216. **JAVAPLUM.COM AND DESIGN**, SCRIPPS TREASURE COAST PUBLISHING COMPANY, (U.S. CLS. 100, 101 AND 102). SN 77-072,577. PUB. 1-1-2008. FILED 12-28-2006.
- 3,397,227 (*See Class 16 for this trademark*).
- 3,397,228 (*See Class 16 for this trademark*).
- 3,397,241. **LAKE NORMAN CONVENTION & VISITORS BUREAU AND DESIGN**, LAKE NORMAN CONVENTION & VISITORS BUREAU, MULTIPLE CLASS, (INT. CLS. 35, 39 AND 43), (U.S. CLS. 100, 101, 102 AND 105). SN 77-078,118. PUB. 1-1-2008. FILED 1-8-2007.
- 3,397,252. **TOOLCRITIC.COM (BLOCK FORM)**, CRITICAL PURSUITS, (U.S. CLS. 100, 101 AND 102). SN 77-080,854. PUB. 1-1-2008. FILED 1-11-2007.
- 3,397,259. **COGWHEEL MARKETING (BLOCK FORM)**, CAMPBELL MITHUN LLC, (U.S. CLS. 100, 101 AND 102). SN 77-082,683. PUB. 1-1-2008. FILED 1-14-2007.
- 3,397,261. **MODAGO (STYLIZED)**, MODAGO SHOWROOMS, (U.S. CLS. 100, 101 AND 102). SN 77-084,206. PUB. 1-1-2008. FILED 1-16-2007.
- 3,397,262. **CLEARSTATE AND DESIGN**, CLEARSTATE (PTE.) LTD., (U.S. CLS. 100, 101 AND 102). SN 77-084,269. PUB. 1-1-2008. FILED 1-17-2007.
- 3,397,266. **BIZ BUILDERS AND DESIGN**, RESTAR ASSOCIATES, LLC, (U.S. CLS. 100, 101 AND 102). SN 77-085,755. PUB. 1-1-2008. FILED 1-18-2007.
- 3,397,271. **FIRE DAWG 343 AND DESIGN**, JULIE QUIGLEY, (U.S. CLS. 100, 101 AND 102). SN 77-087,187. PUB. 9-25-2007. FILED 1-19-2007.
- 3,397,275. **POWER MATRIX (BLOCK FORM)**, ITV MARKETING GROUP, INC., (U.S. CLS. 100, 101 AND 102). SN 77-087,454. PUB. 1-1-2008. FILED 1-21-2007.
- 3,397,278 (*See Class 25 for this trademark*).
- 3,397,279 (*See Class 25 for this trademark*).
- 3,397,280. **TAKE A HIT. PASS IT ON. (BLOCK FORM)**, INDIE911, LLC, MULTIPLE CLASS, (INT. CLS. 35, 41 AND 42), (U.S. CLS. 100, 101, 102 AND 107). SN 77-088,476. PUB. 1-1-2008. FILED 1-22-2007.
- 3,397,288. **TURNER EVENTS MARKETING AND DESIGN**, TURNER EVENTS AND MARKETING, LLC, (U.S. CLS. 100, 101 AND 102). SN 77-091,208. PUB. 1-1-2008. FILED 1-25-2007.
- 3,397,312. **2CAST (BLOCK FORM)**, 2CAST, INC., MULTIPLE CLASS, (INT. CLS. 35 AND 42), (U.S. CLS. 100, 101 AND 102). SN 77-097,421. PUB. 1-1-2008. FILED 2-1-2007.
- 3,397,342. **GROUNDWORK EQUITY (BLOCK FORM)**, GROUNDWORK EQUITY, LLC, MULTIPLE CLASS, (INT. CLS. 35 AND 36), (U.S. CLS. 100, 101 AND 102). SN 77-104,150. PUB. 1-1-2008. FILED 2-9-2007.
- 3,397,344. **AMERICA'S YARN STORE (BLOCK FORM)**, VALLEY FIBERS CORPORATION, DBA WEBS, (U.S. CLS. 100, 101 AND 102). SN 77-105,922. PUB. 1-1-2008. FILED 2-13-2007.
- 3,397,346. **PARTS.COM FOR EVERY PART OF YOUR LIFE (STYLIZED)**, INTELLIGENTZ CORPORATION, MULTIPLE CLASS, (INT. CLS. 35 AND 42), (U.S. CLS. 100, 101 AND 102). SN 77-106,484. PUB. 9-25-2007. FILED 2-13-2007.
- 3,397,349. **GLOBECHARGE (BLOCK FORM)**, GLOBECHARGE PTY LTD, MULTIPLE CLASS, (INT. CLS. 35 AND 36), (U.S. CLS. 100, 101 AND 102). SN 77-107,480. PUB. 1-1-2008. FILED 2-14-2007.
- 3,397,356. **I360 TECHNOLOGIES AND DESIGN**, I360TECHNOLOGIES, INC., MULTIPLE CLASS, (INT. CLS. 35 AND 42), (U.S. CLS. 100, 101 AND 102). SN 77-109,125. PUB. 1-1-2008. FILED 2-16-2007.
- 3,397,357. **FIG AND DESIGN**, FINANCIAL INDEPENDENCE GROUP, INC., (U.S. CLS. 100, 101 AND 102). SN 77-109,451. PUB. 1-1-2008. FILED 2-16-2007.
- 3,397,361. **THE GRASSROOTS OUTDOOR ALLIANCE (BLOCK FORM)**, GRASSROOTS OUTDOOR ALLIANCE, INC., (U.S. CLS. 100, 101 AND 102). SN 77-110,486. PUB. 1-1-2008. FILED 2-19-2007.
- 3,397,372. **CORVIDEA (BLOCK FORM)**, CORVIDEA, LLC, MULTIPLE CLASS, (INT. CLS. 35 AND 42), (U.S. CLS. 100, 101 AND 102). SN 77-113,946. PUB. 1-1-2008. FILED 2-22-2007.
- 3,397,383. **ALISO VIEJO FAMILY RESOURCE CENTER AND DESIGN**, CITY OF ALISO VIEJO, MULTIPLE CLASS, (INT. CLS. 35, 41 AND 44), (U.S. CLS. 100, 101, 102 AND 107). SN 77-118,756. PUB. 1-1-2008. FILED 2-28-2007.
- 3,397,392. **OSI RESTAURANT PARTNERS INC (STYLIZED)**, OSI RESTAURANT PARTNERS, LLC, MULTIPLE CLASS, (INT. CLS. 35 AND 43), (U.S. CLS. 100, 101 AND 102). SN 77-122,344. PUB. 1-1-2008. FILED 3-6-2007.
- 3,397,393. **EXTRA INNINGS (BLOCK FORM)**, EXTRA INNINGS, INC., MULTIPLE CLASS, (INT. CLS. 35 AND 41), (U.S. CLS. 100, 101, 102 AND 107). SN 77-122,609. PUB. 1-1-2008. FILED 3-5-2007.

- 3,397,395. **LITTLE CITY KIDS AND DESIGN**. LITTLE CITY KIDS FRANCHISE SERVICES, LLC, MULTIPLE CLASS, (INT. CLS. 35 AND 43), (U.S. CLS. 100, 101 AND 102). SN 77-123,656. PUB. 1-1-2008. FILED 3-6-2007.
- 3,397,398. **CGFNS QUALIFYING EXAM (BLOCK FORM)**. COMMISSION ON GRADUATES OF FOREIGN NURSING SCHOOLS, MULTIPLE CLASS, (INT. CLS. 35 AND 41), (U.S. CLS. 100, 101, 102 AND 107). SN 77-125,238. PUB. 1-1-2008. FILED 3-8-2007.
- 3,397,401. **M MRBUYBACK AND DESIGN**. NATIONAL FRANCHISE CENTER, INC., (U.S. CLS. 100, 101 AND 102). SN 77-126,213. PUB. 1-1-2008. FILED 3-8-2007.
- 3,397,403. **DIGITAL SIGNAGE EXPO RETAIL HOSPITALITY FINANCIAL PUBLIC SPACES AND DESIGN**. EXPONATION, L.L.C., (U.S. CLS. 100, 101 AND 102). SN 77-127,109. PUB. 9-25-2007. FILED 3-9-2007.
- 3,397,408. **BILLTRUST (BLOCK FORM)**. FACTOR SYSTEMS, INC., MULTIPLE CLASS, (INT. CLS. 35 AND 36), (U.S. CLS. 100, 101 AND 102). SN 77-129,786. PUB. 1-1-2008. FILED 3-13-2007.
- 3,397,417. **VSA PARTNERS, INC. (BLOCK FORM)**. VSA PARTNERS, INC., MULTIPLE CLASS, (INT. CLS. 35 AND 42), (U.S. CLS. 100, 101 AND 102). SN 77-135,820. PUB. 1-1-2008. FILED 3-20-2007.
- 3,397,418. **VSA (STYLIZED)**. VSA PARTNERS, INC., MULTIPLE CLASS, (INT. CLS. 35 AND 42), (U.S. CLS. 100, 101 AND 102). SN 77-135,934. PUB. 1-1-2008. FILED 3-20-2007.
- 3,397,433. **EQUIPPING LEADERS FOR GREATER SERVICE (BLOCK FORM)**. CLD CONSULTANTS, INC., (U.S. CLS. 100, 101 AND 102). SN 77-139,758. PUB. 1-1-2008. FILED 3-25-2007.
- 3,397,443. **WILLIAM-NEIL ASSOCIATES (BLOCK FORM)**. CABELA'S INC., (U.S. CLS. 100, 101 AND 102). SN 77-143,314. PUB. 1-1-2008. FILED 3-29-2007.
- 3,397,444. **GINN AND DESIGN**. GINN REAL ESTATE COMPANY, LLC, MULTIPLE CLASS, (INT. CLS. 35, 36 AND 37), (U.S. CLS. 100, 101, 102, 103 AND 106). SN 77-144,005. PUB. 1-1-2008. FILED 3-29-2007.
- 3,397,458. **GINN RESORTS AND DESIGN**. GINN REAL ESTATE COMPANY, LLC, MULTIPLE CLASS, (INT. CLS. 35 AND 37), (U.S. CLS. 100, 101, 102, 103 AND 106). SN 77-151,766. PUB. 1-1-2008. FILED 4-9-2007.
- 3,397,465. **WRANGLER WRAPID WRESPONSE (BLOCK FORM)**. WRANGLER APPAREL CORP., (U.S. CLS. 100, 101 AND 102). SN 77-153,862. PUB. 1-1-2008. FILED 4-11-2007.
- 3,397,467. **MASTERCARE (BLOCK FORM)**. KAZI, ANWAR, (U.S. CLS. 100, 101 AND 102). SN 77-154,593. PUB. 1-1-2008. FILED 4-11-2007.
- 3,397,470. **VIRTUAL HOMES EXPERIENCE THE FUTURE OF REAL ESTATE TODAY AND DESIGN**. VIRTUAL HOMES INCORPORATED, MULTIPLE CLASS, (INT. CLS. 35 AND 42), (U.S. CLS. 100, 101 AND 102). SN 77-155,279. PUB. 1-1-2008. FILED 4-12-2007.
- 3,397,478. **ESP (BLOCK FORM)**. E-VENTUS CORPORATION, (U.S. CLS. 100, 101 AND 102). SN 77-159,715. PUB. 1-1-2008. FILED 4-18-2007.
- 3,397,484. **URBAN SOLE (BLOCK FORM)**. URBAN SOLE, (U.S. CLS. 100, 101 AND 102). SN 77-161,551. PUB. 1-1-2008. FILED 4-20-2007.
- 3,397,496. **PEETNIKS (BLOCK FORM)**. PEET'S TRADE-MARK COMPANY, (U.S. CLS. 100, 101 AND 102). SN 77-165,751. PUB. 1-1-2008. FILED 4-25-2007.
- 3,397,500 (See Class 29 for this trademark).
- 3,397,509. **MSPA (BLOCK FORM)**. MYSTERY SHOPPING PROVIDERS ASSOCIATION, (U.S. CLS. 100, 101 AND 102). SN 77-169,646. PUB. 1-1-2008. FILED 5-1-2007.
- 3,397,518 (See Class 16 for this trademark).
- 3,397,519. **AMERICAN PERFORMANCE PARTS WAREHOUSE, INC. (BLOCK FORM)**. AMERICAN PERFORMANCE PARTS WAREHOUSE, INC., (U.S. CLS. 100, 101 AND 102). SN 77-174,470. PUB. 1-1-2008. FILED 5-7-2007.
- 3,397,520. **BEPĚŠKA AND DESIGN**. BERIOZKASHOP.COM, INC., (U.S. CLS. 100, 101 AND 102). SN 77-174,599. PUB. 1-1-2008. FILED 5-7-2007.
- 3,397,523. **FIRST TEAM (BLOCK FORM)**. AUTOMOTIVE RESOURCES DEVELOPMENT GROUP, LLC, MULTIPLE CLASS, (INT. CLS. 35, 36, 37 AND 39), (U.S. CLS. 100, 101, 102, 103, 105 AND 106). SN 77-175,626. PUB. 10-9-2007. FILED 5-8-2007.
- 3,397,526. **...AND WE DELIVER (BLOCK FORM)**. BAY RIDGE AUTOMOTIVE MANAGEMENT CORP., (U.S. CLS. 100, 101 AND 102). SN 77-176,488. PUB. 1-1-2008. FILED 5-9-2007.
- 3,397,533. **ALTRAC II ALBORS . ALNET LANGUAGE & TRANSPORTATION SERVICES AND DESIGN**. ALNET TRANSPORTATION, INC., MULTIPLE CLASS, (INT. CLS. 35 AND 41), (U.S. CLS. 100, 101, 102 AND 107). SN 77-180,948. PUB. 1-1-2008. FILED 5-15-2007.
- 3,397,536. **ETHNIC COMMUNICATIONS (BLOCK FORM)**. ETHNIC COMMUNICATIONS, INC., (U.S. CLS. 100, 101 AND 102). SN 77-181,080. PUB. 1-1-2008. FILED 5-15-2007.
- 3,397,549. **DATAKOMTOOLS.COM THE WEB'S BEST SOURCE FOR TELECOM TOOLS AND TESTERS AND DESIGN**. WISE COMPONENTS, INC., (U.S. CLS. 100, 101 AND 102). SN 77-186,803. PUB. 1-1-2008. FILED 5-22-2007.
- 3,397,550. **LIBERATE YOUR BRAND (BLOCK FORM)**. THE SPARK AGENCY, INC., (U.S. CLS. 100, 101 AND 102). SN 77-186,819. PUB. 1-1-2008. FILED 5-22-2007.
- 3,397,551. **PRIVATE DENTAL NETWORK AND DESIGN**. CAFOLLA, MARK, MULTIPLE CLASS, (INT. CLS. 35 AND 41), (U.S. CLS. 100, 101, 102 AND 107). SN 77-188,911. PUB. 1-1-2008. FILED 5-23-2007.
- 3,397,564. **VIVIT AND DESIGN**. OPENVIEW FORUM, MULTIPLE CLASS, (INT. CLS. 35, 38 AND 42), (U.S. CLS. 100, 101, 102 AND 104). SN 77-193,229. PUB. 1-1-2008. FILED 5-30-2007.
- 3,397,573. **ACTION TRAILER DEPOT AND DESIGN**. ACTION TRAILER DEPOT, (U.S. CLS. 100, 101 AND 102). SN 77-194,247. PUB. 1-1-2008. FILED 5-31-2007.
- 3,397,587 (See Class 28 for this trademark).
- 3,397,590. **HOUSE OF SILK FLOWERS (BLOCK FORM)**. HOUSE OF SILK FLOWERS, INC., (U.S. CLS. 100, 101 AND 102). SN 77-197,744. PUB. 1-1-2008. FILED 6-5-2007.
- 3,397,592. **NATIONAL FEDERATION OF PARALEGAL ASSOCIATIONS INC. AND DESIGN**. NATIONAL FEDERATION OF PARALEGAL ASSOCIATIONS, INC., (U.S. CLS. 100, 101 AND 102). SN 77-198,215. PUB. 1-1-2008. FILED 6-5-2007.
- 3,397,594. **ONE DAY, ONE DEAL (BLOCK FORM)**. WOOT, INC., (U.S. CLS. 100, 101 AND 102). SN 77-198,751. PUB. 1-1-2008. FILED 6-6-2007.
- 3,397,595. **BERIOZKA (BLOCK FORM)**. BERIOZKASHOP.COM, INC., (U.S. CLS. 100, 101 AND 102). SN 77-198,765. PUB. 1-1-2008. FILED 6-6-2007.
- 3,397,601. **BIRTHDAY CONNECTIONS (BLOCK FORM)**. CORSICA ENTERPRISES, LTD., (U.S. CLS. 100, 101 AND 102). SN 77-200,389. PUB. 1-1-2008. FILED 6-7-2007.
- 3,397,602. **BIRTHDAY CONNECTIONS AND DESIGN**. CORSICA ENTERPRISES, LTD., (U.S. CLS. 100, 101 AND 102). SN 77-200,410. PUB. 1-1-2008. FILED 6-7-2007.
- 3,397,616. **UNIBOX (BLOCK FORM)**. UNIBOX EXPRESS SYSTEMS CORP., (U.S. CLS. 100, 101 AND 102). SN 77-202,337. PUB. 1-1-2008. FILED 6-10-2007.
- 3,397,618. **VITAL PAINTBALL AND DESIGN**. VITALPAINTBALL, LLC., MULTIPLE CLASS, (INT. CLS. 35 AND 41), (U.S. CLS. 100, 101, 102 AND 107). SN 77-202,481. PUB. 1-1-2008. FILED 6-11-2007.
- 3,397,633. **CREATION TECHNOLOGIES (BLOCK FORM)**. CREATION TECHNOLOGIES, (U.S. CLS. 100, 101 AND 102). SN 77-206,691. PUB. 1-1-2008. FILED 6-14-2007.
- 3,397,641 (See Class 4 for this trademark).
- 3,397,644. **YALLA (BLOCK FORM)**. VELEZ, BEN, (U.S. CLS. 100, 101 AND 102). SN 77-207,884. PUB. 1-1-2008. FILED 6-16-2007.
- 3,397,646. **LONGHORN CABINETS AND DESIGN**. LONGHORN CABINETS, (U.S. CLS. 100, 101 AND 102). SN 77-208,448. PUB. 1-1-2008. FILED 6-18-2007.
- 3,397,676. **ATLANTA KITCHEN & BATH (STYLIZED)**. ATLANTA KITCHEN & BATH CABINET OUTLET, INC., MULTIPLE CLASS, (INT. CLS. 35, 37 AND 42), (U.S. CLS. 100, 101, 102, 103 AND 106). SN 77-214,396. PUB. 1-1-2008. FILED 6-25-2007.
- 3,397,690. **SAFE SECURITY ASSESSMENT FOR EMPLOYEES (BLOCK FORM)**. PREVENT LOSS, LTD., (U.S. CLS. 100, 101 AND 102). SN 77-215,864. PUB. 1-1-2008. FILED 6-26-2007.

- 3,397,693. **A ALLSTAR SUPPLY, INC. PACKAGING AND INDUSTRIAL SUPPLIES AND DESIGN.** ALLSTAR SUPPLY, INC., (U.S. CLS. 100, 101 AND 102). SN 77-216,088. PUB. 1-1-2008. FILED 6-26-2007.
- 3,397,696. **DELICIOUS & TRADITIONAL BUBBLE TEA CAFE AND DESIGN.** MAX AND SEATTLE CO INC. DBA BUBBLE ISLAND, MULTIPLE CLASS, (INT. CLS. 35 AND 43), (U.S. CLS. 100, 101 AND 102). SN 77-216,603. PUB. 1-1-2008. FILED 6-27-2007.
- 3,397,698. **SPOTVIEWER (BLOCK FORM).** DAKOTA VIDEO & POST PRODUCTIONS, L.L.C., (U.S. CLS. 100, 101 AND 102). SN 77-216,691. PUB. 1-1-2008. FILED 6-27-2007.
- 3,397,704. **RESPECT 21 PREVENTING UNDERAGE ACCESS AND DESIGN.** MILLER PRODUCTS COMPANY, (U.S. CLS. 100, 101 AND 102). SN 77-216,993. PUB. 1-1-2008. FILED 6-27-2007.
- 3,397,705. **PRO-FRUIT (BLOCK FORM).** PRO-FRUIT MARKETING, INC., (U.S. CLS. 100, 101 AND 102). SN 77-216,994. PUB. 1-1-2008. FILED 6-27-2007.
- 3,397,709. **LI LEVEL ONE PERSONNEL SUCCESSFUL STAFFING SOLUTIONS . . . BEGIN AT LEVEL ONE AND DESIGN.** LEVEL ONE PERSONNEL, INC., (U.S. CLS. 100, 101 AND 102). SN 77-217,853. PUB. 1-1-2008. FILED 6-28-2007.
- 3,397,711. **BIPS (BLOCK FORM).** WIEDEMANN & LOMASNEY, LLC, (U.S. CLS. 100, 101 AND 102). SN 77-218,410. PUB. 1-1-2008. FILED 6-28-2007.
- 3,397,713. **VIRTUTRIX AND DESIGN.** VIRTUTRIX, INC., MULTIPLE CLASS, (INT. CLS. 35 AND 42), (U.S. CLS. 100, 101 AND 102). SN 77-218,845. PUB. 1-1-2008. FILED 6-29-2007.
- 3,397,715 (*See Class 9 for this trademark*).
- 3,397,725. **HEAVENLY COUTURE AND DESIGN.** HEAVENLY COUTURE, (U.S. CLS. 100, 101 AND 102). SN 77-219,704. PUB. 1-1-2008. FILED 6-29-2007.
- 3,397,727. **RACING AGAINST DIABETES (BLOCK FORM).** RACING AGAINST DIABETES FOUNDATION, INC., (U.S. CLS. 100, 101 AND 102). SN 77-219,832. PUB. 1-1-2008. FILED 6-30-2007.
- 3,397,739. **TREK BICYCLE STORE (BLOCK FORM).** TREK BICYCLE CORPORATION, (U.S. CLS. 100, 101 AND 102). SN 77-221,529. PUB. 1-1-2008. FILED 7-3-2007.
- 3,397,752. **RIA INCUBATOR (BLOCK FORM).** MARKET-COUNSEL, LLC, (U.S. CLS. 100, 101 AND 102). SN 77-223,020. PUB. 1-1-2008. FILED 7-5-2007.
- 3,397,770. **NURSINGHOMERANK.COM AND DESIGN.** REMWES MEDICAL, LLC, (U.S. CLS. 100, 101 AND 102). SN 77-224,539. PUB. 1-1-2008. FILED 7-9-2007.
- 3,397,775. **URBAN WATER MANAGEMENT AND DESIGN.** PENNWELL CORPORATION, (U.S. CLS. 100, 101 AND 102). SN 77-224,828. PUB. 1-1-2008. FILED 7-9-2007.
- 3,397,779. **9 N NINE NORTH RECORDS AND DESIGN.** TRUE NORTH, LLC, (U.S. CLS. 100, 101 AND 102). SN 77-225,080. PUB. 1-1-2008. FILED 7-9-2007.
- 3,397,784. **ZELKY (BLOCK FORM).** ZELKY, INC., MULTIPLE CLASS, (INT. CLS. 35, 42 AND 45), (U.S. CLS. 100, 101 AND 102). SN 77-225,399. PUB. 1-1-2008. FILED 7-10-2007.
- 3,397,799. **KIPLING AND DESIGN.** KIPLING APPAREL CORP., (U.S. CLS. 100, 101 AND 102). SN 77-226,170. PUB. 1-1-2008. FILED 7-10-2007.
- 3,397,802. **ABDO EICK & MEYERS LLP CERTIFIED PUBLIC ACCOUNTANTS & CONSULTANTS 15273486 AND DESIGN.** ABDO, EICK & MEYERS LLP, (U.S. CLS. 100, 101 AND 102). SN 77-226,238. PUB. 1-1-2008. FILED 7-10-2007.
- 3,397,806. **CHERRYSTONEIT (BLOCK FORM).** CHERRYSTONEIT, INC., MULTIPLE CLASS, (INT. CLS. 35 AND 42), (U.S. CLS. 100, 101 AND 102). SN 77-226,273. PUB. 1-1-2008. FILED 7-10-2007.
- 3,397,808. **@DDRESS.COM AND DESIGN.** WHITEPAGES.COM, INC., (U.S. CLS. 100, 101 AND 102). SN 77-226,331. PUB. 1-1-2008. FILED 7-10-2007.
- 3,397,814. **NAVMAP (BLOCK FORM).** APEX, LLC, (U.S. CLS. 100, 101 AND 102). SN 77-226,619. PUB. 1-1-2008. FILED 7-11-2007.
- 3,397,822. **MAPNAV (BLOCK FORM).** APEX, LLC, (U.S. CLS. 100, 101 AND 102). SN 77-226,828. PUB. 1-1-2008. FILED 7-11-2007.
- 3,397,829. **SMART ASSORTMENT A TREE OF LIFE PROGRAM AND DESIGN.** TREE OF LIFE, INC., (U.S. CLS. 100, 101 AND 102). SN 77-227,144. PUB. 1-1-2008. FILED 7-11-2007.
- 3,397,847. **VISION & VIBE (BLOCK FORM).** MODY, MIHIR, (U.S. CLS. 100, 101 AND 102). SN 77-227,427. PUB. 1-1-2008. FILED 7-11-2007.
- 3,397,852. **BABYSHOWERDEPOT.COM (BLOCK FORM).** BABYSHOWERDEPOT.COM LLC, (U.S. CLS. 100, 101 AND 102). SN 77-227,542. PUB. 1-1-2008. FILED 7-11-2007.
- 3,397,866 (*See Class 25 for this trademark*).
- 3,397,869. **PAVEMENT DEPOT (BLOCK FORM).** PAVEMENT DEPOT OF MARYLAND, LLC, (U.S. CLS. 100, 101 AND 102). SN 77-227,914. PUB. 1-1-2008. FILED 7-12-2007.
- 3,397,872. **OPPORTUNITY DOESN'T KNOCK... IT CALLS! (BLOCK FORM).** VOICESTAR, INC., (U.S. CLS. 100, 101 AND 102). SN 77-227,927. PUB. 1-1-2008. FILED 7-12-2007.
- 3,397,886 (*See Class 31 for this trademark*).
- 3,397,890. **PRODISO AND DESIGN.** PRODISO, LLC, (U.S. CLS. 100, 101 AND 102). SN 77-228,333. PUB. 1-1-2008. FILED 7-12-2007.
- 3,397,893. **ANTARRA (BLOCK FORM).** LOGICAL PERCEPTIONS, INC., (U.S. CLS. 100, 101 AND 102). SN 77-228,495. PUB. 1-1-2008. FILED 7-12-2007.
- 3,397,899. **PROJECTGROUND (BLOCK FORM).** PROJECTGROUND, INC., (U.S. CLS. 100, 101 AND 102). SN 77-228,735. PUB. 1-1-2008. FILED 7-12-2007.
- 3,397,912. **THREESIXTY SOURCING AND DESIGN.** THREESIXTY SOURCING LTD., (U.S. CLS. 100, 101 AND 102). SN 77-228,887. PUB. 1-1-2008. FILED 7-13-2007.
- 3,397,919. **RITZCAMERA.COM & ELECTRONICS (BLOCK FORM).** RITZ CAMERA CENTERS, INC., (U.S. CLS. 100, 101 AND 102). SN 77-228,960. PUB. 1-1-2008. FILED 7-13-2007.
- 3,397,930. **3 DEUCE BRANDING (BLOCK FORM).** THREE DEUCE BRANDING, LLC, (U.S. CLS. 100, 101 AND 102). SN 77-229,084. PUB. 1-1-2008. FILED 7-13-2007.
- 3,397,935. **CLEAR BRAND VISION - BOLD BRAND IDEAS - A WINNING HAND (BLOCK FORM).** THREE DEUCE BRANDING, LLC, (U.S. CLS. 100, 101 AND 102). SN 77-229,143. PUB. 1-1-2008. FILED 7-13-2007.
- 3,397,944. **PROSOURCE MORTGAGE MARKETING (BLOCK FORM).** PROSOURCE MORTGAGE MARKETING, INC., (U.S. CLS. 100, 101 AND 102). SN 77-229,307. PUB. 1-1-2008. FILED 7-13-2007.
- 3,397,948. **GREEN MONSTER (BLOCK FORM).** BOSTON RED SOX BASEBALL CLUB LIMITED PARTNERSHIP, (U.S. CLS. 100, 101 AND 102). SN 77-229,387. PUB. 1-1-2008. FILED 7-13-2007.
- 3,397,961. **SMRP (BLOCK FORM).** SOCIETY FOR MAINTENANCE AND RELIABILITY PROFESSIONALS, (U.S. CLS. 100, 101 AND 102). SN 77-229,632. PUB. 1-1-2008. FILED 7-13-2007.
- 3,397,964. **STRATSTAFF (BLOCK FORM).** STRATSTAFF, LLC, (U.S. CLS. 100, 101 AND 102). SN 77-229,647. PUB. 1-1-2008. FILED 7-13-2007.
- 3,397,973. **BOX-O-BOX (BLOCK FORM).** BOX-O-BOX, LLC, (U.S. CLS. 100, 101 AND 102). SN 77-229,857. PUB. 1-1-2008. FILED 7-14-2007.
- 3,397,974. **TO SIMPLY GIVE IS THE SWEETEST GIFT (BLOCK FORM).** RICHARD, RACHELLE, (U.S. CLS. 100, 101 AND 102). SN 77-229,859. PUB. 1-1-2008. FILED 7-14-2007.
- 3,397,988. **GLOBAL GIG (BLOCK FORM).** GLOBAL GIG, INC., (U.S. CLS. 100, 101 AND 102). SN 77-230,127. PUB. 1-1-2008. FILED 7-16-2007.
- 3,397,996. **MISCELLANEOUS DESIGN.** SCHALLERT, JON, AND SCHALLERT, MARGARET, (U.S. CLS. 100, 101 AND 102). SN 77-230,312. PUB. 1-1-2008. FILED 7-16-2007.
- 3,398,007. **DESTINATION BUSINESS BOOTCAMP (BLOCK FORM).** THE SCHALLERT GROUP, INC., (U.S. CLS. 100, 101 AND 102). SN 77-230,467. PUB. 1-1-2008. FILED 7-16-2007.
- 3,398,013. **CE CRAFTS ETC! (BLOCK FORM).** CRAFTS, ETC!, LTD., (U.S. CLS. 100, 101 AND 102). SN 77-230,509. PUB. 1-1-2008. FILED 7-16-2007.
- 3,398,032. **BARKWORKS (BLOCK FORM).** CHIEN ET. CHAT, INC., (U.S. CLS. 100, 101 AND 102). SN 77-230,778. PUB. 1-1-2008. FILED 7-16-2007.

- 3,398,036. **IONIC OASIS (BLOCK FORM)**. IONIC OASIS, LLC, (U.S. CLS. 100, 101 AND 102). SN 77-230,839. PUB. 1-1-2008. FILED 7-16-2007.
- 3,398,039. **WHAT DOES YOUR BRAND SOUND LIKE? (BLOCK FORM)**. RUMBLEFISH, INC., (U.S. CLS. 100, 101 AND 102). SN 77-230,860. PUB. 1-1-2008. FILED 7-16-2007.
- 3,398,041. **GLOBAL REACH - LOCAL TOUCH (BLOCK FORM)**. EVENTPRO STRATEGIES, INC., (U.S. CLS. 100, 101 AND 102). SN 77-230,887. PUB. 1-1-2008. FILED 7-16-2007.
- 3,398,057. **INSOUND (BLOCK FORM)**. INSOUND LLC, (U.S. CLS. 100, 101 AND 102). SN 77-231,165. PUB. 1-1-2008. FILED 7-17-2007.
- 3,398,061. **IWOLF DYNAMIC INTELLIGENCE DELIVERED AND DESIGN**. INTELLIDYN CORP., (U.S. CLS. 100, 101 AND 102). SN 77-231,243. PUB. 1-1-2008. FILED 7-17-2007.
- 3,398,069. **DIVERSIFIED FLEET SERVICES INTERNATIONAL (BLOCK FORM)**. AUTOMOTIVE RENTALS, INC., (U.S. CLS. 100, 101 AND 102). SN 77-231,384. PUB. 1-1-2008. FILED 7-17-2007.
- 3,398,070. **DIVERSIFIED FLEET SERVICES INTERNATIONAL (BLOCK FORM)**. AUTOMOTIVE RENTALS, INC., MULTIPLE CLASS, (INT. CLS. 35 AND 39), (U.S. CLS. 100, 101, 102 AND 105). SN 77-231,388. PUB. 1-1-2008. FILED 7-17-2007.
- 3,398,072. **DR. SCHICK'S DERMACEUTICALS (BLOCK FORM)**. DERMFX, P.C., (U.S. CLS. 100, 101 AND 102). SN 77-231,400. PUB. 1-1-2008. FILED 7-17-2007.
- 3,398,082. **RELIGHTNY (BLOCK FORM)**. RELIGHTNY, (U.S. CLS. 100, 101 AND 102). SN 77-231,571. PUB. 1-1-2008. FILED 7-17-2007.
- 3,398,091. **MISCELLANEOUS DESIGN**. EVENTPRO STRATEGIES, INC., (U.S. CLS. 100, 101 AND 102). SN 77-231,720. PUB. 1-1-2008. FILED 7-17-2007.
- 3,398,092. **JUDGING AMERICA'S BEST (BLOCK FORM)**. AMERICAN CULINARY CHEFSBEST, INC., (U.S. CLS. 100, 101 AND 102). SN 77-231,758. PUB. 1-1-2008. FILED 7-17-2007.
- 3,398,094. **RELIGHTNY AND DESIGN**. RELIGHTNY, (U.S. CLS. 100, 101 AND 102). SN 77-231,801. PUB. 1-1-2008. FILED 7-17-2007.
- 3,398,102. **GROW YOURSELF TO GROW YOUR BUSINESS (BLOCK FORM)**. EMERSON, MELINDA F., MULTIPLE CLASS, (INT. CLS. 35 AND 41), (U.S. CLS. 100, 101, 102 AND 107). SN 77-231,893. PUB. 1-1-2008. FILED 7-17-2007.
- 3,398,105. **URBANIMAL AND DESIGN**. URBANIMAL, LLC, (U.S. CLS. 100, 101 AND 102). SN 77-231,954. PUB. 1-1-2008. FILED 7-17-2007.
- 3,398,117. **THE BELL TREE (BLOCK FORM)**. DCM ALLIANCE, LLC, (U.S. CLS. 100, 101 AND 102). SN 77-232,135. PUB. 1-1-2008. FILED 7-17-2007.
- 3,398,118. **TUFF BLOCKS (BLOCK FORM)**. HIGH TECH BLOCKS LLC, (U.S. CLS. 100, 101 AND 102). SN 77-232,141. PUB. 1-1-2008. FILED 7-17-2007.
- 3,398,126. **BRADLEY-MORRIS (BLOCK FORM)**. BRADLEY-MORRIS, INC., (U.S. CLS. 100, 101 AND 102). SN 77-232,264. PUB. 1-1-2008. FILED 7-18-2007.
- 3,398,128. **POWERHIRE (BLOCK FORM)**. BRADLEY-MORRIS, INC., (U.S. CLS. 100, 101 AND 102). SN 77-232,289. PUB. 1-1-2008. FILED 7-18-2007.
- 3,398,132. **GHISALLO (BLOCK FORM)**. GHISALLO HOLDINGS, LLC, MULTIPLE CLASS, (INT. CLS. 35 AND 41), (U.S. CLS. 100, 101, 102 AND 107). SN 77-232,357. PUB. 1-1-2008. FILED 7-18-2007.
- 3,398,134. **ACCIDENTAL PREN-HER (BLOCK FORM)**. REID, SUSAN LEE, (U.S. CLS. 100, 101 AND 102). SN 77-232,422. PUB. 1-1-2008. FILED 7-18-2007.
- 3,398,135. **THE BEST BRANDS IN THE INDUSTRY ALL HAVE THE SAME ADDRESS (BLOCK FORM)**. RETAIL STORE NETWORKS, INC., DBA WHOLESALPET.COM, (U.S. CLS. 100, 101 AND 102). SN 77-232,444. PUB. 1-1-2008. FILED 7-18-2007.
- 3,398,137. **BIRTHDAYSCENES.COM BIRTHDAY SCENES AND DESIGN**. BIRTHDAY SCENES, INC., (U.S. CLS. 100, 101 AND 102). SN 77-232,448. PUB. 1-1-2008. FILED 7-18-2007.
- 3,398,139. **UNIVERSAL (BLOCK FORM)**. UNIVERSAL DATA CORPORATION, (U.S. CLS. 100, 101 AND 102). SN 77-232,471. PUB. 1-1-2008. FILED 7-18-2007.
- 3,398,152. **ANCHIN (BLOCK FORM)**. ANCHIN, BLOCK & ANCHIN LLP, MULTIPLE CLASS, (INT. CLS. 35 AND 36), (U.S. CLS. 100, 101 AND 102). SN 77-232,708. PUB. 1-1-2008. FILED 7-18-2007.
- 3,398,155. **FLEXMAX (BLOCK FORM)**. THE REHMANN GROUP, (U.S. CLS. 100, 101 AND 102). SN 77-232,740. PUB. 1-1-2008. FILED 7-18-2007.
- 3,398,157. **CHESTERFIELD ECONOMIC DEVELOPMENT BUSINESS STARTS HERE AND DESIGN**. COUNTY OF CHESTERFIELD, VIRGINIA, (U.S. CLS. 100, 101 AND 102). SN 77-232,754. PUB. 1-1-2008. FILED 7-18-2007.
- 3,398,176. **OUTSOURCE YOUR LIFE (BLOCK FORM)**. METRO ENTERPRISES, INC., DBA DOMYSTUFF.COM, (U.S. CLS. 100, 101 AND 102). SN 77-233,180. PUB. 1-1-2008. FILED 7-18-2007.
- 3,398,183. **WE MAKE TALENT WORK (BLOCK FORM)**. PARTNERS IN HUMAN RESOURCES INTERNATIONAL, INC., MULTIPLE CLASS, (INT. CLS. 35 AND 41), (U.S. CLS. 100, 101, 102 AND 107). SN 77-233,455. PUB. 1-1-2008. FILED 7-19-2007.
- 3,398,184. **DOBLIN (BLOCK FORM)**. DOBLIN INC., (U.S. CLS. 100, 101 AND 102). SN 77-233,464. PUB. 1-1-2008. FILED 7-19-2007.
- 3,398,196. **JETQUOTE AND DESIGN**. DANIELS WHOLESALE SIGN & PLASTICS, INC., (U.S. CLS. 100, 101 AND 102). SN 77-233,793. PUB. 1-1-2008. FILED 7-19-2007.
- 3,398,234. **WAA (BLOCK FORM)**. WISCONSIN ARBORIST ASSOCIATION, INC., (U.S. CLS. 100, 101 AND 102). SN 77-234,678. PUB. 1-1-2008. FILED 7-20-2007.
- 3,398,246. **DRAFT DAY (BLOCK FORM)**. THE CHRIS DRAFT FAMILY FOUNDATION, (U.S. CLS. 100, 101 AND 102). SN 77-237,091. PUB. 1-1-2008. FILED 7-24-2007.
- 3,398,264. **WHERE THE PEOPLE ARE (BLOCK FORM)**. TACODA, INC., (U.S. CLS. 100, 101 AND 102). SN 77-242,980. PUB. 1-1-2008. FILED 7-31-2007.
- 3,398,279. **BANKOFATHLETES INVESTING IN TALENTS. AND DESIGN. 1 SPORT LLC**, (U.S. CLS. 100, 101 AND 102). SN 77-246,412. PUB. 1-1-2008. FILED 8-3-2007.
- 3,398,290. **ERS AND DESIGN**. ENVIRONMENTAL RESOURCE SERVICES, INC., (U.S. CLS. 100, 101 AND 102). SN 77-250,152. PUB. 1-1-2008. FILED 8-8-2007.
- 3,398,291. **USHORSE.BIZ AND DESIGN**. USHORSE.BIZ, INC., (U.S. CLS. 100, 101 AND 102). SN 77-250,281. PUB. 1-1-2008. FILED 8-8-2007.
- 3,398,297. **RADIANCE (BLOCK FORM)**. BOSA DEVELOPMENT CALIFORNIA II INC., (U.S. CLS. 100, 101 AND 102). SN 77-250,623. PUB. 1-1-2008. FILED 8-8-2007.
- 3,398,305. **DOWN EAST (STYLIZED)**. DOWN EAST ENTERPRISE, INC., (U.S. CLS. 100, 101 AND 102). SN 77-252,380. PUB. 1-1-2008. FILED 8-10-2007.
- 3,398,307. **INDIA SPLENDOR (BLOCK FORM)**. TRUSTEE OF MGLOBAL TRUST, MULTIPLE CLASS, (INT. CLS. 35 AND 41), (U.S. CLS. 100, 101, 102 AND 107). SN 77-252,949. PUB. 1-1-2008. FILED 8-10-2007.
- 3,398,319. **EAGLETAX AND DESIGN**. EAGLE TAX SERVICES GROUP, INC., (U.S. CLS. 100, 101 AND 102). SN 77-255,657. PUB. 1-1-2008. FILED 8-15-2007.
- 3,398,320. **EAGLETAX AND DESIGN**. EAGLE TAX SERVICES GROUP, INC., (U.S. CLS. 100, 101 AND 102). SN 77-255,678. PUB. 1-1-2008. FILED 8-15-2007.
- 3,398,330 (*See Class 12 for this trademark*).
- 3,398,339. **FORE! DAD (BLOCK FORM)**. GOLFSMITH INTERNATIONAL, INC., (U.S. CLS. 100, 101 AND 102). SN 77-269,727. PUB. 1-1-2008. FILED 8-31-2007.
- 3,398,347. **ACCOUNTNOW (BLOCK FORM)**. ACCOUNTNOW, INC., MULTIPLE CLASS, (INT. CLS. 35, 36 AND 45), (U.S. CLS. 100, 101 AND 102). SN 77-296,747. PUB. 1-1-2008. FILED 10-4-2007.
- 3,398,349 (*See Class 9 for this trademark*).
- 3,398,354 (*See Class 9 for this trademark*).
- 3,398,365. **BESTCHOICEVACUUMS.COM (BLOCK FORM)**. IAN DESIGN, INC., (U.S. CLS. 100, 101 AND 102). SN 78-377,462. PUB. 12-7-2004. FILED 3-3-2004.
- 3,398,370. **Q QUALITY TONNES CARBON REDUCTIONS WITH A SOCIAL BENEFIT AND DESIGN**. QUALITY TONNES, LLC, (U.S. CLS. 100, 101 AND 102). SN 78-424,530. PUB. 1-1-2008. FILED 5-25-2004.

- 3,398,371 (*See Class 14 for this trademark.*)
- 3,398,381. **ON YOU GO (BLOCK FORM)**. CALIFORNIA STATE AUTOMOBILE ASSOCIATION, MULTIPLE CLASS, (INT. CLS. 35, 36, 37, 39, 42 AND 43), (U.S. CLS. 100, 101, 102, 103, 105 AND 106). SN 78-508,661. PUB. 9-12-2006. FILED 10-29-2004.
- 3,398,384 (*See Class 14 for this trademark.*)
- 3,398,395. **FLOWERKISSES (BLOCK FORM)**. ESCALANTE, THOMAS ANTHONY, (U.S. CLS. 100, 101 AND 102). SN 78-560,227. PUB. 1-1-2008. FILED 2-3-2005.
- 3,398,396 (*See Class 9 for this trademark.*)
- 3,398,407 (*See Class 9 for this trademark.*)
- 3,398,425. **RAPID SYSTEM REGIONAL AGILE PORT INTERMODAL DISTRIBUTION AND DESIGN**. DELAWARE RIVER MARITIME ENTERPRISE COUNCIL, MULTIPLE CLASS, (INT. CLS. 35 AND 45), (U.S. CLS. 100, 101 AND 102). SN 78-695,530. PUB. 1-1-2008. FILED 8-18-2005.
- 3,398,435 (*See Class 16 for this trademark.*)
- 3,398,437 (*See Class 16 for this trademark.*)
- 3,398,441. **SERVICE! EVALUATION CONCEPTS THE EYES OF THE CUSTOMER THE EARS OF MANAGEMENT AND DESIGN**. SERVICE EVALUATION CONCEPTS, INC., (U.S. CLS. 100, 101 AND 102). SN 78-726,553. PUB. 1-1-2008. FILED 10-4-2005.
- 3,398,442. **BUILD YOUR OWN DIAMOND PENDANT (BLOCK FORM)**. BLUE NILE, INC., (U.S. CLS. 100, 101 AND 102). SN 78-730,266. PUB. 1-1-2008. FILED 10-10-2005.
- 3,398,443. **GOLFCHIX (BLOCK FORM)**. MTT MEDIAWORKS, MULTIPLE CLASS, (INT. CLS. 35, 38, 39 AND 41), (U.S. CLS. 100, 101, 102, 104, 105 AND 107). SN 78-735,178. PUB. 9-25-2007. FILED 10-18-2005.
- 3,398,458. **MISCELLANEOUS DESIGN**. INDUSTRIAL TOWER AND WIRELESS, LLC, MULTIPLE CLASS, (INT. CLS. 35, 37, 38 AND 42), (U.S. CLS. 100, 101, 102, 103, 104 AND 106). SN 78-769,135. PUB. 1-1-2008. FILED 12-8-2005.
- 3,398,468. **OPTICA ITALEE (BLOCK FORM)**. ITALEE OPTICS, INC., (U.S. CLS. 100, 101 AND 102). SN 78-796,168. PUB. 1-1-2008. FILED 1-20-2006.
- 3,398,470. **DIRECT SUPPLY ELDERCARE INTERIORS AND DESIGN**. DIRECT SUPPLY, INC., (U.S. CLS. 100, 101 AND 102). SN 78-798,155. PUB. 1-1-2008. FILED 1-24-2006.
- 3,398,471 (*See Class 9 for this trademark.*)
- 3,398,477. **O.C.F. OBSESSIVE COMPULSIVE FISHING AND DESIGN**. ELY CHAMBER OF COMMERCE, (U.S. CLS. 100, 101 AND 102). SN 78-813,636. PUB. 1-1-2008. FILED 2-13-2006.
- 3,398,485. **W WOMEN IN CONSULTING AND DESIGN**. WOMEN IN CONSULTING, MULTIPLE CLASS, (INT. CLS. 35, 38 AND 41), (U.S. CLS. 100, 101, 102, 104 AND 107). SN 78-823,364. PUB. 1-1-2008. FILED 2-25-2006.
- 3,398,491. **COLLEGIATE SUPERSTORE (BLOCK FORM)**. BARNES & NOBLE COLLEGE BOOKSELLERS, INC., (U.S. CLS. 100, 101 AND 102). SN 78-836,339. PUB. 1-1-2008. FILED 3-14-2006.
- 3,398,501. **VEROS AND DESIGN**. VEROS SOFTWARE INC., (U.S. CLS. 100, 101 AND 102). SN 78-846,743. PUB. 1-1-2008. FILED 3-27-2006.
- 3,398,508. **1 STOP WEDDING SHOP AND DESIGN**. ONE STOP WEDDING SHOP, L.L.C., MULTIPLE CLASS, (INT. CLS. 35 AND 41), (U.S. CLS. 100, 101, 102 AND 107). SN 78-850,337. PUB. 1-1-2008. FILED 3-30-2006.
- 3,398,514. **WOVI AND DESIGN**. WOVI, INC., MULTIPLE CLASS, (INT. CLS. 35 AND 41), (U.S. CLS. 100, 101, 102 AND 107). SN 78-858,571. PUB. 1-1-2008. FILED 4-11-2006.
- 3,398,518 (*See Class 5 for this trademark.*)
- 3,398,520. **PRECISION CONVERTING (BLOCK FORM)**. HIS COMPANY, INC., MULTIPLE CLASS, (INT. CLS. 35 AND 40), (U.S. CLS. 100, 101, 102, 103 AND 106). SN 78-866,368. PUB. 1-1-2008. FILED 4-20-2006.
- 3,398,527. **PREFERRED MOVES (BLOCK FORM)**. CAPARO REAL ESTATE, DBA COLDWELL BANKER PREFERRED, MULTIPLE CLASS, (INT. CLS. 35 AND 36), (U.S. CLS. 100, 101 AND 102). SN 78-871,795. PUB. 1-1-2008. FILED 4-28-2006.
- 3,398,544 (*See Class 30 for this trademark.*)
- 3,398,552. **THE MEREDITH GROUP, INC. (BLOCK FORM)**. THE MEREDITH GROUP, INC., (U.S. CLS. 100, 101 AND 102). SN 78-905,932. PUB. 1-1-2008. FILED 6-12-2006.
- 3,398,554. **EVEREST COLD STORAGE AND DESIGN**. EVEREST COLD STORAGE LIMITED, (U.S. CLS. 100, 101 AND 102). SN 78-908,835. PUB. 1-1-2008. FILED 6-15-2006.
- 3,398,555. **UNIMIN (BLOCK FORM)**. UNIMIN CORPORATION, MULTIPLE CLASS, (INT. CLS. 35, 37, 40 AND 42), (U.S. CLS. 100, 101, 102, 103 AND 106). SN 78-910,036. PUB. 1-1-2008. FILED 6-16-2006.
- 3,398,557. **CAREMORE (BLOCK FORM)**. CAREMORE HEALTH PLAN, MULTIPLE CLASS, (INT. CLS. 35, 36, 41 AND 44), (U.S. CLS. 100, 101, 102 AND 107). SN 78-911,545. PUB. 1-1-2008. FILED 6-19-2006.
- 3,398,558. **THE FAIRTAX (BLOCK FORM)**. AMERICANS FOR FAIR TAXATION, (U.S. CLS. 100, 101 AND 102). SN 78-915,815. PUB. 1-1-2008. FILED 6-23-2006.
- 3,398,570. **RAZOR PAGES (STYLIZED)**. RAZORPAGES, INC., (U.S. CLS. 100, 101 AND 102). SN 78-927,495. PUB. 1-1-2008. FILED 7-12-2006.
- 3,398,571. **THELMA AND LOUISE (BLOCK FORM)**. THELMA AND LOUISE CLUB LIMITED, MULTIPLE CLASS, (INT. CLS. 35 AND 43), (U.S. CLS. 100, 101 AND 102). SN 78-929,043. PUB. 1-1-2008. FILED 7-13-2006.
- 3,398,572. **SIGNATURECELEBRITIES.COM AND DESIGN**. SIGNATURE CELEBRITIES, INC., (U.S. CLS. 100, 101 AND 102). SN 78-930,254. PUB. 1-1-2008. FILED S.R. 7-14-2006; AM. P.R. 7-24-2007.
- 3,398,582. **CHRITTO (BLOCK FORM)**. MUELLER, DITTMAR, MULTIPLE CLASS, (INT. CLS. 35, 37, 40 AND 42), (U.S. CLS. 100, 101, 102, 103 AND 106). SN 78-942,347. PUB. 1-1-2008. FILED 8-1-2006.
- 3,398,590. **DIMENSION DESIGN AND DESIGN**. M. ROGERS DESIGN, INC., MULTIPLE CLASS, (INT. CLS. 35, 37 AND 42), (U.S. CLS. 100, 101, 102, 103 AND 106). SN 78-956,728. PUB. 1-1-2008. FILED 8-21-2006.
- 3,398,595. **BELIEVE IT (BLOCK FORM)**. CAREMORE HEALTH PLAN, MULTIPLE CLASS, (INT. CLS. 35, 36, 41 AND 44), (U.S. CLS. 100, 101, 102 AND 107). SN 78-959,984. PUB. 1-1-2008. FILED 8-24-2006.
- 3,398,600 (*See Class 3 for this trademark.*)
- 3,398,605 (*See Class 9 for this trademark.*)
- 3,398,607. **MOTHERTALK (BLOCK FORM)**. MOTHERTALK, INC., (U.S. CLS. 100, 101 AND 102). SN 78-969,821. PUB. 1-1-2008. FILED 9-8-2006.
- 3,398,613 (*See Class 3 for this trademark.*)
- 3,398,614 (*See Class 9 for this trademark.*)
- 3,398,622. **TYPE FACE (BLOCK FORM)**. JULIA TODOROW, MULTIPLE CLASS, (INT. CLS. 35 AND 41), (U.S. CLS. 100, 101, 102 AND 107). SN 79-014,880. PUB. 1-1-2008. FILED 3-18-2005.
- 3,398,636 (*See Class 9 for this trademark.*)
- 3,398,637 (*See Class 9 for this trademark.*)
- 3,398,641. **CRYSTAL WORLDS (BLOCK FORM)**. SWAROVSKI AKTIENGESELLSCHAFT, MULTIPLE CLASS, (INT. CLS. 35 AND 41), (U.S. CLS. 100, 101, 102 AND 107). SN 79-024,448. PUB. 1-1-2008. FILED 3-9-2006.
- 3,398,646 (*See Class 16 for this trademark.*)
- 3,398,649 (*See Class 9 for this trademark.*)
- 3,398,659 (*See Class 9 for this trademark.*)
- 3,398,660 (*See Class 9 for this trademark.*)
- 3,398,661. **HUNTING HEADS BERATUNGSINSTITUT FÜR DIE BESETZUNG VON FACH- UND FÜHRUNGSPPOSITIONEN AND DESIGN**. UWE ZIRBES, (U.S. CLS. 100, 101 AND 102). SN 79-028,567. PUB. 1-1-2008. FILED 7-12-2006.
- 3,398,670. **NEULAND & PARTNER AND DESIGN**. NEULAND & PARTNER BERATENDE; DIPLOM-KAUFFRAU DIPLOM-DESIGNER; MODERATOREN UND SEMINAR-TRAINER, MULTIPLE CLASS, (INT. CLS. 35 AND 41), (U.S. CLS. 100, 101, 102 AND 107). SN 79-030,074. PUB. 1-1-2008. FILED 9-9-2006.
- 3,398,675 (*See Class 8 for this trademark.*)
- 3,398,684 (*See Class 7 for this trademark.*)
- 3,398,697 (*See Class 9 for this trademark.*)
- 3,398,698. **ECC EUROPEAN COMMODITY CLEARING AND DESIGN**. EUROPEAN COMMODITY CLEARING AG, MULTIPLE CLASS, (INT. CLS. 35, 36 AND 39), (U.S. CLS. 100, 101, 102 AND 105). SN 79-032,512. PUB. 1-1-2008. FILED 9-28-2006.
- 3,398,701 (*See Class 9 for this trademark.*)
- 3,398,705 (*See Class 3 for this trademark.*)

3,398,711 (*See Class 9 for this trademark*).
 3,398,716 (*See Class 7 for this trademark*).
 3,398,717 (*See Class 9 for this trademark*).
 3,398,752 (*See Class 29 for this trademark*).
 3,398,754 (*See Class 18 for this trademark*).
 3,398,755 (*See Class 3 for this trademark*).
 3,398,758 (*See Class 11 for this trademark*).
 3,398,759 (*See Class 11 for this trademark*).
 3,398,761. **WDEAL (STYLIZED)**. WENGO, MULTIPLE CLASS, (INT. CLS. 35, 36 AND 38), (U.S. CLS. 100, 101, 102 AND 104). SN 79-035,812. PUB. 1-1-2008. FILED 1-3-2007.
 3,398,764 (*See Class 4 for this trademark*).
 3,398,765. **BIOTRIAL (BLOCK FORM)**. BIOTRIAL, MULTIPLE CLASS, (INT. CLS. 35 AND 42), (U.S. CLS. 100, 101 AND 102). SN 79-036,053. PUB. 1-1-2008. FILED 8-8-2006.
 3,398,775 (*See Class 9 for this trademark*).
 3,398,778. **MISCELLANEOUS DESIGN**. CHINA JIANYIN INVESTMENT LIMITED, MULTIPLE CLASS, (INT. CLS. 35 AND 36), (U.S. CLS. 100, 101 AND 102). SN 79-036,849. PUB. 1-1-2008. FILED 2-13-2007.
 3,398,784 (*See Class 9 for this trademark*).
 3,398,791 (*See Class 16 for this trademark*).
 3,398,804. **FAMIPIX (BLOCK FORM)**. SKWORTSOW KOSTER MEDIA GROEP (SKMG) B.V., MULTIPLE CLASS, (INT. CLS. 35, 40, 41 AND 42), (U.S. CLS. 100, 101, 102, 103, 106 AND 107). SN 79-040,155. PUB. 1-1-2008. FILED 12-19-2006.
 3,398,810 (*See Class 9 for this trademark*).
 3,398,813 (*See Class 9 for this trademark*).
 3,398,822 (*See Class 9 for this trademark*).

CLASS 36—INSURANCE AND FINANCIAL

3,396,819. **PAYMENT SOLUTIONS**. PAYMENT SOLUTIONS, (U.S. CLS. 100, 101 AND 102). SN 76-395,400. PUB. 1-1-2008. FILED 4-15-2002.
 3,396,826. **BR AND DESIGN**. BERTHOLON-ROWLAND CORP., (U.S. CLS. 100, 101 AND 102). SN 76-531,141. PUB. 1-1-2008. FILED 7-21-2003.
 3,396,830. **THE MELLON GROUP (BLOCK FORM)**. BANK OF NEW YORK MELLON CORPORATION, THE, (U.S. CLS. 100, 101 AND 102). SN 76-571,128. PUB. 1-1-2008. FILED 1-20-2004.
 3,396,833. **CPMKTS THE CAPITAL MARKETS INDEX AND DESIGN**. DORCHESTER CAPITAL MANAGEMENT COMPANY, (U.S. CLS. 100, 101 AND 102). SN 76-608,542. PUB. 1-1-2008. FILED 8-25-2004.
 3,396,835 (*See Class 9 for this trademark*).
 3,396,838. **PANTHER CLUB (BLOCK FORM)**. UNIVERSITY OF PITTSBURGH - OF THE COMMONWEALTH SYSTEM OF HIGHER EDUCATION, (U.S. CLS. 100, 101 AND 102). SN 76-626,236. PUB. 1-1-2008. FILED 12-22-2004.
 3,396,842 (*See Class 35 for this trademark*).
 3,396,868. **ATLANTIC NATIONAL BANK BRUNSWICK GEORGIA AND DESIGN**. ATLANTIC NATIONAL BANK, (U.S. CLS. 100, 101 AND 102). SN 76-664,751. PUB. 9-25-2007. FILED 8-11-2006.
 3,396,877. **HARTZ CAPITAL, INC. (BLOCK FORM)**. HARTZ CAPITAL, INC., (U.S. CLS. 100, 101 AND 102). SN 76-668,874. PUB. 1-1-2008. FILED 11-13-2006.
 3,396,888. **LEVEL FOUR AND DESIGN**. LEVEL FOUR GROUP, LLC, (U.S. CLS. 100, 101 AND 102). SN 76-670,273. PUB. 1-1-2008. FILED 12-13-2006.
 3,396,890. **FIRST CHILDREN'S FINANCE AND DESIGN**. FIRST CHILDREN'S FINANCE, (U.S. CLS. 100, 101 AND 102). SN 76-670,310. PUB. 1-1-2008. FILED 12-14-2006.
 3,396,909. **THE LEUKEMIA CUP REGATTA THE LEUKEMIA & LYMPHOMA SOCIETY AND DESIGN**. THE LEUKEMIA & LYMPHOMA SOCIETY, INC., (U.S. CLS. 100, 101 AND 102). SN 76-675,077. PUB. 1-1-2008. FILED 4-5-2007.
 3,396,910. **LEUKEMIA CUP REGATTA (BLOCK FORM)**. THE LEUKEMIA & LYMPHOMA SOCIETY, INC., (U.S. CLS. 100, 101 AND 102). SN 76-675,078. PUB. 1-1-2008. FILED 4-5-2007.
 3,396,927. **LYTLE STATE BANK (BLOCK FORM)**. LYTLE STATE BANK, (U.S. CLS. 100, 101 AND 102). SN 76-677,734. PUB. 1-1-2008. FILED 6-1-2007.
 3,396,958. **INTERLUTION (BLOCK FORM)**. BESSETTE, MATTHEW J., DBA INTERLUTION, (U.S. CLS. 100, 101 AND 102). SN 77-001,263. PUB. 1-1-2008. FILED 9-18-2006.
 3,396,962. **...BECAUSE POTENTIAL HAS NO BOUNDARIES (BLOCK FORM)**. STANFORD FINANCIAL GROUP COMPANY, (U.S. CLS. 100, 101 AND 102). SN 77-003,969. PUB. 1-1-2008. FILED S.R. 9-21-2006; AM. P.R. 5-2-2007.
 3,396,992 (*See Class 9 for this trademark*).
 3,397,007. **CALIFORNIA CLASSIC FINANCIAL (BLOCK FORM)**. CALIFORNIA CLASSIC FINANCIAL PROPERTIES CORP., (U.S. CLS. 100, 101 AND 102). SN 77-024,871. PUB. 1-1-2008. FILED 10-19-2006.
 3,397,045 (*See Class 9 for this trademark*).
 3,397,055. **ACCESSIBLE LIFE (BLOCK FORM)**. THE WESTERN AND SOUTHERN LIFE INSURANCE COMPANY, (U.S. CLS. 100, 101 AND 102). SN 77-041,131. PUB. 1-1-2008. FILED 11-10-2006.
 3,397,058. **MISCELLANEOUS DESIGN**. THE MOST VENERABLE ORDER OF THE HOSPITAL OF ST. JOHN OF JERUSALEM, (U.S. CLS. 100, 101 AND 102). SN 77-042,028. PUB. 1-1-2008. FILED 11-11-2006.
 3,397,086. **ACIC AND DESIGN**. RTW, INC., (U.S. CLS. 100, 101 AND 102). SN 77-050,057. PUB. 1-1-2008. FILED 11-22-2006.
 3,397,087. **BCIC AND DESIGN**. RTW, INC., (U.S. CLS. 100, 101 AND 102). SN 77-050,062. PUB. 1-1-2008. FILED 11-22-2006.
 3,397,096 (*See Class 35 for this trademark*).
 3,397,104. **BANKERS INSURANCE CENTER (BLOCK FORM)**. CORPORATION FOR AMERICAN BANKING, (U.S. CLS. 100, 101 AND 102). SN 77-054,051. PUB. 1-1-2008. FILED 11-30-2006.
 3,397,114 (*See Class 35 for this trademark*).
 3,397,134. **OFFICIALS FOR KIDS (BLOCK FORM)**. MICHIGAN HIGH SCHOOL ATHLETIC ASSOCIATION, (U.S. CLS. 100, 101 AND 102). SN 77-061,130. PUB. 4-17-2007. FILED 12-11-2006.
 3,397,136. **A CAR DONATED IS A JOB CREATED (BLOCK FORM)**. STEP 13, INC., MULTIPLE CLASS, (INT. CLS. 36 AND 37), (U.S. CLS. 100, 101, 102, 103 AND 106). SN 77-061,407. PUB. 1-1-2008. FILED 12-11-2006.
 3,397,144. **H-CARD (BLOCK FORM)**. H-CARD, LLC, (U.S. CLS. 100, 101 AND 102). SN 77-063,016. PUB. 1-1-2008. FILED 12-13-2006.
 3,397,145. **HCARD AND DESIGN**. H-CARD, LLC, (U.S. CLS. 100, 101 AND 102). SN 77-063,034. PUB. 1-1-2008. FILED 12-13-2006.
 3,397,155. **MISCELLANEOUS DESIGN**. EMIGRANT BANK, (U.S. CLS. 100, 101 AND 102). SN 77-064,324. PUB. 1-1-2008. FILED 12-14-2006.
 3,397,157. **HOPE HELP HERE FOR YOU (STYLIZED)**. ALS OF MICHIGAN, INC., (U.S. CLS. 100, 101 AND 102). SN 77-064,391. PUB. 1-1-2008. FILED 12-14-2006.
 3,397,176. **SERVICE NET (BLOCK FORM)**. CAPITALSOURCE FINANCE LLC, AS COLLATERAL AGENT, (U.S. CLS. 100, 101 AND 102). SN 77-068,072. PUB. 1-1-2008. FILED 12-20-2006.
 3,397,184. **LEE EQUITY PARTNERS AND DESIGN**. LEE EQUITY PARTNERS, LLC, (U.S. CLS. 100, 101 AND 102). SN 77-068,668. PUB. 1-1-2008. FILED 12-20-2006.
 3,397,185 (*See Class 35 for this trademark*).
 3,397,187 (*See Class 35 for this trademark*).
 3,397,204 (*See Class 35 for this trademark*).
 3,397,205 (*See Class 35 for this trademark*).
 3,397,206 (*See Class 35 for this trademark*).
 3,397,207 (*See Class 35 for this trademark*).
 3,397,217. **REAL PEOPLE. WISE CHOICES. (BLOCK FORM)**. STERLING LIFE INSURANCE COMPANY, (U.S. CLS. 100, 101 AND 102). SN 77-073,021. PUB. 1-1-2008. FILED 12-28-2006.
 3,397,220. **MYTRUSTON AND DESIGN**. SCAMSAFE, INC., (U.S. CLS. 100, 101 AND 102). SN 77-073,703. PUB. 1-1-2008. FILED 12-29-2006.
 3,397,221. **SAFEGUARD YOUR GOOD NAME (BLOCK FORM)**. SCAMSAFE, INC., (U.S. CLS. 100, 101 AND 102). SN 77-073,705. PUB. 1-1-2008. FILED 12-29-2006.
 3,397,222. **TRUSTON (BLOCK FORM)**. SCAMSAFE, INC., (U.S. CLS. 100, 101 AND 102). SN 77-073,706. PUB. 1-1-2008. FILED 12-29-2006.

- 3,397,223. **TRUSTON AND DESIGN. SCAMSAFE, INC.**, (U.S. CLS. 100, 101 AND 102). SN 77-073,707. PUB. 1-1-2008. FILED 12-29-2006.
- 3,397,227 (*See Class 16 for this trademark.*)
- 3,397,228 (*See Class 16 for this trademark.*)
- 3,397,258. **SIMPLIFYING REAL ESTATE (BLOCK FORM).** TRAN, ANH HAO, (U.S. CLS. 100, 101 AND 102). SN 77-082,570. PUB. 1-1-2008. FILED 1-13-2007.
- 3,397,264. **TRANSFORM GREEN LISTING (BLOCK FORM).** TRANSFORM REAL ESTATE, (U.S. CLS. 100, 101 AND 102). SN 77-085,043. PUB. 1-1-2008. FILED 1-17-2007.
- 3,397,276. **KCS KELLER COLLEGE SERVICES AND DESIGN.** KELLER COLLEGE SERVICES, LLC, MULTIPLE CLASS, (INT. CLS. 36 AND 41), (U.S. CLS. 100, 101, 102 AND 107). SN 77-087,645. PUB. 9-25-2007. FILED 1-22-2007.
- 3,397,290. **100 HOMES INC AND DESIGN.** 100 HOMES, INC., MULTIPLE CLASS, (INT. CLS. 36 AND 41), (U.S. CLS. 100, 101, 102 AND 107). SN 77-091,568. PUB. 1-1-2008. FILED 1-25-2007.
- 3,397,295. **AMERICAP FINANCIAL, INC. (BLOCK FORM).** AMERICAP FINANCIAL, INC., (U.S. CLS. 100, 101 AND 102). SN 77-094,635. PUB. 1-1-2008. FILED 1-30-2007.
- 3,397,323 (*See Class 3 for this trademark.*)
- 3,397,342 (*See Class 35 for this trademark.*)
- 3,397,349 (*See Class 35 for this trademark.*)
- 3,397,380. **APLA AIDS PROJECT LOS ANGELES AND DESIGN.** AIDS PROJECT LOS ANGELES, (U.S. CLS. 100, 101 AND 102). SN 77-116,494. PUB. 1-1-2008. FILED 2-26-2007.
- 3,397,408 (*See Class 35 for this trademark.*)
- 3,397,425. **FLEXABLE REAL ESTATE SOLUTIONS "FLEXIBLE FEES AND SERVICES" AND DESIGN.** MARIA LO BIANCO, (U.S. CLS. 100, 101 AND 102). SN 77-137,250. PUB. 1-1-2008. FILED 3-21-2007.
- 3,397,444 (*See Class 35 for this trademark.*)
- 3,397,446. **PINK RIBBON ROUND UP AND DESIGN.** PINK RIBBON ROUND-UP, INC., (U.S. CLS. 100, 101 AND 102). SN 77-144,742. PUB. 1-1-2008. FILED 3-30-2007.
- 3,397,448. **S&P CUSTOM INDICES (BLOCK FORM).** THE MCGRAW-HILL COMPANIES, INC., (U.S. CLS. 100, 101 AND 102). SN 77-146,517. PUB. 1-1-2008. FILED 4-2-2007.
- 3,397,449. **S&P CUSTOM INDEX (BLOCK FORM).** THE MCGRAW-HILL COMPANIES, INC., (U.S. CLS. 100, 101 AND 102). SN 77-146,530. PUB. 1-1-2008. FILED 4-2-2007.
- 3,397,457 (*See Class 16 for this trademark.*)
- 3,397,486. **THE MIGRAINE AND PAIN FUND AND DESIGN.** THE MIGRAINE AND PAIN FUND, INC., (U.S. CLS. 100, 101 AND 102). SN 77-162,957. PUB. 1-1-2008. FILED 4-23-2007.
- 3,397,491. **SIR GROOVY AND DESIGN.** SIR GROOVY INC., MULTIPLE CLASS, (INT. CLS. 36 AND 45), (U.S. CLS. 100, 101 AND 102). SN 77-164,798. PUB. 1-1-2008. FILED 4-24-2007.
- 3,397,507. **ARGONAUT RETAIL MEMBER ARGONAUT GROUP AND DESIGN.** ARGONAUT GROUP, INC., (U.S. CLS. 100, 101 AND 102). SN 77-168,536. PUB. 1-1-2008. FILED 4-29-2007.
- 3,397,515. **EXACTRAC (BLOCK FORM).** JPMORGAN CHASE & CO., (U.S. CLS. 100, 101 AND 102). SN 77-173,228. PUB. 1-1-2008. FILED 5-4-2007.
- 3,397,516. **SUCCESS IN EXCESS (BLOCK FORM).** CORPORATE PROPERTY DISPOSITIONS, (U.S. CLS. 100, 101 AND 102). SN 77-173,307. PUB. 1-1-2008. FILED 5-4-2007.
- 3,397,518 (*See Class 16 for this trademark.*)
- 3,397,523 (*See Class 35 for this trademark.*)
- 3,397,529. **877-FAST-BAIL (BLOCK FORM).** ABC BAIL BONDS, INC., (U.S. CLS. 100, 101 AND 102). SN 77-177,463. PUB. 1-1-2008. FILED 5-10-2007.
- 3,397,538. **VERACITY PAYMENT SOLUTIONS, CONNECTING RELATIONSHIPS TO SUCCESS AND DESIGN.** VERACITY PAYMENT SOLUTIONS, INC., (U.S. CLS. 100, 101 AND 102). SN 77-181,873. PUB. 1-1-2008. FILED 5-15-2007.
- 3,397,540. **HTS HUGHES TRANSACTION SERVICES AND DESIGN.** HUGHESWARE COMPUTER SERVICES, L.L.C., (U.S. CLS. 100, 101 AND 102). SN 77-182,363. PUB. 1-1-2008. FILED 5-16-2007.
- 3,397,571. **INSUREHEALTH (BLOCK FORM).** BRODY, RONALD F., (U.S. CLS. 100, 101 AND 102). SN 77-194,098. PUB. 1-1-2008. FILED 5-31-2007.
- 3,397,589. **STOREVAULT (BLOCK FORM).** NETWORK APPLIANCE, INC., MULTIPLE CLASS, (INT. CLS. 36, 37 AND 42), (U.S. CLS. 100, 101, 102, 103 AND 106). SN 77-197,234. PUB. 1-1-2008. FILED 6-4-2007.
- 3,397,669. **COCONUT GROVE BANK AND DESIGN.** COCONUT GROVE BANK, (U.S. CLS. 100, 101 AND 102). SN 77-213,126. PUB. 1-1-2008. FILED 6-22-2007.
- 3,397,677. **PROPAPAY INSTANTPAY (BLOCK FORM).** PROPAPAY USA, INC., (U.S. CLS. 100, 101 AND 102). SN 77-214,466. PUB. 1-1-2008. FILED 6-25-2007.
- 3,397,681. **CUSN CREDIT UNION SERVICE NETWORK AND DESIGN.** CU SERVICE NETWORK, INC., (U.S. CLS. 100, 101 AND 102). SN 77-215,391. PUB. 1-1-2008. FILED 6-26-2007.
- 3,397,697. **LUBBOCK'S FIRST NAME IN APPRAISALS AND ESTATE SALES (BLOCK FORM).** MADDOX, EDDIE, (U.S. CLS. 100, 101 AND 102). SN 77-216,678. PUB. 1-1-2008. FILED 6-27-2007.
- 3,397,699. **MORQUEST (BLOCK FORM).** MORQUEST, LLC, (U.S. CLS. 100, 101 AND 102). SN 77-216,796. PUB. 1-1-2008. FILED 6-27-2007.
- 3,397,710. **TICKETING 2.0 (BLOCK FORM).** THE TICKET RESERVE, INC., (U.S. CLS. 100, 101 AND 102). SN 77-218,005. PUB. 1-1-2008. FILED 6-28-2007.
- 3,397,753. **INNOVATIVE LENDING GROUP AND DESIGN.** OPTIMUM SYNERGY ENTERPRISES, (U.S. CLS. 100, 101 AND 102). SN 77-223,051. PUB. 1-1-2008. FILED 7-5-2007.
- 3,397,759. **THE BEST OF URBAN LIVING (BLOCK FORM).** SAAMAN DEVELOPMENT LLC, MULTIPLE CLASS, (INT. CLS. 36 AND 37), (U.S. CLS. 100, 101, 102, 103 AND 106). SN 77-223,290. PUB. 1-1-2008. FILED 7-6-2007.
- 3,397,765. **BRIDGEBAY (BLOCK FORM).** BRIDGEBAY FINANCIAL, INC., (U.S. CLS. 100, 101 AND 102). SN 77-224,125. PUB. 1-1-2008. FILED 7-7-2007.
- 3,397,768. **INFUND (BLOCK FORM).** FIRST INSURANCE FUNDING CORP., (U.S. CLS. 100, 101 AND 102). SN 77-224,481. PUB. 1-1-2008. FILED 7-9-2007.
- 3,397,769. **FIRST FUNDING SOLUTIONS (BLOCK FORM).** FIRST INSURANCE FUNDING CORP., (U.S. CLS. 100, 101 AND 102). SN 77-224,517. PUB. 1-1-2008. FILED 7-9-2007.
- 3,397,783. **PEMBROKE POINTE (BLOCK FORM).** PEMBROKE POINT PHASE I LLC, (U.S. CLS. 100, 101 AND 102). SN 77-225,392. PUB. 1-1-2008. FILED 7-10-2007.
- 3,397,790. **ARCH RE FACULTATIVE (BLOCK FORM).** ARCH CAPITAL GROUP (U.S.) INC., (U.S. CLS. 100, 101 AND 102). SN 77-225,582. PUB. 1-1-2008. FILED 7-10-2007.
- 3,397,827. **POKER4LIFE AND DESIGN.** SCHWARTZ, JEREMY S., AND RUBY, ETHAN, MULTIPLE CLASS, (INT. CLS. 36 AND 41), (U.S. CLS. 100, 101, 102 AND 107). SN 77-226,986. PUB. 1-1-2008. FILED 7-11-2007.
- 3,397,896. **NATION'S CHOICE REALTY (BLOCK FORM).** WILLIAMS, DEBRA JEAN, (U.S. CLS. 100, 101 AND 102). SN 77-228,637. PUB. 1-1-2008. FILED 7-12-2007.
- 3,397,914. **NATIONAL PROBATE RESCUE (BLOCK FORM).** NATIONAL PROBATE RESCUE, INC., (U.S. CLS. 100, 101 AND 102). SN 77-228,908. PUB. 1-1-2008. FILED 7-13-2007.
- 3,397,915. **PROBATE RESCUE (BLOCK FORM).** NATIONAL PROBATE RESCUE, INC., (U.S. CLS. 100, 101 AND 102). SN 77-228,923. PUB. 1-1-2008. FILED 7-13-2007.
- 3,397,926. **CLARITY SIMPLIFY. STRATIFY. PREDICT. AND DESIGN.** CLAYTON SERVICES, INC., (U.S. CLS. 100, 101 AND 102). SN 77-229,030. PUB. 1-1-2008. FILED 7-13-2007.
- 3,397,927. **HISTORIC GUAISTI DISTRICT AND DESIGN.** OLIVERMCMILLAN, LLC, MULTIPLE CLASS, (INT. CLS. 36 AND 37), (U.S. CLS. 100, 101, 102, 103 AND 106). SN 77-229,050. PUB. 1-1-2008. FILED 7-13-2007.
- 3,397,929. **TVALLEY (BLOCK FORM).** SALLS, ALAN, (U.S. CLS. 100, 101 AND 102). SN 77-229,075. PUB. 1-1-2008. FILED 7-13-2007.
- 3,397,940. **PACIFICRATE MORTGAGE INC AND DESIGN.** PACIFIC RATE MORTGAGE, INC., (U.S. CLS. 100, 101 AND 102). SN 77-229,243. PUB. 1-1-2008. FILED 7-13-2007.
- 3,397,958. **LINDENHURST VILLAGE GREEN AND DESIGN.** OLIVERMCMILLAN, LLC, MULTIPLE CLASS, (INT. CLS. 36 AND 37), (U.S. CLS. 100, 101, 102, 103 AND 106). SN 77-229,564. PUB. 1-1-2008. FILED 7-13-2007.
- 3,397,960. **EVERETT RIVERFRONT AND DESIGN.** OLI-

- VERMCMILLAN, LLC, MULTIPLE CLASS, (INT. CLS. 36 AND 37), (U.S. CLS. 100, 101, 102, 103 AND 106). SN 77-229,595. PUB. 1-1-2008. FILED 7-13-2007.
- 3,397,997. **WEST COAST MERCHANT SERVICES (BLOCK FORM)**. WEST COAST BANCORP, (U.S. CLS. 100, 101 AND 102). SN 77-230,315. PUB. 1-1-2008. FILED 7-16-2007.
- 3,398,012. **CETALUS (BLOCK FORM)**. CETALUS LLC, (U.S. CLS. 100, 101 AND 102). SN 77-230,485. PUB. 1-1-2008. FILED 7-16-2007.
- 3,398,021. **MISCELLANEOUS DESIGN**. GOVERNMENT EMPLOYEES INSURANCE COMPANY, (U.S. CLS. 100, 101 AND 102). SN 77-230,612. PUB. 1-1-2008. FILED 7-16-2007.
- 3,398,027. **PH AND DESIGN**. PLANET HOLLYWOOD (REGION IV), INC., (U.S. CLS. 100, 101 AND 102). SN 77-230,744. PUB. 1-1-2008. FILED 7-16-2007.
- 3,398,037. **E3FINANCIAL FOUNDED BY ENTREPRENEURS FOR ENTREPRENEURS (STYLIZED)**. E3 FINANCIAL, INC., (U.S. CLS. 100, 101 AND 102). SN 77-230,844. PUB. 1-1-2008. FILED 7-16-2007.
- 3,398,055. **OAKLEAF FINANCIAL SERVICES (BLOCK FORM)**. STURGIS BANK & TRUST COMPANY, (U.S. CLS. 100, 101 AND 102). SN 77-231,133. PUB. 1-1-2008. FILED 7-17-2007.
- 3,398,056. **ARCIS (BLOCK FORM)**. ISNARD, ARNAUD, (U.S. CLS. 100, 101 AND 102). SN 77-231,146. PUB. 1-1-2008. FILED 7-17-2007.
- 3,398,062. **HELPING YOU WIN THE BATTLES OF LIFE (BLOCK FORM)**. LIBERTY ASSURANCE GROUP, DBA LIBERTY ASSURANCE GROUP, (U.S. CLS. 100, 101 AND 102). SN 77-231,246. PUB. 1-1-2008. FILED 7-17-2007.
- 3,398,097. **THE STATE LIFE INSURANCE COMPANY (BLOCK FORM)**. THE STATE LIFE INSURANCE COMPANY, (U.S. CLS. 100, 101 AND 102). SN 77-231,844. PUB. 1-1-2008. FILED 7-17-2007.
- 3,398,111. **SUWANABEE (BLOCK FORM)**. HART, BEVERLY, (U.S. CLS. 100, 101 AND 102). SN 77-232,036. PUB. 1-1-2008. FILED 7-17-2007.
- 3,398,120. **SECURITYCHOICE (BLOCK FORM)**. WELLPOINT, INC., (U.S. CLS. 100, 101 AND 102). SN 77-232,160. PUB. 1-1-2008. FILED 7-17-2007.
- 3,398,121. **SMARTVALUE (BLOCK FORM)**. WELLPOINT, INC., (U.S. CLS. 100, 101 AND 102). SN 77-232,161. PUB. 1-1-2008. FILED 7-17-2007.
- 3,398,141. **GUARANTEEDWEATHER (BLOCK FORM)**. MSI GUARANTEEDWEATHER, LLC, (U.S. CLS. 100, 101 AND 102). SN 77-232,475. PUB. 1-1-2008. FILED 7-18-2007.
- 3,398,146. **BETTER WORLD MORTGAGE (BLOCK FORM)**. TOTAL SUCCESS TECHNOLOGIES, INC., (U.S. CLS. 100, 101 AND 102). SN 77-232,596. PUB. 1-1-2008. FILED 7-18-2007.
- 3,398,152 (*See Class 35 for this trademark*).
- 3,398,154. **NETSFORLIFE (BLOCK FORM)**. EPISCOPAL RELIEF AND DEVELOPMENT, (U.S. CLS. 100, 101 AND 102). SN 77-232,733. PUB. 1-1-2008. FILED 7-18-2007.
- 3,398,181. **CREDIT GENIE (BLOCK FORM)**. CREDIT GENIE FRANCHISING, LLC, DBA CREDIT GENIE, (U.S. CLS. 100, 101 AND 102). SN 77-233,424. PUB. 1-1-2008. FILED 7-19-2007.
- 3,398,182. **THE INCOME GENERATOR (BLOCK FORM)**. ARLEN CORPORATION, (U.S. CLS. 100, 101 AND 102). SN 77-233,454. PUB. 1-1-2008. FILED 7-19-2007.
- 3,398,185. **YOUR FIRST STEP TO BETTER CREDIT (BLOCK FORM)**. CREDIT GENIE FRANCHISING, LLC, DBA CREDIT GENIE, (U.S. CLS. 100, 101 AND 102). SN 77-233,475. PUB. 1-1-2008. FILED 7-19-2007.
- 3,398,210. **FROM BAYSHORE TO THE BEACHES WE SELL TAMPA BAY! (BLOCK FORM)**. ZITO, DEBORAH J., (U.S. CLS. 100, 101 AND 102). SN 77-234,038. PUB. 1-1-2008. FILED 7-19-2007.
- 3,398,222. **TEAMLEGAL (BLOCK FORM)**. PROFESSIONAL LAW ENFORCEMENT ASSOCIATION, INC., (U.S. CLS. 100, 101 AND 102). SN 77-234,395. PUB. 1-1-2008. FILED 7-20-2007.
- 3,398,228. **BA BUSINESS ACQUISITIONS, LTD. (STYLIZED)**. BUSINESS ACQUISITIONS, LTD., (U.S. CLS. 100, 101 AND 102). SN 77-234,578. PUB. 1-1-2008. FILED 7-20-2007.
- 3,398,240. **GREAT-WEST (BLOCK FORM)**. GREAT-WEST LIFE & ANNUITY INSURANCE COMPANY, (U.S. CLS. 100, 101 AND 102). SN 77-236,443. PUB. 1-1-2008. FILED 7-23-2007.
- 3,398,241. **GW AND DESIGN**. GREAT-WEST LIFE & ANNUITY INSURANCE COMPANY, (U.S. CLS. 100, 101 AND 102). SN 77-236,519. PUB. 1-1-2008. FILED 7-23-2007.
- 3,398,247. **VIRGIN (BLOCK FORM)**. VIRGIN ENTERPRISES LIMITED, (U.S. CLS. 100, 101 AND 102). SN 77-237,167. PUB. 1-1-2008. FILED 7-24-2007.
- 3,398,248. **VIRGIN AND DESIGN**. VIRGIN ENTERPRISES LIMITED, (U.S. CLS. 100, 101 AND 102). SN 77-237,172. PUB. 1-1-2008. FILED 7-24-2007.
- 3,398,253. **ARCH RE FACULTATIVE AND DESIGN**. ARCH CAPITAL GROUP (U.S.) INC., (U.S. CLS. 100, 101 AND 102). SN 77-239,214. PUB. 1-1-2008. FILED 7-26-2007.
- 3,398,286. **FIRST CITIZENS DIRECT (BLOCK FORM)**. FIRST CITIZENS BANCSHARES, INC., (U.S. CLS. 100, 101 AND 102). SN 77-248,867. PUB. 1-1-2008. FILED 8-7-2007.
- 3,398,327. **IN-SYNCH WITH YOUR GROWING BUSINESS (BLOCK FORM)**. THE TRAVELERS INDEMNITY COMPANY, (U.S. CLS. 100, 101 AND 102). SN 77-257,282. PUB. 1-1-2008. FILED 8-16-2007.
- 3,398,330 (*See Class 12 for this trademark*).
- 3,398,333. **EQUITY STREET AND DESIGN**. SUTTON GREEN, LLC, (U.S. CLS. 100, 101 AND 102). SN 77-260,871. PUB. 1-1-2008. FILED 8-21-2007.
- 3,398,347 (*See Class 35 for this trademark*).
- 3,398,350. **ALPHAGEN**. GARTMORE INVESTMENT MANAGEMENT PLC, (U.S. CLS. 100, 101 AND 102). SN 78-087,757. PUB. 9-14-2004. FILED 10-10-2001.
- 3,398,371 (*See Class 14 for this trademark*).
- 3,398,381 (*See Class 35 for this trademark*).
- 3,398,385 (*See Class 18 for this trademark*).
- 3,398,386 (*See Class 18 for this trademark*).
- 3,398,391. **MARCHEDESPARTENAIRESMONDIAUX.COM (BLOCK FORM)**. AGA KHAN FOUNDATION CANADA, (U.S. CLS. 100, 101 AND 102). SN 78-547,666. PUB. 7-3-2007. FILED 1-14-2005.
- 3,398,393. **SECOND CHANCE CHECKING (BLOCK FORM)**. WOODFOREST NATIONAL BANK, (U.S. CLS. 100, 101 AND 102). SN 78-548,014. PUB. 7-18-2006. FILED 1-14-2005.
- 3,398,420. **MISCELLANEOUS DESIGN**. DARWIN PROFESSIONAL UNDERWRITERS, INC., (U.S. CLS. 100, 101 AND 102). SN 78-678,172. PUB. 1-1-2008. FILED 7-26-2005.
- 3,398,440. **BLUEGREEN RESORTS (BLOCK FORM)**. BLUEGREEN CORPORATION, MULTIPLE CLASS, (INT. CLS. 36 AND 37), (U.S. CLS. 100, 101, 102, 103 AND 106). SN 78-723,337. PUB. 1-1-2008. FILED 9-29-2005.
- 3,398,451. **E ENSURANCE.COM (STYLIZED)**. COHEN, DOUGLAS A., (U.S. CLS. 100, 101 AND 102). SN 78-754,127. PUB. 10-17-2006. FILED 11-15-2005.
- 3,398,473. **CARS AND DESIGN**. CAPITAL AUTOMOTIVE LLC, (U.S. CLS. 100, 101 AND 102). SN 78-806,269. PUB. 1-1-2008. FILED 2-3-2006.
- 3,398,484. **KC KUSHCASH AND DESIGN**. BIOXESS CORPORATION, (U.S. CLS. 100, 101 AND 102). SN 78-822,294. PUB. 1-1-2008. FILED 2-23-2006.
- 3,398,527 (*See Class 35 for this trademark*).
- 3,398,543. **FOR THE IF IN LIFE (BLOCK FORM)**. METROPOLITAN LIFE INSURANCE COMPANY, (U.S. CLS. 100, 101 AND 102). SN 78-899,479. PUB. 1-1-2008. FILED 6-2-2006.
- 3,398,557 (*See Class 35 for this trademark*).
- 3,398,559. **NETAGENT (BLOCK FORM)**. ALL CITIES REALTY, INC., (U.S. CLS. 100, 101 AND 102). SN 78-916,262. PUB. 1-1-2008. FILED 6-24-2006.
- 3,398,595 (*See Class 35 for this trademark*).
- 3,398,600 (*See Class 3 for this trademark*).
- 3,398,698 (*See Class 35 for this trademark*).
- 3,398,711 (*See Class 9 for this trademark*).
- 3,398,735 (*See Class 7 for this trademark*).
- 3,398,736. **SINTONIA AND DESIGN**. EDIZIONE HOLDING S.P.A., (U.S. CLS. 100, 101 AND 102). SN 79-034,812. PUB. 1-1-2008. FILED 12-18-2006.
- 3,398,761 (*See Class 35 for this trademark*).
- 3,398,767. **LOBNEK WEALTH MANAGEMENT (BLOCK FORM)**. LOBNEK WEALTH MANAGEMENT SA; C/O SERCOFIN, SOCIÉTÉ DE SERVICES; COMPTABLES ET FINANCIERS SA, (U.S. CLS. 100, 101 AND 102). SN 79-036,142. PUB. 1-1-2008. FILED 1-25-2007.

3,398,775 (*See Class 9 for this trademark.*)
 3,398,778 (*See Class 35 for this trademark.*)
 3,398,790. **ALLIANZ GLOBAL CORPORATE & SPECIALTY (BLOCK FORM)**. ALLIANZ SE, MULTIPLE CLASS, (INT. CLS. 36, 42 AND 45), (U.S. CLS. 100, 101 AND 102). SN 79-038,458. PUB. 1-1-2008. FILED 1-4-2007.
 3,398,810 (*See Class 9 for this trademark.*)

CLASS 37—CONSTRUCTION AND REPAIR

3,396,842 (*See Class 35 for this trademark.*)
 3,396,853. **U.S. BRICK & BLOCK SYSTEMS, INC. (BLOCK FORM)**. U.S. BRICK & BLOCK SYSTEMS, INC., (U.S. CLS. 100, 103 AND 106). SN 76-657,526. PUB. 1-1-2008. FILED 3-30-2006.
 3,396,861. **LOVE A CHILD (BLOCK FORM)**. LOVE A CHILD, INC., MULTIPLE CLASS, (INT. CLS. 37, 43 AND 44), (U.S. CLS. 100, 101, 103 AND 106). SN 76-661,285. PUB. 1-1-2008. FILED 6-8-2006.
 3,396,881 (*See Class 35 for this trademark.*)
 3,396,892. **WE VALUE WHAT YOU VALUE (BLOCK FORM)**. ALLEN EDWIN COMPANY, INC., (U.S. CLS. 100, 103 AND 106). SN 76-670,321. PUB. 1-1-2008. FILED 12-14-2006.
 3,396,898. **BEDROC (BLOCK FORM)**. BEDROC CONTRACTING, LLC, (U.S. CLS. 100, 103 AND 106). SN 76-671,964. PUB. 1-1-2008. FILED 1-29-2007.
 3,396,952. **PRO ONCALL TECHNOLOGIES AND DESIGN**. PRO ONCALL TECHNOLOGIES, LLC, MULTIPLE CLASS, (INT. CLS. 37 AND 42), (U.S. CLS. 100, 101, 103 AND 106). SN 76-679,961. PUB. 1-1-2008. FILED 7-25-2007.
 3,396,957. **MR. CLEAN-A-CAN AND DESIGN**. USA FRANCHISING LLC, (U.S. CLS. 100, 103 AND 106). SN 77-000,708. PUB. 1-1-2008. FILED 9-15-2006.
 3,396,965 (*See Class 35 for this trademark.*)
 3,396,976 (*See Class 7 for this trademark.*)
 3,396,977 (*See Class 7 for this trademark.*)
 3,397,022. **MASTERBUILDER FELLOWSHIP FOR THE BUILT ENVIRONMENT INCORPORATED AND DESIGN**. MASTERBUILDER FELLOWSHIP FOR THE BUILT ENVIRONMENT, INCORPORATED, MULTIPLE CLASS, (INT. CLS. 37 AND 42), (U.S. CLS. 100, 101, 103 AND 106). SN 77-028,670. PUB. 1-1-2008. FILED 10-25-2006.
 3,397,033 (*See Class 19 for this trademark.*)
 3,397,076. **MAVERICK CONSTRUCTION COMPANY AND DESIGN**. MAVCO, INC., (U.S. CLS. 100, 103 AND 106). SN 77-047,257. PUB. 1-1-2008. FILED 11-18-2006.
 3,397,088. **AROUND YOUR HOUSE, LLC HOME IMPROVEMENT SPECIALISTS AND DESIGN**. PINCUS, ALLAN D, (U.S. CLS. 100, 103 AND 106). SN 77-050,633. PUB. 1-1-2008. FILED 11-25-2006.
 3,397,093. **WALSH CONSTRUCTION (BLOCK FORM)**. THE WALSH GROUP LTD., (U.S. CLS. 100, 103 AND 106). SN 77-051,901. PUB. 1-1-2008. FILED 11-28-2006.
 3,397,108. **VIKING FENCE CO. AND DESIGN**. VIKING FENCE COMPANY, INC., (U.S. CLS. 100, 103 AND 106). SN 77-056,321. PUB. 1-1-2008. FILED 12-4-2006.
 3,397,110 (*See Class 9 for this trademark.*)
 3,397,136 (*See Class 36 for this trademark.*)
 3,397,185 (*See Class 35 for this trademark.*)
 3,397,187 (*See Class 35 for this trademark.*)
 3,397,218. **WE'LL MAKE IT RIGHT, RIGHT AWAY. (BLOCK FORM)**. MANHEIM AUCTIONS, INC., (U.S. CLS. 100, 103 AND 106). SN 77-073,135. PUB. 1-1-2008. FILED 12-29-2006.
 3,397,255 (*See Class 11 for this trademark.*)
 3,397,303. **PANASONIC (BLOCK FORM)**. MATSUSHITA ELECTRIC INDUSTRIAL CO., LTD., (U.S. CLS. 100, 103 AND 106). SN 77-096,157. PUB. 1-1-2008. FILED 1-31-2007.
 3,397,314. **CAPX (BLOCK FORM)**. GIBRALTAR CONSTRUCTION CO., (U.S. CLS. 100, 103 AND 106). SN 77-097,623. PUB. 1-1-2008. FILED 2-2-2007.
 3,397,388. **EXPERTS IN WATER DAMAGE EMERGENCY SERVICES RESTORATION 100% UNCONDITIONAL GUARANTEE AND DESIGN**. EMERGENCY SERVICES RESTORATION, INC., (U.S. CLS. 100, 103 AND 106). SN 77-120,874. PUB. 1-1-2008. FILED 3-2-2007.
 3,397,444 (*See Class 35 for this trademark.*)
 3,397,450. **FRIDAYMAID AND DESIGN**. YONG I. KIM, (U.S. CLS. 100, 103 AND 106). SN 77-146,931. PUB. 1-1-2008. FILED 4-3-2007.
 3,397,458 (*See Class 35 for this trademark.*)
 3,397,487. **PARAGON SLATE AND DESIGN**. PROBITY, LLC, (U.S. CLS. 100, 103 AND 106). SN 77-163,405. PUB. 1-1-2008. FILED 4-23-2007.
 3,397,493. **FOR MECHANICS KNOWN FOR THEIR WORK AND THEIR WORD, TRUST THE MIDAS TOUCH (BLOCK FORM)**. MIDAS INTERNATIONAL CORPORATION, (U.S. CLS. 100, 103 AND 106). SN 77-165,382. PUB. 1-1-2008. FILED 4-25-2007.
 3,397,494. **CONFÍA EN LOS QUE SABEN. MECÁNICOS MIDAS (BLOCK FORM)**. MIDAS INTERNATIONAL CORPORATION, (U.S. CLS. 100, 103 AND 106). SN 77-165,392. PUB. 1-1-2008. FILED 4-25-2007.
 3,397,498 (*See Class 2 for this trademark.*)
 3,397,504. **WATCH 9-1-1 (BLOCK FORM)**. KENNETH JAMES PEDERSEN, (U.S. CLS. 100, 103 AND 106). SN 77-168,157. PUB. 1-1-2008. FILED 4-27-2007.
 3,397,508. **SCRUBS CLEANING SERVICE AND DESIGN**. DIRSCHERL, DANIEL D., (U.S. CLS. 100, 103 AND 106). SN 77-169,529. PUB. 1-1-2008. FILED 4-30-2007.
 3,397,523 (*See Class 35 for this trademark.*)
 3,397,532. **RESTORATION WINDOWS.COM THE REPLACEMENT WINDOW ALTERNATIVE AND DESIGN**. RESTORATION WINDOWS, (U.S. CLS. 100, 103 AND 106). SN 77-179,539. PUB. 1-1-2008. FILED 5-12-2007.
 3,397,535. **PHOENIX BUILDING SOLUTIONS, INC. (BLOCK FORM)**. PHOENIX BUILDING SOLUTIONS, INC., (U.S. CLS. 100, 103 AND 106). SN 77-181,009. PUB. 1-1-2008. FILED 5-15-2007.
 3,397,589 (*See Class 36 for this trademark.*)
 3,397,596. **MISCELLANEOUS DESIGN**. GAHANNA-CREEK-SIDE INVESTMENTS LLC, (U.S. CLS. 100, 103 AND 106). SN 77-198,789. PUB. 1-1-2008. FILED 6-6-2007.
 3,397,603. **MORTENSON AND DESIGN**. M. A. MORTENSON COMPANY, MULTIPLE CLASS, (INT. CLS. 37 AND 45), (U.S. CLS. 100, 101, 103 AND 106). SN 77-200,428. PUB. 1-1-2008. FILED 6-7-2007.
 3,397,632. **KESSLER WOODS AND DESIGN**. HOLLEY, JAMES M., (U.S. CLS. 100, 103 AND 106). SN 77-206,310. PUB. 1-1-2008. FILED 6-14-2007.
 3,397,642. **MANSFIELD (BLOCK FORM)**. MANSFIELD OIL COMPANY OF GAINESVILLE, INC., (U.S. CLS. 100, 103 AND 106). SN 77-207,342. PUB. 1-1-2008. FILED 6-15-2007.
 3,397,666. **K-DIRECT (BLOCK FORM)**. EVERGREEN ENERGY INC., MULTIPLE CLASS, (INT. CLS. 37 AND 42), (U.S. CLS. 100, 101, 103 AND 106). SN 77-212,536. PUB. 1-1-2008. FILED 6-21-2007.
 3,397,676 (*See Class 35 for this trademark.*)
 3,397,685. **I'LL BEE THERE (BLOCK FORM)**. I'LL BEE THERE ANIMAL AND BEE REMOVAL, INC., (U.S. CLS. 100, 103 AND 106). SN 77-215,470. PUB. 1-1-2008. FILED 6-26-2007.
 3,397,735. **FORT SERVICES AND DESIGN**. TONY FORT SERVICES, LLC, (U.S. CLS. 100, 103 AND 106). SN 77-221,203. PUB. 1-1-2008. FILED 7-3-2007.
 3,397,759 (*See Class 36 for this trademark.*)
 3,397,766. **GO FROM GRAY TO GREAT (BLOCK FORM)**. COMFORT WINDOW CO., INC., (U.S. CLS. 100, 103 AND 106). SN 77-224,368. PUB. 1-1-2008. FILED 7-9-2007.
 3,397,797. **EL AND DESIGN**. EDIFICE, INC., (U.S. CLS. 100, 103 AND 106). SN 77-226,029. PUB. 1-1-2008. FILED 7-10-2007.
 3,397,820. **INNEREAM (BLOCK FORM)**. NOWAK PIPE REAMING, INC., (U.S. CLS. 100, 103 AND 106). SN 77-226,801. PUB. 1-1-2008. FILED 7-11-2007.
 3,397,864. **MISCELLANEOUS DESIGN**. CUSHING, EDWIN A., (U.S. CLS. 100, 103 AND 106). SN 77-227,851. PUB. 1-1-2008. FILED 7-12-2007.
 3,397,871. **THE SOLARMINIUMS (BLOCK FORM)**. HARE, KENNETH E., (U.S. CLS. 100, 103 AND 106). SN 77-227,926. PUB. 1-1-2008. FILED 7-12-2007.
 3,397,891. **ENCORE (BLOCK FORM)**. W.H. PAIGE AND CO., INC., MULTIPLE CLASS, (INT. CLS. 37 AND 41), (U.S. CLS. 100, 101, 103, 106 AND 107). SN 77-228,362. PUB. 1-1-2008. FILED 7-12-2007.

- 3,397,892. **ACTUALLY CLEAN (BLOCK FORM)**. JASON BAILEY, (U.S. CLS. 100, 103 AND 106). SN 77-228,368. PUB. 1-1-2008. FILED 7-12-2007.
- 3,397,927 (*See Class 36 for this trademark*).
- 3,397,934. **CALLAHAN CONSTRUCTION CC AND DESIGN**. CALLAHAN CONSTRUCTION, INC., (U.S. CLS. 100, 103 AND 106). SN 77-229,134. PUB. 1-1-2008. FILED 7-13-2007.
- 3,397,958 (*See Class 36 for this trademark*).
- 3,397,960 (*See Class 36 for this trademark*).
- 3,397,982. **THE NAME YOU KNOW, THE PEOPLE YOU TRUST (BLOCK FORM)**. COMFORT WINDOW CO., INC., (U.S. CLS. 100, 103 AND 106). SN 77-229,981. PUB. 1-1-2008. FILED 7-15-2007.
- 3,397,989. **PPE SAFETYWARE SERVICES (BLOCK FORM)**. GEAR WASH LLC, (U.S. CLS. 100, 103 AND 106). SN 77-230,200. PUB. 1-1-2008. FILED 7-16-2007.
- 3,398,060. **GROUNDZERO SERVICES (BLOCK FORM)**. GROUND ZERO SERVICES, LLC, (U.S. CLS. 100, 103 AND 106). SN 77-231,230. PUB. 1-1-2008. FILED 7-17-2007.
- 3,398,131. **FLOORS-2-LOVE (BLOCK FORM)**. LIQUID SOLID SURFACE FRANCHISING, LTD., (U.S. CLS. 100, 103 AND 106). SN 77-232,339. PUB. 1-1-2008. FILED 7-18-2007.
- 3,398,149. **WHEREVER YOU WALK (BLOCK FORM)**. LIQUID SOLID SURFACE FRANCHISING, LTD., (U.S. CLS. 100, 103 AND 106). SN 77-232,649. PUB. 1-1-2008. FILED 7-18-2007.
- 3,398,153. **EDGE-TO-EDGE ADVANTAGE (BLOCK FORM)**. PATIO ENCLOSURES, INC., (U.S. CLS. 100, 103 AND 106). SN 77-232,728. PUB. 1-1-2008. FILED 7-18-2007.
- 3,398,161. **YOU DON'T JUST NEED A PLUMBER....YOU NEED A LITTLE TLC (BLOCK FORM)**. TLC COMPANY INC., (U.S. CLS. 100, 103 AND 106). SN 77-232,815. PUB. 1-1-2008. FILED 7-18-2007.
- 3,398,164. **SERVICWORKS (BLOCK FORM)**. THE MATWORKS COMPANY, LLC, (U.S. CLS. 100, 103 AND 106). SN 77-232,899. PUB. 1-1-2008. FILED 7-18-2007.
- 3,398,168. **BUG BITES (BLOCK FORM)**. CENTEX CORPORATION, (U.S. CLS. 100, 103 AND 106). SN 77-232,976. PUB. 1-1-2008. FILED 7-18-2007.
- 3,398,190. **X OUT AND DESIGN**. X-OUT PEST SERVICES, LLC, (U.S. CLS. 100, 103 AND 106). SN 77-233,527. PUB. 1-1-2008. FILED 7-19-2007.
- 3,398,191. **X OUT (BLOCK FORM)**. X-OUT PEST SERVICES, LLC, (U.S. CLS. 100, 103 AND 106). SN 77-233,535. PUB. 1-1-2008. FILED 7-19-2007.
- 3,398,330 (*See Class 12 for this trademark*).
- 3,398,344. **MISCELLANEOUS DESIGN**. CENTEX CORPORATION, (U.S. CLS. 100, 103 AND 106). SN 77-279,088. PUB. 1-1-2008. FILED 9-13-2007.
- 3,398,345. **EFFICIENT-C (BLOCK FORM)**. CENTEX CORPORATION, (U.S. CLS. 100, 103 AND 106). SN 77-279,091. PUB. 1-1-2008. FILED 9-13-2007.
- 3,398,360 (*See Class 7 for this trademark*).
- 3,398,371 (*See Class 14 for this trademark*).
- 3,398,381 (*See Class 35 for this trademark*).
- 3,398,383. **CONTECH (BLOCK FORM)**. CONTECH CONSTRUCTION PRODUCTS INC., MULTIPLE CLASS, (INT. CLS. 37 AND 40), (U.S. CLS. 100, 103 AND 106). SN 78-521,296. PUB. 1-1-2008. FILED 11-22-2004.
- 3,398,384 (*See Class 14 for this trademark*).
- 3,398,413. **APEX DIGITAL, LLC AND DESIGN**. DYCOM IDENTITY, LLC, (U.S. CLS. 100, 103 AND 106). SN 78-665,531. PUB. 11-27-2007. FILED 7-7-2005.
- 3,398,414. **APEX DIGITAL (BLOCK FORM)**. DYCOM IDENTITY, LLC, (U.S. CLS. 100, 103 AND 106). SN 78-665,536. PUB. 11-27-2007. FILED 7-7-2005.
- 3,398,415. **APEX (BLOCK FORM)**. DYCOM IDENTITY, LLC, (U.S. CLS. 100, 103 AND 106). SN 78-665,688. PUB. 11-27-2007. FILED 7-7-2005.
- 3,398,421. **NORMENT (BLOCK FORM)**. NORMENT SECURITY GROUP, INC., MULTIPLE CLASS, (INT. CLS. 37 AND 42), (U.S. CLS. 100, 101, 103 AND 106). SN 78-679,901. PUB. 1-1-2008. FILED 7-27-2005.
- 3,398,440 (*See Class 36 for this trademark*).
- 3,398,458 (*See Class 35 for this trademark*).
- 3,398,488. **BRINGING THE POWER OF TOMORROW TO BUSINESS TODAY (BLOCK FORM)**. OSAM DOCUMENT SOLUTIONS INC, MULTIPLE CLASS, (INT. CLS. 37 AND 42), (U.S. CLS. 100, 101, 103 AND 106). SN 78-826,760. PUB. 1-1-2008. FILED 3-1-2006.
- 3,398,555 (*See Class 35 for this trademark*).
- 3,398,560 (*See Class 9 for this trademark*).
- 3,398,582 (*See Class 35 for this trademark*).
- 3,398,590 (*See Class 35 for this trademark*).
- 3,398,600 (*See Class 3 for this trademark*).
- 3,398,653 (*See Class 9 for this trademark*).
- 3,398,684 (*See Class 7 for this trademark*).
- 3,398,715 (*See Class 10 for this trademark*).
- 3,398,719 (*See Class 10 for this trademark*).
- 3,398,723 (*See Class 19 for this trademark*).
- 3,398,734 (*See Class 7 for this trademark*).
- 3,398,735 (*See Class 7 for this trademark*).
- 3,398,760 (*See Class 9 for this trademark*).
- 3,398,764 (*See Class 4 for this trademark*).
- 3,398,795 (*See Class 12 for this trademark*).
- 3,398,832 (*See Class 20 for this trademark*).

CLASS 38—COMMUNICATION

- 3,396,839 (*See Class 35 for this trademark*).
- 3,396,955. **KFSH (BLOCK FORM)**. SALEM COMMUNICATIONS HOLDING CORPORATION, (U.S. CLS. 100, 101 AND 104). SN 77-000,591. PUB. 1-1-2008. FILED 9-15-2006.
- 3,396,966 (*See Class 9 for this trademark*).
- 3,396,971. **SPOT ON NETWORKS (BLOCK FORM)**. SPOT-ON NETWORKS, LLC, (U.S. CLS. 100, 101 AND 104). SN 77-007,655. PUB. 1-1-2008. FILED 9-26-2006.
- 3,396,982. **KFAX (BLOCK FORM)**. SALEM COMMUNICATIONS HOLDING CORPORATION, (U.S. CLS. 100, 101 AND 104). SN 77-014,602. PUB. 1-1-2008. FILED 10-5-2006.
- 3,396,984. **KFIS (BLOCK FORM)**. SALEM COMMUNICATIONS HOLDING CORPORATION, (U.S. CLS. 100, 101 AND 104). SN 77-015,099. PUB. 1-1-2008. FILED 10-5-2006.
- 3,396,987. **KKFS (BLOCK FORM)**. SALEM COMMUNICATIONS HOLDING CORPORATION, (U.S. CLS. 100, 101 AND 104). SN 77-015,804. PUB. 1-1-2008. FILED 10-6-2006.
- 3,396,999. **KGU (BLOCK FORM)**. SALEM COMMUNICATIONS HOLDING CORPORATION, (U.S. CLS. 100, 101 AND 104). SN 77-022,814. PUB. 1-1-2008. FILED 10-17-2006.
- 3,397,001. **KKLA (BLOCK FORM)**. SALEM COMMUNICATIONS HOLDING CORPORATION, (U.S. CLS. 100, 101 AND 104). SN 77-023,942. PUB. 1-1-2008. FILED 10-18-2006.
- 3,397,011. **HTC TECHNOLOGIES AND DESIGN**. HTC HOLDING CO., (U.S. CLS. 100, 101 AND 104). SN 77-025,999. PUB. 1-1-2008. FILED 10-20-2006.
- 3,397,015. **KCBQ (BLOCK FORM)**. SALEM COMMUNICATIONS HOLDING CORPORATION, (U.S. CLS. 100, 101 AND 104). SN 77-026,974. PUB. 1-1-2008. FILED 10-23-2006.
- 3,397,026. **KRLA (BLOCK FORM)**. SALEM COMMUNICATIONS HOLDING CORPORATION, (U.S. CLS. 100, 101 AND 104). SN 77-030,115. PUB. 1-1-2008. FILED 10-26-2006.
- 3,397,041. **PUNKY MOMS (BLOCK FORM)**. PUNKY MOMS, (U.S. CLS. 100, 101 AND 104). SN 77-035,088. PUB. 1-1-2008. FILED 11-2-2006.
- 3,397,069. **COAST TO COAST (BLOCK FORM)**. WLF | THE WILLIAMS LAW FIRM, PC, MULTIPLE CLASS, (INT. CLS. 38 AND 41), (U.S. CLS. 100, 101, 104 AND 107). SN 77-045,548. PUB. 1-1-2008. FILED 11-16-2006.
- 3,397,091. **ONE SIMPLE CONNECTION (BLOCK FORM)**. US CABLE OF COASTAL TEXAS, (U.S. CLS. 100, 101 AND 104). SN 77-050,993. PUB. 1-1-2008. FILED 11-27-2006.
- 3,397,138. **WINNING SPORTS PLAYS (BLOCK FORM)**. PATRICK, RICHARD V., MULTIPLE CLASS, (INT. CLS. 38 AND 41), (U.S. CLS. 100, 101, 104 AND 107). SN 77-062,186. PUB. 1-1-2008. FILED 12-12-2006.
- 3,397,143. **THE BLACK COFFEE CHANNEL (BLOCK FORM)**. WELCH, CEDRIC, (U.S. CLS. 100, 101 AND 104). SN 77-062,976. PUB. 1-1-2008. FILED 12-13-2006.
- 3,397,167 (*See Class 35 for this trademark*).
- 3,397,237. **DIGERATI NETWORKS AND DESIGN**. ATSI COMMUNICATIONS, INC., (U.S. CLS. 100, 101 AND 104). SN 77-077,155. PUB. 1-1-2008. FILED 1-5-2007.
- 3,397,319. **JUMP MOBILE (STYLIZED)**. CRICKET COMMUNICATIONS, INC., (U.S. CLS. 100, 101 AND 104). SN 77-

- 098,180. PUB. 1-1-2008. FILED 2-2-2007.
- 3,397,320. **I ISTARLIVE AND DESIGN**. UNITED IMPACT MEDIA, MULTIPLE CLASS, (INT. CLS. 38 AND 42), (U.S. CLS. 100, 101 AND 104). SN 77-098,631. PUB. 1-1-2008. FILED 2-3-2007.
- 3,397,368. **TRAVELPOD (BLOCK FORM)**. TRIPADVISOR LLC, MULTIPLE CLASS, (INT. CLS. 38, 39, 41, 42 AND 43), (U.S. CLS. 100, 101, 104, 105 AND 107). SN 77-112,122. PUB. 1-1-2008. FILED 2-21-2007.
- 3,397,439. **OCTOPUS OPEN (BLOCK FORM)**. DEUTSCHE TELEKOM AG, (U.S. CLS. 100, 101 AND 104). SN 77-141,737. PUB. 1-1-2008. FILED 3-27-2007.
- 3,397,518 (*See Class 16 for this trademark*).
- 3,397,564 (*See Class 35 for this trademark*).
- 3,397,587 (*See Class 28 for this trademark*).
- 3,397,648. **SCLAFANI WILLIAMS (BLOCK FORM)**. WILLIAMS, FREIDA SCLAFANI, MULTIPLE CLASS, (INT. CLS. 38, 41 AND 42), (U.S. CLS. 100, 101, 104 AND 107). SN 77-209,227. PUB. 1-1-2008. FILED S.R. 6-19-2007; AM. P.R. 10-24-2007.
- 3,397,663. **DCTV (BLOCK FORM)**. PUBLIC ACCESS CORPORATION OF THE DISTRICT OF COLUMBIA, (U.S. CLS. 100, 101 AND 104). SN 77-212,105. PUB. 1-1-2008. FILED 6-21-2007.
- 3,397,722. **TUVISION AND DESIGN**. TELEVISION DE LAS AMERICAS, LLC, MULTIPLE CLASS, (INT. CLS. 38 AND 41), (U.S. CLS. 100, 101, 104 AND 107). SN 77-219,299. PUB. 1-1-2008. FILED 6-29-2007.
- 3,397,760. **NO LINE LEFT BEHIND (BLOCK FORM)**. ERNEST COMMUNICATIONS, INC., (U.S. CLS. 100, 101 AND 104). SN 77-213,303. PUB. 1-1-2008. FILED 7-6-2007.
- 3,397,812 (*See Class 9 for this trademark*).
- 3,397,956. **DAILY DOSE (BLOCK FORM)**. LIMELIFE, INC., (U.S. CLS. 100, 101 AND 104). SN 77-229,513. PUB. 1-1-2008. FILED 7-13-2007.
- 3,397,986. **PHILIP (BLOCK FORM)**. ATZEMOGLOU, GEORGIOS FILIPPOS, DBA ATZEMOGLOU, GEORGE PHILIP, MULTIPLE CLASS, (INT. CLS. 38 AND 42), (U.S. CLS. 100, 101 AND 104). SN 77-230,077. PUB. 1-1-2008. FILED 7-16-2007.
- 3,398,087. **OUTDOOR CHANNEL AND DESIGN**. THE OUTDOOR CHANNEL, INC., MULTIPLE CLASS, (INT. CLS. 38 AND 41), (U.S. CLS. 100, 101, 104 AND 107). SN 77-231,686. PUB. 1-1-2008. FILED 7-17-2007.
- 3,398,349 (*See Class 9 for this trademark*).
- 3,398,354 (*See Class 9 for this trademark*).
- 3,398,410. **JC-TV (BLOCK FORM)**. TRINITY CHRISTIAN CENTER OF SANTA ANA, INC., MULTIPLE CLASS, (INT. CLS. 38 AND 41), (U.S. CLS. 100, 101, 104 AND 107). SN 78-641,329. PUB. 1-1-2008. FILED 6-1-2005.
- 3,398,443 (*See Class 35 for this trademark*).
- 3,398,458 (*See Class 35 for this trademark*).
- 3,398,466 (*See Class 9 for this trademark*).
- 3,398,485 (*See Class 35 for this trademark*).
- 3,398,614 (*See Class 9 for this trademark*).
- 3,398,621 (*See Class 9 for this trademark*).
- 3,398,637 (*See Class 9 for this trademark*).
- 3,398,659 (*See Class 9 for this trademark*).
- 3,398,660 (*See Class 9 for this trademark*).
- 3,398,686 (*See Class 9 for this trademark*).
- 3,398,701 (*See Class 9 for this trademark*).
- 3,398,709 (*See Class 9 for this trademark*).
- 3,398,711 (*See Class 9 for this trademark*).
- 3,398,717 (*See Class 9 for this trademark*).
- 3,398,735 (*See Class 7 for this trademark*).
- 3,398,761 (*See Class 35 for this trademark*).
- 3,398,783. **GOMEDIA (BLOCK FORM)**. MOMAC B.V., (U.S. CLS. 100, 101 AND 104). SN 79-037,297. PUB. 1-1-2008. FILED 2-26-2007.
- 3,398,813 (*See Class 9 for this trademark*).
- 3,398,822 (*See Class 9 for this trademark*).
- 3,396,881 (*See Class 35 for this trademark*).
- 3,396,954. **BOSTON PARTY TOURS AND DESIGN**. BOSTON PARTY TOURS, INC., (U.S. CLS. 100 AND 105). SN 77-000,490. PUB. 1-1-2008. FILED 9-15-2006.
- 3,396,960 (*See Class 35 for this trademark*).
- 3,396,997. **CELEBRITY JET CHARTER ABOVE ALL AND DESIGN**. CELEBRITY JET CHARTER, LLC, (U.S. CLS. 100 AND 105). SN 77-022,022. PUB. 1-1-2008. FILED 10-16-2006.
- 3,397,003. **ENCORE AVIATION (BLOCK FORM)**. DERRY-BERRY, DOUGLAS, (U.S. CLS. 100 AND 105). SN 77-024,167. PUB. 1-1-2008. FILED 10-18-2006.
- 3,397,060. **PROJECT RISE AND DESIGN**. PROJECT R.I.S.E., INC., MULTIPLE CLASS, (INT. CLS. 39 AND 41), (U.S. CLS. 100, 101, 105 AND 107). SN 77-042,521. PUB. 1-1-2008. FILED 11-13-2006.
- 3,397,241 (*See Class 35 for this trademark*).
- 3,397,268. **EXCURSION SOCIETY (BLOCK FORM)**. CARLSON TRAVEL GROUP, INC., (U.S. CLS. 100 AND 105). SN 77-086,460. PUB. 1-1-2008. FILED 1-19-2007.
- 3,397,297. **ROCKIN BOXES AND DESIGN**. DEVON GLENN, (U.S. CLS. 100 AND 105). SN 77-095,031. PUB. 1-1-2008. FILED 1-30-2007.
- 3,397,368 (*See Class 38 for this trademark*).
- 3,397,405. **DIVERSITY. DELIVERED. (BLOCK FORM)**. DEHCO, INC., (U.S. CLS. 100 AND 105). SN 77-127,694. PUB. 1-1-2008. FILED 3-10-2007.
- 3,397,427. **SPAGRAMS AND DESIGN**. ULTRA RAYZ, INC., (U.S. CLS. 100 AND 105). SN 77-137,700. PUB. 1-1-2008. FILED 3-22-2007.
- 3,397,522. **TRIP DOGS TRAVEL (BLOCK FORM)**. TRIP DOGS TRAVEL SERVICES, LLC, (U.S. CLS. 100 AND 105). SN 77-175,509. PUB. 1-1-2008. FILED 5-8-2007.
- 3,397,523 (*See Class 35 for this trademark*).
- 3,397,634. **CREATION TECHNOLOGIES (BLOCK FORM)**. CREATION TECHNOLOGIES, (U.S. CLS. 100 AND 105). SN 77-206,759. PUB. 1-1-2008. FILED 6-14-2007.
- 3,397,641 (*See Class 4 for this trademark*).
- 3,397,651. **MAIL FOR YOU INC (BLOCK FORM)**. MAIL FOR YOU INC., (U.S. CLS. 100 AND 105). SN 77-210,064. PUB. 1-1-2008. FILED 6-19-2007.
- 3,397,678. **COME PLAY YOUR WAY (BLOCK FORM)**. WASHINGTON COUNTY VISITORS ASSOCIATION, (U.S. CLS. 100 AND 105). SN 77-214,983. PUB. 1-1-2008. FILED 6-25-2007.
- 3,397,687. **OUR BUSINESS IS MOVING (BLOCK FORM)**. ALL WAYS MOVING & STORAGE, (U.S. CLS. 100 AND 105). SN 77-215,489. PUB. 1-1-2008. FILED S.R. 6-26-2007; AM. P.R. 11-29-2007.
- 3,397,738. **JETHERE AND DESIGN**. WAYNE C. HENDERSON, (U.S. CLS. 100 AND 105). SN 77-221,518. PUB. 1-1-2008. FILED 7-3-2007.
- 3,397,763. **TRAVELICIOUS (BLOCK FORM)**. MACK, NICHOLAS, (U.S. CLS. 100 AND 105). SN 77-223,896. PUB. 1-1-2008. FILED 7-6-2007.
- 3,397,809. **AG DEPOT D AND DESIGN**. UAP DISTRIBUTION, INC., MULTIPLE CLASS, (INT. CLS. 39 AND 40), (U.S. CLS. 100, 103, 105 AND 106). SN 77-226,343. PUB. 1-1-2008. FILED 7-10-2007.
- 3,397,959. **BROWN BAG NATURALS AND DESIGN**. BROWN BAG NATURALS, (U.S. CLS. 100 AND 105). SN 77-229,585. PUB. 1-1-2008. FILED 7-13-2007.
- 3,397,971. **BACKUP FREEDOM (STYLIZED)**. RC GENERAL ENTERPRISES, INC., (U.S. CLS. 100 AND 105). SN 77-229,769. PUB. 1-1-2008. FILED 7-13-2007.
- 3,398,067. **DUMPMATCH (BLOCK FORM)**. DUMPMATCH, LLC, (U.S. CLS. 100 AND 105). SN 77-231,323. PUB. 1-1-2008. FILED 7-17-2007.
- 3,398,070 (*See Class 35 for this trademark*).
- 3,398,166. **PAUL TRANSPORTATION INC. AND DESIGN**. PAUL TRANSPORTATION, INC., (U.S. CLS. 100 AND 105). SN 77-232,948. PUB. 1-1-2008. FILED 7-18-2007.
- 3,398,217. **MERMAIDS CRUISE AND DESIGN**. SAN FRANCISCO BAY BOAT CRUISES, LLC, (U.S. CLS. 100 AND 105). SN 77-234,210. PUB. 1-1-2008. FILED 7-19-2007.
- 3,398,330 (*See Class 12 for this trademark*).
- 3,398,381 (*See Class 35 for this trademark*).
- 3,398,416. **T DEUTSCHE TELEKOM AND DESIGN**. DEUTSCHE TELEKOM AG, (U.S. CLS. 100 AND 105). SN

CLASS 39—TRANSPORTATION AND STORAGE

3,396,842 (*See Class 35 for this trademark*).

- 78-667,232. PUB. 1-1-2008. FILED 7-11-2005.
- 3,398,434. **AIR AMBULANCE SPECIALISTS, INC. WHEN QUALITY AND TRUST COUNTS AND DESIGN.** AIR AMBULANCE SPECIALISTS, INC., (U.S. CLS. 100 AND 105). SN 78-713,227. PUB. 1-1-2008. FILED 9-14-2005.
- 3,398,443 (*See Class 35 for this trademark.*).
- 3,398,455. **TR TARGA AND DESIGN.** TARGA RESOURCES, INC., (U.S. CLS. 100 AND 105). SN 78-765,091. PUB. 1-1-2008. FILED 12-1-2005.
- 3,398,464 (*See Class 16 for this trademark.*).
- 3,398,528. **DE VINO'S PIZZA AND DESIGN.** RMLL INC, MULTIPLE CLASS, (INT. CLS. 39 AND 43), (U.S. CLS. 100, 101 AND 105). SN 78-874,028. PUB. 1-1-2008. FILED 5-2-2006.
- 3,398,564. **MR. PORTER (BLOCK FORM).** PORTER AVIATION HOLDINGS INC., (U.S. CLS. 100 AND 105). SN 78-922,513. PUB. 1-1-2008. FILED 7-5-2006.
- 3,398,573. **VIATOR (BLOCK FORM).** VIATOR, INC., MULTIPLE CLASS, (INT. CLS. 39, 41, 43 AND 44), (U.S. CLS. 100, 101, 105 AND 107). SN 78-931,291. PUB. 10-2-2007. FILED 7-17-2006.
- 3,398,608. **YOUR WINDOW TO THE MAYAN RIVIERA (BLOCK FORM).** LATIN AMERICAN ONLINE SERVICES, INC., MULTIPLE CLASS, (INT. CLS. 39, 42 AND 43), (U.S. CLS. 100, 101 AND 105). SN 78-970,445. PUB. 1-1-2008. FILED 9-8-2006.
- 3,398,619 (*See Class 7 for this trademark.*).
- 3,398,686 (*See Class 9 for this trademark.*).
- 3,398,693. **UPGRADE TO BRITISH AIRWAYS (BLOCK FORM).** BRITISH AIRWAYS PLC, MULTIPLE CLASS, (INT. CLS. 39 AND 43), (U.S. CLS. 100, 101 AND 105). SN 79-032,033. PUB. 1-1-2008. FILED 11-15-2006.
- 3,398,698 (*See Class 35 for this trademark.*).
- 3,398,717 (*See Class 9 for this trademark.*).
- 3,398,764 (*See Class 4 for this trademark.*).
- 3,398,785. **KEOLIS MOVING FURTHER TOGETHER AND DESIGN.** KEOLIS, (U.S. CLS. 100 AND 105). SN 79-038,169. PUB. 1-1-2008. FILED 3-23-2007.
- 3,398,795 (*See Class 12 for this trademark.*).
- DONALD C., (U.S. CLS. 100, 103 AND 106). SN 77-215,283. PUB. 1-1-2008. FILED 6-26-2007.
- 3,397,689. **OWEN BIOSCIENCES (BLOCK FORM).** OWEN BIOSCIENCES, INC., (U.S. CLS. 100, 103 AND 106). SN 77-215,857. PUB. 1-1-2008. FILED 6-26-2007.
- 3,397,750 (*See Class 9 for this trademark.*).
- 3,397,771 (*See Class 19 for this trademark.*).
- 3,397,809 (*See Class 39 for this trademark.*).
- 3,397,902. **STOP-N-GO LINE (BLOCK FORM).** GOLDEN APPLIX CO., INC., (U.S. CLS. 100, 103 AND 106). SN 77-228,767. PUB. 1-1-2008. FILED 7-13-2007.
- 3,397,918. **JABIL AND DESIGN.** JABIL CIRCUIT, INC., MULTIPLE CLASS, (INT. CLS. 40 AND 42), (U.S. CLS. 100, 101, 103 AND 106). SN 77-228,952. PUB. 1-1-2008. FILED 7-13-2007.
- 3,398,002. **GEOPLASMA (BLOCK FORM).** GEOPLASMA, LLC, (U.S. CLS. 100, 103 AND 106). SN 77-230,402. PUB. 1-1-2008. FILED 7-16-2007.
- 3,398,053. **SONOCO RECYCLING AND DESIGN.** SPC RESOURCES, INC., (U.S. CLS. 100, 103 AND 106). SN 77-231,091. PUB. 1-1-2008. FILED 7-17-2007.
- 3,398,364. **RAPID CASTING (BLOCK FORM).** RAPID PRODUCT DEVELOPMENT GROUP, INC., (U.S. CLS. 100, 103 AND 106). SN 78-370,795. PUB. 1-1-2008. FILED 2-19-2004.
- 3,398,383 (*See Class 37 for this trademark.*).
- 3,398,384 (*See Class 14 for this trademark.*).
- 3,398,506. **HAYNES (BLOCK FORM).** R AND J CORPORATION, DBA HAYNES MANUFACTURING COMPANY, (U.S. CLS. 100, 103 AND 106). SN 78-849,053. PUB. 1-1-2008. FILED 3-29-2006.
- 3,398,520 (*See Class 35 for this trademark.*).
- 3,398,555 (*See Class 35 for this trademark.*).
- 3,398,579. **ALL BIOLOGY NEEDS A LITTLE CHEMISTRY (BLOCK FORM).** THERMO FISHER SCIENTIFIC (MILWAUKEE) LLC, (U.S. CLS. 100, 103 AND 106). SN 78-937,220. PUB. 8-7-2007. FILED 7-25-2006.
- 3,398,580. **YOU IMAGINE IT. WE CREATE IT. (BLOCK FORM).** THERMO FISHER SCIENTIFIC (MILWAUKEE) LLC, (U.S. CLS. 100, 103 AND 106). SN 78-937,236. PUB. 8-7-2007. FILED 7-25-2006.
- 3,398,582 (*See Class 35 for this trademark.*).
- 3,398,585. **ACCIONA PIONEERS IN DEVELOPMENT AND SUSTAINABILITY (BLOCK FORM).** ACCIONA, S.A., (U.S. CLS. 100, 103 AND 106). SN 78-953,671. PUB. 1-1-2008. FILED 8-16-2006.
- 3,398,696 (*See Class 7 for this trademark.*).
- 3,398,753 (*See Class 1 for this trademark.*).
- 3,398,804 (*See Class 35 for this trademark.*).

CLASS 40—MATERIAL TREATMENT

- 3,396,879. **VARIX (BLOCK FORM).** ALLAIRE, ROSS, (U.S. CLS. 100, 103 AND 106). SN 76-669,097. PUB. 1-1-2008. FILED 11-16-2006.
- 3,396,913 (*See Class 35 for this trademark.*).
- 3,396,951. **HURRICANE LINE AND DESIGN.** LA BELLE TIME, (U.S. CLS. 100, 103 AND 106). SN 76-679,929. PUB. 1-1-2008. FILED 7-26-2007.
- 3,397,075. **GET YOUR FILL (BLOCK FORM).** HYALURON, INC., (U.S. CLS. 100, 103 AND 106). SN 77-047,137. PUB. 1-1-2008. FILED 11-17-2006.
- 3,397,084. **ALLSTAR FRESH WATER SYSTEMS AND DESIGN.** ALLSTAR WATER SYSTEMS, INC., (U.S. CLS. 100, 103 AND 106). SN 77-049,324. PUB. 1-1-2008. FILED 11-21-2006.
- 3,397,385. **BULL HEAD PRODUCTS AND DESIGN.** CHUDINA JR, GEORGE J, (U.S. CLS. 100, 103 AND 106). SN 77-119,959. PUB. 1-1-2008. FILED 3-1-2007.
- 3,397,397 (*See Class 16 for this trademark.*).
- 3,397,537 (*See Class 9 for this trademark.*).
- 3,397,635. **CREATION TECHNOLOGIES (BLOCK FORM).** CREATION TECHNOLOGIES, (U.S. CLS. 100, 103 AND 106). SN 77-206,764. PUB. 1-1-2008. FILED 6-14-2007.
- 3,397,638. **UNITED CALIFORNIA RETURNS (BLOCK FORM).** UNITED CALIFORNIA RETURNS, (U.S. CLS. 100, 103 AND 106). SN 77-207,155. PUB. 1-1-2008. FILED 6-15-2007.
- 3,397,639. **THINK BLUE, LIVE GREEN (BLOCK FORM).** UNITED CALIFORNIA RETURNS, (U.S. CLS. 100, 103 AND 106). SN 77-207,161. PUB. 1-1-2008. FILED 6-15-2007.
- 3,397,640. **MISCELLANEOUS DESIGN.** UNITED CALIFORNIA RETURNS, (U.S. CLS. 100, 103 AND 106). SN 77-207,171. PUB. 1-1-2008. FILED 6-15-2007.
- 3,397,674. **FOXFIRE ENTERPRISES INC. AND DESIGN.** FOXFIRE ENTERPRISES, INC., (U.S. CLS. 100, 103 AND 106). SN 77-213,625. PUB. 1-1-2008. FILED 6-22-2007.
- 3,397,680. **GATOR MACHINE SHOP (BLOCK FORM).** BRITT,

CLASS 41—EDUCATION AND ENTERTAINMENT

- 3,396,828. **STORM SOCCER EL PASO, TEXAS EST. 00' AND DESIGN.** PORTILLO, EDMUNDO, (U.S. CLS. 100, 101 AND 107). SN 76-563,900. PUB. 6-14-2005. FILED 12-8-2003.
- 3,396,848 (*See Class 9 for this trademark.*).
- 3,396,857. **KENT TRAILS AND DESIGN.** KENT COUNTY, (U.S. CLS. 100, 101 AND 107). SN 76-659,258. PUB. 1-1-2008. FILED 4-28-2006.
- 3,396,859 (*See Class 9 for this trademark.*).
- 3,396,860. **CHILDCARE EDUCATION INSTITUTE AND DESIGN.** CHILDCARE EDUCATION INSTITUTE, LLC, (U.S. CLS. 100, 101 AND 107). SN 76-661,144. PUB. 1-1-2008. FILED 6-6-2006.
- 3,396,863. **PURPLE SKY (STYLIZED).** CLEAR PHOENIX MEDIA, (U.S. CLS. 100, 101 AND 107). SN 76-663,124. PUB. 1-1-2008. FILED 7-17-2006.
- 3,396,866. **THINK ABOUT TOMORROW (BLOCK FORM).** MASSACHUSETTS HIGHER EDUCATION ASSISTANCE CORPORATION, DBA AMERICAN STUDENT ASSISTANCE, (U.S. CLS. 100, 101 AND 107). SN 76-664,488. PUB. 1-1-2008. FILED 8-11-2006.
- 3,396,873. **WTTU WORLD TRADITIONAL TAEKWONDO UNION AND DESIGN.** AMERICAN TAEKWONDO ASSOCIATION, INC., DBA AMERICAN TAEKWONDO ASSOCIATION, (U.S. CLS. 100, 101 AND 107). SN 76-668,358.

- PUB. 1-1-2008. FILED 11-1-2006.
 3,396,881 (*See Class 35 for this trademark*).
 3,396,891. **FIRST CHILDREN'S FINANCE AND DESIGN.** FIRST CHILDREN'S FINANCE, (U.S. CLS. 100, 101 AND 107). SN 76-670,320. PUB. 1-1-2008. FILED 12-14-2006.
 3,396,901 (*See Class 9 for this trademark*).
 3,396,904. **ABILITY MOUNTAIN AND DESIGN.** ABILITY MOUNTAIN INSTITUTE, (U.S. CLS. 100, 101 AND 107). SN 76-673,232. PUB. 1-1-2008. FILED 2-26-2007.
 3,396,922 (*See Class 35 for this trademark*).
 3,396,926 (*See Class 35 for this trademark*).
 3,396,936. **PURE REALITY SET APART BY DIVINE DESIGN AND DESIGN.** ALBERT C. PIERRE COMMUNITY SERVICE CENTER, INC., (U.S. CLS. 100, 101 AND 107). SN 76-679,043. PUB. 1-1-2008. FILED 7-2-2007.
 3,396,959. **K AND DESIGN.** CYBERNET ENTERTAINMENT, LLC, (U.S. CLS. 100, 101 AND 107). SN 77-001,274. PUB. 9-25-2007. FILED 9-18-2006.
 3,396,981 (*See Class 16 for this trademark*).
 3,396,983. **"WE BUILD LEADERS, ONE BLACKBELT AT A TIME." (BLOCK FORM).** AUTHENTIC MARTIAL ARTS INTERNATIONAL, INC., (U.S. CLS. 100, 101 AND 107). SN 77-014,777. PUB. 1-1-2008. FILED 10-5-2006.
 3,396,992 (*See Class 9 for this trademark*).
 3,396,993. **YOUR HEALTH. YOUR LIFE. YOUR CLUB. (BLOCK FORM).** WEST COAST ATHLETIC CLUBS, INC., (U.S. CLS. 100, 101 AND 107). SN 77-019,661. PUB. 1-1-2008. FILED 10-12-2006.
 3,397,016. **PPI (BLOCK FORM).** PACIFIC PENSION INSTITUTE, A PUBLIC BENEFIT CORPORATION, (U.S. CLS. 100, 101 AND 107). SN 77-027,370. PUB. 1-1-2008. FILED 10-23-2006.
 3,397,024. **PINE GROVE (BLOCK FORM).** FORREST GENERAL HOSPITAL, MULTIPLE CLASS, (INT. CLS. 41, 44 AND 45), (U.S. CLS. 100, 101 AND 107). SN 77-029,822. PUB. 1-1-2008. FILED 10-26-2006.
 3,397,025. **PINE GROVE BEHAVIORAL HEALTH & ADDICTION SERVICES AND DESIGN.** FORREST GENERAL HOSPITAL, MULTIPLE CLASS, (INT. CLS. 41, 44 AND 45), (U.S. CLS. 100, 101 AND 107). SN 77-029,844. PUB. 1-1-2008. FILED 10-26-2006.
 3,397,032. **ONE PLACE. MANY SOLUTIONS. (BLOCK FORM).** FORREST GENERAL HOSPITAL, MULTIPLE CLASS, (INT. CLS. 41, 44 AND 45), (U.S. CLS. 100, 101 AND 107). SN 77-032,312. PUB. 1-1-2008. FILED 10-30-2006.
 3,397,040 (*See Class 9 for this trademark*).
 3,397,051 (*See Class 5 for this trademark*).
 3,397,060 (*See Class 39 for this trademark*).
 3,397,069 (*See Class 38 for this trademark*).
 3,397,070 (*See Class 9 for this trademark*).
 3,397,073. **WE'LL SHARE & SAVE & SPEND SMART TOO! (BLOCK FORM).** LANZA ENTERTAINMENT COMPANY, LLC, (U.S. CLS. 100, 101 AND 107). SN 77-046,711. PUB. 1-1-2008. FILED 11-17-2006.
 3,397,079. **ISTEC (STYLIZED).** ISTEC, INC., MULTIPLE CLASS, (INT. CLS. 41 AND 42), (U.S. CLS. 100, 101 AND 107). SN 77-047,869. PUB. 1-1-2008. FILED 11-20-2006.
 3,397,082. **EPISCOPAL CHURCH CENTER (BLOCK FORM).** THE EPISCOPAL CHURCH, (U.S. CLS. 100, 101 AND 107). SN 77-048,514. PUB. 1-1-2008. FILED 11-21-2006.
 3,397,097. **GEORGIA EDUCATIONAL TECHNOLOGY CONSORTIUM, INC. AND DESIGN.** GEORGIA EDUCATIONAL TECHNOLOGY CONSORTIUM, INC., (U.S. CLS. 100, 101 AND 107). SN 77-052,576. PUB. 1-1-2008. FILED 11-29-2006.
 3,397,103. **MUSIC CITY CONNECTION: HEROES BEHIND THE HITS (BLOCK FORM).** NASHVILLE CONVENTION & VISITORS BUREAU, (U.S. CLS. 100, 101 AND 107). SN 77-053,950. PUB. 1-1-2008. FILED 11-30-2006.
 3,397,110 (*See Class 9 for this trademark*).
 3,397,119. **GOLFNOW.COM THE POWER TO PLAY MORE AND DESIGN.** GOLFNOW INC., (U.S. CLS. 100, 101 AND 107). SN 77-057,700. PUB. 1-1-2008. FILED 12-5-2006.
 3,397,122 (*See Class 9 for this trademark*).
 3,397,124. **PHILLY'S HOME GAME (BLOCK FORM).** GREENWOOD FINANCE, INC., (U.S. CLS. 100, 101 AND 107). SN 77-058,400. PUB. 1-1-2008. FILED 12-6-2006.
 3,397,125 (*See Class 35 for this trademark*).
 3,397,138 (*See Class 38 for this trademark*).
 3,397,151. **SCHMOOZ-A-PALOOZA (BLOCK FORM).** SN EVENTS INC., (U.S. CLS. 100, 101 AND 107). SN 77-064,020. PUB. 1-1-2008. FILED 12-14-2006.
 3,397,156. **NUMBTHUMB (BLOCK FORM).** NUMBTHUMB-COM LLC, (U.S. CLS. 100, 101 AND 107). SN 77-064,368. PUB. 1-1-2008. FILED 12-14-2006.
 3,397,165. **KOKUA FESTIVAL (BLOCK FORM).** KOKUA HAWAII FOUNDATION, (U.S. CLS. 100, 101 AND 107). SN 77-065,670. PUB. 1-1-2008. FILED 12-15-2006.
 3,397,171. **ANSWER-WITHIN SYSTEM (BLOCK FORM).** BR CONSULTING, INC., (U.S. CLS. 100, 101 AND 107). SN 77-066,802. PUB. 1-1-2008. FILED 12-18-2006.
 3,397,188 (*See Class 9 for this trademark*).
 3,397,189. **CFC COMBAT FIGHTING CHAMPIONSHIPS (BLOCK FORM).** COMBAT FIGHTING CHAMPIONSHIPS, LLC, (U.S. CLS. 100, 101 AND 107). SN 77-069,014. PUB. 1-1-2008. FILED 12-21-2006.
 3,397,190. **CFC COMBAT . FIGHTING CHAMPIONSHIPS AND DESIGN.** COMBAT FIGHTING CHAMPIONSHIPS, LLC, (U.S. CLS. 100, 101 AND 107). SN 77-069,022. PUB. 1-1-2008. FILED 12-21-2006.
 3,397,200. **BANACHEK (BLOCK FORM).** BANACHEK, INC., (U.S. CLS. 100, 101 AND 107). SN 77-069,949. PUB. 1-1-2008. FILED 12-21-2006.
 3,397,214. **IMAN INNER-CITY MUSLIM ACTION NETWORK AND DESIGN.** INNER-CITY MUSLIM ACTION NETWORK, MULTIPLE CLASS, (INT. CLS. 41, 43 AND 44), (U.S. CLS. 100, 101 AND 107). SN 77-072,454. PUB. 1-1-2008. FILED 12-28-2006.
 3,397,219 (*See Class 16 for this trademark*).
 3,397,226. **ASTO AND DESIGN.** AMERICAN SOCCER TENNIS ORGANIZATION, LLC, (U.S. CLS. 100, 101 AND 107). SN 77-074,703. PUB. 1-1-2008. FILED 1-2-2007.
 3,397,229. **BIZBOXSERIES.COM (BLOCK FORM).** BEE HIVE HEAD PRODUCTIONS, LLC, (U.S. CLS. 100, 101 AND 107). SN 77-075,480. PUB. 1-1-2008. FILED 1-3-2007.
 3,397,234. **OMAHA THEATER COMPANY (BLOCK FORM).** OMAHA THEATER COMPANY, (U.S. CLS. 100, 101 AND 107). SN 77-076,330. PUB. 1-1-2008. FILED 1-4-2007.
 3,397,239. **YOURTEACHER AND DESIGN.** CLASSMATE, L.L.C., (U.S. CLS. 100, 101 AND 107). SN 77-077,644. PUB. 1-1-2008. FILED 1-7-2007.
 3,397,246. **GRANDMASTER CHOE'S EASTERN PHILOSOPHY CENTER AND DESIGN.** JIMONG CHOE, (U.S. CLS. 100, 101 AND 107). SN 77-078,828. PUB. 1-1-2008. FILED 1-9-2007.
 3,397,250. **CLINFOSOURCE (BLOCK FORM).** CLINFOSOURCE, (U.S. CLS. 100, 101 AND 107). SN 77-080,335. PUB. 1-1-2008. FILED 1-10-2007.
 3,397,256. **DISNEY'S FAIRY TALE WEDDINGS (BLOCK FORM).** DISNEY ENTERPRISES, INC., (U.S. CLS. 100, 101 AND 107). SN 77-081,972. PUB. 1-1-2008. FILED 1-12-2007.
 3,397,276 (*See Class 36 for this trademark*).
 3,397,280 (*See Class 35 for this trademark*).
 3,397,282. **YALE-NEW HAVEN TEACHERS INSTITUTE (BLOCK FORM).** YALE UNIVERSITY, (U.S. CLS. 100, 101 AND 107). SN 77-088,969. PUB. 1-1-2008. FILED 1-23-2007.
 3,397,285. **DESIGN . BUILD . FLY AIAA AND DESIGN.** AMERICAN INSTITUTE OF AERONAUTICS AND ASTRONAUTICS, INC., (U.S. CLS. 100, 101 AND 107). SN 77-089,736. PUB. 1-1-2008. FILED 1-24-2007.
 3,397,290 (*See Class 36 for this trademark*).
 3,397,292. **T-TRAX PRODUCTIONS (BLOCK FORM).** J7 RECORDS, INC., (U.S. CLS. 100, 101 AND 107). SN 77-093,110. PUB. 1-1-2008. FILED 1-29-2007.
 3,397,306. **HARBOR ISLES (BLOCK FORM).** JELD-WEN, INC., (U.S. CLS. 100, 101 AND 107). SN 77-096,745. PUB. 1-1-2008. FILED 2-1-2007.
 3,397,307. **HARBOR ISLES TENNIS & FITNESS CLUB AND DESIGN.** JELD-WEN, INC., (U.S. CLS. 100, 101 AND 107). SN 77-096,753. PUB. 1-1-2008. FILED 2-1-2007.
 3,397,318. **MISCELLANEOUS DESIGN.** THE UNIVERSITY OF SOUTH DAKOTA, (U.S. CLS. 100, 101 AND 107). SN 77-098,035. PUB. 1-1-2008. FILED 2-2-2007.
 3,397,322. **REGIONS UNIVERSITY (BLOCK FORM).** REGIONS ASSET COMPANY, (U.S. CLS. 100, 101 AND 107).

- SN 77-098,922. PUB. 6-5-2007. FILED 2-5-2007.
 3,397,330 (*See Class 16 for this trademark*).
 3,397,331. **LIFE'S HEADWATERS (BLOCK FORM)**. GARY S. STEVENS FOUNDATION, (U.S. CLS. 100, 101 AND 107). SN 77-101,509. PUB. 1-1-2008. FILED 2-7-2007.
 3,397,333. **H LIFE'S HEADWATERS (STYLIZED)**. GARY S. STEVENS FOUNDATION, (U.S. CLS. 100, 101 AND 107). SN 77-101,770. PUB. 1-1-2008. FILED 2-7-2007.
 3,397,343. **RADIOTRON (BLOCK FORM)**. RIVAS, JULIO CESAR, (U.S. CLS. 100, 101 AND 107). SN 77-105,648. PUB. 1-1-2008. FILED 2-12-2007.
 3,397,347. **FOX SOCCER REPORT (BLOCK FORM)**. TWENTIETH CENTURY FOX FILM CORPORATION, (U.S. CLS. 100, 101 AND 107). SN 77-106,609. PUB. 1-1-2008. FILED 2-13-2007.
 3,397,348 (*See Class 16 for this trademark*).
 3,397,354. **SAN FRANCISCO LESBIAN GAY BISEXUAL TRANSGENDER PRIDE CELEBRATION COMMITTEE, INC. (BLOCK FORM)**. SAN FRANCISCO LESBIAN GAY BISEXUAL TRANSGENDER PRIDE CELEBRATION COMMITTEE, INC., (U.S. CLS. 100, 101 AND 107). SN 77-108,932. PUB. 1-1-2008. FILED 2-15-2007.
 3,397,368 (*See Class 38 for this trademark*).
 3,397,379. **APLA AIDS PROJECT LOS ANGELES AND DESIGN. AIDS PROJECT LOS ANGELES**, (U.S. CLS. 100, 101 AND 107). SN 77-116,488. PUB. 1-1-2008. FILED 2-26-2007.
 3,397,383 (*See Class 35 for this trademark*).
 3,397,393 (*See Class 35 for this trademark*).
 3,397,398 (*See Class 35 for this trademark*).
 3,397,402. **ROMANCE: B(UY) THE BOOK (BLOCK FORM)**. MICHELLE BUONFIGLIO, (U.S. CLS. 100, 101 AND 107). SN 77-126,469. PUB. 1-1-2008. FILED 3-9-2007.
 3,397,410. **ISLAND GROOVIN' AND DESIGN**. FRANK D. FAKINOS, (U.S. CLS. 100, 101 AND 107). SN 77-130,384. PUB. 9-25-2007. FILED 3-14-2007.
 3,397,412 (*See Class 9 for this trademark*).
 3,397,426. **AMAZINFLATES (BLOCK FORM)**. RIVERA, RONNIE, (U.S. CLS. 100, 101 AND 107). SN 77-137,618. PUB. 1-1-2008. FILED 3-22-2007.
 3,397,428. **SCORES MEXICAN MUSIC AND DESIGN. TERCERO RODRIGUEZ, ALDO ERNESTO**, (U.S. CLS. 100, 101 AND 107). SN 77-138,394. PUB. 1-1-2008. FILED 3-23-2007.
 3,397,430. **MOOS FROM THE FARM (BLOCK FORM)**. FARMS FOR CITY KIDS FOUNDATION, INC., (U.S. CLS. 100, 101 AND 107). SN 77-139,392. PUB. 1-1-2008. FILED 3-23-2007.
 3,397,431 (*See Class 9 for this trademark*).
 3,397,457 (*See Class 16 for this trademark*).
 3,397,459. **JUQUEMOS EN ESPAÑOL (BLOCK FORM)**. SUSY DORN PRODUCTIONS, LLC, (U.S. CLS. 100, 101 AND 107). SN 77-152,053. PUB. 1-1-2008. FILED 4-9-2007.
 3,397,464. **ONLINE TRADING . ACADEMY . AND DESIGN**. NEWPORT EXCHANGE HOLDINGS, INC., (U.S. CLS. 100, 101 AND 107). SN 77-153,308. PUB. 1-1-2008. FILED 4-10-2007.
 3,397,482. **CAMP BOMBSHELL AND DESIGN**. SAN PEDRO, PATRICIA, (U.S. CLS. 100, 101 AND 107). SN 77-161,285. PUB. 1-1-2008. FILED 4-19-2007.
 3,397,489. **PROVISION THEATER (BLOCK FORM)**. PROVISION THEATER COMPANY, (U.S. CLS. 100, 101 AND 107). SN 77-164,019. PUB. 1-1-2008. FILED 4-24-2007.
 3,397,492 (*See Class 25 for this trademark*).
 3,397,502. **YOGA 1-2-3 READY (BLOCK FORM)**. CHATTERELLI, SHELLY, AND PARKER, ANGELA, (U.S. CLS. 100, 101 AND 107). SN 77-167,474. PUB. 1-1-2008. FILED 4-27-2007.
 3,397,524. **U AND DESIGN**. U-S.S. MEDICAL CORP., (U.S. CLS. 100, 101 AND 107). SN 77-175,797. PUB. 1-1-2008. FILED 5-8-2007.
 3,397,533 (*See Class 35 for this trademark*).
 3,397,534 (*See Class 9 for this trademark*).
 3,397,543. **MISCELLANEOUS DESIGN**. HIGH ENERGY DECISIONS, LLC, (U.S. CLS. 100, 101 AND 107). SN 77-183,854. PUB. 1-1-2008. FILED 5-17-2007.
 3,397,551 (*See Class 35 for this trademark*).
 3,397,552. **MARYLAND ATHLETIC ASSOCIATION PUBLIC SECONDARY SCHOOLS AND DESIGN**. MARYLAND PUBLIC SECONDARY SCHOOLS ATHLETIC ASSOCIATION (MPSSAA), (U.S. CLS. 100, 101 AND 107). SN 77-189,134. PUB. 1-1-2008. FILED 5-24-2007.
 3,397,553. **MISCELLANEOUS DESIGN**. LFP IP, LLC, (U.S. CLS. 100, 101 AND 107). SN 77-189,249. PUB. 1-1-2008. FILED 5-24-2007.
 3,397,554. **CONCRETEBEAT (BLOCK FORM)**. YEE, BENJAMIN, (U.S. CLS. 100, 101 AND 107). SN 77-189,331. PUB. 1-1-2008. FILED 5-24-2007.
 3,397,555. **KEITH LOCKHART & FRIENDS (BLOCK FORM)**. BOSTON SYMPHONY ORCHESTRA, INC., (U.S. CLS. 100, 101 AND 107). SN 77-189,428. PUB. 1-1-2008. FILED 5-24-2007.
 3,397,557. **GATEWAY COMMUNITY COLLEGE (BLOCK FORM)**. MARICOPA COUNTY COMMUNITY COLLEGE DISTRICT, (U.S. CLS. 100, 101 AND 107). SN 77-189,779. PUB. 1-1-2008. FILED 5-24-2007.
 3,397,561 (*See Class 9 for this trademark*).
 3,397,575. **WE JOY SING AND DESIGN**. WEJOYSING, INC., (U.S. CLS. 100, 101 AND 107). SN 77-194,318. PUB. 11-27-2007. FILED 5-31-2007.
 3,397,578. **FAMILY PLUS (BLOCK FORM)**. BOYS & GIRLS CLUBS OF AMERICA, (U.S. CLS. 100, 101 AND 107). SN 77-195,105. PUB. 1-1-2008. FILED 6-1-2007.
 3,397,588. **POCKET PRESENTATION COACH (BLOCK FORM)**. D'ARCY, JAN T., (U.S. CLS. 100, 101 AND 107). SN 77-197,078. PUB. 1-1-2008. FILED 6-4-2007.
 3,397,598. **PAW CORNER A CORNER FOR ALL PAWS! AND DESIGN**. ROGER L. ZAPATA, (U.S. CLS. 100, 101 AND 107). SN 77-199,273. PUB. 1-1-2008. FILED 6-6-2007.
 3,397,599. **ATMOSPHERE (BLOCK FORM)**. CUTLIP, CHERYL HEBERT, (U.S. CLS. 100, 101 AND 107). SN 77-200,082. PUB. 1-1-2008. FILED 6-7-2007.
 3,397,607. **FIFTH POWER FITNESS (BLOCK FORM)**. WARDEN, CHRISTOPHER STEPHEN, (U.S. CLS. 100, 101 AND 107). SN 77-200,949. PUB. 1-1-2008. FILED 6-7-2007.
 3,397,618 (*See Class 35 for this trademark*).
 3,397,620. **GENERAL COUNSEL INSTITUTE PRESENTED BY BAKER DONELSON AND DESIGN**. BAKER, DONELSON, BEARMAN, CALDWELL & BERKOWITZ, PC, (U.S. CLS. 100, 101 AND 107). SN 77-202,543. PUB. 1-1-2008. FILED 6-11-2007.
 3,397,626. **SLEEPLESS NIGHT (BLOCK FORM)**. CITY OF MIAMI BEACH, (U.S. CLS. 100, 101 AND 107). SN 77-204,297. PUB. 11-27-2007. FILED 6-12-2007.
 3,397,628. **ALISHA THE ACTIVE SHARK (BLOCK FORM)**. REGAN, JR., ROLAND J., AND MULLALY, ROBERT W., (U.S. CLS. 100, 101 AND 107). SN 77-204,531. PUB. 1-1-2008. FILED 6-12-2007.
 3,397,637. **BACKSHOT PRODUCTIONS AND DESIGN**. GORDON, DWAYNE, (U.S. CLS. 100, 101 AND 107). SN 77-207,058. PUB. 1-1-2008. FILED 6-15-2007.
 3,397,643. **THE ART OF WORK, THE WORK OF ART (BLOCK FORM)**. GOLDMAN, SUSAN, AND DANA, RICHARD, AND SEGALL, LEWIS, (U.S. CLS. 100, 101 AND 107). SN 77-207,792. PUB. 1-1-2008. FILED 6-15-2007.
 3,397,648 (*See Class 38 for this trademark*).
 3,397,654. **LAUNCH + + + AND DESIGN**. LAUNCH MATH LLC, (U.S. CLS. 100, 101 AND 107). SN 77-210,506. PUB. 1-1-2008. FILED 6-20-2007.
 3,397,662. **FITNESS MAXX "I BRING OUT THE RESULTS YOU CAN SEE." AND DESIGN**. FITNESS MAXX, (U.S. CLS. 100, 101 AND 107). SN 77-211,642. PUB. 1-1-2008. FILED 6-21-2007.
 3,397,668. **NOR'EASTER SEASON PASS AND DESIGN**. MOUNT SNOW, LTD., (U.S. CLS. 100, 101 AND 107). SN 77-213,109. PUB. 1-1-2008. FILED 6-22-2007.
 3,397,670. **SWINGTOWNS (BLOCK FORM)**. STREET INK CORPORATION, MULTIPLE CLASS, (INT. CLS. 41 AND 45), (U.S. CLS. 100, 101 AND 107). SN 77-213,135. PUB. 1-1-2008. FILED 6-22-2007.
 3,397,682. **SOCIETY FOR THE ARTS IN HEALTHCARE AND DESIGN**. SOCIETY FOR THE ARTS IN HEALTHCARE, (U.S. CLS. 100, 101 AND 107). SN 77-215,419. PUB. 1-1-2008. FILED 6-26-2007.
 3,397,706 (*See Class 9 for this trademark*).
 3,397,707. **RETIREMENT ENVIRONMENT (BLOCK FORM)**. REDMOND, ELAINE, AND ROWLINGS, SCOTT, (U.S. CLS. 100, 101 AND 107). SN 77-217,704. PUB. 1-1-2008.

- FILED 6-28-2007.
- 3,397,708. **THE RECLINERS AND DESIGN**. YOUNG, RUSSELL, (U.S. CLS. 100, 101 AND 107). SN 77-217,801. PUB. 1-1-2008. FILED 6-28-2007.
- 3,397,712. **B. BETTER CREATING A BETTER WAY OF BEING AND DESIGN**. B.BETTER SUCCESS COACHING AND CONSULTING, LLC, (U.S. CLS. 100, 101 AND 107). SN 77-218,821. PUB. 1-1-2008. FILED 6-29-2007.
- 3,397,714. **BALLS-N-STRIKES AND DESIGN**. BALLS-N-STRIKES GROUP, INC., (U.S. CLS. 100, 101 AND 107). SN 77-218,846. PUB. 1-1-2008. FILED 6-29-2007.
- 3,397,716. **RADIO ORENOVSCOTIA AND DESIGN**. ST. JAMES, CHARLES, (U.S. CLS. 100, 101 AND 107). SN 77-218,891. PUB. 1-1-2008. FILED 6-29-2007.
- 3,397,717. **SEE YOUR POTENTIAL. CREATE YOUR RESULTS. (BLOCK FORM)**. TERRY STEVENS, INC., (U.S. CLS. 100, 101 AND 107). SN 77-218,968. PUB. 1-1-2008. FILED 6-29-2007.
- 3,397,722 (See Class 38 for this trademark).
- 3,397,726 (See Class 25 for this trademark).
- 3,397,732. **GOLF LAB AND DESIGN**. GOLF LAB, LLC, (U.S. CLS. 100, 101 AND 107). SN 77-220,870. PUB. 1-1-2008. FILED 7-2-2007.
- 3,397,740. **CHEER-BLING TUMBLING: THE BLING IN CHEERLEADING (BLOCK FORM)**. CHEER-BLING, LLC, (U.S. CLS. 100, 101 AND 107). SN 77-221,688. PUB. 1-1-2008. FILED 7-3-2007.
- 3,397,747. **DARK EDGE ENTERTAINMENT (BLOCK FORM)**. JAGELS, DANIEL, (U.S. CLS. 100, 101 AND 107). SN 77-222,580. PUB. 1-1-2008. FILED 7-5-2007.
- 3,397,757. **PARAMOUNT EDUCATIONAL SEMINARS (BLOCK FORM)**. PARAMOUNT EDUCATIONAL SEMINARS, LLC, (U.S. CLS. 100, 101 AND 107). SN 77-223,263. PUB. 1-1-2008. FILED 7-6-2007.
- 3,397,778. **2 FOR 10 WITH MELISSA. CHEAP. EASY. TASTY. (BLOCK FORM)**. BUTTERY MOON MEDIA LLC, (U.S. CLS. 100, 101 AND 107). SN 77-225,068. PUB. 1-1-2008. FILED 7-9-2007.
- 3,397,785. **QUANTUM VIOLET FOCUS (BLOCK FORM)**. STRICKLAND, KAREN, (U.S. CLS. 100, 101 AND 107). SN 77-225,435. PUB. 1-1-2008. FILED 7-10-2007.
- 3,397,794. **LITTLE RACQUETS (BLOCK FORM)**. LITTLE RACQUETS, LLC, (U.S. CLS. 100, 101 AND 107). SN 77-225,829. PUB. 1-1-2008. FILED 7-10-2007.
- 3,397,795. **ATWORK! CHANGING THE FACE OF EMPLOYMENT AND DESIGN**. ATWORK!, (U.S. CLS. 100, 101 AND 107). SN 77-225,896. PUB. 1-1-2008. FILED 7-10-2007.
- 3,397,796. **MISCELLANEOUS DESIGN. HOMEBASE YOUTH SERVICES, INC., MULTIPLE CLASS, (INT. CLS. 41, 43 AND 44)**, (U.S. CLS. 100, 101 AND 107). SN 77-225,939. PUB. 1-1-2008. FILED 7-10-2007.
- 3,397,800. **FOR HOW YOU TRAIN...SO SHALL YOU FIGHT (BLOCK FORM)**. KFD TRAINING & CONSULTATION, LLC, (U.S. CLS. 100, 101 AND 107). SN 77-226,190. PUB. 1-1-2008. FILED 7-10-2007.
- 3,397,801. **GEMEANI (BLOCK FORM)**. GEMENY, STEVEN E., (U.S. CLS. 100, 101 AND 107). SN 77-226,223. PUB. 1-1-2008. FILED 7-10-2007.
- 3,397,817. **VIRGINIA RENAISSANCE FAIRE (BLOCK FORM)**. OUT OF THE WOODWORK PRODUCTIONS, INC., (U.S. CLS. 100, 101 AND 107). SN 77-226,739. PUB. 1-1-2008. FILED 7-11-2007.
- 3,397,819. **MISCELLANEOUS DESIGN**. HEARTLAND, LLC, (U.S. CLS. 100, 101 AND 107). SN 77-226,788. PUB. 1-1-2008. FILED 7-11-2007.
- 3,397,823. **EDUCATIONAL ADVANTAGE, INC. AND DESIGN**. EDUCATIONAL ADVANTAGE, INC., (U.S. CLS. 100, 101 AND 107). SN 77-226,851. PUB. 1-1-2008. FILED 7-11-2007.
- 3,397,824. **NOBODY SMILING.COM (BLOCK FORM)**. NOBODYSMILING INC, (U.S. CLS. 100, 101 AND 107). SN 77-226,872. PUB. 1-1-2008. FILED 7-11-2007.
- 3,397,827 (See Class 36 for this trademark).
- 3,397,838. **BEAUTY AND THE BLOG (BLOCK FORM)**. SEPHORA USA, INC., (U.S. CLS. 100, 101 AND 107). SN 77-227,281. PUB. 1-1-2008. FILED 7-11-2007.
- 3,397,858. **PIANAFIDDLE (BLOCK FORM)**. DEGRAFF, ADAM J., (U.S. CLS. 100, 101 AND 107). SN 77-227,764. PUB. 1-1-2008. FILED 7-12-2007.
- 3,397,859. **SHAMU ROCKS (BLOCK FORM)**. SEA WORLD, INC., (U.S. CLS. 100, 101 AND 107). SN 77-227,778. PUB. 1-1-2008. FILED 7-12-2007.
- 3,397,868. **UNCOVER THE STASHED CASH (BLOCK FORM)**. YONKERS RACING CORPORATION, (U.S. CLS. 100, 101 AND 107). SN 77-227,912. PUB. 1-1-2008. FILED 7-12-2007.
- 3,397,873. **BEING BLISS YOGA (BLOCK FORM)**. MILLER, JANE E., (U.S. CLS. 100, 101 AND 107). SN 77-227,951. PUB. 1-1-2008. FILED 7-12-2007.
- 3,397,875. **SEDUCED BY A COUGAR (BLOCK FORM)**. LA TOURAINE, INC., (U.S. CLS. 100, 101 AND 107). SN 77-227,986. PUB. 1-1-2008. FILED 7-12-2007.
- 3,397,876. **GETTING FULLY ENGAGED (BLOCK FORM)**. LGE PERFORMANCE SYSTEMS, INC. DBA HUMAN PERFORMANCE INSTITUTE, (U.S. CLS. 100, 101 AND 107). SN 77-228,014. PUB. 1-1-2008. FILED 7-12-2007.
- 3,397,880. **ASIAN 1 ON 1 (BLOCK FORM)**. LA TOURAINE, INC., (U.S. CLS. 100, 101 AND 107). SN 77-228,071. PUB. 1-1-2008. FILED 7-12-2007.
- 3,397,883. **DIARY OF A NANNY (BLOCK FORM)**. LA TOURAINE, INC., (U.S. CLS. 100, 101 AND 107). SN 77-228,116. PUB. 1-1-2008. FILED 7-12-2007.
- 3,397,884. **NAUGHTY FLIPSIDE (BLOCK FORM)**. LA TOURAINE, INC., (U.S. CLS. 100, 101 AND 107). SN 77-228,127. PUB. 1-1-2008. FILED 7-12-2007.
- 3,397,888. **WORK-ABLE (BLOCK FORM)**. AUCTION INN CORPORATION, (U.S. CLS. 100, 101 AND 107). SN 77-228,299. PUB. 1-1-2008. FILED 7-12-2007.
- 3,397,889. **POPPY-LACED (BLOCK FORM)**. SIDIGU, ANNAH O., (U.S. CLS. 100, 101 AND 107). SN 77-228,329. PUB. 1-1-2008. FILED 7-12-2007.
- 3,397,891 (See Class 37 for this trademark).
- 3,397,895. **THE YARD (BLOCK FORM)**. THE YARD, INC., (U.S. CLS. 100, 101 AND 107). SN 77-228,555. PUB. 1-1-2008. FILED 7-12-2007.
- 3,397,901. **THE BAY STATE (BLOCK FORM)**. THE BAY STATE, (U.S. CLS. 100, 101 AND 107). SN 77-228,760. PUB. 1-1-2008. FILED 7-13-2007.
- 3,397,923. **GATEWAY DOG TRAINING (BLOCK FORM)**. GATEWAY DOG TRAINING, INC., (U.S. CLS. 100, 101 AND 107). SN 77-229,000. PUB. 1-1-2008. FILED 7-13-2007.
- 3,397,967. **STD FILMS (BLOCK FORM)**. ZINK, JASON W., (U.S. CLS. 100, 101 AND 107). SN 77-229,655. PUB. 1-1-2008. FILED 7-13-2007.
- 3,397,978. **NEVER QUIT (STYLIZED)**. MCCUE, MATT, J, DBA MCCUE TRAINING, (U.S. CLS. 100, 101 AND 107). SN 77-229,885. PUB. 1-1-2008. FILED 7-14-2007.
- 3,397,979. **BAD DATA (BLOCK FORM)**. JAMES ROGER NELSON BLUE, DBA JIMMY BLUE, (U.S. CLS. 100, 101 AND 107). SN 77-229,886. PUB. 1-1-2008. FILED 7-14-2007.
- 3,397,980. **HOT FOR WORDS (BLOCK FORM)**. COMO, CHARLES T., (U.S. CLS. 100, 101 AND 107). SN 77-229,891. PUB. 1-1-2008. FILED 7-14-2007.
- 3,397,987. **SPACE LIBRARY (BLOCK FORM)**. SPACE EXPLORERS, INC., (U.S. CLS. 100, 101 AND 107). SN 77-230,107. PUB. 1-1-2008. FILED 7-16-2007.
- 3,397,995. **HEALTHCORPS (BLOCK FORM)**. HEALTHCORPS, (U.S. CLS. 100, 101 AND 107). SN 77-230,301. PUB. 1-1-2008. FILED 7-16-2007.
- 3,398,000. **DESTINATION UNIVERSITY (BLOCK FORM)**. THE SCHALLERT GROUP, INC., (U.S. CLS. 100, 101 AND 107). SN 77-230,388. PUB. 1-1-2008. FILED 7-16-2007.
- 3,398,006. **MISCELLANEOUS DESIGN**. THE SCHALLERT GROUP, INC., (U.S. CLS. 100, 101 AND 107). SN 77-230,449. PUB. 1-1-2008. FILED 7-16-2007.
- 3,398,020. **HEALTH CORPS EDUCATING THE STUDENT BODY AND DESIGN**. HEALTHCORPS, (U.S. CLS. 100, 101 AND 107). SN 77-230,601. PUB. 1-1-2008. FILED 7-16-2007.
- 3,398,022. **CYPRESS STRING QUARTET (BLOCK FORM)**. CYPRESS PERFORMING ARTS ASSOCIATION, (U.S. CLS. 100, 101 AND 107). SN 77-230,618. PUB. 1-1-2008. FILED 7-16-2007.
- 3,398,023. **HEALTHCORPS EDUCATING THE STUDENT BODY AND DESIGN**. HEALTHCORPS, (U.S. CLS. 100, 101 AND 107). SN 77-230,662. PUB. 1-1-2008. FILED 7-16-2007.
- 3,398,026. **WHITEDINGO (BLOCK FORM)**. HOLLIDAY II, DAVID, (U.S. CLS. 100, 101 AND 107). SN 77-230,715. PUB. 1-1-2008. FILED 7-16-2007.

- 3,398,029. **THE WEDDING BUREAU (BLOCK FORM)**. THE WEDDING BUREAU, INC., (U.S. CLS. 100, 101 AND 107). SN 77-230,760. PUB. 1-1-2008. FILED 7-16-2007.
- 3,398,030. **DEEP (BLOCK FORM)**. TYCOON DYNASTY, INC., (U.S. CLS. 100, 101 AND 107). SN 77-230,764. PUB. 1-1-2008. FILED 7-16-2007.
- 3,398,031. **LET A PHOTOJOURNALIST'S EYE CAPTURE YOUR HEART (BLOCK FORM)**. THE WEDDING BUREAU, INC., (U.S. CLS. 100, 101 AND 107). SN 77-230,765. PUB. 1-1-2008. FILED 7-16-2007.
- 3,398,043. **WU-YIN YAN-JING (BLOCK FORM)**. MILES SR, RAY, (U.S. CLS. 100, 101 AND 107). SN 77-230,934. PUB. 1-1-2008. FILED 7-16-2007.
- 3,398,059. **HIPPIE RADIO AND DESIGN**. DIDIER, ANTHONY G, (U.S. CLS. 100, 101 AND 107). SN 77-231,222. PUB. 1-1-2008. FILED 7-17-2007.
- 3,398,063. **NO PROGRESS (BLOCK FORM)**. LANDERS, KEVIN, (U.S. CLS. 100, 101 AND 107). SN 77-231,291. PUB. 1-1-2008. FILED 7-17-2007.
- 3,398,065. **SOUL PROPRIETOR (BLOCK FORM)**. MARTELLO, KEN, (U.S. CLS. 100, 101 AND 107). SN 77-231,298. PUB. 1-1-2008. FILED 7-17-2007.
- 3,398,075. **SHIFT YOUR PERSPECTIVE (STYLIZED)**. MUSEUM OF CONTEMPORARY ART JACKSONVILLE, INC., (U.S. CLS. 100, 101 AND 107). SN 77-231,483. PUB. 1-1-2008. FILED 7-17-2007.
- 3,398,083. **COOLFIRE MEDIA (BLOCK FORM)**. COOLFIRE MEDIA, LLC, (U.S. CLS. 100, 101 AND 107). SN 77-231,623. PUB. 1-1-2008. FILED 7-17-2007.
- 3,398,085. **IU IS RED HOT (BLOCK FORM)**. THE TRUSTEES OF INDIANA UNIVERSITY, (U.S. CLS. 100, 101 AND 107). SN 77-231,639. PUB. 1-1-2008. FILED 7-17-2007.
- 3,398,087 (*See Class 38 for this trademark*).
- 3,398,095. **ROK BOX AND DESIGN**. THE 67 GROUP, LLC, DBA ANGEL MUSIC GROUP, (U.S. CLS. 100, 101 AND 107). SN 77-231,811. PUB. 1-1-2008. FILED 7-17-2007.
- 3,398,101. **COLORS OF THE RAINBOW TEAM MATCH (BLOCK FORM)**. AMERICAN BALLROOM THEATER COMPANY, INC., (U.S. CLS. 100, 101 AND 107). SN 77-231,863. PUB. 1-1-2008. FILED 7-17-2007.
- 3,398,102 (*See Class 35 for this trademark*).
- 3,398,109. **OPERATION PAINTBALL ISLAND ONE WEEK. ONE ISLAND. ONE MILLION DOLLARS. (BLOCK FORM)**. MAHONEY JR., MICHAEL, (U.S. CLS. 100, 101 AND 107). SN 77-232,000. PUB. 1-1-2008. FILED 7-17-2007.
- 3,398,119. **KICKSWISH (BLOCK FORM)**. SHERMAN, MICHAEL D, (U.S. CLS. 100, 101 AND 107). SN 77-232,150. PUB. 1-1-2008. FILED 7-17-2007.
- 3,398,122. **STALLED AND DESIGN**. JENSEN, JAY L., (U.S. CLS. 100, 101 AND 107). SN 77-232,175. PUB. 1-1-2008. FILED 7-18-2007.
- 3,398,123. **HOURLY-ZERO (BLOCK FORM)**. HOURLY-ZERO CRISIS CONSULTING LTD., MULTIPLE CLASS, (INT. CLS. 41 AND 45), (U.S. CLS. 100, 101 AND 107). SN 77-232,180. PUB. 1-1-2008. FILED 7-18-2007.
- 3,398,132 (*See Class 35 for this trademark*).
- 3,398,140. **UMLA UNIVERSITY OF MARKETING LOS ANGELES AND DESIGN**. UNIVERSITY OF MARKETING, LA, INC., (U.S. CLS. 100, 101 AND 107). SN 77-232,473. PUB. 1-1-2008. FILED 7-18-2007.
- 3,398,142. **CUENTE CON NOSOTROS (BLOCK FORM)**. ENTRAVISION COMMUNICATIONS CORPORATION, (U.S. CLS. 100, 101 AND 107). SN 77-232,499. PUB. 1-1-2008. FILED 7-18-2007.
- 3,398,162. **NEUSPORT FOOTBALL CLUB (BLOCK FORM)**. NEUSPORT FOOTBALL CLUB, (U.S. CLS. 100, 101 AND 107). SN 77-232,830. PUB. 1-1-2008. FILED 7-18-2007.
- 3,398,165. **WHITE ORCHID (BLOCK FORM)**. A WHITE ORCHID WEDDING, INC., (U.S. CLS. 100, 101 AND 107). SN 77-232,947. PUB. 1-1-2008. FILED 7-18-2007.
- 3,398,183 (*See Class 35 for this trademark*).
- 3,398,186. **ANDLAB-EDU (BLOCK FORM)**. PARK, SUNOOK, (U.S. CLS. 100, 101 AND 107). SN 77-233,479. PUB. 1-1-2008. FILED 7-19-2007.
- 3,398,203. **C C COVIDIEN (STYLIZED)**. COVIDIEN AG, (U.S. CLS. 100, 101 AND 107). SN 77-233,857. PUB. 1-1-2008. FILED 7-19-2007.
- 3,398,207. **EVENINGS UNDER THE STARS (BLOCK FORM)**. SOUTH SHORE CONSERVATORY OF MUSIC, INC., (U.S. CLS. 100, 101 AND 107). SN 77-233,950. PUB. 1-1-2008. FILED 7-19-2007.
- 3,398,213 (*See Class 9 for this trademark*).
- 3,398,215. **MOMCARE (BLOCK FORM)**. BROWN, NEIL, (U.S. CLS. 100, 101 AND 107). SN 77-234,175. PUB. 1-1-2008. FILED 7-19-2007.
- 3,398,225. **MINIMAL ART (BLOCK FORM)**. MINIMAL ART, (U.S. CLS. 100, 101 AND 107). SN 77-234,547. PUB. 1-1-2008. FILED 7-20-2007.
- 3,398,261. **GO DIEGO GO! (BLOCK FORM)**. VIACOM INTERNATIONAL INC., (U.S. CLS. 100, 101 AND 107). SN 77-241,722. PUB. 1-1-2008. FILED 7-30-2007.
- 3,398,263. **LAS VEGAS TURKEY SHOOT (BLOCK FORM)**. NEUSPORT FOOTBALL CLUB, (U.S. CLS. 100, 101 AND 107). SN 77-242,516. PUB. 1-1-2008. FILED 7-30-2007.
- 3,398,288. **DOWN EAST (STYLIZED)**. DOWN EAST ENTERPRISE, INC., (U.S. CLS. 100, 101 AND 107). SN 77-249,700. PUB. 1-1-2008. FILED 8-8-2007.
- 3,398,300. **MACON'S HOME PAGE (BLOCK FORM)**. MCCLATCHY U.S.A., INC., (U.S. CLS. 100, 101 AND 107). SN 77-251,523. PUB. 1-1-2008. FILED 8-9-2007.
- 3,398,301. **SALSAMORE (BLOCK FORM)**. LE, VIET N., DBA SALSAMORE, (U.S. CLS. 100, 101 AND 107). SN 77-251,530. PUB. 1-1-2008. FILED 8-9-2007.
- 3,398,306. **RTVIM AND DESIGN**. OVERSEAS MEDIA INC, (U.S. CLS. 100, 101 AND 107). SN 77-252,507. PUB. 1-1-2008. FILED 8-10-2007.
- 3,398,307 (*See Class 35 for this trademark*).
- 3,398,317. **GENERATION GIVING IRA WORKSHOP (BLOCK FORM)**. COVENANT RELIANCE PRODUCERS, LLC, (U.S. CLS. 100, 101 AND 107). SN 77-255,061. PUB. 1-1-2008. FILED 8-14-2007.
- 3,398,326. **TIMELESS FITNESS 24 HOUR ACCESS (BLOCK FORM)**. POWERSHOP GYM, INC., (U.S. CLS. 100, 101 AND 107). SN 77-257,131. PUB. 1-1-2008. FILED 8-16-2007.
- 3,398,349 (*See Class 9 for this trademark*).
- 3,398,392. **BIG SCREEN CLASSROOM (BLOCK FORM)**. REGAL CINEMEDIA CORPORATION, (U.S. CLS. 100, 101 AND 107). SN 78-548,003. PUB. 1-1-2008. FILED 1-14-2005.
- 3,398,396 (*See Class 9 for this trademark*).
- 3,398,407 (*See Class 9 for this trademark*).
- 3,398,410 (*See Class 38 for this trademark*).
- 3,398,417. **THE TTABLOG (BLOCK FORM)**. JOHN L. WELCH, (U.S. CLS. 100, 101 AND 107). SN 78-669,946. PUB. 1-1-2008. FILED 7-13-2005.
- 3,398,435 (*See Class 16 for this trademark*).
- 3,398,443 (*See Class 35 for this trademark*).
- 3,398,450. **CONNECTICUT AUDUBON SOCIETY EAGLE FESTIVAL ON THE CONNECTICUT RIVER NEW ENGLAND'S PREMIER ECOEVENT AND DESIGN**. THE CONNECTICUT AUDUBON SOCIETY, INC., (U.S. CLS. 100, 101 AND 107). SN 78-753,881. PUB. 1-2-2007. FILED 11-15-2005.
- 3,398,460. **APEX (BLOCK FORM)**. ROBERT A. TOIGO FOUNDATION, (U.S. CLS. 100, 101 AND 107). SN 78-779,272. PUB. 1-1-2008. FILED 12-22-2005.
- 3,398,466 (*See Class 9 for this trademark*).
- 3,398,469. **RHYTHM HOUSE (BLOCK FORM)**. FARRINGTON PRODUCTIONS, INC., (U.S. CLS. 100, 101 AND 107). SN 78-797,008. PUB. 1-1-2008. FILED 1-23-2006.
- 3,398,472. **LOTUS (BLOCK FORM)**. LULU'S, LLC, MULTIPLE CLASS, (INT. CLS. 41 AND 43), (U.S. CLS. 100, 101 AND 107). SN 78-804,342. PUB. 1-1-2008. FILED 2-1-2006.
- 3,398,475. **PREP CAMP EXCEL (BLOCK FORM)**. EDUCATION UNLIMITED, INC., (U.S. CLS. 100, 101 AND 107). SN 78-809,843. PUB. 10-17-2006. FILED 2-8-2006.
- 3,398,478 (*See Class 9 for this trademark*).
- 3,398,479. **NO DRAWING-SENSORY MARK**. TIVO BRANDS LLC, (U.S. CLS. 100, 101 AND 107). SN 78-815,914. PUB. 1-1-2008. FILED 2-15-2006.
- 3,398,480. **NO DRAWING-SENSORY MARK**. TIVO BRANDS LLC, (U.S. CLS. 100, 101 AND 107). SN 78-815,932. PUB. 1-1-2008. FILED 2-15-2006.
- 3,398,481. **NO DRAWING-SENSORY MARK**. TIVO BRANDS LLC, (U.S. CLS. 100, 101 AND 107). SN 78-815,952. PUB. 1-1-2008. FILED 2-15-2006.
- 3,398,485 (*See Class 35 for this trademark*).

3,398,499 (See Class 9 for this trademark).
 3,398,500. **EASTON GYM CO. (BLOCK FORM)**. JOHNSON & SHADLE LLC, (U.S. CLS. 100, 101 AND 107). SN 78-846,087. PUB. 7-31-2007. FILED 3-24-2006.
 3,398,502. **MISCELLANEOUS DESIGN**. MILWAUKEE COUNTY DEPARTMENT OF AGING, (U.S. CLS. 100, 101 AND 107). SN 78-847,144. PUB. 1-1-2008. FILED 3-27-2006.
 3,398,503. **LTC: LET'S TAKE CARE (BLOCK FORM)**. MILWAUKEE COUNTY DEPARTMENT OF AGING, (U.S. CLS. 100, 101 AND 107). SN 78-847,162. PUB. 1-1-2008. FILED 3-27-2006.
 3,398,508 (See Class 35 for this trademark).
 3,398,513. **EPIC MEDIA GROUP (BLOCK FORM)**. EPIC MEDIA GROUP LLC, (U.S. CLS. 100, 101 AND 107). SN 78-858,348. PUB. 1-1-2008. FILED 4-10-2006.
 3,398,514 (See Class 35 for this trademark).
 3,398,521 (See Class 9 for this trademark).
 3,398,522. **COLDSTREAMS (BLOCK FORM)**. COLDSTREAMS GROUP, (U.S. CLS. 100, 101 AND 107). SN 78-867,277. PUB. 1-1-2008. FILED 4-21-2006.
 3,398,539. **NATIONAL HOLISTIC INSTITUTE AND DESIGN**. NATIONAL HOLISTIC INSTITUTE, (U.S. CLS. 100, 101 AND 107). SN 78-883,584. PUB. 1-1-2008. FILED 5-15-2006.
 3,398,540. **INTERNATIONAL FELLOWSHIP OF CHRISTIANS AND JEWS AND DESIGN**. INTERNATIONAL FELLOWSHIP OF CHRISTIANS AND JEWS, INC., (U.S. CLS. 100, 101 AND 107). SN 78-885,660. PUB. 1-1-2008. FILED 5-17-2006.
 3,398,541. **THIS MUSIC (BLOCK FORM)**. THIS MUSIC, LLC, (U.S. CLS. 100, 101 AND 107). SN 78-886,477. PUB. 1-1-2008. FILED 5-18-2006.
 3,398,550. **DESIGN NOTES (BLOCK FORM)**. DESIGN WITHIN REACH, INC., (U.S. CLS. 100, 101 AND 107). SN 78-904,750. PUB. 1-1-2008. FILED 6-9-2006.
 3,398,557 (See Class 35 for this trademark).
 3,398,566. **GREENHOUSE (BLOCK FORM)**. AOL LLC, MULTIPLE CLASS, (INT. CLS. 41 AND 42), (U.S. CLS. 100, 101 AND 107). SN 78-923,231. PUB. 1-1-2008. FILED 7-6-2006.
 3,398,573 (See Class 39 for this trademark).
 3,398,578. **BE A RED STAR AND DESIGN**. AOL LLC, (U.S. CLS. 100, 101 AND 107). SN 78-936,659. PUB. 1-1-2008. FILED 7-25-2006.
 3,398,581. **AMERICAN MINUTE (BLOCK FORM)**. AMERISEARCH, INC., (U.S. CLS. 100, 101 AND 107). SN 78-939,642. PUB. 1-1-2008. FILED 7-28-2006.
 3,398,583. **THE FACES OF FLU (BLOCK FORM)**. R&R HEALTHCARE COMMUNICATIONS, INC., (U.S. CLS. 100, 101 AND 107). SN 78-949,737. PUB. 11-27-2007. FILED 8-10-2006.
 3,398,587. **GEOGRAPHY ALIVE! (BLOCK FORM)**. TEACHERS' CURRICULUM INSTITUTE, INC., (U.S. CLS. 100, 101 AND 107). SN 78-955,362. PUB. 1-1-2008. FILED 8-18-2006.
 3,398,595 (See Class 35 for this trademark).
 3,398,605 (See Class 9 for this trademark).
 3,398,611. **CATZ (BLOCK FORM)**. UBISOFT INC., (U.S. CLS. 100, 101 AND 107). SN 78-973,167. PUB. 11-27-2007. FILED 9-13-2006.
 3,398,613 (See Class 3 for this trademark).
 3,398,614 (See Class 9 for this trademark).
 3,398,622 (See Class 35 for this trademark).
 3,398,637 (See Class 9 for this trademark).
 3,398,641 (See Class 35 for this trademark).
 3,398,659 (See Class 9 for this trademark).
 3,398,660 (See Class 9 for this trademark).
 3,398,662 (See Class 16 for this trademark).
 3,398,670 (See Class 35 for this trademark).
 3,398,686 (See Class 9 for this trademark).
 3,398,748 (See Class 7 for this trademark).
 3,398,751 (See Class 9 for this trademark).
 3,398,769. **EQLEQTEQ (BLOCK FORM)**. MARK MCKENZIE, (U.S. CLS. 100, 101 AND 107). SN 79-036,422. PUB. 1-1-2008. FILED 2-22-2007.
 3,398,784 (See Class 9 for this trademark).
 3,398,804 (See Class 35 for this trademark).
 3,398,822 (See Class 9 for this trademark).

CLASS 42—SCIENTIFIC AND COMPUTER SERVICES

3,396,814. **INETSMART**. ONGKO, PETER, (U.S. CLS. 100 AND 101). SN 75-836,401. PUB. 1-1-2008. FILED 11-1-1999.
 3,396,835 (See Class 9 for this trademark).
 3,396,841 (See Class 9 for this trademark).
 3,396,844 (See Class 19 for this trademark).
 3,396,881 (See Class 35 for this trademark).
 3,396,926 (See Class 35 for this trademark).
 3,396,939. **TRUDY DUJARDIN (BLOCK FORM)**. TRUDY DUJARDIN LLC, (U.S. CLS. 100 AND 101). SN 76-679,480. PUB. 1-1-2008. FILED 7-13-2007.
 3,396,946. **RADON-EASE (BLOCK FORM)**. RADON-EASE, INC., (U.S. CLS. 100 AND 101). SN 76-679,613. PUB. 1-1-2008. FILED 7-18-2007.
 3,396,952 (See Class 37 for this trademark).
 3,396,960 (See Class 35 for this trademark).
 3,396,969 (See Class 35 for this trademark).
 3,396,975 (See Class 9 for this trademark).
 3,396,981 (See Class 16 for this trademark).
 3,397,000. **MISCELLANEOUS DESIGN**. SCREEN IMAGING TECHNOLOGY, INC., (U.S. CLS. 100 AND 101). SN 77-023,815. PUB. 1-1-2008. FILED 10-18-2006.
 3,397,010. **TTC AND DESIGN**. TAXI TECHNOLOGY CORPORATION, (U.S. CLS. 100 AND 101). SN 77-025,874. PUB. 1-1-2008. FILED 10-20-2006.
 3,397,022 (See Class 37 for this trademark).
 3,397,034. **NSIT TECHNOLOGIES (BLOCK FORM)**. DALLA BETTA, RALPH A., (U.S. CLS. 100 AND 101). SN 77-033,349. PUB. 1-1-2008. FILED 10-31-2006.
 3,397,046. **XTRAK (BLOCK FORM)**. USCALIBRATION INCORPORATED, (U.S. CLS. 100 AND 101). SN 77-037,544. PUB. 1-1-2008. FILED 11-6-2006.
 3,397,047. **"WE WROTE THE BOOK ON IT..." (BLOCK FORM)**. WYATT, AUSTIN & ASSOCIATES, P.C., (U.S. CLS. 100 AND 101). SN 77-037,593. PUB. 1-1-2008. FILED 11-6-2006.
 3,397,048. **INTERCOMM (BLOCK FORM)**. BNY CONVERGEX GROUP, LLC, (U.S. CLS. 100 AND 101). SN 77-038,233. PUB. 1-1-2008. FILED 11-7-2006.
 3,397,056. **MAPS MIDWEST AGRONOMIC PROFESSIONAL SERVICES AND DESIGN**. NEW COOPERATIVE, INC., (U.S. CLS. 100 AND 101). SN 77-041,218. PUB. 1-1-2008. FILED 11-10-2006.
 3,397,059. **REDEFINING THE RETAIL EXPERIENCE (BLOCK FORM)**. GFX INTERNATIONAL, INC., (U.S. CLS. 100 AND 101). SN 77-042,271. PUB. 1-1-2008. FILED 11-13-2006.
 3,397,072. **REPUTATIONDEFENDER (BLOCK FORM)**. REPUTATIONDEFENDER, INC., (U.S. CLS. 100 AND 101). SN 77-046,395. PUB. 1-1-2008. FILED 11-17-2006.
 3,397,079 (See Class 41 for this trademark).
 3,397,110 (See Class 9 for this trademark).
 3,397,122 (See Class 9 for this trademark).
 3,397,140. **PRACTICE CHARTS AND DESIGN**. PGMS, INC., (U.S. CLS. 100 AND 101). SN 77-062,344. PUB. 1-1-2008. FILED 12-12-2006.
 3,397,141. **ESN (BLOCK FORM)**. ENGINEERING SERVICES NETWORK, INC., (U.S. CLS. 100 AND 101). SN 77-062,509. PUB. 1-1-2008. FILED 12-12-2006.
 3,397,142. **SHOULDER TO SHOULDER (BLOCK FORM)**. ENGINEERING SERVICES NETWORK, INC., (U.S. CLS. 100 AND 101). SN 77-062,569. PUB. 1-1-2008. FILED 12-12-2006.
 3,397,149. **SINO GEO AND DESIGN**. SINO GEOPHYSICAL CO., LTD., (U.S. CLS. 100 AND 101). SN 77-063,684. PUB. 1-1-2008. FILED 12-13-2006.
 3,397,161. **360 RF (BLOCK FORM)**. TESTING CORP., (U.S. CLS. 100 AND 101). SN 77-064,960. PUB. 1-1-2008. FILED 12-15-2006.
 3,397,167 (See Class 35 for this trademark).
 3,397,168 (See Class 35 for this trademark).
 3,397,178. **SITELIFE (BLOCK FORM)**. PLUCK CORPORATION, (U.S. CLS. 100 AND 101). SN 77-068,404. PUB. 1-1-2008. FILED 12-20-2006.
 3,397,194 (See Class 20 for this trademark).
 3,397,202. **EZNETPUBLISH AND DESIGN**. ACTION ONLINE, LLC, (U.S. CLS. 100 AND 101). SN 77-070,289. PUB. 1-1-2008. FILED 12-22-2006.

- 3,397,204 (*See Class 35 for this trademark.*)
 3,397,205 (*See Class 35 for this trademark.*)
 3,397,206 (*See Class 35 for this trademark.*)
 3,397,207 (*See Class 35 for this trademark.*)
 3,397,280 (*See Class 35 for this trademark.*)
 3,397,312 (*See Class 35 for this trademark.*)
 3,397,316 (*See Class 9 for this trademark.*)
 3,397,320 (*See Class 38 for this trademark.*)
 3,397,346 (*See Class 35 for this trademark.*)
 3,397,348 (*See Class 16 for this trademark.*)
 3,397,352. **BCPO (BLOCK FORM)**. NAPO, INC. D/B/A NATIONAL ASSOCIATION OF PROFESSIONAL ORGANIZERS, (U.S. CLS. 100 AND 101). SN 77-108,555. PUB. 1-1-2008. FILED 2-15-2007.
 3,397,356 (*See Class 35 for this trademark.*)
 3,397,368 (*See Class 38 for this trademark.*)
 3,397,371. **MYPRIVACY (BLOCK FORM)**. REPUTATIONDEFENDER, INC., (U.S. CLS. 100 AND 101). SN 77-112,859. PUB. 1-1-2008. FILED 2-21-2007.
 3,397,372 (*See Class 35 for this trademark.*)
 3,397,417 (*See Class 35 for this trademark.*)
 3,397,418 (*See Class 35 for this trademark.*)
 3,397,423. **ZINGERDING (BLOCK FORM)**. LOWTWAITE, STEVE, (U.S. CLS. 100 AND 101). SN 77-136,492. PUB. 1-1-2008. FILED 3-21-2007.
 3,397,435. **FAMILY PURSUIT (BLOCK FORM)**. FAMILY PURSUIT, LC, (U.S. CLS. 100 AND 101). SN 77-140,770. PUB. 1-1-2008. FILED 3-26-2007.
 3,397,454. **NIAMOD AND DESIGN**. BORGIA, WILLIAM, MULTIPLE CLASS, (INT. CLS. 42 AND 45), (U.S. CLS. 100 AND 101). SN 77-150,338. PUB. 1-1-2008. FILED 4-6-2007.
 3,397,461. **FSIX (BLOCK FORM)**. BILLINGS, ROGER E., (U.S. CLS. 100 AND 101). SN 77-152,162. PUB. 1-1-2008. FILED 4-9-2007.
 3,397,470 (*See Class 35 for this trademark.*)
 3,397,473. **DCG (STYLIZED)**. OBJECTIVE INTEGRITY, INC., (U.S. CLS. 100 AND 101). SN 77-158,731. PUB. 1-1-2008. FILED 4-17-2007.
 3,397,474. **DCG AND DESIGN**. OBJECTIVE INTEGRITY, INC., (U.S. CLS. 100 AND 101). SN 77-159,340. PUB. 1-1-2008. FILED 4-18-2007.
 3,397,511. **E-URBAN (BLOCK FORM)**. HUMPHREYS & PARTNERS ARCHITECTS, L.P., (U.S. CLS. 100 AND 101). SN 77-170,195. PUB. 1-1-2008. FILED 5-1-2007.
 3,397,534 (*See Class 9 for this trademark.*)
 3,397,537 (*See Class 9 for this trademark.*)
 3,397,564 (*See Class 35 for this trademark.*)
 3,397,582. **REGISSEP (BLOCK FORM)**. REGIS TECHNOLOGIES, INC., (U.S. CLS. 100 AND 101). SN 77-195,484. PUB. 1-1-2008. FILED 6-1-2007.
 3,397,583. **BLUE MOUSE MONKEY AND DESIGN**. JULIA STOOPS, (U.S. CLS. 100 AND 101). SN 77-195,712. PUB. 1-1-2008. FILED 6-1-2007.
 3,397,584. **ECOLECT (BLOCK FORM)**. GEBBIA, JOSEPH N., AND GRIGSBY, MATT, (U.S. CLS. 100 AND 101). SN 77-196,296. PUB. 1-1-2008. FILED 6-3-2007.
 3,397,589 (*See Class 36 for this trademark.*)
 3,397,591. **THE GEEK GODDESS AND DESIGN**. LERNER, JAIME K. DBA THE GEEK GODDESS, (U.S. CLS. 100 AND 101). SN 77-197,903. PUB. 1-1-2008. FILED 6-5-2007.
 3,397,606. **APROPEAUX DESIGN (BLOCK FORM)**. CYNTHIA ERB, (U.S. CLS. 100 AND 101). SN 77-200,757. PUB. 1-1-2008. FILED 6-7-2007.
 3,397,627. **AMCA INTERNATIONAL AND DESIGN**. AIR MOVEMENT AND CONTROL ASSOCIATION, INC., (U.S. CLS. 100 AND 101). SN 77-204,319. PUB. 1-1-2008. FILED 6-12-2007.
 3,397,636. **CREATION TECHNOLOGIES (BLOCK FORM)**. CREATION TECHNOLOGIES, (U.S. CLS. 100 AND 101). SN 77-206,769. PUB. 1-1-2008. FILED 6-14-2007.
 3,397,641 (*See Class 4 for this trademark.*)
 3,397,645. **I INTERACTIVE VIEWS AND DESIGN**. INTERACTIVE VIEWS INCORPORATED, (U.S. CLS. 100 AND 101). SN 77-208,438. PUB. 1-1-2008. FILED 6-18-2007.
 3,397,648 (*See Class 38 for this trademark.*)
 3,397,661. **MYTA (BLOCK FORM)**. THE MYTA CORPORATION, (U.S. CLS. 100 AND 101). SN 77-211,609. PUB. 1-1-2008. FILED 6-21-2007.
 3,397,666 (*See Class 37 for this trademark.*)
 3,397,667. **DRI AND DESIGN**. DRI MANAGEMENT SYSTEMS, INC., (U.S. CLS. 100 AND 101). SN 77-212,626. PUB. 1-1-2008. FILED 6-21-2007.
 3,397,676 (*See Class 35 for this trademark.*)
 3,397,688. **PROCON AND DESIGN**. PROCON INC., (U.S. CLS. 100 AND 101). SN 77-215,762. PUB. 1-1-2008. FILED 6-26-2007.
 3,397,694. **LA PLAYA MAPPING AND DESIGN**. BARTLE, CHERYL, (U.S. CLS. 100 AND 101). SN 77-216,270. PUB. 1-1-2008. FILED 6-26-2007.
 3,397,713 (*See Class 35 for this trademark.*)
 3,397,745. **COTTONBLEND (BLOCK FORM)**. TICKETMASTER CORPORATION, (U.S. CLS. 100 AND 101). SN 77-222,470. PUB. 1-1-2008. FILED 7-5-2007.
 3,397,746. **COTTONBLEND AND DESIGN**. TICKETMASTER CORPORATION, (U.S. CLS. 100 AND 101). SN 77-222,482. PUB. 1-1-2008. FILED 7-5-2007.
 3,397,748. **XL AND DESIGN**. XL ACADEMICS, INC., (U.S. CLS. 100 AND 101). SN 77-222,639. PUB. 1-1-2008. FILED 7-5-2007.
 3,397,750 (*See Class 9 for this trademark.*)
 3,397,784 (*See Class 35 for this trademark.*)
 3,397,805. **? AND DESIGN**. WAGNER, STEVE, (U.S. CLS. 100 AND 101). SN 77-226,255. PUB. 1-1-2008. FILED 7-10-2007.
 3,397,806 (*See Class 35 for this trademark.*)
 3,397,815. **CT CHRISTOPHER TECHNOLOGIES (STYLIZED)**. CHRISTOPHER TECHNOLOGIES, LLC, (U.S. CLS. 100 AND 101). SN 77-226,620. PUB. 1-1-2008. FILED 7-11-2007.
 3,397,821 (*See Class 9 for this trademark.*)
 3,397,853. **ACHPPE (BLOCK FORM)**. PAYMENT SYSTEMS GROUP, INC., (U.S. CLS. 100 AND 101). SN 77-227,591. PUB. 1-1-2008. FILED 7-11-2007.
 3,397,854. **CCPPE (BLOCK FORM)**. PAYMENT SYSTEMS GROUP, INC., (U.S. CLS. 100 AND 101). SN 77-227,592. PUB. 1-1-2008. FILED 7-12-2007.
 3,397,857. **A MORE SUCCESSFUL PRACTICE BY DESIGN (BLOCK FORM)**. HEALTHCARE FACILITIES SOLUTIONS, INC., (U.S. CLS. 100 AND 101). SN 77-227,741. PUB. 1-1-2008. FILED 7-12-2007.
 3,397,870. **ALCYONE TECHNOLOGIES (BLOCK FORM)**. ROSA MARIA BOLIVAR GARCIA, (U.S. CLS. 100 AND 101). SN 77-227,924. PUB. 1-1-2008. FILED 7-12-2007.
 3,397,905. **UTILITEAM (BLOCK FORM)**. ZAPDOT INTERACTIVE, LLC, (U.S. CLS. 100 AND 101). SN 77-228,804. PUB. 1-1-2008. FILED 7-13-2007.
 3,397,906. **FOCUS ON YOUR GAME (BLOCK FORM)**. ZAPDOT INTERACTIVE, LLC, (U.S. CLS. 100 AND 101). SN 77-228,819. PUB. 1-1-2008. FILED 7-13-2007.
 3,397,909. **T AND DESIGN**. ZAPDOT INTERACTIVE, LLC, (U.S. CLS. 100 AND 101). SN 77-228,843. PUB. 1-1-2008. FILED 7-13-2007.
 3,397,910. **GLAM SQUAD DECORATORS (BLOCK FORM)**. FULLER, CHEVON, (U.S. CLS. 100 AND 101). SN 77-228,859. PUB. 1-1-2008. FILED 7-13-2007.
 3,397,918 (*See Class 40 for this trademark.*)
 3,397,951. **RESEARCHTRAIL (BLOCK FORM)**. RESEARCHTRAIL LTD., (U.S. CLS. 100 AND 101). SN 77-229,469. PUB. 1-1-2008. FILED 7-13-2007.
 3,397,975. **HEAVENLY BIRTHDAY (BLOCK FORM)**. HEAVENLY BIRTHDAY, L.L.C., (U.S. CLS. 100 AND 101). SN 77-229,876. PUB. 1-1-2008. FILED 7-14-2007.
 3,397,986 (*See Class 38 for this trademark.*)
 3,398,035. **THE INSPIRED ROOM (BLOCK FORM)**. MICHAELS, MELISSA, DBA THE INSPIRED ROOM, (U.S. CLS. 100 AND 101). SN 77-230,822. PUB. 1-1-2008. FILED 7-16-2007.
 3,398,058. **CLUSTERBLOGS (BLOCK FORM)**. IDEUM INC., (U.S. CLS. 100 AND 101). SN 77-231,201. PUB. 1-1-2008. FILED 7-17-2007.
 3,398,068. **NÜREGIME (BLOCK FORM)**. PEREZ, JORGE, (U.S. CLS. 100 AND 101). SN 77-231,330. PUB. 1-1-2008. FILED 7-17-2007.
 3,398,074. **Q AND DESIGN**. TEAM QUALITY SERVICES, INC., (U.S. CLS. 100 AND 101). SN 77-231,459. PUB. 1-1-2008. FILED 7-17-2007.
 3,398,078. **RESQ (BLOCK FORM)**. THE ARC GROUP, LLC.,

(U.S. CLS. 100 AND 101). SN 77-231,514. PUB. 1-1-2008. FILED 7-17-2007.

3,398,114. **WEBSITES UNDER YOUR CONTROL (BLOCK FORM)**. SHOLAR, WILLIAM, (U.S. CLS. 100 AND 101). SN 77-232,082. PUB. 1-1-2008. FILED 7-17-2007.

3,398,163. **SIMPLEPORT (BLOCK FORM)**. SIMPLE BUSINESS SYSTEMS, INC., (U.S. CLS. 100 AND 101). SN 77-232,868. PUB. 1-1-2008. FILED 7-18-2007.

3,398,205. **CABLEWISE (BLOCK FORM)**. UTILX CORPORATION, (U.S. CLS. 100 AND 101). SN 77-233,935. PUB. 1-1-2008. FILED 7-19-2007.

3,398,218. **STAPLE DESIGN (BLOCK FORM)**. STAPLE DESIGN STUDIO INC., (U.S. CLS. 100 AND 101). SN 77-234,219. PUB. 1-1-2008. FILED 7-19-2007.

3,398,275. **FREEWHEEL (BLOCK FORM)**. AUTODESK, INC., (U.S. CLS. 100 AND 101). SN 77-245,284. PUB. 1-1-2008. FILED 8-2-2007.

3,398,322. **MISCELLANEOUS DESIGN**. HOWSTUFFWORKS, INC., (U.S. CLS. 100 AND 101). SN 77-256,061. PUB. 1-1-2008. FILED 8-15-2007.

3,398,330 (*See Class 12 for this trademark*).

3,398,341. **TWISTHINK DESIGN TECHNOLOGY STRATEGY (STYLIZED)**. TWISTHINK, LLC, (U.S. CLS. 100 AND 101). SN 77-271,669. PUB. 1-1-2008. FILED 9-5-2007.

3,398,349 (*See Class 9 for this trademark*).

3,398,354 (*See Class 9 for this trademark*).

3,398,356 (*See Class 9 for this trademark*).

3,398,379. **ASSAY DESIGNS (BLOCK FORM)**. ASSAY DESIGNS, INC., (U.S. CLS. 100 AND 101). SN 78-499,819. PUB. 1-1-2008. FILED 10-14-2004.

3,398,381 (*See Class 35 for this trademark*).

3,398,384 (*See Class 14 for this trademark*).

3,398,387 (*See Class 9 for this trademark*).

3,398,396 (*See Class 9 for this trademark*).

3,398,407 (*See Class 9 for this trademark*).

3,398,411 (*See Class 10 for this trademark*).

3,398,418. **HARBORVIEW (BLOCK FORM)**. HARBORVIEW MEDICAL CENTER, MULTIPLE CLASS, (INT. CLS. 42 AND 44). (U.S. CLS. 100 AND 101). SN 78-673,209. PUB. 1-1-2008. FILED 7-19-2005.

3,398,421 (*See Class 37 for this trademark*).

3,398,422. **S SMITH ENGINEERING AND DESIGN**. SMITH ENGINEERING CONSULTANTS, INC., (U.S. CLS. 100 AND 101). SN 78-682,521. PUB. 1-1-2008. FILED 8-1-2005.

3,398,438 (*See Class 9 for this trademark*).

3,398,458 (*See Class 35 for this trademark*).

3,398,471 (*See Class 9 for this trademark*).

3,398,474. **CI COUPONS . INC MOTIVATE AND DESIGN**. COUPONS, INC., (U.S. CLS. 100 AND 101). SN 78-807,889. PUB. 1-1-2008. FILED 2-6-2006.

3,398,488 (*See Class 37 for this trademark*).

3,398,493. **THE PHARMACEUTICAL VALUE INDEX (BLOCK FORM)**. CENTER FOR VALUE-BASED MEDICINE, LLC, (U.S. CLS. 100 AND 101). SN 78-840,873. PUB. 1-1-2008. FILED 3-20-2006.

3,398,505. **GLANCE AND DESIGN**. GLANCE NETWORKS, INC., (U.S. CLS. 100 AND 101). SN 78-848,650. PUB. 1-1-2008. FILED 3-29-2006.

3,398,555 (*See Class 35 for this trademark*).

3,398,566 (*See Class 41 for this trademark*).

3,398,582 (*See Class 35 for this trademark*).

3,398,590 (*See Class 35 for this trademark*).

3,398,608 (*See Class 39 for this trademark*).

3,398,614 (*See Class 9 for this trademark*).

3,398,618. **ADO IT (STYLIZED)**. BOC ASSET MANAGEMENT GMBH, (U.S. CLS. 100 AND 101). SN 79-007,151. PUB. 1-1-2008. FILED 11-3-2004.

3,398,637 (*See Class 9 for this trademark*).

3,398,648 (*See Class 9 for this trademark*).

3,398,653 (*See Class 9 for this trademark*).

3,398,657 (*See Class 9 for this trademark*).

3,398,659 (*See Class 9 for this trademark*).

3,398,660 (*See Class 9 for this trademark*).

3,398,663 (*See Class 9 for this trademark*).

3,398,674 (*See Class 6 for this trademark*).

3,398,684 (*See Class 7 for this trademark*).

3,398,686 (*See Class 9 for this trademark*).

3,398,696 (*See Class 7 for this trademark*).

3,398,697 (*See Class 9 for this trademark*).

3,398,701 (*See Class 9 for this trademark*).

3,398,711 (*See Class 9 for this trademark*).

3,398,717 (*See Class 9 for this trademark*).

3,398,735 (*See Class 7 for this trademark*).

3,398,758 (*See Class 11 for this trademark*).

3,398,759 (*See Class 11 for this trademark*).

3,398,760 (*See Class 9 for this trademark*).

3,398,763 (*See Class 7 for this trademark*).

3,398,765 (*See Class 35 for this trademark*).

3,398,790 (*See Class 36 for this trademark*).

3,398,804 (*See Class 35 for this trademark*).

CLASS 43—HOTEL AND RESTAURANT SERVICES

3,396,849. **MOONSHADOWS (BLOCK FORM)**. C & M PEACE ENTERPRISES, INC., (U.S. CLS. 100 AND 101). SN 76-652,430. PUB. 1-1-2008. FILED 12-27-2005.

3,396,861 (*See Class 37 for this trademark*).

3,396,883. **GB GOOD BUDDIES BBQ AND DESIGN**. BUDDIES BBQ & SOUTHERN FOOD COMPANY, LLC, (U.S. CLS. 100 AND 101). SN 76-669,680. PUB. 1-1-2008. FILED 11-29-2006.

3,396,981 (*See Class 16 for this trademark*).

3,397,008. **HOTEL TERRA (BLOCK FORM)**. TERRA PROPERTY MANAGEMENT, (U.S. CLS. 100 AND 101). SN 77-025,162. PUB. 1-1-2008. FILED 10-19-2006.

3,397,020. **PASTAVINO TRATTORIA AND DESIGN**. ROMUALDO LAMBERTI, (U.S. CLS. 100 AND 101). SN 77-027,989. PUB. 1-1-2008. FILED 10-24-2006.

3,397,023. **MIKE & C'S FAMILY SPORTS GRILL (BLOCK FORM)**. MICHAEL F. HEALY, (U.S. CLS. 100 AND 101). SN 77-029,355. PUB. 1-1-2008. FILED 10-25-2006.

3,397,057. **MAGGIE MOORE'S IRISH PUB & RESTAURANT (BLOCK FORM)**. MOORE, JOHN, (U.S. CLS. 100 AND 101). SN 77-041,856. PUB. 1-1-2008. FILED 11-10-2006.

3,397,063. **MISCELLANEOUS DESIGN**. SAMARA, JAWAD N., (U.S. CLS. 100 AND 101). SN 77-042,781. PUB. 1-1-2008. FILED 11-13-2006.

3,397,112. **URBAN FARMING AND DESIGN**. URBAN FARMING, INC., (U.S. CLS. 100 AND 101). SN 77-057,139. PUB. 1-1-2008. FILED 12-5-2006.

3,397,150. **TOOTSA'S AND DESIGN**. TOOTSA'S, LLC, (U.S. CLS. 100 AND 101). SN 77-063,976. PUB. 1-1-2008. FILED 12-14-2006.

3,397,179. **TR'S (BLOCK FORM)**. MIELE, PATRICK A., (U.S. CLS. 100 AND 101). SN 77-068,460. PUB. 1-1-2008. FILED 12-20-2006.

3,397,180. **TR'S AND DESIGN**. MIELE, PATRICK A., (U.S. CLS. 100 AND 101). SN 77-068,495. PUB. 1-1-2008. FILED 12-20-2006.

3,397,214 (*See Class 41 for this trademark*).

3,397,219 (*See Class 16 for this trademark*).

3,397,224. **KEATING HOUSE (BLOCK FORM)**. SCOTT, DOUGLAS BRYCE, AND BALTIC, BENJAMIN FRANKLIN, (U.S. CLS. 100 AND 101). SN 77-073,971. PUB. 1-1-2008. FILED 12-31-2006.

3,397,241 (*See Class 35 for this trademark*).

3,397,249. **GUIDE PROGRAM (BLOCK FORM)**. GUIDE PROGRAM, INC., MULTIPLE CLASS, (INT. CLS. 43, 44 AND 45). (U.S. CLS. 100 AND 101). SN 77-080,277. PUB. 1-1-2008. FILED 1-10-2007.

3,397,253 (*See Class 30 for this trademark*).

3,397,254 (*See Class 30 for this trademark*).

3,397,272. **OYSTER KING (BLOCK FORM)**. LANZO, CHARLES P., (U.S. CLS. 100 AND 101). SN 77-087,227. PUB. 1-1-2008. FILED 1-19-2007.

3,397,278 (*See Class 25 for this trademark*).

3,397,279 (*See Class 25 for this trademark*).

3,397,298. **CUCOS MEXICAN CAFE (STYLIZED)**. BANNER MANAGEMENT INC., (U.S. CLS. 100 AND 101). SN 77-095,287. PUB. 1-1-2008. FILED 1-31-2007.

3,397,315. **CRAZY DUTCHMAN (BLOCK FORM)**. CISCO'S, INC., (U.S. CLS. 100 AND 101). SN 77-097,634. PUB. 1-1-2008. FILED 2-2-2007.

3,397,368 (*See Class 38 for this trademark*).

3,397,390. **MAISON (STYLIZED)**. KOR REALTY GROUP, L.L.C., (U.S. CLS. 100 AND 101). SN 77-121,193. PUB. 1-1-2008. FILED 3-2-2007.

3,397,392 (*See Class 35 for this trademark*).

3,397,395 (*See Class 35 for this trademark*).

3,397,429. **MOMMA GOLDBERG'S DELI AND DESIGN**. MOMMA GOLDBERG'S DELI, INC., (U.S. CLS. 100 AND 101). SN 77-138,417. PUB. 1-1-2008. FILED 3-23-2007.

3,397,460 (*See Class 25 for this trademark*).

3,397,468. **LOS TOROS AND DESIGN**. LOS TOROS MEXICAN RESTAURANT, INC., (U.S. CLS. 100 AND 101). SN 77-154,976. PUB. 1-1-2008. FILED 4-12-2007.

3,397,469. **LOS TOROS MEXICAN RESTAURANT (BLOCK FORM)**. LOS TOROS MEXICAN RESTAURANT, INC., (U.S. CLS. 100 AND 101). SN 77-154,982. PUB. 1-1-2008. FILED 4-12-2007.

3,397,556. **EST. 1907 CR ROTHMANN'S STEAKHOUSE & GRILL AND DESIGN**. BOULDER CREEK PROPERTIES LLC, (U.S. CLS. 100 AND 101). SN 77-189,706. PUB. 1-1-2008. FILED 5-24-2007.

3,397,586. **CHART HOUSE RESTAURANT AND DESIGN**. CHLN, INC., (U.S. CLS. 100 AND 101). SN 77-196,635. PUB. 1-1-2008. FILED 6-4-2007.

3,397,600. **BASE2STAY (BLOCK FORM)**. BASE2STAY LIMITED, (U.S. CLS. 100 AND 101). SN 77-200,384. PUB. 1-1-2008. FILED 6-7-2007.

3,397,605. **ROSA MEXICANO (STYLIZED)**. ROSA MEXICANO BRANDS, INC., (U.S. CLS. 100 AND 101). SN 77-200,591. PUB. 1-1-2008. FILED 6-7-2007.

3,397,623. **PITA FACTORY A DIVISION OF WRAPP IT UP AND DESIGN**. PIFA ENTERPRISES CORP., (U.S. CLS. 100 AND 101). SN 77-202,909. PUB. 1-1-2008. FILED 6-11-2007.

3,397,696 (*See Class 35 for this trademark*).

3,397,741 (*See Class 30 for this trademark*).

3,397,756. **WHICH WICH ? SUPERIOR SANDWICHES AND DESIGN**. SINELLI, JEFFREY, (U.S. CLS. 100 AND 101). SN 77-223,247. PUB. 1-1-2008. FILED 7-6-2007.

3,397,758. **MISCELLANEOUS DESIGN**. SINELLI, JEFFREY, (U.S. CLS. 100 AND 101). SN 77-223,285. PUB. 1-1-2008. FILED 7-6-2007.

3,397,796 (*See Class 41 for this trademark*).

3,397,804. **CBGB (BLOCK FORM)**. KRISTAL, HILLEL, (U.S. CLS. 100 AND 101). SN 77-226,252. PUB. 1-1-2008. FILED 7-10-2007.

3,397,833. **AMERICAN HOUSE AND DESIGN**. AMERICAN HOUSE LICENSING LLC, (U.S. CLS. 100 AND 101). SN 77-227,233. PUB. 1-1-2008. FILED 7-11-2007.

3,397,843 (*See Class 16 for this trademark*).

3,398,024. **THE SAGAMORE AND DESIGN**. GREEN ISLAND ASSOCIATES, (U.S. CLS. 100 AND 101). SN 77-230,672. PUB. 1-1-2008. FILED 7-16-2007.

3,398,108. **ROVER RETREAT AND DESIGN**. ROVER RETREAT FRANCHISING, LLC, (U.S. CLS. 100 AND 101). SN 77-231,996. PUB. 1-1-2008. FILED 7-17-2007.

3,398,110. **SEOUL BROS. (BLOCK FORM)**. SEOUL BROS. GROUP, INC., (U.S. CLS. 100 AND 101). SN 77-232,021. PUB. 1-1-2008. FILED 7-17-2007.

3,398,115. **SEOUL BROS. AND DESIGN**. SEOUL BROS. GROUP, INC., (U.S. CLS. 100 AND 101). SN 77-232,087. PUB. 1-1-2008. FILED 7-17-2007.

3,398,144. **MOCCA - RESTAURANT - LOUNGE ESPRESSO - BAR - WWW.MOCCALOUNGE.COM AND DESIGN**. CUP-CAFE NY, LLC, DBA MOCCA LOUNGE, (U.S. CLS. 100 AND 101). SN 77-232,554. PUB. 1-1-2008. FILED 7-18-2007.

3,398,156. **QUENCH YOUR CRUNCH! (BLOCK FORM)**. K & S ENTERPRISES, (U.S. CLS. 100 AND 101). SN 77-232,748. PUB. 1-1-2008. FILED 7-18-2007.

3,398,239. **MISCELLANEOUS DESIGN**. BRIGHT HORIZONS LIMITED PARTNERSHIP, (U.S. CLS. 100 AND 101). SN 77-236,197. PUB. 1-1-2008. FILED 7-23-2007.

3,398,254. **CELEBREE LEARNING CENTERS AND DESIGN**. CELEBREE HOLDINGS, INC., (U.S. CLS. 100 AND 101). SN 77-239,299. PUB. 1-1-2008. FILED 7-26-2007.

3,398,268. **LUCA PIZZA DI ROMA (BLOCK FORM)**. PIZZA DI ROMA INTERNATIONAL, INC., (U.S. CLS. 100 AND 101). SN 77-244,022. PUB. 1-1-2008. FILED 8-1-2007.

3,398,285. **MISCELLANEOUS DESIGN**. VALIANT GROUP, INC., (U.S. CLS. 100 AND 101). SN 77-248,513. PUB. 1-1-2008.

FILED 8-6-2007.

3,398,381 (*See Class 35 for this trademark*).

3,398,385 (*See Class 18 for this trademark*).

3,398,386 (*See Class 18 for this trademark*).

3,398,394. **ROSIE O'GRADY'S (BLOCK FORM)**. TREL RESTAURANT INC., (U.S. CLS. 100 AND 101). SN 78-556,633. PUB. 1-1-2008. FILED 1-31-2005.

3,398,464 (*See Class 16 for this trademark*).

3,398,472 (*See Class 41 for this trademark*).

3,398,478 (*See Class 9 for this trademark*).

3,398,496. **SLIM ORLANDO'S PHILLYSTEAK & GYROS WINGS AND DESIGN**. SARAH SALIM SORATHIA INC, (U.S. CLS. 100 AND 101). SN 78-843,805. PUB. 1-1-2008. FILED 3-22-2006.

3,398,512. **COWGIRLS SALOON & TEQUILARIA AND DESIGN**. KATHLEEN HANSEN, (U.S. CLS. 100 AND 101). SN 78-853,842. PUB. 1-1-2008. FILED 4-4-2006.

3,398,528 (*See Class 39 for this trademark*).

3,398,571 (*See Class 35 for this trademark*).

3,398,573 (*See Class 39 for this trademark*).

3,398,577. **ELECTRONIC BEATS EB AND DESIGN**. DEUTSCHE TELEKOM AG, (U.S. CLS. 100 AND 101). SN 78-936,021. PUB. 1-1-2008. FILED 7-24-2006.

3,398,600 (*See Class 3 for this trademark*).

3,398,608 (*See Class 39 for this trademark*).

3,398,610. **DISH GOURMET (BLOCK FORM)**. DISH, LLC, (U.S. CLS. 100 AND 101). SN 78-972,794. PUB. 1-1-2008. FILED 9-12-2006.

3,398,646 (*See Class 16 for this trademark*).

3,398,693 (*See Class 39 for this trademark*).

3,398,714 (*See Class 25 for this trademark*).

CLASS 44—MEDICAL, BEAUTY AND AGRICULTURAL SERVICES

3,396,837. **WELLNESS BY DESIGN (BLOCK FORM)**. ALEXIAN BROTHERS OF AMERICA, INC., (U.S. CLS. 100 AND 101). SN 76-620,353. PUB. 1-1-2008. FILED 11-12-2004.

3,396,841 (*See Class 9 for this trademark*).

3,396,861 (*See Class 37 for this trademark*).

3,396,881 (*See Class 35 for this trademark*).

3,396,922 (*See Class 35 for this trademark*).

3,396,974. **HEALTHWAYS AND DESIGN**. HEALTHWAYS, INC., (U.S. CLS. 100 AND 101). SN 77-010,762. PUB. 1-1-2008. FILED 9-29-2006.

3,396,981 (*See Class 16 for this trademark*).

3,397,024 (*See Class 41 for this trademark*).

3,397,025 (*See Class 41 for this trademark*).

3,397,032 (*See Class 41 for this trademark*).

3,397,051 (*See Class 5 for this trademark*).

3,397,065. **CSSTEST (BLOCK FORM)**. CSS TEST INC., MULTIPLE CLASS, (INT. CLS. 44 AND 45), (U.S. CLS. 100 AND 101). SN 77-043,857. PUB. 1-1-2008. FILED 11-14-2006.

3,397,078. **RELAXATION & RETREAT (BLOCK FORM)**. RELAXATION & RETREAT MESSAGES OF YORK, LLC, (U.S. CLS. 100 AND 101). SN 77-047,510. PUB. 1-1-2008. FILED 11-20-2006.

3,397,123. **ONE THERAPIST TO ONE PATIENT...ONE AT A TIME. EVERY TIME! (BLOCK FORM)**. PROFITNESS PHYSICAL THERAPY, P.C., (U.S. CLS. 100 AND 101). SN 77-058,380. PUB. 1-1-2008. FILED 12-6-2006.

3,397,158. **MISCELLANEOUS DESIGN**. HERITAGE NEW YORK, IPA INC., (U.S. CLS. 100 AND 101). SN 77-064,420. PUB. 1-1-2008. FILED 12-14-2006.

3,397,159. **MISCELLANEOUS DESIGN**. HERITAGE NEW YORK IPA, INC., (U.S. CLS. 100 AND 101). SN 77-064,451. PUB. 1-1-2008. FILED 12-14-2006.

3,397,169 (*See Class 35 for this trademark*).

3,397,196. **FASTGRO CONVERSION PROGRAM AND DESIGN**. BECK'S HYBRIDS, (U.S. CLS. 100 AND 101). SN 77-069,398. PUB. 1-1-2008. FILED 12-21-2006.

3,397,214 (*See Class 41 for this trademark*).

3,397,231. **BOB 3600 EMERGENCY MEDICAL ALERT SYSTEM AND DESIGN**. CRITICAL SIGNAL TECHNOLOGIES, (U.S. CLS. 100 AND 101). SN 77-076,185. PUB. 1-1-2008. FILED 1-4-2007.

- 3,397,232. **BOB 4000 EMERGENCY MEDICAL ALERT SYSTEM AND DESIGN**. CRITICAL SIGNAL TECHNOLOGIES, (U.S. CLS. 100 AND 101). SN 77-076,203. PUB. 1-1-2008. FILED 1-4-2007.
- 3,397,240. **HEALTHTIME (BLOCK FORM)**. UNITED TECHNOLOGIES CORPORATION, (U.S. CLS. 100 AND 101). SN 77-077,908. PUB. 1-1-2008. FILED 1-8-2007.
- 3,397,245. **NATURAL HORIZONS WELLNESS CENTER (BLOCK FORM)**. NATURAL HORIZONS WELLNESS CENTER, (U.S. CLS. 100 AND 101). SN 77-078,603. PUB. 1-1-2008. FILED 1-9-2007.
- 3,397,249 (*See Class 43 for this trademark*).
- 3,397,304. **PCM (BLOCK FORM)**. GATEWAY HEALTH PLAN L.P., (U.S. CLS. 100 AND 101). SN 77-096,487. PUB. 1-1-2008. FILED 2-1-2007.
- 3,397,309. **FIRST FORENSIC AND DESIGN**. FIRST FORENSIC, INCORPORATED, (U.S. CLS. 100 AND 101). SN 77-097,229. PUB. 1-1-2008. FILED 2-1-2007.
- 3,397,335. **ECONEUTRAL (BLOCK FORM)**. ERA ECOSYSTEM RESTORATION ASSOCIATES INC, (U.S. CLS. 100 AND 101). SN 77-101,946. PUB. 1-1-2008. FILED 2-7-2007.
- 3,397,339. **CODEHEART (BLOCK FORM)**. KING'S DAUGHTERS' MEDICAL CENTER, (U.S. CLS. 100 AND 101). SN 77-103,444. PUB. 1-1-2008. FILED 2-9-2007.
- 3,397,362. **HEALTHY LIVING THROUGH HEALTHY TOUCH (BLOCK FORM)**. CONNECTING TOUCH THERAPY & WELLNESS CENTER, INC., (U.S. CLS. 100 AND 101). SN 77-111,166. PUB. 1-1-2008. FILED 2-20-2007.
- 3,397,381 (*See Class 5 for this trademark*).
- 3,397,383 (*See Class 35 for this trademark*).
- 3,397,411 (*See Class 3 for this trademark*).
- 3,397,414. **WHITE'S PEDIATRICS HALOS FOR HEALTH AND DESIGN**. WHITE, JEFFEORY H. MD/PC, (U.S. CLS. 100 AND 101). SN 77-134,462. PUB. 9-25-2007. FILED 3-19-2007.
- 3,397,479. **TEXAS SURGICAL ASSOCIATES AND DESIGN**. TEXAS SURGICAL ASSOCIATES, L.L.P., (U.S. CLS. 100 AND 101). SN 77-159,969. PUB. 1-1-2008. FILED 4-18-2007.
- 3,397,497. **AMERICAN HEALTH CENTERS CHIROPRACTIC FITNESS REHABILITATION AND DESIGN**. LANHAM, CORP., (U.S. CLS. 100 AND 101). SN 77-165,927. PUB. 1-1-2008. FILED 4-25-2007.
- 3,397,541. **MISCELLANEOUS DESIGN**. CAPITAL BLUE-CROSS, (U.S. CLS. 100 AND 101). SN 77-182,437. PUB. 1-1-2008. FILED 5-16-2007.
- 3,397,572. **REHABILITATION & PAIN CENTER AND DESIGN**. SURGEON'S MANAGEMENT, INC., (U.S. CLS. 100 AND 101). SN 77-194,180. PUB. 1-1-2008. FILED 5-31-2007.
- 3,397,577. **BROWN HAND CENTER MICHAEL G. BROWN, M.D. FOUNDER AND DESIGN**. SURGEON'S MANAGEMENT, INC., (U.S. CLS. 100 AND 101). SN 77-194,419. PUB. 1-1-2008. FILED 5-31-2007.
- 3,397,585. **BREAKTHROUGH ENERGETICS (BLOCK FORM)**. DRAPER-O'CROTTY, HEATHER D., (U.S. CLS. 100 AND 101). SN 77-196,329. PUB. 1-1-2008. FILED 6-3-2007.
- 3,397,672. **IMWELL HEALTH (BLOCK FORM)**. IMWELL HEALTH, LLC, (U.S. CLS. 100 AND 101). SN 77-213,421. PUB. 1-1-2008. FILED 6-22-2007.
- 3,397,728. **MIO (BLOCK FORM)**. PHYSICAL ENTERPRISES INC., (U.S. CLS. 100 AND 101). SN 77-220,013. PUB. 1-1-2008. FILED 7-1-2007.
- 3,397,781. **ANAD (BLOCK FORM)**. NATIONAL ASSOCIATION OF ANOREXIA NERVOSA AND ASSOCIATED DISORDERS, (U.S. CLS. 100 AND 101). SN 77-225,127. PUB. 1-1-2008. FILED 7-9-2007.
- 3,397,789. **SHAPEFIT (BLOCK FORM)**. SHAPEFIT, LLC, (U.S. CLS. 100 AND 101). SN 77-225,548. PUB. 1-1-2008. FILED 7-10-2007.
- 3,397,796 (*See Class 41 for this trademark*).
- 3,397,811. **THE MALLOW CENTER (BLOCK FORM)**. GARY W. MALLOW, M.D., P.A., (U.S. CLS. 100 AND 101). SN 77-226,420. PUB. 1-1-2008. FILED 7-10-2007.
- 3,397,897. **EXECUTIVE TURF MANAGEMENT, INC. AND DESIGN**. EXECUTIVE TURF MANAGEMENT, INC., (U.S. CLS. 100 AND 101). SN 77-228,665. PUB. 1-1-2008. FILED 7-12-2007.
- 3,397,937. **PHYSICAL CAPACITY PROFILE (BLOCK FORM)**. OCCUPATIONAL PERFORMANCE CENTER, INC., (U.S. CLS. 100 AND 101). SN 77-229,153. PUB. 1-1-2008. FILED 7-13-2007.
- 3,397,946. **PRECISION NUTRIENTS (BLOCK FORM)**. DR. JIMMY, INC., (U.S. CLS. 100 AND 101). SN 77-229,359. PUB. 1-1-2008. FILED 7-13-2007.
- 3,397,985. **SLIM DIAMOND (BLOCK FORM)**. FAITH HOLISTIC HEALTHCARE, (U.S. CLS. 100 AND 101). SN 77-230,066. PUB. 1-1-2008. FILED 7-16-2007.
- 3,398,018. **LIFESTAR NETWORK (BLOCK FORM)**. LIFESTAR NETWORK, LLC, (U.S. CLS. 100 AND 101). SN 77-230,578. PUB. 1-1-2008. FILED 7-16-2007.
- 3,398,033. **HEAVEN SCENT (BLOCK FORM)**. GONTOWSKI, RENEE A., (U.S. CLS. 100 AND 101). SN 77-230,784. PUB. 1-1-2008. FILED 7-16-2007.
- 3,398,042. **PETAHOLICS (BLOCK FORM)**. PETAHOLICS LLC, (U.S. CLS. 100 AND 101). SN 77-230,893. PUB. 1-1-2008. FILED 7-16-2007.
- 3,398,044. **MARY SCHOOK (BLOCK FORM)**. BEAUTY BY MARY SCHOOK, LLC., (U.S. CLS. 100 AND 101). SN 77-230,940. PUB. 1-1-2008. FILED 7-16-2007.
- 3,398,064. **THE VILLAGE BARBER-ETTES AND DESIGN**. JONES MANAGEMENT SERVICES, LLC, (U.S. CLS. 100 AND 101). SN 77-231,296. PUB. 1-1-2008. FILED 7-17-2007.
- 3,398,174. **MISCELLANEOUS DESIGN**. WRIGHT, JAMES P DDS, (U.S. CLS. 100 AND 101). SN 77-233,167. PUB. 1-1-2008. FILED 7-18-2007.
- 3,398,187. **EARLY OPTIONS (BLOCK FORM)**. JOAN FLEISCHMAN MD PC, (U.S. CLS. 100 AND 101). SN 77-233,513. PUB. 1-1-2008. FILED 7-19-2007.
- 3,398,200 (*See Class 31 for this trademark*).
- 3,398,232. **BABY SOUND CHECK (BLOCK FORM)**. JOHN TRACY CLINIC, (U.S. CLS. 100 AND 101). SN 77-234,618. PUB. 1-1-2008. FILED 7-20-2007.
- 3,398,284. **ORGANIC LAWNS AND DESIGN**. ORGANIC LAWNS, (U.S. CLS. 100 AND 101). SN 77-248,001. PUB. 1-1-2008. FILED 8-6-2007.
- 3,398,315. **MISCELLANEOUS DESIGN**. IT'S ALL GOOD-HEALTH, INC., (U.S. CLS. 100 AND 101). SN 77-254,699. PUB. 1-1-2008. FILED 8-14-2007.
- 3,398,355. **HEALTH SOLUTIONS**. HEALTH SOLUTIONS OF MORTON, LLC, (U.S. CLS. 100 AND 101). SN 78-156,540. PUB. 9-27-2005. FILED 8-21-2002.
- 3,398,385 (*See Class 18 for this trademark*).
- 3,398,386 (*See Class 18 for this trademark*).
- 3,398,404. **PACIFIC SUN (BLOCK FORM)**. PACIFIC SUN, L.A., (U.S. CLS. 100 AND 101). SN 78-600,262. PUB. 1-1-2008. FILED 4-1-2005.
- 3,398,418 (*See Class 42 for this trademark*).
- 3,398,482 (*See Class 10 for this trademark*).
- 3,398,490. **THE TRILOGY OF OPTIMAL HEALTH (BLOCK FORM)**. JASON ENTERPRISES, INC., (U.S. CLS. 100 AND 101). SN 78-832,229. PUB. 1-1-2008. FILED 3-8-2006.
- 3,398,509. **EAST CAROLINA HEART INSTITUTE AND DESIGN**. PITT COUNTY MEMORIAL HOSPITAL, INCORPORATED, AND EAST CAROLINA UNIVERSITY, (U.S. CLS. 100 AND 101). SN 78-850,470. PUB. 1-1-2008. FILED 3-30-2006.
- 3,398,557 (*See Class 35 for this trademark*).
- 3,398,568. **BOOTHE EYE CARE & LASER CENTER (BLOCK FORM)**. BOOTHE, WILLIAM A., MD, (U.S. CLS. 100 AND 101). SN 78-925,363. PUB. 1-1-2008. FILED 7-10-2006.
- 3,398,573 (*See Class 39 for this trademark*).
- 3,398,595 (*See Class 35 for this trademark*).
- 3,398,601. **RICHLAND ANIMAL HOSPITAL AND DESIGN**. RICHLAND ANIMAL HOSPITAL, (U.S. CLS. 100 AND 101). SN 78-965,146. PUB. 1-1-2008. FILED 8-31-2006.
- 3,398,603. **HEALING BRILLIANTLY (BLOCK FORM)**. LASERCARE THERAPEUTICS INC., (U.S. CLS. 100 AND 101). SN 78-967,114. PUB. 1-1-2008. FILED 9-5-2006.
- 3,398,705 (*See Class 3 for this trademark*).
- 3,398,755 (*See Class 3 for this trademark*).
- 3,398,758 (*See Class 11 for this trademark*).
- 3,398,759 (*See Class 11 for this trademark*).

CLASS 45—PERSONAL AND LEGAL SERVICES

- 3,396,843. **SHADI.COM DREAMS INTO REALITY AND DESIGN.** SHADI.COM DIVISION OF AMPAK BILLING CORP., (U.S. CLS. 100 AND 101). SN 76-643,117. PUB. 1-1-2008. FILED 7-19-2005.
- 3,396,862. **PET-TO-GO (STYLIZED).** VALLEY FEED AND SUPPLY, INC., (U.S. CLS. 100 AND 101). SN 76-662,048. PUB. 1-1-2008. FILED 6-22-2006.
- 3,396,872 (*See Class 35 for this trademark.*).
- 3,396,881 (*See Class 35 for this trademark.*).
- 3,396,911. **TRANSFORMATIONAL ENERGY RELEASE (BLOCK FORM).** HARRIS, LAWRENCE J., (U.S. CLS. 100 AND 101). SN 76-675,241. PUB. 1-1-2008. FILED 4-9-2007.
- 3,396,973. **THE DOWN TO EARTH DAD (BLOCK FORM).** THE DOWN TO EARTH DAD, LLC, (U.S. CLS. 100 AND 101). SN 77-009,935. PUB. 1-1-2008. FILED 9-28-2006.
- 3,396,981 (*See Class 16 for this trademark.*).
- 3,396,998 (*See Class 35 for this trademark.*).
- 3,397,024 (*See Class 41 for this trademark.*).
- 3,397,025 (*See Class 41 for this trademark.*).
- 3,397,032 (*See Class 41 for this trademark.*).
- 3,397,065 (*See Class 44 for this trademark.*).
- 3,397,068. **EPISCOPAL CHURCH CENTER (BLOCK FORM).** THE EPISCOPAL CHURCH, (U.S. CLS. 100 AND 101). SN 77-044,615. PUB. 1-1-2008. FILED 11-15-2006.
- 3,397,168 (*See Class 35 for this trademark.*).
- 3,397,249 (*See Class 43 for this trademark.*).
- 3,397,274. **WILD HORSE ADULT RESORT & SPA AND DESIGN.** CASH ASSET MANAGEMENT, LLC, (U.S. CLS. 100 AND 101). SN 77-087,383. PUB. 1-1-2008. FILED 1-20-2007.
- 3,397,454 (*See Class 42 for this trademark.*).
- 3,397,463. **MOCHA MOMS (BLOCK FORM).** MOCHA MOMS, INC., (U.S. CLS. 100 AND 101). SN 77-153,165. PUB. 1-1-2008. FILED 4-10-2007.
- 3,397,491 (*See Class 36 for this trademark.*).
- 3,397,521. **DOCKUCHEK (BLOCK FORM).** INVESTIGATIVE CONSULTANTS, INC., (U.S. CLS. 100 AND 101). SN 77-175,399. PUB. 1-1-2008. FILED 5-8-2007.
- 3,397,545. **ARCHSTONE LAW GROUP (BLOCK FORM).** VAN WERT, ZIMMER & CONLIN, P.C., (U.S. CLS. 100 AND 101). SN 77-184,926. PUB. 1-1-2008. FILED 5-18-2007.
- 3,397,570. **CARDWAYS (BLOCK FORM).** ARROWEYE SOLUTIONS, INC., (U.S. CLS. 100 AND 101). SN 77-194,054. PUB. 1-1-2008. FILED 5-31-2007.
- 3,397,603 (*See Class 37 for this trademark.*).
- 3,397,611. **OPERATING EXPERIENCE. OPERATING EFFICIENCY. (BLOCK FORM).** BEACON LAW ADVISORS, PLLC, (U.S. CLS. 100 AND 101). SN 77-201,390. PUB. 1-1-2008. FILED 6-8-2007.
- 3,397,647. **I WANT U (BLOCK FORM).** MANA INTERNET SOLUTIONS, (U.S. CLS. 100 AND 101). SN 77-208,893. PUB. 1-1-2008. FILED 6-18-2007.
- 3,397,652. **LIVING LIFE FULLY (BLOCK FORM).** THOMAS WALSH, (U.S. CLS. 100 AND 101). SN 77-210,233. PUB. 1-1-2008. FILED 6-19-2007.
- 3,397,670 (*See Class 41 for this trademark.*).
- 3,397,701. **THE COMPOSED DOMAIN (BLOCK FORM).** ROSS, REBECCA, (U.S. CLS. 100 AND 101). SN 77-216,906. PUB. 1-1-2008. FILED 6-27-2007.
- 3,397,730. **AN EXTRA PAIR OF HANDS AND DESIGN.** AN EXTRA PAIR OF HANDS, LLC, (U.S. CLS. 100 AND 101). SN 77-220,362. PUB. 1-1-2008. FILED 7-2-2007.
- 3,397,744. **CONNECT AMERICA (BLOCK FORM).** CONNEC-TAMERICA.COM, LLC, (U.S. CLS. 100 AND 101). SN 77-222,331. PUB. 1-1-2008. FILED 7-5-2007.
- 3,397,784 (*See Class 35 for this trademark.*).
- 3,397,791. **PROVIDING CREATIVE AND PRACTICAL SOLUTIONS AT UNSURPASSED VALUE (BLOCK FORM).** SHOOK, HARDY & BACON L.L.P., (U.S. CLS. 100 AND 101). SN 77-225,625. PUB. 1-1-2008. FILED 7-10-2007.
- 3,397,798. **AGING AT HOME (BLOCK FORM).** AGING AT HOME, LTD., (U.S. CLS. 100 AND 101). SN 77-226,084. PUB. 1-1-2008. FILED 7-10-2007.
- 3,397,878 (*See Class 9 for this trademark.*).
- 3,397,920. **WE DON'T JUST ANSWER THE QUESTIONS . . . WE QUESTION THE ANSWERS (BLOCK FORM).** OVED & OVED LLP, (U.S. CLS. 100 AND 101). SN 77-228,963. PUB. 1-1-2008. FILED 7-13-2007.
- 3,397,921. **NAM (BLOCK FORM).** NATIONAL ARBITRATION AND MEDIATION, INC., (U.S. CLS. 100 AND 101). SN 77-228,990. PUB. 1-1-2008. FILED 7-13-2007.
- 3,397,931. **IPRACTICE (BLOCK FORM).** PROSKAUER ROSE LLP, (U.S. CLS. 100 AND 101). SN 77-229,092. PUB. 1-1-2008. FILED 7-13-2007.
- 3,397,969. **POWERSCREEN HIRING AND RISK MANAGEMENT TOOLS (BLOCK FORM).** INFORMATIVE SOLUTIONS, (U.S. CLS. 100 AND 101). SN 77-229,712. PUB. 1-1-2008. FILED 7-13-2007.
- 3,398,079. **INTUITIVE GIFTS (BLOCK FORM).** HALL, SARAH K., AND KAGETA, MARIA L., (U.S. CLS. 100 AND 101). SN 77-231,520. PUB. 1-1-2008. FILED 7-17-2007.
- 3,398,123 (*See Class 41 for this trademark.*).
- 3,398,136. **SHABEAR (BLOCK FORM).** SHABEAR INC., (U.S. CLS. 100 AND 101). SN 77-232,445. PUB. 1-1-2008. FILED 7-18-2007.
- 3,398,202. **LEGAL INSIGHT. TRUSTED COUNSEL. (BLOCK FORM).** MCGRATH NORTH MULLIN & KRATZ, PC LLO, (U.S. CLS. 100 AND 101). SN 77-233,843. PUB. 1-1-2008. FILED 7-19-2007.
- 3,398,214. **RUNNINGBEAR (BLOCK FORM).** HOSKET, GARY W., (U.S. CLS. 100 AND 101). SN 77-234,148. PUB. 1-1-2008. FILED 7-19-2007.
- 3,398,271. **COLORADO STATE PATROL STATE PATROL COLORADO AND DESIGN.** COLORADO STATE PATROL, (U.S. CLS. 100 AND 101). SN 77-244,464. PUB. 1-1-2008. FILED 8-1-2007.
- 3,398,287. **BEHIND THE BEAN (BLOCK FORM).** LYMA-BEAN, LLC, (U.S. CLS. 100 AND 101). SN 77-249,152. PUB. 1-1-2008. FILED 8-7-2007.
- 3,398,347 (*See Class 35 for this trademark.*).
- 3,398,385 (*See Class 18 for this trademark.*).
- 3,398,386 (*See Class 18 for this trademark.*).
- 3,398,425 (*See Class 35 for this trademark.*).
- 3,398,531. **GOTHICMATCH.COM (BLOCK FORM).** SUCCESSFULMATCH.COM, INC., (U.S. CLS. 100 AND 101). SN 78-876,468. PUB. 1-1-2008. FILED 5-4-2006.
- 3,398,532. **AGEMATCH.COM (BLOCK FORM).** SUCCESSFULMATCH.COM, INC., (U.S. CLS. 100 AND 101). SN 78-876,491. PUB. 1-1-2008. FILED 5-4-2006.
- 3,398,533. **INTERRACIALMATCH.COM (BLOCK FORM).** SUCCESSFULMATCH.COM, INC., (U.S. CLS. 100 AND 101). SN 78-876,494. PUB. 1-1-2008. FILED 5-4-2006.
- 3,398,600 (*See Class 3 for this trademark.*).
- 3,398,686 (*See Class 9 for this trademark.*).
- 3,398,709 (*See Class 9 for this trademark.*).
- 3,398,711 (*See Class 9 for this trademark.*).
- 3,398,751 (*See Class 9 for this trademark.*).
- 3,398,790 (*See Class 36 for this trademark.*).
- 3,398,791 (*See Class 16 for this trademark.*).

* * * * *

SECTION 2.—PRIOR UNITED STATES CLASSIFICATION

CERTIFICATION MARKS

CLASS A—GOODS

3,396,912. **HPVA HARDWOOD PLYWOOD AND VENEER ASSOCIATION AND DESIGN.** HARDWOOD PLYWOOD & VENEER ASSOCIATION, SN 76-675,323. PUB. 1-1-2008. FILED 4-10-2007.

3,396,956. **PECORINO TOSCANO DOP TP AND DESIGN.** CONSORZIO TUTELA PECORINO TOSCANO D.O.P., SN 77-000,683. PUB. 1-1-2008. FILED 9-15-2006.

3,397,028. **IDAHO EASTERN OREGON SPANISH SWEET ONIONS AND DESIGN.** IDAHO-EASTERN OREGON ONION COMMITTEE, SN 77-031,426. PUB. 1-1-2008. FILED 10-27-2006.

3,397,175. **ACMI CL ART & CREATIVE MATERIALS INSTI-**

TUTE CERTIFIED CONFORMS TO ASTM D 4236 AND DESIGN. THE ART & CREATIVE MATERIALS INSTITUTE, INC., SN 77-067,927. PUB. 1-1-2008. FILED 12-19-2006.

CLASS B—SERVICES

3,398,529. **FRANCHISE RESEARCH INSTITUTE FRANCHISE APPROVED AND DESIGN.** JOHNSON FRANCHISE CONSULTING, INC., SN 78-875,147. PUB. 1-1-2008. FILED 5-3-2006.

3,398,569. **ECOCERTIFIED (BLOCK FORM).** ECOQUEST INTERNATIONAL, INC., SN 78-926,857. PUB. 9-25-2007. FILED 7-11-2006.

* * * * *

TRADEMARK REGISTRATIONS ISSUED UNDER SECTION 1(d)

The following marks have registered on the Principal Register pursuant to the intent-to-use provisions of Section 1(d) of the Trademark Act of 1946, as amended.

SECTION 1.— INTERNATIONAL CLASSIFICATION

The short titles associated below with the international class numbers are terms designed merely for quick identification and are not an official part of the international classification. The full names of international classes are given in section 6.1 of the trademark rules of practice.

The designation "U.S. Cl." appearing in this section refers to the U.S. class in effect prior to Sep. 1, 1973 rather than the international class which applies to applications filed on or after that date. For adoption of international classification see notice in the OFFICIAL GAZETTE of Jun. 26, 1973 (911 O.G. TM 210).

Application in more than one class

3,398,836. YAHOO! INC., SUNNYVALE, CA. SN 75-300,217.
PUB. 11-17-1998, FILED 5-28-1997.

YAHOO!

OWNER OF U.S. REG. NOS. 1,572,204, 2,040,222, AND OTHERS.

CLASS 3—COSMETICS AND CLEANING PREPARATIONS

FOR SUN BLOCK (U.S. CLS. 1, 4, 6, 50, 51 AND 52).
FIRST USE 6-30-2007; IN COMMERCE 6-30-2007.

CLASS 16—PAPER GOODS AND PRINTED MATTER

FOR PAPER AND STATIONERY ITEMS, NAMELY, PAPER POSTCARDS, PERSONAL DIARIES, AND DECORATIVE PENCIL TOP ORNAMENTS (U.S. CLS. 2, 5, 22, 23, 29, 37, 38 AND 50).
FIRST USE 2-28-1998; IN COMMERCE 2-28-1998.

CLASS 24—FABRICS

FOR THROW BLANKETS (U.S. CLS. 42 AND 50).
FIRST USE 10-31-2007; IN COMMERCE 10-31-2007.

3,398,842. E J ACQUISITION LLC, NEW YORK, NY. SN 76-301,442. PUB. 9-3-2002, FILED 8-16-2001.



CLASS 25—CLOTHING

FOR BELTS (U.S. CLS. 22 AND 39).
FIRST USE 5-30-2007; IN COMMERCE 5-30-2007.

CLASS 26—FANCY GOODS

FOR BELT BUCKLES NOT OF PRECIOUS METAL (U.S. CLS. 37, 39, 40, 42 AND 50).
FIRST USE 5-30-2007; IN COMMERCE 5-30-2007.

3,398,843. PENGUIN GROUP (USA) INC., NEW YORK, NY.
SN 76-320,692. PUB. 12-9-2003, FILED 10-3-2001.

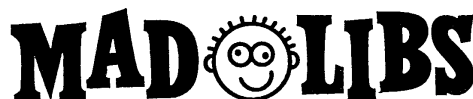

OWNER OF U.S. REG. NOS. 1,018,812 AND 2,333,753.

CLASS 16—PAPER GOODS AND PRINTED MATTER

FOR GREETING CARDS, PAPER PARTY FAVORS (U.S. CLS. 2, 5, 22, 23, 29, 37, 38 AND 50).
FIRST USE 6-24-2005; IN COMMERCE 6-24-2005.

CLASS 25—CLOTHING

FOR T-SHIRTS (U.S. CLS. 22 AND 39).
FIRST USE 12-0-2005; IN COMMERCE 12-0-2005.

CLASS 28—TOYS AND SPORTING GOODS

FOR CARD GAMES; HAND HELD UNIT FOR PLAYING ELECTRONIC GAMES (U.S. CLS. 22, 23, 38 AND 50).
FIRST USE 5-0-2002; IN COMMERCE 5-0-2002.

3,398,844. TEMENOS HEADQUARTERS SA, 1205 GENEVA, SWITZERLAND. SN 76-320,792. PUB. 3-7-2006, FILED 10-2-2001.

TEMENOS eMerge

PRIORITY CLAIMED UNDER SEC. 44(D) ON SWITZERLAND APPLICATION NO. 05679/2001, FILED 6-7-2001.

CLASS 9—ELECTRICAL AND SCIENTIFIC APPARATUS

FOR COMPUTER SOFTWARE FOR USE IN TRADING, ACCOUNTING, REPORTING AND OPERATIONAL FACILITIES MANAGEMENT BY FINANCIAL INSTITUTIONS; COMPUTER PROGRAMS FOR USE IN TRADING, ACCOUNTING, REPORTING AND OPERATIONAL FACILITIES MANAGEMENT BY FINANCIAL INSTITUTIONS (U.S. CLS. 21, 23, 26, 36 AND 38).
FIRST USE 1-3-2003; IN COMMERCE 1-3-2003.

CLASS 16—PAPER GOODS AND PRINTED MATTER

FOR BOOKLETS DESCRIBING THE FUNCTIONALITY AND FEATURES OF COMPUTER SOFTWARE SYSTEMS FOR USE IN FINANCIAL INSTITUTIONS, PRINTED TEACHING MATERIALS ON HOW TO USE COMPUTER SOFTWARE SYSTEMS FOR USE IN FINANCIAL INSTITUTIONS; EDUCATIONAL PUBLICATIONS, NAMELY, TRAINING MANUALS IN THE FIELD OF COMPUTER SOFTWARE SYSTEMS FOR USE IN FINANCIAL INSTITUTIONS (U.S. CLS. 2, 5, 22, 23, 29, 37, 38 AND 50).
FIRST USE 1-3-2003; IN COMMERCE 1-3-2003.

3,398,845. FLAGSHIP VENTURES MANAGEMENT, INC., CAMBRIDGE, MA. SN 76-328,914. PUB. 9-27-2005, FILED 10-23-2001.

FLAGSHIP VENTURES

NO CLAIM IS MADE TO THE EXCLUSIVE RIGHT TO USE "VENTURES", APART FROM THE MARK AS SHOWN.

CLASS 35—ADVERTISING AND BUSINESS

FOR NEW BUSINESS VENTURE PLANNING, MANAGEMENT AND CONSULTATION (U.S. CLS. 100, 101 AND 102).
FIRST USE 4-30-2001; IN COMMERCE 4-30-2001.

CLASS 36—INSURANCE AND FINANCIAL

FOR FINANCIAL INVESTMENT IN NEW BUSINESS VENTURES; INVESTMENT SERVICES IN THE FIELDS OF VENTURE CAPITAL AND PRIVATE EQUITY (U.S. CLS. 100, 101 AND 102).
FIRST USE 4-30-2001; IN COMMERCE 4-30-2001.

3,398,847. PRITEST, INC., REDMOND, WA. SN 76-383,026. PUB. 1-21-2003, FILED 3-18-2002.



The logo for Pritest features the word "Pritest" in a bold, sans-serif font. Above the letter 'i' is a stylized graphic element consisting of a curved line that forms a partial circle, resembling a smile or a diagnostic symbol.

CLASS 1—CHEMICALS

FOR DIAGNOSTIC REAGENTS FOR SCIENTIFIC AND RESEARCH APPLICATIONS (U.S. CLS. 1, 5, 6, 10, 26 AND 46).
FIRST USE 11-22-2005; IN COMMERCE 11-22-2005.

CLASS 5—PHARMACEUTICALS

FOR DIAGNOSTIC REAGENTS FOR MEDICAL APPLICATIONS (U.S. CLS. 6, 18, 44, 46, 51 AND 52).
FIRST USE 11-22-2005; IN COMMERCE 11-22-2005.

CLASS 10—MEDICAL APPARATUS

FOR MEDICAL DEVICES, NAMELY, OPTICAL CHEMICAL SENSOR FOR MEDICAL TESTING AND DIAGNOSTIC USE (U.S. CLS. 26, 39 AND 44).
FIRST USE 4-13-2006; IN COMMERCE 4-13-2006.

3,398,850. STARSAT, LLC, LOUISVILLE, KY. SN 76-450,375. PUB. 9-28-2004, FILED 9-16-2002.

STARSAT

CLASS 9—ELECTRICAL AND SCIENTIFIC APPARATUS

FOR SECURITY AND SURVEILLANCE SYSTEMS COMPRISED PRIMARILY OF COMPUTER EQUIPMENT, NAMELY, DESKTOP COMPUTERS, POINTER DEVICES, MONITORS, KVM SWITCHES, NETWORK HUBS, MOTION SENSORS, DIGITAL CAMERAS AND SOFTWARE; ELECTRONIC DELIVERY SYSTEMS FOR RETAILER SPECIFIC ADVERTISEMENTS AND PROMOTIONS COMPRISED PRIMARILY OF COMPUTER EQUIPMENT, NAMELY, DIGITAL SIGNBOARDS, MONITORS, DIGITAL CAMERAS AND SOFTWARE, AND NETWORKING EQUIPMENT, NAMELY, ROUTERS, HUBS, AND SWITCHES, AND SOFTWARE; DATA COLLECTION SYSTEMS FOR INVENTORY TRACKING AND MANAGEMENT SYSTEMS COMPRISED PRIMARILY OF COMPUTER EQUIPMENT, NAMELY, DESKTOP COMPUTERS, POINTER DEVICES, MONITORS, TOUCHSCREEN MONITORS, INPUT TERMINALS, AND SCANNERS, DIGITAL CAMERAS AND SOFTWARE, AND NETWORKING EQUIPMENT, NAMELY, NETWORK ROUTERS, HUBS, SWITCHES AND SOFTWARE (U.S. CLS. 21, 23, 26, 36 AND 38).
FIRST USE 7-7-2004; IN COMMERCE 7-7-2004.

CLASS 35—ADVERTISING AND BUSINESS

FOR PROVIDING INVENTORY TRACKING AND MANAGEMENT SERVICES FOR OTHERS IN THE FIELDS OF RETAIL SERVICES, GOVERNMENTAL TRANSACTIONS, RESTAURANTS, AND PUBLIC ACCOMMODATIONS, BY WAY OF COMMUNICATIONS, TELECOMMUNICATIONS AND COMPUTER EQUIPMENT; PROVIDING INVENTORY TRACKING AND MANAGEMENT SERVICES INFORMATION OVER THE INTERNET (U.S. CLS. 100, 101 AND 102).
FIRST USE 7-7-2004; IN COMMERCE 7-7-2004.

CLASS 38—COMMUNICATION

FOR ONLINE DOCUMENT DELIVERY VIA A GLOBAL COMPUTER NETWORK, NAMELY, DELIVERY OF RETAILER SPECIFIC ADVERTISEMENTS AND PROMOTIONS BY WAY OF COMMUNICATIONS, TELECOMMUNICATIONS, COMPUTER AND EQUIPMENT (U.S. CLS. 100, 101 AND 104).

FIRST USE 7-7-2004; IN COMMERCE 7-7-2004.

CLASS 45—PERSONAL AND LEGAL SERVICES

FOR PROVIDING SECURITY AND SURVEILLANCE SERVICES FOR OTHERS, NAMELY, MONITORING RETAIL TRANSACTIONS, GOVERNMENTAL TRANSACTIONS, RESTAURANT TRANSACTIONS AND PUBLIC ACCOMMODATION TRANSACTIONS, UTILIZING COMPUTERS, SOFTWARE, DIGITAL CAMERAS; PROVIDING SECURITY AND SURVEILLANCE INFORMATION OVER THE INTERNET (U.S. CLS. 100 AND 101).

FIRST USE 7-7-2004; IN COMMERCE 7-7-2004.

3,398,854. UNION PACIFIC RAILROAD COMPANY, OMAHA, NE. SN 76-479,579. PUB. 8-31-2004, FILED 12-31-2002.

**CLASS 8—HAND TOOLS**

FOR HAND TOOLS, NAMELY, WRENCHES; HAND TOOLS, NAMELY, SOCKET SETS; HAND TOOLS, NAMELY, SOCKET AND SCREWDRIVER SETS; HAND TOOLS, NAMELY, SETS OF SCREWDRIVERS, PLIERS, WRENCHES AND TAPE MEASURES; MULTI-FUNCTION HAND TOOLS COMPRISED OF SCREWDRIVERS, KNIVES, PLIERS, FILES AND CAN OPENERS; MULTI FUNCTION HAND TOOLS COMPRISED OF SCISSORS, FILES AND KNIVES; POCKET KNIVES; HUNTING KNIVES; HAND TOOLS, NAMELY, AUTOMOTIVE ICE SCRAPERS; TRAVEL KITS CONSISTING OF SCISSORS AND MANICURE IMPLEMENTS, NAMELY, NAIL FILES AND NAIL CLIPPERS (U.S. CLS. 23, 28 AND 44).

FIRST USE 0-0-1990; IN COMMERCE 0-0-1990.

CLASS 9—ELECTRICAL AND SCIENTIFIC APPARATUS

FOR VIDEO TAPES FEATURING RAILROAD RELATED TOPICS; PERSONAL RADIOS; DISPOSABLE CAMERAS; PERSONAL CD PLAYERS; LASER POINTERS; DECORATIVE MAGNETS; COMPUTER PERIPHERAL MOUSE PADS; PERSONAL SECURITY ALARMS; MODEM CABLES; TELEPHONE CABLES; THERMOMETERS NOT FOR MEDICAL USE; EYEGGLASS SECURITY CHAINS; TAPE MEASURES; TIRE PRESSURE GAUGES; LEATHER AND LEATHER-LIKE CD CASES (U.S. CLS. 21, 23, 26, 36 AND 38).

FIRST USE 0-0-1993; IN COMMERCE 0-0-1993.

CLASS 11—ENVIRONMENTAL CONTROL APPARATUS

FOR ELECTRIC INDOOR GRILLS; FLASHLIGHTS; ELECTRIC LANTERNS; OIL LANTERNS; AND LAMPS (U.S. CLS. 13, 21, 23, 31 AND 34).

FIRST USE 0-0-1990; IN COMMERCE 0-0-1990.

CLASS 12—VEHICLES

FOR LICENSE PLATE HOLDERS (U.S. CLS. 19, 21, 23, 31, 35 AND 44).

FIRST USE 0-0-1996; IN COMMERCE 0-0-1996.

CLASS 14—JEWELRY

FOR DESK CLOCKS; WALL CLOCKS; AND MEDALLIONS OF PRECIOUS METALS (U.S. CLS. 2, 27, 28 AND 50).

FIRST USE 0-0-1980; IN COMMERCE 0-0-1980.

CLASS 16—PAPER GOODS AND PRINTED MATTER

FOR PAPERWEIGHTS; LEATHER AND LEATHER-LIKE PHOTO ALBUMS; LEATHER AND LEATHER-LIKE CHECKBOOK COVERS; LEATHER AND LEATHER-LIKE STATIONARY-TYPE PORTFOLIOS; LEATHER AND LEATHER-LIKE TRAVEL DOCUMENT HOLDERS; CARDBOARD COASTERS, DESKTOP BUSINESS CARD HOLDERS; STICKERS; AND MAPS (U.S. CLS. 2, 5, 22, 23, 29, 37, 38 AND 50).

FIRST USE 0-0-1930; IN COMMERCE 0-0-1930.

CLASS 18—LEATHER GOODS

FOR LUGGAGE; LEATHER AND LEATHER-LIKE BRIEFCASES; HANGING LUGGAGE BAGS; SUITCASES; GYM BAGS; BACKPACKS; SADDLES; UMBRELLAS; LEATHER AND LEATHER-LIKE WALLETS; LEATHER AND LEATHER-LIKE CLUTCH PURSE; TRAVEL KITS SOLD EMPTY; LEATHER AND LEATHER-LIKE BRIEFCASE-TYPE PORTFOLIOS; LEATHER AND LEATHER-LIKE BUSINESS CARD CASES; LEATHER AND LEATHER-LIKE KEY-CHAINS; LEATHER AND LEATHER-LIKE LUGGAGE TAGS; CHILDREN'S BACKPACKS; FANNY PACKS (U.S. CLS. 1, 2, 3, 22 AND 41).

FIRST USE 0-0-1990; IN COMMERCE 0-0-1990.

CLASS 20—FURNITURE AND ARTICLES NOT OTHERWISE CLASSIFIED

FOR PICTURE FRAMES; CLIP HOLDERS FOR BADGES; NON-ELECTRIC FANS FOR PERSONAL USE; HAND HELD PAPER FANS (U.S. CLS. 2, 13, 22, 25, 32 AND 50).

FIRST USE 0-0-1993; IN COMMERCE 0-0-1993.

CLASS 21—HOUSEWARES AND GLASS

FOR WIND CHIMES; LEATHER AND LEATHER-LIKE COASTERS; BARWARE OF CRYSTAL AND GLASS, NAMELY, DRINKING GLASSES; PLASTIC WATER BOTTLES SOLD EMPTY; CANDY DISHES OF CRYSTAL OR GLASS; THERMAL INSULATED CONTAINERS FOR BEVERAGES; THERMAL INSULATED WRAPS FOR CANS AND BOTTLES; KITCHEN UTENSILS, NAMELY, ICE CREAM SCOOPS; CUTTING BOARDS OF WOOD AND PLASTIC; BARBECUE TOOL SETS OF FORK, SPATULA AND TONGS; AND INSULATED LUNCH BAGS (U.S. CLS. 2, 13, 23, 29, 30, 33, 40 AND 50).

FIRST USE 0-0-1993; IN COMMERCE 0-0-1993.

CLASS 22—CORDAGE AND FIBERS

FOR LANYARDS FOR HOLDING BADGES (U.S. CLS. 1, 2, 7, 19, 22, 42 AND 50).

FIRST USE 0-0-1999; IN COMMERCE 0-0-1999.

CLASS 24—FABRICS

FOR BED BLANKETS; AFGHANS; CLOTH FLAGS; BEACH TOWELS; AND PLASTIC PLACE MATS (U.S. CLS. 42 AND 50).

FIRST USE 0-0-1990; IN COMMERCE 0-0-1990.

CLASS 25—CLOTHING

FOR LEATHER AND LEATHER-LIKE JACKETS; CHILDREN'S ROMPERS; CHILDREN'S OVERALLS; T-SHIRTS; SWEATERS; EARMUFFS; AND VISORS (U.S. CLS. 22 AND 39).

FIRST USE 0-0-1975; IN COMMERCE 0-0-1975.

CLASS 26—FANCY GOODS

FOR CLOTH PATCHES FOR CLOTHING (U.S. CLS. 37, 39, 40, 42 AND 50).

FIRST USE 0-0-1960; IN COMMERCE 0-0-1960.

CLASS 28—TOYS AND SPORTING GOODS

FOR SCALE MODEL TRAINS, BATTERY OPERATED TOY TRAINS, WIND-UP TOY TRAINS, SOFT SCULPTURE PLUSH TOYS, BEAN-BAG TOYS, WOODEN TOY TRAINS, YO-YOS, DOMINOES, GOLF CLUBS, SPORT BALLS, SNOW GLOBES, SPORTING GOODS, NAMELY, TOSS DISCS, CHILDREN'S WIRE CONSTRUCTION ACTIVITY TOYS, BUBBLE MAKING TOYS, MUSICAL TOYS AND TOY WHISTLES (U.S. CLS. 22, 23, 38 AND 50).

FIRST USE 0-0-1990; IN COMMERCE 0-0-1990.

3,398,868. JOSEPH CAMPBELL FOUNDATION, SAN ANSELMO, CA. SN 76-550,611. PUB. 1-2-2007, FILED 10-9-2003.

JOSEPH CAMPBELL

THE NAME "JOSEPH CAMPBELL" DOES NOT IDENTIFY A LIVING INDIVIDUAL.

CLASS 9—ELECTRICAL AND SCIENTIFIC APPARATUS

FOR PRE-RECORDED AUDIO AND VIDEO CASSETTES AND CDS FEATURING LECTURES IN THE FIELD OF MYTHOLOGY AND COMPARATIVE RELIGION (U.S. CLS. 21, 23, 26, 36 AND 38).

FIRST USE 0-0-1988; IN COMMERCE 0-0-1988.

CLASS 16—PAPER GOODS AND PRINTED MATTER

FOR BOOKS ON THE SUBJECTS OF MYTHOLOGY AND COMPARATIVE RELIGION, NOTE CARDS AND BOOKMARKS (U.S. CLS. 2, 5, 22, 23, 29, 37, 38 AND 50).

FIRST USE 5-0-1988; IN COMMERCE 5-0-1988.

CLASS 25—CLOTHING

FOR T-SHIRTS (U.S. CLS. 22 AND 39).

FIRST USE 7-0-1992; IN COMMERCE 6-0-2006.

3,398,873. F&W ASSOCIATES, INC., MILWAUKIE, OR. SN 76-559,955. PUB. 9-21-2004, FILED 10-27-2003.

CONSONUS

THE FOREIGN WORDING IN THE MARK TRANSLATES INTO ENGLISH AS HARMONIOUS.

CLASS 35—ADVERTISING AND BUSINESS

FOR PHARMACY SERVICES; TEMPORARY STAFFING SERVICES IN THE HEALTHCARE FIELD; PERSONNEL RECRUITMENT SERVICES IN THE FIELD OF HEALTHCARE (U.S. CLS. 100, 101 AND 102).

FIRST USE 11-1-2003; IN COMMERCE 11-1-2003.

CLASS 44—MEDICAL, BEAUTY AND AGRICULTURAL SERVICES

FOR HEALTHCARE CONSULTATION SERVICES; HEALTHCARE SERVICES; PHYSICAL REHABILITATION SERVICES; HOME HEALTHCARE SERVICES; PHARMACEUTICAL ADVISORY SERVICES; PHYSICAL, OCCUPATIONAL, AND SPEECH THERAPY SERVICES; LONG TERM HEALTHCARE SERVICES (U.S. CLS. 100 AND 101).

FIRST USE 11-1-2003; IN COMMERCE 11-1-2003.

3,398,879. GEORGE ZIMMER 1988 LIVING TRUST, COMPRISING JAMES ZIMMER, LAURIE ECKSTEIN, DAVID EDWAB AND CHARLES BRESLER ALL U.S. CITIZEN., FREMONT, CA. SN 76-586,192. PUB. 3-1-2005, FILED 4-12-2004.



OWNER OF U.S. REG. NO. 2,655,808.

THE STIPLING IS A FEATURE OF THE MARK AND DOES NOT INDICATE COLOR.

THE LIKENESS (OR, "PORTRAIT") IN THE MARK IDENTIFIES A LIVING INDIVIDUAL WHOSE CONSENT IS OF RECORD.

THE MARK CONSISTS OF A LIKENESS (OR, "PORTRAIT") OF "GEORGE ZIMMER'S" FACE.

CLASS 37—CONSTRUCTION AND REPAIR

FOR DRY CLEANING AND LAUNDRY SERVICES (U.S. CLS. 100, 103 AND 106).

FIRST USE 3-0-2005; IN COMMERCE 3-0-2005.

CLASS 40—MATERIAL TREATMENT

FOR TAILORING AND CLOTHING ALTERATION (U.S. CLS. 100, 103 AND 106).

FIRST USE 3-0-2005; IN COMMERCE 3-0-2005.

3,398,880. LANGER, ALEXANDER G., BOSTON, MA. SN 76-597,527. PUB. 12-5-2006, FILED 6-14-2004.

FLYING LURE

THE MARK CONSISTS OF STANDARD CHARACTERS WITHOUT CLAIM TO ANY PARTICULAR FONT, STYLE, SIZE, OR COLOR.

CLASS 28—TOYS AND SPORTING GOODS

FOR FISHING LURES AND FISHING EQUIPMENT, NAMELY, WEIGHTS, FISHING RODS, REELS (U.S. CLS. 22, 23, 38 AND 50).

FIRST USE 2-0-1989; IN COMMERCE 2-0-1989.

CLASS 35—ADVERTISING AND BUSINESS

FOR DIRECT RESPONSE RETAIL SERVICES BY MEANS OF INFOMERCIALS IN THE FIELD OF FISHING LURES AND FISHING RODS (U.S. CLS. 100, 101 AND 102).

FIRST USE 2-0-1989; IN COMMERCE 2-0-1989.

3,398,883. TV GUIDE MAGAZINE GROUP, INC., LOS ANGELES, CA. SN 76-602,006. PUB. 8-30-2005, FILED 7-14-2004.

i-Guide

OWNER OF U.S. REG. NOS. 650,942, 2,833,591, AND OTHERS.

CLASS 38—COMMUNICATION

FOR COMMUNICATIONS SERVICES, NAMELY, THE TRANSMISSION AND DELIVERY OF PROMOTIONAL, INFORMATIONAL, AND INTERACTIVE TELEVISION PROGRAMMING SERVICES VIA BROADCAST, CABLE, SATELLITE AND ON-LINE ELECTRONIC COMMUNICATIONS NETWORKS LIMITED TO THE FOLLOWING SUBJECT MATTER: (1) VIDEO PROGRAM LISTINGS; (2) TELEVISION LISTINGS; (3) INFORMATION ON VIDEO PROGRAMMING; (4) INFORMATION ON TELEVISION PROGRAMMING; OR (5) INTERACTIVE OR ELECTRONIC PROGRAM GUIDES RELATED TO TELEVISION OR VIDEO PROGRAMMING. SUCH SERVICES SHALL SPECIFICALLY EXCLUDE SEARCH ENGINE SERVICES AND ALL OTHER SERVICES ON, OVER OR UTILIZING THE INTERNET OTHER THAN THE DISPLAY OF A PROGRAM GUIDE FOR TELEVISION, VIDEO OR AUDIO PROGRAMS AND THE ADVERTISING OF THE SAME ON THIRD-PARTY WEB SITES OR ONE OF ITS OWN WEB SITES (U.S. CLS. 100, 101 AND 104).

FIRST USE 7-31-2004; IN COMMERCE 7-31-2004.

CLASS 41—EDUCATION AND ENTERTAINMENT

FOR ENTERTAINMENT SERVICES, NAMELY, THE PRODUCTION AND DISTRIBUTION OF PROMOTIONAL, INFORMATIONAL, AND INTERACTIVE TELEVISION PROGRAMMING SERVICES VIA BROADCAST, CABLE, SATELLITE AND ON-LINE ELECTRONIC COMMUNICATIONS NETWORKS LIMITED TO FOLLOWING SUBJECT MATTER: (1) VIDEO PROGRAM LISTINGS; (2) TELEVISION LISTINGS; (3) INFORMATION ON VIDEO PROGRAMMING; (4) INFORMATION ON TELEVISION PROGRAMMING; OR (5) INTERACTIVE OR ELECTRONIC PROGRAM GUIDES RELATED TO TELEVISION OR VIDEO PROGRAMMING. SUCH SERVICES SHALL SPECIFICALLY EXCLUDE SEARCH ENGINE SERVICES AND ALL OTHER SERVICES ON, OVER OR UTILIZING THE INTERNET OTHER THAN THE DISPLAY OF A PROGRAM GUIDE FOR TELEVISION, VIDEO OR AUDIO PROGRAMS AND THE ADVERTISING OF THE SAME ON THIRD-PARTY WEB SITES OR ONE OF ITS OWN WEB SITES (U.S. CLS. 100, 101 AND 107).

FIRST USE 7-31-2004; IN COMMERCE 7-31-2004.

3,398,885. SALAAM REMI MUSIC, LLC, MIAMI, FL. SN 76-608,191. PUB. 8-15-2006, FILED 8-18-2004.



CLASS 9—ELECTRICAL AND SCIENTIFIC APPARATUS

FOR PRE-RECORDED SOUND RECORDINGS AND AUDIO DEVICES, NAMELY, COMPACT DISCS, VIDEO DISCS, PHONOGRAPH RECORDS, VIDEO AND AUDIO CASSETTE TAPES AND MOTION PICTURES FEATURING MUSIC AND VOCAL PERFORMANCES (U.S. CLS. 21, 23, 26, 36 AND 38).

FIRST USE 7-17-2003; IN COMMERCE 2-27-2005.

CLASS 25—CLOTHING

FOR HATS, T-SHIRTS, SWEAT SHIRTS, SWEAT PANTS, SWEATERS, WRIST BANDS, HEAD-BANDS, JACKETS, SOCKS, SHOES AND LINGERIE (U.S. CLS. 22 AND 39).

FIRST USE 8-14-2007; IN COMMERCE 9-14-2007.

CLASS 41—EDUCATION AND ENTERTAINMENT

FOR LIVE MUSIC AND VOCAL PERFORMANCES, SONGWRITING, MUSIC PRODUCTION, AUDIO RECORDING AND CASSETTE AND DVD VIDEO PRODUCTION SERVICES FOR OTHERS, LIVE PERFORMANCES BY MUSICAL GROUPS, RECORDING STUDIOS (U.S. CLS. 100, 101 AND 107).

FIRST USE 9-27-2002; IN COMMERCE 9-27-2002.

3,398,886. SALAAM REMI MUSIC, LLC, MIAMI, FL. SN 76-608,192. PUB. 8-15-2006, FILED 8-18-2004.

BOOMTUNES

THE MARK CONSISTS OF STANDARD CHARACTERS

WITHOUT CLAIM TO ANY PARTICULAR FONT, STYLE, SIZE, OR COLOR.

3,398,900. EQUUSTYLE, INC., GOLDEN, CO. SN 76-641,736. PUB. 8-29-2006, FILED 6-27-2005.

CLASS 9—ELECTRICAL AND SCIENTIFIC APPARATUS

FOR PRE-RECORDED SOUND RECORDINGS AND AUDIO DEVICES, NAMELY, COMPACT DISCS, VIDEO DISCS, PHONOGRAPH RECORDS, VIDEO AND AUDIO CASSETTE TAPES AND MOTION PICTURES FEATURING MUSIC AND VOCAL PERFORMANCES (U.S. CLS. 21, 23, 26, 36 AND 38).

FIRST USE 7-17-2003; IN COMMERCE 2-27-2005.

CLASS 25—CLOTHING

FOR HATS, T-SHIRTS, SWEAT SHIRTS, SWEAT PANTS, SWEATERS, WRISTS BANDS, HEAD-BANDS, JACKETS, SOCKS, SHOES AND LINGERIE (U.S. CLS. 22 AND 39).

FIRST USE 5-14-2007; IN COMMERCE 9-14-2007.

CLASS 41—EDUCATION AND ENTERTAINMENT

FOR LIVE MUSIC AND VOCAL PERFORMANCES, SONGWRITING, MUSIC PRODUCTION, AUDIO RECORDING AND CASSETTE AND DVD VIDEO PRODUCTION SERVICES FOR OTHERS, LIVE PERFORMANCES BY MUSICAL GROUPS, RECORDING STUDIOS (U.S. CLS. 100, 101 AND 107).

FIRST USE 9-27-2002; IN COMMERCE 9-27-2002.

EQUUSTYLE

THE MARK CONSISTS OF STANDARD CHARACTERS WITHOUT CLAIM TO ANY PARTICULAR FONT, STYLE, SIZE, OR COLOR.

CLASS 20—FURNITURE AND ARTICLES NOT OTHERWISE CLASSIFIED

FOR PICTURE FRAMES AND PILLOWS (U.S. CLS. 2, 13, 22, 25, 32 AND 50).

FIRST USE 5-16-2007; IN COMMERCE 5-16-2007.

CLASS 25—CLOTHING

FOR CLOTHING FOR MEN, WOMEN AND CHILDREN, NAMELY T-SHIRTS, SWEATSHIRTS, VESTS, SLEEPWEAR, HATS, CAPS, AND VISORS (U.S. CLS. 22 AND 39).

FIRST USE 5-16-2007; IN COMMERCE 5-16-2007.

CLASS 35—ADVERTISING AND BUSINESS

FOR RETAIL STORE SERVICES AND WHOLESALE STORES, FEATURING HOME FURNISHINGS, HOUSEWARES, FURNITURE, LEATHER GOODS, CLOTHING, CLOTHING ACCESSORIES, HEADWEAR, LUGGAGE, BAGS, ARTWORK, AND PRINTED MATTER (U.S. CLS. 100, 101 AND 102).

FIRST USE 5-8-2007; IN COMMERCE 5-24-2007.

3,398,887. THE GYM WMD, INC., MONTVALE, NJ. SN 76-608,451. PUB. 7-5-2005, FILED 8-24-2004.

E3

THE MARK CONSISTS OF STANDARD CHARACTERS WITHOUT CLAIM TO ANY PARTICULAR FONT, STYLE, SIZE, OR COLOR.

CLASS 5—PHARMACEUTICALS

FOR VITAMIN SUPPLEMENTS (U.S. CLS. 6, 18, 44, 46, 51 AND 52).

FIRST USE 12-14-2005; IN COMMERCE 12-14-2006.

CLASS 44—MEDICAL, BEAUTY AND AGRICULTURAL SERVICES

FOR WEIGHT REDUCTION DIET PLANNING AND SUPERVISION FEATURING EXERCISE PROGRAMS (U.S. CLS. 100 AND 101).

FIRST USE 12-14-2005; IN COMMERCE 12-14-2006.

3,398,903. NAMCO BANDAI GAMES INC., TOKYO, JAPAN. SN 76-644,246. PUB. 4-25-2006, FILED 8-4-2005.

GAPLUS

THE MARK CONSISTS OF STANDARD CHARACTERS WITHOUT CLAIM TO ANY PARTICULAR FONT, STYLE, SIZE, OR COLOR.

CLASS 9—ELECTRICAL AND SCIENTIFIC APPARATUS

FOR VIDEO GAME CARTRIDGES AND COMPUTER GAME PROGRAMS (U.S. CLS. 21, 23, 26, 36 AND 38).

FIRST USE 10-22-1996; IN COMMERCE 10-22-1996.

CLASS 28—TOYS AND SPORTING GOODS

FOR COIN-OPERATED AMUSEMENT GAME MACHINES (U.S. CLS. 22, 23, 38 AND 50).

FIRST USE 10-22-1996; IN COMMERCE 10-22-1996.

3,398,920. NOAH'S NATURALS, LLC, LOS ANGELES, CA. SN 76-658,918. PUB. 2-20-2007, FILED 4-24-2006.

3,398,927. NORTH DAKOTA STATE UNIVERSITY OF AGRICULTURE AND APPLIED SCIENCE, FARGO, ND. SN 76-661,895. PUB. 7-3-2007, FILED 6-16-2006.

HEAL THYSELF

CLASS 3—COSMETICS AND CLEANING PREPARATIONS

FOR AROMATHERAPY BODY CARE PRODUCTS, NAMELY, BODY LOTION, SHOWER GEL, CUTICLE CREAM, SHAMPOO, CONDITIONER, NON-MEDICATED LIP BALM, SOAP, BODY POLISH, BODY AND FOOT SCRUB AND NON-MEDICATED FOOT CREAM (U.S. CLS. 1, 4, 6, 50, 51 AND 52).

FIRST USE 10-1-2006; IN COMMERCE 10-1-2006.

CLASS 5—PHARMACEUTICALS

FOR ANALGESIC BALMS (U.S. CLS. 6, 18, 44, 46, 51 AND 52).

FIRST USE 10-1-2006; IN COMMERCE 10-1-2006.

3,398,923. TIM & ANDY LLC, MANHEIM, PA. SN 76-659,717. PUB. 7-10-2007, FILED 5-8-2006.



Pure Fruit. Naturally Delicious.

NO CLAIM IS MADE TO THE EXCLUSIVE RIGHT TO USE "PURE FRUIT", APART FROM THE MARK AS SHOWN.

THE COLOR(S) BLUE, WHITE, ORANGE, YELLOW, RED, BLACK, GREEN, BROWN, AND PURPLE IS/ARE CLAIMED AS A FEATURE OF THE MARK.

THE COLOR BLUE APPEARS IN THE WORDS "ORCHARD FREEZE". BETWEEN THE VERTICAL ARRANGEMENT OF "ORCHARD FREEZE" IS AN ORANGE SLICE THAT IS ORANGE AND YELLOW, A RED APPLE WITH A BROWN STEM AND GREEN LEAF THAT IS OUTLINED IN BLACK, AND PURPLE GRAPES THAT ARE OUTLINED IN BLACK. BEHIND THE WORDS "ORCHARD FREEZE" AND FRUIT GRAPHIC IS A BLUE AND WHITE SNOWFLAKE. BENEATH THE SNOWFLAKE ARE THE WORDS "PURE FRUIT. NATURALLY DELICIOUS". WHICH ARE IN BLUE.

CLASS 29—MEATS AND PROCESSED FOODS

FOR FRUIT-BASED FOOD BEVERAGES (U.S. CL. 46). FIRST USE 7-6-2006; IN COMMERCE 7-6-2006.

CLASS 32—LIGHT BEVERAGES

FOR FROZEN FRUIT BEVERAGES; ICED FRUIT BEVERAGES (U.S. CLS. 45, 46 AND 48). FIRST USE 7-6-2006; IN COMMERCE 7-6-2006.



THE COLOR(S) GREEN, YELLOW, AND WHITE IS/ARE CLAIMED AS A FEATURE OF THE MARK.

THE COLOR GREEN (PMS 343 GREEN) APPEARS IN THE OUTLINES OF THE MARK. THE COLOR YELLOW (PMS 123 YELLOW) APPEARS IN THE FUR AREA OF THE HEAD. THE COLOR WHITE APPEARS IN THE HORNS AND WHITES OF THE EYES. (PMS = PANTONE MATCHING SYSTEM)

CLASS 16—PAPER GOODS AND PRINTED MATTER

FOR EVENT PROGRAMS, GREETING CARDS, LETTERHEAD PAPER, STATIONERY, STICKERS, DECALS, BUMPER STICKERS (U.S. CLS. 2, 5, 22, 23, 29, 37, 38 AND 50).

FIRST USE 7-11-2006; IN COMMERCE 7-11-2006.

CLASS 25—CLOTHING

FOR PANTS, SHIRTS, SHORT-SLEEVED OR LONG-SLEEVED T-SHIRTS, SWEAT SHIRTS, JACKETS, HEADGEAR, NAMELY, HATS AND CAPS (U.S. CLS. 22 AND 39).

FIRST USE 7-11-2006; IN COMMERCE 7-11-2006.

3,398,950. NINA CUSANELLI LLC, DAYTON, MD. SN 76-668,823. PUB. 8-28-2007, FILED 11-13-2006.

HEROES CROSS

THE MARK CONSISTS OF STANDARD CHARACTERS WITHOUT CLAIM TO ANY PARTICULAR FONT, STYLE, SIZE, OR COLOR.

NO CLAIM IS MADE TO THE EXCLUSIVE RIGHT TO USE "CROSS", APART FROM THE MARK AS SHOWN.

CLASS 14—JEWELRY

FOR JEWELRY, NAMELY, NECKLACES AND LAPEL PINS THAT ARE IN THE SHAPE OF CROSSES AND THAT ARE REPRESENTATIONS OF VARIOUS HEROES (U.S. CLS. 2, 27, 28 AND 50).

FIRST USE 1-1-2007; IN COMMERCE 1-1-2007.

CLASS 20—FURNITURE AND ARTICLES NOT OTHERWISE CLASSIFIED

FOR SOFT, DECORATIVE WALL SCULPTURES IN THE SHAPE OF CROSSES THAT REPRESENT VARIOUS HEROES, AND DECORATIVE WALL PLACQUES IN THE SHAPE OF CROSSES THAT REPRESENT VARIOUS HEROES (U.S. CLS. 2, 13, 22, 25, 32 AND 50).

FIRST USE 7-26-2007; IN COMMERCE 7-26-2007.

3,398,960. PROFESSIONAL BULL RIDERS, INC., COLORADO SPRINGS, CO. SN 76-978,735. PUB. 2-21-2006, FILED 6-3-2005.



NO CLAIM IS MADE TO THE EXCLUSIVE RIGHT TO USE "8 SECOND" FOR "TRADING CARD GAMES" IN INTERNATIONAL CLASSES 28 AND 41 ONLY, APART FROM THE MARK AS SHOWN.

THE STIPPLING IS FOR SHADING PURPOSES.

CLASS 16—PAPER GOODS AND PRINTED MATTER

FOR PRINTED MATTER, NAMELY, POSTERS AND BROCHURES ABOUT BULL RIDING, DECALS, BUMPER STICKERS, CALENDARS, PENS AND NEWSPAPERS AND MAGAZINES ABOUT BULL RIDING (U.S. CLS. 2, 5, 22, 23, 29, 37, 38 AND 50).

FIRST USE 7-31-2006; IN COMMERCE 7-31-2006.

CLASS 25—CLOTHING

FOR CLOTHING FOR MEN AND WOMEN, NAMELY, SHIRTS, SWEATSHIRTS, BASEBALL STYLE CAPS AND JACKETS (U.S. CLS. 22 AND 39).

FIRST USE 10-31-2006; IN COMMERCE 10-31-2006.

3,398,961. TRADEMARK MANAGEMENT COMPANY, MERIDIAN, ID. SN 77-000,092. PUB. 4-3-2007, FILED 9-15-2006.

CREATE AN OCCASION

THE MARK CONSISTS OF STANDARD CHARACTERS WITHOUT CLAIM TO ANY PARTICULAR FONT, STYLE, SIZE, OR COLOR.

CLASS 29—MEATS AND PROCESSED FOODS

FOR APPETIZERS AND HORS D'OEUVRES CONSISTING OF MEATS, POULTRY, FISH, FRUITS, VEGETABLES, MUSHROOMS AND CHEESE (U.S. CL. 46).

FIRST USE 9-15-2007; IN COMMERCE 9-15-2007.

CLASS 30—STAPLE FOODS

FOR APPETIZERS AND HORS D'OEUVRES CONSISTING OF PASTRY, BREAD AND DOUGH; BAKERY DESSERTS; DESSERT MOUSSE, PUDDINGS, AND SOUFFLES (U.S. CL. 46).

FIRST USE 7-30-2007; IN COMMERCE 7-30-2007.

3,398,984. FOREMOST DENTAL LLC, ENGLEWOOD, NJ. SN 77-007,428. PUB. 7-17-2007, FILED 9-26-2006.



OWNER OF U.S. REG. NOS. 1,414,695 AND 2,621,765.

NO CLAIM IS MADE TO THE EXCLUSIVE RIGHT TO USE "DENTAL", APART FROM THE MARK AS SHOWN.

THE COLOR GRAY IS INTENDED TO INDICATE SHADING OR CONTRAST ONLY AND COLOR IS NOT CLAIMED AS A FEATURE OF THE MARK.

CLASS 3—COSMETICS AND CLEANING PREPARATIONS

FOR DENTAL PRODUCTS, NAMELY, PROPHY PASTE (U.S. CLS. 1, 4, 6, 50, 51 AND 52).

FIRST USE 12-28-2006; IN COMMERCE 12-28-2006.

CLASS 5—PHARMACEUTICALS

FOR DENTAL PRODUCTS, NAMELY, FLUORIDE GEL AND FLUORIDE FOAM FOR USE IN PREVENTIVE DENTISTRY; TOPICAL ANESTHETICS (U.S. CLS. 6, 18, 44, 46, 51 AND 52).

FIRST USE 12-27-2006; IN COMMERCE 12-27-2006.

3,398,998. COMCAST SPORTSNET PHILADELPHIA, L.P., PHILADELPHIA, PA. SN 77-010,844. PUB. 7-24-2007, FILED 9-29-2006.

CSN

THE MARK CONSISTS OF STANDARD CHARACTERS WITHOUT CLAIM TO ANY PARTICULAR FONT, STYLE, SIZE, OR COLOR.

CLASS 38—COMMUNICATION

FOR TELEVISION BROADCASTING SERVICES (U.S. CLS. 100, 101 AND 104).

FIRST USE 10-1-1997; IN COMMERCE 10-1-1997.

CLASS 41—EDUCATION AND ENTERTAINMENT

FOR ENTERTAINMENT SERVICES, NAMELY, PRODUCTION OF A SERIES OF SPORTS-RELATED TELEVISION PROGRAMS (U.S. CLS. 100, 101 AND 107).
FIRST USE 10-1-1997; IN COMMERCE 10-1-1997.

3,399,008. WHAM-O, INC., EMERYVILLE, CA. SN 77-017,248.
PUB. 3-13-2007, FILED 10-9-2006.

ZECTRON

THE MARK CONSISTS OF STANDARD CHARACTERS WITHOUT CLAIM TO ANY PARTICULAR FONT, STYLE, SIZE, OR COLOR.

CLASS 17—RUBBER GOODS

FOR COMPOSITIONS NAMELY, SYNTHETIC RUBBER USED IN THE MANUFACTURE OF SPORT AND TOY BALLS; FEATURES OF SPORT AND TOY BALLS NAMELY, SYNTHETIC RUBBER; COMPOSITIONS NAMELY, SYNTHETIC RUBBER USED IN THE MANUFACTURE OF FOOTWEAR (U.S. CLS. 1, 5, 12, 13, 35 AND 50).
FIRST USE 6-0-1965; IN COMMERCE 6-0-1965.

CLASS 25—CLOTHING

FOR FOOTWEAR; FEATURE OF FOOTWEAR NAMELY, A SOLE WITH MULTIDIRECTIONAL TRACTION (U.S. CLS. 22 AND 39).
FIRST USE 8-0-2006; IN COMMERCE 8-0-2006.

CLASS 28—TOYS AND SPORTING GOODS

FOR SPORT AND TOY BALLS (U.S. CLS. 22, 23, 38 AND 50).
FIRST USE 6-0-1965; IN COMMERCE 6-0-1965.

3,399,022. COLWELL INDUSTRIES, INC., MINNEAPOLIS, MN. SN 77-022,567. PUB. 5-8-2007, FILED 10-17-2006.

COLOURS BEYOND COMPARE

THE MARK CONSISTS OF STANDARD CHARACTERS WITHOUT CLAIM TO ANY PARTICULAR FONT, STYLE, SIZE, OR COLOR.

NO CLAIM IS MADE TO THE EXCLUSIVE RIGHT TO USE "COLORS", APART FROM THE MARK AS SHOWN.

CLASS 35—ADVERTISING AND BUSINESS

FOR BUSINESS CONSULTING AND RESEARCH SERVICES IN THE FIELD OF MERCHANDISING AIDS FOR COLOR OR SURFACE MATERIAL SELECTION AND MATCHING, AND CONTROL OF COLOR IN THE MANUFACTURING PROCESS (U.S. CLS. 100, 101 AND 102).
FIRST USE 4-18-2007; IN COMMERCE 4-18-2007.

CLASS 40—MATERIAL TREATMENT

FOR MANUFACTURING SERVICES FOR OTHERS OF PAINT, COLOR AND SURFACE MATERIAL SAMPLES FOR A WIDE VARIETY OF INDUSTRIES (U.S. CLS. 100, 103 AND 106).
FIRST USE 4-18-2007; IN COMMERCE 4-18-2007.

3,399,023. W. R. RAYSON CO., INC., BURGAW, NC. SN 77-022,576. PUB. 4-17-2007, FILED 10-17-2006.

RAYTATTZ

THE MARK CONSISTS OF STANDARD CHARACTERS WITHOUT CLAIM TO ANY PARTICULAR FONT, STYLE, SIZE, OR COLOR.

CLASS 8—HAND TOOLS

FOR DISPOSABLE RAZORS (U.S. CLS. 23, 28 AND 44).
FIRST USE 1-11-2007; IN COMMERCE 1-11-2007.

CLASS 16—PAPER GOODS AND PRINTED MATTER

FOR DISPOSABLE PAPER TOWELS; DISPOSABLE WIPES NOT IMPREGNATED WITH CHEMICALS OR COMPOUNDS; DISPOSABLE PAPER INSTRUMENT TRAY COVERS (U.S. CLS. 2, 5, 22, 23, 29, 37, 38 AND 50).
FIRST USE 1-11-2007; IN COMMERCE 1-11-2007.

CLASS 21—HOUSEWARES AND GLASS

FOR TATTOO INK CUPS; DISPOSABLE LATEX GLOVES FOR GENERAL USE; DISPOSABLE PLASTIC GLOVES FOR GENERAL USE (U.S. CLS. 2, 13, 23, 29, 30, 33, 40 AND 50).
FIRST USE 1-11-2007; IN COMMERCE 1-11-2007.

3,399,027. STERLING STARS, INC., SCARSDALE, NY. SN 77-026,297. PUB. 3-27-2007, FILED 10-20-2006.

3,399,050. EISAI INC., WOODCLIFF LAKE, NJ. SN 77-036,724. PUB. 2-20-2007, FILED 11-3-2006.



The logo for mindforegolf.com features a stylized black arch above the text "mindforegolf.com". The text "mindforegolf" is in a bold, lowercase sans-serif font, and ".com" is in a smaller font size to the right.

CLASS 41—EDUCATION AND ENTERTAINMENT

FOR PERSONAL COACHING SERVICES IN THE FIELD OF GOLF; BUSINESS TRAINING; TRAINING SERVICES IN THE FIELD OF EXECUTIVE COACHING, PERSONAL COACHING, MARKETING, ORGANIZATIONAL EFFECTIVENESS, TEAM BUILDING, PSYCHOLOGICAL TESTING, AND PSYCHOLOGICAL TESTING SERVICES; PROVIDING PERSONAL COACHING SERVICES IN THE FIELD OF GOLF VIA THE INTERNET; PROVIDING BUSINESS TRAINING VIA THE INTERNET; PROVIDING TRAINING SERVICES IN THE FIELD OF EXECUTIVE COACHING, PERSONAL COACHING, MARKETING, ORGANIZATIONAL EFFECTIVENESS, TEAM BUILDING, PSYCHOLOGICAL TESTING, AND PSYCHOLOGICAL TESTING SERVICES (U.S. CLS. 100, 101 AND 107).

FIRST USE 7-4-2007; IN COMMERCE 9-17-2007.

CLASS 44—MEDICAL, BEAUTY AND AGRICULTURAL SERVICES

FOR PSYCHOLOGICAL COUNSELING, PSYCHOLOGICAL COUNSELING IN THE FIELD OF SPORTS; PSYCHOLOGICAL COUNSELING IN THE NATURE OF PERSONALITY PROFILING, PREFERENCE PROFILING, AND WHOLE BRAIN THINKING; PSYCHOLOGICAL COUNSELING, PSYCHOLOGICAL COUNSELING IN THE FIELD OF SPORTS; PSYCHOLOGICAL COUNSELING IN THE NATURE OF PERSONALITY PROFILING, PREFERENCE PROFILING, AND WHOLE BRAIN THINKING VIA THE INTERNET (U.S. CLS. 100 AND 101).

FIRST USE 1-25-2007; IN COMMERCE 1-25-2007.

3,399,047. CRYSTALIER, LIMITED, EVERGREEN, CO. SN 77-035,822. PUB. 6-12-2007, FILED 11-2-2006.

BIPS

THE MARK CONSISTS OF STANDARD CHARACTERS WITHOUT CLAIM TO ANY PARTICULAR FONT, STYLE, SIZE, OR COLOR.

CLASS 21—HOUSEWARES AND GLASS

FOR FIGURINES OF CRYSTAL AND GLASS (U.S. CLS. 2, 13, 23, 29, 30, 33, 40 AND 50).

FIRST USE 12-25-2007; IN COMMERCE 12-25-2007.

CLASS 35—ADVERTISING AND BUSINESS

FOR RETAIL STORE SERVICES, WHOLESALE STORE SERVICES, MAIL ORDER SERVICES, AND ONLINE STORE SERVICES FEATURING FIGURINES OF CRYSTAL AND GLASS (U.S. CLS. 100, 101 AND 102).

FIRST USE 12-25-2007; IN COMMERCE 12-25-2007.

TIME TO TREASURE

THE MARK CONSISTS OF STANDARD CHARACTERS WITHOUT CLAIM TO ANY PARTICULAR FONT, STYLE, SIZE, OR COLOR.

CLASS 16—PAPER GOODS AND PRINTED MATTER

FOR PUBLICATIONS AND EDUCATIONAL MATERIALS IN THE FIELDS OF AGING, DEMENTIA AND ALZHEIMER'S DISEASE, NAMELY, BROCHURES, BOOKLETS, LEAFLETS, FOLDERS, CIRCULARS, AND INSERTS (U.S. CLS. 2, 5, 22, 23, 29, 37, 38 AND 50).

FIRST USE 2-0-2007; IN COMMERCE 2-0-2007.

CLASS 44—MEDICAL, BEAUTY AND AGRICULTURAL SERVICES

FOR PROVIDING A DISEASE MANAGEMENT PROGRAM FOR THE DIAGNOSIS, TREATMENT AND MANAGEMENT OF ALZHEIMER'S DISEASE (U.S. CLS. 100 AND 101).

FIRST USE 2-0-2007; IN COMMERCE 2-0-2007.

3,399,054. KAPLAN, INC., NEW YORK, NY. SN 77-038,411. PUB. 3-20-2007, FILED 11-7-2006.

MOMENTUM MATH

THE MARK CONSISTS OF STANDARD CHARACTERS WITHOUT CLAIM TO ANY PARTICULAR FONT, STYLE, SIZE, OR COLOR.

NO CLAIM IS MADE TO THE EXCLUSIVE RIGHT TO USE "MATH", APART FROM THE MARK AS SHOWN.

CLASS 16—PAPER GOODS AND PRINTED MATTER

FOR PRINTED EDUCATIONAL MATERIALS IN THE FIELD OF MATHEMATICAL KNOWLEDGE AND SKILLS (U.S. CLS. 2, 5, 22, 23, 29, 37, 38 AND 50).

FIRST USE 4-2-2007; IN COMMERCE 4-2-2007.

CLASS 41—EDUCATION AND ENTERTAINMENT

FOR EDUCATIONAL SERVICES, NAMELY PROGRAMS TO IMPROVE STUDENTS' MATHEMATICAL KNOWLEDGE AND SKILLS (U.S. CLS. 100, 101 AND 107).

FIRST USE 4-2-2007; IN COMMERCE 4-2-2007.

3,399,055. AMERICAN LEBANESE SYRIAN ASSOCIATED CHARITIES, INC., MEMPHIS, TN. SN 77-038,534. PUB. 6-5-2007, FILED 11-7-2006.

SCHOOLAPALOOZA

THE MARK CONSISTS OF STANDARD CHARACTERS WITHOUT CLAIM TO ANY PARTICULAR FONT, STYLE, SIZE, OR COLOR.

CLASS 25—CLOTHING

FOR SHIRTS; SHORT-SLEEVED OR LONG-SLEEVED T-SHIRTS (U.S. CLS. 22 AND 39).
FIRST USE 1-25-2007; IN COMMERCE 1-25-2007.

CLASS 36—INSURANCE AND FINANCIAL

FOR CHARITABLE FUND RAISING (U.S. CLS. 100, 101 AND 102).
FIRST USE 1-25-2007; IN COMMERCE 1-25-2007.

3,399,058. THE RED FLAG GROUP LIMITED, HONG KONG, HONG KONG. SN 77-040,113. PUB. 6-19-2007, FILED 11-9-2006.



NO CLAIM IS MADE TO THE EXCLUSIVE RIGHT TO USE "GROUP", APART FROM THE MARK AS SHOWN.

THE COLOR(S) RED AND WHITE IS/ARE CLAIMED AS A FEATURE OF THE MARK.

THE WORDS "RED FLAG GROUP" AND THE DIVIDED VERTICAL LINE ARE WHITE ON A RED RECTANGULAR BACKGROUND.

CLASS 35—ADVERTISING AND BUSINESS

FOR BUSINESS MANAGEMENT CONSULTANCY AND ADVISORY SERVICES; MANAGEMENT AND BUSINESS CONSULTING SERVICES IN THE FIELD OF COMPLIANCE PROGRAMS (U.S. CLS. 100, 101 AND 102).

FIRST USE 12-1-2006; IN COMMERCE 12-1-2006.

CLASS 41—EDUCATION AND ENTERTAINMENT

FOR BUSINESS TRAINING; PROVIDING ON-LINE TRAINING COURSES AND SEMINARS IN THE FIELD OF COMPLIANCE AND LEGAL ISSUES (U.S. CLS. 100, 101 AND 107).

FIRST USE 12-1-2006; IN COMMERCE 12-1-2006.

CLASS 42—SCIENTIFIC AND COMPUTER SERVICES

FOR LEGAL SERVICES; REVIEWING STANDARDS AND PRACTICES TO ASSURE COMPLIANCE WITH ANTI-BRIBERY, ANTI-TRUST, EXPORT CONTROL AND CORPORATE GOVERNANCE LAWS AND REGULATIONS (U.S. CLS. 100 AND 101).

FIRST USE 12-1-2006; IN COMMERCE 12-1-2006.

3,399,085. AMPC, INC., AMES, IA. SN 77-052,650. PUB. 6-26-2007, FILED 11-29-2006.

KEEP IT REAL

THE MARK CONSISTS OF STANDARD CHARACTERS WITHOUT CLAIM TO ANY PARTICULAR FONT, STYLE, SIZE, OR COLOR.

CLASS 29—MEATS AND PROCESSED FOODS

FOR PROTEIN FOR USE AS A FOOD ADDITIVE (U.S. CL. 46).

FIRST USE 2-21-2005; IN COMMERCE 2-21-2005.

CLASS 30—STAPLE FOODS

FOR FOOD ADDITIVES FOR NON-NUTRITIONAL PURPOSES FOR USE AS A FLAVORING, INGREDIENT OR FILLER (U.S. CL. 46).

FIRST USE 2-21-2005; IN COMMERCE 2-21-2005.

3,399,097. MÉTHODE L'AUDACE, LLC, TULSA, OK. SN 77-061,686. PUB. 7-24-2007, FILED 12-11-2006.

MÉTHODE L'AUDACE

THE MARK CONSISTS OF STANDARD CHARACTERS WITHOUT CLAIM TO ANY PARTICULAR FONT, STYLE, SIZE, OR COLOR.

THE FOREIGN WORDING IN THE MARK TRANSLATES INTO ENGLISH AS METHOD AND AUDACITY.

CLASS 16—PAPER GOODS AND PRINTED MATTER

FOR PRINTED INSTRUCTIONAL, EDUCATIONAL, AND TEACHING MATERIALS IN THE FIELD OF MUSIC LESSONS AND PHILOSOPHY OF TEACHING MUSIC; PRINTED TEACHING ACTIVITY GUIDES IN THE FIELD OF MUSIC LESSONS AND PHILOSOPHY OF TEACHING MUSIC; PUBLICATIONS, NAMELY, BROCHURES, BOOKLETS, AND TEACHING MATERIALS IN THE FIELD OF MUSIC LESSONS AND PHILOSOPHY OF TEACHING MUSIC; PRINTED MUSIC BOOKS; PRINTED LESSONS ON MUSIC; PAPER TEACHING MATERIALS IN THE FIELD OF MUSIC LESSONS AND PHILOSOPHY OF TEACHING MUSIC (U.S. CLS. 2, 5, 22, 23, 29, 37, 38 AND 50).

FIRST USE 3-0-2006; IN COMMERCE 3-0-2006.

CLASS 41—EDUCATION AND ENTERTAINMENT

FOR EDUCATION SERVICES, NAMELY, PROVIDING CLASSES, SEMINARS AND WORKSHOPS IN THE FIELD OF MUSIC; TEACHING IN THE FIELD OF MUSIC; INSTRUCTION IN THE FIELD OF MUSIC; PROVIDING FACILITIES FOR MUSIC TRAINING (U.S. CLS. 100, 101 AND 107).

FIRST USE 3-0-2006; IN COMMERCE 3-0-2006.

3,399,104. ELIF LEATHER GOODS, LLC, RUTHERFORD, NJ. SN 77-063,320. PUB. 7-24-2007, FILED 12-13-2006.



THE COLOR(S) BLACK, WHITE, RED (PANTONE 704) IS/ARE CLAIMED AS A FEATURE OF THE MARK.

THE MARK CONSISTS OF A BUTTERFLY WITH A STYLIZED LETTER E IN THE CENTER ALL IN RED (PANTONE 704), AND NAME ELIF IN DIDOT FONT IN BLACK.

CLASS 9—ELECTRICAL AND SCIENTIFIC APPARATUS

FOR CASES FOR MOBILE PHONES; CASES FOR SPECTACLES AND SUNGLASSES; COMPUTER CARRYING CASES; LAPTOP CARRYING CASES (U.S. CLS. 21, 23, 26, 36 AND 38).

FIRST USE 1-1-2007; IN COMMERCE 5-26-2007.

CLASS 18—LEATHER GOODS

FOR BACKPACKS; BRIEFCASES; BUSINESS CARD CASES; BUSINESS CASES; COIN PURSES; COSMETIC BAGS SOLD EMPTY; GARMENT BAGS FOR TRAVEL; HANDBAGS; KEY CASES; LEATHER BAGS, SUITCASES AND WALLETS; LEATHER BRIEFCASES; LEATHER HANDBAGS; PURSES; TRAVEL BAGS; WALLETS (U.S. CLS. 1, 2, 3, 22 AND 41).

FIRST USE 1-1-2007; IN COMMERCE 5-26-2007.

3,399,106. ELMER'S PRODUCTS, INC., COLUMBUS, OH. SN 77-063,980. PUB. 9-4-2007, FILED 12-14-2006.



OWNER OF U.S. REG. NOS. 2,951,462, 3,199,830, AND OTHERS.

THE COLOR(S) SILVER, BLUE, AND BLACK IS/ARE CLAIMED AS A FEATURE OF THE MARK.

THE MARK CONSISTS OF THE TRADE DRESS CHARACTERIZING THE FRONT FACE OF THE PACKAGING FOR APPLICANT'S GOODS, NAMELY, (1) TWO SILVER VERTICAL BANDS CROSSING TO FORM AN "X" SPANNING THE PACKAGE FACE; (2) TWO BLACK TRIANGLES EXTENDING FROM THE CENTER OF THE "X" UPWARDS AND DOWNWARDS; (3) TWO BLUE TRIANGLES EXTENDING FROM THE CENTER OF THE "X" LEFT AND RIGHT, (4) BEGINNING ON THE SILVER VERTICAL BANDS FORMING THE "X" AND EXTENDING TO THE RIGHT THROUGH THE BLUE TRIANGLE IS THE WORD "X-ACTO" IN SILVER LETTERING, AND (5) BLACK SHADING APPEARING BEHIND THE WORD "X-ACTO".

CLASS 8—HAND TOOLS

FOR HAND TOOLS FOR HOBBIES, ARTS, AND CRAFTS, NAMELY, KNIVES, KNIFE BLADES, MAT CUTTERS, COMPASS CUTTERS, BLADE SAFETY CAPS, C-CLAMPS, PLIERS, CORNER CLAMPS, METAL VISE GRIPS, TWEEZERS, SAWS AND HAND SAW BLADES, METAL VISES, MITRE BOX AND DRILL BITS FOR HAND DRILLS (U.S. CLS. 23, 28 AND 44).

FIRST USE 2-1-2007; IN COMMERCE 2-1-2007.

CLASS 16—PAPER GOODS AND PRINTED MATTER

FOR BATTERY POWERED AND MANUALLY OPERATED PENCIL SHARPENERS; OFFICE PRODUCTS, NAMELY, ELECTRIC PENCIL SHARPENER, PAPER TRIMMERS, ELECTRONIC STAPLERS; MANUAL STAPLERS; BATTERY OPERATED LETTER OPENER; PAPER PUNCHES; BULLDOG CLIPS (U.S. CLS. 2, 5, 22, 23, 29, 37, 38 AND 50).

FIRST USE 2-1-2007; IN COMMERCE 2-1-2007.

3,399,161. AUGUST HOME PUBLISHING COMPANY, DES MOINES, IA. SN 77-090,281. PUB. 7-31-2007, FILED 1-24-2007.

WOODSMITH SHOP

THE MARK CONSISTS OF STANDARD CHARACTERS WITHOUT CLAIM TO ANY PARTICULAR FONT, STYLE, SIZE, OR COLOR.

OWNER OF U.S. REG. NOS. 1,179,071 AND 2,171,810.

CLASS 9—ELECTRICAL AND SCIENTIFIC APPARATUS

FOR DIGITAL MATERIALS, NAMELY, CD'S, DVD'S, DOWNLOADABLE AUDIO AND VIDEO FILES, FEATURING WOODWORKING (U.S. CLS. 21, 23, 26, 36 AND 38).

FIRST USE 11-10-2007; IN COMMERCE 11-10-2007.

CLASS 38—COMMUNICATION

FOR STREAMING OF VIDEO MATERIAL ON THE INTERNET IN THE FIELD OF WOODWORKING (U.S. CLS. 100, 101 AND 104).

FIRST USE 10-5-2007; IN COMMERCE 10-5-2007.

CLASS 41—EDUCATION AND ENTERTAINMENT

FOR TELEVISION PROGRAMS IN THE FIELD OF WOODWORKING; ENTERTAINMENT IN THE NATURE OF ON-GOING TELEVISION PROGRAMS IN THE FIELD OF WOODWORKING; ENTERTAINMENT SERVICES, NAMELY, PROVIDING A TELEVISION PROGRAM IN THE FIELD OF WOODWORKING VIA A GLOBAL COMPUTER NETWORK (U.S. CLS. 100, 101 AND 107).

FIRST USE 11-10-2007; IN COMMERCE 11-10-2007.

3,399,194. ROCK HARDWEAR, LITTLETON, CO. SN 77-104,701. PUB. 9-11-2007, FILED 2-12-2007.



THE COLOR(S) BLACK AND GREY IS/ARE CLAIMED AS A FEATURE OF THE MARK.

THE MARK CONSISTS OF A TRIANGULAR MOUNTAIN SPLIT IN TWO SECTIONS, THE BOTTOM SECTION AND THE UPPER SECTION, THE WORD "ROCK" POSITIONED TO THE LEFT OF THE TRIANGLE, AND THE WORD "HARDWEAR" POSITIONED BELOW THE TRIANGLE.

CLASS 18—LEATHER GOODS

FOR ALL PURPOSE SPORT BAGS; ALL-PURPOSE ATHLETIC BAGS; ALL-PURPOSE CARRYING BAGS; ATHLETIC BAGS; BABY BACKPACKS; BACKPACKS; BAGS AND HOLDALLS FOR SPORTS CLOTHING; BAGS FOR CARRYING BABIES' ACCESSORIES; BAGS FOR SPORTS; CARRY-ALL BAGS; CARRY-ON BAGS; CHALK BAGS; DIAPER BAGS; DUFFEL BAGS; DUFFEL BAGS FOR TRAVEL; DUFFLE BAGS; FANNY PACKS; GARMENT BAGS FOR TRAVEL; GENERAL PURPOSE BAGS FOR CARRYING YOGA EQUIPMENT; GYM BAGS; HIKING BAGS; HIKING POLES; HIKING RUCKSACKS; HIKING STICKS; MESH SHOPPING BAGS; ROLL BAGS; SCHOOL BAGS; SCHOOL BOOK BAGS; SCHOOLCHILDREN'S BACKPACKS; SHAVING BAGS SOLD EMPTY; SHOE BAGS FOR TRAVEL; SHOULDER BAGS; SMALL BACKPACKS; SMALL BAGS FOR MEN; SPORTS BAGS; SPORTS PACKS; SPORTSMAN'S HUNTING BAGS; TOTE BAGS; TRAVEL BAGS; TRAVELING BAGS; WAIST BAGS (U.S. CLS. 1, 2, 3, 22 AND 41).

FIRST USE 0-0-2000; IN COMMERCE 0-0-2000.

CLASS 20—FURNITURE AND ARTICLES NOT OTHERWISE CLASSIFIED

FOR SLEEPING BAG LINERS; SLEEPING BAGS; SLEEPING MATS; SLUMBER BAGS (U.S. CLS. 2, 13, 22, 25, 32 AND 50).

FIRST USE 3-31-2007; IN COMMERCE 6-15-2007.

CLASS 21—HOUSEWARES AND GLASS

FOR COFFEE CUPS; CUPS; SPORTS BOTTLES SOLD EMPTY (U.S. CLS. 2, 13, 23, 29, 30, 33, 40 AND 50).

FIRST USE 3-31-2007; IN COMMERCE 6-15-2007.

CLASS 25—CLOTHING

FOR ANKLE BOOTS; ANKLE SOCKS; ANKLETS; ANTI-PERSPIRANT SOCKS; ATHLETIC FOOTWEAR; BEACH FOOTWEAR; BICYCLE GLOVES; BICYCLING GLOVES; BOOTS; BOXER SHORTS; BRIEFS; CAMP SHIRTS; CAPS; CHILDREN'S AND INFANTS' CLOTH BIBS; CHILDREN'S CLOTH EATING BIBS; CHILDREN'S HEADWEAR; CLEATS FOR ATTACHMENT TO SPORTS SHOES; CLIMBING BOOTS; CLOTH BIBS; CLOTHING FOR WEAR IN JUDO PRACTICES; CLOTHING FOR WEAR IN WRESTLING GAMES; CLOTHING, NAMELY, ARM WARMERS; CLOTHING, NAMELY, KNEE WARMERS; CLOTHING, NAMELY, NECK TUBES; CLOTHING, NAMELY, WRAP-AROUNDS; DENIM JACKETS;

3,399,167. CATHERINES OF CALIFORNIA, INC., LOS ANGELES, CA. SN 77-091,866. PUB. 8-21-2007, FILED 1-26-2007.

RIGHT FIT BY CATHERINES

THE MARK CONSISTS OF STANDARD CHARACTERS WITHOUT CLAIM TO ANY PARTICULAR FONT, STYLE, SIZE, OR COLOR.

OWNER OF U.S. REG. NOS. 1,343,457, 3,006,871, AND OTHERS.

CLASS 25—CLOTHING

FOR WOMEN'S WEARING APPAREL, NAMELY, JEANS, PANTS (U.S. CLS. 22 AND 39).

FIRST USE 8-1-2007; IN COMMERCE 8-1-2007.

CLASS 35—ADVERTISING AND BUSINESS

FOR RETAIL STORE SERVICES FEATURING WOMEN'S WEARING APPAREL AND ACCESSORIES; COMPUTERIZED ON-LINE RETAIL STORE SERVICES FEATURING WOMEN'S WEARING APPAREL AND ACCESSORIES; MAIL ORDER CATALOG SERVICES FEATURING WOMEN'S WEARING APPAREL AND ACCESSORIES (U.S. CLS. 100, 101 AND 102).

FIRST USE 8-1-2007; IN COMMERCE 8-1-2007.

DENIMS; DOWN JACKETS; FISHERMEN'S JACKETS; FLEECE SHORTS; FLIP FLOPS; FOOTWEAR; FOOTWEAR FOR MEN; FOOTWEAR FOR MEN AND WOMEN; FOOTWEAR FOR TRACK AND FIELD ATHLETICS; FOOTWEAR FOR WOMEN; FOOTWEAR NOT FOR SPORTS; GLOVES; GLOVES INCLUDING THOSE MADE OF SKIN, HIDE OR FUR; GOLF SHIRTS; GYM SHORTS; HATS; HEADWEAR; HIKING BOOTS; HOODS; INFANT AND TODDLER ONE PIECE CLOTHING; INFANTS' SHOES AND BOOTS; INSOLES; JERSEYS; JOGGING PANTS; KNIT SHIRTS; KNITTED UNDERWEAR; LACE BOOTS; LADIES' BOOTS; LADIES' UNDERWEAR; LEATHER BELTS; MEN'S SOCKS; MOTORCYCLE GLOVES; MOUNTAINEERING BOOTS; PANTIES, SHORTS AND BRIEFS; PANTS; POLO SHIRTS; RAIN BOOTS; RAIN JACKETS; RAINPROOF JACKETS; RIDING GLOVES; RUGBY SHORTS; SHORT-SLEEVED OR LONG-SLEEVED T-SHIRTS; SHORT-SLEEVED SHIRTS; SHORTS; SKI BOOT BAGS; SKI BOOTS; SKI GLOVES; SKI JACKETS; SKI PANTS; SKULLIES; SNOW PANTS; SNOWBOARD BOOTS; SNOWBOARD GLOVES; SNOWBOARD PANTS; SOCKS; SPORT SHIRTS; SPORTS BRA; SPORTS JACKETS; SPORTS JERSEYS; SPORTS JERSEYS AND BREECHES FOR SPORTS; SPORTS OVERUNIFORMS; SPORTS SHIRTS; SPORTS SHIRTS WITH SHORT SLEEVES; SWEAT PANTS; SWEAT SHIRTS; SWEAT SHORTS; T-SHIRTS; THONGS; TOPS; TRACK PANTS; UNDERWEAR; WALKING SHORTS; WATERPROOF JACKETS AND PANTS; WIND RESISTANT JACKETS; WIND SHIRTS; WIND-JACKETS; WINTER BOOTS; WOMEN'S UNDERWEAR; WOVEN OR KNITTED UNDERWEAR (U.S. CLS. 22 AND 39).

FIRST USE 0-0-2000; IN COMMERCE 0-0-2000.

3,399,200. NAUTEC INDUSTRIA METALURGICA LTDA, CAXIAS DO SUL, BRAZIL. SN 77-109,117. PUB. 8-14-2007, FILED 2-16-2007.



THE MARK CONSISTS OF STYLIZED LETTER "N" FOLLOWED BY STYLIZED WORD "NAUTOS".

CLASS 6—METAL GOODS

FOR ANCHORS; BUCKLES OF COMMON METAL; CABLE THIMBLES OF METAL; EYE BOLTS; FERRULES OF METAL FOR CANES AND WALKING-STICKS; MARINE ANCHORS; METAL BOLLARDS; METAL CABLE WIRE; METAL CHAINS; METAL CLOSURES FOR CONTAINERS; METAL EXPANSION JOINTS FOR PIPING AND DUCTING; METAL EYE BOLTS; METAL HARDWARE NAMELY, PULLEYS; METAL HARDWARE, NAMELY, WASHERS; METAL HINGES; METAL HOOKS; METAL KEY RINGS; METAL LADDERS; METAL LATCHES; METAL MARINE HARDWARE, NAMELY, THIMBLES; METAL NUTS; METAL PIPE COUPLINGS AND JOINTS; METAL PLUGS; METAL POLES; METAL POSTS; METAL PULLEYS, SPRINGS AND VALVES; METAL RIVETS; METAL SCREWS; METAL WEATHER VANES; METAL WINDOW FRAMES; MOORING BOLLARDS OF METAL; NAILS; WIRE; WIRE ROPES (U.S. CLS. 2, 12, 13, 14, 23, 25 AND 50).

FIRST USE 7-2-1997; IN COMMERCE 1-1-2006.

CLASS 12—VEHICLES

FOR BOATS AND STRUCTURAL PARTS THEREFOR; MAST PLATFORMS FOR YACHTS; MASTS FOR BOATS; SCREW PROPELLERS; YACHTS (U.S. CLS. 19, 21, 23, 31, 35 AND 44).

FIRST USE 7-2-1997; IN COMMERCE 1-1-2006.

3,399,257. MAYER, CRAIG R., AUSTIN, TX. SN 77-136,097. PUB. 9-18-2007, FILED 3-20-2007.

OurShore

THE MARK CONSISTS OF STANDARD CHARACTERS WITHOUT CLAIM TO ANY PARTICULAR FONT, STYLE, SIZE, OR COLOR.

CLASS 35—ADVERTISING AND BUSINESS

FOR ADVISORY AND CONSULTANCY SERVICES RELATING TO EXPORT, EXPORT SERVICES, EXPORT PROMOTION INFORMATION AND SERVICES; ASSISTANCE, ADVISORY SERVICES AND CONSULTANCY WITH REGARD TO BUSINESS PLANNING, BUSINESS ANALYSIS, BUSINESS MANAGEMENT, AND BUSINESS ORGANIZATION; BUSINESS ADVISORY SERVICES, CONSULTANCY AND INFORMATION; BUSINESS CONSULTATION; BUSINESS CONSULTATION AND MANAGEMENT REGARDING MARKETING ACTIVITIES AND LAUNCHING OF NEW PRODUCTS; BUSINESS CONSULTATION SERVICES; BUSINESS CONSULTING AND BUSINESS INFORMATION FOR ENTERPRISES; BUSINESS CONSULTING AND INFORMATION SERVICES; BUSINESS CONSULTING SERVICES RELATING TO PRODUCT DISTRIBUTION, OPERATIONS MANAGEMENT SERVICES, LOGISTICS, REVERSE LOGISTICS, SUPPLY CHAIN, AND PRODUCTION SYSTEMS AND DISTRIBUTION SOLUTIONS; BUSINESS CONSULTING, MANAGEMENT, PLANNING AND SUPERVISION; BUSINESS MANAGEMENT AND CONSULTATION; BUSINESS MANAGEMENT CONSULTANCY AND ADVISORY SERVICES; BUSINESS MANAGEMENT CONSULTANCY AS WELL AS DEVELOPMENT OF PROCESSES FOR THE ANALYSIS AND THE IMPLEMENTATION OF STRATEGY PLANS AND MANAGEMENT PROJECTS; BUSINESS MANAGEMENT CONSULTANCY SERVICES; BUSINESS MANAGEMENT CONSULTATION; BUSINESS MANAGEMENT CONSULTING AND ADVISORY SERVICES; BUSINESS MANAGEMENT CONSULTING WITH RELATION TO STRATEGY, MARKETING, PRODUCTION, PERSONNEL AND RETAIL SALE MATTERS; BUSINESS ORGANISATION AND MANAGEMENT CONSULTING SERVICES; BUSINESS ORGANIZATION AND OPERATION CONSULTANCY; CONSULTING SERVICES IN BUSINESS ORGANIZATION AND MANAGEMENT; CONSULTING SERVICES IN THE AREA OF SUSTAINABLE BUSINESS SOLUTIONS; ECONOMIC CONSULTING AND INFORMATION FOR THE INDUSTRIAL AND COMMERCIAL SECTORS FOR PLANNING, ORGANIZING, MONITORING AND CARRYING OUT UNIQUE AND COMPLEX PROJECTS IN DIFFERENT SECTORS OF ONE OR SEVERAL COMPANIES; INFORMATION, ADVISORY AND CONSULTANCY SERVICES RELATING TO BUSINESS AND MANAGEMENT OR BUSINESS ADMINISTRATION, INCLUDING SUCH SERVICES PROVIDED ON LINE OR VIA THE INTERNET; MANAGEMENT AND BUSINESS CONSULTING SERVICES IN THE FIELD OF SOFTWARE DEVELOPMENT; PROFESSIONAL BUSINESS CONSULTATION; PROVIDING BUSINESS MANAGEMENT INFORMATION IN CONNECTION WITH CONSULTING AND ADVISORY SERVICES IN THE FIELD OF STRATEGIC PLANNING (U.S. CLS. 100, 101 AND 102).

FIRST USE 5-12-2007; IN COMMERCE 5-12-2007.

CLASS 42—SCIENTIFIC AND COMPUTER SERVICES

FOR COMPUTER SOFTWARE CONSULTANCY; COMPUTER SOFTWARE CONSULTATION; CONSULTANCY IN THE FIELD OF SOFTWARE DESIGN; CONSULTING SERVICES IN THE FIELD OF OFFICE AND WORK-PLACE AUTOMATION; INFORMATION TECHNOLOGY CONSULTATION; MANAGEMENT AND CONSULTATION IN THE FIELD OF HUMAN FACTORS ENGINEERING (U.S. CLS. 100 AND 101).

FIRST USE 5-12-2007; IN COMMERCE 5-12-2007.

3,399,309. TRINITY MANAGEMENT SERVICES, SAN FRANCISCO, CA. SN 78-227,501. PUB. 1-13-2004, FILED 3-19-2003.

TRINITY PLACE

OWNER OF U.S. REG. NOS. 1,785,824, 2,604,643, AND OTHERS.

NO CLAIM IS MADE TO THE EXCLUSIVE RIGHT TO USE "PLACE", APART FROM THE MARK AS SHOWN.

CLASS 36—INSURANCE AND FINANCIAL

FOR RENTING, LEASING, MANAGEMENT OF COMMERCIAL, RETAIL AND RESIDENTIAL REAL ESTATE (U.S. CLS. 100, 101 AND 102).

FIRST USE 3-21-2007; IN COMMERCE 3-21-2007.

CLASS 37—CONSTRUCTION AND REPAIR

FOR DEVELOPING COMMERCIAL, RETAIL AND RESIDENTIAL REAL ESTATE; AND PROVIDING MAINTENANCE SERVICES FOR COMMERCIAL, RETAIL AND RESIDENTIAL REAL ESTATE (U.S. CLS. 100, 103 AND 106).

FIRST USE 3-21-2007; IN COMMERCE 3-21-2007.

3,399,316. CENTEX/TAYLOR, LLC, CHANTILLY, VA. SN 78-247,090. PUB. 7-27-2004, FILED 5-8-2003.

WAR ADMIRAL**CLASS 25—CLOTHING**

FOR GOLF-RELATED CLOTHING, NAMELY, SHIRTS, SWEATERS, HATS, ALL SOLD IN GOLF-PRO SHOPS (U.S. CLS. 22 AND 39).

FIRST USE 7-31-2007; IN COMMERCE 7-31-2007.

CLASS 28—TOYS AND SPORTING GOODS

FOR GOLF AND GOLF COURSE RELATED ACCESSORIES, NAMELY, GOLF BALLS (U.S. CLS. 22, 23, 38 AND 50).

FIRST USE 7-31-2007; IN COMMERCE 7-31-2007.

3,399,320. JOHNS MANVILLE, DENVER, CO. SN 78-251,658. PUB. 8-3-2004, FILED 5-19-2003.

SUMMIT CLUB

NO CLAIM IS MADE TO THE EXCLUSIVE RIGHT TO USE "CLUB", APART FROM THE MARK AS SHOWN.

CLASS 35—ADVERTISING AND BUSINESS

FOR INCENTIVE AWARD PROGRAMS FOR ROOFING CONTRACTORS TO PROMOTE THE SALE OF ROOFING PRODUCTS AND ON-THE-JOB SAFETY; AND SALES LEADS IN THE NATURE OF REFERRALS TO ROOFING CONTRACTORS IN THE FIELD OF ROOFING SERVICES (U.S. CLS. 100, 101 AND 102).

FIRST USE 2-11-2005; IN COMMERCE 2-11-2005.

CLASS 41—EDUCATION AND ENTERTAINMENT

FOR EDUCATIONAL SERVICES, NAMELY, PROVIDING TRAINING PROGRAMS AND SEMINARS ON THE SUBJECT OF ROOF BUILDING, PRODUCT INSTALLATION, AND SAFETY; AND EDUCATIONAL SERVICES, NAMELY, PROVIDING INCENTIVES TO ROOFING CONTRACTORS TO DEMONSTRATE EXCELLENCE IN THE FIELD OF ROOFING (U.S. CLS. 100, 101 AND 107).

FIRST USE 2-11-2005; IN COMMERCE 2-11-2005.

3,399,322. S.S. TARIS ZEYTIN VE ZEYTINYAGI TARIM SATIS KOOPERATIFLERI BIRLIGI, ALSANCAK-IZMIR, TURKEY. SN 78-253,662. PUB. 9-14-2004, FILED 5-23-2003.

CLASS 1—CHEMICALS

FOR NATURAL MATERIALS FOR USE IN THE PRODUCTION OF COSMETICS, NAMELY, BOTANICAL EXTRACTS (U.S. CLS. 1, 5, 6, 10, 26 AND 46).

FIRST USE 8-9-2004; IN COMMERCE 8-9-2004.

CLASS 2—PAINTS

FOR NATURAL MATERIALS FOR USE IN THE PRODUCTION OF COSMETICS, NAMELY, COLORANTS (U.S. CLS. 6, 11 AND 16).

FIRST USE 8-9-2004; IN COMMERCE 8-9-2004.

CLASS 3—COSMETICS AND CLEANING PREPARATIONS

FOR BLEACHING PREPARATIONS AND OTHER SUBSTANCES, NAMELY, BLUEING FOR LAUNDRY USE; PERFUMERY, COSMETICS, PRE-MOISTENED COSMETIC AND CLEANING TISSUE PAPERS, PADS AND COTTONS, NAMELY, COSMETIC PADS, COTTON FOR COSMETIC PURPOSES, SOAPS; PREPARATIONS FOR DENTAL CARE, NAMELY, TOOTH PASTE, NON-MEDICATED DENTAL RINSE; SCOURING ABRASIVE PREPARATIONS, NAMELY, SCOURING POWDERS, POLISHERS, NAMELY, SHOE POLISH, NAIL POLISH; NATURAL MATERIALS FOR PRODUCTION OF COSMETICS, PERFUMERY AND SOAPS, NAMELY, ESSENTIAL OILS (U.S. CLS. 1, 4, 6, 50, 51 AND 52).

FIRST USE 8-9-2004; IN COMMERCE 8-9-2004.

CLASS 29—MEATS AND PROCESSED FOODS

FOR OLIVES, NAMELY, PROCESSED OLIVES, PICKLES, EDIBLE OILS AND FATS, MARGARINE, BUTTER, FRUITS, NAMELY, PROCESSED FRUITS, TINNED FROZEN FRUITS, COOKED FRUITS, JAMS, MARMALADE, FRUIT PEEL, STEWED FRUIT, DRIED FRUIT, PRESERVED FRUIT, FRUIT PULP, PEANUT AND NUT BUTTER; SALAD OIL (U.S. CL. 46).

FIRST USE 8-9-2004; IN COMMERCE 8-9-2004.

CLASS 30—STAPLE FOODS

FOR GRAPE MOLASSES, KETCHUP, MAYONNAISE, MUSTARD, SAUCES FOR USE AS CONDIMENTS, NAMELY, SALAD DRESSING, SAUCES FOR SALADS, TOMATO SAUCE, NON-NUTRITIONAL AROMATIC PREPARATIONS FOR FOOD, NOT BEING ESSENTIAL OILS, YEAST, BAKING POWDERS, VANILLA, SPICES, HERB TEA FOR FOOD PURPOSES, ICED TEAS, LIME TEA, SAHLEP, A THICK FERMENTED NON-ALCOHOLIC GRAIN-BASED BEVERAGE (U.S. CL. 46).
FIRST USE 8-9-2004; IN COMMERCE 8-9-2004.

3,399,332. FLAGSHIP STUDIOS, INC., SAN FRANCISCO, CA. SN 78-296,895. PUB. 9-14-2004, FILED 9-5-2003.

FLAGSHIP STUDIOS

NO CLAIM IS MADE TO THE EXCLUSIVE RIGHT TO USE STUDIOS, APART FROM THE MARK AS SHOWN.

3,399,328. COMPTON, PATRICIA, J, KAILUA, HI. SN 78-271,844. PUB. 8-31-2004, FILED 7-8-2003.

PATANJALI**CLASS 25—CLOTHING**

FOR CLOTHING, NAMELY T-SHIRTS (U.S. CLS. 22 AND 39).
FIRST USE 11-23-2007; IN COMMERCE 11-23-2007.

CLASS 9—ELECTRICAL AND SCIENTIFIC APPARATUS

FOR COMPUTER GAME SOFTWARE (U.S. CLS. 21, 23, 26, 36 AND 38).
FIRST USE 10-31-2007; IN COMMERCE 10-31-2007.

CLASS 35—ADVERTISING AND BUSINESS

FOR ONLINE RETAIL SERVICES FEATURING YOGA PRODUCTS (U.S. CLS. 100, 101 AND 102).
FIRST USE 11-21-2007; IN COMMERCE 11-28-2007.

CLASS 41—EDUCATION AND ENTERTAINMENT

FOR COMPUTER AND VIDEO GAME PRODUCTION; PROVIDING ONLINE INTERACTIVE COMPUTER GAMES (U.S. CLS. 100, 101 AND 107).
FIRST USE 10-31-2007; IN COMMERCE 10-31-2007.

CLASS 41—EDUCATION AND ENTERTAINMENT

FOR YOGA TRAINING COURSES (U.S. CLS. 100, 101 AND 107).
FIRST USE 11-21-2007; IN COMMERCE 11-21-2007.

3,399,330. BRISTOL-MYERS SQUIBB COMPANY, NEW YORK, NY. SN 78-285,521. PUB. 8-31-2004, FILED 8-11-2003.

FREEDOM TO DISCOVER**CLASS 16—PAPER GOODS AND PRINTED MATTER**

FOR PRINTED MATTER, NAMELY, BROCHURES AND PROGRAM LITERATURE, FEATURING INFORMATION IN THE FIELD OF MEDICAL RESEARCH (U.S. CLS. 2, 5, 22, 23, 29, 37, 38 AND 50).
FIRST USE 12-31-1977; IN COMMERCE 12-31-1977.

3,399,333. TRISH MCEVOY LTD., NEW YORK, NY. SN 78-300,265. PUB. 8-10-2004, FILED 9-15-2003.

THE POWER OF MAKEUP

NO CLAIM IS MADE TO THE EXCLUSIVE RIGHT TO USE "MAKEUP", APART FROM THE MARK AS SHOWN.

CLASS 36—INSURANCE AND FINANCIAL

FOR PROVISION OF GRANTS TO SCIENTISTS TO CONDUCT MEDICAL RESEARCH (U.S. CLS. 100, 101 AND 102).
FIRST USE 12-31-1977; IN COMMERCE 12-31-1977.

CLASS 3—COSMETICS AND CLEANING PREPARATIONS

FOR COSMETICS, NAMELY, FOUNDATION, BLUSH, PRESSED POWDER, UNDER EYE COVER, EYE SHADOW, EYE LINER, LIP GLOSS, AND LIPSTICK (U.S. CLS. 1, 4, 6, 50, 51 AND 52).
FIRST USE 6-1-2004; IN COMMERCE 6-1-2004.

CLASS 41—EDUCATION AND ENTERTAINMENT

FOR ONLINE NEWSLETTERS AND INFORMATION IN THE FIELD OF MEDICAL RESEARCH AND RESEARCH AWARDS (U.S. CLS. 100, 101 AND 107).
FIRST USE 12-31-1977; IN COMMERCE 12-31-1977.

CLASS 21—HOUSEWARES AND GLASS

FOR COSMETIC CONTAINERS SOLD EMPTY, NAMELY, COMPACTS FOR FOUNDATION, BLUSH, PRESSED POWDER, UNDER EYE COVER, EYE SHADOW, EYE LINER, LIP GLOSS, AND LIPSTICK (U.S. CLS. 2, 13, 23, 29, 30, 33, 40 AND 50).
FIRST USE 6-1-2004; IN COMMERCE 6-1-2004.

3,399,338. MUGGERUD, LAWRENCE, NEW YORK, NY. SN 78-322,807. PUB. 7-20-2004, FILED 11-4-2003.

MASHUP

THE MARK CONSISTS OF STANDARD CHARACTERS WITHOUT CLAIM TO ANY PARTICULAR FONT, STYLE, SIZE, OR COLOR.

CLASS 9—ELECTRICAL AND SCIENTIFIC APPARATUS

FOR ELECTRICAL APPARATUS, NAMELY, PRE-RECORDED PHONOGRAPH RECORDS, COMPACT DISCS AND AUDIO CASSETTES FEATURING MUSIC (U.S. CLS. 21, 23, 26, 36 AND 38).
FIRST USE 0-0-2003; IN COMMERCE 0-0-2003.

CLASS 41—EDUCATION AND ENTERTAINMENT

FOR ENTERTAINMENT SERVICES, NAMELY, LIVE DJ SERVICES (U.S. CLS. 100, 101 AND 107).
FIRST USE 0-0-2002; IN COMMERCE 0-0-2002.

3,399,340. ESPN, INC., BRISTOL, CT. SN 78-326,712. PUB. 12-20-2005, FILED 11-12-2003.

ESPNU

THE MARK CONSISTS OF STANDARD CHARACTERS WITHOUT CLAIM TO ANY PARTICULAR FONT, STYLE, SIZE, OR COLOR.

OWNER OF U.S. REG. NOS. 1,345,096, 2,147,722, AND OTHERS.

CLASS 38—COMMUNICATION

FOR ENTERTAINMENT SERVICES, NAMELY, BROADCASTING OF CABLE TELEVISION SPORTS, ENTERTAINMENT, NEWS, SPORTS PROGRAMS, COLLEGE SPORTS EVENTS AND OTHER RELATED AND ANCILLARY PROGRAMMING RENDERED THROUGH THE MEDIA OF TELEVISION AND RADIO (U.S. CLS. 100, 101 AND 104).
FIRST USE 3-4-2005; IN COMMERCE 3-4-2005.

CLASS 41—EDUCATION AND ENTERTAINMENT

FOR ENTERTAINMENT SERVICES, NAMELY, PRODUCTION OF CABLE TELEVISION SPORTS, ENTERTAINMENT, NEWS, SPORTS PROGRAMS, COLLEGE SPORTS EVENTS AND OTHER RELATED AND ANCILLARY PROGRAMMING RENDERED THROUGH THE MEDIA OF TELEVISION AND RADIO; ENTERTAINMENT SERVICES, NAMELY, PROVIDING TELEVISION PROGRAMMING AND INFORMATION IN THE FIELD OF SPORTS, ENTERTAINMENT, NEWS, SPORTS PROGRAMS, COLLEGE SPORTS EVENTS AND OTHER RELATED AND ANCILLARY PROGRAMMING RENDERED VIA COMPUTER BY MEANS OF A GLOBAL COMPUTER NETWORK (U.S. CLS. 100, 101 AND 107).
FIRST USE 3-4-2005; IN COMMERCE 3-4-2005.

3,399,348. CJ APPAREL GROUP, LLC, NORTHBROOK, IL. SN 78-336,621. PUB. 9-19-2006, FILED 12-4-2003.

CARIBBEAN JOE

THE MARK CONSISTS OF STANDARD CHARACTERS WITHOUT CLAIM TO ANY PARTICULAR FONT, STYLE, SIZE, OR COLOR.

OWNER OF U.S. REG. NO. 2,845,458.

CLASS 9—ELECTRICAL AND SCIENTIFIC APPARATUS

FOR SUNGLASSES; SUNGLASS CASES (U.S. CLS. 21, 23, 26, 36 AND 38).
FIRST USE 8-1-2003; IN COMMERCE 8-1-2007.

CLASS 18—LEATHER GOODS

FOR HANDBAGS MADE OF CLOTH AND LEATHER, SHOULDER BAGS, PURSES (U.S. CLS. 1, 2, 3, 22 AND 41).

FIRST USE 12-1-2002; IN COMMERCE 7-18-2007.

CLASS 25—CLOTHING

FOR LADIES AND MEN'S APPAREL, FOOTWEAR AND HEADWEAR, NAMELY, DRESSES, SUITS, SHIRTS, BLOUSES, SKIRTS, BELTS, GLOVES, PANTS, JEANS, PEDDLE PUSHERS, CROPPED PANTS, T-SHIRTS, SHORTS, SWEATERS, SWEATSHIRTS, JACKETS, VESTS, COATS, PARKAS, RAINWEAR, HATS, CAPS, VISORS, SHAWLS, SCARVES, TIES, ASCOTS, NECKERCHIEFS, SHOES, BOOTS, SNEAKERS, SANDALS, SOCKS, SLIPPERS, SWIMWEAR, SLEEPWEAR, LINGERIE, NIGHTGOWNS, NIGHTSHIRTS, PAJAMAS, UNDERWEAR, ROBES, NIGHTSHIRTS (U.S. CLS. 22 AND 39).

FIRST USE 6-1-2001; IN COMMERCE 6-19-2007.

3,399,349. WARNER BROS. ENTERTAINMENT INC., BURBANK, CA. SN 78-339,960. PUB. 3-28-2006, FILED 12-12-2003.



RECORDS

OWNER OF U.S. REG. NOS. 1,521,037, 2,726,867, AND OTHERS.

NO CLAIM IS MADE TO THE EXCLUSIVE RIGHT TO USE "RECORDS", APART FROM THE MARK AS SHOWN.

THE MARK CONSISTS OF "WB" IN SHIELD AND RECORDS.

CLASS 9—ELECTRICAL AND SCIENTIFIC APPARATUS

FOR PRE-RECORDED RECORDS, COMPACT DISCS, AUDIOTAPES, VIDEOTAPES, DVDS AND AUDIO/VISUAL DISCS, ALL FEATURING MUSIC (U.S. CLS. 21, 23, 26, 36 AND 38).

FIRST USE 3-19-1958; IN COMMERCE 3-19-1958.

CLASS 41—EDUCATION AND ENTERTAINMENT

FOR ENTERTAINMENT SERVICES IN THE NATURE OF RECORD PRODUCTION SERVICES (U.S. CLS. 100, 101 AND 107).

FIRST USE 3-19-1958; IN COMMERCE 3-19-1958.

3,399,353. GENERAL ELECTRIC COMPANY, SCHENECTADY, NY. SN 78-343,029. PUB. 9-20-2005, FILED 12-18-2003.

GE

THE MARK CONSISTS OF STANDARD CHARACTERS WITHOUT CLAIM TO ANY PARTICULAR FONT, STYLE, SIZE, OR COLOR.

OWNER OF U.S. REG. NOS. 871,259, 1,020,378, AND 1,197,111.

CLASS 7—MACHINERY

FOR AXIAL AND CENTRIFUGAL COMPRESSORS; RECIPROCATING COMPRESSORS; SCREW AND VANE COMPRESSORS; ROTARY, VACUUM, ELECTRIC, SUBMERSIBLE AND CENTRIFUGAL PUMPS; TURBO EXPANDERS, NAMELY, COMPRESSORS; CNG REFUELING MACHINES FOR LAND VEHICLES AND INDUSTRIAL EQUIPMENT AND ACCESSORIES AND PARTS FOR ALL THE FOREGOING, NAMELY, PUMPS, VALVES, FUEL FILTERS, FILTER CASINGS, DISTRIBUTOR ROTORS, BLADES, BEARINGS AND MECHANICAL SEALS; GAS TURBINES; STEAM TURBINES; STEAM CONDENSERS (U.S. CLS. 13, 19, 21, 23, 31, 34 AND 35).

FIRST USE 12-31-1996; IN COMMERCE 12-31-1996.

CLASS 11—ENVIRONMENTAL CONTROL APPARATUS

FOR HEAT EXCHANGERS; CHEMICAL HEAVY WALL REACTORS AND NUCLEAR REACTORS AND ACCESSORIES AND COMPONENT PARTS THEREOF, NAMELY, HEAT PUMPS, STEAM VALVES AND VALES FOR REGULATING THE FLOW OF GASES AND LIQUIDS (U.S. CLS. 13, 21, 23, 31 AND 34).

FIRST USE 12-31-1996; IN COMMERCE 12-31-1996.

CLASS 37—CONSTRUCTION AND REPAIR

FOR INSTALLATION, MAINTENANCE AND REPAIR SERVICES FOR COMPRESSORS AND PUMPS, NAMELY, MACHINES, TURBO EXPANDERS, FUEL PUMPS AND FUEL DISTRIBUTION EQUIPMENT, CNG REFUELING EQUIPMENT, GAS TURBINES, STEAM TURBINES, AIR COOLED HEAT EXCHANGERS, STEAM CONDENSERS, HEAVY WALL REACTORS AND TUBULAR REACTORS; OIL AND GAS PIPELINE MAINTENANCE AND REPAIR SERVICES; OIL WELL CASING, TUBING AND DRILL PIPE INSTALLATION; RENTAL OF OIL AND GAS WELL DRILLING TOOLS (U.S. CLS. 100, 103 AND 106).

FIRST USE 12-31-1996; IN COMMERCE 12-31-1996.

CLASS 42—SCIENTIFIC AND COMPUTER SERVICES

FOR ENGINEERING SERVICES; TECHNICAL CONSULTATION AND RESEARCH SERVICES IN THE OIL AND GAS INDUSTRIES; OIL AND GAS EXPLORATION SERVICES; GEOPHYSICAL EXPLORATION FOR THE OIL AND GAS INDUSTRIES; ANALYSIS OF OIL AND GAS FIELDS; OIL AND GAS PROSPECTING, NAMELY, WELL LOGGING AND TESTING; OIL AND GAS WELL TESTING; OIL AND GAS PIPELINE INSPECTION; REMOTE MONITORING AND DIAGNOSTIC SERVICES FOR COMPRESSORS AND PUMPS, NAMELY, MACHINES, TURBO EXPANDERS, FUEL PUMPS AND FUEL DISTRIBUTION EQUIPMENT, CNG REFUELING EQUIPMENT, GAS TURBINES, STEAM TURBINES, AIR COOLED HEAT EXCHANGERS, STEAM CONDENSERS, HEAVY WALL REACTORS AND TUBULAR REACTORS (U.S. CLS. 100 AND 101).

FIRST USE 12-31-1996; IN COMMERCE 12-31-1996.

3,399,356. WARNER BROS. RECORDS INC., BURBANK, CA.
SN 78-351,110. PUB. 10-19-2004, FILED 1-13-2004.

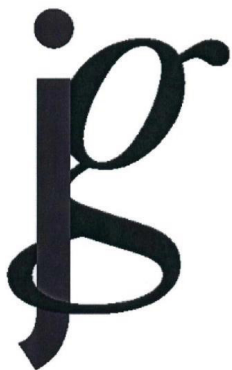

CLASS 6—METAL GOODS

FOR METAL KEY CHAINS (U.S. CLS. 2, 12, 13, 14, 23,
25 AND 50).
FIRST USE 10-10-2007; IN COMMERCE 10-10-2007.

CLASS 18—LEATHER GOODS

FOR GYM BAGS (U.S. CLS. 1, 2, 3, 22 AND 41).
FIRST USE 1-4-2007; IN COMMERCE 1-4-2007.

CLASS 21—HOUSEWARES AND GLASS

FOR MUGS (U.S. CLS. 2, 13, 23, 29, 30, 33, 40 AND 50).
FIRST USE 10-10-2007; IN COMMERCE 10-10-2007.

CLASS 25—CLOTHING

FOR CLOTHING, NAMELY, BASEBALL CAPS, HATS,
T-SHIRTS, SWEATSHIRTS AND JACKETS (U.S. CLS. 22
AND 39).
FIRST USE 12-7-2006; IN COMMERCE 12-7-2006.

3,399,358. EAGLE MATERIALS IP LLC, DALLAS, TX. SN 78-
355,884. PUB. 1-9-2007, FILED 1-22-2004.



NO CLAIM IS MADE TO THE EXCLUSIVE RIGHT TO
USE "MATERIALS", APART FROM THE MARK AS
SHOWN.

THE MARK CONSISTS OF THE WORDS "EAGLE MATE-
RIALS", THE LETTERS "EM" AND AN EAGLE'S HEAD.

CLASS 16—PAPER GOODS AND PRINTED MATTER

FOR PAPERBOARD, EXCLUDING MAILING GOODS
(U.S. CLS. 2, 5, 22, 23, 29, 37, 38 AND 50).
FIRST USE 1-23-2007; IN COMMERCE 1-23-2007.

CLASS 19—NON-METALLIC BUILDING MA- TERIALS

FOR CONSTRUCTION PRODUCTS, NAMELY, CE-
MENT, READYMIX CONCRETE, AGGREGATES CON-
SISTING PRIMARILY OF STONE, SAND, AND GRAVEL
FOR USE IN MANUFACTURING CONCRETE, AS-
PHALT AND ROAD BASE; AND GYPSUM WALL-
BOARD (U.S. CLS. 1, 12, 33 AND 50).

FIRST USE 8-7-2007; IN COMMERCE 8-7-2007.

3,399,360. NEXANTIS CORPORATION, TOKYO, JAPAN. SN
78-361,740. PUB. 8-29-2006, FILED 2-3-2004.

SECURESCOUT

THE MARK CONSISTS OF STANDARD CHARACTERS
WITHOUT CLAIM TO ANY PARTICULAR FONT, STYLE,
SIZE, OR COLOR.

CLASS 9—ELECTRICAL AND SCIENTIFIC APPARATUS

FOR COMPUTER SOFTWARE FOR WORD PROCES-
SING AND FOR USE AS A SPREADSHEET; COMPUTER
SOFTWARE FOR USE IN FINANCIAL ACCOUNTING,
SALES FORCE AUTOMATION, SUPPLY CHAIN MAN-
AGEMENT, CUSTOMER RELATIONSHIP MANAGE-
MENT AND ENTERPRISE RESOURCE PLANNING;
DATABASE MANAGEMENT SOFTWARE FOR USE IN
THE FIELD OF HUMAN RESOURCES; COMPUTER
SOFTWARE FOR USE IN CAPTURING, ORGANIZING
AND SHARING ONLINE CONTENT AND FOR USE IN
DATABASE MANAGEMENT; COMPUTER SOFTWARE
FOR USE IN PREVENTING PENETRATION OF THE
SECURITY OF THE COMPUTER NETWORKS; COMPU-
TERS AND ELECTRONIC TECHNOLOGY, NAMELY,
PERSONAL COMPUTER, PERSONAL DIGITAL ASSIS-
TANCE, PORTABLE MP3 PLAYER, DIGITAL CAMERA,
IMAGE SCANNER, DIGITAL PRINTER, CIRCUIT
BOARD, HARD DISK DRIVE, OPTICAL DISC DRIVE,
MEMORY CARD, LOCAL AREA NETWORK COMPU-
TER CARDS FOR CONNECTING PORTABLE COMPU-
TER DEVICES TO COMPUTER NETWORKS AND
MODEM; COMPUTER HARDWARE (U.S. CLS. 21, 23,
26, 36 AND 38).

FIRST USE 1-1-2004; IN COMMERCE 1-1-2004.

CLASS 42—SCIENTIFIC AND COMPUTER SERVICES

FOR CREATION AND DESIGN OF COMPUTER SOFT-
WARE FOR OTHERS; MAINTENANCE OF COMPUTER
SOFTWARE; DESIGN OF COMPUTERS FOR OTHERS;
LEASING OF COMPUTERS (U.S. CLS. 100 AND 101).

FIRST USE 1-1-2004; IN COMMERCE 1-1-2004.

3,399,375. DALEY, DAHLIA C, BOWIE, MD. SN 78-415,506.
PUB. 9-13-2005, FILED 5-8-2004.

FinanceArk

THE MARK CONSISTS OF STANDARD CHARACTERS WITHOUT CLAIM TO ANY PARTICULAR FONT, STYLE, SIZE, OR COLOR.

CLASS 35—ADVERTISING AND BUSINESS

FOR ACCOUNTING SERVICES, TAX CONSULTATION, TAX PREPARATION (U.S. CLS. 100, 101 AND 102).
FIRST USE 1-1-2003; IN COMMERCE 10-1-2003.

CLASS 36—INSURANCE AND FINANCIAL

FOR FINANCIAL PLANNING, FINANCIAL INFORMATION PROVIDED BY ELECTRONIC MEANS, FINANCIAL SERVICES IN THE NATURE OF AN INVESTMENT SECURITY, INSURANCE BROKERAGE, MORTGAGE BROKERAGE (U.S. CLS. 100, 101 AND 102).
FIRST USE 1-1-2003; IN COMMERCE 10-1-2003.

3,399,378. ARMCHAIR SAILOR, INC., SEATTLE, WA. SN 78-424,263. PUB. 9-13-2005, FILED 5-25-2004.



NO CLAIM IS MADE TO THE EXCLUSIVE RIGHT TO USE "BOOKS" AND "CHARTS", APART FROM THE MARK AS SHOWN.

THE MARK CONSISTS OF A SAILOR SITTING IN AN ARMCHAIR, READING A BOOK AND SMOKING A PIPE. THE WORDS "ARMCHAIR SAILOR" AND "BOOKS & CHARTS" AND STYLIZED FISH DESIGNS SURROUND THE SAILOR IN A OVAL BORDER PATTERN.

CLASS 25—CLOTHING

FOR CLOTHING FOR MEN, WOMEN AND CHILDREN, NAMELY, SHIRTS; CLOTHING FOR MEN, WOMEN AND CHILDREN, NAMELY, HATS (U.S. CLS. 22 AND 39).

FIRST USE 1-1-1987; IN COMMERCE 1-1-1987.

CLASS 35—ADVERTISING AND BUSINESS

FOR RETAIL AND ON-LINE RETAIL STORE SERVICES FEATURING WEATHER INSTRUMENTS, COMPASSES, ELECTRONIC AND PAPER NAVIGATION CHARTS, SOFTWARE, BINOCULARS, CLOCKS AND WATCHES, SEXTANTS, WINDVANES, MARINE ART, BOOKS, VIDEOS, GIFTS, MUSIC, GALLEY EQUIPMENT, MODELS AND MODEL KITS, HATS, SHIRTS, AND LIGHTHOUSES (U.S. CLS. 100, 101 AND 102).

FIRST USE 1-1-1987; IN COMMERCE 1-1-1987.

3,399,384. GENEON ENTERTAINMENT (USA) INC., LONG BEACH, CA. AND VICTOR ENTERTAINMENT, INC., MINATO-KU, TOKYO, JAPAN. AND TOKUMA SHOTEN PUBLISHING CO., LTD., MINATO-KU, TOKYO, JAPAN. SN 78-450,004. PUB. 6-14-2005, FILED 7-13-2004.

SAMURAI CHAMPLOO

THE MARK CONSISTS OF STANDARD CHARACTERS WITHOUT CLAIM TO ANY PARTICULAR FONT, STYLE, SIZE, OR COLOR.

CLASS 9—ELECTRICAL AND SCIENTIFIC APPARATUS

FOR CARTOON VIDEO RECORDINGS; VIDEO GAME SOFTWARE; MUSICAL SOUND RECORDINGS (U.S. CLS. 21, 23, 26, 36 AND 38).

FIRST USE 1-11-2005; IN COMMERCE 1-11-2005.

CLASS 16—PAPER GOODS AND PRINTED MATTER

FOR ROLE PLAYING GAME BOOKS; ANIME FAN GUIDE BOOKS; TRADING CARDS; GRAPHIC NOVELS; POSTERS; STATIONERY; STICKERS (U.S. CLS. 2, 5, 22, 23, 29, 37, 38 AND 50).

FIRST USE 8-0-2005; IN COMMERCE 8-0-2005.

CLASS 25—CLOTHING

FOR FOOTWEAR; HEADWEAR; SHIRTS; T-SHIRTS; JACKETS; SWEATSUITS; MASQUERADE COSTUMES (U.S. CLS. 22 AND 39).

FIRST USE 5-0-2005; IN COMMERCE 5-0-2005.

CLASS 28—TOYS AND SPORTING GOODS

FOR ACTION FIGURES AND ACCESSORIES THEREFOR; COLLECTABLE TOY FIGURES; TOY FIGURES; PLUSH TOYS; TOY WEAPONS; HAND HELD UNIT FOR PLAYING ELECTRONIC GAMES; STAND ALONE VIDEO GAME MACHINES; ROLE PLAYING GAMES (U.S. CLS. 22, 23, 38 AND 50).

FIRST USE 12-0-2005; IN COMMERCE 12-0-2005.

3,399,386. WRANGLER APPAREL CORP., WILMINGTON, DE. SN 78-458,687. PUB. 10-4-2005, FILED 7-29-2004.

20X

THE MARK CONSISTS OF STANDARD CHARACTERS WITHOUT CLAIM TO ANY PARTICULAR FONT, STYLE, SIZE, OR COLOR.

OWNER OF U.S. REG. NO. 2,374,103.

CLASS 9—ELECTRICAL AND SCIENTIFIC APPARATUS

FOR PROTECTIVE CLOTHING, NAMELY, GLOVES (U.S. CLS. 21, 23, 26, 36 AND 38).
FIRST USE 1-31-2007; IN COMMERCE 1-31-2007.

CLASS 21—HOUSEWARES AND GLASS

FOR WORK GLOVES IN THE NATURE OF HOUSEHOLD GLOVES FOR GENERAL USE; GARDENING GLOVES (U.S. CLS. 2, 13, 23, 29, 30, 33, 40 AND 50).
FIRST USE 1-31-2007; IN COMMERCE 1-31-2007.

CLASS 25—CLOTHING

FOR GLOVES (U.S. CLS. 22 AND 39).
FIRST USE 1-31-2007; IN COMMERCE 1-31-2007.

3,399,388. SNYDER, STEPHEN B., FISHERS, IN. SN 78-462,324. PUB. 11-29-2005, FILED 8-5-2004.

Improve your credit
scores improve
your lifestyle

THE MARK CONSISTS OF STANDARD CHARACTERS WITHOUT CLAIM TO ANY PARTICULAR FONT, STYLE, SIZE, OR COLOR.

CLASS 16—PAPER GOODS AND PRINTED MATTER

FOR PRINTED INSTRUCTIONAL, EDUCATIONAL, AND TEACHING MATERIALS IN THE AREAS OF PERSONAL FINANCE, CREDIT SCORES AND CREDIT MANAGEMENT (U.S. CLS. 2, 5, 22, 23, 29, 37, 38 AND 50).
FIRST USE 3-2-2006; IN COMMERCE 3-2-2006.

CLASS 41—EDUCATION AND ENTERTAINMENT

FOR EDUCATIONAL SERVICES, NAMELY, CONDUCTING SEMINARS IN THE FIELD OF PERSONAL FINANCE, CREDIT SCORES AND CREDIT MANAGEMENT; ENTERTAINMENT SERVICES, NAMELY, PRODUCTION OF RADIO AND TELEVISION PROGRAMS IN THE FIELD OF PERSONAL FINANCE, CREDIT SCORES AND CREDIT MANAGEMENT; ENTERTAINMENT SERVICES, NAMELY, PERSONAL APPEARANCES ON RADIO AND TELEVISION BY PERSONAL FINANCE EXPERT, IN THE FIELD OF PERSONAL FINANCE, CREDIT SCORES AND CREDIT MANAGEMENT (U.S. CLS. 100, 101 AND 107).
FIRST USE 3-2-2006; IN COMMERCE 3-2-2006.

3,399,391. HEB GROCERY COMPANY, L.P., SAN ANTONIO, TX. SN 78-469,271. PUB. 9-6-2005, FILED 8-18-2004.

H-E-B BABY

THE MARK CONSISTS OF STANDARD CHARACTERS WITHOUT CLAIM TO ANY PARTICULAR FONT, STYLE, SIZE, OR COLOR.

OWNER OF U.S. REG. NOS. 1,867,930, 2,556,749, AND 2,798,052.

NO CLAIM IS MADE TO THE EXCLUSIVE RIGHT TO USE "BABY", APART FROM THE MARK AS SHOWN.

CLASS 1—CHEMICALS

FOR DISTILLED WATER (U.S. CLS. 1, 5, 6, 10, 26 AND 46).
FIRST USE 3-0-2007; IN COMMERCE 3-0-2007.

CLASS 3—COSMETICS AND CLEANING PREPARATIONS

FOR BABY HEALTH AND BEAUTY AIDS, NAMELY, HAIR SHAMPOO, SKIN SOAPS, AND BODY WASH; SKIN AND BODY LOTIONS AND MOISTURIZERS, BABY OIL, BABY POWDER, NON-MEDICATED DIAPER RASH OINTMENT AND LOTION; PRE-MOISTENED, DISPOSABLE BABY WIPES (U.S. CLS. 1, 4, 6, 50, 51 AND 52).
FIRST USE 6-0-2005; IN COMMERCE 6-0-2005.

CLASS 5—PHARMACEUTICALS

FOR INFANT FORMULA; INFANT AND CHILDREN PHARMACEUTICAL PREPARATIONS, NAMELY, PEDIATRIC ELECTROLYTE (U.S. CLS. 6, 18, 44, 46, 51 AND 52).
FIRST USE 3-0-2003; IN COMMERCE 3-0-2003.

CLASS 16—PAPER GOODS AND PRINTED MATTER

FOR DISPOSABLE DIAPERS (U.S. CLS. 2, 5, 22, 23, 29, 37, 38 AND 50).
FIRST USE 3-0-2005; IN COMMERCE 3-0-2005.

CLASS 32—LIGHT BEVERAGES

FOR FRUIT JUICE (U.S. CLS. 45, 46 AND 48).
FIRST USE 2-0-2003; IN COMMERCE 2-0-2003.

3,399,397. EYE CORP PTY LIMITED, PYRMONT, NSW, AUSTRALIA. SN 78-484,389. PUB. 9-5-2006, FILED 9-15-2004.



CLASS 35—ADVERTISING AND BUSINESS

FOR ADVERTISING SERVICES, NAMELY, PROMOTING THE GOODS AND SERVICES OF OTHERS THROUGH THE USE OF BILLBOARD, DIGITAL SIGNAGE ADVERTISING NETWORKS AND ONLINE ADVERTISING ON INTERACTIVE COMPUTER COMMUNICATION NETWORKS, OUT-OF-HOME/OUTDOOR ADVERTISING; ADVERTISING VIA LIGHT BOXES, ON STREET FURNITURE AND AT POINT OF SALE; UPDATING AND DISSEMINATION OF ADVERTISING MATERIAL; RENTAL OF ADVERTISING SPACE; MARKETING RESEARCH; DEVELOPMENT OF MARKETING STRATEGIES, CONCEPTS AND MATERIAL IN THE ADVERTISING FIELD (U.S. CLS. 100, 101 AND 102).
FIRST USE 3-0-2004; IN COMMERCE 1-3-2006.

CLASS 42—SCIENTIFIC AND COMPUTER SERVICES

FOR COMPUTER SOFTWARE DESIGN AND MAINTENANCE; GRAPHIC DESIGN OF MULTIMEDIA PRESENTATIONS AND ADVERTISING CAMPAIGNS; GRAPHIC DESIGN OF ADVERTISING MATERIAL (U.S. CLS. 100 AND 101).
FIRST USE 3-0-2004; IN COMMERCE 1-3-2006.

3,399,399. MICROSAIC SYSTEMS LIMITED, WOKING, SURREY, UNITED KINGDOM. SN 78-484,955. PUB. 11-1-2005, FILED 9-16-2004.

MICROSAIC

THE MARK CONSISTS OF STANDARD CHARACTERS WITHOUT CLAIM TO ANY PARTICULAR FONT, STYLE,

SIZE, OR COLOR.

CLASS 9—ELECTRICAL AND SCIENTIFIC APPARATUS

FOR MICRO ELECTRO MECHANICAL SYSTEMS (MEMS) STRUCTURES, NAMELY, INDUCTORS, RELAYS, SWITCHES, CONNECTORS, ELECTRODES, LASERS AND SCANNERS; INTEGRATED CIRCUITS; SOLID STATE INTEGRATED CIRCUITS; SOLID STATE ELECTRICAL INTEGRATED CIRCUITS, MASS SPECTROMETERS AND COMPONENTS THEREFOR, NAMELY, CHIPS, MINIATURE MASS SPECTROMETERS AND COMPONENTS THEREFOR, NAMELY, CHIPS; MEASUREMENT APPARATUS AND DEVICES, NAMELY, MEMS DEVICES FOR THE MEASUREMENT OF CONSTITUENTS OF CHEMICAL COMPOUNDS; SENSOR DEVICES, NAMELY, SENSORS FOR THE ANALYSIS OF CHEMICAL CONSTITUENTS (U.S. CLS. 21, 23, 26, 36 AND 38).
FIRST USE 11-0-2005; IN COMMERCE 11-0-2005.

CLASS 42—SCIENTIFIC AND COMPUTER SERVICES

FOR ADVISORY SERVICES RELATED TO THE DESIGN AND FABRICATION OF MICRO ELECTRO MECHANICAL SYSTEMS (MEMS) SYSTEMS; ENGINEERING SERVICES; CIRCUIT DESIGN SERVICES FOR OTHERS; MEMS DESIGN SERVICES FOR OTHERS (U.S. CLS. 100 AND 101).
FIRST USE 11-0-2005; IN COMMERCE 11-0-2005.

3,399,400. CHENONE STORES LIMITED, LAHORE, PAKISTAN. SN 78-488,843. PUB. 2-14-2006, FILED 9-23-2004.

CHENONE

THE MARK CONSISTS OF STANDARD CHARACTERS WITHOUT CLAIM TO ANY PARTICULAR FONT, STYLE, SIZE, OR COLOR.

CLASS 24—FABRICS

FOR TEXTILE MATERIAL, NAMELY, HEMP CLOTH, COTTON FABRICS, CORD FABRICS AND ADHESIVE-BONDED CLOTH ALL USED IN THE FURTHER MANUFACTURE OF CLOTHING, CURTAINS AND BEDDING; TEXTILE GOODS, NAMELY, HANDKERCHIEFS OF TEXTILE, NAPKINS OF TEXTILE, BATH TOWELS, TOWEL USED TO COVER PILLOWS, TEXTILE BED AND BATH SHEETS; BED AND TABLE COVERS, NAMELY, BED BLANKETS, BEDSPREADS, BED LINEN, QUILTS, PILLOWCASES, BED SHEETS, BAG-SHAPED QUILT COVERS, CUSHION COVERS, WOOLEN BLANKETS AND TICKING FABRICS, UPHOLSTERY FABRIC USED IN THE MANUFACTURE OF TABLE CLOTHS, TABLE CLOTHS NOT OF PAPER, PLACEMATS NOT OF PAPER, AND TABLE RUNNERS NOT OF PAPER (U.S. CLS. 42 AND 50).
FIRST USE 7-28-2007; IN COMMERCE 7-28-2007.

CLASS 25—CLOTHING

FOR CLOTHING, NAMELY, PANTS, SHIRTS, DENIM JEANS, OVERALLS, SHORTS, T-SHIRTS, SHIRTS, WORKSHIRTS, BLOUSES, PULLOVERS, TANK TOPS, HALTER TOPS, JERSEYS, JACKETS, WIND RESISTANT JACKETS, RAINCOATS, COATS, VESTS, BLAZERS, SWEATERS, SWEATSHIRTS, SWEATPANTS, WOMEN'S SUITS, MEN'S SUITS, DRESSES, SKIRTS, SWIMMING TRUNKS, BATHING SUITS, BEACH WEAR, BIKINIS, ACTIVE WEAR, NAMELY, SWEATSUITS, CAMISOLES, LINGERIE, NIGHTGOWNS, HOSIERY, BANDANAS, SCARVES, BELTS, GLOVES, AND UNDERWEAR; HEADWEAR; FOOTWEAR (U.S. CLS. 22 AND 39).

FIRST USE 7-28-2007; IN COMMERCE 7-28-2007.

3,399,402. JASPAL COMPANY LIMITED, BANGKOK 10260, THAILAND. SN 78-490,510. PUB. 11-15-2005, FILED 9-28-2004.

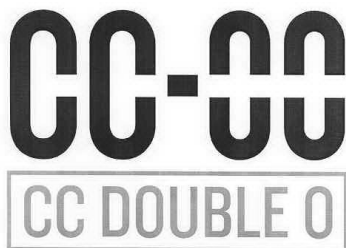
**CLASS 18—LEATHER GOODS**

FOR BAGS FOR TRAVEL, TEXTILE SHOPPING BAGS, BACKPACKS, BAGS FOR CAMPERS, NAMELY, RUCKSACKS, BAGS FOR CLIMBERS, NAMELY, HIKING BAGS, BEACH BAGS, BRIEFCASES, GARMENT BAGS FOR TRAVEL, HANDBAGS, MESH NET BAGS FOR SHOPPING, POCKET WALLETS, PURSES, SCHOOL BAGS, SCHOOL SATCHELS, SUITCASES, TRAVELING TRUNKS AND LUGGAGE (U.S. CLS. 1, 2, 3, 22 AND 41).

FIRST USE 2-21-2005; IN COMMERCE 11-27-2006.

CLASS 25—CLOTHING

FOR SUITS, SHIRTS, T-SHIRTS, BLOUSES WITH SPAGHETTI STRAPS, VESTS, WAISTCOATS, SLEEVELESS SHIRTS, OVERCOATS, JACKETS, PULLOVERS, ANORAKS, BATHROBES, KNIT SHIRTS, TRACKSUITS, EVENING GOWNS, SHORTS, TROUSERS, SKIRTS, UNDERWEAR, SCARVES, SHAWLS, HATS, STOCKINGS, SOCKS, GLOVES, TIES, BELTS, CASUAL SHOES, SLIPPERS, SPORT SHOES, HIGH HEELED SHOES, BOOTS AND SANDALS (U.S. CLS. 22 AND 39).

FIRST USE 2-21-2005; IN COMMERCE 11-27-2006.

3,399,407. WEBMETHODS, INC., FAIRFAX, VA. SN 78-500,765. PUB. 3-27-2007, FILED 10-15-2004.

GET THERE FASTER.

THE MARK CONSISTS OF STANDARD CHARACTERS WITHOUT CLAIM TO ANY PARTICULAR FONT, STYLE, SIZE, OR COLOR.

CLASS 9—ELECTRICAL AND SCIENTIFIC APPARATUS

FOR COMPUTER SOFTWARE FOR ALLOWING APPLICATION INTEGRATION BETWEEN DIFFERENT BUSINESSES USING THE GLOBAL COMPUTER NETWORK PROTOCOLS (U.S. CLS. 21, 23, 26, 36 AND 38).

FIRST USE 4-1-2002; IN COMMERCE 4-1-2002.

CLASS 41—EDUCATION AND ENTERTAINMENT

FOR COMPUTER EDUCATION TRAINING SERVICES, NAMELY, TRAINING IN THE USE OF COMPUTER SOFTWARE FOR ALLOWING APPLICATION INTEGRATION BETWEEN DIFFERENT BUSINESSES USING THE GLOBAL COMPUTER NETWORK PROTOCOLS (U.S. CLS. 100, 101 AND 107).

FIRST USE 4-1-2002; IN COMMERCE 4-1-2002.

CLASS 42—SCIENTIFIC AND COMPUTER SERVICES

FOR COMPUTER SOFTWARE DESIGN FOR OTHERS; INSTALLATION AND IMPLEMENTATION OF COMPUTER SOFTWARE FOR OTHERS; CONSULTING SERVICES IN THE FIELD OF COMPUTER SOFTWARE FOR ALLOWING APPLICATION INTEGRATION BETWEEN DIFFERENT BUSINESSES USING THE GLOBAL COMPUTER NETWORK PROTOCOLS (U.S. CLS. 100 AND 101).

FIRST USE 4-1-2002; IN COMMERCE 4-1-2002.

3,399,409. HERBALIFE INTERNATIONAL, INC., LOS ANGELES, CA. SN 78-502,406. PUB. 9-5-2006, FILED 10-19-2004.

HERBALIFE NUTRITION CLUB

THE MARK CONSISTS OF STANDARD CHARACTERS WITHOUT CLAIM TO ANY PARTICULAR FONT, STYLE, SIZE, OR COLOR.

OWNER OF U.S. REG. NOS. 1,254,211, 2,512,368, AND OTHERS.

NO CLAIM IS MADE TO THE EXCLUSIVE RIGHT TO USE "NUTRITION CLUB", APART FROM THE MARK AS SHOWN.

CLASS 35—ADVERTISING AND BUSINESS

FOR PROVIDING INFORMATION IN THE FIELDS OF MULTI-LEVEL MARKETING AND DEVELOPMENT OF SMALL BUSINESSES (U.S. CLS. 100, 101 AND 102).

FIRST USE 12-0-2004; IN COMMERCE 12-0-2004.

CLASS 44—MEDICAL, BEAUTY AND AGRICULTURAL SERVICES

FOR PROVIDING INFORMATION IN THE FIELDS OF HEALTH AND NUTRITION (U.S. CLS. 100 AND 101).

FIRST USE 12-0-2004; IN COMMERCE 12-0-2004.

3,399,416. HEALTHY DIRECTIONS, LLC, POTOMAC, MD.
SN 78-507,440. PUB. 7-3-2007, FILED 10-28-2004.

SIMPLE LIVING

THE MARK CONSISTS OF STANDARD CHARACTERS WITHOUT CLAIM TO ANY PARTICULAR FONT, STYLE, SIZE, OR COLOR.

CLASS 16—PAPER GOODS AND PRINTED MATTER

FOR CATALOGS PROVIDING PRODUCTS AND SERVICES IN THE FIELDS OF TIME MANAGEMENT, PERSONAL FINANCES, ORGANIZING, STORAGE SYSTEMS, TRAVEL, ENTERTAINING, PERSONAL GROWTH, CAREER, RELATIONSHIPS, CLEANING, NUTRITION, FOOD, COOKING, HOME DECOR, GARDENING, HEALTH, CLOTHING, PERSONAL CARE AND GROOMING, COSMETICS, FITNESS AND MATTERS OF GENERAL INTEREST RELATED TO LIVING A SIMPLER, MORE FULFILLING LIFESTYLE; NEWSLETTERS FEATURING INFORMATION AND ADVICE AND COMMENTARY IN THE FIELD OF TIME MANAGEMENT, PERSONAL FINANCES, ORGANIZING, STORAGE SYSTEMS, TRAVEL, ENTERTAINING, PERSONAL GROWTH, CAREER, RELATIONSHIPS, CLEANING, NUTRITION, FOOD, COOKING, HOME DECOR, GARDENING, HEALTH, CLOTHING, PERSONAL CARE AND GROOMING, COSMETICS, FITNESS AND MATTERS OF GENERAL INTEREST RELATED TO LIVING A SIMPLER, MORE FULFILLING LIFESTYLE (U.S. CLS. 2, 5, 22, 23, 29, 37, 38 AND 50).

FIRST USE 1-15-1993; IN COMMERCE 1-15-1993.

CLASS 35—ADVERTISING AND BUSINESS

FOR ONLINE CATALOG SERVICES PROVIDING PRODUCTS AND SERVICES IN THE FIELD OF TIME MANAGEMENT, PERSONAL FINANCES, ORGANIZING, STORAGE SYSTEMS, TRAVEL, ENTERTAINING, PERSONAL GROWTH, CAREER, RELATIONSHIPS, CLEANING, NUTRITION, FOOD, COOKING, HOME DECOR, GARDENING, HEALTH, CLOTHING, PERSONAL CARE AND GROOMING, COSMETICS, FITNESS AND MATTERS OF GENERAL INTEREST RELATED TO LIVING A SIMPLER, MORE FULFILLING LIFESTYLE (U.S. CLS. 100, 101 AND 102).

FIRST USE 1-0-1993; IN COMMERCE 12-0-2004.

CLASS 36—INSURANCE AND FINANCIAL

FOR ONLINE SERVICES, NAMELY, PROVIDING A WEBSITE FEATURING INFORMATION, ADVICE AND COMMENTARY IN THE FIELD OF PERSONAL FINANCES (U.S. CLS. 100, 101 AND 102).

FIRST USE 1-0-1993; IN COMMERCE 12-0-2004.

CLASS 39—TRANSPORTATION AND STORAGE

FOR ONLINE SERVICES, NAMELY, PROVIDING A WEBSITE FEATURING INFORMATION, ADVICE, AND COMMENTARY IN THE FIELD OF TRAVEL (U.S. CLS. 100 AND 105).

FIRST USE 1-0-1993; IN COMMERCE 12-0-2004.

CLASS 41—EDUCATION AND ENTERTAINMENT

FOR ONLINE SERVICES, NAMELY, PROVIDING A WEBSITE FEATURING INFORMATION, ADVICE, AND COMMENTARY IN THE FIELD OF CAREER COUNSELING, FITNESS, AND ENTERTAINING (U.S. CLS. 100, 101 AND 107).

FIRST USE 9-4-1996; IN COMMERCE 9-4-1996.

CLASS 42—SCIENTIFIC AND COMPUTER SERVICES

FOR ONLINE SERVICES, NAMELY, PROVIDING A WEBSITE FEATURING INFORMATION, ADVICE, AND COMMENTARY IN THE FIELD OF HOME DECOR (U.S. CLS. 100 AND 101).

FIRST USE 1-0-1993; IN COMMERCE 12-0-2004.

CLASS 43—HOTEL AND RESTAURANT SERVICES

FOR ONLINE SERVICES, NAMELY, PROVIDING A WEBSITE FEATURING INFORMATION, ADVICE, AND COMMENTARY IN THE FIELDS OF FOOD, COOKING, AND FOOD PREPARATION (U.S. CLS. 100 AND 101).

FIRST USE 1-0-1993; IN COMMERCE 12-0-2004.

CLASS 44—MEDICAL, BEAUTY AND AGRICULTURAL SERVICES

FOR ONLINE SERVICES, NAMELY, PROVIDING A WEBSITE FEATURING INFORMATION, ADVICE, AND COMMENTARY IN THE FIELDS OF NUTRITION AND GARDENING; PROVIDING A WEBSITE FEATURING INFORMATION, ADVICE, AND COMMENTARY IN THE FIELDS OF PERSONAL HEALTH AND PERSONAL CARE AND GROOMING (U.S. CLS. 100 AND 101).

FIRST USE 1-0-1993; IN COMMERCE 12-0-2004.

CLASS 45—PERSONAL AND LEGAL SERVICES

FOR ONLINE SERVICES, NAMELY, PROVIDING A WEBSITE FEATURING INFORMATION, ADVICE AND COMMENTARY IN THE FIELDS OF TIME MANAGEMENT, HOME ORGANIZING AND STORAGE SYSTEMS, PERSONAL GROWTH, PERSONAL RELATIONSHIPS, AND MATTERS OF GENERAL INTEREST RELATED TO LIVING A SIMPLER, MORE FULFILLING LIFESTYLE; ONLINE SERVICES NAMELY, PROVIDING A WEBSITE FEATURING FASHION INFORMATION, ADVICE, AND COMMENTARY IN THE FIELDS OF CLOTHING AND COSMETICS (U.S. CLS. 100 AND 101).

FIRST USE 1-0-1993; IN COMMERCE 12-0-2004.

3,399,419. MUREX S.A.S., PARIS, FRANCE. SN 78-509,325. PUB. 12-20-2005, FILED 11-1-2004.

MX.3

THE MARK CONSISTS OF STANDARD CHARACTERS WITHOUT CLAIM TO ANY PARTICULAR FONT, STYLE, SIZE, OR COLOR.

CLASS 9—ELECTRICAL AND SCIENTIFIC APPARATUS

FOR COMPUTER SOFTWARE USED FOR VALUATION, MANAGEMENT, AND PROCESSING OF FINANCIAL TRANSACTIONS IN THE FIELDS OF CAPITAL MARKETS, BUSINESS AND FINANCE (U.S. CLS. 21, 23, 26, 36 AND 38).

FIRST USE 10-0-2004; IN COMMERCE 10-0-2004.

CLASS 42—SCIENTIFIC AND COMPUTER SERVICES

FOR COMPUTER PROGRAMMING FOR OTHERS, COMPUTER SOFTWARE DESIGN AND UPDATING COMPUTER SOFTWARE FOR OTHERS, CONSULTATION SERVICES RELATING TO COMPUTER PROGRAMS (U.S. CLS. 100 AND 101).

FIRST USE 10-0-2004; IN COMMERCE 10-0-2004.

3,399,426. CAVANAGH GROUP INTERNATIONAL, INC., DULUTH, GA. SN 78-513,555. PUB. 9-26-2006, FILED 11-9-2004.

CHRISTMAS EVE

THE MARK CONSISTS OF STANDARD CHARACTERS WITHOUT CLAIM TO ANY PARTICULAR FONT, STYLE, SIZE, OR COLOR.

CLASS 11—ENVIRONMENTAL CONTROL APPARATUS

FOR ELECTRIC LIGHTS FOR CHRISTMAS AND HOLIDAY TREES (U.S. CLS. 13, 21, 23, 31 AND 34).

FIRST USE 11-0-2006; IN COMMERCE 7-0-2007.

CLASS 15—MUSICAL INSTRUMENTS

FOR MUSICAL CHRISTMAS AND HOLIDAY ORNAMENTS (U.S. CLS. 2, 21 AND 36).

FIRST USE 11-0-2006; IN COMMERCE 7-0-2007.

CLASS 28—TOYS AND SPORTING GOODS

FOR CHRISTMAS AND HOLIDAY TRIM-A-TREE MERCHANDISE, NAMELY, CHRISTMAS TREE ORNAMENTS, ARTIFICIAL TREES AND ARTIFICIAL GARLAND, CHRISTMAS STOCKINGS, CHRISTMAS TREE SKIRTS, CHRISTMAS TREE DECORATIONS, CHRISTMAS SNOW GLOBES, CHRISTMAS MOBILES (U.S. CLS. 22, 23, 38 AND 50).

FIRST USE 11-0-2006; IN COMMERCE 7-0-2007.

3,399,429. ACCOR, EVRY, FRANCE. SN 78-516,427. PUB. 3-21-2006, FILED 11-12-2004.

WORK-LIFE EXPRESS

THE MARK CONSISTS OF STANDARD CHARACTERS WITHOUT CLAIM TO ANY PARTICULAR FONT, STYLE, SIZE, OR COLOR.

CLASS 9—ELECTRICAL AND SCIENTIFIC APPARATUS

FOR DOWNLOADABLE ELECTRONIC PUBLICATIONS IN THE NATURE OF NEWSLETTERS, ARTICLES AND INFORMATION SHEETS IN THE FIELD OF HEALTH, EDUCATION, FINANCE, FAMILY ISSUES, DEPENDENT CARE AND LEGAL ISSUES (U.S. CLS. 21, 23, 26, 36 AND 38).

FIRST USE 5-11-1998; IN COMMERCE 5-11-1998.

CLASS 35—ADVERTISING AND BUSINESS

FOR PROVIDING REFERRALS IN THE FIELD OF DEPENDENT CARE, PHYSICAL AND MENTAL HEALTH, MEDICAL CARE, FINANCE, LEGAL MATTERS, TAXES, FAMILY, RETIREMENT, ESTATE PLANNING, REAL ESTATE, HOME MAINTENANCE, CLEANING AND SAFETY, CAREER SERVICES, RELOCATION, TRANSPORTATION, AUTO REPAIR, TRAVEL, EDUCATION, NUTRITION, FITNESS, SHOPPING, ENTERTAINMENT, DINING, RECREATION AND LODGING; PROVIDING INFORMATION AND CONSULTING IN THE FIELD OF RELOCATION AND TAX MATTERS (U.S. CLS. 100, 101 AND 102).

FIRST USE 5-11-1998; IN COMMERCE 5-11-1998.

CLASS 36—INSURANCE AND FINANCIAL

FOR PROVIDING INFORMATION AND CONSULTING IN THE FIELD OF FINANCE, REAL ESTATE AND INSURANCE VIA A CUSTOMIZABLE INTERACTIVE WEBSITE (U.S. CLS. 100, 101 AND 102).

FIRST USE 10-15-1998; IN COMMERCE 10-15-1998.

CLASS 42—SCIENTIFIC AND COMPUTER SERVICES

FOR PROVIDING INFORMATION AND CONSULTING SERVICES IN THE FIELD OF LEGAL MATTERS VIA A CUSTOMIZABLE INTERACTIVE WEBSITE (U.S. CLS. 100 AND 101).

FIRST USE 5-11-1998; IN COMMERCE 5-11-1998.

3,399,438. INTERNATIONAL BUSINESS MACHINES CORPORATION, ARMONK, NY. SN 78-521,460. PUB. 3-14-2006, FILED 11-22-2004.

3,399,448. KABUSHIKI KAISHA G-MODE, DBA G-MODE CO., LTD., TOKYO, JAPAN. SN 78-530,670. PUB. 3-21-2006, FILED 12-10-2004.

GLOBAL INNOVATION OUTLOOK

THE MARK CONSISTS OF STANDARD CHARACTERS WITHOUT CLAIM TO ANY PARTICULAR FONT, STYLE, SIZE, OR COLOR.

NO CLAIM IS MADE TO THE EXCLUSIVE RIGHT TO USE "GLOBAL", APART FROM THE MARK AS SHOWN.

CLASS 16—PAPER GOODS AND PRINTED MATTER

FOR PRINTED MATTER, NAMELY, INFORMATIONAL SHEETS, BOOKS, BROCHURES, WRITTEN PRESENTATIONS AND TEACHING MATERIALS, ALL RELATING TO DESIGNING AND DEVELOPING A COMPUTER HARDWARE ARCHITECTURE AND COMPUTER SOFTWARE APPLICATIONS AND PROGRAMS; EDUCATIONAL BOOKS AND PUBLICATIONS, NAMELY, TRAINING MANUALS IN THE FIELD OF INFORMATION TECHNOLOGY AND COMPUTER PRODUCTS AND SERVICES (U.S. CLS. 2, 5, 22, 23, 29, 37, 38 AND 50).

FIRST USE 6-1-2004; IN COMMERCE 6-1-2004.

CLASS 35—ADVERTISING AND BUSINESS

FOR BUSINESS MANAGEMENT CONSULTING SERVICES AND BUSINESS CONSULTING SERVICES; ARRANGING AND CONDUCTING TRADE SHOW EXHIBITIONS IN THE FIELD OF INFORMATION TECHNOLOGY AND COMPUTER PRODUCTS AND SERVICES (U.S. CLS. 100, 101 AND 102).

FIRST USE 6-1-2004; IN COMMERCE 6-1-2004.

CLASS 41—EDUCATION AND ENTERTAINMENT

FOR EDUCATIONAL SERVICES, NAMELY, CONFERENCES, EXHIBITIONS, SYMPOSIUMS, PRESENTATIONS, TECHNICAL DEMONSTRATIONS AND TRAINING SEMINARS, ALL IN THE FIELD OF INFORMATION TECHNOLOGY AND COMPUTER PRODUCTS AND SERVICES (U.S. CLS. 100, 101 AND 107).

FIRST USE 6-1-2004; IN COMMERCE 6-1-2004.

CLASS 42—SCIENTIFIC AND COMPUTER SERVICES

FOR CONSULTING SERVICES CONCERNING DESIGN AND DEVELOPMENT OF COMPUTER SOFTWARE PROGRAMS AND ARCHITECTURE AND COMPUTER HARDWARE ARCHITECTURE; CONSULTING SERVICES IN THE FIELD OF DESIGNING, DEVELOPING AND USING COMPUTER HARDWARE AND COMPUTER SOFTWARE (U.S. CLS. 100 AND 101).

FIRST USE 6-1-2004; IN COMMERCE 6-1-2004.

MAGICAL DROP

THE MARK CONSISTS OF STANDARD CHARACTERS WITHOUT CLAIM TO ANY PARTICULAR FONT, STYLE, SIZE, OR COLOR.

CLASS 9—ELECTRICAL AND SCIENTIFIC APPARATUS

FOR COMPUTER VIDEO GAME PROGRAMS; DOWNLOADABLE COMPUTER VIDEO GAME PROGRAMS; PRERECORDED COMPUTER VIDEO GAME PROGRAMS ON CARTRIDGES, CASSETTES, MAGNETIC CARDS, AND COMPACT DISCS (U.S. CLS. 21, 23, 26, 36 AND 38).

FIRST USE 10-3-2005; IN COMMERCE 10-3-2005.

CLASS 41—EDUCATION AND ENTERTAINMENT

FOR ENTERTAINMENT SERVICES, NAMELY, PROVIDING AN ON-LINE COMPUTER GAME (U.S. CLS. 100, 101 AND 107).

FIRST USE 10-3-2005; IN COMMERCE 10-3-2005.

3,399,453. TIMEWATCH PLC, LONDON, UNITED KINGDOM. SN 78-533,762. PUB. 3-7-2006, FILED 12-16-2004.

TIMEWATCH

THE MARK CONSISTS OF STANDARD CHARACTERS WITHOUT CLAIM TO ANY PARTICULAR FONT, STYLE, SIZE, OR COLOR.

CLASS 9—ELECTRICAL AND SCIENTIFIC APPARATUS

FOR BUSINESS AND PROJECT MANAGEMENT SOFTWARE FOR TIME, BILLING AND EXPENSE RECORDKEEPING (U.S. CLS. 21, 23, 26, 36 AND 38).

FIRST USE 12-31-1998; IN COMMERCE 12-31-1998.

CLASS 35—ADVERTISING AND BUSINESS

FOR CONSULTING SERVICES IN THE FIELD OF RESOURCE AND PROJECT SCHEDULING AND TIME RECORDING (U.S. CLS. 100, 101 AND 102).

FIRST USE 12-31-1998; IN COMMERCE 12-31-1998.

CLASS 41—EDUCATION AND ENTERTAINMENT

FOR TRAINING SERVICES IN THE FIELD OF BUSINESS AND PROJECT MANAGEMENT SOFTWARE; TRAINING SERVICES IN THE FIELD OF RESOURCE AND PROJECT SCHEDULING AND TIME RECORDING (U.S. CLS. 100, 101 AND 107).

FIRST USE 12-31-1998; IN COMMERCE 12-31-1998.

CLASS 42—SCIENTIFIC AND COMPUTER SERVICES

FOR DESIGN AND DEVELOPMENT OF SOFTWARE FOR BUSINESS AND PROJECT MANAGEMENT FOR OTHERS; CONSULTING AND INSTALLATION SERVICES IN THE FIELD OF BUSINESS AND PROJECT MANAGEMENT SOFTWARE (U.S. CLS. 100 AND 101).

FIRST USE 12-31-1998; IN COMMERCE 12-31-1998.

3,399,455. DYWIDAG-SYSTEMS INTERNATIONAL GMBH, D-85609 ASCHHEIM, FED REP GERMANY. SN 78-539,384. PUB. 2-13-2007, FILED 12-29-2004.

DYWI

THE MARK CONSISTS OF STANDARD CHARACTERS WITHOUT CLAIM TO ANY PARTICULAR FONT, STYLE, SIZE, OR COLOR.

CLASS 2—PAINTS

FOR SET TABLE AND/OR ANTICORROSIVE COATING MATERIALS FOR INJECTION INTO CONSTRUCTION ELEMENTS; ANTICORROSIVE COATING MATERIALS, NAMELY WAX AND GREASE FOR INJECTION INTO CONSTRUCTION ELEMENTS; COATINGS OF HARDENING LIQUID SYNTHETIC MATERIALS FOR USE IN CIVIL ENGINEERING, FOR IMPREGNATING, COATING, CONGLUTINATION, INJECTION AND ANCHORING OF CONSTRUCTION ELEMENTS (U.S. CLS. 6, 11 AND 16).

FIRST USE 4-0-2004; IN COMMERCE 6-22-2007.

CLASS 6—METAL GOODS

FOR METAL BUILDING MATERIALS, NAMELY SOFFITS AND FASCIA; PORTABLE BUILDINGS OF METAL; GOODS OF METAL, NOT INCLUDED IN OTHER CLASSES, NAMELY REINFORCING ELEMENTS OF STEEL FOR REINFORCED CONCRETE, STEEL TENDONS FOR PRE-STRESSED CONCRETE IN THE FORM OF RODS, WIRES OR STRANDS; STEEL TENSION ELEMENTS FOR GROUND AND ROCK ANCHORS; ANCHORING ELEMENTS THEREFOR, NAMELY ANCHORING BOLTS, SCREWS, SLEEVES, SHIMS; METAL DUCTS AND SHEATHING (U.S. CLS. 2, 12, 13, 14, 23, 25 AND 50).

FIRST USE 4-0-2004; IN COMMERCE 6-22-2007.

CLASS 7—MACHINERY

FOR MACHINES AND POWERED MACHINE TOOLS FOR STRUCTURAL AND CIVIL ENGINEERING, NAMELY MECHANICAL AND HYDRAULIC PRESSES; MACHINES FOR STRAIGHTENING AND BENDING STEEL RODS; MACHINES FOR CUTTING OR ROLLING OF THREADS ON REINFORCING ELEMENTS; MACHINES FOR PROCESSING, INSTALLING, CUTTING, BENDING, BINDING AND ANCHORING OF ROD-SHAPED SUPPORTING ELEMENTS MACHINES FOR INSERTION OF RODS AND STRANDS; MACHINES FOR SCREWING AND AFFIXING METAL RODS; MACHINES FOR TENSIONING OF PRE-STRESSING ELEMENTS; HYDRAULIC JACKS; MACHINES FOR TREATING AND INJECTING SET TABLE AND/OR ANTI-CORROSIVE MATERIALS; EXCAVATING MACHINES FOR UNDERGROUND PIPE LAYING OPERATIONS INVOLVING GROUND DISPLACEMENT OR REMOVAL; CONTROLLABLE HORIZONTAL DRILLING EQUIPMENT AND HORIZONTAL SHIELD DRIVING EQUIPMENT FOR WALK-IN AND NON-WALK-IN PIPELINES; MOVABLE METAL SCAFFOLDING FOR BRIDGE CONSTRUCTION IN CANTILEVER CONSTRUCTION AND INCREMENTAL LAUNCHING; MACHINES FOR THE MANUFACTURING OF PRECAST CONCRETE PARTS (U.S. CLS. 13, 19, 21, 23, 31, 34 AND 35).

FIRST USE 4-0-2004; IN COMMERCE 6-22-2007.

CLASS 8—HAND TOOLS

FOR HAND-OPERATED TOOLS FOR USE IN STRUCTURAL AND CIVIL ENGINEERING; NAMELY FOR PROCESSING, INSTALLING, ANCHORING AND BINDING ROD-SHAPED SUPPORTING ELEMENTS, NAMELY CUTTING AND BENDING TOOLS; APPARATUS FOR INSERTION OF RODS, SCREWING APPLIANCES; HAND-OPERATED TOOLS FOR TENSIONING OF PRE-STRESSING ELEMENTS; HAND-OPERATED TOOLS FOR TREATING AND INJECTING SET TABLE AND/OR ANTI-CORROSIVE MATERIALS (U.S. CLS. 23, 28 AND 44).

FIRST USE 4-0-2004; IN COMMERCE 6-22-2007.

CLASS 9—ELECTRICAL AND SCIENTIFIC APPARATUS

FOR OPTICAL, ELECTRIC AND ELECTRONIC APPARATUS FOR USE IN STRUCTURAL AND CIVIL ENGINEERING, NAMELY, FOR MEASURING AND REGISTERING DISTANCES, ANGLES, HEIGHTS AND POSITIONS, NAMELY LASERS, INSTRUMENTS FOR MEASURING LENGTH, AND LEVEL MEASURING MACHINES; SENSOR DEVICES FOR MEASURING AND/OR MONITORING THE REGISTERED TENSION FORCE BY OPTICAL, ELECTRIC OR ELECTRONIC MEANS (U.S. CLS. 21, 23, 26, 36 AND 38).

FIRST USE 4-0-2004; IN COMMERCE 6-22-2007.

CLASS 19—NON-METALLIC BUILDING MATERIALS

FOR NON-METAL BUILDING MATERIALS, NAMELY SOFFITS AND FASCIA; SLIDING MOLDING AND CLIMBING FORMS AND ARMAMENTS OF PRIMARILY WOOD; REINFORCING ELEMENTS OF FIBER COMPOSITES FOR CONCRETE; TENSION ELEMENTS OF FIBER COMPOSITES FOR EARTH AND ROCK ANCHORS; ANCHORING ELEMENTS THEREFOR, NAMELY ANCHORING BOLTS, SCREWS, SLEEVES, SHIMS OF PLASTIC; PLASTIC DUCTS AND SHEATHING; SET TABLE AND/OR ANTICORROSIVE MATERIALS FOR INJECTION INTO CONSTRUCTION ELEMENTS; HARDENING LIQUID SYNTHETIC MATERIALS FOR USE IN CIVIL ENGINEERING, FOR INJECTION AND ANCHORING OF CONSTRUCTION ELEMENTS (U.S. CLS. 1, 12, 33 AND 50).

FIRST USE 4-0-2004; IN COMMERCE 6-22-2007.

CLASS 35—ADVERTISING AND BUSINESS

FOR ARRANGING OF CONTRACTUAL CONSTRUCTION TRADE SERVICES WITH THIRD PARTIES; BUSINESS MANAGEMENT AND CONSULTING SERVICES FOR STRUCTURAL AND CIVIL ENGINEERING FIRMS; AND DATA PROCESSING IN THE FIELD OF CONSTRUCTION PROJECT MANAGEMENT (U.S. CLS. 100, 101 AND 102).

FIRST USE 4-0-2004; IN COMMERCE 6-22-2007.

3,399,456. THERAPYZONE, INC., DENVER, CO. SN 78-543,494. PUB. 4-3-2007, FILED 1-6-2005.

CLASS 36—INSURANCE AND FINANCIAL

FOR FINANCIAL CONSULTING SERVICES RELATING TO CONSTRUCTION PROJECTS (U.S. CLS. 100, 101 AND 102).

FIRST USE 4-0-2004; IN COMMERCE 6-22-2007.

MARV

CLASS 37—CONSTRUCTION AND REPAIR

FOR CONSTRUCTION SERVICES, NAMELY INSTALLING SUPPORTING ELEMENTS IN CONSTRUCTION WORKS, LAYING REINFORCING RODS AND PRESTRESSING ELEMENTS, TENSIONING PRESTRESSING ELEMENTS, ERECTING SCAFFOLDING AND SLIDING MOLDINGS AND CLIMBING FORMS, ERECTING BUILDINGS OF REINFORCED CONCRETE USING SLIDING MOLDINGS AND CLIMBING FORMS, INSTALLING SUBTERRANEAN CURTAINS AND POSTS, FIXING GROUND ANCHORS AND ROCK ANCHORS; MOUNTING TENSION AND COMPRESSION PILES, GROUND AND ROCK ANCHORS AS WELL AS ROCK AND GROUND SPIKES MADE OF METAL OR FIBER COMPOSITES; INSTALLATION AND ASSEMBLY OF BARS, NAMELY ON SUSPENSION BRIDGES AND CABLE-STAYED BRIDGES; REPAIR AND MAINTENANCE WORK ON BUILDINGS, DEMOLITION OF BUILDINGS, EXCAVATION SERVICES, BRIDGE CONSTRUCTION; CONSTRUCTING PERMANENT TRACKS FOR RAILWAYS, CONSTRUCTING EARTHWORKS; CONSTRUCTION OF INDUSTRIAL PLANTS; PAINTING OF CONSTRUCTION ELEMENTS WITH ANTI-CORROSIVE MATERIALS; EARTH EXCAVATION THROUGH BLASTING; ROAD AND PATH BUILDING AND BUILDING ROADS FOR VEHICLES, NAMELY RAIL-BORNE VEHICLES; TUNNEL AND MINING GALLERY CONSTRUCTION, CONSTRUCTION OF PIPELINES BY SUBTERRANEAN PIPE DRIVE, CONSTRUCTION OF PIPELINES AND SUPPORT STRUCTURES IN WATER; RENTAL OF BUILDING CONSTRUCTION MACHINES, TOOLS, AND CONSTRUCTION VEHICLES (U.S. CLS. 100, 103 AND 106).

FIRST USE 4-0-2004; IN COMMERCE 6-22-2007.

THE MARK CONSISTS OF STANDARD CHARACTERS WITHOUT CLAIM TO ANY PARTICULAR FONT, STYLE, SIZE, OR COLOR.

THE NAME SHOWN IN THE MARK DOES NOT IDENTIFY A PARTICULAR LIVING INDIVIDUAL.

CLASS 10—MEDICAL APPARATUS

FOR FITNESS EQUIPMENT AND EXERCISERS, NAMELY, HAND GRIPS; RESISTANCE BANDS, TUBES AND CABLES; ROPES; RUBBER BANDS AND TUBES FOR RESISTANCE EXERCISES; MANUAL CHEST, SHOULDER, ARM, WRIST AND ELBOW EXERCISERS; OVERDOOR PULLEY EXERCISERS; JOINT EXERCISER USED TO IMPROVE RANGE OF MOTION; LEG AND BACK EXTENSION EXERCISERS; MANUAL ROTATOR CUFF, BICEP AND TRICEPS EXERCISERS; ALL USED FOR PHYSICAL THERAPY AND REHABILITATION (U.S. CLS. 26, 39 AND 44).

FIRST USE 6-9-2005; IN COMMERCE 6-9-2005.

CLASS 28—TOYS AND SPORTING GOODS

FOR FITNESS EQUIPMENT AND EXERCISERS, NAMELY, HAND GRIPS; RESISTANCE BANDS, TUBES AND CABLES; ROPES; RUBBER BANDS AND TUBES FOR RESISTANCE EXERCISES; MANUAL CHEST, SHOULDER, ARM, WRIST AND ELBOW EXERCISERS; OVERDOOR PULLEY EXERCISERS; JOINT EXERCISER USED TO IMPROVE RANGE OF MOTION; LEG AND BACK EXTENSION EXERCISERS; MANUAL ROTATOR CUFF, BICEP AND TRICEPS EXERCISERS; ALL USED FOR ATHLETIC TRAINING, ATHLETIC CONDITIONING, FLEXIBILITY TRAINING, RANGE OF MOTION TRAINING AND STRENGTH TRAINING (U.S. CLS. 22, 23, 38 AND 50).

FIRST USE 6-9-2005; IN COMMERCE 6-9-2005.

CLASS 42—SCIENTIFIC AND COMPUTER SERVICES

FOR ARCHITECTURAL AND CONSTRUCTION DRAFTING, TECHNICAL CONSULTANCY IN THE FIELD OF ARCHITECTURE AND ENGINEERING, ARCHITECTURAL DESIGN AND ENGINEERING SERVICES, COMPUTER PROGRAMMING FOR OTHERS; SCIENTIFIC AND TECHNOLOGICAL RESEARCH IN THE FIELD OF STRUCTURAL ENGINEERING AND CONSTRUCTION; LABORATORY TESTING SERVICES FOR CONSTRUCTION AND ENGINEERING PRODUCTS AND MATERIALS (U.S. CLS. 100 AND 101).

FIRST USE 4-0-2004; IN COMMERCE 6-22-2007.

3,399,470. SCHAUB, ELISA R., SUNRISE BEACH, MO. SN 78-561,926. PUB. 5-23-2006, FILED 2-7-2005.

Lake People

THE MARK CONSISTS OF STANDARD CHARACTERS WITHOUT CLAIM TO ANY PARTICULAR FONT, STYLE, SIZE, OR COLOR.

CLASS 18—LEATHER GOODS

FOR BEACH BAGS (U.S. CLS. 1, 2, 3, 22 AND 41). FIRST USE 6-8-2001; IN COMMERCE 7-1-2005.

CLASS 25—CLOTHING

FOR CLOTHING, NAMELY, SHIRTS, PANTS, SHORTS, HATS, CAPS, VISORS, SANDALS, SWIM WEAR, NIGHTSHIRTS, AND BEACHWEAR (U.S. CLS. 22 AND 39). FIRST USE 6-8-2001; IN COMMERCE 7-1-2005.

3,399,473. ALTANA PHARMA AG, KONSTANZ, FED REP GERMANY. SN 78-564,498. PUB. 9-5-2006, FILED 2-10-2005.

TRUE MEASURES
OF GERD

PRIORITY CLAIMED UNDER SEC. 44(D) ON FED REP GERMANY APPLICATION NO. 30447126.7/4, FILED 8-14-2004, REG. NO. 30447126, DATED 9-17-2004, EXPIRES 8-31-2014.

OWNER OF U.S. REG. NOS. 2,925,388, 2,935,027, AND 2,938,096.

NO CLAIM IS MADE TO THE EXCLUSIVE RIGHT TO USE "GERD", APART FROM THE MARK AS SHOWN.

THE MARK CONSISTS OF THE WORDS "TRUE MEASURES" ABOVE A RULERED LINE, ABOVE THE WORDS "OF GERD".

CLASS 5—PHARMACEUTICALS

FOR (BASED ON 44(E)) PHARMACEUTICAL PREPARATIONS FOR THE TREATMENT OF GASTRO-INTESTINAL DISEASES AND CONDITIONS (U.S. CLS. 6, 18, 44, 46, 51 AND 52).

CLASS 9—ELECTRICAL AND SCIENTIFIC APPARATUS

FOR ELECTRONIC INSTRUCTIONAL MATERIALS IN THE FORM OF PRE-RECORDED DVDS FOR THE FIELDS OF MEDICINE AND SCIENCE (U.S. CLS. 21, 23, 26, 36 AND 38). FIRST USE 5-25-2006; IN COMMERCE 5-25-2006.

CLASS 16—PAPER GOODS AND PRINTED MATTER

FOR (BASED ON 44(E)) PRINTED MATTER, NAMELY, BOOKS, JOURNALS, PERIODICALS, PAMPHLETS AND PHOTOGRAPHS, INSTRUCTIONAL AND TEACHING MATERIAL, EXCEPT APPARATUS, NAMELY, PRINTED INSTRUCTIONAL MATERIALS IN THE FORM OF BOOKS, GUIDES, BOOKLETS, BROCHURES AND CHARTS FOR THE FIELDS OF MEDICINE AND SCIENCE (U.S. CLS. 2, 5, 22, 23, 29, 37, 38 AND 50).

CLASS 35—ADVERTISING AND BUSINESS

FOR (BASED ON 44(E)) ARRANGING AND CONDUCTING TRADE SHOW EXHIBITIONS IN THE FIELD OF MEDICAL EDUCATION (U.S. CLS. 100, 101 AND 102).

CLASS 41—EDUCATION AND ENTERTAINMENT

FOR (BASED ON 44(E)) EDUCATIONAL SERVICES, NAMELY, CONDUCTING CLASSES, SEMINARS, CONFERENCES, SYMPOSIA AND WORKSHOPS FOR CONSUMERS AND HEALTHCARE PROFESSIONALS IN THE FIELD OF HEALTHCARE, MEDICAL RESEARCH AND MEDICAL SCIENCE (U.S. CLS. 100, 101 AND 107).

CLASS 44—MEDICAL, BEAUTY AND AGRICULTURAL SERVICES

FOR (BASED ON 44(E)) MEDICAL AND PHARMACEUTICAL SERVICES, NAMELY, COUNSELLING FOR CONSUMERS AND HEALTHCARE PROFESSIONALS IN THE FIELDS OF HEALTHCARE, MEDICAL RESEARCH AND MEDICAL SCIENCE TO PHYSICIANS AND OTHER MEDICAL SPECIALISTS (U.S. CLS. 100 AND 101).

3,399,476. LEISURE BOY, LLC, OCONOMOWOC, WI. SN 78-567,993. PUB. 1-3-2006, FILED 2-15-2005.

GET LEISURIZED

THE MARK CONSISTS OF STANDARD CHARACTERS WITHOUT CLAIM TO ANY PARTICULAR FONT, STYLE, SIZE, OR COLOR.

CLASS 25—CLOTHING

FOR CLOTHING, NAMELY, T-SHIRTS, SHIRT, SHORTS AND HATS (U.S. CLS. 22 AND 39). FIRST USE 11-12-2004; IN COMMERCE 1-17-2005.

CLASS 41—EDUCATION AND ENTERTAINMENT

FOR ENTERTAINMENT SERVICES IN THE NATURE OF A CONTINUING REALITY BASED TELEVISION PROGRAM (U.S. CLS. 100, 101 AND 107).

FIRST USE 11-12-2004; IN COMMERCE 1-30-2007.

3,399,479. IDEA AMERICA LLC, HELENA, MT. SN 78-569,390. PUB. 12-16-2005, FILED 2-17-2005.



THE COLORS RED (PANTONE 032) AND BLACK ARE CLAIMED AS FEATURES OF THE MARK.

THE MARK CONSISTS OF THE WORDS "LUSCIOUS LURES" IN RED DEPICTED AS STYLIZED SCRIPT CHARACTERS HAVING THE COMMON LETTER "L" USED IN EACH WORD, WITH THE FIRST AND LAST LETTERS HAVING STYLIZED FISH HOOK BARB ENDS AND LOOP, AND A WOMANS FACE AND SHOULDERS IN BLACK AND HAIR AND LIPS IN THE COLOR RED.

CLASS 25—CLOTHING

FOR CLOTHING CONSISTING OF OUTERWEAR T-SHIRTS, SWEAT SHIRTS, HATS, CAPS, JACKETS, SHORTS, SWEAT PANTS, POLO SHIRTS AND DRESS SHIRTS (U.S. CLS. 22 AND 39).

FIRST USE 7-16-2006; IN COMMERCE 7-16-2006.

CLASS 28—TOYS AND SPORTING GOODS

FOR SPORTING GOODS SPECIFICALLY FISHING LURES AND CHRISTMAS TREE ORNAMENTS (U.S. CLS. 22, 23, 38 AND 50).

FIRST USE 7-16-2006; IN COMMERCE 7-16-2006.

3,399,481. MICHAEL DAVID WARD PRODUCTIONS, INC., SANTA ROSA, CA. SN 78-574,499. PUB. 12-6-2005, FILED 2-24-2005.

THE MARK CONSISTS OF STANDARD CHARACTERS WITHOUT CLAIM TO ANY PARTICULAR FONT, STYLE, SIZE, OR COLOR.

CLASS 16—PAPER GOODS AND PRINTED MATTER

FOR NOTE CARDS, GREETING CARDS, STATIONERY, BOOKS AND MAGAZINES FEATURING HUMOR AND CHILDREN'S STORIES, GRAPHIC AND PRINTED ART REPRODUCTIONS, PAINTINGS, DRAWINGS, LITHOGRAPHS (U.S. CLS. 2, 5, 22, 23, 29, 37, 38 AND 50).

FIRST USE 9-15-2006; IN COMMERCE 9-15-2006.

CLASS 25—CLOTHING

FOR CLOTHING, NAMELY, T-SHIRTS (U.S. CLS. 22 AND 39).

FIRST USE 9-15-2006; IN COMMERCE 9-15-2006.

3,399,483. CALE ACCESS AB, 171 25 SOLNA, SWEDEN. SN 78-580,040. PUB. 12-12-2006, FILED 3-4-2005.

THE MARK CONSISTS OF STANDARD CHARACTERS WITHOUT CLAIM TO ANY PARTICULAR FONT, STYLE, SIZE, OR COLOR.

CLASS 9—ELECTRICAL AND SCIENTIFIC APPARATUS

FOR PARKING METERS; TICKET MACHINES; PAYING MACHINES IN THE NATURE OF AUTOMATED MACHINES FOR SELF SERVICE PAYMENT OF FEES; MAGNETIC AND OPTICAL DATA MEDIA AND RECORDED COMPUTER SOFTWARE ALL RELATING TO THE OPERATION OF RATE SYSTEMS FOR PARKING METERS AND OTHER ADMINISTRATIVE CONTROLS LINKED TO PARKING METERS REGARDING PAYMENTS AND RESERVATIONS; AUTOMATIC TIME SWITCHES; TIME REGISTERING APPARATUS, NAMELY, TIME REGISTERING DEVICES; MACHINES FOR VENDING APPLICATIONS, NAMELY, VENDING MACHINES; COMPUTER NETWORKING HARDWARE; SOFTWARE MODULES; COMPUTER PROGRAM MONITORS; ACCESS CONTROL AND ALARM MONITORING SYSTEMS (U.S. CLS. 21, 23, 26, 36 AND 38).

FIRST USE 0-0-1955; IN COMMERCE 0-0-1976.

CLASS 37—CONSTRUCTION AND REPAIR

FOR PROGRAMS AND SYSTEMS INSTALLATIONS IN THE FIELD OF VEHICLE PARKING; REPAIR SERVICE AND MAINTENANCE OF COMPUTER HARDWARE; INSTALLATION, MAINTENANCE, SERVICE AND REPAIRING ELECTRONIC EQUIPMENT RELATING TO THE OPERATING OF RATE SYSTEMS FOR PARKING METERS AND OTHER ADMINISTRATIVE CONTROLS LINKED TO PARKING METERS REGARDING PAYMENT AND RESERVATIONS; REPAIR, INSTALLATION AND SERVICE OF PARKING METERS (U.S. CLS. 100, 103 AND 106).

FIRST USE 0-0-1955; IN COMMERCE 0-0-1976.

3,399,485. INTERNATIONAL COURIER NETWORK, INC., NEW YORK, NY. SN 78-583,766. PUB. 6-20-2006, FILED 3-9-2005.

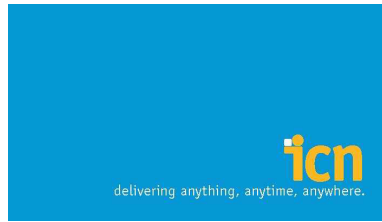

NO CLAIM IS MADE TO THE EXCLUSIVE RIGHT TO USE "DELIVERING ANYTHING, ANYTIME, ANYWHERE", APART FROM THE MARK AS SHOWN.

THE COLOR(S) WHITE, BLUE AND GOLD IS/ARE CLAIMED AS A FEATURE OF THE MARK.

THE MARK CONSISTS OF A BLUE RECTANGLE, THE WORDS "DELIVERING ANYTHING, ANYTIME, ANYWHERE." IN WHITE, AND THE LETTERS "ICN" IN GOLD WITH THE LETTER "I" IN THE FORM OF A MAN HOLDING A PACKAGE THAT IS COMPOSED OF A WHITE SQUARE.

CLASS 35—ADVERTISING AND BUSINESS

FOR POSTAL SERVICES, NAMELY, MAIL SORTING, HANDLING AND RECEIVING, ORDER FULFILLMENT SERVICES (U.S. CLS. 100, 101 AND 102).

FIRST USE 3-31-2005; IN COMMERCE 3-31-2005.

CLASS 39—TRANSPORTATION AND STORAGE

FOR TRANSPORTATION SERVICES, NAMELY, TRANSPORTATION OF DOCUMENTS, GOODS AND PARCELS BY LAND, SEA AND AIR; PACKAGING OF GOODS FOR TRANSPORTATION AND STORAGE; POSTAL SERVICES, NAMELY, PARCEL DELIVERY AND PACKAGING ARTICLES FOR TRANSPORTATION; STORAGE AND DELIVERY OF GOODS; COURIER SERVICES; SHIPPING, NAMELY, FREIGHT TRANSPORTATION BY SHIP, AIRCRAFT, RAIL CARRIER AND MOTOR VEHICLE, AND FREIGHT FORWARDING; FREIGHT BROKERAGE AND FORWARDING OF CARGO; WAREHOUSING SERVICES, NAMELY, STORAGE, DISTRIBUTION, PICK-UP AND PACKAGING FOR SHIPMENT OF DOCUMENTS, PACKAGES, RAW MATERIALS AND OTHER FREIGHT FOR OTHERS (U.S. CLS. 100 AND 105).

FIRST USE 3-31-2005; IN COMMERCE 3-31-2005.

3,399,492. STRATEGY COMPANION TAIWAN CORPORATION, TAIPEI, TAIWAN. SN 78-596,162. PUB. 1-16-2007, FILED 3-28-2005.



NO CLAIM IS MADE TO THE EXCLUSIVE RIGHT TO USE "2004 AND ANALYZER", APART FROM THE MARK AS SHOWN.

THE COLOR(S) ORANGE, WHITE, BLUE, YELLOW, GREEN AND BLACK IS/ARE CLAIMED AS A FEATURE OF THE MARK.

THE MARK CONSISTS OF THE WORDS "2004 STRAT-

EGY COMPANION" AND "ANALYZER" AND FIVE 3-DIMENSIONAL BLOCKS, ONE ORANGE IN COLOR, ONE WHITE IN COLOR, ONE BLUE IN COLOR, ONE YELLOW IN COLOR AND ONE GREEN IN COLOR; AND THE COLOR BLACK APPEARS IN ALL WORDING IN THE MARK.

CLASS 9—ELECTRICAL AND SCIENTIFIC APPARATUS

FOR BUSINESS INTELLIGENCE SOFTWARE (U.S. CLS. 21, 23, 26, 36 AND 38).

FIRST USE 12-1-2004; IN COMMERCE 12-1-2004.

CLASS 42—SCIENTIFIC AND COMPUTER SERVICES

FOR COMPUTER CONSULTATION SERVICES IN THE FIELD OF DESIGN, SELECTION, IMPLEMENTATION AND USE OF COMPUTER HARDWARE AND COMPUTER SYSTEMS RELATING TO BUSINESS INTELLIGENCE HARDWARE AND SOFTWARE (U.S. CLS. 100 AND 101).

FIRST USE 12-1-2004; IN COMMERCE 12-1-2004.

3,399,498. TSAI, LEE & CHEN PATENT ATTORNEYS COMPANY, TAIPEI 104, TAIWAN. SN 78-598,839. PUB. 2-13-2007, FILED 3-31-2005.

THE MARK CONSISTS OF STANDARD CHARACTERS WITHOUT CLAIM TO ANY PARTICULAR FONT, STYLE, SIZE, OR COLOR.

CLASS 35—ADVERTISING AND BUSINESS

FOR CONSULTING SERVICES IN THE FIELD OF BRAND MANAGEMENT AND PROVIDING BRAND STRATEGIES (U.S. CLS. 100, 101 AND 102).

FIRST USE 2-1-2005; IN COMMERCE 6-1-2005.

CLASS 42—SCIENTIFIC AND COMPUTER SERVICES

FOR DOMESTIC AND OVERSEAS PATENT AGENT SERVICES IN DEALING WITH AND APPLYING FOR INTELLECTUAL PROPERTY RIGHTS AND THE RELATED MATTERS, NAMELY, PATENT SEARCH AND ANALYSIS, DRAFTING PATENT SPECIFICATION, PATENT PROSECUTION, TRADEMARK SEARCH, TRADEMARK MONITORING AND DUE DILIGENCE SERVICES; PREVENTATIVE CONSULTATION SERVICES FOR NEGOTIATING LEASING, LICENSING, RECORDING AND TRANSFERRING OF INTELLECTUAL PROPERTY RIGHTS; LEGAL CONSULTATION AND LITIGATION SUPPORT SERVICES (U.S. CLS. 100 AND 101).

FIRST USE 2-1-2005; IN COMMERCE 6-1-2005.

3,399,500. HEART TO HEART INTERNATIONAL, INC.,
OLATHE, KS. SN 78-599,934. PUB. 6-13-2006, FILED 4-1-
2005.

3,399,506. BEATTIE, ROGER L., BOUNTIFUL, UT. SN 78-
604,532. PUB. 8-15-2006, FILED 4-8-2005.



Middle Class Millionaire

THE MARK CONSISTS OF STANDARD CHARACTERS
WITHOUT CLAIM TO ANY PARTICULAR FONT, STYLE,
SIZE, OR COLOR.

NO CLAIM IS MADE TO THE EXCLUSIVE RIGHT TO
USE "INTERNATIONAL", APART FROM THE MARK AS
SHOWN.

THE COLOR(S) BLACK AND RED IS/ARE CLAIMED AS
A FEATURE OF THE MARK.

THE COLOR(S) BLACK APPEARS IN THE WORDS
"HEART TO HEART" AND "...CONNECTING YOU TO A
WORLD IN NEED". THE COLOR RED APPEARS IN THE
WORD "INTERNATIONAL", AS WELL AS WITHIN A FIRST
PORTION OF THE SHADED CIRCLE THAT FORMS AN
ILLUSTRATIVE HEART PARTIALLY SURROUNDED BY
AN UNSHADED OUTLINING HEART AND A SECOND
PORTION FORMING THE REMAINDER OF THE SHADED
CIRCLE EXCEPT FOR AN UNSHADED PARTIAL CIRCLE
FORMED THEREIN.

CLASS 35—ADVERTISING AND BUSINESS

FOR CHARITABLE SERVICES, NAMELY, RECRUIT-
ING VOLUNTEERS ON A GLOBAL SCALE AND ORGA-
NIZING AND CONDUCTING VOLUNTEER PROGRAMS
AND COMMUNITY DEVELOPMENT SERVICE PRO-
JECTS (U.S. CLS. 100, 101 AND 102).

FIRST USE 3-5-2007; IN COMMERCE 3-5-2007.

CLASS 36—INSURANCE AND FINANCIAL

FOR CHARITABLE SERVICES, NAMELY, ACCEPT-
ING AND ADMINISTERING HUMANITARIAN AID IN
THE FORM OF MONETARY CHARITABLE CONTRI-
BUTIONS (U.S. CLS. 100, 101 AND 102).

FIRST USE 3-5-2007; IN COMMERCE 3-5-2007.

CLASS 41—EDUCATION AND ENTERTAIN- MENT

FOR CHARITABLE SERVICES, NAMELY, PROVID-
ING HUMANITARIAN AID IN THE FORM OF TOYS
AND SCHOOL SUPPLIES TO CHILDREN IN NEED (U.S.
CLS. 100, 101 AND 107).

FIRST USE 3-5-2007; IN COMMERCE 3-5-2007.

CLASS 44—MEDICAL, BEAUTY AND AGRI- CULTURAL SERVICES

FOR CHARITABLE SERVICES, NAMELY, PROVID-
ING HUMANITARIAN AID IN THE FORM OF MEDI-
CAL SERVICES TO UNDERDEVELOPED COUNTRIES
(U.S. CLS. 100 AND 101).

FIRST USE 3-5-2007; IN COMMERCE 3-5-2007.

CLASS 16—PAPER GOODS AND PRINTED MATTER

FOR PRINTED INSTRUCTIONAL MATERIALS,
NAMELY, SERIES OF BOOKS, WORKBOOKS IN THE
FIELD OF REAL ESTATE INVESTMENT, INCLUDING
AUDIO CDS SOLD AS A UNIT THEREWITH (U.S. CLS.
2, 5, 22, 23, 29, 37, 38 AND 50).

FIRST USE 1-28-2005; IN COMMERCE 1-28-2005.

CLASS 41—EDUCATION AND ENTERTAIN- MENT

FOR EDUCATIONAL SERVICES, NAMELY, CON-
DUCTING CLASSES, SEMINARS, AND WORKSHOPS
IN THE FIELD OF REAL ESTATE INVESTMENT;
TRAINING SERVICES IN THE FIELD OF REAL ESTATE
INVESTMENT (U.S. CLS. 100, 101 AND 107).

FIRST USE 3-31-2006; IN COMMERCE 10-25-2006.

3,399,509. ESAB GROUP, INC., FLORENCE, SC. SN 78-
609,223. PUB. 7-11-2006, FILED 4-14-2005.

M3 PLASMA

THE MARK CONSISTS OF STANDARD CHARACTERS
WITHOUT CLAIM TO ANY PARTICULAR FONT, STYLE,
SIZE, OR COLOR.

NO CLAIM IS MADE TO THE EXCLUSIVE RIGHT TO
USE "PLASMA", APART FROM THE MARK AS SHOWN.

CLASS 7—MACHINERY

FOR PLASMA ARC CUTTING MACHINES, AND
PARTS AND SPARES THEREFORE (U.S. CLS. 13, 19,
21, 23, 31, 34 AND 35).

FIRST USE 6-0-2006; IN COMMERCE 6-0-2006.

CLASS 9—ELECTRICAL AND SCIENTIFIC APPARATUS

FOR COMPUTER HARDWARE FOR USE WITH PLASMA ARC CUTTING MACHINES; INDUSTRIAL PROCESS CONTROL SOFTWARE FOR USE WITH PLASMA ARC CUTTING MACHINES (U.S. CLS. 21, 23, 26, 36 AND 38).

FIRST USE 6-0-2006; IN COMMERCE 6-0-2006.

3,399,521. DUMONT, STEFANIE, CARLSBAD, CA. SN 78-623,545. PUB. 1-31-2006, FILED 5-5-2005.

POSITIVE PENELOPE

THE MARK CONSISTS OF STANDARD CHARACTERS WITHOUT CLAIM TO ANY PARTICULAR FONT, STYLE, SIZE, OR COLOR.

CLASS 16—PAPER GOODS AND PRINTED MATTER

FOR SERIES OF FICTION BOOKS (U.S. CLS. 2, 5, 22, 23, 29, 37, 38 AND 50).

FIRST USE 2-15-2006; IN COMMERCE 2-15-2006.

CLASS 28—TOYS AND SPORTING GOODS

FOR DOLLS AND ACCESSORIES THEREFOR (U.S. CLS. 22, 23, 38 AND 50).

FIRST USE 2-15-2006; IN COMMERCE 2-15-2006.

3,399,525. MUIA, TONY, BROOKLYN, NY. SN 78-626,287. PUB. 8-29-2006, FILED 5-10-2005.

A SLICE OF BROOKLYN

THE MARK CONSISTS OF STANDARD CHARACTERS WITHOUT CLAIM TO ANY PARTICULAR FONT, STYLE, SIZE, OR COLOR.

NO CLAIM IS MADE TO THE EXCLUSIVE RIGHT TO USE "BROOKLYN", APART FROM THE MARK AS SHOWN.

CLASS 25—CLOTHING

FOR CLOTHING PRODUCTS, NAMELY, T-SHIRTS, SWEATSHIRTS, POLO SHIRTS, DENIM SHIRTS, COTTON LONG-SLEEVE SHIRTS, JACKETS, TURTLENECKS, BLAZERS, SWEATERS, APRONS, BOXER SHORTS, BASEBALL CAPS AND NECKTIES (U.S. CLS. 22 AND 39).

FIRST USE 5-0-2005; IN COMMERCE 5-0-2005.

CLASS 39—TRANSPORTATION AND STORAGE

FOR ARRANGING AND CONDUCTING GUIDED TRAVEL TOURS (U.S. CLS. 100 AND 105).

FIRST USE 5-0-2005; IN COMMERCE 5-0-2005.

3,399,526. MUIA, TONY, BROOKLYN, NY. SN 78-626,345. PUB. 11-14-2006, FILED 5-10-2005.



NO CLAIM IS MADE TO THE EXCLUSIVE RIGHT TO USE "BROOKLYN" OR "PIZZA TOUR", APART FROM THE MARK AS SHOWN.

CLASS 25—CLOTHING

FOR CLOTHING PRODUCTS, NAMELY, T-SHIRTS, SWEATSHIRTS, POLO SHIRTS, DENIM SHIRTS, COTTON LONG-SLEEVE SHIRTS, JACKETS, TURTLENECKS, BLAZERS, SWEATERS, APRONS, BOXER SHORTS, BASEBALL CAPS AND NECKTIES (U.S. CLS. 22 AND 39).

FIRST USE 5-0-2005; IN COMMERCE 5-0-2005.

CLASS 39—TRANSPORTATION AND STORAGE

FOR ARRANGING AND CONDUCTING GUIDED TRAVEL TOURS (U.S. CLS. 100 AND 105).

FIRST USE 5-0-2005; IN COMMERCE 5-0-2005.

3,399,529. ANTHONY, ALICE, DBA ANTHONY'S HOME OF ALEECE'S PITA CHIPS, EAST PEORIA, IL. SN 78-627,490. PUB. 5-1-2007, FILED 5-11-2005.



THE COLOR(S) RED AND GOLD IS/ARE CLAIMED AS A FEATURE OF THE MARK.

THE MARK CONSISTS OF THE WORD "ALEECE'S" AND A GRAIN HUSK, WHERE THE COLOR RED APPEARS IN THE WORDING "ALEECE'S", THE COLOR GOLD APPEARS IN THE GRAIN HUSK BELOW THE WORDING "ALEECE'S" AND THE COLOR GOLD OUTLINES THE WORDING "ALEECE'S".

CLASS 29—MEATS AND PROCESSED FOODS

FOR CHEESE FOOD; CHEESE SPREADS; FOOD PACKAGE COMBINATIONS CONSISTING PRIMARILY OF CHEESE, MEAT AND/OR PROCESSED FRUIT; FRUIT-BASED SPREADS; HUMMUS; SNACK DIPS EXCLUDING SALSA AND OTHER SAUCES USED AS DIPS; TAPENADES (U.S. CL. 46).

FIRST USE 6-0-2004; IN COMMERCE 6-0-2004.

CLASS 30—STAPLE FOODS

FOR FLOUR-BASED CHIPS; PITA-BREAD CHIPS (U.S. CL. 46).

FIRST USE 6-0-2004; IN COMMERCE 6-0-2004.

3,399,534. RUNNYC.COM LLC, BROOKLYN, NY. SN 78-636,451. PUB. 9-19-2006, FILED 5-24-2005.



NO CLAIM IS MADE TO THE EXCLUSIVE RIGHT TO USE "RUN NYC .COM", APART FROM THE MARK AS SHOWN.

THE COLOR(S) ORANGE, BLUE AND WHITE IS/ARE CLAIMED AS A FEATURE OF THE MARK.

THE MARK CONSISTS OF A LARGE SQUARE DIVIDED INTO FOUR (4) SECTIONS AT FORTY-FIVE (45) DEGREE ANGLES AT EACH CORNER OF THE SQUARE CONVERGING ON A SMALL CENTER WHITE SQUARE. THE COLOR BLUE APPEARS IN THE SECTIONS TO THE LEFT AND RIGHT OF THE CENTER WHITE SQUARE AND IN THE UPPERCASE WORDS "RUN" AND "NYC" AND IN THE LOWER CASE WORDS "STAY FOCUSED". THE COLOR ORANGE APPEARS IN THE SECTIONS ABOVE AND BELOW THE CENTER WHITE SQUARE AND IN THE LOWERCASE WORDS ".COM". THE COLOR WHITE ALSO APPEARS IN RANDOMLY DISPERSED QUADRANGLE SHAPES IN EACH OF THE FOUR SECTIONS WITHIN THE LARGE SQUARE.

CLASS 25—CLOTHING

FOR CLOTHING, NAMELY, SHIRTS, T-SHIRTS, SHORT SLEEVED T-SHIRTS, LONG SLEEVED T-SHIRTS, POLO SHIRTS, GOLF SHIRTS, OPEN-NECKED SHIRTS, JOGGING OUTFITS, JOGGING PANTS, JOGGING SUITS, SHORTS, SWEAT SHORTS, SWEAT BANDS, AND SWIM TRUNKS (U.S. CLS. 22 AND 39).

FIRST USE 4-1-2006; IN COMMERCE 4-1-2006.

CLASS 35—ADVERTISING AND BUSINESS

FOR PROMOTING SPORTS COMPETITION AND/OR EVENTS OF OTHERS TO RUNNERS, SWIMMERS, BICYCLISTS, TRIATHLETES AND ATHLETES; PROMOTING THE GOODS AND SERVICES OF OTHERS BY ARRANGING FOR SPONSORS TO AFFILIATE THEIR GOODS AND SERVICES WITH RUNNING; PROMOTING THE GOODS AND SERVICES OF OTHERS BY PROVIDING HYPERTEXT LINKS TO THE WEB SITES OF OTHERS; PROMOTING THE GOODS AND SERVICES OF OTHERS BY PROVIDING A WEB SITE AT WHICH USERS CAN LINK TO INFORMATION, ARTICLES, AND PRODUCTS PERTAINING TO HEALTH AND FITNESS FOR RUNNERS, SWIMMERS, BICYCLISTS, TRIATHLETES AND ATHLETES IN THE ATHLETIC COMMUNITY; PROMOTING, ADVERTISING AND MARKETING OF THE ON-LINE WEBSITES OF OTHERS PERTAINING TO RUNNERS, SWIMMERS, BICYCLISTS, TRIATHLETES AND ATHLETES IN THE ATHLETIC COMMUNITY (U.S. CLS. 100, 101 AND 102).

FIRST USE 4-1-2006; IN COMMERCE 4-1-2006.

CLASS 41—EDUCATION AND ENTERTAINMENT

FOR PHYSICAL FITNESS CONSULTATION AND INSTRUCTION TO RUNNERS, SWIMMERS, BICYCLISTS, TRIATHLETES AND ATHLETES IN THE ATHLETIC COMMUNITY; AND EDUCATIONAL SERVICES BY PROVIDING CONSULTATION SERVICES IN THE FIELD OF RUNNING, SWIMMING, BICYCLING AND TRIATHLON FOR RUNNERS, SWIMMERS, BICYCLISTS, TRIATHLETES AND ATHLETES IN THE ATHLETIC COMMUNITY (U.S. CLS. 100, 101 AND 107).

FIRST USE 4-1-2006; IN COMMERCE 4-1-2006.

3,399,536. FORMOSA SAINT JOSE CORP., TAIPEI, TAIWAN. SN 78-637,077. PUB. 8-15-2006, FILED 5-25-2005.



OWNER OF TAIWAN REG. NO. 1120831, DATED 9-16-2004, EXPIRES 9-15-2014.

CLASS 12—VEHICLES

FOR STEERING WHEEL COVERS, FITTED COVERS FOR AUTOMOBILES AND MOTORCYCLES (U.S. CLS. 19, 21, 23, 31, 35 AND 44).

FIRST USE 8-11-2000; IN COMMERCE 9-21-2006.

CLASS 27—FLOOR COVERINGS

FOR FLOOR MATS FOR VEHICLES (U.S. CLS. 19, 20, 37, 42 AND 50).

FIRST USE 8-11-2000; IN COMMERCE 3-13-2006.

3,399,543. MONITOR COMPANY GROUP LIMITED PARTNERSHIP, CAMBRIDGE, MA. SN 78-646,009. PUB. 9-12-2006, FILED 6-8-2005.

ORGANIZATIONSCAN

THE MARK CONSISTS OF STANDARD CHARACTERS WITHOUT CLAIM TO ANY PARTICULAR FONT, STYLE, SIZE, OR COLOR.

CLASS 9—ELECTRICAL AND SCIENTIFIC APPARATUS

FOR COMPUTER SOFTWARE FOR DATA ANALYSIS IN THE FIELD OF BUSINESS MANAGEMENT AND CONSULTING (U.S. CLS. 21, 23, 26, 36 AND 38).

FIRST USE 0-0-1995; IN COMMERCE 0-0-1995.

CLASS 35—ADVERTISING AND BUSINESS

FOR BUSINESS MANAGEMENT CONSULTING SERVICES (U.S. CLS. 100, 101 AND 102).

FIRST USE 6-7-2005; IN COMMERCE 6-7-2005.

3,399,545. NIGHT TERRORZ INC., BELLEROSE, NY. SN 78-651,907. PUB. 3-28-2006, FILED 6-16-2005.

NIGHT TERRORZ

THE MARK CONSISTS OF STANDARD CHARACTERS WITHOUT CLAIM TO ANY PARTICULAR FONT, STYLE, SIZE, OR COLOR.

CLASS 25—CLOTHING

FOR CLOTHING, NAMELY, CAPS, JACKETS, JEANS, JERSEYS, PAJAMAS, PANTS, T-SHIRTS AND UNDERWEAR (U.S. CLS. 22 AND 39).
FIRST USE 12-20-2006; IN COMMERCE 12-20-2006.

CLASS 26—FANCY GOODS

FOR CLOTH PATCHES FOR CLOTHING (U.S. CLS. 37, 39, 40, 42 AND 50).
FIRST USE 12-20-2006; IN COMMERCE 12-20-2006.

3,399,566. DGDawg REELS, ELK GROVE, CA. SN 78-667,374. PUB. 9-12-2006, FILED 7-11-2005.

DGDawg Reels

THE MARK CONSISTS OF STANDARD CHARACTERS WITHOUT CLAIM TO ANY PARTICULAR FONT, STYLE, SIZE, OR COLOR.

CLASS 41—EDUCATION AND ENTERTAINMENT

FOR PHOTO EDITING (U.S. CLS. 100, 101 AND 107).
FIRST USE 11-1-2007; IN COMMERCE 11-1-2007.

CLASS 42—SCIENTIFIC AND COMPUTER SERVICES

FOR DESIGN AND DEVELOPMENT OF MULTIMEDIA PRODUCTS (U.S. CLS. 100 AND 101).
FIRST USE 11-1-2007; IN COMMERCE 11-1-2007.

3,399,569. ALTICOR INC., ADA, MI. SN 78-668,336. PUB. 4-4-2006, FILED 7-12-2005.

KRAKOOSH

THE MARK CONSISTS OF STANDARD CHARACTERS WITHOUT CLAIM TO ANY PARTICULAR FONT, STYLE, SIZE, OR COLOR.

CLASS 16—PAPER GOODS AND PRINTED MATTER

FOR HEALTH AND FITNESS MAGAZINES AND CATALOGS AND STICKERS (U.S. CLS. 2, 5, 22, 23, 29, 37, 38 AND 50).
FIRST USE 10-16-2005; IN COMMERCE 10-15-2005.

CLASS 18—LEATHER GOODS

FOR BACKPACKS AND ALL-PURPOSE SPORT BAGS (U.S. CLS. 1, 2, 3, 22 AND 41).
FIRST USE 10-16-2005; IN COMMERCE 10-16-2005.

CLASS 21—HOUSEWARES AND GLASS

FOR PLASTIC WATER BOTTLES SOLD EMPTY (U.S. CLS. 2, 13, 23, 29, 30, 33, 40 AND 50).
FIRST USE 10-15-2005; IN COMMERCE 10-15-2005.

CLASS 25—CLOTHING

FOR CLOTHING, NAMELY, T-SHIRTS, SHIRTS, SWEAT SUITS; HEADWEAR (U.S. CLS. 22 AND 39).
FIRST USE 10-16-2005; IN COMMERCE 10-16-2005.

CLASS 32—LIGHT BEVERAGES

FOR ENERGY DRINKS (U.S. CLS. 45, 46 AND 48).
FIRST USE 10-16-2005; IN COMMERCE 10-16-2005.

3,399,578. SCHLUTER-SYSTEMS KG, ISERLOHN, FED REP GERMANY. SN 78-675,231. PUB. 9-5-2006, FILED 7-21-2005.

KERDI

THE MARK CONSISTS OF STANDARD CHARACTERS WITHOUT CLAIM TO ANY PARTICULAR FONT, STYLE, SIZE, OR COLOR.

OWNER OF U.S. REG. NO. 1,645,259.

CLASS 1—CHEMICALS

FOR ADHESIVES FOR SETTING MORTARS (U.S. CLS. 1, 5, 6, 10, 26 AND 46).
FIRST USE 12-31-2005; IN COMMERCE 12-31-2005.

CLASS 17—RUBBER GOODS

FOR SETTING MATERIALS COMPRISED OF CAULKINGS (U.S. CLS. 1, 5, 12, 13, 35 AND 50).
FIRST USE 12-31-2005; IN COMMERCE 12-31-2005.

CLASS 19—NON-METALLIC BUILDING MATERIALS

FOR SETTING MATERIALS COMPRISED OF MORTARS (U.S. CLS. 1, 12, 33 AND 50).
FIRST USE 12-31-2005; IN COMMERCE 12-31-2005.

3,399,582. THE INSTITUTE OF ELECTRICAL AND ELECTRONICS ENGINEERS, INC., PISCATAWAY, NJ. SN 78-678,931. PUB. 10-10-2006, FILED 7-26-2005.

STIX FONTS

THE MARK CONSISTS OF STANDARD CHARACTERS WITHOUT CLAIM TO ANY PARTICULAR FONT, STYLE, SIZE, OR COLOR.

NO CLAIM IS MADE TO THE EXCLUSIVE RIGHT TO USE "FONTS", APART FROM THE MARK AS SHOWN.

CLASS 9—ELECTRICAL AND SCIENTIFIC APPARATUS

FOR PRINTING FONTS THAT CAN BE DOWNLOADED PROVIDED BY MEANS OF ELECTRONIC TRANSMISSION (U.S. CLS. 21, 23, 26, 36 AND 38).

FIRST USE 10-31-2007; IN COMMERCE 10-31-2007.

CLASS 16—PAPER GOODS AND PRINTED MATTER

FOR PRINTING FONTS (U.S. CLS. 2, 5, 22, 23, 29, 37, 38 AND 50).

FIRST USE 10-31-2007; IN COMMERCE 10-31-2007.

3,399,590. VERICAL, INCORPORATED, ALEXANDRIA, VA. SN 78-685,673. PUB. 5-1-2007, FILED 8-4-2005.

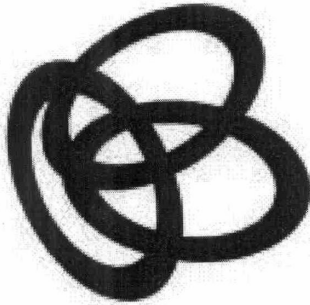

THE MARK CONSISTS OF THREE INTERTWINED RINGS.

CLASS 35—ADVERTISING AND BUSINESS

FOR ONLINE RETAIL AND WHOLESALE STORE SERVICES IN THE FIELD OF ELECTRONIC EQUIPMENT AND COMPONENTS; PROVIDING RETAIL AND WHOLESALE INFORMATION ABOUT THE AVAILABILITY OF AND DEMAND FOR ELECTRONIC EQUIPMENT AND COMPONENTS (U.S. CLS. 100, 101 AND 102).

FIRST USE 4-0-2007; IN COMMERCE 4-0-2007.

CLASS 42—SCIENTIFIC AND COMPUTER SERVICES

FOR PROVIDING AUTHENTICATION AND QUALITY ASSURANCE SERVICES IN THE FIELD OF ELECTRONIC EQUIPMENT AND COMPONENTS (U.S. CLS. 100 AND 101).

FIRST USE 4-0-2007; IN COMMERCE 4-0-2007.

3,399,591. PHILIP MORRIS USA INC., RICHMOND, VA. SN 78-688,593. PUB. 12-12-2006, FILED 8-9-2005.



**Prevención del
consumo de tabaco
en los jóvenes**

NO CLAIM IS MADE TO THE EXCLUSIVE RIGHT TO USE "PREVENCION DEL CONSUMO DE TABACO EN LOS JOVENES", APART FROM THE MARK AS SHOWN.

THE COLOR(S) BLUE AND GREEN IS/ARE CLAIMED AS A FEATURE OF THE MARK.

THE MARK CONSISTS OF THE WORDS "PREVENCION DEL CONSUMO DE TABACO EN LOS JOVENES" IN BLUE AND AN INTERLOCKING SQUARE DESIGN IN GREEN AND BLUE TO THE LEFT OF THE WORDING.

THE FOREIGN WORDING IN THE MARK TRANSLATES INTO ENGLISH AS PREVENTION OF THE CONSUMPTION OF TOBACCO IN YOUTH OR YOUTH SMOKING PREVENTION.

CLASS 16—PAPER GOODS AND PRINTED MATTER

FOR BROCHURES, PAMPHLETS, INFORMATIONAL TIP SHEETS ABOUT YOUTH SMOKING PREVENTION, POSITIVE YOUTH DEVELOPMENT, AND SMOKING CESSATION PROGRAMS; PRINTED SIGNS MADE OF PAPER AND CARDBOARD; STATIONERY; PRINTED INSTRUCTIONAL, EDUCATIONAL AND TEACHING MATERIALS IN THE FIELD OF YOUTH SMOKING PREVENTION, POSITIVE YOUTH DEVELOPMENT, AND SMOKING CESSATION PROGRAMS (U.S. CLS. 2, 5, 22, 23, 29, 37, 38 AND 50).

FIRST USE 10-31-2005; IN COMMERCE 10-31-2005.

CLASS 35—ADVERTISING AND BUSINESS

FOR PROMOTING PUBLIC AWARENESS OF THE NEED FOR YOUTH SMOKING PREVENTION, POSITIVE YOUTH DEVELOPMENT, AND SMOKING CESSATION PROGRAMS (U.S. CLS. 100, 101 AND 102).

FIRST USE 10-31-2005; IN COMMERCE 10-31-2005.

CLASS 44—MEDICAL, BEAUTY AND AGRICULTURAL SERVICES

FOR PROVIDING A WEBSITE FEATURING YOUTH SMOKING PREVENTION, POSITIVE YOUTH DEVELOPMENT, AND SMOKING CESSATION PROGRAM INFORMATION (U.S. CLS. 100 AND 101).

FIRST USE 10-31-2005; IN COMMERCE 10-31-2005.

3,399,597. OPTIMUS INTERNATIONAL, INC., MURPHY, TX. SN 78-694,751. PUB. 10-17-2006, FILED 8-17-2005.



NO CLAIM IS MADE TO THE EXCLUSIVE RIGHT TO USE "REAL ARMOR" AND REPRESENTATION OF THE SWORD, APART FROM THE MARK AS SHOWN.

THE MARK CONSISTS OF THE WORDS REAL ARMOR OF GOD IN STYLIZED LETTERING. A SWORD EXTENDS THROUGH THE "O" IN ARMOR AND A DIAMOND SHAPE

IS CENTERED WITHIN THE "O" IN GOD.

CLASS 8—HAND TOOLS

FOR REPLICA HISTORICAL WEAPONS, NAMELY, ROMAN, MEDIEVAL, RENAISSANCE, CIVIL WAR, AND PIRATE WEAPONS, NAMELY, AXES; BLADES FOR KNIVES USED AS WEAPONS AND SWORDS; DAGGERS; FLAILS; JAPANESE SWORDS; MACES; PIKES; SABRES; SIDE ARMS, NOT INCLUDING FIRE-ARMS, NAMELY, SWORDS, SPEARS, AND WAR HAMMERS; SWORD BELTS (U.S. CLS. 23, 28 AND 44).
FIRST USE 7-25-2005; IN COMMERCE 7-25-2005.

CLASS 9—ELECTRICAL AND SCIENTIFIC APPARATUS

FOR REPLICA HISTORICAL BODY ARMOR, NAMELY, ROMAN, MEDIEVAL, RENAISSANCE, CIVIL WAR, AND PIRATE BODY ARMOR AND PROTECTIVE BODY ARMOR, CHAIN MAIL AND GAUNTLETS; PROTECTIVE CLOTHING; PROTECTIVE HELMETS; HAND-HELD PROTECTIVE SHIELDS USED AS BODY ARMOR; AND SLASH AND STAB RESISTANT BODY ARMOR (U.S. CLS. 21, 23, 26, 36 AND 38).
FIRST USE 7-25-2005; IN COMMERCE 7-25-2005.

CLASS 14—JEWELRY

FOR WITNESSING AND EVANGELISM TOOLS, NAMELY, NON-MONETARY COINS (U.S. CLS. 2, 27, 28 AND 50).
FIRST USE 3-31-2006; IN COMMERCE 3-31-2006.

CLASS 25—CLOTHING

FOR THEMED REPLICA HISTORICAL CLOTHING, NAMELY, ROMAN, MEDIEVAL, RENAISSANCE, CIVIL WAR, AND PIRATE ATTIRE, NAMELY, BELTS, BELTS MADE OF LEATHER, BLOUSES, CAPES, FOLK COSTUMES, COSTUMES FOR USE IN ROLE PLAYING GAMES, DRESSES, FOOTWEAR, GLOVES, GOWNS, HALLOWEEN COSTUMES, HATS, JERKINS, JERSEYS, LEATHER SHOES, MASQUERADE COSTUMES AND MASKS SOLD IN CONNECTION THEREWITH, MEN'S AND WOMEN'S JACKETS, COATS, NECKTIES, DRESS SHIRTS, CASUAL SHIRTS, TROUSERS, VESTS, PETTICOATS, RELIGIOUS COSTUMES IN THE NATURE OF ROBES, TUNICS, HEAD WEAR, SANDALS AND FOOTWEAR, SHIRTS, SHIRTS, TOGAS, NON-CLERICAL TUNICS, WOMEN'S CEREMONIAL DRESSES, AND WRIST BANDS (U.S. CLS. 22 AND 39).
FIRST USE 7-25-2005; IN COMMERCE 7-25-2005.

3,399,599. HALLER, REESE R., BAY CITY, MI. SN 78-695,940.
PUB. 7-31-2007, FILED 8-18-2005.

Fred The Mouse

THE MARK CONSISTS OF STANDARD CHARACTERS WITHOUT CLAIM TO ANY PARTICULAR FONT, STYLE, SIZE, OR COLOR.

CLASS 9—ELECTRICAL AND SCIENTIFIC APPARATUS

FOR AUDIO RECORDINGS FEATURING A SERIES OF FICTIONAL STORIES (U.S. CLS. 21, 23, 26, 36 AND 38).
FIRST USE 12-1-2007; IN COMMERCE 12-1-2007.

CLASS 16—PAPER GOODS AND PRINTED MATTER

FOR SERIES OF FICTION BOOKS (U.S. CLS. 2, 5, 22, 23, 29, 37, 38 AND 50).
FIRST USE 9-7-2005; IN COMMERCE 9-7-2005.

3,399,604. CIBA SPECIALTY CHEMICALS CORPORATION, TARRYTOWN, NY. SN 78-699,627. PUB. 7-25-2006, FILED 8-24-2005.

TINOSORB

THE MARK CONSISTS OF STANDARD CHARACTERS WITHOUT CLAIM TO ANY PARTICULAR FONT, STYLE, SIZE, OR COLOR.

OWNER OF U.S. REG. NO. 2,432,284.

CLASS 1—CHEMICALS

FOR ACTIVE CHEMICAL SUNSCREEN AGENTS USED IN THE MANUFACTURE OF COSMETICS (U.S. CLS. 1, 5, 6, 10, 26 AND 46).
FIRST USE 9-25-2007; IN COMMERCE 9-25-2007.

CLASS 3—COSMETICS AND CLEANING PREPARATIONS

FOR PERSONAL SUNSCREEN LOTION AND CREAMS; PERSONAL SUN BLOCK LOTIONS AND CREAMS (U.S. CLS. 1, 4, 6, 50, 51 AND 52).
FIRST USE 9-25-2007; IN COMMERCE 9-25-2007.

3,399,613. ONTHANK, CHRISTOPHER, WILTON, CT. SN 78-708,085. PUB. 4-24-2007, FILED 9-7-2005.

DOG GONE SMART

THE MARK CONSISTS OF STANDARD CHARACTERS WITHOUT CLAIM TO ANY PARTICULAR FONT, STYLE, SIZE, OR COLOR.

CLASS 9—ELECTRICAL AND SCIENTIFIC APPARATUS

FOR PRE-RECORDED DVDS AND VIDEO CASSETTES FEATURING DOG TRAINING INSTRUCTION (U.S. CLS. 21, 23, 26, 36 AND 38).
FIRST USE 8-1-2005; IN COMMERCE 8-1-2005.

CLASS 12—VEHICLES

FOR SEAT COVERS FOR VEHICLES (U.S. CLS. 19, 21, 23, 31, 35 AND 44).
FIRST USE 12-20-2007; IN COMMERCE 12-20-2007.

CLASS 18—LEATHER GOODS

FOR PET LEASHES, PET COLLARS, DOG JACKETS, AND FABRIC CRATE PADS FOR USE IN PET TRAINING (U.S. CLS. 1, 2, 3, 22 AND 41).
FIRST USE 10-30-2007; IN COMMERCE 10-30-2007.

CLASS 20—FURNITURE AND ARTICLES NOT OTHERWISE CLASSIFIED

FOR DOG BEDS; CRATE PADS FOR CUSHIONING AS PET BEDDING (U.S. CLS. 2, 13, 22, 25, 32 AND 50).
FIRST USE 12-15-2006; IN COMMERCE 12-15-2006.

CLASS 35—ADVERTISING AND BUSINESS

FOR RETAIL STORE SERVICES FEATURING PET SUPPLIES (U.S. CLS. 100, 101 AND 102).
FIRST USE 8-28-1998; IN COMMERCE 8-28-1998.

CLASS 41—EDUCATION AND ENTERTAINMENT

FOR DOG TRAINING SERVICES; DOG SWIMMING INSTRUCTION; ORGANIZING AND CONDUCTING DOG SHOWS AND EXHIBITIONS (U.S. CLS. 100, 101 AND 107).
FIRST USE 2-28-1995; IN COMMERCE 2-28-1995.

CLASS 43—HOTEL AND RESTAURANT SERVICES

FOR PROVIDING CANINE CENTER SERVICES, NAMELY, DAYCARE AND BOARDING SERVICES (U.S. CLS. 100 AND 101).
FIRST USE 8-28-1998; IN COMMERCE 8-28-1998.

CLASS 44—MEDICAL, BEAUTY AND AGRICULTURAL SERVICES

FOR PROVIDING CANINE CENTER SERVICES, NAMELY, CANINE REHABILITATION, DOG WASHING AND DOG WALKING SERVICES (U.S. CLS. 100 AND 101).
FIRST USE 8-20-2002; IN COMMERCE 8-20-2002.

CLASS 25—CLOTHING

FOR CLOTHING, NAMELY, APRONS, ASCOTS, ATHLETIC FOOTWEAR, ATHLETIC SHOES, ATHLETIC UNIFORMS, BANDANAS, CAPS, BATH SLIPPERS, BATHING CAPS, BATHING SUITS, BATHING TRUNKS, BATHROBES, BEACH COVER-UPS, BEACH SHOES, BEACHWEAR, BEANIES, BELTS, BERETS, BERMUDA SHORTS, BIKINIS, BLAZERS, BLOUSES, BODY SHAPERS, BODY SUITS, BOXER SHORTS, BRAS, BRASSIERES, BRIEFS, CAMP SHIRTS, CAPS, CARDIGANS, CHEF'S HATS, WRAP-AROUNDS, COATS, COLLARS, CROP TOPS, CUFFS, DENIM JACKETS, EAR MUFFS, GOLF SHIRTS, GYM SHORTS, HALTER TOPS, HATS, HEAD BANDS, HEADWEAR, INFANTWEAR, JACKETS, JEANS, JOGGING SUITS, LEATHER JACKETS, LEG WARMERS, LEGGINGS, LIGHT-REFLECTING JACKETS, LINGERIE, LOUNGEWEAR, MOCK TURTLE-NECK SWEATERS, MONEY BELTS, MUFFLERS, NECK BANDS, NECKWEAR, NIGHT SHIRTS, PAJAMAS, PANTIES, PANTS, POLO SHIRTS, PONCHOS, PULLOVERS, RAIN JACKETS, SANDALS, SASHES, SCARVES, SHAWLS, SHIRTS, SHOES, SHORTS, SLEEP SHIRTS, SLEEPWEAR, SLIPPERS, SNEAKERS, SOCKS, SPORT COATS, SPORT SHIRTS, SUN VISORS, SWEAT BANDS, SWEAT PANTS, SWEAT SHIRTS, SWEAT SHORTS, SWEAT SUITS, SWEATERS, SWEAT SOCKS, SWIM CAPS, SWIM TRUNKS, SWIM WEAR, SWIMMING CAPS, SWIMSUITS, TANK TOPS, T-SHIRTS, VISORS, V-NECK SWEATERS, WIND RESISTANT JACKETS, WRIST BANDS, AND WRISTBANDS CONTAINING A COOLING SUBSTANCE TO COOL THE WEARER (U.S. CLS. 22 AND 39).

FIRST USE 2-19-2006; IN COMMERCE 2-19-2006.

CLASS 41—EDUCATION AND ENTERTAINMENT

FOR ENTERTAINMENT SERVICES IN THE NATURE OF BICYCLE RACES BY A PROFESSIONAL RACING TEAM; ENTERTAINMENT SERVICES, NAMELY, PARTICIPATION BY A BICYCLE RACING TEAM IN ORGANIZED BICYCLE RACES, AND PERSONAL APPEARANCES BY MEMBERS OF THE BICYCLE RACING TEAM AT RELATED EVENTS, NAMELY, BICYCLE SHOWS AND EXHIBITIONS (U.S. CLS. 100, 101 AND 107).

FIRST USE 2-19-2006; IN COMMERCE 2-19-2006.

3,399,630. CENTRAL RESERVATION ASSOCIATION OF DESTINATION RESORTS, INC., DENVER, CO. SN 78-722,820. PUB. 1-16-2007, FILED 9-28-2005.

3,399,615. UNITED CYCLING, LLC, NEWPORT BEACH, CA. SN 78-709,043. PUB. 8-22-2006, FILED 9-8-2005.

CENRES

UNITED PRO CYCLING TEAM

THE MARK CONSISTS OF STANDARD CHARACTERS WITHOUT CLAIM TO ANY PARTICULAR FONT, STYLE, SIZE, OR COLOR.

CLASS 35—ADVERTISING AND BUSINESS

FOR PROMOTING THE RESERVATION AND BOOKING SERVICES OF OTHERS BY DISTRIBUTING ADVERTISING MATERIALS THROUGH A VARIETY OF METHODS (U.S. CLS. 100, 101 AND 102).

FIRST USE 12-0-2007; IN COMMERCE 12-0-2007.

THE MARK CONSISTS OF STANDARD CHARACTERS WITHOUT CLAIM TO ANY PARTICULAR FONT, STYLE, SIZE, OR COLOR.

NO CLAIM IS MADE TO THE EXCLUSIVE RIGHT TO USE PRO CYCLING TEAM, APART FROM THE MARK AS SHOWN.

CLASS 39—TRANSPORTATION AND STORAGE

FOR PROVIDING INFORMATION AND MAKING RESERVATIONS AND BOOKINGS FOR TRANSPORTATION; ORGANIZATION, BOOKING AND ARRANGEMENT OF EXCURSIONS, DAY TRIPS AND SIGHTSEEING TOURS; TRAVEL AND TOUR INFORMATION AND RESERVATION SERVICES; TRAVEL INFORMATION SERVICES, NAMELY, TRAVEL AND TOUR INFORMATION SERVICE VIA THE INTERNET AND TELEPHONE; COORDINATING TRAVEL ARRANGEMENTS FOR INDIVIDUALS AND FOR GROUPS (U.S. CLS. 100 AND 105).

FIRST USE 12-0-2007; IN COMMERCE 12-0-2007.

CLASS 43—HOTEL AND RESTAURANT SERVICES

FOR PROVIDING INFORMATION AND MAKING RESERVATIONS AND BOOKINGS FOR TEMPORARY LODGING; PROVIDING INFORMATION AND MAKING RESERVATIONS AND BOOKINGS FOR RESTAURANTS AND MEALS; TRAVEL AGENCY SERVICES, NAMELY, RESERVATIONS AND BOOKING FOR TEMPORARY LODGING VIA THE INTERNET AND TELEPHONE (U.S. CLS. 100 AND 101).

FIRST USE 12-0-2007; IN COMMERCE 12-0-2007.

3,399,636. CLICKEATS, INC., BELLEVUE, WA. SN 78-726,204. PUB. 3-27-2007, FILED 10-4-2005.

order in ▪ dine out ▪ online

NO CLAIM IS MADE TO THE EXCLUSIVE RIGHT TO USE "ONLINE", APART FROM THE MARK AS SHOWN.

THE MARK CONSISTS OF THE WORDS "ORDER IN DINE OUT ONLINE" WRITTEN IN A STYLIZED FONT WITH A SQUARE BULLET BETWEEN THE WORDS "IN" AND "DINE" AND BETWEEN THE WORDS "OUT" AND "ONLINE".

CLASS 35—ADVERTISING AND BUSINESS

FOR MARKETING SERVICES, NAMELY, PROVIDING A WEB SITE WITH AN ON LINE DIRECTORY AND INFORMATIONAL SERVICES, DESIGNED TO GENERATE SALES TRAFFIC VIA HYPERLINKS TO WEB SITES OF PARTICIPATING RESTAURANTS (U.S. CLS. 100, 101 AND 102).

FIRST USE 6-15-2005; IN COMMERCE 5-4-2007.

CLASS 42—SCIENTIFIC AND COMPUTER SERVICES

FOR PROVIDING ONLINE NON-DOWNLOADABLE APPLICATION SOFTWARE TO RESTAURANTS IN ORDER TO FACILITATE THE RESTAURANTS' CREATION OF INTERACTIVE WEB SITES FOR ONLINE FOOD ORDERING AND MENU MANAGEMENT (U.S. CLS. 100 AND 101).

FIRST USE 6-15-2005; IN COMMERCE 5-4-2007.

3,399,647. TWEEN BRANDS INVESTMENT, LLC, NEW ALBANY, OH. SN 78-737,488. PUB. 8-14-2007, FILED 10-20-2005.

SHINE AT JUSTICE

THE MARK CONSISTS OF STANDARD CHARACTERS WITHOUT CLAIM TO ANY PARTICULAR FONT, STYLE, SIZE, OR COLOR.

OWNER OF U.S. REG. NOS. 2,990,417 AND 3,006,487.

CLASS 3—COSMETICS AND CLEANING PREPARATIONS

FOR COSMETICS, ARTIFICIAL FINGERNAILS, BEAUTY CREAMS AND GELS, DECORATIVE TRANSFERS AND SKIN JEWELS FOR COSMETIC PURPOSES, DUSTING POWDERS, PERFUMES AND PERSONAL FRAGRANCES, HAIR CARE PREPARATIONS AND DYES, MAKE-UP KITS COMPRISED OF COSMETICS AND BEAUTY CARE PRODUCTS, AND FINGER AND TOE NAIL CARE PRODUCTS, POLISH AND REMOVER (U.S. CLS. 1, 4, 6, 50, 51 AND 52).

FIRST USE 10-20-2005; IN COMMERCE 8-21-2006.

CLASS 41—EDUCATION AND ENTERTAINMENT

FOR ENTERTAINMENT SERVICES, NAMELY, CONDUCTING PARTIES (U.S. CLS. 100, 101 AND 107).

FIRST USE 10-20-2005; IN COMMERCE 8-21-2006.

3,399,648. COBRA GOLF INCORPORATED, CARLSBAD, CA. SN 78-737,693. PUB. 1-17-2006, FILED 10-21-2005.

FIT TO SPEED

THE MARK CONSISTS OF STANDARD CHARACTERS WITHOUT CLAIM TO ANY PARTICULAR FONT, STYLE, SIZE, OR COLOR.

CLASS 28—TOYS AND SPORTING GOODS

FOR GOLF EQUIPMENT, NAMELY, GOLF CLUBS (U.S. CLS. 22, 23, 38 AND 50).

FIRST USE 10-0-2006; IN COMMERCE 10-0-2006.

CLASS 41—EDUCATION AND ENTERTAINMENT

FOR FITTING OF GOLF CLUBS TO INDIVIDUAL USERS (U.S. CLS. 100, 101 AND 107).

FIRST USE 10-0-2006; IN COMMERCE 10-0-2006.

3,399,652. VILEX, INC., PITTSBURGH, PA. SN 78-739,251.
 PUB. 7-24-2007, FILED 10-24-2005.



OWNER OF U.S. REG. NO. 3,043,406.

CLASS 10—MEDICAL APPARATUS

FOR SURGICAL INSTRUMENTS, NAMELY, METAL SURGICAL TOOLS TO FACILITATE THE IMPLANTATION OF ORTHOPEDIC AND PODIATRY SURGICAL IMPLANTS; POWER SYSTEMS AND ACCESSORIES FOR SURGICAL USE, NAMELY, ELECTRIC POWERED CONSOLE WITH CONTROL/DISPLAY PANEL, POWER CORD, FOOT SWITCH, MOTOR CORD, MOTOR, AND METAL SURGICAL TOOLS TO FACILITATE THE IMPLANTATION OF ORTHOPEDIC AND PODIATRY SURGICAL IMPLANTS; AND ORTHOPEDIC AND PODIATRIC SURGICAL IMPLANTS COMPRISING ARTIFICIAL MATERIAL (U.S. CLS. 26, 39 AND 44).
 FIRST USE 7-15-1996; IN COMMERCE 7-15-1996.

CLASS 35—ADVERTISING AND BUSINESS

FOR DISTRIBUTORSHIP SERVICES IN THE FIELD OF PODIATRIC IMPLANTS AND SURGICAL INSTRUMENTS; RETAIL CONSIGNMENT BY REPRESENTATIVES IN THE FIELD OF PODIATRIC IMPLANTS AND SURGICAL INSTRUMENTS; RETAIL SERVICES BY DIRECT TELEPHONE SOLICITATION BY SALES AGENTS IN THE FIELD OF PODIATRIC IMPLANTS AND SURGICAL INSTRUMENTS; INDEPENDENT SALES REPRESENTATIVES IN THE FIELD OF PODIATRIC IMPLANTS AND SURGICAL INSTRUMENTS (U.S. CLS. 100, 101 AND 102).
 FIRST USE 12-31-1996; IN COMMERCE 12-31-1996.

CLASS 44—MEDICAL, BEAUTY AND AGRICULTURAL SERVICES

FOR RENTAL OF MEDICAL EQUIPMENT IN THE FIELD OF PODIATRIC IMPLANTS AND SURGICAL INSTRUMENTS (U.S. CLS. 100 AND 101).
 FIRST USE 12-31-1996; IN COMMERCE 12-31-1996.

3,399,654. GROVE FARM COMPANY, INCORPORATED, LIHUE, HI. SN 78-741,299. PUB. 8-8-2006, FILED 10-26-2005.



NO CLAIM IS MADE TO THE EXCLUSIVE RIGHT TO USE "SINCE 1864", APART FROM THE MARK AS SHOWN.

CLASS 35—ADVERTISING AND BUSINESS

FOR REAL ESTATE SALES MANAGEMENT; REAL ESTATE AUCTIONS; REAL ESTATE MARKETING SERVICES, NAMELY, ON-LINE SERVICES FEATURING TOURS OF RESIDENTIAL AND COMMERCIAL REAL ESTATE (U.S. CLS. 100, 101 AND 102).
 FIRST USE 10-23-2005; IN COMMERCE 10-23-2005.

CLASS 36—INSURANCE AND FINANCIAL

FOR ASSESSMENT AND MANAGEMENT OF REAL ESTATE; FINANCIAL INVESTMENT IN THE FIELD OF REAL ESTATE; FINANCIAL VALUATION OF PERSONAL PROPERTY AND REAL ESTATE; LAND ACQUISITION, NAMELY, REAL ESTATE BROKERAGE; LEASING OF REAL ESTATE; OPERATING MARKET-PLACES FOR SELLERS OF REAL ESTATE; PROVIDING INFORMATION IN THE FIELD OF REAL ESTATE BY MEANS OF LINKING THE WEB SITE TO OTHER WEB SITES FEATURING REAL ESTATE INFORMATION; REAL ESTATE ACQUISITION SERVICES; REAL ESTATE AGENCIES; REAL ESTATE APPRAISAL; REAL ESTATE BROKERAGE; REAL ESTATE CONSULTATION (U.S. CLS. 100, 101 AND 102).
 FIRST USE 10-23-2005; IN COMMERCE 10-23-2005.

3,399,655. KURTZ, MITCHELL A., NEW YORK, NY. SN 78-742,618. PUB. 1-16-2007, FILED 10-28-2005.



THE MARK CONSISTS OF STANDARD CHARACTERS WITHOUT CLAIM TO ANY PARTICULAR FONT, STYLE, SIZE, OR COLOR.

CLASS 35—ADVERTISING AND BUSINESS

FOR TAX PLANNING AND BUSINESS CORPORATE AND ORGANIZATIONAL SUCCESSION PLANNING (U.S. CLS. 100, 101 AND 102).
 FIRST USE 9-7-2006; IN COMMERCE 9-7-2006.

CLASS 36—INSURANCE AND FINANCIAL

FOR FINANCIAL SERVICES, NAMELY, COMPREHENSIVE FINANCIAL PLANNING INCLUDING ASSISTING OTHERS WITH INVESTMENT PLANNING, RETIREMENT PLANNING, ESTATE PLANNING, BUSINESS PLANNING, AND INSURANCE PLANNING (U.S. CLS. 100, 101 AND 102).
 FIRST USE 9-7-2006; IN COMMERCE 9-7-2006.

3,399,657. ELECTRONICS FOR IMAGING, INC., FOSTER CITY, CA. SN 78-744,632. PUB. 7-11-2006, FILED 11-1-2005.



THE COLOR(S) RED AND BLACK IS/ARE CLAIMED AS A FEATURE OF THE MARK.
 THE MARK CONSISTS OF A STYLIZED UPPER CASE "J"

WITH THE UPPER PORTION IN RED AND THE LOWER PORTION IN BLACK, THE LETTERS ETRION IN BLACK, AND THE "DOT" OVER THE LETTER "I" IN RED.

CLASS 2—PAINTS

FOR PRINTING INKS; NEWS INKS; FLEXOGRAPHIC INKS; PRINTING VARNISH; COLOR PRINTING PIGMENTS; COLORANTS FOR USE IN THE MANUFACTURE OF PRINTING INKS AND LACQUERS FOR PRINTING PURPOSES; PRINTERS' INK AND INK JET PRINTERS INK; INK FOR USE WITH DIGITAL PRINTERS AND TONER CARTRIDGES FOR USE WITH DIGITAL PRINTERS; PRINTING INKS FOR USE BY COMMERCIAL AND INDUSTRIAL PRINTERS IN THE GRAPHIC ARTS INDUSTRY (U.S. CLS. 6, 11 AND 16).

FIRST USE 2-0-2003; IN COMMERCE 4-0-2003.

CLASS 3—COSMETICS AND CLEANING PREPARATIONS

FOR PRINTING PRESS WASH SOLUTION (U.S. CLS. 1, 4, 6, 50, 51 AND 52).

FIRST USE 2-0-2003; IN COMMERCE 4-0-2003.

CLASS 9—ELECTRICAL AND SCIENTIFIC APPARATUS

FOR LASER PRINTERS; DIGITAL PRINTERS; INK JET PRINTERS; DOT MATRIX PRINTERS; COMPUTER PRINTERS; COMPUTER SOFTWARE PROGRAM THAT CALCULATES COST PARAMETERS FOR PRINTING JOBS; COMPUTER HARDWARE AND SOFTWARE FOR PRE-FLIGHTING, COLOR MANAGEMENT, IMAGE PROCESSING, RASTER IMAGE PROCESSING, AND COLOR AND IMAGE CALIBRATION; COMPONENT PARTS FOR PRINTERS, NAMELY, PRINTHEADS, PRINTHEAD CONTROL ELECTRONICS, MACHINE CONTROL ELECTRONICS, INK DELIVERY UNITS, PAPER HANDLING UNITS, CURING STATIONS FOR ATTACHMENT TO PRINTERS, CURING LAMPS FOR ATTACHMENT TO PRINTERS, DRYING STATIONS FOR ATTACHMENT TO PRINTERS, PRINTHEAD MOUNTINGS FOR ATTACHMENT TO PRINTERS, PRINTHEAD MAINTENANCE UNITS, RASTER IMAGE PROCESSING UNITS (U.S. CLS. 21, 23, 26, 36 AND 38).

FIRST USE 2-0-2003; IN COMMERCE 4-0-2003.

CLASS 37—CONSTRUCTION AND REPAIR

FOR INSTALLATION, REPAIR AND MAINTENANCE OF PRINTING EQUIPMENT (U.S. CLS. 100, 103 AND 106).

FIRST USE 2-0-2003; IN COMMERCE 4-0-2003.

CLASS 40—MATERIAL TREATMENT

FOR PRINTING; OFFSET PRINTING; CUSTOM MANUFACTURE OF INK AND INK RELATED PRODUCTS; CONSULTATION SERVICES, NAMELY, ADVICE RELATING TO THE MANUFACTURE OF INK AND INK RELATED PRODUCTS; CONSULTATION SERVICES RELATING TO DIGITAL PRINTING; PROVIDING INFORMATION IN THE FIELD OF PRINTING VIA THE INTERNET (U.S. CLS. 100, 103 AND 106).

FIRST USE 2-0-2003; IN COMMERCE 4-0-2003.

CLASS 41—EDUCATION AND ENTERTAINMENT

FOR TRAINING SERVICES IN THE FIELD OF PRINTING (U.S. CLS. 100, 101 AND 107).

FIRST USE 2-0-2003; IN COMMERCE 4-0-2003.

CLASS 42—SCIENTIFIC AND COMPUTER SERVICES

FOR TECHNICAL CONSULTATION AND RESEARCH IN THE FIELD OF PRINTING; CONSULTING SERVICES IN THE FIELD OF DESIGN, SELECTION, IMPLEMENTATION, INTEGRATION AND USE OF DIGITAL PRINTING SYSTEMS FOR OTHERS; PRINTING PROCESS CONSULTATION, NAMELY, PROVIDING QUALITY ASSURANCE AND EVALUATION SERVICES IN THE FIELD OF PRINTING PROCESSES, PRINTING PROJECTS, INK TO PAPER APPLICATION PROCESSES AND PRINTED DOCUMENTATION BINDING PROCESSES, FOR PURPOSES OF IMPROVING QUALITY, EFFICIENCY, REDUCING WASTE AND INCREASING PRODUCTIVITY; GRAPHIC ART DESIGNS; PROVIDING SPECIFIC INFORMATION AS REQUESTED BY CUSTOMERS VIA THE INTERNET (U.S. CLS. 100 AND 101).

FIRST USE 2-0-2003; IN COMMERCE 4-0-2003.

3,399,664. MICHAEL DAVID WARD PRODUCTIONS, INC., SANTA ROSA, CA. SN 78-746,938. PUB. 4-11-2006, FILED 11-4-2005.

LOWEEN

THE MARK CONSISTS OF STANDARD CHARACTERS WITHOUT CLAIM TO ANY PARTICULAR FONT, STYLE, SIZE, OR COLOR.

CLASS 16—PAPER GOODS AND PRINTED MATTER

FOR NOTE CARDS, GREETING CARDS, STATIONERY, BOOKS AND MAGAZINES FEATURING HUMOR AND CHILDREN'S STORIES, AND PAINTINGS (U.S. CLS. 2, 5, 22, 23, 29, 37, 38 AND 50).

FIRST USE 5-19-2006; IN COMMERCE 5-19-2006.

CLASS 25—CLOTHING

FOR T-SHIRTS (U.S. CLS. 22 AND 39).

FIRST USE 5-19-2006; IN COMMERCE 5-19-2006.

3,399,665. WINGATE HEALTHCARE, INC., NEEDHAM, MA. SN 78-747,142. PUB. 3-13-2007, FILED 11-4-2005.

PAVILION SUITES

THE MARK CONSISTS OF STANDARD CHARACTERS WITHOUT CLAIM TO ANY PARTICULAR FONT, STYLE, SIZE, OR COLOR.

NO CLAIM IS MADE TO THE EXCLUSIVE RIGHT TO USE "SUITES", APART FROM THE MARK AS SHOWN.

CLASS 36—INSURANCE AND FINANCIAL

FOR LEASING, RENTAL AND MANAGEMENT OF REAL ESTATE IN THE NATURE OF SENIOR RESIDENTIAL RETIREMENT, INDEPENDENT LIVING, ASSISTED LIVING, SKILLED NURSING, NURSING HOME AND LONG TERM CARE FACILITIES (U.S. CLS. 100, 101 AND 102).
FIRST USE 10-0-2006; IN COMMERCE 10-0-2006.

CLASS 44—MEDICAL, BEAUTY AND AGRICULTURAL SERVICES

FOR PROVIDING SKILLED NURSING, NURSING HOME AND LONG TERM CARE NURSING FACILITIES (U.S. CLS. 100 AND 101).
FIRST USE 10-0-2006; IN COMMERCE 10-0-2006.

3,399,668. 3DH COMMUNICATIONS, INC., NORCROSS, GA.
SN 78-748,221. PUB. 3-6-2007, FILED 11-7-2005.

LEADING THE DIMENSIONAL
REVOLUTION

THE MARK CONSISTS OF STANDARD CHARACTERS WITHOUT CLAIM TO ANY PARTICULAR FONT, STYLE, SIZE, OR COLOR.

CLASS 40—MATERIAL TREATMENT

FOR SCANNING OF THREE-DIMENSIONAL MULTIMEDIA CONTENT FOR OTHERS (U.S. CLS. 100, 103 AND 106).
FIRST USE 2-1-2006; IN COMMERCE 2-1-2006.

CLASS 41—EDUCATION AND ENTERTAINMENT

FOR PRODUCTION OF THREE-DIMENSIONAL MULTIMEDIA CONTENT FOR OTHERS, NAMELY, PLANNING, STORYBOARDING, MODELING, ANIMATION AND VIDEO CAPTURE (U.S. CLS. 100, 101 AND 107).
FIRST USE 2-1-2006; IN COMMERCE 2-1-2006.

3,399,671. COMPUTER ASSOCIATES THINK, INC., ISLANDIA, NY. SN 78-749,491. PUB. 10-2-2007, FILED 11-8-2005.



OWNER OF U.S. REG. NOS. 2,396,840, 2,784,648, AND 2,858,307.

CLASS 9—ELECTRICAL AND SCIENTIFIC APPARATUS

FOR HOUSE MARK OF COMPUTER SOFTWARE PRODUCTS, NAMELY, ENTERPRISE MANAGEMENT SOFTWARE FOR DISTRIBUTING SOFTWARE AMONG COMPUTERS, MAINTAINING HARDWARE AND SOFTWARE INVENTORIES, CONFIGURING COMPUTERS, AND PROTECTING LOCAL DATA AND MANAGING REMOTE COMPUTER SYSTEMS, COMPUTER SOFTWARE FOR CREATING AND ACCESSING SEARCHABLE DATABASES OF THE USERS' BUSINESS INFORMATION BY AUTHORIZED USERS; COMPUTER SOFTWARE FOR COMPUTER APPLICATION DEVELOPMENT, COMPUTER SOFTWARE FOR DATA STORAGE MANAGEMENT, DATABASE MANAGEMENT SOFTWARE, COMPUTER SOFTWARE FOR COMPUTER USER IDENTIFICATION AND AUTHENTICATION, PASSWORD AUTHENTICATION, SIGN-ON CONTROL AND ENCRYPTION; COMPUTER SOFTWARE FOR ADMINISTRATION OF COMPUTER LOCAL AREA NETWORKS, VIRTUAL PRIVATE NETWORKS AND WIDE AREA NETWORKS; COMPUTER SOFTWARE FOR COLLECTING, VIEWING AND ANALYZING COMPUTER HARDWARE INVENTORY DATA; COMPUTER BUSINESS APPLICATION SOFTWARE FOR STORAGE OF DATA, DATA SECURITY PROTECTION, DATA BACKUP, DATA RESTORING AND DATA SHARING DIRECTLY FOR THE USER OR FOR ANOTHER APPLICATION PROGRAM FOR USE IN BUSINESS; COMPUTER SOFTWARE FOR MONITORING AND CONTROLLING ACCESS TO GLOBAL COMPUTER NETWORKS, COMPUTER SOFTWARE FOR MONITORING, TRACKING, TROUBLESHOOTING AND INVESTIGATING WEB INFRASTRUCTURE; AND COMPUTER SOFTWARE FOR DATA RETENTION AND DATA INDEXING TO DEMONSTRATE BEST PRACTICES WITH REGULATIONS APPLICABLE TO THE INDUSTRY FOR USE IN THE FIELDS OF DATA COMMUNICATIONS AND TELECOMMUNICATIONS (U.S. CLS. 21, 23, 26, 36 AND 38).

FIRST USE 1-5-2006; IN COMMERCE 1-5-2006.

CLASS 42—SCIENTIFIC AND COMPUTER SERVICES

FOR COMPUTER CONSULTING SERVICES; COMPUTER SECURITY SERVICES, NAMELY, RESTRICTING ACCESS TO AND BY COMPUTER NETWORKS TO AND OF UNDESIRED WEBSITES, MEDIA AND INDIVIDUALS AND FACILITIES; DATA ENCRYPTION SERVICES, NAMELY, ADMINISTRATION OF DIGITAL KEYS AND DIGITAL CERTIFICATES TO ENSURE SECURITY OF ELECTRONICALLY TRANSMITTED DATA AND INFORMATION; TECHNICAL SUPPORT, NAMELY, REMOTE AND ON-SITE MONITORING OF NETWORK SYSTEMS; ON-LINE TECHNICAL SUPPORT SERVICES, NAMELY, TROUBLESHOOTING OF COMPUTER HARDWARE AND SOFTWARE PROBLEMS VIA A GLOBAL COMPUTER NETWORK; ON-LINE COMPUTER SERVICES, NAMELY, PROVIDING UPGRADES OF COMPUTER SOFTWARE AND MAINTENANCE OF INTERNAL COMPUTER NETWORK SOFTWARE; COMPUTER NETWORK DESIGN SERVICES FOR OTHERS (U.S. CLS. 100 AND 101).

FIRST USE 1-5-2006; IN COMMERCE 1-5-2006.

3,399,672. SUMMIT LABORATORIES, INC., HARVEY, IL.
SN 78-749,527. PUB. 3-6-2007, FILED 11-8-2005.

3,399,681. ILLUMINATING CONCEPTS, LTD., FARMING-
TON HILLS, MI. SN 78-755,866. PUB. 11-14-2006, FILED
11-17-2005.

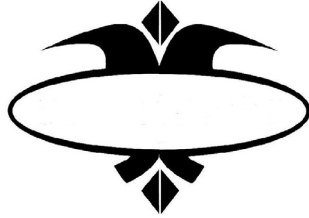

OWNER OF U.S. REG. NO. 828,884.
THE MARK CONSISTS OF A STYLIZED DEPICTION OF
A JESTER'S HAT.

CLASS 3—COSMETICS AND CLEANING PREPARATIONS

FOR DEPILATORIES; DEPILATORY CREAMS; EXFOLIANTS FOR SKIN; HAIR CARE PREPARATIONS; HAIR CONDITIONERS; SKIN CREAMS; SKIN MOISTURIZER; SKIN TONERS; SKIN WHITENING CREAMS (U.S. CLS. 1, 4, 6, 50, 51 AND 52).
FIRST USE 10-31-2003; IN COMMERCE 10-31-2003.

CLASS 5—PHARMACEUTICALS

FOR HAIR GROWTH STIMULANTS (U.S. CLS. 6, 18, 44, 46, 51 AND 52).
FIRST USE 10-31-2003; IN COMMERCE 10-31-2003.

3,399,677. HALLMARK, DAVID A., PORTSMOUTH, NH. SN
78-753,458. PUB. 8-8-2006, FILED 11-14-2005.



THE MARK CONSISTS OF STYLIZED WORDS "VIN" AND "FIZ" WITH A BUNCH OF GRAPES BETWEEN THE WORDS.

CLASS 16—PAPER GOODS AND PRINTED MATTER

FOR BALL POINT PENS; ENVELOPES FOR STATIONERY USE; MAPS; MOUNTED POSTERS; POSTERS; IRON-ON TRANSFERS (U.S. CLS. 2, 5, 22, 23, 29, 37, 38 AND 50).
FIRST USE 7-1-2006; IN COMMERCE 1-4-2007.

CLASS 25—CLOTHING

FOR BASEBALL CAPS; T-SHIRTS (U.S. CLS. 22 AND 39).
FIRST USE 7-1-2006; IN COMMERCE 1-4-2007.

MEDIAMORFX

THE MARK CONSISTS OF STANDARD CHARACTERS WITHOUT CLAIM TO ANY PARTICULAR FONT, STYLE, SIZE, OR COLOR.

CLASS 9—ELECTRICAL AND SCIENTIFIC APPARATUS

FOR COMPUTER HARDWARE AND SOFTWARE FOR MONITORING, CONTROLLING AND INTEGRATING MULTIMEDIA DEVICES, NAMELY, AUDIO, VIDEO, DIGITAL MEDIA AND GRAPHICS CONTENT DELIVERY DEVICES AND LIGHTING SYSTEMS, NAMELY, SENSORS, TWO WAY COMMUNICATION DEVICES, LIGHTING CONTROLS AND ELECTRIC LIGHTING FIXTURES AND PARTS AND ACCESSORIES THEREFOR TO CREATE AUDIOVISUAL EFFECTS IN COMBINATION WITH DIGITAL CONTENT AND MULTIMEDIA OUTPUT FOR PERSONAL USE AND USE BY BUSINESSES AND GOVERNMENTAL AGENCIES (U.S. CLS. 21, 23, 26, 36 AND 38).
FIRST USE 12-8-2002; IN COMMERCE 2-2-2004.

CLASS 37—CONSTRUCTION AND REPAIR

FOR INSTALLATION, REPAIR, AND MAINTENANCE OF COMPUTER HARDWARE AND SOFTWARE, MULTIMEDIA PRODUCTS AND LIGHTING SYSTEMS FOR PERSONAL USE AND USE BY BUSINESSES AND GOVERNMENTAL AGENCIES (U.S. CLS. 100, 103 AND 106).
FIRST USE 12-8-2002; IN COMMERCE 2-2-2004.

CLASS 42—SCIENTIFIC AND COMPUTER SERVICES

FOR ANALYSIS, DESIGN AND DEVELOPMENT OF COMPUTER HARDWARE AND SOFTWARE, MULTIMEDIA PRODUCTS AND LIGHTING SYSTEMS FOR PERSONAL USE AND USE BY BUSINESSES AND GOVERNMENTAL AGENCIES, INSTALLATION, REPAIR AND MAINTENANCE OF COMPUTER SOFTWARE (U.S. CLS. 100 AND 101).
FIRST USE 12-8-2002; IN COMMERCE 2-2-2004.

3,399,684. THANG LONG GARMENTS COMPANY LIMITED, VUNG TAU CITY, BA RIA - VUNG TAU PROVINCE, VIETNAM. SN 78-756,645. PUB. 8-8-2006, FILED 11-17-2005.

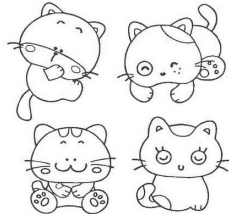

CLASS 18—LEATHER GOODS

FOR HANDBAGS, TRAVEL BAGS, SHOULDER BAGS, PURSES, DRAWSTRING POUCHES, FELT POUCHES, POUCHES OF LEATHER, LEATHER BAGS FOR MERCHANDISE PACKAGING IN THE NATURE OF ENVELOPES OR POUCHES, TOOL POUCHES SOLD EMPTY, WALLETS (U.S. CLS. 1, 2, 3, 22 AND 41).
FIRST USE 1-30-2007; IN COMMERCE 1-30-2007.

CLASS 20—FURNITURE AND ARTICLES NOT OTHERWISE CLASSIFIED

FOR MATTRESSES, CUSHIONS, PILLOWS, PET CUSHIONS, PICTURE FRAMES NOT OF PRECIOUS METAL, NAME-PLATE OF TEXTILE (U.S. CLS. 2, 13, 22, 25, 32 AND 50).
FIRST USE 1-30-2007; IN COMMERCE 1-30-2007.

CLASS 24—FABRICS

FOR BED BLANKETS, TEXTILE PLACE MATS, PILLOWCASES, COVERS FOR CUSHIONS, CURTAINS, TABLE CLOTHS NOT OF PAPER, MATTRESS COVERS, TEXTILE WALL HANGINGS (U.S. CLS. 42 AND 50).
FIRST USE 1-30-2007; IN COMMERCE 1-30-2007.

CLASS 25—CLOTHING

FOR APRONS, JACKETS, PYJAMAS, TROUSERS, JUMPER SKIRT, T-SHIRT, SLIPPERS, HATS, BLOUSES, GLOVES OF TEXTILE (U.S. CLS. 22 AND 39).
FIRST USE 1-30-2007; IN COMMERCE 1-30-2007.

3,399,685. MATTHEY-JOHNSON, PHYLLIS A., DILLSBURG, PA. SN 78-756,664. PUB. 4-24-2007, FILED 11-17-2005.

VIKTOR'S PROMISE

THE MARK CONSISTS OF STANDARD CHARACTERS WITHOUT CLAIM TO ANY PARTICULAR FONT, STYLE, SIZE, OR COLOR.

CLASS 16—PAPER GOODS AND PRINTED MATTER

FOR PAPER AND PRINTED MATTER, NAMELY, PRE-WRITTEN ARTICLES FOR REPUBLICATION BY OTHERS IN BOOKLETS, BROCHURES, MAGAZINES, MANUALS, NEWSLETTERS, NEWSPAPERS, PAMPHLETS AND PERIODICALS FEATURING INFORMATION AND STORIES RELATING PRIMARILY TO ORPHAN AND DESTITUTE CHILDREN WORLDWIDE; ALBUMS, NAMELY, PHOTOGRAPH AND SCRAPBOOK; BOOK COVERS; BOOKMARKS, CALENDARS, COLORING AND ACTIVITY BOOKS; PRINTED GREETING CARDS; PENS AND PENCILS; PHOTOGRAPHS AND PRINTS MOUNTED AND UNMOUNTED; PORTRAITS; POSTERS, POSTCARDS; STATIONERY, NAMELY, BINDERS, FOLDERS, NOTEBOOKS, PADS; STICKERS AND DECALS (U.S. CLS. 2, 5, 22, 23, 29, 37, 38 AND 50).
FIRST USE 11-18-2005; IN COMMERCE 11-18-2005.

CLASS 41—EDUCATION AND ENTERTAINMENT

FOR CHARITABLE SERVICES, NAMELY, PROVIDING PLAY EQUIPMENT (U.S. CLS. 100, 101 AND 107).
FIRST USE 11-18-2005; IN COMMERCE 11-18-2005.

3,399,692. ASCENT MEDIA GROUP, LLC, SANTA MONICA, CA. SN 78-758,728. PUB. 3-20-2007, FILED 11-21-2005.

C03

THE MARK CONSISTS OF STANDARD CHARACTERS WITHOUT CLAIM TO ANY PARTICULAR FONT, STYLE, SIZE, OR COLOR.

CLASS 40—MATERIAL TREATMENT

FOR FILM AND VIDEO PROCESSING SERVICES, NAMELY, COLOR CORRECTION, IMAGE STANDARDS CONVERSION, ELECTRONICALLY PRODUCING VIDEOTAPE FROM MOTION PICTURE FILM; MOTION PICTURE FILM AND VIDEOTAPE DATA COMPRESSION SERVICES; VIDEOTAPE, AUDIO TAPE AND MOTION PICTURE FILM DUPLICATION; DUPLICATION OF STANDARD AND HIGH-DEFINITION AUDIOVISUAL DAILIES/RUSHES, PREVIEWS AND DIGITAL INTERMEDIATES FOR OTHERS; FINISHING AND COMPOSITING OF FILM AND VIDEO AND CONFORMING OF SAME (U.S. CLS. 100, 103 AND 106).
FIRST USE 12-31-1997; IN COMMERCE 12-31-1997.

CLASS 41—EDUCATION AND ENTERTAINMENT

FOR MOTION PICTURE FILM, VIDEOTAPE AND DIGITAL VIDEO LABORATORY AND POST-PRODUCTION SERVICES, NAMELY, FEATURE FILM MASTERING SERVICES; POST-PRODUCTION SERVICES FOR THE TELEVISION AND MOTION PICTURE INDUSTRY IN THE NATURE OF PROVIDING COMPUTER GENERATED SPECIAL EFFECTS; PRODUCTION OF STANDARD AND HIGH-DEFINITION AUDIOVISUAL DAILIES/RUSHES, PREVIEWS AND DIGITAL INTERMEDIATES FOR OTHERS; TITLING FOR FILM AND TELEVISION (U.S. CLS. 100, 101 AND 107).
FIRST USE 12-31-1997; IN COMMERCE 12-31-1997.

3,399,694. THANG LONG GARMENTS COMPANY LIMITED, VUNG TAU CITY, BA RIA-VUNG TAU PROVINCE, VIETNAM. SN 78-759,910. PUB. 8-8-2006, FILED 11-23-2005.



CLASS 18—LEATHER GOODS

FOR HANDBAGS, TRAVEL BAGS, SHOULDER BAGS, PURSES, DRAWSTRING POUCHES, FELT POUCHES, POUCHES OF LEATHER, LEATHER BAGS FOR MERCHANDISE PACKAGING IN THE NATURE OF ENVELOPES OR POUCHES, TOOL POUCHES SOLD EMPTY, WALLETS (U.S. CLS. 1, 2, 3, 22 AND 41).
FIRST USE 1-30-2007; IN COMMERCE 1-30-2007.

CLASS 20—FURNITURE AND ARTICLES NOT OTHERWISE CLASSIFIED

FOR MATTRESSES, CUSHIONS, PILLOWS, PET CUSHIONS, PICTURE FRAMES NOT OF PRECIOUS METAL, NAME-PLATE OF TEXTILE (U.S. CLS. 2, 13, 22, 25, 32 AND 50).
FIRST USE 1-30-2007; IN COMMERCE 1-30-2007.

CLASS 24—FABRICS

FOR BED BLANKETS, TEXTILE PLACE MATS, PILLOWCASES, COVERS FOR CUSHIONS, CURTAINS, TABLE CLOTHS NOT OF PAPER, MATTRESS COVERS, TEXTILE WALL HANGINGS (U.S. CLS. 42 AND 50).
FIRST USE 1-30-2007; IN COMMERCE 1-30-2007.

CLASS 25—CLOTHING

FOR APRONS, JACKETS, PYJAMAS, TROUSERS, JUMPER SKIRT, T-SHIRT, SLIPPERS, HATS, BLOUSES, GLOVES OF TEXTILE (U.S. CLS. 22 AND 39).
FIRST USE 1-30-2007; IN COMMERCE 1-30-2007.

3,399,696. BOSSDEV INC., ST. CLAIR SHORES, MI. SN 78-760,555. PUB. 3-6-2007, FILED 11-23-2005.

BOSSDEV

THE MARK CONSISTS OF STANDARD CHARACTERS WITHOUT CLAIM TO ANY PARTICULAR FONT, STYLE, SIZE, OR COLOR.

CLASS 9—ELECTRICAL AND SCIENTIFIC APPARATUS

FOR DOWNLOADABLE COMPUTER SOFTWARE FOR USE IN KNOWLEDGE AND LOGISTICS MANAGEMENT THAT MAY BE ACCESSIBLE VIA A GLOBAL COMPUTER NETWORK; DOWNLOADABLE COMPUTER SOFTWARE FOR USE IN KNOWLEDGE, INVENTORY AND FINANCE MANAGEMENT THAT MAY BE ACCESSIBLE VIA A GLOBAL COMPUTER NETWORK; COMPUTER SOFTWARE FOR THE COLLECTION, EDITING, ORGANIZING, MODIFYING, TRANSMISSION, OUTPUT AND SHARING OF DATA AND INFORMATION; DOWNLOADABLE COMPUTER SOFTWARE FEATURING EDUCATION AND TRAINING IN KNOWLEDGE, INVENTORY AND FINANCE MANAGEMENT THAT MAY BE ACCESSIBLE VIA A GLOBAL COMPUTER NETWORK (U.S. CLS. 21, 23, 26, 36 AND 38).
FIRST USE 4-0-2005; IN COMMERCE 4-0-2005.

CLASS 37—CONSTRUCTION AND REPAIR

FOR MAINTENANCE AND REPAIR OF COMPUTER HARDWARE AND COMPUTER NETWORKS (U.S. CLS. 100, 103 AND 106).
FIRST USE 4-0-2005; IN COMMERCE 4-0-2005.

CLASS 42—SCIENTIFIC AND COMPUTER SERVICES

FOR PROVIDING TEMPORARY USE OF ON-LINE NON-DOWNLOADABLE SOFTWARE FOR USE IN KNOWLEDGE AND LOGISTICS MANAGEMENT THAT MAY BE ACCESSIBLE VIA A GLOBAL COMPUTER NETWORK; PROVIDING TEMPORARY USE OF ON-LINE NON-DOWNLOADABLE SOFTWARE FOR USE IN KNOWLEDGE, INVENTORY AND FINANCE MANAGEMENT THAT MAY BE ACCESSIBLE VIA A GLOBAL COMPUTER NETWORK; PROVIDING TEMPORARY USE OF ON-LINE NON-DOWNLOADABLE SOFTWARE FEATURING EDUCATION AND TRAINING IN KNOWLEDGE, INVENTORY AND FINANCE MANAGEMENT THAT MAY BE ACCESSIBLE VIA A GLOBAL COMPUTER NETWORK; DESIGN, DEVELOPMENT, IMPLEMENTATION AND MAINTENANCE OF COMPUTER SOFTWARE SYSTEMS THAT MAY BE ACCESSIBLE VIA A GLOBAL COMPUTER NETWORK; DESIGN, DEVELOPMENT, IMPLEMENTATION AND MAINTENANCE OF COMPUTER SOFTWARE SYSTEMS FOR USE WITH EDUCATION AND TRAINING THAT MAY BE ACCESSIBLE VIA A GLOBAL COMPUTER NETWORK; CREATING AND MAINTAINING WEB SITES AND WEB CONTENT FOR OTHERS; CONSULTING SERVICES IN THE FIELD OF COMPUTER HARDWARE AND SOFTWARE; PROVIDING QUALITY ASSURANCE AND ADVISORY SERVICES IN THE FIELD OF COMPUTER SOFTWARE AND HARDWARE; MAINTENANCE AND REPAIR OF COMPUTER SOFTWARE (U.S. CLS. 100 AND 101).
FIRST USE 6-0-2004; IN COMMERCE 6-0-2004.

3,399,704. VIDEO PROFESSOR, INC., LAKEWOOD, CO. SN 78-764,342. PUB. 1-9-2007, FILED 12-1-2005.

SOFTWARE SAVERS

THE MARK CONSISTS OF STANDARD CHARACTERS WITHOUT CLAIM TO ANY PARTICULAR FONT, STYLE, SIZE, OR COLOR.

OWNER OF U.S. REG. NO. 2,962,585.
NO CLAIM IS MADE TO THE EXCLUSIVE RIGHT TO USE "SOFTWARE", APART FROM THE MARK AS SHOWN.

CLASS 9—ELECTRICAL AND SCIENTIFIC APPARATUS

FOR SOFTWARE USED IN THE FIELD OF TRAINING, NAMELY, SOFTWARE USED FOR TRAINING AND INSTRUCTION IN THE USE OF COMPUTERS AND COMPUTER SOFTWARE (U.S. CLS. 21, 23, 26, 36 AND 38).

FIRST USE 8-30-2002; IN COMMERCE 8-30-2002.

CLASS 35—ADVERTISING AND BUSINESS

FOR COMPUTERIZED ONLINE RETAIL STORE SERVICES AND MAIL ORDER SERVICES FEATURING COMPUTER SOFTWARE AND COMPUTER SOFTWARE UPDATES (U.S. CLS. 100, 101 AND 102).

FIRST USE 8-30-2002; IN COMMERCE 8-30-2002.

3,399,734. MARK ANTHONY INTERNATIONAL SRL, ROCKLEY, CHRIST CHURCH, BARBADOS. SN 78-775,379. PUB. 6-6-2006, FILED 12-16-2005.

MIKE'S LIGHT

THE MARK CONSISTS OF STANDARD CHARACTERS WITHOUT CLAIM TO ANY PARTICULAR FONT, STYLE, SIZE, OR COLOR.

OWNER OF U.S. REG. NOS. 2,501,401, 2,577,759, AND OTHERS.

NO CLAIM IS MADE TO THE EXCLUSIVE RIGHT TO USE "LIGHT" AS TO THE GOODS IN INTERNATIONAL CLASSES 32 AND 33, APART FROM THE MARK AS SHOWN.

CLASS 18—LEATHER GOODS

FOR BAGS, NAMELY, BACKPACKS (U.S. CLS. 1, 2, 3, 22 AND 41).

FIRST USE 10-20-2004; IN COMMERCE 10-20-2004.

CLASS 25—CLOTHING

FOR CLOTHING, NAMELY, SHIRTS, T-SHIRTS (U.S. CLS. 22 AND 39).

FIRST USE 1-5-2004; IN COMMERCE 1-5-2004.

CLASS 32—LIGHT BEVERAGES

FOR FLAVORED BREWED MALT-BASED ALCOHOLIC BEVERAGES IN THE NATURE OF A BEER (U.S. CLS. 45, 46 AND 48).

FIRST USE 1-5-2004; IN COMMERCE 1-5-2004.

CLASS 33—WINES AND SPIRITS

FOR FLAVORED ALCOHOLIC MALT COOLERS (U.S. CLS. 47 AND 49).

FIRST USE 1-5-2004; IN COMMERCE 1-5-2004.

3,399,737. GREATWIDE LOGISTICS SERVICES, INC., DALLAS, TX. SN 78-776,497. PUB. 12-12-2006, FILED 12-19-2005.

GREATWIDE DEDICATED TRANSPORT

THE MARK CONSISTS OF STANDARD CHARACTERS WITHOUT CLAIM TO ANY PARTICULAR FONT, STYLE, SIZE, OR COLOR.

NO CLAIM IS MADE TO THE EXCLUSIVE RIGHT TO USE "DEDICATED TRANSPORT", APART FROM THE MARK AS SHOWN.

CLASS 35—ADVERTISING AND BUSINESS

FOR WAREHOUSE MANAGEMENT AND OPERATION; AND FREIGHT MANAGEMENT, NAMELY, PROVIDING ELECTRONIC TRACKING OF FREIGHT INFORMATION TO OTHERS, AND INFORMATION MANAGEMENT SERVICES, NAMELY, SHIPMENT PROCESSING, PREPARING SHIPMENT DOCUMENTS AND INVOICES, TRACKING DOCUMENTS, PACKAGES AND FREIGHT OVER COMPUTER NETWORKS, INTRANETS AND INTERNETS (U.S. CLS. 100, 101 AND 102).

FIRST USE 1-6-2006; IN COMMERCE 1-6-2006.

CLASS 39—TRANSPORTATION AND STORAGE

FOR FREIGHT TRANSPORTATION BY TRUCK; AND TRANSPORT BROKERAGE (U.S. CLS. 100 AND 105).

FIRST USE 1-6-2006; IN COMMERCE 1-6-2006.

3,399,739. KIOSK INFORMATION SYSTEMS, INC., LOUISVILLE, CO. SN 78-777,543. PUB. 7-31-2007, FILED 12-20-2005.



NO CLAIM IS MADE TO THE EXCLUSIVE RIGHT TO USE "KIOSK", APART FROM THE MARK AS SHOWN.

CLASS 9—ELECTRICAL AND SCIENTIFIC APPARATUS

FOR KIOSKS, NAMELY, COMPUTER-OPERATED KIOSKS COMPRISED OF COMPUTER HARDWARE AND SOFTWARE FOR USE IN A WIDE VARIETY OF APPLICATIONS, NAMELY, ALLOWING THE PUBLIC TO ACCESS INFORMATION, OBTAIN GOODS AND SERVICES, AND CARRY ON TRANSACTIONS VIA A GLOBAL COMPUTER NETWORK, NAMELY, THE PURCHASE OF GOODS AND SERVICES, AND ELECTRONIC CASH, CREDIT AND DEBIT TRANSACTIONS (U.S. CLS. 21, 23, 26, 36 AND 38).

FIRST USE 1-9-2006; IN COMMERCE 1-9-2006.

CLASS 37—CONSTRUCTION AND REPAIR

FOR INSTALLATION AND MAINTENANCE OF COMPUTER-OPERATED KIOSKS USED FOR PROVIDING ACCESS TO A GLOBAL COMPUTER NETWORK (U.S. CLS. 100, 103 AND 106).

FIRST USE 1-9-2006; IN COMMERCE 1-9-2006.

CLASS 40—MATERIAL TREATMENT

FOR CUSTOM MANUFACTURE OF COMPUTER-OPERATED KIOSKS USED FOR PROVIDING ACCESS TO A GLOBAL COMPUTER NETWORK (U.S. CLS. 100, 103 AND 106).

FIRST USE 1-9-2006; IN COMMERCE 1-9-2006.

CLASS 42—SCIENTIFIC AND COMPUTER SERVICES

FOR CUSTOM DESIGN OF COMPUTER-OPERATED KIOSKS USED FOR PROVIDING ACCESS TO A GLOBAL COMPUTER NETWORK; INSTALLATION AND MAINTENANCE OF COMPUTER SOFTWARE IN COMPUTER-OPERATED KIOSKS USED FOR PROVIDING ACCESS TO A GLOBAL COMPUTER NETWORK (U.S. CLS. 100 AND 101).

FIRST USE 1-9-2006; IN COMMERCE 1-9-2006.

CLASS 16—PAPER GOODS AND PRINTED MATTER

FOR PRINTED TESTING MATERIALS FOR USE IN ASSESSING JOB SKILLS; PRINTED INSTRUCTIONAL MATERIALS FOR USE IN JOB SKILL TRAINING; PRINTED INSTRUCTIONAL MATERIALS IN THE FIELD OF HUMAN RESOURCES; STRUCTURED INTERVIEW FORMS USED TO INTERVIEW JOB APPLICANTS OVER THE TELEPHONE TO DETERMINE VERBAL COMMUNICATION SKILLS, INCLUDING PACE, VOLUME, SOUND QUALITY, ENUNCIATION, AND COMMAND OF THE LANGUAGE; INTERVIEW FORMS, INSTRUCTION SHEETS, AND AUDIO CASSETTE TAPES SOLD AND USED AS A UNIT FOR TRAINING THE INTERVIEWERS; STRUCTURED JOB SKILLS FORM USED TO IDENTIFY AND RECORD EMPLOYMENT SKILLS AND SKILL LEVELS AND TO CREATE EMPLOYMENT CAREER DEVELOPMENT PLANS FOR JOB APPLICANTS, AND INSTRUCTIONAL MANUALS FOR USE THEREWITH, DISTRIBUTED AS A UNIT; PRINTED TESTING MATERIALS USED TO EVALUATE EMPLOYEE SKILLS AT TASKS NEEDED FOR LIGHT INDUSTRIAL WORK AND INSTRUCTIONAL MANUALS SOLD TOGETHER AS A UNIT; WRITTEN TEST AND SCORING MATERIALS, AND SAMPLE AUDIOCASSETTE DICTATION TAPES FURNISHED THEREWITH AS A UNIT, FOR EVALUATING THE PROFICIENCY OF COMPUTERIZED OFFICE EQUIPMENT OPERATORS; PRINTED EMPLOYEE INTAKE FORMS; BUSINESS FORMS; PRINTED AND PARTIALLY PRINTED FORMS; PRINTED TRAINING MANUALS FOR JOB SKILL TRAINING; PRINTED MONOGRAPHS, NEWSLETTERS AND BULLETINS, ALL IN THE FIELD OF HUMAN RESOURCES; MAGAZINES AND NEWSLETTERS, REPORTS AND PRINTED INSTRUCTIONAL MATERIALS FEATURING ARTICLES ABOUT CAREER MANAGEMENT, CAREER PLACEMENT, CAREER RECRUITING, EMPLOYMENT COUNSELING, EMPLOYMENT OUTPLACEMENT, HUMAN RESOURCE CONSULTATION, PERSONNEL MANAGEMENT CONSULTATION, PERSONNEL RETENTION CONSULTATION, CAREER MANAGEMENT CONSULTATION, RETIREMENT COUNSELING AND PLANNING (U.S. CLS. 2, 5, 22, 23, 29, 37, 38 AND 50).

FIRST USE 2-21-2006; IN COMMERCE 2-21-2006.

3,399,743. MANPOWER INC., MILWAUKEE, WI. SN 78-780,208. PUB. 12-5-2006, FILED 12-23-2005.

CLASS 35—ADVERTISING AND BUSINESS

FOR EMPLOYMENT AGENCY SERVICES; TEMPORARY AND PERMANENT EMPLOYMENT AGENCY SERVICES; EMPLOYEE LEASING; EMPLOYMENT RELATED SERVICES, NAMELY PROVIDING JOB PLACEMENT, CAREER DEVELOPMENT, EMPLOYMENT RECRUITMENT, AND GENERAL EMPLOYMENT INFORMATION TO OTHERS; PERSONNEL MANAGEMENT, HUMAN RESOURCES MANAGEMENT; SUPPLYING TO OTHERS ON A TEMPORARY AND PERMANENT BASIS ENGINEERS, COMPUTER PROGRAMMERS, DRAFTSMEN, AND SKILLED TECHNICAL PERSONNEL; PROVIDING AND MANAGING CONTRACT PERSONNEL PROGRAMS; ANALYZING AND CONSULTING ON PERSONNEL NEEDS; PROVIDING CONTRACT, TEMPORARY, AND PERMANENT PERSONNEL STAFFING SERVICES; ARRANGING FOR AND MANAGING THE PROVISION OF TEMPORARY CONTRACT PERSONNEL; PERSONNEL MANAGEMENT AND CONSULTANCY SERVICES; PROVIDING INFORMATION AND CONSULTANCY SERVICES ON THE PROCUREMENT OF TEMPORARY, CONTRACT, AND PERMANENT PERSONNEL; COMPUTER ON-LINE ORDERING VIA A GLOBAL INFORMATION NETWORK, AND PROVIDING COMPUTER ON-LINE REPORTS VIA A GLOBAL INFORMATION NETWORK, ALL IN THE FIELD OF PERSONNEL PROCUREMENT; HUMAN RESOURCES CONSULTING ON RECRUITING AND TESTING OF EMPLOYEES; CONTRACT AND PERMANENT STAFFING AGENCY SERVICES FEATURING STAFF PROFESSIONALS IN FINANCE, INFORMATION TECHNOLOGY, ENGINEERING, SCIENTIFIC AND TECHNICAL PERSONNEL, AS WELL AS OFFICE ADMINISTRATIVE STAFF, FACTORY STAFF, INDUSTRIAL STAFF AND CALL CENTER STAFF; SERVING AS A HUMAN RESOURCE DEPARTMENT FOR OTHERS; TESTING TO DETERMINE EMPLOYMENT SKILLS; EMPLOYMENT COUNSELING; WORKFORCE DEVELOPMENT SERVICES, NAMELY, PERSONNEL MANAGEMENT SERVICES; PROVIDING

WHAT DO YOU DO?

THE MARK CONSISTS OF STANDARD CHARACTERS WITHOUT CLAIM TO ANY PARTICULAR FONT, STYLE, SIZE, OR COLOR.

CAREER INFORMATION VIA A WEBSITE ON A GLOBAL INFORMATION NETWORK; PROVIDING INFORMATION ON JOBS VIA A WEBSITE ON A GLOBAL INFORMATION NETWORK; PROVIDING AN ON-LINE COMPUTER DATABASE IN THE FIELDS OF CONTRACT AND PERMANENT PERSONNEL STAFFING; PROVIDING EMPLOYEE SCREENING AND ASSESSMENT TOOLS VIA A WEBSITE ON A GLOBAL INFORMATION NETWORK; RESUME LISTING SERVICES; RESUME MATCHING SERVICES; BUSINESS PROCESS OUTSOURCING SERVICES; PROVISION OF TESTING SERVICES DESIGNED TO DETERMINE THE INDUSTRIAL SKILLS, DEXTERITY AND HAND-EYE COORDINATION OF EMPLOYEE AND TEMPORARY HELP PERSONNEL; PERSONALITY TESTING AND PROFILING SERVICES FOR USE IN THE FIELD OF HUMAN RESOURCES; TEMPORARY PERSONNEL SERVICES; PLACEMENT OF TEMPORARY PERSONNEL; PLACEMENT OF PERMANENT PERSONNEL; PERSONNEL RECRUITMENT; EMPLOYMENT AGENCY SERVICES; PSYCHOLOGICAL TESTING FOR THE SELECTION OF PERSONNEL TO DETERMINE THEIR SUITABILITY FOR EMPLOYMENT; TESTING OF INDIVIDUALS TO DETERMINE EMPLOYMENT SKILLS; PROVISION OF JOB CANDIDATE EVALUATION AND SELECTION SERVICES; DEMONSTRATION AND SALES PROMOTION SERVICES; OFFICE FUNCTIONS; BUSINESS INFORMATION AND CONSULTANCY SERVICES RELATING TO THE PROCUREMENT OF TEMPORARY AND CONTRACT PERSONNEL; PERSONNEL MANAGEMENT AND CONSULTING SERVICES IN THE FIELD OF HUMAN RESOURCES; BUSINESS CONSULTATION SERVICES, NAMELY CAREER MANAGEMENT SERVICES, CAREER PLACEMENT SERVICES, CAREER RECRUITING SERVICES, EMPLOYMENT COUNSELING SERVICES, EMPLOYMENT OUTPLACEMENT SERVICES, CAREER RECRUITING SERVICES, EMPLOYMENT COUNSELING SERVICES, EMPLOYMENT OUTPLACEMENT SERVICES, HUMAN RESOURCE CONSULTATION SERVICES, PERSONNEL MANAGEMENT CONSULTATION SERVICES, PERSONNEL RETENTION CONSULTATION SERVICES AND CAREER MANAGEMENT CONSULTATION SERVICES; RESUME LISTING SERVICES; RESUME MATCHING SERVICES; BUSINESS PROCESS OUTSOURCING SERVICES; TEMPORARY PROFESSIONAL PERSONNEL SERVICES; PLACEMENT OF TEMPORARY PROFESSIONAL PERSONNEL; RECRUITMENT OF PROFESSIONAL PERSONNEL; EMPLOYMENT AGENCIES FOR THE PLACEMENT OF PROFESSIONAL PERSONNEL; TESTING OF INDIVIDUALS TO DETERMINE EMPLOYMENT SKILLS; TESTING DESIGNED TO DETERMINE THE INDUSTRIAL SKILLS, DEXTERITY AND HAND-EYE COORDINATION OF EMPLOYEE AND TEMPORARY HELP PERSONNEL; PERSONNEL TESTING OF ALL KINDS, NAMELY TESTING OF JOB AND BUSINESS SKILLS, INFORMATION TECHNOLOGY AND SOFTWARE USE SKILLS, PERSONALITY TESTING AND PROFILING FOR USE IN THE FIELD OF HUMAN RESOURCES (U.S. CLS. 100, 101 AND 102).

FIRST USE 2-21-2006; IN COMMERCE 2-21-2006.

CLASS 41—EDUCATION AND ENTERTAINMENT

FOR PROVIDING TRAINING IN BUSINESS AND JOB SKILLS AND OFFICE TECHNOLOGY; PROVIDING ON-LINE COURSES OF STUDY IN THE FOLLOWING - INFORMATION TECHNOLOGY, SOFTWARE USE, JOB AND BUSINESS SKILLS VIA A WEBSITE ON A GLOBAL INFORMATION NETWORK; CAREER COUNSELING SERVICES; EDUCATION AND TRAINING SERVICES, NAMELY, PROVIDING TRAINING IN RELATION TO JOB SEARCH, CAREER DEVELOPMENT, SELF-MARKETING, INTERVIEW SKILLS, RESEARCH WORKSHOPS AND TRAINING OF HUMAN RESOURCE PERSONNEL IN EMPLOYMENT SEPARATION ISSUES; INSTRUCTION SERVICES RELATING TO BUSINESS AND DATA PROCESSING; TRAINING SERVICES FOR PERSONNEL, NAMELY, TRAINING IN ACCOUNTING SKILLS, INFORMATION TECHNOLOGY SKILLS, OFFICE SKILLS, CLERICAL SKILLS CALL CENTER SKILLS, CUSTOMER SERVICE SKILLS, WORD PROCESSING SKILLS; PROVISION OF SKILL ASSESSMENT COURSES (U.S. CLS. 100, 101 AND 107).

FIRST USE 2-21-2006; IN COMMERCE 2-21-2006.

3,399,744. ACCORDENCE, INC., BURLINGAME, CA. SN 78-780,302. PUB. 3-20-2007, FILED 12-23-2005.

ICON

THE MARK CONSISTS OF STANDARD CHARACTERS WITHOUT CLAIM TO ANY PARTICULAR FONT, STYLE, SIZE, OR COLOR.

CLASS 35—ADVERTISING AND BUSINESS

FOR BUSINESS CONSULTING SERVICES IN THE FIELDS OF BUSINESS NEGOTIATION, BUSINESS PERSUASION AND CONFLICT RESOLUTION IN BUSINESS (U.S. CLS. 100, 101 AND 102).

FIRST USE 1-0-2005; IN COMMERCE 1-0-2005.

CLASS 41—EDUCATION AND ENTERTAINMENT

FOR TRAINING SERVICES IN THE FIELDS OF NEGOTIATION, PERSUASION AND CONFLICT RESOLUTION (U.S. CLS. 100, 101 AND 107).

FIRST USE 1-0-2005; IN COMMERCE 1-0-2005.

CLASS 42—SCIENTIFIC AND COMPUTER SERVICES

FOR MEDIATION SERVICES; CONSULTING IN THE FIELD OF LABOR NEGOTIATION AND CONFLICT RESOLUTION IN MEDIATION (U.S. CLS. 100 AND 101).

FIRST USE 1-0-2005; IN COMMERCE 1-0-2005.

3,399,747. PROXYMED, INC., NORCROSS, GA. SN 78-780,846. PUB. 3-20-2007, FILED 12-27-2005.

IT'S ABOUT TIME

THE MARK CONSISTS OF STANDARD CHARACTERS WITHOUT CLAIM TO ANY PARTICULAR FONT, STYLE, SIZE, OR COLOR.

CLASS 35—ADVERTISING AND BUSINESS

FOR MEDICAL CLAIMS MANAGEMENT SERVICES, NAMELY, RECEIVING, IMAGING, DATA ENTERING, AND RE-PRICING OF TRANSACTIONS THAT ARE ORIGINATED BY PHYSICIANS, HOSPITALS, AND ANCILLARY MEDICAL CARE PROVIDERS, AND REVIEWING HOSPITAL-ORIGINATED INVOICES; COMPUTERIZED DATABASE MANAGEMENT SERVICES IN THE FIELD OF HEALTH CARE AND MEDICAL CLAIMS (U.S. CLS. 100, 101 AND 102).

FIRST USE 12-9-2005; IN COMMERCE 12-9-2005.

CLASS 38—COMMUNICATION

FOR PROVIDING ACCESS VIA A COMPUTER NETWORK SUCH AS A GLOBAL COMPUTER NETWORK, TO FACILITIES FOR ENABLING PHYSICIANS, PHARMACIES, LABORATORIES, PAYERS AND OTHERS IN THE FIELD OF HEALTHCARE TO ENTER AND PROCESS TRANSACTIONS IN THE FIELD OF HEALTHCARE THROUGH THE SECURE EXCHANGE OF ELECTRONIC MESSAGES (U.S. CLS. 100, 101 AND 104).
FIRST USE 12-9-2005; IN COMMERCE 12-9-2005.

CLASS 42—SCIENTIFIC AND COMPUTER SERVICES

FOR PROVIDING TEMPORARY USE OF ON-LINE, NON-DOWNLOADABLE SOFTWARE FOR ENABLING PHYSICIANS, PHARMACIES, LABORATORIES, PAYORS AND OTHERS TO ENTER AND PROCESS TRANSACTIONS IN THE HEALTHCARE FIELD; PROVIDING TEMPORARY USE OF ON-LINE, NON-DOWNLOADABLE COMPUTER SOFTWARE FOR ORDERING CLINICAL TESTS AND FOR REPORTING AND RETRIEVING RESULTS OF SUCH TESTS; PROVIDING TEMPORARY USE OF NON-DOWNLOADABLE COMPUTER SOFTWARE FOR MONITORING AND COMMUNICATING INFORMATION TO USERS AS TO THE STATUS OF PRINTERS USED BY PHARMACIES, CLINICS, PHYSICIAN OFFICES, MEDICAL LABORATORIES OR OTHERS IN THE HEALTHCARE FIELD (U.S. CLS. 100 AND 101).

FIRST USE 12-9-2005; IN COMMERCE 12-9-2005.

3,399,754. ACK VENTURES HOLDINGS, LLC, DELRAY BEACH, FL. SN 78-782,033. PUB. 8-29-2006, FILED 12-28-2005.

DIGDOO

THE MARK CONSISTS OF STANDARD CHARACTERS WITHOUT CLAIM TO ANY PARTICULAR FONT, STYLE, SIZE, OR COLOR.

CLASS 9—ELECTRICAL AND SCIENTIFIC APPARATUS

FOR COMPUTER APPLICATION SOFTWARE FOR MOBILE PHONES; COMPUTER GAME PROGRAMS; COMPUTER GAME SOFTWARE; COMPUTER SOFTWARE FOR WIRELESS CONTENT DELIVERY; COMPUTER SOFTWARE TO ENABLE THE TRANSMISSION OF PHOTOGRAPHS TO MOBILE TELEPHONES; DOWNLOADABLE RING TONES, GRAPHICS AND MUSIC VIA A GLOBAL COMPUTER NETWORK AND WIRELESS DEVICES; ELECTRONIC GAME PROGRAMS; ELECTRONIC GAME SOFTWARE FOR CELLULAR TELEPHONES; ELECTRONIC GAME SOFTWARE FOR HANDHELD ELECTRONIC DEVICES; ELECTRONIC GAME SOFTWARE FOR WIRELESS DEVICES; MOBILE COMPUTING AND OPERATING PLATFORMS CONSISTING OF DATA TRANSCIEVERS, WIRELESS NETWORKS AND GATEWAYS FOR COLLECTION AND MANAGEMENT OF DATA (U.S. CLS. 21, 23, 26, 36 AND 38).

FIRST USE 3-21-2006; IN COMMERCE 3-21-2006.

CLASS 35—ADVERTISING AND BUSINESS

FOR DISTRIBUTORSHIPS IN THE FIELD OF WIRELESS GAME SOFTWARE AND WIRELESS ENTERTAINMENT SOFTWARE (U.S. CLS. 100, 101 AND 102).

FIRST USE 3-21-2006; IN COMMERCE 3-21-2006.

CLASS 38—COMMUNICATION

FOR WIRELESS COMMUNICATIONS SERVICES, NAMELY, TRANSMISSION OF GRAPHICS TO MOBILE TELEPHONES; WIRELESS ELECTRONIC TRANSMISSION OF VOICE SIGNALS, DATA, FACSIMILES, IMAGES AND INFORMATIONS (U.S. CLS. 100, 101 AND 104).

FIRST USE 3-21-2006; IN COMMERCE 3-21-2006.

CLASS 41—EDUCATION AND ENTERTAINMENT

FOR ORGANIZATION OF GAMES; PROVIDING A COMPUTER GAME THAT MAY BE ACCESSED NETWORK-WIDE BY NETWORK USERS; PROVIDING INFORMATION ON-LINE RELATING TO COMPUTER GAMES AND COMPUTER ENHANCEMENTS FOR GAMES (U.S. CLS. 100, 101 AND 107).

FIRST USE 3-21-2006; IN COMMERCE 3-21-2006.

3,399,764. CINTEX INTERNATIONAL (CANADA) LIMITED, MISSISSAUGA, ONTARIO, CANADA. SN 78-787,310. PUB. 10-3-2006, FILED 1-9-2006.

MISSION SOCCER

THE MARK CONSISTS OF STANDARD CHARACTERS WITHOUT CLAIM TO ANY PARTICULAR FONT, STYLE, SIZE, OR COLOR.

OWNER OF CANADA REG. NO. TMA591,945, DATED 10-9-2003, EXPIRES 10-9-2018.

NO CLAIM IS MADE TO THE EXCLUSIVE RIGHT TO USE "SOCCER", APART FROM THE MARK AS SHOWN.

CLASS 18—LEATHER GOODS

FOR ALL PURPOSE SPORT BAGS, TRAVELING BAGS, HANDBAGS, KNAPSACKS, WAIST PACKS, SHOEBAGS FOR TRAVEL, BRIEFCASES, SUITCASES AND UMBRELLAS (U.S. CLS. 1, 2, 3, 22 AND 41).

FIRST USE 10-9-2003; IN COMMERCE 11-5-2007.

CLASS 25—CLOTHING

FOR CLOTHING FOR SPORTS AND LEISURE, NAMELY, SPORTS SUITS, JACKETS, RAIN PROOF JACKETS, T-SHIRTS, TROUSERS, SHORTS, HATS, CAPS, PARKAS, SWEATERS, SOCKS, GLOVES AND SPORT GLOVES, BLUE JEANS, KNITTED JOGGING SUITS, KNITTED SHORTS, KNITTED PULLOVERS, KNITTED TROUSERS, KNITTED CARDIGANS, BATHING CAPS, BATHING SUITS, SHIRTS, SKI SUITS, LINGERIE, FOOTWEAR AND SPORTS FOOTWEAR, SWEAT BANDS (U.S. CLS. 22 AND 39).

FIRST USE 10-9-2003; IN COMMERCE 11-5-2007.

CLASS 28—TOYS AND SPORTING GOODS

FOR GYMNASTIC AND SPORTING GOODS AND EQUIPMENT, NAMELY, SOCCER BALLS, FOOTBALLS, BASKETBALLS, TENNIS BALLS, SPORTS BALLS, SMALL SPORTS BALLS; ATHLETIC SPORTING GOODS, NAMELY, ATHLETIC WRIST AND JOINT SUPPORTS, SHIN GUARDS WITH OR WITHOUT ANKLE GUARDS, KNEE BRACES, THIGH BRACES (U.S. CLS. 22, 23, 38 AND 50).

FIRST USE 10-9-2003; IN COMMERCE 11-5-2007.

3,399,782. KOBACKER, SOPHIA T., LAGUNA BEACH, CA.
SN 78-795,118. PUB. 8-28-2007, FILED 1-19-2006.

3,399,786. CATALYST INTERNATIONAL, INC., FOLCROFT, PA. SN 78-795,865. PUB. 4-10-2007, FILED 1-20-2006.

Soul Wings

THE MARK CONSISTS OF STANDARD CHARACTERS WITHOUT CLAIM TO ANY PARTICULAR FONT, STYLE, SIZE, OR COLOR.

NO CLAIM IS MADE TO THE EXCLUSIVE RIGHT TO USE "SOUL", APART FROM THE MARK AS SHOWN.

CLASS 9—ELECTRICAL AND SCIENTIFIC APPARATUS

FOR AUDIO VISUAL RECORDINGS RELATING TO LIFE VISION, LIFE ENHANCEMENT, ANGEL COMMUNICATION, SPIRITUALITY, HEALING AND FENG SHUI, FEATURING MUSIC, SPOKEN WORD AND RECORDED SOUNDS RECORDED ON CD'S, DVD'S AND OTHER ELECTRONIC FORMATS (U.S. CLS. 21, 23, 26, 36 AND 38).

FIRST USE 9-24-2004; IN COMMERCE 7-1-2005.

CLASS 16—PAPER GOODS AND PRINTED MATTER

FOR ORACLE CARDS, PRINTED EDUCATIONAL MATERIALS, BOOKS AND MAGAZINES RELATING TO LIFE VISION, LIFE ENHANCEMENT, ANGEL COMMUNICATION, SPIRITUALITY, HEALING AND FENG SHUI (U.S. CLS. 2, 5, 22, 23, 29, 37, 38 AND 50).

FIRST USE 9-24-2004; IN COMMERCE 7-1-2005.

CLASS 41—EDUCATION AND ENTERTAINMENT

FOR EDUCATION SERVICES, NAMELY, PROVIDING CLASSES, SEMINARS, WORKSHOPS, INFORMAL PROGRAMS, TUTORING AND MENTORING IN THE FIELD OF LIFE VISION, LIFE ENHANCEMENT, ANGEL COMMUNICATION, SPIRITUALITY, HEALING AND FENG SHUI, THROUGH ON-LINE AND OFF-LINE MEANS AND PRINTABLE MATERIALS DISTRIBUTED THEREWITH; ENTERTAINMENT SERVICES, NAMELY, PROVIDING A WEBSITE FEATURING, PHOTOGRAPHIC, AUDIO, VIDEO AND PROSE PRESENTATIONS FEATURING LIFE VISION AND ENHANCEMENT AND SPIRITUALITY, AND PRESENTATION OF LIVE SHOW PERFORMANCES ABOUT LIFE VISION, LIFE ENHANCEMENT, ANGEL COMMUNICATION, SPIRITUALITY, HEALING AND FENG SHUI (U.S. CLS. 100, 101 AND 107).

FIRST USE 9-24-2004; IN COMMERCE 7-1-2005.

CLASS 45—PERSONAL AND LEGAL SERVICES

FOR PROVIDING ON-LINE INFORMATION AND CONSULTATION IN THE FIELD OF SPIRITUALITY, SELF-HELP, AND PERSONAL EMPOWERMENT SUBJECT MATTERS SUCH AS LIFE VISION, LIFE ENHANCEMENT, ANGEL COMMUNICATION, SPIRITUALITY, AND SPIRITUAL HEALING (U.S. CLS. 100 AND 101).

FIRST USE 9-24-2004; IN COMMERCE 7-1-2005.

Comfor-Prene

THE MARK CONSISTS OF STANDARD CHARACTERS WITHOUT CLAIM TO ANY PARTICULAR FONT, STYLE, SIZE, OR COLOR.

CLASS 17—RUBBER GOODS

FOR HIGH DENSITY OPEN CELL URETHANE FOAM FOR DESIGNING CUSHIONING PRODUCTS FOR DIRECT CONTACT WITH THE SKIN (U.S. CLS. 1, 5, 12, 13, 35 AND 50).

FIRST USE 6-30-2006; IN COMMERCE 6-30-2006.

CLASS 24—FABRICS

FOR FABRIC MATERIAL, NAMELY, HIGH PERFORMANCE POLYURETHANE FOAM USED IN THE MANUFACTURE OF MEDICAL, SURGICAL AND ORTHOPEDIC SOFT GOODS, SPORTSWEAR, OUTERWEAR, FOOTWEAR, GLOVES AND MILITARY CLOTHING (U.S. CLS. 42 AND 50).

FIRST USE 6-30-2006; IN COMMERCE 6-30-2006.

3,399,792. EXELOGY INCORPORATED, SUNNYVALE, CA.
SN 78-796,879. PUB. 4-10-2007, FILED 1-23-2006.

ACCOMPLICE

THE MARK CONSISTS OF STANDARD CHARACTERS WITHOUT CLAIM TO ANY PARTICULAR FONT, STYLE, SIZE, OR COLOR.

CLASS 9—ELECTRICAL AND SCIENTIFIC APPARATUS

FOR COMPUTER SOFTWARE FOR MANAGING, VIEWING AND EDITING PERSONAL INFORMATION, FILES, DOCUMENTS AND MESSAGES; COMPUTER SOFTWARE FOR TASK AND CALENDAR MANAGEMENT; COMPUTER SOFTWARE FOR E-MAIL MANAGEMENT; COMPUTER SOFTWARE FOR PROJECT COLLABORATION; MOBILE COMPUTERS; COMMUNICATIONS DEVICES, NAMELY, PERSONAL DIGITAL ASSISTANTS AND CELL PHONES (U.S. CLS. 21, 23, 26, 36 AND 38).

FIRST USE 2-6-2006; IN COMMERCE 10-13-2006.

CLASS 42—SCIENTIFIC AND COMPUTER SERVICES

FOR COMPUTER CONSULTING SERVICES (U.S. CLS. 100 AND 101).

FIRST USE 10-13-2006; IN COMMERCE 10-13-2006.

3,399,796. MITSUBISHI KAGAKU IMAGING CORP., CHESAPEAKE, VA. SN 78-798,544. PUB. 4-10-2007, FILED 1-24-2006.

MK IMAGING

THE MARK CONSISTS OF STANDARD CHARACTERS WITHOUT CLAIM TO ANY PARTICULAR FONT, STYLE, SIZE, OR COLOR.

NO CLAIM IS MADE TO THE EXCLUSIVE RIGHT TO USE "IMAGING", APART FROM THE MARK AS SHOWN.

CLASS 2—PAINTS

FOR PRINTER, COPIER AND FACSIMILE MACHINE SUPPLIES, NAMELY, TONER (U.S. CLS. 6, 11 AND 16). FIRST USE 3-0-2006; IN COMMERCE 3-0-2006.

CLASS 9—ELECTRICAL AND SCIENTIFIC APPARATUS

FOR PARTS AND ACCESSORIES AND REPLACEMENT PARTS FOR PRINTERS, COPIERS AND FACSIMILE MACHINES, NAMELY, DRUMS AND DRUM UNITS (U.S. CLS. 21, 23, 26, 36 AND 38). FIRST USE 3-0-2006; IN COMMERCE 3-0-2006.

3,399,800. EMBARQ HOLDINGS COMPANY LLC, OVERLAND PARK, KS. SN 78-799,208. PUB. 12-19-2006, FILED 1-25-2006.

EMBARQ

THE MARK CONSISTS OF STANDARD CHARACTERS WITHOUT CLAIM TO ANY PARTICULAR FONT, STYLE, SIZE, OR COLOR.

CLASS 9—ELECTRICAL AND SCIENTIFIC APPARATUS

FOR PRE-PAID MAGNETICALLY-ENCODED CALLING CARDS; TELEPHONES; DOWNLOADABLE SOFTWARE FOR USE AS A DATABASE VIA A GLOBAL COMPUTER NETWORK THAT ENABLES THE USER TO DOWNLOAD GAMES, RING TONES, GRAPHICS AND MUSIC TO COMPUTERS AND WIRELESS DEVICES (U.S. CLS. 21, 23, 26, 36 AND 38). FIRST USE 5-17-2006; IN COMMERCE 5-17-2006.

CLASS 16—PAPER GOODS AND PRINTED MATTER

FOR PRE-PAID NON-MAGNETICALLY ENCODED CALLING CARDS (U.S. CLS. 2, 5, 22, 23, 29, 37, 38 AND 50). FIRST USE 5-17-2006; IN COMMERCE 5-17-2006.

CLASS 35—ADVERTISING AND BUSINESS

FOR RETAIL STORE SERVICES FEATURING TELECOMMUNICATIONS PRODUCTS AND SERVICES, NAMELY, TELECOMMUNICATIONS SERVICE PLANS AND TELECOMMUNICATIONS SERVICE ACTIVATION, TELEPHONES AND TELEPHONE ACCESSORIES; OPERATION OF TELECOMMUNICATION NETWORK FACILITIES FOR OTHERS (U.S. CLS. 100, 101 AND 102). FIRST USE 5-17-2006; IN COMMERCE 5-17-2006.

CLASS 36—INSURANCE AND FINANCIAL

FOR PRE-PAID TELECOMMUNICATIONS PAYMENT AND TELEPHONE CALLING CARD SERVICES (U.S. CLS. 100, 101 AND 102). FIRST USE 5-17-2006; IN COMMERCE 5-17-2006.

CLASS 37—CONSTRUCTION AND REPAIR

FOR INSTALLATION OF TELECOMMUNICATIONS EQUIPMENT (U.S. CLS. 100, 103 AND 106). FIRST USE 5-17-2006; IN COMMERCE 5-17-2006.

CLASS 38—COMMUNICATION

FOR AUDIO AND VIDEO TELECONFERENCING SERVICES (U.S. CLS. 100, 101 AND 104). FIRST USE 5-17-2006; IN COMMERCE 5-17-2006.

CLASS 42—SCIENTIFIC AND COMPUTER SERVICES

FOR COMPUTER SERVICES, NAMELY, RESTRICTING ACCESS TO AND BY COMPUTER NETWORKS TO AND OF UNDESIRE WEB SITES, MEDIA, INDIVIDUALS AND FACILITIES TO PREVENT DISTRIBUTED DENIAL (DDOS) ATTACKS ON NETWORKS AND SERVERS (U.S. CLS. 100 AND 101). FIRST USE 5-17-2006; IN COMMERCE 5-17-2006.

3,399,811. ARKANSAS FACE VENEER COMPANY, INC., BENTON, AR. SN 78-803,529. PUB. 4-17-2007, FILED 1-31-2006.

MOUNTAIN HOME CEDAR

THE MARK CONSISTS OF STANDARD CHARACTERS WITHOUT CLAIM TO ANY PARTICULAR FONT, STYLE, SIZE, OR COLOR.

NO CLAIM IS MADE TO THE EXCLUSIVE RIGHT TO USE "CEDAR", APART FROM THE MARK AS SHOWN.

CLASS 3—COSMETICS AND CLEANING PREPARATIONS

FOR CEDAR AROMA ROOM SPRAYS, CEDAR SACHETS (U.S. CLS. 1, 4, 6, 50, 51 AND 52). FIRST USE 10-1-2005; IN COMMERCE 10-1-2005.

CLASS 5—PHARMACEUTICALS

FOR CEDAR WOOD NOVELTY PRODUCTS FOR USE AS CLOTHING PROTECTORS AND DEODORIZERS IN THE FORM OF BLOCKS, BALLS, BEARS, HEARTS, CUBES, HOOK-UPS, AND HANGER RINGS (U.S. CLS. 6, 18, 44, 46, 51 AND 52). FIRST USE 10-1-2005; IN COMMERCE 10-1-2005.

CLASS 19—NON-METALLIC BUILDING MATERIALS

FOR CEDAR WOOD PRODUCTS, NAMELY, PANELING AND MOLDING (U.S. CLS. 1, 12, 33 AND 50).
FIRST USE 10-1-2005; IN COMMERCE 10-1-2005.

3,399,824. TRUE VALUE COMPANY, CHICAGO, IL. SN 78-809,630. PUB. 10-9-2007, FILED 2-8-2006.

CLASS 20—FURNITURE AND ARTICLES NOT OTHERWISE CLASSIFIED

FOR CEDAR WOOD PRODUCTS, NAMELY, KITS CONSISTING PRIMARILY OF WOOD PANELS FOR USE IN LINING CLOSETS; SHELVING; CEDAR WOOD DRAWER LINERS (U.S. CLS. 2, 13, 22, 25, 32 AND 50).
FIRST USE 10-1-2005; IN COMMERCE 10-1-2005.

3,399,821. SAGE RETAIL, INC., GLENCOE, IL. SN 78-808,181.
PUB. 5-8-2007, FILED 2-6-2006.

CLASS 6—METAL GOODS

FOR METAL ROBE HOOKS (U.S. CLS. 2, 12, 13, 14, 23, 25 AND 50).
FIRST USE 11-0-2005; IN COMMERCE 11-0-2005.

CLASS 11—ENVIRONMENTAL CONTROL APPARATUS

FOR FAUCETS; BATH HARDWARE, NAMELY, FIXED SPOUTS ON WALLS AND DIRECTLY ON THE BATHS AND BASINS (U.S. CLS. 13, 21, 23, 31 AND 34).
FIRST USE 11-0-2005; IN COMMERCE 11-0-2005.

SAGE ALLIANCES**CLASS 21—HOUSEWARES AND GLASS**

FOR BATH ACCESSORIES, NAMELY, TOWEL BARS, TOWEL RINGS, TOILET TISSUE HOLDERS (U.S. CLS. 2, 13, 23, 29, 30, 33, 40 AND 50).
FIRST USE 11-0-2005; IN COMMERCE 11-0-2005.

THE MARK CONSISTS OF STANDARD CHARACTERS WITHOUT CLAIM TO ANY PARTICULAR FONT, STYLE, SIZE, OR COLOR.

NO CLAIM IS MADE TO THE EXCLUSIVE RIGHT TO USE "ALLIANCES", APART FROM THE MARK AS SHOWN.

3,399,825. MARCELLUS, ALVIN, A., ANAHEIM, CA. SN 78-810,500. PUB. 9-19-2006, FILED 2-8-2006.

CLASS 35—ADVERTISING AND BUSINESS

FOR MARKETING SERVICES FOR COMMERCIAL PROPERTY OWNERS, NAMELY, THE PROVISION OF SIGNAGE FOR COMMERCIAL PROPERTIES; REAL ESTATE CONSULTING SERVICES TO COMMERCIAL PROPERTY OWNERS IN THE NATURE OF PROPERTY ENHANCEMENT STRATEGIES AND REGARDING THE PROPER BALANCE OF BUILDING AMENITIES SUCH AS RESTAURANTS, COFFEE SHOPS AND SUNDRY SHOPS; REAL ESTATE BROKERAGE SERVICES, NAMELY, MATCHING COMMERCIAL PROPERTY OWNERS WITH RESTAURANT, COFFEE SHOP AND SUNDRY SHOP OPERATORS FOR THE PURPOSE OF ESTABLISHING A LEASE (U.S. CLS. 100, 101 AND 102).
FIRST USE 12-1-2007; IN COMMERCE 12-1-2007.

WINGED EXPRESS

THE MARK CONSISTS OF STANDARD CHARACTERS WITHOUT CLAIM TO ANY PARTICULAR FONT, STYLE, SIZE, OR COLOR.

CLASS 25—CLOTHING

FOR HATS; JACKETS; SHIRTS (U.S. CLS. 22 AND 39).
FIRST USE 1-0-1969; IN COMMERCE 1-0-1969.

CLASS 36—INSURANCE AND FINANCIAL

FOR REAL ESTATE BROKERAGE SERVICES FOR COMMERCIAL PROPERTY OWNERS TO ASSIST IN PROCURING RETAIL TENANTS (U.S. CLS. 100, 101 AND 102).
FIRST USE 12-1-2007; IN COMMERCE 12-1-2007.

CLASS 28—TOYS AND SPORTING GOODS

FOR MODEL CARS (U.S. CLS. 22, 23, 38 AND 50).
FIRST USE 11-15-2005; IN COMMERCE 11-15-2005.

3,399,827. VECTOR PRODUCTS, INC., PLANTATION, FL. SN 78-810,844. PUB. 3-27-2007, FILED 2-9-2006.

TRAILTRACKER

THE MARK CONSISTS OF STANDARD CHARACTERS WITHOUT CLAIM TO ANY PARTICULAR FONT, STYLE, SIZE, OR COLOR.

CLASS 9—ELECTRICAL AND SCIENTIFIC APPARATUS

FOR COMBINATION TV AND LANTERN-STYLE FLASHLIGHT AND LED/AM/FM WEATHER BAND RADIO WITH INCLEMENT WEATHER WARNING SYSTEM, DYNAMO-POWERED AND RECHARGEABLE CAPABILITIES SOLD AS A UNIT; AM/FM WEATHER BAND RADIO WITH INCLEMENT WEATHER WARNING SYSTEM, DYNAMO-POWERED AND RECHARGEABLE CAPABILITIES; WALKIE-TALKIES; PORTABLE TWO-WAY HANDHELD RADIOS; TWO-WAY RADIOS (U.S. CLS. 21, 23, 26, 36 AND 38).

FIRST USE 1-12-2006; IN COMMERCE 1-12-2006.

CLASS 11—ENVIRONMENTAL CONTROL APPARATUS

FOR COMBINATION ELECTRIC LANTERN, FLASHLIGHT AND LED/AM/FM WEATHER BAND RADIO WITH INCLEMENT WEATHER WARNING SYSTEM, DYNAMO-POWERED AND RECHARGEABLE CAPABILITIES, SOLD AS A UNIT (U.S. CLS. 13, 21, 23, 31 AND 34).

FIRST USE 1-12-2006; IN COMMERCE 1-12-2006.

3,399,830. SOMERSET PHARMACEUTICALS, INC., TAMPA, FL. SN 78-811,907. PUB. 9-19-2006, FILED 2-10-2006.

UNIQUE DELIVERY, PROVEN RESULTS

THE MARK CONSISTS OF STANDARD CHARACTERS WITHOUT CLAIM TO ANY PARTICULAR FONT, STYLE, SIZE, OR COLOR.

CLASS 5—PHARMACEUTICALS

FOR PHARMACEUTICAL PREPARATIONS FOR THE TREATMENT OF DEPRESSION, AND OTHER NEUROLOGICAL AND/OR MENTAL CONDITIONS OR DISEASES, ADMINISTERED THROUGH A TRANSDERMAL PATCH (U.S. CLS. 6, 18, 44, 46, 51 AND 52).

FIRST USE 4-1-2006; IN COMMERCE 4-1-2006.

CLASS 16—PAPER GOODS AND PRINTED MATTER

FOR PRINTED MATTER, NAMELY, PROMOTIONAL MATERIALS, INFORMATIONAL MATERIALS, BROCHURES, PAMPHLETS, NEWSLETTERS AND STATIONERY RELATING TO PHARMACEUTICALS AND THE TREATMENT AND PREVENTION OF DISEASES (U.S. CLS. 2, 5, 22, 23, 29, 37, 38 AND 50).

FIRST USE 4-1-2006; IN COMMERCE 4-1-2006.

CLASS 42—SCIENTIFIC AND COMPUTER SERVICES

FOR PHARMACEUTICAL RESEARCH AND DEVELOPMENT SERVICES (U.S. CLS. 100 AND 101).

FIRST USE 4-1-2006; IN COMMERCE 4-1-2006.

3,399,837. PRECISION TOOL, DIE AND MACHINE CO., INC., LOUISVILLE, KY. SN 78-814,640. PUB. 10-24-2006, FILED 2-14-2006.

NTH/WORKS

THE MARK CONSISTS OF STANDARD CHARACTERS WITHOUT CLAIM TO ANY PARTICULAR FONT, STYLE, SIZE, OR COLOR.

THE WORDING "NTH" HAS NO MEANING OTHER THAN TRADEMARK SIGNIFICANCE.

CLASS 40—MATERIAL TREATMENT

FOR ASSEMBLY OF PRODUCTS FOR OTHERS, POWDER COATING AND ELECTROSTATIC PAINTING, REPROGRAPHIC IMAGING SERVICES, NAMELY, PHOTOGRAPHIC REPRODUCTION AND PRINTING ON METAL FOR OTHERS, SCREEN PRINTING, METAL FABRICATION, FINISHING AND STAMPING (U.S. CLS. 100, 103 AND 106).

FIRST USE 4-3-2006; IN COMMERCE 4-3-2006.

CLASS 42—SCIENTIFIC AND COMPUTER SERVICES

FOR INDUSTRIAL DESIGN CONSULTING SERVICES (U.S. CLS. 100 AND 101).

FIRST USE 4-3-2006; IN COMMERCE 4-3-2006.

3,399,867. IMG WORLDWIDE, INC., CLEVELAND, OH. SN 78-826,401. PUB. 4-24-2007, FILED 3-1-2006.

OWNER OF U.S. REG. NOS. 1,232,130, 2,333,751, AND OTHERS.

THE COLOR(S) BLUE IS/ARE CLAIMED AS A FEATURE OF THE MARK.

THE MARK CONSISTS OF THE LETTERS "IMG" WITH THREE TRIANGLES IN THE MIDDLE OF THE LETTER "M", ALL IN BLUE.

CLASS 35—ADVERTISING AND BUSINESS

FOR MANAGEMENT OF CELEBRITIES, PERFORMING ARTISTS, MODELS, PROFESSIONAL ATHLETES, BROADCASTERS, AUTHORS AND DESIGNERS; BUSINESS SERVICES, NAMELY, MANAGEMENT OF THE PERSONAL AFFAIRS OF OTHERS; ASSISTANCE IN MANAGEMENT OF BUSINESS ACTIVITIES AND EVENTS; PROCURING AND NEGOTIATING CONTRACTS, LICENSES, AND ENDORSEMENTS FOR OTHERS; PROMOTING THE GOODS AND SERVICES OF OTHERS VIA ELECTRONIC MEDIA; ADVERTISING SERVICES; PROVIDING COMMERCIAL INFORMATION, VIA PRINT AND ELECTRONIC MEDIA, IN THE FIELDS OF FASHION, SPORTS, CONSUMER PRODUCTS, LICENSING AND ENDORSEMENTS; ADVERTISING AND PUBLICITY SERVICES, NAMELY, PROMOTING THE GOODS, SERVICES, BRAND IDENTITY, AND COMMERCIAL INFORMATION AND NEWS OF THIRD PARTIES THROUGH PRINT, AUDIO, VIDEO, DIGITAL AND ON-LINE MEDIA; ADVERTISING, INCLUDING PROMOTION OF PRODUCTS AND SERVICES OF THIRD PARTIES THROUGH SPONSORING ARRANGEMENTS AND LICENSE AGREEMENTS; ADVERTISING CONSULTATION; COMMERCIAL CONSULTANCY; MARKETING CONSULTING; SPONSORSHIP CONSULTING; SALES PROMOTION AND PUBLIC RELATIONS CONSULTING SERVICES; MODELING AGENCIES; PLANNING AND CONDUCTING OF TRADE SHOWS, EVENTS, EXHIBITIONS AND PRESENTATIONS FOR PROMOTING THE GOODS AND SERVICES OF OTHERS; MARKETING AND PROMOTIONAL SERVICES FOR RECREATIONAL OR LEISURE FACILITIES OWNED BY OTHERS (U.S. CLS. 100, 101 AND 102).
FIRST USE 3-31-2006; IN COMMERCE 3-31-2006.

CLASS 38—COMMUNICATION

FOR STREAMING OF VIDEO MATERIAL ON THE INTERNET AND OTHER ELECTRONIC MEDIA (U.S. CLS. 100, 101 AND 104).
FIRST USE 3-31-2006; IN COMMERCE 3-31-2006.

CLASS 41—EDUCATION AND ENTERTAINMENT

FOR ARRANGING AND CONDUCTING ATHLETIC COMPETITIONS AND EVENTS, FASHION SHOWS, EXHIBITIONS, CONFERENCES, CONCERTS, HOME AND GARDEN SHOWS, AWARD CEREMONIES, AND GENERAL ENTERTAINMENT SHOWS; ENTERTAINMENT SERVICES, NAMELY, PROVIDING TELEVISION AND OTHER VIDEO PROGRAMS IN THE FIELDS OF SPORTS, FASHION, REALITY PROGRAMMING AND GENERAL ENTERTAINMENT; PRODUCTION OF VIDEO PROGRAM CONTENT; PUBLISHING OF PRINTED PUBLICATIONS, BOOKS AND MAGAZINES; PUBLISHING OF ELECTRONIC PUBLICATIONS; PROVIDING INFORMATION IN THE FIELD OF SPORTS, ARTS AND ENTERTAINMENT VIA ELECTRONIC MEDIA; INSTRUCTION IN TENNIS, GOLF, SOCCER, BASEBALL, BASKETBALL, IMPROVING PHYSICAL ATHLETIC PERFORMANCE, MENTAL CONDITIONING FOR IMPROVED PERFORMANCE IN SPORTS AND ATHLETIC ACTIVITIES AND LIFE SKILLS, AND OFFICIATING AND CAMPS COMPRISING SUCH INSTRUCTION (U.S. CLS. 100, 101 AND 107).
FIRST USE 3-31-2006; IN COMMERCE 3-31-2006.

CLASS 42—SCIENTIFIC AND COMPUTER SERVICES

FOR LICENSING OF INTELLECTUAL PROPERTY (U.S. CLS. 100 AND 101).
FIRST USE 3-31-2006; IN COMMERCE 3-31-2006.

3,399,889. COMMON GROUND ALLIANCE, CHANTILLY, VA. SN 78-836,042. PUB. 12-5-2006, FILED 3-13-2006.



THE COLORS BLACK, YELLOW, GREEN, GRAY, AND BROWN ARE CLAIMED AS A FEATURE OF THE MARK.

THE MARK CONSISTS OF THE NUMERALS 811 IN YELLOW WITH A STYLIZED LIGHT AND DARK GRAY SHOVEL HEAD EXTENDING FROM THE MIDDLE 1. THE SHOVEL IS PENETRATING A STYLIZED PIECE OF GROUND COLORED IN GREEN AND BROWN AND THE IMAGES ARE ALL OUTLINED IN BLACK.

CLASS 35—ADVERTISING AND BUSINESS

FOR PROMOTION AND MARKETING SERVICES RELATING TO THE USE OF THE TELEPHONE FOR CONNECTING EXCAVATORS AND CONSUMERS TO NORTH AMERICAN NOTIFICATION CENTERS WHICH CONTACT UTILITY COMPANIES TO MARK THE LOCATION OF UNDERGROUND FACILITIES PRIOR TO EXCAVATION (U.S. CLS. 100, 101 AND 102).
FIRST USE 3-0-2007; IN COMMERCE 3-0-2007.

CLASS 41—EDUCATION AND ENTERTAINMENT

FOR EDUCATION SERVICES, NAMELY, SEMINARS, CLASSES, WORKSHOPS, AND ON-LINE VERSIONS OF THE SAME RELATING TO THE USE OF THE TELEPHONE FOR CONNECTING EXCAVATORS AND CONSUMERS TO NORTH AMERICAN NOTIFICATION CENTERS WHICH CONTACT UTILITY COMPANIES TO MARK THE LOCATION OF UNDERGROUND FACILITIES PRIOR TO EXCAVATION AND DISTRIBUTION OF COURSE MATERIALS IN CONNECTION THEREWITH (U.S. CLS. 100, 101 AND 107).
FIRST USE 3-0-2007; IN COMMERCE 3-0-2007.

3,399,914. GERLACH, PAUL H., SAN JOSE, CA. SN 78-851,071. PUB. 11-28-2006, FILED 3-31-2006.

THE GERLACH MODEL

THE MARK CONSISTS OF STANDARD CHARACTERS WITHOUT CLAIM TO ANY PARTICULAR FONT, STYLE, SIZE, OR COLOR.

CLASS 16—PAPER GOODS AND PRINTED MATTER

FOR PRINTED INSTRUCTIONAL, EDUCATIONAL, AND TEACHING MATERIALS IN THE FIELDS OF BUSINESS, PSYCHOLOGY, PERSONAL DEVELOPMENT AND ACHIEVEMENT, PERSONAL AWARENESS, AND SELF-HELP (U.S. CLS. 2, 5, 22, 23, 29, 37, 38 AND 50).

FIRST USE 8-15-2007; IN COMMERCE 8-15-2007.

CLASS 41—EDUCATION AND ENTERTAINMENT

FOR PERSONAL LIFE COACHING SESSIONS, NAMELY, CONDUCTING INDIVIDUAL SESSIONS, GROUP SESSIONS, CLASSES, SEMINARS, WORKSHOPS, PRESENTATIONS, TRAINING PROGRAMS, MENTORING, AND PROVIDING COURSES OF INSTRUCTION IN THE FIELDS OF BUSINESS, PSYCHOLOGY, PERSONAL DEVELOPMENT AND ACHIEVEMENT, PERSONAL AWARENESS, AND SELF-HELP (U.S. CLS. 100, 101 AND 107).

FIRST USE 8-15-2007; IN COMMERCE 8-15-2007.

3,399,916. HERBA ENTERPRISE, INC., SAN FRANCISCO, CA. SN 78-851,875. PUB. 10-24-2006, FILED 3-31-2006.

DAFENG

THE MARK CONSISTS OF STANDARD CHARACTERS WITHOUT CLAIM TO ANY PARTICULAR FONT, STYLE, SIZE, OR COLOR.

THE FOREIGN WORDING IN THE MARK TRANSLATES INTO ENGLISH AS "BIG HARVEST".

CLASS 5—PHARMACEUTICALS

FOR DIETARY SUPPLEMENTS, DIETARY FOOD SUPPLEMENTS AND NUTRITIONAL SUPPLEMENTS (U.S. CLS. 6, 18, 44, 46, 51 AND 52).

FIRST USE 9-0-2007; IN COMMERCE 9-0-2007.

CLASS 30—STAPLE FOODS

FOR TEA, HERBAL TEA FOR FOOD PURPOSES AND HERBAL FOOD BEVERAGES (U.S. CL. 46).

FIRST USE 9-0-2007; IN COMMERCE 9-0-2007.

3,399,926. SARGENTO FOODS, INC., PLYMOUTH, WI. SN 78-855,901. PUB. 9-5-2006, FILED 4-6-2006.

SONORA VALLEY

THE MARK CONSISTS OF STANDARD CHARACTERS WITHOUT CLAIM TO ANY PARTICULAR FONT, STYLE, SIZE, OR COLOR.

CLASS 29—MEATS AND PROCESSED FOODS

FOR CHEESE, CHEESE DIP (U.S. CL. 46).

FIRST USE 10-1-2006; IN COMMERCE 10-1-2006.

CLASS 30—STAPLE FOODS

FOR SNACK MIX CONSISTING PRIMARILY OF CHEESE, CHEESE SAUCES, PRETZELS, CRACKERS OR CHIPS; SNACK FOOD, NAMELY, CHEESE, CHEESE SAUCES, PRETZELS, CRACKERS OR CHIPS; CHEESE SAUCE (U.S. CL. 46).

FIRST USE 10-1-2006; IN COMMERCE 10-1-2006.

3,399,929. BM DIRECT, ROCHESTER, MN. SN 78-857,332. PUB. 11-14-2006, FILED 4-9-2006.

BETWEEN MIRAGES

THE MARK CONSISTS OF STANDARD CHARACTERS WITHOUT CLAIM TO ANY PARTICULAR FONT, STYLE, SIZE, OR COLOR.

CLASS 25—CLOTHING

FOR CLOTHING, NAMELY, SHIRTS, T-SHIRTS AND HATS (U.S. CLS. 22 AND 39).

FIRST USE 5-11-2007; IN COMMERCE 5-11-2007.

CLASS 41—EDUCATION AND ENTERTAINMENT

FOR ENTERTAINMENT SERVICES, NAMELY, LIVE PERFORMANCES BY A MUSICAL GROUP (U.S. CLS. 100, 101 AND 107).

FIRST USE 5-11-2007; IN COMMERCE 5-11-2007.

3,399,931. ACH FOOD COMPANIES, INC., CORDOVA, TN. SN 78-858,247. PUB. 3-27-2007, FILED 4-10-2006.

LOOKING FOR FLAVOR? LOOK FOR THE "D"

THE MARK CONSISTS OF STANDARD CHARACTERS WITHOUT CLAIM TO ANY PARTICULAR FONT, STYLE, SIZE, OR COLOR.

CLASS 1—CHEMICALS

FOR EMULSIFIERS FOR USE IN THE MANUFACTURE OF FOOD AND PASTRIES (U.S. CLS. 1, 5, 6, 10, 26 AND 46).

FIRST USE 3-22-2004; IN COMMERCE 3-22-2004.

CLASS 30—STAPLE FOODS

FOR SPICES; PEPPER; SALT; SEASONINGS; FLAVORED SALT; GARLIC SALT; SAUCES FOR MEAT, SEAFOOD AND VEGETABLES; GRAVIES; GARLIC POWDER; BAKERY GOODS—NAMELY, DOUGHS AND PASTRIES; EDIBLE CAKE AND DESSERT DECORATIONS; GRAVY MIXES; MEAT TENDERIZERS; MARINADE BAG WITH MIXTURES OF SPICES AND SEASONING SOLD AS A UNIT (U.S. CL. 46).

FIRST USE 3-22-2004; IN COMMERCE 3-22-2004.

3,399,934. BR CONSULTING, INC., SEDONA, AZ. SN 78-858,862. PUB. 7-17-2007, FILED 4-11-2006.

3,399,942. VECTOR PRODUCTS, INC., FT. LAUDERDALE, FL. SN 78-861,921. PUB. 4-3-2007, FILED 4-14-2006.

POSITION THERAPY



THE MARK CONSISTS OF STANDARD CHARACTERS WITHOUT CLAIM TO ANY PARTICULAR FONT, STYLE, SIZE, OR COLOR.

NO CLAIM IS MADE TO THE EXCLUSIVE RIGHT TO USE "THERAPY", APART FROM THE MARK AS SHOWN.

CLASS 41—EDUCATION AND ENTERTAINMENT

FOR INSTRUCTION SERVICES, NAMELY, CLASSES IN NATURAL HEALING METHODS, POSTURE, BREATHING, MEDITATION TO INCREASE ENERGY, AND IMPROVE PHYSICAL, ENERGETIC AND PSYCHO-EMOTIONAL HEALTH (U.S. CLS. 100, 101 AND 107).
FIRST USE 1-20-2006; IN COMMERCE 1-20-2006.

CLASS 44—MEDICAL, BEAUTY AND AGRICULTURAL SERVICES

FOR HEALTHCARE SERVICES USING EXERCISES; MEDICAL SERVICES USING THERAPEUTIC EXERCISES (U.S. CLS. 100 AND 101).
FIRST USE 1-20-2006; IN COMMERCE 1-20-2006.

3,399,941. CONKIN COMPANY, INC., SHAKOPEE, MN. SN 78-861,692. PUB. 8-1-2006, FILED 4-14-2006.



THE COLOR(S) SEPIA IS/ARE CLAIMED AS A FEATURE OF THE MARK.

THE MARK CONSISTS OF A SEPIA COLORED ARMADILLO.

CLASS 2—PAINTS

FOR EXTERIOR AND INTERIOR PAINTS; COATINGS IN THE NATURE OF WOOD SEALERS AND PROTECTORS (U.S. CLS. 6, 11 AND 16).
FIRST USE 9-0-2007; IN COMMERCE 9-0-2007.

CLASS 19—NON-METALLIC BUILDING MATERIALS

FOR PETROLEUM-BASED ASPHALT COATINGS, ASPHALT PRIMERS; ASPHALT FILLER, AND ASPHALT PATCH (U.S. CLS. 1, 12, 33 AND 50).
FIRST USE 9-0-2007; IN COMMERCE 9-0-2007.

CLASS 9—ELECTRICAL AND SCIENTIFIC APPARATUS

FOR COMBINATION TV AND LANTERN-STYLE FLASHLIGHT AND LED/AM/FM WEATHER BAND RADIO WITH INCLEMENT WEATHER WARNING SYSTEM, DYNAMO-POWERED AND RECHARGEABLE CAPABILITIES SOLD AS A UNIT; AM/FM WEATHER BAND RADIO WITH INCLEMENT WEATHER WARNING SYSTEM, DYNAMO-POWERED AND RECHARGEABLE CAPABILITIES (U.S. CLS. 21, 23, 26, 36 AND 38).
FIRST USE 3-31-2006; IN COMMERCE 3-31-2006.

CLASS 11—ENVIRONMENTAL CONTROL APPARATUS

FOR COMBINATION ELECTRIC LANTERN, FLASHLIGHT AND LED/AM/FM WEATHER BAND RADIO WITH INCLEMENT WEATHER WARNING SYSTEM, DYNAMO-POWERED AND RECHARGEABLE CAPABILITIES, SOLD AS A UNIT (U.S. CLS. 13, 21, 23, 31 AND 34).
FIRST USE 3-31-2006; IN COMMERCE 3-31-2006.

3,399,953. TAPUZ PEOPLE LTD., RAMAT GAN, ISRAEL. SN 78-867,654. PUB. 2-13-2007, FILED 4-24-2006.



NO CLAIM IS MADE TO THE EXCLUSIVE RIGHT TO USE "BLOGTV", APART FROM THE MARK AS SHOWN.

THE COLOR(S) ORANGE, OLIVE GREEN AND BLACK IS/ARE CLAIMED AS A FEATURE OF THE MARK.

THE MARK CONSISTS OF THE EXPRESSION "BLOGTV". THE WORD "BLOG" IS OLIVE GREEN AND "TV" IS ORANGE WITH BLACK OUTLINE AND AN ORANGE KEYHOLE WITH A BLACK EYEBALL INSIDE WITH BLACK OUTLINE IN BLACK BRACKETS ABOVE THE EXPRESSION "BLOGTV".

CLASS 9—ELECTRICAL AND SCIENTIFIC APPARATUS

FOR COMMUNICATIONS SOFTWARE FOR CONNECTING PEOPLE OVER THE INTERNET, FIX AND MOBILE, USING CHATS, MESSAGE BOARDS, INSTANT MESSENGER AND TALK BACKS; COMPUTER SOFTWARE FOR ENABLING LIVE AND RECORDED VIDEO BROADCASTING USING WEB CAMS OR MOBILE PHONES, WATCHING LIVE OR RECORDED VIDEO SHOWS OR FILES, UPLOADING, POSTING, DISPLAYING, TAGGING AND SHARING LIVE AND RECORDED VIDEO FILES, PROVIDING ELECTRONIC MEDIA OR INFORMATION OVER THE INTERNET, FIX AND MOBILE, TELEVISION OR OTHER COMMUNICATIONS NETWORK (U.S. CLS. 21, 23, 26, 36 AND 38).
FIRST USE 3-21-2004; IN COMMERCE 5-15-2007.

CLASS 38—COMMUNICATION

FOR BROADCASTING PROGRAMS VIA A GLOBAL COMPUTER NETWORK; MOBILE MEDIA AND ENTERTAINMENT SERVICES IN THE NATURE OF ELECTRONIC TRANSMISSION OF ENTERTAINMENT MEDIA CONTENT (U.S. CLS. 100, 101 AND 104).
FIRST USE 3-21-2004; IN COMMERCE 5-15-2007.

CLASS 41—EDUCATION AND ENTERTAINMENT

FOR ENTERTAINMENT IN THE NATURE OF LIVE PERFORMANCES BY PEOPLE USING WEB CAMS OR MOBILE PHONES; ENTERTAINMENT, NAMELY, A CONTINUING LIVE AND RECORDED VIDEO REALITY SHOW BROADCAST OVER TELEVISION, SATELLITE, AUDIO, AND VIDEO MEDIA; ONLINE JOURNALS, NAMELY, BLOGS FEATURING LIVE AND RECORDED VIDEO SHOWS USING WEB CAMS OR MOBILE PHONES (U.S. CLS. 100, 101 AND 107).
FIRST USE 3-21-2004; IN COMMERCE 5-15-2007.

3,399,955. PFIZER INC., NEW YORK, NY. SN 78-868,256. PUB. 10-10-2006, FILED 4-24-2006.

RELEASE THE RELIEF

THE MARK CONSISTS OF STANDARD CHARACTERS WITHOUT CLAIM TO ANY PARTICULAR FONT, STYLE, SIZE, OR COLOR.

CLASS 16—PAPER GOODS AND PRINTED MATTER

FOR PRINTED MATERIALS, NAMELY, BOOKLETS, BROCHURES, NEWSLETTERS, MANUALS, LEAFLETS, CHARTS, CATALOGS AND POSTERS RELATED TO URINARY DISEASES AND URINARY PROBLEMS (U.S. CLS. 2, 5, 22, 23, 29, 37, 38 AND 50).
FIRST USE 5-31-2006; IN COMMERCE 5-31-2006.

CLASS 44—MEDICAL, BEAUTY AND AGRICULTURAL SERVICES

FOR MEDICAL INFORMATION SERVICES, NAMELY, PROVIDING INFORMATION RELATED TO URINARY DISEASES AND URINARY PROBLEMS; ON-LINE INFORMATION SERVICES, NAMELY, PROVIDING INFORMATION RELATED TO URINARY DISEASES AND URINARY PROBLEMS (U.S. CLS. 100 AND 101).
FIRST USE 5-31-2006; IN COMMERCE 5-31-2006.

3,399,975. MOLEON, GARY, RIDGEWOOD, NJ. SN 78-882,686. PUB. 1-2-2007, FILED 5-12-2006.

QRO

THE MARK CONSISTS OF STANDARD CHARACTERS WITHOUT CLAIM TO ANY PARTICULAR FONT, STYLE, SIZE, OR COLOR.

CLASS 25—CLOTHING

FOR BASEBALL CAPS; CHEF'S HATS; HATS; HEADGEAR, NAMELY, HATS AND CAPS; SMALL HATS (U.S. CLS. 22 AND 39).
FIRST USE 5-12-2006; IN COMMERCE 5-12-2006.

CLASS 30—STAPLE FOODS

FOR ARTICHOKE SAUCE; BARBECUE SAUCE; CHEESE SAUCE; CHILI SAUCE; CONDIMENT, NAMELY, PEPPER SAUCE; FISH SAUCE; HOT SAUCE; MIX FOR MAKING COMBINED NOODLE AND SAUCE DISH; PICANTE SAUCE; PIZZA SAUCE; READY-MADE SAUCES; SALAD SAUCES; SAUCES; SAUCES FOR BARBECUED MEAT; SLOPPY JOE SAUCE; SOY SAUCE; SOY SAUCE; SPAGHETTI SAUCE; TARTAR SAUCE; TERIYAKI SAUCE; TOMATO SAUCE (U.S. CL. 46).
FIRST USE 5-12-2006; IN COMMERCE 5-12-2006.

3,399,976. MOLEON, GARY, RIDGEWOOD, NJ. SN 78-882,698. PUB. 12-26-2006, FILED 5-12-2006.

THE HOT HEARD 'ROUND THE WORLD

THE MARK CONSISTS OF STANDARD CHARACTERS WITHOUT CLAIM TO ANY PARTICULAR FONT, STYLE, SIZE, OR COLOR.

CLASS 25—CLOTHING

FOR BASEBALL CAPS; CHEF'S HATS; HATS; HEADGEAR, NAMELY, HATS AND CAPS; SMALL HATS (U.S. CLS. 22 AND 39).
FIRST USE 5-12-2006; IN COMMERCE 5-12-2006.

CLASS 30—STAPLE FOODS

FOR ARTICHOKE SAUCE; BARBECUE SAUCE; CHEESE SAUCE; CHILI SAUCE; CONDIMENT, NAMELY, PEPPER SAUCE; FISH SAUCE; HOT SAUCE; MIX FOR MAKING COMBINED NOODLE AND SAUCE DISH; PICANTE SAUCE; PIZZA SAUCE; READY-MADE SAUCES; SALAD SAUCES; SAUCES; SAUCES FOR BARBECUED MEAT; SLOPPY JOE SAUCE; SOY SAUCE; SOY SAUCE; SPAGHETTI SAUCE; TARTAR SAUCE; TERIYAKI SAUCE; TOMATO SAUCE (U.S. CL. 46).
FIRST USE 5-12-2006; IN COMMERCE 5-12-2006.

3,399,977. STARBRIDGE LLC, SAN DIEGO, CA. SN 78-883,088. PUB. 5-29-2007, FILED 5-13-2006.



STARBRIDGE

THE COLOR(S) DARK BLUE AND GOLD IS/ARE CLAIMED AS A FEATURE OF THE MARK.

THE MARK CONSISTS OF TWO CONJOINED RINGS WITH AN EIGHT-SIDED STAR AT THE AREA OF CONJUNCTION OF THE TWO RINGS. THE RINGS AND COMPANY NAME ARE BLUE AND THE STAR IS GOLD.

CLASS 35—ADVERTISING AND BUSINESS

FOR ACQUISITION AND MERGER CONSULTATION; BUSINESS ACQUISITION AND MERGER CONSULTATION; BUSINESS ACQUISITIONS CONSULTATION; BUSINESS CONSULTATION SERVICES; BUSINESS CONSULTING AND BUSINESS INFORMATION FOR ENTERPRISES; BUSINESS MANAGEMENT CONSULTATION; BUSINESS MERGER CONSULTATION; BUSINESS ORGANIZATION AND OPERATION CONSULTANCY; BUSINESS RELOCATION CONSULTING; BUSINESS RESEARCH CONSULTATION; BUSINESS SERVICES, NAMELY, MATCHING POTENTIAL PRIVATE INVESTORS WITH ENTREPRENEURS NEEDING FUNDING; COMMERCIAL CONSULTANCY; CONSULTANCY SERVICES REGARDING BUSINESS STRATEGIES; CONSULTATION IN THE FIELD OF BUSINESS ACQUISITIONS; CONSULTATION SERVICES IN THE FIELD OF COMPANY, BUSINESS SECTOR AND INDUSTRY DATA AND RESEARCH (U.S. CLS. 100, 101 AND 102).

FIRST USE 3-13-2006; IN COMMERCE 5-13-2006.

CLASS 36—INSURANCE AND FINANCIAL

FOR CAPITAL INVESTMENT CONSULTATION; EQUITY CAPITAL INVESTMENT; MANAGEMENT OF A CAPITAL INVESTMENT FUND; REAL ESTATE EQUITY SHARING, NAMELY, MANAGING AND ARRANGING FOR CO-OWNERSHIP OF REAL ESTATE; VENTURE CAPITAL FUNDING SERVICES TO EMERGING AND START-UP COMPANIES; VENTURE CAPITAL SERVICES, NAMELY, PROVIDING FINANCING TO EMERGING AND START-UP COMPANIES (U.S. CLS. 100, 101 AND 102).

FIRST USE 3-13-2006; IN COMMERCE 5-13-2006.

3,399,998. PIRATES MUTINY, LLC, MAGALUF, MALLORCA, SPAIN. SN 78-902,032. PUB. 1-9-2007, FILED 6-6-2006.

PIRATES MUTINY

THE MARK CONSISTS OF STANDARD CHARACTERS WITHOUT CLAIM TO ANY PARTICULAR FONT, STYLE, SIZE, OR COLOR.

CLASS 9—ELECTRICAL AND SCIENTIFIC APPARATUS

FOR PRE-RECORDED CD'S, LASER DISKS AND DVD'S FEATURING A THEATRICAL PRODUCTION (U.S. CLS. 21, 23, 26, 36 AND 38).

FIRST USE 9-1-2006; IN COMMERCE 9-1-2006.

CLASS 16—PAPER GOODS AND PRINTED MATTER

FOR BALL POINT PENS; COLOURED PENS; EVENT PROGRAMS; GENERAL PURPOSE PLASTIC BAGS; GIFT CARDS; INK PENS; MAPS; MERCHANDISE BAGS; PENS; POSTERS; POSTERS MADE OF PAPER; SOUVENIR PROGRAMS CONCERNING THEATRICAL PRODUCTION; TEMPORARY TATTOOS; TRADING CARDS (U.S. CLS. 2, 5, 22, 23, 29, 37, 38 AND 50).

FIRST USE 9-1-2006; IN COMMERCE 9-1-2006.

CLASS 25—CLOTHING

FOR BANDANAS; BASEBALL CAPS; CAPS; CAPS WITH VISORS; DRESS SHIRTS; HALLOWEEN COSTUMES; KNIT SHIRTS; MASQUERADE COSTUMES; POLO SHIRTS; SHORT-SLEEVED OR LONG-SLEEVED T-SHIRTS; SKULL CAPS; SWEAT SHIRTS; T-SHIRTS (U.S. CLS. 22 AND 39).

FIRST USE 9-1-2006; IN COMMERCE 9-1-2006.

CLASS 28—TOYS AND SPORTING GOODS

FOR PLUSH TOYS; STUFFED TOY ANIMALS; TOY SWORDS (U.S. CLS. 22, 23, 38 AND 50).

FIRST USE 9-1-2006; IN COMMERCE 9-1-2006.

CLASS 41—EDUCATION AND ENTERTAINMENT

FOR ENTERTAINMENT IN THE NATURE OF THEATER PRODUCTIONS; ENTERTAINMENT NAMELY, PRODUCTION OF THEATRICAL SHOWS (U.S. CLS. 100, 101 AND 107).

FIRST USE 9-1-2006; IN COMMERCE 9-1-2006.

3,400,007. SETCOM MEDIA, INC., MT. PLEASANT, SC. SN 78-905,023. PUB. 5-8-2007, FILED 6-9-2006.

SCBIZ

THE MARK CONSISTS OF STANDARD CHARACTERS WITHOUT CLAIM TO ANY PARTICULAR FONT, STYLE, SIZE, OR COLOR.

CLASS 16—PAPER GOODS AND PRINTED MATTER

FOR PRINTED PUBLICATIONS FEATURING BUSINESS NEWS, BUSINESS AND ECONOMIC DATA AND REGIONAL DEVELOPMENT INFORMATION (U.S. CLS. 2, 5, 22, 23, 29, 37, 38 AND 50).

FIRST USE 2-9-2007; IN COMMERCE 2-9-2007.

CLASS 35—ADVERTISING AND BUSINESS

FOR PROVIDING BUSINESS AND ECONOMIC DATA AND REGIONAL DEVELOPMENT INFORMATION VIA THE INTERNET; PROVIDING BUSINESS NEWS VIA THE INTERNET (U.S. CLS. 100, 101 AND 102).

FIRST USE 2-26-2007; IN COMMERCE 2-26-2007.

3,400,011. MASSIVE ENTERTAINMENT AB, MALMO, SWEDEN. SN 78-907,411. PUB. 10-2-2007, FILED 6-13-2006.

WORLD IN CONFLICT

THE MARK CONSISTS OF STANDARD CHARACTERS WITHOUT CLAIM TO ANY PARTICULAR FONT, STYLE, SIZE, OR COLOR.

CLASS 9—ELECTRICAL AND SCIENTIFIC APPARATUS

FOR COMPUTER GAME SOFTWARE AND INSTRUCTION MANUALS SOLD AS A UNIT THEREWITH; COMPUTER SCREEN SAVER SOFTWARE; ENTERTAINMENT SOFTWARE IN THE NATURE OF A GAME CAPABLE OF BEING PLAYED ON A PERSONAL COMPUTER, TELEVISION GAMING SYSTEM, OR GLOBAL COMPUTER NETWORK, DOWNLOADABLE ELECTRONIC PUBLICATIONS IN THE NATURE OF NEWSLETTERS, MAGAZINES AND CATALOGS IN THE FIELD OF COMPUTER GAMES; MOUSE PADS (U.S. CLS. 21, 23, 26, 36 AND 38).

FIRST USE 9-18-2007; IN COMMERCE 9-18-2007.

CLASS 41—EDUCATION AND ENTERTAINMENT

FOR PROVIDING ON-LINE COMPUTER GAMES, TIPS AND STRATEGIES FOR COMPUTER GAMES; ARRANGING AND CONDUCTING COMPUTER GAME COMPETITIONS (U.S. CLS. 100, 101 AND 107).

FIRST USE 9-18-2007; IN COMMERCE 9-18-2007.

3,400,014. FOREMOST DENTAL LLC, ENGLEWOOD, NJ. SN 78-910,855. PUB. 7-17-2007, FILED 6-19-2006.

KOLORZ

THE MARK CONSISTS OF STANDARD CHARACTERS WITHOUT CLAIM TO ANY PARTICULAR FONT, STYLE, SIZE, OR COLOR.

CLASS 3—COSMETICS AND CLEANING PREPARATIONS

FOR DENTAL PRODUCTS, NAMELY, PROPHY PASTE (U.S. CLS. 1, 4, 6, 50, 51 AND 52).

FIRST USE 12-28-2006; IN COMMERCE 12-28-2006.

CLASS 5—PHARMACEUTICALS

FOR DENTAL PRODUCTS, NAMELY, FLUORIDE GEL AND FLUORIDE FOAM FOR USE IN PREVENTIVE DENTISTRY; TOPICAL ANESTHETICS (U.S. CLS. 6, 18, 44, 46, 51 AND 52).

FIRST USE 12-27-2006; IN COMMERCE 12-27-2006.

3,400,015. BERRY PLASTICS HOLDING CORPORATION, EVANSVILLE, IN. SN 78-911,235. PUB. 1-16-2007, FILED 6-19-2006.

POLYNASH

THE MARK CONSISTS OF STANDARD CHARACTERS WITHOUT CLAIM TO ANY PARTICULAR FONT, STYLE, SIZE, OR COLOR.

CLASS 16—PAPER GOODS AND PRINTED MATTER

FOR ADHESIVE TAPE FOR STATIONERY AND HOUSEHOLD USE (U.S. CLS. 2, 5, 22, 23, 29, 37, 38 AND 50).

FIRST USE 12-1-2006; IN COMMERCE 12-1-2006.

CLASS 17—RUBBER GOODS

FOR ADHESIVE TAPE FOR INDUSTRIAL AND COMMERCIAL USE (U.S. CLS. 1, 5, 12, 13, 35 AND 50).

FIRST USE 12-1-2006; IN COMMERCE 12-1-2006.

3,400,037. RATCHET, INC., MINNEAPOLIS, MN. SN 78-922,479. PUB. 8-21-2007, FILED 7-5-2006.

ratchet

THE MARK CONSISTS OF STANDARD CHARACTERS WITHOUT CLAIM TO ANY PARTICULAR FONT, STYLE, SIZE, OR COLOR.

CLASS 9—ELECTRICAL AND SCIENTIFIC APPARATUS

FOR COMPUTER SOFTWARE USED FOR BUILDING, OPERATING, MAINTAINING, AND UPGRADING WEBSITES, DATABASES, AND INTERACTIVE COMPUTER NETWORKS IN THE FIELD OF ONLINE COMMERCE, ADVERTISING, AND PUBLIC RELATIONS, FOR WEB AND DESKTOP APPLICATIONS (U.S. CLS. 21, 23, 26, 36 AND 38).

FIRST USE 6-23-2006; IN COMMERCE 6-30-2006.

CLASS 42—SCIENTIFIC AND COMPUTER SERVICES

FOR COMPUTER SOFTWARE CONSULTATION, COMPUTER SOFTWARE DESIGN, COMPUTER PROGRAMMING, MAINTENANCE OF COMPUTER SOFTWARE, AND COMPUTER SOFTWARE DEVELOPMENT FOR BUILDING, OPERATING, MAINTAINING, AND UPGRADING WEBSITES, DATABASES, AND INTERACTIVE COMPUTER NETWORKS IN THE FIELD OF ONLINE COMMERCE, ADVERTISING, AND PUBLIC RELATIONS (U.S. CLS. 100 AND 101).

FIRST USE 6-23-2006; IN COMMERCE 6-30-2006.

3,400,038. RATCHET, INC., MINNEAPOLIS, MN. SN 78-922,532. PUB. 8-21-2007, FILED 7-5-2006.

RATCHET

THE MARK CONSISTS OF STYLIZED PRESENTATION OF THE WORD "RATCHET".

CLASS 9—ELECTRICAL AND SCIENTIFIC APPARATUS

FOR COMPUTER SOFTWARE USED FOR BUILDING, OPERATING, MAINTAINING, AND UPGRADING WEBSITES, DATABASES, AND INTERACTIVE COMPUTER NETWORKS IN THE FIELD OF ONLINE COMMERCE, ADVERTISING, AND PUBLIC RELATIONS, FOR WEB AND DESKTOP APPLICATIONS (U.S. CLS. 21, 23, 26, 36 AND 38).

FIRST USE 6-23-2006; IN COMMERCE 6-30-2006.

CLASS 42—SCIENTIFIC AND COMPUTER SERVICES

FOR COMPUTER SOFTWARE CONSULTATION, COMPUTER SOFTWARE DESIGN, COMPUTER PROGRAMMING, MAINTENANCE OF COMPUTER SOFTWARE, AND COMPUTER SOFTWARE DEVELOPMENT FOR BUILDING, OPERATING, MAINTAINING, AND UPGRADING WEBSITES, DATABASES, AND INTERACTIVE COMPUTER NETWORKS IN THE FIELD OF ONLINE COMMERCE, ADVERTISING, AND PUBLIC RELATIONS (U.S. CLS. 100 AND 101).

FIRST USE 6-23-2006; IN COMMERCE 6-30-2006.

3,400,039. RATCHET, INC., MINNEAPOLIS, MN. SN 78-922,544. PUB. 8-21-2007, FILED 7-5-2006.



THE MARK CONSISTS OF ABSTRACTION OF RATCHET.

CLASS 9—ELECTRICAL AND SCIENTIFIC APPARATUS

FOR COMPUTER SOFTWARE USED FOR BUILDING, OPERATING, MAINTAINING, AND UPGRADING WEBSITES, DATABASES, AND INTERACTIVE COMPUTER NETWORKS IN THE FIELD OF ONLINE COMMERCE, ADVERTISING, AND PUBLIC RELATIONS, FOR WEB AND DESKTOP APPLICATIONS (U.S. CLS. 21, 23, 26, 36 AND 38).

FIRST USE 6-23-2006; IN COMMERCE 6-30-2006.

CLASS 42—SCIENTIFIC AND COMPUTER SERVICES

FOR COMPUTER SOFTWARE CONSULTATION, COMPUTER SOFTWARE DESIGN, COMPUTER PROGRAMMING, MAINTENANCE OF COMPUTER SOFTWARE, AND COMPUTER SOFTWARE DEVELOPMENT FOR BUILDING, OPERATING, MAINTAINING, AND UPGRADING WEBSITES, DATABASES, AND INTERACTIVE COMPUTER NETWORKS IN THE FIELD OF ONLINE COMMERCE, ADVERTISING, AND PUBLIC RELATIONS (U.S. CLS. 100 AND 101).

FIRST USE 6-23-2006; IN COMMERCE 6-30-2006.

3,400,046. YAMAGUCHI ELECTRIC INDUSTRY CO., LTD., TOKYO, 154, JAPAN. SN 78-926,767. PUB. 3-13-2007, FILED 7-11-2006.

YEC

THE MARK CONSISTS OF STANDARD CHARACTERS WITHOUT CLAIM TO ANY PARTICULAR FONT, STYLE, SIZE, OR COLOR.

CLASS 7—MACHINERY

FOR AUTOMOTIVE IGNITION COMPONENTS, NAMELY, DISTRIBUTOR CAPS, ROTORS, COILS, PLUGS, PLUG WIRES, CONDENSERS (U.S. CLS. 13, 19, 21, 23, 31, 34 AND 35).

FIRST USE 7-1-1963; IN COMMERCE 7-1-1963.

CLASS 9—ELECTRICAL AND SCIENTIFIC APPARATUS

FOR ELECTRICAL SWITCHES AND IGNITION CONTROL MODULES (U.S. CLS. 21, 23, 26, 36 AND 38).

FIRST USE 7-1-1963; IN COMMERCE 7-1-1963.

CLASS 12—VEHICLES

FOR MOTOR VEHICLE BACKUP BEEPERS (U.S. CLS. 19, 21, 23, 31, 35 AND 44).

FIRST USE 7-1-1963; IN COMMERCE 7-1-1963.

3,400,050. SEC INSIGHT, INC., PLYMOUTH, MN. SN 78-929,808. PUB. 9-4-2007, FILED 7-14-2006.

DISCLOSURE INSIGHT

THE MARK CONSISTS OF STANDARD CHARACTERS WITHOUT CLAIM TO ANY PARTICULAR FONT, STYLE, SIZE, OR COLOR.

NO CLAIM IS MADE TO THE EXCLUSIVE RIGHT TO USE "DISCLOSURE", APART FROM THE MARK AS SHOWN.

CLASS 35—ADVERTISING AND BUSINESS

FOR ANALYZING AND COMPILING INFORMATION ON SEC FILINGS AND RELATED INVESTMENT DATA FOR MEASURING THE PERFORMANCE OF FINANCIAL MARKETS (U.S. CLS. 100, 101 AND 102).

FIRST USE 7-0-2007; IN COMMERCE 7-0-2007.

CLASS 36—INSURANCE AND FINANCIAL

FOR PROVIDING FINANCIAL INFORMATION AND INVESTMENT INFORMATION SERVICES REGARDING SEC SECURITIES FILINGS AND RELATED FINANCIAL INVESTMENTS (U.S. CLS. 100, 101 AND 102).

FIRST USE 7-0-2007; IN COMMERCE 7-0-2007.

3,400,055. UBROADCAST, INC., SAN DIEGO, CA. SN 78-932,327. PUB. 7-31-2007, FILED 7-18-2006.

UBROADCAST

THE MARK CONSISTS OF STANDARD CHARACTERS WITHOUT CLAIM TO ANY PARTICULAR FONT, STYLE, SIZE, OR COLOR.

CLASS 9—ELECTRICAL AND SCIENTIFIC APPARATUS

FOR DOWNLOADABLE SOFTWARE THAT ENABLES MULTIPLE USERS WITH THE ABILITY TO BROADCAST AND LISTEN TO PROGRAMS VIA THE INTERNET (U.S. CLS. 21, 23, 26, 36 AND 38).
FIRST USE 1-30-2006; IN COMMERCE 1-30-2007.

CLASS 38—COMMUNICATION

FOR TRANSMISSION OF INFORMATION AND BROADCASTING OF RADIO SHOWS VIA THE INTERNET, PROVIDING MULTIPLE USERS WITH THE ABILITY AND ACCESS TO BROADCAST AND LISTEN TO LIVE RADIO SHOWS VIA THE INTERNET, WHEREIN SUCH RADIO SHOWS INCLUDE BOTH LIVE AND PRE-RECORDED CONTENT (U.S. CLS. 100, 101 AND 104).
FIRST USE 1-30-2006; IN COMMERCE 1-30-2007.

CLASS 41—EDUCATION AND ENTERTAINMENT

FOR ENTERTAINMENT SERVICES IN THE NATURE OF CONTENT PREPARATION FOR INTERNET RADIO SHOWS (U.S. CLS. 100, 101 AND 107).
FIRST USE 1-30-2006; IN COMMERCE 1-30-2007.

CLASS 42—SCIENTIFIC AND COMPUTER SERVICES

FOR PROVIDING ONLINE NONDOWNLOADABLE SOFTWARE THAT ENABLES MULTIPLER USERS WITH THE ABILITY TO BROADCAST AND LISTEN TO RADIO PROGRAMS VIA THE INTERNET; HOSTING OF DIGITAL CONTENT ON THE INTERNET (U.S. CLS. 100 AND 101).
FIRST USE 1-30-2006; IN COMMERCE 1-30-2007.

3,400,056. UBROADCAST, INC., SAN DIEGO, CA. SN 78-932,336. PUB. 8-7-2007, FILED 7-18-2006.



THE MARK CONSISTS OF THE WORD "UBROADCAST" WITH 3 SEMI-CIRCLES REPRESENTING PULSES TO THE LEFT OF AND OVER THE "U".

CLASS 9—ELECTRICAL AND SCIENTIFIC APPARATUS

FOR DOWNLOADABLE SOFTWARE THAT ENABLES MULTIPLE USERS WITH THE ABILITY TO BROADCAST AND LISTEN TO PROGRAMS VIA THE INTERNET (U.S. CLS. 21, 23, 26, 36 AND 38).
FIRST USE 1-30-2006; IN COMMERCE 1-30-2007.

CLASS 38—COMMUNICATION

FOR TRANSMISSION OF INFORMATION AND BROADCASTING OF RADIO SHOWS VIA THE INTERNET, PROVIDING MULTIPLE USERS WITH THE ABILITY AND ACCESS TO BROADCAST AND LISTEN TO LIVE RADIO SHOWS VIA THE INTERNET, WHEREIN SUCH RADIO SHOWS INCLUDE BOTH LIVE AND PRE-RECORDED CONTENT (U.S. CLS. 100, 101 AND 104).
FIRST USE 1-30-2006; IN COMMERCE 1-30-2007.

CLASS 41—EDUCATION AND ENTERTAINMENT

FOR ENTERTAINMENT SERVICES IN THE NATURE OF CONTENT PREPARATION FOR INTERNET RADIO SHOWS (U.S. CLS. 100, 101 AND 107).
FIRST USE 1-30-2006; IN COMMERCE 1-30-2007.

CLASS 42—SCIENTIFIC AND COMPUTER SERVICES

FOR PROVIDING ONLINE NONDOWNLOADABLE SOFTWARE THAT ENABLES MULTIPLER USERS WITH THE ABILITY TO BROADCAST AND LISTEN TO PROGRAMS VIA THE INTERNET; HOSTING OF DIGITAL CONTENT ON THE INTERNET (U.S. CLS. 100 AND 101).
FIRST USE 1-30-2006; IN COMMERCE 1-30-2007.

3,400,058. HR CAPITAL MANAGEMENT, ROCKVILLE, MD. SN 78-934,448. PUB. 9-4-2007, FILED 7-21-2006.



THE COLOR(S) BLUE, LIGHT BLUE, AND BLACK IS/ ARE CLAIMED AS A FEATURE OF THE MARK.

THE FIRST STYLIZED FIGURE HAS BLACK HEAD WITH A BLUE CHEST AND ARMS, THE SECOND STYLIZED FIGURE HAS A BLACK HEAD AND LIGHT BLUE CHEST ARMS; THE THIRD STYLIZED FIGURE HAS A BLACK HEAD WITH A BLUE CHEST AND ARMS, THE WORD "PAY" APPEARS IN BLACK AND THE WORD "STAFF" APPEARS IN BLUE.

CLASS 35—ADVERTISING AND BUSINESS

FOR SERVING AS A HUMAN RESOURCES DEPARTMENT FOR OTHERS; PERSONNEL PLACEMENT AND RECRUITMENT; TRANSCRIPTION OF WRITTEN LEGAL DOCUMENTS AND NOTES (U.S. CLS. 100, 101 AND 102).
FIRST USE 11-1-2005; IN COMMERCE 1-1-2006.

CLASS 36—INSURANCE AND FINANCIAL

FOR ADMINISTRATION OF EMPLOYEE BENEFITS PLANS (U.S. CLS. 100, 101 AND 102).
FIRST USE 11-1-2005; IN COMMERCE 1-1-2006.

3,400,072. PAYNE, LARRY J., LOS ANGELES, CA. SN 78-939,488. PUB. 3-20-2007, FILED 7-27-2006.

3,400,089. PATIENT POWER, MERCER ISLAND, WA. SN 78-945,889. PUB. 9-4-2007, FILED 8-6-2006.

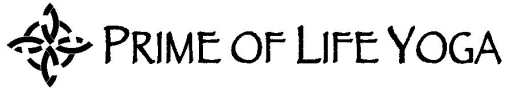

NO CLAIM IS MADE TO THE EXCLUSIVE RIGHT TO USE "YOGA", APART FROM THE MARK AS SHOWN.

CLASS 9—ELECTRICAL AND SCIENTIFIC APPARATUS

FOR AUDIO RECORDINGS FEATURING A STYLE AND PRESENTATION OF YOGA AND RELATED INFORMATION INCORPORATING INSTRUCTION AND TECHNIQUES DESIGNED FOR THE PARTICULAR NEEDS AND GOALS OF PEOPLE OVER 40 FOR OPTIMUM WELL-BEING; DOWNLOADABLE ELECTRONIC PUBLICATIONS IN THE NATURE OF BOOKS AND MAGAZINES IN THE FIELD OF A STYLE AND PRESENTATION OF YOGA AND RELATED INFORMATION INCORPORATING INSTRUCTION AND TECHNIQUES DESIGNED FOR THE PARTICULAR NEEDS AND GOALS OF PEOPLE OVER 40 FOR OPTIMUM WELL-BEING; PRE-RECORDED CD'S, VIDEO TAPES, LASER DISKS AND DVD'S FEATURING A STYLE AND PRESENTATION OF YOGA AND RELATED INFORMATION INCORPORATING INSTRUCTION AND TECHNIQUES DESIGNED FOR THE PARTICULAR NEEDS AND GOALS OF PEOPLE OVER 40 FOR OPTIMUM WELL-BEING; VIDEO RECORDINGS FEATURING A STYLE AND PRESENTATION OF YOGA AND RELATED INFORMATION INCORPORATING INSTRUCTION AND TECHNIQUES DESIGNED FOR THE PARTICULAR NEEDS AND GOALS OF PEOPLE OVER 40 FOR OPTIMUM WELL-BEING (U.S. CLS. 21, 23, 26, 36 AND 38).
FIRST USE 8-28-2006; IN COMMERCE 8-28-2006.

CLASS 41—EDUCATION AND ENTERTAINMENT

FOR EDUCATION SERVICES, NAMELY, PROVIDING SEMINARS, WORKSHOPS, CLASSES, RETREATS, LECTURES, AND CULTURAL ACTIVITIES IN THE FIELDS OF A STYLE AND PRESENTATION OF YOGA AND RELATED INFORMATION INCORPORATING INSTRUCTION AND TECHNIQUES DESIGNED FOR THE PARTICULAR NEEDS AND GOALS OF PEOPLE OVER 40 FOR OPTIMUM WELL-BEING; ENTERTAINMENT SERVICES, NAMELY, PROVIDING A RADIO PROGRAM IN THE FIELD OF A STYLE AND PRESENTATION OF YOGA AND RELATED INFORMATION INCORPORATING INSTRUCTION AND TECHNIQUES DESIGNED FOR THE PARTICULAR NEEDS AND GOALS OF PEOPLE OVER 40 FOR OPTIMUM WELL-BEING VIA A GLOBAL COMPUTER NETWORK; ENTERTAINMENT, NAMELY, A CONTINUING EDUCATIONAL SHOW BROADCAST OVER TELEVISION, SATELLITE, AUDIO, AND VIDEO MEDIA FEATURING A STYLE AND PRESENTATION OF YOGA AND RELATED INFORMATION INCORPORATING INSTRUCTION AND TECHNIQUES DESIGNED FOR THE PARTICULAR NEEDS AND GOALS OF PEOPLE OVER 40 FOR OPTIMUM WELL-BEING (U.S. CLS. 100, 101 AND 107).
FIRST USE 12-18-2007; IN COMMERCE 12-18-2007.

PATIENT POWER

THE MARK CONSISTS OF STANDARD CHARACTERS WITHOUT CLAIM TO ANY PARTICULAR FONT, STYLE, SIZE, OR COLOR.

NO CLAIM IS MADE TO THE EXCLUSIVE RIGHT TO USE "PATIENT", APART FROM THE MARK AS SHOWN.

CLASS 38—COMMUNICATION

FOR TELECOMMUNICATION SERVICES, NAMELY, BROADCAST AND TRANSMISSION OF CONTENT IN THE FORM OF LIVE AND ON-DEMAND TALK SHOW STYLE BROADCASTS REGARDING HEALTH AND MEDICAL TOPICS ON-LINE AND OVER THE INTERNET, RADIO, CELLULAR TELEPHONES, AND OTHER ELECTRONIC MEDIA WHEREBY HEALTHCARE CONSUMERS, PROSPECTIVE PATIENTS, PATIENTS, CAREGIVERS AND THE GENERAL PUBLIC CAN HEAR DIRECTLY FROM RENOWNED MEDICAL EXPERTS ON TOPICS OF THEIR CHOICE AND, AT THEIR OPTION, TO ASK QUESTIONS (U.S. CLS. 100, 101 AND 104).

FIRST USE 2-13-2005; IN COMMERCE 2-13-2005.

CLASS 41—EDUCATION AND ENTERTAINMENT

FOR PRODUCTION AND DISTRIBUTION OF AUDIO CONTENT FROM RADIO AND ONLINE BROADCASTS REGARDING THE FIELDS OF HEALTH AND MEDICINE (U.S. CLS. 100, 101 AND 107).

FIRST USE 2-13-2005; IN COMMERCE 2-13-2005.

3,400,090. TRAVEL GROUP ADVENTURES, INC., ANAHEIM, CA. SN 78-946,458. PUB. 3-20-2007, FILED 8-7-2006.



NO CLAIM IS MADE TO THE EXCLUSIVE RIGHT TO USE "INTERNATIONAL TRAVEL", APART FROM THE MARK AS SHOWN.

THE COLOR(S) ORANGE, RED, GRAY, BLACK, AND WHITE IS/ARE CLAIMED AS A FEATURE OF THE MARK.

THE COLORS RED, BLACK, ORANGE AND WHITE APPEAR IN THE SPECIAL FORM SQUARE DESIGN AND THE COLOR BLACK APPEARS IN THE WORDING OF THE MARK.

THE MARK CONSISTS OF GEOMETRICAL SHAPES FORMING ONE SQUARE.

CLASS 39—TRANSPORTATION AND STORAGE

FOR ARRANGING TRAVEL TOURS; COORDINATING TRAVEL ARRANGEMENTS FOR INDIVIDUALS AND FOR GROUPS; ORGANISATION OF SIGHTSEEING TOURS; ORGANISATION OF TRAVEL; ORGANIZATION OF EXCURSIONS, SIGHTSEEING TOURS, HOLIDAYS, TOURS AND TRAVEL; ORGANIZATION, BOOKING AND ARRANGEMENT OF EXCURSIONS, DAY TRIPS AND SIGHTSEEING TOURS (U.S. CLS. 100 AND 105).

FIRST USE 5-17-2007; IN COMMERCE 5-17-2007.

CLASS 43—HOTEL AND RESTAURANT SERVICES

FOR MAKING HOTEL RESERVATIONS FOR OTHERS; PROVIDING TRAVEL LODGING INFORMATION SERVICES AND TRAVEL LODGING BOOKING AGENCY SERVICES FOR TRAVELERS; RESERVATION OF HOTEL ROOMS FOR TRAVELERS; TRAVEL AGENCY SERVICES, NAMELY, MAKING RESERVATIONS AND BOOKING FOR TEMPORARY LODGING (U.S. CLS. 100 AND 101).

FIRST USE 5-17-2007; IN COMMERCE 5-17-2007.

3,400,091. SETCOM MEDIA, INC., MT. PLEASANT, SC. SN 78-946,586. PUB. 5-15-2007, FILED 8-7-2006.

**CLASS 16—PAPER GOODS AND PRINTED MATTER**

FOR PRINTED PUBLICATIONS FEATURING BUSINESS NEWS, BUSINESS AND ECONOMIC DATA AND REGIONAL DEVELOPMENT INFORMATION (U.S. CLS. 2, 5, 22, 23, 29, 37, 38 AND 50).

FIRST USE 2-9-2007; IN COMMERCE 2-9-2007.

CLASS 35—ADVERTISING AND BUSINESS

FOR PROVIDING BUSINESS AND ECONOMIC DATA AND REGIONAL DEVELOPMENT INFORMATION VIA THE INTERNET; PROVIDING BUSINESS NEWS VIA THE INTERNET (U.S. CLS. 100, 101 AND 102).

FIRST USE 2-26-2007; IN COMMERCE 2-26-2007.

3,400,092. SETCOM MEDIA, INC., MT. PLEASANT, SC. SN 78-946,595. PUB. 5-15-2007, FILED 8-7-2006.

SOUTH CAROLINA'S MEDIA
ENGINE FOR ECONOMIC GROWTH

THE MARK CONSISTS OF STANDARD CHARACTERS WITHOUT CLAIM TO ANY PARTICULAR FONT, STYLE, SIZE, OR COLOR.

CLASS 16—PAPER GOODS AND PRINTED MATTER

FOR PRINTED PUBLICATIONS FEATURING BUSINESS NEWS, BUSINESS AND ECONOMIC DATA AND REGIONAL DEVELOPMENT INFORMATION (U.S. CLS. 2, 5, 22, 23, 29, 37, 38 AND 50).

FIRST USE 2-26-2007; IN COMMERCE 2-26-2007.

CLASS 35—ADVERTISING AND BUSINESS

FOR PROVIDING BUSINESS AND ECONOMIC DATA AND REGIONAL DEVELOPMENT INFORMATION VIA THE INTERNET; PROVIDING BUSINESS NEWS VIA THE INTERNET (U.S. CLS. 100, 101 AND 102).

FIRST USE 2-9-2007; IN COMMERCE 2-9-2007.

3,400,098. MCFERSON, CASSANDRA, WASHINGTON, DC. SN 78-949,557. PUB. 4-10-2007, FILED 8-10-2006.

**MPWR: More Possibilities
Within Reach**

THE MARK CONSISTS OF STANDARD CHARACTERS WITHOUT CLAIM TO ANY PARTICULAR FONT, STYLE, SIZE, OR COLOR.

CLASS 35—ADVERTISING AND BUSINESS

FOR ADVERTISING AND PUBLICITY SERVICES; PROVIDING CONSUMER INFORMATION SERVICES AND MAKING REFERRALS IN THE FIELD OF ENTERTAINMENT SERVICES FOR PRODUCTS, SERVICES, EVENTS, ACTIVITIES, FACILITIES AND LOCATIONS; PROVIDING INFORMATION ABOUT THE GOODS AND SERVICES OF OTHERS VIA THE GLOBAL COMPUTER NETWORK; PROVIDING ONLINE DIRECTORY INFORMATION SERVICES ALSO FEATURING HYPERLINKS TO OTHER WEB SITES (U.S. CLS. 100, 101 AND 102).

FIRST USE 10-1-2006; IN COMMERCE 3-25-2007.

CLASS 41—EDUCATION AND ENTERTAINMENT

FOR ONLINE JOURNALS, NAMELY, BLOGS FEATURING NEWS, INFORMATION, DIARIES, COMMENTARY, PHOTOS, MINI-ESSAYS, PROJECT UPDATES, PROFESSIONAL, AUTOBIOGRAPHICAL, AND BIOGRAPHICAL OR PERSONAL INFORMATION TO CONNECT INDIVIDUALS IN THE FIELD OF PERSONAL INTERESTS, PROFESSIONAL INTERESTS, LEISURE INTERESTS, AND OTHER GENERAL INTERESTS (U.S. CLS. 100, 101 AND 107).

FIRST USE 9-23-2004; IN COMMERCE 3-25-2007.

3,400,107. KOLALOKA INDUSTRIES, LP, DALLAS, TX. SN 78-953,205. PUB. 4-3-2007, FILED 8-16-2006.

PEGA DE LOCURA

THE MARK CONSISTS OF STANDARD CHARACTERS WITHOUT CLAIM TO ANY PARTICULAR FONT, STYLE,

SIZE, OR COLOR.

THE FOREIGN WORDING IN THE MARK TRANSLATES INTO ENGLISH AS "IT BEATS OF MADNESS".

CLASS 1—CHEMICALS

FOR ADHESIVES FOR GENERAL INDUSTRIAL USE (U.S. CLS. 1, 5, 6, 10, 26 AND 46).
FIRST USE 12-10-2007; IN COMMERCE 12-10-2007.

CLASS 16—PAPER GOODS AND PRINTED MATTER

FOR ADHESIVES FOR STATIONERY AND HOUSEHOLD USE (U.S. CLS. 2, 5, 22, 23, 29, 37, 38 AND 50).
FIRST USE 12-10-2007; IN COMMERCE 12-10-2007.

3,400,108. KOLALOKA INDUSTRIES, LP, DALLAS, TX. SN 78-953,208. PUB. 4-3-2007, FILED 8-16-2006.

HAPPY GLUE

THE MARK CONSISTS OF STANDARD CHARACTERS WITHOUT CLAIM TO ANY PARTICULAR FONT, STYLE, SIZE, OR COLOR.

NO CLAIM IS MADE TO THE EXCLUSIVE RIGHT TO USE "GLUE", APART FROM THE MARK AS SHOWN.

CLASS 1—CHEMICALS

FOR ADHESIVES FOR GENERAL INDUSTRIAL USE (U.S. CLS. 1, 5, 6, 10, 26 AND 46).
FIRST USE 12-10-2007; IN COMMERCE 12-10-2007.

CLASS 16—PAPER GOODS AND PRINTED MATTER

FOR ADHESIVES FOR STATIONERY AND HOUSEHOLD USE (U.S. CLS. 2, 5, 22, 23, 29, 37, 38 AND 50).
FIRST USE 12-10-2007; IN COMMERCE 12-10-2007.

3,400,112. PLANET HOLLYWOOD (REGION IV), INC., ORLANDO, FL. SN 78-954,154. PUB. 3-20-2007, FILED 8-17-2006.



THE COLOR(S) RED AND BLUE IS/ARE CLAIMED AS A FEATURE OF THE MARK.

THE MARK CONSISTS OF TWO RED LOWER CASE LETTERS, "PH", THAT ARE PLACED WITHIN TWO BLUE CONCENTRIC SEMI-CIRCLES OF DIFFERENT DIAMETERS.

CLASS 25—CLOTHING

FOR CLOTHING, NAMELY, T-SHIRTS, SHIRTS, SWEATSHIRTS, POLO SHIRTS, SPORT SHIRTS, SHORTS, JACKETS AND CAPS (U.S. CLS. 22 AND 39).
FIRST USE 11-16-2007; IN COMMERCE 11-16-2007.

CLASS 41—EDUCATION AND ENTERTAINMENT

FOR CASINO ENTERTAINMENT SERVICES (U.S. CLS. 100, 101 AND 107).
FIRST USE 11-16-2007; IN COMMERCE 11-16-2007.

CLASS 43—HOTEL AND RESTAURANT SERVICES

FOR HOTEL, RESTAURANT AND BAR SERVICES (U.S. CLS. 100 AND 101).
FIRST USE 11-16-2007; IN COMMERCE 11-16-2007.

3,400,125. BERKSON, HOWARD C., SAN DIEGO, CA. SN 78-957,383. PUB. 4-24-2007, FILED 8-22-2006.



THE MARK CONSISTS OF STYLIZED WORD "ANTHOLOGY" PRINTED ON A MUSICAL STAFF COMPRISED OF FIVE HORIZONTAL LINES.

CLASS 41—EDUCATION AND ENTERTAINMENT

FOR ENTERTAINMENT IN THE NATURE OF VISUAL AND AUDIO PERFORMANCES, AND MUSICAL, VARIETY, NEWS AND COMEDY SHOWS; ENTERTAINMENT IN THE NATURE OF VISUAL AND AUDIO PERFORMANCES, NAMELY, MUSICAL BAND, ROCK GROUP, GYMNASTIC, DANCE, AND BALLET PERFORMANCES; ENTERTAINMENT NAMELY, LIVE PERFORMANCES BY A MUSICAL BAND; ENTERTAINMENT, NAMELY, LIVE MUSIC CONCERTS; ENTERTAINMENT, NAMELY, LIVE PERFORMANCES BY MUSICAL BANDS; PRESENTATION OF LIVE SHOW PERFORMANCES; PRESENTATION OF MUSICAL PERFORMANCE (U.S. CLS. 100, 101 AND 107).
FIRST USE 5-14-2007; IN COMMERCE 5-14-2007.

CLASS 43—HOTEL AND RESTAURANT SERVICES

FOR RESTAURANT AND BAR SERVICES (U.S. CLS. 100 AND 101).
FIRST USE 5-14-2007; IN COMMERCE 5-14-2007.

3,400,137. CARDIAC WELLNESS SUPPLEMENTS LLC, WRIGHTSVILLE BEACH, NC. SN 78-958,515. PUB. 4-17-2007, FILED 8-23-2006.



CLASS 5—PHARMACEUTICALS

FOR NUTRITIONAL AND DIETARY SUPPLEMENTS (U.S. CLS. 6, 18, 44, 46, 51 AND 52).
FIRST USE 7-1-2007; IN COMMERCE 7-1-2007.

CLASS 44—MEDICAL, BEAUTY AND AGRICULTURAL SERVICES

FOR HEART DISEASE PREVENTION, WELLNESS AND REHABILITATION SERVICES, NAMELY, THE PROVISION OF MEDICAL ADVISORY AND PHYSICAL THERAPY SERVICES FOR PREVENTION OF HEART DISEASE, EARLY ASSESSMENT OF CARDIOVASCULAR RISK FACTORS, MAINTENANCE OF CARDIAC WELLNESS, CARDIOVASCULAR RISK REDUCTION AND CARDIAC REHABILITATION; AND INDIVIDUAL AND GROUP CARDIOVASCULAR HEALTH COUNSELING; MEDICAL IMAGING SERVICES (U.S. CLS. 100 AND 101).

FIRST USE 7-1-2007; IN COMMERCE 7-1-2007.

3,400,159. TOPPER'S PIZZA, INC., WHITEWATER, WI. SN 78-963,992. PUB. 4-17-2007, FILED 8-30-2006.



OWNER OF U.S. REG. NOS. 2,716,892, 3,055,127, AND OTHERS.

NO CLAIM IS MADE TO THE EXCLUSIVE RIGHT TO USE "PIZZA", APART FROM THE MARK AS SHOWN.

THE MARK CONSISTS OF THE WORDS "TOPPERS PIZZA" ON A GEOMETRIC DESIGN WITH A CROWN ABOVE, ALL WITH A DROP SHADOW.

CLASS 39—TRANSPORTATION AND STORAGE

FOR PIZZA DELIVERY SERVICES (U.S. CLS. 100 AND 105).

FIRST USE 8-31-2006, THE MARK WAS FIRST USED ANYWHERE IN A DIFFERENT FORM OTHER THAN THAT SOUGHT TO BE REGISTERED ON 04/00/1993.; IN COMMERCE 8-31-2006, 04/00/1993..

CLASS 43—HOTEL AND RESTAURANT SERVICES

FOR RESTAURANT SERVICES (U.S. CLS. 100 AND 101).

FIRST USE 8-31-2006, THE MARK WAS FIRST USED ANYWHERE IN A DIFFERENT FORM OTHER THAN THAT SOUGHT TO BE REGISTERED ON 04/00/1993.; IN COMMERCE 8-31-2006, 04/00/1993..

3,400,160. CALP CORPORATION, TOKYO, JAPAN. SN 78-964,109. PUB. 4-24-2007, FILED 8-30-2006.



OWNER OF JAPAN REG. NO. 1731320, DATED 11-27-1984, EXPIRES 11-27-2014.

CLASS 1—CHEMICALS

FOR UNPROCESSED PLASTICS IN ALL FORMS (U.S. CLS. 1, 5, 6, 10, 26 AND 46).

FIRST USE 5-26-1979; IN COMMERCE 4-13-2005.

CLASS 17—RUBBER GOODS

FOR PLASTICS IN THE FORM OF PELLETS AND SHEETS FOR USE IN MANUFACTURING; SEMI-PROCESSED PLASTICS IN THE FORM OF PELLETS OR SHEETS (U.S. CLS. 1, 5, 12, 13, 35 AND 50).

FIRST USE 5-26-1979; IN COMMERCE 4-13-2005.

3,400,170. 1514890 ONTARIO INC., DBA GONGSHOW GEAR, PAKENHAM, ONTARIO, CANADA. SN 78-965,747. PUB. 4-24-2007, FILED 9-1-2006.

GONGSHOW

THE MARK CONSISTS OF STANDARD CHARACTERS WITHOUT CLAIM TO ANY PARTICULAR FONT, STYLE, SIZE, OR COLOR.

OWNER OF U.S. REG. NO. 3,101,236.

CLASS 25—CLOTHING

FOR CLOTHING, NAMELY, HATS, SHIRTS, PANTS, SHOES AND JACKETS (U.S. CLS. 22 AND 39).

FIRST USE 10-1-2005; IN COMMERCE 10-1-2006.

CLASS 26—FANCY GOODS

FOR BELT BUCKLES (U.S. CLS. 37, 39, 40, 42 AND 50).
FIRST USE 10-1-2005; IN COMMERCE 10-1-2006.

3,400,199. LIGHT DIMENSIONS, INC., PALO ALTO, CA. SN
78-972,932. PUB. 5-22-2007, FILED 9-12-2006.

REJUVAWAND

THE MARK CONSISTS OF STANDARD CHARACTERS
WITHOUT CLAIM TO ANY PARTICULAR FONT, STYLE,
SIZE, OR COLOR.

CLASS 10—MEDICAL APPARATUS

FOR LIGHT-ENHANCED PRODUCTS FOR COSMETIC
AND THERAPEUTIC USE, NAMELY, LASER AND
OTHER LIGHT-ENHANCED DEVICES, NAMELY,
LIGHT-EMITTING SKIN-TREATMENT WANDS AND
LIGHT-EMITTING HAIRBRUSHES, COMBS AND
TOOTHBRUSHES, FOR PERSONAL CARE AND TREAT-
MENT OF SKIN, HAIR, AND TEETH (U.S. CLS. 26, 39
AND 44).

FIRST USE 2-28-2007; IN COMMERCE 2-28-2007.

CLASS 21—HOUSEWARES AND GLASS

FOR HAND-HELD PRODUCTS FOR SKIN CARE
TREATMENT, HAIR CARE AND ORAL CARE,
NAMELY, WRINKLE-REDUCING WANDS, ACNE-
TREATMENT WANDS, HAIRBRUSHES, COMBS AND
TOOTHBRUSHES; PERSONAL CARE PRODUCTS FOR
COSMETIC USE AT HOME, NAMELY, HAIRBRUSHES,
COMBS AND TOOTHBRUSHES (U.S. CLS. 2, 13, 23, 29,
30, 33, 40 AND 50).

FIRST USE 2-28-2007; IN COMMERCE 2-28-2007.

3,400,208. PS HERE LLC, DALLAS, TX. SN 78-978,922. PUB.
9-5-2006, FILED 12-1-2004.

here!

THE STIPPLING IS FOR SHADING PURPOSES ONLY.

CLASS 9—ELECTRICAL AND SCIENTIFIC APPARATUS

FOR PRE-RECORDED DVDS IN THE FIELD OF
COMEDY, DRAMA, MUSICALS, ROMANCE, EROTICA,
MYSTERY, SUSPENSE, HORROR, ACTION, DOCUMEN-
TARY, NEWS, VARIETY TALK SHOWS AND FAMILY
(U.S. CLS. 21, 23, 26, 36 AND 38).

FIRST USE 5-22-2006; IN COMMERCE 5-22-2006.

CLASS 38—COMMUNICATION

FOR CABLE AND SATELLITE TELEVISION BROAD-
CASTING (U.S. CLS. 100, 101 AND 104).

FIRST USE 8-19-2003; IN COMMERCE 8-19-2003.

CLASS 41—EDUCATION AND ENTERTAINMENT

FOR PRODUCTION AND DISTRIBUTION OF MOTION
PICTURES, MADE FOR TELEVISION MOVIES,
AND TELEVISION SERIES, IN THE FIELD OF COME-
DY, DRAMA, MUSICALS, ROMANCE, EROTICA, MYSTERY,
SUSPENSE, HORROR, ACTION,
DOCUMENTARY, NEWS, VARIETY TALK SHOWS
AND FAMILY; TELEVISION PROGRAMMING; PRO-
VIDING MOTION PICTURES OVER A GLOBAL COM-
PUTER NETWORK; ENTERTAINMENT IN THE
NATURE OF THE DISPLAY OF MOTION PICTURES
AND MADE FOR TELEVISION MOVIES, IN THE FIELD
OF COMEDY, DRAMA, MUSICALS, ROMANCE, ERO-
TICA, MYSTERY, SUSPENSE, HORROR, ACTION, DOC-
UMENTARY, NEWS, VARIETY TALK SHOWS AND
FAMILY; ENTERTAINMENT IN THE NATURE OF ON-
GOING TELEVISION PROGRAMS IN THE FIELD OF
COMEDY, DRAMA, MUSICALS, ROMANCE, EROTICA,
MYSTERY, SUSPENSE, HORROR, ACTION, DOCUMEN-
TARY, NEWS, VARIETY TALK SHOWS AND FAMILY;
AND CONDUCTING A FILM FESTIVAL (U.S. CLS. 100,
101 AND 107).

FIRST USE 2-22-2002; IN COMMERCE 2-22-2002.

3,400,210. CUSTOM BUILDING PRODUCTS, INC., SEAL
BEACH, CA. SN 78-979,386. PUB. 7-10-2007, FILED 10-27-
2005.

CBP

THE MARK CONSISTS OF STANDARD CHARACTERS
WITHOUT CLAIM TO ANY PARTICULAR FONT, STYLE,
SIZE, OR COLOR.

CLASS 2—PAINTS

FOR SEALER COATINGS FOR USE ON CERAMIC
TILE, NATURAL STONE FLOORS, CONCRETE, AND
MASONRY; FLOOR PROTECTION VARNISHES FOR
USE ON CERAMIC TILE, NATURAL STONE FLOORS,
CONCRETE, AND MASONRY (U.S. CLS. 6, 11 AND 16).

FIRST USE 3-15-2006; IN COMMERCE 3-15-2006.

CLASS 19—NON-METALLIC BUILDING MATERIALS

FOR FLOOR PATCHING MATERIALS, NAMELY,
SEALERS FOR CERAMIC TILE, NATURAL STONE
FLOORS, CONCRETE, AND MASONRY (U.S. CLS. 1,
12, 33 AND 50).

FIRST USE 3-15-2006; IN COMMERCE 3-15-2006.

3,400,211. PS HERE LLC, DALLAS, TX. SN 78-979,387. PUB. 9-5-2006, FILED 9-8-2004.

CLASS 16—PAPER GOODS AND PRINTED MATTER

FOR PRINTED EDUCATIONAL AND TEACHING MATERIALS, NAMELY, BOOKS, WORKBOOKS, TRAINING MANUALS AND INSTRUCTIONAL MANUALS IN THE FIELD OF K THROUGH 12 EDUCATION SCHOOL IMPROVEMENTS, K THROUGH 12 EDUCATION STANDARDS BASED PROGRAM DEVELOPMENT, K THROUGH 12 EDUCATION STUDENT ASSESSMENT EVALUATION AND K THROUGH 12 EDUCATION POLICY STUDIES, K THROUGH 12 EDUCATION STRATEGIC PLANNING AND K THROUGH 12 EDUCATION LEADERSHIP DEVELOPMENT (U.S. CLS. 2, 5, 22, 23, 29, 37, 38 AND 50).

FIRST USE 0-0-2006; IN COMMERCE 0-0-2006.

HERE!

THE MARK CONSISTS OF STANDARD CHARACTERS WITHOUT CLAIM TO ANY PARTICULAR FONT, STYLE, SIZE, OR COLOR.

CLASS 9—ELECTRICAL AND SCIENTIFIC APPARATUS

FOR PRE-RECORDED DVDS IN THE FIELD OF COMEDY, DRAMA, MUSICALS, ROMANCE, EROTICA, MYSTERY, SUSPENSE, HORROR, ACTION, DOCUMENTARY, NEWS, VARIETY TALK SHOWS AND FAMILY (U.S. CLS. 21, 23, 26, 36 AND 38).

FIRST USE 5-22-2006; IN COMMERCE 5-22-2006.

CLASS 41—EDUCATION AND ENTERTAINMENT

FOR PRODUCTION AND DISTRIBUTION OF MOTION PICTURES, MADE FOR TELEVISION MOVIES, AND TELEVISION SERIES, IN THE FIELD OF COMEDY, DRAMA, MUSICALS, ROMANCE, EROTICA, MYSTERY, SUSPENSE, HORROR, ACTION, DOCUMENTARY, NEWS, VARIETY TALK SHOWS AND FAMILY; TELEVISION PROGRAMMING; PROVIDING MOTION PICTURES OVER A GLOBAL COMPUTER NETWORK; ENTERTAINMENT IN THE NATURE OF THE DISPLAY OF MOTION PICTURES AND MADE FOR TELEVISION MOVIES, IN THE FIELD OF COMEDY, DRAMA, MUSICALS, ROMANCE, EROTICA, MYSTERY, SUSPENSE, HORROR, ACTION, DOCUMENTARY, NEWS, VARIETY TALK SHOWS AND FAMILY; ENTERTAINMENT IN THE NATURE OF ONGOING TELEVISION PROGRAMS IN THE FIELD OF COMEDY, DRAMA, MUSICALS, ROMANCE, EROTICA, MYSTERY, SUSPENSE, HORROR, ACTION, DOCUMENTARY, NEWS, VARIETY TALK SHOWS AND FAMILY; AND CONDUCTING A FILM FESTIVAL (U.S. CLS. 100, 101 AND 107).

FIRST USE 2-22-2002; IN COMMERCE 2-22-2002.

CLASS 41—EDUCATION AND ENTERTAINMENT

FOR PROVIDING EDUCATIONAL TRAINING AND COURSES OF INSTRUCTION, NAMELY, SEMINARS, WORKSHOPS, AND PROFESSIONAL DEVELOPMENT CLASSES, IN THE FIELD OF K THROUGH 12 EDUCATION SCHOOL IMPROVEMENTS, K THROUGH 12 EDUCATION STANDARDS BASED PROGRAM DEVELOPMENT, K THROUGH 12 EDUCATION STUDENT ASSESSMENT EVALUATION AND K THROUGH 12 EDUCATION POLICY STUDIES, K THROUGH 12 EDUCATION STRATEGIC PLANNING AND K THROUGH 12 EDUCATION LEADERSHIP DEVELOPMENT; CONDUCTING EDUCATIONAL RESEARCH FOR OTHERS IN THE FIELD OF K THROUGH 12 EDUCATION SCHOOL IMPROVEMENT; DEVELOPMENT OF EDUCATIONAL PROGRAMS FOR OTHERS IN THE FIELD OF K THROUGH 12 SCHOOL IMPROVEMENT; EDUCATIONAL CONSULTING SERVICES FOR OTHERS IN THE FIELD OF K THROUGH 12 EDUCATION SCHOOL IMPROVEMENTS, K THROUGH 12 EDUCATION STANDARDS BASED PROGRAM DEVELOPMENT, K THROUGH 12 EDUCATION STUDENT ASSESSMENT EVALUATION AND K THROUGH 12 EDUCATION POLICY STUDIES, K THROUGH 12 EDUCATION STRATEGIC PLANNING AND K THROUGH 12 EDUCATION LEADERSHIP DEVELOPMENT (U.S. CLS. 100, 101 AND 107).

FIRST USE 0-0-2006; IN COMMERCE 0-0-2006.

3,400,214. MID-CONTINENT RESEARCH FOR EDUCATION AND LEARNING, DENVER, CO. SN 78-979,606. PUB. 11-14-2006, FILED 7-29-2005.

SUCCESS IN SIGHT

THE MARK CONSISTS OF STANDARD CHARACTERS WITHOUT CLAIM TO ANY PARTICULAR FONT, STYLE, SIZE, OR COLOR.

3,400,226. LYTX LLC, NEW YORK, NY. SN 78-979,676. PUB. 2-27-2007, FILED 12-1-2005.

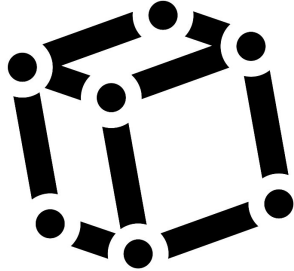

CLASS 36—INSURANCE AND FINANCIAL

FOR CONSULTING SERVICES, NAMELY, RESEARCH AND ANALYSIS IN THE FIELD OF FINANCIAL INTELLIGENCE FOR MAPPING CORPORATE RELATIONSHIPS AND TRANSACTIONS INVOLVING CORPORATIONS, INDIVIDUALS, AND GOVERNMENT ENTITIES; PROVIDING INFORMATION IN THE FIELD OF FINANCIAL INTELLIGENCE FOR MAPPING CORPORATE RELATIONSHIPS AND TRANSACTIONS INVOLVING CORPORATIONS, INDIVIDUALS, AND GOVERNMENT ENTITIES; ANALYZING AND COMPILING DATA FOR USE IN THE FIELD OF FINANCIAL INTELLIGENCE FOR MAPPING CORPORATE RELATIONSHIPS AND TRANSACTIONS INVOLVING CORPORATIONS, INDIVIDUALS, AND GOVERNMENT ENTITIES (U.S. CLS. 100, 101 AND 102).

FIRST USE 5-0-2006; IN COMMERCE 5-0-2006.

CLASS 35—ADVERTISING AND BUSINESS

FOR BUSINESS CONSULTING AND INFORMATION SERVICES; CONSULTING SERVICES, NAMELY, RESEARCH AND ANALYSIS IN THE FIELDS OF BUSINESS INTELLIGENCE, CORPORATE OWNERSHIP AND CONTROL, CORPORATE MANAGEMENT, ACCOUNTING; PROVIDING INFORMATION IN THE FIELDS OF BUSINESS INTELLIGENCE, CORPORATE OWNERSHIP AND CONTROL, CORPORATE MANAGEMENT, ACCOUNTING; ANALYZING AND COMPILING DATA FOR USE IN THE FIELDS OF BUSINESS INTELLIGENCE, CORPORATE OWNERSHIP AND CONTROL, CORPORATE MANAGEMENT, ACCOUNTING (U.S. CLS. 100, 101 AND 102).

FIRST USE 5-0-2006; IN COMMERCE 5-0-2006.

* * * * *

SECTION 2.— INTERNATIONAL CLASSIFICATION

The short titles associated below with the international class numbers are terms designed merely for quick identification and are not an official part of the international classification. The full names of international classes are given in section 6.1 of the trademark rules of practice.

The designation "U.S. Cl." appearing in this section refers to the U.S. class in effect prior to Sep. 1, 1973 rather than the international class which applies to applications filed on or after that date. For adoption of international classification see notice in the OFFICIAL GAZETTE of Jun. 26, 1973 (911 O.G. TM 210).

Application in one class

CLASS 1—CHEMICALS

3,399,092. VISION CO., LLC, GREENWOOD VILLAGE, CO. SN 77-059,968. PUB. 7-3-2007, FILED 12-8-2006.

CLASS 1—(Continued).

3,399,228. LOVELAND PRODUCTS, INC., GREELEY, CO. SN 77-119,864. PUB. 7-17-2007, FILED 3-1-2007.

BLOX

THE MARK CONSISTS OF STANDARD CHARACTERS WITHOUT CLAIM TO ANY PARTICULAR FONT, STYLE, SIZE, OR COLOR.

FOR STAIN AND MOISTURE REPELLANT AND FABRIC PROTECTANT FOR USE ON FABRICS, TEXTILES, CARPETS, LEATHER, VINYL, SUEDE, FURNITURE, AND UPHOLSTERY; STAIN AND MOISTURE REPELLANT USED IN THE MANUFACTURE OF FABRICS, TEXTILES, CARPETS, LEATHER, VINYL, SUEDE, FURNITURE, AND UPHOLSTERY (U.S. CLS. 1, 5, 6, 10, 26 AND 46).

FIRST USE 10-1-2007; IN COMMERCE 10-1-2007.

POTENZA

THE MARK CONSISTS OF STANDARD CHARACTERS WITHOUT CLAIM TO ANY PARTICULAR FONT, STYLE, SIZE, OR COLOR.

THE FOREIGN WORDING IN THE MARK TRANSLATES INTO ENGLISH AS POWER, POTENCY, OR MIGHT.

FOR PLANT GROWTH REGULATORS FOR AGRICULTURAL USE (U.S. CLS. 1, 5, 6, 10, 26 AND 46).

FIRST USE 4-17-2007; IN COMMERCE 4-17-2007.

3,399,110. HONEYWELL INTERNATIONAL INC., MORRISTOWN, NJ. SN 77-067,206. PUB. 5-1-2007, FILED 12-19-2006.

HONEYWELL LABREADY

THE MARK CONSISTS OF STANDARD CHARACTERS WITHOUT CLAIM TO ANY PARTICULAR FONT, STYLE, SIZE, OR COLOR.

OWNER OF U.S. REG. NO. 2,579,957.

FOR SOLVENTS FOR LABORATORY APPLICATIONS (U.S. CLS. 1, 5, 6, 10, 26 AND 46).

FIRST USE 4-30-2007; IN COMMERCE 4-30-2007.

3,399,293. CRODA, INC., EDISON, NJ. SN 77-159,575. PUB. 9-18-2007, FILED 4-18-2007.

DIVERSACLEAN SRS

THE MARK CONSISTS OF STANDARD CHARACTERS WITHOUT CLAIM TO ANY PARTICULAR FONT, STYLE, SIZE, OR COLOR.

FOR CHEMICALS FOR FURTHER MANUFACTURE OF CLEANING FORMULATIONS FOR USE IN HOUSEHOLD, INSTITUTIONAL AND INDUSTRIAL APPLICATIONS (U.S. CLS. 1, 5, 6, 10, 26 AND 46).

FIRST USE 2-1-2007; IN COMMERCE 2-1-2007.

CLASS 1—(Continued).

3,399,462. BAYER AKTIENGESELLSCHAFT, LEVERKUSEN-BAYERWERK, FED REP GERMANY. SN 78-551,761. PUB. 9-13-2005, FILED 1-21-2005.

BAYHYTHERM

THE MARK CONSISTS OF STANDARD CHARACTERS WITHOUT CLAIM TO ANY PARTICULAR FONT, STYLE, SIZE, OR COLOR.

FOR CHEMICAL PRODUCTS FOR INDUSTRIAL PURPOSES, NAMELY, WATER-RAREFIABLE BINDING AGENTS FOR THERMALLY HARDENING LACQUERS (U.S. CLS. 1, 5, 6, 10, 26 AND 46).

FIRST USE 5-31-2005; IN COMMERCE 1-30-2007.

3,399,559. D & S FARMS, PITTSBORO, NJ. SN 78-660,955. PUB. 4-11-2006, FILED 6-29-2005.

Chicks' Mix

THE MARK CONSISTS OF STANDARD CHARACTERS WITHOUT CLAIM TO ANY PARTICULAR FONT, STYLE, SIZE, OR COLOR.

FOR ORGANIC PLANT FOOD, NAMELY, POULTRY MANURE PELLETS (U.S. CLS. 1, 5, 6, 10, 26 AND 46).

FIRST USE 1-27-2007; IN COMMERCE 1-27-2007.

3,399,585. EQUICHEMICALS, LP, HOUSTON, TX. SN 78-680,788. PUB. 4-11-2006, FILED 7-28-2005.

STARFLEX

THE MARK CONSISTS OF STANDARD CHARACTERS WITHOUT CLAIM TO ANY PARTICULAR FONT, STYLE, SIZE, OR COLOR.

FOR POLYMERS SOLD IN BULK FOR USE IN MANUFACTURING IN A VARIETY OF INDUSTRIES (U.S. CLS. 1, 5, 6, 10, 26 AND 46).

FIRST USE 11-2-2007; IN COMMERCE 11-2-2007.

CLASS 1—(Continued).

3,399,645. SCHIRALDI, DAVID ANTHONY, SHAKER HEIGHTS, OH. SN 78-735,839. PUB. 11-21-2006, FILED 10-18-2005.

AEROCLAY

THE MARK CONSISTS OF STANDARD CHARACTERS WITHOUT CLAIM TO ANY PARTICULAR FONT, STYLE, SIZE, OR COLOR.

FOR CERAMIC COMPOSITIONS IN THE SOLID STATE FOR MANUFACTURE OF FIBROUS MONOLITHIC CERAMIC COMPARTMENTS FOR USE IN HIGH TEMPERATURE APPLICATIONS; POLYMER COMPOSITIONS USED IN THE MANUFACTURE OF COMMERCIAL AND INDUSTRIAL GOODS, NAMELY, CELL-CONTAINING CONSTRUCTS, LOW DENSITY COMPOSITES, LOW DENSITY MOLDED FOAMS, FREEZE DRIED FOAMS, SOLID FOAMS, FOAM PARTICLES, AND RANDOM MATRIX FORMS, WHEREIN THE GOODS DO NOT INCLUDE CHINA CLAY THAT HAS BEEN DRIED AND AIR SEPARATED TO REMOVE COARSE PARTICLES (U.S. CLS. 1, 5, 6, 10, 26 AND 46).

FIRST USE 1-31-2007; IN COMMERCE 1-31-2007.

3,399,733. COSMOAGRO, S.A., PALMIRA VALLE, COLOMBIA. SN 78-774,806. PUB. 9-26-2006, FILED 12-16-2005.

COSMO-FLUX

THE MARK CONSISTS OF STANDARD CHARACTERS WITHOUT CLAIM TO ANY PARTICULAR FONT, STYLE, SIZE, OR COLOR.

OWNER OF COLOMBIA REG. NO. 171341, DATED 12-30-1994, EXPIRES 12-30-2014.

FOR NON IONIC ADJUVANT COMPOUND TO BE USED WITH AGROCHEMICAL COMPOUNDS (U.S. CLS. 1, 5, 6, 10, 26 AND 46).

FIRST USE 12-31-1999; IN COMMERCE 8-1-2007.

3,399,779. BUNGE OILS, INC., ST. LOUIS, MO. SN 78-794,595. PUB. 9-12-2006, FILED 1-19-2006.

AGRITECH

THE MARK CONSISTS OF STANDARD CHARACTERS WITHOUT CLAIM TO ANY PARTICULAR FONT, STYLE, SIZE, OR COLOR.

FOR HYDRAULIC FLUIDS FOR GENERAL USE (U.S. CLS. 1, 5, 6, 10, 26 AND 46).

FIRST USE 12-0-2006; IN COMMERCE 12-0-2006.

CLASS 1—(Continued).

3,399,887. GANZHOU RARE EARTH METALS CO., LTD.,
JIANGXI PROVINCE, CHINA. SN 78-834,915. PUB. 10-31-
2006, FILED 3-10-2006.



THE NON-LATIN CHARACTER(S) IN THE MARK
TRANSLITERATES INTO KE; LI, AND THIS MEANS
SCIENCE; TO STRIVE IN ENGLISH.

FOR RARE EARTH METALS; LANTHANUM; CER-
IUM; PRASEODYMIUM; NEODYMIUM; SAMARIUM;
EUROPIUM; CHEMICALS FOR USE IN INDUSTRY,
SCIENCE AND PHOTOGRAPHY, NAMELY GADOLI-
NIUM, LUTECIUM; YTTRIUM; DYSPROSIUM; TER-
BIUM; HOLMIUM; ERBIUM; THULIUM; YTTERBIUM;
ALLOYS OF RARE EARTH METALS (U.S. CLS. 1, 5, 6,
10, 26 AND 46).

FIRST USE 2-21-2004; IN COMMERCE 3-10-2006.

3,400,016. SMARTPOOL INCORPORATED, LAKEWOOD, NJ.
SN 78-911,589. PUB. 9-4-2007, FILED 6-19-2006.

SALT CELL GUARD

THE MARK CONSISTS OF STANDARD CHARACTERS
WITHOUT CLAIM TO ANY PARTICULAR FONT, STYLE,
SIZE, OR COLOR.

NO CLAIM IS MADE TO THE EXCLUSIVE RIGHT TO
USE "SALT CELL", APART FROM THE MARK AS SHOWN.

FOR WATER TREATMENT CHEMICALS FOR USE IN
SWIMMING POOLS, SPAS AND HOT TUBS (U.S. CLS. 1,
5, 6, 10, 26 AND 46).

FIRST USE 9-30-2006; IN COMMERCE 9-30-2006.

CLASS 1—(Continued).

3,400,176. AMERITYRE, BOULDER CITY, NV. SN 78-967,270.
PUB. 4-24-2007, FILED 9-5-2006.

AMERIFILL

THE MARK CONSISTS OF STANDARD CHARACTERS
WITHOUT CLAIM TO ANY PARTICULAR FONT, STYLE,
SIZE, OR COLOR.

FOR CHEMICAL COMPOUNDS FOR USE AS A TIRE
FILL TO FILL THE VOID IN A PNEUMATIC TIRE (U.S.
CLS. 1, 5, 6, 10, 26 AND 46).

FIRST USE 1-3-2008; IN COMMERCE 1-3-2008.

3,400,194. LYONDELL CHEMICAL COMPANY, HOUSTON,
TX. SN 78-971,090. PUB. 5-15-2007, FILED 9-11-2006.

ARCTIC SHIELD

THE MARK CONSISTS OF STANDARD CHARACTERS
WITHOUT CLAIM TO ANY PARTICULAR FONT, STYLE,
SIZE, OR COLOR.

OWNER OF U.S. REG. NO. 2,973,703.
FOR DEICER FLUIDS USED ON AIRCRAFT (U.S.
CLS. 1, 5, 6, 10, 26 AND 46).

FIRST USE 12-21-2007; IN COMMERCE 12-21-2007.

CLASS 2—PAINTS

3,399,142. SEWERTUFF, LLC, FRANKLIN PARK, IL. SN 77-
079,831. PUB. 9-18-2007, FILED 1-10-2007.

SEWERTUFF

THE MARK CONSISTS OF STANDARD CHARACTERS
WITHOUT CLAIM TO ANY PARTICULAR FONT, STYLE,
SIZE, OR COLOR.

FOR ADHESIVE COATINGS FOR THE PROTECTION
OF CONCRETE, MASONRY AND STEEL (U.S. CLS. 6, 11
AND 16).

FIRST USE 2-1-2007; IN COMMERCE 2-1-2007.

CLASS 2—(Continued).

3,399,598. TRUE VALUE COMPANY, CHICAGO, IL. SN 78-695,898. PUB. 12-20-2005, FILED 8-18-2005.

SIMPLY PLAYFUL

THE MARK CONSISTS OF STANDARD CHARACTERS WITHOUT CLAIM TO ANY PARTICULAR FONT, STYLE, SIZE, OR COLOR.

FOR PAINT (U.S. CLS. 6, 11 AND 16).
FIRST USE 2-0-2006; IN COMMERCE 2-0-2006.

3,400,051. THE VALSPAR CORPORATION, MINNEAPOLIS, MN. SN 78-931,147. PUB. 2-27-2007, FILED 7-17-2006.

THE BEAUTY GOES ON

THE MARK CONSISTS OF STANDARD CHARACTERS WITHOUT CLAIM TO ANY PARTICULAR FONT, STYLE, SIZE, OR COLOR.

FOR FULL LINE OF INTERIOR AND EXTERIOR COATINGS, NAMELY, PAINTS, STAINS, VARNISHES AND PRIMERS FOR WOOD, PLASTIC, METAL, FIBER-GLASS, PLASTER, CONCRETE, GLASS, AND PAPER SURFACES, RESIDENTIAL AND COMMERCIAL BUILDINGS, SIDING, FURNITURE, MOTOR VEHICLES, TRAILERS, INDUSTRIAL EQUIPMENT, FARM EQUIPMENT, CONTAINERS, METAL GOODS, AND APPLIANCES (U.S. CLS. 6, 11 AND 16).
FIRST USE 1-0-2007; IN COMMERCE 1-0-2007.

CLASS 3—COSMETICS AND CLEANING PREPARATIONS

3,398,987. KAMSUT, INC., THOUSAND OAKS, CA. SN 77-007,632. PUB. 7-3-2007, FILED 9-26-2006.

OCEAN BLU

THE MARK CONSISTS OF STANDARD CHARACTERS WITHOUT CLAIM TO ANY PARTICULAR FONT, STYLE, SIZE, OR COLOR.

FOR BODY SOAP (U.S. CLS. 1, 4, 6, 50, 51 AND 52).
FIRST USE 7-31-2006; IN COMMERCE 7-31-2006.

CLASS 3—(Continued).

3,399,026. JAFER LIMITED, HAMILTON, HM, BERMUDA. SN 77-025,366. PUB. 8-14-2007, FILED 10-19-2006.



OWNER OF U.S. REG. NO. 2,968,525.
THE COLOR(S) PURPLE, WHITE, YELLOW, GREEN, AND BLACK IS/ARE CLAIMED AS A FEATURE OF THE MARK.

THE MARK CONSISTS OF PURPLE FLOWERS WITH WHITE AND YELLOW CENTERS AND GREEN AND YELLOW STEMS AND THE WORD "L'ESSENCE" WRITTEN VERTICALLY, ORIENTED BOTTOM TO TOP, IN BLACK LETTERING; AND THE COLOR WHITE APPEARS AS THE BACKGROUND COLOR IN THE MARK.

THE FOREIGN WORDING IN THE MARK TRANSLATES INTO ENGLISH AS THE ESSENCE.

FOR FRAGRANCES FOR PERSONAL USE, TOILET WATER, AND COLOGNE (U.S. CLS. 1, 4, 6, 50, 51 AND 52).

FIRST USE 5-4-2006; IN COMMERCE 11-5-2007.

3,399,031. TED GIBSON & COMPANY, INC., NEW YORK, NY. SN 77-028,532. PUB. 8-7-2007, FILED 10-24-2006.

DAILY NOURISH

THE MARK CONSISTS OF STANDARD CHARACTERS WITHOUT CLAIM TO ANY PARTICULAR FONT, STYLE, SIZE, OR COLOR.

FOR HAIR CARE PRODUCTS, NAMELY, HAIR CONDITIONERS (U.S. CLS. 1, 4, 6, 50, 51 AND 52).
FIRST USE 1-23-2007; IN COMMERCE 1-23-2007.

CLASS 3—(Continued).

3,399,035. COSMETIC SPECIALTY LABS, INC., LAWTON, OK. SN 77-029,936. PUB. 6-5-2007, FILED 10-26-2006.

TZ

THE MARK CONSISTS OF STANDARD CHARACTERS WITHOUT CLAIM TO ANY PARTICULAR FONT, STYLE, SIZE, OR COLOR.

FOR BODY SCRUBS, BATH GELS, BODY CREAMS, BODY LOTIONS, BATH CRYSTALS, MASSAGE OILS, BODY MISTS, SHAVING CREAMS, SKIN CLEANSERS, BODY LOTIONS, NAMELY, WARMING AND SILICONE LOTIONS (U.S. CLS. 1, 4, 6, 50, 51 AND 52).

FIRST USE 2-0-2007; IN COMMERCE 3-0-2007.

3,399,090. MOTHERS POLISHES WAXES CLEANERS, HUNTINGTON BEACH, CA. SN 77-057,680. PUB. 6-5-2007, FILED 12-5-2006.

POWERPLASTIC

THE MARK CONSISTS OF STANDARD CHARACTERS WITHOUT CLAIM TO ANY PARTICULAR FONT, STYLE, SIZE, OR COLOR.

OWNER OF U.S. REG. NOS. 3,028,180, 3,053,890, AND 3,062,702.

FOR PREPARATIONS FOR CLEANING, POLISHING AND PROTECTING PLASTIC (U.S. CLS. 1, 4, 6, 50, 51 AND 52).

FIRST USE 12-1-2006; IN COMMERCE 12-1-2006.

3,399,115. SERAPH COSMETICS, INC., HOLLYWOOD, CA. SN 77-068,854. PUB. 7-24-2007, FILED 12-20-2006.

Seraph

THE MARK CONSISTS OF STANDARD CHARACTERS WITHOUT CLAIM TO ANY PARTICULAR FONT, STYLE, SIZE, OR COLOR.

FOR BODY AND BEAUTY CARE COSMETICS; CLEANSING CREAMS; CONCEALERS; COSMETIC CREAMS FOR SKIN CARE; COSMETIC PENCILS; COSMETIC PREPARATIONS FOR EYE LASHES; COSMETIC PREPARATIONS FOR SKIN RENEWAL; COSMETIC ROUGES; COSMETIC SUN-PROTECTING PREPARATIONS; COSMETICS; COSMETICS NAMELY COMPACTS; MAKE-UP KITS COMPRISED OF EYE SHADOWS, BLUSH, LIP GLOSSES; PENCILS FOR COSMETIC PURPOSES (U.S. CLS. 1, 4, 6, 50, 51 AND 52).

FIRST USE 9-26-2007; IN COMMERCE 9-26-2007.

CLASS 3—(Continued).

3,399,154. JAFER LIMITED, HAMILTON, HM, BERMUDA. SN 77-085,639. PUB. 9-18-2007, FILED 1-18-2007.

THE ENGLISH TRANSLATION OF THE WORD "DEO DE SEDA" IN THE MARK IS GOD OF SILK.

FOR DEODORANT FOR PERSONAL USE, ANTIPERSPIRANTS (U.S. CLS. 1, 4, 6, 50, 51 AND 52).

FIRST USE 12-31-2005; IN COMMERCE 11-30-2007.

3,399,176. ALCHEMY WORLDWIDE, LLC, SHERMAN OAKS, CA. SN 77-097,383. PUB. 7-24-2007, FILED 2-1-2007.

THE SCIENCE OF YOUNGER LOOKING SKIN

THE MARK CONSISTS OF STANDARD CHARACTERS WITHOUT CLAIM TO ANY PARTICULAR FONT, STYLE, SIZE, OR COLOR.

FOR COSMETICS AND SKIN CARE PRODUCTS, NAMELY, NON-MEDICATED SKIN CARE PREPARATIONS (U.S. CLS. 1, 4, 6, 50, 51 AND 52).

FIRST USE 9-14-2006; IN COMMERCE 9-14-2006.

3,399,177. ELEMENTAGE, LLC, NEW YORK, NY. SN 77-097,515. PUB. 7-31-2007, FILED 2-2-2007.

ELEMENTAGE

THE MARK CONSISTS OF STANDARD CHARACTERS WITHOUT CLAIM TO ANY PARTICULAR FONT, STYLE, SIZE, OR COLOR.

FOR HAIR CARE PREPARATIONS (U.S. CLS. 1, 4, 6, 50, 51 AND 52).

FIRST USE 6-20-2007; IN COMMERCE 6-20-2007.

CLASS 3—(Continued).

3,399,204. ANDERSON, DOUGLAS, SAN DIEGO, CA. SN 77-111,261. PUB. 8-14-2007, FILED 2-20-2007.

PERIOGEN

THE MARK CONSISTS OF STANDARD CHARACTERS WITHOUT CLAIM TO ANY PARTICULAR FONT, STYLE, SIZE, OR COLOR.

FOR NON-MEDICATED MOUTHWASH AND GARGLE (U.S. CLS. 1, 4, 6, 50, 51 AND 52).

FIRST USE 2-14-2007; IN COMMERCE 3-11-2007.

CLASS 3—(Continued).

3,399,245. ADVANCE MERCHANDISING COMPANY, INC., ROANOKE, VA. SN 77-129,768. PUB. 7-24-2007, FILED 3-13-2007.



OWNER OF U.S. REG. NOS. 1,484,796, 1,847,137, AND OTHERS.

NO CLAIM IS MADE TO THE EXCLUSIVE RIGHT TO USE "AUTO PARTS", APART FROM THE MARK AS SHOWN.

THE MARK CONSISTS OF STYLIZED WORDS "ADVANCE AUTO PARTS" IN STACKED FORMAT, FOLLOWED BY A FLAGPOLE AND A CHECKERED FLAG.

FOR DISPOSABLE WIPES IMPREGNATED WITH CHEMICALS OR COMPOUNDS FOR CLEANING AND CONDITIONING LEATHER; DISPOSABLE WIPES IMPREGNATED WITH CHEMICALS OR COMPOUNDS FOR CLEANING GLASS SURFACES (U.S. CLS. 1, 4, 6, 50, 51 AND 52).

FIRST USE 2-28-2004; IN COMMERCE 7-30-2007.

3,399,212. JUNELAB, LLC, CHEVY CHASE, MD. SN 77-113,216. PUB. 9-11-2007, FILED 2-22-2007.



THE COLOR(S) RED, PINK, YELLOW, WHITE AND BLUE IS/ARE CLAIMED AS A FEATURE OF THE MARK.

THE MARK CONSISTS OF THE WORDING "JUNELAB" IN BLUE LETTERING AND THE DESIGN OF A ROSE WITH RED, PINK, YELLOW AND WHITE PETALS.

FOR COSMETIC CREAMS (U.S. CLS. 1, 4, 6, 50, 51 AND 52).

FIRST USE 10-15-2006; IN COMMERCE 1-1-2007.

3,399,288. MIRACLE WORLD CORPORATION, SANTA CLARA, CA. SN 77-155,762. PUB. 9-11-2007, FILED 4-13-2007.



OWNER OF U.S. REG. NO. 3,134,339.

THE COLOR(S) BLACK, PINK, ORANGE, YELLOW, GREEN, BLUE AND PURPLE IS/ARE CLAIMED AS A FEATURE OF THE MARK.

THE MARK CONSISTS OF A BLACK SINGLE HAIR, SURROUNDED BY THE CIRCULAR STYLIZED WORDING "MIRACLE" IN PINK, ORANGE, YELLOW, GREEN, BLUE AND PURPLE.

FOR HAIR SHAMPOO AND CONDITIONER (U.S. CLS. 1, 4, 6, 50, 51 AND 52).

FIRST USE 5-1-2007; IN COMMERCE 5-1-2007.

CLASS 3—(Continued).

3,399,318. COSMETIC CREATIV SERVICE GMBH, KARLSFELD, FED REP GERMANY. SN 78-248,434. PUB. 9-7-2004, FILED 5-12-2003.

CLASS 3—(Continued).

3,399,354. LUCIO SANTORO AND MEERA SANTORO PARTNERSHIP, THE, LONDON, UNITED KINGDOM. SN 78-343,223. PUB. 5-3-2005, FILED 12-19-2003.

**MA
KE
UP** **FACTORY**

SWANKY MODES

THE MARK CONSISTS OF STANDARD CHARACTERS WITHOUT CLAIM TO ANY PARTICULAR FONT, STYLE, SIZE, OR COLOR.

OWNER OF U.S. REG. NO. 2,727,234.

FOR PERFUME; COSMETICS, NAMELY, NAIL VARNISH AND PREPARATIONS FOR REINFORCING AND STRENGTHENING NAILS, NON-MEDICATED LIP-BALMS, LIPSTICK, LIP GLOSS, BODY GLITTER, BODY SHIMMER, BODY SOUFFLE, MASCARA, FACE-POWDER, EYE-SHADOWS, EYE-LINERS; TOILETRIES, NAMELY, BUBBLE-BATHS, BODY SPRAYS, BODY SPRITZERS, SKIN MOISTURIZERS, BODY SCRUBS; HAIR LOTIONS, NAMELY, HAIR GEL, HAIR MOUSSE AND HAIR SPRAYS, SKIN SOAP, BATH SALTS, BATH BEADS, SHOWER GELS, ESSENTIAL OILS FOR PERSONAL USE, DENTIFRICE, HAIR GLITTER, HAIR MASCARA (U.S. CLS. 1, 4, 6, 50, 51 AND 52).

FIRST USE 6-0-2001; IN COMMERCE 8-15-2007.

3,399,359. CGE ENTERPRISES, LLC, MANCHESTER CENTER, VT. SN 78-356,798. PUB. 11-9-2004, FILED 1-23-2004.

OWNER OF FED REP GERMANY REG. NO. 30255121, DATED 1-9-2003, EXPIRES 11-30-2012.

NO CLAIM IS MADE TO THE EXCLUSIVE RIGHT TO USE MAKE UP, APART FROM THE MARK AS SHOWN.

FOR PREPARATIONS FOR BODY AND BEAUTY CARE, NAMELY SOAPS, NAMELY HAND SOAP, FACE SOAP, BODY SOAP; PERFUMES; ETHEREAL OILS FOR PERSONAL USE; WOMEN'S COSMETICS; EYEBROW COSMETICS; EYEBROW PENCILS; COSMETIC PREPARATIONS FOR BATHS, NAMELY BATH OILS AND BATH SALTS; COSMETIC CREAMS; ARTIFICIAL EYELASHES; ARTIFICIAL FINGER NAILS; NAIL VARNISH; LIPSTICKS; BEAUTY MASKS; COSMETIC PREPARATIONS FOR SLIMMING PURPOSES, NAMELY SLIMMING CREAMS AND SLIMMING GELS; MAKE-UP POWDER; MEN'S COSMETICS, NAMELY AFTER-SHAVE LOTIONS, SHAVE CREAMS, SKIN CREAMS, HAIR LOTIONS, SHAMPOOS AND HAIR DYES (U.S. CLS. 1, 4, 6, 50, 51 AND 52).

FIRST USE 11-15-2007; IN COMMERCE 11-15-2007.

BODY ON TAP

THE MARK CONSISTS OF STANDARD CHARACTERS WITHOUT CLAIM TO ANY PARTICULAR FONT, STYLE, SIZE, OR COLOR.

FOR HAIR SHAMPOOS, AND CONDITIONERS (U.S. CLS. 1, 4, 6, 50, 51 AND 52).

FIRST USE 10-1-2007; IN COMMERCE 10-1-2007.

CLASS 3—(Continued).

3,399,374. DESIGNER SKIN, L.L.C., PHOENIX, AZ. SN 78-413,119. PUB. 3-15-2005, FILED 5-4-2004.

GOLDEN SPLENDOR

THE MARK CONSISTS OF STANDARD CHARACTERS WITHOUT CLAIM TO ANY PARTICULAR FONT, STYLE, SIZE, OR COLOR.
FOR INDOOR TANNING PREPARATIONS (U.S. CLS. 1, 4, 6, 50, 51 AND 52).
FIRST USE 12-1-2007; IN COMMERCE 12-1-2007.

3,399,382. ACTION LLC, VIRGINIA BEACH, VA. SN 78-445,676. PUB. 6-21-2005, FILED 7-2-2004.

BIO-ZYME 3

THE MARK CONSISTS OF STANDARD CHARACTERS WITHOUT CLAIM TO ANY PARTICULAR FONT, STYLE, SIZE, OR COLOR.
FOR CLEANING SOLUTIONS FOR SURGICAL INSTRUMENTS (U.S. CLS. 1, 4, 6, 50, 51 AND 52).
FIRST USE 7-2-2004; IN COMMERCE 7-2-2004.

CLASS 3—(Continued).

3,399,440. BOTICA COMERCIAL FARMACEUTICA LTDA, SAO JOSE DOS PINAIS - PARANA, BRAZIL. SN 78-522,464. PUB. 2-14-2006, FILED 11-24-2004.

**Universal
Solutions**

O Boticário

OWNER OF U.S. REG. NOS. 2,233,304, 2,946,446, AND OTHERS.
THE ENGLISH TRANSLATION OF THE WORDING "O Boticário" IS THE PHARMACIST.
FOR COSMETICS, PERFUMERY AND PERSONAL HYGIENE PRODUCTS, NAMELY, TOILET WATER, COLOGNE WATER, LAVENDER WATER, TOILET SOAPS, DEODORANT SOAPS, OILS FOR TOILETRY PURPOSES, NON-MEDICATED TOILETRIES, BATH OILS FOR COSMETIC PURPOSES, COSMETIC OILS, NON-MEDICATED BATH SALTS, PRE-SHAVE AND AFTER-SHAVE GELS, LOTIONS AND CREAMS, BODY AND BEAUTY CARE COSMETICS, BEAUTY MASKS, COSMETIC PENCILS, PRE-MOISTENED COSMETIC WIPES IMPREGNATED WITH COSMETIC LOTIONS, PERFUMERY, HAIR SHAMPOOS AND CONDITIONERS (U.S. CLS. 1, 4, 6, 50, 51 AND 52).
FIRST USE 11-1-2004; IN COMMERCE 11-1-2004.

3,399,477. HYUNDAI CORPORATION, SEOUL, REPUBLIC OF KOREA. SN 78-568,431. PUB. 4-3-2007, FILED 2-16-2005.

HYUNDAI

OWNER OF U.S. REG. NOS. 2,967,626, 3,080,116, AND OTHERS.
THE ENGLISH TRANSLATION OF "HYUNDAI" IS MODERN.
FOR BATH SOAPS, COSMETIC SOAPS, DEODORANT SOAP, HAIR SHAMPOOS, SOAP FOR BRIGHTENING TEXTILE, SKIN POLISHERS MADE IN PART OF RICE BRAN, CLEANSERS FOR DETERGENT PURPOSES, NAMELY, LAUNDRY DETERGENT, ALMOND SOAP, HAIR RINSES, COSMETIC SOAPS AND DENTIFRICE (U.S. CLS. 1, 4, 6, 50, 51 AND 52).
FIRST USE 1-2-2007; IN COMMERCE 1-2-2007.

CLASS 3—(Continued).

3,399,522. PARFUMS CARLO CORINTO PARIS S.A.R.L., PARIS, FRANCE. SN 78-624,726. PUB. 9-5-2006, FILED 5-6-2005.



OWNER OF U.S. REG. NOS. 1,386,458 AND 1,833,590.
NO CLAIM IS MADE TO THE EXCLUSIVE RIGHT TO USE "PARIS", APART FROM THE MARK AS SHOWN.
THE NAME(S), PORTRAIT(S), AND/OR SIGNATURE(S) SHOWN IN THE MARK DOES NOT IDENTIFY A PARTICULAR LIVING INDIVIDUAL.

"THE COLOR(S) BLUE AND RED IS/ARE CLAIMED AS A FEATURE OF THE MARK."

THE MARK CONSISTS OF THE TERM "BLU" THAT APPEARS IN THE COLOR BLUE, AND THE TERM "STREMO" THAT APPEARS IN THE COLOR RED, BOTH EMPHASIZED BY A RED LINE UNDERLINE. THE WORDING "CARLO CORINTO PARIS" ALL APPEARS IN THE COLOR BLUE.

FOR PERFUMERY (U.S. CLS. 1, 4, 6, 50, 51 AND 52).
FIRST USE 6-13-2005; IN COMMERCE 6-13-2005.

3,399,540. L'OREAL USA CREATIVE, INC., NEW YORK, NY. SN 78-641,030. PUB. 2-21-2006, FILED 6-1-2005.

CLEAN RUSH

THE MARK CONSISTS OF STANDARD CHARACTERS WITHOUT CLAIM TO ANY PARTICULAR FONT, STYLE, SIZE, OR COLOR.

OWNER OF U.S. REG. NOS. 2,595,884 AND 2,900,869.
FOR HAIR CARE PREPARATION (U.S. CLS. 1, 4, 6, 50, 51 AND 52).
FIRST USE 4-0-2006; IN COMMERCE 4-0-2006.

3,399,572. LABORATOIRE COSMEPRO INC., LONGUEUIL, CANADA. SN 78-671,171. PUB. 5-16-2006, FILED 7-15-2005.

NATURE'S MOISTURE FOR YOUR HAIR

THE MARK CONSISTS OF STANDARD CHARACTERS WITHOUT CLAIM TO ANY PARTICULAR FONT, STYLE, SIZE, OR COLOR.

NO CLAIM IS MADE TO THE EXCLUSIVE RIGHT TO USE "HAIR", APART FROM THE MARK AS SHOWN.
FOR HAIR SHAMPOO AND HAIR CONDITIONER (U.S. CLS. 1, 4, 6, 50, 51 AND 52).
FIRST USE 4-2-2007; IN COMMERCE 4-2-2007.

CLASS 3—(Continued).

3,399,601. W LAB ACQUISITION CORP., BOSTON, MA. SN 78-697,401. PUB. 9-12-2006, FILED 8-22-2005.

PROLIGHTEN

THE MARK CONSISTS OF STANDARD CHARACTERS WITHOUT CLAIM TO ANY PARTICULAR FONT, STYLE, SIZE, OR COLOR.

FOR NON-MEDICATED SKIN CARE PREPARATIONS (U.S. CLS. 1, 4, 6, 50, 51 AND 52).

FIRST USE 8-10-2005; IN COMMERCE 8-10-2005.

3,399,714. INTERNATIONAL SPECIALTY TREATMENTS, LLC, OAKVILLE, CT. SN 78-767,740. PUB. 1-2-2007, FILED 12-6-2005.

Wrinkle Recovery

THE MARK CONSISTS OF STANDARD CHARACTERS WITHOUT CLAIM TO ANY PARTICULAR FONT, STYLE, SIZE, OR COLOR.

NO CLAIM IS MADE TO THE EXCLUSIVE RIGHT TO USE "WRINKLE", APART FROM THE MARK AS SHOWN.

FOR NON-MEDICATED ANTI-AGING SKIN CARE PRODUCTS, NAMELY, SERUMS, CLEANSERS, TONERS, CREAMS, LOTIONS, EYE GEL, EYE CREAM, MASKS, SCRUBS, FOUNDATION, LIP COLOR, LIP TREATMENTS, BLUSH, EYE SHADOW, POWDER AND SOAP (U.S. CLS. 1, 4, 6, 50, 51 AND 52).

FIRST USE 3-4-2006; IN COMMERCE 3-4-2006.

3,399,728. ROJAS, CESAR MAURICIO ROJAS, BOGOTA, COLOMBIA. SN 78-773,824. PUB. 8-29-2006, FILED 12-15-2005.

BIOFOS BIOTECHNOLOGY

THE MARK CONSISTS OF STANDARD CHARACTERS WITHOUT CLAIM TO ANY PARTICULAR FONT, STYLE, SIZE, OR COLOR.

NO CLAIM IS MADE TO THE EXCLUSIVE RIGHT TO USE "BIOTECHNOLOGY", APART FROM THE MARK AS SHOWN.

THE WORDING "BIOFOS" HAS NO MEANING IN A FOREIGN LANGUAGE.

FOR COSMETICS (U.S. CLS. 1, 4, 6, 50, 51 AND 52).
FIRST USE 5-3-2007; IN COMMERCE 5-3-2007.

CLASS 3—(Continued).

3,399,731. DEL LABORATORIES, INC., UNIONDALE, NY. SN 78-774,764. PUB. 8-22-2006, FILED 12-16-2005.

LIPPIN' LARGE

THE MARK CONSISTS OF STANDARD CHARACTERS WITHOUT CLAIM TO ANY PARTICULAR FONT, STYLE, SIZE, OR COLOR.
 FOR COSMETICS: LIPSTICK; NON-MEDICATED LIP CARE PREPARATIONS (U.S. CLS. 1, 4, 6, 50, 51 AND 52).
 FIRST USE 12-1-2007; IN COMMERCE 12-1-2007.

CLASS 3—(Continued).

3,399,791. HD NUTRITION, INC., COSTA MESA, CA. SN 78-796,820. PUB. 5-8-2007, FILED 1-23-2006.

RESTORATE

THE MARK CONSISTS OF STANDARD CHARACTERS WITHOUT CLAIM TO ANY PARTICULAR FONT, STYLE, SIZE, OR COLOR.
 FOR AMINO ACIDS SOLD AS AN INGREDIENT OF AND FOR ENHANCING THE ABSORPTION OF NON-MEDICATED TOPICAL SKIN CARE PRODUCTS (U.S. CLS. 1, 4, 6, 50, 51 AND 52).
 FIRST USE 3-0-2006; IN COMMERCE 3-0-2006.

3,399,765. BIO-LOGIC AQUA TECHNOLOGIES, INC., GRANTS PASS, OR. SN 78-788,603. PUB. 9-12-2006, FILED 1-10-2006.

PURRFECT EYES

THE MARK CONSISTS OF STANDARD CHARACTERS WITHOUT CLAIM TO ANY PARTICULAR FONT, STYLE, SIZE, OR COLOR.
 NO CLAIM IS MADE TO THE EXCLUSIVE RIGHT TO USE "EYES", APART FROM THE MARK AS SHOWN.
 FOR NON-MEDICATED GROOMING PREPARATIONS FOR CATS, NAMELY, EYE LIQUID, NAMELY, PURIFIED WATER IN A SPRAY CONTAINER FOR REFRESHING TEAR FILM (U.S. CLS. 1, 4, 6, 50, 51 AND 52).
 FIRST USE 2-22-2007; IN COMMERCE 2-22-2007.

3,399,797. KOVACH, BARBARA, J, FRANKLIN, MI. AND DARWISH, TIMOTHY, A, FRANKLIN, MI. SN 78-798,604. PUB. 7-3-2007, FILED 1-24-2006.

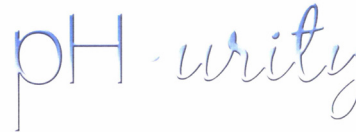

3,399,768. PERFECT PERCEPTIONS, LLC, FLOURTOWN, PA. SN 78-789,838. PUB. 9-5-2006, FILED 1-11-2006.

Melancholy Baby

THE MARK CONSISTS OF STANDARD CHARACTERS WITHOUT CLAIM TO ANY PARTICULAR FONT, STYLE, SIZE, OR COLOR.
 FOR COSMETICS (U.S. CLS. 1, 4, 6, 50, 51 AND 52).
 FIRST USE 4-1-2007; IN COMMERCE 6-1-2007.

THE COLOR(S) BLUE, WHITE AND BLACK IS/ARE CLAIMED AS A FEATURE OF THE MARK.
 THE COLOR(S) BLUE, WHITE AND BLACK APPEAR IN THE LETTERS.
 FOR ALL-PURPOSE CLEANERS; AUTOMOBILE CLEANERS; CARPET CLEANERS; CLEANER FOR USE ON HARD SURFACES; CLEANING PREPARATIONS FOR HOUSEHOLD PURPOSES; CLEANING PREPARATIONS FOR HARD SURFACES; DE-GREASING PREPARATIONS FOR HOUSEHOLD PURPOSES; DEGREASING PREPARATIONS NOT USED IN MANUFACTURING PROCESSES FOR CLEANING METAL, PLASTIC AND SYNTHETIC SURFACES; DETERGENTS FOR AUTOMOBILES; FLOOR STRIPPING/CLEANING PREPARATION; GLASS CLEANERS; HOUSEHOLD CLEANING PREPARATIONS; OVEN CLEANERS; PET STAIN REMOVERS; PREPARATIONS FOR CLEANING, PROTECTING AND PRESERVING VEHICLE SURFACES; SPOT REMOVER; STAIN REMOVERS; UPHOLSTERY CLEANERS; WHITEWALL CLEANERS (U.S. CLS. 1, 4, 6, 50, 51 AND 52).
 FIRST USE 11-30-2005; IN COMMERCE 12-1-2006.

CLASS 3—(Continued).

3,399,836. AMIR, INC., EAGAN, MN. SN 78-814,137. PUB. 10-3-2006, FILED 2-14-2006.

KEEPIN IT REAL

THE MARK CONSISTS OF STANDARD CHARACTERS WITHOUT CLAIM TO ANY PARTICULAR FONT, STYLE, SIZE, OR COLOR.

FOR HAIR CARE PRODUCTS, NAMELY, SHAMPOO, HAIR CONDITIONER, HAIR SPRAY, HAIR CARE GELS AND CREAMS, AND HAIR REPAIR CREAMS (U.S. CLS. 1, 4, 6, 50, 51 AND 52).

FIRST USE 8-1-2007; IN COMMERCE 8-1-2007.

CLASS 3—(Continued).

3,399,860. SERAPH COSMETICS, INC., HOLLYWOOD, CA. SN 78-822,267. PUB. 10-10-2006, FILED 2-23-2006.



THE COLORS BLACK AND WHITE ARE CLAIMED AS A FEATURE OF THE MARK.

THE MARK CONSISTS OF "SERAPH" IN CAPITAL LETTERS OVER A GIRL ANGEL WITH WINGS HOLDING THE WORLD FLOATING BETWEEN HER HANDS.

FOR BODY AND BEAUTY CARE COSMETICS; CLEANSING CREAMS; CONCEALERS; COSMETIC CREAMS FOR SKIN CARE; COSMETIC PENCILS; COSMETIC PREPARATIONS FOR EYE LASHES; COSMETIC PREPARATIONS FOR SKIN RENEWAL; COSMETIC ROUGES; COSMETIC SUN-PROTECTING PREPARATIONS; COSMETICS; COSMETICS, NAMELY, CONTACTS; MAKE-UP KITS COMPRISED OF EYE SHADOWS, BLUSH, LIP GLOSSES; PENCILS FOR COSMETIC PURPOSES (U.S. CLS. 1, 4, 6, 50, 51 AND 52).

FIRST USE 9-26-2007; IN COMMERCE 9-26-2007.

3,399,847. SAVE YOUR WORLD, LLC, SHORT HILLS, NJ. SN 78-818,761. PUB. 10-31-2006, FILED 2-20-2006.

Save your Rainforest

THE MARK CONSISTS OF STANDARD CHARACTERS WITHOUT CLAIM TO ANY PARTICULAR FONT, STYLE, SIZE, OR COLOR.

FOR SHAMPOO, HAIR CONDITIONER, SOAPS, FACE CREAM (U.S. CLS. 1, 4, 6, 50, 51 AND 52).

FIRST USE 5-23-2007; IN COMMERCE 5-23-2007.

3,399,870. APPLIED GENETICS INCORPORATED DERMATICS, FREEPORT, NY. SN 78-828,213. PUB. 8-29-2006, FILED 3-3-2006.

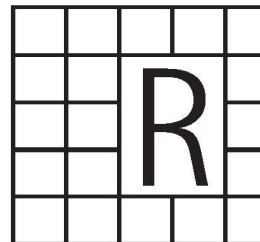

THE MARK CONSISTS OF THE LETTER "R" AND A GRID.

FOR NON-MEDICATED SKIN CARE PREPARATIONS (U.S. CLS. 1, 4, 6, 50, 51 AND 52).

FIRST USE 3-16-2006; IN COMMERCE 3-16-2006.

CLASS 3—(Continued).

3,399,878. BATH & BODY WORKS, INC., REYNOLDSBURG, OH. SN 78-832,353. PUB. 9-12-2006, FILED 3-8-2006.

CLASS 3—(Continued).

3,399,899. PEPPERMINTS SALON, INC., BEECHHURST, NY. SN 78-842,282. PUB. 11-7-2006, FILED 3-21-2006.

WAIT A MINUTE

THE MARK CONSISTS OF STANDARD CHARACTERS WITHOUT CLAIM TO ANY PARTICULAR FONT, STYLE, SIZE, OR COLOR.

FOR PERSONAL CARE PRODUCTS, NAMELY, NAIL POLISH DRYING DROPS (U.S. CLS. 1, 4, 6, 50, 51 AND 52).

FIRST USE 6-6-2007; IN COMMERCE 6-6-2007.



FOR COSMETICS, NAMELY, LIP GLOSS (U.S. CLS. 1, 4, 6, 50, 51 AND 52).

FIRST USE 10-15-2007; IN COMMERCE 10-15-2007.

3,399,898. PEPPERMINTS SALON, INC., BEECHHURST, NY. SN 78-842,262. PUB. 11-7-2006, FILED 3-21-2006.

3,399,901. PEPPERMINTS SALON, INC., BEECHHURST, NY. SN 78-842,298. PUB. 11-7-2006, FILED 3-21-2006.

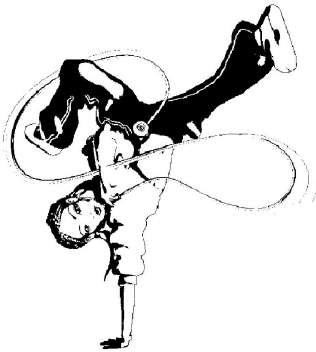

FOR COSMETICS, NAMELY, LIP GLOSS (U.S. CLS. 1, 4, 6, 50, 51 AND 52).
FIRST USE 10-15-2007; IN COMMERCE 10-15-2007.

FOR COSMETICS, NAMELY, LIP GLOSS (U.S. CLS. 1, 4, 6, 50, 51 AND 52).
FIRST USE 10-15-2007; IN COMMERCE 10-15-2007.

CLASS 3—(Continued).

3,399,902. PEPPERMINTS SALON, INC., BEECHHURST, NY.
SN 78-842,311. PUB. 11-7-2006, FILED 3-21-2006.



FOR COSMETICS, NAMELY, LIP GLOSS (U.S. CLS. 1, 4, 6, 50, 51 AND 52).
FIRST USE 10-15-2007; IN COMMERCE 10-15-2007.

3,400,012. ALCHEMY WORLDWIDE, LLC, SHERMAN
OAKS, CA. SN 78-908,530. PUB. 1-30-2007, FILED 6-14-2006.

Youthology 90 Second Wrinkle Removing Eye Serum

THE MARK CONSISTS OF STANDARD CHARACTERS WITHOUT CLAIM TO ANY PARTICULAR FONT, STYLE, SIZE, OR COLOR.

NO CLAIM IS MADE TO THE EXCLUSIVE RIGHT TO USE "90 SECOND WRINKLE REMOVING EYE SERUM", APART FROM THE MARK AS SHOWN.

FOR COSMETICS AND SKIN CARE PRODUCTS, NAMELY, NON-MEDICATED EYE SERUM, NON-MEDICATED FACIAL MASK; AND NON-MEDICATED ANTI-WRINKLE SERUM (U.S. CLS. 1, 4, 6, 50, 51 AND 52).
FIRST USE 9-14-2006; IN COMMERCE 9-14-2006.

3,400,033. THE PROCTER & GAMBLE COMPANY, CINCINNATI, OH. SN 78-921,327. PUB. 7-24-2007, FILED 6-30-2006.

RESTORING SHINE

THE MARK CONSISTS OF STANDARD CHARACTERS WITHOUT CLAIM TO ANY PARTICULAR FONT, STYLE, SIZE, OR COLOR.

FOR HAIR CARE PREPARATIONS (U.S. CLS. 1, 4, 6, 50, 51 AND 52).
FIRST USE 1-31-2007; IN COMMERCE 1-31-2007.

CLASS 3—(Continued).

3,400,061. RHOADES, DEAN L., BEVERLY HILLS, CA. SN 78-936,352. PUB. 3-13-2007, FILED 7-24-2006.

JewelTherapy

THE MARK CONSISTS OF STANDARD CHARACTERS WITHOUT CLAIM TO ANY PARTICULAR FONT, STYLE, SIZE, OR COLOR.

OWNER OF U.S. REG. NO. 2,896,222.

FOR COSMETICS, NAMELY, SKIN TONERS, SKIN CREME, SKIN MOISTURIZERS, HYDRATING MOISTURIZERS, FACIAL AND BODY SCRUBS, FACIAL LOTION, BODY LOTION AND FACIAL AND SKIN CLEANSERS (U.S. CLS. 1, 4, 6, 50, 51 AND 52).
FIRST USE 11-1-2007; IN COMMERCE 11-1-2007.

3,400,071. J. P. DURGA, L.L.C., PORT LUDLOW, WA. SN 78-939,292. PUB. 9-4-2007, FILED 7-27-2006.

SUPREME SOLUTION

THE MARK CONSISTS OF STANDARD CHARACTERS WITHOUT CLAIM TO ANY PARTICULAR FONT, STYLE, SIZE, OR COLOR.

NO CLAIM IS MADE TO THE EXCLUSIVE RIGHT TO USE "SOLUTION", APART FROM THE MARK AS SHOWN. FOR SKIN MOISTURIZER (U.S. CLS. 1, 4, 6, 50, 51 AND 52).

FIRST USE 10-31-2006; IN COMMERCE 10-31-2006.

3,400,078. ELLA BLUE INC., ELK GROVE, CA. SN 78-941,836.
PUB. 3-13-2007, FILED 8-1-2006.

LASHZILLA

THE MARK CONSISTS OF STANDARD CHARACTERS WITHOUT CLAIM TO ANY PARTICULAR FONT, STYLE, SIZE, OR COLOR.

FOR COSMETICS (U.S. CLS. 1, 4, 6, 50, 51 AND 52).
FIRST USE 11-15-2007; IN COMMERCE 11-15-2007.

CLASS 3—(Continued).

3,400,146. AMOREPACIFIC CORPORATION, SEOUL, REPUBLIC OF KOREA. SN 78-961,727. PUB. 4-24-2007, FILED 8-28-2006.

LANEIGE DESIGNING PEARL PACT

THE MARK CONSISTS OF STANDARD CHARACTERS WITHOUT CLAIM TO ANY PARTICULAR FONT, STYLE, SIZE, OR COLOR.

OWNER OF U.S. REG. NOS. 2,110,811, 2,408,553, AND 3,087,975.

FOR SOLID MAKE-UP POWDER FOR COMPACTS; LIQUID FOUNDATION; CREAMY FOUNDATION; MAKE-UP FOUNDATIONS; FACE POWDER (U.S. CLS. 1, 4, 6, 50, 51 AND 52).

FIRST USE 5-0-2006; IN COMMERCE 7-0-2006.

3,400,196. L'OREAL, PARIS, FRANCE. SN 78-971,665. PUB. 8-28-2007, FILED 9-11-2006.

DEPSEA
SMOOTHING
FOUNDATION

NO CLAIM IS MADE TO THE EXCLUSIVE RIGHT TO USE "SMOOTHING", APART FROM THE MARK AS SHOWN.

FOR HAIR STYLING PREPARATIONS (U.S. CLS. 1, 4, 6, 50, 51 AND 52).
FIRST USE 8-1-2007; IN COMMERCE 8-1-2007.

CLASS 3—(Continued).

3,400,198. L. C. LICENSING, INC., NEW YORK, NY. SN 78-972,509. PUB. 4-17-2007, FILED 9-12-2006.

LIZ CLAIBORNE RED SUNSET

THE MARK CONSISTS OF STANDARD CHARACTERS WITHOUT CLAIM TO ANY PARTICULAR FONT, STYLE, SIZE, OR COLOR.

OWNER OF U.S. REG. NOS. 2,916,333, 3,089,407, AND OTHERS.

THE NAME "LIZ CLAIBORNE" IDENTIFIES A LIVING INDIVIDUAL WHOSE CONSENT IS OF RECORD.

FOR PERFUMES (U.S. CLS. 1, 4, 6, 50, 51 AND 52).
FIRST USE 9-18-2006; IN COMMERCE 9-18-2006.

CLASS 4—LUBRICANTS AND FUELS

3,398,863. WILLIAMS, GARY, SANTA CLARA, CA. SN 76-518,856. PUB. 8-24-2004, FILED 5-8-2003.

GREEN D

FOR BIODIESEL FUELS AND NON-CHEMICAL ENGINE TREATMENTS AND ADDITIVES FOR ENGINE OILS; GASOLINE AND DIESEL FUELS; TRANSMISSION FLUIDS AND COOLING SYSTEMS (U.S. CLS. 1, 6 AND 15).

FIRST USE 7-0-2007; IN COMMERCE 9-0-2007.

3,399,502. SPANJAARD GROUP LIMITED, WYNBERG, SANDTON 2196, GAUTENG, SOUTH AFRICA. SN 78-600,947. PUB. 9-19-2006, FILED 4-4-2005.



OWNER OF U.S. REG. NO. 1,122,643.
THE COLOR(S) RED, BLACK, AND WHITE IS/ARE CLAIMED AS A FEATURE OF THE MARK.

THE MARK CONSISTS OF A SMALL RED BOX WITH A BLACK AND WHITE SWIRL DIAGONALLY ACROSS IT, UNDERNEATH WHICH IS THE WORD "SPANJAARD" IN BLACK, STYLIZED LETTERING. TO THE RIGHT OF THIS BOX IS THE WORD "SPANJAARD" IN BLACK LETTERING BETWEEN TWO HORIZONTAL RED STRIPES.

FOR GEAR OILS; LUBRICATING OILS; PENETRATING OIL; ALL PURPOSE LUBRICANTS; GRAPHITE LUBRICANTS; INDUSTRIAL LUBRICANTS; LUBRICANTS FOR INDUSTRIAL MACHINERY; LUBRICANTS FOR MARINE MACHINERY; AUTOMOTIVE GREASES; GENERAL PURPOSE GREASES; GREASE FOR MACHINES; INDUSTRIAL GREASES; LUBRICATION GREASE FOR VEHICLES; NON-CHEMICAL ADDITIVES FOR MOTOR OILS AND FUELS (U.S. CLS. 1, 6 AND 15).
FIRST USE 0-0-1998; IN COMMERCE 0-0-1998.

CLASS 4—(Continued).

3,399,514. VERASUN AURORA CORPORATION, BROOKINGS, SD. SN 78-617,201. PUB. 9-19-2006, FILED 4-26-2005.



THE MARK CONSISTS OF A STYLIZED LETTER "V" COMBINED WITH A SUN DESIGN, A STYLIZED LETTER "E", AND THE STYLIZED NUMBERS "8" AND "5", ALL WITHIN A RECTANGLE WITH ROUNDED CORNERS.

FOR ETHANOL FUEL AND ETHANOL FUEL MIXTURES (U.S. CLS. 1, 6 AND 15).

FIRST USE 5-0-2005; IN COMMERCE 5-0-2005.

3,399,515. VERASUN AURORA CORPORATION, BROOKINGS, SD. SN 78-617,204. PUB. 9-19-2006, FILED 4-26-2005.

VE85

THE MARK CONSISTS OF STANDARD CHARACTERS WITHOUT CLAIM TO ANY PARTICULAR FONT, STYLE, SIZE, OR COLOR.

FOR ETHANOL FUEL AND ETHANOL FUEL MIXTURES (U.S. CLS. 1, 6 AND 15).

FIRST USE 5-0-2005; IN COMMERCE 5-0-2005.

3,399,549. CHIMNEY SWEEPING LOG, LLC, LAS VEGAS, NV. SN 78-656,466. PUB. 8-22-2006, FILED 6-22-2005.

CREOSOTE SWEEPING LOG

THE MARK CONSISTS OF STANDARD CHARACTERS WITHOUT CLAIM TO ANY PARTICULAR FONT, STYLE, SIZE, OR COLOR.

OWNER OF U.S. REG. NO. 2,798,087.

NO CLAIM IS MADE TO THE EXCLUSIVE RIGHT TO USE "CREOSOTE" AND "LOG", APART FROM THE MARK AS SHOWN.

FOR CHEMICALLY TREATED FIREPLACE LOG USED IN FIREPLACES AND WOODSTOVES (U.S. CLS. 1, 6 AND 15).

FIRST USE 6-1-2005; IN COMMERCE 9-1-2005.

CLASS 4—(Continued).

3,399,851. CUSTOM SYNTHESIS, LLC, ANDERSON, SC. SN 78-819,500. PUB. 5-1-2007, FILED 2-21-2006.

POLYPHOS

THE MARK CONSISTS OF STANDARD CHARACTERS WITHOUT CLAIM TO ANY PARTICULAR FONT, STYLE, SIZE, OR COLOR.

FOR LUBRICATING OILS (U.S. CLS. 1, 6 AND 15).

FIRST USE 7-1-2007; IN COMMERCE 1-2-2008.

3,400,117. AMERICA YA MEI LI CHEMICAL ENGINEERING LIMITED, GUANGZHOU, CHINA. SN 78-956,165. PUB. 4-24-2007, FILED 8-21-2006.



FOR INDUSTRIAL LUBRICANTS; DUST BINDING COMPOSITIONS; ALL PURPOSE LUBRICANTS; GRANULAR ABSORBENT OIL-BASED COMPOSITION FOR ABSORBING SPILLS FROM FLOORS; BELT DRESSINGS; MOTOR OIL; INDUSTRIAL OILS; CUTTING FLUIDS; MINERAL OIL FOR USE IN THE MANUFACTURE OF PAINT; SOYBEAN OIL FOR USE IN THE MANUFACTURE OF PAINTS AND OTHER COATINGS; INDUSTRIAL GREASES (U.S. CLS. 1, 6 AND 15).

FIRST USE 4-18-2000; IN COMMERCE 2-26-2007.

CLASS 5—PHARMACEUTICALS

CLASS 5—(Continued).

3,398,889. NATURE FRIEND, INC., HACIENDA HEIGHTS, CA. SN 76-614,023. PUB. 8-8-2006, FILED 9-27-2004.



OWNER OF U.S. REG. NOS. 2,594,168 AND 2,778,944. THE MARK CONSISTS OF "NATURE FRIEND" AND DESIGN, WHEREIN THE DESIGN COMPRISES OF A MISCELLANEOUS DESIGN IS PLACED BESIDE THE STYLIZED WORDINGS "NATURE FRIEND," WHEREIN THE DESIGN COMPRISES A THE STYLIZED LETTERS "NHF".

FOR SANITARY PADS, PANTY LINERS; ADULT DIAPERS; ALLERGY MEDICATIONS; BABY FOOD; BREAST PADS; CAFFEINE PREPARATIONS FOR STIMULATIVE USE; COUGH LOZENGES; COD LIVER OIL; AND CHOLESTEROL REDUCERS (U.S. CLS. 6, 18, 44, 46, 51 AND 52).
FIRST USE 10-31-2007; IN COMMERCE 10-31-2007.

3,398,934. PURE N.R.G. PRODUCTS, INC., MANALAPAN, NJ. SN 76-664,244. PUB. 3-20-2007, FILED 8-7-2006.

PETAMINS

THE MARK CONSISTS OF STANDARD CHARACTERS WITHOUT CLAIM TO ANY PARTICULAR FONT, STYLE, SIZE, OR COLOR.

FOR DOG AND CAT VITAMINS, MINERALS AND FOOD SUPPLEMENTS (U.S. CLS. 6, 18, 44, 46, 51 AND 52).
FIRST USE 6-1-2007; IN COMMERCE 6-1-2007.

CLASS 5—(Continued).

3,398,945. SILVERADE LLC, EAST BRUNSWICK, NJ. SN 76-667,119. PUB. 4-17-2007, FILED 10-10-2006.



NO CLAIM IS MADE TO THE EXCLUSIVE RIGHT TO USE "AG", APART FROM THE MARK AS SHOWN. FOR COLLOIDAL SILVER MINERAL SUPPLEMENT (U.S. CLS. 6, 18, 44, 46, 51 AND 52).
FIRST USE 5-1-2007; IN COMMERCE 5-1-2007.

3,398,946. SILVERADE LLC, EAST BRUNSWICK, NJ. SN 76-667,333. PUB. 4-24-2007, FILED 10-10-2006.

SILVERADE

THE MARK CONSISTS OF STANDARD CHARACTERS WITHOUT CLAIM TO ANY PARTICULAR FONT, STYLE, SIZE, OR COLOR.

FOR COLLOIDAL SILVER MINERAL SUPPLEMENT (U.S. CLS. 6, 18, 44, 46, 51 AND 52).
FIRST USE 5-1-2007; IN COMMERCE 5-1-2007.

3,398,973. THE LIFE VESSEL CORPORATION, COTTONWOOD, AZ. SN 77-004,364. PUB. 4-3-2007, FILED 9-21-2006.

EQUINE ADVANTAGE

THE MARK CONSISTS OF STANDARD CHARACTERS WITHOUT CLAIM TO ANY PARTICULAR FONT, STYLE, SIZE, OR COLOR.

NO CLAIM IS MADE TO THE EXCLUSIVE RIGHT TO USE "EQUINE", APART FROM THE MARK AS SHOWN.

FOR ANIMAL FEED ADDITIVE FOR USE AS A NUTRITIONAL SUPPLEMENT FOR MEDICAL PURPOSES; DIETARY SUPPLEMENTS FOR ANIMALS (U.S. CLS. 6, 18, 44, 46, 51 AND 52).
FIRST USE 9-0-2006; IN COMMERCE 4-0-2007.

CLASS 5—(Continued).

3,399,034. WYETH HOLDINGS CORPORATION, MADISON, NJ. SN 77-029,694. PUB. 7-31-2007, FILED 10-26-2006.



OWNER OF U.S. REG. NOS. 1,160,579 AND 1,675,671. THE COLOR(S) LIGHT AND DARK REDS, LIGHT AND DARK ORANGES, LIGHT AND DARK YELLOWS, LIGHT AND DARK GREENS, AND LIGHT AND DARK BLUES IS/ARE CLAIMED AS A FEATURE OF THE MARK.

THE COLOR(S) LIGHT AND DARK REDS, LIGHT AND DARK ORANGES, LIGHT AND DARK YELLOWS, LIGHT AND DARK GREENS, AND LIGHT AND DARK BLUES APPEAR FROM LEFT TO RIGHT IN AN ARCHING BAND.

THE MARK CONSISTS OF AN ARCHING BAND OF COLORS RANGING, FROM LEFT TO RIGHT, FROM RED TO ORANGE, TO YELLOW, TO GREEN, TO BLUE.

FOR DIETARY AND NUTRITIONAL SUPPLEMENTS (U.S. CLS. 6, 18, 44, 46, 51 AND 52).

FIRST USE 6-1-2007; IN COMMERCE 6-1-2007.

3,399,111. SPINAL RESTORATION, INC., AUSTIN, TX. SN 77-067,448. PUB. 10-2-2007, FILED 12-19-2006.

BIOSTAT BIOLOGX

THE MARK CONSISTS OF STANDARD CHARACTERS WITHOUT CLAIM TO ANY PARTICULAR FONT, STYLE, SIZE, OR COLOR.

NO CLAIM IS MADE TO THE EXCLUSIVE RIGHT TO USE "BIOLOGICS", APART FROM THE MARK AS SHOWN.

FOR PHARMACEUTICAL PREPARATIONS, NAMELY, FIBRIN SEALANT, POLYMERS, BONE CEMENTS AND HYDROGELS FOR FILLING TEARS AND DEFECTS AND PROMOTING HEALING OF THE ANULUS OF THE DEGENERATED SPINAL DISC (U.S. CLS. 6, 18, 44, 46, 51 AND 52).

FIRST USE 12-18-2007; IN COMMERCE 12-18-2007.

3,399,119. SCHOLTEN, INGO, KONSTANZ, FED REP GERMANY. SN 77-069,018. PUB. 8-28-2007, FILED 12-21-2006.

prolipid

THE MARK CONSISTS OF STANDARD CHARACTERS WITHOUT CLAIM TO ANY PARTICULAR FONT, STYLE, SIZE, OR COLOR.

CLASS 5—(Continued).

PRIORITY CLAIMED UNDER SEC. 44(D) ON FED REP GERMANY APPLICATION NO. 30654011.8, FILED 8-31-2006.

FOR DIETARY AND NUTRITIONAL SUPPLEMENTS; NUTRACEUTICALS FOR USE AS A DIETARY SUPPLEMENT (U.S. CLS. 6, 18, 44, 46, 51 AND 52).

FIRST USE 8-31-2006; IN COMMERCE 10-1-2007.

3,399,138. E. EXCEL INTERNATIONAL, INC., SANDY, UT. SN 77-077,107. PUB. 6-12-2007, FILED 1-5-2007.

POLY5

THE MARK CONSISTS OF STANDARD CHARACTERS WITHOUT CLAIM TO ANY PARTICULAR FONT, STYLE, SIZE, OR COLOR.

FOR NUTRITIONAL SUPPLEMENTS, IN POWDER AND CAPSULE FORM, DERIVED PRIMARILY FROM FRUITS, VEGETABLES, HERBS AND OTHER PLANTS (U.S. CLS. 6, 18, 44, 46, 51 AND 52).

FIRST USE 2-5-2007; IN COMMERCE 2-5-2007.

3,399,143. RIDLEY BLOCK OPERATIONS, INC., MANKATO, MN. SN 77-080,205. PUB. 8-21-2007, FILED 1-10-2007.

FORAGE-LYX

THE MARK CONSISTS OF STANDARD CHARACTERS WITHOUT CLAIM TO ANY PARTICULAR FONT, STYLE, SIZE, OR COLOR.

OWNER OF U.S. REG. NOS. 1,407,344, 1,894,794, AND OTHERS.

FOR ANIMAL FEED SUPPLEMENTS (U.S. CLS. 6, 18, 44, 46, 51 AND 52).

FIRST USE 2-27-2007; IN COMMERCE 3-5-2007.

3,399,153. LOVELAND PRODUCTS, INC., GREELEY, CO. SN 77-085,232. PUB. 8-21-2007, FILED 1-17-2007.

COVERT

THE MARK CONSISTS OF STANDARD CHARACTERS WITHOUT CLAIM TO ANY PARTICULAR FONT, STYLE, SIZE, OR COLOR.

FOR INSECTICIDE (U.S. CLS. 6, 18, 44, 46, 51 AND 52).

FIRST USE 2-1-2007; IN COMMERCE 2-1-2007.

CLASS 5—(Continued).

3,399,159. KEMIN INDUSTRIES, INC., DES MOINES, IA. SN 77-088,709. PUB. 8-21-2007, FILED 1-23-2007.

ANAEBAN

THE MARK CONSISTS OF STANDARD CHARACTERS WITHOUT CLAIM TO ANY PARTICULAR FONT, STYLE, SIZE, OR COLOR.

FOR DIETARY SUPPLEMENTS, NAMELY, PROBIOTIC SUBSTANCES FOR USE IN THE TREATMENT OF GASTROINTESTINAL CONDITIONS, DIARRHEA, HEARTBURN, ACID INDIGESTION, LACTOSE INTOLERANCE, IRRITABLE BOWEL SYNDROME, GAS AND FOR THE IMPROVEMENT OF DIGESTIVE HEALTH AND ENHANCEMENT OF THE BODY'S NATURAL IMMUNE SYSTEM; NUTRITIVE SUBSTANCES OF MICROORGANISM CULTURES, NAMELY, MICROORGANISMS AND COMPONENTS THEREOF FOR USE IN THE TREATMENT OF GASTROINTESTINAL CONDITIONS, DIARRHEA, HEARTBURN, ACID INDIGESTION, LACTOSE INTOLERANCE, IRRITABLE BOWEL SYNDROME, GAS AND FOR THE IMPROVEMENT OF DIGESTIVE HEALTH AND ENHANCEMENT OF THE BODY'S NATURAL IMMUNE SYSTEM FOR MEDICAL OR VETERINARY USE; PHARMACEUTICAL AND VETERINARY PREPARATIONS FOR USE IN THE TREATMENT OF GASTROINTESTINAL CONDITIONS, DIARRHEA, HEARTBURN, ACID INDIGESTION, LACTOSE INTOLERANCE, IRRITABLE BOWEL SYNDROME, GAS AND FOR THE IMPROVEMENT OF DIGESTIVE HEALTH AND ENHANCEMENT OF THE BODY'S NATURAL IMMUNE SYSTEM; DIETETIC SUBSTANCES, NAMELY, DIETARY SUPPLEMENTS ADAPTED FOR MEDICAL OR VETERINARY USE; BIOLOGICAL AND CHEMICAL PREPARATIONS, NAMELY, DIETARY SUPPLEMENTS FOR USE IN THE TREATMENT OF GASTROINTESTINAL CONDITIONS, DIARRHEA, HEARTBURN, ACID INDIGESTION, LACTOSE INTOLERANCE, IRRITABLE BOWEL SYNDROME, GAS AND FOR THE IMPROVEMENT OF DIGESTIVE HEALTH AND ENHANCEMENT OF THE BODY'S NATURAL IMMUNE SYSTEM; AND DIAGNOSTIC REAGENTS FOR CLINICAL OR MEDICAL OR VETERINARY LABORATORY USE; FERMENTS FOR MEDICAL OR VETERINARY LABORATORY USE (U.S. CLS. 6, 18, 44, 46, 51 AND 52).

FIRST USE 12-29-2004; IN COMMERCE 5-1-2006.

3,399,184. WOODWARD, JOHN R., DALLAS, TX. SN 77-100,092. PUB. 8-14-2007, FILED 2-6-2007.

TWIST 25

THE MARK CONSISTS OF STANDARD CHARACTERS WITHOUT CLAIM TO ANY PARTICULAR FONT, STYLE, SIZE, OR COLOR.

FOR PHARMACEUTICAL PREPARATIONS FOR THE TREATMENT OF SEXUAL DYSFUNCTION IN FEMALES (U.S. CLS. 6, 18, 44, 46, 51 AND 52).

FIRST USE 9-14-2007; IN COMMERCE 9-14-2007.

CLASS 5—(Continued).

3,399,186. RIDLEY BLOCK OPERATIONS, INC., MANKATO, MN. SN 77-100,223. PUB. 8-21-2007, FILED 2-6-2007.

BREED-UP

THE MARK CONSISTS OF STANDARD CHARACTERS WITHOUT CLAIM TO ANY PARTICULAR FONT, STYLE, SIZE, OR COLOR.

FOR ANIMAL FEED SUPPLEMENTS (U.S. CLS. 6, 18, 44, 46, 51 AND 52).

FIRST USE 2-28-2007; IN COMMERCE 2-28-2007.

3,399,187. ZYCAL BIOCEUTICALS, INC., SOUTHBOROUGH, MA. SN 77-100,396. PUB. 8-7-2007, FILED 2-6-2007.

Pro-Stiminol

THE MARK CONSISTS OF STANDARD CHARACTERS WITHOUT CLAIM TO ANY PARTICULAR FONT, STYLE, SIZE, OR COLOR.

FOR NUTRITIONAL SUPPLEMENT FOR IMPROVING BONE HEALTH (U.S. CLS. 6, 18, 44, 46, 51 AND 52).

FIRST USE 8-1-2007; IN COMMERCE 8-1-2007.

3,399,199. SELLION, INC., NORTH KINGSTOWN, RI. SN 77-108,664. PUB. 8-14-2007, FILED 2-15-2007.

imVia

THE MARK CONSISTS OF THE WORD "IMVIA" WITH A LEAF ABOVE THE LETTER "V".

FOR DIETARY AND NUTRITIONAL SUPPLEMENTS; HOMEOPATHIC SUPPLEMENTS; VITAMIN SUPPLEMENTS (U.S. CLS. 6, 18, 44, 46, 51 AND 52).

FIRST USE 1-16-2008; IN COMMERCE 1-16-2008.

CLASS 5—(Continued).

3,399,219. DIVERSIFIED ADVANTAGE GROUP, INC., NEWPORT BEACH, CA. SN 77-116,713. PUB. 8-21-2007, FILED 2-26-2007.

RESVANTAGE

THE MARK CONSISTS OF STANDARD CHARACTERS WITHOUT CLAIM TO ANY PARTICULAR FONT, STYLE, SIZE, OR COLOR.

FOR DIETARY AND NUTRITIONAL SUPPLEMENTS (U.S. CLS. 6, 18, 44, 46, 51 AND 52).
FIRST USE 8-0-2007; IN COMMERCE 8-0-2007.

3,399,242. DISTRIBUIDORA DE ALIMENTOS NATURALES Y NUTRICIONALES, S.A. DE C.V., MEXICO, MEXICO. SN 77-128,934. PUB. 9-11-2007, FILED 3-12-2007.

ARTRIKROL

THE MARK CONSISTS OF STANDARD CHARACTERS WITHOUT CLAIM TO ANY PARTICULAR FONT, STYLE, SIZE, OR COLOR.

FOR OINTMENTS FOR MUSCULAR ILLNESS FOR HUMAN (U.S. CLS. 6, 18, 44, 46, 51 AND 52).
FIRST USE 1-2-2008; IN COMMERCE 1-2-2008.

3,399,243. DISTRIBUIDORA DE ALIMENTOS NATURALES Y NUTRICIONALES, S.A. DE C.V., MEXICO, MEXICO. SN 77-128,948. PUB. 9-11-2007, FILED 3-12-2007.

SALIDOL-NF

THE MARK CONSISTS OF STANDARD CHARACTERS WITHOUT CLAIM TO ANY PARTICULAR FONT, STYLE, SIZE, OR COLOR.

FOR OINTMENTS FOR MUSCULAR ILLNESS FOR HUMAN (U.S. CLS. 6, 18, 44, 46, 51 AND 52).
FIRST USE 1-2-2008; IN COMMERCE 1-2-2008.

CLASS 5—(Continued).

3,399,254. JACK ORETSKY HOLDINGS, LLC, WEST PALM BEACH, FL. SN 77-133,901. PUB. 9-18-2007, FILED 3-18-2007.

Relaxity

THE MARK CONSISTS OF STANDARD CHARACTERS WITHOUT CLAIM TO ANY PARTICULAR FONT, STYLE, SIZE, OR COLOR.

FOR DIETARY SUPPLEMENTS FOR HUMAN CONSUMPTION; FOOD SUPPLEMENTS; HERBAL SUPPLEMENTS; HOMEOPATHIC SUPPLEMENTS; NUTRACEUTICALS FOR USE AS A DIETARY SUPPLEMENT; VITAMIN AND MINERAL SUPPLEMENTS; VITAMIN SUPPLEMENT IN TABLET FORM FOR USE IN MAKING AN EFFERVESCENT BEVERAGE WHEN ADDED TO WATER (U.S. CLS. 6, 18, 44, 46, 51 AND 52).
FIRST USE 10-1-2007; IN COMMERCE 10-1-2007.

3,399,261. PATENTHEALTH, LLC, CANTON, OH. SN 77-140,595. PUB. 9-25-2007, FILED 3-26-2007.

APATRIM

THE MARK CONSISTS OF STANDARD CHARACTERS WITHOUT CLAIM TO ANY PARTICULAR FONT, STYLE, SIZE, OR COLOR.

FOR DIETARY SUPPLEMENTS FOR WEIGHT LOSS (U.S. CLS. 6, 18, 44, 46, 51 AND 52).
FIRST USE 8-1-2007; IN COMMERCE 8-1-2007.

3,399,286. THE PROCTER & GAMBLE COMPANY, CINCINNATI, OH. SN 77-153,342. PUB. 9-25-2007, FILED 4-10-2007.

FEBREZE TO GO

THE MARK CONSISTS OF STANDARD CHARACTERS WITHOUT CLAIM TO ANY PARTICULAR FONT, STYLE, SIZE, OR COLOR.

FOR DEODORANTS FOR CLOTHING OR TEXTILES (U.S. CLS. 6, 18, 44, 46, 51 AND 52).
FIRST USE 7-30-2007; IN COMMERCE 7-30-2007.

CLASS 5—(Continued).

3,399,352. HELENA HOLDING COMPANY, WILMINGTON, DE. SN 78-342,998. PUB. 9-21-2004, FILED 12-18-2003.

CLASS 5—(Continued).

3,399,357. SMITHKLINE BEECHAM PLC, BRENTFORD, MIDDLESEX, UNITED KINGDOM. SN 78-351,805. PUB. 11-9-2004, FILED 1-14-2004.

CITRU-SPERSE

THE MARK CONSISTS OF STANDARD CHARACTERS WITHOUT CLAIM TO ANY PARTICULAR FONT, STYLE, SIZE, OR COLOR.
FOR INSECTICIDES AND FUNGICIDES FOR THE AGRICULTURAL MARKET (U.S. CLS. 6, 18, 44, 46, 51 AND 52).
FIRST USE 6-15-2006; IN COMMERCE 6-15-2006.

MEJORALITO

THE MARK CONSISTS OF STANDARD CHARACTERS WITHOUT CLAIM TO ANY PARTICULAR FONT, STYLE, SIZE, OR COLOR.
OWNER OF U.S. REG. NO. 1,311,969.
FOR ANALGESIC PREPARATIONS (U.S. CLS. 6, 18, 44, 46, 51 AND 52).
FIRST USE 2-28-2007; IN COMMERCE 2-28-2007.

3,399,369. BRISTOL-MYERS SQUIBB COMPANY, NEW YORK, NY. SN 78-392,518. PUB. 7-12-2005, FILED 3-29-2004.

3,399,355. MEDINICHE, INC., CHESTERFIELD, MO. SN 78-349,709. PUB. 10-12-2004, FILED 1-9-2004.

IXEMPRA

THE MARK CONSISTS OF STANDARD CHARACTERS WITHOUT CLAIM TO ANY PARTICULAR FONT, STYLE, SIZE, OR COLOR.
THE MARK DOES NOT HAVE ANY MEANING IN A FOREIGN LANGUAGE.
FOR PHARMACEUTICAL PREPARATIONS FOR THE TREATMENT AND PREVENTION OF CANCER (U.S. CLS. 6, 18, 44, 46, 51 AND 52).
FIRST USE 10-22-2007; IN COMMERCE 10-22-2007.

Transitia

3,399,420. S. C. JOHNSON & SON, INC., RACINE, WI. SN 78-510,106. PUB. 10-4-2005, FILED 11-2-2004.

VANILLA MINT CRÉME

THE MARK CONSISTS OF STANDARD CHARACTERS WITHOUT CLAIM TO ANY PARTICULAR FONT, STYLE, SIZE, OR COLOR.
FOR DIETARY SUPPLEMENTS (U.S. CLS. 6, 18, 44, 46, 51 AND 52).
FIRST USE 10-17-2007; IN COMMERCE 10-17-2007.

THE MARK CONSISTS OF STANDARD CHARACTERS WITHOUT CLAIM TO ANY PARTICULAR FONT, STYLE, SIZE, OR COLOR.
NO CLAIM IS MADE TO THE EXCLUSIVE RIGHT TO USE "VANILLA MINT", APART FROM THE MARK AS SHOWN.
FOR AIR FRESHENERS (U.S. CLS. 6, 18, 44, 46, 51 AND 52).
FIRST USE 11-4-2007; IN COMMERCE 11-4-2007.

CLASS 5—(Continued).

3,399,431. S. C. JOHNSON & SON, INC., RACINE, WI. SN 78-518,125. PUB. 10-4-2005, FILED 11-16-2004.

CREMA DE VAINILLA Y MENTA

THE MARK CONSISTS OF STANDARD CHARACTERS WITHOUT CLAIM TO ANY PARTICULAR FONT, STYLE, SIZE, OR COLOR.

NO CLAIM IS MADE TO THE EXCLUSIVE RIGHT TO USE "VAINILLA Y MENTA", APART FROM THE MARK AS SHOWN.

THE FOREIGN WORDING IN THE MARK TRANSLATES INTO ENGLISH AS VANILLA MINT CREME.

FOR AIR FRESHENERS (U.S. CLS. 6, 18, 44, 46, 51 AND 52).

FIRST USE 11-4-2007; IN COMMERCE 11-4-2007.

3,399,433. PFIZER INC., NEW YORK, NY. SN 78-519,568. PUB. 9-27-2005, FILED 11-18-2004.

CERENIA

THE MARK CONSISTS OF STANDARD CHARACTERS WITHOUT CLAIM TO ANY PARTICULAR FONT, STYLE, SIZE, OR COLOR.

FOR VETERINARY PREPARATIONS AND SUBSTANCES, NAMELY, AN ANTIEMETIC FOR CANINES (U.S. CLS. 6, 18, 44, 46, 51 AND 52).

FIRST USE 7-30-2007; IN COMMERCE 7-30-2007.

3,399,441. BIOCROWN, INC., PLACENTIA, CA. SN 78-523,355. PUB. 3-28-2006, FILED 11-28-2004.

**CLASS 5—(Continued).**

NO CLAIM IS MADE TO THE EXCLUSIVE RIGHT TO USE "SUPPLEMENTS", APART FROM THE MARK AS SHOWN. THE COLOR(S) BLUE, WHITE, GRAY AND YELLOW IS/ ARE CLAIMED AS A FEATURE OF THE MARK.

THE COLORS BLUE, WHITE, YELLOW AND GRAY APPEAR IN THE MARK AS FOLLOWS: "BIOCROWN" IS IN WHITE, "SUPPLEMENTS" IS IN GRAY ON A YELLOW OVAL ALL OVERLAID ON A BLUE BACKGROUND.

FOR DIETARY SUPPLEMENTS (U.S. CLS. 6, 18, 44, 46, 51 AND 52).

FIRST USE 4-11-2005; IN COMMERCE 4-11-2005.

3,399,449. MISSION PHARMACAL COMPANY, SAN ANTONIO, TX. SN 78-530,760. PUB. 9-13-2005, FILED 12-10-2004.

CITRANATAL

THE MARK CONSISTS OF STANDARD CHARACTERS WITHOUT CLAIM TO ANY PARTICULAR FONT, STYLE, SIZE, OR COLOR.

FOR PRENATAL MULTI-VITAMINS AND MULTI-MINERALS (U.S. CLS. 6, 18, 44, 46, 51 AND 52).

FIRST USE 11-20-2007; IN COMMERCE 11-20-2007.

3,399,451. E. I. DU PONT DE NEMOURS AND COMPANY, WILMINGTON, DE. SN 78-533,707. PUB. 9-13-2005, FILED 12-16-2004.

PUNCH

THE MARK CONSISTS OF STANDARD CHARACTERS WITHOUT CLAIM TO ANY PARTICULAR FONT, STYLE, SIZE, OR COLOR.

FOR FUNGICIDES FOR USE IN AGRICULTURE (U.S. CLS. 6, 18, 44, 46, 51 AND 52).

FIRST USE 7-3-2007; IN COMMERCE 7-3-2007.

CLASS 5—(Continued).

3,399,454. HERBORIUM, INC., TEANECK, NJ. SN 78-533,861. PUB. 9-13-2005, FILED 12-16-2004.

**IT'S BETTER TO DO
IT NATURALLY**

THE MARK CONSISTS OF STANDARD CHARACTERS WITHOUT CLAIM TO ANY PARTICULAR FONT, STYLE, SIZE, OR COLOR.
FOR HERBAL DIETARY SUPPLEMENTS (U.S. CLS. 6, 18, 44, 46, 51 AND 52).
FIRST USE 2-1-2006; IN COMMERCE 2-1-2006.

3,399,478. ALLERGAN, INC., IRVINE, CA. SN 78-568,827. PUB. 11-15-2005, FILED 2-16-2005.

COMBIGAN

THE MARK CONSISTS OF STANDARD CHARACTERS WITHOUT CLAIM TO ANY PARTICULAR FONT, STYLE, SIZE, OR COLOR.
FOR PHARMACEUTICAL PREPARATIONS FOR THE TREATMENT OF GLAUCOMA (U.S. CLS. 6, 18, 44, 46, 51 AND 52).
FIRST USE 8-16-2001; IN COMMERCE 11-12-2007.

3,399,512. ESAKI MEDICAL INSTRUMENT CO., LTD., NAGAOKAKYO-SHI, JAPAN. SN 78-612,994. PUB. 8-1-2006, FILED 4-20-2005.

STRINTEX

FOR MEDICAL ADHESIVE TAPE (U.S. CLS. 6, 18, 44, 46, 51 AND 52).
FIRST USE 9-1-2006; IN COMMERCE 9-1-2006.

CLASS 5—(Continued).

3,399,626. W.F. YOUNG, INCORPORATED, EAST LONG-MEADOW, MA. SN 78-719,508. PUB. 6-13-2006, FILED 9-23-2005.

DURABOND TECHNOLOGY

THE MARK CONSISTS OF STANDARD CHARACTERS WITHOUT CLAIM TO ANY PARTICULAR FONT, STYLE, SIZE, OR COLOR.
NO CLAIM IS MADE TO THE EXCLUSIVE RIGHT TO USE "TECHNOLOGY", APART FROM THE MARK AS SHOWN.
FOR INSECT REPELLENTS (U.S. CLS. 6, 18, 44, 46, 51 AND 52).
FIRST USE 12-9-2005; IN COMMERCE 12-9-2005.

3,399,644. TOPOTARGET A/S, COPENHAGEN, DENMARK. SN 78-732,996. PUB. 6-13-2006, FILED 10-13-2005.

TOTECT

THE MARK CONSISTS OF STANDARD CHARACTERS WITHOUT CLAIM TO ANY PARTICULAR FONT, STYLE, SIZE, OR COLOR.
FOR PHARMACEUTICAL PREPARATIONS FOR THE PROPHYLAXIS AND TREATMENT OF TISSUE DAMAGE CAUSED BY CYTOTOXIC AGENTS (U.S. CLS. 6, 18, 44, 46, 51 AND 52).
FIRST USE 10-15-2007; IN COMMERCE 10-15-2007.

3,399,766. BIO-LOGIC AQUA TECHNOLOGIES, INC., GRANTS PASS, OR. SN 78-788,627. PUB. 9-12-2006, FILED 1-10-2006.

ESSENTIAL EYE WASH

THE MARK CONSISTS OF STANDARD CHARACTERS WITHOUT CLAIM TO ANY PARTICULAR FONT, STYLE, SIZE, OR COLOR.
NO CLAIM IS MADE TO THE EXCLUSIVE RIGHT TO USE "EYE WASH", APART FROM THE MARK AS SHOWN.
FOR EYE WASH, NAMELY, PURIFIED WATER IN A SPRAY CONTAINER FOR REFRESHING TEAR FILM (U.S. CLS. 6, 18, 44, 46, 51 AND 52).
FIRST USE 3-5-2007; IN COMMERCE 5-5-2007.

CLASS 5—(Continued).

3,399,773. NUFARM AMERICAS INC., BURR RIDGE, IL. SN 78-792,672. PUB. 9-12-2006, FILED 1-17-2006.

CUTBACK

THE MARK CONSISTS OF STANDARD CHARACTERS WITHOUT CLAIM TO ANY PARTICULAR FONT, STYLE, SIZE, OR COLOR.

FOR HERBICIDES FOR AGRICULTURAL USE; HERBICIDES FOR DOMESTIC USE; INSECTICIDES; PESTICIDES FOR AGRICULTURAL, COMMERCIAL, DOMESTIC AND INDUSTRIAL USE (U.S. CLS. 6, 18, 44, 46, 51 AND 52).

FIRST USE 1-31-2007; IN COMMERCE 1-31-2007.

3,399,886. DISTRIBUIDORA DE ALIMENTOS NATURALES Y NUTRICIONALES, S.A. DE C.V., MEXICO, DISTRITO FEDERAL, MEXICO. SN 78-833,861. PUB. 1-2-2007, FILED 3-9-2006.

BRONCORUB

THE MARK CONSISTS OF STANDARD CHARACTERS WITHOUT CLAIM TO ANY PARTICULAR FONT, STYLE, SIZE, OR COLOR.

OWNER OF U.S. REG. NO. 2,605,751.
FOR MEDICINES AND PHARMACEUTICAL PREPARATIONS, NAMELY, MEDICATED OINTMENTS MADE OF NATURAL EXTRACTS FOR TREATING RESPIRATORY ILLNESS (U.S. CLS. 6, 18, 44, 46, 51 AND 52).

FIRST USE 8-22-2002; IN COMMERCE 8-22-2002.

3,399,903. GENCOR PACIFIC, INC., AUSTIN, TX. SN 78-842,427. PUB. 11-14-2006, FILED 3-21-2006.

PUNICAGEN

THE MARK CONSISTS OF STANDARD CHARACTERS WITHOUT CLAIM TO ANY PARTICULAR FONT, STYLE, SIZE, OR COLOR.

FOR DIETARY SUPPLEMENTS (U.S. CLS. 6, 18, 44, 46, 51 AND 52).

FIRST USE 8-6-2007; IN COMMERCE 8-6-2007.

CLASS 5—(Continued).

3,400,106. A. M. TODD COMPANY, KALAMAZOO, MI. SN 78-952,205. PUB. 4-3-2007, FILED 8-15-2006.

ECH-CELLENT

THE MARK CONSISTS OF STANDARD CHARACTERS WITHOUT CLAIM TO ANY PARTICULAR FONT, STYLE, SIZE, OR COLOR.

FOR MEDICINAL HERB EXTRACTS (U.S. CLS. 6, 18, 44, 46, 51 AND 52).

FIRST USE 3-0-2007; IN COMMERCE 3-0-2007.

3,400,187. CROSBY SERVICES, INC., PROVO, UT. SN 78-970,386. PUB. 5-1-2007, FILED 9-8-2006.

HOODIA FUSION

THE MARK CONSISTS OF STANDARD CHARACTERS WITHOUT CLAIM TO ANY PARTICULAR FONT, STYLE, SIZE, OR COLOR.

NO CLAIM IS MADE TO THE EXCLUSIVE RIGHT TO USE "HOODIA", APART FROM THE MARK AS SHOWN.

FOR DIETARY AND NUTRITIONAL SUPPLEMENTS; DIETARY AND NUTRITIONAL SUPPLEMENTS FOR SUPPRESSING APPETITE, BURNING FAT, AND BOOSTING ENERGY (U.S. CLS. 6, 18, 44, 46, 51 AND 52).

FIRST USE 2-28-2007; IN COMMERCE 2-28-2007.

CLASS 6—METAL GOODS

3,398,890. NUAIR MANUFACTURING COMPANY, TAMPA, FL. SN 76-616,731. PUB. 10-11-2005, FILED 10-19-2004.

NuGroove

THE MARK CONSISTS OF STANDARD CHARACTERS WITHOUT CLAIM TO ANY PARTICULAR FONT, STYLE, SIZE, OR COLOR.

OWNER OF U.S. REG. NOS. 1,748,508, 2,778,506, AND OTHERS.

FOR METAL WINDOWS AND WINDOW COMPONENTS, NAMELY, ADD-ON DECORATIVE GRIDS (U.S. CLS. 2, 12, 13, 14, 23, 25 AND 50).

FIRST USE 1-1-2006; IN COMMERCE 1-1-2006.

CLASS 6—(Continued).

3,398,979. MORSE, WILLIAM N., ELLICOTT CITY, MD. SN 77-006,345. PUB. 5-22-2007, FILED 9-25-2006.



NO CLAIM IS MADE TO THE EXCLUSIVE RIGHT TO USE "PARKING", APART FROM THE MARK AS SHOWN. FOR NON-LUMINOUS AND NON-MECHANICAL METAL SIGNS (U.S. CLS. 2, 12, 13, 14, 23, 25 AND 50). FIRST USE 11-30-2003; IN COMMERCE 10-26-2006.

3,399,056. CHROME HEARTS LLC, HOLLYWOOD, CA. SN 77-039,028. PUB. 10-9-2007, FILED 11-7-2006.



OWNER OF U.S. REG. NOS. 2,192,539, 3,061,598, AND OTHERS.

NO CLAIM IS MADE TO THE EXCLUSIVE RIGHT TO USE "CHROME", APART FROM THE MARK AS SHOWN.

FOR HARDWARE MADE OF METAL, NAMELY, CABINET PULLS, DOOR KNOBS, DOOR HANDLES AND DOOR HINGES (U.S. CLS. 2, 12, 13, 14, 23, 25 AND 50).

FIRST USE 11-22-2006; IN COMMERCE 11-22-2006.

CLASS 6—(Continued).

3,399,214. SECURITY BOSS MANUFACTURING, LLC, PLYMOUTH, WI. SN 77-115,093. PUB. 8-21-2007, FILED 2-23-2007.

SECURITY BOSS

THE MARK CONSISTS OF STANDARD CHARACTERS WITHOUT CLAIM TO ANY PARTICULAR FONT, STYLE, SIZE, OR COLOR.

FOR PET DOORS, PRIMARILY OF METAL (U.S. CLS. 2, 12, 13, 14, 23, 25 AND 50).

FIRST USE 5-17-2007; IN COMMERCE 5-26-2007.

3,399,235. MAXAL INTERNATIONAL, INC., TRAVERSE CITY, MI. SN 77-123,432. PUB. 9-4-2007, FILED 3-6-2007.

CYBERAL

THE MARK CONSISTS OF STANDARD CHARACTERS WITHOUT CLAIM TO ANY PARTICULAR FONT, STYLE, SIZE, OR COLOR.

FOR ALUMINUM WELDING WIRE (U.S. CLS. 2, 12, 13, 14, 23, 25 AND 50).

FIRST USE 12-3-2007; IN COMMERCE 12-3-2007.

3,399,268. MASTERCRAFT INDUSTRIES, INC., RICE LAKE, WI. SN 77-146,252. PUB. 10-9-2007, FILED 4-2-2007.

EZnSTAL

THE MARK CONSISTS OF STANDARD CHARACTERS WITHOUT CLAIM TO ANY PARTICULAR FONT, STYLE, SIZE, OR COLOR.

FOR DRAWER GUIDE MOUNTING SYSTEM COMPRISED PRIMARILY OF A SELF-CENTERING METAL MOUNTING BRACKET FOR DRAWERS USED IN THE MANUFACTURE AND ASSEMBLY OF CABINETS AND FURNITURE (U.S. CLS. 2, 12, 13, 14, 23, 25 AND 50).

FIRST USE 7-15-2007; IN COMMERCE 7-15-2007.

CLASS 6—(Continued).

3,399,300. METALS USA BUILDING PRODUCTS, L.P., HOUSTON, TX. SN 77-189,290. PUB. 10-2-2007, FILED 5-24-2007.



OWNER OF U.S. REG. NOS. 2,425,483, 2,451,306, AND OTHERS.

NO CLAIM IS MADE TO THE EXCLUSIVE RIGHT TO USE "ROOFING PRODUCTS", APART FROM THE MARK AS SHOWN.

THE MARK CONSISTS OF A STYLIZED A.

FOR METAL AND STONE COATED METAL ROOFING TILES; STONE COATED METAL ROOFING PANELS; METAL ROOF AND PATIO SYSTEM COMPONENTS COMPRISING OF BEAMS, POSTS, RAFTERS, TUBES, AND SINGLE SKIN AND STRUCTURAL INSULATED ROOF PANELS, ALL MADE OF ALUMINUM OR METAL ALLOY (U.S. CLS. 2, 12, 13, 14, 23, 25 AND 50).

FIRST USE 7-1-2007; IN COMMERCE 7-1-2007.

3,399,466. SUTTON, ADAM, KANEHOE, HI. SN 78-558,431. PUB. 9-12-2006, FILED 2-1-2005.

WEEP TRACK

THE MARK CONSISTS OF STANDARD CHARACTERS WITHOUT CLAIM TO ANY PARTICULAR FONT, STYLE, SIZE, OR COLOR.

NO CLAIM IS MADE TO THE EXCLUSIVE RIGHT TO USE "TRACK", APART FROM THE MARK AS SHOWN.

FOR METAL WALL TRACKS FOR USE IN BUILDING CONSTRUCTION (U.S. CLS. 2, 12, 13, 14, 23, 25 AND 50). FIRST USE 11-18-2004; IN COMMERCE 5-11-2005.

CLASS 6—(Continued).

3,399,678. GUARDIAN POOL FENCE SYSTEMS, INC., VAN NUYS, CA. SN 78-753,621. PUB. 2-6-2007, FILED 11-14-2005.

GUARDIAN PET FENCE SYSTEMS

THE MARK CONSISTS OF STANDARD CHARACTERS WITHOUT CLAIM TO ANY PARTICULAR FONT, STYLE, SIZE, OR COLOR.

OWNER OF U.S. REG. NOS. 2,273,407 AND 2,963,700.

NO CLAIM IS MADE TO THE EXCLUSIVE RIGHT TO USE "PET FENCE SYSTEMS", APART FROM THE MARK AS SHOWN.

FOR FENCE SYSTEM COMPRISED OF WIRE MESH SECTIONS AND METAL SUPPORT POLES FOR CONTAINING PETS (U.S. CLS. 2, 12, 13, 14, 23, 25 AND 50).

FIRST USE 10-31-2007; IN COMMERCE 10-31-2007.

3,399,840. GRANT PRIDECO, L.P., HOUSTON, TX. SN 78-815,423. PUB. 9-12-2006, FILED 2-15-2006.

TURBOTORQUE

THE MARK CONSISTS OF STANDARD CHARACTERS WITHOUT CLAIM TO ANY PARTICULAR FONT, STYLE, SIZE, OR COLOR.

FOR THREADED METAL DRILL PIPE CONNECTIONS USED ON METAL DRILL PIPE FOR THE DRILLING OF OIL AND GAS WELLS AND OTHER EARTH BOREHOLES (U.S. CLS. 2, 12, 13, 14, 23, 25 AND 50).

FIRST USE 4-30-2007; IN COMMERCE 4-30-2007.

3,399,918. RIFAST SYSTEMS LLC, LINCOLNWOOD, IL. SN 78-852,964. PUB. 11-7-2006, FILED 4-3-2006.

Pressin

THE MARK CONSISTS OF STANDARD CHARACTERS WITHOUT CLAIM TO ANY PARTICULAR FONT, STYLE, SIZE, OR COLOR.

FOR METAL FASTENERS, NAMELY, SCREWS, NUTS, BOLTS AND CLINCH AND STAKE FASTENERS (U.S. CLS. 2, 12, 13, 14, 23, 25 AND 50).

FIRST USE 12-10-2006; IN COMMERCE 12-10-2006.

CLASS 6—(Continued).

3,400,113. VARCO PRUDEN BUILDINGS, INC., MEMPHIS, TN. SN 78-954,566. PUB. 5-8-2007, FILED 8-17-2006.

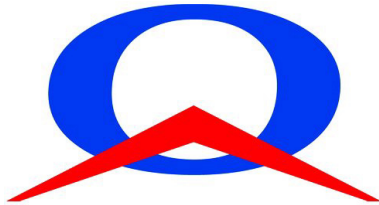

OWNER OF U.S. REG. NO. 926,653.
THE COLOR(S) RED AND BLUE IS/ARE CLAIMED AS A FEATURE OF THE MARK.

THE MARK CONSISTS OF A CHEVRON DESIGN IN THE COLOR RED IN FRONT OF AN "O" DESIGN IN THE COLOR BLUE.

FOR METAL BUILDINGS AND CONSTRUCTION PRODUCTS, NAMELY, PREFABRICATED METAL BUILDINGS, PRIMARY STEEL STRUCTURAL FRAMING, SECONDARY STEEL STRUCTURAL COMPONENTS, NAMELY, METAL JOISTS, METAL PIPES, METAL TUBES FOR INDUSTRIAL USE, AND METAL WALL AND ROOFING PANELS (U.S. CLS. 2, 12, 13, 14, 23, 25 AND 50).

FIRST USE 0-0-2006; IN COMMERCE 0-0-2006.

CLASS 6—(Continued).

3,400,148. TUBOS DE ACERO DE MEXICO S.A., VERACRUZ, MEXICO. SN 78-962,061. PUB. 4-17-2007, FILED 8-28-2006.

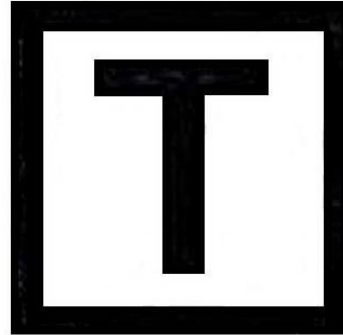

FOR METAL TUBE CONNECTORS (U.S. CLS. 2, 12, 13, 14, 23, 25 AND 50).
FIRST USE 7-10-2006; IN COMMERCE 10-0-2006.

3,400,158. ISOTECH LABORATORIES, INC., CHAMPAIGN, IL. SN 78-963,863. PUB. 4-24-2007, FILED 8-30-2006.



OWNER OF U.S. REG. NO. 2,838,483.
FOR METAL CONTAINERS FOR THE HARVESTING AND TRANSPORTATION OF GASEOUS OR LIQUID SAMPLES FOR TESTING (U.S. CLS. 2, 12, 13, 14, 23, 25 AND 50).
FIRST USE 6-30-2000; IN COMMERCE 6-30-2000.

3,400,177. CREATIVE DESIGN GROUP, DEERFIELD, FL. SN 78-968,259. PUB. 5-8-2007, FILED 9-6-2006.

CUSTOM HEMISPHERIC

THE MARK CONSISTS OF STANDARD CHARACTERS WITHOUT CLAIM TO ANY PARTICULAR FONT, STYLE, SIZE, OR COLOR.

NO CLAIM IS MADE TO THE EXCLUSIVE RIGHT TO USE "CUSTOM", APART FROM THE MARK AS SHOWN.

FOR ROUND BOTTOM INDUSTRIAL MIXING VESSEL MADE PRIMARILY OF METAL (U.S. CLS. 2, 12, 13, 14, 23, 25 AND 50).

FIRST USE 7-1-2006; IN COMMERCE 7-1-2006.

BETTA TREASURES COLLECTION

THE MARK CONSISTS OF STANDARD CHARACTERS WITHOUT CLAIM TO ANY PARTICULAR FONT, STYLE, SIZE, OR COLOR.

NO CLAIM IS MADE TO THE EXCLUSIVE RIGHT TO USE "BETTA" AND "COLLECTION", APART FROM THE MARK AS SHOWN.

FOR SCULPTURES MADE OF NON-PRECIOUS METALS (U.S. CLS. 2, 12, 13, 14, 23, 25 AND 50).

FIRST USE 2-0-2007; IN COMMERCE 2-0-2007.

CLASS 7—MACHINERY

3,398,881. FRANK'S INTERNATIONAL, INC., HOUSTON, TX. SN 76-599,870. PUB. 7-31-2007, FILED 6-28-2004.

ANACONDA

FOR MACHINE PARTS FOR OILFIELD EQUIPMENT, NAMELY, LOAD LIFT RINGS, AND THREAD PROTECTORS FOR USE ON OILFIELD CASING BEFORE SUCH CASING IS RUN INTO AN EARTH WELL BORE (U.S. CLS. 13, 19, 21, 23, 31, 34 AND 35).

FIRST USE 5-3-2004; IN COMMERCE 5-3-2004.

3,398,891. THE GORMAN-RUPP COMPANY, MANSFIELD, OH. SN 76-617,633. PUB. 10-4-2005, FILED 10-26-2004.

COUNT ON IT

THE MARK CONSISTS OF STANDARD CHARACTERS WITHOUT CLAIM TO ANY PARTICULAR FONT, STYLE, SIZE, OR COLOR.

FOR INDUSTRIAL PUMPS, PUMPING APPARATUS, AND ACCESSORIES AND PARTS THEREFORE, NAMELY, CENTRIFUGAL PUMPS, SELF-PRIMING CENTRIFUGAL PUMPS, STRAIGHT CENTRIFUGAL PUMPS, REFUELLER PUMPS, SUBMERSIBLE PUMPS, DIAPHRAGM PUMPS, ROTARY GEAR PUMPS, SELF PRIMING GEAR PUMPS, POWER TAKE OFF PUMPS, IRRIGATION PUMPS, MULTI-STAGE HIGH PRESSURE PUMPS, SELF-PRIMING PETROLEUM PUMPS, AGRICULTURAL PUMPS, FIRE PUMPS, OSCILLATING PUMPS, ENGINE-DRIVEN PUMPS; SEWAGE PUMPING SYSTEMS, COMPRISING SELF-PRIMING CENTRIFUGAL SOLIDS HANDLING PUMPS, MOTORS, CONTROLS, PIPING AND STATION ENCLOSURES FOR SEWAGE PUMPING SYSTEMS; PRESSURE BOOSTING PUMPING STATIONS, COMPRISING PUMPS, MOTORS, CONTROLS, PIPING, VALVES, AND ENCLOSURES FOR PUMPING STATIONS AND REPAIR PARTS FOR ALL OF THE ABOVE (U.S. CLS. 13, 19, 21, 23, 31, 34 AND 35).
FIRST USE 7-1-2006; IN COMMERCE 11-22-2006.

CLASS 7—(Continued).

3,398,902. DG PERFORMANCE SPECIALTIES, INC, ANAHEIM, CA. SN 76-642,416. PUB. 9-26-2006, FILED 7-7-2005.

ROAD BURNER

THE MARK CONSISTS OF STANDARD CHARACTERS WITHOUT CLAIM TO ANY PARTICULAR FONT, STYLE, SIZE, OR COLOR.

OWNER OF U.S. REG. NO. 2,560,324.

FOR MOTORCYCLE EXHAUST SYSTEMS COMPRISED OF ENGINE MUFFLERS, EXHAUST PIPES, EXHAUST TIPS AND MOUNTING HARDWARE THEREFOR (U.S. CLS. 13, 19, 21, 23, 31, 34 AND 35).

FIRST USE 4-30-2005; IN COMMERCE 3-8-2006.

3,398,968. WASHTEC HOLDING GMBH, AUGSBURG, FED REP GERMANY. SN 77-002,929. PUB. 5-8-2007, FILED 9-20-2006.

SOFTLINE

THE MARK CONSISTS OF STANDARD CHARACTERS WITHOUT CLAIM TO ANY PARTICULAR FONT, STYLE, SIZE, OR COLOR.

FOR CAR WASHING EQUIPMENT, NAMELY, AUTOMATIC TUNNEL AND CONVEYOR-STYLE MACHINES FOR WASHING, WAXING AND DRYING THE EXTERIOR SURFACE OF AN AUTOMOTIVE VEHICLE AND VACUUMING THE INTERIOR OF SUCH VEHICLE, AND COMPONENT PARTS THEREOF (U.S. CLS. 13, 19, 21, 23, 31, 34 AND 35).

FIRST USE 10-9-2007; IN COMMERCE 10-23-2007.

3,399,287. CURRAN MANUFACTURING CORPORATION, HAUPPAUGE, NY. SN 77-153,609. PUB. 9-11-2007, FILED 4-11-2007.

ROTA-RACK

THE MARK CONSISTS OF STANDARD CHARACTERS WITHOUT CLAIM TO ANY PARTICULAR FONT, STYLE, SIZE, OR COLOR.

FOR MACHINERY, NAMELY, PARTS ACCUMULATOR (U.S. CLS. 13, 19, 21, 23, 31, 34 AND 35).

FIRST USE 6-12-2007; IN COMMERCE 6-12-2007.

CLASS 7—(Continued).

3,399,329. MITSUBISHI ELECTRIC CORPORATION, TOKYO, JAPAN. SN 78-281,098. PUB. 9-13-2005, FILED 7-30-2003.

MICRO SPARK COATING

PRIORITY CLAIMED UNDER SEC. 44(D) ON JAPAN APPLICATION NO. 2003-054989, FILED 7-2-2003.

NO CLAIM IS MADE TO THE EXCLUSIVE RIGHT TO USE "COATING", APART FROM THE MARK AS SHOWN.

FOR ELECTRIC DISCHARGE MACHINES FOR USE IN MAKING A METALLIC OR CERAMIC LAYER ON THE SURFACE OF METALLIC PRODUCTS OR METALLIC PARTS OF PRODUCTS IN THE FIELD OF VEHICLES AND INDUSTRIAL MACHINES AND TOOLS (U.S. CLS. 13, 19, 21, 23, 31, 34 AND 35).

FIRST USE 6-12-2003; IN COMMERCE 8-31-2004.

3,399,389. STEWART STEEL INC., WEYBURN, SASKATCHEWAN, CANADA. SN 78-463,455. PUB. 7-4-2006, FILED 8-6-2004.

AXCELLER

THE MARK CONSISTS OF STANDARD CHARACTERS WITHOUT CLAIM TO ANY PARTICULAR FONT, STYLE, SIZE, OR COLOR.

PRIORITY CLAIMED UNDER SEC. 44(D) ON CANADA APPLICATION NO. 1201552, FILED 2-6-2004, REG. NO. TMA655019, DATED 12-14-2005, EXPIRES 12-14-2020.

FOR ROTOR CONVERSION KITS FOR AGRICULTURAL MACHINERY, NAMELY, COMBINES (U.S. CLS. 13, 19, 21, 23, 31, 34 AND 35).

FIRST USE 3-20-2007; IN COMMERCE 3-20-2007.

3,399,444. PENTAIR PUMP GROUP, INC., GOLDEN VALLEY, MN. SN 78-524,933. PUB. 3-13-2007, FILED 12-1-2004.



OWNER OF U.S. REG. NOS. 1,881,877 AND 1,888,217. THE MARK CONSISTS OF EDWARDS AND A CIRCULAR DESIGN WITH A GEAR IN THE CENTER.

FOR ROTARY PUMPS (U.S. CLS. 13, 19, 21, 23, 31, 34 AND 35).

FIRST USE 3-10-2005; IN COMMERCE 3-10-2005.

CLASS 7—(Continued).

3,399,464. INTERNATIONAL CATALYST TECHNOLOGY, INC., AUBURN HILLS, MI. SN 78-554,199. PUB. 4-25-2006, FILED 1-26-2005.

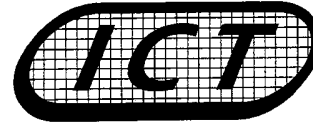

International Catalyst Technology

NO CLAIM IS MADE TO THE EXCLUSIVE RIGHT TO USE "CATALYST TECHNOLOGY", APART FROM THE MARK AS SHOWN.

THE MARK CONSISTS OF THE CAPITALIZED LETTERS "ICT" SET IN A SLANTED OVAL WITH A HONEYCOMBED BACKGROUND. UNDERNEATH THE OVAL IS THE WORDING "INTERNATIONAL CATALYST TECHNOLOGY".

FOR EMISSION REDUCTION UNITS FOR MOTORS AND ENGINES, NAMELY, CATALYTIC CONVERTERS (U.S. CLS. 13, 19, 21, 23, 31, 34 AND 35).

FIRST USE 10-1-2002; IN COMMERCE 10-1-2002.

3,399,503. EMERSON ELECTRIC CO., ST. LOUIS, MO. SN 78-601,489. PUB. 7-11-2006, FILED 4-4-2005.

**STRONGER. FASTER.
LONGER LIFE.**

THE MARK CONSISTS OF STANDARD CHARACTERS WITHOUT CLAIM TO ANY PARTICULAR FONT, STYLE, SIZE, OR COLOR.

FOR POWER TOOLS AND POWER TOOL ACCESSORIES, NAMELY, POWER SAW BLADES AND DRILL BITS (U.S. CLS. 13, 19, 21, 23, 31, 34 AND 35).

FIRST USE 6-20-2005; IN COMMERCE 6-20-2005.

3,399,558. STOWE WOODWARD COMPANY LLC, YOUNGSVILLE, NC. SN 78-660,695. PUB. 3-14-2006, FILED 6-29-2005.

STARGATE

THE MARK CONSISTS OF STANDARD CHARACTERS WITHOUT CLAIM TO ANY PARTICULAR FONT, STYLE, SIZE, OR COLOR.

FOR MACHINE PARTS, NAMELY, POLYMERIC COVERS FOR SUPERCALNDAR ROLLS AND OTHER INDUSTRIAL ROLLS FOR USE, FOR EXAMPLE, IN THE PAPERMAKING AND PRINT INDUSTRIES (U.S. CLS. 13, 19, 21, 23, 31, 34 AND 35).

FIRST USE 2-3-2006; IN COMMERCE 2-3-2006.

CLASS 7—(Continued).

3,399,712. HY-TECH WORLDWIDE, INC., LAS VEGAS, NV.
SN 78-766,977. PUB. 8-1-2006, FILED 12-5-2005.

ProFormHT

THE MARK CONSISTS OF STANDARD CHARACTERS WITHOUT CLAIM TO ANY PARTICULAR FONT, STYLE, SIZE, OR COLOR.

FOR MACHINES FOR HYDROFORMING PLASTIC SHEETS (U.S. CLS. 13, 19, 21, 23, 31, 34 AND 35).
FIRST USE 2-28-2007; IN COMMERCE 2-28-2007.

3,399,723. DMS ELECTRIC APPARATUS SERVICE, INC.,
KALAMAZOO, MI. SN 78-772,608. PUB. 4-17-2007, FILED
12-13-2005.

MOTOR MATTRESS

THE MARK CONSISTS OF STANDARD CHARACTERS WITHOUT CLAIM TO ANY PARTICULAR FONT, STYLE, SIZE, OR COLOR.

NO CLAIM IS MADE TO THE EXCLUSIVE RIGHT TO USE "MOTOR", APART FROM THE MARK AS SHOWN.

FOR INDUSTRIAL MACHINE MOTOR MOUNTS IN THE NATURE OF TRANSITION BASES THAT ACCOMMODATE DIFFERENT TYPES AND SIZES OF INDUSTRIAL MOTORS (U.S. CLS. 13, 19, 21, 23, 31, 34 AND 35).
FIRST USE 10-9-2006; IN COMMERCE 10-9-2006.

3,399,873. MARVEL MANUFACTURING COMPANY, INC.,
OSHKOSH, WI. SN 78-829,770. PUB. 10-24-2006, FILED 3-6-
2006.

8 MARK III

THE MARK CONSISTS OF STANDARD CHARACTERS WITHOUT CLAIM TO ANY PARTICULAR FONT, STYLE, SIZE, OR COLOR.

OWNER OF U.S. REG. NO. 1,569,259.
FOR POWER-OPERATED BAND SAWS AND METAL CUTTING MACHINES (U.S. CLS. 13, 19, 21, 23, 31, 34 AND 35).
FIRST USE 3-27-2006; IN COMMERCE 3-27-2006.

CLASS 7—(Continued).

3,399,879. STOWE WOODWARD LLC, WESTBOROUGH,
MA. SN 78-832,465. PUB. 10-31-2006, FILED 3-8-2006.

REELTIGHT

THE MARK CONSISTS OF STANDARD CHARACTERS WITHOUT CLAIM TO ANY PARTICULAR FONT, STYLE, SIZE, OR COLOR.

FOR MACHINE PARTS, NAMELY, INDUSTRIAL ROLL COVERS FOR USE IN PAPERMAKING MACHINES (U.S. CLS. 13, 19, 21, 23, 31, 34 AND 35).
FIRST USE 2-2-2006; IN COMMERCE 2-2-2006.

3,399,880. STOWE WOODWARD LLC, WESTBOROUGH,
MA. SN 78-832,475. PUB. 10-24-2006, FILED 3-8-2006.

WIRESAVER

THE MARK CONSISTS OF STANDARD CHARACTERS WITHOUT CLAIM TO ANY PARTICULAR FONT, STYLE, SIZE, OR COLOR.

FOR MACHINE PARTS, NAMELY, INDUSTRIAL ROLL COVERS FOR USE IN PAPERMAKING MACHINES (U.S. CLS. 13, 19, 21, 23, 31, 34 AND 35).
FIRST USE 2-2-2006; IN COMMERCE 2-2-2006.

3,399,881. STOWE WOODWARD LLC, WESTBOROUGH,
MA. SN 78-832,477. PUB. 10-31-2006, FILED 3-8-2006.

R2

THE MARK CONSISTS OF STANDARD CHARACTERS WITHOUT CLAIM TO ANY PARTICULAR FONT, STYLE, SIZE, OR COLOR.

FOR MACHINE PARTS, NAMELY, INDUSTRIAL ROLL COVERS FOR USE IN PAPERMAKING MACHINES (U.S. CLS. 13, 19, 21, 23, 31, 34 AND 35).
FIRST USE 2-2-2006; IN COMMERCE 2-2-2006.

CLASS 7—(Continued).

3,399,882. STOWE WOODWARD LLC, WESTBOROUGH, MA. SN 78-832,484. PUB. 10-31-2006, FILED 3-8-2006.

CLASS 7—(Continued).

3,400,145. TOOLINGHOUSE.COM, FOWLERVILLE, MI. SN 78-961,479. PUB. 10-2-2007, FILED 8-28-2006.

EC1000

THE MARK CONSISTS OF STANDARD CHARACTERS WITHOUT CLAIM TO ANY PARTICULAR FONT, STYLE, SIZE, OR COLOR.

FOR MACHINE PARTS, NAMELY, INDUSTRIAL ROLL COVERS FOR USE IN PAPERMAKING MACHINES (U.S. CLS. 13, 19, 21, 23, 31, 34 AND 35).
FIRST USE 2-2-2006; IN COMMERCE 2-2-2006.

3,399,979. NATIONAL AUTOMOTIVE PARTS ASSOCIATION, ATLANTA, GA. SN 78-883,782. PUB. 6-5-2007, FILED 5-15-2006.

QuickKut

THE MARK CONSISTS OF STANDARD CHARACTERS WITHOUT CLAIM TO ANY PARTICULAR FONT, STYLE, SIZE, OR COLOR.

FOR MILLING CUTTERS; POWER TOOLS, NAMELY, END MILLS (U.S. CLS. 13, 19, 21, 23, 31, 34 AND 35).
FIRST USE 1-1-2008; IN COMMERCE 1-1-2008.

NAPA POWER SPORT

THE MARK CONSISTS OF STANDARD CHARACTERS WITHOUT CLAIM TO ANY PARTICULAR FONT, STYLE, SIZE, OR COLOR.

OWNER OF U.S. REG. NOS. 840,448 AND 1,656,107.
NO CLAIM IS MADE TO THE EXCLUSIVE RIGHT TO USE "POWER SPORT", APART FROM THE MARK AS SHOWN.

FOR OIL FILTERS, AIR FILTERS FOR VEHICLE MOTORS AND ENGINES, AND FUEL FILTERS (U.S. CLS. 13, 19, 21, 23, 31, 34 AND 35).
FIRST USE 7-0-2007; IN COMMERCE 7-0-2007.

3,400,150. MATSUSHITA ELECTRIC WORKS, LTD., OSAKA, JAPAN. SN 78-962,840. PUB. 4-24-2007, FILED 8-29-2006.

REVOLITHIUM

3,400,040. HY-KO PRODUCTS COMPANY, NORTHFIELD, OH. SN 78-922,597. PUB. 2-27-2007, FILED 7-5-2006.

THE MARK CONSISTS OF STANDARD CHARACTERS WITHOUT CLAIM TO ANY PARTICULAR FONT, STYLE, SIZE, OR COLOR.

FOR METALWORKING MACHINE TOOLS; CUTTING MACHINES FOR METALWORKING; DRILLING MACHINES FOR METALWORKING; GRINDING MACHINES FOR METALWORKING; SAW TOOTH SETTING MACHINES FOR LUMBERING OR WOODWORKING SAWS; WOODWORKING SAW TOOTH SETTING MACHINES; PLYWOOD FINISHING MACHINES; ELECTRIC DRIVERS; POWER OPERATED WRENCHES; POWER OPERATED ELECTRIC DRILLS; POWER TOOLS, NAMELY, IMPACT DRIVERS; ROTARY HAMMER DRILLS; POWER OPERATED CIRCULAR SAWS; RECIPROCATING SAWS; POWER OPERATED CAULKING GUNS; GRINDING MACHINES FOR METALWORKING; POWER OPERATED RIVET GUNS; JIG SAWS (U.S. CLS. 13, 19, 21, 23, 31, 34 AND 35).
FIRST USE 11-1-2006; IN COMMERCE 11-1-2006.

KID+

THE MARK CONSISTS OF STANDARD CHARACTERS WITHOUT CLAIM TO ANY PARTICULAR FONT, STYLE, SIZE, OR COLOR.

FOR MACHINES FOR MATCHING CUT KEYS TO KEY BLANKS, CUTTING KEY BLANKS, AND MONITORING KEY INVENTORIES (U.S. CLS. 13, 19, 21, 23, 31, 34 AND 35).
FIRST USE 5-31-2005; IN COMMERCE 3-31-2007.

CLASS 7—(Continued).

3,400,155. SEJINIGB CO., LTD., KYUNGGI-DO, REPUBLIC OF KOREA. SN 78-963,571. PUB. 4-24-2007, FILED 8-30-2006.

Xeno-Quadro

THE MARK CONSISTS IN PART OF A STYLIZED GEAR AND CIRCLE DESIGN.

FOR GEAR BOXES FOR MACHINES; TRANSMISSION GEARS FOR MACHINES; INDUSTRIAL ROBOTS (U.S. CLS. 13, 19, 21, 23, 31, 34 AND 35).

FIRST USE 10-18-2007; IN COMMERCE 10-18-2007.

CLASS 8—(Continued).

3,399,450. LOGGERHEAD TOOLS LLC, PALOS PARK, IL. SN 78-532,361. PUB. 3-28-2006, FILED 12-14-2004.

**CLASS 8—HAND TOOLS**

3,399,099. HUNTER'S SPECIALTIES, INC., CEDAR RAPIDS, IA. SN 77-062,153. PUB. 7-10-2007, FILED 12-12-2006.

FOR HAND TOOLS, NAMELY, NUT DRIVERS, PLIERS, WIRE STRIPPERS, WIRE CUTTERS (U.S. CLS. 23, 28 AND 44).

FIRST USE 6-0-2006; IN COMMERCE 6-0-2006.

BUTT OUT

THE MARK CONSISTS OF STANDARD CHARACTERS WITHOUT CLAIM TO ANY PARTICULAR FONT, STYLE, SIZE, OR COLOR.

FOR HAND TOOL FOR FIELD DRESSING LARGE GAME ANIMALS (U.S. CLS. 23, 28 AND 44).

FIRST USE 12-27-2006; IN COMMERCE 12-27-2006.

3,399,563. KOLLER ENTERPRISES, INC., FENTON, MO. SN 78-664,455. PUB. 10-3-2006, FILED 7-6-2005.

3,399,218. EASCO HAND TOOLS, INC., SIMSBURY, CT. SN 77-116,342. PUB. 9-25-2007, FILED 2-26-2007.

KEEPING OUR COUNTRY CLEAN
ONE PILE AT A TIME

STEELGRIP

THE MARK CONSISTS OF STANDARD CHARACTERS WITHOUT CLAIM TO ANY PARTICULAR FONT, STYLE, SIZE, OR COLOR.

OWNER OF U.S. REG. NO. 1,526,506.
SEC. 2(F).

FOR HAND TOOLS, NAMELY, SCREWDRIVERS, SOCKETS AND RATCHETING WRENCHES (U.S. CLS. 23, 28 AND 44).

FIRST USE 4-0-2007; IN COMMERCE 4-0-2007.

THE MARK CONSISTS OF STANDARD CHARACTERS WITHOUT CLAIM TO ANY PARTICULAR FONT, STYLE, SIZE, OR COLOR.

FOR RAKES AND GRABBERS, NAMELY, CLAW TONGS FOR COLLECTING AND DISPOSING OF PET WASTE (U.S. CLS. 23, 28 AND 44).

FIRST USE 3-0-2006; IN COMMERCE 3-0-2006.

CLASS 8—(Continued).

3,399,675. THE PREMIUM CONNECTION, INC., LAS VEGAS, NV. SN 78-753,311. PUB. 4-17-2007, FILED 11-14-2005.



NO CLAIM IS MADE TO THE EXCLUSIVE RIGHT TO USE "GARDEN", APART FROM THE MARK AS SHOWN.

FOR LAWN AND GARDEN TOOLS, NAMELY, HAND OPERATED PRUNERS, CULTIVATORS, TROWELS, SPADES, WEEDING BLADES, GARDENING SHEARS AND CLIPPERS, SHOVELS, HAND OPERATED LAWN EDGERS, NON-ELECTRIC WEED TRIMMERS, HOES, HAND OPERATED LOPPERS; GARDENING TOOL KITS CONSISTING OF COMBINATIONS OF THE ABOVE GARDENING TOOLS, PROTECTIVE GARDENING GLOVES, GARDENING APRON AND UTILITY BELT SOLD AS A UNIT (U.S. CLS. 23, 28 AND 44).
FIRST USE 1-14-2005; IN COMMERCE 4-30-2005.

3,400,221. MICHIGAN INDUSTRIAL TOOLS, GRAND RAPIDS, MI. SN 78-979,651. PUB. 2-27-2007, FILED 11-17-2005.

MAXCRAFT

THE MARK CONSISTS OF STANDARD CHARACTERS WITHOUT CLAIM TO ANY PARTICULAR FONT, STYLE, SIZE, OR COLOR.

FOR HAND TOOLS, NAMELY, SOCKET WRENCHES, SCREWDRIVERS, SCREWDRIVER BITS, PLIERS, PRY BARS, BOLT CUTTERS, CLAMPS, FILES, CHISELS, UTILITY KNIVES, HAND SAWS, METAL CUTTERS, SCRAPERS, KNIVES, ADJUSTABLE WRENCHES, RATCHET WRENCHES, SOCKET WRENCH EXTENSIONS AND EXTENSION BARS; WRENCHES, SCREWDRIVERS, PLIERS, AND HAMMERS; HEX KEY WRENCHES, HAMMERS, TIN SNIPS, WIRE STRIPPERS AND CUTTERS (U.S. CLS. 23, 28 AND 44).
FIRST USE 12-1-2005; IN COMMERCE 12-1-2005.

CLASS 9—ELECTRICAL AND SCIENTIFIC APPARATUS

3,398,839. BULLSEYE TELECOM, INC., SOUTHFIELD, MI. SN 76-061,515. PUB. 3-20-2007, FILED 6-2-2000.

BULLSEYE WEB

NO CLAIM IS MADE TO THE EXCLUSIVE RIGHT TO USE "WEB", APART FROM THE MARK AS SHOWN.

FOR COMPUTER SOFTWARE BUILDING AND CUSTOMIZING WEBSITE APPLICATIONS (U.S. CLS. 21, 23, 26, 36 AND 38).
FIRST USE 1-31-2000; IN COMMERCE 1-31-2000.

CLASS 9—(Continued).

3,398,856. VECTOR PRODUCTS, INC., FT. LAUDERDALE, FL. SN 76-488,618. PUB. 9-23-2003, FILED 2-10-2003.

SSC

FOR AUTOMOTIVE AND MARINE BATTERY JUMP STARTERS (U.S. CLS. 21, 23, 26, 36 AND 38).
FIRST USE 6-10-2004; IN COMMERCE 6-10-2004.

3,398,867. NISSAN JIDOSHA KABUSHIKI KAISHA, TA NISSAN MOTOR CO., LTD., YOKOHAMA-SHI, KANAGAWA-KEN, JAPAN. SN 76-548,123. PUB. 3-15-2005, FILED 9-12-2003.

NISSAN

FOR CONSUMER ELECTRONICS PRODUCTS, NAMELY AUDIO AND VIDEO PLAYERS/ RECORDERS; HEADPHONES, PORTABLE AUDIO PLAYERS/ RECORDERS (U.S. CLS. 21, 23, 26, 36 AND 38).
FIRST USE 6-1-2006; IN COMMERCE 6-1-2006.

3,398,888. LUXPRO CORPORATION, NEIHU DISTRICT, TAIPEI CITY, TAIWAN. SN 76-613,987. PUB. 9-13-2005, FILED 9-30-2004.

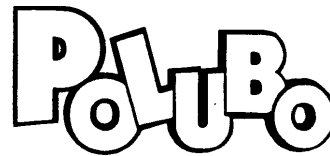

FOR LANGUAGE LEARNING MACHINES, NAMELY, DIGITAL AUDIO PLAYERS CONTAINING STORAGE DEVICE SUCH AS MEMORIES OR HARD DISKS; PORTABLE LISTENING DEVICES, NAMELY, MP3 PLAYERS; ELECTRONIC POCKET DICTIONARIES; ELECTRONIC POCKET TRANSLATORS; ELECTRONIC PERSONAL ORGANIZERS; DIGITAL VIDEO DISC PLAYERS; VCD MACHINES; MUSICAL JUKE BOXES; ELECTRONIC PUBLICATIONS, NAMELY, BOOKS, MAGAZINES AND MANUALS FEATURING LANGUAGE LEARNING, TRAVELLING, NOVELS AND COOKING RECORDED ON COMPUTER MEDIA; STEREO AMPLIFIERS; STEREO RECEIVERS; STEREO TUNERS; TELEVISION SETS; AUDIO CASSETTE RECORDERS; AUDIO TAPE RECORDERS; DIGITAL AUDIO PLAYERS; RADIOS; DIGITAL VIDEO RECORDERS; LOUDSPEAKERS; MICROPHONES (U.S. CLS. 21, 23, 26, 36 AND 38).
FIRST USE 8-14-2007; IN COMMERCE 8-14-2007.

CLASS 9—(Continued).

3,398,899. ENTERTAINMENT PROPERTIES HOLDINGS, LTD., OCEAN RIDGE, FL. SN 76-641,280. PUB. 3-14-2006, FILED 6-20-2005.

LAFFLINK

THE MARK CONSISTS OF STANDARD CHARACTERS WITHOUT CLAIM TO ANY PARTICULAR FONT, STYLE, SIZE, OR COLOR.

FOR DVD'S AND COMPUTER DIGITAL FILES DOWNLOADABLE FROM A WEBSITE FEATURING PRERECORDED COMEDIC PERFORMANCES, COMEDIC VIDEOS, JOKES, FUNNY COMMENTS BY FAMOUS PEOPLE, FUNNY STORIES AND COMEDY INDUSTRY NEWS (U.S. CLS. 21, 23, 26, 36 AND 38).

FIRST USE 8-30-1999; IN COMMERCE 8-30-1999.

3,398,908. WEEKEND WARRIOR PRODUCTIONS L.L.C., DENHAM SPRINGS, LA. SN 76-649,478. PUB. 2-6-2007, FILED 10-31-2005.

WHITETAIL PRO LOG

THE MARK CONSISTS OF STANDARD CHARACTERS WITHOUT CLAIM TO ANY PARTICULAR FONT, STYLE, SIZE, OR COLOR.

NO CLAIM IS MADE TO THE EXCLUSIVE RIGHT TO USE WHITETAIL AND LOG, APART FROM THE MARK AS SHOWN.

FOR COMPUTER SOFTWARE FOR USE IN MANAGEMENT OF WILDLIFE AND GAME (U.S. CLS. 21, 23, 26, 36 AND 38).

FIRST USE 8-5-2006; IN COMMERCE 8-5-2006.

CLASS 9—(Continued).

3,398,912. DIABLOSPORT, LLC, BOCA RATON, FL. SN 76-652,856. PUB. 9-12-2006, FILED 1-4-2006.

MAFIA

OWNER OF U.S. REG. NO. 2,947,507.
FOR ELECTRONIC APPARATUS FOR USE WITH A VEHICLE, NAMELY, AN ELECTRONIC MASS AIR FLOW SENSOR INTERFACE ADAPTER THAT ALLOWS RECALIBRATION AND CONTROL OF OUTPUT SIGNALS FROM THE MASS AIR FLOW SENSOR TO ADJUST AND SUPPORT FORCED INDUCTION TUNING AND OTHER ENGINE AND TRANSMISSION VEHICLE PARAMETERS (U.S. CLS. 21, 23, 26, 36 AND 38).
FIRST USE 8-22-2005; IN COMMERCE 8-0-2007.

3,398,921. VERNIER SOFTWARE & TECHNOLOGY LLC, BEAVERTON, OR. SN 76-659,313. PUB. 3-20-2007, FILED 5-1-2006.

SENSORDAQ

THE MARK CONSISTS OF STANDARD CHARACTERS WITHOUT CLAIM TO ANY PARTICULAR FONT, STYLE, SIZE, OR COLOR.

FOR USB INTERFACE DEVICE TO CONNECT PROBES, SENSORS, METERS, CONTROL UNITS, COUNTERS, AMPLIFIERS, MONITORING DEVICES, ELECTRODES, MOTION DETECTORS, BALANCE DEVICES, AND PHOTOGATES TO A COMPUTER TO RECORD DATA FOR USE IN ELEMENTARY, JUNIOR HIGH SCHOOL, HIGH SCHOOL, AND COLLEGE CLASSROOMS AND LABORATORIES (U.S. CLS. 21, 23, 26, 36 AND 38).

FIRST USE 6-1-2006; IN COMMERCE 2-16-2007.

CLASS 9—(Continued).

3,398,930. TROXLER ELECTRONIC LABORATORIES, INC., RESEARCH TRIANGLE PARK, NC. SN 76-663,961. PUB. 3-27-2007, FILED 8-1-2006.

X MARKS THE SPOT

THE MARK CONSISTS OF STANDARD CHARACTERS WITHOUT CLAIM TO ANY PARTICULAR FONT, STYLE, SIZE, OR COLOR.

FOR ELECTRONIC INSTRUMENTS, NAMELY, ELECTRONIC GAUGES FOR NONDESTRUCTIVE TESTING OF SOIL, ASPHALT, AND CONCRETE; ELECTRONIC INSTRUMENTS, NAMELY, ELECTRONIC GAUGES FOR TESTING SOIL MOISTURE; ELECTRONIC INSTRUMENTS, NAMELY, ELECTRONIC GAUGES FOR TESTING ASPHALT AND CONCRETE DENSITY (U.S. CLS. 21, 23, 26, 36 AND 38).

FIRST USE 12-18-2007; IN COMMERCE 12-18-2007.

3,398,944. LITEL INSTRUMENTS, SAN DIEGO, CA. SN 76-666,540. PUB. 5-1-2007, FILED 9-22-2006.

Hyper NA SMI

THE MARK CONSISTS OF STANDARD CHARACTERS WITHOUT CLAIM TO ANY PARTICULAR FONT, STYLE, SIZE, OR COLOR.

FOR COMPONENTS OF OPTICAL INSTRUMENTS FOR USE IN THE SEMICONDUCTOR INDUSTRY, NAMELY, APPARATUS COMPRISED OF COMPUTER SOFTWARE FOR USE IN ANALYZING DATA RECEIVED FROM AN IMAGE CAPTURE TOOL AND IN-SITU IMAGING OBJECTIVES OF THE PINHOLE, REFRACTIVE OR REFLECTIVE KIND, IN THE SAME FORM FACTOR AS A STANDARD RETICLE FOR USE IN EXPOSING PHOTOGRAPHICALLY PREPARED PATTERNS ON PROJECTION IMAGING SYSTEMS THAT POTENTIALLY OPERATE AT NUMERICAL APERTURES ABOVE ONE, AND IMAGES THAT ARE USED FOR MEASURING AND AIMING TO THE SURFACES OF WAFERS FOR USE IN MANUFACTURING OF INTEGRATED CIRCUITS (U.S. CLS. 21, 23, 26, 36 AND 38).

FIRST USE 1-1-2005; IN COMMERCE 6-1-2005.

CLASS 9—(Continued).

3,398,947. PERSONNEL DATA SYSTEMS, INC., DBA PDS, BLUE BELL, PA. SN 76-667,558. PUB. 5-22-2007, FILED 10-16-2006.

VISTA HRMS

THE MARK CONSISTS OF STANDARD CHARACTERS WITHOUT CLAIM TO ANY PARTICULAR FONT, STYLE, SIZE, OR COLOR.

NO CLAIM IS MADE TO THE EXCLUSIVE RIGHT TO USE "HRMS", APART FROM THE MARK AS SHOWN.

FOR COMPUTER SOFTWARE FOR USE IN HUMAN RESOURCE MANAGEMENT, NAMELY, IN MAINTAINING PERSONNEL AND BENEFITS RECORDS AND IN PROCESSING PAYROLLS (U.S. CLS. 21, 23, 26, 36 AND 38).

FIRST USE 10-31-2007; IN COMMERCE 10-31-2007.

3,398,958. KING TECHNOLOGY OF MISSOURI, INC., O'FALLON, MO. SN 76-673,998. PUB. 9-11-2007, FILED 3-13-2007.

VisiLock

THE MARK CONSISTS OF STANDARD CHARACTERS WITHOUT CLAIM TO ANY PARTICULAR FONT, STYLE, SIZE, OR COLOR.

FOR WATERPROOF ELECTRICAL WIRE CONNECTION SPLICE BOX PRE-FILLED WITH WATERPROOFING SEALANT GEL (U.S. CLS. 21, 23, 26, 36 AND 38).

FIRST USE 4-12-2007; IN COMMERCE 4-12-2007.

3,398,966. HI-TECH ELECTRONIC DISPLAYS, INC., CLEARWATER, FL. SN 77-001,969. PUB. 5-1-2007, FILED 9-19-2006.

LOKNLITE

THE MARK CONSISTS OF STANDARD CHARACTERS WITHOUT CLAIM TO ANY PARTICULAR FONT, STYLE, SIZE, OR COLOR.

FOR LIGHT EMITTING DIODE DISPLAYS (U.S. CLS. 21, 23, 26, 36 AND 38).

FIRST USE 7-17-2007; IN COMMERCE 7-17-2007.

CLASS 9—(Continued).

3,398,974. WEBROOT SOFTWARE, INC., BOULDER, CO. SN 77-004,530. PUB. 5-8-2007, FILED 9-21-2006.



OWNER OF U.S. REG. NO. 2,753,274.
 THE MARK CONSISTS OF STYLIZED MAN, WOMAN AND CHILD FIGURES WITH THE MAN AND WOMAN PROTECTING THE CHILD, ALL INSIDE A CIRCLE.
 FOR COMPUTER SOFTWARE FOR MONITORING THE ACTIVITIES OF A COMPUTER USER, PREVENTING THE EXECUTION OF UNAUTHORIZED PROGRAMS, AND DETERRING ACCESS TO OFFENSIVE CONTENT ON THE INTERNET (U.S. CLS. 21, 23, 26, 36 AND 38).
 FIRST USE 9-15-2006; IN COMMERCE 1-30-2007.

3,398,981. KONAMI GAMING, INC., LAS VEGAS, NV. SN 77-007,170. PUB. 1-23-2007, FILED 9-25-2006.

RUINS OF GOLD

THE MARK CONSISTS OF STANDARD CHARACTERS WITHOUT CLAIM TO ANY PARTICULAR FONT, STYLE, SIZE, OR COLOR.
 OWNER OF U.S. REG. NOS. 2,502,228, 2,973,855, AND OTHERS.
 FOR ELECTRONIC GAME PROGRAMS; GAMING EQUIPMENT, NAMELY, SLOT MACHINES WITH OR WITHOUT VIDEO OUTPUT; GAMING MACHINES; MACHINES FOR PLAYING GAMES OF CHANCE; SLOT MACHINES (U.S. CLS. 21, 23, 26, 36 AND 38).
 FIRST USE 6-3-2005; IN COMMERCE 6-3-2005.

CLASS 9—(Continued).

3,398,982. KONAMI GAMING, INC., LAS VEGAS, NV. SN 77-007,171. PUB. 1-23-2007, FILED 9-25-2006.

SUPER RUINS OF GOLD

THE MARK CONSISTS OF STANDARD CHARACTERS WITHOUT CLAIM TO ANY PARTICULAR FONT, STYLE, SIZE, OR COLOR.
 OWNER OF U.S. REG. NOS. 2,502,228, 2,973,855, AND OTHERS.
 FOR ELECTRONIC GAME PROGRAMS; GAMING EQUIPMENT, NAMELY, SLOT MACHINES WITH OR WITHOUT VIDEO OUTPUT; GAMING MACHINES; MACHINES FOR PLAYING GAMES OF CHANCE; SLOT MACHINES (U.S. CLS. 21, 23, 26, 36 AND 38).
 FIRST USE 10-27-2005; IN COMMERCE 10-27-2005.

3,398,983. KONAMI GAMING, INC., LAS VEGAS, NV. SN 77-007,172. PUB. 1-23-2007, FILED 9-26-2006.

PRIZE CATCH

THE MARK CONSISTS OF STANDARD CHARACTERS WITHOUT CLAIM TO ANY PARTICULAR FONT, STYLE, SIZE, OR COLOR.
 FOR ELECTRONIC GAME PROGRAMS; GAMING EQUIPMENT, NAMELY, SLOT MACHINES WITH OR WITHOUT VIDEO OUTPUT; GAMING MACHINES; MACHINES FOR PLAYING GAMES OF CHANCE; SLOT MACHINES (U.S. CLS. 21, 23, 26, 36 AND 38).
 FIRST USE 12-9-2005; IN COMMERCE 12-9-2005.

3,398,996. SENSOR SWITCH, INC., WALLINGFORD, CT. SN 77-009,600. PUB. 5-8-2007, FILED 9-28-2006.

NLIGHT

THE MARK CONSISTS OF STANDARD CHARACTERS WITHOUT CLAIM TO ANY PARTICULAR FONT, STYLE, SIZE, OR COLOR.
 FOR ELECTRONIC SYSTEM FOR CONTROLLING SENSOR AND LIGHTING CONTROL DEVICES (U.S. CLS. 21, 23, 26, 36 AND 38).
 FIRST USE 5-8-2007; IN COMMERCE 5-8-2007.

CLASS 9—(Continued).

3,399,005. SDI TECHNOLOGIES, INC., RAHWAY, NJ. SN 77-014,272. PUB. 9-11-2007, FILED 10-5-2006.

OUTLOUD

THE MARK CONSISTS OF STANDARD CHARACTERS WITHOUT CLAIM TO ANY PARTICULAR FONT, STYLE, SIZE, OR COLOR.

FOR AUDIO SPEAKER SYSTEMS COMPRISED OF AUDIO SPEAKERS AND AMPLIFIERS (U.S. CLS. 21, 23, 26, 36 AND 38).

FIRST USE 3-0-2007; IN COMMERCE 3-0-2007.

3,399,021. HOSPIRA, INC., LAKE FOREST, IL. SN 77-022,524. PUB. 5-8-2007, FILED 10-17-2006.

HOSPIRA MEDNET INTEGRATOR

THE MARK CONSISTS OF STANDARD CHARACTERS WITHOUT CLAIM TO ANY PARTICULAR FONT, STYLE, SIZE, OR COLOR.

OWNER OF U.S. REG. NO. 3,005,020.

NO CLAIM IS MADE TO THE EXCLUSIVE RIGHT TO USE "INTEGRATOR", APART FROM THE MARK AS SHOWN.

FOR COMPONENT OF COMPUTER SOFTWARE FOR PROVIDING COMMUNICATION OF DATA AMONG MEDICAL DEVICES, NAMELY, MEDICATION ADMINISTRATION DEVICES AND PATIENT MONITORING DEVICES, AND BETWEEN SUCH MEDICAL DEVICES AND COMPUTERS, MONITORS OR COMMUNICATIONS DEVICES IN A HOSPITAL OR IN A LOCATION REMOTE FROM THE HOSPITAL TO MONITOR, MANAGE, SUPPORT VERIFICATION AND DOCUMENTATION OF MEDICATION DELIVERY TO PATIENTS, AND IDENTIFY ANY PROBLEMS THEREWITH (U.S. CLS. 21, 23, 26, 36 AND 38).

FIRST USE 11-16-2007; IN COMMERCE 11-16-2007.

CLASS 9—(Continued).

3,399,025. ADRENALIN GAMING, LLC., LADERA RANCH, CA. SN 77-024,752. PUB. 8-21-2007, FILED 10-19-2006.

JACKPOT IN THE BOX

THE MARK CONSISTS OF STANDARD CHARACTERS WITHOUT CLAIM TO ANY PARTICULAR FONT, STYLE, SIZE, OR COLOR.

FOR GAMING MACHINES, NAMELY, SLOT MACHINES WITH OR WITHOUT VIDEO OUTPUT USED IN A CASINO; ELECTRIC OR ELECTRO-MECHANICAL GAMING TABLES WITH VIDEO OUTPUT USED IN A CASINO (U.S. CLS. 21, 23, 26, 36 AND 38).

FIRST USE 2-1-2005; IN COMMERCE 2-1-2005.

3,399,042. ETERLINK INTERNATIONAL CORPORATION, SACRAMENTO, CA. SN 77-033,680. PUB. 4-17-2007, FILED 10-31-2006.

GEE U

THE MARK CONSISTS OF STANDARD CHARACTERS WITHOUT CLAIM TO ANY PARTICULAR FONT, STYLE, SIZE, OR COLOR.

FOR CASES FOR ELECTRONIC DIARIES; CASES FOR MOBILE PHONES; CASES FOR TELEPHONES; PROTECTIVE CARRYING CASES FOR PORTABLE MUSIC PLAYERS, NAMELY, MP3 PLAYERS (U.S. CLS. 21, 23, 26, 36 AND 38).

FIRST USE 12-2-2007; IN COMMERCE 12-2-2007.

3,399,043. NOVA GAMING, LLC, GREENVILLE, SC. SN 77-033,884. PUB. 5-29-2007, FILED 11-1-2006.

UGP

THE MARK CONSISTS OF STANDARD CHARACTERS WITHOUT CLAIM TO ANY PARTICULAR FONT, STYLE, SIZE, OR COLOR.

FOR COMPUTER PROGRAMS FOR USE WITH GAMING MACHINES (U.S. CLS. 21, 23, 26, 36 AND 38).

FIRST USE 11-14-2006; IN COMMERCE 11-14-2006.

CLASS 9—(Continued).

3,399,048. CADILLAC JACK, INC., DULUTH, GA. SN 77-036,192. PUB. 6-5-2007, FILED 11-3-2006.

JAZZ NIGHTS

THE MARK CONSISTS OF STANDARD CHARACTERS WITHOUT CLAIM TO ANY PARTICULAR FONT, STYLE, SIZE, OR COLOR.
FOR GAMING DEVICES, NAMELY, GAMING MACHINES (U.S. CLS. 21, 23, 26, 36 AND 38).
FIRST USE 1-2-2008; IN COMMERCE 1-2-2008.

3,399,057. AOL LLC, DULLES, VA. SN 77-039,426. PUB. 8-28-2007, FILED 11-8-2006.

BLUESTRING

THE MARK CONSISTS OF STANDARD CHARACTERS WITHOUT CLAIM TO ANY PARTICULAR FONT, STYLE, SIZE, OR COLOR.
FOR DOWNLOADABLE COMPUTER SOFTWARE FOR STORING, ORGANIZING, AND SHARING DATA, INFORMATION, TEXT, IMAGES, GRAPHICS, VIDEOS, MUSIC, ELECTRONIC MAILS (U.S. CLS. 21, 23, 26, 36 AND 38).
FIRST USE 9-17-2007; IN COMMERCE 9-17-2007.

3,399,060. GRIDWAVE RECORDS, INC., SANDWICH, IL. SN 77-040,521. PUB. 6-19-2007, FILED 11-9-2006.

GRIDWAVE RECORDS

THE MARK CONSISTS OF STANDARD CHARACTERS WITHOUT CLAIM TO ANY PARTICULAR FONT, STYLE, SIZE, OR COLOR.
NO CLAIM IS MADE TO THE EXCLUSIVE RIGHT TO USE "RECORDS", APART FROM THE MARK AS SHOWN.
FOR PRERECORDED PHONOGRAPH RECORDS, AUDIO CASSETTE TAPES, COMPACT DISCS, DIGITAL VIDEO DISCS, MP3S, PRERECORDED AUDIO VISUAL RECORDS IN ANALOG DISC AND DIGITAL DISC CONFIGURATIONS, AND ANALOG MAGNETIC TAPE AND DIGITAL MAGNETIC TAPE CONFIGURATIONS, ALL FEATURING MUSIC (U.S. CLS. 21, 23, 26, 36 AND 38).
FIRST USE 7-10-2007; IN COMMERCE 7-13-2007.

CLASS 9—(Continued).

3,399,065. GATEWAY, INC., IRVINE, CA. SN 77-041,848. PUB. 5-22-2007, FILED 11-10-2006.



THE MARK CONSISTS OF THE LETTERS F AND X. THE MARK HAS NO SPECIFIC MEANING OR COLOR.
FOR COMPUTERS AND COMPUTER PERIPHERALS (U.S. CLS. 21, 23, 26, 36 AND 38).
FIRST USE 10-30-2006; IN COMMERCE 10-30-2006.

3,399,069. JUST A MOM MARKETING (JAMM), LLC, WARSON WOODS, MO. SN 77-045,438. PUB. 6-19-2007, FILED 11-16-2006.

THE 3 SQUARES

THE MARK CONSISTS OF STANDARD CHARACTERS WITHOUT CLAIM TO ANY PARTICULAR FONT, STYLE, SIZE, OR COLOR.
FOR PRE-RECORDED DVDS, CDS AND VIDEO TAPES IN THE FIELD OF CHILDREN'S HEALTH, NUTRITION, AND FITNESS (U.S. CLS. 21, 23, 26, 36 AND 38).
FIRST USE 12-0-2006; IN COMMERCE 12-0-2006.

3,399,086. MATSKIV, VICTOR M., WALNUT CREEK, CA. SN 77-053,626. PUB. 7-3-2007, FILED 11-30-2006.

BAREFLOW

THE MARK CONSISTS OF STANDARD CHARACTERS WITHOUT CLAIM TO ANY PARTICULAR FONT, STYLE, SIZE, OR COLOR.
FOR COMPUTER SOFTWARE FOR COMPUTER SYSTEM AND APPLICATION DEVELOPMENT, DEPLOYMENT AND MANAGEMENT (U.S. CLS. 21, 23, 26, 36 AND 38).
FIRST USE 11-24-2007; IN COMMERCE 11-24-2007.

CLASS 9—(Continued).

3,399,094. DESERT DREAMS PRODUCTIONS, LLC, PHOENIX, AZ. SN 77-061,337. PUB. 9-4-2007, FILED 12-11-2006.

TORCH ROCK

THE MARK CONSISTS OF STANDARD CHARACTERS WITHOUT CLAIM TO ANY PARTICULAR FONT, STYLE, SIZE, OR COLOR.

NO CLAIM IS MADE TO THE EXCLUSIVE RIGHT TO USE "ROCK", APART FROM THE MARK AS SHOWN.

FOR MUSICAL ENTERTAINMENT RECORDED ON CARTRIDGES, DISCS, CD-ROMS, CASSETTES, TAPES AND MINI DISCS; VIDEO AND COMPUTER GAME SOFTWARE (U.S. CLS. 21, 23, 26, 36 AND 38).
FIRST USE 9-14-2006; IN COMMERCE 9-14-2006.

CLASS 9—(Continued).

3,399,101. LIN, GUNAG, GREER, SC. SN 77-062,515. PUB. 7-3-2007, FILED 12-12-2006.



Ever Sport

NO CLAIM IS MADE TO THE EXCLUSIVE RIGHT TO USE "SPORT", APART FROM THE MARK AS SHOWN.

THE MARK CONSISTS OF A CIRCLE SPLIT HORIZONTALLY WITH TWO WING TYPE FEATURES IN THE MIDDLE, WITH THE WORDS "EVER SPORT" WRITTEN UNDER THE LOGO.

FOR SUNGLASSES (U.S. CLS. 21, 23, 26, 36 AND 38).
FIRST USE 1-1-2007; IN COMMERCE 1-1-2007.

3,399,102. PHOTODEX CORPORATION, AUSTIN, TX. SN 77-063,009. PUB. 7-10-2007, FILED 12-13-2006.

PROSHOW MEDIASOURCE

THE MARK CONSISTS OF STANDARD CHARACTERS WITHOUT CLAIM TO ANY PARTICULAR FONT, STYLE, SIZE, OR COLOR.

OWNER OF U.S. REG. NO. 2,906,600.
FOR COMPUTER SOFTWARE FOR CREATING AND PLAYING MULTI-MEDIA PRESENTATIONS AND INSTRUCTIONAL MANUALS INCLUDED THEREWITH (U.S. CLS. 21, 23, 26, 36 AND 38).

FIRST USE 1-14-2007; IN COMMERCE 1-14-2007.

3,399,117. DELL INC., ROUND ROCK, TX. SN 77-068,993. PUB. 6-5-2007, FILED 12-20-2006.

VOSTRO

3,399,098. ABOUNDI, INC., NASHUA, NH. SN 77-062,144. PUB. 7-10-2007, FILED 12-12-2006.



NO CLAIM IS MADE TO THE EXCLUSIVE RIGHT TO USE "COMMERCIAL QUALITY", APART FROM THE MARK AS SHOWN.

THE MARK CONSISTS OF A CIRCULAR MEDALLION HAVING THE WORDS "COMMERCIAL QUALITY" AROUND THE PERIMETER WITH AN EAGLE AND THE ABOUNDI LOGO IN THE INTERIOR.

FOR LAN (LOCAL AREA NETWORK) ACCESS POINTS FOR CONNECTING NETWORK COMPUTER USERS; LAN (LOCAL OPERATING NETWORK) HARDWARE (U.S. CLS. 21, 23, 26, 36 AND 38).
FIRST USE 9-1-2007; IN COMMERCE 9-1-2007.

THE MARK CONSISTS OF STANDARD CHARACTERS WITHOUT CLAIM TO ANY PARTICULAR FONT, STYLE, SIZE, OR COLOR.

THE ENGLISH TRANSLATION OF THE WORD "VOSTRO" IN THE MARK IS "YOURS".

FOR COMPUTER HARDWARE, NAMELY, LAPTOP COMPUTERS, NOTEBOOK COMPUTERS, DESK TOP COMPUTERS, PERSONAL COMPUTERS, COMPUTERS (U.S. CLS. 21, 23, 26, 36 AND 38).
FIRST USE 7-31-2007; IN COMMERCE 7-31-2007.

CLASS 9—(Continued).

3,399,127. APPASSURE SOFTWARE, INC., RESTON, VA. SN 77-072,348. PUB. 8-21-2007, FILED 12-28-2006.

REPLAY

THE MARK CONSISTS OF STANDARD CHARACTERS WITHOUT CLAIM TO ANY PARTICULAR FONT, STYLE, SIZE, OR COLOR.

FOR COMPUTER SOFTWARE FOR ENABLING RECOVERY OF COMPUTER APPLICATION DATA AFTER LOSS OF THE DATA (U.S. CLS. 21, 23, 26, 36 AND 38).
FIRST USE 6-1-2007; IN COMMERCE 6-1-2007.

3,399,130. LIN, GUANG, GREER, SC. SN 77-073,312. PUB. 7-3-2007, FILED 12-29-2006.

Ever Sport

FOR CASES FOR SPECTACLES AND SUNGLASSES; FRAMES FOR SPECTACLES AND SUNGLASSES; LENSES FOR SUNGLASSES; SUNGLASS LENSES; SUNGLASSES (U.S. CLS. 21, 23, 26, 36 AND 38).
FIRST USE 1-1-2007; IN COMMERCE 1-1-2007.

3,399,131. WMS GAMING INC., WAUKEGAN, IL. SN 77-074,527. PUB. 5-1-2007, FILED 1-2-2007.

SUPER EASY MONEY

THE MARK CONSISTS OF STANDARD CHARACTERS WITHOUT CLAIM TO ANY PARTICULAR FONT, STYLE, SIZE, OR COLOR.

OWNER OF U.S. REG. NO. 3,004,885.
FOR GAMING MACHINES THAT GENERATE OR DISPLAY WAGER OUTCOMES; GAMING SOFTWARE THAT GENERATES OR DISPLAYS WAGER OUTCOMES OF GAMING MACHINES (U.S. CLS. 21, 23, 26, 36 AND 38).
FIRST USE 8-8-2007; IN COMMERCE 8-8-2007.

CLASS 9—(Continued).

3,399,133. MTS PRODUCTS, SUN VALLEY, CA. SN 77-074,627. PUB. 6-12-2007, FILED 1-2-2007.

MITYX

THE MARK CONSISTS OF STANDARD CHARACTERS WITHOUT CLAIM TO ANY PARTICULAR FONT, STYLE, SIZE, OR COLOR.

FOR COMPUTER OPERATING SYSTEMS; OPERATING SYSTEM PROGRAMS (U.S. CLS. 21, 23, 26, 36 AND 38).

FIRST USE 10-0-2006; IN COMMERCE 10-0-2006.

3,399,134. BAUDTEC CORPORATION, TAIPEI COUNTY, TAIWAN. SN 77-075,750. PUB. 7-31-2007, FILED 1-4-2007.

BAUDTEC

THE MARK CONSISTS OF STANDARD CHARACTERS WITHOUT CLAIM TO ANY PARTICULAR FONT, STYLE, SIZE, OR COLOR.

FOR COMPUTER INTERFACE CARDS, NETWORK COMMUNICATION EQUIPMENT, NAMELY, OPTICAL CABLES, INTERNET PHONES, MODEMS, COMPUTER NETWORK HUBS AND ROUTERS, GATEWAY ROUTERS IN THE NATURE OF COMPUTER CONTROL HARDWARE, NAMELY, FOR TRANSMITTING AND RECEIVING DATA OVER COMPUTER NETWORKS, NAMELY, VOICE OVER INTERNET PROTOCOL, LOCAL AREA NETWORK, WIDE LOCAL AREA NETWORK, VIRTUAL PRIVATE NETWORK, DIGITAL SUBSCRIBER LINE, AND WIRELESS TELECOMMUNICATIONS NETWORKS, POWERLINE ETHERNET ADAPTER, MOBILE MULTIMEDIA VIEWERS IN THE NATURE OF MP3 PLAYER AND MP4 PLAYER, POWER OVER ETHERNET SWITCHES (U.S. CLS. 21, 23, 26, 36 AND 38).

FIRST USE 7-1-2004; IN COMMERCE 12-0-2004.

3,399,140. MARK-10 CORPORATION, COPIAGUE, NY. SN 77-077,827. PUB. 7-24-2007, FILED 1-8-2007.

Mesur

THE MARK CONSISTS OF STANDARD CHARACTERS WITHOUT CLAIM TO ANY PARTICULAR FONT, STYLE, SIZE, OR COLOR.

FOR COMPUTER SOFTWARE FOR THE COLLECTION, EDITING, ORGANIZING, MODIFYING, BOOK MARKING, TRANSMISSION, STORAGE AND SHARING OF DATA AND INFORMATION (U.S. CLS. 21, 23, 26, 36 AND 38).

FIRST USE 10-18-2007; IN COMMERCE 10-18-2007.

CLASS 9—(Continued).

3,399,141. BUYONEERS, LLC, CHANDLER, AZ. SN 77-078,523. PUB. 8-21-2007, FILED 1-9-2007.

CLASS 9—(Continued).

3,399,151. SAMSUNG ELECTRONICS CO., LTD., SUWON-SI, GYEONGGI-DO, REPUBLIC OF KOREA. SN 77-085,013. PUB. 7-31-2007, FILED 1-17-2007.



NO CLAIM IS MADE TO THE EXCLUSIVE RIGHT TO USE "A LIMITED LIABILITY COMPANY", APART FROM THE MARK AS SHOWN.

THE MARK CONSISTS OF THE NAME "BUYONEERS" IN ITALIC FONT. A CIRCLE SURROUNDING A SIDE-VIEW OF THE BUST OF A MAN IN ANTIQUATED ATTIRE, DESIGNED SUCH AS TO GIVE THE IMPRESSION OF A THREE-DIMENSIONAL COIN IS USED IN PLACE OF THE LETTER "O" IN THE AFOREMENTIONED NAME "BUYONEERS". THE PHRASE "A LIMITED LIABILITY COMPANY" APPEARS IN SMALLER LETTERS, RIGHT-ALIGNED UNDER THE AFOREMENTIONED NAME "BUYONEERS".

FOR DIGITAL MATERIALS, NAMELY, CDS, DVDS, DOWNLOADABLE AUDIO AND VIDEO MEDIA FEATURING CLASSICAL MUSIC: PERFORMANCE OR INSTRUCTION (U.S. CLS. 21, 23, 26, 36 AND 38).

FIRST USE 1-1-2007; IN COMMERCE 3-1-2007.

THE WAFER

THE MARK CONSISTS OF STANDARD CHARACTERS WITHOUT CLAIM TO ANY PARTICULAR FONT, STYLE, SIZE, OR COLOR.

FOR MOBILE TELEPHONES (U.S. CLS. 21, 23, 26, 36 AND 38).

FIRST USE 5-3-2007; IN COMMERCE 5-3-2007.

3,399,190. IMAGINE COMMUNICATIONS, INC., CARDIFF-BY-THE-SEA, CA. SN 77-103,057. PUB. 8-14-2007, FILED 2-8-2007.

ICE-Q

THE MARK CONSISTS OF STANDARD CHARACTERS WITHOUT CLAIM TO ANY PARTICULAR FONT, STYLE, SIZE, OR COLOR.

FOR A FEATURE AND CAPABILITY OF DIGITAL VIDEO SOFTWARE AND HARDWARE FOR MEASURING DIGITAL VIDEO QUALITY (U.S. CLS. 21, 23, 26, 36 AND 38).

FIRST USE 11-29-2007; IN COMMERCE 11-29-2007.

3,399,145. BUILD-A-BEAR RETAIL MANAGEMENT, INC., ST. LOUIS, MO. SN 77-081,099. PUB. 6-5-2007, FILED 1-11-2007.

HEART STUFF

THE MARK CONSISTS OF STANDARD CHARACTERS WITHOUT CLAIM TO ANY PARTICULAR FONT, STYLE, SIZE, OR COLOR.

OWNER OF U.S. REG. NO. 2,399,648.

NO CLAIM IS MADE TO THE EXCLUSIVE RIGHT TO USE "HEART", APART FROM THE MARK AS SHOWN.

FOR ELECTRONIC SOUND DEVICE CONTAINING A RECORDED HEART BEAT SOUND FOR PLACEMENT INSIDE A STUFFED OR PLUSH TOY ANIMAL OR DOLL (U.S. CLS. 21, 23, 26, 36 AND 38).

FIRST USE 2-1-2007; IN COMMERCE 2-1-2007.

3,399,191. CLOUD 9 GAMES, INC, AUSTIN, TX. SN 77-103,281. PUB. 8-14-2007, FILED 2-9-2007.

Heavenly Harmony

THE MARK CONSISTS OF STANDARD CHARACTERS WITHOUT CLAIM TO ANY PARTICULAR FONT, STYLE, SIZE, OR COLOR.

FOR COMPUTER GAME SOFTWARE (U.S. CLS. 21, 23, 26, 36 AND 38).

FIRST USE 6-1-2007; IN COMMERCE 6-1-2007.

CLASS 9—(Continued).

3,399,202. ROZIN OPTICAL INTERNATIONAL LLC, MIAMI, FL. SN 77-110,550. PUB. 9-18-2007, FILED 2-19-2007.



NO CLAIM IS MADE TO THE EXCLUSIVE RIGHT TO USE "OCCHIALI", APART FROM THE MARK AS SHOWN. THE ENGLISH TRANSLATION OF "ALPI OCCHIALI" IS ALPS GLASSES. FOR OPTICAL FRAMES (U.S. CLS. 21, 23, 26, 36 AND 38). FIRST USE 9-1-1995; IN COMMERCE 9-1-1995.

3,399,208. HELIO LLC, LOS ANGELES, CA. SN 77-111,826. PUB. 8-14-2007, FILED 2-20-2007.

OCEAN

THE MARK CONSISTS OF STANDARD CHARACTERS WITHOUT CLAIM TO ANY PARTICULAR FONT, STYLE, SIZE, OR COLOR. FOR WIRELESS COMMUNICATION DEVICES, NAMELY, MOBILE HANDSETS IN THE NATURE OF A COMBINATION PERSONAL DIGITAL ASSISTANT, TELEPHONE, CAMERA, GLOBAL POSITIONING AND MAPPING DEVICE, TELEVISION, RADIO, VIDEO AND AUDIO PLAYER AND RECORDER (U.S. CLS. 21, 23, 26, 36 AND 38). FIRST USE 5-11-2007; IN COMMERCE 5-11-2007.

CLASS 9—(Continued).

3,399,241. PEAVEY ELECTRONICS CORPORATION, MERIDIAN, MS. SN 77-128,693. PUB. 9-18-2007, FILED 3-12-2007.

CHERRY BOMB

THE MARK CONSISTS OF STANDARD CHARACTERS WITHOUT CLAIM TO ANY PARTICULAR FONT, STYLE, SIZE, OR COLOR. FOR MICROPHONES (U.S. CLS. 21, 23, 26, 36 AND 38). FIRST USE 1-18-2007; IN COMMERCE 1-18-2007.

3,399,246. MERCURY ENTERPRISES, INC., CLEARWATER, FL. SN 77-130,406. PUB. 8-7-2007, FILED 3-14-2007.

NIFOMETER

THE MARK CONSISTS OF STANDARD CHARACTERS WITHOUT CLAIM TO ANY PARTICULAR FONT, STYLE, SIZE, OR COLOR. FOR NEGATIVE INSPIRATORY FORCE DISPOSABLE MANOMETER (U.S. CLS. 21, 23, 26, 36 AND 38). FIRST USE 11-16-2007; IN COMMERCE 11-16-2007.

3,399,265. COMRENT INTERNATIONAL, LLC, OWINGS, MD. SN 77-143,546. PUB. 9-25-2007, FILED 3-29-2007.

VOLTLOC

THE MARK CONSISTS OF STANDARD CHARACTERS WITHOUT CLAIM TO ANY PARTICULAR FONT, STYLE, SIZE, OR COLOR. FOR PORTABLE MEDIUM VOLTAGE POWER CABLE DEVICES (U.S. CLS. 21, 23, 26, 36 AND 38). FIRST USE 8-1-2007; IN COMMERCE 8-1-2007.

CLASS 9—(Continued).

3,399,273. PLAYFIRST, INC., SAN FRANCISCO, CA. SN 77-147,895. PUB. 8-28-2007, FILED 4-3-2007.

Dream Chronicles

THE MARK CONSISTS OF STANDARD CHARACTERS WITHOUT CLAIM TO ANY PARTICULAR FONT, STYLE, SIZE, OR COLOR.

FOR COMPUTER GAME SOFTWARE; ELECTRONIC GAME SOFTWARE; GAME SOFTWARE; VIDEO GAME SOFTWARE (U.S. CLS. 21, 23, 26, 36 AND 38).

FIRST USE 4-26-2007; IN COMMERCE 4-26-2007.

3,399,281. NAMCO BANDAI GAMES AMERICA INC., SANTA CLARA, CA. SN 77-150,944. PUB. 10-9-2007, FILED 4-6-2007.

ULTIMATE NINJA HEROES

THE MARK CONSISTS OF STANDARD CHARACTERS WITHOUT CLAIM TO ANY PARTICULAR FONT, STYLE, SIZE, OR COLOR.

FOR COMPUTER GAME PROGRAMS; COMPUTER GAME SOFTWARE; INTERACTIVE MULTIMEDIA COMPUTER GAME PROGRAM; INTERACTIVE VIDEO GAME PROGRAMS; VIDEO GAME CARTRIDGES; VIDEO GAME SOFTWARE (U.S. CLS. 21, 23, 26, 36 AND 38).

FIRST USE 8-28-2007; IN COMMERCE 8-28-2007.

3,399,294. INTEC INC., MIAMI, FL. SN 77-165,653. PUB. 8-14-2007, FILED 4-25-2007.

MAX LIVE

THE MARK CONSISTS OF STANDARD CHARACTERS WITHOUT CLAIM TO ANY PARTICULAR FONT, STYLE, SIZE, OR COLOR.

FOR WIRELESS HEADSET INCORPORATING A MICROPHONE FOR USE WITH A COMPUTER GAMING DEVICE, AND EARPHONES (U.S. CLS. 21, 23, 26, 36 AND 38).

FIRST USE 8-17-2004; IN COMMERCE 8-17-2004.

CLASS 9—(Continued).

3,399,298. KLEIN, ELLIOT, NEW YORK, NY. SN 77-184,382. PUB. 10-16-2007, FILED 5-18-2007.

PRIVATAG

THE MARK CONSISTS OF STANDARD CHARACTERS WITHOUT CLAIM TO ANY PARTICULAR FONT, STYLE, SIZE, OR COLOR.

FOR RADIO FREQUENCY IDENTIFICATION (RFID) TAGS DESIGNED TO PROTECT AND OPTIONALLY SHIELD FROM RFID ENERGY FOR AIRLINE BAGGAGE IDENTIFICATION WITH PRIVACY PROTECTION SERVICE FEATURES (U.S. CLS. 21, 23, 26, 36 AND 38).

FIRST USE 4-21-2007; IN COMMERCE 9-18-2007.

3,399,306. SYMANTEC CORPORATION, CUPERTINO, CA. SN 78-183,388. PUB. 1-20-2004, FILED 11-8-2002.

SESA

FOR COMPUTER ANTIVIRUS SOFTWARE; INTERNET SECURITY SOFTWARE; ENTERPRISE SECURITY SOFTWARE; INTRUSION DETECTION SOFTWARE; FIREWALL SOFTWARE; PRIVACY CONTROL SOFTWARE; CONTENT FILTERING SOFTWARE; CLONING SOFTWARE FOR CLONING COMPUTER OPERATING SYSTEMS; COMPUTER SOFTWARE FOR THE CREATION OF A VIRTUAL PRIVATE NETWORK; COMPUTER SOFTWARE AND DOWNLOADABLE COMPUTER SOFTWARE, NAMELY, UTILITY SOFTWARE; COMPUTER UTILITY SOFTWARE FOR REMOVAL OF COMPUTER APPLICATIONS AND SOFTWARE; UTILITY SOFTWARE FOR FACILITATING COMPUTER USE AT REMOTE LOCATIONS AND FOR FACILITATING COMMUNICATIONS AMONG MOBILE USERS OVER NETWORKS; COMPUTER SOFTWARE, NAMELY, MIDDLEWARE FOR INTERFACING CLIENT APPLICATIONS AND NETWORKED OR HOST BASED DATABASES; COMPUTER SOFTWARE AND DOWNLOADABLE COMPUTER SOFTWARE FOR USE IN UPDATING OTHER COMPUTER SOFTWARE; COMPUTER SOFTWARE FOR USE IN NETWORKING APPLICATIONS, NAMELY, COMMUNICATIONS SOFTWARE FOR CONNECTING COMPUTER NETWORK USERS; COMPUTER SOFTWARE FOR SENDING AND RECEIVING FACSIMILE TRANSMISSIONS FROM COMPUTERS AND NOTEBOOK COMPUTERS; COMPUTER SOFTWARE FOR CONNECTING AND MANAGING REMOTE COMPUTERS, FOR SYNCHRONIZATION OF

CLASS 9—(Continued).

FILES THROUGH E-MAIL, FOR PROVIDING SECURITY TO REMOTE COMPUTER USERS, FOR IMPLEMENTING COMPUTER, SOFTWARE AND NETWORK SECURITY MEASURES FOR REMOTE COMPUTER USERS; COMPUTER SOFTWARE FOR FILE MANAGEMENT AND TRANSFER, FOR TELECOMMUTING, FOR FACSIMILE TRANSMISSION, FOR MOBILE COMPUTING AND FOR USE WITH A HOME OR REMOTE OFFICE, NAMELY, FOR REMOTELY ACCESSING OTHER COMPUTER NETWORKS; COMPUTER SOFTWARE AND ELECTRONIC DATABASES RECORDED ON COMPUTER MEDIA FOR USE IN DIAGNOSIS, REPAIR AND CONFIGURATION OF COMPUTERS, COMPUTER SOFTWARE AND COMPUTER PERIPHERALS; USER MANUALS SUPPLIED WITH ALL OF THE FOREGOING; COMPUTER HARDWARE; COMPUTER HARDWARE APPLIANCES THAT PROVIDE FIREWALL, CONTENT FILTERING, INTRUSION ALERT, VIRUS PROTECTION, VIRTUAL PRIVATE NETWORKING AND OTHER SECURITY FUNCTIONS (U.S. CLS. 21, 23, 26, 36 AND 38).

FIRST USE 11-0-2002; IN COMMERCE 11-0-2002.

3,399,308. CATAPHORA, INC., REDWOOD CITY, CA. SN 78-225,416. PUB. 7-20-2004, FILED 3-13-2003.

GET US BEFORE THEY GET YOU

FOR COMPUTER SOFTWARE, NAMELY, SOFTWARE FOR ACCESSING, COLLECTING, STORING, ORGANIZING, AGGREGATING, MANAGING, AND ANALYZING ELECTRONIC DOCUMENTS AND DATA FOR USE IN THE LEGAL FIELD; COMPUTER SOFTWARE, NAMELY, LITIGATION-SUPPORT SOFTWARE FOR USE IN THE LEGAL FIELD; COMPUTER SOFTWARE, NAMELY, SOFTWARE FOR REGULATORY COMPLIANCE MANAGEMENT IN THE LEGAL FIELD; COMPUTER SOFTWARE, NAMELY, SOFTWARE TO CREATE CHARTS, GRAPHS, STATISTICAL SUMMARIES AND DIAGRAMS TO VISUALIZE SEQUENCES OF EVENTS FOR USE IN THE LEGAL FIELD; COMPUTER SOFTWARE, NAMELY, SOFTWARE TO RECONSTRUCT COMPLEX EVIDENCE AND SEQUENCES OF EVENTS FOR USE IN THE LEGAL FIELD; DATABASE MANAGEMENT SOFTWARE; DATABASE MANAGEMENT SOFTWARE FOR USE IN DOCUMENT MANAGEMENT AND KNOWLEDGE MANAGEMENT (U.S. CLS. 21, 23, 26, 36 AND 38).

FIRST USE 10-11-2007; IN COMMERCE 10-11-2007.

3,399,311. VISUAL CHANGES SKIN CARE INTERNATIONAL, INC., FRESNO, CA. SN 78-235,359. PUB. 8-17-2004, FILED 4-8-2003.

VISUAL *Changes*
SKIN CARE INTERNATIONAL

NO CLAIM IS MADE TO THE EXCLUSIVE RIGHT TO USE "SKIN CARE INTERNATIONAL", APART FROM THE MARK AS SHOWN.

FOR PRE-RECORDED ELECTRONIC MEDIA, NAMELY, COMPACT DISCS ON BEAUTY AND MOTIVATIONAL TOPICS (U.S. CLS. 21, 23, 26, 36 AND 38).

FIRST USE 5-31-2004; IN COMMERCE 5-31-2004.

CLASS 9—(Continued).

3,399,312. IP UNITY GLENAYRE, INC., DULUTH, GA. SN 78-239,679. PUB. 3-23-2004, FILED 4-18-2003.

VERSERA ICE

OWNER OF U.S. REG. NO. 2,754,066.

FOR COMPUTER HARDWARE; COMPUTER PERIPHERALS; TELECOMMUNICATIONS HARDWARE, NAMELY, DIGITAL TELEPHONE LINE CARDS, FAX CARDS, NETWORK INTERFACE CARDS, SYSTEM DISCS, DISC CONTROLLERS, BACK-UP STREAMING TAPES, POWER SUPPLIES, MODEMS, ALL FOR USE IN TELEPHONY SYSTEMS, MULTIMEDIA MESSAGING SYSTEMS, VOICE NAVIGATION SYSTEMS, VOICE PORTAL SYSTEMS; COMPUTER PROGRAMS FOR TELEPHONY AND MULTIMEDIA MESSAGING SYSTEMS, NAMELY, FOR PROVIDING CALL ANSWERING, UNIVERSAL MAILBOX, MESSAGE STORE AND FORWARDING AND RETRIEVAL, VIRTUAL TELEPHONY, FAX MESSAGING, TEXT MESSAGING, E-MAIL MESSAGING, VIDEO MESSAGING, SHORT MESSAGE SERVICE, CALL MANAGEMENT, AND INTEGRATED VOICE, FAX, TEXT, E-MAIL AND VIDEO MESSAGING FUNCTIONS; COMPUTER PROGRAMS FOR THE MANAGEMENT AND ANALYSIS OF WIRELESS NETWORKS; COMPUTER PROGRAMS FOR PROVIDING DATA NETWORK ACCESS TO MULTIMEDIA MESSAGING SYSTEMS (U.S. CLS. 21, 23, 26, 36 AND 38).

FIRST USE 2-0-2005; IN COMMERCE 2-0-2005.

3,399,321. SYNCHROPLEX IMAGING SYSTEMS, INC., OVERLAND PARK, KS. SN 78-251,890. PUB. 8-31-2004, FILED 5-20-2003.

SYNCHROPLEX IMAGING SYSTEMS

NO CLAIM IS MADE TO THE EXCLUSIVE RIGHT TO USE "IMAGING SYSTEMS", APART FROM THE MARK AS SHOWN.

FOR COMPUTER SOFTWARE CONTAINED ON CD ROM FOR USE IN CONNECTION WITH TEMPLATES FOR DIGITAL PHOTOGRAPHY (U.S. CLS. 21, 23, 26, 36 AND 38).

FIRST USE 9-14-2004; IN COMMERCE 9-14-2004.

3,399,324. MOTOROLA, INC., LIBERTYVILLE, IL. SN 78-255,958. PUB. 7-27-2004, FILED 5-29-2003.

NEURFON

FOR SENSORS FOR WIRELESS COMMUNICATION, INTEGRATED CIRCUITS, WIRELESS VOICE, DATA AND VIDEO COMMUNICATIONS AND COMPUTER NETWORKING EQUIPMENT, NAMELY, RADIO TRANSMITTERS, RADIO RECEIVERS, RADIO BASE STATIONS, SWITCHES, ROUTERS, CELL SITES, ANTENNAS, RELAYS, COMPUTER SOFTWARE FOR IMPLEMENTING, OPERATING AND CUSTOMIZING VOICE, DISPATCH, DATA AND PAGING COMMUNICATION SYSTEMS, COMPUTER SOFTWARE FOR PROVIDING WIRELESS INTERNET ACCESS FROM COMMUNICATIONS EQUIPMENT AND INFRASTRUCTURE (U.S. CLS. 21, 23, 26, 36 AND 38).

FIRST USE 2-28-2005; IN COMMERCE 2-28-2005.

CLASS 9—(Continued).

3,399,331. ELECTRO SOURCE, LLC, SHERMAN OAKS, CA. SN 78-291,947. PUB. 5-17-2005, FILED 8-25-2003.



FOR COMPUTER CONTROLLER FOR VIDEO GAMES; COMPUTER SOFTWARE FOR USE WITH VIDEO GAMES; STEERING WHEELS FOR VIDEO GAMES; VIDEO GAME CONTROLLER; RACING WHEEL FOR VIDEO GAMES; VIDEO GAME CARTRIDGES; VIDEO GAME DISKS; VIDEO GAME EQUIPMENT CONTAINING MEMORY DEVICES; VIDEO GAME HARDWARE; VIDEO CABLES; VIDEO GAME INTERACTIVE CONTROL FLOOR PADS OR MATS; VIDEO GAME INTERACTIVE REMOTE CONTROL UNITS; VIDEO GAME ACCESSORIES, NAMELY CLEANING KITS, VIDEO GAME HOLDERS AND STANDS, MULTIPLE PLAYER ADAPTERS, RF SWITCH ADAPTERS FOR CONNECTING VIDEO GAME DEVICES TO EXTERNAL MONITORS, VIDEO GAME CD CLEANERS, VIDEO GAME VIBRATION GENERATORS, COMBINATION DVD AND VIDEO GAME CONTROLLERS, SYSTEM SELECTORS FOR SELECTING BETWEEN MULTIPLE SIGNALS, AND VIDEO GAME SOFTWARE, CD'S AND DISKS (U.S. CLS. 21, 23, 26, 36 AND 38).
FIRST USE 11-1-2003; IN COMMERCE 11-1-2003.

3,399,345. SPONSORDIRECT, LLC, TARRYTOWN, NY. SN 78-333,245. PUB. 8-31-2004, FILED 11-25-2003.

GRANTPORT

THE MARK CONSISTS OF STANDARD CHARACTERS WITHOUT CLAIM TO ANY PARTICULAR FONT, STYLE, SIZE, OR COLOR.

FOR COMPUTER SOFTWARE FOR USE IN RECEIVING, SCREENING, RESPONDING TO, MANAGING AND TRACKING UNSOLICITED PHILANTHROPY GRANT PROPOSALS (U.S. CLS. 21, 23, 26, 36 AND 38).
FIRST USE 11-16-2007; IN COMMERCE 11-16-2007.

CLASS 9—(Continued).

3,399,376. AUSTIN, DALLAS, ATLANTA, GA. SN 78-416,241. PUB. 3-1-2005, FILED 5-10-2004.

ROWDY FILMS

THE MARK CONSISTS OF STANDARD CHARACTERS WITHOUT CLAIM TO ANY PARTICULAR FONT, STYLE, SIZE, OR COLOR.

OWNER OF U.S. REG. NO. 2,315,414.
NO CLAIM IS MADE TO THE EXCLUSIVE RIGHT TO USE "FILMS", APART FROM THE MARK AS SHOWN.
FOR MUSICAL SOUND RECORDINGS AND AUDIO-VISUAL RECORDINGS (U.S. CLS. 21, 23, 26, 36 AND 38).
FIRST USE 9-0-2007; IN COMMERCE 9-0-2007.

3,399,385. DISNEY ENTERPRISES, INC., BURBANK, CA. SN 78-458,041. PUB. 9-6-2005, FILED 7-28-2004.

DISNEY FLIX

THE MARK CONSISTS OF STANDARD CHARACTERS WITHOUT CLAIM TO ANY PARTICULAR FONT, STYLE, SIZE, OR COLOR.

NO CLAIM IS MADE TO THE EXCLUSIVE RIGHT TO USE "FLICKS", APART FROM THE MARK AS SHOWN.
FOR CAMCORDERS AND COMPUTER SOFTWARE ENABLING USERS TO CREATE MOVIES (U.S. CLS. 21, 23, 26, 36 AND 38).
FIRST USE 11-29-2007; IN COMMERCE 11-29-2007.

CLASS 9—(Continued).

3,399,415. VANTAGE CONTROLS, INC., OREM, UT. SN 78-506,944. PUB. 8-22-2006, FILED 10-27-2004.

CLASS 9—(Continued).

3,399,424. CYBERSET, LLC, SAN FRANCISCO, CA. SN 78-512,217. PUB. 12-19-2006, FILED 11-5-2004.

THEATREPOINT

THE MARK CONSISTS OF STANDARD CHARACTERS WITHOUT CLAIM TO ANY PARTICULAR FONT, STYLE, SIZE, OR COLOR.

FOR ELECTRICAL AND ELECTRONIC DEVICES, NAMELY, BUILDING AUTOMATION CONTROLLERS, KEYPADS, REMOTE CONTROLS, RS-232 STATIONS, POWER ENCLOSURE HUBS, THERMOSTAT STATIONS, RELAY STATIONS, INPUT STATIONS, OUTPUT STATIONS, INFRA-RED EMITTER STATIONS, DIMMER STATIONS, LCD CONTROL STATIONS, RELAY MODULES, DIMMING MODULES, REMOTE INFRA-RED RECEIVERS, DMX COMMUNICATION STATIONS, WIRELESS TRANSCEIVERS, INTERACTIVE TOUCHSCREEN CONTROLLERS, VIDEO DISPLAY SCREENS FOR HOME AUDIO AND VIDEO DEVICE CONTROL AND MONITORING, AND MODEMS FOR OPERATING BUILDING AUTOMATION SYSTEMS, ENVIRONMENTAL CONDITION SYSTEMS, WATER SYSTEMS, AUDIO SYSTEMS, VIDEO SYSTEMS, TELEPHONE SYSTEMS, INTERCOM SYSTEMS, VIDEO AND BUILDING AMENITIES INCLUDING VIDEO CAMERAS, TELEVISIONS, AUDIO AMPLIFIERS, AND RADIOS; AUDIO SPEAKERS; COMPUTER PROGRAMS FOR BUILDING AUTOMATION SYSTEMS (U.S. CLS. 21, 23, 26, 36 AND 38).

FIRST USE 9-17-2002; IN COMMERCE 9-17-2002.

CYBERSET

THE MARK CONSISTS OF STANDARD CHARACTERS WITHOUT CLAIM TO ANY PARTICULAR FONT, STYLE, SIZE, OR COLOR.

FOR MUSICAL SOUND RECORDINGS; MUSICAL VIDEO RECORDINGS; PRERECORDED AUDIO CASSETTES FEATURING MUSIC; PRERECORDED COMPACT DISCS FEATURING MUSIC; PRERECORDED VIDEO CASSETTES FEATURING MUSIC AND MUSICAL PERFORMANCES; PRERECORDED DVDS FEATURING MUSIC AND MUSICAL PERFORMANCES; COMPUTER FILES CONTAINING ENCODED MUSIC THAT IS DOWNLOADED FROM A REMOTE COMPUTER SITE; DOWNLOADABLE MUSICAL SOUND RECORDINGS; DOWNLOADABLE RING TONES AND MUSIC VIA A GLOBAL COMPUTER NETWORK AND WIRELESS DEVICES; SOUND RECORDINGS FEATURING MUSIC; DOWNLOADABLE VIDEO RECORDINGS FEATURING MUSIC AND MUSIC PERFORMANCES (U.S. CLS. 21, 23, 26, 36 AND 38).

FIRST USE 1-31-2005; IN COMMERCE 1-31-2005.

3,399,422. QUANTUM CORPORATION, SAN JOSE, CA. SN 78-510,625. PUB. 10-4-2005, FILED 11-3-2004.

3,399,432. WMS GAMING INC., WAUKEGAN, IL. SN 78-518,622. PUB. 9-13-2005, FILED 11-17-2004.



OWNER OF U.S. REG. NOS. 2,373,379, 2,864,338, AND 2,864,339.

SEC. 2(F) AS TO "DLT".

FOR COMPUTER TAPE DRIVES, COMPUTER TAPE CARTRIDGES, COMPUTER TAPE CARTRIDGE AUTOLOADERS, COMPUTER TAPE LIBRARIES WITH MULTIPLE COMPUTER DATA DRIVES, MULTIPLE COMPUTER TAPE CARTRIDGES AND AUTOMATIC COMPUTER TAPE CARTRIDGE LOAD/UNLOAD SYSTEMS AND THE SOFTWARE REQUIRED TO OPERATE THE COMPUTER TAPE DRIVES, AUTOLOADERS AND LIBRARIES (U.S. CLS. 21, 23, 26, 36 AND 38).

FIRST USE 6-1-2005; IN COMMERCE 6-1-2005.

STEER CRAZY

THE MARK CONSISTS OF STANDARD CHARACTERS WITHOUT CLAIM TO ANY PARTICULAR FONT, STYLE, SIZE, OR COLOR.

FOR GAMING MACHINES (U.S. CLS. 21, 23, 26, 36 AND 38).

FIRST USE 9-12-2005; IN COMMERCE 9-12-2005.

CLASS 9—(Continued).

3,399,434. I.E.P.C. CORP, HUNTINGTON BEACH, CA. SN 78-519,754. PUB. 1-24-2006, FILED 11-18-2004.

CLASS 9—(Continued).

3,399,443. LUDINGTON TECHNOLOGIES, INC., ESCANABA, MI. SN 78-524,735. PUB. 3-28-2006, FILED 11-30-2004.

VB

THE MARK CONSISTS OF STANDARD CHARACTERS WITHOUT CLAIM TO ANY PARTICULAR FONT, STYLE, SIZE, OR COLOR.

FOR ELECTRICAL CONTROLLERS USED ALONE OR AS COMPONENTS OF LIGHTING CONTROL NETWORKS (U.S. CLS. 21, 23, 26, 36 AND 38).

FIRST USE 10-4-2007; IN COMMERCE 10-4-2007.

PLOW HARD

THE MARK CONSISTS OF STANDARD CHARACTERS WITHOUT CLAIM TO ANY PARTICULAR FONT, STYLE, SIZE, OR COLOR.

NO CLAIM IS MADE TO THE EXCLUSIVE RIGHT TO USE "PLOW", APART FROM THE MARK AS SHOWN.

FOR ELECTRICAL PRODUCTS FOR SNOW REMOVAL AND ROAD TRACTION EQUIPMENT, NAMELY, ELECTRICAL CONNECTORS, ELECTRIC SWITCHES, CIRCUITRY, ELECTRONIC CONTROLS FOR MOTORS AND HYDRAULIC SYSTEMS, CONTROL WIRING FOR ELECTRICAL PUMPS, HYDRAULIC SYSTEMS AND LIGHTING SYSTEMS, LIGHT WIRING HARNESES, LIGHTING ADAPTERS (U.S. CLS. 21, 23, 26, 36 AND 38).

FIRST USE 11-29-2007; IN COMMERCE 11-29-2007.

3,399,442. DATACOLOR HOLDING AG., LUZERN, SWITZERLAND. SN 78-523,502. PUB. 11-14-2006, FILED 11-29-2004.

3,399,447. DOGWATCH INC., NATICK, MA. SN 78-528,190. PUB. 6-19-2007, FILED 12-7-2004.



THE COLOR(S) BLACK, GRAY AND RED IS/ARE CLAIMED AS A FEATURE OF THE MARK.

THE COLOR BLACK APPEARS IN THE "SPYDER" PORTION OF THE MARK. THE COLOR GRAY APPEARS IN THE WORDS "COLORVISION" AND "STUDIO." THE COLOR RED APPEARS IN THE "2PRO" PORTION OF THE MARK.

FOR COLOR MEASURING APPARATUSES, NAMELY, COLORIMETERS AND COLOR MEASURING SOFTWARE FOR COLOR EDITING, COLOR MEASUREMENT AND CALIBRATION OF COMPUTER AND VIDEO DISPLAYS SUCH AS CATHODE RAY TUBE (CRT), LIQUID CRYSTAL DISPLAY (LCD) AND LAPTOP COMPUTER DISPLAYS (U.S. CLS. 21, 23, 26, 36 AND 38).

FIRST USE 9-24-2004; IN COMMERCE 9-24-2004.

**It's All About
Your Dog.**

THE MARK CONSISTS OF STANDARD CHARACTERS WITHOUT CLAIM TO ANY PARTICULAR FONT, STYLE, SIZE, OR COLOR.

NO CLAIM IS MADE TO THE EXCLUSIVE RIGHT TO USE "DOG", APART FROM THE MARK AS SHOWN.

FOR ELECTRONIC PET CONTAINMENT SYSTEMS COMPRISING A TRANSMITTER AND RECEIVER (U.S. CLS. 21, 23, 26, 36 AND 38).

FIRST USE 7-12-2004; IN COMMERCE 7-12-2004.

CLASS 9—(Continued).

3,399,490. FRAUDHALT LTD, DUBLIN 3, IRELAND. SN 78-594,975. PUB. 7-11-2006, FILED 3-25-2005.

CARDSAFE

THE MARK CONSISTS OF STANDARD CHARACTERS WITHOUT CLAIM TO ANY PARTICULAR FONT, STYLE, SIZE, OR COLOR.

FOR ELECTRONIC SYSTEMS FOR VERIFYING HOLOGRAMS, NAMELY, VERIFYING HOLOGRAMS ON CREDIT, DEBIT OR CHARGE CARDS, IDENTIFICATION CARDS, SECURITY CARDS, KEYCARDS OR THE LIKE, AS WELL AS A HOLOGRAM ON A DOCUMENT, SUCH AS A DEED, SECURITY DOCUMENT, LABEL, ADMISSION TICKET, CURRENCY NOTE, LABEL FOR MEDICINE OR A PACKET FOR MEDICINE, OR OTHER SUCH DOCUMENT, LABEL, PACKAGE OR CARD, WITH THE SYSTEM COMPRISED PRIMARILY OF OPTICAL SCANNERS AND OPERATING SOFTWARE THEREFOR (U.S. CLS. 21, 23, 26, 36 AND 38).

FIRST USE 3-1-2004; IN COMMERCE 3-1-2004.

3,399,496. CATERPILLAR INC., PEORIA, IL. SN 78-597,328. PUB. 7-25-2006, FILED 3-29-2005.

PROCEED

THE MARK CONSISTS OF STANDARD CHARACTERS WITHOUT CLAIM TO ANY PARTICULAR FONT, STYLE, SIZE, OR COLOR.

FOR COMPUTER PROGRAMS AND SOFTWARE WHICH APPLY STATISTICAL ANALYSIS, DATA ANALYSIS AND PREDICTIVE ANALYSIS TO SIMULATE, MODEL, PREDICT, AND OPTIMIZE THE OUTCOME OF COMPLEX MANUFACTURING PROCESSES (U.S. CLS. 21, 23, 26, 36 AND 38).

FIRST USE 8-30-2005; IN COMMERCE 8-30-2005.

CLASS 9—(Continued).

3,399,499. PANASAS, INC., FREMONT, CA. SN 78-598,974. PUB. 1-3-2006, FILED 3-31-2005.

ACCELERATING TIME TO RESULTS

THE MARK CONSISTS OF STANDARD CHARACTERS WITHOUT CLAIM TO ANY PARTICULAR FONT, STYLE, SIZE, OR COLOR.

FOR DATA STORAGE DEVICES FOR USE IN A COMPUTER NETWORK, NAMELY, DEVICES CONTAINING DISK DRIVES, PROCESSORS, CACHE MEMORY, CONTROLLERS AND LINKS TO CONNECT THE DEVICES WITH COMPUTER NETWORKS AND SOFTWARE FOR DATA STORAGE DEVICES (U.S. CLS. 21, 23, 26, 36 AND 38).

FIRST USE 0-0-2003; IN COMMERCE 0-0-2003.

3,399,518. SUPERIOR ESSEX COMMUNICATIONS LP, ATLANTA, GA. SN 78-620,091. PUB. 9-5-2006, FILED 4-29-2005.

10G^C

FOR LOCAL AREA NETWORK DATA AND TELECOMMUNICATIONS WIRING SYSTEM COMPRISED OF HIGH-SPEED COPPER ELECTRICAL DATA COMMUNICATIONS CABLES AND ELECTRICAL CONNECTORS (U.S. CLS. 21, 23, 26, 36 AND 38).

FIRST USE 5-0-2005; IN COMMERCE 5-0-2005.

3,399,551. INSIGHT EQUITY A.P.X., LP, DBA VISION-EASE LENS, SOUTHLAKE, TX. SN 78-657,288. PUB. 9-26-2006, FILED 6-23-2005.

THE ULTIMATE EVERYWEAR LENS

THE MARK CONSISTS OF STANDARD CHARACTERS WITHOUT CLAIM TO ANY PARTICULAR FONT, STYLE, SIZE, OR COLOR.

NO CLAIM IS MADE TO THE EXCLUSIVE RIGHT TO USE "ULTIMATE" AND "LENS", APART FROM THE MARK AS SHOWN.

FOR OPHTHALMIC LENSES FOR EYEGASSES (U.S. CLS. 21, 23, 26, 36 AND 38).

FIRST USE 12-0-2005; IN COMMERCE 12-0-2005.

CLASS 9—(Continued).

3,399,567. CABOT SAFETY INTERMEDIATE CORPORATION, NEWARK, DE. SN 78-667,462. PUB. 4-4-2006, FILED 7-11-2005.

SINGULAR

THE MARK CONSISTS OF STANDARD CHARACTERS WITHOUT CLAIM TO ANY PARTICULAR FONT, STYLE, SIZE, OR COLOR.

FOR RESPIRATORS, NAMELY, SAFETY MASK-STYLE RESPIRATORS, RESPIRATOR FILTERS, RESPIRATOR MASK FILTERS AND CARTRIDGES, AND PARTS THEREOF, FOR FILTERING PARTICULATE MATTER ONLY AND NOT FOR ARTIFICIAL RESPIRATION OR FOR USE WITH THERAPEUTIC RESPIRATION EQUIPMENT OR FOR THE TREATMENT OF RESPIRATORY DISEASES OR DISORDERS (U.S. CLS. 21, 23, 26, 36 AND 38).

FIRST USE 10-0-2005; IN COMMERCE 10-0-2005.

3,399,573. INSIGHT EQUITY A.P.X., LP, DBA VISION-EASE LENS, SOUTHLAKE, TX. SN 78-672,507. PUB. 8-29-2006, FILED 7-18-2005.

SUNRX

THE MARK CONSISTS OF STANDARD CHARACTERS WITHOUT CLAIM TO ANY PARTICULAR FONT, STYLE, SIZE, OR COLOR.

OWNER OF U.S. REG. NOS. 1,742,188, 2,569,678, AND OTHERS.

FOR OPHTHALMIC LENSES FOR EYEGLASSES (U.S. CLS. 21, 23, 26, 36 AND 38).

FIRST USE 8-0-1991; IN COMMERCE 8-0-1991.

3,399,587. DENISE N. BOOTHMAN AND GEORGE J. BOOTHMAN, IV PARTNERSHIP, THE, DBA EVERY DAY'S A WIN, PHILADELPHIA, PA. SN 78-682,907. PUB. 4-18-2006, FILED 8-1-2005.

EVERY DAY'S A WIN

THE MARK CONSISTS OF STANDARD CHARACTERS WITHOUT CLAIM TO ANY PARTICULAR FONT, STYLE, SIZE, OR COLOR.

FOR EAR PLUGS FOR SWIMMING (U.S. CLS. 21, 23, 26, 36 AND 38).

FIRST USE 8-1-2007; IN COMMERCE 8-1-2007.

CLASS 9—(Continued).

3,399,589. TEST-UM, INC., CAMARILLO, CA. SN 78-683,705. PUB. 8-15-2006, FILED 8-2-2005.

LANROAMER

THE MARK CONSISTS OF STANDARD CHARACTERS WITHOUT CLAIM TO ANY PARTICULAR FONT, STYLE, SIZE, OR COLOR.

FOR APPARATUS FOR VERIFICATION OF WIRING FAULTS AND CONFIGURATIONS OF DATA CABLES (U.S. CLS. 21, 23, 26, 36 AND 38).

FIRST USE 2-0-2006; IN COMMERCE 2-0-2006.

3,399,593. AUTHENTIDATE HOLDING CORP., BERKELEY HEIGHTS, NJ. SN 78-691,668. PUB. 11-14-2006, FILED 8-12-2005.

AUTHENTIFAX

THE MARK CONSISTS OF STANDARD CHARACTERS WITHOUT CLAIM TO ANY PARTICULAR FONT, STYLE, SIZE, OR COLOR.

FOR DOCUMENT AND DATA MANAGEMENT AND PROCESSING SOFTWARE FOR USE IN AUTHENTICATION, TIME STAMPING AND VERIFICATION OF DOCUMENTS AND DATA FILES, STORAGE, TRANSMISSION AND RETRIEVAL OF DOCUMENTS AND DATA FILES, CONVERSION OF DOCUMENTS INTO ELECTRONIC, MAGNETIC, OPTICAL OR OTHER FORMATS, AND CODING OF DOCUMENTS AND DATA FILES IN THE FIELD OF ELECTRONIC DOCUMENT MANAGEMENT (U.S. CLS. 21, 23, 26, 36 AND 38).

FIRST USE 2-0-2005; IN COMMERCE 2-0-2005.

3,399,605. WMS GAMING INC., WAUKEGAN, IL. SN 78-700,183. PUB. 6-26-2007, FILED 8-25-2005.

GREAT WALL

THE MARK CONSISTS OF STANDARD CHARACTERS WITHOUT CLAIM TO ANY PARTICULAR FONT, STYLE, SIZE, OR COLOR.

FOR GAMING MACHINES (U.S. CLS. 21, 23, 26, 36 AND 38).

FIRST USE 9-12-2005; IN COMMERCE 9-12-2005.

CLASS 9—(Continued).

3,399,618. GUARDID SYSTEMS, INC., SAN MATEO, CA. SN 78-713,043. PUB. 12-26-2006, FILED 9-14-2005.

IDVAULT

THE MARK CONSISTS OF STANDARD CHARACTERS WITHOUT CLAIM TO ANY PARTICULAR FONT, STYLE, SIZE, OR COLOR.

FOR COMPUTER HARDWARE, NAMELY, HAND-HELD DEVICES FOR MAINTAINING ONLINE PASSWORDS AND CONFIDENTIAL INFORMATION (U.S. CLS. 21, 23, 26, 36 AND 38).

FIRST USE 6-6-2006; IN COMMERCE 6-6-2006.

3,399,629. TECHGUARD SECURITY L.L.C., CHESTERFIELD, MO. SN 78-721,671. PUB. 9-12-2006, FILED 9-27-2005.

POLIWALL A CRACKER

THE MARK CONSISTS OF STANDARD CHARACTERS WITHOUT CLAIM TO ANY PARTICULAR FONT, STYLE, SIZE, OR COLOR.

FOR COMPUTER SECURITY PRODUCTS, NAMELY, COMPUTER SOFTWARE AND HARDWARE TO PROVIDE SECURE ACCESS AND TO PREVENT UNAUTHORIZED ACCESS TO COMPUTER NETWORKS AND SYSTEMS, AND USER MANUALS AND TECHNICAL/INSTRUCTIONAL MANUALS SOLD THEREWITH (U.S. CLS. 21, 23, 26, 36 AND 38).

FIRST USE 8-0-2006; IN COMMERCE 8-0-2006.

3,399,633. RADIO SYSTEMS CORPORATION, KNOXVILLE, TN. SN 78-723,340. PUB. 6-6-2006, FILED 9-29-2005.

GLOWGRIP

THE MARK CONSISTS OF STANDARD CHARACTERS WITHOUT CLAIM TO ANY PARTICULAR FONT, STYLE, SIZE, OR COLOR.

FOR HAND-HELD TRANSMITTERS FOR ELECTRONIC ANIMAL CONFINEMENT SYSTEMS AND ELECTRONIC ANIMAL TRAINING SYSTEMS (U.S. CLS. 21, 23, 26, 36 AND 38).

FIRST USE 2-28-2007; IN COMMERCE 2-28-2007.

CLASS 9—(Continued).

3,399,641. MEADWESTVACO CORPORATION, GLEN ALLEN, VA. SN 78-732,261. PUB. 6-13-2006, FILED 10-13-2005.



OWNER OF U.S. REG. NOS. 1,072,214, 2,194,133, AND OTHERS.

FOR PROTECTIVE CARRYING CASES FOR PORTABLE MUSIC PLAYERS NAMELY MP3 PLAYERS; PROTECTIVE CARRYING CASES FOR PERSONAL DIGITAL ASSISTANTS (PDA); CASES FOR MOBILE PHONES; COMPUTER CARRYING CASES (U.S. CLS. 21, 23, 26, 36 AND 38).

FIRST USE 9-16-2007; IN COMMERCE 9-16-2007.

3,399,651. MYSPACE, INC., BEVERLY HILLS, CA. SN 78-738,140. PUB. 6-6-2006, FILED 10-21-2005.

MYSACE RECORDS

THE MARK CONSISTS OF STANDARD CHARACTERS WITHOUT CLAIM TO ANY PARTICULAR FONT, STYLE, SIZE, OR COLOR.

NO CLAIM IS MADE TO THE EXCLUSIVE RIGHT TO USE "RECORDS", APART FROM THE MARK AS SHOWN, FOR PRERECORDED MUSIC ON DVD AND OTHER MEDIA (U.S. CLS. 21, 23, 26, 36 AND 38).

FIRST USE 11-30-2005; IN COMMERCE 11-30-2005.

CLASS 9—(Continued).

3,399,659. KABUSHIKI KAISHA BANDAI, AKA BANDAI CO., LTD., TAITO-KU, JAPAN. SN 78-745,264. PUB. 5-29-2007, FILED 11-2-2005.

GUNPEY

THE MARK CONSISTS OF STANDARD CHARACTERS WITHOUT CLAIM TO ANY PARTICULAR FONT, STYLE, SIZE, OR COLOR.
OWNER OF JAPAN REG. NO. 4408568, DATED 8-11-2000, EXPIRES 8-11-2010.
FOR PRE-RECORDED PROGRAMS FOR GAMES WITH LIQUID CRYSTAL DISPLAYS; COMPUTER PROGRAMS FEATURING STILL IMAGES WITH SOUND, DYNAMIC IMAGES WITH SOUND AND VIDEOS OF DOWNLOADABLE CHARACTERS; HOME COMPUTER GAMES RECORDED ON DISCS (U.S. CLS. 21, 23, 26, 36 AND 38).
FIRST USE 11-14-2006; IN COMMERCE 11-14-2006.

CLASS 9—(Continued).

3,399,667. 3DH COMMUNICATIONS, INC., NORCROSS, GA. SN 78-748,192. PUB. 3-6-2007, FILED 11-7-2005.

HOLOPLAYER

THE MARK CONSISTS OF STANDARD CHARACTERS WITHOUT CLAIM TO ANY PARTICULAR FONT, STYLE, SIZE, OR COLOR.
FOR COMPUTER SOFTWARE FOR GRAPHICAL APPLICATIONS, NAMELY, FOR THE CREATION, DELIVERY, EDITING AND VIEWING OF THREE-DIMENSIONAL MULTIMEDIA (U.S. CLS. 21, 23, 26, 36 AND 38).
FIRST USE 9-1-2006; IN COMMERCE 9-1-2006.

3,399,670. SANSAY, INC., SAN DIEGO, CA. SN 78-748,811. PUB. 7-11-2006, FILED 11-7-2005.

SANSAY

THE MARK CONSISTS OF STANDARD CHARACTERS WITHOUT CLAIM TO ANY PARTICULAR FONT, STYLE, SIZE, OR COLOR.
FOR COMPUTER HARDWARE FOR TELECOMMUNICATIONS AND DATA NETWORKING (U.S. CLS. 21, 23, 26, 36 AND 38).
FIRST USE 12-31-2003; IN COMMERCE 12-31-2003.

3,399,666. 3DH COMMUNICATIONS, INC., NORCROSS, GA. SN 78-748,186. PUB. 3-6-2007, FILED 11-7-2005.

HOLOSTATION

THE MARK CONSISTS OF STANDARD CHARACTERS WITHOUT CLAIM TO ANY PARTICULAR FONT, STYLE, SIZE, OR COLOR.
FOR COMPUTERS, COMPUTER HARDWARE, COMPUTER SOFTWARE PROGRAMS FOR USE IN SCANNING, GENERATING AND DISPLAYING THREE-DIMENSIONAL IMAGERY IN THE FIELDS OF EDUCATION, MARKETING, ADVERTISING, MEDICINE, NATURAL RESOURCES, GAMING, MEDIA PRODUCTION, FAITH BASED INDUSTRIES, TELECOMMUNICATIONS AND BROADCASTING, COMPUTER PERIPHERALS AND USERS MANUALS SOLD AS A UNIT THEREWITH (U.S. CLS. 21, 23, 26, 36 AND 38).
FIRST USE 9-1-2006; IN COMMERCE 9-1-2006.

3,399,673. ROBOTOLZ LIMITED, KWUN TONG, KOWLOON, HONG KONG. SN 78-749,680. PUB. 7-18-2006, FILED 11-8-2005.

EPLANE

THE MARK CONSISTS OF STANDARD CHARACTERS WITHOUT CLAIM TO ANY PARTICULAR FONT, STYLE, SIZE, OR COLOR.
FOR SURVEYING APPARATUS, NAMELY, AN ALIGNMENT TOOL USING A LASER FOR DETERMINING ELEVATION LEVELS (U.S. CLS. 21, 23, 26, 36 AND 38).
FIRST USE 3-0-2006; IN COMMERCE 3-0-2006.

CLASS 9—(Continued).

3,399,697. CHEER APPAREL, LLC, CHARLOTTE, NC. SN 78-761,068. PUB. 9-5-2006, FILED 11-26-2005.

PYRA

THE MARK CONSISTS OF STANDARD CHARACTERS WITHOUT CLAIM TO ANY PARTICULAR FONT, STYLE, SIZE, OR COLOR.

FOR PROTECTIVE APPAREL FOR CHEERLEADING (U.S. CLS. 21, 23, 26, 36 AND 38).

FIRST USE 11-28-2007; IN COMMERCE 11-28-2007.

3,399,705. ZELKOVA, LITHONIA, GA. SN 78-765,296. PUB. 2-6-2007, FILED 12-2-2005.



NO CLAIM IS MADE TO THE EXCLUSIVE RIGHT TO USE "TRAINER", APART FROM THE MARK AS SHOWN.

FOR PRE-RECORDED AUDIO PROGRAMS ON PHONOGRAPH ALBUMS, COMPACT DISCS, PHONOGRAPH RECORDS, AUDIO CASSETTES, MP3, INTEGRATED CIRCUITS, MAGNETIC DATA CARRIERS, AND DIGITAL AUDIO TAPES CONTAINING HEALTH AND FITNESS EXERCISE PROGRAMS; PRE-RECORDED AUDIOVISUAL PROGRAMS ON VIDEO CASSETTES, LASER DISCS, DVDS, AND CD-ROMS CONTAINING HEALTH AND FITNESS EXERCISE PROGRAMS; AND DOWNLOADABLE AUDIO AND VIDEO RECORDINGS CONTAINING HEALTH AND FITNESS EXERCISE PROGRAMS (U.S. CLS. 21, 23, 26, 36 AND 38).

FIRST USE 5-0-2006; IN COMMERCE 5-0-2006.

CLASS 9—(Continued).

3,399,713. GLOBAL NAVIGATION INC., LA VERNE, CA. SN 78-767,564. PUB. 8-8-2006, FILED 12-6-2005.

ENTRADA

THE MARK CONSISTS OF STANDARD CHARACTERS WITHOUT CLAIM TO ANY PARTICULAR FONT, STYLE, SIZE, OR COLOR.

THE ENGLISH TRANSLATION OF "ENTRADA" IS ENTRANCE.

FOR GLOBAL POSITIONING SYSTEM (GPS) CONSISTING OF COMPUTERS, COMPUTER SOFTWARE, TRANSMITTERS, RECEIVERS, AND NETWORK INTERFACE DEVICES; NAVIGATION APPARATUS FOR VEHICLES IN THE NATURE OF ON-BOARD COMPUTERS (U.S. CLS. 21, 23, 26, 36 AND 38).

FIRST USE 6-12-2007; IN COMMERCE 6-12-2007.

3,399,715. LOVEMYPETS, LLC, TAYLORS, SC. SN 78-769,161. PUB. 9-5-2006, FILED 12-8-2005.

LOVEMYPETSGPS

THE MARK CONSISTS OF STANDARD CHARACTERS WITHOUT CLAIM TO ANY PARTICULAR FONT, STYLE, SIZE, OR COLOR.

FOR TRANSMITTER AND RECEIVER USED TO LOCATE LOST PETS; ELECTRONIC ANIMAL TRACKING UNIT COMPRISING TRANSMITTER AND RECEIVER COLLARS (U.S. CLS. 21, 23, 26, 36 AND 38).

FIRST USE 9-18-2007; IN COMMERCE 9-18-2007.

CLASS 9—(Continued).

3,399,716. NEW YORK CENTER FOR COACHING, INC., THE, NEW YORK, NY. SN 78-769,341. PUB. 8-15-2006, FILED 12-8-2005.

STRATEGIC CONVERSATIONS

THE MARK CONSISTS OF STANDARD CHARACTERS WITHOUT CLAIM TO ANY PARTICULAR FONT, STYLE, SIZE, OR COLOR.

NO CLAIM IS MADE TO THE EXCLUSIVE RIGHT TO USE "CONVERSATIONS", APART FROM THE MARK AS SHOWN.

FOR ELECTRONIC PUBLICATIONS, NAMELY, BOOKS FEATURING INTERPERSONAL COMMUNICATION RECORDED ON COMPUTER MEDIA; PRE-RECORDED CDS AND AUDIO RECORDINGS IN THE FIELD OF INTERPERSONAL COMMUNICATION (U.S. CLS. 21, 23, 26, 36 AND 38).
FIRST USE 6-7-2006; IN COMMERCE 6-28-2006.

3,399,732. ENVIRONMENT ONE CORPORATION, NISKAYUNA, NY. SN 78-774,767. PUB. 8-22-2006, FILED 12-16-2005.

E/ONE SENTRY

THE MARK CONSISTS OF STANDARD CHARACTERS WITHOUT CLAIM TO ANY PARTICULAR FONT, STYLE, SIZE, OR COLOR.

OWNER OF U.S. REG. NO. 2,333,343.
FOR INDICATOR AND COMMUNICATION PANEL FOR UTILITY SYSTEM, NAMELY, AN ALARM INDICATOR AND PREDICTIVE STATUS NOTIFIER FOR A GRINDER PUMP STATION OF A LOW PRESSURE SEWER SYSTEM (U.S. CLS. 21, 23, 26, 36 AND 38).
FIRST USE 11-8-2007; IN COMMERCE 11-8-2007.

CLASS 9—(Continued).

3,399,746. CAPTARIS, INC., BELLEVUE, WA. SN 78-780,504. PUB. 10-17-2006, FILED 12-23-2005.

RIGHTFAX

THE MARK CONSISTS OF STANDARD CHARACTERS WITHOUT CLAIM TO ANY PARTICULAR FONT, STYLE, SIZE, OR COLOR.

OWNER OF U.S. REG. NO. 2,578,897.
FOR COMPUTER SOFTWARE FOR ASSEMBLING, PROCESSING, MANAGING, TRANSMITTING AND ARCHIVING OF FACSIMILES; COMPUTER SOFTWARE FOR FACILITATING INTEGRATION OF FAX FUNCTIONALITY WITH EMAIL SYSTEMS, CUSTOMER RELATION MANAGEMENT SYSTEMS, ENTERPRISE RESOURCE PLANNING SYSTEMS, DOCUMENT MANAGEMENT SYSTEMS, CONTENT MANAGEMENT SYSTEMS, DATABASE SYSTEMS, SCANNING, COPY, AND PRINTING SYSTEMS, AND COMPUTER LEGACY SYSTEMS; COMPUTER SOFTWARE FOR FACSIMILE TRANSMISSION VIA FAX DEVICE, EMAIL AND INTERNET DELIVERY; COMPUTER SOFTWARE FOR SECURE DELIVERY OF ELECTRONIC DOCUMENTS (U.S. CLS. 21, 23, 26, 36 AND 38).
FIRST USE 5-12-1997; IN COMMERCE 5-12-1997.

3,399,748. MERIT INDUSTRIES, INC., BENSALEM, PA. SN 78-781,475. PUB. 4-10-2007, FILED 12-28-2005.

MoD • BoX
INTERNET • JUKEBOX

NO CLAIM IS MADE TO THE EXCLUSIVE RIGHT TO USE "INTERNET JUKEBOX", APART FROM THE MARK AS SHOWN.

THE MARK CONSISTS OF AN OVAL BETWEEN THE WORDING "MOD BOX" ABOVE THE WORDING "INTERNET JUKEBOX" AND A CIRCLE BETWEEN THE WORDING "INTERNET" AND "JUKEBOX".

FOR DIGITAL JUKE BOXES, VIDEO TOUCH SCREENS AND VIDEO DISPLAY MONITORS (U.S. CLS. 21, 23, 26, 36 AND 38).
FIRST USE 1-19-2006; IN COMMERCE 1-19-2006.

3,399,755. VISION TECH AMERICA, INC., MOUNTAIN VIEW, CA. SN 78-782,626. PUB. 1-2-2007, FILED 12-29-2005.

BOYO
VISION

CLASS 9—(Continued).

NO CLAIM IS MADE TO THE EXCLUSIVE RIGHT TO USE "VISION", APART FROM THE MARK AS SHOWN.

THE MARK CONSISTS OF THE TERM "BOYO" WHICH IS IN LARGE CAPITAL LETTERS. THE "O'S" OF "BOYO" EACH HAVE A DOT INSIDE THEM. THE "O'S" AND THE "Y" ARE INTENDED TO FORM EYES WITH A NOSE. UNDER THE "Y" IS THE TERM "VISION".

FOR MOBILE ELECTRONICS SYSTEMS, NAMELY, MOBILE COMPUTERS, MOBILE RADIOS, MOBILE TELEPHONES; ELECTRONIC NAVIGATIONAL DEVICES, NAMELY, WIRELESS TELEPHONY APPARATUS AND GLOBAL POSITIONING SYSTEM (GPS) CONSISTING OF COMPUTER SOFTWARE FOR NAVIGATION AND NAVIGATIONAL RECEIVERS; AUTOMOBILE BACKUP VIEW SYSTEMS CONSISTING OF VIDEO CAMERAS, VIDEO MONITORS, AND ELECTRICAL CONTROLLERS (U.S. CLS. 21, 23, 26, 36 AND 38).

FIRST USE 12-1-2005; IN COMMERCE 12-1-2005.

3,399,771. WEISS INSTRUMENTS, INC., HOLTSVILLE, NY. SN 78-791,457. PUB. 4-3-2007, FILED 1-13-2006.



The logo for Solar MetriX features the word "Solar" in a stylized, italicized font above the word "MetriX", which is in a larger, bold, italicized font. A horizontal line is positioned above the "Solar" text.

NO CLAIM IS MADE TO THE EXCLUSIVE RIGHT TO USE "SOLAR", APART FROM THE MARK AS SHOWN.

FOR THERMOMETERS AND PRESSURE GAUGES (U.S. CLS. 21, 23, 26, 36 AND 38).

FIRST USE 2-0-2007; IN COMMERCE 2-0-2007.

3,399,781. QUADSYSTEMS, SUSSEX, WI. SN 78-794,952. PUB. 9-12-2006, FILED 1-19-2006.

QUADSYSTEMS

THE MARK CONSISTS OF STANDARD CHARACTERS WITHOUT CLAIM TO ANY PARTICULAR FONT, STYLE, SIZE, OR COLOR.

OWNER OF U.S. REG. NOS. 1,434,317, 2,569,525, AND OTHERS.

FOR COMPUTER SOFTWARE IN THE FIELD OF PRINT PRODUCTION, GRAPHIC DESIGN, PREPRESS LAYOUT AND COMMERCIAL PRINTING (U.S. CLS. 21, 23, 26, 36 AND 38).

FIRST USE 9-0-2005; IN COMMERCE 10-0-2007.

CLASS 9—(Continued).

3,399,794. ROCKFORD CORPORATION, TEMPE, AZ. SN 78-798,472. PUB. 8-22-2006, FILED 1-24-2006.

ROCKFORD ACOUSTIC DESIGN

THE MARK CONSISTS OF STANDARD CHARACTERS WITHOUT CLAIM TO ANY PARTICULAR FONT, STYLE, SIZE, OR COLOR.

OWNER OF U.S. REG. NOS. 1,216,478, 2,679,953, AND 2,840,359.

NO CLAIM IS MADE TO THE EXCLUSIVE RIGHT TO USE "ACOUSTIC DESIGN", APART FROM THE MARK AS SHOWN.

FOR AUDIO EQUIPMENT, NAMELY STEREOS, CD PLAYERS, MP3 PLAYERS, RADIOS, AUDIO SPEAKERS, WOOFERS, SUBWOOFERS, SPEAKER ENCLOSURES, SPEAKER HOUSINGS, AMPLIFIERS, POWER AMPLIFIERS, PREAMPLIFIERS, EQUALIZERS, CROSSOVERS, SIGNAL PROCESSORS, ACCESSORIES FOR AUDIO EQUIPMENT (U.S. CLS. 21, 23, 26, 36 AND 38).

FIRST USE 8-1-2006; IN COMMERCE 8-1-2006.

3,399,795. ROCKFORD CORPORATION, TEMPE, AZ. SN 78-798,474. PUB. 8-22-2006, FILED 1-24-2006.



The logo for Rockford Acoustic Design features the word "ROCKFORD" in a bold, sans-serif font above the words "ACOUSTIC DESIGN" in a smaller, sans-serif font. A stylized graphic element resembling a speaker or sound wave is positioned to the left of the text.

OWNER OF U.S. REG. NOS. 1,216,478, 2,679,953, AND 2,840,359.

NO CLAIM IS MADE TO THE EXCLUSIVE RIGHT TO USE "ACOUSTIC DESIGN", APART FROM THE MARK AS SHOWN.

FOR AUDIO EQUIPMENT, NAMELY STEREOS, CD PLAYERS, MP3 PLAYERS, RADIOS, AUDIO SPEAKERS, WOOFERS, SUBWOOFERS, SPEAKER ENCLOSURES, SPEAKER HOUSINGS, AMPLIFIERS, POWER AMPLIFIERS, PREAMPLIFIERS, EQUALIZERS, CROSSOVERS, SIGNAL PROCESSORS, ACCESSORIES FOR AUDIO EQUIPMENT (U.S. CLS. 21, 23, 26, 36 AND 38).

FIRST USE 8-1-2006; IN COMMERCE 8-1-2006.

3,399,801. SPINWAVE SYSTEMS, INC., WESTFORD, MA. SN 78-799,710. PUB. 4-17-2007, FILED 1-26-2006.

SPINWAVE

THE MARK CONSISTS OF STANDARD CHARACTERS WITHOUT CLAIM TO ANY PARTICULAR FONT, STYLE, SIZE, OR COLOR.

FOR ELECTRONIC COMMUNICATIONS INSTRUMENTS AND COMPONENTS, NAMELY, A WIRELESS SENSOR NETWORKING SYSTEM OF SENSORS AND LOW-POWER, SHORT-DISTANCE WIRELESS COMMUNICATIONS HARDWARE AND SOFTWARE USED TO PROPAGATE SENSOR DATA AND CONTROL ACTUATORS (U.S. CLS. 21, 23, 26, 36 AND 38).

FIRST USE 1-28-2007; IN COMMERCE 2-23-2007.

CLASS 9—(Continued).

3,399,807. TYCO ELECTRONICS CORPORATION, MIDDLE-TOWN, PA. SN 78-802,651. PUB. 10-10-2006, FILED 1-30-2006.

CLASS 9—(Continued).

3,399,834. MTS MEDICATION TECHNOLOGIES, INC., ST. PETERSBURG, FL. SN 78-813,666. PUB. 5-15-2007, FILED 2-13-2006.

LIGHT-N-LOK

MEDTIMES

THE MARK CONSISTS OF STANDARD CHARACTERS WITHOUT CLAIM TO ANY PARTICULAR FONT, STYLE, SIZE, OR COLOR.

FOR ELECTRICAL CONNECTORS FOR BALLASTS IN FLUORESCENT LIGHTING FIXTURES (U.S. CLS. 21, 23, 26, 36 AND 38).

FIRST USE 10-31-2007; IN COMMERCE 10-31-2007.

THE MARK CONSISTS OF STANDARD CHARACTERS WITHOUT CLAIM TO ANY PARTICULAR FONT, STYLE, SIZE, OR COLOR.

FOR COMPUTER WORKSTATION FOR MANAGEMENT AND SECURE ACCESS TO MEDICATION, CONSISTING OF COMPUTER HARDWARE, COMPUTER SOFTWARE, AND AN ELECTRONIC STORAGE UNIT; COMPUTER SOFTWARE, NAMELY, SOFTWARE FOR TRACKING, DELIVERY, IDENTIFICATION, STORAGE, ADMINISTERING, AUDITING, REPORTING AND MANAGEMENT OF MEDICATION; COMPUTER SOFTWARE, NAMELY, SOFTWARE FOR MANAGEMENT AND SECURE STORAGE OF INFORMATION RELATING TO MEDICINE, PATIENTS, DOCTORS, PHARMACIES AND HEALTH CARE FACILITIES (U.S. CLS. 21, 23, 26, 36 AND 38).

FIRST USE 8-19-2003; IN COMMERCE 8-19-2003.

3,399,817. NEC ELECTRONICS CORPORATION, KANAGAWA, JAPAN. SN 78-806,248. PUB. 10-31-2006, FILED 2-3-2006.

3,399,839. ROCKET GAMING SYSTEMS, LLC, LAS VEGAS, NV. SN 78-814,928. PUB. 5-1-2007, FILED 2-14-2006.

All Flash

BURSTING BALLOONS

THE MARK CONSISTS OF STANDARD CHARACTERS WITHOUT CLAIM TO ANY PARTICULAR FONT, STYLE, SIZE, OR COLOR.

NO CLAIM IS MADE TO THE EXCLUSIVE RIGHT TO USE "FLASH", APART FROM THE MARK AS SHOWN.

FOR SEMICONDUCTORS, INTEGRATED CIRCUITS, MICROCONTROLLERS, FLASH MICROCONTROLLERS, COMPUTER MEMORIES, NAMELY, FLASH MEMORIES, READY ONLY MEMORIES (ROMS), RANDOM ACCESS MEMORIES (RAMS) (U.S. CLS. 21, 23, 26, 36 AND 38).

FIRST USE 2-14-2006; IN COMMERCE 2-14-2006.

THE MARK CONSISTS OF STANDARD CHARACTERS WITHOUT CLAIM TO ANY PARTICULAR FONT, STYLE, SIZE, OR COLOR.

FOR GAMING MACHINES, NAMELY, BINGO-RELATED GAMES AND SLOT MACHINES (U.S. CLS. 21, 23, 26, 36 AND 38).

FIRST USE 11-13-2007; IN COMMERCE 11-13-2007.

CLASS 9—(Continued).

3,399,841. ARISTOCRAT TECHNOLOGIES AUSTRALIA PTY LTD, LANE COVE, NEW SOUTH WALES, AUSTRALIA. SN 78-816,879. PUB. 9-12-2006, FILED 2-16-2006.

TIKI TALK

THE MARK CONSISTS OF STANDARD CHARACTERS WITHOUT CLAIM TO ANY PARTICULAR FONT, STYLE, SIZE, OR COLOR.

FOR GAMING DEVICES, NAMELY, GAMING MACHINES AND COMPUTER SOFTWARE USED THEREWITH TO ENABLE THE GAMING MACHINE TO RUN (U.S. CLS. 21, 23, 26, 36 AND 38).

FIRST USE 9-6-2007; IN COMMERCE 9-6-2007.

CLASS 9—(Continued).

3,399,884. LEVITON MANUFACTURING CO., INC., LITTLE NECK, NY. SN 78-832,731. PUB. 3-27-2007, FILED 3-8-2006.

LEVITON ARCHITECTURAL EDITION

THE MARK CONSISTS OF STANDARD CHARACTERS WITHOUT CLAIM TO ANY PARTICULAR FONT, STYLE, SIZE, OR COLOR.

OWNER OF U.S. REG. NOS. 1,892,953, 2,795,564, AND OTHERS.

NO CLAIM IS MADE TO THE EXCLUSIVE RIGHT TO USE "ARCHITECTURAL EDITION", APART FROM THE MARK AS SHOWN.

FOR LOUDSPEAKERS; VOLUME CONTROLS; SUBWOOFERS; AUDIO/VIDEO RECEIVERS; CD PLAYERS; DVD PLAYERS; DIGITAL MEDIA PLAYERS; HOME THEATER SYSTEMS AND MULTI-ROOM MUSIC SYSTEMS COMPRISING AUDIO-VIDEO ELECTRONIC COMPONENTS, NAMELY, SUBWOOFERS, AUDIO/VIDEO RECEIVERS, CD PLAYERS, DVD PLAYERS AND DIGITAL MEDIA PLAYERS; INSTALLATION ACCESSORIES SOLD AS A UNIT WITH THE AFOREMENTIONED SOUND EQUIPMENT, NAMELY, BRACKETS, DISTRIBUTION MODULES, WALL PLATES (U.S. CLS. 21, 23, 26, 36 AND 38).

FIRST USE 7-19-2006; IN COMMERCE 8-1-2006.

3,399,868. ERGODYNE CORPORATION, ST. PAUL, MN. SN 78-827,021. PUB. 10-10-2006, FILED 3-2-2006.

CORE. PERFORMANCE WORKWEAR

THE MARK CONSISTS OF STANDARD CHARACTERS WITHOUT CLAIM TO ANY PARTICULAR FONT, STYLE, SIZE, OR COLOR.

NO CLAIM IS MADE TO THE EXCLUSIVE RIGHT TO USE "WORKWEAR", APART FROM THE MARK AS SHOWN.

FOR PROTECTIVE CLOTHING (U.S. CLS. 21, 23, 26, 36 AND 38).

FIRST USE 11-17-2007; IN COMMERCE 11-17-2007.

3,399,885. MICROSOFT CORPORATION, REDMOND, WA. SN 78-832,853. PUB. 1-2-2007, FILED 3-8-2006.

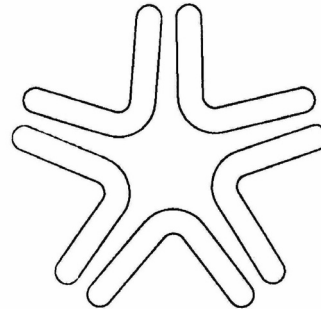

FOR HOUSE MARK FOR A FULL LINE OF COMPUTER SOFTWARE (U.S. CLS. 21, 23, 26, 36 AND 38).

FIRST USE 3-0-2006; IN COMMERCE 3-0-2006.

CLASS 9—(Continued).

3,399,891. SPIELO MANUFACTURING ULC, MONCTON, NEW BRUNSWICK, CANADA. SN 78-836,838. PUB. 9-19-2006, FILED 3-14-2006.

TREASURE MOUNTAIN KENO

THE MARK CONSISTS OF STANDARD CHARACTERS WITHOUT CLAIM TO ANY PARTICULAR FONT, STYLE, SIZE, OR COLOR.

NO CLAIM IS MADE TO THE EXCLUSIVE RIGHT TO USE "KENO", APART FROM THE MARK AS SHOWN.

FOR RECONFIGURABLE CASINO AND LOTTERY GAMING EQUIPMENT, NAMELY, SLOT MACHINES, AND OPERATIONAL COMPUTER GAME SOFTWARE THEREFOR (U.S. CLS. 21, 23, 26, 36 AND 38).

FIRST USE 9-4-2006; IN COMMERCE 9-4-2006.

3,399,900. GARMIN LTD., GEORGE TOWN, CAYMAN ISLANDS. SN 78-842,295. PUB. 2-27-2007, FILED 3-21-2006.



OWNER OF U.S. REG. NOS. 2,949,731 AND 3,107,462.

NO CLAIM IS MADE TO THE EXCLUSIVE RIGHT TO USE "GPS LOCK", APART FROM THE MARK AS SHOWN.

FOR THEFT DETERRENT SOFTWARE SOLD AS A COMPONENT OF GLOBAL POSITIONING SYSTEM (GPS) UNITS (U.S. CLS. 21, 23, 26, 36 AND 38).

FIRST USE 5-0-2006; IN COMMERCE 5-0-2006.

3,399,911. HADALA, ANTHONY J., BRECKSVILLE, OH. SN 78-847,998. PUB. 4-24-2007, FILED 3-28-2006.

KEG STRIP

THE MARK CONSISTS OF STANDARD CHARACTERS WITHOUT CLAIM TO ANY PARTICULAR FONT, STYLE,

CLASS 9—(Continued).

SIZE, OR COLOR.

OWNER OF U.S. REG. NO. 2,772,602.

NO CLAIM IS MADE TO THE EXCLUSIVE RIGHT TO USE "KEG", APART FROM THE MARK AS SHOWN.

FOR LIQUID LEVEL SENSORS (U.S. CLS. 21, 23, 26, 36 AND 38).

FIRST USE 1-7-2008; IN COMMERCE 1-7-2008.

3,399,913. GE HEALTHCARE BIOSCIENCE BIOPROCESS CORP., PISCATAWAY, NJ. SN 78-850,025. PUB. 9-19-2006, FILED 3-30-2006.

WAVEPOD

THE MARK CONSISTS OF STANDARD CHARACTERS WITHOUT CLAIM TO ANY PARTICULAR FONT, STYLE, SIZE, OR COLOR.

FOR LABORATORY EQUIPMENT, NAMELY, LABORATORY INSTRUMENTS FOR MEASURING AND CONTROLLING CELL AND FERMENTATION BIOREACTORS; LABORATORY INSTRUMENTS FOR MEASURING AND CONTROLLING CELL AND FERMENTATION BIOREACTORS FOR USE IN THE PHARMACEUTICAL AND CHEMICAL INDUSTRIES; APPARATUS FOR CELL CULTURE FOR LABORATORY AND INDUSTRIAL USE, NAMELY, INSTRUMENTS FOR MEASURING AND CONTROLLING CELL AND FERMENTATION BIOREACTORS; ELECTRONIC TEST AND MEASUREMENT DEVICES FOR USE IN THE PHARMACEUTICAL AND CHEMICAL INDUSTRIES, NAMELY, INSTRUMENTATION USED TO MEASURE AND CONTROL CELL AND FERMENTATION BIOREACTORS; TOOL MEASURING INSTRUMENTS; COMPUTER-CONTROLLED ELECTRONIC APPARATUS FOR ELECTROPHYSIOLOGICAL MEASUREMENT AND TESTING OF CELLS; ELECTRONIC APPARATUS FOR ELECTROPHYSIOLOGICAL MEASUREMENT AND TESTING OF CELLS (U.S. CLS. 21, 23, 26, 36 AND 38).

FIRST USE 4-16-2007; IN COMMERCE 4-16-2007.

3,399,923. SCHOLASTIC INC., NEW YORK, NY. SN 78-854,624. PUB. 11-21-2006, FILED 4-5-2006.

PIRATE REVENGE

THE MARK CONSISTS OF STANDARD CHARACTERS WITHOUT CLAIM TO ANY PARTICULAR FONT, STYLE, SIZE, OR COLOR.

FOR PRERECORDED CD-ROMS, VIDEOS AND INTERACTIVE MULTIMEDIA COMPUTER GAME SOFTWARE FOR CHILDREN (U.S. CLS. 21, 23, 26, 36 AND 38).

FIRST USE 11-1-2006; IN COMMERCE 11-1-2006.

CLASS 9—(Continued).

3,399,924. SCHOLASTIC INC., NEW YORK, NY. SN 78-855,374. PUB. 11-21-2006, FILED 4-6-2006.

OUT OF TIME

THE MARK CONSISTS OF STANDARD CHARACTERS WITHOUT CLAIM TO ANY PARTICULAR FONT, STYLE, SIZE, OR COLOR.

FOR PRERECORDED CD-ROMS, VIDEOS AND INTERACTIVE MULTIMEDIA COMPUTER GAME SOFTWARE FOR CHILDREN (U.S. CLS. 21, 23, 26, 36 AND 38).
FIRST USE 11-1-2006; IN COMMERCE 11-1-2006.

3,399,928. IMARKET SERVICES, LLC, SANTA MONICA, CA. SN 78-857,045. PUB. 2-13-2007, FILED 4-7-2006.



FOR DOWNLOADABLE AUDIO AND VIDEO MATERIALS ON THE INTERNET, NAMELY, LIVE AND PRERECORDED DOWNLOADABLE SOUND RECORDINGS AND VIDEO CLIPS FEATURING COMEDY MATERIAL FOR ENTERTAINMENT PURPOSES (U.S. CLS. 21, 23, 26, 36 AND 38).

FIRST USE 2-24-2006; IN COMMERCE 2-24-2006.

3,399,936. ID INTERACTIVE LLC, DELRAY BEACH, OH. SN 78-859,503. PUB. 11-21-2006, FILED 4-12-2006.

MUSIC FOR TUNES

THE MARK CONSISTS OF STANDARD CHARACTERS WITHOUT CLAIM TO ANY PARTICULAR FONT, STYLE, SIZE, OR COLOR.

FOR GAMING MACHINES, NAMELY, DEVICES WHICH ACCEPT A WAGER, AND COMPUTER SOFTWARE ASSOCIATED THEREWITH (U.S. CLS. 21, 23, 26, 36 AND 38).

FIRST USE 3-21-2006; IN COMMERCE 11-8-2006.

CLASS 9—(Continued).

3,399,952. MULTIMEDIA GAMES, INC., AUSTIN, TX. SN 78-867,112. PUB. 5-1-2007, FILED 4-21-2006.

Royal Crown Jewels

THE MARK CONSISTS OF STANDARD CHARACTERS WITHOUT CLAIM TO ANY PARTICULAR FONT, STYLE, SIZE, OR COLOR.

OWNER OF U.S. REG. NOS. 2,521,216 AND 2,769,429.
FOR GAMING MACHINES, NAMELY, ELECTRONIC SLOT AND BINGO MACHINES; VIDEO LOTTERY TERMINALS (U.S. CLS. 21, 23, 26, 36 AND 38).
FIRST USE 9-1-2006; IN COMMERCE 9-1-2006.

3,399,957. INNOVATI, INC., HSINCHU, TAIWAN. SN 78-870,757. PUB. 6-26-2007, FILED 4-27-2006.



FOR MICROCOMPUTERS; MICRO-PROCESSORS; CENTRAL PROCESSING UNITS (CPU); MICROPROCESSORS, COMPUTER HARDWARE; PERSONAL COMPUTER; ELECTRIC DATA PROCESSOR; COMPUTERS; DISC MEMORIES; COMPUTER PROGRAMS FOR WORD PROCESSING AND THE SOFTWARE IS FILED-SPECIFIC FOR USE IN INTEGRATED DEVELOPMENT ENVIRONMENT OF MICROCONTROLLER-BASED SYSTEMS; COMPUTER SOFTWARE FOR WORD PROCESSING AND THE SOFTWARE IS FILED-SPECIFIC FOR USE IN INTEGRATED DEVELOPMENT ENVIRONMENT OF MICROCONTROLLER-BASED SYSTEMS; COMPUTER SOFTWARE FOR WORD PROCESSING AND THE SOFTWARE IS FILED-SPECIFIC FOR USE IN INTEGRATED DEVELOPMENT ENVIRONMENT OF MICROCONTROLLER-BASED SYSTEMS AND MAY BE DOWNLOADED FROM A GLOBAL COMPUTER NETWORK; COMPUTER SOFTWARE PLATFORMS FOR ROBOTICS CONTROL FOR MICROCONTROLLER-

CLASS 9—(Continued).

BASED SYSTEMS; COMPUTER FIRMWARE FOR ROBOTICS USE IN CONTROL AND COMMUNICATION OF MICROCONTROLLER-BASED SYSTEMS; PROGRAM WRITER, NAMELY, PROGRAM WRITER IS AN APPARATUS TO WRITE MACHINE CODE INTO THE MICROCONTROLLER UNIT FOR CONTROLLING ROBOTICS; PROGRAMMING MACHINE, NAMELY, PROGRAM MACHINE IS AN APPARATUS TO WRITE MACHINE CODE INTO THE MICROCONTROLLER UNIT FOR CONTROLLING ROBOTICS; MICRO-PROCESSOR EMULATOR, NAMELY, MICRO-PROCESSOR EMULATOR IS A HARDWARE UNIT TO SIMULATE THE ROBOTICS' BEHAVIORS ACCORDING TO USER'S PROGRAM; MICRO-COMPUTER SIMULATOR, NAMELY, MICRO-COMPUTER SIMULATOR IS JUST A SOFTWARE UTILITY TO VIRTUALLY SIMULATE THE ROBOTICS' BEHAVIORS ACCORDING TO USER'S PROGRAM; READ-ONLY DISC MEMORIES; READ-ONLY COMPUTER MEMORIES; FLOATING-POINT COMPUTER CHIP; INTEGRATED CIRCUIT BOARD (U.S. CLS. 21, 23, 26, 36 AND 38).

FIRST USE 10-30-2007; IN COMMERCE 10-30-2007.

3,399,971. SIERRA NEVADA CORPORATION, SPARKS, NV.
SN 78-878,465. PUB. 7-31-2007, FILED 5-8-2006.

Combat Controller

THE MARK CONSISTS OF STANDARD CHARACTERS WITHOUT CLAIM TO ANY PARTICULAR FONT, STYLE, SIZE, OR COLOR.

FOR HANDHELD REMOTE CONTROL INTERFACE FOR REMOTE NAVIGATION OF HANDHELD COMPUTER TO BE USED IN CONJUNCTION WITH HELMET-MOUNTED HEADS-UP LCD DISPLAY (U.S. CLS. 21, 23, 26, 36 AND 38).

FIRST USE 9-7-2004; IN COMMERCE 9-7-2004.

3,399,972. SIERRA NEVADA CORPORATION, SPARKS, NV.
SN 78-878,541. PUB. 8-21-2007, FILED 5-8-2006.

TACTISIGHT

THE MARK CONSISTS OF STANDARD CHARACTERS WITHOUT CLAIM TO ANY PARTICULAR FONT, STYLE, SIZE, OR COLOR.

THE WORDING "TACTISIGHT" HAS NO MEANING IN A FOREIGN LANGUAGE.

FOR TACTICAL INFORMATION SYSTEM CONSISTING OF A HELMET-MOUNTED HIGH RANGE COLOR CAMERA FOR CAPTURING VIDEO AND STILL IMAGERY, HAND-HELD COMPUTER, AND A LCD DISPLAY CAPABLE OF DISPLAYING COMPUTER DISPLAYS OR VIDEOS FROM THE CAMERA, WHICH ARE ATTACHABLE TO A HELMET OR THE BODY (U.S. CLS. 21, 23, 26, 36 AND 38).

FIRST USE 3-1-2004; IN COMMERCE 3-1-2004.

CLASS 9—(Continued).

3,399,981. ETRIAL COMMUNICATIONS, INC., DENVER, CO. SN 78-888,077. PUB. 7-17-2007, FILED 5-19-2006.



THE MARK CONSISTS OF A LYNX EMERGING FROM A CD-ROM, WHICH IS EMERGING FROM A SERIES OF JEWEL CASES.

FOR COMPUTER SOFTWARE FOR ASSISTANCE IN LITIGATION AND PREPARATION OF TRIAL AND APPELLATE BRIEFS; COMPUTER SOFTWARE FOR ASSISTANCE IN LITIGATION AND PREPARATION OF TRIAL AND APPELLATE BRIEFS THAT MAY BE DOWNLOADED FROM A GLOBAL COMPUTER NETWORK (U.S. CLS. 21, 23, 26, 36 AND 38).

FIRST USE 7-1-2006; IN COMMERCE 7-1-2006.

3,399,982. BARMATE LIMITED, WHETSTONE, LONDON, UNITED KINGDOM. SN 78-889,717. PUB. 5-22-2007, FILED 5-23-2006.

BARMATE

THE MARK CONSISTS OF STANDARD CHARACTERS WITHOUT CLAIM TO ANY PARTICULAR FONT, STYLE, SIZE, OR COLOR.

FOR REAL-TIME LOCATION SYSTEM COMPRISING COMPUTER HARDWARE AND COMPUTER SOFTWARE FOR USE IN DETERMINING THE PHYSICAL LOCATION OF CUSTOMERS REQUIRING FOOD AND BEVERAGE SERVICE IN THE FOOD AND BEVERAGE AND HOSPITALITY INDUSTRY (U.S. CLS. 21, 23, 26, 36 AND 38).

FIRST USE 10-12-2007; IN COMMERCE 10-12-2007.

CLASS 9—(Continued).

3,399,983. HYNIX SEMICONDUCTOR INC., KYOUNGKI-DO, REPUBLIC OF KOREA. SN 78-890,437. PUB. 4-3-2007, FILED 5-23-2006.



OWNER OF U.S. REG. NO. 1,432,737.
FOR AUDIO MIXERS, AUDIO AMPLIFIERS, AUDIO PROCESSING EQUIPMENT, NAMELY LIMITERS AND COMPRESSORS; AUDIO SPEAKERS, SPEAKERS FOR COMPUTERS, CDMA (CODE DIVISION MULTIPLE ACCESS) PHONES, GSM (GLOBAL SYSTEM FOR MOBILE COMMUNICATIONS) PHONES, DMB (DIGITAL MULTIMEDIA BROADCASTING) PHONES; CD PLAYERS; VCD (VIDEO COMPACT DISK) PLAYERS; DVD PLAYERS; SATELLITE RECEIVERS; CRT (CATHODE-RAY TUBE) TV'S, LCD (LIQUID CRYSTAL DISPLAY) TV'S, PDP (PLASMA DISPLAY PANEL) TV, TELEVISION APPARATUS FOR PROJECTION PURPOSES; BATTERIES; FAX MACHINES; MP3 PLAYERS; GLOBAL POSITIONING SYSTEM (GPS) CONSISTING OF COMPUTERS, COMPUTER SOFTWARE, TRANSMITTERS, RECEIVERS, AND NETWORK INTERFACE DEVICES; CAMERAS, DIGITAL CAMERAS; CAR NAVIGATION COMPUTERS, NAVIGATION APPARATUS FOR VEHICLES IN THE NATURE OF ON-BOARD COMPUTERS, TV RECEIVERS; TV PROMPTER; VIDEO GAME MACHINES FOR USE WITH TELEVISION; TV SATELLITE BROADCASTING RECEIVERS; DMB (DIGITAL MULTIMEDIA BROADCASTING) RECEIVERS; PHOTO-TELEGRAPHY APPARATUS; MOVIE PROJECTORS, MULTIMEDIA PROJECTORS, VIDEO PROJECTORS, LIQUID CRYSTAL DISPLAY (LCD) PROJECTORS; VIDEO GAME INTERACTIVE HAND HELD REMOTE CONTROLS FOR PLAYING ELECTRONIC GAMES; PMP (PORTABLE MULTIMEDIA PLAYER); DIGITAL DOOR LOCKS, ELECTRIC OR ELECTRONIC DOOR OPENERS AND ELECTRONIC DOOR CLOSING SYSTEMS; HOME AUTOMATION SYSTEM COMPRISING COMPUTERS, OPERATING SOFTWARE, VIDEO CAMERAS, LIGHTING CONTROL PANELS, LIGHTING CONTROL SOFTWARE FOR HOME BANKING, HOME SECURITY AND HOME LIGHTING AND COOLING, VIDEO MONITOR TO DOOR CAMERA, AUDIO OR VIDEO INTERCOM, ACCESS CONTROL AND ALARM MONITORING SYSTEMS, TELEVISIONS AND PHONES FOR KITCHEN (U.S. CLS. 21, 23, 26, 36 AND 38).

FIRST USE 12-21-2006; IN COMMERCE 12-21-2006.

CLASS 9—(Continued).

3,399,985. GAMETECH INTERNATIONAL, INC., RENO, NV. SN 78-891,268. PUB. 1-2-2007, FILED 5-24-2006.

GAMBLERS EDGE POKER

THE MARK CONSISTS OF STANDARD CHARACTERS WITHOUT CLAIM TO ANY PARTICULAR FONT, STYLE, SIZE, OR COLOR.

NO CLAIM IS MADE TO THE EXCLUSIVE RIGHT TO USE "GAMBLERS" AND "POKER", APART FROM THE MARK AS SHOWN.

FOR GAMING EQUIPMENT, NAMELY, VIDEO POKER GAME MACHINES (U.S. CLS. 21, 23, 26, 36 AND 38).

FIRST USE 6-8-2007; IN COMMERCE 6-8-2007.

3,399,987. HARRIS CORPORATION, MELBOURNE, FL. SN 78-892,695. PUB. 12-19-2006, FILED 5-25-2006.

FIREFISH

THE MARK CONSISTS OF STANDARD CHARACTERS WITHOUT CLAIM TO ANY PARTICULAR FONT, STYLE, SIZE, OR COLOR.

FOR COMPUTER SOFTWARE, NAMELY, APPLICATION SOFTWARE FOR EXTRACTING INFORMATION FROM CELLULAR TELEPHONES AND CELLULAR TELEPHONE SIM CARDS (U.S. CLS. 21, 23, 26, 36 AND 38).

FIRST USE 6-19-2007; IN COMMERCE 6-19-2007.

3,399,990. VONAGE MARKETING INC., HOLMDEL, NJ. SN 78-893,098. PUB. 6-5-2007, FILED 5-25-2006.

VONAGE TALK

THE MARK CONSISTS OF STANDARD CHARACTERS WITHOUT CLAIM TO ANY PARTICULAR FONT, STYLE, SIZE, OR COLOR.

OWNER OF U.S. REG. NOS. 2,614,773, 2,804,958, AND 2,848,258.

NO CLAIM IS MADE TO THE EXCLUSIVE RIGHT TO USE "TALK", APART FROM THE MARK AS SHOWN.

FOR COMPUTER TELEPHONY SOFTWARE, NAMELY, SOFTWARE APPLICATION FOR ESTABLISHING AND PERFORMING PHONE CALLS OVER A VARIETY OF NETWORKS IN THE NATURE OF THE INTERNET (U.S. CLS. 21, 23, 26, 36 AND 38).

FIRST USE 7-10-2007; IN COMMERCE 7-10-2007.

CLASS 9—(Continued).

3,399,994. SPIELO MANUFACTURING ULC, MONCTON, NEW BRUNSWICK, CANADA. SN 78-898,218. PUB. 9-12-2006, FILED 6-1-2006.

LAND OF THE WILD

THE MARK CONSISTS OF STANDARD CHARACTERS WITHOUT CLAIM TO ANY PARTICULAR FONT, STYLE, SIZE, OR COLOR.

FOR RECONFIGURABLE CASINO AND LOTTERY GAMING EQUIPMENT, NAMELY, SLOT MACHINES, AND OPERATIONAL COMPUTER GAME SOFTWARE THEREFOR (U.S. CLS. 21, 23, 26, 36 AND 38).

FIRST USE 9-12-2007; IN COMMERCE 9-12-2007.

3,399,997. SANGAMENT, INC., WESTBURY, NY. SN 78-899,191. PUB. 4-10-2007, FILED 6-2-2006.

DJ REKHA

THE MARK CONSISTS OF STANDARD CHARACTERS WITHOUT CLAIM TO ANY PARTICULAR FONT, STYLE, SIZE, OR COLOR.

NO CLAIM IS MADE TO THE EXCLUSIVE RIGHT TO USE "DJ", APART FROM THE MARK AS SHOWN.

THE NAME(S), PORTRAIT(S), AND/OR SIGNATURE(S) SHOWN IN THE MARK IDENTIFIES "REKHA" MALHOTRA A/K/A "DJ REKHA", WHOSE CONSENT(S) TO REGISTER IS SUBMITTED.

FOR AUDIO RECORDINGS FEATURING MUSIC; DOWNLOADABLE MUSICAL SOUND RECORDINGS; DOWNLOADABLE RING TONES, GRAPHICS AND MUSIC VIA A GLOBAL COMPUTER NETWORK AND WIRELESS DEVICES; DOWNLOADABLE VIDEO RECORDINGS FEATURING MUSIC; MUSICAL SOUND RECORDINGS; MUSICAL VIDEO RECORDINGS; PHONOGRAPH RECORD SLEEVES; PHONOGRAPH RECORDS FEATURING MUSIC; PLASTIC AND CARDBOARD CASES FOR STORING RECORD ALBUMS; PRE-RECORDED CD'S, VIDEO TAPES, LASER DISKS AND DVD'S FEATURING MUSIC; VIDEO RECORDINGS FEATURING MUSIC; VISUAL RECORDINGS AND AUDIO VISUAL RECORDINGS FEATURING MUSIC AND ANIMATION (U.S. CLS. 21, 23, 26, 36 AND 38).

FIRST USE 1-10-1996; IN COMMERCE 9-25-2007.

CLASS 9—(Continued).

3,399,999. LEAPFROG ENTERPRISES, INC., EMERYVILLE, CA. SN 78-902,163. PUB. 8-7-2007, FILED 6-6-2006.

BIG LEAP

THE MARK CONSISTS OF STANDARD CHARACTERS WITHOUT CLAIM TO ANY PARTICULAR FONT, STYLE, SIZE, OR COLOR.

OWNER OF U.S. REG. NOS. 2,705,238, 2,798,129, AND OTHERS.

FOR EDUCATIONAL KITS COMPRISED PRIMARILY OF PRERECORDED AUDIO AND VIDEO COMPACT DISCS AND CASSETTES, BOOKS, CARDS, PUZZLES MADE OF PAPER AND CARDBOARD, INSTRUCTIONAL MANUALS, POSTERS, ELECTRONIC AND INTERACTIVE MULTIPLE ACTIVITY TOYS, ELECTRONIC AND INTERACTIVE PLUSH TOYS, ELECTRONIC COLORING AND READING TOYS, HAND HELD UNIT FOR PLAYING ELECTRONIC GAMES, MAGNETIC LETTERS AND NUMBERS, MAGNETIC READING GAMES, MAGNETIC SPELLING GAMES AND MAGNETIC MATH GAMES, ELECTRONIC EDUCATIONAL GAME MACHINES FOR CHILDREN, BATTERY-OPERATED LEARNING UNITS AND BATTERY POWERED GAME UNITS IN THE NATURE OF EDUCATIONAL GAME MACHINES AND PRINTED MATTER, NAMELY, PRINTED GUIDES FOR TEACHERS AND CLASSROOM USE, BOOKS AND FLASH CARDS ALL IN THE FIELDS OF AN FOR TEACHING CHILDREN READING, MATH, PHONICS, SPELLING AND LANGUAGE ARTS ALL SOLD AS A UNIT (U.S. CLS. 21, 23, 26, 36 AND 38).

FIRST USE 4-30-2006; IN COMMERCE 4-30-2006.

3,400,001. KABUSHIKI KAISHA BANPRESTO (BANPRESTO CO., LTD.), SHINAGAWA-KU, TOKYO, JAPAN. SN 78-902,438. PUB. 4-3-2007, FILED 6-7-2006.

SWORDCRAFT STORY

THE MARK CONSISTS OF STANDARD CHARACTERS WITHOUT CLAIM TO ANY PARTICULAR FONT, STYLE, SIZE, OR COLOR.

NO CLAIM IS MADE TO THE EXCLUSIVE RIGHT TO USE "STORY", APART FROM THE MARK AS SHOWN.

FOR COMPUTER GAME SOFTWARE, NAMELY VIDEO GAME CARTRIDGE (U.S. CLS. 21, 23, 26, 36 AND 38).

FIRST USE 4-25-2003; IN COMMERCE 7-25-2006.

CLASS 9—(Continued).

3,400,020. VOLK OPTICAL INC., MENTOR, OH. SN 78-914,327. PUB. 9-11-2007, FILED 6-22-2006.

OPTIFLEX

THE MARK CONSISTS OF STANDARD CHARACTERS WITHOUT CLAIM TO ANY PARTICULAR FONT, STYLE, SIZE, OR COLOR.

FOR ELECTROMECHANICAL DEVICE, NAMELY, A TENSION-CONTROLLED MECHANICAL ARM FOR HOLDING, MOVING AND POSITIONING OPHTHALMIC LENSES (U.S. CLS. 21, 23, 26, 36 AND 38).

FIRST USE 3-30-2007; IN COMMERCE 3-30-2007.

3,400,021. COMMONWEALTH EDISON COMPANY, CHICAGO, IL. SN 78-914,667. PUB. 4-17-2007, FILED 6-22-2006.

DC IN A BOX

THE MARK CONSISTS OF STANDARD CHARACTERS WITHOUT CLAIM TO ANY PARTICULAR FONT, STYLE, SIZE, OR COLOR.

NO CLAIM IS MADE TO THE EXCLUSIVE RIGHT TO USE "DC", APART FROM THE MARK AS SHOWN.

FOR ELECTRICAL SUBSTATIONS (U.S. CLS. 21, 23, 26, 36 AND 38).

FIRST USE 12-1-2003; IN COMMERCE 4-1-2005.

3,400,023. LASER TECHNOLOGY, INC., ENGLEWOOD, CO. AND KAMA-TECH, HK LTD., TSIM SHA TSUI, HONG KONG. SN 78-915,265. PUB. 5-1-2007, FILED 6-23-2006.

TRUSPEED

THE MARK CONSISTS OF STANDARD CHARACTERS WITHOUT CLAIM TO ANY PARTICULAR FONT, STYLE, SIZE, OR COLOR.

FOR LASER SPEED GUNS USED TO MEASURE SPEED AND DISTANCE (U.S. CLS. 21, 23, 26, 36 AND 38).

FIRST USE 10-13-2007; IN COMMERCE 10-13-2007.

CLASS 9—(Continued).

3,400,028. STATICOFF, LLC, SOUTH PORTLAND, ME. SN 78-918,725. PUB. 5-8-2007, FILED 6-28-2006.

STATICOFF

THE MARK CONSISTS OF STANDARD CHARACTERS WITHOUT CLAIM TO ANY PARTICULAR FONT, STYLE, SIZE, OR COLOR.

FOR ELECTROSTATIC DISCHARGE DEVICE FOR PREVENTING ELECTRICAL SHOCK (U.S. CLS. 21, 23, 26, 36 AND 38).

FIRST USE 5-19-2006; IN COMMERCE 12-11-2007.

3,400,042. AUSTHINK SOFTWARE PTY LTD, CARLTON, VICTORIA, AUSTRALIA. SN 78-923,171. PUB. 4-17-2007, FILED 7-6-2006.

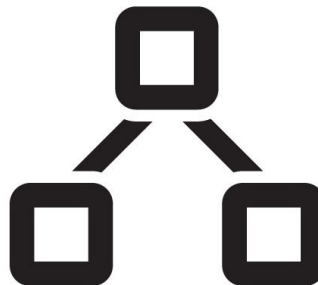

THE MARK CONSISTS OF THREE SQUARES WITH ROUNDED CORNERS IN AN TRIANGLE ARRANGEMENT. THERE ARE STRAIGHT LINES BETWEEN THE BOTTOM OF THE SQUARE AT THE APEX OF THE TRIANGLE AND THE TOP OF THE SQUARES AT THE FOOT OF THE TRIANGLE. THESE LINES DO NOT TOUCH THE SQUARE AT THE APEX OR THE SQUARES BELOW.

FOR COMPUTER SOFTWARE AND PROGRAMS FOR USE IN THE VISUAL REPRESENTATION, MANIPULATION AND EVALUATION OF IDEA CONCEPTUAL RELATIONSHIPS, ARGUMENT AND ARGUMENT STRUCTURES FOR USE IN EDUCATION, BUSINESS, GOVERNMENT AND FOR PERSONAL USE; COMPUTER SOFTWARE FOR THE CREATION AND MANIPULATION OF GROUPING, IDEA, CONCEPT, MIND AND ARGUMENT MAPS FOR USE IN EDUCATION, BUSINESS, GOVERNMENT AND FOR PERSONAL USE (U.S. CLS. 21, 23, 26, 36 AND 38).

FIRST USE 7-19-2006; IN COMMERCE 8-31-2006.

CLASS 9—(Continued).

3,400,043. KIOSK INFORMATION SYSTEMS, INC., LOUISVILLE, CO. SN 78-923,824. PUB. 8-28-2007, FILED 7-6-2006.

ZAZOOX

THE MARK CONSISTS OF STANDARD CHARACTERS WITHOUT CLAIM TO ANY PARTICULAR FONT, STYLE, SIZE, OR COLOR.

FOR INTERACTIVE COMPUTER SYSTEMS COMPRISED OF SELF-SERVICE TERMINALS AND GAMING STATIONS, FEATURING INPUT DEVICES NAMELY, CREDIT CARD READERS, CLUB CARD READERS, BILL ACCEPTORS, COIN ACCEPTORS, BILL AND COIN RECYCLERS, KEYBOARD INPUT, BAR CODE SCANNER, PAYMENT ENGINE AND RELATED SOFTWARE FOR A VARIETY OF PAYMENT METHODS INCLUDING CASH, CREDIT, DEBIT, VOUCHER OR PREPAID ACCOUNTS FOR VARIOUS APPLICATIONS, NAMELY VIDEO DOWNLOAD AND PRE-VIEWING, MUSIC DOWNLOAD AND PREVIEWING, ONLINE AMUSEMENT GAMING, INTERNET ACCESS, EMAIL, VIDEO EMAIL, DIGITAL PHOTO PROCESSING, CELL PHONE RING TONE AND OTHER CONTENT DELIVERY, NAMELY, GAMES, AUDIO BOOKS, MOVIES, VIDEOS, AND TELEVISION SHOWS, VOICE OVER INTERNET PROTOCOL USAGE (VOIP), BILL PAYMENT, ON-LINE SHOPPING, MOVIE RENTAL AND VIEWING, TV RENTAL AND VIEWING AND OTHER ONLINE OR INTERNET APPLICATIONS, NAMELY PC GAMES (U.S. CLS. 21, 23, 26, 36 AND 38).

FIRST USE 12-18-2006; IN COMMERCE 12-18-2006.

3,400,044. PAXIOM, INC., MONTREAL, CANADA. SN 78-925,030. PUB. 9-4-2007, FILED 7-7-2006.

High Dream

THE MARK CONSISTS OF STANDARD CHARACTERS WITHOUT CLAIM TO ANY PARTICULAR FONT, STYLE, SIZE, OR COLOR.

FOR WEIGHING EQUIPMENT, NAMELY, SCALES AND BALANCES (U.S. CLS. 21, 23, 26, 36 AND 38).

FIRST USE 1-1-2005; IN COMMERCE 1-1-2005.

3,400,064. GREGORY ENTERPRISES, INC., GARLAND, TX. SN 78-937,020. PUB. 3-27-2007, FILED 7-25-2006.

RAM JACK

CLASS 9—(Continued).

THE MARK CONSISTS OF STANDARD CHARACTERS WITHOUT CLAIM TO ANY PARTICULAR FONT, STYLE, SIZE, OR COLOR.

OWNER OF U.S. REG. NOS. 1,539,595 AND 1,592,360.
FOR COMPUTER SOFTWARE FOR USE IN FOUNDATION DESIGN AND DETERMINING PIER AND PILE CAPACITY (U.S. CLS. 21, 23, 26, 36 AND 38).
FIRST USE 8-28-2007; IN COMMERCE 8-28-2007.

3,400,073. CHECKPOINT SYSTEMS, INC., THOROFARE, NJ. SN 78-939,827. PUB. 3-13-2007, FILED 7-28-2006.

VisiPlus

THE MARK CONSISTS OF STANDARD CHARACTERS WITHOUT CLAIM TO ANY PARTICULAR FONT, STYLE, SIZE, OR COLOR.

FOR OPTICAL SENSOR TO MEASURE TRAFFIC COUNTS IN RETAIL ENVIRONMENTS (U.S. CLS. 21, 23, 26, 36 AND 38).

FIRST USE 5-30-2006; IN COMMERCE 6-5-2006.

3,400,077. PRIME WIRE & CABLE, INC., LOS ANGELES, CA. SN 78-941,691. PUB. 3-6-2007, FILED 7-31-2006.

QUICK FLIP

THE MARK CONSISTS OF STANDARD CHARACTERS WITHOUT CLAIM TO ANY PARTICULAR FONT, STYLE, SIZE, OR COLOR.

FOR ELECTRICAL EXTENSION CORDS (U.S. CLS. 21, 23, 26, 36 AND 38).

FIRST USE 9-30-2006; IN COMMERCE 9-30-2006.

3,400,084. SURVIVAL ARMOR, INC., FORT MYERS, FL. SN 78-944,831. PUB. 3-6-2007, FILED 8-4-2006.

VISIBALLISTICS

THE MARK CONSISTS OF STANDARD CHARACTERS WITHOUT CLAIM TO ANY PARTICULAR FONT, STYLE, SIZE, OR COLOR.

FOR BULLET-PROOF VESTS (U.S. CLS. 21, 23, 26, 36 AND 38).

FIRST USE 4-26-2007; IN COMMERCE 4-26-2007.

CLASS 9—(Continued).

3,400,085. SURVIVAL ARMOR, INC., FORT MYERS, FL. SN 78-944,845. PUB. 3-6-2007, FILED 8-4-2006.

VERTEX

THE MARK CONSISTS OF STANDARD CHARACTERS WITHOUT CLAIM TO ANY PARTICULAR FONT, STYLE, SIZE, OR COLOR.

FOR BULLET-PROOF VESTS (U.S. CLS. 21, 23, 26, 36 AND 38).

FIRST USE 4-26-2007; IN COMMERCE 4-26-2007.

3,400,100. KIDTHING, INC., DEL MAR, CA. SN 78-950,741. PUB. 4-3-2007, FILED 8-11-2006.

kidthing

THE MARK CONSISTS OF STANDARD CHARACTERS WITHOUT CLAIM TO ANY PARTICULAR FONT, STYLE, SIZE, OR COLOR.

NO CLAIM IS MADE TO THE EXCLUSIVE RIGHT TO USE "KID", APART FROM THE MARK AS SHOWN.

FOR CHILDREN'S DOWNLOADABLE EDUCATIONAL SOFTWARE (U.S. CLS. 21, 23, 26, 36 AND 38).

FIRST USE 5-1-2007; IN COMMERCE 5-1-2007.

3,400,102. MANLEY, MARLEEN R., ACWORTH, GA. AND MANLEY, BYRON J., ACWORTH, GA. SN 78-950,898. PUB. 4-3-2007, FILED 8-12-2006.

EdgeryDoo

THE MARK CONSISTS OF STANDARD CHARACTERS WITHOUT CLAIM TO ANY PARTICULAR FONT, STYLE, SIZE, OR COLOR.

FOR GRADUATED RULERS (U.S. CLS. 21, 23, 26, 36 AND 38).

FIRST USE 11-3-2006; IN COMMERCE 11-3-2006.

CLASS 9—(Continued).

3,400,114. WHITESMOKE, INC., WILMINGTON, DE. SN 78-954,922. PUB. 4-3-2007, FILED 8-17-2006.

WHITESMOKE.COM

THE MARK CONSISTS OF STANDARD CHARACTERS WITHOUT CLAIM TO ANY PARTICULAR FONT, STYLE, SIZE, OR COLOR.

FOR COMPUTER SOFTWARE FOR USE IN WORD PROCESSING, ELECTRONIC MAIL WRITING AND ELECTRONIC INSTANT MESSAGING, TO SPELL-CHECK, GRAMMAR-CHECK, SUGGEST WORD SELECTION, SUGGEST ALTERNATE TERMINOLOGY TO ENRICH TEXT, AND PROVIDE WORD-PROCESSING TEMPLATES FOR LETTERS, EMAILS, LEGAL DOCUMENTS, AND OTHER BUSINESS AND PROFESSIONAL DOCUMENTS. FOR PERSONALIZATION; COMPUTER SOFTWARE TO PROVIDE DICTIONARY DEFINITIONS, FOR USE AS A DICTIONARY, FOR USE AS A THESAURUS, AND TO PROVIDE ACCESS TO AN ONLINE MEDICAL DICTIONARY AND THESAURUS; COMPUTER SOFTWARE TO PROVIDE ASSISTANCE IN THE PREPARATION OF ON-LINE WRITTEN DATING PROFILES (U.S. CLS. 21, 23, 26, 36 AND 38).

FIRST USE 12-31-2003; IN COMMERCE 12-31-2003.

3,400,119. WMS GAMING INC., WAUKEGAN, IL. SN 78-956,249. PUB. 3-13-2007, FILED 8-21-2006.

IT PAID FROM OUTER SPACE

THE MARK CONSISTS OF STANDARD CHARACTERS WITHOUT CLAIM TO ANY PARTICULAR FONT, STYLE, SIZE, OR COLOR.

FOR GAMING MACHINES THAT GENERATE OR DISPLAY WAGER OUTCOMES; GAMING SOFTWARE THAT GENERATES OR DISPLAYS WAGER OUTCOMES OF GAMING MACHINES (U.S. CLS. 21, 23, 26, 36 AND 38).

FIRST USE 11-14-2006; IN COMMERCE 11-14-2006.

CLASS 9—(Continued).

3,400,120. WMS GAMING INC., WAUKEGAN, IL. SN 78-956,341. PUB. 3-13-2007, FILED 8-21-2006.

CRYSTAL FOREST

THE MARK CONSISTS OF STANDARD CHARACTERS WITHOUT CLAIM TO ANY PARTICULAR FONT, STYLE, SIZE, OR COLOR.

FOR GAMING MACHINES THAT GENERATE OR DISPLAY WAGER OUTCOMES; GAMING SOFTWARE THAT GENERATES OR DISPLAYS WAGER OUTCOMES OF GAMING MACHINES (U.S. CLS. 21, 23, 26, 36 AND 38).

FIRST USE 11-14-2006; IN COMMERCE 11-14-2006.

3,400,135. KABUSHIKI KAISHA BANPRESTO (BANPRESTO CO., LTD.), SHINAGAWA-KU, TOKYO, JAPAN. SN 78-958,192. PUB. 1-30-2007, FILED 8-23-2006.

ARTONELICO

THE MARK CONSISTS OF STANDARD CHARACTERS WITHOUT CLAIM TO ANY PARTICULAR FONT, STYLE, SIZE, OR COLOR.

FOR COMPUTER GAME SOFTWARE, NAMELY, VIDEO GAME CARTRIDGE (U.S. CLS. 21, 23, 26, 36 AND 38).

FIRST USE 1-26-2006; IN COMMERCE 2-6-2007.

3,400,136. SENSORY ANALYTICS, LLC, GREENSBORO, NC. SN 78-958,200. PUB. 4-10-2007, FILED 8-23-2006.

SensorMetric

THE MARK CONSISTS OF STANDARD CHARACTERS WITHOUT CLAIM TO ANY PARTICULAR FONT, STYLE, SIZE, OR COLOR.

FOR SOFTWARE FOR MEASUREMENT STANDARD DEVICES FOR NANOMETROLOGY, NAMELY, MEASURING TOOLS HAVING A PATTERN IN THE MICROMETER OR NANOMETER RANGES (U.S. CLS. 21, 23, 26, 36 AND 38).

FIRST USE 6-30-2006; IN COMMERCE 6-30-2006.

CLASS 9—(Continued).

3,400,161. KIOSK INFORMATION SYSTEMS, INC., LOUISVILLE, CO. SN 78-964,183. PUB. 8-21-2007, FILED 8-30-2006.



FOR INTERACTIVE COMPUTER SYSTEMS COMPRISED OF SELF-SERVICE TERMINALS AND GAMING STATIONS, FEATURING INPUT DEVICES, NAMELY, CREDIT CARD READERS, CLUB CARD READERS, BILL ACCEPTORS, COIN ACCEPTORS, BILL AND COIN RECYCLERS, KEYBOARD INPUT, BAR CODE SCANNER, PAYMENT ENGINE AND RELATED SOFTWARE FOR A VARIETY OF PAYMENT METHODS INCLUDING CASH, CREDIT, DEBIT, VOUCHER OR PREPAID ACCOUNTS FOR VARIOUS APPLICATIONS, NAMELY, VIDEO DOWNLOAD AND PRE-VIEWING, MUSIC DOWNLOAD AND PREVIEWING, ONLINE AMUSEMENT GAMING, INTERNET ACCESS, EMAIL, VIDEO EMAIL, DIGITAL PHOTO PROCESSING, CELL PHONE RING TONE AND OTHER CONTENT DELIVERY, NAMELY, GAMES, AUDIO BOOKS, MOVIES, VIDEOS, AND TELEVISION SHOWS, VOICE OVER INTERNET PROTOCOL USAGE (VOIP), BILL PAYMENT, ON-LINE SHOPPING, MOVIE RENTAL AND VIEWING, TV RENTAL AND VIEWING AND OTHER ONLINE OR INTERNET APPLICATIONS, NAMELY PC GAMES (U.S. CLS. 21, 23, 26, 36 AND 38).

FIRST USE 12-18-2006; IN COMMERCE 12-18-2006.

3,400,166. ADVANCED BIOMETRIC SOLUTIONS, INC., NEW YORK, NY. SN 78-965,222. PUB. 4-24-2007, FILED 8-31-2006.

DoorPass

THE MARK CONSISTS OF STANDARD CHARACTERS WITHOUT CLAIM TO ANY PARTICULAR FONT, STYLE, SIZE, OR COLOR.

FOR SOFTWARE FOR HUMAN RESOURCES MANAGEMENT WITH AN INTEGRATED BIOMETRIC IDENTITY VERIFICATION SECURITY SYSTEM (U.S. CLS. 21, 23, 26, 36 AND 38).

FIRST USE 10-1-2007; IN COMMERCE 10-1-2007.

CLASS 9—(Continued).

3,400,171. VIVA VISION, INC., SAN DIEGO, CA. SN 78-965,969. PUB. 5-1-2007, FILED 9-1-2006.

VIVA VISION TV

THE MARK CONSISTS OF STANDARD CHARACTERS WITHOUT CLAIM TO ANY PARTICULAR FONT, STYLE, SIZE, OR COLOR.

NO CLAIM IS MADE TO THE EXCLUSIVE RIGHT TO USE "TV", APART FROM THE MARK AS SHOWN.

FOR COMPUTER SOFTWARE AND HARDWARE FOR USE IN DELIVERING LIVE STREAMING VIDEO OVER A COMPUTER NETWORK SERVER FOR A GLOBAL INFORMATION NETWORK, OR THROUGH OTHER VIDEO TRANSMISSION VEHICLES, NAMELY, WIRELESS DEVICES (U.S. CLS. 21, 23, 26, 36 AND 38).
FIRST USE 11-14-2006; IN COMMERCE 11-14-2006.

3,400,173. MSC.SOFTWARE CORPORATION, SANTA ANA, CA. SN 78-966,904. PUB. 2-6-2007, FILED 9-5-2006.

SIMTEMPLATE

THE MARK CONSISTS OF STANDARD CHARACTERS WITHOUT CLAIM TO ANY PARTICULAR FONT, STYLE, SIZE, OR COLOR.

OWNER OF U.S. REG. NO. 3,030,400.

FOR FEATURE OF COMPUTER SOFTWARE, NAMELY, ENTERPRISE SIMULATION PROCESS AUTOMATION TEMPLATES FOR ENGINEERING ANALYSIS (U.S. CLS. 21, 23, 26, 36 AND 38).

FIRST USE 9-28-2006; IN COMMERCE 9-28-2006.

3,400,178. NOPEC, INC., PASADENA, CA. SN 78-968,332. PUB. 4-24-2007, FILED 9-6-2006.

NOPEC

THE MARK CONSISTS OF STANDARD CHARACTERS WITHOUT CLAIM TO ANY PARTICULAR FONT, STYLE, SIZE, OR COLOR.

FOR APPARATUS FOR CONVERTING ELECTRONIC RADIATION TO ELECTRICAL ENERGY, NAMELY, PHOTOVOLTAIC ROOFING MEMBERS; APPARATUS FOR CONVERTING ELECTRONIC RADIATION TO ELECTRICAL ENERGY, NAMELY, PHOTOVOLTAIC SOLAR MODULES (U.S. CLS. 21, 23, 26, 36 AND 38).
FIRST USE 9-14-2006; IN COMMERCE 10-16-2006.

CLASS 9—(Continued).

3,400,200. SPRAYING SYSTEMS CO., WHEATON, IL. SN 78-973,309. PUB. 5-15-2007, FILED 9-13-2006.

SPRAYWARE

THE MARK CONSISTS OF STANDARD CHARACTERS WITHOUT CLAIM TO ANY PARTICULAR FONT, STYLE, SIZE, OR COLOR.

FOR COMPUTER SOFTWARE FOR DETERMINING OPTIMAL SPRAY NOZZLES AND ACCESSORY REQUIREMENTS FOR SPRAY APPLICATIONS AND ALLOWING SUBSEQUENT ORDERING OF THE SELECTED SPRAY NOZZLES AND ACCESSORIES OVER A GLOBAL COMPUTER NETWORK (U.S. CLS. 21, 23, 26, 36 AND 38).

FIRST USE 1-1-2007; IN COMMERCE 7-26-2007.

3,400,202. IVB, INC., VAN NUYS, CA. SN 78-973,779. PUB. 9-4-2007, FILED 9-13-2006.

Baikal Films

THE MARK CONSISTS OF STANDARD CHARACTERS WITHOUT CLAIM TO ANY PARTICULAR FONT, STYLE, SIZE, OR COLOR.

NO CLAIM IS MADE TO THE EXCLUSIVE RIGHT TO USE "FILMS", APART FROM THE MARK AS SHOWN.
SEC. 2(F).

FOR PRE-RECORDED CD'S, VIDEO TAPES, LASER DISKS AND DVD'S FEATURING DOCUMENTARIES WITH THE SUBJECT MATTER OF YOUTH, NATURIST, HISTORICAL, SOCIAL, CULTURAL, MILITARY, EDUCATIONAL AND SPORT ACTIVITIES MOSTLY IN EASTERN EUROPE (U.S. CLS. 21, 23, 26, 36 AND 38).
FIRST USE 1-1-2000; IN COMMERCE 1-1-2000.

3,400,204. DIGITAL PAYMENT TECHNOLOGIES CORP., BURNABY, BRITISH COLUMBIA, CANADA. SN 78-974,252. PUB. 5-15-2007, FILED 9-14-2006.

LUKE

THE MARK CONSISTS OF STANDARD CHARACTERS WITHOUT CLAIM TO ANY PARTICULAR FONT, STYLE, SIZE, OR COLOR.

FOR ELECTRONIC, AUTOMATED PAYMENT STATIONS (U.S. CLS. 21, 23, 26, 36 AND 38).
FIRST USE 12-30-2006; IN COMMERCE 12-30-2006.

CLASS 9—(Continued).

3,400,212. JUSTSYSTEMS CORPORATION, TOKUSHIMA, JAPAN. SN 78-979,427. PUB. 4-4-2006, FILED 11-16-2004.

XFY

THE MARK CONSISTS OF STANDARD CHARACTERS WITHOUT CLAIM TO ANY PARTICULAR FONT, STYLE, SIZE, OR COLOR.

FOR BLANK MAGNETIC COMPUTER DISCS AND BLANK OPTICAL DISCS ON WHICH COMPUTER PROGRAMS ARE RECORDED; DOWNLOADABLE ELECTRONIC PUBLICATIONS, NAMELY, MAGAZINE AND MANUAL FEATURING INFORMATION ABOUT COMPUTER SOFTWARE; COMPUTER PROGRAMS, NAMELY, PROGRAMS TO DESIGN, CREATE, EDIT AND PUBLISH XML AND WORD PROCESSING DOCUMENTS; COMPUTER PROGRAMS THAT ASSIST USERS IN DESIGNING, CREATING, EDITING, PUBLISHING AND COMPLETING XML AND WORD PROCESSING DOCUMENTS; COMPUTER PROGRAMS FOR ENHANCING THE CAPABILITIES OF WEB BROWSER SOFTWARE; COMPUTER PROGRAMS FOR DEVELOPING OTHER COMPUTER PROGRAMS; COMPILER PROGRAMS, EDITOR PROGRAMS, DEBUGGER PROGRAMS AND UTILITY PROGRAMS FOR CREATING AND TESTING OTHER COMPUTER PROGRAMS, CREATING INTERNAL NETWORK AND INTERNET APPLICATIONS; COMPUTER PROGRAMS FOR ASSISTING DEVELOPERS IN CREATING PROGRAM CODE FOR USE IN MULTIPLE APPLICATION PROGRAMS; INTERNAL COMPUTER NETWORKS AND THE INTERNET; COMPUTER PROGRAMS FOR RUNNING DEVELOPMENT PROGRAMS AND APPLICATION PROGRAMS; COMPUTER PROGRAMS FOR PROVIDING ACCESS TO XML DOCUMENTS AND PROVIDING MANIPULATION CAPABILITIES OF XML DOCUMENTS; COMPUTER PROGRAMS FOR CREATION, MANAGEMENT AND DEVELOPMENT OF XML SCHEMA; COMPUTER PROGRAMS FOR CONNECTING TO REMOTE COMPUTERS AND COMPUTER NETWORKS VIA GLOBAL COMMUNICATIONS NETWORKS TO ALLOW THE EXCHANGE OF INFORMATION AND DATA AND THE BROWSING OF WEBSITES; COMPUTER PROGRAMS FOR SEARCHING THE CONTENTS OF REMOTE COMPUTERS AND COMPUTER NETWORKS; COMPUTER PROGRAMS FOR ACCESSING, CREATING, EDITING AND MANAGING GENERAL USE DATABASES AND TRANSFERRING DATA TO

CLASS 9—(Continued).

AND FROM DATABASES; ELECTRONIC SPREADSHEET SOFTWARE; COMPUTER PROGRAMS FOR USE IN THE WORD PROCESSING, CALENDAR AND SCHEDULING, DESKTOP PUBLISHING, IMAGE EDITING, GRAPHICS CREATION AND EDITING, DRAWING, CREATION OF MULTIMEDIA PRESENTATIONS, CUSTOMER MANAGEMENT, BUSINESS PLANNING, AND BUSINESS FINANCIAL MANAGEMENT; COMPUTER PROGRAMS FOR DESIGNING, CREATING, MAINTAINING AND ACCESSING CUSTOMIZED INTERNAL NETWORK SITES AND INTERNET SITES; COMPUTER PROGRAMS FOR MANAGING, VIEWING, AND EDITING FILES, DOCUMENTS, ADDRESS BOOK PROGRAMS, PROGRAMS FOR CORRECTING TYPOGRAPHICAL AND CAPITALIZATION ERRORS, COMPUTER PROGRAMS, NAMELY, GRAPHICS, IMAGING AND PRESENTATION PROGRAMS FOR PRINTED AND ELECTRONIC DOCUMENTS AND PRESENTATIONS, AND USER MANUALS SOLD TOGETHER WITH THE PROGRAMS AS A UNIT (U.S. CLS. 21, 23, 26, 36 AND 38).

FIRST USE 11-16-2004; IN COMMERCE 11-16-2004.

CLASS 10—MEDICAL APPARATUS

3,398,861. GRAY TEK, INC., NEWARK, DE. SN 76-509,317. PUB. 5-9-2006, FILED 4-25-2003.

AMAIRICA

FOR INFLATABLE STRUCTURES IN THE NATURE OF INFLATABLE MATTRESSES FOR MOVING LOADS, FOR USE IN LOAD TRANSFERRING AND MEDICAL INDUSTRIES (U.S. CLS. 26, 39 AND 44).

FIRST USE 2-25-2003; IN COMMERCE 2-25-2003.

3,398,878. ISCIENCE INTERVENTIONAL CORPORATION, MENLO PARK, CA. SN 76-578,075. PUB. 1-17-2006, FILED 2-27-2004.

ISCIENCE SURGICAL

THE MARK CONSISTS OF STANDARD CHARACTERS WITHOUT CLAIM TO ANY PARTICULAR FONT, STYLE, SIZE, OR COLOR.

NO CLAIM IS MADE TO THE EXCLUSIVE RIGHT TO USE "SURGICAL", APART FROM THE MARK AS SHOWN, FOR ACCOUSTICAL AND ELECTROMAGNETIC MEDICAL DIAGNOSTIC IMAGING APPARATUS AND COMPONENTS THEREOF FOR USE IN OPHTHALMIC DIAGNOSIS AND RELATED MEDICAL PROCEDURES; SURGICAL INSTRUMENTS FOR USE IN OPHTHALMIC SURGERY; AND OPHTHALMIC IMPLANTS, NAMELY, STENTS AND SUTURE CLIPS (U.S. CLS. 26, 39 AND 44).

FIRST USE 10-9-2006; IN COMMERCE 10-9-2006.

CLASS 10—(Continued).

3,398,898. CORDIS CORPORATION, MIAMI LAKES, FL. SN 76-637,115. PUB. 4-10-2007, FILED 4-26-2005.

TRUFILL DCS ORBIT

THE MARK CONSISTS OF STANDARD CHARACTERS WITHOUT CLAIM TO ANY PARTICULAR FONT, STYLE, SIZE, OR COLOR.

NO CLAIM IS MADE TO THE EXCLUSIVE RIGHT TO USE "DCS", APART FROM THE MARK AS SHOWN.

FOR ARTIFICIAL MEDICAL EMBOLIZATION DEVICES, NAMELY, DETACHABLE COILS (U.S. CLS. 26, 39 AND 44).

FIRST USE 10-21-2003; IN COMMERCE 10-21-2003.

3,398,911. FUJIFILM CORPORATION, TOKYO, JAPAN. SN 76-651,933. PUB. 4-17-2007, FILED 12-15-2005.

FCR CARBON

THE MARK CONSISTS OF STANDARD CHARACTERS WITHOUT CLAIM TO ANY PARTICULAR FONT, STYLE, SIZE, OR COLOR.

FOR MEDICAL DIAGNOSTIC APPARATUS, NAMELY, DIGITAL X-RAY SYSTEMS FOR READING, PROCESSING AND RECORDING DIAGNOSTIC IMAGES BY RADIOGRAPHY (U.S. CLS. 26, 39 AND 44).

FIRST USE 11-0-2005; IN COMMERCE 11-0-2005.

3,398,963. REGENCY INTERNATIONAL MARKETING, LLC, LAS VEGAS, NV. SN 77-000,956. PUB. 5-1-2007, FILED 9-15-2006.

SILIQUE

THE MARK CONSISTS OF STANDARD CHARACTERS WITHOUT CLAIM TO ANY PARTICULAR FONT, STYLE, SIZE, OR COLOR.

FOR BREAST PROSTHESES (U.S. CLS. 26, 39 AND 44).

FIRST USE 5-8-2007; IN COMMERCE 5-8-2007.

CLASS 10—(Continued).

3,398,964. REGENCY INTERNATIONAL MARKETING, LLC, LAS VEGAS, NV. SN 77-000,968. PUB. 5-1-2007, FILED 9-15-2006.

Silique
designed for a new you

THE MARK CONSISTS OF SILIQUE DESIGNED FOR A NEW YOU WITH HEART DESIGN.

FOR BREAST PROSTHESES (U.S. CLS. 26, 39 AND 44).

FIRST USE 5-8-2007; IN COMMERCE 5-8-2007.

3,399,018. GENERAL MEDVENTURES INTERNATIONAL, LLC, EARTH CITY, MO. SN 77-022,070. PUB. 5-8-2007, FILED 10-16-2006.

GEMINI

THE MARK CONSISTS OF STANDARD CHARACTERS WITHOUT CLAIM TO ANY PARTICULAR FONT, STYLE, SIZE, OR COLOR.

FOR MASSAGE MACHINES (U.S. CLS. 26, 39 AND 44).

FIRST USE 12-20-2007; IN COMMERCE 12-20-2007.

3,399,124. K2M, INC., LEESBURG, VA. SN 77-070,146. PUB. 4-24-2007, FILED 12-22-2006.

SERENGETI

THE MARK CONSISTS OF STANDARD CHARACTERS WITHOUT CLAIM TO ANY PARTICULAR FONT, STYLE, SIZE, OR COLOR.

FOR SURGICAL INSTRUMENTS USED IN SPINAL SURGERY (U.S. CLS. 26, 39 AND 44).

FIRST USE 12-18-2006; IN COMMERCE 12-18-2006.

CLASS 10—(Continued).

3,399,152. SPORTSPOWER, LTD., HUNGHOM KOWLOON, HONG KONG. SN 77-085,029. PUB. 9-4-2007, FILED 1-17-2007.

CLASS 10—(Continued).

3,399,172. HILLIOS, SONIA R., SOUTHAMPTON, MA. AND HILLIOS, CHRISTOPHER H., SOUTHAMPTON, MA. SN 77-096,838. PUB. 8-7-2007, FILED 2-1-2007.

ÖLUFFA

THE MARK CONSISTS OF STANDARD CHARACTERS WITHOUT CLAIM TO ANY PARTICULAR FONT, STYLE, SIZE, OR COLOR.

FOR ABDOMINAL PADS; ACUPUNCTURE INSTRUMENTS; APPARATUS FOR MAGNET THERAPY; BED VIBRATORS; BLOOD PRESSURE MEASURING APPARATUS; BLOOD PRESSURE MONITORS; CARBON ARC LAMP UNITS FOR THERAPEUTIC PURPOSES; CASES FITTED FOR MEDICAL INSTRUMENTS AND/OR FOR USE BY DOCTORS; CHEMICALLY ACTIVATED HOT AND COLD GEL PACKS FOR MEDICAL PURPOSES; CLINICAL THERMOMETERS; DENTAL INSTRUMENTS, NAMELY, ORAL IRRIGATORS; ELECTRIC FOOT SPA MASSAGERS; ELECTRIC MASSAGE APPARATUS FOR HOUSEHOLD USE; ELECTRIC MASSAGE APPLIANCES, NAMELY, ELECTRIC VIBRATING MASSAGER; ELECTROMEDICAL REHABILITATIVE AND PAIN MANAGEMENT PRODUCTS FOR CLINICAL AND HOME USE, NAMELY, ELECTRICAL NERVE AND MUSCLE STIMULATORS, ULTRASONIC STIMULATORS, MAGNET THERAPY STIMULATORS AND LASER THERAPY STIMULATORS; EXERCISE MACHINES FOR THERAPEUTIC PURPOSES; FEVER THERMOMETERS; GLOVES FOR MASSAGE; GUM MASSAGING INSTRUMENTS; HEATING CUSHIONS FOR MEDICAL PURPOSES; HEATING PADS FOR MEDICAL PURPOSES; INFRARED RADIATOR UNITS FOR THERAPEUTIC PURPOSES; INHALERS FOR THERAPEUTIC USE; INJECTION INSTRUMENTS WITH NEEDLES; LACTATION MASSAGE BARS; LITHOTOMICAL INSTRUMENTS; MAGNETIC RESONANCE CT APPARATUS; MAGNETS FOR MEDICAL PURPOSES; MASSAGE APPARATUS; MASSAGE APPARATUS; MASSAGE CHAIRS; MASSAGE TABLES; MASSAGERS IN THE NATURE OF ELECTROMECHANICAL MASSAGE MECHANISM FOR CHAIRS; MASSAGING APPARATUS FOR PERSONAL USE; MEDICAL DIAGNOSTIC APPARATUS, ANALYTICAL APPARATUS FOR MEDICAL PURPOSES AND BLOOD PRESSURE MEASURING APPARATUS; MEDICAL HEARING INSTRUMENTS AND PARTS OF SUCH DEVICES; MEDICAL ICE PACKS; MEDICAL PRODUCTS, NAMELY, THERAPEUTIC MATTRESS SUPPORT; ORTHOTICS FOR FEET; THERAPEUTIC EYE HYDRATION GOGGLES FOR THE TREATMENT OF DRY EYES; THERAPEUTIC SAUNAS; THERMAL PACKS FOR FIRST AID PURPOSES; THERMOMETERS FOR MEDICAL PURPOSES; ULTRAVIOLET RADIATOR UNITS FOR THERAPEUTIC PURPOSES; WHIRLPOOLS FOR USE IN HOSPITALS OR FOR THERAPEUTIC USE (U.S. CLS. 26, 39 AND 44). FIRST USE 12-31-2007; IN COMMERCE 12-31-2007.

CONFIDISC

THE MARK CONSISTS OF STANDARD CHARACTERS WITHOUT CLAIM TO ANY PARTICULAR FONT, STYLE, SIZE, OR COLOR.

FOR HYPODERMIC SYRINGES (U.S. CLS. 26, 39 AND 44). FIRST USE 3-16-2007; IN COMMERCE 6-21-2007.

3,399,225. PRIMA DENTAL GROUP, GLOUCESTER, UNITED KINGDOM. SN 77-119,627. PUB. 9-4-2007, FILED 3-1-2007.

Prima Electra Bur

THE MARK CONSISTS OF STANDARD CHARACTERS WITHOUT CLAIM TO ANY PARTICULAR FONT, STYLE, SIZE, OR COLOR.

OWNER OF U.S. REG. NO. 2,856,337.
NO CLAIM IS MADE TO THE EXCLUSIVE RIGHT TO USE "BUR", APART FROM THE MARK AS SHOWN.
FOR DENTAL BURS (U.S. CLS. 26, 39 AND 44).
FIRST USE 3-1-2007; IN COMMERCE 3-1-2007.

3,399,226. PRIMA DENTAL GROUP, GLOUCESTER, UNITED KINGDOM. SN 77-119,663. PUB. 9-4-2007, FILED 3-1-2007.

Predator AccuPrep

THE MARK CONSISTS OF STANDARD CHARACTERS WITHOUT CLAIM TO ANY PARTICULAR FONT, STYLE, SIZE, OR COLOR.

OWNER OF U.S. REG. NO. 2,757,221.
FOR DENTAL BURS (U.S. CLS. 26, 39 AND 44).
FIRST USE 3-1-2007; IN COMMERCE 3-1-2007.

CLASS 10—(Continued).

3,399,280. TRANSPHOTON CORP., MIAMI, FL. SN 77-150,910. PUB. 10-2-2007, FILED 4-6-2007.

C!

THE MARK CONSISTS OF STANDARD CHARACTERS WITHOUT CLAIM TO ANY PARTICULAR FONT, STYLE, SIZE, OR COLOR.

FOR MEDICAL APPARATUS AND INSTRUMENTS FOR DIAGNOSTIC RADIO PHARMACEUTICAL USE (U.S. CLS. 26, 39 AND 44).

FIRST USE 6-1-2007; IN COMMERCE 6-1-2007.

CLASS 10—(Continued).

3,399,364. NUVASIVE, INC., SAN DIEGO, CA. SN 78-373,526. PUB. 11-22-2005, FILED 2-24-2004.

MAS

THE MARK CONSISTS OF STANDARD CHARACTERS WITHOUT CLAIM TO ANY PARTICULAR FONT, STYLE, SIZE, OR COLOR.

FOR PRODUCTS FOR USE IN SPINE SURGERY, NAMELY SURGICAL ACCESS SYSTEMS CONSISTING PRIMARILY OF RETRACTORS, NEEDLES, CANNULAE, AND TROCARS; INTERVERTEBRAL IMPLANTS CONSISTING PRIMARILY OF BONE GRAFT AND PROSTHETIC AND FILLING MATERIALS, NAMELY, ARTIFICIAL MATERIALS FOR USE IN SPINAL FUSION SURGERY; AND INTRA-OPERATIVE NERVE MONITORING SYSTEMS, CONSISTING PRIMARILY OF STIMULATION ELECTRODES, RETURN ELECTRODES, AND CONTROL UNITS AS A COMPONENT THEREOF FOR MEDICAL USE (U.S. CLS. 26, 39 AND 44).

FIRST USE 10-26-2004; IN COMMERCE 10-26-2004.

3,399,305. BIOCURY MEDICAL INSTRUMENTS, INC., CANTON, OH. SN 78-179,089. PUB. 1-20-2004, FILED 10-28-2002.

SWEEP

FOR DENTAL OR ORAL HYGIENE INSTRUMENTS; NAMELY, DEVICE USED TO REMOVE SUBSTANCE BUILD-UP FROM THE TONGUE (U.S. CLS. 26, 39 AND 44).

FIRST USE 4-12-2006; IN COMMERCE 4-12-2006.

3,399,370. ASHTON INDUSTRIES, INC., BOXFORD, MA. SN 78-397,107. PUB. 3-1-2005, FILED 4-6-2004.

3,399,335. ONSET MEDICAL CORPORATION, IRVINE, CA. SN 78-304,647. PUB. 5-23-2006, FILED 9-24-2003.

**PATHWAY ACCESS SHEATH
CATHETER**

NO CLAIM IS MADE TO THE EXCLUSIVE RIGHT TO USE "ACCESS SHEATH CATHETER", APART FROM THE MARK AS SHOWN.

FOR MEDICAL DEVICES, NAMELY, EXPANDABLE ACCESS SHEATHS FOR UROLOGICAL USE SOLD TO UROLOGISTS OR PURCHASING AGENTS FOR UROLOGISTS (U.S. CLS. 26, 39 AND 44).

FIRST USE 2-19-2004; IN COMMERCE 2-19-2004.

ARCHANGELS

THE MARK CONSISTS OF STANDARD CHARACTERS WITHOUT CLAIM TO ANY PARTICULAR FONT, STYLE, SIZE, OR COLOR.

FOR ORTHOTIC INSERTS FOR FOOTWEAR (U.S. CLS. 26, 39 AND 44).

FIRST USE 11-2-2007; IN COMMERCE 11-2-2007.

CLASS 10—(Continued).

3,399,380. THE SEABERG COMPANY, INC., NEWPORT, OR. SN 78-438,495. PUB. 10-18-2005, FILED 6-21-2004.

SAM SUGAR TONG

THE MARK CONSISTS OF STANDARD CHARACTERS WITHOUT CLAIM TO ANY PARTICULAR FONT, STYLE, SIZE, OR COLOR.

OWNER OF U.S. REG. NOS. 1,384,137 AND 2,918,142.

NO CLAIM IS MADE TO THE EXCLUSIVE RIGHT TO USE "SUGAR TONG", APART FROM THE MARK AS SHOWN.

FOR ORTHOPEDIC SPLINTS, FOREARM ORTHOSES, ANKLE ORTHOSES, ANKLE BRACES, AND FOREARM BRACES (U.S. CLS. 26, 39 AND 44).

FIRST USE 8-31-2007; IN COMMERCE 8-31-2007.

CLASS 10—(Continued).

3,399,445. AMGEN INC., THOUSAND OAKS, CA. SN 78-525,858. PUB. 9-27-2005, FILED 12-2-2004.

SURECLICK

THE MARK CONSISTS OF STANDARD CHARACTERS WITHOUT CLAIM TO ANY PARTICULAR FONT, STYLE, SIZE, OR COLOR.

FOR INJECTORS FOR MEDICAL PURPOSES; EXCLUDING INJECTORS FOR GROWTH HORMONE PRODUCTS (U.S. CLS. 26, 39 AND 44).

FIRST USE 7-31-2006; IN COMMERCE 7-31-2006.

3,399,467. SMYTH, STUART KJ, SHELBURNE, VT. SN 78-558,663. PUB. 1-24-2006, FILED 2-2-2005.

3,399,392. FUTUREMATRIX INTERVENTIONAL, INC., ATHENS, TX. SN 78-470,039. PUB. 8-30-2005, FILED 8-19-2004.

**FUTURE MATRIX
INTERVENTIONAL**

THE MARK CONSISTS OF STANDARD CHARACTERS WITHOUT CLAIM TO ANY PARTICULAR FONT, STYLE, SIZE, OR COLOR.

NO CLAIM IS MADE TO THE EXCLUSIVE RIGHT TO USE "INTERVENTIONAL", APART FROM THE MARK AS SHOWN.

FOR SURGICAL INSTRUMENTS AND APPARATUS FOR USE IN CARDIOVASCULAR SURGERY, INTERVENTIONAL SURGERY AND BIOPSIES; MEDICAL DEVICES, NAMELY, VASCULAR AND CARDIOVASCULAR CATHETERS, BALLOONS, BALLOON INFLATION APPARATUS AND PARTS THEREFOR; MEDICAL DEVICES, NAMELY, BIOPSY INSTRUMENTS (U.S. CLS. 26, 39 AND 44).

FIRST USE 7-0-2006; IN COMMERCE 7-0-2006.

AugmentRx

THE MARK CONSISTS OF STANDARD CHARACTERS WITHOUT CLAIM TO ANY PARTICULAR FONT, STYLE, SIZE, OR COLOR.

FOR MEDICAL DEVICES, NAMELY, BIOCERAMIC INJECTABLE COMPOSITES, BIOCERAMIC INJECTABLE DELIVERY KIT FOR SURGERY COMPRISED OF DISPOSABLE FLEXIBLE NEEDLES, RIGID NEEDLES, CYSTOSCOPIC PLACEMENT GUIDE FOR URETHRA, DISPOSABLE ENDOSCOPE SHEATH, ENDOSCOPIC BIOCERAMIC APPLICATION INSTRUMENT, PRESSURE TRANSDUCER, CATHETER, AND SCAFFOLDING FOR TISSUE ENGINEERING (U.S. CLS. 26, 39 AND 44).

FIRST USE 4-23-2004, THE MARK WAS FIRST USED ANYWHERE IN A DIFFERENT FORM OTHER THAN THAT SOUGHT TO BE REGISTERED ON 04/22/2004; IN COMMERCE 12-7-2005, THE MARK WAS FIRST USED IN COMMERCE IN A DIFFERENT FORM OTHER THAN THAT SOUGHT TO BE REGISTERED ON 04/22/2004..

CLASS 10—(Continued).

3,399,493. CARDIAC SCIENCE CORPORATION, BOTHELL, WA. SN 78-596,237. PUB. 9-19-2006, FILED 3-28-2005.

HEARTSTRIDE

THE MARK CONSISTS OF STANDARD CHARACTERS WITHOUT CLAIM TO ANY PARTICULAR FONT, STYLE, SIZE, OR COLOR.

FOR MEDICAL EQUIPMENT, NAMELY, COMPUTER-BASED STRESS TEST SYSTEMS COMPRISED OF COMPUTER HARDWARE AND SOFTWARE, FOR COLLECTING, ANALYZING, STORING, AND PRESENTING CARDIOPULMONARY DATA (U.S. CLS. 26, 39 AND 44). FIRST USE 4-18-2006; IN COMMERCE 4-18-2006.

3,399,505. O2 INNOVATIONS LLC, WEST PITTSSTON, PA. SN 78-603,477. PUB. 5-15-2007, FILED 4-6-2005.

Oxygen is Beautiful

THE MARK CONSISTS OF STANDARD CHARACTERS WITHOUT CLAIM TO ANY PARTICULAR FONT, STYLE, SIZE, OR COLOR.

NO CLAIM IS MADE TO THE EXCLUSIVE RIGHT TO USE "OXYGEN", APART FROM THE MARK AS SHOWN.

FOR OXYGEN PRODUCTS, EQUIPMENT, AND DELIVERY SYSTEMS FOR DISPENSING NON-MEDICAL OXYGEN, NAMELY, PORTABLE OXYGEN BAR, OXYGEN CONCENTRATORS, OXYGEN SUPPLY CYLINDERS, OXYGEN CANISTERS, OXYGEN PURIFIERS, OXYGEN MASKS, NASAL CANNULAE, HEADSET WITH OXYGEN DISPENSING MOUTHPIECE, OXYGEN HOSES, MOUTHPIECES AND AIR INTAKE FILTERS, AND MOUTHPIECE COVERS; APPARATUS FOR DISPENSING NON-MEDICAL OXYGEN AND AROMATHERAPY FOR RELAXATION THERAPY (U.S. CLS. 26, 39 AND 44).

FIRST USE 9-0-2005; IN COMMERCE 9-0-2005.

CLASS 10—(Continued).

3,399,510. SIEMENS MEDICAL SOLUTIONS USA, INC., MALVERN, PA. SN 78-610,254. PUB. 4-10-2007, FILED 4-15-2005.

G50

THE MARK CONSISTS OF STANDARD CHARACTERS WITHOUT CLAIM TO ANY PARTICULAR FONT, STYLE, SIZE, OR COLOR.

FOR ULTRASOUND DIAGNOSTIC SYSTEM, COMPRISING, ULTRASOUND DIAGNOSTIC APPARATUS, ULTRASOUND PLATFORM AND RELATED SOFTWARE FOR OPERATING ULTRASOUND MACHINES, AND FOR RECORDING, PROCESSING AND DISPLAYING INFORMATION OBTAINED DURING ULTRASOUND DIAGNOSTIC PROCEDURES SOLD AS A UNIT WITH ULTRASOUND SYSTEMS (U.S. CLS. 26, 39 AND 44).

FIRST USE 11-0-2002; IN COMMERCE 11-0-2002.

3,399,519. VOIKEX, INC., MANHATTAN BEACH, CA. SN 78-620,687. PUB. 2-7-2006, FILED 5-2-2005.

VOIKEX

THE MARK CONSISTS OF STANDARD CHARACTERS WITHOUT CLAIM TO ANY PARTICULAR FONT, STYLE, SIZE, OR COLOR.

FOR MEDICAL DIAGNOSTIC EQUIPMENT, NAMELY, DEVICES FOR MONITORING AND RECORDING THE INTERVALS BETWEEN KICKS OF A BABY IN THE BELLY OF AN EXPECTANT MOTHER (U.S. CLS. 26, 39 AND 44).

FIRST USE 7-0-2007; IN COMMERCE 7-0-2007.

3,399,533. THERMOGENESIS CORPORATION, RANCHO CORDOVA, CA. SN 78-634,312. PUB. 9-12-2006, FILED 5-20-2005.

AXP

THE MARK CONSISTS OF STANDARD CHARACTERS WITHOUT CLAIM TO ANY PARTICULAR FONT, STYLE, SIZE, OR COLOR.

FOR MEDICAL DEVICES AND EQUIPMENT, NAMELY, A DEVICE TO HARVEST CELLS FROM BLOOD OR BONE MARROW (U.S. CLS. 26, 39 AND 44).

FIRST USE 9-1-2005; IN COMMERCE 9-1-2005.

CLASS 10—(Continued).

3,399,538. BOSTON SCIENTIFIC SCIMED, INC., MAPLE GROVE, MN. SN 78-638,222. PUB. 10-10-2006, FILED 5-26-2005.

FATHOM

THE MARK CONSISTS OF STANDARD CHARACTERS WITHOUT CLAIM TO ANY PARTICULAR FONT, STYLE, SIZE, OR COLOR.

FOR MEDICAL GUIDEWIRES FOR USE IN PERIPHERAL VASCULATURE (U.S. CLS. 26, 39 AND 44).
FIRST USE 7-1-2005; IN COMMERCE 7-1-2005.

3,399,646. NELLCOR PURITAN BENNETT INCORPORATED, BOULDER, CO. SN 78-736,278. PUB. 6-20-2006, FILED 10-19-2005.

N-560

THE MARK CONSISTS OF STANDARD CHARACTERS WITHOUT CLAIM TO ANY PARTICULAR FONT, STYLE, SIZE, OR COLOR.

FOR MEDICAL DEVICES, NAMELY, PULSE OXIMETERS (U.S. CLS. 26, 39 AND 44).
FIRST USE 7-3-2006; IN COMMERCE 7-3-2006.

3,399,669. D4D TECHNOLOGIES, LLC, RICHARDSON, TX. SN 78-748,735. PUB. 7-11-2006, FILED 11-7-2005.

E4D

THE MARK CONSISTS OF STANDARD CHARACTERS WITHOUT CLAIM TO ANY PARTICULAR FONT, STYLE, SIZE, OR COLOR.

FOR DENTAL INSTRUMENTS, NAMELY, DENTAL TOOLS, IMAGING SYSTEMS, SOFTWARE AND MILLING MACHINES FOR MANUFACTURING DENTAL PROSTHETICS (U.S. CLS. 26, 39 AND 44).
FIRST USE 2-2-2007; IN COMMERCE 2-2-2007.

CLASS 10—(Continued).

3,399,753. VERTIFLEX, INC., SAN CLEMENTE, CA. SN 78-781,858. PUB. 3-20-2007, FILED 12-28-2005.

THE MARK CONSISTS OF THE TERM "VERTIFLEX" WITH UPPERCASE "V" AND "F", A STYLIZED "X" AND THE REMAINDER OF THE LETTERS IN LOWERCASE.

FOR SURGICAL IMPLANTS COMPRISING ARTIFICIAL MATERIAL (U.S. CLS. 26, 39 AND 44).
FIRST USE 8-25-2005; IN COMMERCE 9-19-2006.

3,399,763. OLYMPUS CORPORATION, TOKYO, JAPAN. SN 78-786,607. PUB. 1-16-2007, FILED 1-6-2006.

GIF-H180

THE MARK CONSISTS OF STANDARD CHARACTERS WITHOUT CLAIM TO ANY PARTICULAR FONT, STYLE, SIZE, OR COLOR.

OWNER OF U.S. REG. NOS. 1,816,763, 2,840,901, AND 2,978,653.
FOR MEDICAL AND SURGICAL VIDEO ENDOSCOPES (U.S. CLS. 26, 39 AND 44).
FIRST USE 1-2-2006; IN COMMERCE 1-2-2006.

3,399,777. ACCELERATED CARE PLUS CORP., RENO, NV. SN 78-793,723. PUB. 9-12-2006, FILED 1-18-2006.

OMNIPAD

THE MARK CONSISTS OF STANDARD CHARACTERS WITHOUT CLAIM TO ANY PARTICULAR FONT, STYLE, SIZE, OR COLOR.

FOR SENSORY LIGHT THERAPY UNIT (U.S. CLS. 26, 39 AND 44).
FIRST USE 9-0-2006; IN COMMERCE 9-0-2006.

CLASS 10—(Continued).

3,399,819. ORTHOLUTION CO., LTD., SEOUL, REPUBLIC OF KOREA. SN 78-806,596. PUB. 4-17-2007, FILED 2-3-2006.

ORLUS

THE MARK CONSISTS OF STANDARD CHARACTERS WITHOUT CLAIM TO ANY PARTICULAR FONT, STYLE, SIZE, OR COLOR.

FOR ORTHODONTIC MACHINES AND INSTRUMENTS FOR DENTAL PURPOSES; PROSTHETIC MACHINES AND INSTRUMENTS FOR DENTAL PURPOSES; DENTAL TREATMENT UNITS, NAMELY, DENTAL FIXATION SCREWS, GUIDED BONE REGENERATION (GBR) SCREWS (U.S. CLS. 26, 39 AND 44).

FIRST USE 5-9-2006; IN COMMERCE 5-9-2006.

3,399,849. ARTHREX, INC., NAPLES, FL. SN 78-819,079. PUB. 4-17-2007, FILED 2-20-2006.

PROSTOP

THE MARK CONSISTS OF STANDARD CHARACTERS WITHOUT CLAIM TO ANY PARTICULAR FONT, STYLE, SIZE, OR COLOR.

FOR MEDICAL IMPLANTS, NAMELY, AN IMPLANT COMPRISING ARTIFICIAL MATERIALS USED FOR ARTHROEREISIS REPAIR (U.S. CLS. 26, 39 AND 44).

FIRST USE 7-27-2006; IN COMMERCE 7-27-2006.

3,399,864. HYPOGUARD AMERICA LIMITED, EDINA, MN. SN 78-826,038. PUB. 5-15-2007, FILED 3-1-2006.

PROGRIP

THE MARK CONSISTS OF STANDARD CHARACTERS WITHOUT CLAIM TO ANY PARTICULAR FONT, STYLE, SIZE, OR COLOR.

FOR SLIPPAGE CONTROL PADS MADE OF RUBBER-LIKE MATERIAL SOLD AS AN INTEGRAL COMPONENT OF BLOOD GLUCOSE METERS; BLOOD GLUCOSE METERS (U.S. CLS. 26, 39 AND 44).

FIRST USE 4-14-2006; IN COMMERCE 4-14-2006.

CLASS 10—(Continued).

3,399,894. FANARO, MARY, SHERMAN OAKS, CA. SN 78-841,258. PUB. 7-24-2007, FILED 3-20-2006.



NO CLAIM IS MADE TO THE EXCLUSIVE RIGHT TO USE "CONDOMS", APART FROM THE MARK AS SHOWN. THE COLOR(S) BROWN, RED, YELLOW, GREEN, PINK AND BLACK IS/ARE CLAIMED AS A FEATURE OF THE MARK.

THE COLOR BROWN APPEARS IN THE TERMS "PEACE" AND "OF MIND", THE COLOR RED APPEARS IN THE PEACE HAND DESIGN, THE COLOR YELLOW APPEARS IN THE TOP PORTION OF THE MAP OF AFRICA, THE COLOR GREEN APPEARS IN THE BOTTOM HALF OF THE MAP OF AFRICA, THE TERM PINK APPEARS IN THE TERM "CONDOMS" AND THE COLOR BLACK APPEARS IN THE RECTANGLE BEHIND THE ENTIRE DESIGN AND WORDING IN THE MARK.

FOR CONDOMS (U.S. CLS. 26, 39 AND 44).
FIRST USE 12-3-2007; IN COMMERCE 12-3-2007.

3,399,919. GENDEX CORPORATION, DES PLAINES, IL. SN 78-853,112. PUB. 9-12-2006, FILED 4-4-2006.



OWNER OF U.S. REG. NO. 1,310,934.
FOR DENTAL X-RAY APPARATUS (U.S. CLS. 26, 39 AND 44).
FIRST USE 8-27-2007; IN COMMERCE 8-27-2007.

CLASS 10—(Continued).

3,399,920. GENDEX CORPORATION, DES PLAINES, IL. SN 78-853,115. PUB. 9-12-2006, FILED 4-4-2006.



FOR DENTAL X-RAY APPARATUS (U.S. CLS. 26, 39 AND 44).
FIRST USE 8-27-2007; IN COMMERCE 8-27-2007.

3,399,992. BSN MEDICAL GMBH, HAMBURG, FED REP GERMANY. SN 78-895,871. PUB. 6-19-2007, FILED 5-30-2006.

CompriFoam

THE MARK CONSISTS OF STANDARD CHARACTERS WITHOUT CLAIM TO ANY PARTICULAR FONT, STYLE, SIZE, OR COLOR.

PRIORITY CLAIMED UNDER SEC. 44(D) ON FED REP GERMANY APPLICATION NO. 30626727.6, FILED 4-26-2006.

OWNER OF U.S. REG. NOS. 1,747,623 AND 3,063,947.

FOR PADDING MATERIAL FOR MEDICAL PURPOSES, NAMELY, PADDING APPLIED AS A LAYER UNDER A BANDAGE OR COMPRESSION STOCKING TO EVENLY DISTRIBUTE PRESSURE (U.S. CLS. 26, 39 AND 44).

FIRST USE 7-0-2006; IN COMMERCE 7-0-2006.

3,400,026. COHERA MEDICAL, INC., PITTSBURGH, PA. SN 78-917,254. PUB. 8-14-2007, FILED 6-26-2006.



NO CLAIM IS MADE TO THE EXCLUSIVE RIGHT TO USE "TISSUE GLUE", APART FROM THE MARK AS SHOWN.

THE MARK CONSISTS OF THE STYLIZED WORD "TISSUGLU" PARTIALLY ENCIRCLED BY A SPHERE FORMING FROM THE SECOND LETTER "U".

FOR SYNTHETIC BIODEGRADABLE PREPARATIONS, NAMELY SURGICAL GLUE, FOR THE PURPOSES OF DEEP WOUND TREATMENT AND SOFT TISSUE REPAIR NOT FOR USE BY DENTAL SURGEONS (U.S. CLS. 26, 39 AND 44).

FIRST USE 11-29-2007; IN COMMERCE 11-29-2007.

CLASS 11—ENVIRONMENTAL CONTROL APPARATUS

3,398,848. AMTROL INC., WEST WARWICK, RI. SN 76-421,964. PUB. 10-3-2006, FILED 6-17-2002.



OWNER OF U.S. REG. NOS. 1,264,849, 1,326,576, AND 2,604,069.

FOR EQUIPMENT FOR USE IN RESIDENTIAL AND COMMERCIAL WATER TREATMENT APPLICATIONS, NAMELY, ION EXCHANGE UNITS, CARTRIDGE FILTRATION UNITS, IRON REMOVAL UNITS, CHEMICAL STERILIZATION UNITS, REVERSE OSMOSIS FILTRATION UNITS, ULTRA VIOLET STERILIZATION UNITS, AND ALL STRUCTURAL COMPONENTS CONTAINED THEREIN (U.S. CLS. 13, 21, 23, 31 AND 34).

FIRST USE 12-15-2001; IN COMMERCE 12-15-2001.

3,398,874. STUDOR, INC., DUNEDIN, FL. SN 76-564,860. PUB. 11-23-2004, FILED 12-12-2003.

ULTRA-VENT

THE MARK CONSISTS OF STANDARD CHARACTERS WITHOUT CLAIM TO ANY PARTICULAR FONT, STYLE, SIZE, OR COLOR.

FOR AIR ADMITTANCE VALVES USED TO VENTILATE A TOILET WATER TRAP SEAL (U.S. CLS. 13, 21, 23, 31 AND 34).

FIRST USE 11-1-2007; IN COMMERCE 11-1-2007.

3,398,907. THE DIAGNOSTIC GROUP, INC., NEENAH, WI. SN 76-646,579. PUB. 5-30-2006, FILED 9-12-2005.

XERICURE

THE MARK CONSISTS OF STANDARD CHARACTERS WITHOUT CLAIM TO ANY PARTICULAR FONT, STYLE, SIZE, OR COLOR.

OWNER OF U.S. REG. NO. 1,729,154.

FOR DRYERS FOR EVAPORATING LIQUIDS FROM COATINGS, INKS AND SUBSTRATES ON MOVING PAPER, FILM AND FOIL FOR INDUSTRIAL USE (U.S. CLS. 13, 21, 23, 31 AND 34).

FIRST USE 4-30-2007; IN COMMERCE 4-30-2007.

CLASS 11—(Continued).

3,399,067. KOHLER CO., KOHLER, WI. SN 77-043,813. PUB. 10-2-2007, FILED 11-14-2006.

LATITUDE

THE MARK CONSISTS OF STANDARD CHARACTERS WITHOUT CLAIM TO ANY PARTICULAR FONT, STYLE, SIZE, OR COLOR.

FOR SINKS (U.S. CLS. 13, 21, 23, 31 AND 34).
FIRST USE 1-1-2002; IN COMMERCE 1-1-2002.

CLASS 11—(Continued).

3,399,576. BE AEROSPACE, INC., WELLINGTON, FL. SN 78-674,695. PUB. 8-29-2006, FILED 7-20-2005.

XCELIS

THE MARK CONSISTS OF STANDARD CHARACTERS WITHOUT CLAIM TO ANY PARTICULAR FONT, STYLE, SIZE, OR COLOR.

FOR AIRPLANE GALLEY REFRIGERATION EQUIPMENT, NAMELY, FOOD AND BEVERAGE CHILLING UNITS (U.S. CLS. 13, 21, 23, 31 AND 34).
FIRST USE 11-0-2005; IN COMMERCE 11-0-2005.

3,399,071. LI, LI, RICHMOND HILL, ONTARIO, CANADA. AND DING, BEI, RICHMOND HILL, ONTARIO, CANADA. SN 77-047,626. PUB. 7-3-2007, FILED 11-20-2006.

YARDS & BEYOND

THE MARK CONSISTS OF STANDARD CHARACTERS WITHOUT CLAIM TO ANY PARTICULAR FONT, STYLE, SIZE, OR COLOR.

FOR LIGHTING FIXTURES AND STRUCTURAL PARTS THEREFOR (U.S. CLS. 13, 21, 23, 31 AND 34).
FIRST USE 5-15-2007; IN COMMERCE 5-15-2007.

3,399,583. METAL FORM MANUFACTURING COMPANY, PHOENIX, AZ. SN 78-679,932. PUB. 4-3-2007, FILED 7-27-2005.

CIRRUS COOLING

THE MARK CONSISTS OF STANDARD CHARACTERS WITHOUT CLAIM TO ANY PARTICULAR FONT, STYLE, SIZE, OR COLOR.

NO CLAIM IS MADE TO THE EXCLUSIVE RIGHT TO USE "COOLING", APART FROM THE MARK AS SHOWN.
FOR HEATING, VENTILATION AND AIR CONDITIONING EQUIPMENT, NAMELY, EVAPORATIVE COOLERS, VENTILATING FANS, AIR DUCTS AND PLENUMS, AIR FLOW SILENCERS, EVAPORATIVE COOLING PADS, AND AIR CONDITIONERS FOR COMMERCIAL AND HOUSEHOLD USE (U.S. CLS. 13, 21, 23, 31 AND 34).

FIRST USE 12-31-2005; IN COMMERCE 12-31-2005.

3,399,234. ROCHESTER, ALTON D., LAKELAND, FL. SN 77-122,761. PUB. 10-16-2007, FILED 3-5-2007.



OWNER OF U.S. REG. NO. 2,453,044.

NO CLAIM IS MADE TO THE EXCLUSIVE RIGHT TO USE "AQUA SOFT", APART FROM THE MARK AS SHOWN.

THE COLOR(S) GREEN, NAVY BLUE AND TURQUOISE IS/ARE CLAIMED AS A FEATURE OF THE MARK.

THE COLOR GREEN APPEARS IN THE WORD "AQUA", THE COLOR NAVY BLUE APPEARS IN THE WORD "SOFT", THE COLOR TURQUOISE APPEARS IN ALL THREE RAIN DROPS.

FOR WATER CONDITIONING UNITS; WATER SOFTENING UNITS; WATER TREATMENT EQUIPMENT, NAMELY, REVERSE OSMOSIS FILTRATION UNITS (U.S. CLS. 13, 21, 23, 31 AND 34).

FIRST USE 12-15-2007; IN COMMERCE 12-15-2007.

3,399,588. CHAUVET & SONS, INC., HOLLYWOOD, FL. SN 78-683,567. PUB. 10-17-2006, FILED 8-2-2005.

CHAUVET Q-SCAN

THE MARK CONSISTS OF STANDARD CHARACTERS WITHOUT CLAIM TO ANY PARTICULAR FONT, STYLE, SIZE, OR COLOR.

OWNER OF U.S. REG. NO. 2,890,766.
FOR COMMERCIAL ENTERTAINMENT LIGHTING SYSTEM CONSISTING OF LIGHTS COMPRISED OF LASERS AND ELECTRONIC EFFECTS LIGHTING FOR PARTY-THEMED DECORATIVE PURPOSES (U.S. CLS. 13, 21, 23, 31 AND 34).

FIRST USE 7-0-2007; IN COMMERCE 7-0-2007.

CLASS 11—(Continued).

3,399,741. ARAMCO IMPORTS INC., COMMERCE , CALIFORNIA 90040 USA, CA. SN 78-778,746. PUB. 8-29-2006, FILED 12-21-2005.

ALPINE AIR

THE MARK CONSISTS OF STANDARD CHARACTERS WITHOUT CLAIM TO ANY PARTICULAR FONT, STYLE, SIZE, OR COLOR.

NO CLAIM IS MADE TO THE EXCLUSIVE RIGHT TO USE "AIR", APART FROM THE MARK AS SHOWN.

FOR ELECTRIC FANS; ELECTRIC HEATING FANS FOR COMMERCIAL AND INDUSTRIAL USE (U.S. CLS. 13, 21, 23, 31 AND 34).

FIRST USE 12-28-2005; IN COMMERCE 8-0-2006.

CLASS 11—(Continued).

3,400,025. HEATER CRAFT MARINE PRODUCTS, RATHDRUM, ID. SN 78-917,240. PUB. 9-4-2007, FILED 6-26-2006.

AIR FUSION

THE MARK CONSISTS OF STANDARD CHARACTERS WITHOUT CLAIM TO ANY PARTICULAR FONT, STYLE, SIZE, OR COLOR.

FOR HEATERS AND AIR CONDITIONERS FOR BOATS, CARS, TRUCKS AND RECREATIONAL VEHICLES (U.S. CLS. 13, 21, 23, 31 AND 34).

FIRST USE 10-6-2006; IN COMMERCE 10-6-2006.

3,399,780. MOEN INCORPORATED, NORTH OLMSTED, OH. SN 78-794,726. PUB. 7-4-2006, FILED 1-19-2006.

CHOICEFLO FILTRATION

THE MARK CONSISTS OF STANDARD CHARACTERS WITHOUT CLAIM TO ANY PARTICULAR FONT, STYLE, SIZE, OR COLOR.

NO CLAIM IS MADE TO THE EXCLUSIVE RIGHT TO USE "FILTRATION", APART FROM THE MARK AS SHOWN.

FOR FAUCETS, NAMELY KITCHEN FAUCETS, FAUCET HANDLES, AND FAUCET VALVES; WATER FILTRATION UNITS FOR DOMESTIC USE; PLUMBING FITTINGS, NAMELY, FAUCET FILTERS; WATER FILTERS; AND WATER FILTER CARTRIDGES (U.S. CLS. 13, 21, 23, 31 AND 34).

FIRST USE 10-15-2007; IN COMMERCE 10-15-2007.

3,400,045. EXCALIBUR ELECTRONICS, INC., MIAMI, FL. SN 78-925,508. PUB. 3-13-2007, FILED 7-10-2006.

EZ CRANK

THE MARK CONSISTS OF STANDARD CHARACTERS WITHOUT CLAIM TO ANY PARTICULAR FONT, STYLE, SIZE, OR COLOR.

NO CLAIM IS MADE TO THE EXCLUSIVE RIGHT TO USE "CRANK", APART FROM THE MARK AS SHOWN.

FOR FLASHLIGHTS (U.S. CLS. 13, 21, 23, 31 AND 34).

FIRST USE 8-31-2006; IN COMMERCE 8-31-2006.

3,399,892. LETHERT, ANDREW J., DBA DECCO BATH & SHOWER WORKS, CORP., FORT MYERS, FL. SN 78-838,688. PUB. 11-21-2006, FILED 3-16-2006.

DÉCCO BATH & SHOWER WORKS

THE MARK CONSISTS OF STANDARD CHARACTERS WITHOUT CLAIM TO ANY PARTICULAR FONT, STYLE, SIZE, OR COLOR.

NO CLAIM IS MADE TO THE EXCLUSIVE RIGHT TO USE "BATH & SHOWER", APART FROM THE MARK AS SHOWN.

FOR BATHTUB AND SHOWER ENCLOSURES (U.S. CLS. 13, 21, 23, 31 AND 34).

FIRST USE 11-30-2006; IN COMMERCE 11-30-2006.

3,400,048. VOGELZANG INTERNATIONAL CORPORATION, HOLLAND, MI. SN 78-928,885. PUB. 9-4-2007, FILED 7-13-2006.

HEAT GRABBER

THE MARK CONSISTS OF STANDARD CHARACTERS WITHOUT CLAIM TO ANY PARTICULAR FONT, STYLE, SIZE, OR COLOR.

NO CLAIM IS MADE TO THE EXCLUSIVE RIGHT TO USE "HEAT", APART FROM THE MARK AS SHOWN.

FOR AN APPARATUS FOR RECYCLING AND RETAINING HEAT FROM A HEAT SOURCE IN THE NATURE OF FIREPLACE INSERTS USED AS HEAT EXCHANGERS (U.S. CLS. 13, 21, 23, 31 AND 34).

FIRST USE 11-1-2007; IN COMMERCE 11-1-2007.

CLASS 11—(Continued).

3,400,080. GREENHECK FAN CORPORATION, SCHOFFIELD, WI. SN 78-943,483. PUB. 4-17-2007, FILED 8-2-2006.

ACCUREX

THE MARK CONSISTS OF STANDARD CHARACTERS WITHOUT CLAIM TO ANY PARTICULAR FONT, STYLE, SIZE, OR COLOR.

FOR VENTILATION EXHAUST FANS; HEATING AND COOLING VENTILATION EQUIPMENT, NAMELY, HOT AND COOL AIR BLOWERS, GAS AND ELECTRIC HEATERS FOR COMMERCIAL AND INDUSTRIAL USE, DIRECT EXPANSION AND CHILLED WATER COOLERS FOR COOLING AIR; EXHAUST HOODS FOR KITCHENS; AND VENTILATION CONTROL DAMPERS (U.S. CLS. 13, 21, 23, 31 AND 34).

FIRST USE 8-31-2007; IN COMMERCE 8-31-2007.

3,400,105. THE VOLLRATH COMPANY, L.L.C., SHEBOYGAN, WI. SN 78-951,636. PUB. 2-13-2007, FILED 8-14-2006.

MIRAGE

THE MARK CONSISTS OF STANDARD CHARACTERS WITHOUT CLAIM TO ANY PARTICULAR FONT, STYLE, SIZE, OR COLOR.

FOR COOKING RANGES (U.S. CLS. 13, 21, 23, 31 AND 34).

FIRST USE 5-31-2007; IN COMMERCE 7-31-2007.

3,400,133. KOHLER CO., KOHLER, WI. SN 78-958,084. PUB. 10-2-2007, FILED 8-22-2006.

SOUTHHAVEN

THE MARK CONSISTS OF STANDARD CHARACTERS WITHOUT CLAIM TO ANY PARTICULAR FONT, STYLE, SIZE, OR COLOR.

OWNER OF U.S. REG. NOS. 2,182,297, 2,909,243, AND 3,158,740.

FOR SINKS (U.S. CLS. 13, 21, 23, 31 AND 34).
FIRST USE 7-1-2003; IN COMMERCE 7-1-2003.

CLASS 11—(Continued).

3,400,228. INTERNATIONAL GROWER'S SUPPLY INCORPORATED, CULVER CITY, CA. SN 78-979,713. PUB. 3-14-2006, FILED 11-17-2004.

DEAU PASSE

THE MARK CONSISTS OF STANDARD CHARACTERS WITHOUT CLAIM TO ANY PARTICULAR FONT, STYLE, SIZE, OR COLOR.

THE FOREIGN WORDING IN THE MARK TRANSLATES INTO ENGLISH AS "OF WATER PASSING".

FOR AIR PURIFYING EQUIPMENT NAMELY, CHARCOAL CARBON FILTERS FOR USE IN GREENHOUSES, HOUSES, DOG RUNS, AIR DUCTS, POWER VENTILATED AIR DUCTS, AND AIR FILTRATION DUCTS; AIR FILTER MACHINES FOR USE IN PLANT GROWING PROCESSES (U.S. CLS. 13, 21, 23, 31 AND 34).

FIRST USE 10-1-2007; IN COMMERCE 10-15-2007.

CLASS 12—VEHICLES

3,398,865. EDWARD L. PAXTON AND LLOYD M. PAXTON PARTNERSHIP, THE, SALEM, UT. SN 76-543,072. PUB. 5-24-2005, FILED 8-20-2003.

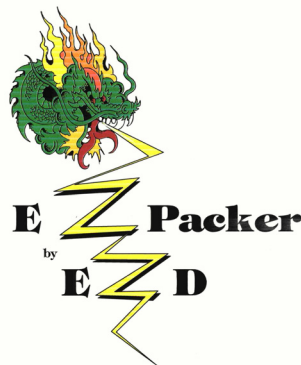

THE COLOR(S) ARE YELLOW, GREEN, RED, AND BLACK IS/ARE CLAIMED AS A FEATURE OF THE MARK.

THE MARK CONSISTS OF THE HEAD OF THE DRAGON HAS YELLOW, GREEN, RED WITH YELLOW LIGHTNING BOLT COMING FROM MOUTH TO FROM THE LETTER "Z" IN YELLOW BACKED IN BLACK WITH THE LETTERS "E Z PACKER BY E Z D" IN BLACK THE "Z" YELLOW WITH BLACK BACKING.

FOR INFLATABLE POONTOON BOAT ACCESSORIES, NAMELY, CARRIERS ATTACHED TO THE BACK OF VEHICLES AND WHEELS TO MOVE AROUND ON LAND BY HAND (U.S. CLS. 19, 21, 23, 31, 35 AND 44).

FIRST USE 5-21-2003; IN COMMERCE 5-21-2003.

CLASS 12—(Continued).

3,398,896. LYONS, ROBERT L., III, MIDLOTHIAN, IL. SN 76-628,759. PUB. 3-20-2007, FILED 1-21-2005.

SOUTHSIDE CHOPPERS

THE MARK CONSISTS OF STANDARD CHARACTERS WITHOUT CLAIM TO ANY PARTICULAR FONT, STYLE, SIZE, OR COLOR.

NO CLAIM IS MADE TO THE EXCLUSIVE RIGHT TO USE "CHOPPERS", APART FROM THE MARK AS SHOWN.

FOR CUSTOM BUILT MOTORCYCLES; MOTORCYCLE STRUCTURAL PARTS, NAMELY, FRAMES, BRAKE PEDALS, KICK STANDS, FILLER PANELS, BELT GUARDS, RISERS, RISER CAPS, FRONT ENDS, ROLLING CHASSIS, PRIMARY DRIVE COVERS, MOTORCYCLE HANDLEBARS; MOTORCYCLE GAS TANKS; MOTORCYCLE FENDERS; MOTORCYCLE FORKS; AND MOTORCYCLE WHEEL RIMS (U.S. CLS. 19, 21, 23, 31, 35 AND 44).

FIRST USE 11-1-2004; IN COMMERCE 11-1-2004.

3,398,901. F.TECH INCORPORATION, SAITAMA, JAPAN. SN 76-642,254. PUB. 10-24-2006, FILED 7-6-2005.



FOR AUTOMOBILES AND STRUCTURAL PARTS THEREFORE; TWO-WHEELED MOTOR VEHICLES AND THEIR STRUCTURAL PARTS THEREFORE; BICYCLES AND THEIR STRUCTURAL PARTS THEREFORE; MACHINE ELEMENTS FOR LAND VEHICLES, NAMELY, BODIES, CHASSIS, TORSION BARS, BUMPERS, COUPLINGS, SHOCK ABSORBERS, SUSPENSIONS, SHOCK ABSORBING SPRINGS, SUSPENSION SPRINGS, AXLE SHAFTS, CLUTCHES, BRAKES, AND ACCELERATOR PEDALS (U.S. CLS. 19, 21, 23, 31, 35 AND 44).

FIRST USE 6-5-2005; IN COMMERCE 6-5-2007.

CLASS 12—(Continued).

3,398,926. QINGDAO HUATIAN HAND TRUCK LTD., LLC, QINGDAO, CHINA. SN 76-661,625. PUB. 4-10-2007, FILED 6-15-2006.



HT tires

NO CLAIM IS MADE TO THE EXCLUSIVE RIGHT TO USE "TIRES", APART FROM THE MARK AS SHOWN.

FOR WHEELS FOR WHEELBARROWS, GARDEN CARTS, HANDTRUCKS AND LAWN MOWERS (U.S. CLS. 19, 21, 23, 31, 35 AND 44).

FIRST USE 11-30-2007; IN COMMERCE 11-30-2007.

3,398,949. AT CONCEPTS, INC., HOMER GLEN, IL. SN 76-668,356. PUB. 7-10-2007, FILED 11-1-2006.

LADDER LUGGER

NO CLAIM IS MADE TO THE EXCLUSIVE RIGHT TO USE "LADDER", APART FROM THE MARK AS SHOWN.

FOR MON-MOTORIZED WHEELED CART USED OF TRANSPORTING LONG OR OVERSIZED OBJECTS (U.S. CLS. 19, 21, 23, 31, 35 AND 44).

FIRST USE 10-10-2006; IN COMMERCE 10-10-2006.

3,399,129. RETROBELT USA, LLC, CHINO, CA. SN 77-072,957. PUB. 7-10-2007, FILED 12-28-2006.

RETROBELT USA

THE MARK CONSISTS OF STANDARD CHARACTERS WITHOUT CLAIM TO ANY PARTICULAR FONT, STYLE, SIZE, OR COLOR.

NO CLAIM IS MADE TO THE EXCLUSIVE RIGHT TO USE "USA", APART FROM THE MARK AS SHOWN.

FOR THREE POINT AND TWO POINT SEAT BELTS FOR USE IN CLASSIC AND VINTAGE VEHICLES (U.S. CLS. 19, 21, 23, 31, 35 AND 44).

FIRST USE 3-19-2007; IN COMMERCE 3-19-2007.

CLASS 12—(Continued).

3,399,144. ON SITE CONCRETE INC., SACRAMENTO, CA. SN 77-080,320. PUB. 8-28-2007, FILED 1-10-2007.



NO CLAIM IS MADE TO THE EXCLUSIVE RIGHT TO USE "CONCRETE", APART FROM THE MARK AS SHOWN. FOR CONCRETE MIXING TRUCKS AND TRAILERS FOR USE AT OR ON THE JOB SITE (U.S. CLS. 19, 21, 23, 31, 35 AND 44).

FIRST USE 4-1-2006; IN COMMERCE 4-1-2006.

3,399,237. THE BRAUN CORPORATION, WINAMAC, IN. SN 77-123,796. PUB. 6-26-2007, FILED 3-6-2007.

BRAUNABILITY

THE MARK CONSISTS OF STANDARD CHARACTERS WITHOUT CLAIM TO ANY PARTICULAR FONT, STYLE, SIZE, OR COLOR.

FOR MOBILITY PRODUCTS AND RELATED ACCESSORIES FOR THE HANDICAPPED, NAMELY, WHEELCHAIR LIFTS FOR VEHICLES, INCLUDING TRUCKS, VANS, MINIVANS, MOTOR HOMES, BUSES, AND PUBLIC TRANSPORTATION AND STRUCTURAL PARTS THEREFOR; SEAT BASES, POWER SEATS, COMPANION SEATS; DOOR OPERATORS, ELECTRONIC CONTROLLERS FOR WHEELCHAIR LIFTS AND RAMPS, MAGNETIC SWITCHING APPARATUS FOR LOWERED FLOOR MINIVANS; VEHICLE TOP-MOUNTED WHEELCHAIR CARRIERS; HAND CONTROLS FOR THE OPERATION OF WHEELCHAIR LIFTS AND RAMPS; POWER TRANSFER SEATS FOR VEHICLES TO PROVIDE EASIER INGRESS TO AND EGRESS FROM A VEHICLE FOR DISABLED OR MOBILITY IMPAIRED PEOPLE; LAND VEHICLES, NAMELY, AUTOMOBILES, MOTOR HOMES, VANS, MINIVANS AND BUSES FEATURING LOWERED FLOORS AND LEVEL-CHANGE DEVICES TO FACILITATE INGRESS AND EGRESS FOR PASSENGERS IN WHEELCHAIRS, AND STRUCTURAL PARTS AND FITTINGS FOR THE AFORESAID; LIFTING INSTALLATIONS, NAMELY, LIFTING APPARATUS FOR VEHICLES FOR STORING WHEELCHAIRS IN ROOF-TOP CARRIERS (U.S. CLS. 19, 21, 23, 31, 35 AND 44).

FIRST USE 10-1-2007; IN COMMERCE 10-1-2007.

CLASS 12—(Continued).

3,399,361. FORD MOTOR COMPANY, DEARBORN, MI. SN 78-362,223. PUB. 9-14-2004, FILED 2-4-2004.

MERCURY MILAN

THE MARK CONSISTS OF STANDARD CHARACTERS WITHOUT CLAIM TO ANY PARTICULAR FONT, STYLE, SIZE, OR COLOR.

FOR MOTOR VEHICLES, NAMELY, AUTOMOBILES (U.S. CLS. 19, 21, 23, 31, 35 AND 44).

FIRST USE 2-9-2005; IN COMMERCE 2-9-2005.

3,399,575. BENEFICIAL DESIGNS, INC., MINDEN, NV. SN 78-673,912. PUB. 4-4-2006, FILED 7-19-2005.

FlexRim

THE MARK CONSISTS OF STANDARD CHARACTERS WITHOUT CLAIM TO ANY PARTICULAR FONT, STYLE, SIZE, OR COLOR.

FOR WHEELS FOR WHEELCHAIRS (U.S. CLS. 19, 21, 23, 31, 35 AND 44).

FIRST USE 9-18-2007; IN COMMERCE 9-18-2007.

CLASS 12—(Continued).

3,399,707. CAMPAGNOLO S.R.L., VICENZA, ITALY. SN 78-765,342. PUB. 11-14-2006, FILED 12-2-2005.

KHAMSIN

THE MARK CONSISTS OF STANDARD CHARACTERS WITHOUT CLAIM TO ANY PARTICULAR FONT, STYLE, SIZE, OR COLOR.

FOR BICYCLES; BICYCLE PARTS, COMPONENTS AND ACCESSORIES, NAMELY, BICYCLE FRAMES, TUBES AND CONNECTORS FOR BICYCLE FRAMES, BICYCLE WHEELS, RIMS AND SPOKES FOR BICYCLE WHEELS, PEDALS, HUBS, FAST-LOCKING APPARATUS, NAMELY, WHEEL HUBS FEATURING QUICK RELEASE SKEWERS CONTROLLED BY CAM LEVERS FOR FAST LOCKING OF SAME, CHANGE-SPEED GEARS AND FRONT CHANGERS, CRANKS, SIMPLE AND MULTIPLE GEAR WHEELS, CRANKS WITH GEAR WHEELS, DERAILLEURS, CRANKS, SIMPLE AND MULTIPLE GEAR WHEELS, CRANKS WITH GEAR WHEELS, GEARS, FREE WHEELS, DRIVE CHAINS, BRAKES, DRIVE AND CONTROL APPARATUS FOR CHANGE-SPEED GEARS, DERAILLEURS AND BRAKES, CABLE GUIDES, KNOBS, CONTROLS AND LEVERS, PILLARS AND SADDLES, PUMPS AND PUMP BEARINGS, PINS AND BEARINGS FOR CRANKS AND PEDALS, STEERING KNUCKLES AND BEARINGS AND BUSHES THEREFOR, FRONT AND BACK FORKS, CABLES AND SHEATHES, FASTENING CLIPS, CENTRAL MOVEMENT CASES, HANDLE-BAR CONNECTIONS AND HANDLE-BARS, FORKS AND CUSHIONED FORKS, KICKSTANDS, BICYCLE STANDS, TIRES AND TUBULAR TIRES, INNER TUBES, TIRES FOR BICYCLES, ALL FOR BICYCLES (U.S. CLS. 19, 21, 23, 31, 35 AND 44).

FIRST USE 4-27-2006; IN COMMERCE 5-17-2006.

3,399,769. PHY-CON INC., OAK LAWN, IL. SN 78-790,024. PUB. 3-20-2007, FILED 1-12-2006.

SpareGuard

THE MARK CONSISTS OF STANDARD CHARACTERS WITHOUT CLAIM TO ANY PARTICULAR FONT, STYLE, SIZE, OR COLOR.

FOR ANTI-THEFT DEVICE FOR USE WITH AUTOMOBILE SPARE TIRES (U.S. CLS. 19, 21, 23, 31, 35 AND 44).

FIRST USE 12-0-2006; IN COMMERCE 7-18-2007.

CLASS 12—(Continued).

3,399,776. CHINA NATIONAL AERO-TECHNOLOGY IMP. & EXP. GUANGZHOU CORPORATION, DONGSHAN, GUANGZHOU, CHINA. SN 78-793,491. PUB. 4-10-2007, FILED 1-18-2006.



THE COLOR(S) RED, ORANGE, YELLOW, AND BLACK IS/ARE CLAIMED AS A FEATURE OF THE MARK.

THE COLOR RED APPEARS IN THE LOWER PORTION OF THE HORIZONTAL BARS AND IN THE STYLIZED LETTER "T". THE COLOR ORANGE APPEARS IN THE UPPER HORIZONTAL BAR, THE ORANGE CHANGING TO YELLOW AT THE NARROW END OF THE BAR, AND THE COLOR BLACK APPEARS IN THE LETTERS "ONARO" AND IN THE OUTLINE OF THE LOWER PORTION OF THE STYLIZED LETTER "T".

FOR VEHICLES, NAMELY, ELECTRIC CARS, MOTORIZED GOLF CARTS, ALL TERRAIN VEHICLES (ATV'S), RECREATIONAL VEHICLES, NAMELY, CAMPER, RAILWAY CARS, AUTOMOBILES, CAMPER SHELLS, TRAILER HITCHES, MOTORCYCLES, BABY CARRIAGES, HANDCARTS WITH WHEELS AND WHEELCHAIRS (U.S. CLS. 19, 21, 23, 31, 35 AND 44).

FIRST USE 2-1-2004; IN COMMERCE 8-1-2006.

3,399,785. CONTINENTAL AUTOMOTIVE LICENSING CORP., AUBURN HILLS, MI. SN 78-795,604. PUB. 9-12-2006, FILED 1-20-2006.

S371

THE MARK CONSISTS OF STANDARD CHARACTERS WITHOUT CLAIM TO ANY PARTICULAR FONT, STYLE, SIZE, OR COLOR.

FOR TIRES (U.S. CLS. 19, 21, 23, 31, 35 AND 44).

FIRST USE 9-26-2006; IN COMMERCE 9-26-2006.

CLASS 12—(Continued).

3,399,804. CONTAINER YACHTS LLC, BUFFALO, NY. SN 78-800,363. PUB. 4-10-2007, FILED 1-26-2006.

FAR HARBOUR 39

THE MARK CONSISTS OF STANDARD CHARACTERS WITHOUT CLAIM TO ANY PARTICULAR FONT, STYLE, SIZE, OR COLOR.

NO CLAIM IS MADE TO THE EXCLUSIVE RIGHT TO USE "39", APART FROM THE MARK AS SHOWN. FOR BOAT (U.S. CLS. 19, 21, 23, 31, 35 AND 44). FIRST USE 10-18-2007; IN COMMERCE 10-18-2007.

3,399,805. CONTAINER YACHTS LLC, BUFFALO, NY. SN 78-800,385. PUB. 4-10-2007, FILED 1-26-2006.

FH 39

THE MARK CONSISTS OF STANDARD CHARACTERS WITHOUT CLAIM TO ANY PARTICULAR FONT, STYLE, SIZE, OR COLOR.

NO CLAIM IS MADE TO THE EXCLUSIVE RIGHT TO USE "39", APART FROM THE MARK AS SHOWN. FOR BOAT (U.S. CLS. 19, 21, 23, 31, 35 AND 44). FIRST USE 10-18-2007; IN COMMERCE 10-18-2007.

3,399,852. OSHKOSH TRUCK CORPORATION, OSHKOSH, WI. SN 78-819,569. PUB. 4-17-2007, FILED 2-21-2006.

OSHKOSH

THE MARK CONSISTS OF STANDARD CHARACTERS WITHOUT CLAIM TO ANY PARTICULAR FONT, STYLE, SIZE, OR COLOR.

OWNER OF U.S. REG. NOS. 840,787 AND 1,194,281. SEC. 2(F). FOR LAND VEHICLES, NAMELY, TACTICAL WHEELED VEHICLES FOR ON AND OFF-ROAD APPLICATIONS (U.S. CLS. 19, 21, 23, 31, 35 AND 44). FIRST USE 9-30-1976; IN COMMERCE 9-30-1976.

CLASS 12—(Continued).

3,400,027. MONAHAN PRODUCTS, LLC, ROCKLAND, MA. SN 78-917,520. PUB. 9-12-2006, FILED 6-27-2006.



NO CLAIM IS MADE TO THE EXCLUSIVE RIGHT TO USE "BABY", APART FROM THE MARK AS SHOWN.

THE COLOR(S) WHITE AND ORANGE IS/ARE CLAIMED AS A FEATURE OF THE MARK.

THE MARK CONSISTS OF WHITE LETTERING WITH AN ORANGE BACKGROUND AND ORANGE FLOWER ABOVE THE FIRST "B".

FOR BABY STROLLERS (U.S. CLS. 19, 21, 23, 31, 35 AND 44). FIRST USE 9-10-2006; IN COMMERCE 9-10-2006.

3,400,041. BROCK WELD, CERRITOS, CA. SN 78-922,899. PUB. 7-31-2007, FILED 7-5-2006.

BMF WHEELS

THE MARK CONSISTS OF STANDARD CHARACTERS WITHOUT CLAIM TO ANY PARTICULAR FONT, STYLE, SIZE, OR COLOR.

NO CLAIM IS MADE TO THE EXCLUSIVE RIGHT TO USE "WHEELS", APART FROM THE MARK AS SHOWN. FOR LAND VEHICLES PARTS, NAMELY, WHEELS (U.S. CLS. 19, 21, 23, 31, 35 AND 44). FIRST USE 5-1-2007; IN COMMERCE 10-1-2007.

3,400,066. CHENG SHIN RUBBER USA, INC., SUWANEE, GA. SN 78-937,846. PUB. 3-6-2007, FILED 7-26-2006.

MA-Z4S

THE MARK CONSISTS OF STANDARD CHARACTERS WITHOUT CLAIM TO ANY PARTICULAR FONT, STYLE, SIZE, OR COLOR.

FOR TIRES (U.S. CLS. 19, 21, 23, 31, 35 AND 44). FIRST USE 7-0-2007; IN COMMERCE 7-0-2007.

CLASS 12—(Continued).

3,400,103. SCHWINN ACQUISITION, LLC, MADISON, WI.
SN 78-951,023. PUB. 4-3-2007, FILED 8-13-2006.

WORLD

THE MARK CONSISTS OF STANDARD CHARACTERS
WITHOUT CLAIM TO ANY PARTICULAR FONT, STYLE,
SIZE, OR COLOR.

FOR BICYCLES AND ELECTRIC BICYCLES (U.S. CLS.
19, 21, 23, 31, 35 AND 44).
FIRST USE 11-0-2007; IN COMMERCE 11-0-2007.

3,400,191. REINOSO RODRIGUEZ, CESAR TULLIO, BOGO-
TA, COLOMBIA. SN 78-970,837. PUB. 4-24-2007, FILED 9-
10-2006.

INR

THE MARK CONSISTS OF STANDARD CHARACTERS
WITHOUT CLAIM TO ANY PARTICULAR FONT, STYLE,
SIZE, OR COLOR.

FOR LAND VEHICLES; LAND VEHICLE PARTS,
NAMELY, SUSPENSION BUSHINGS; WHEEL RIMS;
PNEUMATIC TYRES (U.S. CLS. 19, 21, 23, 31, 35 AND
44).

FIRST USE 12-31-1996; IN COMMERCE 12-31-2004.

CLASS 13—FIREARMS

3,399,661. AUSTIN POWDER COMPANY, CLEVELAND, OH.
SN 78-745,576. PUB. 8-15-2006, FILED 11-2-2005.

E*STAR

THE MARK CONSISTS OF STANDARD CHARACTERS
WITHOUT CLAIM TO ANY PARTICULAR FONT, STYLE,
SIZE, OR COLOR.

OWNER OF U.S. REG. NOS. 1,497,635, 1,555,697, AND
OTHERS.

FOR DETONATORS (U.S. CLS. 2 AND 9).
FIRST USE 5-0-2007; IN COMMERCE 5-0-2007.

CLASS 14—JEWELRY**CLASS 14—(Continued).**

3,398,957. WALGREEN CO., DEERFIELD, IL. SN 76-673,661.
PUB. 7-24-2007, FILED 3-6-2007.

THE PURE CRYSTAL COLLECTION

THE MARK CONSISTS OF STANDARD CHARACTERS
WITHOUT CLAIM TO ANY PARTICULAR FONT, STYLE,
SIZE, OR COLOR.

NO CLAIM IS MADE TO THE EXCLUSIVE RIGHT TO
USE "CRYSTAL COLLECTION", APART FROM THE MARK
AS SHOWN.

FOR JEWELRY (U.S. CLS. 2, 27, 28 AND 50).
FIRST USE 9-12-2007; IN COMMERCE 9-12-2007.

3,398,997. INVICTA WATCH COMPANY OF AMERICA,
INC., HOLLYWOOD, FL. SN 77-009,797. PUB. 5-15-2007,
FILED 9-28-2006.

TECHNOFIBER

THE MARK CONSISTS OF STANDARD CHARACTERS
WITHOUT CLAIM TO ANY PARTICULAR FONT, STYLE,
SIZE, OR COLOR.

FOR WATCH BANDS AND STRAPS; WATCHES (U.S.
CLS. 2, 27, 28 AND 50).

FIRST USE 2-15-2007; IN COMMERCE 2-15-2007.

3,399,032. THE RED RIBBON FOUNDATION, INC, GREEN-
WICH, CT. SN 77-029,192. PUB. 5-8-2007, FILED 10-25-2006.

RED RIBBON EMBRACELET

THE MARK CONSISTS OF STANDARD CHARACTERS
WITHOUT CLAIM TO ANY PARTICULAR FONT, STYLE,
SIZE, OR COLOR.

FOR CHARITY BRACELETS (U.S. CLS. 2, 27, 28 AND
50).

FIRST USE 10-24-2006; IN COMMERCE 10-24-2006.

CLASS 14—(Continued).

3,399,285. UNITED COLOR GEMS, INC., NEW YORK, NY. SN 77-153,256. PUB. 10-9-2007, FILED 4-10-2007.

CLASS 14—(Continued).

3,399,662. RUBIN, STEPHAN R., NEW YORK, NY. SN 78-745,580. PUB. 8-15-2006, FILED 11-2-2005.

UCG

THE MARK CONSISTS OF STANDARD CHARACTERS WITHOUT CLAIM TO ANY PARTICULAR FONT, STYLE, SIZE, OR COLOR.

FOR JEWELRY (U.S. CLS. 2, 27, 28 AND 50).
FIRST USE 3-5-2007; IN COMMERCE 3-5-2007.

WHAT WOULD BUDDHA DO?

THE MARK CONSISTS OF STANDARD CHARACTERS WITHOUT CLAIM TO ANY PARTICULAR FONT, STYLE, SIZE, OR COLOR.

FOR JEWELRY (U.S. CLS. 2, 27, 28 AND 50).
FIRST USE 10-29-2007; IN COMMERCE 10-29-2007.

3,399,482. WIN SUN JEWELLERY COMPANY LIMITED, TSIMSHATSUI EAST, KOWLOON, HONG KONG. SN 78-580,003. PUB. 2-28-2006, FILED 3-4-2005.

3,399,738. THE HERFF JONES COMPANY OF INDIANA, INC., INDIANAPOLIS, IN. SN 78-777,356. PUB. 11-7-2006, FILED 12-20-2005.

Ma Choisie

THE FOREIGN WORDING IN THE MARK TRANSLATES INTO ENGLISH AS "MY CHOICE".

FOR JEWELLERY, BODY JEWELLERY, PEARLS, JEWELLERY MOUNTED WITH PEARLS AND OTHER PRECIOUS STONES, PEARL NECKLACES, PRECIOUS STONES, CUFF-LINKS, TIE CLIPS, RINGS, BRACELETS, EARRINGS, NECKLACES, BROOCHES; CLOCKS, WATCHES, HOROLOGICAL AND CHRONOMETRIC INSTRUMENTS (U.S. CLS. 2, 27, 28 AND 50).

FIRST USE 10-17-2006; IN COMMERCE 10-17-2006.

CRIMSON GOLD

THE MARK CONSISTS OF STANDARD CHARACTERS WITHOUT CLAIM TO ANY PARTICULAR FONT, STYLE, SIZE, OR COLOR.

NO CLAIM IS MADE TO THE EXCLUSIVE RIGHT TO USE "GOLD", APART FROM THE MARK AS SHOWN.

FOR JEWELRY; JEWELRY FINDINGS; WATCHES (U.S. CLS. 2, 27, 28 AND 50).

FIRST USE 1-11-2006; IN COMMERCE 1-11-2006.

3,399,660. RUBIN, STEPHAN R., NEW YORK, NY. SN 78-745,574. PUB. 8-15-2006, FILED 11-2-2005.

3,399,831. DANGLER, PAUL J., SARASOTA, FL. SN 78-812,255. PUB. 10-3-2006, FILED 2-10-2006.

WWBD

THE MARK CONSISTS OF STANDARD CHARACTERS WITHOUT CLAIM TO ANY PARTICULAR FONT, STYLE, SIZE, OR COLOR.

FOR JEWELRY (U.S. CLS. 2, 27, 28 AND 50).
FIRST USE 10-29-2007; IN COMMERCE 10-29-2007.

dangler studios

THE MARK CONSISTS OF STANDARD CHARACTERS WITHOUT CLAIM TO ANY PARTICULAR FONT, STYLE, SIZE, OR COLOR.

NO CLAIM IS MADE TO THE EXCLUSIVE RIGHT TO USE "STUDIOS", APART FROM THE MARK AS SHOWN.

FOR JEWELRY (U.S. CLS. 2, 27, 28 AND 50).
FIRST USE 1-1-2000; IN COMMERCE 1-1-2000.

CLASS 14—(Continued).

3,399,939. GRAPHILUX INTERNATIONAL S.A., LUXEMBOURG, LUXEMBOURG. SN 78-860,432. PUB. 12-26-2006, FILED 4-12-2006.

CRYSTAL-BIBLE

THE MARK CONSISTS OF STANDARD CHARACTERS WITHOUT CLAIM TO ANY PARTICULAR FONT, STYLE, SIZE, OR COLOR.

FOR WATCHES; JEWELRY, NAMELY, RINGS, CHAINS, PENDANTS, BROOCHES, CUFF LINKS, TIE PINS (U.S. CLS. 2, 27, 28 AND 50).

FIRST USE 5-30-2006; IN COMMERCE 5-30-2006.

3,399,978. CORD, BARRY STEVEN, NEW YORK, NY. SN 78-883,247. PUB. 12-26-2006, FILED 5-15-2006.

CROCODILEHALL

THE MARK CONSISTS OF STANDARD CHARACTERS WITHOUT CLAIM TO ANY PARTICULAR FONT, STYLE, SIZE, OR COLOR.

FOR ARTICLES MADE WHOLLY OR IN PART OF PRECIOUS METALS, NAMELY, RINGS, EARRINGS, NECKLACES, BRACELETS, PENDANTS, WATCHES, CUFF LINKS, CIGARETTE LIGHTERS AND BELT BUCKLES (U.S. CLS. 2, 27, 28 AND 50).

FIRST USE 6-15-2006; IN COMMERCE 6-15-2006.

3,400,052. MOVADO LLC, WILMINGTON, DE. SN 78-931,644. PUB. 2-20-2007, FILED 7-18-2006.

SOLIRI

THE MARK CONSISTS OF STANDARD CHARACTERS WITHOUT CLAIM TO ANY PARTICULAR FONT, STYLE, SIZE, OR COLOR.

FOR JEWELRY (U.S. CLS. 2, 27, 28 AND 50).
FIRST USE 6-20-2007; IN COMMERCE 6-20-2007.

CLASS 14—(Continued).

3,400,207. GAMBILL, SHANNON, LOUISVILLE, KY. SN 78-978,712. PUB. 8-29-2006, FILED 11-1-2005.

CRITTER CRUSADE

THE MARK CONSISTS OF STANDARD CHARACTERS WITHOUT CLAIM TO ANY PARTICULAR FONT, STYLE, SIZE, OR COLOR.

FOR CHILDREN'S TRINKETS, NAMELY, NECKLACES, BRACELETS AND ANKLE BRACELETS, FOR WEAR AROUND THE NECK, ANKLES AND WRISTS; BELT BUCKLES OF PRECIOUS METAL (U.S. CLS. 2, 27, 28 AND 50).

FIRST USE 6-24-2005; IN COMMERCE 6-24-2005.

CLASS 15—MUSICAL INSTRUMENTS

3,399,236. CAGAN, LEIGH DAVID, SAN JOSE, CA. SN 77-123,639. PUB. 9-11-2007, FILED 3-6-2007.

Crosscut Custom Guitars

THE MARK CONSISTS OF STANDARD CHARACTERS WITHOUT CLAIM TO ANY PARTICULAR FONT, STYLE, SIZE, OR COLOR.

NO CLAIM IS MADE TO THE EXCLUSIVE RIGHT TO USE "CUSTOM GUITARS", APART FROM THE MARK AS SHOWN.

FOR GUITARS (U.S. CLS. 2, 21 AND 36).

FIRST USE 4-12-2007; IN COMMERCE 7-6-2007.

3,399,260. MPG BASS GUITARS, COLORADO SPRINGS, CO. SN 77-139,610. PUB. 10-2-2007, FILED 3-24-2007.

THE MARK CONSISTS OF THE STYLIZED LETTERING "MPG".

FOR BASS GUITARS; ELECTRIC BASSES; ELECTRIC GUITARS; GUITARS; MUSICAL INSTRUMENTS, NAMELY, BASS GUITARS (U.S. CLS. 2, 21 AND 36).
FIRST USE 5-1-2006; IN COMMERCE 8-1-2006.

CLASS 15—(Continued).

3,399,484. YOUNG CHANG AKKI CO, LTD., INCHEON, REPUBLIC OF KOREA. SN 78-581,809. PUB. 12-19-2006, FILED 3-7-2005.



OWNER OF U.S. REG. NO. 2,194,811.
NO CLAIM IS MADE TO THE EXCLUSIVE RIGHT TO USE "SINCE 1852", APART FROM THE MARK AS SHOWN. "THE NAME(S), PORTRAIT(S), AND/OR SIGNATURE(S) SHOWN IN THE MARK DOES NOT IDENTIFY A PARTICULAR LIVING INDIVIDUAL."

THE MARK CONSISTS OF THE WORDING ALBERT WEBER ON ONE LINE AND SINCE 1852 UNDERNEATH A CIRCULAR DESIGN FEATURE. THE CIRCULAR DESIGN FEATURE IS A MEDALLION ON WHICH ARE EMBOSSED TWO STALKS OF GRAIN FORMING A CIRCLE INSIDE OF WHICH IS A BIRD-LIKE IMAGE.

FOR MUSICAL INSTRUMENTS, NAMELY, PIANOS, ORGANS, HARMONICAS AND GUITARS; AND ELECTRIC MUSICAL INSTRUMENTS, NAMELY, DIGITAL PIANOS, SYNTHESIZERS, AND KEYBOARDS (U.S. CLS. 2, 21 AND 36).

FIRST USE 5-12-2005; IN COMMERCE 5-12-2005.

CLASS 15—(Continued).

3,400,062. JACK DANIEL'S PROPERTIES, INC., SAN RAFAEL, CA. SN 78-936,416. PUB. 3-6-2007, FILED 7-24-2006.



OWNER OF U.S. REG. NOS. 1,290,702, 2,898,085, AND OTHERS.

NO CLAIM IS MADE TO THE EXCLUSIVE RIGHT TO USE "BRAND", APART FROM THE MARK AS SHOWN.

THE NAME(S), PORTRAIT(S), AND/OR SIGNATURE(S) SHOWN IN THE MARK DOES NOT IDENTIFY A PARTICULAR LIVING INDIVIDUAL.

THE MARK CONSISTS OF THE WORDS "JACK DANIEL'S" ARCHED OVER THE WORDS AND NUMERAL "OLD NO 7 BRAND" INSIDE A CIRCLE; THE "O" IN THE WORD "NO" IS UNDERLINED.

FOR GUITAR STRAPS (U.S. CLS. 2, 21 AND 36).
FIRST USE 10-7-2004; IN COMMERCE 10-7-2004.

CLASS 16—PAPER GOODS AND PRINTED MATTER

3,398,859. MUSE IMAGERY, LLC, LAS VEGAS, NV. SN 76-505,627. PUB. 7-6-2004, FILED 4-10-2003.

SETS SPIRITUALLY ENLIGHTENING THOUGHTS**JACK DANIEL'S**

THE MARK CONSISTS OF STANDARD CHARACTERS WITHOUT CLAIM TO ANY PARTICULAR FONT, STYLE, SIZE, OR COLOR.

OWNER OF U.S. REG. NOS. 1,290,702, 2,898,085, AND OTHERS.

THE NAME(S), PORTRAIT(S), AND/OR SIGNATURE(S) SHOWN IN THE MARK DOES NOT IDENTIFY A PARTICULAR LIVING INDIVIDUAL.

FOR GUITARS, GUITAR PICKS (U.S. CLS. 2, 21 AND 36).
FIRST USE 4-15-2004; IN COMMERCE 4-15-2004.

THE MARK CONSISTS OF STANDARD CHARACTERS WITHOUT CLAIM TO ANY PARTICULAR FONT, STYLE, SIZE, OR COLOR.

FOR BOOKS ON RELIGION, PERSONAL GROWTH AND SELF-MOTIVATION, MAGAZINES ON RELIGION, PERSONAL GROWTH AND SELF-MOTIVATION, PERIODICALS ON RELIGION, PERSONAL GROWTH AND SELF-MOTIVATION, PRINTED MATERIALS, NAMELY, WORKBOOKS, OUTLINES, AND JOURNALS ON RELIGION, PERSONAL GROWTH AND SELF-MOTIVATION, STATIONERY, NOTE CARDS, NOTE PADS, NOTE PAPER, CALENDARS, APPOINTMENTS BOOKS, ADDRESS BOOKS, POSTERS, PHOTOGRAPHIC PRINTS, CHILDREN'S ACTIVITY BOOK (U.S. CLS. 2, 5, 22, 23, 29, 37, 38 AND 50).

FIRST USE 11-0-2003; IN COMMERCE 11-0-2003.

CLASS 16—(Continued).

3,398,860. J.S. ENGLISH CO., CHAGRIN FALLS, OH. SN 76-507,491. PUB. 8-17-2004, FILED 4-17-2003.

BIBLE IN A NUTSHELL

NO CLAIM IS MADE TO THE EXCLUSIVE RIGHT TO USE "BIBLE", APART FROM THE MARK AS SHOWN.

FOR PRINTED BIBLE SUMMARIES, STORIES AND READINGS CONTAINED IN NUT-SHAPED CONTAINERS (U.S. CLS. 2, 5, 22, 23, 29, 37, 38 AND 50).

FIRST USE 11-8-2007; IN COMMERCE 11-8-2007.

3,398,905. WOODESSEN, INC., HUNTINGTON BEACH, CA. SN 76-645,809. PUB. 6-13-2006, FILED 8-29-2005.

WOODESSEN

THE MARK CONSISTS OF STANDARD CHARACTERS WITHOUT CLAIM TO ANY PARTICULAR FONT, STYLE, SIZE, OR COLOR.

FOR DESK SETS, NAMELY, PAPER HOLDERS, STATIONERY HOLDERS, TRAYS, TIDY IN THE NATURE OF A DESKTOP ORGANIZER, CALENDAR HOLDERS, PENHOLDERS AND GLOBES (U.S. CLS. 2, 5, 22, 23, 29, 37, 38 AND 50).

FIRST USE 1-13-2006; IN COMMERCE 3-15-2006.

3,398,919. KOTOBUKI & CO., LTD., SAITAMA-KEN, JAPAN. SN 76-656,458. PUB. 10-24-2006, FILED 3-13-2006.

TRIFIT

THE MARK CONSISTS OF STANDARD CHARACTERS WITHOUT CLAIM TO ANY PARTICULAR FONT, STYLE, SIZE, OR COLOR.

FOR WRITING INSTRUMENTS (U.S. CLS. 2, 5, 22, 23, 29, 37, 38 AND 50).

FIRST USE 10-23-2001; IN COMMERCE 1-21-2002.

CLASS 16—(Continued).

3,398,935. BEYOND MASK, INC., WASHINGTON, DC. SN 76-664,542. PUB. 9-18-2007, FILED 8-14-2006.

PRISM OF CONSCIOUSNESS

THE MARK CONSISTS OF STANDARD CHARACTERS WITHOUT CLAIM TO ANY PARTICULAR FONT, STYLE, SIZE, OR COLOR.

FOR PRINTED EDUCATIONAL MATERIALS, NAMELY, ARTICLES, PRINTED INSTRUCTIONAL MATERIALS AND CHECKLISTS ON THE SUBJECT OF IDENTIFYING THE LEVEL OF CONSCIOUSNESS OF PERSONS PARTICIPATING IN CREATIVE ARTS AND CREATIVE ARTS THERAPY TRAINING FOR THE ENHANCEMENT OF INTEGRATION, PERSONAL AND SPIRITUAL GROWTH (U.S. CLS. 2, 5, 22, 23, 29, 37, 38 AND 50).

FIRST USE 12-14-2007; IN COMMERCE 12-14-2007.

3,398,990. SHAH, MITAL MAHESH, WESTFORD, MA. SN 77-008,217. PUB. 5-22-2007, FILED 9-27-2006.

well-souled

THE MARK CONSISTS OF STANDARD CHARACTERS WITHOUT CLAIM TO ANY PARTICULAR FONT, STYLE, SIZE, OR COLOR.

FOR COFFEE TABLE BOOKS FEATURING FASHION, STYLE, CULTURE, TOURISM AND SPORTING (U.S. CLS. 2, 5, 22, 23, 29, 37, 38 AND 50).

FIRST USE 9-1-2007; IN COMMERCE 9-12-2007.

3,399,002. ROARING SPRING BLANK BOOK CO., ROARING SPRING, PA. SN 77-012,503. PUB. 5-15-2007, FILED 10-3-2006.

ALWAYS COOL

THE MARK CONSISTS OF STANDARD CHARACTERS WITHOUT CLAIM TO ANY PARTICULAR FONT, STYLE, SIZE, OR COLOR.

FOR NOTEBOOKS (U.S. CLS. 2, 5, 22, 23, 29, 37, 38 AND 50).

FIRST USE 1-0-2007; IN COMMERCE 1-0-2007.

CLASS 16—(Continued).

3,399,030. FUNKY DARLIN', LLC, ANDALUSIA, AL. SN 77-028,519. PUB. 5-29-2007, FILED 10-24-2006.

FUNKY DARLIN'

THE MARK CONSISTS OF STANDARD CHARACTERS WITHOUT CLAIM TO ANY PARTICULAR FONT, STYLE, SIZE, OR COLOR.

FOR ARTWORK, PAINTINGS AND CARDS, NAMELY, ORIGINAL WATERCOLOR PAINTINGS, PRINTS CONTAINING SCANNED IMAGES OF ORIGINAL WATERCOLOR PAINTINGS, GICLEE PRINTS OF ORIGINAL WATERCOLOR PAINTINGS, AND CARDS IMPRINTED WITH SCANNED IMAGES OF ORIGINAL WATERCOLOR PAINTINGS (U.S. CLS. 2, 5, 22, 23, 29, 37, 38 AND 50).

FIRST USE 7-14-2007; IN COMMERCE 7-14-2007.

3,399,061. TESKY, STEPHEN V., RIO RANCHO, NM. SN 77-040,569. PUB. 6-12-2007, FILED 11-9-2006.

T's Diner

THE MARK CONSISTS OF STANDARD CHARACTERS WITHOUT CLAIM TO ANY PARTICULAR FONT, STYLE, SIZE, OR COLOR.

FOR COMIC STRIPS (U.S. CLS. 2, 5, 22, 23, 29, 37, 38 AND 50).

FIRST USE 10-19-2007; IN COMMERCE 10-19-2007.

3,399,081. SPLAT*R KATCH*R, INC., TAMPA, FL. SN 77-050,870. PUB. 6-19-2007, FILED 11-27-2006.

SPLAT*R KATCH*R

THE MARK CONSISTS OF STANDARD CHARACTERS WITHOUT CLAIM TO ANY PARTICULAR FONT, STYLE, SIZE, OR COLOR.

FOR PAPER DROP CLOTHS (U.S. CLS. 2, 5, 22, 23, 29, 37, 38 AND 50).

FIRST USE 10-27-2006; IN COMMERCE 1-9-2008.

CLASS 16—(Continued).

3,399,082. SPLAT*R KATCH*R, INC., TAMPA, FL. SN 77-050,879. PUB. 6-19-2007, FILED 11-27-2006.

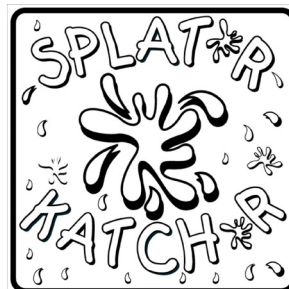

THE MARK CONSISTS OF THE WORDS "SPLAT*R KATCH*R" SURROUNDED BY AMORPHOUS SHAPES.

FOR PAPER DROP CLOTHS (U.S. CLS. 2, 5, 22, 23, 29, 37, 38 AND 50).

FIRST USE 10-27-2006; IN COMMERCE 1-9-2008.

3,399,088. STEINMEYER, NANCY L., BULL VALLEY, IL. SN 77-054,927. PUB. 7-24-2007, FILED 12-1-2006.

Global Warming Warriors

THE MARK CONSISTS OF STANDARD CHARACTERS WITHOUT CLAIM TO ANY PARTICULAR FONT, STYLE, SIZE, OR COLOR.

NO CLAIM IS MADE TO THE EXCLUSIVE RIGHT TO USE "GLOBAL WARMING", APART FROM THE MARK AS SHOWN.

FOR PAPER BADGES; PRINTED INSTRUCTIONAL, EDUCATIONAL, AND TEACHING MATERIALS IN THE FIELD OF GLOBAL WARMING (U.S. CLS. 2, 5, 22, 23, 29, 37, 38 AND 50).

FIRST USE 2-6-2007; IN COMMERCE 10-23-2007.

3,399,157. FIRSTMERIT CORPORATION, AKRON, OH. SN 77-087,681. PUB. 6-12-2007, FILED 1-22-2007.

FUTURE VALUES

THE MARK CONSISTS OF STANDARD CHARACTERS WITHOUT CLAIM TO ANY PARTICULAR FONT, STYLE, SIZE, OR COLOR.

FOR MAGAZINES FEATURING BANKING SERVICES (U.S. CLS. 2, 5, 22, 23, 29, 37, 38 AND 50).

FIRST USE 1-1-2007; IN COMMERCE 1-1-2007.

CLASS 16—(Continued).

3,399,171. SCHOLASTIC INC., NEW YORK, NY. SN 77-096,679. PUB. 8-7-2007, FILED 2-1-2007.

WORD FORWARD

THE MARK CONSISTS OF STANDARD CHARACTERS WITHOUT CLAIM TO ANY PARTICULAR FONT, STYLE, SIZE, OR COLOR.

NO CLAIM IS MADE TO THE EXCLUSIVE RIGHT TO USE "WORD", APART FROM THE MARK AS SHOWN.

FOR PRINTED EDUCATIONAL AND TEACHING MATERIALS IN THE FIELD OF VOCABULARY INSTRUCTION FOR ELEMENTARY SCHOOLS (U.S. CLS. 2, 5, 22, 23, 29, 37, 38 AND 50).

FIRST USE 6-1-2007; IN COMMERCE 6-1-2007.

3,399,182. RICHARDS, CONRAD R, FRESH MEADOWS, NY. SN 77-099,818. PUB. 8-7-2007, FILED 2-5-2007.



THE COLOR(S) BLUE AND BLACK IS/ARE CLAIMED AS A FEATURE OF THE MARK.

THE MARK CONSISTS OF "R" STYLISH LETTER IS BLUE AND "A" STYLISH LETTER IS BLACK.

FOR EDUCATIONAL PUBLICATIONS, NAMELY, TRAINING MANUALS IN THE FIELD OF REAL ESTATE EDUCATION (U.S. CLS. 2, 5, 22, 23, 29, 37, 38 AND 50).

FIRST USE 1-0-2007; IN COMMERCE 1-0-2007.

3,399,231. STERLING PUBLISHING CO., INC., NEW YORK, NY. SN 77-122,371. PUB. 9-18-2007, FILED 3-5-2007.

I'M GOING TO WRITE

THE MARK CONSISTS OF STANDARD CHARACTERS WITHOUT CLAIM TO ANY PARTICULAR FONT, STYLE, SIZE, OR COLOR.

OWNER OF U.S. REG. NO. 3,177,948.

CLASS 16—(Continued).

NO CLAIM IS MADE TO THE EXCLUSIVE RIGHT TO USE "WRITE", APART FROM THE MARK AS SHOWN.

FOR CHILDREN'S BOOKS, CHILDREN'S INSTRUCTIONAL BOOKS AND WORKBOOKS (U.S. CLS. 2, 5, 22, 23, 29, 37, 38 AND 50).

FIRST USE 10-31-2007; IN COMMERCE 10-31-2007.

3,399,315. GAREB SHAMUS ENTERPRISES, INC., CONGERS, NY. SN 78-246,137. PUB. 9-14-2004, FILED 5-6-2003.

BLACK BULL ENTERTAINMENT

NO CLAIM IS MADE TO THE EXCLUSIVE RIGHT TO USE "ENTERTAINMENT", APART FROM THE MARK AS SHOWN.

FOR STATIONERY, PRINTED PUBLICATIONS, NAMELY, COMIC BOOKS, STICKERS, DECALS, PENS, PAINTBRUSHES AND WRITING PADS (U.S. CLS. 2, 5, 22, 23, 29, 37, 38 AND 50).

FIRST USE 8-0-2000; IN COMMERCE 8-0-2000.

3,399,365. S.D. WARREN COMPANY, DBA SAPPI FINE PAPER NORTH AMERICA, BOSTON, MA. SN 78-376,241. PUB. 12-21-2004, FILED 3-1-2004.

LIFE WITH PRINT

THE MARK CONSISTS OF STANDARD CHARACTERS WITHOUT CLAIM TO ANY PARTICULAR FONT, STYLE, SIZE, OR COLOR.

FOR PRINTING PAPER (U.S. CLS. 2, 5, 22, 23, 29, 37, 38 AND 50).

FIRST USE 11-20-2007; IN COMMERCE 11-20-2007.

3,399,367. SELLARS ABSORBENT MATERIALS, INC., MILWAUKEE, WI. SN 78-381,365. PUB. 10-4-2005, FILED 3-10-2004.

TOOL BOX

THE MARK CONSISTS OF STANDARD CHARACTERS WITHOUT CLAIM TO ANY PARTICULAR FONT, STYLE, SIZE, OR COLOR.

FOR PAPER TOWELS COMPRISED OF WOOD PULP AND BINDING AGENTS (U.S. CLS. 2, 5, 22, 23, 29, 37, 38 AND 50).

FIRST USE 4-6-2007; IN COMMERCE 4-6-2007.

CLASS 16—(Continued).

3,399,396. DICKERSON, KIMBERLY, NEW YORK, NY. SN 78-482,168. PUB. 10-18-2005, FILED 9-12-2004.

FOR SERIES OF FICTION CHILDREN'S BOOKS; NON-FICTION CHILDREN'S BOOKS; MAGAZINES PERTAINING TO CHILDREN'S ISSUES; PAMPHLETS PERTAINING TO CHILDREN'S ISSUES; NEWSPAPERS; NEWSLETTERS PERTAINING TO CHILDREN'S ISSUES; JOURNALS PERTAINING TO CHILDREN'S ISSUES; AND INFORMATIONAL BUSINESS LETTERS PERTAINING TO CHILDREN'S ISSUES (U.S. CLS. 2, 5, 22, 23, 29, 37, 38 AND 50).
FIRST USE 5-5-2006; IN COMMERCE 5-5-2006.

3,399,411. ZS PUBLISHING, INC., TORONTO, ONTARIO, CANADA. SN 78-503,505. PUB. 9-27-2005, FILED 10-21-2004.

Jewish Living

THE MARK CONSISTS OF STANDARD CHARACTERS WITHOUT CLAIM TO ANY PARTICULAR FONT, STYLE, SIZE, OR COLOR.

NO CLAIM IS MADE TO THE EXCLUSIVE RIGHT TO USE "JEWISH", APART FROM THE MARK AS SHOWN.

FOR PERIODICALS AND MAGAZINES IN THE FIELD OF JEWISH RELIGION AND CULTURE (U.S. CLS. 2, 5, 22, 23, 29, 37, 38 AND 50).

FIRST USE 11-15-2007; IN COMMERCE 11-15-2007.

CLASS 16—(Continued).

3,399,414. KNOWLEDGE ESSENTIALS, LLC, OKLAHOMA CITY, OK. SN 78-504,679. PUB. 2-14-2006, FILED 10-22-2004.

THE STIPPLING IS FOR SHADING PURPOSES ONLY. THE MARK CONSISTS OF THE WORDS "KNOWLEDGE" AND "ESSENTIALS" WITH A BOOK PLACED BETWEEN THE TWO WORDS.

FOR PRINTED INSTRUCTIONAL, EDUCATIONAL AND TEACHING MATERIALS IN THE FIELD OF CHILDREN'S EDUCATION IN MATHEMATICS, SCIENCE, HISTORY, ENGLISH, AND FOREIGN LANGUAGE SKILLS; SERIES OF BOOKS IN THE FIELD OF CHILDREN'S EDUCATION IN MATHEMATICS, SCIENCE, HISTORY, ENGLISH, AND FOREIGN LANGUAGE SKILLS (U.S. CLS. 2, 5, 22, 23, 29, 37, 38 AND 50).
FIRST USE 10-27-2007; IN COMMERCE 10-27-2007.

3,399,457. NEWCOME KARTARIK, MARY JO, SHOREVIEW, MN. SN 78-546,305. PUB. 3-21-2006, FILED 1-12-2005.

My peace of PEACE

THE MARK CONSISTS OF STANDARD CHARACTERS WITHOUT CLAIM TO ANY PARTICULAR FONT, STYLE, SIZE, OR COLOR.

FOR CARDS, NAMELY, GREETING (U.S. CLS. 2, 5, 22, 23, 29, 37, 38 AND 50).

FIRST USE 0-0-2002; IN COMMERCE 0-0-2002.

CLASS 16—(Continued).

3,399,474. HOLLANDER, TAMEIRA L., LITTLETON, CO. SN 78-565,135. PUB. 10-3-2006, FILED 2-10-2005.

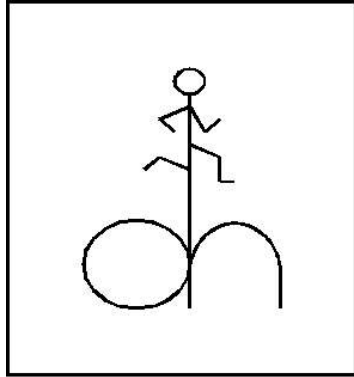

THE MARK CONSISTS OF LOWERCASE "D" AND "H" WITH A SHARED STEM CONTAINING A STICK FIGURE RUNNING, TO SYMBOLIZE "DYNAMIC HEALTH".
 FOR HANDBOOK DESCRIBING A SIMPLIFIED METHOD TO EFFECT WEIGHT LOSS THROUGH BEHAVIOR MODIFICATION USING A COLLECTION OF CHARTS TO IDENTIFY AND RECORD PROGRESS TOWARD THE USER'S GOALS FOR FITNESS AND DAILY LIFESTYLE IMPROVEMENT (U.S. CLS. 2, 5, 22, 23, 29, 37, 38 AND 50).
 FIRST USE 5-19-2007; IN COMMERCE 5-19-2007.

3,399,487. GOALSGUY LEARNING SYSTEMS, INC., PALM HARBOR, FL. SN 78-589,452. PUB. 12-13-2005, FILED 3-17-2005.

**FOCUS FOLLOW ONE
 COURSE UNTIL
 SUCCESSFUL**

THE MARK CONSISTS OF STANDARD CHARACTERS WITHOUT CLAIM TO ANY PARTICULAR FONT, STYLE, SIZE, OR COLOR.
 FOR SERIES OF BOOKS CONCERNING THE ACHIEVEMENT OF PERSONAL AND PROFESSIONAL GOALS (U.S. CLS. 2, 5, 22, 23, 29, 37, 38 AND 50).
 FIRST USE 9-30-2005; IN COMMERCE 9-30-2005.

CLASS 16—(Continued).

3,399,535. TWENTIETH CENTURY FOX FILM CORPORATION, LOS ANGELES, CA. SN 78-637,052. PUB. 2-14-2006, FILED 5-25-2005.

FAMILY GUY

THE MARK CONSISTS OF STANDARD CHARACTERS WITHOUT CLAIM TO ANY PARTICULAR FONT, STYLE, SIZE, OR COLOR.
 OWNER OF U.S. REG. NOS. 2,314,755, 2,625,497, AND OTHERS.
 FOR POSTERS; WALL CALENDARS; GREETING CARDS; NOTE PADS; NOTEBOOKS; TRADING CARDS; MEMO PADS; ADDRESS BOOKS; DATE BOOKS; BOOK COVERS; PENS; PENCILS; FICTIONAL NOVELS; HUMOR BOOKS; COMIC BOOKS (U.S. CLS. 2, 5, 22, 23, 29, 37, 38 AND 50).
 FIRST USE 4-30-2005; IN COMMERCE 4-30-2005.

3,399,542. VANILLA GORILLA, L.P., LONG BEACH, CA. SN 78-645,802. PUB. 3-7-2006, FILED 6-7-2005.

Jesse James

FOR PAPER OR CARDBOARD ARTICLES AND PRINTED MATTER, NAMELY, POSTERS, COLORING BOOKS, CHILDREN'S STORYBOOKS, LOOSE LEAF BINDERS, SCRAPBOOK ALBUMS, CELS AND TWO-DIMENSIONAL PRINTS, CARDBOARD, STATIONERY, MOUNTED AND/OR UNMOUNTED PHOTOGRAPHS, COMIC BOOKS, NOTEBOOKS, PENCILS, STICKERS, ERASERS, PENCIL SHARPENERS, PENCIL CASES, STAPLERS, WRITING PAPER, ENVELOPES, PAPER WEIGHTS, PAPER COASTERS, PAPER MATS, DRAWING RULERS, TRADING CARDS (U.S. CLS. 2, 5, 22, 23, 29, 37, 38 AND 50).
 FIRST USE 5-31-2004; IN COMMERCE 5-31-2004.

3,399,544. TALMADGE, CANDACE L., LANCASTER, TX. SN 78-649,598. PUB. 2-21-2006, FILED 6-13-2005.

GREEN STONE OF HEALING

THE MARK CONSISTS OF STANDARD CHARACTERS WITHOUT CLAIM TO ANY PARTICULAR FONT, STYLE, SIZE, OR COLOR.
 FOR SERIES OF FICTION BOOKS (U.S. CLS. 2, 5, 22, 23, 29, 37, 38 AND 50).
 FIRST USE 3-25-2005; IN COMMERCE 3-25-2005.

CLASS 16—(Continued).

3,399,570. DENVER NUGGETS LIMITED PARTNERSHIP, THE, DENVER, CO. SN 78-668,801. PUB. 4-4-2006, FILED 7-12-2005.



THE MARK CONSISTS OF TWO CROSSING PICKAXES OVER A BASKETBALL WITH A MOUNTAIN DESIGN ALL INSIDE A CIRCLE.

FOR PUBLICATIONS AND PRINTED MATTER, NAMELY BASKETBALL TRADING CARDS, TRADING CARDS, STICKERS, DECALS, COMMEMORATIVE BASKETBALL STAMPS, COLLECTIBLE CARDBOARD TRADING DISCS, MEMO BOARDS, CLIPBOARDS, PAPER COASTERS, POST CARDS, PLACE MATS OF PAPER, FACIAL TISSUES, NOTE CARDS, MEMO PADS, NOTE PADS, BALL POINT PENS, RUBBER BANDS, PENCILS, PEN AND PAPER HOLDERS, DESKTOP DOCUMENT STANDS, SCRAP BOOKS, RUBBER STAMPS, PAPER BANNERS AND FLAGS, BOOKMARKS, 3-RING BINDERS, STATIONERY FOLDERS, WIREBOUND NOTEBOOKS, PORTFOLIO NOTEBOOKS, UNMOUNTED AND MOUNTED PHOTOGRAPHS, POSTERS, CALENDARS, BUMPER STICKERS, BOOK COVERS, WRAPPING PAPER, CHILDREN'S ACTIVITY BOOKS, CHILDREN'S COLORING BOOKS, STATISTICAL BOOKS, GUIDE BOOKS, AND REFERENCE BOOKS IN THE FIELD OF BASKETBALL, MAGAZINES IN THE FIELD OF BASKETBALL, CATALOGS FEATURING BASKETBALL, COMMEMORATIVE GAME AND SOUVENIR PROGRAMS, PAPER PENNANTS, STATIONERY, STATIONERY-TYPE PORTFOLIOS, INVITATION CARDS, PRINTED CERTIFICATES, GREETING CARDS, CHRISTMAS CARDS, HOLIDAY CARDS, STATISTICAL SHEETS FOR BASKETBALL TOPICS, NEWSLETTERS, BROCHURES, PAMPHLETS, AND GAME SCHEDULES IN THE FIELD OF BASKETBALL, BANK CHECKS, CHECK BOOK COVERS, CHECK BOOK HOLDERS, CREDIT CARDS AND TELEPHONE CALLING CARDS NOT MAGNETICALLY ENCODED (U.S. CLS. 2, 5, 22, 23, 29, 37, 38 AND 50).

FIRST USE 11-1-2006; IN COMMERCE 11-1-2006.

3,399,581. HERALD MEDIA INC., SEOUL, REPUBLIC OF KOREA. SN 78-678,735. PUB. 12-19-2006, FILED 7-26-2005.

THE KOREA HERALD

THE MARK CONSISTS OF STANDARD CHARACTERS WITHOUT CLAIM TO ANY PARTICULAR FONT, STYLE, SIZE, OR COLOR.

CLASS 16—(Continued).

NO CLAIM IS MADE TO THE EXCLUSIVE RIGHT TO USE "KOREA", APART FROM THE MARK AS SHOWN.

FOR NEWSPAPERS (U.S. CLS. 2, 5, 22, 23, 29, 37, 38 AND 50).

FIRST USE 8-15-1965; IN COMMERCE 9-14-2007.

3,399,595. MEADWESTVACO CORPORATION, GLEN ALLEN, VA. SN 78-693,281. PUB. 5-2-2006, FILED 8-16-2005.

FLIRTY FLORALS

THE MARK CONSISTS OF STANDARD CHARACTERS WITHOUT CLAIM TO ANY PARTICULAR FONT, STYLE, SIZE, OR COLOR.

NO CLAIM IS MADE TO THE EXCLUSIVE RIGHT TO USE FLORALS, APART FROM THE MARK AS SHOWN.

FOR NOTEBOOKS; BINDERS; STATIONERY-TYPE PORTFOLIOS; FILE FOLDERS; MEMO BOOKS (U.S. CLS. 2, 5, 22, 23, 29, 37, 38 AND 50).

FIRST USE 9-16-2007; IN COMMERCE 9-16-2007.

3,399,640. UNITED INFOXCHANGE, LLC, BYFIELD, MA. SN 78-728,232. PUB. 6-27-2006, FILED 10-6-2005.

Valet

THE MARK CONSISTS OF STANDARD CHARACTERS WITHOUT CLAIM TO ANY PARTICULAR FONT, STYLE, SIZE, OR COLOR.

FOR PERIODICAL MAGAZINES FEATURING NEWS AND INFORMATION RELATING TO THE HEALTH CARE INDUSTRY, SPECIFICALLY NEWS AND ARTICLES ON HEALTH CARE STUDIES AND BREAKTHROUGHS IN DIETARY AND NUTRITIONAL SUPPLEMENTS, PERSONALIZED IN-HOME HEALTH ASSESSMENT SERVICES, AND NEWS ON CURRENT HEALTH EVENTS, BUSINESS LEADERS AND AWARDS GIVEN FOR ACHIEVEMENTS IN THE HEALTH CARE INDUSTRY (U.S. CLS. 2, 5, 22, 23, 29, 37, 38 AND 50).

FIRST USE 9-1-2007; IN COMMERCE 9-1-2007.

CLASS 16—(Continued).

3,399,642. MEADWESTVACO CORPORATION, GLEN ALLEN, VA. SN 78-732,262. PUB. 6-13-2006, FILED 10-13-2005.



OWNER OF U.S. REG. NOS. 1,072,214, 2,194,133, AND OTHERS.
FOR LUNCH BAGS (U.S. CLS. 2, 5, 22, 23, 29, 37, 38 AND 50).
FIRST USE 4-30-2007; IN COMMERCE 4-30-2007.

CLASS 16—(Continued).

3,399,702. BURGOS, MARGARET ANN, NEW YORK, NY. SN 78-763,383. PUB. 10-10-2006, FILED 11-30-2005.

THE SOLUTION DECK

THE MARK CONSISTS OF STANDARD CHARACTERS WITHOUT CLAIM TO ANY PARTICULAR FONT, STYLE, SIZE, OR COLOR.
NO CLAIM IS MADE TO THE EXCLUSIVE RIGHT TO USE "DECK", APART FROM THE MARK AS SHOWN.
FOR TAROT CARDS (U.S. CLS. 2, 5, 22, 23, 29, 37, 38 AND 50).
FIRST USE 11-16-2007; IN COMMERCE 11-21-2007.

3,399,686. WIENER, ALLISON LEIGH, CHAPPAQUA, NY. SN 78-757,177. PUB. 3-13-2007, FILED 11-18-2005.

Ms. W's Workshop

THE MARK CONSISTS OF STANDARD CHARACTERS WITHOUT CLAIM TO ANY PARTICULAR FONT, STYLE, SIZE, OR COLOR.
FOR EDUCATIONAL SKILL KITS CONSISTING OF PLASTIC SHAPES AND PLASTIC STRINGS FOR TEACHING MATHEMATICAL CONCEPTS (U.S. CLS. 2, 5, 22, 23, 29, 37, 38 AND 50).
FIRST USE 5-18-2006; IN COMMERCE 5-18-2006.

3,399,760. KOVARCIK, THOMAS J., NEW YORK, NY. SN 78-785,378. PUB. 9-12-2006, FILED 1-5-2006.

LAYMAN THOMAS'

THE MARK CONSISTS OF STANDARD CHARACTERS WITHOUT CLAIM TO ANY PARTICULAR FONT, STYLE, SIZE, OR COLOR.
FOR HEALTH BOOKS, COOKBOOKS, AND CHILDREN'S BOOKS (U.S. CLS. 2, 5, 22, 23, 29, 37, 38 AND 50).
FIRST USE 8-1-2007; IN COMMERCE 8-1-2007.

3,399,699. INTEGRITY PARTNERS, INC., LOS ANGELES, CA. SN 78-761,718. PUB. 10-10-2006, FILED 11-28-2005.



NO CLAIM IS MADE TO THE EXCLUSIVE RIGHT TO USE "AB", APART FROM THE MARK AS SHOWN.
FOR EXERCISE WORKBOOKS; EXERCISE JOURNALS; EXERCISE DIARIES; MEAL PLAN WORKBOOKS; MEAL PLAN JOURNALS; MEAL PLAN DIARIES (U.S. CLS. 2, 5, 22, 23, 29, 37, 38 AND 50).
FIRST USE 5-2-2006; IN COMMERCE 5-2-2006.

3,399,772. SWANSON, JOHN WESTWOOD, PORTLAND, OR. SN 78-792,579. PUB. 10-10-2006, FILED 1-16-2006.



THE MARK CONSISTS OF THE DESIGN OF AN ANVIL INCORPORATED INTO A STYLIZED LETTER "M".
FOR FLASH CARDS FOR THE EDUCATION OF CHILDREN ABOUT SUNDRY OBJECTS (U.S. CLS. 2, 5, 22, 23, 29, 37, 38 AND 50).
FIRST USE 4-5-2007; IN COMMERCE 8-13-2007.

CLASS 16—(Continued).

3,399,863. TOTANI CORPORATION, MINAMI-KU, KYOTO, JAPAN. SN 78-824,871. PUB. 5-1-2007, FILED 2-28-2006.

BOX POUCH

THE MARK CONSISTS OF STANDARD CHARACTERS WITHOUT CLAIM TO ANY PARTICULAR FONT, STYLE, SIZE, OR COLOR.

NO CLAIM IS MADE TO THE EXCLUSIVE RIGHT TO USE "POUCH", APART FROM THE MARK AS SHOWN.

FOR GENERAL PURPOSE PLASTIC BAGS; PLASTIC SHOPPING BAGS (U.S. CLS. 2, 5, 22, 23, 29, 37, 38 AND 50).

FIRST USE 10-10-2007; IN COMMERCE 10-10-2007.

CLASS 16—(Continued).

3,400,049. BORG UNLIMITED INC., MONTEREY PARK, CA. SN 78-929,141. PUB. 2-27-2007, FILED 7-13-2006.

3rd HAND

THE MARK CONSISTS OF STANDARD CHARACTERS WITHOUT CLAIM TO ANY PARTICULAR FONT, STYLE, SIZE, OR COLOR.

FOR PLASTIC PAGES FOR HOLDING PLAYS, GAME PLANS, SCHEDULES AND ROUTINES FOR ATHLETIC USE (U.S. CLS. 2, 5, 22, 23, 29, 37, 38 AND 50).

FIRST USE 8-1-2006; IN COMMERCE 8-1-2006.

3,399,966. ANIMALATIONS LLC, LAS VEGAS, NV. SN 78-875,990. PUB. 9-11-2007, FILED 5-3-2006.



THE COLOR(S) TAN, BROWN, BLACK, PURPLE, ORANGE, RED AND YELLOW IS/ARE CLAIMED AS A FEATURE OF THE MARK.

THE MARK CONSISTS OF AN OWL WITH A TAN FACE, A LIGHT BROWN BODY, DARK BROWN WINGS, A RED TONGUE, YELLOW CLAWS EYES AND FACE, AND BLACK FEET AND PERCH, WITH THE WORDS, ORIN THE OWL APPEARING IN PURPLE WITH AN ORANGE OUTLINE.

FOR PRINTED MATTER FEATURING INSPIRATIONAL MESSAGES, NAMELY, BOOK MARKS AND STICKERS (U.S. CLS. 2, 5, 22, 23, 29, 37, 38 AND 50).

FIRST USE 2-1-2007; IN COMMERCE 2-1-2007.

3,400,121. PUERINI, RUSSELL ANTHONY, MIDDLETOWN, RI. SN 78-956,347. PUB. 9-11-2007, FILED 8-21-2006.

DrySleeve

THE MARK CONSISTS OF STANDARD CHARACTERS WITHOUT CLAIM TO ANY PARTICULAR FONT, STYLE, SIZE, OR COLOR.

FOR PAPER SLEEVES AND CARDBOARD SLEEVES, NAMELY, PAPER AND CARDBOARD CUP SLEEVES DESIGNED TO FIT IN BEVERAGE CARRIERS; PAPER AND CARDBOARD CUP SLEEVES FOR HOLDING A BEVERAGE; PAPER AND CARDBOARD SLEEVES FOR HOLDING A BEVERAGE CONTAINER; PAPER AND CARDBOARD DISPOSABLE MUG HANDLES; REUSABLE HANDLES OF PAPER AND CARDBOARD FOR DISPOSABLE CUPS; PAPER AND CARDBOARD CUP SLEEVES WITH HANDLES; PAPER AND CARDBOARD SLEEVES THAT CAN BE PRINTED UPON, ALLOWING CUPS TO FUNCTION AS MUGS; SLEEVES OF RECYCLED PAPER AND CARDBOARD FOR HOLDING DISPOSABLE BEVERAGE CONTAINERS (U.S. CLS. 2, 5, 22, 23, 29, 37, 38 AND 50).

FIRST USE 8-7-2006; IN COMMERCE 8-7-2006.

CLASS 16—(Continued).

3,400,168. CRAIG ANTHONY POLSTON, FREDERICKSBURG, VA. SN 78-965,528. PUB. 4-3-2007, FILED 8-31-2006.

CLASS 17—(Continued).

3,398,965. REINOSO-RODRIGUEZ, CESAR TULIO, BOGOTÁ DC, COLOMBIA. SN 77-001,246. PUB. 5-1-2007, FILED 9-18-2006.

Marriage University

INR

THE MARK CONSISTS OF STANDARD CHARACTERS WITHOUT CLAIM TO ANY PARTICULAR FONT, STYLE, SIZE, OR COLOR.

NO CLAIM IS MADE TO THE EXCLUSIVE RIGHT TO USE "MARRIAGE", APART FROM THE MARK AS SHOWN.

FOR BOOKLETS IN THE FIELD OF MARRIAGE AND FAMILY ENRICHMENT; BOOKS IN THE FIELD OF MARRIAGE AND FAMILY ENRICHMENT; EDUCATIONAL BOOKS FEATURING LESSONS ON MARRIAGE AND FAMILY ENRICHMENT; GUIDE BOOKS FEATURING LESSONS ON MARRIAGE AND FAMILY ENRICHMENT; PRINTED GUIDES FOR LESSONS ON MARRIAGE AND FAMILY ENRICHMENT; PRINTED PRODUCTS, NAMELY, PRODUCT GUIDES FEATURING LESSONS ON MARRIAGE AND FAMILY ENRICHMENT; PRINTED TEACHING ACTIVITY GUIDES IN THE FIELD OF LESSONS ON MARRIAGE AND FAMILY ENRICHMENT; PUBLICATIONS, NAMELY, BROCHURES, BOOKLETS, AND TEACHING MATERIALS IN THE FIELD OF LESSONS ON MARRIAGE AND FAMILY ENRICHMENT; RELIGIOUS BOOKS; STUDY GUIDES (U.S. CLS. 2, 5, 22, 23, 29, 37, 38 AND 50).

FIRST USE 10-12-2007; IN COMMERCE 10-15-2007.

THE MARK CONSISTS OF STANDARD CHARACTERS WITHOUT CLAIM TO ANY PARTICULAR FONT, STYLE, SIZE, OR COLOR.

FOR CONNECTING HOSES FOR VEHICLE RADIATORS; FLEXIBLE PLASTIC HOSES FOR USE IN VENTILATION; FLOATING ANTI-POLLUTION BARRIERS; HOSES FOR AIR CONDITIONERS MADE OF RUBBER OR PLASTIC; INSULATING PAINT; NON-METAL TUBING AND TUBING COUPLINGS FOR JOINING AND TERMINATING PIPES; RUBBER TUBES AND PIPES; SEMI-PROCESSED PLASTIC IN THE FORM OF FILMS, SHEETS, TUBES, BARS, OR RODS; VEHICLE RADIATOR CONNECTING HOSES (U.S. CLS. 1, 5, 12, 13, 35 AND 50).

FIRST USE 12-31-1996; IN COMMERCE 12-31-2004.

3,400,205. HORIZON CHRISTIAN FELLOWSHIP, SAN DIEGO, CA. SN 78-974,856. PUB. 5-1-2007, FILED 9-14-2006.

3,399,270. CELPLAST METALLIZED PRODUCTS LTD., TORONTO, CANADA. SN 77-146,842. PUB. 10-2-2007, FILED 4-2-2007.

HORIZON

ENVIROMET

THE MARK CONSISTS OF STANDARD CHARACTERS WITHOUT CLAIM TO ANY PARTICULAR FONT, STYLE, SIZE, OR COLOR.

FOR PUBLICATIONS, NAMELY, BIBLES DISTRIBUTED IN PRINT FORM; PUBLICATIONS, NAMELY, MAGAZINES, BOOKS AND BOOKLETS IN THE FIELD OF RELIGION, DISTRIBUTED IN PRINT FORM; RELIGIOUS BOOKS; AND RELIGIOUS CIRCULAR LETTERS (U.S. CLS. 2, 5, 22, 23, 29, 37, 38 AND 50).

FIRST USE 12-31-1978; IN COMMERCE 12-31-1978.

THE MARK CONSISTS OF STANDARD CHARACTERS WITHOUT CLAIM TO ANY PARTICULAR FONT, STYLE, SIZE, OR COLOR.

FOR TRANSPARENT, METALLIZED PLASTIC BARRIER FILMS USED AS PACKAGING FOR FOOD AND USED AS INDUSTRIAL OR COMMERCIAL NON-FOOD PACKING (U.S. CLS. 1, 5, 12, 13, 35 AND 50).

FIRST USE 6-1-2007; IN COMMERCE 8-1-2007.

CLASS 17—RUBBER GOODS

CLASS 17—(Continued).

3,399,568. TKJ CORPORATION, TOKYO, JAPAN. SN 78-668,238. PUB. 7-18-2006, FILED 7-12-2005.

SUNNY HOSE

THE MARK CONSISTS OF STANDARD CHARACTERS WITHOUT CLAIM TO ANY PARTICULAR FONT, STYLE, SIZE, OR COLOR.

NO CLAIM IS MADE TO THE EXCLUSIVE RIGHT TO USE "HOSE", APART FROM THE MARK AS SHOWN.

FOR NON-METALLIC HOSE PIPES (U.S. CLS. 1, 5, 12, 13, 35 AND 50).

FIRST USE 0-0-1962; IN COMMERCE 0-0-1998.

3,399,949. LION COPOLYMER, LLC, BATON ROUGE, LA. SN 78-865,668. PUB. 5-29-2007, FILED 4-20-2006.



NO CLAIM IS MADE TO THE EXCLUSIVE RIGHT TO USE "COPOLYMER", APART FROM THE MARK AS SHOWN.

FOR ELASTOMERIC POLYMERS, NAMELY, RUBBER (U.S. CLS. 1, 5, 12, 13, 35 AND 50).

FIRST USE 2-0-2006; IN COMMERCE 2-0-2006.

3,400,022. US GREENFIBER, LLC, CHARLOTTE, NC. SN 78-915,244. PUB. 8-21-2007, FILED 6-23-2006.

FRM

THE MARK CONSISTS OF STANDARD CHARACTERS WITHOUT CLAIM TO ANY PARTICULAR FONT, STYLE, SIZE, OR COLOR.

FOR FIRE BARRIER SYSTEM COMPRISED OF CHEMICALLY TREATED LOOSE FILL FIBER; ACOUSTICAL INSULATION FOR BUILDINGS; ARCHITECTURAL ACOUSTICAL PRODUCTS, NAMELY, SOUND ABSORBERS AND DIFFUSERS CONSISTING OF CHEMICALLY TREATED LOOSE FILL FIBER; BUILDING INSULATION (U.S. CLS. 1, 5, 12, 13, 35 AND 50).

FIRST USE 4-21-2005; IN COMMERCE 4-21-2005.

CLASS 17—(Continued).

3,400,141. STRAIGHT LINE INSULATION I, LP, SOUTH HOUSTON, TX. SN 78-960,017. PUB. 4-24-2007, FILED 8-24-2006.

STRONGSEAM

THE MARK CONSISTS OF STANDARD CHARACTERS WITHOUT CLAIM TO ANY PARTICULAR FONT, STYLE, SIZE, OR COLOR.

FOR BUILDING INSULATION SYSTEM CONSISTING OF INTERLOCKING COMPOSITE PANELS CREATED FROM A METALLIC OUTER SKIN LAMINATED TO THERMAL INSULATION (U.S. CLS. 1, 5, 12, 13, 35 AND 50).

FIRST USE 1-14-2008; IN COMMERCE 1-14-2008.

CLASS 18—LEATHER GOODS

3,398,838. HEREFORD BI-PRODUCTS, INC., HEREFORD, TX. SN 75-983,606. PUB. 11-11-2003, FILED 2-24-2000.

HUNGRY DOG

NO CLAIM IS MADE TO THE EXCLUSIVE RIGHT TO USE "DOG", APART FROM THE MARK AS SHOWN.

FOR RAWHIDE CHEWS (U.S. CLS. 1, 2, 3, 22 AND 41).

FIRST USE 7-0-2000; IN COMMERCE 7-0-2000.

3,398,855. SCRATCH MEDIA PRODUCTIONS, LLC, NEW YORK, NY. SN 76-483,663. PUB. 4-5-2005, FILED 1-21-2003.



FOR BACKPACKS, BOOK BAGS AND SHOULDER BAGS (U.S. CLS. 1, 2, 3, 22 AND 41).

FIRST USE 7-15-2007; IN COMMERCE 7-15-2007.

CLASS 18—(Continued).

3,398,875. SUSAN DELL, INC., NEW YORK, NY. SN 76-565,100. PUB. 9-7-2004, FILED 12-4-2003.

PHI

THE MARK CONSISTS OF STANDARD CHARACTERS WITHOUT CLAIM TO ANY PARTICULAR FONT, STYLE, SIZE, OR COLOR.

FOR BAGS, NAMELY, ATHLETIC BAGS, BEACH BAGS, DUFFEL BAGS, HANDBAGS AND LEATHER SHOPPING BAGS (U.S. CLS. 1, 2, 3, 22 AND 41).
FIRST USE 11-11-2004; IN COMMERCE 11-11-2004.

3,398,988. THERMOS L.L.C., ROLLING MEADOWS, IL. SN 77-007,704. PUB. 5-15-2007, FILED 9-26-2006.

FOOGO

THE MARK CONSISTS OF STANDARD CHARACTERS WITHOUT CLAIM TO ANY PARTICULAR FONT, STYLE, SIZE, OR COLOR.

FOR INSULATED DIAPER BAGS, BAGS FOR CARRYING BABY ACCESSORIES (U.S. CLS. 1, 2, 3, 22 AND 41).
FIRST USE 8-2-2007; IN COMMERCE 8-2-2007.

3,399,044. ASA HANDBAGS, INC, LOS ANGELES, CA. SN 77-034,593. PUB. 6-5-2007, FILED 11-1-2006.

Baby Queen

THE MARK CONSISTS OF STANDARD CHARACTERS WITHOUT CLAIM TO ANY PARTICULAR FONT, STYLE, SIZE, OR COLOR.

NO CLAIM IS MADE TO THE EXCLUSIVE RIGHT TO USE "BABY", APART FROM THE MARK AS SHOWN.
FOR HANDBAGS; LUGGAGE; WALLETS (U.S. CLS. 1, 2, 3, 22 AND 41).
FIRST USE 10-25-2007; IN COMMERCE 11-20-2007.

CLASS 18—(Continued).

3,399,116. AR NEW YORK LIMITED CORP., UNION, NJ. SN 77-068,879. PUB. 7-3-2007, FILED 12-20-2006.



THE COLOR(S) YELLOW, DARK GREY AND WHITE IS/ARE CLAIMED AS A FEATURE OF THE MARK.

THE MARK CONSISTS OF THE LOGO OF A STANDING DUCK IN YELLOW WITH WHITE GAPS. THE CHARACTERS "ARNY" ARE IN DARK GREY.

FOR EVENING HANDBAGS; HANDBAGS (U.S. CLS. 1, 2, 3, 22 AND 41).
FIRST USE 1-10-2008; IN COMMERCE 1-10-2008.

3,399,264. KREPAK, WENDY, WINTER SPRINGS, FL. SN 77-142,401. PUB. 10-2-2007, FILED 3-28-2007.

CARD CUBBY

THE MARK CONSISTS OF STANDARD CHARACTERS WITHOUT CLAIM TO ANY PARTICULAR FONT, STYLE, SIZE, OR COLOR.

NO CLAIM IS MADE TO THE EXCLUSIVE RIGHT TO USE "CARD", APART FROM THE MARK AS SHOWN.

FOR LEATHER CARRYING CASES (U.S. CLS. 1, 2, 3, 22 AND 41).
FIRST USE 11-7-2007; IN COMMERCE 11-7-2007.

3,399,336. AIGNER-CLARK LLC, LONE TREE, CO. SN 78-309,353. PUB. 5-25-2004, FILED 10-3-2003.

THE PERFECT DRIVE

OWNER OF U.S. REG. NOS. 3,263,276, 3,349,270, AND OTHERS.

FOR LUGGAGE (U.S. CLS. 1, 2, 3, 22 AND 41).
FIRST USE 2-16-2007; IN COMMERCE 2-16-2007.

CLASS 18—(Continued).

3,399,346. QUIKSILVER, INC., HUNTINGTON BEACH, CA. SN 78-335,232. PUB. 9-14-2004, FILED 12-2-2003.

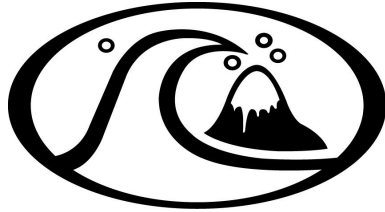

FOR BACKPACKS, WALLETS, TRAVEL BAGS, DUFFEL BAGS AND ATHLETIC BAGS (U.S. CLS. 1, 2, 3, 22 AND 41).

FIRST USE 12-5-2007; IN COMMERCE 12-5-2007.

3,399,541. MINNESOTA TWINS, LLC, MINNEAPOLIS, MN. SN 78-642,362. PUB. 7-4-2006, FILED 6-2-2005.

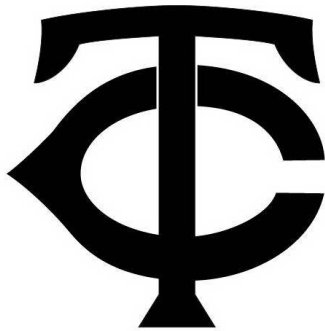

OWNER OF U.S. REG. NOS. 1,210,584 AND 1,535,265. THE MARK CONSISTS OF THE LETTERS "TC" IN STYLIZED FORM.

FOR ATHLETIC BAGS, OVERNIGHT BAGS, DUFFEL BAGS, TOTE BAGS, LUNCH TOTES, ATTACHE CASES, BRIEFCASES, PURSES, WALLETS, BILLFOLDS, FANNY PACKS, WAIST PACKS, BUSINESS CARD CASES, LUGGAGE TAGS, CARD CASES, DOG COLLARS, AND DOG LEASHES (U.S. CLS. 1, 2, 3, 22 AND 41).

FIRST USE 4-0-2005; IN COMMERCE 4-0-2005.

3,399,730. ZUTIS, CERENA WEST, SAN MATEO, CA. SN 774,195. PUB. 8-22-2006, FILED 12-15-2005.

Dream Walker

THE MARK CONSISTS OF STANDARD CHARACTERS WITHOUT CLAIM TO ANY PARTICULAR FONT, STYLE, SIZE, OR COLOR.

FOR DOG HARNESS (U.S. CLS. 1, 2, 3, 22 AND 41). FIRST USE 1-12-2006; IN COMMERCE 7-21-2006.

CLASS 18—(Continued).

3,399,749. DAN RIVER INC., DANVILLE, VA. SN 78-781,646. PUB. 9-12-2006, FILED 12-28-2005.

OMT

THE MARK CONSISTS OF STANDARD CHARACTERS WITHOUT CLAIM TO ANY PARTICULAR FONT, STYLE, SIZE, OR COLOR.

FOR SCENT CONTROL CHEMICAL INGREDIENT SOLD AS AN INTEGRAL COMPONENT OF DUFFLE BAGS (U.S. CLS. 1, 2, 3, 22 AND 41).

FIRST USE 6-26-2006; IN COMMERCE 6-26-2006.

3,399,815. MORGAN MOTOR COMPANY LIMITED, WORCESTERSHIRE, UNITED KINGDOM. SN 78-804,937. PUB. 9-19-2006, FILED 2-1-2006.



OWNER OF U.S. REG. NO. 1,715,474.

FOR TRUNKS, SUIT CASES, TRAVELING BAGS, LEATHER KEY HOLDERS, LEATHER KEY RINGS, UMBRELLAS, ATTACHE CASES, BRIEFCASES, LEATHER SUIT BAGS, WALLETS, PURSES, BUSINESS CARD HOLDERS AND DOCUMENT CASES ALL OF SKIN OR LEATHER, TOILETRY CASES SOLD EMPTY AND VANITY CASES SOLD EMPTY, RUCKSACKS, WAIST PACKS, AND SADDLERY (U.S. CLS. 1, 2, 3, 22 AND 41).

FIRST USE 2-27-2007; IN COMMERCE 2-27-2007.

CLASS 19—NON-METALLIC BUILDING MATERIALS

3,398,948. BILCO COMPANY, THE, WEST HAVEN, CT. SN 76-667,623. PUB. 5-22-2007, FILED 10-13-2006.

STAKWEL

THE MARK CONSISTS OF STANDARD CHARACTERS WITHOUT CLAIM TO ANY PARTICULAR FONT, STYLE, SIZE, OR COLOR.

FOR NON-METAL WINDOW WELLS (U.S. CLS. 1, 12, 33 AND 50).

FIRST USE 4-2-2007; IN COMMERCE 4-2-2007.

CLASS 19—(Continued).

3,398,953. AWI LICENSING COMPANY, WILMINGTON, DE.
SN 76-671,659. PUB. 5-22-2007, FILED 1-22-2007.

CLASS 19—(Continued).

3,399,155. SHAE CORPORATION, DBA PREMIER FLOOR-
ING SOLUTIONS, ANAHEIM, CA. SN 77-085,683. PUB. 8-
28-2007, FILED 1-18-2007.

DEFINITIONS

THE MARK CONSISTS OF STANDARD CHARACTERS
WITHOUT CLAIM TO ANY PARTICULAR FONT, STYLE,
SIZE, OR COLOR.

FOR NON-METAL DECORATIVE ROOM DIVIDER
PANEL HUNG FROM THE CEILING PLANE (U.S. CLS.
1, 12, 33 AND 50).

FIRST USE 2-0-2007; IN COMMERCE 6-0-2007.

FINELINE

THE MARK CONSISTS OF STANDARD CHARACTERS
WITHOUT CLAIM TO ANY PARTICULAR FONT, STYLE,
SIZE, OR COLOR.

FOR HARDWOOD FLOORING (U.S. CLS. 1, 12, 33
AND 50).

FIRST USE 12-31-2005; IN COMMERCE 12-31-2005.

3,399,010. BLESSING, RON, DALLAS, OR. SN 77-018,234.
PUB. 5-22-2007, FILED 10-10-2006.

3,399,205. PEACH STATE MFG., INC., COLLEGE PARK, GA.
SN 77-111,320. PUB. 8-14-2007, FILED 2-20-2007.

GLO-TOP

THE MARK CONSISTS OF STANDARD CHARACTERS
WITHOUT CLAIM TO ANY PARTICULAR FONT, STYLE,
SIZE, OR COLOR.

FOR BUILDING MATERIALS, NAMELY, LUMINOUS
COUNTER TOP BOARDS (U.S. CLS. 1, 12, 33 AND 50).

FIRST USE 8-2-2007; IN COMMERCE 8-2-2007.

CREO-POST

THE MARK CONSISTS OF STANDARD CHARACTERS
WITHOUT CLAIM TO ANY PARTICULAR FONT, STYLE,
SIZE, OR COLOR.

FOR NON-METAL FENCE POSTS (U.S. CLS. 1, 12, 33
AND 50).

FIRST USE 10-17-2007; IN COMMERCE 10-17-2007.

3,399,100. PACIFIC COAST BUILDING PRODUCTS, INC.,
RANCHO CORDOVA, CA. SN 77-062,423. PUB. 7-17-2007,
FILED 12-12-2006.

3,399,206. PEACH STATE MFG., INC., COLLEGE PARK, GA.
SN 77-111,323. PUB. 8-28-2007, FILED 2-20-2007.

**PREMIER
*Advantage***

OWNER OF U.S. REG. NO. 2,478,033.
THE MARK CONSISTS OF THE WORDS "PREMIER
ADVANTAGE" IN STYLIZED LETTERING.

FOR ASPHALT ROOFING SHINGLES (U.S. CLS. 1, 12,
33 AND 50).

FIRST USE 9-13-2007; IN COMMERCE 11-12-2007.

DURA DECKING

THE MARK CONSISTS OF STANDARD CHARACTERS
WITHOUT CLAIM TO ANY PARTICULAR FONT, STYLE,
SIZE, OR COLOR.

NO CLAIM IS MADE TO THE EXCLUSIVE RIGHT TO
USE "DECKING", APART FROM THE MARK AS SHOWN.
FOR LUMBER (U.S. CLS. 1, 12, 33 AND 50).

FIRST USE 7-14-1998; IN COMMERCE 7-14-1998.

CLASS 19—(Continued).

3,399,213. PEACH STATE MFG., INC., COLLEGE PARK, GA. SN 77-113,334. PUB. 8-14-2007, FILED 2-22-2007.

CLASS 19—(Continued).

3,399,628. CLOPAY BUILDING PRODUCTS R&D COMPANY, INC., DBA CLOPAY BUILDING PRODUCTS COMPANY, INC., MASON, OH. SN 78-721,529. PUB. 6-6-2006, FILED 9-27-2005.

CEDA-BOARD

THE MARK CONSISTS OF STANDARD CHARACTERS WITHOUT CLAIM TO ANY PARTICULAR FONT, STYLE, SIZE, OR COLOR.

FOR NON-METAL FENCE BOARDS (U.S. CLS. 1, 12, 33 AND 50).

FIRST USE 10-17-2007; IN COMMERCE 10-17-2007.

LODGEWOOD

THE MARK CONSISTS OF STANDARD CHARACTERS WITHOUT CLAIM TO ANY PARTICULAR FONT, STYLE, SIZE, OR COLOR.

FOR NON-METAL GARAGE DOORS (U.S. CLS. 1, 12, 33 AND 50).

FIRST USE 9-30-2005; IN COMMERCE 9-30-2005.

3,399,334. IDEAL CONCRETE BLOCK COMPANY, INC., WESTFORD, MA. SN 78-303,989. PUB. 9-7-2004, FILED 9-23-2003.

3,399,679. CONKLIN COMPANY, INC., SHAKOPE, MN. SN 78-755,295. PUB. 8-8-2006, FILED 11-16-2005.

OLDE BOSTON

NO CLAIM IS MADE TO THE EXCLUSIVE RIGHT TO USE "BOSTON", APART FROM THE MARK AS SHOWN.

FOR CONSTRUCTION MATERIALS, NAMELY, LANDSCAPE BLOCKS (U.S. CLS. 1, 12, 33 AND 50).

FIRST USE 7-6-2007; IN COMMERCE 7-6-2007.

FLEXIBLE ARMOR AGAINST THE ELEMENTS

THE MARK CONSISTS OF STANDARD CHARACTERS WITHOUT CLAIM TO ANY PARTICULAR FONT, STYLE, SIZE, OR COLOR.

FOR PETROLEUM-BASED ASPHALT COATINGS, ASPHALT PRIMERS, ASPHALT FILLER, AND ASPHALT PATCH (U.S. CLS. 1, 12, 33 AND 50).

FIRST USE 9-0-2007; IN COMMERCE 9-0-2007.

3,399,616. AIRSTRUCTURES WORLDWIDE, LTD., ST. LOUIS, MO. SN 78-710,888. PUB. 5-8-2007, FILED 9-12-2005.

3,399,735. SUMMIT STONE, INC., NORTH LAWRENCE, OH. SN 78-775,907. PUB. 8-22-2006, FILED 12-19-2005.

ARIZON

THE MARK CONSISTS OF STANDARD CHARACTERS WITHOUT CLAIM TO ANY PARTICULAR FONT, STYLE, SIZE, OR COLOR.

FOR BUILDING STRUCTURES, NAMELY, NON-METAL AIR SUPPORTED BUILDINGS AND NON-METAL TENSION SUPPORTED BUILDINGS, NON-METAL FRAME SUPPORTED BUILDINGS, AND NON-METAL FRAME SUPPORTED FABRIC BUILDINGS (U.S. CLS. 1, 12, 33 AND 50).

FIRST USE 2-20-2006; IN COMMERCE 10-3-2006.



THE MARK CONSISTS OF TWO STYLIZED MOUNTAINS WITH ONE OVERLAPPING THE OTHER.

FOR STONE FOR BUILDING AND CONSTRUCTION (U.S. CLS. 1, 12, 33 AND 50).

FIRST USE 6-6-2005; IN COMMERCE 6-6-2005.

CLASS 19—(Continued).

3,399,845. COMC LLC, OMAHA, NE. SN 78-817,224. PUB. 10-10-2006, FILED 2-17-2006.

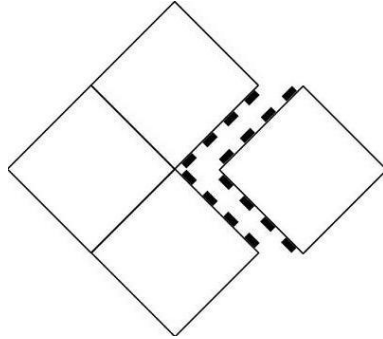

THE MARK CONSISTS OF FOUR SQUARES REPRESENTING INTERLOCKING FLOOR TILES WITH ONE DISENGAGED TILE.
FOR NON-METAL FLOOR TILES (U.S. CLS. 1, 12, 33 AND 50).
FIRST USE 6-14-2006; IN COMMERCE 6-14-2006.

3,399,893. OWENS CORNING INTELLECTUAL CAPITAL, LLC, TOLEDO, OH. SN 78-840,912. PUB. 10-17-2006, FILED 3-20-2006.

THE PREFERRED NAME IN STONE

THE MARK CONSISTS OF STANDARD CHARACTERS WITHOUT CLAIM TO ANY PARTICULAR FONT, STYLE, SIZE, OR COLOR.
NO CLAIM IS MADE TO THE EXCLUSIVE RIGHT TO USE "STONE", APART FROM THE MARK AS SHOWN.
FOR MANUFACTURED STONE; MANUFACTURED STONE VENEER (U.S. CLS. 1, 12, 33 AND 50).
FIRST USE 10-31-2006; IN COMMERCE 10-31-2006.

3,400,030. SOFT-LITE L.L.C., STREETSBORO, OH. SN 78-919,859. PUB. 3-27-2007, FILED 6-29-2006.

ILTIS

THE MARK CONSISTS OF STANDARD CHARACTERS WITHOUT CLAIM TO ANY PARTICULAR FONT, STYLE, SIZE, OR COLOR.
FOR VINYL WINDOWS (U.S. CLS. 1, 12, 33 AND 50).
FIRST USE 11-20-2006; IN COMMERCE 11-20-2006.

CLASS 19—(Continued).

3,400,096. KEYSTONE RETAINING WALL SYSTEMS, INC., MINNEAPOLIS, MN. SN 78-949,352. PUB. 4-17-2007, FILED 8-10-2006.

VERAZZO STONE

THE MARK CONSISTS OF STANDARD CHARACTERS WITHOUT CLAIM TO ANY PARTICULAR FONT, STYLE, SIZE, OR COLOR.
NO CLAIM IS MADE TO THE EXCLUSIVE RIGHT TO USE "STONE", APART FROM THE MARK AS SHOWN.
FOR MODULAR CONCRETE BLOCKS USED TO CONSTRUCT EARTH RETAINING WALLS; MODULAR CONCRETE BLOCKS USED IN LANDSCAPING APPLICATIONS (U.S. CLS. 1, 12, 33 AND 50).
FIRST USE 7-31-2006; IN COMMERCE 2-8-2007.

3,400,152. CRANE PLASTICS SIDING LLC, COLUMBUS, OH. SN 78-963,073. PUB. 4-17-2007, FILED 8-29-2006.

THINK OUTSIDE.

THE MARK CONSISTS OF STANDARD CHARACTERS WITHOUT CLAIM TO ANY PARTICULAR FONT, STYLE, SIZE, OR COLOR.
FOR VINYL SIDING (U.S. CLS. 1, 12, 33 AND 50).
FIRST USE 1-1-2007; IN COMMERCE 1-1-2007.

CLASS 20—FURNITURE AND ARTICLES NOT OTHERWISE CLASSIFIED

3,398,928. ADVANCED SLEEP CONCEPTS, INC., ROME, GA. SN 76-662,209. PUB. 2-13-2007, FILED 6-27-2006.

ENERGY HEALTH SOLUTIONS

THE MARK CONSISTS OF STANDARD CHARACTERS WITHOUT CLAIM TO ANY PARTICULAR FONT, STYLE, SIZE, OR COLOR.
FOR MATTRESSES (U.S. CLS. 2, 13, 22, 25, 32 AND 50).
FIRST USE 2-0-2007; IN COMMERCE 2-0-2007.

CLASS 20—(Continued).

3,398,938. LEE SNIJDERS DESIGNS, PORTER RANCH, CA.
SN 76-664,869. PUB. 4-3-2007, FILED 8-21-2006.



THE NAME LEE SNIJDERS IDENTIFIES A LIVING INDIVIDUAL WHOSE CONSENT IS OF RECORD. FOR FURNITURE (U.S. CLS. 2, 13, 22, 25, 32 AND 50). FIRST USE 3-15-2007; IN COMMERCE 3-15-2007.

3,398,939. LEE SNIJDERS DESIGNS, PORTER RANCH, CA.
SN 76-665,718. PUB. 4-24-2007, FILED 9-7-2006.

LEE SNIJDERS DESIGNS

THE MARK CONSISTS OF STANDARD CHARACTERS WITHOUT CLAIM TO ANY PARTICULAR FONT, STYLE, SIZE, OR COLOR.

NO CLAIM IS MADE TO THE EXCLUSIVE RIGHT TO USE "DESIGNS", APART FROM THE MARK AS SHOWN.

THE NAME "LEE SNIJDERS" IDENTIFIES A LIVING INDIVIDUAL WHOSE CONSENT IS OF RECORD.

FOR FURNITURE (U.S. CLS. 2, 13, 22, 25, 32 AND 50). FIRST USE 3-15-2007; IN COMMERCE 3-15-2007.

3,398,942. L&P PROPERTY MANAGEMENT COMPANY,
SOUTH GATE, CA. SN 76-666,380. PUB. 7-10-2007, FILED
9-21-2006.

MORNING STAR

THE MARK CONSISTS OF STANDARD CHARACTERS WITHOUT CLAIM TO ANY PARTICULAR FONT, STYLE, SIZE, OR COLOR.

FOR SEATING FURNITURE, MATTRESSES AND BOX SPRINGS (U.S. CLS. 2, 13, 22, 25, 32 AND 50). FIRST USE 7-11-2006; IN COMMERCE 7-11-2006.

CLASS 20—(Continued).

3,398,943. L&P PROPERTY MANAGEMENT COMPANY,
SOUTH GATE, CA. SN 76-666,381. PUB. 7-10-2007, FILED
9-21-2006.

FIRST LIGHT

THE MARK CONSISTS OF STANDARD CHARACTERS WITHOUT CLAIM TO ANY PARTICULAR FONT, STYLE, SIZE, OR COLOR.

FOR SEATING FURNITURE, MATTRESSES AND BOX SPRINGS (U.S. CLS. 2, 13, 22, 25, 32 AND 50). FIRST USE 6-15-2006; IN COMMERCE 6-15-2006.

3,399,095. CLINQS, LLC, BROOKLYN, NY. SN 77-061,573.
PUB. 7-10-2007, FILED 12-11-2006.

CLINQS

THE MARK CONSISTS OF STANDARD CHARACTERS WITHOUT CLAIM TO ANY PARTICULAR FONT, STYLE, SIZE, OR COLOR.

FOR DECORATIVE PLASTIC APPLIQUÉS FOR USE ON SURFACES OF GLASS, METAL, TILE, ACRYLIC GLASS AND OTHER SOLID SURFACES (U.S. CLS. 2, 13, 22, 25, 32 AND 50).

FIRST USE 6-26-2007; IN COMMERCE 6-26-2007.

3,399,195. KRUEGER INTERNATIONAL, INC., GREEN
BAY, WI. SN 77-107,351. PUB. 8-14-2007, FILED 2-14-2007.

ATHENS

THE MARK CONSISTS OF STANDARD CHARACTERS WITHOUT CLAIM TO ANY PARTICULAR FONT, STYLE, SIZE, OR COLOR.

FOR FURNITURE (U.S. CLS. 2, 13, 22, 25, 32 AND 50). FIRST USE 8-27-2007; IN COMMERCE 8-27-2007.

CLASS 20—(Continued).

3,399,203. WENGER CORPORATION, OWATONNA, MN. SN 77-110,705. PUB. 7-31-2007, FILED 2-19-2007.



THE MARK CONSISTS OF THE WORD "ACOUSTIC CABINETS" WITH A BOLD LINE ABOVE AND BELOW THE TEXT. THREE VERTICALLY ORIENTED CURVED LINES EXTEND FROM BOTH OF THE BOLD LINES IN A DIRECTION AWAY FROM THE TEXT.

FOR FURNITURE, NAMELY, DISPLAY RACKS, CABINETS AND SHELVES (U.S. CLS. 2, 13, 22, 25, 32 AND 50).

FIRST USE 11-8-2007; IN COMMERCE 11-8-2007.

3,399,250. MICHIGAN TUBE SWAGERS & FABRICATORS, INC., TEMPERANCE, MI. SN 77-131,894. PUB. 9-18-2007, FILED 3-15-2007.

SYNERGREEN

THE MARK CONSISTS OF STANDARD CHARACTERS WITHOUT CLAIM TO ANY PARTICULAR FONT, STYLE, SIZE, OR COLOR.

FOR FURNITURE (U.S. CLS. 2, 13, 22, 25, 32 AND 50).
FIRST USE 10-22-2007; IN COMMERCE 10-22-2007.

3,399,366. HUNTER DOUGLAS INC., UPPER SADDLE RIVER, NJ. SN 78-379,477. PUB. 12-14-2004, FILED 3-5-2004.

ARCHITELLA

THE MARK CONSISTS OF STANDARD CHARACTERS WITHOUT CLAIM TO ANY PARTICULAR FONT, STYLE, SIZE, OR COLOR.

FOR WINDOW BLINDS AND WINDOW SHADES; DOOR BLINDS AND DOOR SHADES (U.S. CLS. 2, 13, 22, 25, 32 AND 50).

FIRST USE 10-0-2006; IN COMMERCE 10-0-2006.

CLASS 20—(Continued).

3,399,488. THE ASHTON-DRAKE GALLERIES, LTD., NILES, IL. SN 78-593,066. PUB. 1-10-2006, FILED 3-23-2005.

**LITTLE DREAM
WEAVERS**

THE MARK CONSISTS OF STANDARD CHARACTERS WITHOUT CLAIM TO ANY PARTICULAR FONT, STYLE, SIZE, OR COLOR.

OWNER OF U.S. REG. NO. 2,229,577.

FOR ORNAMENTS OF RESIN, BONE, IVORY, PLASTER, PLASTIC, WAX, WICKER AND WOOD, EXCLUDING CHRISTMAS TREE ORNAMENTS (U.S. CLS. 2, 13, 22, 25, 32 AND 50).

FIRST USE 3-5-2007; IN COMMERCE 3-5-2007.

3,399,530. CONAIR CORPORATION, STAMFORD, CT. SN 78-628,428. PUB. 2-28-2006, FILED 5-12-2005.

BRILLIANT VIEW MIRROR

THE MARK CONSISTS OF STANDARD CHARACTERS WITHOUT CLAIM TO ANY PARTICULAR FONT, STYLE, SIZE, OR COLOR.

NO CLAIM IS MADE TO THE EXCLUSIVE RIGHT TO USE "MIRROR", APART FROM THE MARK AS SHOWN.

FOR NON-ELECTRIC MIRRORS (U.S. CLS. 2, 13, 22, 25, 32 AND 50).

FIRST USE 8-0-2005; IN COMMERCE 8-0-2005.

3,399,635. OFS SALES CORP., HUNTINGBURG, IN. SN 78-725,850. PUB. 6-20-2006, FILED 10-4-2005.

JEWEL

THE MARK CONSISTS OF STANDARD CHARACTERS WITHOUT CLAIM TO ANY PARTICULAR FONT, STYLE, SIZE, OR COLOR.

FOR OFFICE FURNITURE (U.S. CLS. 2, 13, 22, 25, 32 AND 50).

FIRST USE 3-2-2007; IN COMMERCE 3-2-2007.

CLASS 20—(Continued).

3,399,638. PRINCE LIONHEART, INC., SANTA MARIA, CA.
SN 78-727,449. PUB. 9-4-2007, FILED 10-5-2005.

bébéPOD

OWNER OF U.S. REG. NO. 3,041,974.
THE ENGLISH TRANSLATION OF THE WORD "BÉBÉ"
MEANS "BABY".

FOR INFANT TRAINING DEVICE IN THE NATURE
OF SEATS, FOR HELPING INFANTS SIT UPRIGHT
AND HELPING INFANTS TO LEARN TO SIT UPRIGHT
(U.S. CLS. 2, 13, 22, 25, 32 AND 50).
FIRST USE 5-0-2005; IN COMMERCE 1-1-2006.

3,399,676. AMERICAN STANDARD INTERNATIONAL INC.,
NEW YORK, NY. SN 78-753,426. PUB. 8-22-2006, FILED 11-
14-2005.

SPEED CONNECT

THE MARK CONSISTS OF STANDARD CHARACTERS
WITHOUT CLAIM TO ANY PARTICULAR FONT, STYLE,
SIZE, OR COLOR.

NO CLAIM IS MADE TO THE EXCLUSIVE RIGHT TO
USE "CONNECT", APART FROM THE MARK AS SHOWN.

FOR NON-METAL FASTENING AND CONNECTION
DEVICES FOR SANITARY INSTALLATIONS, NAMELY,
NON-METAL FASTENERS FOR TOILETS, FAUCETS
AND DRAINS (U.S. CLS. 2, 13, 22, 25, 32 AND 50).
FIRST USE 11-1-2005; IN COMMERCE 1-1-2006.

3,399,770. URBAN OUTFITTERS (DELAWARE), INC., PHI-
LADELPHIA, PA. SN 78-790,349. PUB. 9-5-2006, FILED 1-12-
2006.

4040 Locust

THE MARK CONSISTS OF STANDARD CHARACTERS
WITHOUT CLAIM TO ANY PARTICULAR FONT, STYLE,
SIZE, OR COLOR.

FOR INDOOR HOME FURNITURE (U.S. CLS. 2, 13, 22,
25, 32 AND 50).
FIRST USE 5-12-2006; IN COMMERCE 5-12-2006.

CLASS 20—(Continued).

3,399,808. RSI HOME PRODUCTS MANAGEMENT, INC.,
NEWPORT BEACH, CA. SN 78-802,730. PUB. 3-20-2007,
FILED 1-30-2006.

TOUGH FOR ALL YOUR STUFF

THE MARK CONSISTS OF STANDARD CHARACTERS
WITHOUT CLAIM TO ANY PARTICULAR FONT, STYLE,
SIZE, OR COLOR.

FOR CABINETS, NAMELY, KITCHEN CABINETS,
BATHROOM CABINETS, MEDICINE CABINETS, MIR-
RORED CABINETS, STORAGE CABINETS AND GAR-
AGE CABINETS; MIRRORS; COUNTERTOPS; STORAGE
ACCESSORIES, NAMELY, BARS FOR HANGING
CLOTHES, SLIDING CLOTHES RAILS, CLOTHES
HANGERS, STORAGE RACKS, SHOE RACKS, BELT
RACKS, TIE RACKS; PLASTIC STORAGE BINS, GAR-
AGE STORAGE CABINETS AND METAL AND NON-
METAL GARAGE SHELVING; WORK BENCH; WALL-
MOUNTED TOOL RACK (U.S. CLS. 2, 13, 22, 25, 32 AND
50).

FIRST USE 5-31-2007; IN COMMERCE 5-31-2007.

3,399,933. KLEAR-VU CORPORATION, FALL RIVER, MA.
SN 78-858,856. PUB. 1-23-2007, FILED 4-11-2006.

DELIGHTFILL

THE MARK CONSISTS OF STANDARD CHARACTERS
WITHOUT CLAIM TO ANY PARTICULAR FONT, STYLE,
SIZE, OR COLOR.

FOR CUSHIONS FOR CHAIRS AND STOOLS (U.S.
CLS. 2, 13, 22, 25, 32 AND 50).
FIRST USE 12-1-2006; IN COMMERCE 12-1-2006.

CLASS 20—(Continued).

3,399,951. EXPERIENCE HENDRIX, L.L.C., SEATTLE, WA. SN 78-866,262. PUB. 8-14-2007, FILED 4-20-2006.



OWNER OF U.S. REG. NOS. 2,245,408, 3,072,909, AND OTHERS.

NO CLAIM IS MADE TO THE EXCLUSIVE RIGHT TO USE "AUTHENTIC", APART FROM THE MARK AS SHOWN.

THE NAME(S), PORTRAIT(S), AND/OR SIGNATURE(S) SHOWN IN THE MARK DOES NOT IDENTIFY A PARTICULAR LIVING INDIVIDUAL.

THE MARK CONSISTS OF THE WORD "AUTHENTIC" ABOVE AND THE WORD "HENDRIX" BELOW A DESIGN OF A MAN'S HEAD AND SHOULDERS.

FOR NON-METAL AND NON-LEATHER KEY CHAINS; PLAQUES (U.S. CLS. 2, 13, 22, 25, 32 AND 50). FIRST USE 10-24-2003; IN COMMERCE 12-16-2003.

CLASS 20—(Continued).

3,399,959. THRIVENT FINANCIAL LIFELONG RESOURCES INC., APPLETON, WI. SN 78-871,974. PUB. 11-28-2006, FILED 4-28-2006.



FOR NONEDIBLE, PLASTIC CREDIT CARD HOLDERS IN WHICH CREDIT CARDS CAN BE FROZEN FOR SAFE KEEPING (U.S. CLS. 2, 13, 22, 25, 32 AND 50).

FIRST USE 5-14-2007; IN COMMERCE 5-14-2007.

3,400,013. RAFFA, ANTHONY, ORLANDO, FL. SN 78-910,247. PUB. 2-6-2007, FILED 6-16-2006.

BONE - THRONE

THE MARK CONSISTS OF STANDARD CHARACTERS WITHOUT CLAIM TO ANY PARTICULAR FONT, STYLE, SIZE, OR COLOR.

FOR PET BEDS AND PILLOWS (U.S. CLS. 2, 13, 22, 25, 32 AND 50).

FIRST USE 7-1-2006; IN COMMERCE 11-15-2006.

3,399,958. THRIVENT FINANCIAL LIFELONG RESOURCES INC., APPLETON, WI. SN 78-871,958. PUB. 11-28-2006, FILED 4-28-2006.

CARDSICLE

THE MARK CONSISTS OF STANDARD CHARACTERS WITHOUT CLAIM TO ANY PARTICULAR FONT, STYLE, SIZE, OR COLOR.

FOR NONEDIBLE, PLASTIC CREDIT CARD HOLDERS IN WHICH CREDIT CARDS CAN BE FROZEN FOR SAFE KEEPING (U.S. CLS. 2, 13, 22, 25, 32 AND 50).

FIRST USE 5-14-2007; IN COMMERCE 5-14-2007.

3,400,093. IGNITE USA, LLC, CHICAGO, IL. SN 78-947,478. PUB. 3-6-2007, FILED 8-8-2006.

TWOFOLD

THE MARK CONSISTS OF STANDARD CHARACTERS WITHOUT CLAIM TO ANY PARTICULAR FONT, STYLE, SIZE, OR COLOR.

FOR WORKBENCH (U.S. CLS. 2, 13, 22, 25, 32 AND 50). FIRST USE 7-30-2007; IN COMMERCE 7-30-2007.

CLASS 20—(Continued).

3,400,139. TURNBULL ENTERPRISES, INC., SAN CARLOS, CA. SN 78-959,056. PUB. 4-10-2007, FILED 8-23-2006.

NOT JUST ANOTHER... LINE OF BULL

THE MARK CONSISTS OF STANDARD CHARACTERS WITHOUT CLAIM TO ANY PARTICULAR FONT, STYLE, SIZE, OR COLOR.

FOR PLASTIC FIGURINES (U.S. CLS. 2, 13, 22, 25, 32 AND 50).

FIRST USE 5-1-2007; IN COMMERCE 5-1-2007.

3,400,174. BOSSMATE, LLC, CHATTANOOGA, TN. SN 78-967,180. PUB. 4-24-2007, FILED 9-5-2006.

MIGHTYMATE

THE MARK CONSISTS OF STANDARD CHARACTERS WITHOUT CLAIM TO ANY PARTICULAR FONT, STYLE, SIZE, OR COLOR.

FOR WORK SURFACES (U.S. CLS. 2, 13, 22, 25, 32 AND 50).

FIRST USE 9-25-2006; IN COMMERCE 9-25-2006.

3,400,189. DON MECHANICS ENTERPRISES, LTD., ADDISON, TX. SN 78-970,595. PUB. 6-19-2007, FILED 9-8-2006.

ENCHANTED FAIRY DOORS

THE MARK CONSISTS OF STANDARD CHARACTERS WITHOUT CLAIM TO ANY PARTICULAR FONT, STYLE, SIZE, OR COLOR.

NO CLAIM IS MADE TO THE EXCLUSIVE RIGHT TO USE "DOORS", APART FROM THE MARK AS SHOWN.

FOR DECORATIVE MINIATURE ENTRYWAYS OF POLYRESIN FEATURING VARIOUS STYLES OF CASINGS, DOORS, TRANSOMS, SIDELIGHTS, SIDE PANELS AND ENTRANCE STEPS (U.S. CLS. 2, 13, 22, 25, 32 AND 50).

FIRST USE 3-20-2007; IN COMMERCE 3-20-2007.

CLASS 21—HOUSEWARES AND GLASS

CLASS 21—(Continued).

3,398,869. BONGIOVI, JOHN, LOS ANGELES, CA. SN 76-551,255. PUB. 4-24-2007, FILED 9-24-2003.



THE MARK CONSISTS OF A STYLIZED WINGED FOOTBALL.

FOR MUGS; BEVERAGE GLASSWARE; PORTABLE BEVERAGE DISPENSERS; PLASTIC CUPS; DECORATIVE CUPS; COMMEMORATIVE PLATES (U.S. CLS. 2, 13, 23, 29, 30, 33, 40 AND 50).

FIRST USE 1-28-2004; IN COMMERCE 1-28-2004.

3,398,913. RESOURCEFUL PRODUCTS, INC. (THE RPI GROUP), SOLON, OH. SN 76-652,916. PUB. 8-29-2006, FILED 1-5-2006.

STAY FRESH

THE MARK CONSISTS OF STANDARD CHARACTERS WITHOUT CLAIM TO ANY PARTICULAR FONT, STYLE, SIZE, OR COLOR.

FOR PLASTIC FOOD STORAGE CONTAINERS FOR DOMESTIC USE, EXCLUDING PACKAGING FOR MEAT AND POULTRY PRODUCTS (U.S. CLS. 2, 13, 23, 29, 30, 33, 40 AND 50).

FIRST USE 1-5-2006; IN COMMERCE 1-5-2006.

3,399,033. TRU VUE, INC., MCCOOK, IL. SN 77-029,291. PUB. 5-22-2007, FILED 10-25-2006.

CONSERVATION MASTERPIECE

THE MARK CONSISTS OF STANDARD CHARACTERS WITHOUT CLAIM TO ANY PARTICULAR FONT, STYLE, SIZE, OR COLOR.

OWNER OF U.S. REG. NOS. 1,590,940, 1,590,942, AND OTHERS.

FOR GLASS SHEETS FOR PICTURE FRAMES AND DISPLAY CASES (U.S. CLS. 2, 13, 23, 29, 30, 33, 40 AND 50).

FIRST USE 12-18-2006; IN COMMERCE 12-18-2006.

CLASS 21—(Continued).

3,399,217. CRICKET PRODUCTIONS INC, MARLBORO, MA.
SN 77-116,278. PUB. 9-11-2007, FILED 2-26-2007.

ONE TOUCH INSTANT MARINATOR

THE MARK CONSISTS OF STANDARD CHARACTERS WITHOUT CLAIM TO ANY PARTICULAR FONT, STYLE, SIZE, OR COLOR.

NO CLAIM IS MADE TO THE EXCLUSIVE RIGHT TO USE "INSTANT MARINATOR", APART FROM THE MARK AS SHOWN.

FOR PLASTIC MEAT MARINATING CONTAINERS (U.S. CLS. 2, 13, 23, 29, 30, 33, 40 AND 50).

FIRST USE 10-1-2007; IN COMMERCE 10-1-2007.

3,399,290. INVENTAL LABORATORY, INC., MORRO BAY, CA. SN 77-157,862. PUB. 10-9-2007, FILED 4-16-2007.

SEAL SAVER

THE MARK CONSISTS OF STANDARD CHARACTERS WITHOUT CLAIM TO ANY PARTICULAR FONT, STYLE, SIZE, OR COLOR.

FOR HOUSEHOLD CONTAINERS FOR FOODS (U.S. CLS. 2, 13, 23, 29, 30, 33, 40 AND 50).

FIRST USE 10-20-2007; IN COMMERCE 11-10-2007.

3,399,302. SOKOL, BRENT D., LOS ANGELES, CA. AND CHIANG, CHIA C., LOS ANGELES, CA. SN 77-975,172. PUB. 6-19-2007, FILED 11-19-2006.



THE MARK CONSISTS OF A RECTANGULAR SHAPE WITH TEXT.

FOR FRUIT RIPENING BOWLS; SERVINGWARE FOR SERVING FOOD; STORE AND SERVE CONTAINERS FOR FOOD (U.S. CLS. 2, 13, 23, 29, 30, 33, 40 AND 50).

FIRST USE 9-14-2007; IN COMMERCE 9-14-2007.

CLASS 21—(Continued).

3,399,460. FINGERHUT DIRECT MARKETING, INC., EDEN PRAIRIE, MN. SN 78-550,727. PUB. 4-3-2007, FILED 1-20-2005.

COUNTRY BEAR

THE MARK CONSISTS OF STANDARD CHARACTERS WITHOUT CLAIM TO ANY PARTICULAR FONT, STYLE, SIZE, OR COLOR.

OWNER OF U.S. REG. NO. 2,782,394.

FOR DINNERWARE, NAMELY, DINNER PLATES, SALAD PLATES, SOUP/CEREAL BOWLS, MUGS (U.S. CLS. 2, 13, 23, 29, 30, 33, 40 AND 50).

FIRST USE 4-20-1992; IN COMMERCE 4-20-1992.

3,399,554. THE TJX COMPANIES, INC., FRAMINGHAM, MA. SN 78-657,867. PUB. 3-14-2006, FILED 6-24-2005.

WELL EQUIPPED KITCHEN

THE MARK CONSISTS OF STANDARD CHARACTERS WITHOUT CLAIM TO ANY PARTICULAR FONT, STYLE, SIZE, OR COLOR.

OWNER OF U.S. REG. NOS. 2,608,231 AND 2,667,058.

NO CLAIM IS MADE TO THE EXCLUSIVE RIGHT TO USE "KITCHEN", APART FROM THE MARK AS SHOWN.

FOR STEMWARE, NAMELY, GOBLETs, WINE GLASSES, CHAMPAGNE FLUTES, CORDIAL GLASSES, COCKTAIL GLASSES, MARTINI GLASSES, AND MARGARITA GLASSES; DINNERWARE, NAMELY, DINNER PLATES, SALAD PLATES, SOUP BOWLS, AND CEREAL BOWLS; SERVEWARE, NAMELY, DIVIDED PLATES, SERVING PLATTERS, CHIP AND DIP PLATTERS, SERVING BOWLS, AND PITCHERS; CANDLE STICKS MADE OF CRYSTAL OR GLASS; AND VASES MADE OF CRYSTAL OR GLASS (U.S. CLS. 2, 13, 23, 29, 30, 33, 40 AND 50).

FIRST USE 11-8-2007; IN COMMERCE 11-8-2007.

CLASS 21—(Continued).

3,399,693. J & D BRUSH CO., INC., HAUPPAUGE, NY. SN 78-759,059. PUB. 3-20-2007, FILED 11-22-2005.

LURE

THE MARK CONSISTS OF STANDARD CHARACTERS WITHOUT CLAIM TO ANY PARTICULAR FONT, STYLE, SIZE, OR COLOR.

FOR HAIR COMBS AND HAIR BRUSHES (U.S. CLS. 2, 13, 23, 29, 30, 33, 40 AND 50).

FIRST USE 11-26-2007; IN COMMERCE 11-26-2007.

3,399,759. MID-WEST METAL PRODUCTS, INC., MUNCIE, IN. SN 78-783,733. PUB. 3-20-2007, FILED 1-2-2006.



NO CLAIM IS MADE TO THE EXCLUSIVE RIGHT TO USE "FERRET", APART FROM THE MARK AS SHOWN.

FOR CAGES FOR PETS (U.S. CLS. 2, 13, 23, 29, 30, 33, 40 AND 50).

FIRST USE 6-30-2007; IN COMMERCE 6-30-2007.

3,399,848. THERMOS L.L.C., ROLLING MEADOWS, IL. SN 78-818,764. PUB. 5-8-2007, FILED 2-20-2006.

RAYA

THE MARK CONSISTS OF STANDARD CHARACTERS WITHOUT CLAIM TO ANY PARTICULAR FONT, STYLE, SIZE, OR COLOR.

OWNER OF U.S. REG. NO. 2,984,199.

FOR LUNCHBOXES, COOLER BAGS AND THERMALLY INSULATED TOTE BAGS FOR CARRYING CLOSED CONTAINERS OF FOOD AND BEVERAGES (U.S. CLS. 2, 13, 23, 29, 30, 33, 40 AND 50).

FIRST USE 2-15-2007; IN COMMERCE 2-15-2007.

CLASS 21—(Continued).

3,399,989. STELLAR MANUFACTURING, INC., BEND, OR. SN 78-892,931. PUB. 1-2-2007, FILED 5-25-2006.

EZSTREET

THE MARK CONSISTS OF STANDARD CHARACTERS WITHOUT CLAIM TO ANY PARTICULAR FONT, STYLE, SIZE, OR COLOR.

FOR GARBAGE CANS (U.S. CLS. 2, 13, 23, 29, 30, 33, 40 AND 50).

FIRST USE 3-31-2007; IN COMMERCE 3-31-2007.

3,400,172. CNI USA CORP, INC., LAS VEGAS, NV. SN 78-966,867. PUB. 5-1-2007, FILED 9-5-2006.



THE COLOR(S) BLUE IS/ARE CLAIMED AS A FEATURE OF THE MARK.

THE ENTIRE MARK APPEARS IN THE COLOR BLUE.

THE MARK CONSISTS OF STYLIZED LETTERS WITH THE LETTER "O" SIMULATING A REVOLVING ACTION.

FOR BATH BRUSHES; BATH PRODUCTS, NAMELY, LOOFAH SPONGES; COSMETIC BRUSHES; EXFOLIATING PADS; POWER-OPERATED BRUSH USED TO CLEAN AND EXFOLIATE THE SKIN; SCRUBBING BRUSHES; SPONGE MASSAGERS (U.S. CLS. 2, 13, 23, 29, 30, 33, 40 AND 50).

FIRST USE 10-15-2007; IN COMMERCE 12-17-2007.

CLASS 22—CORDAGE AND FIBERS

3,398,940. KELLEY ORNAMENTAL IRON, LLC, DBA PEORIA AWNING, PEORIA, IL. SN 76-665,851. PUB. 5-1-2007, FILED 9-11-2006.

SAVAWN

THE MARK CONSISTS OF STANDARD CHARACTERS WITHOUT CLAIM TO ANY PARTICULAR FONT, STYLE, SIZE, OR COLOR.

FOR WINDOW AWNINGS (U.S. CLS. 1, 2, 7, 19, 22, 42 AND 50).

FIRST USE 6-15-2007; IN COMMERCE 6-15-2007.

CLASS 22—(Continued).

3,399,614. ASAHI KASEI FIBERS CORPORATION, OSAKA, JAPAN. SN 78-708,943. PUB. 6-12-2007, FILED 9-8-2005.

Cyberlon

THE MARK CONSISTS OF STANDARD CHARACTERS WITHOUT CLAIM TO ANY PARTICULAR FONT, STYLE, SIZE, OR COLOR.

FOR ROPES, SYNTHETIC CORDS, SYNTHETIC FIBERS FOR CABLES; SYNTHETIC FIBERS FOR REINFORCING CONCRETE AND ASPHALTS; SYNTHETIC FIBERS FOR REINFORCING PLASTICS; SYNTHETIC FIBERS FOR INSULATION FOR PRINTED CIRCUIT BOARDS, BATTERY SEPARATORS, ELECTROLYTIC CAPACITOR, PARTLY-PROCESSED FRICTION MATERIALS OF BRAKE LININGS AND CLUTCH FACINGS AND REINFORCING SYNTHETIC FIBER GASKETS; AND SYNTHETIC FIBERS FOR MANUFACTURING CUT RESISTANT GLOVES (U.S. CLS. 1, 2, 7, 19, 22, 42 AND 50).

FIRST USE 8-4-2006; IN COMMERCE 11-1-2006.

CLASS 24—(Continued).

3,398,870. BONGIOVI, JOHN, LOS ANGELES, CA. SN 76-551,256. PUB. 4-24-2007, FILED 9-24-2003.



THE MARK CONSISTS OF A STYLIZED WINGED FOOTBALL.

FOR BATH TOWELS; BEACH TOWELS; BEDDING, NAMELY, BED BLANKETS, COMFORTERS, BED SPREADS AND BED LINEN; BATH LINEN, HOUSEHOLD LINENS, CLOTH COASTERS, PLASTIC PLACE MATS, TEXTILE PLACE MATS, VINYL PLACE MATS, TEXTILE NAPKINS, POT HOLDERS, CLOTH PENNANTS, FELT PENNANTS AND TEXTILE WALL HANGINGS (U.S. CLS. 42 AND 50).

FIRST USE 1-28-2004; IN COMMERCE 1-28-2004.

3,399,862. NEMO EQUIPMENT, INC., NASHUA, NH. SN 78-823,253. PUB. 4-24-2007, FILED 2-24-2006.



THE MARK CONSISTS OF THE LETTER "N" FORMING A SHIELD.

FOR CAMPING ACCESSORIES, NAMELY, TENTS (U.S. CLS. 1, 2, 7, 19, 22, 42 AND 50).

FIRST USE 4-7-2005; IN COMMERCE 4-7-2005.

3,399,410. TIONG LIONG INDUSTRIAL CO., LTD., TAI-CHUNG HSIEN, TAIWAN. SN 78-503,129. PUB. 9-27-2005, FILED 10-20-2004.

3W

FOR FABRIC FOR BOOTS AND SHOES, LINEN LINING FABRIC FOR SHOES, FABRIC FOR OUTDOOR WEAR, COTTON CLOTH, POLYESTER FABRIC, NYLON FABRIC, RAYON FABRIC, SAIL CLOTH AND FIBERGLASS FABRICS FOR TEXTILE USE (U.S. CLS. 42 AND 50).

FIRST USE 10-5-2004; IN COMMERCE 9-19-2007.

CLASS 24—FABRICS

CLASS 24—(Continued).

3,399,552. FABRIC EDITIONS LLC, AKA FE ACQUISITION LLC, GREENVILLE, SC. SN 78-657,583. PUB. 3-14-2006, FILED 6-24-2005.



THE COLOR GRAY IS INTENDED TO INDICATE SHADING ONLY.

THE MARK CONSISTS OF THE PHRASE "DESIGN BY THE" PLACED OVER THE WORD "PIECE". THE LETTERS IN THE PHRASE "DESIGN BY THE" ARE STYLIZED IN A SLIGHTLY CURLY FONT. THE LETTERS "P", "I", "E", "C" AND "E", IN THE WORD "PIECE", ARE SEPARATED FROM ONE ANOTHER, WITH EACH LETTER PLACED INSIDE A POLYGON. THE DASHED BORDER SURROUNDING THE LETTERS "P", "I", "E", "C", AND "E", ARE A FEATURE OF THE MARK.

FOR PRE-CUT FABRICS; FABRIC PATCHWORK PIECES AND QUILT AND CRAFT KITS COMPRISED OF FABRIC PATCHWORK PIECES (U.S. CLS. 42 AND 50).

FIRST USE 8-31-2005; IN COMMERCE 8-31-2005.

3,399,557. KOLON GLOTECH, INC., KWACHEON-CITY, KYUNGGI-DO, REPUBLIC OF KOREA. SN 78-659,536. PUB. 3-21-2006, FILED 6-28-2005.

NANOPORA

THE MARK CONSISTS OF STANDARD CHARACTERS WITHOUT CLAIM TO ANY PARTICULAR FONT, STYLE, SIZE, OR COLOR.

FOR COTTON FABRICS, NON-WOVEN TEXTILE FABRICS FOR USE IN THE MANUFACTURE OF CLOTHING; COATED FABRICS WITH RESINS SUCH AS POLYURETHANE, NYLON, POLYESTER, ACRYL FOR USE IN THE MANUFACTURE OF CLOTHING; AND ACETATE FABRICS OR COMBINATIONS THEREOF FOR USE IN THE MANUFACTURE OF CLOTHING; LAMINATED FABRICS WITH RESIN SUCH AS POLYURETHANE, WATER PROOFING FABRIC, KNITTED FABRICS, FOR USE IN THE MANUFACTURE OF CLOTHING (U.S. CLS. 42 AND 50).

FIRST USE 9-1-2006; IN COMMERCE 8-1-2007.

CLASS 24—(Continued).

3,399,719. C.M.I. ENTERPRISES, INC., MIAMI, FL. SN 78-770,238. PUB. 9-12-2006, FILED 12-9-2005.

NBT

THE MARK CONSISTS OF STANDARD CHARACTERS WITHOUT CLAIM TO ANY PARTICULAR FONT, STYLE, SIZE, OR COLOR.

FOR PROTECTIVE COATINGS SOLD AS AN INTEGRAL COMPONENT OF VINYL TEXTILES AND VINYL-COATED SYNTHETIC FABRICS FOR THE MANUFACTURE OF RESIDENTIAL, COMMERCIAL, INDUSTRIAL, MARINE, AIRCRAFT AND AUTOMOTIVE UPHOLSTERY AND TRIM (U.S. CLS. 42 AND 50).

FIRST USE 9-19-2006; IN COMMERCE 9-19-2006.

3,399,940. C.M.I. ENTERPRISES, INC., MIAMI, FL. SN 78-861,688. PUB. 9-12-2006, FILED 4-14-2006.

NANOCIDE

THE MARK CONSISTS OF STANDARD CHARACTERS WITHOUT CLAIM TO ANY PARTICULAR FONT, STYLE, SIZE, OR COLOR.

FOR PROTECTIVE COATINGS SOLD AS AN INTEGRAL COMPONENT OF VINYL TEXTILES AND VINYL COATED SYNTHETIC AND NON-SYNTHETIC FABRICS FOR THE MANUFACTURE OF RESIDENTIAL, COMMERCIAL, INDUSTRIAL, MARINE, AIRCRAFT AND AUTOMOTIVE UPHOLSTERY AND TRIM (U.S. CLS. 42 AND 50).

FIRST USE 9-27-2006; IN COMMERCE 9-27-2006.

CLASS 24—(Continued).

3,399,948. NEWTON, STEVEN J., CLEVER, MO. SN 78-864,615. PUB. 8-28-2007, FILED 4-19-2006.



THE COLOR(S) RED, WHITE, BLUE AND SILVER IS/ARE CLAIMED AS A FEATURE OF THE MARK.

THE MARK CONSISTS OF RED OUTSIDE BORDER SIZE OF 4 INCHES THEN WHITE BORDER SIZE OF 4 INCHES THEN SOLID BLUE INSIDE SIZE OF 21 INCHES THEN SILVER STAR CENTERED IN BLUE FIELD SIZE OF 17 INCHES.

FOR CLOTH AND FABRIC FLAGS FEATURING A SILVER COLORED STAR CREATED TO HONOR WOUNDED ARMED FORCES PERSONNEL (U.S. CLS. 42 AND 50).

FIRST USE 7-1-2005; IN COMMERCE 5-1-2006.

CLASS 25—(Continued).

3,398,841. PRINTMARK INDUSTRIES, INC., HAZLETON, PA. SN 76-285,471. PUB. 5-3-2005, FILED 7-16-2001.

QUIKWEAR

FOR APPAREL AND OUTERWEAR, NAMELY, HATS, CAPS, GLOVES, SCARVES, SWEATERS, SWEATSHIRTS, JACKETS, SHIRTS, BLOUSES, SKIRTS, PANTS, TROUSERS, SHORTS, T-SHIRTS, UNDERWEAR, LINGERIE, FOOTWEAR (U.S. CLS. 22 AND 39).

FIRST USE 7-20-2001; IN COMMERCE 7-20-2001.

3,400,216. LACE LASTICS COMPANY, INC., OXFORD, NC. SN 78-979,628. PUB. 10-3-2006, FILED 1-6-2006.

3,398,852. BOOT ROYALTY COMPANY, L.P., FORT WORTH, TX. SN 76-471,682. PUB. 3-9-2004, FILED 11-27-2002.

SILVERFRESH

THE MARK CONSISTS OF STANDARD CHARACTERS WITHOUT CLAIM TO ANY PARTICULAR FONT, STYLE, SIZE, OR COLOR.

FOR BED LINEN; BED SHEETS; AND PILLOW CASES (U.S. CLS. 42 AND 50).

FIRST USE 5-24-2007; IN COMMERCE 5-24-2007.

**CLASS 25—CLOTHING**

3,398,840. EARNHARDT, TERESA H, MOORESVILLE, NC. SN 76-145,863. PUB. 11-18-2003, FILED 10-12-2000.

**KANNAPOLIS
INTIMIDATORS**

OWNER OF U.S. REG. NO. 2,092,602.

NO CLAIM IS MADE TO THE EXCLUSIVE RIGHT TO USE "KANNAPOLIS", APART FROM THE MARK AS SHOWN.

FOR CLOTHING, NAMELY, SWEATSHIRTS, SHIRTS, SPORT SHIRT, GOLF SHIRTS, T-SHIRTS, JERSEYS, JACKETS, COATS, HATS, CAPS AND WRIST BANDS (U.S. CLS. 22 AND 39).

FIRST USE 4-15-2001; IN COMMERCE 4-15-2001.

OWNER OF U.S. REG. NOS. 525,522, 913,819, AND 2,274,989.

NO CLAIM IS MADE TO THE EXCLUSIVE RIGHT TO USE "COMFORT TECHNOLOGY", APART FROM THE MARK AS SHOWN.

THE LINING IS A FEATURE OF THE MARK AND DOES NOT INDICATE COLOR.

FOR FOOTWEAR, NAMELY, BOOTS AND EXCLUDING ATHLETIC FOOTWEAR (U.S. CLS. 22 AND 39).

FIRST USE 1-0-2005; IN COMMERCE 1-0-2005.

CLASS 25—(Continued).

3,398,853. EDDIE BAUER, INC., BELLEVUE, WA. SN 76-475,072. PUB. 7-15-2003, FILED 12-13-2002.



OWNER OF U.S. REG. NOS. 880,279, 2,325,813, AND OTHERS.

NO CLAIM IS MADE TO THE EXCLUSIVE RIGHT TO USE "SPORT SHOP" OR "SEATTLE", APART FROM THE MARK AS SHOWN.

THE NAME "EDDIE BAUER" DOES NOT IDENTIFY A PARTICULAR LIVING INDIVIDUAL.

FOR CLOTHING, NAMELY, SHIRTS (U.S. CLS. 22 AND 39).

FIRST USE 4-13-2007; IN COMMERCE 4-13-2007.

3,398,858. DUPUIS, MICHAEL J., SACRAMENTO, CA. SN 76-497,895. PUB. 4-17-2007, FILED 3-17-2003.

IN GOD I TRUST

FOR CLOTHING, NAMELY, T-SHIRTS, JACKETS, PANTS, SHORTS, SHIRTS, COATS, SWEATSHIRTS, FASHION ACCESSORIES, NAMELY, BELTS, TIES, GLOVES, SOCKS, HOSIERY, UNDERWEAR, BOXER SHORTS, FOOTWEAR AND HEADWEAR (U.S. CLS. 22 AND 39).

FIRST USE 12-22-2007; IN COMMERCE 12-22-2007.

3,398,862. SPOILED ROTTEN U.S.A., BRONX, NY. SN 76-515,313. PUB. 8-31-2004, FILED 5-19-2003.

SPOILED ROTTEN

OWNER OF U.S. REG. NOS. 1,524,584 AND 2,369,768.
FOR MENS, WOMENS AND CHILDREN'S SPORTSWEAR AND APPAREL, NAMELY, SHORTS, PANTS, SHIRTS, HATS AND JACKETS (U.S. CLS. 22 AND 39).
FIRST USE 8-1-2007; IN COMMERCE 8-1-2007.

CLASS 25—(Continued).

3,398,871. BONGIOVI, JOHN, LOS ANGELES, CA. SN 76-551,257. PUB. 4-24-2007, FILED 9-24-2003.



THE MARK CONSISTS OF A STYLIZED WINGED FOOTBALL.

FOR MEN'S, WOMEN'S AND CHILDREN'S WEARING APPAREL, NAMELY, PANTS, SHIRTS, SLACKS, DRESSES, SKIRTS AND BLOUSES; HEADWEAR, FOOTWEAR; SPORTSWEAR, NAMELY, SWEAT SHIRTS, SWEAT PANTS, WARM-UP SUITS, T-SHIRTS, SHORTS, SPORT SHIRTS, SPORT COATS AND POLO SHIRTS; SWIMWEAR AND BEACHWEAR, NAMELY, BATHING SUITS, ROBES AND COVER-UPS; AND OUTERWEAR, NAMELY, JACKETS, SWEATERS, COATS AND VESTS (U.S. CLS. 22 AND 39).

FIRST USE 1-28-2004; IN COMMERCE 1-28-2004.

3,398,925. PATTON, VALENE, PUYALLUP, WA. SN 76-661,594. PUB. 4-3-2007, FILED 6-15-2006.



THE COLOR(S) LIGHT BLUE, BLUE, BLACK, AND WHITE IS/ARE CLAIMED AS A FEATURE OF THE MARK.

THE COLOR LIGHT BLUE APPEARS IN PART OF THE BELLBOTTOM JEANS AND THE BELT LOOPS OF THE JEANS WHICH IS A REPRESENTATION OF THE LETTER "A"; THE COLOR BLUE APPEARS IN THE FLARE OF THE BOTTOM OF THE BELLBOTTOM JEANS, WHICH REPRESENTS THE LETTER "A"; THE COLOR WHITE APPEARS AS DECORATIVE STARS IN THE FLARE OF THE BELLBOTTOMS WHICH REPRESENTS THE LETTER "A" AND AS THE BELT BUCKLE OF THE BELT; AND THE CORE BLACK APPEARS IN THE BELT OF THE JEANS WHICH IS REPRESENTED AS THE LETTER "A", IN THE SHOES, AND IN THE LETTERS V AND LENE.

FOR PANTS, T-SHIRTS (U.S. CLS. 22 AND 39).
FIRST USE 9-19-2007; IN COMMERCE 9-19-2007.

CLASS 25—(Continued).

3,398,929. HOLT HOSIERY MILLS, INC., BURLINGTON, NC.
SN 76-662,777. PUB. 5-8-2007, FILED 7-10-2006.

PURE CARE

THE MARK CONSISTS OF STANDARD CHARACTERS WITHOUT CLAIM TO ANY PARTICULAR FONT, STYLE, SIZE, OR COLOR.

FOR HOSIERY PRODUCTS, NAMELY, MEN'S AND WOMEN'S SOCKS, PANTYHOSE, TIGHTS, KNEE HIGHS, THIGH HIGHS AND TROUSER SOCKS (U.S. CLS. 22 AND 39).

FIRST USE 8-1-2006; IN COMMERCE 8-1-2006.

3,398,954. STRIKEMASTER CORPORATION, BIG LAKE, MN. SN 76-672,370. PUB. 9-18-2007, FILED 2-7-2007.

HARDWATER WARE BY STRIKEMASTER

THE MARK CONSISTS OF STANDARD CHARACTERS WITHOUT CLAIM TO ANY PARTICULAR FONT, STYLE, SIZE, OR COLOR.

OWNER OF U.S. REG. NO. 2,121,312.

NO CLAIM IS MADE TO THE EXCLUSIVE RIGHT TO USE "WARE", APART FROM THE MARK AS SHOWN.

FOR OUTERWEAR CLOTHING, NAMELY, HATS, VESTS AND JACKETS (U.S. CLS. 22 AND 39).

FIRST USE 4-1-2007; IN COMMERCE 4-1-2007.

3,398,959. TARA GRINNA, INC., CONWAY, SC. SN 76-978,701. PUB. 7-11-2006, FILED 6-7-2004.



NO CLAIM IS MADE TO THE EXCLUSIVE RIGHT TO USE "BIKINIS", APART FROM THE MARK AS SHOWN.

THE NAME KIRSTI GRINNA IDENTIFIES A LIVING INDIVIDUAL WHOSE CONSENT IS OF RECORD.

THE LITERAL PORTION OF THE MARK IS ENTIRELY OF THE ENGLISH LANGUAGE AND CONSISTS OF THE STYLIZED WORDING "KIRSTI GRINNA BIKINIS KGB".

FOR SWIMWEAR, T-SHIRTS, SKIRTS, SHORTS AND BELTS (U.S. CLS. 22 AND 39).

FIRST USE 8-1-2005; IN COMMERCE 8-1-2005.

CLASS 25—(Continued).

3,398,962. CHERISE, LLC, STAMFORD, CT. SN 77-000,746.
PUB. 5-1-2007, FILED 9-15-2006.

THE MARK CONSISTS OF THE WORD CHERISE & DESIGN.

FOR CLOTHING, NAMELY, BERETS, BERMUDA SHORTS, BLOUSES, BOLEROS, BOTTOMS, CAPES, CARDIGANS, COATS, COVERALLS, DRESSES, FROCKS, GLOVES, HALTER TOPS, HEAD WEAR, JACKETS, JEANS, JOGGING SUITS, JUMPERS, JUMPSUITS, LEGGINGS, MITTENS, MUFFLERS, OVERALLS, PANTIES, PANTS, PEDAL PUSHERS, PONCHOS, PULL-OVERS, VESTS, ROMPERS, SARONGS, SCARVES, SHIRTS, SHORTALLS, SHORTS, SKIRTS, SKORTS, JOGGING SUITS, PANTIES, SWEAT SUITS, SUSPENDERS, SWEAT PANTS, SWEAT SHORTS, SWEAT SHIRTS, SWEATERS, TIGHTS, UNDERWEAR, UNDERSHIRTS, UNDERGARMENTS; FOOTWEAR (U.S. CLS. 22 AND 39).

FIRST USE 3-7-2007; IN COMMERCE 3-7-2007.

3,398,971. WESTMOOR MFG. CO., FT. WORT, TX. SN 77-004,035. PUB. 4-3-2007, FILED 9-21-2006.

ROCK & ROLL COWGIRL

THE MARK CONSISTS OF STANDARD CHARACTERS WITHOUT CLAIM TO ANY PARTICULAR FONT, STYLE, SIZE, OR COLOR.

FOR BLOUSES; BOTTOMS; COATS; FOOTWEAR; HEAD WEAR; PANTS; SHIRTS; SHORTS; SKIRTS; T-SHIRTS; TOPS (U.S. CLS. 22 AND 39).

FIRST USE 12-0-2006; IN COMMERCE 12-0-2006.

3,398,972. WESTMOOR MFG. CO., FT. WORT, TX. SN 77-004,042. PUB. 4-3-2007, FILED 9-21-2006.

ROCK & ROLL COWBOY

THE MARK CONSISTS OF STANDARD CHARACTERS WITHOUT CLAIM TO ANY PARTICULAR FONT, STYLE, SIZE, OR COLOR.

OWNER OF U.S. REG. NO. 1,958,194.
FOR COATS; HEAD WEAR; SHIRTS; T-SHIRTS; TOPS (U.S. CLS. 22 AND 39).

FIRST USE 12-0-2006; IN COMMERCE 12-0-2006.

CLASS 25—(Continued).

3,398,975. GRANT, ANGELA, SACRAMENTO, CA. SN 77-004,647. PUB. 5-8-2007, FILED 9-21-2006.



THE MARK CONSISTS OF STYLIZED TEXT OF THE WORDS, "CALI TEN".

FOR CAPRIS; DENIMS; JEANS; PULLOVERS; PUMPS; SANDALS; SHIRTS; SHOES; SKIRTS; T-SHIRTS; TANK TOPS; TROUSERS (U.S. CLS. 22 AND 39).

FIRST USE 2-12-2007; IN COMMERCE 5-18-2007.

3,399,001. ADAMS, SHAWN MAURICE, YONKERS, NY. SN 77-011,620. PUB. 4-17-2007, FILED 10-2-2006.

XTREME YOUR DREAM

THE MARK CONSISTS OF STANDARD CHARACTERS WITHOUT CLAIM TO ANY PARTICULAR FONT, STYLE, SIZE, OR COLOR.

FOR CLOTHING, NAMELY, ADHESIVE BRAS, AFTER SKI BOOTS, ALBS, ANGLERS' SHOES, ANKLE BOOTS, ANKLE GARTERS, ANKLE SOCKS, ANKLET SOCKS, ANORAKS PARKAS, ANTI-PERSPIRANT SOCKS, APRES-SKI SHOES, APRONS, ASCOTS, ATHLETIC FOOTWEAR, ATHLETICS SHOES, ATHLETICS UNIFORMS, BABUSHKAS, BABY BIBS NOT OF PAPER, BABY BUNTING, BABY DOLL PAJAMAS, BALACLAVAS, BALLET SHOES, BALLET SLIPPERS, BALLOON PANTS, BANDANAS, BANDEAUX, BASEBALL CAPS, BASEBALL SHOES, BASKETBALL SNEAKERS, BATH SLIPPERS, BATHING CAPS, BATHING COSTUMES, BATHING COSTUMES FOR WOMEN, BATHING SUITS, BATHING SUITS FOR MEN, BATHING TRUNKS, BATHROBES, BEACH COVERUPS, BEACH FOOTWEAR, BEACH SHOES, BEACHWEAR, BEANIES, BED JACKETS, BELTS, BELTS MADE OF LEATHER, BELTS OF TEXTILE, BERETS, BERMUDA SHORTS, BIB OVERALLS, BIBS NOT OF CLOTH OR PAPER, BICYCLE GLOVES, BICYCLING GLOVES, BIKINIS, BLAZERS, BLOOMERS, BLOUSES, BLOUSONS, BOARD SHORTS, BOARDSHORTS, BOAS, BODY SHAPERS, BODY SUITS, BOLEROS, BOLO TIES, BONNETS, BOOTIES, BOOTS, BOTTOMS, BOW TIES, BOWLING SHOES, BOXER BRIEFS, BOXER SHORTS, BOXING SHOES, BRALLETTES, BRAS, BRASSIERES, BREECHES, BRIEFS, UNDERWEAR BRIEFS, BUSTIERS, BUSTLE HOLDER BANDS FOR OBI (OBIAGE), BUSTLES FOR OBI-KNOTS (OBIAGE-SHIN), BUTTON-FRONT ALOHA SHIRTS, CAPTANS, CAMISETTES, CAMISOLES, CAMP SHIRTS, CANVAS SHOES, CAP VISORS, CAPELETS, CAPES, CAPRI PANTS, CAPRIS, CLOTHING CAPS, CAPS WITH VISORS, CARDIGANS, CARGO PANTS, CASSOCKS, CHAPS, CHASUBLES, CHEF'S HATS, CHEMISES, CHEMISSETTES, CHILDREN'S AND INFANTS' CLOTH BIBS, CHILDREN'S CLOTH EATING BIBS, CHILDREN'S HEADWEAR, CHOIR ROBES, CLAM DIGGERS, CLEATS FOR ATTACHMENT TO SPORTS SHOES, CLIMBING BOOTS, MOUNTAINEERING BOOTS, CLOGS, CLOTH BIBS, CLOTH BIBS FOR ADULT DINERS, CLOTH BIBS FOR USE BY SENIOR CITIZENS OR PHYSICALLY- OR MENTALLY- CHALLENGED PERSONS, CLOTH DIAPERS, CLOTHING FOR WEAR IN JUDO PRACTICES, CLOTHING FOR WEAR IN WRESTLING GAMES, CLOTHING, NAMELY, ARM WARMERS, CLOTHING,

CLASS 25—(Continued).

NAMELY, FOLK COSTUMES, CLOTHING, NAMELY, KNEE WARMERS, CLOTHING, NAMELY, NECK TUBES, CLOTHING, NAMELY, WRAP-AROUNDS, COATS, COATS FOR MEN AND WOMEN, COATS MADE OF COTTON, COATS OF DENIM, COBBLERS' APRONS, COLLAR PROTECTORS, COLLARS, COMBINATIONS, COMPETITORS' NUMBERS OF TEXTILE, CORSELETS, CORSETS COSTUMES FOR USE IN ROLE-PLAYING GAMES, COVERALLS, COVERUPS, CRAVATES, CRAVATS, CREEPERS, CROP TOPS, CUFFS, CULOTTES, CUMMERBUNDS, CYCLING SHOES, CYCLISTS' JERSEYS, DANCE COSTUMES, DECK-SHOES, DENIM JACKETS, DENIM PANTS, DETACHABLE NECKPIECES FOR KIMONOS (HANERI), DICKIES, DISPOSABLE SLIPPERS, DISPOSABLE UNDERWEAR, DO RAGS, DOWN JACKETS, DRESS SHIELDS, DRESS SHIRTS, DRESS SUITS, DRESSES, DRESSES MADE FROM SKINS, DRESSING GOWNS, DRY SUITS, DUNGAREES, DUST COATS, CLOTHING, NAMELY, DUSTERS, EAR MUFFS, EARBANDS, EMBOSSED SOLES AND HEELS OF RUBBER OR OF PLASTIC MATERIALS, ESPADRILLES, EVENING DRESSES, EVENING GOWNS, FABRIC BELTS, FINISHED TEXTILES LININGS FOR GARMENTS, FISHERMANS' JACKETS, FISHING VESTS, FISHING WADERS, FITTED SWIMMING COSTUMES WITH BRA CUPS, FLEECE PULLOVERS, FLEECE SHORTS, FLIGHT SUITS, FLIP FLOP FOOTWEAR, FOAM PEDICURE SLIPPERS, FOOTBALL BOOTS AND STUDS THEREFOR, FOOTBALL SHOES, FOOTWEAR, FOOTWEAR FOR MEN, FOOTWEAR FOR MEN AND WOMEN, FOOTWEAR FOR TRACK AND FIELD ATHLETICS, FOOTWEAR FOR WOMEN, FOOTWEAR MADE OF WOOD, FOOTWEAR NOT FOR SPORTS, FOOTWEAR FOR SPORTS, FOOTWEAR, NAMELY, PUMPS, FOOTWEAR, NAMELY, RUBBERS, FOUL WEATHER GEAR, FOULARDS, FOUNDATION GARMENTS, FROCKS, FULL LENGTH KIMONOS (NAGAGI), FUR CLOAKS, FUR COATS, FUR COATS AND JACKETS, FUR HATS, FUR JACKETS, FUR MUFFS, FUR STOLEES, GABERDINES, GAITERS, GALOSHES, GARTER BELTS, GAUCHOS, GIRDLES, GLOVES, GLOVES FOR PERSONAL HAND CONDITIONING USE, GLOVES INCLUDING THOSE MADE OF SKIN, HIDE OR FUR, GOLF CAPS, GOLF CLEATS, GOLF SHIRTS, GOLF SHOES, GOLF SPIKES, GOLF TROUSERS, GOWNS, GREATCOATS, GYM SHORTS, GYM SUITS, GYMNASIUM SHOES, G-STRINGS, HALLOWEEN COSTUMES, HALLOWEEN COSTUMES AND MASKS SOLD IN CONNECTION THEREWITH, HALTER TOPS, HANDBALL SHOES, HAT BANDS, HATS, HEAD SCARVES, HEAD SWEATBANDS, HEAD WEAR, HEADBANDS, HEADBANDS AGAINST SWEATING, HEADWEAR, HEAVY JACKETS, HEEL INSERTS, HEEL PIECES FOR SHOES, HEELS, HIGH RAIN CLOGS (ASHIDA), HIKING BOOTS, HIPGUARDS ESPECIALLY MADE FOR FISHING, HOCKEY SHOES, HOODS, HOODS, HORSE-RIDING BOOTS, HOSIERY, HOUSECOATS, HUNTING BOOT BAGS, HUNTING VESTS, INFANT AND TODDLER ONE PIECE CLOTHING, INFANT CLOTH DIAPERS, TEXTILE INFANT DIAPER COVER, INFANT SLEEPERS, INFANTS' SHOES AND BOOTS, INFANT TROUSERS, INFANTWEAR, INNER SOLES, INSOLES, INSOLES FOR SHOES AND BOOTS, JACKETS LINERS, JACKETS, JAPANESE FOOTWEAR OF RICE STRAW (WARAJI), JAPANESE SLEEPING ROBES (NEMAKI), JAPANESE SPLIT-TOED WORK FOOTWEAR (JIKATABI), JAPANESE STYLE CLOGS AND SANDALS, JAPANESE STYLE SANDALS OF FELT, JAPANESE STYLE SANDALS (ZORI), JAPANESE STYLE SANDALS OF LEATHER, JAPANESE STYLE SOCKS (TABI COVERS), JAPANESE STYLE SOCKS (TABI), JAPANESE STYLE WOODEN CLOGS (GETA), JAPANESE TOE-STRAP SANDALS (ASAURAZORI), JEANS, JERKINS, JERSEYS, JODHPURS, JOGGING OUTFITS, JOGGING PANTS, JOGGING SUITS, JUDO SUITS, JUMPERS, JUMPSUITS, KARATE SUITS, KENDO OUTFITS, KERCHIEFS, KILTS, KIMONOS, KNEE HIGHS, KNEE-HIGH STOCKINGS, KNICKERS, KNIT SHIRTS, KNITTED CAPS, KNITTED UNDERWEAR, LAB COATS, LACE BOOTS, LADIES' BOOTS, LADIES' SUITS, LADIES' UNDERWEAR, LAYETTES, LEATHER BELTS, LEATHER COATS, LEATHER HEADWEAR, LEATHER JACKETS, LEATHER PANTS, LEATHER SHOES, LEATHER SLIPPERS, LEG SHAPERS, LEG WARMERS, LEGGINGS, LEG-WARMERS, LEOTARDS, LEOTARDS AND TIGHTS FOR WOMEN, MEN AND CHILDREN OF NYLON, COTTON OR OTHER

CLASS 25—(Continued).

TEXTILE FIBERS, LIGHT-REFLECTING COATS, LIGHT-REFLECTING JACKETS, LINGERIE, LIVERIES, LONG JACKETS, LONG SLEEVED VESTS, LOUNGEWEAR, LOW WOODEN CLOGS (HIYORI-GETA), LOW WOODEN CLOGS (KOMA-GETA), MAILLOTS, MANTILLAS, MANTLES, MARTIAL ARTS UNIFORMS, MASQUERADE COSTUMES, MASQUERADE COSTUMES AND MASKS SOLD IN CONNECTION THEREWITH, MATERNITY SLEEPWEAR, MEN AND WOMEN JACKETS, COATS, TROUSERS, VESTS, MEN'S SOCKS, MEN'S SUITS, MEN'S SUITS, WOMEN'S SUITS, METAL FITTINGS FOR JAPANESE STYLE WOODEN CLOGS, MINISKIRTS, MITTENS, MOCCASINS, MOCK TURTLENECK SWEATERS, MONEY BELTS, MORNING COATS, MOTORCYCLE GLOVES, MOTORCYCLIST BOOTS, MUFFLERS, MUFFLERS, MUFFS, MUKLUKS, MULES, MUSCLE TOPS, MUU MUUS, NECK BANDS, NECK GAITERS, NECKERCHIEFS, NECKERCHIEFS, NECKTIES, NECKWEAR, NEGLIGEEES, NIGHT GOWNS, NIGHT SHIRTS, NIGHTCAPS, NIGHTDRESSES, NIGHTIES, NIGHTWEAR, NON-DISPOSABLE CLOTH TRAINING PANTS, NOVELTY HEADWEAR WITH ATTACHED WIGS, NURSE DRESSES, NURSE OVERALLS, NURSE PANTS, NURSE'S ONE PIECE GARMENT FOR INFANTS AND TODDLERS, OPEN-NECKED SHIRTS, OVER COATS, OVERALLS, OVERSHOES, OVER-TROUSERS, PAJAMAS, PANTALOONS, PANTIES, SHORTS AND BRIEFS, PANTS, PANTSUITS, PANTYHOSE, PAPER HATS FOR USE OF CLOTHING ITEMS, PARASOLS, PAREOS, PAREU, PAREUS, PARKAS, PARTS OF CLOTHING, NAMELY, GUSSETS FOR TIGHTS, GUSSETS FOR STOCKINGS, GUSSETS FOR BATHING SUITS, GUSSETS FOR UNDERWEAR, GUSSETS FOR LEOTARDS AND GUSSETS FOR FOOTLETS, PEDAL PUSHERS, PEDICURE SANDALS, PEDICURE SLIPPERS, PEIGNOIRS, PELERINES, PELISSES, PERSPIRATION ABSORBENT UNDERWEAR PETTICOATS, PETTIPANTS, PINAFORES, PIQUE SHIRTS, PLASTIC BABY BIBS, PLAY SUITS, PLEATED SKIRTS FOR FORMAL KIMONOS (HAKAMA), PLUS FOURS, POCKET KERCHIEFS POCKET SQUARES, POLO SHIRTS, PONCHOS, PROTECTIVE METAL MEMBERS FOR SHOES AND BOOTS, PULLOVERS, PUMPS, PUTTEES AND GAITERS, PAJAMAS, QUILTED VESTS, RAIN BOOTS, RAIN COATS, RAIN JACKETS, RAIN SLICKERS, RAIN SUITS, RAIN TROUSERS, RAINCOATS, RAINPROOF JACKETS, RAINWEAR, RASH GUARDS, REMOVABLE COLLARS, RIDING BOOTS, RIDING COATS, RIDING GLOVES, ROBES, ROMPERS, RUBBER SHOES, RUBBER SOLES FOR JIKATABI, RUBBERS, RUGBY SHOES, RUGBY SHORTS, RUGBY TOPS, RUNNING SHOES, SABOTS, SANDALS, SANDAL-CLOGS, SARIS, SARONGS, SASH BANDS FOR KIMONO (OBI), SASHES, SCARVES, SCHOOL UNIFORMS, SCRUBS NOT FOR MEDICAL PURPOSES, SEDGE HATS (SUGE-GASA), SERAPES, SHAMPOO CAPES, SHAWLS, SHAWLS AND HEADSCARVES, SHAWLS AND STOLEES, SHIRTS, SHIRT FRONTS, SHIRT YOKES, SHIRTS, SHIRTS FOR SUITS, SHOE DOWELS, SHOE INSERTS PRIMARILY NON-ORTHOPEDIC PURPOSES, SHOE PEGS, SHOE SOLES, SHOES, SHOE SOLES FOR REPAIR, SHORT OVERCOAT FOR KIMONO (HAORI), SHORT PETTICOATS, SHORT SETS, SHORT TROUSERS, SHORTALLS, SHORTS, SHORT-SLEEVED OR LONG-SLEEVED T-SHIRTS, SHORT-SLEEVED SHIRTS, SHOULDER PADS FOR CLOTHING, SHOULDER SCARVES, SHOULDER WRAPS, SHOWER CAPS, SHRUGS, SILK SCARVES, SINGLETS, SKATING OUTFITS, SKI AND SNOWBOARD SHOES AND PARTS THEREOF, SKI BIBS, SKI BOOTS BAGS, SKI BOOTS, SKI GLOVES, SKI JACKETS, SKI MASKS, SKI PANTS, SKI SUITS, SKI SUITS FOR COMPETITION, SKI WEAR, SKIING SHOES, SKIRT SUITS, SKIRTS, SKIRTS AND DRESSES, SKORTS, SKULL CAPS, HEADWEAR, NAMELY, SKULLIES, SLACKS, SLEEP MASKS, SLEEP SHIRTS, SLEEPING GARMENTS, SLEEPWEAR, SLEEVED OR SLEEVELESS JACKETS, SLEEVELESS JERSEYS, SLIDING SHORTS, SLIPPER SOLES, SLIPPERS, SLIPS, SMALL HATS, SMOCKS, SMOKING JACKETS, SNEAKERS, SNOWBOARDING SUITS, SNOW PANTS, SNOW SUITS, SNOWBOARDING BOOTS, SNOWBOARDING GLOVES, SNOWBOARDING PANTS, SOCCER BOOTS, SOCCER SHOES, SOCK SUSPENDERS, SOCKS, SOCKS AND STOCKINGS, INNER SOLES, SOLES FOR JAPANESE STYLE SANDALS, SPORT COATS, SPORT SHIRTS, SPORTS BRA, SPORTS JACKETS, SPORTS JERSEYS, SPORTS JERSEYS AND BREECHES FOR SPORTS,

CLASS 25—(Continued).

SPORTS OVER UNIFORMS, SPORTS SHIRTS, SPORTS SHIRTS WITH SHORT SLEEVES, STOCKINGS, SWEAT-ABSORBENT STOCKINGS, STOLEES, STRAPLESS BRAS, STRAPS FOR BRAS, STRING FASTENERS FOR HAORI (HAORI-HIMO), STUFF JACKETS, SUEDE JACKETS, SUIT COATS, SUITS, SUITS OF LEATHER, SUN SLEEVES, SUN VISORS, SUNSUITS, SURF WEAR, SUSPENDER BELTS FOR WOMEN, SUSPENDERS, SWADDLING CLOTHES, SWEAT BANDS, SWEAT PANTS, SWEAT SHIRTS, SWEAT SHORTS, SWEAT SUITS, SWEATBANDS, SWEATERS, SWEAT SOCKS, SWIM CAPS, SWIM TRUNKS, SWIM WEAR, SWIM WEAR FOR GENTLEMEN AND LADIES, SWIMMING CAPS, SWIMMING COSTUMES, SWIMMING TRUNKS, SWIMSUITS, TAILLEURS, TANK TOPS, TANKINIS, TANKTOPS, TAP PANTS, TAP SHOES, TEDDIES, TENNIS SHOES, TENNIS WEAR, TEXTILE DIAPERS, TEXTILE NAPPIES, THERMAL SOCKS, THERMAL UNDERWEAR, FOOTWEAR, NAMELY, THONGS, UNDERWEAR, NAMELY, THONGS TIES, TIGHTENING-UP STRINGS FOR KIMONOS (DATEJIME), TIGHTS, TIPS FOR FOOTWEAR, TOBOGGAN HATS, PANTS AND CAPS, TOE BOXES, TOE CAPS, TOE STRAPS FOR JAPANESE STYLE WOODEN CLOGS, TOE STRAPS FOR JAPANESE STYLE SANDALS (ZORI), TONGS, TONGUE OR PULLSTRAP FOR SHOES AND BOOTS, TOP COATS, TOPS, TOQUES, TRACK AND FIELD SHOES, TRACK PANTS, TRACK SUITS, TRAINING SHOES, TRAINING SUITS, TRENCH COATS, TROUSERS, TROUSERS FOR SWEATING, TROUSERS OF LEATHER, TRUNKS, TUNICS, TUQUES, TURBANS, TURTLENECK SWEATERS, TURTLENECKS, TUXEDO BELTS, TUXEDOS, TWIN SETS, T-SHIRTS, UNDER GARMENTS, UNDERARM CLOTHING SHIELDS, UNDERCLOTHES, UNDERGARMENTS, UNDERPANTS, UNDERSHIRTS, UNDERSHIRTS FOR KIMONOS (JUBAN), UNDERSHIRTS FOR KIMONOS (KOSHIMAKI), UNDERSKIRTS, UNDERWEAR, UNIFORMS, UNITARDS, UPPERS FOR JAPANESE STYLE SANDALS, UPPERS OF WOVEN RATTAN FOR JAPANESE STYLE SANDALS, VEILS, VEST EXTENDERS, VESTED SUITS, VESTS, VISORS, VOLLEYBALL SHOES, V-NECK SWEATERS, WAIST BELTS, WAIST STRINGS FOR KIMONOS (KOSHIHIMO), WAISTBANDS, WAISTCOATS, WALKING SHORTS, WARM UP SUITS, WATER SOCKS, WATERPROOF JACKETS AND PANTS, WEDDING DRESSES, WEDDING GOWNS, WET SUIT GLOVES, WET SUITS, WET SUITS FOR WATER-SKIING AND SUB-AQUA, WIND COATS, WIND RESISTANT JACKETS, WIND SHIRTS, WIND VESTS, WINDCHEATERS, WINDJAMMERS, WINDSHIRTS, WIND-JACKETS, WINTER BOOTS, WOMEN'S CEREMONIAL DRESSES, WOMEN'S SHOES, WOMEN'S UNDERWEAR, WOODEN MAIN BODIES OF JAPANESE STYLE WOODEN CLOGS, WOODEN SUPPORTS OF JAPANESE STYLE WOODEN CLOGS, WOOLEN SOCKS, WOOLLY HATS, WORK SHOES AND BOOTS, WORKING OVERALLS, WOVEN OR KNITTED UNDERWEAR, WRAP BELTS FOR KIMONOS (DATEMAKI), WRAPS (CLOTHING), WRIST BANDS, WRISTBANDS CONTAINING A COOLING SUBSTANCE TO COOL WEATHER, YASHMAGHS, ZOOT SUITS, ZORI (U.S. CLS. 22 AND 39).

FIRST USE 12-14-2007; IN COMMERCE 12-20-2007.

3,399,037. 100MC, LLC, LARKSPUR, CA. SN 77-030,931. PUB. 2-20-2007, FILED 10-27-2006.

JACK HAMMER

THE MARK CONSISTS OF STANDARD CHARACTERS WITHOUT CLAIM TO ANY PARTICULAR FONT, STYLE, SIZE, OR COLOR.

CLASS 25—(Continued).

THE NAME JACK HAMMER DOES NOT IDENTIFY A LIVING INDIVIDUAL.

FOR CLOTHING, NAMELY, MEN'S, WOMEN'S AND CHILDREN'S CASUAL AND WORK CLOTHING, NAMELY, CASUAL SHIRTS, WORK SHIRTS, PANTS, SHORTS, WORK GLOVES, JACKETS, UNDERWEAR, TOPS, FOOTWEAR AND HEADWEAR (U.S. CLS. 22 AND 39).

FIRST USE 10-1-2007; IN COMMERCE 10-1-2007.

3,399,041. CHRISTLIKE ENTERPRISES, LLC, LEXINGTON, KY. SN 77-033,368. PUB. 6-19-2007, FILED 10-31-2006.

CHRISTlike

THE MARK CONSISTS OF STANDARD CHARACTERS WITHOUT CLAIM TO ANY PARTICULAR FONT, STYLE, SIZE, OR COLOR.

FOR ANKLE SOCKS; ANKLETS; ATHLETIC SHOES; CANVAS SHOES; CAPRI PANTS; DENIMS; DRESS SHIRTS; GOLF SHIRTS; HEADBANDS; JACKETS; JOGGING PANTS; LEATHER SHOES; LONG SLEEVED VESTS; MEN'S SOCKS; POLO SHIRTS; SHIRTS FOR SUITS; SHORT-SLEEVED OR LONG-SLEEVED T-SHIRTS; SHORT-SLEEVED SHIRTS; SLEEP SHIRTS; SLEEVED OR SLEEVELESS JACKETS; SOCKS; SPORT SHIRTS; SWEAT PANTS; T-SHIRTS; THERMAL SOCKS; TOBOGGAN HATS, PANTS AND CAPS; TRACK PANTS; UNDERSHIRTS; WOMEN'S SHOES; WRISTBANDS, ALL OF THE AFORESAID GOODS HAVING A RELIGIOUS PURPOSE, THEME, OR CONNOTATION (U.S. CLS. 22 AND 39).

FIRST USE 10-14-2007; IN COMMERCE 3-17-2007.

3,399,059. DISGUISE, INC., POWAY, CA. SN 77-040,262. PUB. 4-24-2007, FILED 11-9-2006.

OPERATION RAPID STRIKE

THE MARK CONSISTS OF STANDARD CHARACTERS WITHOUT CLAIM TO ANY PARTICULAR FONT, STYLE, SIZE, OR COLOR.

FOR HALLOWEEN AND MASQUERADE COSTUMES AND MASKS SOLD IN CONNECTION THEREWITH; HEADWEAR, FOOTWEAR AND GLOVES (U.S. CLS. 22 AND 39).

FIRST USE 8-16-2007; IN COMMERCE 8-16-2007.

CLASS 25—(Continued).

3,399,064. DISGUISE, INC., POWAY, CA. SN 77-041,706. PUB. 5-1-2007, FILED 11-10-2006.

CLUB LUX

THE MARK CONSISTS OF STANDARD CHARACTERS WITHOUT CLAIM TO ANY PARTICULAR FONT, STYLE, SIZE, OR COLOR.

FOR HALLOWEEN AND MASQUERADE COSTUMES AND MASKS SOLD IN CONNECTION THEREWITH; HEADWEAR, FOOTWEAR, GLOVES AND HOSIERY (U.S. CLS. 22 AND 39).

FIRST USE 8-6-2007; IN COMMERCE 8-6-2007.

3,399,070. JBF HOLDING LLC, MIAMI GARDENS, FL. SN 77-047,091. PUB. 6-19-2007, FILED 11-17-2006.

BSU Clothing Co.

THE MARK CONSISTS OF STANDARD CHARACTERS WITHOUT CLAIM TO ANY PARTICULAR FONT, STYLE, SIZE, OR COLOR.

NO CLAIM IS MADE TO THE EXCLUSIVE RIGHT TO USE "CLOTHING CO.", APART FROM THE MARK AS SHOWN.

FOR BELTS; CAPS; CHILDREN'S AND INFANTS' CLOTH BIBS; HOODS; INFANT AND TODDLER ONE PIECE CLOTHING; INFANT CLOTH DIAPERS; JERSEYS; LEATHER BELTS; MANTLES; SHORT SETS; SHOULDER WRAPS; TIES; TOPS; UNDERARM CLOTHING SHIELDS; WRAPS (U.S. CLS. 22 AND 39).

FIRST USE 12-20-2007; IN COMMERCE 12-20-2007.

3,399,073. SKECHERS U.S.A., INC. II, MANHATTAN BEACH, CA. SN 77-048,313. PUB. 3-27-2007, FILED 11-20-2006.

SKECH TECHS

THE MARK CONSISTS OF STANDARD CHARACTERS WITHOUT CLAIM TO ANY PARTICULAR FONT, STYLE, SIZE, OR COLOR.

OWNER OF U.S. REG. NOS. 1,851,977, 2,145,468, AND OTHERS.

FOR FOOTWEAR (U.S. CLS. 22 AND 39).

FIRST USE 6-30-2007; IN COMMERCE 6-30-2007.

CLASS 25—(Continued).

3,399,076. WENZHOULIXINLONG IMPORT AND EXPORT COMPANY LTD, XINQIAO, WENZHOUL, CHINA. SN 77-048,823. PUB. 6-5-2007, FILED 11-21-2006.

CLASS 25—(Continued).

3,399,077. WENZHOULIXINLONG IMPORT AND EXPORT COMPANY LTD, WENZHOUL, ZHEJIANG, CHINA. SN 77-048,907. PUB. 6-26-2007, FILED 11-21-2006.



NO CLAIM IS MADE TO THE EXCLUSIVE RIGHT TO USE "SPORT", APART FROM THE MARK AS SHOWN.

FOR ATHLETIC FOOTWEAR; ATHLETIC SHOES; ATHLETIC UNIFORMS; BASEBALL SHOES; BELTS; BOWLING SHOES; BOXING SHOES; CANVAS SHOES; CAPRI PANTS; CAPS; CARGO PANTS; CYCLING SHOES; DECK-SHOES; DENIM JACKETS; DENIMS; DOWN JACKETS; FOOTBALL SHOES; FOOTWEAR FOR TRACK AND FIELD ATHLETICS; GOLF SHOES; GYMNASTIC SHOES; HANDBALL SHOES; HEAVY JACKETS; HOCKEY SHOES; HOODS; INFANT AND TODDLER ONE PIECE CLOTHING; INFANTS' SHOES AND BOOTS; JACKETS; JERSEYS; JOGGING PANTS; LEATHER BELTS; LEATHER JACKETS; LEATHER SHOES; LIGHT-REFLECTING JACKETS; MEN AND WOMEN JACKETS, COATS, TROUSERS, VESTS; PANTS; PERSPIRATION ABSORBENT UNDERWEAR CLOTHING; RAIN JACKETS; RAINPROOF JACKETS; RUBBER SHOES; RUGBY SHOES; RUNNING SHOES; SHOES; SHORT SETS; SHOULDER WRAPS; SKI AND SNOWBOARD SHOES AND PARTS THEREOF; SKI JACKETS; SKI PANTS; SLEEVED OR SLEEVELESS JACKETS; SNOW PANTS; SNOWBOARD PANTS; SOCCER SHOES; SPORTS JACKETS; STUFF JACKETS; SUEDE JACKETS; SWEAT PANTS; TENNIS SHOES; TIES; TOPS; TRACK AND FIELD SHOES; TRACK PANTS; TRAINING SHOES; VOLLEYBALL SHOES; WATERPROOF JACKETS AND PANTS; WIND RESISTANT JACKETS; WIND-JACKETS; WOMEN'S SHOES; WORK SHOES AND BOOTS; WRAPS (U.S. CLS. 22 AND 39).
FIRST USE 1-1-2007; IN COMMERCE 12-1-2007.

FOR ATHLETIC SHOES; ATHLETIC FOOTWEAR; ATHLETIC UNIFORMS; BASEBALL SHOES; BELTS; BOWLING SHOES; BOXING SHOES; CANVAS SHOES; CYCLING SHOES; DECK-SHOES; FOOTBALL SHOES; GOLF SHOES; GYMNASTIC SHOES; HANDBALL SHOES; HOCKEY SHOES; HOODS; INFANT AND TODDLER ONE PIECE CLOTHING; INFANTS' SHOES AND BOOTS; JERSEYS; LEATHER BELTS; LEATHER SHOES; LIGHT REFLECTING JACKETS; MEN AND WOMEN JACKETS, COATS, TROUSERS, VESTS; PANTS; PERSPIRATION ABSORBENT UNDERWEAR CLOTHING; RAIN JACKETS; RUBBER SHOES; RUGBY SHOES; RUNNING SHOES; SHIFTS; SHOES; SHORT SETS; SHOULDER PADS FOR CLOTHING; SHOULDER WRAPS; SKI AND SNOWBOARD SHOES AND PARTS THEREOF; SKI JACKETS; SKIING SHOES; SNOW PANTS; SNOWBOARD PANTS; SOCCER SHOES; SPORTS JACKETS; SUEDE JACKETS; SWEAT PANTS; TAP SHOES; TENNIS SHOES; TIES; TOPS; TRACK AND FIELD SHOES; TRAINING SHOES; VOLLEYBALL SHOES; WATERPROOF JACKETS AND PANTS; WIND RESISTANT JACKETS; WIND-JACKETS; WOMEN'S SHOES; WORK SHOES AND BOOTS; WRAPS (U.S. CLS. 22 AND 39).
FIRST USE 1-1-2007; IN COMMERCE 12-1-2007.

3,399,120. HAGER DESIGN, INC., FRAMINGHAM, MA. SN 77-069,271. PUB. 7-24-2007, FILED 12-21-2006.

HEYDAY

THE MARK CONSISTS OF STANDARD CHARACTERS WITHOUT CLAIM TO ANY PARTICULAR FONT, STYLE, SIZE, OR COLOR.
FOR FOOTWEAR; CLOTHING, NAMELY, T-SHIRTS (U.S. CLS. 22 AND 39).
FIRST USE 1-3-2007; IN COMMERCE 8-20-2007.

CLASS 25—(Continued).

3,399,160. ASICS CORPORATION, CHUO-KU, KOBE, JAPAN. SN 77-089,218. PUB. 5-22-2007, FILED 1-23-2007.

HG10mm

THE MARK CONSISTS OF STANDARD CHARACTERS WITHOUT CLAIM TO ANY PARTICULAR FONT, STYLE, SIZE, OR COLOR.
FOR FOOTWEAR (U.S. CLS. 22 AND 39).
FIRST USE 5-20-2007; IN COMMERCE 5-20-2007.

CLASS 25—(Continued).

3,399,170. ACT OF COMMUNICATION, CULVER CITY, CA. SN 77-095,151. PUB. 7-17-2007, FILED 1-30-2007.

GOOD LAWYER / BAD LAWYER

3,399,162. KEALOPIKO LLC, HONOLULU, HI. SN 77-090,510. PUB. 7-17-2007, FILED 1-24-2007.



THE MARK CONSISTS OF STANDARD CHARACTERS WITHOUT CLAIM TO ANY PARTICULAR FONT, STYLE, SIZE, OR COLOR.
FOR BANDANAS; DRESSES; HATS; JACKETS; PANTS; SHIRTS; SHORTS; SKIRTS; SWEAT SHIRTS; T-SHIRTS (U.S. CLS. 22 AND 39).
FIRST USE 2-24-2006; IN COMMERCE 2-15-2007.

NO CLAIM IS MADE TO THE EXCLUSIVE RIGHT TO USE "STYLED IN HAWAII NEI", APART FROM THE MARK AS SHOWN.

THE ENGLISH TRANSLATION OF KEALOPIKO IS "THE BELLY OF THE FISH" AND THE ENGLISH TRANSLATION OF HAWAII NEI IS "ALL OF HAWAII".

FOR SHIRTS, DRESSES, SKIRTS, AND PANTS (U.S. CLS. 22 AND 39).
FIRST USE 9-1-2006; IN COMMERCE 12-1-2006.

3,399,179. RALPH GLENN, SAN LEANDRO, CA. SN 77-097,849. PUB. 8-14-2007, FILED 2-2-2007.

LANDING FIELD

3,399,164. FUYI INTERNATIONAL TRADING LIMITED, HONG KONG, CHINA. SN 77-090,738. PUB. 7-17-2007, FILED 1-25-2007.

Boblair

FOR COATS; OVERCOATS; JACKETS; OUTERWEAR, NAMELY, BALMACAANS, DUFFLE COATS, DUST COATS, RAGLAN COATS, TRENCH COATS, AND RAIN COATS; T-SHIRTS; VESTS; SWEATERS; DRESSES; SHIRTS; AND PANTS (U.S. CLS. 22 AND 39).
FIRST USE 11-16-2007; IN COMMERCE 11-16-2007.

THE MARK CONSISTS OF STANDARD CHARACTERS WITHOUT CLAIM TO ANY PARTICULAR FONT, STYLE, SIZE, OR COLOR.

FOR DENIMS; HATS; JEANS; KNIT SHIRTS; SHIRTS; SHORT-SLEEVED OR LONG-SLEEVED T-SHIRTS; SMALL HATS; T-SHIRTS (U.S. CLS. 22 AND 39).
FIRST USE 7-11-2007; IN COMMERCE 7-11-2007.

CLASS 25—(Continued).

3,399,189. TIMOTHY D. HUDDLESTON, LLC., HIGH SPRINGS, FL. SN 77-102,699. PUB. 9-18-2007, FILED 2-8-2007.

SWAGGERVILLE

THE MARK CONSISTS OF STANDARD CHARACTERS WITHOUT CLAIM TO ANY PARTICULAR FONT, STYLE, SIZE, OR COLOR.

FOR BERMUDA SHORTS; BOARD SHORTS; BOXER SHORTS; BUTTON-FRONT ALOHA SHIRTS; CAMP SHIRTS; CAPRI PANTS; CARGO PANTS; DRESS SHIRTS; FLEECE SHORTS; GOLF SHIRTS; GYM SHORTS; JOGGING PANTS; KNIT SHIRTS; NIGHT SHIRTS; NURSE PANTS; OPEN-NECKED SHIRTS; PANTIES, SHORTS AND BRIEFS; PANTS; POLO SHIRTS; RUGBY SHORTS; SHIRT FRONTS; SHIRT YOKES; SHIRTS; SHIRTS FOR SUITS; SHORT SETS; SHORT TROUSERS; SHORT-SLEEVED OR LONG-SLEEVED T-SHIRTS; SHORT-SLEEVED SHIRTS; SHORTS; SKI PANTS; SLEEP SHIRTS; SLIDING SHORTS; SNOW PANTS; SNOWBOARD PANTS; SPORT SHIRTS; SPORTS SHIRTS; SPORTS SHIRTS WITH SHORT SLEEVES; SWEAT PANTS; SWEAT SHIRTS; SWEAT SHORTS; T-SHIRTS; TAP PANTS; TRACK PANTS; WALKING SHORTS; WATERPROOF JACKETS AND PANTS; WIND SHIRTS (U.S. CLS. 22 AND 39).

FIRST USE 8-2-2007; IN COMMERCE 9-24-2007.

CLASS 25—(Continued).

3,399,221. BUI, CATHERINE T., ALAMEDA, CA. SN 77-117,615. PUB. 9-4-2007, FILED 2-27-2007.

Lovelina

THE COLOR(S) BLACK AND PINK IS/ARE CLAIMED AS A FEATURE OF THE MARK.

THE COLOR BLACK APPEARS IN THE WORDING "LOVELINA" AND THE COLOR PINK APPEARS IN THE FLOWER DESIGN ABOVE THE "I".

FOR WOMEN'S CLOTHING, NAMELY, TOPS, SHIRTS, BLOUSES, BOTTOMS, PANTS, CAPRIS, SHORTS, SKIRTS, DRESSES, SOCKS, JACKETS AND COATS (U.S. CLS. 22 AND 39).

FIRST USE 8-31-2007; IN COMMERCE 11-30-2007.

3,399,209. QINGBANG, LLC, LOUISVILLE, CO. SN 77-111,868. PUB. 8-14-2007, FILED 2-20-2007.



THE MARK CONSISTS OF A STYLIZED BABY BEAR WEARING A DIAPER AND WITH A STYLIZED HEART ABOVE ITS HEAD.

FOR INFANT AND TODDLER ONE PIECE CLOTHING; INFANTS' TROUSERS; PAJAMAS; PANTS; SHIRTS; SHORTS; SOCKS AND STOCKINGS; SWEAT PANTS; SWEAT SHIRTS; SWEAT SHORTS; T-SHIRTS; WALKING SHORTS (U.S. CLS. 22 AND 39).

FIRST USE 8-10-2007; IN COMMERCE 8-10-2007.

3,399,239. ADELARD AND EDWARDS, INC, MILWAUKEE, WI. SN 77-126,866. PUB. 9-4-2007, FILED 3-9-2007.

FRATELLI ORSINI

THE MARK CONSISTS OF STANDARD CHARACTERS WITHOUT CLAIM TO ANY PARTICULAR FONT, STYLE, SIZE, OR COLOR.

THE ENGLISH TRANSLATION OF THE ITALIAN WORDING "FRATELLI" IS BROTHERS.

FOR GLOVES INCLUDING THOSE MADE OF SKIN, HIDE OR FUR (U.S. CLS. 22 AND 39).

FIRST USE 9-1-2007; IN COMMERCE 9-1-2007.

CLASS 25—(Continued).

3,399,244. KIM, JANET L., HARTSDALE, NY. SN 77-129,087.
PUB. 9-18-2007, FILED 3-13-2007.

THE MARK CONSISTS OF THE NAME "GRAEY" IN A STYLIZED FONT.

FOR T-SHIRTS; TOPS; BOTTOMS; PANTS; SHORTS; SKIRTS; SKIRTS AND DRESSES; DRESSES; SHIRTS; COATS; JACKETS; LEG WARMERS; LEG-WARMERS; LEGGINGS; HATS; SWEATERS; SWEAT SHIRTS; MITTENS; GLOVES; SCARVES; SWIMSUITS; UNDERWEAR; SOCKS AND STOCKINGS; CORSETS; JEANS (U.S. CLS. 22 AND 39).

FIRST USE 6-26-2007; IN COMMERCE 6-26-2007.

3,399,247. WRANGLER APPAREL CORP., WILMINGTON, DE. SN 77-130,873. PUB. 9-11-2007, FILED 3-14-2007.

THE MARK CONSISTS OF THREE ANGLES THAT SUGGEST MOUNTAINS OR PEAKS FOLLOWED BY THE WORDS "TERRAIN BY WRANGLER".

FOR TOPS AND BOTTOMS (U.S. CLS. 22 AND 39).
FIRST USE 10-16-2007; IN COMMERCE 10-16-2007.

3,399,278. A B SEA, LLC, NEW YORK, NY. SN 77-150,208.
PUB. 10-9-2007, FILED 4-5-2007.

a b sea

THE MARK CONSISTS OF STANDARD CHARACTERS WITHOUT CLAIM TO ANY PARTICULAR FONT, STYLE, SIZE, OR COLOR.

FOR ONE PIECE GARMENT FOR INFANTS AND TODDLERS; PANTS; ROBES; SHIRTS (U.S. CLS. 22 AND 39).

FIRST USE 10-1-2007; IN COMMERCE 10-1-2007.

CLASS 25—(Continued).

3,399,299. THE ORVIS COMPANY, INC., MANCHESTER, VT. SN 77-184,639. PUB. 10-2-2007, FILED 5-18-2007.

WEATHERBREAKER

THE MARK CONSISTS OF STANDARD CHARACTERS WITHOUT CLAIM TO ANY PARTICULAR FONT, STYLE, SIZE, OR COLOR.

FOR JACKETS (U.S. CLS. 22 AND 39).

FIRST USE 1-0-2005; IN COMMERCE 1-0-2005.

3,399,304. PROCAPS L.P., VILLE ST. LAURENT, QUEBEC, CANADA. SN 78-161,276. PUB. 6-29-2004, FILED 9-6-2002.

NO CLAIM IS MADE TO THE EXCLUSIVE RIGHT TO USE "PAINTBALL", APART FROM THE MARK AS SHOWN.

FOR CLOTHING, NAMELY, SHIRTS, JERSEYS, SHORTS, T-SHIRTS, SWEATSHIRTS; HEADGEAR, NAMELY, HATS AND CAPS; PAINTBALL JERSEYS (U.S. CLS. 22 AND 39).

FIRST USE 7-0-2002; IN COMMERCE 7-0-2002.

CLASS 25—(Continued).

3,399,317. SUNS LEGACY PARTNERS, LLC, PHOENIX, AZ.
SN 78-247,503. PUB. 3-20-2007, FILED 5-8-2003.



OWNER OF U.S. REG. NO. 1,861,768.
FOR CLOTHING, NAMELY, HOSIERY, FOOTWEAR, BASKETBALL SHOES, BASKETBALL SNEAKERS, T-SHIRTS, SHIRTS, SWEATSHIRTS, SWEATPANTS, PANTS, TANK TOPS, JERSEYS, SHORTS, PAJAMAS, SPORT SHIRTS, RUGBY SHIRTS, SWEATERS, BELTS, TIES, NIGHTSHIRTS, HATS, CAPS, WARM-UP SUITS, WARM-UP PANTS, WARM-UP TOPS, JACKETS, WIND RESISTANT JACKETS, PARKAS, COATS, CLOTH BABY BIBS, HEAD BANDS, WRIST BANDS, APRONS, BOXER SHORTS, SLACKS, CAPS, EAR MUFFS, GLOVES, MITTENS, SCARVES, WOVEN AND KNIT SHIRTS, DRESSES, CHEERLEADING DRESSES AND UNIFORMS (U.S. CLS. 22 AND 39).
FIRST USE 1-1-2003; IN COMMERCE 1-1-2003.

3,399,350. CRYSTAL SPRINGS RANCH, INC., WILSON, WY.
SN 78-340,705. PUB. 9-14-2004, FILED 12-15-2003.

SHOOTING STAR

THE MARK CONSISTS OF STANDARD CHARACTERS WITHOUT CLAIM TO ANY PARTICULAR FONT, STYLE, SIZE, OR COLOR.
FOR CLOTHING, NAMELY SHIRTS, WESTERN SHIRTS, BASEBALL CAPS, HATS, WIND-RESISTANT JACKETS, JACKETS (U.S. CLS. 22 AND 39).
FIRST USE 11-0-2007; IN COMMERCE 11-0-2007.

CLASS 25—(Continued).

3,399,362. VICKY FORM, S.A. DE C.V., TLALNEPNTLA, MEXICO. SN 78-366,415. PUB. 9-26-2006, FILED 2-11-2004.



PRIORITY CLAIMED UNDER SEC. 44(D) ON MEXICO APPLICATION NO. 620926, FILED 9-25-2003.
OWNER OF U.S. REG. NOS. 1,816,944 AND 2,676,614.
THE MARK CONSISTS OF THE WORDS VICKY FORM TOGETHER WITH A DESIGN OF A BUTTERFLY.
FOR CLOTHING, NAMELY, BRAS, T-SHIRTS, UNDERSHIRTS, PANTIES, BIKINIS, GIRDLES, CORSETS, BODICES, TOPS AND UNDERSKIRTS (U.S. CLS. 22 AND 39).
FIRST USE 9-25-2003; IN COMMERCE 2-12-2004.

3,399,372. FRUIT OF THE LOOM, INC., BOWLING GREEN, KY. SN 78-404,608. PUB. 1-25-2005, FILED 4-20-2004.

ART WORKS

THE MARK CONSISTS OF STANDARD CHARACTERS WITHOUT CLAIM TO ANY PARTICULAR FONT, STYLE, SIZE, OR COLOR.
OWNER OF U.S. REG. NO. 1,260,071.
FOR TEE SHIRTS (U.S. CLS. 22 AND 39).
FIRST USE 8-20-2007; IN COMMERCE 8-20-2007.

3,399,393. COLUMBIA INSURANCE COMPANY, OMAHA, NE. SN 78-470,294. PUB. 8-23-2005, FILED 8-19-2004.

PILLOW TOP

CLASS 25—(Continued).

THE MARK CONSISTS OF STANDARD CHARACTERS WITHOUT CLAIM TO ANY PARTICULAR FONT, STYLE, SIZE, OR COLOR.
 FOR FOOTWEAR (U.S. CLS. 22 AND 39).
 FIRST USE 6-0-2004; IN COMMERCE 6-0-2004.

CLASS 25—(Continued).

3,399,446. GUERRA, JOSEFINA R., SYLMAR, CA. AND GUERRA, RAUL, SYLMAR, CA. SN 78-527,061. PUB. 9-12-2006, FILED 12-3-2004.

3,399,417. REID, RALPH, HENDERSON, NV. AND FALLON, ZACH, HENDERSON, NV. SN 78-508,666. PUB. 10-4-2005, FILED 10-29-2004.

DEATH SQUAD

THE MARK CONSISTS OF STANDARD CHARACTERS WITHOUT CLAIM TO ANY PARTICULAR FONT, STYLE, SIZE, OR COLOR.
 FOR CLOTHING, NAMELY, SHIRTS, T-SHIRTS, SHORTS, JACKETS, SWEATERS, AND HATS (U.S. CLS. 22 AND 39).
 FIRST USE 11-20-2007; IN COMMERCE 11-20-2007.

3,399,436. WASHINGTON NATIONALS BASEBALL CLUB, LLC, WASHINGTON, DISTRICT OF COLUMBIA, DC. SN 78-520,967. PUB. 8-22-2006, FILED 11-22-2004.



NO CLAIM IS MADE TO THE EXCLUSIVE RIGHT TO USE "WASHINGTON", APART FROM THE MARK AS SHOWN.
 FOR CLOTHING, NAMELY, CAPS, HATS, SHIRTS, T-SHIRTS, PULLOVERS, BASEBALL UNIFORMS, JERSEYS, JACKETS, TIES (U.S. CLS. 22 AND 39).
 FIRST USE 11-22-2004; IN COMMERCE 11-22-2004.

MÖDID.

FOR CLOTHING, NAMELY, T-SHIRTS, BLOUSES, COATS, SWEATSHIRTS, BATHING SUITS, SLEEPWEAR, HATS, SCARVES, BELTS, EXCLUDING FOOTWEAR (U.S. CLS. 22 AND 39).
 FIRST USE 2-0-2006; IN COMMERCE 2-0-2006.

3,399,461. INNOVATIVE FASHION GROUP CORP., NEW YORK, NY. SN 78-551,722. PUB. 11-28-2006, FILED 1-21-2005.

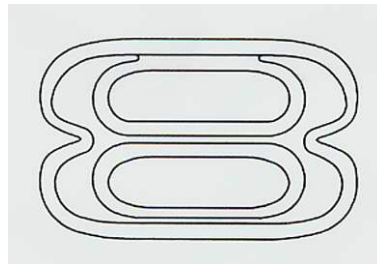

FOR CLOTHING, NAMELY, SHIRTS, T-SHIRTS, PANTS, TOPS, SHORTS, JACKETS, SWEAT SHIRTS, SPORTS BRAS AND MUSCLE TOPS (U.S. CLS. 22 AND 39).
 FIRST USE 4-1-2005; IN COMMERCE 4-1-2005.

CLASS 25—(Continued).

3,399,465. CHUNG, JOO HYUN, LOS ANGELES, CA. SN 78-555,435. PUB. 5-9-2006, FILED 1-27-2005.

INDIGO SIX

THE MARK CONSISTS OF STANDARD CHARACTERS WITHOUT CLAIM TO ANY PARTICULAR FONT, STYLE, SIZE, OR COLOR.

NO CLAIM IS MADE TO THE EXCLUSIVE RIGHT TO USE "INDIGO", APART FROM THE MARK AS SHOWN.

FOR CLOTHING, NAMELY, PANTS, SHIRTS, SHORTS, SUITS, SKIRTS, JACKETS, T-SHIRTS, JERSEYS, TOPS, BLOUSES, TANK TOPS, COATS, COVERALLS, DRESSES, VESTS, JEANS, SWEATERS, MINISKIRTS, AND PAJAMAS (U.S. CLS. 22 AND 39).
FIRST USE 2-15-2006; IN COMMERCE 2-15-2006.

3,399,480. AROFF, PATRICK, SANTA MONICA, CA. SN 78-573,746. PUB. 9-26-2006, FILED 2-23-2005.

Ecstasy

THE MARK CONSISTS OF STANDARD CHARACTERS WITHOUT CLAIM TO ANY PARTICULAR FONT, STYLE, SIZE, OR COLOR.

FOR PROMOTIONAL PRODUCTS, NAMELY, ATHLETIC WEAR AND CLOTHING IN THE NATURE OF TOPS, BOTTOMS, SWIMWEAR, JACKETS, DRESSES, PANTS, T-SHIRTS, SHIRTS, SHORTS, SKIRTS, SWEATPANTS, SWEATSHIRTS AND FOOTWEAR DISTRIBUTED IN CONJUNCTION WITH THE PROMOTION OF ALCOHOLIC BEVERAGES OF THE SAME NAME (U.S. CLS. 22 AND 39).
FIRST USE 8-15-2006; IN COMMERCE 8-15-2006.

CLASS 25—(Continued).

3,399,495. CLARDY, GLINDA, HUNTSVILLE, AL. SN 78-596,731. PUB. 12-27-2005, FILED 3-29-2005.

HERBIN'

THE MARK CONSISTS OF STANDARD CHARACTERS WITHOUT CLAIM TO ANY PARTICULAR FONT, STYLE, SIZE, OR COLOR.

FOR T-SHIRTS AND HATS (U.S. CLS. 22 AND 39).
FIRST USE 3-31-2005; IN COMMERCE 3-31-2005.

3,399,517. WARD, JOHN, MR., GREENWICH, CT. SN 78-619,892. PUB. 3-27-2007, FILED 4-29-2005.

ONLY MINE

THE MARK CONSISTS OF STANDARD CHARACTERS WITHOUT CLAIM TO ANY PARTICULAR FONT, STYLE, SIZE, OR COLOR.

FOR CLOTHING, NAMELY, SHIRTS AND SWEATERS (U.S. CLS. 22 AND 39).
FIRST USE 10-30-2005; IN COMMERCE 10-30-2005.

3,399,520. SMITH NEWS COMPANY, INC., SAN FRANCISCO, CA. SN 78-622,461. PUB. 4-10-2007, FILED 5-4-2005.

DESTINATION BOXER SHORTS

THE MARK CONSISTS OF STANDARD CHARACTERS WITHOUT CLAIM TO ANY PARTICULAR FONT, STYLE, SIZE, OR COLOR.

NO CLAIM IS MADE TO THE EXCLUSIVE RIGHT TO USE "BOXER SHORTS", APART FROM THE MARK AS SHOWN.

FOR BOXER SHORTS SOLD AS SOUVENIR ITEMS IN RETAIL ESTABLISHMENTS WHERE SOUVENIRS ARE TYPICALLY SOLD (U.S. CLS. 22 AND 39).
FIRST USE 4-26-2006; IN COMMERCE 4-26-2006.

CLASS 25—(Continued).

3,399,528. DURAY, JANET M, FARGO, ND. SN 78-627,230.
PUB. 8-15-2006, FILED 5-10-2005.

A Trailer Hauls Yours**Real Bikers Ride...**

FOR T-SHIRTS, JACKETS, SWEATSHIRTS, SHIRTS,
BLOUSES, TANK TOPS (U.S. CLS. 22 AND 39).
FIRST USE 2-26-2007; IN COMMERCE 2-26-2007.

3,399,532. CHINA UNION (CASHMERE) INTERNATIONAL
GROUP LIIMITED, KWAI CHUNG, N.T., HONG KONG.
SN 78-633,591. PUB. 4-4-2006, FILED 5-19-2005.

TRICOTEZ

THE MARK CONSISTS OF STANDARD CHARACTERS
WITHOUT CLAIM TO ANY PARTICULAR FONT, STYLE,
SIZE, OR COLOR.
FOR CLOTHING, NAMELY, SHIRTS, SWEATERS,
AND TOPS (U.S. CLS. 22 AND 39).
FIRST USE 8-31-2007; IN COMMERCE 8-31-2007.

3,399,547. YU, BRYAN, VERNON, CA. SN 78-654,144. PUB. 9-
26-2006, FILED 6-20-2005.

SALUS

THE MARK CONSISTS OF STANDARD CHARACTERS
WITHOUT CLAIM TO ANY PARTICULAR FONT, STYLE,
SIZE, OR COLOR.

THE FOREIGN WORDING IN THE MARK TRANSLATES
INTO ENGLISH AS SAFETY, HELP OR ASSISTANCE,
HEALTH, WELLNESS.

FOR CLOTHING, NAMELY, SHIRTS, PANTS,
SHORTS, TANK TOPS, BLOUSES, COATS, JACKETS,
SWEATSHIRTS, SWEATPANTS, SMOCKS, OVERALLS,
DRESSES, AND T-SHIRTS (U.S. CLS. 22 AND 39).
FIRST USE 1-1-2006; IN COMMERCE 1-1-2006.

CLASS 25—(Continued).

3,399,555. LEE, SACHIHO, TORRANCE, CA. SN 78-658,248.
PUB. 3-28-2006, FILED 6-24-2005.

Kokeshi Ink

THE MARK CONSISTS OF STANDARD CHARACTERS
WITHOUT CLAIM TO ANY PARTICULAR FONT, STYLE,
SIZE, OR COLOR.

NO CLAIM IS MADE TO THE EXCLUSIVE RIGHT TO
USE "KOKESHI", APART FROM THE MARK AS SHOWN.

THE WORD "KOKESHI" IN THE MARK TRANSLATES
INTO ENGLISH AS JAPANESE WOODEN DOLL.

FOR T-SHIRTS, DRESSES, SKIRTS, BLOUSES, PANTS,
SHOES, HATS, HEADGEAR, NAMELY, CAPS, JACKETS,
SWEATERS, KNIT SHIRTS, WOVEN SWEATERS,
COATS, HOSIERY, UNDERWEAR, TANK TOPS, HAL-
TER TOPS, SLEEPWEAR, HOODED SWEATSHIRTS,
SWEATSHIRTS (U.S. CLS. 22 AND 39).

FIRST USE 3-1-2007; IN COMMERCE 3-1-2007.

3,399,556. KOLON GLOTECH, INC., KWACHEON-CITY,
KYUNGGI-DO, REPUBLIC OF KOREA. SN 78-659,534.
PUB. 3-21-2006, FILED 6-28-2005.

NANOPORA

THE MARK CONSISTS OF STANDARD CHARACTERS
WITHOUT CLAIM TO ANY PARTICULAR FONT, STYLE,
SIZE, OR COLOR.

FOR STOCKINGS, SHOES, SHIRTS, OVERCOATS,
JACKETS, UNDERCLOTHING, WATERPROOF CLOTH-
ING, NAMELY, JACKETS, COATS, HATS, CAPS, SLICK-
ERS, PANTS, SHORTS, SHIRTS, T-SHIRTS, AND
SWEATSHIRTS, BATHING SUITS, DRESSING GOWNS,
READY-MADE CLOTHING, NAMELY, JACKETS,
COATS, HATS, CAPS, SLICKERS, PANTS, SHORTS,
SHIRTS, T-SHIRTS, AND SWEATSHIRTS, OUTER
CLOTHING, NAMELY, JACKETS, COATS, HATS, CAPS,
SLICKERS, PANTS, SHORTS, SHIRTS, T-SHIRTS, AND
SWEATSHIRTS (U.S. CLS. 22 AND 39).

FIRST USE 9-1-2006; IN COMMERCE 8-1-2007.

CLASS 25—(Continued).

3,399,586. GARZA, RAYNALDO, MONARCH BEACH, CA. SN 78-682,230. PUB. 12-19-2006, FILED 7-31-2005.

US PROUD

THE MARK CONSISTS OF STANDARD CHARACTERS WITHOUT CLAIM TO ANY PARTICULAR FONT, STYLE, SIZE, OR COLOR.

FOR APPAREL, NAMELY, T-SHIRTS, SHIRTS, TANK TOPS, JOGGING SUITS, POLO SHIRTS, JACKETS, SWEAT SUITS, PANTS; HEADGEAR, NAMELY, CAPS, HATS, HEADBANDS AND BEANIES; AND FOOTWEAR, NAMELY, ATHLETIC SHOES, SNEAKERS (U.S. CLS. 22 AND 39).

FIRST USE 7-3-2005; IN COMMERCE 2-13-2007.

3,399,600. GACITUA, MAXIMILIANO, NEW YORK, NY. SN 78-697,013. PUB. 2-27-2007, FILED 8-21-2005.

LATIN ATHLETIC

THE MARK CONSISTS OF STANDARD CHARACTERS WITHOUT CLAIM TO ANY PARTICULAR FONT, STYLE, SIZE, OR COLOR.

NO CLAIM IS MADE TO THE EXCLUSIVE RIGHT TO USE "ATHLETIC", APART FROM THE MARK AS SHOWN.

FOR T-SHIRTS, JACKETS, JUMPER, JEANS, SOCKS, UNDERWEAR, TRACK SUITS, PULLOVER, SHIRTS, PANTS, SKIRTS, SUITS, COATS, HATS, CAPS, SHOES, SNEAKERS (U.S. CLS. 22 AND 39).

FIRST USE 5-5-2005; IN COMMERCE 1-10-2006.

3,399,602. MAX RAVE, LLC, VERNON, CA. SN 78-698,589. PUB. 5-1-2007, FILED 8-23-2005.

LOLA

THE MARK CONSISTS OF STANDARD CHARACTERS WITHOUT CLAIM TO ANY PARTICULAR FONT, STYLE, SIZE, OR COLOR.

OWNER OF U.S. REG. NOS. 1,301,774 AND 2,463,053.

FOR CLOTHING FOR GIRLS AND WOMEN, NAMELY, JACKETS, COATS, LEATHER COATS, RAIN COATS, DRESSES, EVENING GOWNS, DRESS SHIRTS, KNIT SHIRTS, SUITS, BLOUSES, T-SHIRTS, SKIRTS, SWEATERS, TURTLENECKS, VESTS, CARDIGANS, SUITS, PANTS, SLACKS, TROUSERS, JEANS, NIGHT-GOWNS, SLEEP WEAR, STOCKINGS, PAJAMAS, NECKTIES, GLOVES, SCARVES, TANK TOPS, SHORTS, BELTS, UNDERWEAR, PANTIES, BODY SUITS, SLIPS, BRAS, LINGERIE, BATHING SUITS, FOOTWEAR, SHOES, BEACH SHOES, SANDALS, BOOTS, SLIPPERS, HEADBANDS, HATS AND HEADWEAR (U.S. CLS. 22 AND 39).

FIRST USE 12-0-2005; IN COMMERCE 12-0-2005.

CLASS 25—(Continued).

3,399,632. YOU NEVER KNOW, INC., NEWNAN, GA. SN 78-723,204. PUB. 9-12-2006, FILED 9-29-2005.



THE COLORS BLACK, WHITE, YELLOW, ORANGE AND GRAY ARE CLAIMED AS A FEATURE OF THE MARK.

THE MARK CONSISTS OF A BLACK TRIANGLE DESIGN WITH A YELLOW AND ORANGE SUN IN THE CENTER. A GRAY LIGHTENING BOLT CUTS THROUGH THE CENTER OF THE SUN. THE WORDS "UNLEASH YOUR POTENTIAL" APPEAR IN WHITE UNDERNEATH THE SUN AND LIGHTENING BOLT.

THE MARK CONSISTS OF A TRIANGLE WITH A STYLIZED SUN IN THE CENTER AND A LIGHTENING BOLT SLANTING DOWNWARD FROM RIGHT TO LEFT ACROSS THE SUN. THE WORDING "UNLEASH YOUR POTENTIAL" APPEARS IN CAPITAL LETTERS ACROSS THE BOTTOM OF THE TRIANGLE.

FOR HATS AND SHIRTS (U.S. CLS. 22 AND 39).

FIRST USE 8-1-2006; IN COMMERCE 6-1-2007.

3,399,695. MAJOR LEAGUE BASEBALL PROPERTIES, INC., NEW YORK, NY. SN 78-760,130. PUB. 1-31-2006, FILED 11-23-2005.



OWNER OF U.S. REG. NOS. 2,573,096, 2,971,015, AND OTHERS.

FOR CLOTHING, NAMELY, CAPS, HATS, VISORS, SHIRTS, T-SHIRTS, T, VESTS, PANTS, BASEBALL UNIFORMS, JERSEYS (U.S. CLS. 22 AND 39).

FIRST USE 6-0-2004; IN COMMERCE 6-0-2004.

CLASS 25—(Continued).

3,399,703. PAIVA, INC., INDIANAPOLIS, IN. SN 78-763,654. PUB. 12-12-2006, FILED 11-30-2005.



FOR WOMEN'S CLOTHING, NAMELY WOMEN'S SPORTS APPAREL IN THE NATURE OF BRA TOPS, PANTS, SHIRTS AND SHORTS; AND HEAD WEAR AND FOOTWEAR (U.S. CLS. 22 AND 39).

FIRST USE 4-0-2006; IN COMMERCE 4-0-2006.

3,399,706. EQUITEXX, INC., SAN FRANCISCO, CA. SN 78-765,297. PUB. 5-2-2006, FILED 12-2-2005.

ZEATRO

THE MARK CONSISTS OF STANDARD CHARACTERS WITHOUT CLAIM TO ANY PARTICULAR FONT, STYLE, SIZE, OR COLOR.

FOR EQUESTRIAN APPAREL, NAMELY RIDING BOOTS, PANTS, COATS AND GLOVES (U.S. CLS. 22 AND 39).

FIRST USE 8-5-2004; IN COMMERCE 8-5-2004.

3,399,710. OXFORD INDUSTRIES, INC., ATLANTA, GA. SN 78-766,553. PUB. 1-2-2007, FILED 12-5-2005.

Oxford Golf Collection

THE MARK CONSISTS OF STANDARD CHARACTERS WITHOUT CLAIM TO ANY PARTICULAR FONT, STYLE, SIZE, OR COLOR.

OWNER OF U.S. REG. NOS. 3,003,702 AND 3,014,444.

NO CLAIM IS MADE TO THE EXCLUSIVE RIGHT TO USE "GOLF COLLECTION", APART FROM THE MARK AS SHOWN.

SEC. 2(F).

FOR PANTS; SHIRTS; SWEATERS (U.S. CLS. 22 AND 39).

FIRST USE 1-1-2007; IN COMMERCE 1-1-2007.

CLASS 25—(Continued).

3,399,736. 100MC, LLC, LARKSPUR, CA. SN 78-776,393. PUB. 8-29-2006, FILED 12-19-2005.

LORD OF BALLS

THE MARK CONSISTS OF STANDARD CHARACTERS WITHOUT CLAIM TO ANY PARTICULAR FONT, STYLE, SIZE, OR COLOR.

FOR CLOTHING, NAMELY, MEN'S, WOMEN'S AND CHILDREN'S CASUAL AND DRESS CLOTHING, NAMELY, DRESS AND CASUAL SHIRTS, BLOUSES, PANTS, SHORTS, JACKETS, UNDERWEAR, TOPS, FOOTWEAR AND HEADWEAR (U.S. CLS. 22 AND 39).

FIRST USE 1-1-2001; IN COMMERCE 1-1-2001.

3,399,750. DAN RIVER INC., DANVILLE, VA. SN 78-781,650. PUB. 9-12-2006, FILED 12-28-2005.

OMT

THE MARK CONSISTS OF STANDARD CHARACTERS WITHOUT CLAIM TO ANY PARTICULAR FONT, STYLE, SIZE, OR COLOR.

FOR SCENT CONTROL CHEMICAL INGREDIENT SOLD AS AN INTEGRAL COMPONENT OF CLOTHING, NAMELY, SHIRTS, HEAVYWEIGHT SHIRTS, LIGHTWEIGHT SHIRTS, T-SHIRTS, UNDER SHIRTS, JACKETS, BOMBER JACKETS, PANTS, HUNTING PANTS, FLEECE VESTS, UNDER SHIRTS, CARGO PANTS, OVERALLS, COVERALLS, SHORTS, TOPS, PULLOVERS, COATS, CLOTH SKI BIBS, HEADWEAR, CAPS, HATS, SOCKS, UNDERCLOTHES, GLOVES, RAINWEAR (U.S. CLS. 22 AND 39).

FIRST USE 3-14-2006; IN COMMERCE 3-14-2006.

CLASS 25—(Continued).

3,399,756. MUSHEGAIN, DAVID EDWARD, PASADENA, CA. SN 78-782,654. PUB. 10-31-2006, FILED 12-29-2005.

David Mushegain

THE MARK CONSISTS OF STANDARD CHARACTERS WITHOUT CLAIM TO ANY PARTICULAR FONT, STYLE, SIZE, OR COLOR.

THE NAME "DAVID MUSHEGAIN" IDENTIFIES A LIVING INDIVIDUAL WHOSE CONSENT IS OF RECORD.

FOR MEN'S, WOMEN'S AND CHILDREN'S CLOTHING AND FASHION ACCESSORIES, NAMELY, DRESSES, COATS, SHORTS, SHIRTS, DRESS SHIRTS, PANTS, DRESS PANTS, JEANS, SWEATERS, JACKETS, SUITS, TUXEDOS, DINNER JACKETS, T-SHIRTS, BLOUSES, KNIT TOPS, HALTER TOPS, SMOCK TOPS, VESTS, WIND RESISTANT JACKETS, JOGGING SUITS, SWEATSHIRTS, SWEATPANTS, SKI JACKETS, SKI PANTS, MUFFLERS, HEAD BANDS, HEAD WARMERS, BELTS, GLOVES, MITTENS, SHAWLS, SASHES, SCARVES, PONCHOS, SHOULDER WRAPS, NECKERCHIEFS, STOCKINGS, LEG WARMERS, ARM WARMERS, HOSIERY, SOCKS, TIGHTS, LEGGINGS, LEOTARDS, PAJAMAS, ROBES, NIGHTGOWNS, PANTIES, BRAS, GARTER BELTS, UNDERWEAR, UNDERSHIRTS, RAINWEAR, RAINCOATS, SWIMWEAR, BATHING SUITS, COVER-UPS, AND WOMEN'S LINGERIE, FOOTWEAR, HEADWEAR, NECK TIES, CAPS, AND HATS (U.S. CLS. 22 AND 39).

FIRST USE 1-1-2002; IN COMMERCE 1-1-2005.

3,399,775. MAGNETO LLC, SAN FRANCISCO, CA. SN 78-793,353. PUB. 9-12-2006, FILED 1-17-2006.



FOR SHIRTS, T-SHIRTS, SWEATSHIRTS, PULL-OVERS, HATS, VISORS, WRISTBANDS, BELTS, GLOVES, CAPS, HEAD BANDS, BANDANAS AND JERSEYS (U.S. CLS. 22 AND 39).

FIRST USE 8-20-2006; IN COMMERCE 8-20-2006.

CLASS 25—(Continued).

3,399,778. ROBINSON & MARSHALL TRADING CO, LLC, CONYERS, GA. SN 78-794,256. PUB. 9-12-2006, FILED 1-18-2006.

cultured soles

THE MARK CONSISTS OF STANDARD CHARACTERS WITHOUT CLAIM TO ANY PARTICULAR FONT, STYLE, SIZE, OR COLOR.

FOR SHOES, HATS, SOCKS, SHIRTS, JEANS, WRISTBANDS AND HEADBANDS (U.S. CLS. 22 AND 39).
FIRST USE 2-2-2005; IN COMMERCE 9-2-2006.

3,399,806. KURIHARA CORPORATION, OSAKA-FU, JAPAN. SN 78-802,528. PUB. 9-19-2006, FILED 1-30-2006.

OVERRIDE

THE MARK CONSISTS OF STANDARD CHARACTERS WITHOUT CLAIM TO ANY PARTICULAR FONT, STYLE, SIZE, OR COLOR.

FOR KNITWEAR, NAMELY, KNIT SHIRTS, KNITTED CAPS, KNITTED HATS, KNITTED UNDERWEAR; T-SHIRTS; JERSEYS; SPORT COATS; SPORT SHIRTS; POLO SHIRTS; SWEAT SHIRTS; SWEAT PANTS; SWEAT SUITS; BANDANAS; MUFFLERS; EAR MUFFS; GLOVES, SOCKS; HEADGEAR, NAMELY, HATS AND CAPS; BERETS; VISORS; SUN VISORS; HEADBANDS; SANDALS; EXCLUDING SUNGLASSES, EYEGLASSES, EYEWEAR OR EYEWEAR ACCESSORIES, NAMELY, EYEGLASS CASES, EYEGLASS FRAMES, EYEGLASS CHAINS AND EYEGLASS LENSES; AND FURTHER EXCLUDING ALL HEADGEAR FEATURING SHADED TRANSLUCENT BILLS OR OTHERWISE SUGGESTIVE OR IMITATIVE OF SUNGLASSES, EYEGLASSES OR EYEWEAR (U.S. CLS. 22 AND 39).

FIRST USE 3-1-2007; IN COMMERCE 3-1-2007.

3,399,809. SHOE MAGNATE, INC., CITY OF INDUSTRY, CA. SN 78-803,385. PUB. 4-17-2007, FILED 1-31-2006.

TALISHA ARZIKI

THE MARK CONSISTS OF STANDARD CHARACTERS WITHOUT CLAIM TO ANY PARTICULAR FONT, STYLE, SIZE, OR COLOR.

THE NAME SHOWN IN THE MARK DOES NOT IDENTIFY A PARTICULAR LIVING INDIVIDUAL.
FOR SHOES (U.S. CLS. 22 AND 39).
FIRST USE 1-26-2006; IN COMMERCE 3-1-2006.

CLASS 25—(Continued).

3,399,810. STEWART, ANNE C, MEMPHIS, TN. SN 78-803,395.
PUB. 4-17-2007, FILED 1-31-2006.

KREWE OF COUSINS

THE MARK CONSISTS OF STANDARD CHARACTERS WITHOUT CLAIM TO ANY PARTICULAR FONT, STYLE, SIZE, OR COLOR.

FOR CLOTHING AND OTHER APPAREL, NAMELY, PANTS, SHIRTS, WRISTBANDS, AND CAPS (U.S. CLS. 22 AND 39).

FIRST USE 5-1-2006; IN COMMERCE 5-1-2006.

3,399,812. WICKED FASHIONS, INC., FORT LEE, NJ. SN 78-803,556. PUB. 10-3-2006, FILED 1-31-2006.

SOUTHPOLE

THE MARK CONSISTS OF STANDARD CHARACTERS WITHOUT CLAIM TO ANY PARTICULAR FONT, STYLE, SIZE, OR COLOR.

FOR FOOTWEAR (U.S. CLS. 22 AND 39).

FIRST USE 1-10-2007; IN COMMERCE 1-10-2007.

CLASS 25—(Continued).

3,399,820. BOBO WEAR, INC., PHILADELPHIA, PA. SN 78-807,361. PUB. 9-26-2006, FILED 2-4-2006.



NO CLAIM IS MADE TO THE EXCLUSIVE RIGHT TO USE "WEAR", APART FROM THE MARK AS SHOWN.

THE COLOR(S) BLACK, SLATE BLUE AND BRICK RED IS/ARE CLAIMED AS A FEATURE OF THE MARK.

THE COLOR BLACK APPEARS IN AN OUTER RECTANGLE; THE COLOR SLATE BLUE APPEARS IN AN INNER RECTANGLE CONTAINING THE WORDS BOBO WEAR; THE COLOR BRICK RED APPEARS ON THE LETTERS OF THE WORDS BOBO WEAR AND THE MACRON SYMBOL OVER THE LETTER O IN THE WORD BOBO.

THE MARK CONSISTS OF "BOBO WEAR" WITH A MACRON SYMBOL ABOVE THE LETTER O IN THE WORD BOBO AND DESIGN.

FOR ATHLETIC SHOES; CANVAS SHOES; CAPRI PANTS; DENIMS; POLO SHIRTS; SHIRTS; SHORT-SLEEVED OR LONG-SLEEVED T-SHIRTS; SHORT-SLEEVED SHIRTS; SWEAT PANTS; SWEAT SHIRTS; T-SHIRTS; WOMEN'S SHOES (U.S. CLS. 22 AND 39).

FIRST USE 1-10-2007; IN COMMERCE 1-10-2007.

3,399,828. ROBERTSON, ALAN SCOTT, SANTEE, CA. SN 78-810,902. PUB. 10-3-2006, FILED 2-9-2006.

LIFE'S EDGE

THE MARK CONSISTS OF STANDARD CHARACTERS WITHOUT CLAIM TO ANY PARTICULAR FONT, STYLE, SIZE, OR COLOR.

FOR SHIRTS AND HATS (U.S. CLS. 22 AND 39).

FIRST USE 3-1-2007; IN COMMERCE 3-1-2007.

3,399,832. ENTEBI HAMUI, ALFONSO, MÉXICO, MÉXICO, D.F., MEXICO. SN 78-812,759. PUB. 4-17-2007, FILED 2-11-2006.

ZERY'S

CLASS 25—(Continued).

THE MARK CONSISTS OF STANDARD CHARACTERS WITHOUT CLAIM TO ANY PARTICULAR FONT, STYLE, SIZE, OR COLOR.

FOR SUITS, JACKETS, TROUSERS, SHIRTS, TIES, SHOES, SOCKS, T-SHIRTS, SWEATERS, JEANS AND COATS, FOR KIDS, YOUNG PEOPLE AND GENTLEMEN (U.S. CLS. 22 AND 39).

FIRST USE 12-14-1989; IN COMMERCE 2-10-2006.

3,399,877. EASY CHOICES, INC., MADEIRA BEACH, FL. SN 78-832,020. PUB. 3-6-2007, FILED 3-8-2006.

Freetimers

THE MARK CONSISTS OF STANDARD CHARACTERS WITHOUT CLAIM TO ANY PARTICULAR FONT, STYLE, SIZE, OR COLOR.

FOR GOLF SHIRTS; POLO SHIRTS; SHORT-SLEEVED OR LONG-SLEEVED T-SHIRTS; T-SHIRTS (U.S. CLS. 22 AND 39).

FIRST USE 6-0-2006; IN COMMERCE 11-26-2007.

3,399,897. MOUTAHIR, MEHDI, PROVIDENCE, RI. SN 78-842,115. PUB. 11-14-2006, FILED 3-21-2006.

FLYTOX

THE MARK CONSISTS OF STANDARD CHARACTERS WITHOUT CLAIM TO ANY PARTICULAR FONT, STYLE, SIZE, OR COLOR.

FOR BELTS; CAPS; COATS; GLOVES; HATS; PANTS; SANDALS; SHIRTS; SHOES; SKIRTS; SLEEPWEAR; SNEAKERS; SOCKS; T-SHIRTS; TIES; UNDERWEAR; VESTS (U.S. CLS. 22 AND 39).

FIRST USE 4-2-2007; IN COMMERCE 4-2-2007.

3,399,910. JASSO, BERNARDO CUEVA, GUADALAJARA, MEXICO. SN 78-845,317. PUB. 4-24-2007, FILED 3-24-2006.

SQUALO PUERTO ESCONDIDO

THE MARK CONSISTS OF STANDARD CHARACTERS WITHOUT CLAIM TO ANY PARTICULAR FONT, STYLE, SIZE, OR COLOR.

NO CLAIM IS MADE TO THE EXCLUSIVE RIGHT TO USE "PUERTO ESCONDIDO", APART FROM THE MARK

CLASS 25—(Continued).

AS SHOWN.

THE FOREIGN WORDING IN THE MARK TRANSLATES INTO ENGLISH AS "SHARK" FOR "SQUALO" AND "HIDDEN PORT" FOR "PUERTO ESCONDIDO".

FOR CLOTHING, NAMELY, BEACHWEAR, SHORTS, SKIRTS, PANTS, SHIRTS, BLOUSES, TOPS, TAN TOPS, T-SHIRTS, SWEATSHIRTS AND SWIMWEAR; HEADWEAR, NAMELY, HATS AND CAPS; FOOTWEAR, NAMELY, SANDALS AND SHOES (U.S. CLS. 22 AND 39).

FIRST USE 11-15-2007; IN COMMERCE 11-15-2007.

3,399,915. ALSTON, BRUCE, CHARLOTTE, NC. SN 78-851,116. PUB. 5-15-2007, FILED 3-31-2006.



FOR FULL LINE OF ACTIVE WEAR, NAMELY, SHIRTS, T-SHIRTS, TANK TOPS, ATHLETIC SHIRTS, SPORTS BRAS, SWIM SUITS, WET SUITS, SHORTS, PANTS, LONG UNDERWEAR BOTTOMS, LONG UNDERWEAR TOPS, BATHROBES, ATHLETIC PANTS, LEGGINGS, WARMUP SUITS, PULL-OVERS, SWEAT SUITS, SWEAT SHIRTS, SWEAT PANTS, SWEAT BANDS, RAIN COATS, RAIN HATS, WIND RESISTANT JACKETS, WIND PANTS, SKI PANTS, SKI JACKETS, COATS, HATS, CAPS, MITTENS AND GLOVES (U.S. CLS. 22 AND 39).

FIRST USE 4-7-2006; IN COMMERCE 4-7-2006.

3,399,943. T-TOWN, L.L.C., TUCSON, AZ. SN 78-862,558. PUB. 4-24-2007, FILED 4-17-2006.

SMILY GREEN

THE MARK CONSISTS OF STANDARD CHARACTERS WITHOUT CLAIM TO ANY PARTICULAR FONT, STYLE, SIZE, OR COLOR.

NO CLAIM IS MADE TO THE EXCLUSIVE RIGHT TO USE "GREEN", APART FROM THE MARK AS SHOWN.

THE NAME SHOWN IN THE MARK DOES NOT IDENTIFY A LIVING INDIVIDUAL.

FOR CLOTHING, NAMELY, SHIRTS, HATS, BEANIES, AND UNDERGARMENTS (U.S. CLS. 22 AND 39).

FIRST USE 4-20-2006; IN COMMERCE 4-20-2006.

CLASS 25—(Continued).

3,399,944. OZONE DESIGN INC., NEW YORK, NY. SN 78-862,672. PUB. 4-3-2007, FILED 4-17-2006.

SOCK OF THE MONTH CLUB

THE MARK CONSISTS OF STANDARD CHARACTERS WITHOUT CLAIM TO ANY PARTICULAR FONT, STYLE, SIZE, OR COLOR.

FOR APPAREL, NAMELY, SOCKS, HOSIERY, UNDERWEAR, BODY STOCKINGS, T-SHIRTS, LEGGINGS, LEG WARMERS, LEOTARDS, UNITARDS, KNEE-HIGH STOCKINGS, TIGHTS FOR WOMEN, MEN AND CHILDREN OF NYLON, COTTON OR OTHER TEXTILE FIBERS, BODY SUITS (U.S. CLS. 22 AND 39).

FIRST USE 12-1-2007; IN COMMERCE 12-1-2007.

3,399,945. QVC, INC., WEST CHESTER, PA. SN 78-862,714. PUB. 5-8-2007, FILED 4-17-2006.

ANYBODY

THE MARK CONSISTS OF STANDARD CHARACTERS WITHOUT CLAIM TO ANY PARTICULAR FONT, STYLE, SIZE, OR COLOR.

FOR LINGERIE; LOUNGEWEAR; SLEEPWEAR (U.S. CLS. 22 AND 39).

FIRST USE 2-28-2007; IN COMMERCE 2-28-2007.

3,399,947. VANDERKAM, JACOB, PHELAN, CA. SN 78-863,532. PUB. 6-19-2007, FILED 4-18-2006.



THE MARK CONSISTS OF A HIGHLY STYLIZED LION'S HEAD.

FOR CLOTHING, NAMELY, SHIRTS, SWEATSHIRTS, HATS, PANTS, SHORTS, SWIMWEAR, SHOES, JACKETS, SOCKS, UNDERWEAR, GLOVES BELTS AND ARMBANDS (U.S. CLS. 22 AND 39).

FIRST USE 7-1-2007; IN COMMERCE 10-24-2007.

CLASS 25—(Continued).

3,399,961. CHAVEZ, EDUARDO, MENDOTA HEIGHTS, MN. SN 78-874,603. PUB. 12-5-2006, FILED 5-2-2006.

PRENDIDO

THE MARK CONSISTS OF STANDARD CHARACTERS WITHOUT CLAIM TO ANY PARTICULAR FONT, STYLE, SIZE, OR COLOR.

FOR HEADWEAR, NAMELY CAPS; CLOTHING, NAMELY, SHIRTS, T-SHIRTS, SWEATPANTS, SHORTS AND JACKETS (U.S. CLS. 22 AND 39).

FIRST USE 8-22-2007; IN COMMERCE 8-22-2007.

3,399,993. FRUITFEET, INC., NEW YORK, NY. SN 78-897,364. PUB. 6-12-2007, FILED 5-31-2006.



THE COLOR(S) BLUE AND WHITE IS/ARE CLAIMED AS A FEATURE OF THE MARK.

THE COLOR LIGHT BLUE APPEARS IN SIDE THE DEPICTION OF A PEACH, THE COLOR DARK BLUE APPEARS IN THE WORDS "PÊCHE»BLU MADE FOR TRANSIT" AND IN THE OUTER SHAPE OF THE PEACH, AND THE COLOR WHITE APPEARS AS THE BONES OF A FISH AND IN THE NUMBERS AND THE LETTER "A", NAMELY "0001A".

THE FOREIGN WORDING IN THE MARK TRANSLATES INTO ENGLISH AS BLUE PEACH.

FOR SHIRTS, HATS, AND SHOES (U.S. CLS. 22 AND 39).

FIRST USE 10-15-2006; IN COMMERCE 12-1-2006.

CLASS 25—(Continued).

3,400,009. BOAT MARKETING CORPORATION, WESTPORT, CT. SN 78-905,553. PUB. 4-17-2007, FILED 6-11-2006.

Life begins on the water

THE MARK CONSISTS OF WORDS: "LIFE BEGINS ON THE WATER". NO CLAIM FOR COLOR IS MADE AS COLORS WILL VARY ACROSS DIFFERENT COLORED GARMENTS.

FOR BELTS; BERMUDA SHORTS; FLEECE PULL-OVERS; FLEECE SHORTS; FOUL WEATHER GEAR; JERSEYS; OPEN-NECKED SHIRTS; PANTS; PIQUET SHIRTS; POLO SHIRTS; SHIRTS; SHORT-SLEEVED SHIRTS; SHORTS; SOCKS; SPORT SHIRTS; SPORTS SHIRTS WITH SHORT SLEEVES; SWEAT PANTS; SWEAT SHIRTS; SWIM WEAR; T-SHIRTS; TIES; TOPS; WATERPROOF JACKETS AND PANTS; WIND SHIRTS; WRAPS (U.S. CLS. 22 AND 39).
FIRST USE 7-1-2003; IN COMMERCE 1-30-2007.

3,400,035. SCOTT, SYLVIA, CHARLESTON, SC. SN 78-922,235. PUB. 5-1-2007, FILED 7-4-2006.

JUST DO YOUR BEST

THE MARK CONSISTS OF STANDARD CHARACTERS WITHOUT CLAIM TO ANY PARTICULAR FONT, STYLE, SIZE, OR COLOR.

FOR HATS; HEADBANDS; HEADBANDS AGAINST SWEATING; JACKETS; PANTS; SHORT-SLEEVED OR LONG-SLEEVED T-SHIRTS; SKIRTS AND DRESSES; SWEATERS (U.S. CLS. 22 AND 39).
FIRST USE 4-1-2007; IN COMMERCE 4-1-2007.

CLASS 25—(Continued).

3,400,063. YELL STEEL ENTERPRISE CO. INC., SANTA ANA, CA. SN 78-936,953. PUB. 7-17-2007, FILED 7-25-2006.

GLYDER

THE MARK CONSISTS OF STANDARD CHARACTERS WITHOUT CLAIM TO ANY PARTICULAR FONT, STYLE, SIZE, OR COLOR.

FOR BASEBALL CAPS; BOXER SHORTS; CAP VISORS; FLEECE SHORTS; GOLF SHIRTS; GYM SHORTS; JOGGING PANTS; KNIT SHIRTS; KNITTED CAPS; KNITTED UNDERWEAR; OPEN-NECKED SHIRTS; SHORTS AND BRIEFS; PANTS; PIQUET SHIRTS; POLO SHIRTS; RUGBY SHORTS; SHORT-SLEEVED OR LONG-SLEEVED T-SHIRTS; SHORT-SLEEVED SHIRTS; SHORTS; SLEEP SHIRTS; SLIDING SHORTS; SPORT SHIRTS; SWEAT BANDS; SWEAT SHIRTS; SWEAT SHORTS; SWEAT SUITS; T-SHIRTS; TRACK PANTS; TROUSERS FOR SWEATING; WALKING SHORTS; WATERPROOF JACKETS AND PANTS; WIND SHIRTS; WOVEN OR KNITTED UNDERWEAR (U.S. CLS. 22 AND 39).

FIRST USE 12-4-2007; IN COMMERCE 12-4-2007.

3,400,074. DAEDAL VENTURES, LLC, REDMOND, WA. SN 78-940,030. PUB. 4-10-2007, FILED 7-28-2006.



NO CLAIM IS MADE TO THE EXCLUSIVE RIGHT TO USE "GARMENT", APART FROM THE MARK AS SHOWN. FOR CLOTHING, NAMELY, WOMEN'S UNDERWEAR (U.S. CLS. 22 AND 39).

FIRST USE 10-1-2007; IN COMMERCE 12-27-2007.

3,400,087. LANIFICIO ERMENEGILDO ZEGNA & FIGLI S.P.A., TRIVERO, BIELLA, ITALY. SN 78-945,471. PUB. 3-27-2007, FILED 8-4-2006.

14 MILMIL 14

CLASS 25—(Continued).

THE MARK CONSISTS OF STANDARD CHARACTERS WITHOUT CLAIM TO ANY PARTICULAR FONT, STYLE, SIZE, OR COLOR.

FOR TROUSERS, SUITS, AND JACKETS (U.S. CLS. 22 AND 39).

FIRST USE 11-23-2006; IN COMMERCE 11-23-2006.

CLASS 25—(Continued).

3,400,197. PARK, KENNY J., LOS ANGELES, CA. SN 78-972,230. PUB. 4-24-2007, FILED 9-12-2006.

HIDDEN JEANS

THE MARK CONSISTS OF STANDARD CHARACTERS WITHOUT CLAIM TO ANY PARTICULAR FONT, STYLE, SIZE, OR COLOR.

NO CLAIM IS MADE TO THE EXCLUSIVE RIGHT TO USE "JEANS", APART FROM THE MARK AS SHOWN.

FOR BOTTOMS; JACKETS; JEANS; PANTS; SHIRTS; SHORTS; TANK-TOPS; TOPS (U.S. CLS. 22 AND 39).

FIRST USE 1-15-2008; IN COMMERCE 1-15-2008.

3,400,144. STEWART, GREGORY J., NEW YORK, NY. SN 78-961,317. PUB. 4-17-2007, FILED 8-27-2006.



THE COLOR(S) RED, WHITE, BLACK AND SILVER IS/ ARE CLAIMED AS A FEATURE OF THE MARK.

THE MARK CONSISTS OF PEACE SIGN SYMBOL WITH "JOIN THE OPPOSITION" DESIGN IN RED AND BLACK WITH RED STARS DOTTING THE "I"'S SYMBOLIZING A STRONG FORCE UNITED FOR PEACE.

FOR T-SHIRTS (U.S. CLS. 22 AND 39).

FIRST USE 8-1-2004; IN COMMERCE 10-22-2006.

3,400,206. PENDERGRASS, TORRY, WEST HOLLYWOOD, CA. SN 78-977,339. PUB. 9-26-2006, FILED 1-30-2006.

RED MONKEY

THE MARK CONSISTS OF STANDARD CHARACTERS WITHOUT CLAIM TO ANY PARTICULAR FONT, STYLE, SIZE, OR COLOR.

OWNER OF U.S. REG. NOS. 2,634,447, 2,634,448, AND 2,648,538.

FOR CLOTHING, NAMELY, PANTS, VESTS, T-SHIRTS, SWEATSHIRTS, JEANS, JACKETS; FOOTWEAR, NAMELY, THONGS AND FLIP-FLOPS (U.S. CLS. 22 AND 39).

FIRST USE 1-31-2002; IN COMMERCE 8-31-2002.

3,400,184. DISGUISE, INC., POWAY, CA. SN 78-968,965. PUB. 4-24-2007, FILED 9-7-2006.

ZERO 2 HERO

THE MARK CONSISTS OF STANDARD CHARACTERS WITHOUT CLAIM TO ANY PARTICULAR FONT, STYLE, SIZE, OR COLOR.

FOR HALLOWEEN AND MASQUERADE COSTUMES AND MASKS SOLD IN CONNECTION THEREWITH; HEADWEAR, FOOTWEAR, GLOVES AND HOSIERY (U.S. CLS. 22 AND 39).

FIRST USE 9-6-2007; IN COMMERCE 9-6-2007.

3,400,219. SWAT.FAME, INC., CITY OF INDUSTRY, CA. SN 78-979,640. PUB. 2-27-2007, FILED 11-30-2005.

INDIGO ROYALTY

THE MARK CONSISTS OF STANDARD CHARACTERS WITHOUT CLAIM TO ANY PARTICULAR FONT, STYLE, SIZE, OR COLOR.

NO CLAIM IS MADE TO THE EXCLUSIVE RIGHT TO USE "INDIGO", APART FROM THE MARK AS SHOWN.

FOR CLOTHING, NAMELY, PANTS, CAPRIS, CROPS, BOTTOMS, SHORTS, BERMUDA SHORTS, SKIRTS (U.S. CLS. 22 AND 39).

FIRST USE 8-0-2006; IN COMMERCE 8-0-2006.

CLASS 25—(Continued).

3,400,220. RYAN BASICS LLC, NEW YORK, NY. SN 78-979,642. PUB. 11-7-2006, FILED 5-24-2006.

SEXY BEAST

THE MARK CONSISTS OF STANDARD CHARACTERS WITHOUT CLAIM TO ANY PARTICULAR FONT, STYLE, SIZE, OR COLOR.
FOR TANK TOPS; T-SHIRTS (U.S. CLS. 22 AND 39).
FIRST USE 5-1-2007; IN COMMERCE 5-1-2007.

3,400,222. BAHA MAR RESORTS LTD, NEW PROVIDENCE, BAHAMAS. SN 78-979,659. PUB. 9-7-2004, FILED 8-1-2003.

BAHA MAR

FOR CLOTHES, NAMELY, RESORT-WEAR SHIRTS, JACKETS, SWEATERS, CAPS, HATS, SHORTS, PANTS, FOOTWEAR, SWIMMING AND TENNIS CLOTHING (U.S. CLS. 22 AND 39).
FIRST USE 11-12-2007; IN COMMERCE 11-12-2007.

3,400,223. AFFIRMED ENTERPRISES, LLC, BAL HARBOUR, FL. SN 78-979,666. PUB. 8-30-2005, FILED 9-20-2004.

HARBOR VIEW FARM

THE MARK CONSISTS OF STANDARD CHARACTERS WITHOUT CLAIM TO ANY PARTICULAR FONT, STYLE, SIZE, OR COLOR.
FOR HATS (U.S. CLS. 22 AND 39).
FIRST USE 12-31-2005; IN COMMERCE 12-31-2005.

CLASS 26—FANCY GOODS

CLASS 26—(Continued).

3,399,196. SKECHERS U.S.A., INC. II, MANHATTAN BEACH, CA. SN 77-107,652. PUB. 7-10-2007, FILED 2-14-2007.

CALI BITS

THE MARK CONSISTS OF STANDARD CHARACTERS WITHOUT CLAIM TO ANY PARTICULAR FONT, STYLE, SIZE, OR COLOR.
FOR ORNAMENTS FOR FOOTWEAR AND APPAREL, NAMELY, SHOE ORNAMENTS AND APPAREL ORNAMENTS NOT OF PRECIOUS METAL (U.S. CLS. 37, 39, 40, 42 AND 50).
FIRST USE 3-19-2007; IN COMMERCE 3-19-2007.

3,400,104. HOBBY LOBBY STORES, INC., OKLAHOMA CITY, OK. SN 78-951,372. PUB. 5-1-2007, FILED 8-14-2006.

RIBBON TRENDS

THE MARK CONSISTS OF STANDARD CHARACTERS WITHOUT CLAIM TO ANY PARTICULAR FONT, STYLE, SIZE, OR COLOR.
NO CLAIM IS MADE TO THE EXCLUSIVE RIGHT TO USE "RIBBON", APART FROM THE MARK AS SHOWN.
FOR ORNAMENTAL RIBBONS MADE OF TEXTILES; RIBBONS (U.S. CLS. 37, 39, 40, 42 AND 50).
FIRST USE 9-11-2006; IN COMMERCE 9-11-2006.

CLASS 27—FLOOR COVERINGS

3,398,892. TEXTILE RUBBER & CHEMICAL COMPANY, INC., DALTON, GA. SN 76-619,654. PUB. 11-22-2005, FILED 11-8-2004.

FREE LAY

THE MARK CONSISTS OF STANDARD CHARACTERS WITHOUT CLAIM TO ANY PARTICULAR FONT, STYLE, SIZE, OR COLOR.
FOR CARPET AND FLOOR COVERINGS (U.S. CLS. 19, 20, 37, 42 AND 50).
FIRST USE 6-1-2007; IN COMMERCE 6-1-2007.

CLASS 28—TOYS AND SPORTING GOODS

CLASS 28—(Continued).

3,398,872. AMERICAN GIRL, LLC, EL SEGUNDO, CA. SN 76-554,347. PUB. 4-11-2006, FILED 10-8-2003.

NELLIE O'MALLEY

THE MARK CONSISTS OF STANDARD CHARACTERS WITHOUT CLAIM TO ANY PARTICULAR FONT, STYLE, SIZE, OR COLOR.

THE NAME SHOWN IN THE MARK DOES NOT IDENTIFY A LIVING INDIVIDUAL.

FOR DOLLS, DOLL CLOTHING, AND DOLL ACCESSORIES (U.S. CLS. 22, 23, 38 AND 50).

FIRST USE 10-15-2007; IN COMMERCE 10-15-2007.

3,398,876. DESROSIER, LAURIE M., ACTON, MA. SN 76-573,686. PUB. 4-12-2005, FILED 1-28-2004.

KIDS WITH POSSIBILITIES

THE MARK CONSISTS OF STANDARD CHARACTERS WITHOUT CLAIM TO ANY PARTICULAR FONT, STYLE, SIZE, OR COLOR.

FOR DOLLS (U.S. CLS. 22, 23, 38 AND 50).

FIRST USE 11-17-2007; IN COMMERCE 11-17-2007.

3,398,882. HYMAN, HERBERT B., CAMARILLO, CA. SN 76-601,799. PUB. 9-13-2005, FILED 7-12-2004.

HERBIE'S ONE-PUTT WEDGE

THE MARK CONSISTS OF STANDARD CHARACTERS WITHOUT CLAIM TO ANY PARTICULAR FONT, STYLE, SIZE, OR COLOR.

NO CLAIM IS MADE TO THE EXCLUSIVE RIGHT TO USE "WEDGE", APART FROM THE MARK AS SHOWN.

FOR GOLF CLUBS; HEADS FOR GOLF CLUBS (U.S. CLS. 22, 23, 38 AND 50).

FIRST USE 12-3-2007; IN COMMERCE 12-3-2007.

3,398,895. NALLEY, MARK, MURRIETA, CA. SN 76-624,667. PUB. 9-13-2005, FILED 12-13-2004.

LOCK N LOAD**CLASS 28—(Continued).**

THE MARK CONSISTS OF STANDARD CHARACTERS WITHOUT CLAIM TO ANY PARTICULAR FONT, STYLE, SIZE, OR COLOR.

FOR PHYSICAL FITNESS EQUIPMENT, NAMELY, WEIGHT PLATES FOR WEIGHT LIFTING MACHINES (U.S. CLS. 22, 23, 38 AND 50).

FIRST USE 5-4-2007; IN COMMERCE 5-4-2007.

3,398,951. HASBRO, INC., PAWTUCKET, RI. SN 76-668,827. PUB. 6-5-2007, FILED 11-13-2006.

DAY TO DREAM SOOTHER

THE MARK CONSISTS OF STANDARD CHARACTERS WITHOUT CLAIM TO ANY PARTICULAR FONT, STYLE, SIZE, OR COLOR.

FOR INFANT MUSICAL CRIB TOYS (U.S. CLS. 22, 23, 38 AND 50).

FIRST USE 7-13-2007; IN COMMERCE 7-13-2007.

3,398,970. SOLARI GOLF, INC., MARINA DEL REY, CA. SN 77-003,762. PUB. 5-1-2007, FILED 9-20-2006.

BIGFOOT

THE MARK CONSISTS OF STANDARD CHARACTERS WITHOUT CLAIM TO ANY PARTICULAR FONT, STYLE, SIZE, OR COLOR.

FOR GOLF CLUB ACCESSORIES, NAMELY, GOLF PUTTERS (U.S. CLS. 22, 23, 38 AND 50).

FIRST USE 1-31-2006; IN COMMERCE 1-31-2006.

3,398,992. NOMACO, INC., ZEBULON, NC. SN 77-008,666. PUB. 9-25-2007, FILED 9-27-2006.

DIPPER

THE MARK CONSISTS OF STANDARD CHARACTERS WITHOUT CLAIM TO ANY PARTICULAR FONT, STYLE, SIZE, OR COLOR.

FOR TOYS IN THE NATURE OF FLEXIBLE FOAM RODS FOR RECREATIONAL USE, FLEXIBLE FOAM FLOATATION TOYS CONTAINING CONNECTORS SPECIFICALLY DESIGNS FOR JOINING FOAM TOY RODS, SOLD AS A UNIT, FLEXIBLE FOAM CONSTRUCTION TOYS, AND FLEXIBLE FOAM FLOATATION TOYS (U.S. CLS. 22, 23, 38 AND 50).

FIRST USE 12-1-2006; IN COMMERCE 12-1-2006.

CLASS 28—(Continued).

3,398,993. NOMACO, INC., ZEBULON, NC. SN 77-008,685. PUB. 9-25-2007, FILED 9-27-2006.

LITTLE DIPPER

THE MARK CONSISTS OF STANDARD CHARACTERS WITHOUT CLAIM TO ANY PARTICULAR FONT, STYLE, SIZE, OR COLOR.

FOR TOYS IN THE NATURE OF FLEXIBLE FOAM RODS FOR RECREATIONAL USE, FLEXIBLE FOAM FLOATATION TOYS CONTAINING CONNECTORS SPECIFICALLY DESIGNS FOR JOINING FOAM TOY RODS, SOLD AS A UNIT, FLEXIBLE FOAM CONSTRUCTION TOYS, AND FLEXIBLE FOAM FLOATATION TOYS (U.S. CLS. 22, 23, 38 AND 50).

FIRST USE 12-1-2006; IN COMMERCE 12-1-2006.

3,398,994. NOMACO, INC., ZEBULON, NC. SN 77-008,699. PUB. 9-25-2007, FILED 9-27-2006.

BIG DIPPER

THE MARK CONSISTS OF STANDARD CHARACTERS WITHOUT CLAIM TO ANY PARTICULAR FONT, STYLE, SIZE, OR COLOR.

FOR TOYS IN THE NATURE OF FLEXIBLE FOAM RODS FOR RECREATIONAL USE, FLEXIBLE FOAM FLOATATION TOYS CONTAINING CONNECTORS SPECIFICALLY DESIGNS FOR JOINING FOAM TOY RODS, SOLD AS A UNIT, FLEXIBLE FOAM CONSTRUCTION TOYS, AND FLEXIBLE FOAM FLOATATION TOYS (U.S. CLS. 22, 23, 38 AND 50).

FIRST USE 12-1-2006; IN COMMERCE 12-1-2006.

3,399,016. SOURCENTERPRISES, INC., ANAHEIM, CA. SN 77-021,153. PUB. 5-29-2007, FILED 10-13-2006.

DiRiginal

THE MARK CONSISTS OF STANDARD CHARACTERS WITHOUT CLAIM TO ANY PARTICULAR FONT, STYLE, SIZE, OR COLOR.

FOR BILLIARD PRODUCTS, GAMES, AND ACCESSORIES, NAMELY, BILLIARD BALLS AND BILLIARD GAME PLAYING EQUIPMENT (U.S. CLS. 22, 23, 38 AND 50).

FIRST USE 6-21-2007; IN COMMERCE 6-21-2007.

CLASS 28—(Continued).

3,399,024. KABUSHIKI KAISHA SQUARE ENIX, AKA SQUARE ENIX CO., LTD., TOKYO, JAPAN. SN 77-022,637. PUB. 5-1-2007, FILED 10-17-2006.

MASTERPIECE ARTS

THE MARK CONSISTS OF STANDARD CHARACTERS WITHOUT CLAIM TO ANY PARTICULAR FONT, STYLE, SIZE, OR COLOR.

FOR DOLLS AND TOY FIGURES (U.S. CLS. 22, 23, 38 AND 50).

FIRST USE 11-0-2007; IN COMMERCE 12-0-2007.

3,399,049. NOCONA LEATHER GOODS COMPANY, LTD., NOCONA, TX. SN 77-036,464. PUB. 5-8-2007, FILED 11-3-2006.

DUO PRO

THE MARK CONSISTS OF STANDARD CHARACTERS WITHOUT CLAIM TO ANY PARTICULAR FONT, STYLE, SIZE, OR COLOR.

FOR SPORTING GOODS, NAMELY, BASEBALL BATS, SOFTBALL BATS, WOOD COMPOSITE BASEBALL BATS AND WOOD COMPOSITE SOFTBALL BATS (U.S. CLS. 22, 23, 38 AND 50).

FIRST USE 9-1-2007; IN COMMERCE 9-1-2007.

3,399,093. SOURCENTERPRISES, INC., ANAHEIM, CA. SN 77-060,219. PUB. 6-5-2007, FILED 12-8-2006.

TAG BALL

THE MARK CONSISTS OF STANDARD CHARACTERS WITHOUT CLAIM TO ANY PARTICULAR FONT, STYLE, SIZE, OR COLOR.

NO CLAIM IS MADE TO THE EXCLUSIVE RIGHT TO USE "BALL", APART FROM THE MARK AS SHOWN.

FOR BILLIARD PRODUCTS, GAMES AND ACCESSORIES, NAMELY, BILLIARD BALLS AND BILLIARD PLAYING EQUIPMENT (U.S. CLS. 22, 23, 38 AND 50).

FIRST USE 6-21-2007; IN COMMERCE 6-21-2007.

CLASS 28—(Continued).

3,399,174. TAYLOR MADE GOLF COMPANY, INC., CARLSBAD, CA. SN 77-097,263. PUB. 7-17-2007, FILED 2-1-2007.

LANCER

THE MARK CONSISTS OF STANDARD CHARACTERS WITHOUT CLAIM TO ANY PARTICULAR FONT, STYLE, SIZE, OR COLOR.
FOR GOLF ACCESSORY POUCHES; GOLF BAGS; GOLF GLOVES (U.S. CLS. 22, 23, 38 AND 50).
FIRST USE 10-0-2006; IN COMMERCE 10-0-2006.

3,399,175. TAYLOR MADE GOLF COMPANY, INC., CARLSBAD, CA. SN 77-097,305. PUB. 7-17-2007, FILED 2-1-2007.

ESSEX

THE MARK CONSISTS OF STANDARD CHARACTERS WITHOUT CLAIM TO ANY PARTICULAR FONT, STYLE, SIZE, OR COLOR.
FOR GOLF ACCESSORY POUCHES; GOLF BAGS; GOLF GLOVES (U.S. CLS. 22, 23, 38 AND 50).
FIRST USE 10-0-2006; IN COMMERCE 10-0-2006.

3,399,197. ALSIP & COMPANY, SEATTLE, WA. SN 77-107,766. PUB. 8-21-2007, FILED 2-14-2007.

STRUT!

THE MARK CONSISTS OF STANDARD CHARACTERS WITHOUT CLAIM TO ANY PARTICULAR FONT, STYLE, SIZE, OR COLOR.
FOR CARD GAMES AND TRADING CARD GAMES (U.S. CLS. 22, 23, 38 AND 50).
FIRST USE 11-1-2007; IN COMMERCE 12-7-2007.

CLASS 28—(Continued).

3,399,211. PATCH PRODUCTS, INC., BELOIT, WI. SN 77-113,164. PUB. 8-28-2007, FILED 2-22-2007.

CAN-DO ROO

THE MARK CONSISTS OF STANDARD CHARACTERS WITHOUT CLAIM TO ANY PARTICULAR FONT, STYLE, SIZE, OR COLOR.
FOR PARLOR GAMES (U.S. CLS. 22, 23, 38 AND 50).
FIRST USE 6-22-2007; IN COMMERCE 6-22-2007.

3,399,266. HADASH, EDWARD, BURNSVILLE, MN. SN 77-143,806. PUB. 10-9-2007, FILED 3-29-2007.

RAG ARM

THE MARK CONSISTS OF STANDARD CHARACTERS WITHOUT CLAIM TO ANY PARTICULAR FONT, STYLE, SIZE, OR COLOR.
FOR ATHLETIC GEAR IN THE NATURE OF PERFORMANCE APPAREL, NAMELY, A SLEEVE TO BE WORN ON THE SHOULDER AND ARM FOR MAINTAINING STRENGTH AND ENDURANCE OF A PITCHER'S ARM DURING ATHLETIC ACTIVITY (U.S. CLS. 22, 23, 38 AND 50).
FIRST USE 5-31-2007; IN COMMERCE 5-31-2007.

3,399,303. PEDIGREE DOLLS & TOYS LIMITED, EXETER, DEVON, UNITED KINGDOM. SN 78-159,284. PUB. 8-17-2004, FILED 8-29-2002.

SINDY

OWNER OF U.S. REG. NOS. 1,009,666 AND 1,958,544.
FOR DOLLS AND ACCESSORIES FOR DOLLS; DOLL BEDS, CLOTHES, FEEDING BOTTLES AND HOUSES; TOY FIGURINES; TOY MODEL HOBBY CRAFT KITS (U.S. CLS. 22, 23, 38 AND 50).
FIRST USE 2-16-2005; IN COMMERCE 2-16-2005.

3,399,323. CANEPA, VICKIE P., WESTLAKE VILLAGE, CA. SN 78-255,326. PUB. 2-10-2004, FILED 5-28-2003.

POLLY WANNA PINATA

NO CLAIM IS MADE TO THE EXCLUSIVE RIGHT TO USE "PINATA", APART FROM THE MARK AS SHOWN.
FOR BIRD TOY (U.S. CLS. 22, 23, 38 AND 50).
FIRST USE 9-1-2000; IN COMMERCE 7-6-2002.

CLASS 28—(Continued).

3,399,347. SYLMARK HOLDINGS LIMITED, DUBLIN 2, IRELAND. SN 78-336,027. PUB. 9-7-2004, FILED 12-3-2003.

ABPONY

THE MARK CONSISTS OF STANDARD CHARACTERS WITHOUT CLAIM TO ANY PARTICULAR FONT, STYLE, SIZE, OR COLOR.

FOR EXERCISE MACHINES (U.S. CLS. 22, 23, 38 AND 50).

FIRST USE 10-23-2007; IN COMMERCE 10-23-2007.

3,399,371. J. LLOYD INTERNATIONAL, INC., CEDAR RAPIDS, IA. SN 78-401,721. PUB. 4-3-2007, FILED 4-14-2004.

URBAN NATION

THE MARK CONSISTS OF STANDARD CHARACTERS WITHOUT CLAIM TO ANY PARTICULAR FONT, STYLE, SIZE, OR COLOR.

FOR RADIO CONTROLLED AND REMOTE CONTROLLED TOY VEHICLES (U.S. CLS. 22, 23, 38 AND 50). FIRST USE 12-13-2007; IN COMMERCE 12-13-2007.

CLASS 28—(Continued).

3,399,421. DETROIT PISTONS BASKETBALL COMPANY, AUBURN HILLS, MI. SN 78-510,590. PUB. 5-9-2006, FILED 11-3-2004.



OWNER OF U.S. REG. NOS. 1,085,717, 1,085,719, AND OTHERS.

FOR TOYS, GAMES AND SPORTING GOODS, NAMELY, BASKETBALLS, GOLF BALLS, PLAYGROUND BALLS, SPORTS BALLS, RUBBER ACTION BALLS AND FOAM ACTION BALLS, PLUSH BALLS, PLASTIC BALLS, BASKETBALL NETS, BASKETBALL BACKBOARDS, MINIATURE BASKETBALL BACKBOARDS, PUMPS FOR INFLATING BASKETBALLS, NEEDLES FOR INFLATING BASKETBALLS, GOLF CLUBS, GOLF BAGS, GOLF PUTTERS, GOLF ACCESSORIES, NAMELY, DIVOT REPAIR TOOLS, TEES, BALL MARKERS, GOLF BAG COVERS, CLUB HEAD COVERS, GOLF GLOVES, GOLF BALL SLEEVES, ELECTRONIC BASKETBALL TABLE TOP GAMES, BASKETBALL TABLE TOP GAMES, BASKETBALL BOARD GAMES, ACTION SKILL GAMES, ADULT'S AND CHILDREN'S PARTY GAMES, TRIVIA INFORMATION GAMES AND ELECTRONIC VIDEO ARCADE GAME MACHINES, BASKETBALL KIT COMPRISED OF A NET AND WHISTLE, DOLLS, DECORATIVE DOLLS, COLLECTIBLE DOLLS, TOY ACTION FIGURES, BOBBLEHEAD ACTION FIGURES, STUFFED TOYS, NOVELTY PLUSH TOYS WITH WIGS, JIGSAW PUZZLES AND CHRISTMAS TREE ORNAMENTS, CHRISTMAS STOCKINGS; TOY VEHICLES IN THE NATURE OF CARS, TRUCKS AND VANS, ALL CONTAINING BASKETBALL THEMES, NOVELTY FOAM TOYS IN THE SHAPES OF FINGERS AND TROPHIES, TOY TROPHIES, PLAYING CARDS, CARD GAMES, NOISEMAKERS, PET TOYS; BEACH TOYS, NAMELY, BEACH BALLS, INFLATABLE BALLS, TOY PAILS, TOY SHOVELS, SAND TOYS, SAND BOX TOYS, WATER-SQUIRTING TOYS; BEACH AND POOL ACCESSORIES, NAMELY, SWIM FLOATS, POOL FLOATS, FOAM FLOATS, SWIM RINGS, POOL RINGS, FOAM RINGS, BODY BOARDS, SURF BOARDS, SWIM FINS, SURF FINS, ARM FLOATS AND WATER WING SWIM AIDS FOR RECREATIONAL USE; INFLATABLE TOYS; VOLLEYBALL GAME KITS COMPRISED OF BALL, NET, SIDELINES AND WHISTLE, AND WATER POLO GAME KITS COMPRISED OF BALL, NET AND WHISTLE (U.S. CLS. 22, 23, 38 AND 50).

FIRST USE 5-21-1996; IN COMMERCE 5-21-1996.

CLASS 28—(Continued).

3,399,435. WASHINGTON NATIONALS BASEBALL CLUB, LLC, WASHINGTON, DC. SN 78-520,966. PUB. 11-8-2005, FILED 11-22-2004.



NO CLAIM IS MADE TO THE EXCLUSIVE RIGHT TO USE "WASHINGTON", APART FROM THE MARK AS SHOWN.

THE MARK CONSISTS OF THE STYLIZED, INTERLOCKING LETTERS "DC" WITHIN A DESIGN CONSISTING OF TWO CONCENTRIC CIRCLES BEARING THE WORDS "WASHINGTON NATIONALS" AND TWO STAR DESIGNS.

FOR TOYS AND SPORTING GOODS, NAMELY, STUFFED TOYS, PLUSH TOYS, BOARD GAMES, CARD GAMES, TOY TRUCKS, TOY VEHICLES (U.S. CLS. 22, 23, 38 AND 50).

FIRST USE 12-31-2004; IN COMMERCE 12-31-2004.

3,399,463. BRIDGESTONE SPORTS CO., LTD., TOKYO, JAPAN. SN 78-553,138. PUB. 6-20-2006, FILED 1-25-2005.

BOOM BOOM

THE MARK CONSISTS OF STANDARD CHARACTERS WITHOUT CLAIM TO ANY PARTICULAR FONT, STYLE, SIZE, OR COLOR.

FOR GOLF EQUIPMENT, NAMELY, GOLF BALLS, GOLF CLUBS, GOLF CLUB HEAD COVERS (U.S. CLS. 22, 23, 38 AND 50).

FIRST USE 1-0-2005; IN COMMERCE 1-0-2005.

CLASS 28—(Continued).

3,399,494. CARDIAC SCIENCE CORPORATION, BOTHELL, WA. SN 78-596,239. PUB. 9-19-2006, FILED 3-28-2005.

HEARTSTRIDE

THE MARK CONSISTS OF STANDARD CHARACTERS WITHOUT CLAIM TO ANY PARTICULAR FONT, STYLE, SIZE, OR COLOR.

FOR EXERCISE EQUIPMENT, NAMELY, CONTROL APPARATUS FOR MODULATING A USER WORKOUT ON TREADMILLS (U.S. CLS. 22, 23, 38 AND 50).

FIRST USE 4-18-2006; IN COMMERCE 4-18-2006.

3,399,553. HILLERICH & BRADSBY CO., LOUISVILLE, KY. SN 78-657,703. PUB. 3-14-2006, FILED 6-24-2005.

DYNASTY PLUS

THE MARK CONSISTS OF STANDARD CHARACTERS WITHOUT CLAIM TO ANY PARTICULAR FONT, STYLE, SIZE, OR COLOR.

OWNER OF U.S. REG. NOS. 1,110,611 AND 2,725,773.

FOR GOLF CLUBS (U.S. CLS. 22, 23, 38 AND 50).

FIRST USE 11-27-2007; IN COMMERCE 11-27-2007.

3,399,562. MATTEL, INC., EL SEGUNDO, CA. SN 78-664,311. PUB. 8-22-2006, FILED 7-6-2005.

PJ PARTY

THE MARK CONSISTS OF STANDARD CHARACTERS WITHOUT CLAIM TO ANY PARTICULAR FONT, STYLE, SIZE, OR COLOR.

FOR TOYS, GAMES AND PLAYTHINGS, NAMELY, DOLLS, DOLL CLOTHING AND DOLL ACCESSORIES (U.S. CLS. 22, 23, 38 AND 50).

FIRST USE 12-4-2007; IN COMMERCE 12-4-2007.

CLASS 28—(Continued).

3,399,571. VIVIO, LAVERN W., SPRINGFIELD, TN. SN 78-669,146. PUB. 10-3-2006, FILED 7-13-2005.

ALL-AMERICAN MUTT COMPANY

THE MARK CONSISTS OF STANDARD CHARACTERS WITHOUT CLAIM TO ANY PARTICULAR FONT, STYLE, SIZE, OR COLOR.

NO CLAIM IS MADE TO THE EXCLUSIVE RIGHT TO USE "COMPANY", APART FROM THE MARK AS SHOWN.

FOR COMBINATION GAME SETS, NAMELY, COMBINATION GAME SETS MADE OF WOOD FOR CHECKERS, CHESS, BACKGAMMON AND/OR CHINESE CHECKERS; SHUT THE BOX BOARD GAME SETS MADE OF WOOD; AND TOY WOODEN BUILDING BLOCK SETS (U.S. CLS. 22, 23, 38 AND 50).

FIRST USE 12-1-2007; IN COMMERCE 12-1-2007.

3,399,579. TRUE FITNESS TECHNOLOGY, INC., O'FALLON, MO. SN 78-675,335. PUB. 12-12-2006, FILED 7-21-2005.

TS1

THE MARK CONSISTS OF STANDARD CHARACTERS WITHOUT CLAIM TO ANY PARTICULAR FONT, STYLE, SIZE, OR COLOR.

FOR EXERCISE EQUIPMENT, NAMELY, TREADMILLS, ELLIPTICAL TRAINERS, STATIONARY CYCLES, WEIGHT LIFTING AND STRENGTH MACHINES, AND MULTIPURPOSE STRETCHING APPARATUS TO ENHANCE FLEXIBILITY AND TO EXERCISE, REHABILITATE AND IMPROVE PERFORMANCE OF SPECIFIC BODY MOVEMENTS AND ACTIVITIES (U.S. CLS. 22, 23, 38 AND 50).

FIRST USE 5-0-2006; IN COMMERCE 5-0-2006.

CLASS 28—(Continued).

3,399,619. YELLOW FEVER #1, LLC, MANAGING MEMBER, JAMISON ERNEST REVOCABLE TRUST, NEW YORK, NY. SN 78-713,997. PUB. 5-30-2006, FILED 9-15-2005.

YELLOW FEVER

THE MARK CONSISTS OF STANDARD CHARACTERS WITHOUT CLAIM TO ANY PARTICULAR FONT, STYLE, SIZE, OR COLOR.

OWNER OF U.S. REG. NOS. 2,856,048 AND 2,961,075.

FOR ATHLETIC SPORTING GOODS, NAMELY, ATHLETIC WRIST AND JOINT SUPPORTS; BABY MULTIPLE ACTIVITY TOYS; BAGS FOR SKATEBOARDS; BAGS SPECIALLY ADAPTED FOR SPORTS EQUIPMENT; BALL BEARINGS FOR SKATEBOARDS; BATH TOYS; BATTERY OPERATED ACTION TOYS; BENDABLE TOYS; CAT TOYS; COLLECTABLE TOY FIGURES; DOG TOYS; ELECTRIC ACTION TOYS; INFLATABLE TOYS; MUSICAL TOYS; PLUSH TOYS; PUNCHING TOYS; SAFETY PADDING FOR SKATEBOARDING; SKATEBOARD WHEELS; SKATEBOARDS; SPORT BALLS; SPORTS EQUIPMENT FOR BOXING, MARTIAL ARTS, AND THE LIKE, NAMELY PROTECTIVE BRAS; TOY MASKS; WATER SQUIRTING TOYS (U.S. CLS. 22, 23, 38 AND 50).

FIRST USE 3-7-2006; IN COMMERCE 3-7-2006.

3,399,708. BATTAT INCORPORATED, PLATTSBURGH, NY. SN 78-765,371. PUB. 11-21-2006, FILED 12-2-2005.



OWNER OF U.S. REG. NOS. 3,054,702 AND 3,073,159.

THE MARK CONSISTS OF THE WORD SANDFUN PARTIALLY SURROUNDED BY A STYLIZED SUN RAY DESIGN.

FOR SAND TOYS FOR BEACH PLAY INCLUDING TOY SAND MOLDS, TOY VEHICLES, TOY BUCKETS, AND TOY GARDENING TOOLS IN THE NATURE OF HOES, RAKES, WATERING CANS, AND WHEELBARROWS, AND PLASTIC TUB CONTAINERS FOR THE TOYS SOLD AS A UNIT (U.S. CLS. 22, 23, 38 AND 50).

FIRST USE 3-31-2006; IN COMMERCE 3-31-2006.

CLASS 28—(Continued).

3,399,761. TRUE TEMPER SPORTS, INC., MEMPHIS, TN. SN 78-785,912. PUB. 9-12-2006, FILED 1-5-2006.

CLASS 28—(Continued).

3,399,826. LEACHCO, INC., ADA, OK. SN 78-810,587. PUB. 5-15-2007, FILED 2-8-2006.



FOR GOLF CLUB SHAFTS (U.S. CLS. 22, 23, 38 AND 50).
FIRST USE 3-0-2007; IN COMMERCE 3-0-2007.

3,399,803. WORLD WRESTLING ENTERTAINMENT, INC., STAMFORD, CT. SN 78-800,294. PUB. 9-12-2006, FILED 1-26-2006.

CYBER SUNDAY

THE MARK CONSISTS OF STANDARD CHARACTERS WITHOUT CLAIM TO ANY PARTICULAR FONT, STYLE, SIZE, OR COLOR.

FOR TOY ACTION FIGURES AND ACCESSORIES THEREFOR; CASES FOR ACTION FIGURES; TOY VEHICLES; BOARD GAMES; PLAYING CARDS; TOY SPINNING TOPS; STAND ALONE VIDEO OUTPUT GAME MACHINES FEATURING WRESTLING; ARCADE GAMES RELATED TO WRESTLING; PINBALL GAMES RELATED TO WRESTLING; HAND-HELD UNITS FOR PLAYING ELECTRONIC GAME; TABLE-TOP ACTION SKILL GAMES RELATED TO WRESTLING; JIGSAW PUZZLES; KITES; TOY WRESTLING RINGS; DOLLS; BOBBLE-HEAD DOLLS; PUPPETS; STUFFED TOY ANIMALS; CARD GAMES; TOY GUITARS; WATER GUNS; VINYL PRODUCTS FOR PLAYING IN A POOL, NAMELY, FLOATING PILLOW BACK LOUNGE CHAIR, INFLATABLE TOY RAFTS FOR AQUATIC RECREATIONAL USE; CHRISTMAS TREE DECORATIONS; COSTUME MASKS; TOY BELTS, DOLL FURNITURE; PARTY FAVORS IN THE NATURE OF CRACKERS AND NOISEMAKERS; SKATEBOARDS; BOWLING BALLS AND ACCESSORIES, NAMELY, BOWLING GLOVES, WRIST SUPPORTS, BOWLING BALL BAGS; WINDUP TOYS; TOY SCOOTERS; BOWLING PINS; KNEE AND ELBOW PADS FOR ATHLETIC USE; YO-YO'S; PLASTIC MODEL KITS FOR MAKING TOY VEHICLES; POOL CUES; NOVELTY TOYS, NAMELY, TOY BANKS MADE OF TIN; TOY GUM MACHINES; TOY CANDY BOWL MECHANICAL DISPENSERS; TOY STICK GUM DISPENSERS; TOY GUM FIGURE MAKERS; TOY FOAM HANDS; CONFETTI (U.S. CLS. 22, 23, 38 AND 50).

FIRST USE 12-31-2006; IN COMMERCE 12-31-2006.

TOT POD

THE MARK CONSISTS OF STANDARD CHARACTERS WITHOUT CLAIM TO ANY PARTICULAR FONT, STYLE, SIZE, OR COLOR.

NO CLAIM IS MADE TO THE EXCLUSIVE RIGHT TO USE "TOT", APART FROM THE MARK AS SHOWN.

FOR ACTIVITY CENTERS, NAMELY, PLAY MATS CONTAINING MULTIPLE ACTIVITY TOYS FOR INFANTS, TODDLERS, AND CHILDREN (U.S. CLS. 22, 23, 38 AND 50).

FIRST USE 12-21-2007; IN COMMERCE 12-21-2007.

3,399,907. RE-MENT INTERNATIONAL, INC., IRVINE, CA. SN 78-843,990. PUB. 6-5-2007, FILED 3-23-2006.

THE COLOR(S) RED AND BLACK IS/ARE CLAIMED AS A FEATURE OF THE MARK.

THE MARK CONSISTS OF THE COLOR RED APPEARING ON THE LETTER "R", WHILE THE COLOR BLACK APPEARS ON THE LETTERS "E-MENT".

FOR MINIATURE TOY FIGURES OF FOOD, BEVERAGES, COOKWARE, BAKE WARE, KITCHENWARE, APPLIANCES, FURNITURE, HOUSEHOLD GOODS AND ACCESSORIES, CLOTHING, SHOES AND CLOTHING ACCESSORIES, ANIMALS, COSMETICS, JEWELRIES, HISTORICAL MONUMENTS, CITY SKYLINES, PATRIOTIC ITEMS, AND SEASONAL AND HOLIDAY ITEMS (U.S. CLS. 22, 23, 38 AND 50).

FIRST USE 8-21-2006; IN COMMERCE 8-21-2006.

CLASS 28—(Continued).

3,399,908. RE-MENT INTERNATIONAL, INC., IRVINE, CA.
SN 78-843,993. PUB. 6-5-2007, FILED 3-23-2006.

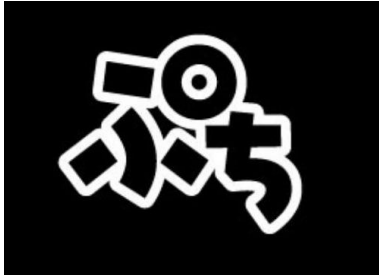

THE MARK CONSISTS OF A STYLIZED VERSION OF THE JAPANESE HIRAGANA CHARACTER.

THE NON-LATIN CHARACTER(S) IN THE MARK TRANSLITERATES INTO THE PHONETIC SOUNDS "POO" AND "CHEE", AND THIS MEANS NOTHING IN ENGLISH.

FOR MINIATURE TOY FIGURES OF FOOD, BEVERAGES, COOKWARE, BAKE WARE, KITCHENWARE, APPLIANCES, FURNITURE, HOUSEHOLD GOODS AND ACCESSORIES, CLOTHING, SHOES AND CLOTHING ACCESSORIES, ANIMALS, COSMETICS, JEWELRIES, HISTORICAL MONUMENTS, CITY SKYLINES, PATRIOTIC ITEMS, AND SEASONAL AND HOLIDAY ITEMS (U.S. CLS. 22, 23, 38 AND 50).

FIRST USE 8-21-2006; IN COMMERCE 8-21-2006.

3,399,954. MATTEL, INC., EL SEGUNDO, CA. SN 78-867,973.
PUB. 6-5-2007, FILED 4-24-2006.

ZIPLINE ATTACK

THE MARK CONSISTS OF STANDARD CHARACTERS WITHOUT CLAIM TO ANY PARTICULAR FONT, STYLE, SIZE, OR COLOR.

FOR TOYS, GAMES AND PLAYTHINGS, NAMELY, TOY ACTION FIGURES, TOY FIGURES, TOY FIGURE PLAYSETS, AND ACCESSORIES FOR ALL OF THE FOREGOING (U.S. CLS. 22, 23, 38 AND 50).

FIRST USE 2-27-2007; IN COMMERCE 2-27-2007.

3,399,973. MISSION CITY PRESS, INC., SAN ANTONIO, TX.
SN 78-881,775. PUB. 5-15-2007, FILED 5-11-2006.

KATHLEEN MCKENZIE

THE MARK CONSISTS OF STANDARD CHARACTERS WITHOUT CLAIM TO ANY PARTICULAR FONT, STYLE, SIZE, OR COLOR.

CLASS 28—(Continued).

THE NAME(S), PORTRAIT(S), AND/OR SIGNATURE(S) SHOWN IN THE MARK DOES NOT IDENTIFY A PARTICULAR LIVING INDIVIDUAL.

FOR DOLL ACCESSORIES; DOLLS (U.S. CLS. 22, 23, 38 AND 50).

FIRST USE 8-30-2006; IN COMMERCE 8-30-2006.

3,399,980. PIXART IMAGING INC., HSIN-CHU, TAIWAN.
SN 78-887,554. PUB. 5-1-2007, FILED 5-19-2006.

MOT Sensor

THE MARK CONSISTS OF STANDARD CHARACTERS WITHOUT CLAIM TO ANY PARTICULAR FONT, STYLE, SIZE, OR COLOR.

NO CLAIM IS MADE TO THE EXCLUSIVE RIGHT TO USE "SENSOR", APART FROM THE MARK AS SHOWN.

FOR HAND HELD UNIT FOR PLAYING VIDEO GAMES (U.S. CLS. 22, 23, 38 AND 50).

FIRST USE 10-1-2007; IN COMMERCE 10-12-2007.

3,400,031. MATTEL, INC., EL SEGUNDO, CA. SN 78-920,875.
PUB. 5-1-2007, FILED 6-30-2006.

TURBO TORNADO

THE MARK CONSISTS OF STANDARD CHARACTERS WITHOUT CLAIM TO ANY PARTICULAR FONT, STYLE, SIZE, OR COLOR.

FOR TOYS, GAMES AND PLAYTHINGS, NAMELY, TOY ACTION FIGURES, TOY FIGURES, AND ACCESSORIES FOR ALL OF THE FOREGOING (U.S. CLS. 22, 23, 38 AND 50).

FIRST USE 3-2-2007; IN COMMERCE 3-2-2007.

CLASS 28—(Continued).

3,400,057. SWING SCIENCE, LLC, INDIANAPOLIS, IN. SN 78-932,780. PUB. 3-27-2007, FILED 7-19-2006.

SWING SCIENCE

THE MARK CONSISTS OF STANDARD CHARACTERS WITHOUT CLAIM TO ANY PARTICULAR FONT, STYLE, SIZE, OR COLOR.

OWNER OF U.S. REG. NO. 2,261,104.

FOR GOLF CLUBS AND COMPONENTS, NAMELY, SHAFTS, HEADS AND GRIPS; GOLF CLUB BAGS (U.S. CLS. 22, 23, 38 AND 50).

FIRST USE 11-17-2005; IN COMMERCE 11-17-2005.

CLASS 28—(Continued).

3,400,115. TY INC., WESTMONT, IL. SN 78-955,116. PUB. 4-3-2007, FILED 8-18-2006.

DEAR GRANDPA

THE MARK CONSISTS OF STANDARD CHARACTERS WITHOUT CLAIM TO ANY PARTICULAR FONT, STYLE, SIZE, OR COLOR.

FOR PLUSH TOYS; SOFT SCULPTURE PLUSH TOYS; SOFT SCULPTURE TOYS; STUFFED TOY ANIMALS; STUFFED TOY BEARS; STUFFED TOYS (U.S. CLS. 22, 23, 38 AND 50).

FIRST USE 3-30-2007; IN COMMERCE 3-30-2007.

3,400,067. FICKETT, GLENN A., TEMPE, AZ. SN 78-937,907. PUB. 3-13-2007, FILED 7-26-2006.

B.A.S.H.

THE MARK CONSISTS OF STANDARD CHARACTERS WITHOUT CLAIM TO ANY PARTICULAR FONT, STYLE, SIZE, OR COLOR.

FOR ARCHERY EQUIPMENT, NAMELY, QUIVERS; ARCHERY QUIVERS; CASES IN THE FORM OF QUIVERS FOR SPORTS IMPLEMENTS (U.S. CLS. 22, 23, 38 AND 50).

FIRST USE 2-0-2007; IN COMMERCE 2-0-2007.

3,400,134. MATTEL, INC., EL SEGUNDO, CA. SN 78-958,109. PUB. 5-22-2007, FILED 8-22-2006.

TOTALLY CHARMED

THE MARK CONSISTS OF STANDARD CHARACTERS WITHOUT CLAIM TO ANY PARTICULAR FONT, STYLE, SIZE, OR COLOR.

FOR TOYS, GAMES AND PLAYTHINGS, NAMELY, DOLLS, DOLL CLOTHING AND DOLL ACCESSORIES, TOY FIGURES AND ACCESSORIES THEREFOR (U.S. CLS. 22, 23, 38 AND 50).

FIRST USE 4-4-2007; IN COMMERCE 4-4-2007.

3,400,101. MATTEL, INC., EL SEGUNDO, CA. SN 78-950,755. PUB. 9-18-2007, FILED 8-11-2006.

SMOKEY

THE MARK CONSISTS OF STANDARD CHARACTERS WITHOUT CLAIM TO ANY PARTICULAR FONT, STYLE, SIZE, OR COLOR.

FOR TOYS, GAMES AND PLAYTHINGS, NAMELY, TOY VEHICLES AND ACCESSORIES THEREFOR (U.S. CLS. 22, 23, 38 AND 50).

FIRST USE 9-4-2007; IN COMMERCE 9-4-2007.

3,400,186. WHAM-O, INC., EMERYVILLE, CA. SN 78-970,012. PUB. 10-9-2007, FILED 9-8-2006.

CLASSIC

THE MARK CONSISTS OF STANDARD CHARACTERS WITHOUT CLAIM TO ANY PARTICULAR FONT, STYLE, SIZE, OR COLOR.

FOR GAMES AND PLAYTHINGS, NAMELY, TOY FLYING DISCS AND SAUCERS USED IN SPORT AND RECREATIONAL ACTIVITIES AND GAMES (U.S. CLS. 22, 23, 38 AND 50).

FIRST USE 0-0-1998; IN COMMERCE 0-0-1998.

CLASS 28—(Continued).

3,400,188. SHIMANO INC., SAKAI CITY, JAPAN. SN 78-970,591. PUB. 7-17-2007, FILED 9-8-2006.

CORE

THE MARK CONSISTS OF STANDARD CHARACTERS WITHOUT CLAIM TO ANY PARTICULAR FONT, STYLE, SIZE, OR COLOR.

OWNER OF JAPAN REG. NO. 4683753, DATED 6-20-2003, EXPIRES 6-20-2013.

FOR FISHING REELS; FISHING TACKLE (U.S. CLS. 22, 23, 38 AND 50).

FIRST USE 7-11-2007; IN COMMERCE 7-11-2007.

CLASS 29—(Continued).

3,398,894. SOL STIX, LLC, MARBLE HILL, GA. SN 76-623,668. PUB. 9-12-2006, FILED 12-8-2004.



3,400,213. PROCAPS L.P., VILLE ST. LAURENT, QUEBEC, CANADA. SN 78-979,576. PUB. 6-29-2004, FILED 9-6-2002.



NO CLAIM IS MADE TO THE EXCLUSIVE RIGHT TO USE "PAINTBALL", APART FROM THE MARK AS SHOWN.

FOR PAINTBALLS (U.S. CLS. 22, 23, 38 AND 50).
FIRST USE 10-26-2004; IN COMMERCE 10-26-2004.

NO CLAIM IS MADE TO THE EXCLUSIVE RIGHT TO USE "GRILLED FOOD ON A STICK", APART FROM THE MARK AS SHOWN.

THE COLORS GRAY, BLACK, WHITE, PURPLE, YELLOW, RED, AND GREEN ARE CLAIMED AS A FEATURE OF THE MARK.

THE COLOR PURPLE APPEARS IN THE BACKGROUND OVAL. THE COLORS YELLOW, RED AND GREEN APPEAR IN THE STICKS. THE COLOR YELLOW APPEARS IN THE TERM "JUSTIX". THE COLOR WHITE APPEARS IN THE WORDS, "GRILLED FOOD ON A STICK". THE COLOR GRAY APPEARS AS A SHADOW OF THE LETTERS IN THE WORD "JUSTIX". THE COLOR BLACK APPEARS AS AN OUTLINE OF THE OVAL.

FOR PREPARED MEALS CONSISTING PRIMARILY OF MEAT, FISH, POULTRY AND VEGETABLES (U.S. CL. 46).

FIRST USE 12-31-2005; IN COMMERCE 12-31-2005.

CLASS 29—MEATS AND PROCESSED FOODS

3,398,877. BUMBLE BEE FOODS, LLC, SAN DIEGO, CA. SN 76-575,133. PUB. 11-30-2004, FILED 2-11-2004.

CATTLE DRIVE GOLD

THE MARK CONSISTS OF STANDARD CHARACTERS WITHOUT CLAIM TO ANY PARTICULAR FONT, STYLE, SIZE, OR COLOR.

FOR CHILI (U.S. CL. 46).
FIRST USE 11-21-2007; IN COMMERCE 11-21-2007.

3,398,906. CAPITOL WHOLESALE MEATS CORPORATION, CHICAGO, IL. SN 76-646,358. PUB. 5-30-2006, FILED 9-7-2005.

FEEDING AMERICA AND THE WORLD

THE MARK CONSISTS OF STANDARD CHARACTERS WITHOUT CLAIM TO ANY PARTICULAR FONT, STYLE, SIZE, OR COLOR.

FOR SAUSAGE (U.S. CL. 46).
FIRST USE 1-0-2006; IN COMMERCE 1-0-2006.

CLASS 29—(Continued).

3,398,985. BBI, INC., WILMINGTON, DE. SN 77-007,479. PUB. 7-24-2007, FILED 9-26-2006.

THE VEGETABLE WITH MORE

THE MARK CONSISTS OF STANDARD CHARACTERS WITHOUT CLAIM TO ANY PARTICULAR FONT, STYLE, SIZE, OR COLOR.

NO CLAIM IS MADE TO THE EXCLUSIVE RIGHT TO USE "VEGETABLE", APART FROM THE MARK AS SHOWN.

FOR PROCESSED, CANNED, DRIED AND FROZEN VEGETABLES (U.S. CL. 46).

FIRST USE 5-0-2006; IN COMMERCE 11-0-2006.

3,398,986. BBI, INC., WILMINGTON, DE. SN 77-007,487. PUB. 7-24-2007, FILED 9-26-2006.

THE VEGGIE WITH MORE

THE MARK CONSISTS OF STANDARD CHARACTERS WITHOUT CLAIM TO ANY PARTICULAR FONT, STYLE, SIZE, OR COLOR.

NO CLAIM IS MADE TO THE EXCLUSIVE RIGHT TO USE "VEGGIE", APART FROM THE MARK AS SHOWN.

FOR PROCESSED, CANNED, DRIED AND FROZEN VEGETABLES (U.S. CL. 46).

FIRST USE 11-0-2006; IN COMMERCE 11-0-2006.

3,399,277. J&B WHOLESALE DISTRIBUTING, INC., ST. MICHAEL, MN. SN 77-149,396. PUB. 10-9-2007, FILED 4-5-2007.

SUPERB & SIMPLE

THE MARK CONSISTS OF STANDARD CHARACTERS WITHOUT CLAIM TO ANY PARTICULAR FONT, STYLE, SIZE, OR COLOR.

FOR FROZEN ENTREES CONSISTING OF SEASONED, MARINATED, BREADED, WRAPPED OR STUFFED MEAT, POULTRY, FISH OR SEAFOOD (U.S. CL. 46).

FIRST USE 10-0-2007; IN COMMERCE 10-0-2007.

CLASS 29—(Continued).

3,399,701. TJ SEVEN INCORPORATION, PINOLE, CA. SN 78-763,377. PUB. 4-3-2007, FILED 11-30-2005.



NO CLAIM IS MADE TO THE EXCLUSIVE RIGHT TO USE THE CHINESE CHARACTERS REPRESENTING "SUPREME NEST", APART FROM THE MARK AS SHOWN.

THE NON-LATIN CHARACTER(S) IN THE MARK TRANSLITERATES INTO SANG WUT SUEI, AND THIS MEANS INTERNAL WATER IN ENGLISH.

FOR EDIBLE BIRD'S NESTS (U.S. CL. 46).

FIRST USE 2-15-2006; IN COMMERCE 2-15-2006.

3,399,752. MARQUEZ BROTHERS INTERNATIONAL, INC., SAN JOSE, CA. SN 78-781,698. PUB. 8-22-2006, FILED 12-28-2005.

OAXAQUEÑA

THE MARK CONSISTS OF STANDARD CHARACTERS WITHOUT CLAIM TO ANY PARTICULAR FONT, STYLE, SIZE, OR COLOR.

THE FOREIGN WORDING IN THE MARK TRANSLATES INTO ENGLISH AS A WOMEN FROM OAXACA.

FOR CHEESE, CREAM, CREAM CHEESE, CHEESE SPREADS (U.S. CL. 46).

FIRST USE 1-31-2006; IN COMMERCE 1-31-2006.

3,399,846. KRAFT FOODS HOLDINGS, INC., NORTHFIELD, IL. SN 78-818,017. PUB. 9-19-2006, FILED 2-17-2006.

FLAVOR LOCK CAP

THE MARK CONSISTS OF STANDARD CHARACTERS WITHOUT CLAIM TO ANY PARTICULAR FONT, STYLE, SIZE, OR COLOR.

NO CLAIM IS MADE TO THE EXCLUSIVE RIGHT TO USE "CAP", APART FROM THE MARK AS SHOWN.

FOR CAPS TO SEAL IN FLAVOR SOLD AS AN INTEGRAL COMPONENT OF PACKAGING FOR CHEESE (U.S. CL. 46).

FIRST USE 6-1-2007; IN COMMERCE 6-1-2007.

CLASS 29—(Continued).

3,399,853. BBI, INC., WILMINGTON, DE. SN 78-819,633. PUB. 7-10-2007, FILED 2-21-2006.

CLASS 29—(Continued).

3,399,932. THE KROGER CO. OF MICHIGAN, LIVONIA, MI. SN 78-858,262. PUB. 10-10-2006, FILED 4-10-2006.

SHOWBOAT

THE MARK CONSISTS OF STANDARD CHARACTERS WITHOUT CLAIM TO ANY PARTICULAR FONT, STYLE, SIZE, OR COLOR.

OWNER OF U.S. REG. NOS. 1,035,452 AND 2,151,718, FOR CANNED PORK AND BEANS IN TOMATO SAUCE, BEANS AND PEAS IN SAUCE OR BRINE (U.S. CL. 46).

FIRST USE 5-0-1954; IN COMMERCE 5-0-1954.

ACTIVE LIFESTYLE

THE MARK CONSISTS OF STANDARD CHARACTERS WITHOUT CLAIM TO ANY PARTICULAR FONT, STYLE, SIZE, OR COLOR.

FOR YOGURT (U.S. CL. 46).

FIRST USE 1-1-2007; IN COMMERCE 1-1-2007.

3,399,861. COMPART FAMILY FARMS, INC., NICOLLET, MN. SN 78-823,174. PUB. 10-17-2006, FILED 2-24-2006.

REDDER IS BETTER

THE MARK CONSISTS OF STANDARD CHARACTERS WITHOUT CLAIM TO ANY PARTICULAR FONT, STYLE, SIZE, OR COLOR.

FOR MEAT (U.S. CL. 46).

FIRST USE 5-7-2006; IN COMMERCE 5-7-2006.

3,400,006. MAIN STREET INGREDIENTS LLC, LA CROSSE, WI. SN 78-904,515. PUB. 9-4-2007, FILED 6-9-2006.

3,399,874. TULLY'S COFFEE CORPORATION, SEATTLE, WA. SN 78-829,924. PUB. 6-26-2007, FILED 3-6-2006.

CAPSTONE

BELLACCINO

THE MARK CONSISTS OF STANDARD CHARACTERS WITHOUT CLAIM TO ANY PARTICULAR FONT, STYLE, SIZE, OR COLOR.

FOR FLAVORED MILK; DAIRY-BASED BEVERAGES; SOY BEVERAGES; FLAVORED SOY BEVERAGES; AND SOY-BASED BEVERAGES (U.S. CL. 46).

FIRST USE 8-1-2006; IN COMMERCE 8-1-2006.

THE MARK CONSISTS OF STANDARD CHARACTERS WITHOUT CLAIM TO ANY PARTICULAR FONT, STYLE, SIZE, OR COLOR.

FOR NONDAIRY CREAMERS; CHEESE POWDERS; MILK POWDERS; CULTURED BUTTERMILK POWDERS; YOGURT POWDERS; SWEET AND SOUR CREAM POWDERS; DAIRY AND NONDAIRY WHIPPED TOPPING BASES; DAIRY-BASED BEVERAGE BLENDS; SOUPS, FLOW AGENTS FOR SHREDDED CHEESE, NAMELY, MILK POWDER PROTEIN BASED ADDITIVE TO PREVENT MOLD AND PREVENT CLUMPING (U.S. CL. 46).

FIRST USE 1-8-2007; IN COMMERCE 1-8-2007.

CLASS 29—(Continued).

3,400,053. ATTACK, INDÚSTRIA COMÉRCIO E REPRESENTAÇÕES LTDA., GASPAR, SANTA CATARINA, BRAZIL. SN 78-932,240. PUB. 2-27-2007, FILED 7-18-2006.



THE FOREIGN WORDING IN THE MARK TRANSLATES INTO ENGLISH AS HOME & FARM.

FOR JAM, NAMELY, CUPUASSÚ JAM, PASSION FRUIT JAM, ASSAI JAM, BANANA JAM, GUAVA JAM, ORANGE JAM, STRAWBERRY JAM, GRAPE JAM, ORANGE JAM; PRESERVED VEGETABLES IN BRINE, NAMELY, WHOLE MINI-CORN IN BRINE, MINI-CARROTS IN BRINE, HEARTS OF REAL PALM OR PALMETTO IN BRINE; PICKLES; PRESERVED VEGETABLES, NAMELY, CUCUMBERS; PRESERVED HEARTS OF PALM; DRIED VEGETABLES; CRYSTALLIZED FRUIT; PROCESSED FRUIT (U.S. CL. 46).

FIRST USE 10-20-2006; IN COMMERCE 10-20-2006.

3,400,088. JOHN B. SANFILIPPO & SON, INC., ELGIN, IL. SN 78-945,689. PUB. 3-20-2007, FILED 8-4-2006.

TROPICAL TWIST

THE MARK CONSISTS OF STANDARD CHARACTERS WITHOUT CLAIM TO ANY PARTICULAR FONT, STYLE, SIZE, OR COLOR.

FOR SNACK MIXES CONSISTING PRIMARILY OF PROCESSED NUTS AND PROCESSED FRUITS (U.S. CL. 46).

FIRST USE 4-12-2006; IN COMMERCE 6-6-2006.

3,400,163. THF EQUITIES, LP, WESTCHESTER, IL. SN 78-964,629. PUB. 4-10-2007, FILED 8-31-2006.

LOTSA' NOODLES

THE MARK CONSISTS OF STANDARD CHARACTERS WITHOUT CLAIM TO ANY PARTICULAR FONT, STYLE, SIZE, OR COLOR.

NO CLAIM IS MADE TO THE EXCLUSIVE RIGHT TO USE "NOODLES", APART FROM THE MARK AS SHOWN.

FOR SOUP (U.S. CL. 46).
FIRST USE 3-31-2007; IN COMMERCE 3-31-2007.

CLASS 30—STAPLE FOODS

3,398,849. MARUKOME KABUSHIKI KAISHA, NAGANO PREFECTURE, JAPAN. SN 76-449,239. PUB. 3-8-2005, FILED 9-11-2002.



FOR JAPANESE MISO-BEAN PASTE; SEASONINGS (U.S. CL. 46).

FIRST USE 4-0-2007; IN COMMERCE 4-0-2007.

3,398,904. TODINNO S.A.C., LIMA 15, PERU. SN 76-645,107. PUB. 3-27-2007, FILED 8-17-2005.

TODINNO GRAN ALMENDRADO

THE MARK CONSISTS OF STANDARD CHARACTERS WITHOUT CLAIM TO ANY PARTICULAR FONT, STYLE, SIZE, OR COLOR.

NO CLAIM IS MADE TO THE EXCLUSIVE RIGHT TO USE "GRAN ALMENDRADO", APART FROM THE MARK AS SHOWN.

THE FOREIGN WORDING IN THE MARK TRANSLATES INTO ENGLISH AS "GREAT ALMOND SHAPED".

FOR PRODUCTS DERIVED FROM FLOUR, NAMELY, SLICED LOAF OF BREAD IN ALL ITS VARIETIES, SPONGE CAKES AS FRUIT ROLL BREADS (U.S. CL. 46).

FIRST USE 10-22-2007; IN COMMERCE 10-22-2007.

3,398,933. TWIN HENS, INC., PRINCETON, NJ. SN 76-664,172. PUB. 7-10-2007, FILED 8-3-2006.



OWNER OF U.S. REG. NO. 2,882,394.
NO CLAIM IS MADE TO THE EXCLUSIVE RIGHT TO USE "WHOLESOME & DELICIOUS POT PIES", APART FROM THE MARK AS SHOWN.

THE MARK CONSISTS OF THE WORDS "TWIN HENS WHOLESOME" & "DELICIOUS POT PIES FROM OUR KITCHEN TO YOURS" AND THE DEPICTION OF TWO CHICKENS.

FOR POT PIES (U.S. CL. 46).
FIRST USE 8-0-2006; IN COMMERCE 8-0-2006.

CLASS 30—(Continued).

3,398,980. MATA, ARIEL ALEJANDRO, TLAJOMULCO DE ZUNIGA, JALISCO, MEXICO. SN 77-006,927. PUB. 6-5-2007, FILED 9-25-2006.

NECTARAVE

THE MARK CONSISTS OF STANDARD CHARACTERS WITHOUT CLAIM TO ANY PARTICULAR FONT, STYLE, SIZE, OR COLOR.

FOR HONEY AND HONEY SUBSTITUTES (U.S. CL. 46).

FIRST USE 2-20-2007; IN COMMERCE 2-20-2007.

3,399,007. GOOD KARMA FOOD TECHNOLOGIES, INC., GLENDALE, CA. SN 77-017,247. PUB. 6-19-2007, FILED 10-9-2006.



OWNER OF U.S. REG. NO. 3,195,270.

NO CLAIM IS MADE TO THE EXCLUSIVE RIGHT TO USE "ORGANIC RICE DIVINE", APART FROM THE MARK AS SHOWN.

THE COLOR(S) WHITE, GOLD, PURPLE, BLUE, AND GREEN IS/ARE CLAIMED AS A FEATURE OF THE MARK.

THE MARK CONSISTS OF THE WORDS "GOOD KARMA" IN GOLD AND THE WORDS "ORGANIC RICE DIVINE" IN WHITE SUPERIMPOSED OVER A PURPLE FIELD OF WHITE STARS WITH THE BLUE AND GREEN PLANET EARTH IN THE RIGHT HAND CORNER. THE EARTH IS SURROUNDED BY A GOLD GLOW.

FOR FROZEN CONFECTIONS AND ICE CREAM SUBSTITUTES ALL CONTAINING ORGANIC RICE (U.S. CL. 46).

FIRST USE 12-11-2006; IN COMMERCE 12-11-2006.

3,399,009. WECAM FOUNDATION, INC., ORLANDO, FL. SN 77-017,704. PUB. 5-22-2007, FILED 10-10-2006.

WECAM FOUNDATION, INC.

THE MARK CONSISTS OF STANDARD CHARACTERS WITHOUT CLAIM TO ANY PARTICULAR FONT, STYLE, SIZE, OR COLOR.

NO CLAIM IS MADE TO THE EXCLUSIVE RIGHT TO USE "FOUNDATION, INC.", APART FROM THE MARK AS SHOWN.

FOR BEVERAGES MADE OF TEA (U.S. CL. 46).
FIRST USE 12-1-2007; IN COMMERCE 12-1-2007.

CLASS 30—(Continued).

3,399,046. H.C. BRILL COMPANY, INC., TUCKER, GA. SN 77-035,538. PUB. 3-6-2007, FILED 11-2-2006.

SNOPRINCE

THE MARK CONSISTS OF STANDARD CHARACTERS WITHOUT CLAIM TO ANY PARTICULAR FONT, STYLE, SIZE, OR COLOR.

FOR FLOUR (U.S. CL. 46).

FIRST USE 1-0-2001; IN COMMERCE 1-0-2001.

3,399,052. INTEGRATED BEVERAGE GROUP, LTD, FARMINGDALE, NY. SN 77-037,336. PUB. 5-22-2007, FILED 11-6-2006.

Throat Cooler

THE MARK CONSISTS OF STANDARD CHARACTERS WITHOUT CLAIM TO ANY PARTICULAR FONT, STYLE, SIZE, OR COLOR.

FOR ICE (U.S. CL. 46).

FIRST USE 3-0-2007; IN COMMERCE 5-0-2007.

3,399,123. CHR. HANSEN INC., MILWAUKEE, WI. SN 77-069,728. PUB. 7-31-2007, FILED 12-21-2006.

FlavorMax

THE MARK CONSISTS OF STANDARD CHARACTERS WITHOUT CLAIM TO ANY PARTICULAR FONT, STYLE, SIZE, OR COLOR.

FOR FLAVOR ENHANCERS USED IN FOOD AND BEVERAGE PRODUCTS (U.S. CL. 46).

FIRST USE 10-29-2006; IN COMMERCE 10-29-2006.

CLASS 30—(Continued).

3,399,125. TRADEMARK MANAGEMENT COMPANY, MERIDIAN, ID. SN 77-070,309. PUB. 7-17-2007, FILED 12-22-2006.

DELIMEX TO GO!

THE MARK CONSISTS OF STANDARD CHARACTERS WITHOUT CLAIM TO ANY PARTICULAR FONT, STYLE, SIZE, OR COLOR.

OWNER OF U.S. REG. NOS. 1,658,372 AND 2,329,583. FOR FROZEN, PACKAGED OR PREPARED MEXICAN FOODS, NAMELY, TAQUITOS, QUESADILLAS, TAMALES, FAJITAS AND BURRITOS (U.S. CL. 46). FIRST USE 7-5-2006; IN COMMERCE 7-5-2006.

3,399,139. HERSHEY CHOCOLATE & CONFECTIONERY CORPORATION, WHEAT RIDGE, CO. SN 77-077,795. PUB. 7-31-2007, FILED 1-10-2007.

REESE'S WHIPPS

THE MARK CONSISTS OF STANDARD CHARACTERS WITHOUT CLAIM TO ANY PARTICULAR FONT, STYLE, SIZE, OR COLOR.

OWNER OF U.S. REG. NOS. 1,074,163, 1,834,806, AND OTHERS. FOR CANDY (U.S. CL. 46). FIRST USE 8-20-2007; IN COMMERCE 8-20-2007.

3,399,156. CASHWELL III, JOHNNY J, MURFREESBORO, TN. SN 77-087,281. PUB. 7-24-2007, FILED 1-20-2007.

**Southern Elegance Bar-B-Q
Sauce**

THE MARK CONSISTS OF STANDARD CHARACTERS WITHOUT CLAIM TO ANY PARTICULAR FONT, STYLE, SIZE, OR COLOR.

NO CLAIM IS MADE TO THE EXCLUSIVE RIGHT TO USE "BAR-B-Q SAUCE", APART FROM THE MARK AS SHOWN. FOR BARBECUE SAUCE (U.S. CL. 46). FIRST USE 6-15-2007; IN COMMERCE 9-1-2007.

CLASS 30—(Continued).

3,399,163. HERSHEY CHOCOLATE & CONFECTIONERY CORPORATION, WHEAT RIDGE, CO. SN 77-090,726. PUB. 7-31-2007, FILED 1-25-2007.



OWNER OF U.S. REG. NO. 3,169,976. NO CLAIM IS MADE TO THE EXCLUSIVE RIGHT TO USE "COCOA IS A NATURAL SOURCE OF FLAVANOL ANTIOXIDANTS", APART FROM THE MARK AS SHOWN. THE MARK CONSISTS OF A COCOA BEAN AND LEAF DESIGN INSIDE TWO CONCENTRIC CIRCLES, WITH A RECTANGLE ATTACHED TO THE BOTTOM OF THE OUTER CIRCLE, AND WITH THE WORDS "COCOA IS A NATURAL SOURCE OF FLAVANOL ANTIOXIDANTS" ENCIRCLING THE COCOA BEAN AND LEAF. FOR CANDY; CHOCOLATE; COCOA (U.S. CL. 46). FIRST USE 3-31-2007; IN COMMERCE 3-31-2007.

3,399,185. SCORE ACQUISITIONS CORP., DBA CODY-KRAMER IMPORTS, BLAUVELT, NY. SN 77-100,094. PUB. 8-28-2007, FILED 2-6-2007.

ENCHANTMINTS

THE MARK CONSISTS OF STANDARD CHARACTERS WITHOUT CLAIM TO ANY PARTICULAR FONT, STYLE, SIZE, OR COLOR.

FOR CONFECTIONERY, NAMELY, CANDY (U.S. CL. 46). FIRST USE 4-1-2007; IN COMMERCE 4-1-2007.

3,399,227. MAXIMUM QUALITY FOODS INC., LINDEN, NJ. SN 77-119,727. PUB. 9-18-2007, FILED 3-1-2007.

MOMMA'S CABIN

CLASS 30—(Continued).

THE MARK CONSISTS OF STANDARD CHARACTERS WITHOUT CLAIM TO ANY PARTICULAR FONT, STYLE, SIZE, OR COLOR.

FOR TABLE SYRUP (U.S. CL. 46).
FIRST USE 9-11-2007; IN COMMERCE 9-11-2007.

3,399,251. GRILL VENTURES, INC., ATLANTA, GA. SN 77-132,644. PUB. 9-18-2007, FILED 3-16-2007.

BIKINI PANINI

THE MARK CONSISTS OF STANDARD CHARACTERS WITHOUT CLAIM TO ANY PARTICULAR FONT, STYLE, SIZE, OR COLOR.

FOR SPECIALTY SANDWICHES (U.S. CL. 46).
FIRST USE 7-9-2007; IN COMMERCE 7-9-2007.

3,399,252. GRILL VENTURES, INC., ATLANTA, GA. SN 77-132,645. PUB. 9-18-2007, FILED 3-16-2007.

TEENI PANINI

THE MARK CONSISTS OF STANDARD CHARACTERS WITHOUT CLAIM TO ANY PARTICULAR FONT, STYLE, SIZE, OR COLOR.

FOR SPECIALTY SANDWICHES (U.S. CL. 46).
FIRST USE 7-9-2007; IN COMMERCE 7-9-2007.

3,399,276. SCHWAN'S IP, LLC, MARSHALL, MN. SN 77-149,208. PUB. 8-14-2007, FILED 4-5-2007.

SCHWAN'S SAUCE IN SECONDS

THE MARK CONSISTS OF STANDARD CHARACTERS WITHOUT CLAIM TO ANY PARTICULAR FONT, STYLE, SIZE, OR COLOR.

FOR SAUCES IN FROZEN CUBE FORM, NAMELY, ALFREDO, MARINARA AND CHEDDAR CHEESE SAUCES (U.S. CL. 46).
FIRST USE 12-31-2007; IN COMMERCE 12-31-2007.

CLASS 30—(Continued).

3,399,297. LOPATIN, JEREMY, ANN ARBOR, MI. AND LOPATIN, AUBREY, ANN ARBOR, MI. SN 77-183,911. PUB. 9-11-2007, FILED 5-17-2007.

ARBOR TEAS

THE MARK CONSISTS OF STANDARD CHARACTERS WITHOUT CLAIM TO ANY PARTICULAR FONT, STYLE, SIZE, OR COLOR.

NO CLAIM IS MADE TO THE EXCLUSIVE RIGHT TO USE "TEAS", APART FROM THE MARK AS SHOWN.
FOR HERB TEA; HERBAL INFUSIONS; TEA; TEA FOR INFUSIONS; TISANES (U.S. CL. 46).
FIRST USE 10-17-2007; IN COMMERCE 10-17-2007.

3,399,319. CHOCOLATE PRINTING COMPANY, INC., INWOOD, NY. SN 78-250,949. PUB. 2-10-2004, FILED 5-16-2003.

CD-LICIOUS

THE MARK CONSISTS OF STANDARD CHARACTERS WITHOUT CLAIM TO ANY PARTICULAR FONT, STYLE, SIZE, OR COLOR.

FOR CANDY AND CHOCOLATE (U.S. CL. 46).
FIRST USE 5-1-2001; IN COMMERCE 5-1-2001.

3,399,327. CARGILL, INCORPORATED, WAYZATA, MN. SN 78-271,029. PUB. 3-21-2006, FILED 7-7-2003.

CREAM GEL

FOR FOOD STARCHES (U.S. CL. 46).
FIRST USE 11-10-2004; IN COMMERCE 11-10-2004.

3,399,337. WRIGHT BROTHERS SALES & MARKETING, INC., KENT, WA. SN 78-321,226. PUB. 8-31-2004, FILED 10-30-2003.

CABO LOCO

THE ENGLISH TRANSLATION OF THE WORD "CABO LOCO" IN THE MARK IS "CRAZY CAPE".

FOR CORN-BASED SNACK FOODS, NAMELY, TORTILLA CHIPS; SALSA (U.S. CL. 46).
FIRST USE 4-1-2005; IN COMMERCE 4-1-2005.

CLASS 30—(Continued).

3,399,344. CARGILL, INCORPORATED, WAYZATA, MN. SN 78-333,153. PUB. 3-22-2005, FILED 11-25-2003.

PROLIA

THE MARK CONSISTS OF STANDARD CHARACTERS WITHOUT CLAIM TO ANY PARTICULAR FONT, STYLE, SIZE, OR COLOR.
FOR SOY FLOUR (U.S. CL. 46).
FIRST USE 6-25-2007; IN COMMERCE 6-25-2007.

CLASS 30—(Continued).

3,399,508. CARGILL, INCORPORATED, WAYZATA, MN. SN 78-607,237. PUB. 8-1-2006, FILED 4-12-2005.

GrainWise

THE MARK CONSISTS OF THE BLACK-AND-WHITE LETTERS "GRAINWISE" IN STYLIZED FORM WITH A STALK OF WHEAT USED IN PLACE OF THE DOT ABOVE THE LETTER "I".
FOR PROCESSED WHEAT (U.S. CL. 46).
FIRST USE 12-31-2005; IN COMMERCE 12-31-2005.

3,399,363. Z INTERNATIONAL, C.A., CARACAS, VENEZUELA. SN 78-367,768. PUB. 7-26-2005, FILED 2-13-2004.



THE STIPPLING IS A FEATURE OF THE MARK.
THE NAME "DON VEITIA" SHOWN IN THE MARK DOES NOT IDENTIFY A PARTICULAR LIVING INDIVIDUAL.
FOR COFFEE AND POWDERED CHOCOLATE (U.S. CL. 46).
FIRST USE 10-22-2005; IN COMMERCE 10-22-2005.

3,399,546. AUSSIE FRANCHISING LLC, WILMINGTON, DE. SN 78-652,290. PUB. 4-10-2007, FILED 6-16-2005.

JUMBUCKS

THE MARK CONSISTS OF STANDARD CHARACTERS WITHOUT CLAIM TO ANY PARTICULAR FONT, STYLE, SIZE, OR COLOR.
FOR PIES WITH VARIOUS FILLINGS (U.S. CL. 46).
FIRST USE 8-1-2003; IN COMMERCE 6-1-2006.

3,399,564. DEHART, GREGORY M., JAMUL, CA. SN 78-664,607. PUB. 3-28-2006, FILED 7-6-2005.



FOR COFFEE (U.S. CL. 46).
FIRST USE 7-6-2005; IN COMMERCE 7-6-2005.

3,399,491. GARRITANO, FRANCO, SAN DIEGO, CA. AND ALAVI, MATT, SAN DIEGO, CA. AND ELLIOTT, KIRK, SAN DIEGO, CA. SN 78-595,428. PUB. 7-18-2006, FILED 3-25-2005.

HAPPY TEA

THE MARK CONSISTS OF STANDARD CHARACTERS WITHOUT CLAIM TO ANY PARTICULAR FONT, STYLE, SIZE, OR COLOR.
NO CLAIM IS MADE TO THE EXCLUSIVE RIGHT TO USE "TEA", APART FROM THE MARK AS SHOWN.
FOR TEA (U.S. CL. 46).
FIRST USE 11-1-2004; IN COMMERCE 9-4-2007.

CLASS 30—(Continued).

3,399,649. BUEHLER FOOD MARKETS, INCORPORATED, WOOSTER, OH. SN 78-737,967. PUB. 7-18-2006, FILED 10-21-2005.



OWNER OF U.S. REG. NO. 3,216,569.
NO CLAIM IS MADE TO THE EXCLUSIVE RIGHT TO USE "COFFEE CO", APART FROM THE MARK AS SHOWN.
THE MARK CONSISTS OF TWO MEN PADDLING A CANOE ABOVE THE OUTLINE OF THE STATE OF OHIO, WITH THE WORDS "SCENIC RIVER COFFEE CO" SUPERIMPOSED OVER THE STATE OUTLINE.

FOR COFFEE; TEA; COCOA; PREPARED COFFEE AND COFFEE-BASED BEVERAGES; PREPARED EXPRESSO AND EXPRESSO-BASED BEVERAGES; BEVERAGES MADE OF TEA; CHAI; BULK COFFEE BEANS; ICED TEA; READY-TO-DRINK TEA; CHOCOLATE FOOD BEVERAGES NOT BEING DAIRY BASED OR VEGETABLE BASED; CHOCOLATE FOOD BEVERAGES NOT BEING DAIRY-BASED OR VEGETABLE BASED WITH COFFEE FLAVORS; HOT CHOCOLATE; COCOA BEVERAGES WITH MILK (U.S. CL. 46).
FIRST USE 2-4-2006; IN COMMERCE 2-4-2006.

3,399,674. CHOCOLADEFABRIKEN LINDT & SPRÜNGLI AG, KILCHBERG, SWITZERLAND. SN 78-749,711. PUB. 7-18-2006, FILED 11-8-2005.

MIDNIGHT REVERIE

THE MARK CONSISTS OF STANDARD CHARACTERS WITHOUT CLAIM TO ANY PARTICULAR FONT, STYLE, SIZE, OR COLOR.
FOR CHOCOLATE BARS (U.S. CL. 46).
FIRST USE 11-9-2007; IN COMMERCE 11-9-2007.

CLASS 30—(Continued).

3,399,726. JOLLIBEE FOODS CORPORATION, PASIG CITY 1600, PHILIPPINES. SN 78-773,483. PUB. 3-20-2007, FILED 12-14-2005.

AMAZING ALOHA

THE MARK CONSISTS OF STANDARD CHARACTERS WITHOUT CLAIM TO ANY PARTICULAR FONT, STYLE, SIZE, OR COLOR.
FOR SANDWICHES (U.S. CL. 46).
FIRST USE 2-9-2004; IN COMMERCE 2-9-2004.

3,399,751. OLD MEETING HOUSE HOMEMADE ICE CREAM LLC, TAMPA, FL. SN 78-781,683. PUB. 8-29-2006, FILED 12-28-2005.

EXCEL ICE CREAM

THE MARK CONSISTS OF STANDARD CHARACTERS WITHOUT CLAIM TO ANY PARTICULAR FONT, STYLE, SIZE, OR COLOR.
NO CLAIM IS MADE TO THE EXCLUSIVE RIGHT TO USE "ICE CREAM", APART FROM THE MARK AS SHOWN.
FOR ICE CREAM, ICE-CREAM PIES, ICE-CREAM CAKES, NOVELTY ICE CREAMS, ICE CREAM SANDWICHES, ICE CREAM MIXES, ICE CREAM SUBSTITUTES, SOY-BASED ICE CREAM SUBSTITUTES (U.S. CL. 46).
FIRST USE 1-1-2005; IN COMMERCE 1-1-2005.

3,399,767. INTERNATIONAL COFFEE & TEA, LLC, DBA THE COFFEE BEAN AND TEA LEAF, LOS ANGELES, CA. SN 78-788,809. PUB. 4-17-2007, FILED 1-10-2006.

FRU-TEA

THE MARK CONSISTS OF STANDARD CHARACTERS WITHOUT CLAIM TO ANY PARTICULAR FONT, STYLE, SIZE, OR COLOR.
FOR LOOSE TEA, TEA BAGS, HOT TEA, ICED TEA, AND TEA-BASED BEVERAGES (U.S. CL. 46).
FIRST USE 3-1-2006; IN COMMERCE 3-1-2006.

CLASS 30—(Continued).

3,399,833. REVOLUTION TEA, LLC, PHOENIX, AZ. SN 78-813,504. PUB. 11-7-2006, FILED 2-13-2006.

REVOLUTION ICED

THE MARK CONSISTS OF STANDARD CHARACTERS WITHOUT CLAIM TO ANY PARTICULAR FONT, STYLE, SIZE, OR COLOR.

OWNER OF U.S. REG. NO. 2,964,518.

NO CLAIM IS MADE TO THE EXCLUSIVE RIGHT TO USE "ICED", APART FROM THE MARK AS SHOWN.

FOR TEA, TEA-BASED BEVERAGES, AROMATIC TEAS, FRUIT TEAS AND FRUIT FLAVORED TEA, AND HERBAL TEAS (U.S. CL. 46).

FIRST USE 5-1-2006; IN COMMERCE 5-1-2006.

3,399,855. STEAK N SHAKE LLC, INDIANAPOLIS, IN. SN 78-820,693. PUB. 6-19-2007, FILED 2-22-2006.

BITS 'N PIECES

THE MARK CONSISTS OF STANDARD CHARACTERS WITHOUT CLAIM TO ANY PARTICULAR FONT, STYLE, SIZE, OR COLOR.

FOR MILK SHAKES (U.S. CL. 46).

FIRST USE 5-17-2006; IN COMMERCE 5-17-2006.

3,399,912. SUSTAINABLE AGRICO, L.L.C., SANTE FE, NM. SN 78-848,690. PUB. 6-19-2007, FILED 3-29-2006.

SANTA CATARINA

THE MARK CONSISTS OF STANDARD CHARACTERS WITHOUT CLAIM TO ANY PARTICULAR FONT, STYLE, SIZE, OR COLOR.

FOR ORGANIC CHOCOLATE (U.S. CL. 46).
FIRST USE 8-0-2006; IN COMMERCE 8-0-2006.

CLASS 30—(Continued).

3,399,921. SUSTAINABLE AGRICO, L.L.C., SANTE FE, NM. SN 78-853,512. PUB. 6-19-2007, FILED 4-4-2006.

VENETO

THE MARK CONSISTS OF STANDARD CHARACTERS WITHOUT CLAIM TO ANY PARTICULAR FONT, STYLE, SIZE, OR COLOR.

FOR ORGANIC CHOCOLATE (U.S. CL. 46).

FIRST USE 8-0-2006; IN COMMERCE 8-0-2006.

3,399,956. QUALITY FOOD BRANDS, INC., SYOSSET, NY. SN 78-870,719. PUB. 12-5-2006, FILED 4-27-2006.

Harvest Hill

THE MARK CONSISTS OF STANDARD CHARACTERS WITHOUT CLAIM TO ANY PARTICULAR FONT, STYLE, SIZE, OR COLOR.

FOR CAKE MIXES, COOKIE MIXES, MUFFIN MIXES, PANCAKE MIXES, MIXES FOR BAKERY GOODS (U.S. CL. 46).

FIRST USE 8-1-2006; IN COMMERCE 9-1-2006.

3,400,036. UNITED BISCUITS (UK) LIMITED, HAYES, MIDDLESEX, UNITED KINGDOM. SN 78-922,392. PUB. 4-17-2007, FILED 7-5-2006.

CARR'S MELTS

THE MARK CONSISTS OF STANDARD CHARACTERS WITHOUT CLAIM TO ANY PARTICULAR FONT, STYLE, SIZE, OR COLOR.

OWNER OF U.S. REG. NOS. 310,969 AND 2,396,154.

NO CLAIM IS MADE TO THE EXCLUSIVE RIGHT TO USE "MELTS", APART FROM THE MARK AS SHOWN.

FOR SAVOURY BISCUITS, CRACKERS (U.S. CL. 46).
FIRST USE 6-0-1999; IN COMMERCE 7-0-2007.

CLASS 30—(Continued).

3,400,099. YANG, XIAOYONG, SICHUAN PROVINCE, CHINA. SN 78-949,932. PUB. 4-3-2007, FILED 8-11-2006.



THE NON-LATIN CHARACTERS IN THE MARK TRANSLITERATE TO "MI"; "LAO"; "TOU" AND THESE MEAN BEIGE; OLD; FIRST IN ENGLISH.

FOR COFFEE; COCOA; TEA; SUGAR; CHOCOLATE; CANDY; HONEY; BISCUITS; COOKIES; CONFECTIONERY, NAMELY, PASTILLES; PANCAKES; PASTRIES; RICE CAKES; PROCESSED OATS; PIES; PROCESSED CEREALS; CORN FLAKES; FLOUR-BASED CHIPS; DRIED SUGARED CAKES OF RICE FLOUR, NAMELY, RAKUGAN; CHINESE RICE NOODLES, NAMELY, BIFUN, UNCOOKED; POPCORN; SOYA FLOUR; FARINACEOUS FOOD PASTES FOR HUMAN CONSUMPTION; EDIBLE FRUIT ICES; ICE CUBES; COOKING SALT; VINEGAR; RELISH; YEAST; FOOD FLAVORINGS, NON-ESSENTIAL OILS; STARCH-BASED THICKENERS FOR WHIPPED CREAM; RICE-BASED SNACK FOODS; APPLE FRITTERS; BANANA FRITTERS; PINEAPPLE FRITTERS; CORN FRITTERS; RICE CRACKERS, NAMELY, SENBEI; EGG ROLLS; CONFECTIONERY, NAMELY, MOON CAKE; FRIED DOUGH COOKIES, NAMELY, KARINTOH (U.S. CL. 46).
FIRST USE 5-30-2005; IN COMMERCE 8-10-2005.

3,400,110. LA TORTILLA FACTORY INC., SANTA ROSA, CA. SN 78-953,743. PUB. 4-17-2007, FILED 8-16-2006.

SMART & DELICIOUS WRAPS

THE MARK CONSISTS OF STANDARD CHARACTERS WITHOUT CLAIM TO ANY PARTICULAR FONT, STYLE, SIZE, OR COLOR.

NO CLAIM IS MADE TO THE EXCLUSIVE RIGHT TO USE "DELICIOUS WRAPS", APART FROM THE MARK AS SHOWN.
FOR TORTILLAS AND SANDWICH WRAPS (U.S. CL. 46).
FIRST USE 10-31-2006; IN COMMERCE 10-31-2006.

CLASS 30—(Continued).

3,400,111. LA TORTILLA FACTORY INC., SANTA ROSA, CA. SN 78-953,750. PUB. 4-17-2007, FILED 8-16-2006.

SMART & DELICIOUS TORTILLAS

THE MARK CONSISTS OF STANDARD CHARACTERS WITHOUT CLAIM TO ANY PARTICULAR FONT, STYLE, SIZE, OR COLOR.

NO CLAIM IS MADE TO THE EXCLUSIVE RIGHT TO USE "DELICIOUS TORTILLAS", APART FROM THE MARK AS SHOWN.

FOR TORTILLAS AND SANDWICH WRAPS (U.S. CL. 46).
FIRST USE 2-28-2007; IN COMMERCE 2-28-2007.

3,400,138. JUDY'S CANDY COMPANY, BERKELEY, CA. SN 78-958,613. PUB. 4-24-2007, FILED 8-23-2006.



OWNER OF U.S. REG. NO. 2,533,954.
NO CLAIM IS MADE TO THE EXCLUSIVE RIGHT TO USE "CANDY COMPANY"; "HANDMADE" AND "THE OLD-FASHIONED WAY", APART FROM THE MARK AS SHOWN.

THE MARK CONSISTS OF THE WORDS "JUDY'S CANDY COMPANY HANDMADE THE OLD-FASHIONED WAY" WITHIN AN OVAL CIRCLE.
FOR CANDY (U.S. CL. 46).
FIRST USE 11-8-2006; IN COMMERCE 11-8-2006.

CLASS 30—(Continued).

3,400,164. SIGNATURE BRANDS LLC, OCALA, FL. SN 78-964,764. PUB. 5-1-2007, FILED 8-31-2006.

MARBLE MIX'INS

THE MARK CONSISTS OF STANDARD CHARACTERS WITHOUT CLAIM TO ANY PARTICULAR FONT, STYLE, SIZE, OR COLOR.

NO CLAIM IS MADE TO THE EXCLUSIVE RIGHT TO USE "MIX'INS", APART FROM THE MARK AS SHOWN.

FOR CANDY, CANDY PIECES, DOUGH, BATTERS, CHOCOLATE CHIPS AND CONFECTIONARY, ALL AS ADD-INS FOR FROZEN DESERTS (U.S. CL. 46).

FIRST USE 4-0-2006; IN COMMERCE 4-0-2006.

3,400,180. REAS' OLIVE RANCH INC., TEMPE, AZ. SN 78-968,513. PUB. 5-1-2007, FILED 9-6-2006.

Chocolives

THE MARK CONSISTS OF STANDARD CHARACTERS WITHOUT CLAIM TO ANY PARTICULAR FONT, STYLE, SIZE, OR COLOR.

FOR CONFECTIONERY, NAMELY, CHOCOLATE MOLDED INTO THE SHAPE OF OLIVES AND STUFFED WITH NUTS AND/OR CREAMS (U.S. CL. 46).

FIRST USE 1-14-2008; IN COMMERCE 1-14-2008.

CLASS 31—NATURAL AGRICULTURAL PRODUCTS

3,399,045. DEL MONTE CORPORATION, SAN FRANCISCO, CA. SN 77-035,293. PUB. 6-5-2007, FILED 11-2-2006.

GROWING YEARS

THE MARK CONSISTS OF STANDARD CHARACTERS WITHOUT CLAIM TO ANY PARTICULAR FONT, STYLE, SIZE, OR COLOR.

FOR PET FOOD (U.S. CLS. 1 AND 46).

FIRST USE 6-6-2007; IN COMMERCE 6-6-2007.

CLASS 31—(Continued).

3,399,108. DEL FRESCO PRODUCE LTD., KINGSVILLE, ONTARIO, CANADA. SN 77-066,576. PUB. 7-17-2007, FILED 12-18-2006.

YOU BET WE'RE FRESH!

THE MARK CONSISTS OF STANDARD CHARACTERS WITHOUT CLAIM TO ANY PARTICULAR FONT, STYLE, SIZE, OR COLOR.

FOR FRESH HYDROPONIC VEGETABLES (U.S. CLS. 1 AND 46).

FIRST USE 2-0-2007; IN COMMERCE 2-0-2007.

3,399,149. SUNSHINE MILLS, INC., RED BAY, AL. SN 77-083,446. PUB. 6-19-2007, FILED 1-16-2007.

NATURE'S MENU

THE MARK CONSISTS OF STANDARD CHARACTERS WITHOUT CLAIM TO ANY PARTICULAR FONT, STYLE, SIZE, OR COLOR.

FOR PET FOOD (U.S. CLS. 1 AND 46).

FIRST USE 5-9-2007; IN COMMERCE 5-9-2007.

3,399,166. PERFORMANCE PET PRODUCTS, LLC, FAIRMONT, MN. SN 77-091,796. PUB. 7-17-2007, FILED 1-26-2007.



OWNER OF U.S. REG. NO. 2,102,185.

NO CLAIM IS MADE TO THE EXCLUSIVE RIGHT TO USE "CANINE", APART FROM THE MARK AS SHOWN.

THE MARK CONSISTS OF A DESIGN OF CONCENTRIC OVALS, ONE SHADED, PLUS HORNS OF AN ANIMAL.

FOR PET TREATS (U.S. CLS. 1 AND 46).

FIRST USE 2-19-2007; IN COMMERCE 2-19-2007.

CLASS 31—(Continued).

3,399,279. RUDY GREEN VENTURES, LLC, LOUISVILLE, KY. SN 77-150,589. PUB. 10-9-2007, FILED 4-6-2007.



NO CLAIM IS MADE TO THE EXCLUSIVE RIGHT TO USE "VENTURES LLC.", APART FROM THE MARK AS SHOWN.

THE MARK CONSISTS OF A STYLIZED RENDITION OF A DOG'S HEAD AND SHOULDERS WITH RADIAL LINES BEGINNING BEHIND THE DOG'S HEAD AND EXTENDING OUTWARD IN THE BACKGROUND; THE DOG'S HEAD APPEARS OVER THE LETTERS "RGV;" AND THE PHRASE "RUDY GREEN VENTURES LLC." IS WRITTEN VERTICALLY ON THE RIGHT BORDER OF THE MARK.

FOR PET FOOD; PET TREATS (U.S. CLS. 1 AND 46).
FIRST USE 1-1-2007; IN COMMERCE 1-1-2007.

3,399,283. RUDY GREEN VENTURES, LLC, LOUISVILLE, KY. SN 77-151,571. PUB. 10-9-2007, FILED 4-9-2007.

RUDY GREEN'S DOGGY CUISINE

THE MARK CONSISTS OF STANDARD CHARACTERS WITHOUT CLAIM TO ANY PARTICULAR FONT, STYLE, SIZE, OR COLOR.

NO CLAIM IS MADE TO THE EXCLUSIVE RIGHT TO USE "DOGGY CUISINE", APART FROM THE MARK AS SHOWN.

FOR PET FOOD; PET TREATS (U.S. CLS. 1 AND 46).
FIRST USE 5-1-2007; IN COMMERCE 5-1-2007.

CLASS 31—(Continued).

3,399,742. DAD'S PRODUCTS CO., INC., DBA DAD'S PET CARE, MEADVILLE, PA. SN 78-779,903. PUB. 9-12-2006, FILED 12-22-2005.

Brush 'Ems

THE MARK CONSISTS OF STANDARD CHARACTERS WITHOUT CLAIM TO ANY PARTICULAR FONT, STYLE, SIZE, OR COLOR.

FOR CAT TREATS; DOG TREATS; PET FOOD (U.S. CLS. 1 AND 46).

FIRST USE 6-15-2007; IN COMMERCE 6-15-2007.

3,400,075. SHANGHAI PEIDI BRAND INT'L TRADE CO., LTD, SHANGHAI, CHINA. SN 78-941,139. PUB. 3-27-2007, FILED 7-31-2006.

PEIDI

THE MARK CONSISTS OF STANDARD CHARACTERS WITHOUT CLAIM TO ANY PARTICULAR FONT, STYLE, SIZE, OR COLOR.

THE WORDING "PEIDI" HAS NO MEANING IN A FOREIGN LANGUAGE.

FOR FOOD AND EDIBLE TREATS FOR PETS, INCLUDING DOGS, CATS, BIRDS, FISH, REPTILES, HORSES, HAMSTERS, GERBILS, FERRETS, RABBITS, SUGAR GLIDERS, AND GUINEA PIGS (U.S. CLS. 1 AND 46).

FIRST USE 12-0-2006; IN COMMERCE 12-0-2006.

CLASS 31—(Continued).

3,400,076. SHANGHAI PEIDI BRAND INT'L TRADE CO., LTD., SHANGHAI, CHINA. SN 78-941,179. PUB. 4-10-2007, FILED 7-31-2006.



THE MARK CONSISTS OF A STYLIZED DESIGN OF A DOG.
 FOR PET TOYS IN THE NATURE OF EDIBLE PET CHEWS; FOOD AND TREATS FOR PETS, INCLUDING DOGS, CATS, BIRDS, FISH, REPTILES, HORSES, HAMSTERS, GERBILS, FERRETS, RABBITS, SUGAR GLIDERS AND GUINEA PIGS (U.S. CLS. 1 AND 46).
 FIRST USE 12-0-2006; IN COMMERCE 12-0-2006.

3,400,167. LA HIGUERA S.A., SAN FELIPE, CHILE. SN 78-965,283. PUB. 9-18-2007, FILED 8-31-2006.



PRIORITY CLAIMED UNDER SEC. 44(D) ON CHILE APPLICATION NO. 738,677, FILED 8-2-2006.
 THE FOREIGN WORDING IN THE MARK TRANSLATES INTO ENGLISH AS THE FIG TREE.
 FOR FRESH FRUIT, EXCLUDING FIGS (U.S. CLS. 1 AND 46).
 FIRST USE 6-0-2007; IN COMMERCE 6-0-2007.

CLASS 32—LIGHT BEVERAGES

CLASS 32—(Continued).

3,398,967. HURRICANE JUICE COMPANY, LLC, SARASOTA, FL. SN 77-002,155. PUB. 5-15-2007, FILED 9-19-2006.



THE MARK CONSISTS OF STYLIZED EQ OFFSET FROM EACH OTHER WITH THE WORDS THIRST EQUALIZER UNDER THE STYLIZED E.
 FOR FRUIT DRINKS; FRUIT-FLAVORED DRINKS; SPORTS DRINKS (U.S. CLS. 45, 46 AND 48).
 FIRST USE 1-10-2007; IN COMMERCE 1-10-2007.

3,398,977. UPLIFT NUTRITION, INC., ROY, UT. SN 77-005,227. PUB. 6-5-2007, FILED 9-22-2006.



THE MARK CONSISTS OF THE WORDS "ACTIVE UPLIFT" BORDERED BY A PAIR OF WINGS AND WITH A HALO ABOVE THE WORDING.
 FOR ENERGY DRINK MIXES (U.S. CLS. 45, 46 AND 48).
 FIRST USE 1-5-2007; IN COMMERCE 3-15-2007.

3,399,136. IZZE BEVERAGE CO., BOULDER, CO. SN 77-076,032. PUB. 5-22-2007, FILED 1-4-2007.

IZZE ESQUE

THE MARK CONSISTS OF STANDARD CHARACTERS WITHOUT CLAIM TO ANY PARTICULAR FONT, STYLE, SIZE, OR COLOR.
 OWNER OF U.S. REG. NO. 2,697,979.
 FOR LIGHT BEVERAGES, NAMELY, SOFT DRINKS, FRUIT JUICE DRINKS (U.S. CLS. 45, 46 AND 48).
 FIRST USE 5-1-2007; IN COMMERCE 5-1-2007.

CLASS 32—(Continued).

3,399,165. ULTIMA FITNESS SUPPLEMENTS, LLC, PLANO, TX. SN 77-090,790. PUB. 7-10-2007, FILED 1-25-2007.

CLASS 32—(Continued).

3,400,003. FOX, SANDY, STUDIO CITY, CA. AND LANG, LEX, STUDIO CITY, CA. SN 78-902,819. PUB. 3-6-2007, FILED 6-7-2006.

KÜL FUEL

GRATITUDE WATER

THE MARK CONSISTS OF STANDARD CHARACTERS WITHOUT CLAIM TO ANY PARTICULAR FONT, STYLE, SIZE, OR COLOR.

THE FOREIGN WORDING IN THE MARK TRANSLATES INTO ENGLISH AS COOL.

FOR SPORTS DRINKS (U.S. CLS. 45, 46 AND 48).
FIRST USE 10-15-2007; IN COMMERCE 11-1-2007.

THE MARK CONSISTS OF STANDARD CHARACTERS WITHOUT CLAIM TO ANY PARTICULAR FONT, STYLE, SIZE, OR COLOR.

NO CLAIM IS MADE TO THE EXCLUSIVE RIGHT TO USE "WATER", APART FROM THE MARK AS SHOWN.

FOR BOTTLED SPRING WATER AND FRUIT JUICES (U.S. CLS. 45, 46 AND 48).
FIRST USE 8-1-2007; IN COMMERCE 8-1-2007.

3,399,381. THE COCA-COLA COMPANY, ATLANTA, GA. SN 78-443,660. PUB. 6-14-2005, FILED 6-30-2004.

3,400,132. ORTEGA, ROLANDO, HEMSTEAD, NY. SN 78-957,883. PUB. 4-10-2007, FILED 8-22-2006.

SIMPLY GRAPEFRUIT

PAP

THE MARK CONSISTS OF STANDARD CHARACTERS WITHOUT CLAIM TO ANY PARTICULAR FONT, STYLE, SIZE, OR COLOR.

NO CLAIM IS MADE TO THE EXCLUSIVE RIGHT TO USE "GRAPEFRUIT", APART FROM THE MARK AS SHOWN.

FOR GRAPEFRUIT JUICE BEVERAGES CONSISTING OF WATER AND NON-CALORIC SWEETNERS, NOT FROM CONCENTRATE (U.S. CLS. 45, 46 AND 48).
FIRST USE 9-1-2007; IN COMMERCE 9-1-2007.

THE MARK CONSISTS OF STANDARD CHARACTERS WITHOUT CLAIM TO ANY PARTICULAR FONT, STYLE, SIZE, OR COLOR.

FOR SOFT DRINKS, NAMELY, CARBONATED SOFT DRINKS (U.S. CLS. 45, 46 AND 48).
FIRST USE 10-31-2006; IN COMMERCE 10-31-2006.

3,400,165. MEIJER, INC., GRAND RAPIDS, MI. SN 78-965,118. PUB. 4-17-2007, FILED 8-31-2006.

3,399,561. COASTAL PROMOTIONS, INC., WEST PALM BEACH, FL. SN 78-663,914. PUB. 12-26-2006, FILED 7-5-2005.

MEIJER FRUIT COOLERS

WILD OLIVE

THE MARK CONSISTS OF STANDARD CHARACTERS WITHOUT CLAIM TO ANY PARTICULAR FONT, STYLE, SIZE, OR COLOR.

OWNER OF U.S. REG. NOS. 1,192,121, 1,333,646, AND 2,261,210.

NO CLAIM IS MADE TO THE EXCLUSIVE RIGHT TO USE "FRUIT COOLERS", APART FROM THE MARK AS SHOWN.

FOR FRUIT JUICES; FRUIT-FLAVORED DRINKS (U.S. CLS. 45, 46 AND 48).
FIRST USE 5-12-2007; IN COMMERCE 5-12-2007.

THE MARK CONSISTS OF STANDARD CHARACTERS WITHOUT CLAIM TO ANY PARTICULAR FONT, STYLE, SIZE, OR COLOR.

FOR NON-ALCOHOLIC FRUIT FLAVORED COCKTAIL MIXES EXCLUDING MIXES FOR DIRTY MARTINI (U.S. CLS. 45, 46 AND 48).
FIRST USE 11-11-2005; IN COMMERCE 11-11-2005.

CLASS 33—WINES AND SPIRITS

CLASS 33—(Continued).

3,398,837. VARELA HERMANOS, S.A., CIUDAD DE PANAMA, PANAMA. SN 75-885,939. PUB. 4-17-2007, FILED 1-4-2000.

ABUELO

FOR RUM (U.S. CLS. 47 AND 49).
FIRST USE 12-31-1959; IN COMMERCE 12-31-1990.

3,398,851. MACKMYRA SVENSK WHISKY AB, SE-81832 VALBO, SWEDEN. SN 76-469,794. PUB. 6-10-2003, FILED 11-26-2002.

MACKMYRA SWEDISH WHISKY

NO CLAIM IS MADE TO THE EXCLUSIVE RIGHT TO USE "SWEDISH WHISKY", APART FROM THE MARK AS SHOWN.

FOR WHISKY (U.S. CLS. 47 AND 49).
FIRST USE 7-12-2006; IN COMMERCE 7-12-2006.

3,398,866. TEQUILA DON JULIO, S.A. DE C.V., ATOTONILCO EL ALTO, JALISCO, MEXICO. SN 76-543,415. PUB. 9-13-2005, FILED 9-8-2003.



THE MARK CONSISTS OF A THREE-DIMENSIONAL CONFIGURATION OF A BOTTLE FOR CONTAINING THE GOODS, SUCH BOTTLE FEATURING EMBOSSED DESIGNS OF PORTIONS OF STYLIZED AGAVE LEAVES.
FOR BEVERAGE ALCOHOL, NAMELY, DISTILLED SPIRITS (U.S. CLS. 47 AND 49).
FIRST USE 12-28-2001; IN COMMERCE 12-28-2001.

CLASS 33—(Continued).

3,398,884. H DE V, LLC, HOOD RIVER, OR. SN 76-604,924. PUB. 8-23-2005, FILED 7-30-2004.

CALIFORNIO

THE MARK CONSISTS OF STANDARD CHARACTERS WITHOUT CLAIM TO ANY PARTICULAR FONT, STYLE, SIZE, OR COLOR.

FOR WINE ORIGINATING IN CALIFORNIA (U.S. CLS. 47 AND 49).
FIRST USE 8-1-2007; IN COMMERCE 8-1-2007.

3,398,991. ERAL BRAVO S.A., MENDOZA, ARGENTINA. SN 77-008,292. PUB. 5-8-2007, FILED 9-27-2006.

ERALES

THE MARK CONSISTS OF STANDARD CHARACTERS WITHOUT CLAIM TO ANY PARTICULAR FONT, STYLE, SIZE, OR COLOR.

FOR WINES (U.S. CLS. 47 AND 49).
FIRST USE 10-17-2006; IN COMMERCE 10-17-2006.

3,399,004. TRIVENTO BODEGAS Y VINEDOS S.A., MAIPU MENDOZA, ARGENTINA. SN 77-013,617. PUB. 4-17-2007, FILED 10-4-2006.

AMADO SUR

THE MARK CONSISTS OF STANDARD CHARACTERS WITHOUT CLAIM TO ANY PARTICULAR FONT, STYLE, SIZE, OR COLOR.

THE FOREIGN WORDING IN THE MARK TRANSLATES INTO ENGLISH AS "BELOVED SOUTH".
FOR WINES (U.S. CLS. 47 AND 49).
FIRST USE 10-31-2006; IN COMMERCE 10-30-2007.

CLASS 33—(Continued).

3,399,128. PIEDMONT DISTILLERS, INC., MADISON, NC. SN 77-072,453. PUB. 8-21-2007, FILED 12-28-2006.

CLASS 33—(Continued).

3,399,292. KAUTZ VINEYARDS, INC, DBA IRONSTONE VINEYARDS, MURPHYS, CA. SN 77-159,285. PUB. 8-21-2007, FILED 4-18-2007.

MIDNIGHT MOON

FILL·MORE·WINE

THE MARK CONSISTS OF STANDARD CHARACTERS WITHOUT CLAIM TO ANY PARTICULAR FONT, STYLE, SIZE, OR COLOR.
NO CLAIM IS MADE TO THE EXCLUSIVE RIGHT TO USE "MOON", APART FROM THE MARK AS SHOWN.
FOR DISTILLED SPIRITS (U.S. CLS. 47 AND 49).
FIRST USE 5-7-2007; IN COMMERCE 5-7-2007.

THE MARK CONSISTS OF STANDARD CHARACTERS WITHOUT CLAIM TO ANY PARTICULAR FONT, STYLE, SIZE, OR COLOR.
FOR WINE (U.S. CLS. 47 AND 49).
FIRST USE 9-30-2007; IN COMMERCE 9-30-2007.

3,399,188. VEEV SPIRITS, LLC, BEVERLY HILLS, CA. SN 77-100,814. PUB. 7-10-2007, FILED 2-6-2007.

3,399,310. CATENA, ERNESTO, BUENOS AIRES, ARGENTINA. SN 78-232,071. PUB. 7-20-2004, FILED 3-31-2003.

FIND YOUR SPIRIT

VIÑA DE LOS PADRILLOS

THE MARK CONSISTS OF STANDARD CHARACTERS WITHOUT CLAIM TO ANY PARTICULAR FONT, STYLE, SIZE, OR COLOR.
FOR DISTILLED SPIRITS (U.S. CLS. 47 AND 49).
FIRST USE 4-22-2007; IN COMMERCE 4-22-2007.

OWNER OF ARGENTINA REG. NO. 1878983, DATED 7-19-2002, EXPIRES 7-19-2012.
THE MARK CONSISTS OF THE MARK AS PRESENTED WITHOUT ANY CLAIM AS TO SPECIAL FORM.
THE FOREIGN WORDING IN THE MARK TRANSLATES INTO ENGLISH AS "VINEYARD OF STALLIONS".
FOR WINES (U.S. CLS. 47 AND 49).
FIRST USE 6-0-2007; IN COMMERCE 10-0-2007.

3,399,269. LONDON GROUP, LLC, OLD WESTBURY, NY. SN 77-146,319. PUB. 10-16-2007, FILED 4-2-2007.

3,399,401. VINTWOOD INTERNATIONAL, LTD., HUNTINGTON, NY. SN 78-489,690. PUB. 1-31-2006, FILED 9-26-2004.

L'ESPRIT DE PARIS

GOLD LABEL

THE MARK CONSISTS OF STANDARD CHARACTERS WITHOUT CLAIM TO ANY PARTICULAR FONT, STYLE, SIZE, OR COLOR.
THE FOREIGN WORDING IN THE MARK TRANSLATES INTO ENGLISH AS THE SPIRIT OF PARIS.
FOR LIQUEURS (U.S. CLS. 47 AND 49).
FIRST USE 5-2-2007; IN COMMERCE 5-23-2007.

THE MARK CONSISTS OF STANDARD CHARACTERS WITHOUT CLAIM TO ANY PARTICULAR FONT, STYLE, SIZE, OR COLOR.
FOR WINE (U.S. CLS. 47 AND 49).
FIRST USE 9-26-2007; IN COMMERCE 9-26-2007.

CLASS 33—(Continued).

3,399,511. ALLIED MANAGEMENT, INC., LIVINGSTON, NJ.
SN 78-611,298. PUB. 7-24-2007, FILED 4-18-2005.

TAXI CAB

THE MARK CONSISTS OF STANDARD CHARACTERS
WITHOUT CLAIM TO ANY PARTICULAR FONT, STYLE,
SIZE, OR COLOR.
FOR WINE (U.S. CLS. 47 AND 49).
FIRST USE 11-10-2006; IN COMMERCE 11-10-2006.

3,399,580. PALM BAY IMPORTS, INC., PORT WASHING-
TON, NY. SN 78-676,552. PUB. 11-7-2006, FILED 7-22-2005.

PETIT BISTRO

THE MARK CONSISTS OF STANDARD CHARACTERS
WITHOUT CLAIM TO ANY PARTICULAR FONT, STYLE,
SIZE, OR COLOR.
THE ENGLISH TRANSLATION OF THE WORDING
"PETIT BISTRO" IN THE MARK IS SMALL CAFÉ.
FOR ALCOHOLIC BEVERAGES, NAMELY, WINE
(U.S. CLS. 47 AND 49).
FIRST USE 5-17-2006; IN COMMERCE 5-17-2006.

3,399,627. DIVINE VODKA, LLC, BARODA, MI. SN 78-
720,473. PUB. 6-20-2006, FILED 9-26-2005.

"THE WINE DRINKER'S VODKA"

THE MARK CONSISTS OF STANDARD CHARACTERS
WITHOUT CLAIM TO ANY PARTICULAR FONT, STYLE,
SIZE, OR COLOR.
NO CLAIM IS MADE TO THE EXCLUSIVE RIGHT TO
USE "VODKA", APART FROM THE MARK AS SHOWN.
FOR VODKA (U.S. CLS. 47 AND 49).
FIRST USE 10-3-2006; IN COMMERCE 10-3-2006.

3,399,658. SHOPPERS VILLAGE LIQUORS, LLC, LEXING-
TON, KY. SN 78-745,129. PUB. 8-1-2006, FILED 11-2-2005.

Parrot Mountain

CLASS 33—(Continued).

THE MARK CONSISTS OF STANDARD CHARACTERS
WITHOUT CLAIM TO ANY PARTICULAR FONT, STYLE,
SIZE, OR COLOR.
FOR WINE (U.S. CLS. 47 AND 49).
FIRST USE 11-1-2007; IN COMMERCE 11-1-2007.

3,399,683. LA RIOJANA COOPERATIVA VITIVINIFRUTICO-
LA DE LA RIOJA LIMITADA, CHILECITO, LA RIOJA,
ARGENTINA. SN 78-756,184. PUB. 8-1-2006, FILED 11-17-
2005.



NO CLAIM IS MADE TO THE EXCLUSIVE RIGHT TO
USE "ARGENTINA", APART FROM THE MARK AS
SHOWN.
THE MARK CONSISTS OF A POLO PLAYER MOUNTED
ON HORSE SURROUNDED BY A CIRCLE WITH THE
WORDING "RAZA ARGENTINA" CONTAINED INSIDE
THE CIRCLE BORDER.
THE FOREIGN WORDING IN THE MARK TRANSLATES
INTO ENGLISH AS "RACE ARGENTINE".
FOR WINES (U.S. CLS. 47 AND 49).
FIRST USE 10-31-2005; IN COMMERCE 5-31-2006.

3,399,711. PROVINA, INCORPORATED, SAN JOSE, CA. SN
78-766,780. PUB. 8-8-2006, FILED 12-5-2005.

WinePod

THE MARK CONSISTS OF STANDARD CHARACTERS
WITHOUT CLAIM TO ANY PARTICULAR FONT, STYLE,
SIZE, OR COLOR.
NO CLAIM IS MADE TO THE EXCLUSIVE RIGHT TO
USE "WINE", APART FROM THE MARK AS SHOWN.
FOR KITS FOR MAKING WINE (U.S. CLS. 47 AND 49).
FIRST USE 1-15-2006; IN COMMERCE 2-18-2006.

CLASS 33—(Continued).

3,399,774. Z & U SPIRITUOSEN MARKETING GMBH, A-1190 VIENNA, AUSTRIA. SN 78-793,274. PUB. 3-20-2007, FILED 1-17-2006.



OWNER OF U.S. REG. NOS. 1,493,429 AND 3,142,303. NO CLAIM IS MADE TO THE EXCLUSIVE RIGHT TO USE "IMPORTED", "SINCE 1790", "HUNGARIAN HERB LIQUEUR ESTABLISHED IN 1790", AND "750 ML LIQUEUR 35% ALC. BY VOL.", APART FROM THE MARK AS SHOWN.

THE COLOR(S) BLACK, RED, GREEN, GOLD AND WHITE IS/ARE CLAIMED AS A FEATURE OF THE MARK. THE COLOR BLACK APPEARS IN THE DEPICTION OF THE THREE-DIMENSIONAL BOTTLE DESIGN, THE SHADING INSIDE THE CREST, THE NUMBERS "1790", THE CENTER OF THE LETTER "A" IN THE WHITE WORDING "ZWACK", AND THE WORDING "HUNGARIAN HERB LIQUEUR ESTABLISHED IN 1790". THE COLOR WHITE APPEARS ON THE OUTSIDE BORDER OF THE RED CIRCLE, THE OUTSIDE BORDER OF THE CROSS IN THE CIRCLE, AND IN THE WORDING "IMPORTED IMPORTED" "ZWACK", "SINCE 1790", AND "750 ML LIQUEUR 35% ALC. BY VOL.". THE COLOR GOLD APPEARS ON THE DEPICTION OF THE CROSS AT THE CENTER OF THE RED CIRCLE, THE HERALDIC LIONS, CROWN, CREST OUTLINE, LETTER "Z", AND THE WORDING "ZWACK" IN THE DESIGN OF THE LIONS AND THE CREST LOCATED ON THE BOTTLE NECK. THE COLOR RED APPEARS AT THE CLOSURE OF THE BOTTLE, ON THE DEPICTION OF THE CIRCLE SURROUNDING THE CROSS, AND IN THE THREE-DIMENSIONAL SHADING OF THE CROSS IN THE CENTER OF THE CIRCLE. THE COLOR GREEN APPEARS ON THE DEPICTION OF THE BOTTLENECK BELOW THE RED CLOSURE. THE THREE DIMENSIONAL MARK CONSISTS OF A BOTTLE IN BLACK WITH RED CLOSURE AND THE GOLD CROSS WITH WHITE BORDERS IN THE CENTER OF THE RED CIRCLE WITH WHITE BORDERS.

THE MARK CONSISTS OF A THREE-DIMENSIONAL BOTTLE DESIGN CONTAINING A DESIGN OF THE LETTER "Z" WITHIN A CREST THAT HAS AN OPEN TOP CROWN OVER IT, A BANNER UNDER IT, AND ONE HERALDIC LION ON THE RIGHT AND LEFT OF THE CREST. THE MARK CONSISTS OF THE WORDING "1790 ZWACK IMPORTED IMPORTED", "ZWACK", "SINCE 1790", "HUNGARIAN HERB LIQUEUR ESTABLISHED IN 1790", AND "750 ML LIQUEUR 35% ALC. BY VOL.".

FOR ALCOHOLIC BEVERAGES, NAMELY, DISTILLED SPIRITS, AND LIQUEURS (U.S. CLS. 47 AND 49).

FIRST USE 3-31-2006; IN COMMERCE 3-31-2006.

CLASS 33—(Continued).

3,399,843. "WHITE GOLD", LLC, MOSCOW, RUSSIAN FED.. SN 78-817,190. PUB. 5-22-2007, FILED 2-17-2006.

WHITE GOLD

THE MARK CONSISTS OF STANDARD CHARACTERS WITHOUT CLAIM TO ANY PARTICULAR FONT, STYLE, SIZE, OR COLOR.

FOR APERITIFS; ORAK; BRANDY; WINE; WHISKEY; GIN; VODKA; PREPARED ALCOHOLIC COCKTAILS; LIQUEURS; ALCOHOLIC BEVERAGES, NAMELY, ALCOHOLIC COFFEE-BASED BEVERAGE; ALCOHOLIC TEA-BASED BEVERAGE; ALCOHOLIC PUNCH; CALVADOS; CHAMPAGNE; COGNAC; CURACAO; HERB LIQUEURS; OUZO; SCHNAPPS; TEQUILA; ALCOHOLIC BEVERAGES CONTAINING FRUIT; DISTILLED SPIRITS; MEAD; PEPPERMINT LIQUEURS; ALCOHOLIC BITTERS; RUM; SAKE; HARD CIDER; RICE ALCOHOL (U.S. CLS. 47 AND 49).

FIRST USE 8-0-2005; IN COMMERCE 8-0-2005.

3,399,844. "WHITE GOLD", LLC, MOSCOW, RUSSIAN FED.. SN 78-817,194. PUB. 5-22-2007, FILED 2-17-2006.



THE COLOR(S) THREE SHADES OF GOLD, BLUE AND WHITE IS/ARE CLAIMED AS A FEATURE OF THE MARK.

THE MARK CONSISTS OF A STYLIZED SHAPE WITH A BACKGROUND OF A FIRST SHADE OF "GOLD", A BLUE TRIM LINE THEREWITHIN, AN INNER OUTLINE OF A SECOND SHADE OF "GOLD", AND AN INNER FIELD OF A THIRD SHADE OF "GOLD", WITH THE WORDS "WHITE GOLD" THEREIN IN "WHITE."

FOR APERITIFS; ORAK; BRANDY; WINE; WHISKEY; GIN; VODKA; PREPARED ALCOHOLIC COCKTAILS; LIQUEURS; ALCOHOLIC BEVERAGES, NAMELY, ALCOHOLIC COFFEE-BASED BEVERAGE; ALCOHOLIC TEA-BASED BEVERAGE; ALCOHOLIC PUNCH; CALVADOS; CHAMPAGNE; COGNAC; CURACAO; HERB LIQUEURS; OUZO; SCHNAPPS; TEQUILA; ALCOHOLIC BEVERAGES CONTAINING FRUIT; DISTILLED SPIRITS; MEAD; PEPPERMINT LIQUEURS; ALCOHOLIC BITTERS; RUM; SAKE; HARD CIDER; RICE ALCOHOL (U.S. CLS. 47 AND 49).

FIRST USE 8-0-2005; IN COMMERCE 8-0-2005.

CLASS 33—(Continued).

3,399,875. ONE TRUE VINE, LLC, ST. HELENA, CA. SN 78-830,337. PUB. 9-5-2006, FILED 3-6-2006.

LAYER CAKE

THE MARK CONSISTS OF STANDARD CHARACTERS WITHOUT CLAIM TO ANY PARTICULAR FONT, STYLE, SIZE, OR COLOR.

FOR WHITE WINE, RED WINE (U.S. CLS. 47 AND 49).
FIRST USE 7-0-2006; IN COMMERCE 7-0-2006.



3,399,909. PHILIPS, DANIEL, OXNARD, CA. SN 78-844,913. PUB. 3-27-2007, FILED 3-23-2006.

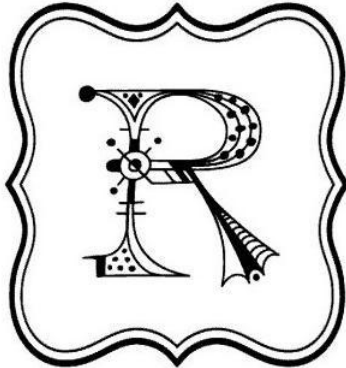

THE MARK CONSISTS OF A STYLIZED LETTER "R".
FOR WINE (U.S. CLS. 47 AND 49).
FIRST USE 12-12-2007; IN COMMERCE 12-12-2007.



3,399,963. GOLDRIDGEPINOT.COM LLC, SEBASTOPOL, CA. SN 78-874,840. PUB. 12-12-2006, FILED 5-2-2006.

WILLIAM WESLEY

THE MARK CONSISTS OF STANDARD CHARACTERS WITHOUT CLAIM TO ANY PARTICULAR FONT, STYLE, SIZE, OR COLOR.

"WILLIAM WESLEY" DOES NOT IDENTIFY A LIVING INDIVIDUAL.

FOR WINE (U.S. CLS. 47 AND 49).
FIRST USE 5-0-2007; IN COMMERCE 5-0-2007.

CLASS 33—(Continued).

3,399,996. CAP VISTALBA SOCIEDAD ANONIMA, MENDOZA, ARGENTINA. SN 78-899,113. PUB. 7-31-2007, FILED 6-2-2006.

TOMERO

THE MARK CONSISTS OF STANDARD CHARACTERS WITHOUT CLAIM TO ANY PARTICULAR FONT, STYLE, SIZE, OR COLOR.

FOR ALCOHOLIC BEVERAGES, NAMELY, WINES (U.S. CLS. 47 AND 49).
FIRST USE 4-30-2006; IN COMMERCE 6-30-2006.



3,400,024. TRIVENTO BODEGAS Y VINEDOS S.A., MENDOZA, ARGENTINA. SN 78-916,303. PUB. 4-17-2007, FILED 6-25-2006.

PAMPAS DEL SUR

THE MARK CONSISTS OF STANDARD CHARACTERS WITHOUT CLAIM TO ANY PARTICULAR FONT, STYLE, SIZE, OR COLOR.

"THE FOREIGN WORDING IN THE MARK TRANSLATES INTO ENGLISH AS OF THE SOUTH."

FOR WINE (U.S. CLS. 47 AND 49).
FIRST USE 12-31-2002; IN COMMERCE 10-30-2007.



3,400,065. JACKSON WINE ESTATES INTERNATIONAL LIMITED, COUNTY DUBLIN, IRELAND. SN 78-937,223. PUB. 3-6-2007, FILED 7-25-2006.

BENVOLIO

THE MARK CONSISTS OF STANDARD CHARACTERS WITHOUT CLAIM TO ANY PARTICULAR FONT, STYLE, SIZE, OR COLOR.

FOR WINE (U.S. CLS. 47 AND 49).
FIRST USE 2-7-2007; IN COMMERCE 2-12-2007.

CLASS 33—(Continued).

3,400,070. LENBRIDGE FORGE PTY. LTD., COLDSTREAM, AUSTRALIA. SN 78-939,085. PUB. 8-14-2007, FILED 7-27-2006.



FOR WINES, BOTTLED TABLE WINES (U.S. CLS. 47 AND 49).
FIRST USE 12-31-2006; IN COMMERCE 12-31-2006.

3,400,082. DIVAS UNCORKED, INC., MILTON, MA. SN 78-944,268. PUB. 3-27-2007, FILED 8-3-2006.



FOR WINE (U.S. CLS. 47 AND 49).
FIRST USE 8-30-2006; IN COMMERCE 9-0-2006.

3,400,169. HARRIS, JEFFREY P., HEALDSBURG, CA. SN 78-965,570. PUB. 4-24-2007, FILED 8-31-2006.

BEDARRA VINEYARDS

THE MARK CONSISTS OF STANDARD CHARACTERS WITHOUT CLAIM TO ANY PARTICULAR FONT, STYLE, SIZE, OR COLOR.

NO CLAIM IS MADE TO THE EXCLUSIVE RIGHT TO USE "VINEYARDS", APART FROM THE MARK AS SHOWN.

FOR WINES (U.S. CLS. 47 AND 49).
FIRST USE 10-13-2007; IN COMMERCE 10-24-2007.

CLASS 33—(Continued).

3,400,190. SAZERAC COMPANY, INC., NEW ORLEANS, LA. SN 78-970,747. PUB. 4-24-2007, FILED 9-9-2006.

CHARTER COUNTRY

THE MARK CONSISTS OF STANDARD CHARACTERS WITHOUT CLAIM TO ANY PARTICULAR FONT, STYLE, SIZE, OR COLOR.

OWNER OF U.S. REG. NOS. 1,309,275 AND 1,825,377.
FOR ALCOHOLIC BEVERAGES, NAMELY, WHISKEY (U.S. CLS. 47 AND 49).

FIRST USE 9-0-2004; IN COMMERCE 9-0-2004.

CLASS 34—SMOKERS' ARTICLES

3,399,368. FAMOUS SMOKE SHOP-PA, INC., EASTON, PA. SN 78-388,975. PUB. 9-6-2005, FILED 3-23-2004.

CRUZ REAL

THE MARK CONSISTS OF STANDARD CHARACTERS WITHOUT CLAIM TO ANY PARTICULAR FONT, STYLE, SIZE, OR COLOR.

THE FOREIGN WORDING IN THE MARK TRANSLATES INTO ENGLISH AS "REAL CROSS".

FOR CIGARS (U.S. CLS. 2, 8, 9 AND 17).
FIRST USE 11-16-2007; IN COMMERCE 11-16-2007.

CLASS 34—(Continued).

3,399,412. K. HANSOTIA & CO., INC., MIAMI, FL. SN 78-503,555. PUB. 10-25-2005, FILED 10-21-2004.

**SHANGHAI TRADING
CO.**

THE MARK CONSISTS OF STANDARD CHARACTERS WITHOUT CLAIM TO ANY PARTICULAR FONT, STYLE, SIZE, OR COLOR.

NO CLAIM IS MADE TO THE EXCLUSIVE RIGHT TO USE "TRADING CO.", APART FROM THE MARK AS SHOWN.

FOR TOBACCO, CIGARETTES, CIGARS, ARTICLES FOR SMOKERS NOT OF PRECIOUS METAL, NAMELY, CIGARETTE LIGHTERS, CIGARETTE CASES, CIGAR CASES, CIGARETTE HOLDERS, AND CIGAR HOLDERS (U.S. CLS. 2, 8, 9 AND 17).

FIRST USE 8-2-2004; IN COMMERCE 9-1-2004.

SERVICE MARKS**CLASS 35—ADVERTISING AND BUSINESS**

3,398,846. LEE, DAVID P., APO, NJ. SN 76-352,312. PUB. 8-10-2004, FILED 12-26-2001.

CHANGEWIRELESS.COM

FOR DIRECT MARKETING ADVERTISING FOR OTHERS, NAMELY, PROVIDING WIRELESS CELLULAR TELEPHONE SUBSCRIPTION MARKETING SERVICES VIA THE GLOBAL COMPUTER NETWORK (U.S. CLS. 100, 101 AND 102).

FIRST USE 10-27-2007; IN COMMERCE 10-27-2007.

3,398,915. LONG, ANNE, GREAT FALLS, VA. SN 76-653,280. PUB. 3-13-2007, FILED 1-12-2006.



NO CLAIM IS MADE TO THE EXCLUSIVE RIGHT TO USE "PARKING & TRANSPORTATION, CONVENIENCE AND EXCELLENCE", APART FROM THE MARK AS

CLASS 35—(Continued).

SHOWN.

THE MARK CONSISTS, IN PART, OF A DESIGN OF A STYLIZED SUN WITHIN A SHADED CIRCLE.

FOR BUSINESS OPERATION, BUSINESS ADMINISTRATION AND OFFICE FUNCTIONS; PROCUREMENT, NAMELY, PURCHASING OFFICE REQUISITES FOR INDUSTRIAL AND COMMERCIAL ENTERPRISES; RENTAL OF OFFICE EQUIPMENT FOR INDUSTRIAL AND COMMERCIAL ENTERPRISES; BUSINESS MANAGEMENT CONSULTING SERVICES RELATING TO SUPPLY CHAIN SOLUTIONS FOR INDUSTRIAL AND COMMERCIAL ENTERPRISES IN THE FIELD OF OFFICE REQUISITES (U.S. CLS. 100, 101 AND 102).

FIRST USE 4-1-2006; IN COMMERCE 4-1-2006.

3,398,917. PARAMOUNT AUTOMOTIVE GROUP, LLC, DBA TRUCK HEAVEN USA, LONGWOOD, FL. SN 76-653,662. PUB. 3-27-2007, FILED 1-19-2006.



NO CLAIM IS MADE TO THE EXCLUSIVE RIGHT TO USE "TRUCK," "USA," AND "THE DESIGN OF THE TRUCK", APART FROM THE MARK AS SHOWN.

FOR AUTOMOBILE DEALERSHIPS FEATURING TRUCKS AND AUTOMOBILES (U.S. CLS. 100, 101 AND 102).

FIRST USE 2-0-2006; IN COMMERCE 2-0-2006.

3,398,924. AELERA CONSULTING CORPORATION, ALPHARETTA, GA. SN 76-660,317. PUB. 3-20-2007, FILED 5-19-2006.

MIGHTYDECK

THE MARK CONSISTS OF STANDARD CHARACTERS WITHOUT CLAIM TO ANY PARTICULAR FONT, STYLE, SIZE, OR COLOR.

FOR CONSULTING AND PROVIDING INFORMATION IN THE FIELDS OF MARKETING, BUSINESS OPERATIONS, BUSINESS DEVELOPMENT, BUSINESS NETWORKING AND BUSINESS COLLABORATION; INFORMATION GATHERING FOR BUSINESS AND TRADE PRACTICES AND ANALYSIS THEREOF (U.S. CLS. 100, 101 AND 102).

FIRST USE 6-12-2007; IN COMMERCE 6-12-2007.

CLASS 35—(Continued).

3,398,931. VERTASOURCE, LLC, BUFFALO, NY. SN 76-664,057. PUB. 4-24-2007, FILED 8-3-2006.

PHILADELPHIAATHOME

THE MARK CONSISTS OF STANDARD CHARACTERS WITHOUT CLAIM TO ANY PARTICULAR FONT, STYLE, SIZE, OR COLOR.

FOR PROVIDING ADVERTISING AND PUBLICITY SERVICES FOR OTHERS FEATURING INFORMATION ABOUT THE GOODS, SERVICES, EVENTS, ACTIVITIES, AND ATTRACTIONS OF OTHERS, IN A PARTICULAR GEOGRAPHIC REGION, NAMELY, PHILADELPHIA, PENNSYLVANIA, VIA A WEBSITE ON A GLOBAL COMPUTER NETWORK (U.S. CLS. 100, 101 AND 102).
FIRST USE 8-20-2006; IN COMMERCE 8-20-2006.

3,398,932. VERTASOURCE, LLC, BUFFALO, NY. SN 76-664,059. PUB. 5-1-2007, FILED 8-3-2006.

CHICAGOATHOME

THE MARK CONSISTS OF STANDARD CHARACTERS WITHOUT CLAIM TO ANY PARTICULAR FONT, STYLE, SIZE, OR COLOR.

FOR PROVIDING ADVERTISING AND PUBLICITY SERVICES FOR OTHERS FEATURING INFORMATION ABOUT THE GOODS, SERVICES, EVENTS, ACTIVITIES, AND ATTRACTIONS OF OTHERS, IN A PARTICULAR GEOGRAPHIC REGION, NAMELY, CHICAGO, ILLINOIS, VIA A WEBSITE ON A GLOBAL COMPUTER NETWORK (U.S. CLS. 100, 101 AND 102).
FIRST USE 7-17-2006; IN COMMERCE 7-17-2006.

3,398,936. HAGUE, GREGORY D., PARADISE VALLEY, AZ. SN 76-664,724. PUB. 7-10-2007, FILED 8-16-2006.

BUYER HUNT

THE MARK CONSISTS OF STANDARD CHARACTERS WITHOUT CLAIM TO ANY PARTICULAR FONT, STYLE, SIZE, OR COLOR.

NO CLAIM IS MADE TO THE EXCLUSIVE RIGHT TO USE "BUYER", APART FROM THE MARK AS SHOWN.

FOR DATA COMPILING, NAMELY, COMPILING A LISTING OF BUYER'S REQUIREMENTS WHICH IS THEN MADE AVAILABLE TO POTENTIAL PROPERTY SELLERS (U.S. CLS. 100, 101 AND 102).
FIRST USE 10-6-2007; IN COMMERCE 10-6-2007.

CLASS 35—(Continued).

3,398,937. THE TRUSTEES OF THE RODNEY A. HAMILTON LIVING TRUST A CALIFORNIA TRUST, COMPRISING RODNEY A. HAMILTON, A UNITED STATES C, LOS ANGELES, CA. SN 76-664,844. PUB. 7-31-2007, FILED 8-18-2006.

NoBootLeg

THE MARK CONSISTS OF STANDARD CHARACTERS WITHOUT CLAIM TO ANY PARTICULAR FONT, STYLE, SIZE, OR COLOR.

FOR PROMOTING THE GOODS AND SERVICES OF OTHERS THROUGH ON-LINE ORDERING AND CATALOGING OF THOSE GOODS AND SERVICES, NAMELY, GENERAL MERCHANDISE, FINANCE, MUSIC RECORDINGS, FOOD, MOVIES, DVD'S, MULTI MEDIA PRODUCTS AND COMPUTER SOFTWARE (U.S. CLS. 100, 101 AND 102).
FIRST USE 10-30-2007; IN COMMERCE 10-30-2007.

3,399,003. POOLPARTY.COM, LLC, CHICAGO, IL. SN 77-013,410. PUB. 7-17-2007, FILED 10-4-2006.



FOR ON-LINE ADVERTISING AND MARKETING SERVICES FEATURING FAMOUS QUOTES IN THE FIELD OF ENTERTAINMENT (U.S. CLS. 100, 101 AND 102).
FIRST USE 5-1-2006; IN COMMERCE 9-1-2006.

CLASS 35—(Continued).

3,399,015. ROBERT E. HOVEY JR., CHICAGO, IL. AND JAMES F. DAVIS II, CHICAGO, IL. SN 77-020,532. PUB. 8-28-2007, FILED 10-13-2006.



NO CLAIM IS MADE TO THE EXCLUSIVE RIGHT TO USE "EVENTS", APART FROM THE MARK AS SHOWN.

THE COLOR(S) BLUE, WHITE, AND SILVER IS/ARE CLAIMED AS A FEATURE OF THE MARK.

THE MARK CONSISTS OF A CURVED BLUE ROAD WITH WHITE DASHES ACCENTED BY A SILVER LINING, TO THE RIGHT OF WHICH APPEAR THE WORDS "RUSH HOUR" IN BLUE AND UNDERLINED IN BLUE, BELOW WHICH APPEARS THE WORD "EVENTS" IN SILVER.

FOR ADVERTISING AGENCIES, NAMELY, PROMOTING THE SERVICES OF CAR DEALERSHIPS THROUGH THE DISTRIBUTION OF PRINTED AND AUDIO PROMOTIONAL MATERIALS AND BY RENDERING SALES PROMOTION ADVICE (U.S. CLS. 100, 101 AND 102).

FIRST USE 4-30-2006; IN COMMERCE 4-30-2006.

3,399,017. CHEMICAL LIGHT, INC., VERNON HILLS, IL. SN 77-021,706. PUB. 5-22-2007, FILED 10-16-2006.

BRIGHTER PROMOTIONS

THE MARK CONSISTS OF STANDARD CHARACTERS WITHOUT CLAIM TO ANY PARTICULAR FONT, STYLE, SIZE, OR COLOR.

NO CLAIM IS MADE TO THE EXCLUSIVE RIGHT TO USE "PROMOTIONS", APART FROM THE MARK AS SHOWN.

FOR PROMOTION AND MARKETING SERVICES AND RELATED CONSULTING; PROVIDING PROMOTIONAL AND MERCHANDISING MATERIALS FOR OTHERS (U.S. CLS. 100, 101 AND 102).

FIRST USE 9-10-2007; IN COMMERCE 9-10-2007.

3,399,019. NECODO, LLC, SEATTLE, WA. SN 77-022,109. PUB. 5-22-2007, FILED 10-16-2006.

NECODO

THE MARK CONSISTS OF STANDARD CHARACTERS WITHOUT CLAIM TO ANY PARTICULAR FONT, STYLE, SIZE, OR COLOR.

FOR ON-LINE RETAIL STORE SERVICES FEATURING DOWNLOADABLE PRE-RECORDED MUSIC AND VIDEO (U.S. CLS. 100, 101 AND 102).

FIRST USE 3-20-2007; IN COMMERCE 3-20-2007.

CLASS 35—(Continued).

3,399,036. LEHMANN MANAGEMENT CORP., CINCINNATI, OH. SN 77-030,667. PUB. 6-12-2007, FILED 10-27-2006.

MODULAR DEPOT

THE MARK CONSISTS OF STANDARD CHARACTERS WITHOUT CLAIM TO ANY PARTICULAR FONT, STYLE, SIZE, OR COLOR.

NO CLAIM IS MADE TO THE EXCLUSIVE RIGHT TO USE "DEPOT", APART FROM THE MARK AS SHOWN.

FOR RETAIL AUTOMOBILE PARTS AND ACCESSORIES STORES (U.S. CLS. 100, 101 AND 102).

FIRST USE 4-25-2003; IN COMMERCE 4-25-2003.

3,399,051. FREUD, ALIZA, MAPLEWOOD, NJ. SN 77-036,870. PUB. 6-5-2007, FILED 11-3-2006.

SheSpeaks

THE MARK CONSISTS OF STANDARD CHARACTERS WITHOUT CLAIM TO ANY PARTICULAR FONT, STYLE, SIZE, OR COLOR.

FOR ADVERTISING AND MARKETING; ADVERTISING SERVICES, NAMELY, PROMOTING AND MARKETING THE GOODS AND SERVICES OF OTHERS THROUGH ALL PUBLIC COMMUNICATION MEANS; ADVERTISING, MARKETING AND PROMOTION SERVICES; ADVICE IN THE FIELD OF BUSINESS MANAGEMENT AND MARKETING; ARRANGING AND CONDUCTING MARKETING PROMOTIONAL EVENTS FOR OTHERS; BUSINESS ADVICE AND ANALYSIS OF MARKETS; BUSINESS CONSULTATION AND MANAGEMENT REGARDING MARKETING ACTIVITIES AND LAUNCHING OF NEW PRODUCTS; BUSINESS MANAGEMENT CONSULTING WITH RELATION TO STRATEGY, MARKETING, PRODUCTION, PERSONNEL AND RETAIL SALE MATTERS; BUSINESS MARKETING CONSULTING SERVICES; BUSINESS MARKETING SERVICES; BUSINESS RESEARCH; BUSINESS RESEARCH AND SURVEYS; BUSINESS RESEARCH CONSULTATION; BUSINESS RESEARCH USING FOCUS GROUPS; COMMERCIAL INFORMATION AGENCIES; CONDUCTING BUSINESS AND MARKET RESEARCH SURVEYS; CONDUCTING BUSINESS RESEARCH AND SURVEYS; CONDUCTING MARKETING STUDIES; CONDUCTING ON-LINE BUSINESS MANAGEMENT RESEARCH SURVEYS; CONSULTATION SERVICES IN THE FIELD OF COMPANY, BUSINESS SECTOR AND INDUSTRY DATA AND RESEARCH; CONSUMER RESEARCH; COOPERATIVE ADVERTISING AND MARKETING; COOPERATIVE ADVERTISING AND MARKETING SERVICES BY WAY OF SOLICITATION, CUSTOMER SERVICE AND PROVIDING MARKETING INFORMATION VIA WEBSITES ON A GLOBAL COMPUTER NETWORK; CREATION OF MARKETING TOOLS DESIGNED TO INCREASE A CLIENT COMPANY'S KNOWLEDGE OF CUSTOMER NEEDS, AND ITS COMPETITORS' PRODUCTS AND SERVICES, PRICING, ADVERTISING STRATEGY AND SALES STRATEGY; DEVELOPMENT OF MARKETING STRATEGIES AND CONCEPTS; DIRECT MARKETING ADVERTISING FOR OTHERS; DIRECT MARKETING SERVICES; GENERAL BUSINESS MERCHANDISING SERVICES, NAMELY, MARKETING; IMPLEMENTA-

CLASS 35—(Continued).

TION AND FOLLOW-UP OF ADVICE IN THE FIELDS OF MARKETING; INFORMATION OR ENQUIRIES ON BUSINESS AND MARKETING; MARKET ANALYSIS; MARKET MANIPULATION, RESEARCH AND ANALYSIS, WHETHER OR NOT VIA THE INTERNET; MARKET OPINION POLLING STUDIES; MARKET REPORTS AND STUDIES; MARKET RESEARCH; MARKET RESEARCH CONSULTATION; MARKET RESEARCH SERVICES; MARKET RESEARCH STUDIES; MARKET SEGMENTATION CONSULTATION; MARKET STUDY AND ANALYSIS OF MARKET STUDIES; MARKETING CONSULTING; MARKETING PLAN DEVELOPMENT; MARKETING SERVICES, NAMELY PROVIDING INFORMATIONAL WEB PAGES DESIGNED TO GENERATE SALES TRAFFIC VIA HYPERLINKS TO OTHER WEB SITES; MEDIA PLANNING, NAMELY, ADVISING THE CLIENT ON THE CORRECT TIMES AND STATIONS TO ADVERTISE BASED ON MEDIA ANALYSIS OF THE MARKET FOR THAT MEDIA; MULTI-LEVEL MARKETING BUSINESS SERVICES; ON-LINE ADVERTISING AND MARKETING SERVICES; PROMOTING, ADVERTISING AND MARKETING OF THE ON-LINE WEBSITES OF OTHERS; PROMOTION AND MARKETING SERVICES AND RELATED CONSULTING; PROMOTION, ADVERTISING AND MARKETING OF ON-LINE WEBSITES; PROVIDING ADVERTISING, MARKETING AND PROMOTIONAL SERVICES, NAMELY, DEVELOPMENT OF ADVERTISING CAMPAIGNS FOR NEW PRODUCT DEVELOPMENT; PROVIDING BUSINESS MARKETING INFORMATION; PROVIDING MARKETING AND PROMOTION OF SPECIAL EVENTS; PROVIDING PROMOTIONAL MARKETING SERVICES TO BUSINESSES IN THE BROADBAND AND MEDIA INDUSTRIES; SHOPPING BY RESEARCHERS WHO POSE AS CUSTOMERS TO EVALUATE THE QUALITY OF SERVICE DELIVERED; STATISTICAL EVALUATIONS OF MARKETING DATA (U.S. CLS. 100, 101 AND 102).
FIRST USE 1-15-2007; IN COMMERCE 2-7-2007.

3,399,078. BEST WESTERN INTERNATIONAL, INC., PHOENIX, AZ. SN 77-049,242. PUB. 7-10-2007, FILED 11-21-2006.

KNOCK KNOCK

THE MARK CONSISTS OF STANDARD CHARACTERS WITHOUT CLAIM TO ANY PARTICULAR FONT, STYLE, SIZE, OR COLOR.

FOR PROVIDING CUSTOMER INFORMATION ABOUT HOTEL, MOTEL AND RESORT HOTEL RATES AND DISCOUNTS VIA A GLOBAL COMPUTER NETWORK (U.S. CLS. 100, 101 AND 102).
FIRST USE 4-9-2007; IN COMMERCE 4-9-2007.

CLASS 35—(Continued).

3,399,084. STONYFIELD FARM, INC., LONDONDERRY, NH. SN 77-052,203. PUB. 8-21-2007, FILED 11-28-2006.

CLIMATE COUNTS

THE MARK CONSISTS OF STANDARD CHARACTERS WITHOUT CLAIM TO ANY PARTICULAR FONT, STYLE, SIZE, OR COLOR.

NO CLAIM IS MADE TO THE EXCLUSIVE RIGHT TO USE "CLIMATE", APART FROM THE MARK AS SHOWN.

FOR PROMOTING PUBLIC AWARENESS OF CLIMATE CHANGE AND THE NEED TO REVERSE ITS DANGERS (U.S. CLS. 100, 101 AND 102).

FIRST USE 12-4-2006; IN COMMERCE 12-4-2006.

3,399,091. RAYMOND A. NUZZO, EAST HAVEN, CT. SN 77-057,935. PUB. 6-26-2007, FILED 12-6-2006.

DUKE AND DUSTY

THE MARK CONSISTS OF STANDARD CHARACTERS WITHOUT CLAIM TO ANY PARTICULAR FONT, STYLE, SIZE, OR COLOR.

THE NAME(S), PORTRAIT(S), AND/OR SIGNATURE(S) SHOWN IN THE MARK DOES NOT IDENTIFY A PARTICULAR LIVING INDIVIDUAL.

FOR ON-LINE ORDERING SERVICES FEATURING FICTION AND NON-FICTION BOOKS ABOUT ANIMALS; ON-LINE RETAIL STORE SERVICES FEATURING FICTION AND NON-FICTION BOOKS ABOUT ANIMALS (U.S. CLS. 100, 101 AND 102).

FIRST USE 6-30-2007; IN COMMERCE 6-30-2007.

3,399,112. TECHNICAL AID CORPORATION, DEDHAM, MA. SN 77-068,175. PUB. 6-19-2007, FILED 12-20-2006.

THINK AGILE WORKFORCE.

THE MARK CONSISTS OF STANDARD CHARACTERS WITHOUT CLAIM TO ANY PARTICULAR FONT, STYLE, SIZE, OR COLOR.

NO CLAIM IS MADE TO THE EXCLUSIVE RIGHT TO USE "WORKFORCE", APART FROM THE MARK AS SHOWN.

FOR EMPLOYMENT AGENCY AND PROVISION OF CONTRACT WORKER SERVICES (U.S. CLS. 100, 101 AND 102).

FIRST USE 9-1-2006; IN COMMERCE 9-1-2006.

CLASS 35—(Continued).

3,399,113. X, INC., DBA ONE STOP SHOP, CANOGA PARK, CA. SN 77-068,272. PUB. 7-10-2007, FILED 12-20-2006.

THE OFFICE CONSUMABLES
DIVISION FOR BUSY COMPANIES

THE MARK CONSISTS OF STANDARD CHARACTERS WITHOUT CLAIM TO ANY PARTICULAR FONT, STYLE, SIZE, OR COLOR.

FOR DISTRIBUTORSHIP IN THE FIELD OF OFFICE SUPPLIES, NAMELY, TONER AND TONER CARTRIDGES FOR PRINTERS, FACSIMILE, PHOTOCOPYING, AND OTHER IMAGE PRODUCING MACHINES, INK CARTRIDGES FOR PRINTERS, FACSIMILE, PHOTOCOPYING, AND OTHER IMAGE PRODUCING MACHINES, OFFICE FURNITURE, JANITORIAL AND SANITATION PRODUCTS AND DATA STORAGE MEDIA, NAMELY, FLASH MEMORY, OPTICAL TAPES, AND MAGNETIC TAPES (U.S. CLS. 100, 101 AND 102).

FIRST USE 1-1-2007; IN COMMERCE 1-1-2007.

3,399,118. BEAUTIFUL BRANDS INTERNATIONAL, INC., TULSA, OK. SN 77-069,004. PUB. 5-1-2007, FILED 12-21-2006.

BEAUTIFUL BRANDS

THE MARK CONSISTS OF STANDARD CHARACTERS WITHOUT CLAIM TO ANY PARTICULAR FONT, STYLE, SIZE, OR COLOR.

NO CLAIM IS MADE TO THE EXCLUSIVE RIGHT TO USE "BRANDS", APART FROM THE MARK AS SHOWN.

FOR CONCEPT AND BRAND DEVELOPMENT IN THE CAFE, RESTAURANT, FAST FOOD, AND PHYSICAL FITNESS INDUSTRIES (U.S. CLS. 100, 101 AND 102).

FIRST USE 9-1-2006; IN COMMERCE 9-1-2006.

CLASS 35—(Continued).

3,399,121. VCFO HOLDINGS, INC., AUSTIN, TX. SN 77-069,327. PUB. 5-1-2007, FILED 12-21-2006.

VCEO

THE MARK CONSISTS OF STANDARD CHARACTERS WITHOUT CLAIM TO ANY PARTICULAR FONT, STYLE, SIZE, OR COLOR.

FOR OUTSOURCED BUSINESS MANAGEMENT AND CONSULTATION; BUSINESS APPRAISAL; BUSINESS NETWORKING; OPERATION OF A BUSINESS FOR OTHERS, NAMELY, TECHNOLOGY COMPANIES; BUSINESS CONSULTATION, NAMELY, PROVIDING ADVICE AND INFORMATION REGARDING CREATING AND BUILDING A BUSINESS; BUSINESS CONSULTATION, NAMELY, PREPARATION AND ADVICE REGARDING BUSINESS PLANS; ADMINISTRATION AND/OR SUPERVISION OF A COMPANY'S BUSINESS AND/OR OFFICE OPERATIONS; BUSINESS SERVICES, NAMELY, NEGOTIATING FINANCING TERMS FOR OTHERS AND ASSISTING ENTREPRENEURS AND COMPANIES IN OBTAINING FINANCING AND IN OBTAINING BUSINESS PARTNERS (U.S. CLS. 100, 101 AND 102).

FIRST USE 11-16-2007; IN COMMERCE 11-16-2007.

3,399,146. HMSHOST CORPORATION, BETHESDA, MD. SN 77-081,716. PUB. 8-14-2007, FILED 1-12-2007.

Ciao

GOURMET MARKET

Fresh Salads • Gourmet Sandwiches • Premium Snacks

NO CLAIM IS MADE TO THE EXCLUSIVE RIGHT TO USE "GOURMET MARKET", "FRESH SALADS", "GOURMET SANDWICHES" AND "PREMIUM SNACKS", APART FROM THE MARK AS SHOWN.

THE WORD "CIAO" IS TRANSLATED AS "HELLO" AND "GOOD-BYE".

FOR FOOD KIOSK SERVICES; RETAIL STORE SERVICES FEATURING CONVENIENCE STORE ITEMS (U.S. CLS. 100, 101 AND 102).

FIRST USE 4-13-2007; IN COMMERCE 4-13-2007.

CLASS 35—(Continued).

3,399,147. FIRST NATIONAL BANK OF OMAHA, OMAHA, NE. SN 77-081,753. PUB. 8-28-2007, FILED 1-12-2007.

MAXIMUM REWARDS

THE MARK CONSISTS OF STANDARD CHARACTERS WITHOUT CLAIM TO ANY PARTICULAR FONT, STYLE, SIZE, OR COLOR.

NO CLAIM IS MADE TO THE EXCLUSIVE RIGHT TO USE "REWARDS", APART FROM THE MARK AS SHOWN.

FOR PROMOTING THE SALE OF CREDIT CARD ACCOUNTS THROUGH THE ADMINISTRATION OF INCENTIVE AWARD PROGRAMS (U.S. CLS. 100, 101 AND 102).

FIRST USE 4-15-2007; IN COMMERCE 4-15-2007.

3,399,148. REDUCE MY FEE, LLC, GREAT NECK, NY. SN 77-081,823. PUB. 8-28-2007, FILED 1-12-2007.

AdPerk

THE MARK CONSISTS OF STANDARD CHARACTERS WITHOUT CLAIM TO ANY PARTICULAR FONT, STYLE, SIZE, OR COLOR.

FOR PROMOTING THE GOODS AND SERVICES OF OTHERS BY DISTRIBUTING ADVERTISING MATERIALS THROUGH A VARIETY OF METHODS (U.S. CLS. 100, 101 AND 102).

FIRST USE 9-23-2006; IN COMMERCE 5-1-2007.

3,399,158. GRAY MANUFACTURING COMPANY, INC., ST. JOSEPH, MO. SN 77-088,032. PUB. 7-24-2007, FILED 1-22-2007.

INNOVATIVE SOLUTIONS

THE MARK CONSISTS OF STANDARD CHARACTERS WITHOUT CLAIM TO ANY PARTICULAR FONT, STYLE, SIZE, OR COLOR.

NO CLAIM IS MADE TO THE EXCLUSIVE RIGHT TO USE "SOLUTIONS", APART FROM THE MARK AS SHOWN.

FOR DEMONSTRATION OF PRODUCTS, NAMELY, PRODUCTS IN THE FIELD OF VEHICLE SERVICE EQUIPMENT AND VEHICLE REPAIR EQUIPMENT (U.S. CLS. 100, 101 AND 102).

FIRST USE 1-18-2008; IN COMMERCE 1-18-2008.

CLASS 35—(Continued).

3,399,168. AMERICAN COIN VAULT, INC, VALLEY STREAM, NY. SN 77-092,424. PUB. 7-10-2007, FILED 1-26-2007.

AUCTIONBLIP

THE MARK CONSISTS OF STANDARD CHARACTERS WITHOUT CLAIM TO ANY PARTICULAR FONT, STYLE, SIZE, OR COLOR.

FOR PROVIDING CUSTOMIZED INFORMATION CONCERNING AUCTIONS TO COLLECTORS AND OTHER BUYERS (U.S. CLS. 100, 101 AND 102).

FIRST USE 10-1-2007; IN COMMERCE 10-1-2007.

3,399,169. AMERICAN COIN VAULT, INC, VALLEY STREAM, NY. SN 77-092,469. PUB. 7-10-2007, FILED 1-26-2007.



THE COLOR(S) BLACK, RED, YELLOW, GREEN AND BLUE IS/ARE CLAIMED AS A FEATURE OF THE MARK.

THE MARK CONSISTS OF THE TERM AUCTIONBLIP, WITH THE LETTER "B" IN RED, THE LETTER "L" IN YELLOW, THE SECOND LETTER "I" IN GREEN, THE LETTER "P" IN BLUE AND THE WORD "AUCTION" IN BLACK.

FOR PROVIDING CUSTOMIZED INFORMATION CONCERNING AUCTIONS TO COLLECTORS AND OTHER BUYERS (U.S. CLS. 100, 101 AND 102).

FIRST USE 10-1-2007; IN COMMERCE 10-1-2007.

3,399,183. ALP NETWORKS LLC, KING OF PRUSSIA, PA. SN 77-100,091. PUB. 8-14-2007, FILED 2-6-2007.

GREENLINK

THE MARK CONSISTS OF STANDARD CHARACTERS WITHOUT CLAIM TO ANY PARTICULAR FONT, STYLE, SIZE, OR COLOR.

FOR CUSTOMER LOYALTY SERVICES AND CUSTOMER CLUB SERVICES, FOR COMMERCIAL, PROMOTIONAL AND/OR ADVERTISING PURPOSES (U.S. CLS. 100, 101 AND 102).

FIRST USE 5-1-2007; IN COMMERCE 5-1-2007.

CLASS 35—(Continued).

3,399,193. ARTHUR L. GRUEN, MD, INC., RANCHO SANTA FE, CA. SN 77-104,130. PUB. 8-7-2007, FILED 2-9-2007.



NO CLAIM IS MADE TO THE EXCLUSIVE RIGHT TO USE "HEALTH", APART FROM THE MARK AS SHOWN.

THE MARK CONSISTS OF A PUZZLE PIECE FOLLOWED BY AN UPPERCASE STYLIZED "E", AN UPPERCASE STYLIZED "A" AND THE WORD "HEALTH" IN ALL UPPERCASE LETTERS.

FOR BUSINESS MANAGEMENT, BILLING, AND BUSINESS MANAGEMENT CONSULTING SERVICES IN CONNECTION WITH THE FACILITATION OF ON-CALL SPECIALTY PHYSICIAN AND EMERGENCY PHYSICIAN SERVICES PROVIDED TO HOSPITALS AND OTHER HEALTHCARE FACILITIES (U.S. CLS. 100, 101 AND 102).

FIRST USE 2-28-2007; IN COMMERCE 3-26-2007.

3,399,201. THOMPSON & CO. OF TAMPA, INC., TAMPA, FL. SN 77-109,479. PUB. 6-26-2007, FILED 2-16-2007.

SHAMELESS BRIBE

THE MARK CONSISTS OF STANDARD CHARACTERS WITHOUT CLAIM TO ANY PARTICULAR FONT, STYLE, SIZE, OR COLOR.

FOR MAIL ORDER SERVICES FEATURING CIGARS (U.S. CLS. 100, 101 AND 102).

FIRST USE 7-1-2007; IN COMMERCE 7-1-2007.

CLASS 35—(Continued).

3,399,210. MAYBARD COMPANY, LLC, POWDER SPRINGS, GA. SN 77-112,019. PUB. 8-14-2007, FILED 2-20-2007.

Cute Shoes

THE MARK CONSISTS OF STANDARD CHARACTERS WITHOUT CLAIM TO ANY PARTICULAR FONT, STYLE, SIZE, OR COLOR.

NO CLAIM IS MADE TO THE EXCLUSIVE RIGHT TO USE "SHOES", APART FROM THE MARK AS SHOWN.

FOR RETAIL STORE SERVICES IN THE FIELD OF FOOTWEAR FOR WOMEN AND CHILDREN, AND FASHION ACCESSORIES SUCH AS PURSES, HANDBAGS, PANTYHOSE, SOCKS, HATS, SUNGLASSES, JEWELRY AS IN EAR RINGS, FINGER RINGS, NECKLACES, BRACELETS (U.S. CLS. 100, 101 AND 102).

FIRST USE 4-7-2007; IN COMMERCE 4-7-2007.

3,399,216. AMBROSE, STEPHEN D, RICHMOND, VA. SN 77-115,607. PUB. 9-25-2007, FILED 2-25-2007.

Compensatory Invoicing

THE MARK CONSISTS OF STANDARD CHARACTERS WITHOUT CLAIM TO ANY PARTICULAR FONT, STYLE, SIZE, OR COLOR.

NO CLAIM IS MADE TO THE EXCLUSIVE RIGHT TO USE "INVOICING", APART FROM THE MARK AS SHOWN.

FOR DATA MANAGEMENT SERVICES FOR USE IN DEBT COLLECTION, NAMELY, ELECTRONIC DATA COLLECTION AND ONLINE CLAIMS MANAGEMENT; INVOICING SERVICES (U.S. CLS. 100, 101 AND 102).

FIRST USE 11-5-2006; IN COMMERCE 1-15-2007.

3,399,229. HALLBERG, HOLLY, MALIBU, CA. SN 77-120,628. PUB. 9-4-2007, FILED 3-2-2007.

HUSET

THE MARK CONSISTS OF STANDARD CHARACTERS WITHOUT CLAIM TO ANY PARTICULAR FONT, STYLE, SIZE, OR COLOR.

THE ENGLISH TRANSLATION OF THE SWEDISH WORDING "HUSET" IS "HOUSE."

FOR RETAIL STORE SERVICES FEATURING SCANDINAVIAN HOUSEWARES AND ART (U.S. CLS. 100, 101 AND 102).

FIRST USE 4-17-2007; IN COMMERCE 11-6-2007.

CLASS 35—(Continued).

3,399,233. COCHRAN, R. KEITH, IRVING, TX. SN 77-122,541.
PUB. 9-18-2007, FILED 3-5-2007.

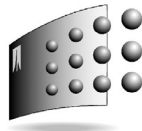

MANAGED *ab intra* **AUDIT**

THE MARK CONSISTS, IN PART, OF A LOGO HAVING A DIMENSIONAL APPEARANCE WITH ROWS OF ESSENTIALLY SPHERICAL DESIGNS.

FOR BUSINESS CONSULTATION SERVICES; BUSINESS INFORMATION AND ACCOUNTING ADVISORY SERVICES (U.S. CLS. 100, 101 AND 102).

FIRST USE 10-16-2007; IN COMMERCE 10-16-2007.

3,399,249. UNIVERSAL CREATIVITY UNLIMITED, INC.,
STUDIO CITY, CA. SN 77-131,380. PUB. 9-18-2007, FILED
3-14-2007.

Universal Creativity Unlimited, Inc.

THE MARK CONSISTS OF STANDARD CHARACTERS WITHOUT CLAIM TO ANY PARTICULAR FONT, STYLE, SIZE, OR COLOR.

NO CLAIM IS MADE TO THE EXCLUSIVE RIGHT TO USE "INC.", APART FROM THE MARK AS SHOWN.

FOR ADVERTISING AND BUSINESS MANAGEMENT CONSULTANCY; ADVERTISING AND BUSINESS SERVICES, NAMELY, SECURING AIRTIME ON ALL FORMS OF MEDIA COMMUNICATIONS STATIONS, SYSTEMS, NETWORKS, AND SERVICES FOR THE PURPOSE OF PROMOTING THE GOODS AND SERVICES OF OTHERS; ADVERTISING AND PROMOTION SERVICES AND RELATED CONSULTING; ADVERTISING CONSULTATION; ADVICE IN THE FIELD OF BUSINESS MANAGEMENT AND MARKETING; ADVICE RELATING TO THE ORGANISATION AND MANAGEMENT OF BUSINESS; ADVISORY SERVICE FOR ORGANIZATIONAL ISSUES AND BUSINESS ADMINISTRATION, WITH AND WITHOUT THE HELP OF ELECTRONIC DATA BASES; ASSISTANCE IN MANAGEMENT OF BUSINESS ACTIVITIES; ASSISTANCE WITH BUSINESS MANAGEMENT AND PLANNING; BUSINESS ACQUISITIONS CONSULTATION; BUSINESS ADMINISTRATION AND MANAGEMENT; BUSINESS ADMINISTRATION AND OFFICE WORK; BUSINESS ADMINISTRATION CONSULTANCY; BUSINESS ADVICE AND INFORMATION; BUSINESS ADVICE, INQUIRIES OR INFORMATION; BUSINESS ADVISORY SERVICES, CONSULTANCY AND INFORMATION; BUSINESS MANAGEMENT AND ADVICE; BUSINESS MANAGEMENT AND CONSULTATION; BUSINESS MANAGEMENT CONSULTANCY SERVICES; BUSINESS ORGANIZATION AND OPERATION CONSULTANCY; BUSINESS ORGANIZATIONAL CONSULTATION; BUSINESS PLANNING (U.S. CLS. 100, 101 AND 102).

FIRST USE 12-28-2006; IN COMMERCE 1-25-2007.

CLASS 35—(Continued).

3,399,253. STUDYGLOBAL M&A SL, BARCELONA, SPAIN.
SN 77-133,702. PUB. 8-21-2007, FILED 3-17-2007.

StudyGlobal

THE MARK CONSISTS OF STANDARD CHARACTERS WITHOUT CLAIM TO ANY PARTICULAR FONT, STYLE, SIZE, OR COLOR.

FOR ADMINISTERING STUDY ABROAD PROGRAMS FOR COLLEGE STUDENTS (U.S. CLS. 100, 101 AND 102).
FIRST USE 10-30-2000; IN COMMERCE 3-15-2002.

3,399,263. AYLMER, HONEE C, KANSAS CITY, MO. SN 77-141,674. PUB. 10-2-2007, FILED 3-27-2007.



THE COLOR(S) BLACK, LIGHT GREEN, PINK, WHITE, PURPLE, DARK GREEN, BLUE, AND YELLOW IS/ARE CLAIMED AS A FEATURE OF THE MARK.

THE MARK CONSISTS OF A PINK FLAMINGO WEARING A PURPLE HAT WITH A LIGHT GREEN FLOWER ON TOP. AROUND THE FLAMINGO'S NECK IS A WHITE NECKLACE. THE TAIL OF THE FLAMINGO IS COLORED IN BLUE, PURPLE AND YELLOW. SEPARATING THE BLACK CURSIVE WORDS "THE" AND "CALICO" IS THE FLAMINGO'S HEAD. THE BODY OF THE FLAMINGO IS LOCATED IN BETWEEN THE WORDS "FLAM" AND "NGO". THESE LETTERS ARE IN DARK GREEN. RUNNING ACROSS FROM TOP TO BOTTOM INSIDE OF EACH LETTER ARE A NUMBER OF PINK SQUARES.

FOR RETAIL CLOTHING BOUTIQUES (U.S. CLS. 100, 101 AND 102).

FIRST USE 8-1-2007; IN COMMERCE 8-1-2007.

3,399,267. WORKPLACE MEDIA, INC., MENTOR, OH. SN 77-146,195. PUB. 9-4-2007, FILED 4-2-2007.

HOW MARKETERS GET TO WORK.

THE MARK CONSISTS OF STANDARD CHARACTERS WITHOUT CLAIM TO ANY PARTICULAR FONT, STYLE, SIZE, OR COLOR.

FOR DIRECT MARKETING SERVICES, NAMELY, THE DEVELOPMENT FOR A CLIENT OF A DIRECT MARKETING PROGRAM THAT TARGETS AND DELIVERS PROMOTIONAL OFFERS TO POTENTIAL CUSTOMERS IN THE WORKPLACE AND ANALYSIS OF THE RESULTS OF THAT DIRECT MARKETING PROGRAM (U.S. CLS. 100, 101 AND 102).

FIRST USE 5-7-2007; IN COMMERCE 5-7-2007.

CLASS 35—(Continued).

3,399,272. ARBOR AND VINE, PORT ORANGE, FL. SN 77-147,505. PUB. 10-2-2007, FILED 4-3-2007.



NO CLAIM IS MADE TO THE EXCLUSIVE RIGHT TO USE "GARDEN ACCESSORIES", APART FROM THE MARK AS SHOWN.

THE MARK CONSISTS OF STYLIZED LETTERING WITH A BIRD BATH WITH BIRD IN IT TO THE LEFT OF THE "A" IN "ARBOR".

FOR RETAIL STORE SERVICES FEATURING HOME AND GARDEN GOODS AND ON-LINE RETAIL STORE SERVICES FEATURING HOME AND GARDEN GOODS (U.S. CLS. 100, 101 AND 102).

FIRST USE 10-1-2007; IN COMMERCE 10-1-2007.

3,399,301. BEST AMERICAN ARTISTS AND ARTISANS, INC., COLUMBUS, OH. SN 77-975,171. PUB. 8-7-2007, FILED 2-12-2007.

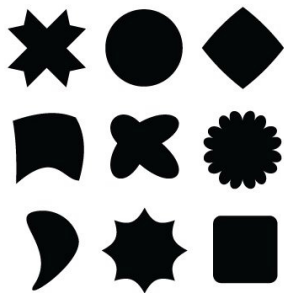

THE MARK CONSISTS OF NINE SHAPES SYMMETRICALLY PLACED WITH THREE IN THE TOP ROW, THREE IN THE MIDDLE ROW AND THREE IN THE BOTTOM ROW.

FOR ON-LINE RETAIL STORE SERVICES, FEATURING CLOTHING, PERSONAL ACCESSORIES, JEWELRY, GIFTS, BAGS AND HOME DÉCOR AND ACCESSORIES (U.S. CLS. 100, 101 AND 102).

FIRST USE 7-4-2007; IN COMMERCE 7-4-2007.

CLASS 35—(Continued).

3,399,307. ANHEUSER-BUSCH, INCORPORATED, ST. LOUIS, MO. SN 78-219,203. PUB. 5-11-2004, FILED 2-26-2003.

BUD LIGHT LOUNGE

OWNER OF U.S. REG. NOS. 666,367, 1,261,873, AND 2,119,771.

NO CLAIM IS MADE TO THE EXCLUSIVE RIGHT TO USE "LOUNGE", APART FROM THE MARK AS SHOWN.

FOR PROMOTING THE CONCERTS OF OTHERS (U.S. CLS. 100, 101 AND 102).

FIRST USE 4-1-2003; IN COMMERCE 4-1-2003.

3,399,314. HSH NORDBANK AG, HAMBURG, FED REP GERMANY. SN 78-241,203. PUB. 11-9-2004, FILED 4-23-2003.

HSH NORDBANK

THE FOREIGN WORDING IN THE MARK TRANSLATES INTO ENGLISH AS NORTH BANK.

FOR BUSINESS SERVICES, NAMELY, BUSINESS MANAGEMENT SERVICES; BUSINESS RESEARCH SERVICES; BUSINESS ANALYSIS AND FORECASTING SERVICES; BUSINESS MANAGEMENT AND BUSINESS CONSULTANCY SERVICES; BUSINESS COST AND BUSINESS STATISTICAL INFORMATION AND ANALYSIS OF SERVICES; TAX PREPARATION AND CONSULTATION SERVICES; BUSINESS APPRAISAL SERVICES; BUSINESS PROJECT ADVISORY AND INFORMATION SERVICES; ADVISORY AND CONSULTANCY SERVICES RELATING TO ALL THE AFORESAID (U.S. CLS. 100, 101 AND 102).

FIRST USE 2-4-2003; IN COMMERCE 2-4-2003.

3,399,325. EXTREME MEDIA AND ENTERTAINMENT LLC, SCOTTSDALE, AZ. SN 78-255,971. PUB. 9-7-2004, FILED 5-29-2003.

**EXTREME SPORTS
MANAGEMENT**

NO CLAIM IS MADE TO THE EXCLUSIVE RIGHT TO USE "MANAGEMENT", APART FROM THE MARK AS SHOWN.

FOR ADVERTISING SERVICES, NAMELY, DISTRIBUTING INFORMATION TO THE PUBLIC REGARDING EVENTS IN THE NATURE OF ENTERTAINMENT; BUSINESS SERVICES, NAMELY, BUSINESS MANAGEMENT; BUSINESS RESEARCH, AND BUSINESS CONSULTATION; MARKETING SERVICES, NAMELY, MARKETING RESEARCH AND MARKETING STUDIES; AND PROMOTIONAL AND PUBLICITY SERVICES, NAMELY, PROMOTING AND PUBLICIZING THE GOODS AND SERVICES OF OTHERS THROUGH THE DISTRIBUTION OF PRINTED AND AUDIOVISUAL MATERIALS (U.S. CLS. 100, 101 AND 102).

FIRST USE 11-0-2007; IN COMMERCE 11-0-2007.

CLASS 35—(Continued).

3,399,339. PHARMETRICS, INC., WATERTOWN, MA. SN 78-324,206. PUB. 12-13-2005, FILED 11-6-2003.

CLASS 35—(Continued).

3,399,342. VEGAS.COM LLC, HENDERSON, NV. SN 78-331,083. PUB. 4-19-2005, FILED 11-20-2003.

PROFILER SERIES

FREQUENT LAS VEGAS POINTS

THE MARK CONSISTS OF STANDARD CHARACTERS WITHOUT CLAIM TO ANY PARTICULAR FONT, STYLE, SIZE, OR COLOR.

FOR CONSULTING SERVICES, NAMELY, ANALYZING THE MARKET POTENTIAL AND SUCCESS OF PHARMACEUTICAL PRODUCTS AND TRENDS AND USES OF PHARMACEUTICAL PRODUCTS (U.S. CLS. 100, 101 AND 102).

FIRST USE 1-2-2003; IN COMMERCE 5-13-2003.

THE MARK CONSISTS OF STANDARD CHARACTERS WITHOUT CLAIM TO ANY PARTICULAR FONT, STYLE, SIZE, OR COLOR.

NO CLAIM IS MADE TO THE EXCLUSIVE RIGHT TO USE "POINTS", APART FROM THE MARK AS SHOWN.

FOR CREDIT CARD REGISTRATION; THEATRICAL TICKETING AGENCIES; PROMOTING THE SALE OF CREDIT CARD ACCOUNTS THROUGH THE ADMINISTRATION OF INCENTIVE AWARD PROGRAMS (U.S. CLS. 100, 101 AND 102).

FIRST USE 10-10-2007; IN COMMERCE 10-10-2007.

3,399,341. CARTRIDGE WORLD NORTH AMERICA, EMERYVILLE, CA. SN 78-328,131. PUB. 9-7-2004, FILED 11-14-2003.

3,399,379. YAMASAN, PLANO, TX. SN 78-435,636. PUB. 9-12-2006, FILED 6-15-2004.

Cartridge Etc.

SHOP MINOYA

THE MARK CONSISTS OF STANDARD CHARACTERS WITHOUT CLAIM TO ANY PARTICULAR FONT, STYLE, SIZE, OR COLOR.

NO CLAIM IS MADE TO THE EXCLUSIVE RIGHT TO USE "CARTRIDGE", APART FROM THE MARK AS SHOWN.

FOR RETAIL AND WHOLESALE STORE SERVICES, INTERNET RETAIL STORES AND WHOLESALE DISTRIBUTORSHIP SERVICES, MAIL ORDER CATALOG SERVICES ALL FEATURING PRINTER AND PHOTOCOPIER CONSUMABLES IN THE NATURE OF CASH REGISTER RIBBONS, COMPUTER PRINTER INK RIBBONS, DUPLICATING INKS, INKS, INK ROLLERS FOR OFFICE MACHINES, FAX ROLLS, OFFICE MACHINE RIBBONS, PAPER, PRINTER INK FOR INKJET AND LASER PRINTERS, PRINTER CARTRIDGES AND TONER, PHOTOCOPIER CARTRIDGES AND TONER, INCLUDING REPLACING PARTS AND CONSUMABLES SUCH AS REFILLING TONER AND INK CARTRIDGES (U.S. CLS. 100, 101 AND 102).

FIRST USE 11-28-2007; IN COMMERCE 11-28-2007.

THE MARK CONSISTS OF STANDARD CHARACTERS WITHOUT CLAIM TO ANY PARTICULAR FONT, STYLE, SIZE, OR COLOR.

NO CLAIM IS MADE TO THE EXCLUSIVE RIGHT TO USE "SHOP", APART FROM THE MARK AS SHOWN.

SHOP MINOYA IS A NON-WHIMSICAL COMBINATION OF WORDS THAT VERY ROUGHLY TRANSLATE, IN A COMBINATION OF ENGLISH AND JAPANESE, TO SHOP AT MINO'S LITTLE STORE.

FOR RETAIL STORE SERVICES FEATURING LOW-COST GENERAL CONSUMER MERCHANDISE (U.S. CLS. 100, 101 AND 102).

FIRST USE 7-31-2004; IN COMMERCE 7-31-2004.

CLASS 35—(Continued).

3,399,387. UNITED STATES MARINE CORPS, A COMPONENT OF THE DEPARTMENT OF THE NAVY, ARLINGTON, VA. SN 78-461,127. PUB. 10-3-2006, FILED 8-3-2004.

MARINE FOR LIFE

THE MARK CONSISTS OF STANDARD CHARACTERS WITHOUT CLAIM TO ANY PARTICULAR FONT, STYLE, SIZE, OR COLOR.

NO CLAIM IS MADE TO THE EXCLUSIVE RIGHT TO USE "MARINE", APART FROM THE MARK AS SHOWN.

FOR PROVIDING REFERRALS IN THE FIELDS OF EMPLOYMENT COUNSELING, OUTPLACEMENT AND CAREER NETWORKING SERVICES; PROVIDING REFERRALS IN THE FIELDS OF PRIMARY, SECONDARY AND POSTSECONDARY EDUCATION INCLUDING VOCATIONAL/TECHNICAL EDUCATION; PROVIDING REFERRALS IN THE FIELD OF CHILDCARE; PROVIDING REFERRALS IN THE FIELD OF MILITARY VETERAN'S BENEFITS; PROVIDING ON-LINE DIRECTORY SERVICES FEATURING THE SERVICES OF OTHERS IN THE FIELDS OF EMPLOYMENT COUNSELING, OUTPLACEMENT AND CAREER NETWORKING, PRIMARY, SECONDARY AND POSTSECONDARY EDUCATION INCLUDING VOCATIONAL/TECHNICAL EDUCATION, CHILDCARE, AND MILITARY VETERAN'S BENEFITS (U.S. CLS. 100, 101 AND 102).

FIRST USE 12-2-2006; IN COMMERCE 12-2-2006.

3,399,398. MARKMONITOR INC., BOISE, ID. SN 78-484,671. PUB. 12-5-2006, FILED 9-16-2004.

EARLY WARNING SYSTEM

THE MARK CONSISTS OF STANDARD CHARACTERS WITHOUT CLAIM TO ANY PARTICULAR FONT, STYLE, SIZE, OR COLOR.

FOR BUSINESS CONSULTATION SERVICES IN THE FIELD OF PREVENTION OF INTERNET FRAUD OR OTHER ILLEGAL ACTIVITIES IN DOMAIN REGISTRATIONS (U.S. CLS. 100, 101 AND 102).

FIRST USE 9-11-2003; IN COMMERCE 9-11-2003.

CLASS 35—(Continued).

3,399,403. STAPLES THE OFFICE SUPERSTORE, LLC, FRAMINGHAM, MA. SN 78-491,302. PUB. 9-19-2006, FILED 9-29-2004.

EDIVERSITY NETWORK

THE MARK CONSISTS OF STANDARD CHARACTERS WITHOUT CLAIM TO ANY PARTICULAR FONT, STYLE, SIZE, OR COLOR.

NO CLAIM IS MADE TO THE EXCLUSIVE RIGHT TO USE "NETWORK", APART FROM THE MARK AS SHOWN.

FOR MAIL ORDER CATALOG SERVICES AND COMPUTERIZED ONLINE RETAIL STORE SERVICES FEATURING OFFICE SUPPLIES, OFFICE EQUIPMENT, INCLUDING COMPUTER HARDWARE, COPIERS AND TELEPHONES, AND OFFICE FURNITURE (U.S. CLS. 100, 101 AND 102).

FIRST USE 10-0-2005; IN COMMERCE 10-0-2005.

3,399,427. ADP, INC., HOFFMAN ESTATES, IL. SN 78-514,744. PUB. 10-4-2005, FILED 11-10-2004.

BUZZ TRAK

THE MARK CONSISTS OF STANDARD CHARACTERS WITHOUT CLAIM TO ANY PARTICULAR FONT, STYLE, SIZE, OR COLOR.

FOR BUSINESS MARKETING SERVICES (U.S. CLS. 100, 101 AND 102).

FIRST USE 12-18-2000; IN COMMERCE 12-18-2000.

3,399,428. THE J. JILL GROUP, INC., HINGHAM, MA. SN 78-515,393. PUB. 10-18-2005, FILED 11-11-2004.

PURE JILL

THE MARK CONSISTS OF STANDARD CHARACTERS WITHOUT CLAIM TO ANY PARTICULAR FONT, STYLE, SIZE, OR COLOR.

FOR RETAIL OUTLETS, MAIL-ORDER CATALOGUE AND ON-LINE CATALOGUE SERVICES FEATURING CLOTHING AND ACCESSORIES (U.S. CLS. 100, 101 AND 102).

FIRST USE 2-14-2000; IN COMMERCE 2-14-2000.

CLASS 35—(Continued).

3,399,430. HOLLYWOOD ENTERTAINMENT CORPORATION, WILSONVILLE, OR. SN 78-517,619. PUB. 5-30-2006, FILED 11-16-2004.

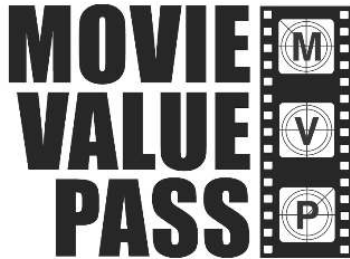

FOR RETAIL STORE SERVICES FEATURING PRE-RECORDED ENTERTAINMENT MEDIA AND ASSOCIATED EQUIPMENT AND ACCESSORIES, VIDEO AND COMPUTER GAMES AND ASSOCIATED EQUIPMENT AND ACCESSORIES, MUSIC AND RELATED HOME ENTERTAINMENT EQUIPMENT AND ACCESSORIES, GAMES, PRINTED PUBLICATIONS, FOODSTUFFS, TOYS, AND COMPUTER SOFTWARE AND HARDWARE, ALL PROVIDED VIA PHYSICAL ESTABLISHMENTS AND VIA A GLOBAL COMMUNICATION NETWORK (U.S. CLS. 100, 101 AND 102).
FIRST USE 8-28-2004; IN COMMERCE 8-28-2004.

3,399,437. CALIBER POINT BUSINESS SOLUTIONS LIMITED, MAHAPE, NAVI MUMBAI, INDIA. SN 78-521,042. PUB. 4-24-2007, FILED 11-22-2004.



NO CLAIM IS MADE TO THE EXCLUSIVE RIGHT TO USE "BUSINESS SOLUTIONS LTD.", APART FROM THE MARK AS SHOWN.
FOR OUTSOURCING IN THE FIELD OF OFFICE AND BUSINESS ADMINISTRATION SERVICES; DATA PROCESSING SERVICES; COLLECTION, PREPARATION, COMPOSITION, STORAGE, PROCESSING, ACQUISITION AND PROVISION OF BUSINESS INFORMATION, DATA, STATISTICS AND INDICES; PROVIDING STATISTICAL INFORMATION FOR BUSINESS OR COMMERCIAL PURPOSES; SERVICES COMPRISING THE RECORDING, TRANSCRIPTION, COMPOSITION, COMPILATION AND SYSTEMATIZATION OF WRITTEN COMMUNICATIONS AND RECORDINGS, AS WELL AS THE COMPILATION OF MATHEMATICAL OR STATISTICAL DATA; BUSINESS ADMINISTRATION AND MANAGEMENT (U.S. CLS. 100, 101 AND 102).
FIRST USE 1-0-2005; IN COMMERCE 1-0-2005.

CLASS 35—(Continued).

3,399,439. GEARHART, HENRY, EAST STROUDSBURG, PA. SN 78-522,400. PUB. 3-21-2006, FILED 11-24-2004.



NO CLAIM IS MADE TO THE EXCLUSIVE RIGHT TO USE "CHRISTMAS", APART FROM THE MARK AS SHOWN.
FOR RETAIL STORE SERVICES FEATURING CHRISTMAS MERCHANDISE, EXCLUDING CHRISTMAS TREES (U.S. CLS. 100, 101 AND 102).
FIRST USE 6-0-2007; IN COMMERCE 6-0-2007.

3,399,458. TOWBIN DODGE, HENDERSON, NV. SN 78-547,207. PUB. 6-20-2006, FILED 1-13-2005.

THE BLUE GENIE

THE MARK CONSISTS OF STANDARD CHARACTERS WITHOUT CLAIM TO ANY PARTICULAR FONT, STYLE, SIZE, OR COLOR.
FOR AUTOMOBILE DEALERSHIPS; PROVIDING INFORMATION ABOUT AUTOMOBILES FOR SALE BY MEANS OF THE INTERNET; RETAIL SERVICES BY DIRECT SOLICITATION BY SALES AGENTS IN CONNECTION WITH NEW AND USED AUTOMOBILES (U.S. CLS. 100, 101 AND 102).
FIRST USE 1-13-2005; IN COMMERCE 1-13-2005.

3,399,468. HIRE DISABILITY SOLUTIONS, LLC, BROOKLYN, NY. SN 78-560,568. PUB. 11-22-2005, FILED 2-4-2005.

BE A HERO HIRE A HERO

THE MARK CONSISTS OF STANDARD CHARACTERS WITHOUT CLAIM TO ANY PARTICULAR FONT, STYLE, SIZE, OR COLOR.
FOR ORGANIZING AND CONDUCTING JOB FAIRS (U.S. CLS. 100, 101 AND 102).
FIRST USE 8-0-2006; IN COMMERCE 8-0-2006.

CLASS 35—(Continued).

3,399,469. HRONCICH, BRIAN M., CRANBERRY TOWNSHIP, PA. SN 78-561,467. PUB. 6-6-2006, FILED 2-6-2005.

REAL REPUBLICAN

THE MARK CONSISTS OF STANDARD CHARACTERS WITHOUT CLAIM TO ANY PARTICULAR FONT, STYLE, SIZE, OR COLOR.

NO CLAIM IS MADE TO THE EXCLUSIVE RIGHT TO USE "REPUBLICAN", APART FROM THE MARK AS SHOWN.

FOR ADVERTISING AND BUSINESS ADVICE RELATING TO POLITICAL CAMPAIGNS (U.S. CLS. 100, 101 AND 102).

FIRST USE 4-5-2005; IN COMMERCE 4-5-2005.

3,399,513. WEST CORPORATION, OMAHA, NE. SN 78-616,051. PUB. 9-12-2006, FILED 4-25-2005.

SMARTSELL ONLINE

THE MARK CONSISTS OF STANDARD CHARACTERS WITHOUT CLAIM TO ANY PARTICULAR FONT, STYLE, SIZE, OR COLOR.

NO CLAIM IS MADE TO THE EXCLUSIVE RIGHT TO USE "ONLINE", APART FROM THE MARK AS SHOWN.

FOR PROMOTING THE GOODS AND SERVICES OF OTHERS BY MEANS OF PROVIDING AND OPERATING LINKS TO WEB SITES OF OTHERS, PROMOTING THE GOODS AND SERVICES OF OTHERS THROUGH ONLINE ORDERING AND CATALOGUING OF THOSE GOODS AND SERVICES; CUSTOMER SERVICES IN THE FIELD OF ONLINE ORDERING AND GENERAL MERCHANDISING; AND BUSINESS CONSULTATION (U.S. CLS. 100, 101 AND 102).

FIRST USE 3-1-2004; IN COMMERCE 3-1-2004.

3,399,516. INTERNATIONAL GLOBAL OPPORTUNITY NETWORK LLC, PORT CHARLOTTE, FL. SN 78-617,218. PUB. 11-14-2006, FILED 4-26-2005.

IGONET

International
Global
Opportunity
Network Inc.

NO CLAIM IS MADE TO THE EXCLUSIVE RIGHT TO USE "INTERNATIONAL GLOBAL" AND "NETWORK INC.", APART FROM THE MARK AS SHOWN.

THE COLOR(S) BLUE IS/ARE CLAIMED AS A FEATURE OF THE MARK.

THE COLOR BLUE APPEARS THROUGHOUT THE

CLASS 35—(Continued).

MARK.

THE MARK CONSISTS OF "INTERNATIONAL GLOBAL OPPORTUNITY NETWORK", THE COMPANY NAME IS SHOWN IN BLUE AND IN GEORGIA FONT. THE COMPANY INTENDS TO DO BUSINESS USING THE ACRONYM "IGONET" WHICH IS SHOWN ALSO IN BLUE AND IN TWO ZEROS FONT STYLE.

FOR NETWORK MARKETING BUSINESS SERVICES, NAMELY, MULTI-LEVEL AND DIRECT RETAIL MARKETING FEATURING VOICE OVER INTERNET PROTOCOL AND WIRELESS HIGH SPEED INTERNET SERVICES FOR OTHERS (U.S. CLS. 100, 101 AND 102).

FIRST USE 11-30-2005; IN COMMERCE 11-30-2005.

3,399,531. IKAN TECHNOLOGIES INC., RIVERSIDE, CT. SN 78-632,790. PUB. 2-7-2006, FILED 5-18-2005.

IKAN

THE MARK CONSISTS OF STANDARD CHARACTERS WITHOUT CLAIM TO ANY PARTICULAR FONT, STYLE, SIZE, OR COLOR.

FOR COMPUTERIZED ONLINE ORDERING FEATURING GENERAL MERCHANDISE AND GENERAL CONSUMER GOODS; PROVIDING AN ON-LINE COMPUTER DATABASE FEATURING TRADE INFORMATION IN THE FIELD OF CONSUMPTION AND RECYCLING HABITS OF CONSUMERS; ADVICE ON THE ANALYSIS OF CONSUMER BUYING HABITS AND NEEDS PROVIDED WITH THE HELP OF SENSORY, QUALITY AND QUANTITY-RELATED DATA; DISTRIBUTION OF SAMPLES FOR PUBLICITY PURPOSES; COMMERCIAL INFORMATION AGENCY SERVICES PROVIDING BUSINESS INFORMATION IN THE FIELD OF MARKETING OR DEMOGRAPHIC DATA RELATING TO CONSUMPTION AND RECYCLING HABITS OF CONSUMERS (U.S. CLS. 100, 101 AND 102).

FIRST USE 9-9-2006; IN COMMERCE 1-31-2007.

3,399,548. AUTHORCONNECT, BERKELEY, CA. SN 78-656,148. PUB. 9-19-2006, FILED 6-22-2005.

AUTHORCONNECT

THE MARK CONSISTS OF STANDARD CHARACTERS WITHOUT CLAIM TO ANY PARTICULAR FONT, STYLE, SIZE, OR COLOR.

FOR ONLINE ADVERTISING AND PROMOTIONAL SERVICES FOR AUTHORS, PUBLISHERS, AND OTHERS WHO PROVIDE WRITING-RELATED SERVICES; ONLINE RETAIL SERVICES FEATURING BOOKS; AND ONLINE DATABASE MANAGEMENT SERVICES (U.S. CLS. 100, 101 AND 102).

FIRST USE 11-0-2006; IN COMMERCE 11-0-2006.

CLASS 35—(Continued).

3,399,550. MATTRESS FIRM, INC., DBA MATTRESS FIRM, HOUSTON, TX. SN 78-656,811. PUB. 9-19-2006, FILED 6-23-2005.



NO CLAIM IS MADE TO THE EXCLUSIVE RIGHT TO USE "SLEEP", APART FROM THE MARK AS SHOWN. FOR RETAIL STORE SERVICES FEATURING SLEEP PRODUCTS (U.S. CLS. 100, 101 AND 102). FIRST USE 12-8-2007; IN COMMERCE 12-8-2007.

CLASS 35—(Continued).

3,399,584. MATTRESS FIRM, INC., DBA MATTRESS FIRM, HOUSTON, TX. SN 78-680,446. PUB. 3-14-2006, FILED 7-28-2005.

REMEDIES FOR A GREAT NIGHT'S SLEEP

THE MARK CONSISTS OF STANDARD CHARACTERS WITHOUT CLAIM TO ANY PARTICULAR FONT, STYLE, SIZE, OR COLOR. FOR RETAIL STORES FEATURING SLEEP PRODUCTS (U.S. CLS. 100, 101 AND 102). FIRST USE 11-24-2007; IN COMMERCE 11-24-2007.

3,399,565. ELECTRONIC CREATIONS CORP., SANTA ROSA, CA. SN 78-665,059. PUB. 3-21-2006, FILED 7-6-2005.

GOAUTO.COM

THE MARK CONSISTS OF STANDARD CHARACTERS WITHOUT CLAIM TO ANY PARTICULAR FONT, STYLE, SIZE, OR COLOR. FOR COMPUTER SERVICES, NAMELY OPERATING A MARKETPLACE ON A GLOBAL COMPUTER NETWORK FOR BUYERS AND SELLERS OF AUTOMOBILES AND OTHER MEANS OF PERSONAL TRANSPORTATION (U.S. CLS. 100, 101 AND 102). FIRST USE 8-15-2006; IN COMMERCE 12-6-2007.

3,399,603. VANCE FROST, SAN ANSELMO, CA. SN 78-699,160. PUB. 5-9-2006, FILED 8-24-2005.

LIVEINMARIN.COM

THE MARK CONSISTS OF STANDARD CHARACTERS WITHOUT CLAIM TO ANY PARTICULAR FONT, STYLE, SIZE, OR COLOR. FOR REAL ESTATE ADVERTISING SERVICES (U.S. CLS. 100, 101 AND 102). FIRST USE 9-17-2004; IN COMMERCE 12-27-2004.

3,399,574. MATTRESS FIRM, INC., DBA MATTRESS FIRM, HOUSTON, TX. SN 78-672,818. PUB. 3-14-2006, FILED 7-18-2005.

YOUR SLEEP PRESCRIPTION

THE MARK CONSISTS OF STANDARD CHARACTERS WITHOUT CLAIM TO ANY PARTICULAR FONT, STYLE, SIZE, OR COLOR. FOR RETAIL STORES FEATURING SLEEP PRODUCTS (U.S. CLS. 100, 101 AND 102). FIRST USE 12-2-2007; IN COMMERCE 12-2-2007.

3,399,611. NOR1, INC., CUPERTINO, CA. SN 78-707,766. PUB. 6-20-2006, FILED 9-7-2005.

NOR1

THE MARK CONSISTS OF STANDARD CHARACTERS WITHOUT CLAIM TO ANY PARTICULAR FONT, STYLE, SIZE, OR COLOR. FOR ONLINE ORDERING SERVICES, NAMELY, PROVIDING FOR THE PURCHASE OF TICKETS TO SPORTING EVENTS, SHOWS, CONCERTS, LODGING, TRAVEL PACKAGES, AND TRANSPORTATION, BY MEANS OF A GLOBAL COMPUTER NETWORK (U.S. CLS. 100, 101 AND 102). FIRST USE 5-25-2005; IN COMMERCE 5-25-2005.

CLASS 35—(Continued).

3,399,617. PRACTICE LIFECYCLE, LLC, BOSTON, MA. SN 78-712,636. PUB. 11-21-2006, FILED 9-14-2005.

PRACTICE LIFECYCLE

THE MARK CONSISTS OF STANDARD CHARACTERS WITHOUT CLAIM TO ANY PARTICULAR FONT, STYLE, SIZE, OR COLOR.

FOR ADVISE IN THE FIELD OF BUSINESS MANAGEMENT AND MARKETING, NAMELY, ADVERTISING, PROMOTION, MARKETING AND BUSINESS STRATEGY FOR FINANCIAL ADVISORS, INVESTMENT ADVISORS, ACCOUNTANTS AND ATTORNEY; PROFESSIONAL BUSINESS CONSULTATION; BUSINESS ORGANIZATION ADVICE, NAMELY, PROVIDING CRITICAL INFORMATION TO BUSINESS PROFESSIONAL WHO NEED TO MAKE DECISIONS FOR NEAR TERM AND LONG TERM STRATEGIC PLANNING (U.S. CLS. 100, 101 AND 102).

FIRST USE 9-14-2005; IN COMMERCE 11-1-2007.

3,399,622. NOR1, INC., CUPERTINO, CA. SN 78-718,243. PUB. 6-20-2006, FILED 9-22-2005.

POWERED BY NOR1

THE MARK CONSISTS OF STANDARD CHARACTERS WITHOUT CLAIM TO ANY PARTICULAR FONT, STYLE, SIZE, OR COLOR.

FOR ONLINE ORDERING SERVICES, NAMELY, PROVIDING FOR THE PURCHASE OF TICKETS TO SPORTING EVENTS, SHOWS, CONCERTS, LODGING, TRAVEL PACKAGES, AND TRANSPORTATION, BY MEANS OF A GLOBAL COMPUTER NETWORK (U.S. CLS. 100, 101 AND 102).

FIRST USE 5-0-2005; IN COMMERCE 5-0-2005.

CLASS 35—(Continued).

3,399,623. NOR1 UPGRADE, CUPERTINO, CA. SN 78-718,249. PUB. 6-20-2006, FILED 9-22-2005.

NOR1 UPGRADE

THE MARK CONSISTS OF STANDARD CHARACTERS WITHOUT CLAIM TO ANY PARTICULAR FONT, STYLE, SIZE, OR COLOR.

FOR ONLINE ORDERING SERVICES, NAMELY, PROVIDING FOR THE PURCHASE OF TICKETS TO SPORTING EVENTS, SHOWS, CONCERTS, LODGING, TRAVEL PACKAGES, AND TRANSPORTATION, BY MEANS OF A GLOBAL COMPUTER NETWORK (U.S. CLS. 100, 101 AND 102).

FIRST USE 5-0-2005; IN COMMERCE 5-0-2005.

3,399,624. NOR1, INC., CUPERTINO, CA. SN 78-718,623. PUB. 6-20-2006, FILED 9-22-2005.



FOR ONLINE ORDERING SERVICES, NAMELY, PROVIDING FOR THE PURCHASE OF TICKETS TO SPORTING EVENTS, SHOWS, CONCERTS, LODGING, TRAVEL PACKAGES, AND TRANSPORTATION, BY MEANS OF A GLOBAL COMPUTER NETWORK (U.S. CLS. 100, 101 AND 102).

FIRST USE 5-0-2005; IN COMMERCE 5-0-2005.

3,399,625. KRALIK, JONATHAN, C, SALT LAKE CITY, UT. SN 78-719,282. PUB. 8-8-2006, FILED 9-23-2005.

Funky Giraffe

THE MARK CONSISTS OF STANDARD CHARACTERS WITHOUT CLAIM TO ANY PARTICULAR FONT, STYLE, SIZE, OR COLOR.

FOR RETAIL STORES FEATURING CLOTHING, AND TOYS (U.S. CLS. 100, 101 AND 102).

FIRST USE 8-1-1998; IN COMMERCE 7-13-2004.

CLASS 35—(Continued).

3,399,682. DININGFEVER LLC, JERSEY CITY, NJ. SN 78-756,111. PUB. 3-13-2007, FILED 11-17-2005.

DININGFEVER

THE MARK CONSISTS OF STANDARD CHARACTERS WITHOUT CLAIM TO ANY PARTICULAR FONT, STYLE, SIZE, OR COLOR.

FOR ADVERTISING AND PUBLICITY SERVICES, NAMELY, PROMOTING THE GOODS, SERVICES, BRAND IDENTITY AND COMMERCIAL INFORMATION AND NEWS OF THIRD PARTIES THROUGH PRINT, AUDIO, VIDEO, DIGITAL AND ON-LINE MEDIUM; ADVERTISING BY TRANSMISSION OF ONLINE PUBLICITY FOR THIRD PARTIES THROUGH ELECTRONIC COMMUNICATIONS NETWORKS (U.S. CLS. 100, 101 AND 102).

FIRST USE 2-28-2006; IN COMMERCE 2-28-2006.

3,399,690. SYSCO CORPORATION, HOUSTON, TX. SN 78-757,768. PUB. 7-25-2006, FILED 11-20-2005.

DEDICATION TO VALUE

THE MARK CONSISTS OF STANDARD CHARACTERS WITHOUT CLAIM TO ANY PARTICULAR FONT, STYLE, SIZE, OR COLOR.

FOR DISTRIBUTORSHIP SERVICES IN THE FIELD OF FOOD AND RELATED NON-FOOD ITEMS TO THE HEALTHCARE INDUSTRY (U.S. CLS. 100, 101 AND 102).

FIRST USE 2-1-2006; IN COMMERCE 2-1-2006.

3,399,718. IT'SUGAR LLC, GREENWICH, CT. SN 78-770,237. PUB. 2-27-2007, FILED 12-9-2005.

IT'SUGAR

THE MARK CONSISTS OF STANDARD CHARACTERS WITHOUT CLAIM TO ANY PARTICULAR FONT, STYLE, SIZE, OR COLOR.

FOR RETAIL STORE SERVICES FEATURING BULK CANDY, NOVELTY CANDY, CONFECTIONARY-BASED GOODS, CHOCOLATE, NUTS, DAIRY PRODUCTS, BAKED GOODS, CANDY-RELATED MERCHANDISE AND GIFT ITEMS (U.S. CLS. 100, 101 AND 102).

FIRST USE 1-18-2006; IN COMMERCE 6-28-2006.

CLASS 35—(Continued).

3,399,757. CONNOR, ROBERT, A., MINNEAPOLIS, MN. SN 78-783,099. PUB. 10-3-2006, FILED 12-30-2005.

HOLODRIVES

THE MARK CONSISTS OF STANDARD CHARACTERS WITHOUT CLAIM TO ANY PARTICULAR FONT, STYLE, SIZE, OR COLOR.

FOR ADVERTISING VIA ELECTRONIC MEDIA AND SPECIFICALLY THE INTERNET (U.S. CLS. 100, 101 AND 102).

FIRST USE 11-26-2007; IN COMMERCE 11-26-2007.

3,399,762. ACCELLER, INC., DBA BUYTELCO, MIAMI, FL. SN 78-786,532. PUB. 10-31-2006, FILED 1-6-2006.

Digital Landing

THE MARK CONSISTS OF STANDARD CHARACTERS WITHOUT CLAIM TO ANY PARTICULAR FONT, STYLE, SIZE, OR COLOR.

NO CLAIM IS MADE TO THE EXCLUSIVE RIGHT TO USE "DIGITAL", APART FROM THE MARK AS SHOWN.

FOR COMPARATIVE MARKETING AND ADVERTISING SERVICES FOR PROVIDERS OF RESIDENTIAL AND BUSINESS TELECOMMUNICATIONS SERVICES, NAMELY, FOR PROVIDERS OF BROADBAND CABLE, DSL, FIBER-OPTIC AND SATELLITE INTERNET ACCESS SERVICES, CABLE AND SATELLITE TELEVISION, VOICE OVER IP, AND LONG-DISTANCE TELEPHONE SERVICES TO HOME USERS; OPERATION OF TELEPHONE CALL CENTERS FOR OTHERS FOR PURPOSES OF MARKETING OF TELECOMMUNICATIONS AND OTHER DIGITAL SERVICES TO HOME USERS AND MARKETING CONSULTING RELATED THERETO (U.S. CLS. 100, 101 AND 102).

FIRST USE 3-1-2007; IN COMMERCE 7-1-2007.

CLASS 35—(Continued).

3,399,822. ASD SPECIALTY HEALTHCARE, INC., DBA AMERISOURCEBERGEN SPECIALTY GROUP, FRISCO, TX. SN 78-808,194. PUB. 9-19-2006, FILED 2-6-2006.

CUBIXX

THE MARK CONSISTS OF STANDARD CHARACTERS WITHOUT CLAIM TO ANY PARTICULAR FONT, STYLE, SIZE, OR COLOR.

FOR PHARMACEUTICAL MANAGEMENT SERVICES FOR OTHERS, NAMELY, INVENTORY MANAGEMENT, REPLENISHING AND RESETTING SERVICES AND AUTOMATED INVENTORY MONITORING SERVICES (U.S. CLS. 100, 101 AND 102).

FIRST USE 12-6-2005; IN COMMERCE 2-10-2006.

CLASS 35—(Continued).

3,399,857. HODGE, BRUCE, GREENFIELD, NY. SN 78-821,866. PUB. 10-17-2006, FILED 2-23-2006.

PRODUCTPIPE

THE MARK CONSISTS OF STANDARD CHARACTERS WITHOUT CLAIM TO ANY PARTICULAR FONT, STYLE, SIZE, OR COLOR.

FOR PROVIDING CONSUMER PRODUCT INFORMATION; PROVIDING COMPARISON SHOPPING INFORMATION; PROVIDING ONLINE DIRECTORY INFORMATION SERVICES ALSO FEATURING HYPERLINKS TO OTHER WEBSITES, DISSEMINATION OF ADVERTISING FOR OTHERS VIA THE INTERNET; ONLINE ADVERTISING SERVICES FOR OTHERS, NAMELY PROVIDING ADVERTISING SPACE ON INTERNET WEB SITES (U.S. CLS. 100, 101 AND 102).

FIRST USE 7-31-2007; IN COMMERCE 7-31-2007.

3,399,829. WHIRLED MUSIC PUBLISHING, INC., PHOENIX, AZ. SN 78-811,157. PUB. 8-21-2007, FILED 2-9-2006.



NO CLAIM IS MADE TO THE EXCLUSIVE RIGHT TO USE "MUSIC", APART FROM THE MARK AS SHOWN.

FOR ADVERTISING AND PROMOTION, NAMELY, LICENSING OF COMPACT DISCS AND INTERNET LINKS FEATURING PRE-RECORDED MUSIC FOR USE IN TELEVISION, RADIO, WIRELESS COMMUNICATION DEVICES AND INTERNET BROADCASTING AND DISTRIBUTION (U.S. CLS. 100, 101 AND 102).

FIRST USE 4-1-2002; IN COMMERCE 4-1-2002.

3,399,858. KEEPYOU, COMPANY, LAS VEGAS, NV. SN 78-822,116. PUB. 4-17-2007, FILED 2-23-2006.

KEEPYOU COMPANY

THE MARK CONSISTS OF STANDARD CHARACTERS WITHOUT CLAIM TO ANY PARTICULAR FONT, STYLE, SIZE, OR COLOR.

FOR PROVIDING NON-MEDICAL ASSISTED LIVING SERVICES IN THE NATURE OF SCHEDULING APPOINTMENTS, ANSWERING THE TELEPHONE, CHECKING MESSAGES, MAIL SORTING, HANDLING AND RECEIVING, AND SECRETARIAL AND CLERICAL SERVICES (U.S. CLS. 100, 101 AND 102).

FIRST USE 2-13-2006; IN COMMERCE 2-13-2006.

CLASS 35—(Continued).

3,399,871. EBAY INC., SAN JOSE, CA. SN 78-829,199. PUB. 4-3-2007, FILED 3-3-2006.

EBAY EXPRESS

THE MARK CONSISTS OF STANDARD CHARACTERS WITHOUT CLAIM TO ANY PARTICULAR FONT, STYLE, SIZE, OR COLOR.

OWNER OF U.S. REG. NOS. 2,218,732 AND 2,420,512.
FOR PROVIDING A SEARCHABLE ONLINE ADVERTISING GUIDE FEATURING THE GOODS AND SERVICES OF ONLINE VENDORS; PROVIDING A SEARCHABLE ONLINE EVALUATION DATABASE FOR BUYERS AND SELLERS; ADVERTISING AND ADVERTISEMENT SERVICES; CUSTOMER LOYALTY SERVICES AND CUSTOMER CLUB SERVICES FOR COMMERCIAL, PROMOTIONAL AND ADVERTISING PURPOSES; PROMOTING THE GOODS AND SERVICES OF OTHERS (U.S. CLS. 100, 101 AND 102).
FIRST USE 4-24-2006; IN COMMERCE 4-24-2006.

3,399,876. PRAXILIENT, INC., NEENAH, WI. SN 78-830,742. PUB. 6-5-2007, FILED 3-7-2006.

converting knowledge into action

THE MARK CONSISTS OF STANDARD CHARACTERS WITHOUT CLAIM TO ANY PARTICULAR FONT, STYLE, SIZE, OR COLOR.

FOR BUSINESS CONSULTING AND INFORMATION SERVICES; BUSINESS CONSULTING SERVICES RELATING TO PRODUCT DISTRIBUTION, OPERATIONS MANAGEMENT SERVICES, LOGISTICS, REVERSE LOGISTICS, SUPPLY CHAIN, AND PRODUCTION SYSTEMS AND DISTRIBUTION SOLUTIONS; BUSINESS MANAGEMENT CONSULTANCY AS WELL AS DEVELOPMENT OF PROCESSES FOR THE ANALYSIS AND THE IMPLEMENTATION OF STRATEGY PLANS AND MANAGEMENT PROJECTS (U.S. CLS. 100, 101 AND 102).

FIRST USE 12-28-2005; IN COMMERCE 12-28-2005.

3,399,905. KUDEVIZ, LARRY, GREENVILLE, SC. SN 78-843,608. PUB. 5-8-2007, FILED 3-22-2006.



NO CLAIM IS MADE TO THE EXCLUSIVE RIGHT TO USE "TARGETMARKET", APART FROM THE MARK AS

CLASS 35—(Continued).

SHOWN.

THE COLOR(S) BLACK, RED, BLUE, AND YELLOW IS/ARE CLAIMED AS A FEATURE OF THE MARK.

THE MARK CONSISTS OF THE COLORS BLACK, RED, YELLOW AND BLUE APPEAR IN THE WORDING "GENESIS". IN THAT THE WORDING "GENESIS" APPEARS IN LOWERCASE LETTERS IN BLACK AND A CHECKERBOARD OF RED, BLUE, YELLOW AND BLACK SQUARES APPEARS IN THE SMALL LETTER "G". THE WORDING "TARGETMARKET" APPEARS IN ALL CAPITAL LETTERS BELOW THE TERM "GENESIS". THE WORDING "ONE-TO-ONE" IS SITUATED BELOW THE WORDING "TARGETMARKET", WITH THE TERM "ONE" APPEARING IN BLACK, THE TERM "-TO-" APPEARING IN BLUE AND THE TERM "ONE" APPEARING IN RED. FINALLY, A TARGET DESIGN APPEARS IN BLACK, BLUE, RED AND YELLOW TO THE RIGHT OF WORDING "GENESIS". THREE YELLOW ARROWS WITH RED ENDS ARE STICKING OUT OF THE TARGET.

FOR DIRECT MAIL ADVERTISING (U.S. CLS. 100, 101 AND 102).

FIRST USE 7-0-2006; IN COMMERCE 7-0-2006.

3,399,970. ANNCO, INC., MILFORD, CT. SN 78-877,897. PUB. 9-12-2006, FILED 5-5-2006.

LOFT FOR LIFE

THE MARK CONSISTS OF STANDARD CHARACTERS WITHOUT CLAIM TO ANY PARTICULAR FONT, STYLE, SIZE, OR COLOR.

FOR ON-LINE AND IN STORE RETAIL STORE SERVICES IN THE FIELDS OF CLOTHING, FOOTWEAR, HANDBAGS, SMALL LEATHER ACCESSORIES, JEWELRY, TOILETRIES, BATH PRODUCTS, AND COSMETIC PRODUCTS (U.S. CLS. 100, 101 AND 102).

FIRST USE 10-0-2006; IN COMMERCE 10-0-2006.

3,399,991. PREVALENCE HEALTH, LLC, JACKSON, MS. SN 78-894,550. PUB. 1-2-2007, FILED 5-26-2006.



NO CLAIM IS MADE TO THE EXCLUSIVE RIGHT TO USE "TRADE MARK", APART FROM THE MARK AS SHOWN.

THE MARK CONSISTS OF OVAL DESIGN WITH PESTLE AND MORTAR ABOVE "TED'S MEDS".

FOR RETAIL PHARMACY SERVICES (U.S. CLS. 100, 101 AND 102).

FIRST USE 9-1-2006; IN COMMERCE 9-1-2006.

CLASS 35—(Continued).

3,400,008. KABUNGA INC, HOUSTON, TX. SN 78-905,535. PUB. 2-27-2007, FILED 6-11-2006.

ABC SHOP

THE MARK CONSISTS OF STANDARD CHARACTERS WITHOUT CLAIM TO ANY PARTICULAR FONT, STYLE, SIZE, OR COLOR.

NO CLAIM IS MADE TO THE EXCLUSIVE RIGHT TO USE "SHOP", APART FROM THE MARK AS SHOWN.

FOR COMPUTERIZED ONLINE ORDERING FEATURING GENERAL MERCHANDISE AND GENERAL CONSUMER GOODS; PROVIDING A SEARCHABLE ONLINE ADVERTISING GUIDE FEATURING THE GOODS AND SERVICES OF OTHER ONLINE VENDORS ON THE INTERNET; PROVIDING AN ONLINE COMMERCIAL INFORMATION DIRECTORY ON THE INTERNET (U.S. CLS. 100, 101 AND 102).
FIRST USE 1-10-2006; IN COMMERCE 7-18-2006.

3,400,017. NEOPSY SYSTEMS LLC, DENVER, CO. SN 78-911,783. PUB. 5-15-2007, FILED 6-19-2006.

ProStyle

THE MARK CONSISTS OF STANDARD CHARACTERS WITHOUT CLAIM TO ANY PARTICULAR FONT, STYLE, SIZE, OR COLOR.

FOR TESTING JOB APPLICANTS FOR OTHERS TO DETERMINE BEHAVIORAL CHARACTERISTICS OF INDIVIDUALS FOR PURPOSES OF JOB PLACEMENT AND ADVANCEMENT VIA A GLOBAL COMPUTER NETWORK; TESTING TO DETERMINE PROFESSIONAL COMPETENCY, NAMELY, PROVIDING ASSESSMENTS OF JOB APPLICANTS CONCERNING THE PSYCHOLOGICAL ATTRIBUTES AND COMPETENCIES WITH SUCCESSFUL PROFILES ASSOCIATED WITH CERTAIN PROFESSIONS AND SPECIALTIES, THE LIKELIHOOD OF SUCCESS AND PREDICTED PERFORMANCE IN CERTAIN PROFESSIONS AND SPECIALTIES, STRENGTHS AND WEAKNESSES OF JOB APPLICANTS AGAINST SPECIFIC SUCCESS PROFILES, AND SUGGESTED AREAS FOR PROFESSIONAL DEVELOPMENTAL FOCUS WITHIN CERTAIN PROFESSIONS AND SPECIALTIES (U.S. CLS. 100, 101 AND 102).
FIRST USE 3-12-2007; IN COMMERCE 3-12-2007.

CLASS 35—(Continued).

3,400,019. DIAMOND AND JEWELRY GALLERY, INC., WOODLAND HILLS, CA. SN 78-913,698. PUB. 4-24-2007, FILED 6-21-2006.



NO CLAIM IS MADE TO THE EXCLUSIVE RIGHT TO USE "DIAMOND AND JEWELRY GALLERY", APART FROM THE MARK AS SHOWN.

THE MARK CONSISTS OF A HAND HOLDING A DIAMOND, AN AMPERSAND INSIDE OF A SQUARE AFTER THE WORD "DIAMOND" AND FOLLOWED BY THE WORDS "JEWELRY GALLERY", THE WORDS BEING UNDERLINED.

FOR WHOLESALE AND RETAIL STORE SERVICES FEATURING JEWELRY (U.S. CLS. 100, 101 AND 102).
FIRST USE 7-0-2006; IN COMMERCE 7-0-2006.

3,400,059. HR CAPITAL MANAGEMENT, INC., ROCKVILLE, MD. SN 78-934,499. PUB. 8-14-2007, FILED 7-21-2006.



THE COLOR(S) BLACK, BLUE, AND YELLOW IS/ARE CLAIMED AS A FEATURE OF THE MARK.

THE FIRST STYLIZED FIGURE CONSISTS OF A BLACK HEAD AND A BLUE CHEST AND ARMS. THE SECOND STYLIZED FIGURE CONSISTS OF A BLACK HEAD AND A YELLOW CHEST AND ARMS. THE THIRD STYLIZED FIGURE CONSISTS OF A BLACK HEAD AND BLUE CHEST AND ARMS. THE COLOR BLUE APPEARS IN THE WORDING "TALENT" AND IN THE UNDERLINE DESIGN. THE COLOR YELLOW APPEARS IN THE WORDING "PRO". THE COLOR BLACK APPEARS IN THE WORDING "PEOPLE RESOURCE SOLUTIONS".

FOR EMPLOYMENT AGENCY SERVICES, NAMELY, TEMPORARY AND PERMANENT STAFFING, PERSONNEL RECRUITMENT, AND HUMAN RESOURCES MANAGEMENT (U.S. CLS. 100, 101 AND 102).
FIRST USE 6-1-2006; IN COMMERCE 6-1-2006.

3,400,068. MILLER BROTHERS FURNITURE, FALLSCREEK, PA. SN 78-938,246. PUB. 3-20-2007, FILED 7-26-2006.

EBENEZER'S FURNITURE FOR THE LITTLE BIT OF SCROOGE IN ALL OF US

THE MARK CONSISTS OF STANDARD CHARACTERS WITHOUT CLAIM TO ANY PARTICULAR FONT, STYLE, SIZE, OR COLOR.

NO CLAIM IS MADE TO THE EXCLUSIVE RIGHT TO USE "FURNITURE", APART FROM THE MARK AS

CLASS 35—(Continued).

SHOWN.
 THE NAME "EBENEZER" DOES NOT IDENTIFY A LIVING INDIVIDUAL.
 FOR RETAIL FURNITURE STORES (U.S. CLS. 100, 101 AND 102).
 FIRST USE 8-1-2006; IN COMMERCE 11-29-2007.

CLASS 35—(Continued).

3,400,116. PANNELL KERR FORSTER OF TEXAS, P.C., HOUSTON, TX. SN 78-955,728. PUB. 7-31-2007, FILED 8-18-2006.

3,400,079. ORANGE COUNTY PARKS AND RECREATION DIVISION, ORLANDO, FL. SN 78-943,214. PUB. 3-27-2007, FILED 8-2-2006.

PKF - PEOPLE THE KEY TO OUR FUTURE

Clean, Green, Fun!

THE COLOR(S) GREEN, ORANGE AND BLUE IS/ARE CLAIMED AS A FEATURE OF THE MARK.
 THE COLORS GREEN, ORANGE AND BLUE APPEAR IN THE WORDS CLEAN, GREEN AND FUN RESPECTIVELY.
 FOR ADVERTISING THROUGH ALL PUBLIC COMMUNICATION MEANS (U.S. CLS. 100, 101 AND 102).
 FIRST USE 4-6-2007; IN COMMERCE 4-6-2007.

THE MARK CONSISTS OF STANDARD CHARACTERS WITHOUT CLAIM TO ANY PARTICULAR FONT, STYLE, SIZE, OR COLOR.
 FOR BUSINESS ADVISORY SERVICES AND ACCOUNTING SERVICES FOR OTHERS; BUSINESS CONSULTING SERVICES; ACCOUNTING SERVICES; BUSINESS AUDITING SERVICES; ACCOUNT AUDITING; TAX CONSULTATION AND ADVISORY SERVICES; PROVIDING BUSINESS MANAGEMENT INFORMATION IN CONNECTION WITH CONSULTING AND ADVISORY SERVICES IN THE FIELD OF STRATEGIC PLANNING (U.S. CLS. 100, 101 AND 102).
 FIRST USE 10-13-2006; IN COMMERCE 10-13-2006.

3,400,081. CRITERIA CORPORATION, LOS ANGELES, CA. SN 78-943,654. PUB. 10-9-2007, FILED 8-2-2006.

3,400,118. GOLDEN GATE ANCILLARY LLC, FORT SMITH, AR. SN 78-956,190. PUB. 6-19-2007, FILED 8-21-2006.

HireSelect

aedon 
staffing

THE MARK CONSISTS OF STANDARD CHARACTERS WITHOUT CLAIM TO ANY PARTICULAR FONT, STYLE, SIZE, OR COLOR.
 FOR CONSULTING SERVICES IN THE FIELD OF HUMAN RESOURCES DEVELOPMENT, NAMELY, FOR THE PROMOTION OF EMPLOYEE RETENTION, CAREER GROWTH, AND INCREASED PRODUCTIVITY FOR EMPLOYEES AND EMPLOYERS; EMPLOYMENT COUNSELING AND RECRUITING; EMPLOYMENT HIRING, RECRUITING, PLACEMENT, STAFFING AND CAREER NETWORKING SERVICES; PSYCHOLOGICAL TESTING FOR THE SELECTION OF PERSONNEL; TESTING TO DETERMINE EMPLOYMENT SKILLS; TESTING TO DETERMINE JOB COMPETENCY; TESTING TO DETERMINE PROFESSIONAL COMPETENCY; WORK ANALYSIS TO DETERMINE WORKER SKILL SETS AND OTHER WORKER REQUIREMENTS (U.S. CLS. 100, 101 AND 102).
 FIRST USE 4-11-2007; IN COMMERCE 4-11-2007.

OWNER OF U.S. REG. NOS. 2,952,410 AND 3,151,939.
 NO CLAIM IS MADE TO THE EXCLUSIVE RIGHT TO USE "STAFFING", APART FROM THE MARK AS SHOWN.
 THE MARK CONSISTS OF THE LITERAL ELEMENT "AEDON" AND FOUR GEOMETRIC SHAPES REPRESENTING A MAN AND A RIBBON. THE GEOMETRIC SHAPES CONSIST OF A CIRCLE REPRESENTING THE HEAD OF THE MAN, AN UPTURNED CRESCENT REPRESENTING THE UPPER BODY OF THE MAN, A DOWN-TURNED CRESCENT REPRESENTING THE LOWER HALF OF THE MAN, AND A CRESCENT WITH THE POINTS FACING THE LEFT REPRESENTING THE RIBBON. THE RIGHT TIPS OF THE CRESCENT REPRESENTING THE MAN'S UPPER AND LOWER HALF ARE TOUCHING THE TOP AND BOTTOM OF THE CRESCENT REPRESENTING THE RIBBON AND THE LITERAL ELEMENT "STAFFING."
 FOR TEMPORARY STAFFING, NAMELY, TEMPORARY EMPLOYMENT AGENCIES (U.S. CLS. 100, 101 AND 102).
 FIRST USE 4-22-2004; IN COMMERCE 4-22-2004.

CLASS 35—(Continued).

3,400,153. MAINTENANCE SUPPLY HEADQUARTERS, LP, STAFFORD, TX. SN 78-963,228. PUB. 4-24-2007, FILED 8-29-2006.



NO CLAIM IS MADE TO THE EXCLUSIVE RIGHT TO USE "MAINTENANCE SUPPLY", APART FROM THE MARK AS SHOWN.

FOR WHOLESALE DISTRIBUTORSHIP AND RETAIL STORE SERVICES FEATURING BUILDING MAINTENANCE SUPPLIES, PARTS, TOOLS AND ACCESSORIES (U.S. CLS. 100, 101 AND 102).

FIRST USE 0-0-2006; IN COMMERCE 0-0-2006.

3,400,156. ARXCEL, INC., WILLIAMSVILLE, NY. SN 78-963,838. PUB. 4-24-2007, FILED 8-30-2006.

ARXANALYSIS

THE MARK CONSISTS OF STANDARD CHARACTERS WITHOUT CLAIM TO ANY PARTICULAR FONT, STYLE, SIZE, OR COLOR.

FOR BUSINESS SERVICES; NAMELY, ADVISING OTHERS WITH RESPECT TO THE DESIGN, DEVELOPMENT, ACQUISITION AND ANALYSIS OF MANAGED HEALTH CARE AND PRESCRIPTION DRUG BENEFIT PLANS (U.S. CLS. 100, 101 AND 102).

FIRST USE 8-31-2006; IN COMMERCE 8-31-2006.

3,400,157. GUIDEPOINT GLOBAL, LLC, NEW YORK, NY. SN 78-963,859. PUB. 5-1-2007, FILED 8-30-2006.

GUIDEPOINT GLOBAL

THE MARK CONSISTS OF STANDARD CHARACTERS WITHOUT CLAIM TO ANY PARTICULAR FONT, STYLE, SIZE, OR COLOR.

NO CLAIM IS MADE TO THE EXCLUSIVE RIGHT TO USE "GLOBAL", APART FROM THE MARK AS SHOWN.

FOR INFORMATION IN BUSINESS MATTERS AND BUSINESS CONSULTING AND INFORMATION SERVICES (U.S. CLS. 100, 101 AND 102).

FIRST USE 11-27-2007; IN COMMERCE 11-27-2007.

CLASS 35—(Continued).

3,400,175. SERVINGSCHOOLS.COM, PORTLAND, ME. SN 78-967,269. PUB. 10-2-2007, FILED 9-5-2006.

VENDORCONNECTION

THE MARK CONSISTS OF STANDARD CHARACTERS WITHOUT CLAIM TO ANY PARTICULAR FONT, STYLE, SIZE, OR COLOR.

FOR PROVIDING ONLINE DIRECTORIES OF PRODUCTS AND SERVICES BY BUSINESSES THAT FOCUS ON SCHOOLS AND PROVIDING LINKS TO THESE WEBSITES (U.S. CLS. 100, 101 AND 102).

FIRST USE 9-1-2006; IN COMMERCE 9-1-2006.

3,400,179. THE FRESH MARKET, INC., GREENSBORO, NC. SN 78-968,399. PUB. 4-24-2007, FILED 9-6-2006.

EXPERIENCE THE FOOD

THE MARK CONSISTS OF STANDARD CHARACTERS WITHOUT CLAIM TO ANY PARTICULAR FONT, STYLE, SIZE, OR COLOR.

FOR RETAIL GROCERY STORE SERVICES (U.S. CLS. 100, 101 AND 102).

FIRST USE 12-26-2007; IN COMMERCE 12-26-2007.

3,400,192. JOHN C. JEPPESEN, DMD, INC., VENTURA, CA. SN 78-970,871. PUB. 6-5-2007, FILED 9-10-2006.

STENOMED

THE MARK CONSISTS OF STANDARD CHARACTERS WITHOUT CLAIM TO ANY PARTICULAR FONT, STYLE, SIZE, OR COLOR.

FOR BILLING SERVICES; MEDICAL TRANSCRIPTION SERVICES (U.S. CLS. 100, 101 AND 102).

FIRST USE 1-16-2008; IN COMMERCE 1-16-2008.

CLASS 35—(Continued).

3,400,195. VCFO HOLDINGS, INC, AUSTIN, TX. SN 78-971,608. PUB. 4-24-2007, FILED 9-11-2006.

CLASS 36—(Continued).

3,398,918. MERRILL LYNCH & CO., INC., NEW YORK, NY. SN 76-655,245. PUB. 4-17-2007, FILED 2-13-2006.

VCONTROLLER

THE MARK CONSISTS OF STANDARD CHARACTERS WITHOUT CLAIM TO ANY PARTICULAR FONT, STYLE, SIZE, OR COLOR.

FOR BUSINESS MANAGEMENT AND CONSULTATION SERVICES IN THE NATURE OF BUDGETING, FORECASTING AND ACCOUNTING SERVICES (U.S. CLS. 100, 101 AND 102).

FIRST USE 7-19-2007; IN COMMERCE 7-19-2007.

TRUST ADMINISTRATIVE ADVANTAGE

THE MARK CONSISTS OF STANDARD CHARACTERS WITHOUT CLAIM TO ANY PARTICULAR FONT, STYLE, SIZE, OR COLOR.

NO CLAIM IS MADE TO THE EXCLUSIVE RIGHT TO USE "TRUST ADMINISTRATIVE", APART FROM THE MARK AS SHOWN.

FOR FINANCIAL SERVICES, NAMELY, THE OFFERING OF A TRUST ACCOUNT PROVIDING INVESTMENT SERVICES AND ADMINISTRATIVE ASSISTANCE TO INDIVIDUAL TRUSTEES (U.S. CLS. 100, 101 AND 102).

FIRST USE 4-1-2006; IN COMMERCE 4-1-2006.

3,400,218. ANDIN INTERNATIONAL INC., NEW YORK, NY. SN 78-979,639. PUB. 8-22-2006, FILED 1-31-2006.

September is Sapphire Month

THE MARK CONSISTS OF STANDARD CHARACTERS WITHOUT CLAIM TO ANY PARTICULAR FONT, STYLE, SIZE, OR COLOR.

NO CLAIM IS MADE TO THE EXCLUSIVE RIGHT TO USE "SAPPHIRE", APART FROM THE MARK AS SHOWN.

FOR ADVERTISING SERVICES, FOR THIRD PARTIES, IN CONNECTION WITH THE COMMERCIALIZATION AND SALE OF JEWELRY, CREATION OF MARKETING TOOLS DESIGNED TO INCREASE A CLIENT COMPANY'S KNOWLEDGE OF CUSTOMER NEEDS AND ITS COMPETITORS PRODUCTS, PRICING, ADVERTISING STRATEGY AND SALES STRATEGY, COOPERATIVE ADVERTISING AND MARKETING AND DISSEMINATION OF ADVERTISING MATERIALS (U.S. CLS. 100, 101 AND 102).

FIRST USE 9-1-2007; IN COMMERCE 9-1-2007.

3,398,922. FLORIDA LEISURE, INC, KISSIMMEE, FL. SN 76-659,353. PUB. 3-20-2007, FILED 5-1-2006.

FLORIDA LEISURE

THE MARK CONSISTS OF STANDARD CHARACTERS WITHOUT CLAIM TO ANY PARTICULAR FONT, STYLE, SIZE, OR COLOR.

NO CLAIM IS MADE TO THE EXCLUSIVE RIGHT TO USE "FLORIDA", APART FROM THE MARK AS SHOWN.

FOR REAL ESTATE SERVICES, NAMELY, REAL ESTATE MANAGEMENT (U.S. CLS. 100, 101 AND 102).

FIRST USE 1-1-2007; IN COMMERCE 1-1-2007.

3,398,941. 735 AVENUE OF THE AMERICAS LLC, BERWYN, PA. SN 76-666,287. PUB. 5-15-2007, FILED 9-19-2006.

CHELSEA STRATUS

THE MARK CONSISTS OF STANDARD CHARACTERS WITHOUT CLAIM TO ANY PARTICULAR FONT, STYLE, SIZE, OR COLOR.

NO CLAIM IS MADE TO THE EXCLUSIVE RIGHT TO USE "CHELSEA", APART FROM THE MARK AS SHOWN.

FOR REAL ESTATE SERVICES, NAMELY, CONDOMINIUM BROKERAGE (U.S. CLS. 100, 101 AND 102).

FIRST USE 3-1-2007; IN COMMERCE 3-1-2007.

CLASS 36—INSURANCE AND FINANCIAL

CLASS 36—(Continued).

3,399,011. ECASH4.NET CORP, NEWARK, DE. SN 77-018,325. PUB. 5-22-2007, FILED 10-11-2006.

PAYTOO

THE MARK CONSISTS OF STANDARD CHARACTERS WITHOUT CLAIM TO ANY PARTICULAR FONT, STYLE, SIZE, OR COLOR.

FOR BILL PAYMENT SERVICES; COLLECTING LICENSE FEES ON BEHALF OF INDEPENDENT WRITERS AND PUBLISHERS AND MAKING PAYMENTS TO THE COPYRIGHT OWNERS OF THE MUSIC; ELECTRONIC COMMERCE PAYMENT SERVICES, NAMELY, ESTABLISHING FUNDED ACCOUNTS USED TO PURCHASE GOODS AND SERVICES ON THE INTERNET; ELECTRONIC PAYMENT, NAMELY, ELECTRONIC PROCESSING AND TRANSMISSION OF BILL PAYMENT DATA; ELECTRONIC PROCESSING OF INSURANCE CLAIMS AND PAYMENT DATA; EQUIPMENT MAINTENANCE CLAIMS PAYMENT SERVICE FOR BUSINESS; FIDUCIARY TAX PAYMENT PROCESSING SERVICES; MAKING PAYMENTS ON PRE-PAID LONG DISTANCE CALLING CARDS FOR RECHARGING MINUTES; MONEY ORDER PAYMENT GUARANTEE SERVICES; PRE-PAID PURCHASE CARD SERVICES, NAMELY, PROCESSING ELECTRONIC PAYMENTS MADE THROUGH PREPAID CARDS; PRE-PAID PURCHASE CARD SERVICES, NAMELY, PROCESSING ELECTRONIC PAYMENTS THROUGH PRE-PAID CARDS; PREPAID CARD SERVICES IN THE NATURE OF MAKING PAYMENT FOR ADDING AIRTIME TO PREPAID OR PAY-AS-YOU-GO WIRELESS SERVICES; PROVIDING ELECTRONIC PROCESSING OF CREDIT CARD TRANSACTIONS AND ELECTRONIC PAYMENTS VIA A GLOBAL COMPUTER NETWORK; PROVIDING MULTIPLE PAYMENT OPTIONS BY MEANS OF CUSTOMER-OPERATED ELECTRONIC TERMINALS AVAILABLE ON-SITE IN RETAIL STORES; TAX PAYMENT PROCESSING SERVICES; WIRELESS TELEPHONE PAYMENT SERVICES, NAMELY, WIRELESS MOBILE TELEPHONE RATE PLANS (U.S. CLS. 100, 101 AND 102).

FIRST USE 1-1-2007; IN COMMERCE 1-1-2007.

3,399,020. HONEYWELL FEDERAL CREDIT UNION, MINNEAPOLIS, MN. SN 77-022,127. PUB. 5-22-2007, FILED 10-16-2006.

ENDURA FINANCIAL FEDERAL CREDIT UNION

THE MARK CONSISTS OF STANDARD CHARACTERS WITHOUT CLAIM TO ANY PARTICULAR FONT, STYLE, SIZE, OR COLOR.

NO CLAIM IS MADE TO THE EXCLUSIVE RIGHT TO USE "FINANCIAL FEDERAL CREDIT UNION", APART FROM THE MARK AS SHOWN.

FOR CREDIT UNION SERVICES (U.S. CLS. 100, 101 AND 102).

FIRST USE 10-17-2007; IN COMMERCE 10-17-2007.

CLASS 36—(Continued).

3,399,079. OXONIA INSURANCE GROUP, INC., PLANTATION, FL. SN 77-049,520. PUB. 4-24-2007, FILED 11-22-2006.

BE CERTAIN. BE CONFIDENT.
BE SURE ABOUT YOUR HEALTH.

THE MARK CONSISTS OF STANDARD CHARACTERS WITHOUT CLAIM TO ANY PARTICULAR FONT, STYLE, SIZE, OR COLOR.

FOR INSURANCE AGENCY AND BROKERAGE SERVICES (U.S. CLS. 100, 101 AND 102).

FIRST USE 12-5-2006; IN COMMERCE 12-5-2006.

3,399,089. SEACROSS GLOBAL ADVISORS LLC, BOSTON, MA. SN 77-056,458. PUB. 8-21-2007, FILED 12-4-2006.

SEACROSS GLOBAL ADVISORS

THE MARK CONSISTS OF STANDARD CHARACTERS WITHOUT CLAIM TO ANY PARTICULAR FONT, STYLE, SIZE, OR COLOR.

NO CLAIM IS MADE TO THE EXCLUSIVE RIGHT TO USE "GLOBAL ADVISORS", APART FROM THE MARK AS SHOWN.

FOR FINANCIAL SERVICES, NAMELY, HEDGE FUND INVESTMENT SERVICES AND INVESTMENT ADVISORY SERVICES (U.S. CLS. 100, 101 AND 102).

FIRST USE 4-1-2007; IN COMMERCE 4-1-2007.

CLASS 36—(Continued).

3,399,096. VAN KAMPEN INVESTMENTS INC., NEW YORK, NY. SN 77-061,629. PUB. 8-21-2007, FILED 12-11-2006.



NO CLAIM IS MADE TO THE EXCLUSIVE RIGHT TO USE THE GREEK SYMBOL "ALPHA", APART FROM THE MARK AS SHOWN.

THE MARK CONSISTS OF THE WORDS "VK ALPHA" IN STYLIZED LETTERS BELOW A GREEK LOWER CASE LETTER REPRESENTING "ALPHA".

FOR FINANCIAL SERVICES, NAMELY, MUTUAL FUND BROKERAGE SERVICES, ADMINISTERING MUTUAL FUND INVESTMENTS, AND FINANCIAL ADVISORY SERVICES (U.S. CLS. 100, 101 AND 102).

FIRST USE 2-0-2007; IN COMMERCE 2-0-2007.

3,399,122. COMMUNITY WEST FOUNDATION, CLEVELAND, OH. SN 77-069,355. PUB. 10-2-2007, FILED 12-21-2006.

Invest West

THE MARK CONSISTS OF STANDARD CHARACTERS WITHOUT CLAIM TO ANY PARTICULAR FONT, STYLE, SIZE, OR COLOR.

NO CLAIM IS MADE TO THE EXCLUSIVE RIGHT TO USE "INVEST", APART FROM THE MARK AS SHOWN.

FOR CHARITABLE FUNDRAISING AND CHARITABLE SERVICES, NAMELY, PROVIDING MONETARY CONTRIBUTIONS TO NOT-FOR-PROFIT OR EDUCATION BASED SERVICES IN WESTERN GREATER CLEVELAND; FINANCIAL CONSULTING SERVICES IN THE AREA OF PHILANTHROPY TO INDIVIDUALS AND CHARITABLE ORGANIZATIONS AND PROFESSIONAL FINANCIAL ADVISORS (U.S. CLS. 100, 101 AND 102).

FIRST USE 1-1-2007; IN COMMERCE 1-1-2007.

CLASS 36—(Continued).

3,399,137. BROTHERHOOD MUTUAL INSURANCE COMPANY, FORT WAYNE, IN. SN 77-076,083. PUB. 7-31-2007, FILED 1-4-2007.

SAFETYCENTRAL

THE MARK CONSISTS OF STANDARD CHARACTERS WITHOUT CLAIM TO ANY PARTICULAR FONT, STYLE, SIZE, OR COLOR.

NO CLAIM IS MADE TO THE EXCLUSIVE RIGHT TO USE "SAFETY", APART FROM THE MARK AS SHOWN.

FOR RISK MANAGEMENT SERVICES; RISK MANAGEMENT CONSULTATION (U.S. CLS. 100, 101 AND 102).

FIRST USE 1-0-2007; IN COMMERCE 8-31-2007.

3,399,178. HIGHER CALL INC, LANCASTER, PA. SN 77-097,560. PUB. 8-14-2007, FILED 2-2-2007.

Feed Your Family Feed The World

THE MARK CONSISTS OF STANDARD CHARACTERS WITHOUT CLAIM TO ANY PARTICULAR FONT, STYLE, SIZE, OR COLOR.

FOR PROVIDING A WEBSITE FEATURING CHARITABLE SERVICES, NAMELY, RAISING FUNDS THROUGH SELLING PRODUCTS (U.S. CLS. 100, 101 AND 102).

FIRST USE 12-7-2007; IN COMMERCE 12-7-2007.

3,399,220. SUNTRUST BANKS, INC., ORLANDO, FL. SN 77-116,903. PUB. 8-28-2007, FILED 2-27-2007.

SIGNATURE ADVANTAGE BROKERAGE FOR BUSINESS

THE MARK CONSISTS OF STANDARD CHARACTERS WITHOUT CLAIM TO ANY PARTICULAR FONT, STYLE, SIZE, OR COLOR.

OWNER OF U.S. REG. NO. 2,848,314.

NO CLAIM IS MADE TO THE EXCLUSIVE RIGHT TO USE "BROKERAGE FOR BUSINESS", APART FROM THE MARK AS SHOWN.

FOR FINANCIAL SERVICES, NAMELY, TRADITIONAL BANKING COMBINED WITH WEALTH MANAGEMENT (U.S. CLS. 100, 101 AND 102).

FIRST USE 5-0-2007; IN COMMERCE 5-0-2007.

CLASS 36—(Continued).

3,399,223. IN THE ARENA, INC., CAMBRIDGE, MA. SN 77-119,311. PUB. 8-28-2007, FILED 3-1-2007.

IN THE ARENA

THE MARK CONSISTS OF STANDARD CHARACTERS WITHOUT CLAIM TO ANY PARTICULAR FONT, STYLE, SIZE, OR COLOR.

FOR CHARITABLE FUNDRAISING SERVICES RELATED TO ATHLETICS, YOUTH ENRICHMENT, AND CIVIC ENGAGEMENT (U.S. CLS. 100, 101 AND 102).

FIRST USE 9-9-2006; IN COMMERCE 9-9-2006.

3,399,224. IN THE ARENA, INC., CAMBRIDGE, MA. SN 77-119,340. PUB. 8-28-2007, FILED 3-1-2007.



THE MARK CONSISTS OF THE HEAD AND ARMS OF A STYLIZED STICK FIGURE. THE ARMS ARE RAISED OVERHEAD, HOLDING UP A CIRCULAR OBJECT. BE-NEATH THE FIGURE ARE THE WORDS "IN THE ARENA".

FOR CHARITABLE FUNDRAISING SERVICES RELATED TO ATHLETICS, YOUTH ENRICHMENT, AND CIVIC ENGAGEMENT (U.S. CLS. 100, 101 AND 102).

FIRST USE 3-13-2007; IN COMMERCE 3-13-2007.

3,399,238. SRQ PROPERTY GROUP, LLC, SARASOTA, FL. SN 77-125,841. PUB. 9-11-2007, FILED 3-8-2007.

GOLFSTYLE

THE MARK CONSISTS OF STANDARD CHARACTERS WITHOUT CLAIM TO ANY PARTICULAR FONT, STYLE, SIZE, OR COLOR.

FOR REAL ESTATE LISTING SERVICES FOR RESIDENTIAL PROPERTIES (U.S. CLS. 100, 101 AND 102).

FIRST USE 8-1-2007; IN COMMERCE 8-1-2007.

CLASS 36—(Continued).

3,399,275. AMERICAN INTERNATIONAL GROUP, INC., NEW YORK, NY. SN 77-148,605. PUB. 9-11-2007, FILED 4-4-2007.

AIG RETIREMENT

THE MARK CONSISTS OF STANDARD CHARACTERS WITHOUT CLAIM TO ANY PARTICULAR FONT, STYLE, SIZE, OR COLOR.

OWNER OF U.S. REG. NOS. 1,172,557, 2,965,066, AND OTHERS.

NO CLAIM IS MADE TO THE EXCLUSIVE RIGHT TO USE "RETIREMENT", APART FROM THE MARK AS SHOWN.

FOR INVESTMENT ADVISORY SERVICES; FINANCIAL INVESTMENT IN THE FIELD OF MUTUAL FUNDS, ANNUITIES, RETIREMENT PLANS, AND ESTATE PLANNING (U.S. CLS. 100, 101 AND 102).

FIRST USE 1-1-2008; IN COMMERCE 1-1-2008.

3,399,326. DISNEY ENTERPRISES, INC., BURBANK, CA. SN 78-262,171. PUB. 9-14-2004, FILED 6-13-2003.

**GRAND CENTRAL
CREATIVE CAMPUS**

FOR REAL ESTATE SERVICES, NAMELY, REAL ESTATE LEASING AND MANAGEMENT SERVICES (U.S. CLS. 100, 101 AND 102).

FIRST USE 11-2-2006; IN COMMERCE 11-2-2006.

3,399,413. FLEETWOOD ENTERPRISES, INC., RIVERSIDE, CA. SN 78-503,948. PUB. 11-29-2005, FILED 10-21-2004.

**THE ROAD TO
HAPPINESS, NOW
OPEN**

THE MARK CONSISTS OF STANDARD CHARACTERS WITHOUT CLAIM TO ANY PARTICULAR FONT, STYLE, SIZE, OR COLOR.

FOR FINANCIAL MANAGEMENT SERVICES, NAMELY, FORMATION, BROKERAGE AND MANAGEMENT OF TIME-SHARE INTERESTS IN RECREATIONAL VEHICLES (U.S. CLS. 100, 101 AND 102).

FIRST USE 1-0-2005; IN COMMERCE 1-0-2005.

CLASS 36—(Continued).

3,399,452. MARSHALL BANKFIRST CORP., MINNEAPOLIS, MN. SN 78-533,708. PUB. 5-23-2006, FILED 12-16-2004.

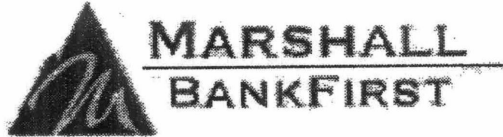

THE MARK CONSISTS OF A DISTINCTIVE LOGO COMPRISING A FANCIFUL DESIGN OF A MOUNTAIN WITH THE LETTER "M" INSIDE THE MOUNTAIN AND THE WORDS "MARSHALL BANKFIRST" BENEATH THE MOUNTAIN.

FOR BANKING SERVICES (U.S. CLS. 100, 101 AND 102).

FIRST USE 8-0-2005; IN COMMERCE 8-0-2005.

CLASS 36—(Continued).

3,399,497. ENVIN, LLC, EXTON, PA. SN 78-598,310. PUB. 12-27-2005, FILED 3-30-2005.

ENVIN

THE MARK CONSISTS OF STANDARD CHARACTERS WITHOUT CLAIM TO ANY PARTICULAR FONT, STYLE, SIZE, OR COLOR.

FOR INSURANCE BROKERAGE SERVICES; INSURANCE BROKERAGE SERVICES IN THE FIELD OF ENVIRONMENTAL INSURANCE; INSURANCE CONSULTATION SERVICES (U.S. CLS. 100, 101 AND 102).

FIRST USE 1-10-2003; IN COMMERCE 1-10-2003.

3,399,471. CHICAGO CLIMATE EXCHANGE, INC., CHICAGO, IL. SN 78-561,993. PUB. 11-15-2005, FILED 2-7-2005.

ECX CFI

THE MARK CONSISTS OF STANDARD CHARACTERS WITHOUT CLAIM TO ANY PARTICULAR FONT, STYLE, SIZE, OR COLOR.

FOR COMMODITY EXCHANGE SERVICES, NAMELY, DIOXIDE AND OTHER GREENHOUSE GAS EMISSIONS EXCHANGE SERVICES THAT FACILITATE THE TRADING OR SALE OF CARBON DIOXIDE AND OTHER GREENHOUSE GAS EMISSIONS ALLOWANCES AND OFFSETS BETWEEN BUSINESS AND OTHER MARKET PARTICIPANTS (U.S. CLS. 100, 101 AND 102).

FIRST USE 4-22-2005; IN COMMERCE 4-22-2005.

3,399,504. CUBIS FINANCIAL, LTD., LAS VEGAS, NV. SN 78-601,737. PUB. 9-12-2006, FILED 4-5-2005.

CUBIS FINANCIAL CORPORATION

THE MARK CONSISTS OF STANDARD CHARACTERS WITHOUT CLAIM TO ANY PARTICULAR FONT, STYLE, SIZE, OR COLOR.

NO CLAIM IS MADE TO THE EXCLUSIVE RIGHT TO USE "FINANCIAL CORPORATION", APART FROM THE MARK AS SHOWN.

FOR FINANCIAL SERVICES IN THE NATURE OF PROVIDING PAYROLL CARD, DEBIT CARD, AND STORED VALUE CARD ACCOUNTS (U.S. CLS. 100, 101 AND 102).

FIRST USE 6-15-2005; IN COMMERCE 6-15-2005.

CLASS 36—(Continued).

3,399,507. PUBLIC BROADCASTING SERVICE, ARLINGTON, VA. SN 78-606,657. PUB. 1-10-2006, FILED 4-12-2005.

PBS FOUNDATION

THE MARK CONSISTS OF STANDARD CHARACTERS WITHOUT CLAIM TO ANY PARTICULAR FONT, STYLE, SIZE, OR COLOR.

OWNER OF U.S. REG. NOS. 1,247,905, 2,707,600, AND OTHERS.

NO CLAIM IS MADE TO THE EXCLUSIVE RIGHT TO USE "FOUNDATION", APART FROM THE MARK AS SHOWN.

FOR CHARITABLE FUNDRAISING SERVICES (U.S. CLS. 100, 101 AND 102).

FIRST USE 6-0-2007; IN COMMERCE 6-0-2007.

CLASS 36—(Continued).

3,399,607. UBS FINANCIAL SERVICES INC., WEEHAWKEN, NJ. SN 78-701,004. PUB. 4-24-2007, FILED 8-26-2005.

STRATEGIC WEALTH PORTFOLIOS

THE MARK CONSISTS OF STANDARD CHARACTERS WITHOUT CLAIM TO ANY PARTICULAR FONT, STYLE, SIZE, OR COLOR.

NO CLAIM IS MADE TO THE EXCLUSIVE RIGHT TO USE "PORTFOLIOS", APART FROM THE MARK AS SHOWN.

FOR STOCK BROKERAGE, MONEY MANAGEMENT, AND INVESTMENT ADVISORY SERVICES (U.S. CLS. 100, 101 AND 102).

FIRST USE 10-0-2006; IN COMMERCE 10-0-2006.

3,399,537. EMERALD HILL CAPITAL PARTNERS, LLC, DOVER, DE. SN 78-638,105. PUB. 8-22-2006, FILED 5-26-2005.

EMERALD HILL CAPITAL PARTNERS

THE MARK CONSISTS OF STANDARD CHARACTERS WITHOUT CLAIM TO ANY PARTICULAR FONT, STYLE, SIZE, OR COLOR.

NO CLAIM IS MADE TO THE EXCLUSIVE RIGHT TO USE "CAPITAL PARTNERS", APART FROM THE MARK AS SHOWN.

FOR FUNDS INVESTMENT AND INVESTMENT OF FUNDS FOR OTHERS (U.S. CLS. 100, 101 AND 102).

FIRST USE 10-25-2007; IN COMMERCE 10-25-2007.

3,399,609. CITIGROUP GLOBAL MARKETS INC., NEW YORK, NY. SN 78-705,103. PUB. 5-16-2006, FILED 9-1-2005.

DISCS

THE MARK CONSISTS OF STANDARD CHARACTERS WITHOUT CLAIM TO ANY PARTICULAR FONT, STYLE, SIZE, OR COLOR.

FOR FINANCIAL AND INVESTMENT SERVICES, NAMELY IN THE NATURE OF AN INVESTMENT SECURITY (U.S. CLS. 100, 101 AND 102).

FIRST USE 8-0-2005; IN COMMERCE 9-0-2005.

3,399,577. FIRST CHOICE MORTGAGE, INC., WAUKESHA, WI. SN 78-675,097. PUB. 2-21-2006, FILED 7-21-2005.



NO CLAIM IS MADE TO THE EXCLUSIVE RIGHT TO USE "MORTGAGE", APART FROM THE MARK AS SHOWN.

FOR MORTGAGE LENDING SERVICES (U.S. CLS. 100, 101 AND 102).

FIRST USE 1-1-2007; IN COMMERCE 1-1-2007.

3,399,689. SYSCO CORPORATION, HOUSTON, TX. SN 78-757,767. PUB. 7-25-2006, FILED 11-20-2005.

DEDICATION TO VALUE

THE MARK CONSISTS OF STANDARD CHARACTERS WITHOUT CLAIM TO ANY PARTICULAR FONT, STYLE, SIZE, OR COLOR.

FOR FINANCIAL MANAGEMENT SERVICES IN THE HEALTHCARE INDUSTRY (U.S. CLS. 100, 101 AND 102).

FIRST USE 2-1-2006; IN COMMERCE 2-1-2006.

CLASS 36—(Continued).

3,399,787. VESTA CREDIT SOLUTIONS, LLC, PORTLAND, WA. SN 78-796,082. PUB. 9-26-2006, FILED 1-20-2006.

**ENHANCED DECISION
MANAGEMENT**

THE MARK CONSISTS OF STANDARD CHARACTERS WITHOUT CLAIM TO ANY PARTICULAR FONT, STYLE, SIZE, OR COLOR.

NO CLAIM IS MADE TO THE EXCLUSIVE RIGHT TO USE "MANAGEMENT", APART FROM THE MARK AS SHOWN.

FOR COMPUTERIZED FINANCIAL SERVICES IN THE FIELD OF CUSTOMER QUALIFICATION, RISK ASSESSMENT AND TELECOMMUNICATIONS CUSTOMER ACCOUNT ACTIVATION (U.S. CLS. 100, 101 AND 102).

FIRST USE 2-1-2005; IN COMMERCE 2-1-2005.

3,399,788. VESTA CREDIT SOLUTIONS, LLC, PORTLAND, WA. SN 78-796,087. PUB. 9-19-2006, FILED 1-20-2006.

EDM

THE MARK CONSISTS OF STANDARD CHARACTERS WITHOUT CLAIM TO ANY PARTICULAR FONT, STYLE, SIZE, OR COLOR.

FOR COMPUTERIZED FINANCIAL SERVICES IN THE FIELD OF CUSTOMER QUALIFICATION, RISK ASSESSMENT AND TELECOMMUNICATIONS CUSTOMER ACCOUNT ACTIVATION (U.S. CLS. 100, 101 AND 102).

FIRST USE 2-1-2005; IN COMMERCE 2-1-2005.

3,399,802. INFINITY INSURANCE COMPANY, BIRMINGHAM, AL. SN 78-800,125. PUB. 4-3-2007, FILED 1-26-2006.

**INFINITY SAFEGUARD
INSURANCE COMPANY**

THE MARK CONSISTS OF STANDARD CHARACTERS WITHOUT CLAIM TO ANY PARTICULAR FONT, STYLE, SIZE, OR COLOR.

OWNER OF U.S. REG. NOS. 1,818,191, 2,472,418, AND OTHERS.

NO CLAIM IS MADE TO THE EXCLUSIVE RIGHT TO USE "INSURANCE COMPANY", APART FROM THE MARK AS SHOWN.

FOR PROPERTY AND CASUALTY INSURANCE UNDERWRITING SERVICES (U.S. CLS. 100, 101 AND 102). FIRST USE 4-9-2007; IN COMMERCE 4-9-2007.

CLASS 36—(Continued).

3,399,816. THE SUSAN G. KOMEN BREAST CANCER FOUNDATION, INC., DALLAS, TX. SN 78-805,285. PUB. 9-5-2006, FILED 2-2-2006.

ON DECK FOR THE CURE

THE MARK CONSISTS OF STANDARD CHARACTERS WITHOUT CLAIM TO ANY PARTICULAR FONT, STYLE, SIZE, OR COLOR.

OWNER OF U.S. REG. NOS. 1,593,469, 2,075,352, AND 2,406,792.

FOR CHARITABLE FUNDRAISING SERVICES, NAMELY, RAISING MONEY FOR BREAST CANCER RESEARCH AND RAISING MONEY FOR LOCAL COMMUNITY BREAST HEALTH AWARENESS PROGRAMS (U.S. CLS. 100, 101 AND 102).

FIRST USE 2-0-2006; IN COMMERCE 2-0-2006.

3,399,835. KRISTYNIK, KRIS, DALLAS, TX. SN 78-813,834. PUB. 9-19-2006, FILED 2-13-2006.

LONGHORN

THE MARK CONSISTS OF STANDARD CHARACTERS WITHOUT CLAIM TO ANY PARTICULAR FONT, STYLE, SIZE, OR COLOR.

FOR HEDGE FUND MANAGEMENT AND INVESTMENT; EQUITY CAPITAL MANAGEMENT SERVICES; INVESTMENT AND FINANCIAL ADVISORY AND MANAGEMENT SERVICES (U.S. CLS. 100, 101 AND 102). FIRST USE 5-0-2006; IN COMMERCE 5-0-2006.

3,399,883. WELLPOINT, INC., INDIANAPOLIS, IN. SN 78-832,679. PUB. 3-13-2007, FILED 3-8-2006.

Q-P3

THE MARK CONSISTS OF STANDARD CHARACTERS WITHOUT CLAIM TO ANY PARTICULAR FONT, STYLE, SIZE, OR COLOR.

FOR HEALTH INSURANCE UNDERWRITING SERVICES FEATURING A PROGRAM TO REWARD PARTICIPATING PHYSICIANS BASED UPON PERFORMANCE CRITERIA (U.S. CLS. 100, 101 AND 102). FIRST USE 11-19-2007; IN COMMERCE 11-19-2007.

CLASS 36—(Continued).

3,399,938. NEW YORK LIFE INSURANCE COMPANY, NEW YORK, NY. SN 78-860,276. PUB. 9-12-2006, FILED 4-12-2006.

GUARANTEES MATTER

THE MARK CONSISTS OF STANDARD CHARACTERS WITHOUT CLAIM TO ANY PARTICULAR FONT, STYLE, SIZE, OR COLOR.

FOR PROVIDING A WEBSITE FEATURING INFORMATION ON FINANCIAL SERVICES, RETIREMENT, INSURANCE, INVESTMENTS AND LIFE PLANNING (U.S. CLS. 100, 101 AND 102).

FIRST USE 5-5-2006; IN COMMERCE 5-5-2006.

3,399,974. MRU HOLDINGS, INC., NEW YORK, NY. SN 78-882,142. PUB. 6-26-2007, FILED 5-12-2006.



FOR FINANCIAL SERVICES, NAMELY, CONSUMER LENDING SERVICES; PROVIDING LOAN FINANCING TO STUDENTS; GUARANTEEING LOAN FINANCING TO STUDENTS; AND PROVIDING FINANCIAL AID TO STUDENTS IN EXCHANGE FOR A FIXED PERCENTAGE OF THE STUDENTS INCOME FOR A SPECIFIED PERIOD (U.S. CLS. 100, 101 AND 102).

FIRST USE 7-7-2007; IN COMMERCE 7-7-2007.

3,399,984. FIRST NATIONAL BANK OF OMAHA, OMAHA, NE. SN 78-890,788. PUB. 10-24-2006, FILED 5-15-2006.

PURITY

THE MARK CONSISTS OF STANDARD CHARACTERS WITHOUT CLAIM TO ANY PARTICULAR FONT, STYLE, SIZE, OR COLOR.

FOR CREDIT CARD SERVICES (U.S. CLS. 100, 101 AND 102).

FIRST USE 7-28-2006; IN COMMERCE 7-28-2006.

CLASS 36—(Continued).

3,399,988. THE BANK OF NOVA SCOTIA, TORONTO, ONTARIO, CANADA. SN 78-892,737. PUB. 4-3-2007, FILED 5-25-2006.

SCOTIALINE GOLD

THE MARK CONSISTS OF STANDARD CHARACTERS WITHOUT CLAIM TO ANY PARTICULAR FONT, STYLE, SIZE, OR COLOR.

OWNER OF U.S. REG. NOS. 1,003,026, 1,427,782, AND OTHERS.

FOR BANKING AND CREDIT CARD SERVICES (U.S. CLS. 100, 101 AND 102).

FIRST USE 4-0-2005; IN COMMERCE 11-0-2007.

3,400,018. CORPORACION ITALCAMBIO, C.A., CARACAS, VENEZUELA. SN 78-911,941. PUB. 2-13-2007, FILED 6-20-2006.

ITALCAMBIO

THE MARK CONSISTS OF STANDARD CHARACTERS WITHOUT CLAIM TO ANY PARTICULAR FONT, STYLE, SIZE, OR COLOR.

FOR CURRENCY AND FOREIGN EXCHANGE TRANSACTIONS SERVICES (U.S. CLS. 100, 101 AND 102).

FIRST USE 9-9-1950; IN COMMERCE 9-9-1950.

3,400,054. DISCOVER RE MANAGERS, INC., FARMINGTON, CT. SN 78-932,244. PUB. 9-25-2007, FILED 7-18-2006.

DISCOVER CUSTOM

THE MARK CONSISTS OF STANDARD CHARACTERS WITHOUT CLAIM TO ANY PARTICULAR FONT, STYLE, SIZE, OR COLOR.

OWNER OF U.S. REG. NOS. 2,424,266, 2,424,267, AND 2,424,268.

FOR PROPERTY AND CASUALTY INSURANCE UNDERWRITING SERVICES, NAMELY, IN THE FIELD OF COMMERCIAL INSURANCE (U.S. CLS. 100, 101 AND 102).

FIRST USE 5-31-2006; IN COMMERCE 8-31-2006.

CLASS 36—(Continued).

3,400,109. SUN LIFE ASSURANCE COMPANY OF CANADA, TORONTO, ONTARIO, CANADA. SN 78-953,584. PUB. 4-10-2007, FILED 8-16-2006.

CLASS 37—(Continued).

3,398,956. CLEAN COMMANDO, LLC, AUSTIN, TX. SN 76-673,444. PUB. 9-11-2007, FILED 3-1-2007.

SUNDEX ADVANTAGE

THE MARK CONSISTS OF STANDARD CHARACTERS WITHOUT CLAIM TO ANY PARTICULAR FONT, STYLE, SIZE, OR COLOR.

OWNER OF U.S. REG. NOS. 2,974,073 AND 3,106,670. FOR INSURANCE SERVICES, NAMELY, ANNUITY UNDERWRITING SERVICES, CONSULTATION AND BROKERAGE SERVICES (U.S. CLS. 100, 101 AND 102). FIRST USE 9-5-2006; IN COMMERCE 9-5-2006.



CLASS 37—CONSTRUCTION AND REPAIR

3,398,910. DILIGENT ENVIRONMENTAL SERVICES, INC., BOCA RATON, FL. SN 76-650,413. PUB. 7-25-2006, FILED 11-16-2005.

THE MARK CONSISTS OF THE WORDS CLEAN COMMANDO FIGHT DIRTY IN A STYLIZED FONT BENEATH THE STYLIZED REPRESENTATION OF A MAN HOLDING A BROOM AND FOUR SOAP BUBBLES.

FOR CLEANING OF RESIDENTIAL HOUSES (U.S. CLS. 100, 103 AND 106). FIRST USE 1-1-2007; IN COMMERCE 1-1-2007.

800DILIGENT.com

THE MARK CONSISTS OF STANDARD CHARACTERS WITHOUT CLAIM TO ANY PARTICULAR FONT, STYLE, SIZE, OR COLOR.

FOR PEST AND TERMITE CONTROL SERVICES, NAMELY RIDDING PROPERTY AND STRUCTURES OF TERMITES AND PESTS AND CONTROLLING AND PROTECTING SUCH PROPERTY AND STRUCTURES AGAINST INFESTATION AND RE-INFESTATION THROUGH THE USE OF CHEMICALS, GASES, TRAPS, AND OTHER DEVICES (U.S. CLS. 100, 103 AND 106). FIRST USE 9-10-2005; IN COMMERCE 1-14-2006.

3,399,040. THE BICYCLE GARAGE, LLC, COLCHESTER, CT. SN 77-033,077. PUB. 7-3-2007, FILED 10-31-2006.

3,398,952. NORTH AMERICAN SERVICE GROUP, LLC, LIVONIA, MI. SN 76-670,677. PUB. 8-21-2007, FILED 12-22-2006.

ROOTER 1

THE MARK CONSISTS OF STANDARD CHARACTERS WITHOUT CLAIM TO ANY PARTICULAR FONT, STYLE, SIZE, OR COLOR.

NO CLAIM IS MADE TO THE EXCLUSIVE RIGHT TO USE "ROOTER", APART FROM THE MARK AS SHOWN.

FOR MUNICIPAL, COMMERCIAL, INDUSTRIAL, AND RESIDENTIAL PLUMBING, SEWER, GREASE TRAP, AND DRAIN CLEANING SERVICES; SEWER LINE REPAIRS (U.S. CLS. 100, 103 AND 106). FIRST USE 10-8-2007; IN COMMERCE 10-8-2007.



NO CLAIM IS MADE TO THE EXCLUSIVE RIGHT TO USE "BICYCLE GARAGE", APART FROM THE MARK AS SHOWN.

THE COLOR(S) RED IS/ARE CLAIMED AS A FEATURE OF THE MARK.

THE MARK CONSISTS OF THE WORDING "BICYCLE GARAGE" IN BLACK AND A STYLIZED LETTER "B" IN RED.

FOR REPAIR OF BICYCLES (U.S. CLS. 100, 103 AND 106). FIRST USE 10-15-2006; IN COMMERCE 11-1-2006.

CLASS 37—(Continued).

3,399,066. SUNPORT HOMES, LLC, BRANDON, FL. SN 77-042,284. PUB. 7-3-2007, FILED 11-13-2006.

SUNPORT HOMES

THE MARK CONSISTS OF STANDARD CHARACTERS WITHOUT CLAIM TO ANY PARTICULAR FONT, STYLE, SIZE, OR COLOR.

NO CLAIM IS MADE TO THE EXCLUSIVE RIGHT TO USE "HOMES", APART FROM THE MARK AS SHOWN.

FOR CONSTRUCTION SERVICES, NAMELY, NEW HOME BUILDING (U.S. CLS. 100, 103 AND 106).

FIRST USE 8-1-2007; IN COMMERCE 8-1-2007.

3,399,240. ANIMALS B' GONE, INC., BETHLEHEM, GA. SN 77-128,297. PUB. 10-9-2007, FILED 3-12-2007.

RodentGuard

THE MARK CONSISTS OF STANDARD CHARACTERS WITHOUT CLAIM TO ANY PARTICULAR FONT, STYLE, SIZE, OR COLOR.

FOR INSTALLATION OF PHYSICAL STRUCTURAL BARRIERS TO KEEP RODENTS OUT OF HOMES (U.S. CLS. 100, 103 AND 106).

FIRST USE 11-11-2007; IN COMMERCE 11-11-2007.

3,399,425. NSB ASSOCIATES, INC., BEVERLY HILLS, CA. SN 78-513,387. PUB. 9-27-2005, FILED 11-8-2004.

NSB NOT SO BAD

THE MARK CONSISTS OF STANDARD CHARACTERS WITHOUT CLAIM TO ANY PARTICULAR FONT, STYLE, SIZE, OR COLOR.

FOR REAL ESTATE DEVELOPMENT SERVICES (U.S. CLS. 100, 103 AND 106).

FIRST USE 10-27-2004; IN COMMERCE 10-27-2004.

CLASS 37—(Continued).

3,399,838. TRI-POWER GROUP, INC., SAN JOSE, CA. SN 78-814,673. PUB. 3-27-2007, FILED 2-14-2006.

BUILDING A WIRELESS WORLD

THE MARK CONSISTS OF STANDARD CHARACTERS WITHOUT CLAIM TO ANY PARTICULAR FONT, STYLE, SIZE, OR COLOR.

FOR CUSTOM CONSTRUCTION OF WIRELESS TELECOMMUNICATIONS NETWORKS, AND CONSULTING SERVICES IN CONNECTION THEREWITH (U.S. CLS. 100, 103 AND 106).

FIRST USE 11-30-2005; IN COMMERCE 11-30-2005.

3,399,917. HOMEFRONTS L.L.C., GRAND RAPIDS, MI. SN 78-852,466. PUB. 11-21-2006, FILED 4-3-2006.

"Here goes the Neighborhood"

THE MARK CONSISTS OF STANDARD CHARACTERS WITHOUT CLAIM TO ANY PARTICULAR FONT, STYLE, SIZE, OR COLOR.

FOR REMODELING OF BUILDING EXTERIORS (U.S. CLS. 100, 103 AND 106).

FIRST USE 4-1-2006; IN COMMERCE 7-15-2006.

3,400,005. MEGATRAN, INC., DORAL, FL. SN 78-904,011. PUB. 1-16-2007, FILED 6-8-2006.



THE MARK CONSISTS OF A STYLIZED LETTER "M" WITH A LINE EXTENDING HORIZONTALLY FROM THE RIGHT EDGE OF THIS LETTER; THE WORD "MEGATRAN" SITTING ATOP THE HORIZONTALLY EXTENDING LINE AND CONSISTING OF STYLIZED ALL-CAPITAL LETTERS WITH THE "M" BEING LARGER THAN THE REMAINING LETTERS; AND THE WORDS "THE POWER OF EXPERIENCE" IMMEDIATELY BELOW THE HORIZONTALLY EXTENDING LINE.

FOR CONSTRUCTION MANAGEMENT; CONSTRUCTION OF ELECTRIC UTILITY INFRASTRUCTURE AND UNDERGROUND UTILITIES (U.S. CLS. 100, 103 AND 106).

FIRST USE 7-27-2007; IN COMMERCE 7-27-2007.

CLASS 37—(Continued).

3,400,126. RHODES DESIGN AND DEVELOPMENT CORPORATION, LAS VEGAS, NV. SN 78-957,644. PUB. 4-17-2007, FILED 8-22-2006.

CLASS 37—(Continued).

3,400,227. FOX RIDGE INVESTMENTS, LLC, LEHI, UT. SN 78-979,703. PUB. 2-27-2007, FILED 5-3-2006.

WEST 57TH

ENCANTA HILLS

THE MARK CONSISTS OF STANDARD CHARACTERS WITHOUT CLAIM TO ANY PARTICULAR FONT, STYLE, SIZE, OR COLOR.

FOR HOMEBUILDING SERVICES IN THE NATURE OF HOUSE BUILDING AND REPAIR, AND BUILDING RENOVATION IN THE FIELD OF RESIDENTIAL HOUSES; DEVELOPMENT OF REAL PROPERTY, NAMELY, REPAIR, IMPROVEMENT, AND NEW CONSTRUCTION OF SINGLE-FAMILY AND MULTI-FAMILY RESIDENTIAL AND MASTER-PLANNED RESIDENTIAL AND COMMERCIAL COMMUNITIES (U.S. CLS. 100, 103 AND 106).

FIRST USE 10-1-2006; IN COMMERCE 10-1-2006.

THE MARK CONSISTS OF STANDARD CHARACTERS WITHOUT CLAIM TO ANY PARTICULAR FONT, STYLE, SIZE, OR COLOR.

FOR REAL ESTATE DEVELOPMENT SERVICES, CONSTRUCTION SERVICES, NAMELY, PLANNING AND DEVELOPING OF RESIDENTIAL COMMUNITIES (U.S. CLS. 100, 103 AND 106).

FIRST USE 9-5-2007; IN COMMERCE 9-5-2007.

3,400,127. RHODES DESIGN AND DEVELOPMENT CORPORATION, LAS VEGAS, NV. SN 78-957,661. PUB. 4-17-2007, FILED 8-22-2006.

CLASS 38—COMMUNICATION

3,398,999. ZEACOM GROUP LIMITED, IRVINE, CA. SN 77-010,949. PUB. 7-24-2007, FILED 9-29-2006.

RHODES RANCH



THE MARK CONSISTS OF STANDARD CHARACTERS WITHOUT CLAIM TO ANY PARTICULAR FONT, STYLE, SIZE, OR COLOR.

FOR HOMEBUILDING SERVICES IN THE NATURE OF HOUSE BUILDING AND REPAIR, AND BUILDING RENOVATION IN THE FIELD OF RESIDENTIAL HOUSES; DEVELOPMENT OF REAL PROPERTY, NAMELY, REPAIR, IMPROVEMENT, AND NEW CONSTRUCTION OF SINGLE-FAMILY AND MULTI-FAMILY RESIDENTIAL AND MASTER-PLANNED RESIDENTIAL AND COMMERCIAL COMMUNITIES (U.S. CLS. 100, 103 AND 106).

FIRST USE 4-1-2006; IN COMMERCE 4-1-2006.

THE COLOR(S) ORANGE AND BLACK IS/ARE CLAIMED AS A FEATURE OF THE MARK.

THE MARK CONSISTS OF THE LETTERS "YOUMAIL" FOLLOWED BY A COLON AND THEN THREE RIGHT-SIDE PARENTHETICALS INCREASING IN SIZE FROM LEFT TO RIGHT. THE COLON AND THE LETTERS YOU ARE ORANGE IN COLOR. THE PARENTHETICALS AND THE LETTERS "MAIL" ARE BLACK IN COLOR.

FOR WIRELESS VOICE MAIL SERVICES (U.S. CLS. 100, 101 AND 104).

FIRST USE 9-27-2006; IN COMMERCE 9-27-2006.

CLASS 38—(Continued).

3,399,028. DOTSTER, INC., VANCOUVER, WA. SN 77-027,909.
PUB. 3-20-2007, FILED 10-24-2006.



OWNER OF U.S. REG. NO. 2,611,501.
THE MARK CONSISTS OF THE WORDS "MYINTERNET"
WITH THE FIGURE OF A PERSON AS THE LETTER "I".
FOR PROVIDING MULTIPLE-USER ACCESS TO A
GLOBAL COMPUTER INFORMATION NETWORK;
ELECTRONIC MAIL SERVICES FOR OTHERS OVER A
GLOBAL COMPUTER NETWORK; ELECTRONIC MAIL
FORWARDING SERVICES FOR OTHERS OVER A GLO-
BAL COMPUTER NETWORK; WEB SITE FORWARDING
SERVICES FOR OTHERS OVER A GLOBAL COMPUTER
NETWORK (U.S. CLS. 100, 101 AND 104).
FIRST USE 1-1-2006; IN COMMERCE 1-1-2006.

CLASS 38—(Continued).

3,399,181. ABOVENET, INC., WHITE PLAINS, NY. SN 77-
099,554. PUB. 8-7-2007, FILED 2-5-2007.

JABNET

THE MARK CONSISTS OF STANDARD CHARACTERS
WITHOUT CLAIM TO ANY PARTICULAR FONT, STYLE,
SIZE, OR COLOR.

FOR A TELECOMMUNICATIONS OPTICAL NET-
WORK SERVICE PROVIDING PRIVATE, SWITCHABLE
CONNECTIVITY BETWEEN CONTENT CREATORS IN
THE MOTION PICTURE AND TELEVISION INDUSTRY
(U.S. CLS. 100, 101 AND 104).

FIRST USE 2-28-2007; IN COMMERCE 4-18-2007.

3,399,296. PEERLESS NETWORK, LLC, CHICAGO, IL. SN 77-
169,096. PUB. 10-23-2007, FILED 4-30-2007.

Peerless Network

3,399,107. QWEST COMMUNICATIONS INTERNATIONAL
INC., DENVER, CO. SN 77-065,012. PUB. 7-10-2007, FILED
12-15-2006.



THE MARK CONSISTS OF STANDARD CHARACTERS
WITHOUT CLAIM TO ANY PARTICULAR FONT, STYLE,
SIZE, OR COLOR.

OWNER OF U.S. REG. NOS. 2,205,095 AND 2,849,226.
FOR PROVIDING ACCESS TO TELECOMMUNICA-
TION NETWORKS (U.S. CLS. 100, 101 AND 104).
FIRST USE 6-12-2001; IN COMMERCE 6-12-2004.

THE MARK CONSISTS OF STANDARD CHARACTERS
WITHOUT CLAIM TO ANY PARTICULAR FONT, STYLE,
SIZE, OR COLOR.

NO CLAIM IS MADE TO THE EXCLUSIVE RIGHT TO
USE "NETWORK", APART FROM THE MARK AS SHOWN.

FOR TELECOMMUNICATION SERVICES, NAMELY,
LOCAL AND LONG DISTANCE TRANSMISSION OF
VOICE, DATA, GRAPHICS BY MEANS OF TELEPHONE,
TELEGRAPHIC, CABLE, AND SATELLITE TRANSMIS-
SIONS; TELECOMMUNICATION ACCESS SERVICES;
TELECOMMUNICATIONS GATEWAY SERVICES; TEL-
ECOMMUNICATIONS RESELLER SERVICES, NAMELY,
PROVIDING LONG DISTANCE TELECOMMUNICA-
TION SERVICES; TELECOMMUNICATIONS SERVICES,
NAMELY PROVIDING FIBER OPTIC NETWORK SER-
VICES; TRANSFER OF DATA BY TELECOMMUNICA-
TIONS; TRANSMISSION OF INFORMATION ON
OPTICAL TELECOMMUNICATION NETWORKS; COM-
MUNICATIONS VIA MULTINATIONAL TELECOMMUN-
ICATION NETWORKS; DATA TRANSMISSION AND
RECEPTION SERVICES VIA TELECOMMUNICATION
MEANS; HIGH BIT-RATE DATA TRANSMISSION SER-
VICES FOR TELECOMMUNICATION NETWORK OP-
ERATORS; PROVIDING ACCESS TO
TELECOMMUNICATION NETWORKS; PROVIDING
ELECTRONIC TELECOMMUNICATION CONNec-
TIONS; PROVIDING THIRD PARTY USERS WITH
ACCESS TO TELECOMMUNICATION INFRASTRUC-
TURE (U.S. CLS. 100, 101 AND 104).

FIRST USE 5-21-2007; IN COMMERCE 10-1-2007.

CLASS 38—(Continued).

3,399,524. EASTERN BROADCASTING CO., LTD., TAIPEI, TAIWAN. SN 78-626,016. PUB. 6-20-2006, FILED 5-9-2005.

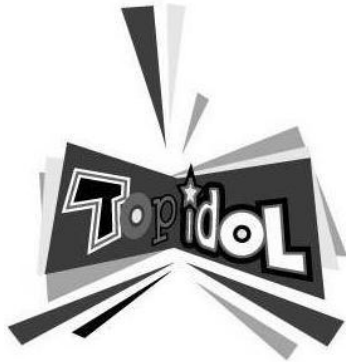

THE GRAY TONES IN THE MARK ARE INTENDED TO INDICATE SHADING OR CONTRAST ONLY.

THE MARK CONSISTS OF THE STYLIZED WORDING "TOPIDOL" WITH THE LETTER "I" HAVING A STAR ABOVE IT, AND A SHADED BOW-TIE SHAPED CARRIER WITH TRIANGLES SURROUNDING THE CARRIER.

FOR CABLE TELEVISION BROADCASTING; BROADCASTING PROGRAMS VIA A GLOBAL COMPUTER NETWORK; TELEVISION BROADCASTING; RADIO BROADCASTING; TELECOMMUNICATION SERVICES, NAMELY, LOCAL AND LONG DISTANCE TRANSMISSION OF VOICE, DATA, GRAPHICS BY MEANS OF TELEPHONE, TELEGRAPHIC, CABLE, SATELLITE TRANSMISSIONS, AND GLOBAL COMPUTER NETWORK; TELECOMMUNICATION SERVICES, NAMELY, PERSONAL COMMUNICATION SERVICES VIA TELEPHONE, TELEGRAMS, FACSIMILE AND COMPUTERS; PROVIDING TELECOMMUNICATIONS CONNECTIONS TO A GLOBAL COMPUTER NETWORK; PROVIDING ELECTRONIC TELECOMMUNICATION CONNECTIONS; COMPUTER AIDED TRANSMISSION OF INFORMATION AND IMAGES; ELECTRONIC DATA TRANSMISSION, NAMELY, TRANSMISSION OF DATABASE INFORMATION FOR IMAGES VIA GLOBAL COMPUTER NETWORK; PROVIDING ON-LINE CHAT ROOMS AND ELECTRONIC BULLETIN BOARDS FOR TRANSMISSION OF MESSAGES AMONG USERS IN THE FIELD OF GENERAL INTEREST; ON-LINE DOCUMENT AND DATA DELIVERY VIA A GLOBAL COMPUTER NETWORK; COMMUNICATION VIA OPTICAL FIBER NETWORKS; TRANSMISSION OF INFORMATION ON OPTICAL TELECOMMUNICATION NETWORKS; SATELLITE, CABLE, NETWORK TRANSMISSION OF SOUNDS, IMAGES, SIGNALS AND DATA; SATELLITE AIDED TRANSMISSION OF MESSAGES AND IMAGES (U.S. CLS. 100, 101 AND 104).
FIRST USE 4-14-2005; IN COMMERCE 5-9-2005.

3,399,631. CELLCO PARTNERSHIP, DBA VERIZON WIRELESS, BASKING RIDGE, NJ. SN 78-722,932. PUB. 6-20-2006, FILED 9-29-2005.

ES LA COMPANIA

THE MARK CONSISTS OF STANDARD CHARACTERS WITHOUT CLAIM TO ANY PARTICULAR FONT, STYLE,

CLASS 38—(Continued).

SIZE, OR COLOR.

THE FOREIGN WORDING IN THE MARK TRANSLATES INTO ENGLISH AS IT'S THE COMPANY.

FOR TELECOMMUNICATIONS SERVICES, NAMELY, WIRELESS PHONE SERVICES (U.S. CLS. 100, 101 AND 104).

FIRST USE 9-8-2006; IN COMMERCE 9-8-2006.

3,399,687. MOG, INC., KENSINGTON, CA. SN 78-757,434. PUB. 2-27-2007, FILED 11-18-2005.

MOG

THE MARK CONSISTS OF STANDARD CHARACTERS WITHOUT CLAIM TO ANY PARTICULAR FONT, STYLE, SIZE, OR COLOR.

FOR PROVIDING ON-LINE CHAT ROOMS, ELECTRONIC BULLETIN BOARDS, AND ON-LINE FORUMS FOR TRANSMISSION OF MESSAGES AMONG COMPUTER USERS CONCERNING MUSIC, MOVIES, AND TELEVISION; PROVIDING EMAIL AND INSTANT MESSAGING SERVICES; TRANSMISSION OF AUDIO AND VIDEO FILES VIA COMMUNICATIONS NETWORKS; TRANSMISSION OF PEER TO PEER NETWORKING AND FILE SHARING INFORMATION VIA COMMUNICATIONS NETWORKS (U.S. CLS. 100, 101 AND 104).

FIRST USE 6-20-2006; IN COMMERCE 6-20-2006.

3,399,720. LIBERATION MANAGEMENT LLC, SAN DIEGO, CA. SN 78-770,522. PUB. 8-15-2006, FILED 12-9-2005.

ALL ROAD COMMUNICATIONS

THE MARK CONSISTS OF STANDARD CHARACTERS WITHOUT CLAIM TO ANY PARTICULAR FONT, STYLE, SIZE, OR COLOR.

NO CLAIM IS MADE TO THE EXCLUSIVE RIGHT TO USE "COMMUNICATIONS", APART FROM THE MARK AS SHOWN.

FOR SATELLITE COMMUNICATION SERVICES (U.S. CLS. 100, 101 AND 104).

FIRST USE 6-1-2006; IN COMMERCE 6-1-2006.

CLASS 38—(Continued).

3,399,721. CHUNGHWA TELECOM CO., LTD., TAIPEI, TAIWAN. SN 78-771,667. PUB. 11-7-2006, FILED 12-12-2005.



THE MARK CONSISTS OF THE STYLIZED LETTERS "XUITE" WITH THE DOT ABOVE THE "I" HAVING A FLOWER PETAL LIKE CONTOUR CONTAINED THEREIN WITH THE "E" HAVING THE PETAL LIKE CONTOUR CONTAINED IN AN UPPER PORTION THEREOF.

FOR TELECOMMUNICATIONS ROUTING AND JUNCTION SERVICES; PROVIDING FRAME RELAY CONNECTIVITY SERVICES FOR DATA TRANSFER; VOICE MAIL SERVICES; PROVIDING MULTIPLE USER DIAL-UP AND DEDICATED ACCESS TO THE INTERNET; DELIVERY OF PERSONALIZED GREETING CARDS TO OTHERS VIA ELECTRONIC MAIL; RENTAL OF SET-TOP BOXES FOR USE WITH TELEVISIONS; VOICE OVER IP SERVICES; PROVIDING TELECOMMUNICATIONS CONNECTIONS TO A GLOBAL COMPUTER NETWORK; SATELLITE TRANSMISSION SERVICES; TELEPHONE VOICE MESSAGING SERVICES; VOICE OVER INTERNET PROTOCOL (VOIP) SERVICES; ELECTRONIC DATA INTERCHANGE (EDI) SERVICES; PROVIDING ON-LINE CHAT ROOMS FOR TRANSMISSION OF MESSAGES AMONG COMPUTER USERS IN THE FIELD OF GENERAL INTEREST; PROVIDING ON-LINE ELECTRONIC BULLETIN BOARDS FOR TRANSMISSION OF MESSAGES AMONG COMPUTER USERS IN THE FIELD OF GENERAL INTEREST; COMMUNICATION BY TELEGRAM; DELIVERY OF MESSAGES BY ELECTRONIC TRANSMISSION; ELECTRONIC MAIL SERVICES; ELECTRONIC STORE-AND-FORWARD MESSAGING; ELECTRONIC TRANSMISSION OF DATA AND DOCUMENTS VIA COMPUTER TERMINALS; ELECTRONIC TRANSMISSION OF MESSAGES AND DATA; TELEPHONE COMMUNICATION SERVICES; VIDEO TEXT SERVICES; ELECTRONIC DELIVERY OF IMAGES AND PHOTOGRAPHS VIA A GLOBAL COMPUTER NETWORK; E-MAIL FORWARDING SERVICES; PROVIDING ON-LINE FORUMS FOR TRANSMISSION OF MESSAGES AMONG COMPUTER USERS CONCERNING GENERAL INTERESTS; STREAMING OF AUDIO MATERIAL ON THE INTERNET; STREAMING OF VIDEO MATERIAL ON THE INTERNET; WEB MESSAGING; WEB SITE FORWARDING SERVICES; WIRELESS BROADBAND COMMUNICATION SERVICES; INSTANT MESSAGING SERVICES; COMMUNICATIONS SERVICES, NAMELY, TRANSMITTING STREAMED SOUND AND AUDIO-VISUAL RECORDINGS VIA THE INTERNET; PROVIDING ON-LINE LIST SERVERS FOR TRANSMISSION OF MESSAGES AMONG COMPUTER USERS CONCERNING GENERAL INTEREST; TELECOMMUNICATIONS SERVICES, NAMELY PROVIDING FIBER OPTIC NETWORK SERVICES; WORLDWIDE SWITCHED TEXT AND MESSAGE TRANSMISSION SERVICES; PROVIDING ON-LINE CHAT ROOMS AND ELECTRONIC BULLETIN BOARDS FOR TRANSMISSION OF MESSAGES AMONG USERS IN THE FIELD OF GENERAL INTEREST; PAY-PER-VIEW TELEVISION TRANSMISSION SERVICES; COMMUNICATION SERVICES, NAMELY, ELECTRONIC TRANSMISSION OF DATA AND DOCUMENTS AMONG USERS OF COMPUTERS; TELEPHONE TELECOMMUNICATIONS SERVICES PROVIDED VIA PREPAID TELEPHONE CALLING CARDS; PROVIDING ON-LINE COMMUNICATIONS LINKS WHICH TRANSFER THE WEBSITE USER TO OTHER LOCAL AND GLOBAL

CLASS 38—(Continued).

WEB PAGES; PROVIDING PRIVATE AND SECURE REAL TIME ELECTRONIC COMMUNICATION OVER A COMPUTER NETWORK; VOICE CHAT SERVICES; WEB CASTING SERVICES; VIDEO-ON-DEMAND TRANSMISSION SERVICES; WIRELESS FACSIMILE MAIL SERVICES; CELLULAR TELEPHONE COMMUNICATION; COMMUNICATION BY ELECTRONIC COMPUTER TERMINALS; COMMUNICATION VIA COMPUTER TERMINALS, BY DIGITAL TRANSMISSION OR BY SATELLITE; COMMUNICATIONS BY COMPUTER TERMINALS; COMMUNICATIONS VIA FIBER-OPTIC NETWORKS; DATA COMMUNICATION BY ELECTRONIC MAIL; INFORMATION TRANSMISSION SERVICES VIA DIGITAL NETWORKS; INFORMATION TRANSMISSION VIA ELECTRONIC COMMUNICATION NETWORKS; PROVIDING E-MAIL SERVICES; SECURE E-MAIL SERVICES; VIRTUAL CHAT ROOMS ESTABLISHED VIA TEXT MESSAGING; ELECTRONIC, ELECTRIC, AND DIGITAL TRANSMISSION OF VOICE, DATA, IMAGES, SIGNALS, AND MESSAGES (U.S. CLS. 100, 101 AND 104).

FIRST USE 4-1-2005; IN COMMERCE 4-1-2005.

3,399,865. CITY OF NORTH KANSAS CITY, NORTH KANSAS CITY, MO. SN 78-826,135. PUB. 4-17-2007, FILED 3-1-2006.



FOR PROVIDING HIGH SPEED INTERNET ACCESS; DIGITAL TELECOMMUNICATIONS AND INFORMATION SERVICES, NAMELY, THE ELECTRONIC TRANSMISSION OF DATA, VOICE, MUSIC, AND IMAGES; E-MAIL SERVICES (U.S. CLS. 100, 101 AND 104).

FIRST USE 12-7-2005; IN COMMERCE 12-7-2005.

3,399,866. CITY OF NORTH KANSAS CITY, NORTH KANSAS CITY, MO. SN 78-826,144. PUB. 4-17-2007, FILED 3-1-2006.

LINKCITY

THE MARK CONSISTS OF STANDARD CHARACTERS WITHOUT CLAIM TO ANY PARTICULAR FONT, STYLE, SIZE, OR COLOR.

FOR PROVIDING HIGH SPEED INTERNET ACCESS; DIGITAL TELECOMMUNICATIONS AND INFORMATION SERVICES, NAMELY, THE ELECTRONIC TRANSMISSION OF DATA, VOICE, MUSIC, AND IMAGES; E-MAIL SERVICES (U.S. CLS. 100, 101 AND 104).

FIRST USE 12-7-2005; IN COMMERCE 12-7-2005.

CLASS 38—(Continued).

3,399,872. EBAY INC., SAN JOSE, CA. SN 78-829,200. PUB. 4-3-2007, FILED 3-3-2006.

EBAY EXPRESS

THE MARK CONSISTS OF STANDARD CHARACTERS WITHOUT CLAIM TO ANY PARTICULAR FONT, STYLE, SIZE, OR COLOR.

OWNER OF U.S. REG. NOS. 2,218,732 AND 2,420,512.

FOR TELECOMMUNICATIONS SERVICES, NAMELY, THE ELECTRONIC TRANSMISSION OF DATA AND INFORMATION; PAGING SERVICES; PROVIDING AN ONLINE, INTERACTIVE BULLETIN BOARD FOR THE TRANSMISSION OF MESSAGES AMONG COMPUTER USERS CONCERNING HOBBIES, COLLECTIBLES, TRADING, AND THE SALE OF GOODS AND SERVICES VIA A GLOBAL COMMUNICATIONS NETWORK (U.S. CLS. 100, 101 AND 104).

FIRST USE 4-24-2006; IN COMMERCE 4-24-2006.

3,399,937. CONSTANT CONTACT, INC., WALTHAM, MA. SN 78-859,684. PUB. 12-5-2006, FILED 4-12-2006.

CONNECT UP

THE MARK CONSISTS OF STANDARD CHARACTERS WITHOUT CLAIM TO ANY PARTICULAR FONT, STYLE, SIZE, OR COLOR.

FOR PROVIDING ONLINE CHAT ROOMS AND ELECTRONIC BULLETIN BOARDS IN THE FIELD OF ONLINE MARKETING (U.S. CLS. 100, 101 AND 104).

FIRST USE 6-1-2007; IN COMMERCE 6-1-2007.

3,400,002. GLASS, PATRICK, D, SAN DIEGO, CA. SN 78-902,768. PUB. 7-3-2007, FILED 6-7-2006.

FullFiggas

THE MARK CONSISTS OF STANDARD CHARACTERS WITHOUT CLAIM TO ANY PARTICULAR FONT, STYLE, SIZE, OR COLOR.

FOR PROVIDING ON-LINE ELECTRONIC BULLETIN BOARDS FOR TRANSMISSION OF MESSAGES AMONG COMPUTER USERS CONCERNING FULL FIGURED PEOPLE (U.S. CLS. 100, 101 AND 104).

FIRST USE 4-4-2005; IN COMMERCE 4-4-2005.

CLASS 38—(Continued).

3,400,069. ALVAREZ, VERONICA M., LOS ANGELES, CA. SN 78-938,303. PUB. 3-20-2007, FILED 7-26-2006.

LatinosConnected

THE MARK CONSISTS OF STANDARD CHARACTERS WITHOUT CLAIM TO ANY PARTICULAR FONT, STYLE, SIZE, OR COLOR.

FOR PROVIDING AN ONLINE COMMUNITY FOR LATINOS AND HISPANICS FEATURING ON-LINE CHAT ROOMS, FORUMS, DISCUSSION GROUPS AND INTERACTIVE BULLETIN BOARDS FOR POSTING AND SHARING INFORMATION AND FOR TRANSMISSION OF MESSAGES AMONG COMPUTER USERS CONCERNING ACTIVITIES, IMMIGRATION, POLITICS, HEALTH, FAMILY, BUSINESS, EVENTS, CULTURE, MUSIC, ARTS, SPORTS, RECIPES AND INFORMATION ON A WIDE VARIETY OF TOPICS OF GENERAL INTEREST TO COMMUNITY MEMBERS; AND TRANSMISSION AND SHARING OF MESSAGES, DATA, VIDEO AND IMAGES (U.S. CLS. 100, 101 AND 104).

FIRST USE 12-1-2006; IN COMMERCE 12-1-2006.

3,400,083. RCN TELECOM SERVICES, INC., PRINCETON, NJ. SN 78-944,392. PUB. 3-6-2007, FILED 8-3-2006.



OWNER OF U.S. REG. NOS. 2,230,674, 2,403,440, AND OTHERS.

NO CLAIM IS MADE TO THE EXCLUSIVE RIGHT TO USE "MUSIC", APART FROM THE MARK AS SHOWN.

THE MARK CONSISTS, IN PART, OF A SOLID STAR.

FOR TELECOMMUNICATION SERVICES, NAMELY, THE ONLINE TRANSMISSION OF STREAMED AND DOWNLOADABLE MUSIC FILES (U.S. CLS. 100, 101 AND 104).

FIRST USE 8-16-2006; IN COMMERCE 9-1-2006.

3,400,181. NETCHOICETV INC., PETALUMA, CA. SN 78-968,525. PUB. 4-24-2007, FILED 9-6-2006.

MYPATH TV

THE MARK CONSISTS OF STANDARD CHARACTERS WITHOUT CLAIM TO ANY PARTICULAR FONT, STYLE, SIZE, OR COLOR.

CLASS 38—(Continued).

NO CLAIM IS MADE TO THE EXCLUSIVE RIGHT TO USE "TV", APART FROM THE MARK AS SHOWN.
 FOR STREAMING OF VIDEO MATERIAL ON THE INTERNET (U.S. CLS. 100, 101 AND 104).
 FIRST USE 9-0-2006; IN COMMERCE 9-0-2006.

CLASS 39—(Continued).

3,399,262. EXPERT TRAVEL SERVICES, LLC, PATCHOGUE, NY. SN 77-140,686. PUB. 9-25-2007, FILED 3-26-2007.

CLASS 39—TRANSPORTATION AND STORAGE

3,398,914. LONG, ANNE, GREAT FALLS, VA. SN 76-653,278.
 PUB. 3-13-2007, FILED 1-12-2006.



NO CLAIM IS MADE TO THE EXCLUSIVE RIGHT TO USE "PARKING & TRANSPORTATION, CONVENIENCE AND EXCELLENCE", APART FROM THE MARK AS SHOWN.

THE MARK CONSISTS, IN PART, OF A DESIGN OF A STYLIZED SUN WITHIN A SHADED CIRCLE.

FOR VALET PARKING; CAR PARKING; VEHICLE PARKING; PARKING GARAGE SERVICES; PARKING LOT SERVICES (U.S. CLS. 100 AND 105).

FIRST USE 4-1-2006; IN COMMERCE 4-1-2006.

EXPERTFLYER

THE MARK CONSISTS OF STANDARD CHARACTERS WITHOUT CLAIM TO ANY PARTICULAR FONT, STYLE, SIZE, OR COLOR.

FOR TRAVEL INFORMATION SERVICES, NAMELY, PROVIDING INFORMATION CONCERNING TRAVEL AND TRAVEL-RELATED TOPICS INCLUDING FARES, FARE RULES, PENALTIES AND ROUTING INFORMATION, FLIGHT AVAILABILITY, SEATING WITH SEAT MAPS, UPGRADES, FREQUENT FLYER MILES, AWARDS AND UPGRADES, FLIGHT STATUS AND DELAYS, FLIGHT DETAILS, INCLUDING, MEALS, EQUIPMENT, FLIGHT TIMES, STOPOVERS, AIRPORT SECURITY LINE DELAY INFORMATION, AIRPORT DELAY INFORMATION; PROVIDING FLIGHT ALERT INFORMATION TO SUBSCRIBERS VIA E-MAIL, CELL PHONE, PDA, OR OTHER WIRELESS PORTABLE DEVICE (U.S. CLS. 100 AND 105).

FIRST USE 1-27-2004; IN COMMERCE 1-7-2005.

3,399,634. PHAETON AVIATION, INC., CHAPEL HILL, NC. SN 78-723,892. PUB. 9-5-2006, FILED 9-30-2005.



NO CLAIM IS MADE TO THE EXCLUSIVE RIGHT TO USE "AVIATION" AND THE HAWKER 800 DESIGN, APART FROM THE MARK AS SHOWN.

THE COLOR(S) DARK GREEN, LIGHT BLUE, WHITE, SILVER AND GOLD IS/ARE CLAIMED AS A FEATURE OF THE MARK.

THE MARK CONSISTS OF THE DESIGN OF A HAWKER 800 AIRCRAFT WITH CONTRAILS EMANATING FROM BEHIND THE AIRCRAFT WITH THE AIRCRAFT FLYING BETWEEN THE WORDS PHAETON AND AVIATION. THE NOSE CONE OF THE AIRCRAFT IS WHITE WITH GOLD STRIPES AND DARK GREEN. THE WINGS OF THE AIRCRAFT ARE SILVER. THE WORDS PHAETON AND AVIATION ARE DARK GREEN AND THE CONTRAIL IS LIGHT BLUE.

FOR AIR TRANSPORTION SERVICES; AIRCRAFT CHARTERING SERVICES (U.S. CLS. 100 AND 105).

FIRST USE 5-29-2007; IN COMMERCE 5-29-2007.

HEALTHY CRUISE

THE MARK CONSISTS OF STANDARD CHARACTERS WITHOUT CLAIM TO ANY PARTICULAR FONT, STYLE, SIZE, OR COLOR.

NO CLAIM IS MADE TO THE EXCLUSIVE RIGHT TO USE "CRUISE", APART FROM THE MARK AS SHOWN.

FOR BOAT CRUISES (U.S. CLS. 100 AND 105).

FIRST USE 9-30-2007; IN COMMERCE 9-30-2007.

3,399,192. YUND, JENNIFER L., DELRAY BEACH, FL. SN 77-103,738. PUB. 9-11-2007, FILED 2-9-2007.

CLASS 39—(Continued).

3,399,722. PRICELINE.COM INCORPORATED, NORWALK, CT. SN 78-772,270. PUB. 10-3-2006, FILED 12-13-2005.

TripFilter

THE MARK CONSISTS OF THE COINED, SINGLE WORD "TRIPFILTER", WITH THE "T" AND THE "F" IN A LARGER FONT THAN THE REST OF THE LETTERS. FOR PROVIDING TRAVEL INFORMATION VIA AN ONLINE WEB SITE THAT CUSTOMIZES TRAVEL AND TRANSPORTATION SEARCH RESULTS COMPILED BY THE USER (U.S. CLS. 100 AND 105). FIRST USE 12-0-2005; IN COMMERCE 12-0-2005.

3,399,758. AIR COURIER DISPATCH, INC., MARIETTA, GA. SN 78-783,203. PUB. 3-27-2007, FILED 12-30-2005.

Aeropoint Delivery Solutions

THE MARK CONSISTS OF STANDARD CHARACTERS WITHOUT CLAIM TO ANY PARTICULAR FONT, STYLE, SIZE, OR COLOR. NO CLAIM IS MADE TO THE EXCLUSIVE RIGHT TO USE "DELIVERY SOLUTIONS", APART FROM THE MARK AS SHOWN. FOR TRANSPORTATION AND DELIVERY OF PERSONAL PROPERTY BY AIR, RAIL, BOAT, AND MOTOR VEHICLE (U.S. CLS. 100 AND 105). FIRST USE 6-1-2006; IN COMMERCE 6-1-2006.

3,399,895. REALTY RESCUE, INC., LOS ANGELES, CA. SN 78-841,369. PUB. 3-20-2007, FILED 3-20-2006.

We do it ... so you don't have to.

THE MARK CONSISTS OF STANDARD CHARACTERS WITHOUT CLAIM TO ANY PARTICULAR FONT, STYLE, SIZE, OR COLOR. FOR STORAGE AND DELIVERY OF REALTY SIGNS (U.S. CLS. 100 AND 105). FIRST USE 4-1-2006; IN COMMERCE 4-20-2006.

CLASS 39—(Continued).

3,399,904. REALTY RESCUE, INC., LOS ANGELES, CA. SN 78-843,375. PUB. 3-20-2007, FILED 3-22-2006.



NO CLAIM IS MADE TO THE EXCLUSIVE RIGHT TO USE "REALTY", APART FROM THE MARK AS SHOWN. THE COLOR(S) WHITE, RED, BLACK AND BLUE IS/ARE CLAIMED AS A FEATURE OF THE MARK. THE MARK CONSISTS OF A BLACK REAL ESTATE SIGN ENCIRCLED BY A RED AND WHITE LIFE PRESERVER, ON A BLUE BACKGROUND WITH LETTERS FORMING THE WORDS REALTY RESCUE. THE WORDS, REALTY RESCUE, IS WHITE. FOR STORAGE AND DELIVERY OF REALTY/OPEN HOUSE SIGNS (U.S. CLS. 100 AND 105). FIRST USE 4-1-2006; IN COMMERCE 4-20-2006.

3,400,209. UNION PACIFIC RAILROAD COMPANY, OMAHA, NE. SN 78-978,974. PUB. 10-10-2006, FILED 9-9-2005.

ENGINES OF CHANGE

THE MARK CONSISTS OF STANDARD CHARACTERS WITHOUT CLAIM TO ANY PARTICULAR FONT, STYLE, SIZE, OR COLOR. FOR FREIGHT TRANSPORTATION BY TRAIN (U.S. CLS. 100 AND 105). FIRST USE 1-0-2006; IN COMMERCE 1-0-2006.

CLASS 40—MATERIAL TREATMENT

3,398,955. CALIFORNIA CUSTOM FRUITS AND FLAVORS, INC., IRWINDALE, CA. SN 76-672,482. PUB. 9-18-2007, FILED 2-9-2007.

CHILLTECH

THE MARK CONSISTS OF STANDARD CHARACTERS WITHOUT CLAIM TO ANY PARTICULAR FONT, STYLE, SIZE, OR COLOR. FOR CUSTOM MANUFACTURE OF FOOD PRODUCTS TO THE ORDER AND SPECIFICATION OF OTHERS, NAMELY, PROCESSED FRUIT BASES FOR THE DAIRY AND BAKERY INDUSTRIES MANUFACTURED BY COOLING FRUIT BASES FOR PURPOSES OF MAINTAINING FRUIT IDENTITY AND EXTENDING SHELF LIFE (U.S. CLS. 100, 103 AND 106). FIRST USE 6-18-2007; IN COMMERCE 6-18-2007.

CLASS 40—(Continued).

3,399,087. PIATT, BRETT T., OXNARD, CA. SN 77-053,810. PUB. 7-3-2007, FILED 11-30-2006.



NO CLAIM IS MADE TO THE EXCLUSIVE RIGHT TO USE "COTTON", APART FROM THE MARK AS SHOWN. THE MARK CONSISTS OF STICK FIGURE SITTING INDIAN STYLE IN FRONT OF A COTTON BALL. UNDER THE LOGO IS THE WORDS "COTTON 4 PEOPLE". FOR IMPRINTING MESSAGES ON T-SHIRTS (U.S. CLS. 100, 103 AND 106). FIRST USE 7-1-2007; IN COMMERCE 10-1-2007.

3,399,489. JEFFREY R. TINO, LAS VEGAS, NV. SN 78-594,281. PUB. 3-7-2006, FILED 3-24-2005.

RECOGNITION EXPRESS

THE MARK CONSISTS OF STANDARD CHARACTERS WITHOUT CLAIM TO ANY PARTICULAR FONT, STYLE, SIZE, OR COLOR. NO CLAIM IS MADE TO THE EXCLUSIVE RIGHT TO USE "EXPRESS", APART FROM THE MARK AS SHOWN. FOR MANUFACTURE NAME BADGES, PLAQUES AND SIGNBOARDS OF PLASTIC OR WOODEN PARTS TO ORDER AND/OR SPECIFICATION OF OTHERS (U.S. CLS. 100, 103 AND 106). FIRST USE 11-1-1982; IN COMMERCE 11-1-1982.

CLASS 40—(Continued).

3,399,700. BROWN, JEFF, OXNARD, CA. SN 78-762,835. PUB. 8-22-2006, FILED 11-29-2005.



NO CLAIM IS MADE TO THE EXCLUSIVE RIGHT TO USE "BREWING COMPANY", APART FROM THE MARK AS SHOWN. THE MARK CONSISTS, IN PART, OF A TRIDENT WITH THE LETTERS "HBL" FORMING THE TINES OF THE TRIDENT, CROSSED SURFBOARDS AND OCEAN RIPPLES THAT APPEAR AT THE BOTTOM OF THE TRIDENT. FOR MICRO-BREWERY SERVICES (U.S. CLS. 100, 103 AND 106). FIRST USE 1-17-2007; IN COMMERCE 2-7-2007.

3,399,850. PANOLAM INDUSTRIES INTERNATIONAL, INC., SHELTON, CT. SN 78-819,410. PUB. 9-12-2006, FILED 2-21-2006.

RESOPREG

THE MARK CONSISTS OF STANDARD CHARACTERS WITHOUT CLAIM TO ANY PARTICULAR FONT, STYLE, SIZE, OR COLOR. OWNER OF U.S. REG. NO. 800,838. FOR PAPER TREATMENT (U.S. CLS. 100, 103 AND 106). FIRST USE 12-29-1964; IN COMMERCE 12-29-1964.

3,400,095. GRAPHIC SERVICES IMAGING, INC., STERLING HEIGHTS, MI. SN 78-948,251. PUB. 3-27-2007, FILED 8-9-2006.



CLASS 40—(Continued).

NO CLAIM IS MADE TO THE EXCLUSIVE RIGHT TO USE "STUDIO", APART FROM THE MARK AS SHOWN.

THE COLOR(S) BLUE, YELLOW, MAGENTA, RED, BLACK, GRAY AND GOLDENROD IS/ARE CLAIMED AS A FEATURE OF THE MARK.

THE MARK CONSISTS OF THREE CONCENTRIC CIRCLES BIASECTED HORIZONTALLY AND VERTICALLY BY TWO PERPENDICULAR LINES WHICH EXTEND BEYOND THE OUTERMOST CIRCLE. THE FOUR AREA SEGMENTS FORMED BY THE INTERSECTION OF THE HORIZONTAL AND VERTICAL LINES AND THE MIDDLE AND INNERMOST CONCENTRIC CIRCLES ARE COLORED BLUE, MAGENTA, YELLOW AND BLACK. THE FOUR QUADRANTS OF THE INNERMOST CIRCLE ARE GRAY. THE STYLIZED BLOCK LETTERS "GSI" IN THE COLOR GOLDENROD ARE ON A BLACK HORIZONTALLY-ELONGATED ELLIPSE. FOLLOWING THE LETTERS "GSI" IS THE WORD STUDIO IN YELLOW LETTERS. A HORIZONTAL RED LINE EXTENDS FROM THE END OF THE WORD STUDIO BEYOND THE HORIZONTALLY-ELONGATED BLACK ELLIPSE.

FOR ELECTRONIC IMAGING, SCANNING, DIGITIZING, ALTERATION AND/OR RETOUCHING OF PHOTOGRAPHIC IMAGES; PHOTOGRAPHIC RETOUCHING (U.S. CLS. 100, 103 AND 106).

FIRST USE 10-1-2006; IN COMMERCE 1-1-2007.

CLASS 41—EDUCATION AND ENTERTAINMENT

3,398,857. ENGINEERING FITNESS INTERNATIONAL CORP., DBA TOTAL GYM, DBA EFI AND DBA EFI MEDICAL SYSTEMS, SAN DIEGO, CA. SN 76-494,906. PUB. 12-2-2003, FILED 3-6-2003.

GRAVITY Studio

NO CLAIM IS MADE TO THE EXCLUSIVE RIGHT TO USE "STUDIO", APART FROM THE MARK AS SHOWN.

FOR EXERCISE SERVICES, NAMELY, PERSONAL TRAINER SERVICES, PHYSICAL FITNESS CONSULTATION, PHYSICAL FITNESS INSTRUCTION, PHYSICAL FITNESS TRAINING, EXERCISE TRAINING SERVICES (U.S. CLS. 100, 101 AND 107).

FIRST USE 9-12-2007; IN COMMERCE 9-12-2007.

3,398,864. AEROBICS AND FITNESS ASSOCIATION OF AMERICA, SHERMAN OAKS, CA. SN 76-535,245. PUB. 9-14-2004, FILED 7-24-2003.

AFAA SHAPE-UP CENTER

OWNER OF U.S. REG. NOS. 1,430,614 AND 2,595,711. NO CLAIM IS MADE TO THE EXCLUSIVE RIGHT TO USE "SHAPE-UP CENTER", APART FROM THE MARK AS SHOWN.

FOR INSTRUCTIONAL SERVICES, NAMELY, CONDUCTING WORKSHOPS, SEMINARS AND CLASSES ON THE SUBJECTS OF EXERCISE AND FITNESS, AND PROVIDING INFORMATION, ADVICE AND INSTRUCTION OVER A GLOBAL COMPUTER NETWORK ON THE SUBJECTS OF EXERCISE AND FITNESS (U.S. CLS. 100, 101 AND 107).

FIRST USE 12-1-2007; IN COMMERCE 12-1-2007.

CLASS 41—(Continued).

3,398,893. CONNECTIONS ACADEMY, LLC, BALTIMORE, MD. SN 76-622,655. PUB. 12-20-2005, FILED 11-30-2004.

LEAP
Longitudinal Evaluation
of Academic Progress

NO CLAIM IS MADE TO THE EXCLUSIVE RIGHT TO USE "EVALUATION OF ACADEMIC PROGRESS", APART FROM THE MARK AS SHOWN.

THE COLORS BLUE AND BLACK ARE CLAIMED AS A FEATURE OF THE MARK.

THE COLOR BLUE APPEARS WITHIN THE WORDING DESIGN OF "LEAP" OF THE MARK; THE COLOR BLACK APPEARS IN THE OUTLINE OF THE WORDING DESIGN OF "LEAP" AND IN THE WORDING "LONGITUDINAL EVALUATION OF ACADEMIC PROGRESS" OF THE MARK.

FOR EDUCATIONAL SERVICES, NAMELY, PROVIDING WEB-BASED EDUCATIONAL LEVEL ASSESSMENT SERVICES, PROVIDING CUSTOMIZED EDUCATIONAL PROGRAMS TO AID IN THE INSTRUCTING OF STUDENTS AND CHILDREN IN CONNECTION WITH CORE SCHOLASTIC SUBJECTS SUCH AS READING, WRITING AND MATH; PROVIDING AND ADMINISTERING EDUCATIONAL ASSESSMENT TESTS AND ONLINE EDUCATIONAL ASSESSMENT TESTS TO STUDENTS AND CHILDREN (U.S. CLS. 100, 101 AND 107).

FIRST USE 11-0-2004; IN COMMERCE 11-0-2004.

3,398,909. FUTURE FORTUNES, INC., OAK HILL, OH. SN 76-649,584. PUB. 9-12-2006, FILED 11-1-2005.

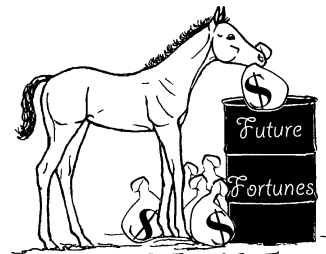

FOR EQUINE INCENTIVE PROGRAMS, NAMELY, PROVIDING RECOGNITION AND AWARDS TO REGISTERED FOALS AND STALLIONS AND THEIR RIDERS, BREEDERS AND OWNERS TO DEMONSTRATE EXCELLENCE IN THE FIELD OF HORSE BREEDING AND PERFORMANCE (U.S. CLS. 100, 101 AND 107).

FIRST USE 2-1-2003; IN COMMERCE 2-1-2003.

CLASS 41—(Continued).

3,398,969. SUNDANCE CHANNEL, LLC, NEW YORK, NY. SN 77-003,638. PUB. 5-1-2007, FILED 9-20-2006.

ONE PUNK UNDER GOD

THE MARK CONSISTS OF STANDARD CHARACTERS WITHOUT CLAIM TO ANY PARTICULAR FONT, STYLE, SIZE, OR COLOR.

FOR ENTERTAINMENT SERVICES IN THE NATURE OF A DOCUMENTARY TELEVISION SERIES; ENTERTAINMENT SERVICES, NAMELY, PROVIDING INFORMATION RELATED TO A DOCUMENTARY SERIES VIA THE GLOBAL COMPUTER NETWORK (U.S. CLS. 100, 101 AND 107).

FIRST USE 12-13-2006; IN COMMERCE 12-13-2006.

3,399,062. THE CHILDREN'S MUSEUM OF INDIANAPOLIS, INC., INDIANAPOLIS, IN. SN 77-040,743. PUB. 5-8-2007, FILED 11-9-2006.

**THE POWER OF CHILDREN:
MAKING A DIFFERENCE**

THE MARK CONSISTS OF STANDARD CHARACTERS WITHOUT CLAIM TO ANY PARTICULAR FONT, STYLE, SIZE, OR COLOR.

FOR MUSEUM SERVICES (U.S. CLS. 100, 101 AND 107).

FIRST USE 11-10-2007; IN COMMERCE 11-10-2007.

3,399,063. THE CHILDREN'S MUSEUM OF INDIANAPOLIS, INC., INDIANAPOLIS, IN. SN 77-040,757. PUB. 5-8-2007, FILED 11-9-2006.

THE POWER OF CHILDREN

THE MARK CONSISTS OF STANDARD CHARACTERS WITHOUT CLAIM TO ANY PARTICULAR FONT, STYLE, SIZE, OR COLOR.

FOR MUSEUM SERVICES (U.S. CLS. 100, 101 AND 107).

FIRST USE 11-10-2007; IN COMMERCE 11-10-2007.

CLASS 41—(Continued).

3,399,105. AIRS HUMAN CAPITAL SOLUTIONS, INC., WHITE RIVER JUNCTION, VT. SN 77-063,330. PUB. 7-10-2007, FILED 12-13-2006.

XTREMELAB

THE MARK CONSISTS OF STANDARD CHARACTERS WITHOUT CLAIM TO ANY PARTICULAR FONT, STYLE, SIZE, OR COLOR.

FOR EDUCATIONAL SERVICES, NAMELY, PROVIDING COURSES OF INSTRUCTION TO TEACH SOURCERS AND RECRUITERS TECHNIQUES FOR FINDING CANDIDATES ON THE INTERNET (U.S. CLS. 100, 101 AND 107).

FIRST USE 12-6-2006; IN COMMERCE 12-6-2006.

3,399,109. HDNET LLC, DALLAS, TX. SN 77-066,747. PUB. 4-24-2007, FILED 12-18-2006.

GREAT STORIES WELL TOLD

THE MARK CONSISTS OF STANDARD CHARACTERS WITHOUT CLAIM TO ANY PARTICULAR FONT, STYLE, SIZE, OR COLOR.

FOR ENTERTAINMENT IN THE NATURE OF ON-GOING TELEVISION PROGRAMS IN THE FIELD OF MOVIES (U.S. CLS. 100, 101 AND 107).

FIRST USE 1-5-2007; IN COMMERCE 1-5-2007.

3,399,132. MEREDITH CORPORATION, DES MOINES, IA. SN 77-074,592. PUB. 5-22-2007, FILED 1-2-2007.

MORE TIME

THE MARK CONSISTS OF STANDARD CHARACTERS WITHOUT CLAIM TO ANY PARTICULAR FONT, STYLE, SIZE, OR COLOR.

OWNER OF U.S. REG. NOS. 2,154,334, 3,066,964, AND 3,076,663.

FOR EDUCATION AND ENTERTAINMENT, NAMELY, PROVIDING A RADIO PROGRAM FEATURING A VARIETY OF SUBJECTS OF INTEREST TO WOMEN OVER THE AGE OF 40 (U.S. CLS. 100, 101 AND 107).

FIRST USE 1-16-2007; IN COMMERCE 1-16-2007.

CLASS 41—(Continued).

3,399,135. SCHOLASTIC INC., NEW YORK, NY. SN 77-075,994. PUB. 8-7-2007, FILED 1-4-2007.

BOOKFLIX

THE MARK CONSISTS OF STANDARD CHARACTERS WITHOUT CLAIM TO ANY PARTICULAR FONT, STYLE, SIZE, OR COLOR.

FOR EDUCATIONAL SERVICES, NAMELY, PROVIDING AN ONLINE READING PROGRAM FOR CHILDREN WHICH INCORPORATES THE USE OF INTERACTIVE FICTIONAL VIDEO STORYBOOKS WITH RELATED NONFICTION PRINT CONTENT AND DISTRIBUTION OF THE NONFICTION PRINT CONTENT IN CONNECTION THEREWITH (U.S. CLS. 100, 101 AND 107).

FIRST USE 6-12-2007; IN COMMERCE 6-12-2007.

3,399,150. AMF BOWLING WORLDWIDE, INC., MECHANICSVILLE, VA. SN 77-084,782. PUB. 8-28-2007, FILED 1-17-2007.

STRIKINGLY DIFFERENT

THE MARK CONSISTS OF STANDARD CHARACTERS WITHOUT CLAIM TO ANY PARTICULAR FONT, STYLE, SIZE, OR COLOR.

FOR BOWLING ALLEY SERVICES; PROVIDING FACILITIES FOR RECREATIONAL ACTIVITIES, NAMELY, BILLIARDS; AMUSEMENT CENTERS FEATURING COIN-OPERATED VIDEO GAMES AND STAND ALONE VIDEO GAME MACHINES (U.S. CLS. 100, 101 AND 107).

FIRST USE 10-31-2005; IN COMMERCE 2-28-2006.

3,399,173. ARIZONA CHAPTER AMERICAN PARKINSON DISEASE ASSOCIATION, TUCSON, AZ. SN 77-096,880. PUB. 7-24-2007, FILED 2-1-2007.

Power over
Arizona Chapter Parkinson's
American Parkinson Disease Association

NO CLAIM IS MADE TO THE EXCLUSIVE RIGHT TO USE "ARIZONA CHAPTER" AND "AMERICAN PARKINSON DISEASE ASSOCIATION", APART FROM THE MARK AS SHOWN.

FOR DEVELOPMENT AND DISSEMINATION OF EDUCATIONAL MATERIALS OF OTHERS IN THE FIELD OF PARKINSON'S DISEASE (U.S. CLS. 100, 101 AND 107).

FIRST USE 1-0-2007; IN COMMERCE 1-0-2007.

CLASS 41—(Continued).

3,399,232. EMPLOYEE & FAMILY RESOURCES, DES MOINES, IA. SN 77-122,508. PUB. 8-21-2007, FILED 3-5-2007.

NAVIGATING YOUR FUTURE

THE MARK CONSISTS OF STANDARD CHARACTERS WITHOUT CLAIM TO ANY PARTICULAR FONT, STYLE, SIZE, OR COLOR.

FOR LIFE COACHING, NAMELY, PERSONAL COACHING SERVICES IN THE FIELD OF PERSONAL, EMOTIONAL, BUSINESS, PSYCHOLOGICAL, AND SOCIAL DEVELOPMENT; PERSONAL COACHING SERVICES IN THE FIELD OF PERSONAL, EMOTIONAL, BUSINESS, PSYCHOLOGICAL, AND SOCIAL DEVELOPMENT (U.S. CLS. 100, 101 AND 107).

FIRST USE 6-1-2007; IN COMMERCE 6-1-2007.

3,399,248. KIRSCH, MICHAEL I., SYOSSET, NY. SN 77-131,185. PUB. 9-11-2007, FILED 3-14-2007.

We Tigers

THE MARK CONSISTS OF STANDARD CHARACTERS WITHOUT CLAIM TO ANY PARTICULAR FONT, STYLE, SIZE, OR COLOR.

FOR ENTERTAINMENT SERVICES, NAMELY, LIVE MUSICAL BAND PERFORMANCES (U.S. CLS. 100, 101 AND 107).

FIRST USE 12-19-2007; IN COMMERCE 12-19-2007.

3,399,255. LAMPESE, RICHARD, SETAUKET, NY. AND CARPENTER, FRED, SETAUKET, NY. SN 77-134,846. PUB. 9-18-2007, FILED 3-19-2007.

IDRIVEINMOVIE

THE MARK CONSISTS OF STANDARD CHARACTERS WITHOUT CLAIM TO ANY PARTICULAR FONT, STYLE, SIZE, OR COLOR.

FOR ENTERTAINMENT SERVICES NAMELY, PROVIDING A WEBSITE FEATURING, PHOTOGRAPHIC, AUDIO, VIDEO AND PROSE PRESENTATIONS FEATURING FULL LENGTH AND SHORT FEATURE FILMS, MOVIES, AND MOVIE TRAILERS (U.S. CLS. 100, 101 AND 107).

FIRST USE 3-23-2007; IN COMMERCE 3-23-2007.

CLASS 41—(Continued).

3,399,258. MINSKY, RICHARD P., HUDSON, NY. SN 77-137,283. PUB. 9-18-2007, FILED 3-22-2007.

SLART

THE MARK CONSISTS OF STANDARD CHARACTERS WITHOUT CLAIM TO ANY PARTICULAR FONT, STYLE, SIZE, OR COLOR.

FOR MULTIMEDIA PUBLISHING OF BOOKS, MAGAZINES, JOURNALS, SOFTWARE, GAMES, MUSIC, AND ELECTRONIC PUBLICATIONS; ON-LINE PUBLICATION OF ART; PUBLICATION OF ELECTRONIC MAGAZINES; PUBLICATION OF ELECTRONIC NEWSPAPERS ACCESSIBLE VIA A GLOBAL COMPUTER NETWORK; PUBLICATION OF THE EDITORIAL CONTENT OF SITES ACCESSIBLE VIA A GLOBAL COMPUTER NETWORK; PUBLISHING OF ELECTRONIC PUBLICATIONS; ART EXHIBITIONS; CONDUCTING WORKSHOPS AND SEMINARS IN ART; INSTRUCTION IN THE FIELD OF ART; WORKSHOPS AND SEMINARS IN THE FIELD OF ART; PUBLICATION AND EDITING OF PRINTED MATTER; PUBLICATION OF BOOKS; PUBLICATION OF BOOKS, MAGAZINES, ALMANACS AND JOURNALS; PUBLICATION OF BOOKS, OF MAGAZINES, OF JOURNALS, OF NEWSPAPERS, OF PERIODICALS, OF CATALOGS, OF BROCHURES; PUBLICATION OF BOOKS, REVIEWS; PUBLICATION OF BROCHURES; PUBLICATION OF DOCUMENTS IN THE FIELD OF TRAINING, SCIENCE, PUBLIC LAW AND SOCIAL AFFAIRS; PUBLICATION OF JOURNALS; PUBLICATION OF LEAFLETS; PUBLICATION OF MAGAZINES; PUBLICATION OF MANUALS; PUBLICATION OF MUSICAL TEXTS; PUBLICATION OF PRINTED MATTER; PUBLICATION OF TEXT BOOKS; PUBLICATION OF TEXTS, BOOKS, JOURNALS; PUBLICATION OF TEXTS, BOOKS, MAGAZINES AND OTHER PRINTED MATTER; EDUCATION IN THE FIELD OF ART RENDERED THROUGH CORRESPONDENCE COURSES; EDUCATION IN THE FIELD OF ART RENDERED THROUGH VIDEO CONFERENCE; EDUCATIONAL SERVICES IN THE NATURE OF ART SCHOOLS; ORGANIZING COMMUNITY FESTIVALS FEATURING A VARIETY OF ACTIVITIES, NAMELY, SPORTING EVENTS, ART EXHIBITIONS, FLEA MARKETS, ETHNIC DANCES AND THE LIKE (U.S. CLS. 100, 101 AND 107).

FIRST USE 12-9-2006; IN COMMERCE 12-14-2006.

3,399,259. BALANCE, SAN FRANCISCO, CA. SN 77-137,851. PUB. 9-18-2007, FILED 3-22-2007.

BALANCETRACK

THE MARK CONSISTS OF STANDARD CHARACTERS WITHOUT CLAIM TO ANY PARTICULAR FONT, STYLE, SIZE, OR COLOR.

FOR EDUCATIONAL SERVICES, NAMELY, CONDUCTING SEMINARS AND WORKSHOPS IN THE FIELD OF FINANCIAL LITERACY AND PERSONAL FINANCIAL MANAGEMENT AND DISTRIBUTION OF COURSE MATERIAL IN CONNECTION THEREWITH (U.S. CLS. 100, 101 AND 107).

FIRST USE 11-8-2007; IN COMMERCE 11-8-2007.

CLASS 41—(Continued).

3,399,274. VICTORIA QUADE, CHICAGO, IL. SN 77-148,408. PUB. 10-9-2007, FILED 4-4-2007.

SUNDAY SCHOOL CINEMA

THE MARK CONSISTS OF STANDARD CHARACTERS WITHOUT CLAIM TO ANY PARTICULAR FONT, STYLE, SIZE, OR COLOR.

FOR ENTERTAINMENT IN THE NATURE OF LIVE THEATER PRODUCTIONS (U.S. CLS. 100, 101 AND 107). FIRST USE 6-3-2007; IN COMMERCE 6-3-2007.

3,399,282. MEREDITH CORPORATION, DES MOINES, IA. SN 77-151,011. PUB. 10-9-2007, FILED 4-6-2007.

LIVING THE COUNTRY LIFE

THE MARK CONSISTS OF STANDARD CHARACTERS WITHOUT CLAIM TO ANY PARTICULAR FONT, STYLE, SIZE, OR COLOR.

OWNER OF U.S. REG. NO. 2,716,071. FOR ENTERTAINMENT, NAMELY, PROVIDING A RADIO PROGRAM FEATURING TOPICS OF INTEREST TO INDIVIDUALS WITH A RURAL LIFESTYLE (U.S. CLS. 100, 101 AND 107).

FIRST USE 9-4-2007; IN COMMERCE 9-4-2007.

3,399,284. CHICKASAW NATION, ADA, OK. SN 77-152,798. PUB. 10-9-2007, FILED 4-10-2007.

PLAY IT SAFE

THE MARK CONSISTS OF STANDARD CHARACTERS WITHOUT CLAIM TO ANY PARTICULAR FONT, STYLE, SIZE, OR COLOR.

FOR ENTERTAINMENT SERVICES, NAMELY, PRODUCTION AND DISTRIBUTION OF A GAME SHOW; PROVIDING FACILITIES FOR GAME SHOWS (U.S. CLS. 100, 101 AND 107).

FIRST USE 4-1-2007; IN COMMERCE 4-1-2007.

CLASS 41—(Continued).

3,399,289. ALL 4 KIDS, LLC, KINGWOOD, TX. SN 77-157,124. PUB. 10-16-2007, FILED 4-15-2007.

CLASS 41—(Continued).

3,399,395. DAVID M GRASMICK, UPLAND, CA. SN 78-474,377. PUB. 7-19-2005, FILED 8-26-2004.

Chefs 2 Be

Homework on Wheels

THE MARK CONSISTS OF STANDARD CHARACTERS WITHOUT CLAIM TO ANY PARTICULAR FONT, STYLE, SIZE, OR COLOR.

FOR EDUCATIONAL SERVICES, NAMELY, CONDUCTING CLASSES IN THE FIELD OF COOKING AND DISTRIBUTION OF COURSE MATERIAL IN CONNECTION THEREWITH; EDUCATIONAL SERVICES, NAMELY, DEVELOPING, ARRANGING, AND CONDUCTING EDUCATIONAL CONFERENCES AND PROGRAMS AND PROVIDING COURSES OF INSTRUCTION IN THE FIELD OF COOKING; EDUCATIONAL SERVICES, NAMELY, CONDUCTING CLASSES IN THE FIELD OF COOKING; INSTRUCTION IN THE FIELD OF COOKING; PROVIDING A WEBSITE THAT FEATURES INFORMAL INSTRUCTION ON COOKING (U.S. CLS. 100, 101 AND 107).
FIRST USE 6-6-2006; IN COMMERCE 8-8-2007.

THE MARK CONSISTS OF STANDARD CHARACTERS WITHOUT CLAIM TO ANY PARTICULAR FONT, STYLE, SIZE, OR COLOR.

SEC. 2(F).
FOR TUTORING AND HELP WITH HOMEWORK (U.S. CLS. 100, 101 AND 107).
FIRST USE 9-1-2002; IN COMMERCE 10-1-2002.

3,399,408. AMERICAN ELECTRIC POWER COMPANY, INC., COLUMBUS, OH. SN 78-501,848. PUB. 9-27-2005, FILED 10-19-2004.

3,399,351. SCREENLIFE, LLC, SEATTLE, WA. SN 78-342,828. PUB. 9-21-2004, FILED 12-18-2003.

Bright Start

SCENE IT?

THE MARK CONSISTS OF STANDARD CHARACTERS WITHOUT CLAIM TO ANY PARTICULAR FONT, STYLE, SIZE, OR COLOR.

OWNER OF U.S. REG. NO. 2,751,317.
FOR PROVIDING AN ONLINE COMPUTER GAME (U.S. CLS. 100, 101 AND 107).
FIRST USE 12-0-2004; IN COMMERCE 12-0-2004.

THE MARK CONSISTS OF STANDARD CHARACTERS WITHOUT CLAIM TO ANY PARTICULAR FONT, STYLE, SIZE, OR COLOR.

FOR EDUCATION IN THE FIELD OF EARLY CHILDHOOD SCIENCE EDUCATION; EDUCATION SERVICES IN THE NATURE OF COURSES AT THE UNIVERSITY LEVEL REGARDING EARLY CHILDHOOD SCIENCE EDUCATION; INSTRUCTION IN THE FIELD OF EARLY CHILDHOOD SCIENCE EDUCATION; TEACHING IN THE FIELD OF EARLY CHILDHOOD SCIENCE EDUCATION; DEVELOPING EDUCATIONAL MANUALS FOR OTHERS IN THE FIELD OF EARLY CHILDHOOD SCIENCE EDUCATION; DEVELOPMENT AND DISSEMINATION OF EDUCATIONAL MATERIALS OF OTHERS IN THE FIELD OF EARLY CHILDHOOD SCIENCE EDUCATION (U.S. CLS. 100, 101 AND 107).
FIRST USE 7-13-2007; IN COMMERCE 7-13-2007.

CLASS 41—(Continued).

3,399,418. EDUCATION MANAGEMENT LLC, PITTSBURGH, PA. SN 78-508,936. PUB. 10-17-2006, FILED 11-1-2004.

THE ART INSTITUTE OF JACKSONVILLE

THE MARK CONSISTS OF STANDARD CHARACTERS WITHOUT CLAIM TO ANY PARTICULAR FONT, STYLE, SIZE, OR COLOR.

OWNER OF U.S. REG. NOS. 1,608,534, 2,409,652, AND OTHERS.

NO CLAIM IS MADE TO THE EXCLUSIVE RIGHT TO USE "ART INSTITUTE", APART FROM THE MARK AS SHOWN.

SEC. 2(F).

FOR EDUCATIONAL SERVICES, NAMELY, PROVIDING COURSES OF INSTRUCTION AT THE POSTSECONDARY LEVEL (U.S. CLS. 100, 101 AND 107).

FIRST USE 1-8-2007; IN COMMERCE 1-8-2007.

CLASS 41—(Continued).

3,399,523. ESCUELA DE DECORACION VERACRUZ AC., ZAPOCAN, MEXICO. SN 78-625,962. PUB. 4-10-2007, FILED 5-9-2005.

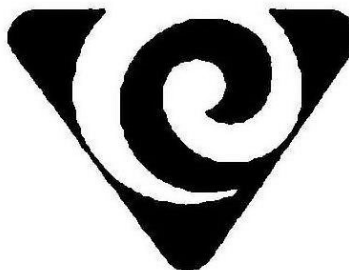

THE MARK CONSISTS OF A SPIRAL INSIDE OF A TRIANGLE WITH ROUNDED EDGES.

FOR PROVIDING COURSES OF INSTRUCTION AT THE HIGH SCHOOL AND UNIVERSITY LEVEL (U.S. CLS. 100, 101 AND 107).

FIRST USE 10-18-2005; IN COMMERCE 10-18-2005.

3,399,423. KONAMI DIGITAL ENTERTAINMENT CO. LTD., TOKYO 107-8324, JAPAN. SN 78-512,197. PUB. 10-4-2005, FILED 11-5-2004.

CODED ARMS

THE MARK CONSISTS OF STANDARD CHARACTERS WITHOUT CLAIM TO ANY PARTICULAR FONT, STYLE, SIZE, OR COLOR.

OWNER OF U.S. REG. NO. 3,160,967.

FOR ENTERTAINMENT SERVICES, NAMELY, PROVIDING ON-LINE COMPUTER GAMES; PROVIDING INFORMATION ABOUT COMPUTER GAMES THROUGH THE WEB SITES (U.S. CLS. 100, 101 AND 107).

FIRST USE 9-18-2007; IN COMMERCE 9-18-2007.

3,399,560. LUCASFILM LTD., SAN FRANCISCO, CA. SN 78-662,707. PUB. 3-14-2006, FILED 7-1-2005.



SKYWALKER SOUND

OWNER OF U.S. REG. NOS. 2,621,715 AND 2,729,615. NO CLAIM IS MADE TO THE EXCLUSIVE RIGHT TO USE "SOUND", APART FROM THE MARK AS SHOWN.

THE MARK CONSISTS OF THE WORDS "SKYWALKER SOUND" WITH THE DESIGN OF A BIRD IN A CIRCLE.

FOR AUDIO SERVICES, NAMELY, SOUND DESIGN, SOUND EDITING, SOUND RECORDING, SOUND MIXING, PRODUCTION OF SOUND EFFECTS FOR MOTION PICTURES, TELEVISION, VIDEO, TRAILERS, COMPUTER GAMES, VIDEO GAMES, COMMERCIALS, WEBSITES AND THEME RIDES; RENTAL OF STAGES, STUDIOS AND EQUIPMENT FOR SOUND DESIGN, EDITING, RECORDING, MIXING AND SOUND EFFECT PRODUCTION; TECHNICAL CONSULTING RELATING TO AUDIO SERVICES, NAMELY, SOUND DESIGN, EDITING, RECORDING, MIXING AND PRODUCTION OF SOUND EFFECTS IN MOTION PICTURES, TV, VIDEO, TRAILERS, COMPUTER GAMES, VIDEO GAMES, COMMERCIALS, WEBSITES AND THEME RIDES (U.S. CLS. 100, 101 AND 107).

FIRST USE 6-12-2005; IN COMMERCE 6-12-2005.

3,399,501. LEVINE, SUZANNE BRAUN, NEW YORK, NY. SN 78-600,874. PUB. 1-3-2006, FILED 4-4-2005.

INVENTING THE REST OF OUR LIVES

THE MARK CONSISTS OF STANDARD CHARACTERS WITHOUT CLAIM TO ANY PARTICULAR FONT, STYLE, SIZE, OR COLOR.

FOR EDUCATIONAL SERVICES, NAMELY, PROVIDING CONFERENCES, SPEECHES, WORKSHOPS, SEMINARS AND TRAINING PROGRAMS RELATING TO WOMEN'S ISSUES (U.S. CLS. 100, 101 AND 107).

FIRST USE 6-0-2005; IN COMMERCE 6-0-2005.

CLASS 41—(Continued).

3,399,592. NATIONAL INSTITUTE FOR LEARNING DISABILITIES, INC., NORFOLK, VA. SN 78-689,257. PUB. 4-10-2007, FILED 8-10-2005.

NILD Group Educational Therapy

THE MARK CONSISTS OF STANDARD CHARACTERS WITHOUT CLAIM TO ANY PARTICULAR FONT, STYLE, SIZE, OR COLOR.

OWNER OF U.S. REG. NOS. 2,386,890 AND 2,496,597.

NO CLAIM IS MADE TO THE EXCLUSIVE RIGHT TO USE "GROUP EDUCATIONAL THERAPY", APART FROM THE MARK AS SHOWN.

FOR EDUCATIONAL SERVICES IN THE NATURE OF SPECIAL EDUCATION PROGRAMS WITHIN SCHOOLS WHICH FOCUS ON STIMULATING DEFICIT AREAS OF PERCEPTION AND COGNITION IN ORDER TO ENABLE SPECIAL NEEDS STUDENTS TO BECOME ACTIVE, INDEPENDENT LEARNERS IN THE REGULAR CLASSROOM (U.S. CLS. 100, 101 AND 107).

FIRST USE 6-11-2007; IN COMMERCE 6-11-2007.

3,399,594. UNIVERSITY OF NORTH CAROLINA AT GREENSBORO, THE, GREENSBORO, NC. SN 78-692,890. PUB. 5-9-2006, FILED 8-15-2005.



OWNER OF U.S. REG. NO. 1,776,610.
NO CLAIM IS MADE TO THE EXCLUSIVE RIGHT TO USE "SCHOOL" AND "REAL COLLEGE CREDIT IN HIGH SCHOOL", APART FROM THE MARK AS SHOWN.

THE COLORS GRAY, BLUE, AND WHITE ARE CLAIMED AS A FEATURE OF THE MARK.

THE "U" IS WHITE OUTLINED IN GRAY, THE BACKGROUND OVAL IS BLUE OUTLINED IN GRAY, THE WORD "SCHOOL" IS BLUE OUTLINED IN GRAY, AND THE WORDING "UNCG" AND "REAL COLLEGE CREDIT IN HIGH SCHOOL" IS GRAY.

FOR EDUCATION SERVICES IN THE NATURE OF COURSES AT THE UNIVERSITY LEVEL FOR HIGH SCHOOL STUDENTS (U.S. CLS. 100, 101 AND 107).

FIRST USE 8-25-2005; IN COMMERCE 5-30-2007.

CLASS 41—(Continued).

3,399,606. INSEL, RACHEL LAUREN, LOS ANGELES, CA. SN 78-700,838. PUB. 8-7-2007, FILED 8-25-2005.

RAD GIRLS

THE MARK CONSISTS OF STANDARD CHARACTERS WITHOUT CLAIM TO ANY PARTICULAR FONT, STYLE, SIZE, OR COLOR.

FOR ENTERTAINMENT IN THE NATURE OF AN ONGOING REALITY BASED TELEVISION PROGRAM (U.S. CLS. 100, 101 AND 107).

FIRST USE 6-15-2005; IN COMMERCE 3-1-2007.

3,399,610. BENNET, CARESSA D., BETHESDA, MD. AND POKONOSKY, JEFF, SAN DIEGO, CA. SN 78-707,430. PUB. 12-26-2006, FILED 9-6-2005.

Kona Buzz

THE MARK CONSISTS OF STANDARD CHARACTERS WITHOUT CLAIM TO ANY PARTICULAR FONT, STYLE, SIZE, OR COLOR.

NO CLAIM IS MADE TO THE EXCLUSIVE RIGHT TO USE "KONA", APART FROM THE MARK AS SHOWN.

FOR EDUCATION SERVICES, NAMELY, PROVIDING INFORMATION ON ATHLETES AND THE TRIATHLONS IN WHICH THEY PARTICIPATE; ENTERTAINMENT IN THE NATURE OF TRIATHLONS (U.S. CLS. 100, 101 AND 107).

FIRST USE 1-1-2007; IN COMMERCE 1-1-2007.

3,399,620. WARNER BROS. ENTERTAINMENT INC., BURBANK, CA. SN 78-714,214. PUB. 5-30-2006, FILED 9-15-2005.

TMZ

THE MARK CONSISTS OF STANDARD CHARACTERS WITHOUT CLAIM TO ANY PARTICULAR FONT, STYLE, SIZE, OR COLOR.

FOR ENTERTAINMENT SERVICES IN THE NATURE OF LIVE-ACTION, COMEDY, AND DRAMA TELEVISION SERIES; PRODUCTION OF LIVE-ACTION, COMEDY, AND DRAMA TELEVISION SERIES (U.S. CLS. 100, 101 AND 107).

FIRST USE 9-10-2007; IN COMMERCE 9-10-2007.

CLASS 41—(Continued).

3,399,621. WNBA ENTERPRISES, LLC, SECAUCUS, NJ. SN 78-715,537. PUB. 4-3-2007, FILED 9-19-2005.



THE MARK CONSISTS OF A BASKETBALL SITTING ON A CLOUD TO THE RIGHT OF A CITY SKYLINE WITH THREE SKYSCRAPERS. A STYLIZED LETTER "S" WRAPS AROUND THE SKYSCRAPERS.

FOR ENTERTAINMENT AND EDUCATIONAL SERVICES IN THE NATURE OF ONGOING TELEVISION AND RADIO PROGRAMS IN THE FIELD OF BASKETBALL AND RENDERING LIVE BASKETBALL GAMES AND BASKETBALL EXHIBITIONS; THE PRODUCTION AND DISTRIBUTION OF RADIO AND TELEVISION BROADCASTS OF BASKETBALL GAMES, BASKETBALL EVENTS AND PROGRAMS IN THE FIELD OF BASKETBALL; CONDUCTING AND ARRANGING BASKETBALL CLINICS AND CAMPS, COACHES CLINICS AND CAMPS, DANCE TEAM CLINICS AND CAMPS AND BASKETBALL EVENTS; ENTERTAINMENT SERVICES IN THE NATURE OF PERSONAL APPEARANCES BY A COSTUMED MASCOT AND/OR DANCE TEAM AT BASKETBALL GAMES AND EXHIBITIONS, CLINICS, CAMPS, PROMOTIONS, AND OTHER BASKETBALL-RELATED EVENTS, SPECIAL EVENTS AND PARTIES; FAN CLUB SERVICES; ENTERTAINMENT SERVICES, NAMELY, PROVIDING A WEBSITE FEATURING THE FOLLOWING CONTENT TELEVISION HIGHLIGHTS, INTERACTIVE TELEVISION HIGHLIGHTS, VIDEO RECORDINGS, VIDEO STREAM RECORDINGS, INTERACTIVE VIDEO HIGHLIGHT SELECTIONS, RADIO PROGRAMS, RADIO HIGHLIGHTS AND AUDIO RECORDINGS IN THE FIELD OF BASKETBALL, BASKETBALL NEWS IN THE NATURE OF INFORMATION, STATISTICS AND TRIVIA ABOUT BASKETBALL, ON-LINE COMPUTER GAMES, VIDEO GAMES, INTERACTIVE VIDEO GAMES, ACTION SKILL GAMES, ARCADE GAMES, ADULTS' AND CHILDREN'S PARTY GAMES, BOARD GAMES, PUZZLES AND TRIVIA GAMES, PROVIDING ON-LINE MAGAZINES, GUIDES, NEWSLETTERS, COLORING BOOKS AND GAME SCHEDULES IN THE FIELD OF BASKETBALL OVER THE INTERNET, PROVIDING AN ONLINE COMPUTER DATABASE IN THE FIELD OF BASKETBALL (U.S. CLS. 100, 101 AND 107).

FIRST USE 9-20-2005; IN COMMERCE 9-20-2005.

CLASS 41—(Continued).

3,399,637. NETWORK ENTERPRISES, INC., NEW YORK, NY. SN 78-726,828. PUB. 6-13-2006, FILED 10-5-2005.

GAME HEAD

THE MARK CONSISTS OF STANDARD CHARACTERS WITHOUT CLAIM TO ANY PARTICULAR FONT, STYLE, SIZE, OR COLOR.

NO CLAIM IS MADE TO THE EXCLUSIVE RIGHT TO USE "GAME", APART FROM THE MARK AS SHOWN.

FOR ENTERTAINMENT SERVICES IN THE NATURE OF AN ON-GOING TELEVISION SERIES, FEATURING LIVE ACTION, COMEDY AND DRAMA; PROVIDING ONLINE INFORMATION IN THE FIELD OF ENTERTAINMENT CONCERNING TELEVISION PROGRAMS (U.S. CLS. 100, 101 AND 107).

FIRST USE 5-9-2007; IN COMMERCE 5-9-2007.

3,399,691. SYSCO CORPORATION, HOUSTON, TX. SN 78-757,769. PUB. 7-25-2006, FILED 11-20-2005.

DEDICATION TO VALUE

THE MARK CONSISTS OF STANDARD CHARACTERS WITHOUT CLAIM TO ANY PARTICULAR FONT, STYLE, SIZE, OR COLOR.

FOR EDUCATION AND TRAINING SERVICES FOR HEALTHCARE PROFESSIONALS, NAMELY, PROVIDING TRAINING COURSES AND TRAINING PRESENTATIONS IN THE FIELDS OF FOOD SAFETY, DIET PLANNING AND SUPERVISION, AND MENU PLANNING (U.S. CLS. 100, 101 AND 107).

FIRST USE 2-1-2006; IN COMMERCE 2-1-2006.

CLASS 41—(Continued).

3,399,698. YOUTHNET OF GREATER KANSAS CITY, KANSAS CITY, MO. SN 78-761,589. PUB. 8-8-2006, FILED 11-28-2005.

Science and Math Matter

THE MARK CONSISTS OF STANDARD CHARACTERS WITHOUT CLAIM TO ANY PARTICULAR FONT, STYLE, SIZE, OR COLOR.

NO CLAIM IS MADE TO THE EXCLUSIVE RIGHT TO USE "SCIENCE AND MATH", APART FROM THE MARK AS SHOWN.

FOR CHARITABLE EDUCATION SERVICES, NAMELY, PROVIDING INFORMATION, RESEARCH AND ASSISTANCE WITH HOMEWORK ASSIGNMENTS TO STUDENTS ATTENDING GRADES KINDERGARTEN THROUGH TWELFTH GRADES VIA TELEPHONE CALL CENTER AND ONLINE RESPONSE SERVICES ON ALL SUBJECTS COVERED IN GRADES KINDERGARTEN THROUGH TWELFTH GRADE, INCLUDING SCIENCE AND MATH (U.S. CLS. 100, 101 AND 107).

FIRST USE 12-1-2006; IN COMMERCE 12-1-2006.

3,399,717. GAREB SHAMUS ENTERPRISES, INC., CONGERS, NY. SN 78-770,112. PUB. 8-1-2006, FILED 12-9-2005.

ANACONDAS

THE MARK CONSISTS OF STANDARD CHARACTERS WITHOUT CLAIM TO ANY PARTICULAR FONT, STYLE, SIZE, OR COLOR.

FOR ENTERTAINMENT SERVICES, NAMELY MARTIAL ARTS SPORTING EVENTS (U.S. CLS. 100, 101 AND 107).

FIRST USE 4-29-2006; IN COMMERCE 4-29-2006.

3,399,724. DISNEY ENTERPRISES, INC., BURBANK, CA. SN 78-773,082. PUB. 3-20-2007, FILED 12-14-2005.

DISNEY'S GAME CAFE

THE MARK CONSISTS OF STANDARD CHARACTERS WITHOUT CLAIM TO ANY PARTICULAR FONT, STYLE, SIZE, OR COLOR.

NO CLAIM IS MADE TO THE EXCLUSIVE RIGHT TO USE GAME, APART FROM THE MARK AS SHOWN.

FOR ENTERTAINMENT SERVICES, NAMELY, PROVIDING ON-LINE COMPUTER GAMES; PROVIDING A WEB SITE FOR DOWNLOADING VIDEO GAMES, COMPUTER GAMES AND INTERACTIVE GAMES (U.S. CLS. 100, 101 AND 107).

FIRST USE 12-30-2005; IN COMMERCE 12-30-2005.

CLASS 41—(Continued).

3,399,740. ILANI, DORIT SUSAN, DESERT HOT SPRINGS, CA. SN 78-778,434. PUB. 4-17-2007, FILED 12-21-2005.

THE PAUSE METHOD

THE MARK CONSISTS OF STANDARD CHARACTERS WITHOUT CLAIM TO ANY PARTICULAR FONT, STYLE, SIZE, OR COLOR.

NO CLAIM IS MADE TO THE EXCLUSIVE RIGHT TO USE "METHOD", APART FROM THE MARK AS SHOWN.

FOR PSYCHO-EDUCATIONAL SERVICES AND MEDITATION TRAINING FEATURING TECHNIQUES FOR EFFECTIVE RESPONSE TO DAILY LIFE IN THE FORM OF GROUP INSTRUCTION OFFERED AT BUSINESS ORGANIZATIONS AND CORPORATIONS (U.S. CLS. 100, 101 AND 107).

FIRST USE 7-11-2006; IN COMMERCE 7-11-2006.

3,399,783. SPACE RADIO PRODUCTIONS LLC, ROSLINDALE, MA. SN 78-795,185. PUB. 10-3-2006, FILED 1-19-2006.

The Beams

THE MARK CONSISTS OF STANDARD CHARACTERS WITHOUT CLAIM TO ANY PARTICULAR FONT, STYLE, SIZE, OR COLOR.

FOR AUDIO RECORDING AND PRODUCTION; ENTERTAINMENT IN THE NATURE OF VISUAL AND AUDIO PERFORMANCES, NAMELY, MUSICAL, VARIETY, NEWS AND COMEDY SHOWS; ENTERTAINMENT NAMELY, PRODUCTION OF CHILDREN'S AUDIO PROGRAMMING; ENTERTAINMENT SERVICES, NAMELY, PROVIDING A RADIO PROGRAM IN THE FIELD OF CHILDREN'S PROGRAMMING VIA A GLOBAL COMPUTER NETWORK; ENTERTAINMENT, NAMELY A CONTINUING CHILDREN'S AUDIO SHOW BROADCAST OVER TELEVISION, SATELLITE, AUDIO, AND VIDEO MEDIA (U.S. CLS. 100, 101 AND 107).

FIRST USE 6-1-2006; IN COMMERCE 6-1-2006.

3,399,793. REV. KEMPF, JOSEPH G., O'FALLON, MO. SN 78-797,973. PUB. 9-19-2006, FILED 1-24-2006.

BIG AL

THE MARK CONSISTS OF STANDARD CHARACTERS WITHOUT CLAIM TO ANY PARTICULAR FONT, STYLE, SIZE, OR COLOR.

FOR EDUCATIONAL ENTERTAINMENT, NAMELY, A CONTINUING SHOW FEATURING MORALS AND RELIGION DISTRIBUTED OVER TELEVISION, SATELLITE, AUDIO AND VIDEO MEDIA, WIRELESS COMMUNICATION, VIDEO ON DEMAND AND THE INTERNET (U.S. CLS. 100, 101 AND 107).

FIRST USE 9-4-2007; IN COMMERCE 9-4-2007.

CLASS 41—(Continued).

3,399,818. NICE GUY STRATEGIES, LLC, NEWBURYPORT, MA. SN 78-806,332. PUB. 4-3-2007, FILED 2-3-2006.

NGS

THE MARK CONSISTS OF STANDARD CHARACTERS WITHOUT CLAIM TO ANY PARTICULAR FONT, STYLE, SIZE, OR COLOR.

FOR EDUCATIONAL SERVICES, NAMELY, CONDUCTING WORKSHOPS AND SEMINARS IN THE FIELD OF BUSINESS BEHAVIORS, PRACTICES, AND STRATEGIES (U.S. CLS. 100, 101 AND 107).

FIRST USE 4-17-2007; IN COMMERCE 4-17-2007.

CLASS 41—(Continued).

3,399,925. PROMOFILM US LLC, HIALEAH, FL. SN 78-855,816. PUB. 11-7-2006, FILED 4-6-2006.

BUENA FORTUNA

THE MARK CONSISTS OF STANDARD CHARACTERS WITHOUT CLAIM TO ANY PARTICULAR FONT, STYLE, SIZE, OR COLOR.

THE FOREIGN WORDING IN THE MARK TRANSLATES INTO ENGLISH AS GOOD FORTUNE.

FOR ENTERTAINMENT IN THE FORM OF A TELEVISION GAME SHOW (U.S. CLS. 100, 101 AND 107).

FIRST USE 1-0-2007; IN COMMERCE 1-0-2007.

3,399,888. MACATAWA BANK CORPORATION, HOLLAND, MI. SN 78-835,336. PUB. 6-5-2007, FILED 3-13-2006.



OWNER OF U.S. REG. NO. 2,874,480.

NO CLAIM IS MADE TO THE EXCLUSIVE RIGHT TO USE "KIDS CLUB BY MACATAWA BANK", APART FROM THE MARK AS SHOWN.

FOR EDUCATIONAL SERVICES, NAMELY, CONDUCTING PROGRAMS IN THE FIELD OF TEACHING CHILDREN ABOUT SAVING AND MANAGING MONEY (U.S. CLS. 100, 101 AND 107).

FIRST USE 4-17-2006; IN COMMERCE 4-17-2006.

3,399,927. HELTON, ANNETTE, DETROIT, MI. AND HOLMES, ROSALIND, DETROIT, MI. SN 78-856,972. PUB. 11-7-2006, FILED 4-7-2006.

THE ORIGINAL VANDELLAS

IMPACT

THE MARK CONSISTS OF STANDARD CHARACTERS WITHOUT CLAIM TO ANY PARTICULAR FONT, STYLE, SIZE, OR COLOR.

FOR PROVIDING RECOGNITION BY WAY OF AWARDS TO DEMONSTRATE EXCELLENCE IN THE FIELD OF ATHLETICS (U.S. CLS. 100, 101 AND 107).

FIRST USE 11-15-2007; IN COMMERCE 11-15-2007.

THE MARK CONSISTS OF STANDARD CHARACTERS WITHOUT CLAIM TO ANY PARTICULAR FONT, STYLE, SIZE, OR COLOR.

FOR ENTERTAINMENT IN THE NATURE OF LIVE MUSICAL PERFORMANCES (U.S. CLS. 100, 101 AND 107).

FIRST USE 2-28-2006; IN COMMERCE 2-28-2006.

CLASS 41—(Continued).

3,399,930. FUNDACIÓ UBUNTU, BARCELONA, SPAIN. SN 78-858,198. PUB. 3-20-2007, FILED 4-10-2006.

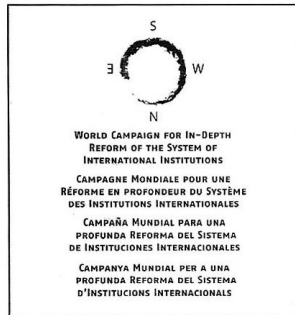

NO CLAIM IS MADE TO THE EXCLUSIVE RIGHT TO USE "WORLD CAMPAIGN", "CAMPAGNE MONDIAL", "CAMPAÑA MUNDIAL" AND "CAMPANYA MUNDIAL", APART FROM THE MARK AS SHOWN.

THE FOREIGN WORDING IN THE MARK TRANSLATES INTO ENGLISH AS WORLD CAMPAIGN FOR IN-DEPTH REFORM OF THE SYSTEM OF INTERNATIONAL INSTITUTIONS.

FOR EDUCATIONAL AND CULTURAL TRAINING SERVICES IN THE FIELD OF HUMAN RIGHTS WITH THE AIM OF DEVELOPING A WORLD CAMPAIGN FOR REFORMING THE SYSTEM OF INTERNATIONAL POLITICAL AND CULTURAL INSTITUTIONS (U.S. CLS. 100, 101 AND 107).

FIRST USE 6-13-2005; IN COMMERCE 4-13-2007.

CLASS 41—(Continued).

3,399,935. HANNA-BARBERA PRODUCTIONS, INC., BURBANK, CA. SN 78-859,249. PUB. 12-12-2006, FILED 4-11-2006.

CAVE KIDS

THE MARK CONSISTS OF STANDARD CHARACTERS WITHOUT CLAIM TO ANY PARTICULAR FONT, STYLE, SIZE, OR COLOR.

OWNER OF U.S. REG. NO. 2,454,377.

NO CLAIM IS MADE TO THE EXCLUSIVE RIGHT TO USE "KIDS", APART FROM THE MARK AS SHOWN.

FOR ENTERTAINMENT SERVICES IN THE NATURE OF LIVE-ACTION, COMEDY, DRAMA AND ANIMATED TELEVISION SERIES; PRODUCTION OF LIVE-ACTION, COMEDY, DRAMA AND ANIMATED TELEVISION SERIES; DISTRIBUTION AND DISPLAY OF LIVE-ACTION, COMEDY, DRAMA AND ANIMATED MOTION PICTURE THEATRICAL FILMS; PRODUCTION OF LIVE-ACTION, COMEDY, DRAMA AND ANIMATED MOTION PICTURE THEATRICAL FILMS; THEATRICAL PERFORMANCES BOTH ANIMATED AND LIVE ACTION; INTERNET SERVICES PROVIDING INFORMATION VIA AN ELECTRONIC GLOBAL COMPUTER NETWORK IN THE FIELD OF ENTERTAINMENT RELATING SPECIFICALLY TO MOVIES AND TELEVISION; PROVIDING NEWS ABOUT CURRENT EVENTS AND ENTERTAINMENT, AND INFORMATION RELATED TO EDUCATION AND CULTURAL EVENTS, VIA A GLOBAL COMPUTER NETWORK; AND PROVIDING ENTERTAINMENT INFORMATION VIA AN ELECTRONIC GLOBAL COMMUNICATIONS NETWORK FEATURING LIVE-ACTION, COMEDY, DRAMA AND ANIMATED PROGRAMS AND PRODUCTION OF LIVE-ACTION COMEDY, DRAMA AND ANIMATED MOTION PICTURE FILMS FOR DISTRIBUTION VIA A GLOBAL COMPUTER NETWORK (U.S. CLS. 100, 101 AND 107).

FIRST USE 8-18-2007; IN COMMERCE 8-18-2007.

3,399,946. KAROTTKI, SALVADOR K., DBA S.B. RECORDING COMPANY, CHICAGO, IL. SN 78-863,474. PUB. 10-17-2006, FILED 4-18-2006.

ROCK APOCALYPSE

THE MARK CONSISTS OF STANDARD CHARACTERS WITHOUT CLAIM TO ANY PARTICULAR FONT, STYLE, SIZE, OR COLOR.

NO CLAIM IS MADE TO THE EXCLUSIVE RIGHT TO USE "ROCK", APART FROM THE MARK AS SHOWN.

FOR ENTERTAINMENT SERVICES, NAMELY, ARRANGING AND CONDUCTING LIVE MUSIC CONCERTS (U.S. CLS. 100, 101 AND 107).

FIRST USE 3-0-2006; IN COMMERCE 7-8-2006.

CLASS 41—(Continued).

3,399,960. REIS, NICHOLAS, LONG ISLAND CITY, NY. SN 78-874,525. PUB. 4-17-2007, FILED 5-2-2006.

ANGELO DIABLO

THE MARK CONSISTS OF STANDARD CHARACTERS WITHOUT CLAIM TO ANY PARTICULAR FONT, STYLE, SIZE, OR COLOR.

THE NAME ANGELO DIABLO DOES NOT IDENTIFY A LIVING INDIVIDUAL.

FOR ENTERTAINMENT SERVICES IN THE NATURE OF LIVE PERFORMANCES BY A MUSICAL BAND (U.S. CLS. 100, 101 AND 107).

FIRST USE 2-2-2007; IN COMMERCE 2-2-2007.

CLASS 41—(Continued).

3,399,969. AMERICAN READING COMPANY, KING OF PRUSSIA, PA. SN 78-877,406. PUB. 2-6-2007, FILED 5-5-2006.

VARSITY COLLECTION

THE MARK CONSISTS OF STANDARD CHARACTERS WITHOUT CLAIM TO ANY PARTICULAR FONT, STYLE, SIZE, OR COLOR.

NO CLAIM IS MADE TO THE EXCLUSIVE RIGHT TO USE "COLLECTION", APART FROM THE MARK AS SHOWN.

FOR EDUCATIONAL SERVICES, NAMELY, A READING PROGRAM FOR MIDDLE, HIGH SCHOOL AND OLDER STUDENTS AND A PROGRAM FOR ASSESSING THE LEVEL OF DIFFICULTY OF BOOKS AS PART OF A READING PROGRAM (U.S. CLS. 100, 101 AND 107).

FIRST USE 6-24-1998; IN COMMERCE 6-24-1998.

3,399,962. INDUSTRIOUS KID, INC., OAKLAND, CA. SN 78-874,818. PUB. 8-29-2006, FILED 5-2-2006.



FOR EDUCATIONAL AND ENTERTAINMENT SERVICES, NAMELY, AN INTERACTIVE ONLINE COMMUNITY IN WHICH CHILDREN CAN UPLOAD AND DOWNLOAD ART AND CREATIVE PROJECTS (U.S. CLS. 100, 101 AND 107).

FIRST USE 6-16-2006; IN COMMERCE 6-16-2006.

3,399,986. KIRKPATRICK, CHRISTOPHER, GLENDALE, CA. SN 78-892,588. PUB. 4-3-2007, FILED 5-25-2006.

Nigels 11

THE MARK CONSISTS OF STANDARD CHARACTERS WITHOUT CLAIM TO ANY PARTICULAR FONT, STYLE, SIZE, OR COLOR.

THE NAME "NIGELS 11" DOES NOT IDENTIFY A LIVING INDIVIDUAL.

FOR ENTERTAINMENT SERVICES, NAMELY, LIVE PERFORMANCES BY A MUSICAL BAND (U.S. CLS. 100, 101 AND 107).

FIRST USE 12-1-2005; IN COMMERCE 1-1-2007.

3,399,964. COSBY, BRIAN K, REX, GA. SN 78-874,957. PUB. 11-21-2006, FILED 5-3-2006.



NO CLAIM IS MADE TO THE EXCLUSIVE RIGHT TO USE "MUSIC" AND "PUBLISHING/PRODUCTIONS", APART FROM THE MARK AS SHOWN.

FOR MUSIC COMPOSITION FOR OTHERS; MUSIC PRODUCTION SERVICES; MUSIC PUBLISHING (U.S. CLS. 100, 101 AND 107).

FIRST USE 11-1-2007; IN COMMERCE 11-1-2007.

3,399,995. MERRITT, LORI FAITH, TUCSON, AZ. SN 78-898,554. PUB. 6-5-2007, FILED 6-1-2006.

Photography By Faith

THE MARK CONSISTS OF STANDARD CHARACTERS WITHOUT CLAIM TO ANY PARTICULAR FONT, STYLE, SIZE, OR COLOR.

NO CLAIM IS MADE TO THE EXCLUSIVE RIGHT TO USE "PHOTOGRAPHY", APART FROM THE MARK AS SHOWN.

FOR PHOTOGRAPHY SERVICES (U.S. CLS. 100, 101 AND 107).

FIRST USE 1-28-2005; IN COMMERCE 2-14-2005.

CLASS 41—(Continued).

3,400,032. COMCAST SPORTS MANAGEMENT SERVICES LLC, PHILADELPHIA, PA. SN 78-921,171. PUB. 2-20-2007, FILED 6-30-2006.

PRO FOOTBALL NOW

THE MARK CONSISTS OF STANDARD CHARACTERS WITHOUT CLAIM TO ANY PARTICULAR FONT, STYLE, SIZE, OR COLOR.

NO CLAIM IS MADE TO THE EXCLUSIVE RIGHT TO USE "PRO FOOTBALL", APART FROM THE MARK AS SHOWN.

FOR ENTERTAINMENT SERVICES, NAMELY, A SERIES OF TELEVISION PROGRAMS FEATURING SPORTS COMMENTARY, DISCUSSIONS AND INTERVIEWS ON THE TOPIC OF PROFESSIONAL FOOTBALL (U.S. CLS. 100, 101 AND 107).

FIRST USE 9-7-2006; IN COMMERCE 9-7-2006.

3,400,047. MWR HOLDINGS, LLC, PARSIPPANY, NJ. SN 78-927,949. PUB. 4-17-2007, FILED 7-12-2006.

THE HONORS CLUB

THE MARK CONSISTS OF STANDARD CHARACTERS WITHOUT CLAIM TO ANY PARTICULAR FONT, STYLE, SIZE, OR COLOR.

FOR EDUCATIONAL SERVICES, NAMELY, A TUTORING PROGRAM FOR ENABLING PARENTS TO PROVIDE TUTORING TO THEIR CHILDREN IN ALL ACADEMIC FIELDS, INCLUDING ASSISTING THE CHILDREN WITH THEIR EVERYDAY HOMEWORK FROM SCHOOL (U.S. CLS. 100, 101 AND 107).

FIRST USE 12-15-2007; IN COMMERCE 12-15-2007.

3,400,094. PARIS, MARTY E., LINCOLNTON, NC. SN 78-947,850. PUB. 3-27-2007, FILED 8-8-2006.

Paris Keeling

THE MARK CONSISTS OF STANDARD CHARACTERS WITHOUT CLAIM TO ANY PARTICULAR FONT, STYLE, SIZE, OR COLOR.

"PARIS KEELING" DOES NOT IDENTIFY A LIVING INDIVIDUAL.

FOR ENTERTAINMENT IN THE NATURE OF VISUAL AND AUDIO PERFORMANCES, NAMELY, MUSICAL BAND, ROCK GROUP, GYMNASIAC, DANCE, AND BALLET PERFORMANCES (U.S. CLS. 100, 101 AND 107).

FIRST USE 10-31-2006; IN COMMERCE 10-31-2006.

CLASS 41—(Continued).

3,400,140. BERMAN INVESTMENT GROUP, NEWPORT BEACH, CA. SN 78-959,993. PUB. 4-24-2007, FILED 8-24-2006.

EASY AS EMAIL

THE MARK CONSISTS OF STANDARD CHARACTERS WITHOUT CLAIM TO ANY PARTICULAR FONT, STYLE, SIZE, OR COLOR.

FOR EDUCATIONAL SERVICES, NAMELY, CONDUCTING CLASSES, SEMINARS, CONFERENCES, MENTORING, AND WORKSHOPS IN THE FIELD OF PERSONAL IMPROVEMENT (U.S. CLS. 100, 101 AND 107).

FIRST USE 1-7-2008; IN COMMERCE 1-7-2008.

3,400,147. LAMANS, KRIS, STUDIO CITY, CA. SN 78-961,803. PUB. 4-24-2007, FILED 8-28-2006.



NO CLAIM IS MADE TO THE EXCLUSIVE RIGHT TO USE "USA", APART FROM THE MARK AS SHOWN.

THE COLOR(S) BRASS AND DARK GREY IS/ARE CLAIMED AS A FEATURE OF THE MARK.

THE MARK CONSISTS OF AN OLD STYLE MICROPHONE WITH LETTERING ON THE FACE PLATE. THE COLOR BRASS APPEARS IN THE LETTERING, THE TOP AND BOTTOM RIBBED PORTIONS OF THE MICROPHONE, THE SIDE PIVOT DISC, AND THE MICROPHONE SUPPORT RING. THE COLOR DARK GREY APPEARS IN THE MICROPHONE FACE PLATE, THE MICROPHONE PIVOT POINTS, AND THE MICROPHONE STAND.

FOR ENTERTAINMENT SERVICES, NAMELY, PROVIDING A SERIES OF TELEVISION PROGRAMS RELATING TO AFRO-AMERICAN MUSICIANS WHO HAVE INFLUENCED OTHER MUSICAL STYLES IN AMERICA AND THE WORLD (U.S. CLS. 100, 101 AND 107).

FIRST USE 9-1-2007; IN COMMERCE 9-1-2007.

CLASS 41—(Continued).

3,400,149. IGT, RENO, NV. SN 78-962,223. PUB. 4-17-2007, FILED 8-28-2006.



OWNER OF U.S. REG. NOS. 1,194,245, 1,208,011, AND 2,909,296.

FOR PROVIDING A COMPUTER GAME OVER GLOBAL COMPUTER NETWORKS; PROVIDING AN ONLINE LIBRARY OF DOWNLOADABLE GAMES (U.S. CLS. 100, 101 AND 107).

FIRST USE 12-22-2005; IN COMMERCE 12-22-2005.

3,400,162. FINAL DRAFT, INC., CALABASAS, CA. SN 78-964,346. PUB. 4-17-2007, FILED 8-30-2006.

TAKE A MEETING

THE MARK CONSISTS OF STANDARD CHARACTERS WITHOUT CLAIM TO ANY PARTICULAR FONT, STYLE, SIZE, OR COLOR.

FOR ORGANIZING AND CONDUCTING SEMINARS, CONFERENCES AND EXPOSITIONS IN THE FIELD OF ENTERTAINMENT, NAMELY, SCRIPTWRITING, SCRIPT DEVELOPMENT, AND SCRIPTWRITING CAREER ADVICE (U.S. CLS. 100, 101 AND 107).

FIRST USE 1-1-2006; IN COMMERCE 1-1-2006.

CLASS 41—(Continued).

3,400,185. MEDED RESOURCES, LLC, ELLICOTT CITY, MD. SN 78-969,909. PUB. 10-16-2007, FILED 9-8-2006.

QUEST MEDED

THE MARK CONSISTS OF STANDARD CHARACTERS WITHOUT CLAIM TO ANY PARTICULAR FONT, STYLE, SIZE, OR COLOR.

NO CLAIM IS MADE TO THE EXCLUSIVE RIGHT TO USE "MED ED", APART FROM THE MARK AS SHOWN.

FOR PROVIDING CONTINUING MEDICAL EDUCATION COURSES FOR HEALTHCARE PROFESSIONALS; EDUCATION SERVICES, NAMELY, CONDUCTING PROGRAMS IN THE FIELD OF QUALITY IMPROVEMENT IN HEALTHCARE (U.S. CLS. 100, 101 AND 107).

FIRST USE 12-7-2006; IN COMMERCE 12-7-2006.

3,400,193. C/HCA, INC., NASHVILLE, TN. SN 78-971,036. PUB. 7-3-2007, FILED 9-11-2006.

CLINICAL LINE LEARNING

THE MARK CONSISTS OF STANDARD CHARACTERS WITHOUT CLAIM TO ANY PARTICULAR FONT, STYLE, SIZE, OR COLOR.

NO CLAIM IS MADE TO THE EXCLUSIVE RIGHT TO USE "CLINICAL" AND "LEARNING", APART FROM THE MARK AS SHOWN.

FOR ONLINE EDUCATIONAL INSTRUCTION IN THE FIELD OF HEALTHCARE; ONLINE HEALTHCARE TRAINING IN THE FIELD OF HEALTHCARE (U.S. CLS. 100, 101 AND 107).

FIRST USE 10-13-2006; IN COMMERCE 10-13-2006.

CLASS 41—(Continued).

3,400,201. WELLS FARGO & COMPANY, MINNEAPOLIS, MN. SN 78-973,631. PUB. 4-24-2007, FILED 9-13-2006.

PAYROLL UNIVERSITY

THE MARK CONSISTS OF STANDARD CHARACTERS WITHOUT CLAIM TO ANY PARTICULAR FONT, STYLE, SIZE, OR COLOR.

NO CLAIM IS MADE TO THE EXCLUSIVE RIGHT TO USE "PAYROLL", APART FROM THE MARK AS SHOWN.

FOR EDUCATIONAL SERVICES, NAMELY PROVIDING TRAINING AND CLASSES, SEMINARS, WORKSHOPS, CONFERENCES, AND ONLINE TRAINING AND CLASSES, SEMINARS, WORKSHOPS, CONFERENCES IN THE FIELDS OF BUSINESS PAYROLL SERVICES (U.S. CLS. 100, 101 AND 107).

FIRST USE 11-10-2006; IN COMMERCE 11-10-2006.

CLASS 41—(Continued).

3,400,217. MAGIC SEASONING BLENDS, INC., HARAHAN, LA. SN 78-979,629. PUB. 2-20-2007, FILED 8-18-2006.

CHEF PAUL PRUDHOMME'S
ALWAYS COOKING

THE MARK CONSISTS OF STANDARD CHARACTERS WITHOUT CLAIM TO ANY PARTICULAR FONT, STYLE, SIZE, OR COLOR.

OWNER OF U.S. REG. NOS. 1,637,034, 2,685,885, AND OTHERS.

THE NAME(S), PORTRAIT(S), AND/OR SIGNATURE(S) SHOWN IN THE MARK IDENTIFIES CHEF PAUL PRUDHOMME, WHOSE CONSENT(S) TO REGISTER IS SUBMITTED.

FOR ENTERTAINMENT SERVICES, NAMELY, A TELEVISION SERIES IN THE FIELD OF COOKING (U.S. CLS. 100, 101 AND 107).

FIRST USE 5-5-2007; IN COMMERCE 5-5-2007.

3,400,203. GALLERY OF THE MASTERS, INC., ST. LOUIS, MO. SN 78-974,209. PUB. 8-21-2007, FILED 9-14-2006.

TRASH OR TREASURE

THE MARK CONSISTS OF STANDARD CHARACTERS WITHOUT CLAIM TO ANY PARTICULAR FONT, STYLE, SIZE, OR COLOR.

FOR ENTERTAINMENT SERVICES, NAMELY, CONDUCTING EXHIBITIONS IN THE FIELD OF EVALUATING AND APPRAISING ART, ANTIQUES, AND OTHER ITEMS OF PERSONAL PROPERTY (U.S. CLS. 100, 101 AND 107).

FIRST USE 10-14-2006; IN COMMERCE 10-14-2006.

CLASS 42—SCIENTIFIC AND COMPUTER SERVICES

3,399,000. MEERA SANTORO AND LUCIO SANTORO PARTNERSHIP, THE, DBA SANTORO LICENSING, LONDON, UNITED KINGDOM. SN 77-011,459. PUB. 5-29-2007, FILED 10-2-2006.

XPOFAIRS

THE MARK CONSISTS OF STANDARD CHARACTERS WITHOUT CLAIM TO ANY PARTICULAR FONT, STYLE, SIZE, OR COLOR.

FOR DEVELOPMENT OF SOFTWARE FOR ONLINE 3D ENVIRONMENTS (U.S. CLS. 100 AND 101).

FIRST USE 12-1-2005; IN COMMERCE 1-1-2007.

CLASS 42—(Continued).

3,399,012. SOCIAL SAUCE, NEW YORK, NY. SN 77-019,534.
PUB. 5-22-2007, FILED 10-12-2006.

SOCIAL SAUCE

THE MARK CONSISTS OF STANDARD CHARACTERS WITHOUT CLAIM TO ANY PARTICULAR FONT, STYLE, SIZE, OR COLOR.

FOR COMPUTER SERVICES, NAMELY, HOSTING ONLINE WEB FACILITIES FOR OTHERS FOR ORGANIZING AND CONDUCTING ONLINE MEETINGS AND GATHERINGS, CREATING AND SHARING DIGITAL CONTENT AND MEDIA, AND HOSTING AND PARTICIPATING IN INTERACTIVE DISCUSSIONS; AND COMPUTER SERVICES IN THE NATURE OF CUSTOMIZED AND CUSTOMIZABLE WEB PAGES FEATURING USER-SUPPLIED INFORMATION, INCLUDING PERSONAL PROFILES, DIARIES, REVIEWS, PICTURES, GRAPHICS, ANIMATIONS, AND AVATARS (U.S. CLS. 100 AND 101).

FIRST USE 1-18-2008; IN COMMERCE 1-18-2008.

3,399,013. SOCIAL SAUCE, NEW YORK, NY. SN 77-019,544.
PUB. 5-22-2007, FILED 10-12-2006.

SOSAUCE

THE MARK CONSISTS OF STANDARD CHARACTERS WITHOUT CLAIM TO ANY PARTICULAR FONT, STYLE, SIZE, OR COLOR.

FOR COMPUTER SERVICES, NAMELY, HOSTING ONLINE WEB FACILITIES FOR OTHERS FOR ORGANIZING AND CONDUCTING ONLINE MEETINGS AND GATHERINGS, CREATING AND SHARING DIGITAL CONTENT AND MEDIA, AND HOSTING AND PARTICIPATING IN INTERACTIVE DISCUSSIONS; AND COMPUTER SERVICES IN THE NATURE OF CUSTOMIZED AND CUSTOMIZABLE WEB PAGES FEATURING USER-SUPPLIED INFORMATION, INCLUDING PERSONAL PROFILES, DIARIES, REVIEWS, PICTURES, GRAPHICS, ANIMATIONS, AND AVATARS (U.S. CLS. 100 AND 101).

FIRST USE 1-18-2008; IN COMMERCE 1-18-2008.

3,399,014. IDENTISPHERE INC, BLOOMINGTON, MN. SN 77-019,848. PUB. 5-22-2007, FILED 10-12-2006.

Identisphere**CLASS 42—(Continued).**

THE MARK CONSISTS OF STANDARD CHARACTERS WITHOUT CLAIM TO ANY PARTICULAR FONT, STYLE, SIZE, OR COLOR.

FOR COMPUTER SOFTWARE DEVELOPMENT (U.S. CLS. 100 AND 101).

FIRST USE 1-16-2007; IN COMMERCE 1-16-2007.

3,399,080. NORTHWEST NOTARY NETWORK, LLC, PORTLAND, OR. SN 77-050,417. PUB. 9-25-2007, FILED 11-24-2006.



NO CLAIM IS MADE TO THE EXCLUSIVE RIGHT TO USE "NATIONWIDE NOTARY NETWORK", APART FROM THE MARK AS SHOWN.

THE COLOR(S) RED, ROYAL BLUE, WHITE AND NAVY BLUE IS/ARE CLAIMED AS A FEATURE OF THE MARK.

THE MARK CONSISTS OF THE FOLLOWING: THE COLOR RED APPEARS IN THE INTERIOR OF THE INNER MOST CIRCLE AND STAR DESIGNS, THE COLOR NAVY BLUE APPEARS AS A THIN BAND COMPRISING THE SECOND CIRCLE FROM THE CENTER, A THIN BAND COMPRISING THE FOURTH CIRCLE FROM THE CENTER, A THICKER BAND COMPRISING THE SIXTH OUTER MOST CIRCLE AND IN THE WORDING "NATIONWIDE NOTARY NETWORK", THE COLOR WHITE APPEARS IN THE LETTER/NUMBER COMBINATION "N3" AND THE BACKGROUND OF THE THIRD CIRCLE FROM THE CENTER AND THE COLOR ROYAL BLUE APPEARS IN THE FIFTH CIRCLE FROM THE CENTER.

FOR NOTARY PUBLIC SERVICES (U.S. CLS. 100 AND 101).

FIRST USE 10-20-2006; IN COMMERCE 10-20-2006.

CLASS 42—(Continued).

3,399,103. THE TECHNOLOGY GUIDE, LLC, CENTENNIAL, CO. SN 77-063,048. PUB. 8-21-2007, FILED 12-13-2006.



**the
TECHNOLOGY GUIDE**
Navigating Technology for Better Solutions

NO CLAIM IS MADE TO THE EXCLUSIVE RIGHT TO USE "TECHNOLOGY", APART FROM THE MARK AS SHOWN.

THE MARK CONSISTS, IN PART, OF A STYLIZED COMPASS WITH TWO SEMICIRCULAR ARCS REPRESENTING MOTION EMANATING FROM EACH END OF THE COMPASS NEEDLE WITH DIRECTIONAL DIAMONDS ON THE TOP AND BOTTOM.

FOR INFORMATION TECHNOLOGY CONSULTATION; CONSULTING SERVICES FOR OTHERS IN THE FIELD OF INFORMATION TECHNOLOGY SYSTEMS ANALYSIS, DESIGN AND IMPLEMENTATION; CONSULTING SERVICES IN THE FIELDS OF SELECTION, DESIGN, IMPLEMENTATION, USE, MONITORING, MAINTENANCE AND REPAIR OF COMPUTER SOFTWARE SYSTEMS FOR OTHERS; INFORMATION TECHNOLOGY SUPPORT SERVICES, NAMELY, DATA, VOICE AND WIRELESS NETWORK IMPLEMENTATION AND MONITORING; TECHNICAL SUPPORT SERVICES, NAMELY, TROUBLESHOOTING OF COMPUTER HARDWARE AND SOFTWARE PROBLEMS; TECHNICAL SUPPORT, NAMELY, MONITORING OF NETWORK SYSTEMS; DESIGN AND DEVELOPMENT OF NETWORKS, DATABASES AND ONLINE COMPUTER SYSTEMS; E-MAIL SYSTEM DESIGN, IMPLEMENTATION, MAINTENANCE AND REPAIR FOR OTHERS; IMPLEMENTATION AND MAINTENANCE FOR OTHERS OF COMPUTER SOFTWARE FOR PBX AND VOIP PHONE SYSTEMS; COMPUTER AND APPLICATION SYSTEMS TESTING FOR OTHERS; COMPUTER PROGRAMMING, MAINTENANCE AND REPAIR OF COMPUTER SOFTWARE; COMPUTER DIAGNOSTIC SERVICES; COMPUTER SERVICES, NAMELY, VIRUS, SPAM AND SPYWARE PROTECTION; DESIGN, CREATION, HOSTING, MAINTENANCE AND MANAGING OF WEBSITES FOR OTHERS; GRAPHIC DESIGN SERVICES (U.S. CLS. 100 AND 101).

FIRST USE 1-1-2005; IN COMMERCE 12-1-2005.

CLASS 42—(Continued).

3,399,198. BUNCHBALL INC., REDWOOD CITY, CA. SN 77-107,866. PUB. 8-14-2007, FILED 2-14-2007.

BUNCHBALL

THE MARK CONSISTS OF STANDARD CHARACTERS WITHOUT CLAIM TO ANY PARTICULAR FONT, STYLE, SIZE, OR COLOR.

FOR APPLICATION SERVICE PROVIDER FEATURING AN APPLICATION PROGRAMMING INTERFACE FOR CREATING COMPUTER GAMES, VIDEO GAMES, SOCIAL NETWORKS AND MULTI-MEDIA NETWORKS; APPLICATION SERVICE PROVIDER, NAMELY, PROVIDING, HOSTING, MANAGING, DESIGNING, DEVELOPING, AND MAINTAINING APPLICATIONS, SOFTWARE, DIGITAL CONTENT, WEBSITES, AND DATABASES IN THE FIELDS OF COMPUTER GAMES, VIDEO GAMES, SOCIAL NETWORKS AND MULTI-MEDIA NETWORKS; DESIGN, DEVELOPMENT AND INSTALLATION OF ONLINE COMPUTER SOFTWARE SYSTEMS; COMPUTER SOFTWARE DESIGN FOR OTHERS; CONSULTING SERVICES IN THE FIELD OF DESIGN, SELECTION, IMPLEMENTATION AND USE OF COMPUTER SOFTWARE FOR OTHERS; CONSULTING SERVICES IN THE FIELD OF DESIGN, SELECTION, IMPLEMENTATION AND USE OF COMPUTER GAMES AND ONLINE COMPUTER GAMES FOR OTHERS; COMPUTER SERVICES, NAMELY, CREATING AN ONLINE COMMUNITY FOR USERS TO PARTICIPATE IN COMPETITIONS, SHOWCASE THEIR SKILLS, GET FEEDBACK FROM THEIR PEERS, FORM VIRTUAL COMMUNITIES, ENGAGE IN SOCIAL NETWORKING AND IMPROVE THEIR TALENT; AND TECHNICAL SUPPORT SERVICES, NAMELY, TROUBLESHOOTING COMPUTER SOFTWARE PROBLEMS; APPLICATION SERVICE PROVIDER FEATURING AN APPLICATION PROGRAMMING INTERFACE FOR CREATING AVATARS, PROFILES, ONLINE LEADER BOARDS, AND VIRTUAL WORLDS; APPLICATION SERVICE PROVIDER FEATURING COMPUTER SOFTWARE FOR TRACKING USER STATISTICS; AND APPLICATION SERVICE PROVIDER FEATURING COMPUTER SOFTWARE FOR CREATING AND MANAGING CUSTOMER INCENTIVE, REWARD AND REDEMPTION PROGRAMS (U.S. CLS. 100 AND 101).

FIRST USE 10-31-2005; IN COMMERCE 10-31-2005.

3,399,180. CHARLESBERND AG, MÜNCHEN, FED REP GERMANY. SN 77-098,669. PUB. 7-31-2007, FILED 2-3-2007.

BRANDRANK

THE MARK CONSISTS OF STANDARD CHARACTERS WITHOUT CLAIM TO ANY PARTICULAR FONT, STYLE, SIZE, OR COLOR.

FOR COMPUTER SERVICES, NAMELY, PROVIDING SEARCH ENGINES FOR OBTAINING DATA ON A GLOBAL COMPUTER NETWORK (U.S. CLS. 100 AND 101).

FIRST USE 1-7-2008; IN COMMERCE 1-7-2008.

3,399,230. J. CRAIG VENTER INSTITUTE, INC., ROCKVILLE, MD. SN 77-121,209. PUB. 9-18-2007, FILED 3-2-2007.

J. Craig Venter

I N S T I T U T E

NO CLAIM IS MADE TO THE EXCLUSIVE RIGHT TO USE "INSTITUTE", APART FROM THE MARK AS SHOWN.

THE NAME(S), PORTRAIT(S), AND/OR SIGNATURE(S) SHOWN IN THE MARK IDENTIFIES "J. CRAIG VENTER", WHOSE CONSENT(S) TO REGISTER IS SUBMITTED.

THE COLOR(S) ORANGE (PANTONE 716), GREEN (PANTONE 369), BLUE (PANTONE 2995), RED (PANTONE 1797) AND BLACK IS/ARE CLAIMED AS A FEATURE OF THE MARK.

CLASS 42—(Continued).

THE MARK CONSISTS OF THE LETTERS "J CRAIG VENTER" (IN MIXED CASE) IN BLACK MYRIAD PRO SEMIBOLD CONDENSED CENTERED DIRECTLY (JUSTIFIED TO THE FULL WIDTH OF THE COLOR BAND) ABOVE 4 SOLID DASHED LINES IN ORANGE (PANTONE 716), GREEN (PANTONE 369), BLUE (PANTONE 2995), RED (PANTONE 1797) AND THE LETTERS "INSTITUTE" (ALL CAPITALS) IN BLACK MYRIAD PRO SEMIBOLD CENTERED (JUSTIFIED TO THE FULL WIDTH OF THE COLOR BAND) DIRECTLY BELOW THE 4 SOLID DASHED LINES. A PERIOD (PUNCTUATION MARK) IS PLACED AFTER THE "J" AND BEFORE "CRAIG".

FOR LABORATORY RESEARCH IN THE FIELD OF GENOMICS, METAGENOMICS; MEDICAL RESEARCH; PRODUCT RESEARCH AND DEVELOPMENT; PROVIDING INFORMATION IN THE FIELD OF PLANT GENETICS RESEARCH RESOURCES; SCIENTIFIC RESEARCH AND DEVELOPMENT; SCIENTIFIC RESEARCH IN THE FIELD OF GENETICS AND GENETIC ENGINEERING (U.S. CLS. 100 AND 101).

FIRST USE 3-1-2007; IN COMMERCE 3-1-2007.

CLASS 42—(Continued).

3,399,394. IONATRON INC., TUSCON, AZ. SN 78-471,787. PUB. 3-14-2006, FILED 8-23-2004.

3,399,291. TPG IT CONSULTING - THE PILOT GROUP, LLC, KATY, TX. SN 77-158,842. PUB. 10-16-2007, FILED 4-17-2007.



NO CLAIM IS MADE TO THE EXCLUSIVE RIGHT TO USE "GROUP" AND "BUSINESS TECHNOLOGY", APART FROM THE MARK AS SHOWN.

THE COLOR(S) NAVY AND BLUE IS/ARE CLAIMED AS A FEATURE OF THE MARK.

THE MARK CONSISTS OF THE WORDS "THE PILOT GROUP" ARE WRITTEN IN TREBUCHET FONT AND ARE NAVY BLUE. THE LETTER O IN THE WORD PILOT IS STYLIZED AS A SHIPS PILOT WHEEL. THE WORDS "NAVIGATING BUSINESS TECHNOLOGY" USE A TREBUCHET FONT BUT ARE REDUCED IN SIZE.

FOR INFORMATION TECHNOLOGY CONSULTATION (U.S. CLS. 100 AND 101).

FIRST USE 4-1-2007; IN COMMERCE 4-28-2007.

IONATRON

THE MARK CONSISTS OF STANDARD CHARACTERS WITHOUT CLAIM TO ANY PARTICULAR FONT, STYLE, SIZE, OR COLOR.

FOR RESEARCH AND DEVELOPMENT IN THE AREAS OF BASIC SCIENCE, LASER DEVELOPMENT, ELECTRICAL POWER SUPPLY DEVELOPMENT, SUPPORT EQUIPMENT PRODUCT DEVELOPMENT; ON SITE TESTING OF DELIVERED PRODUCTS, NAMELY, MOBILE, TRANSPORTABLE AND FIXED INTEGRATED DIRECTED ENERGY SYSTEMS UTILIZING LASER INDUCED PLASMA CHANNELING TECHNOLOGY COMPRISED OF LASERS AND ELECTRICAL POWER SUPPLIES FOR USE IN DISABLING VEHICLES AND ELECTRONIC SYSTEMS, NAMELY, COMPUTERS AND COMMUNICATIONS EQUIPMENT, FOR USE IN LETHAL AND NON-LETHAL COUNTER PERSONNEL APPLICATIONS AND SPECIAL USES FOR MILITARY AND NON-MILITARY PURPOSES (U.S. CLS. 100 AND 101).

FIRST USE 4-23-2007; IN COMMERCE 4-23-2007.

CLASS 42—(Continued).

3,399,459. RAGAN, RAYMOND K, PHOENIX, AZ. SN 78-549,305. PUB. 10-11-2005, FILED 1-18-2005.

LeapDesk

THE MARK CONSISTS OF STANDARD CHARACTERS WITHOUT CLAIM TO ANY PARTICULAR FONT, STYLE, SIZE, OR COLOR.

FOR COMPUTER SERVICE, NAMELY, ACTING AS AN APPLICATION SERVICE PROVIDER IN THE FIELD OF KNOWLEDGE MANAGEMENT TO HOST COMPUTER APPLICATION SOFTWARE FOR THE COLLECTION, EDITING, ORGANIZING, MODIFYING, BOOK MARKING, TRANSMISSION, STORAGE AND SHARING OF DATA AND INFORMATION (U.S. CLS. 100 AND 101).

FIRST USE 7-14-2004; IN COMMERCE 7-14-2004.

3,399,472. HYBRID AIRCRAFT CONSULTANTS INC., EDGEWOOD, NM. SN 78-562,746. PUB. 11-8-2005, FILED 2-8-2005.



THE COLORS YELLOW, ORANGE, AND BLUE ARE CLAIMED AS FEATURES OF THE MARK.

THE MARK CONSISTS OF A BACKGROUND OF A CIRCULAR SUNBURST WITH AN ORANGE CENTER FADING TO A YELLOW OUTER EDGE WITH A BLUE HYBRID AIRCRAFT ON THE TOP WITH BLUE HORIZONTAL LINES RADIATING FROM THE LEFT SIDE OF THE HYBRID AIRCRAFT. THE COLOR BLUE ALSO APPEARS IN THE WORDING AND IN THE TRIANGLE DESIGN ELEMENT.

FOR AIRCRAFT DESIGN, NAMELY, DESIGN AND DEVELOPMENT OF HEAVY-LIFT AND ULTRA HEAVY LIFT AIR VEHICLES (U.S. CLS. 100 AND 101).

FIRST USE 7-3-2003; IN COMMERCE 7-3-2003.

CLASS 42—(Continued).

3,399,486. UNITED DEVELOPMENT SYTEMS, INC., CLEAR-WATER, FL. SN 78-588,369. PUB. 7-4-2006, FILED 3-16-2005.

"AutoTracking"

THE MARK CONSISTS OF STANDARD CHARACTERS WITHOUT CLAIM TO ANY PARTICULAR FONT, STYLE, SIZE, OR COLOR.

FOR ONLINE NON-DOWNLOADABLE COMPUTER SOFTWARE FOR TEMPORARY USE BY FRANCHISED AUTOMOBILE DEALERSHIPS FOR MANAGING A DATABASE AND CREATING AND ACCESSING DAILY, MONTHLY, QUARTERLY AND ANNUAL REPORTS OF THE EFFECTIVENESS OF THEIR FINANCE AND INSURANCE DEPARTMENTS THROUGH A COMPUTER NETWORK, SUCH SOFTWARE ASSISTING MANAGEMENT IN TRACKING SALES FIGURES, PENETRATION LEVELS FOR PRODUCTS SOLD BY THEIR FINANCE AND INSURANCE DEPARTMENTS AND REVENUE AMOUNTS FROM EACH SPECIFIC TRANSACTION (U.S. CLS. 100 AND 101).

FIRST USE 1-18-2007; IN COMMERCE 1-18-2007.

3,399,527. AFI INTERNATIONAL GROUP INC., MILTON, ONTARIO, CANADA. SN 78-627,030. PUB. 1-16-2007, FILED 5-10-2005.

AFI-TRUE-TEAM

THE MARK CONSISTS OF STANDARD CHARACTERS WITHOUT CLAIM TO ANY PARTICULAR FONT, STYLE, SIZE, OR COLOR.

PRIORITY CLAIMED UNDER SEC. 44(D) ON CANADA APPLICATION NO. 1248770, FILED 2-25-2005, REG. NO. TMA659380, DATED 2-20-2006, EXPIRES 2-20-2021.

FOR CONTINGENCY PLANNING AND MITIGATION SERVICES FOR BUSINESSES, NAMELY, LABOR AND MANAGEMENT NEGOTIATIONS AND CONSULTING SERVICES IN CONNECTION WITH STRIKES, LOCK-OUTS AND LABOR RELATIONS MATTERS (U.S. CLS. 100 AND 101).

FIRST USE 1-10-2006; IN COMMERCE 1-10-2006.

CLASS 42—(Continued).

3,399,539. DATAFLOW/ALASKA, INC., ANCHORAGE, AK. SN 78-638,249. PUB. 4-18-2006, FILED 5-26-2005.

The Natural Tag

THE MARK CONSISTS OF STANDARD CHARACTERS WITHOUT CLAIM TO ANY PARTICULAR FONT, STYLE, SIZE, OR COLOR.

FOR PROVIDES AUTOMATED ANALYSIS SERVICES VIA NON-DOWNLOADABLE COMPUTER SOFTWARE FOR USE IN THE RECOGNITION OF INDIVIDUAL ANIMALS TO DETERMINE POPULATION LEVELS OF FREE RANGING ANIMALS (U.S. CLS. 100 AND 101).
FIRST USE 5-3-2005; IN COMMERCE 5-3-2005.

3,399,596. WEST PUBLISHING CORPORATION, EAGAN, MN. SN 78-694,648. PUB. 4-25-2006, FILED 8-17-2005.

COURTEXPRESS

THE MARK CONSISTS OF STANDARD CHARACTERS WITHOUT CLAIM TO ANY PARTICULAR FONT, STYLE, SIZE, OR COLOR.

OWNER OF U.S. REG. NO. 2,364,478.
FOR PROVIDING LITIGATION INFORMATION FROM UNITED STATES COURTS VIA THE GLOBAL COMPUTER NETWORK (U.S. CLS. 100 AND 101).
FIRST USE 3-1-1999; IN COMMERCE 3-1-1999.

3,399,650. HERITAGE PRESERVATION CORPORATION, SPARTANBURG, SC. SN 78-737,995. PUB. 2-13-2007, FILED 10-21-2005.

EZBlue

THE MARK CONSISTS OF STANDARD CHARACTERS WITHOUT CLAIM TO ANY PARTICULAR FONT, STYLE, SIZE, OR COLOR.

FOR PROVIDING TEMPORARY USE OF NON-DOWNLOADABLE SOFTWARE VIA A GLOBAL COMPUTER NETWORK FOR ELECTRONIC DOCUMENT EDITING FOR THE FINANCIAL MARKETS COMMUNITY SERVING INVESTMENT BANKS, SECURITY LAW FIRMS, CORPORATIONS AND INVESTMENT FUNDS (U.S. CLS. 100 AND 101).
FIRST USE 11-7-2005; IN COMMERCE 11-7-2005.

CLASS 42—(Continued).

3,399,656. ALTAIR ENGINEERING, INC., TROY, MI. SN 78-743,785. PUB. 9-5-2006, FILED 10-31-2005.

INNOVATION INTELLIGENCE

THE MARK CONSISTS OF STANDARD CHARACTERS WITHOUT CLAIM TO ANY PARTICULAR FONT, STYLE, SIZE, OR COLOR.

FOR ENGINEERING CONSULTATION SERVICES IN THE FIELD OF ENGINEERING AND INFORMATION TECHNOLOGY; ENGINEERING RESEARCH AND DESIGN FOR OTHERS IN THE FIELDS OF ENGINEERING AND INFORMATION TECHNOLOGY (U.S. CLS. 100 AND 101).

FIRST USE 11-10-2006; IN COMMERCE 11-10-2006.

3,399,688. MOG, INC., KENSINGTON, CA. SN 78-757,438. PUB. 2-27-2007, FILED 11-18-2005.

MOG

THE MARK CONSISTS OF STANDARD CHARACTERS WITHOUT CLAIM TO ANY PARTICULAR FONT, STYLE, SIZE, OR COLOR.

FOR COMPUTER SERVICES, NAMELY, HOSTING WEB SITES OF OTHERS WHO USE THEIR WEB SITE FOR THE PURPOSE OF CONDUCTING ONLINE MEETINGS AND INTERACTIVE DISCUSSIONS; AND COMPUTER SERVICES IN THE NATURE OF CUSTOMIZED WEB PAGES FEATURING USER-DEFINED INFORMATION, PERSONAL PROFILES AND INFORMATION (U.S. CLS. 100 AND 101).

FIRST USE 6-20-2006; IN COMMERCE 6-20-2006.

3,399,745. GIGATOR LLC, KANEHOE, HI. SN 78-780,463. PUB. 9-12-2006, FILED 12-23-2005.

ISLANDA

THE MARK CONSISTS OF STANDARD CHARACTERS WITHOUT CLAIM TO ANY PARTICULAR FONT, STYLE, SIZE, OR COLOR.

FOR COMPUTER SOFTWARE DEVELOPMENT; DESIGN AND DEVELOPMENT OF ONLINE COMPUTER SOFTWARE SYSTEMS; INFORMATION TECHNOLOGY CONSULTATION; INTEGRATION OF COMPUTER SYSTEMS AND NETWORKS (U.S. CLS. 100 AND 101).
FIRST USE 2-19-2007; IN COMMERCE 2-19-2007.

CLASS 42—(Continued).

3,399,784. VICUS THERAPEUTICS, LLC, MORRISTOWN, NJ. SN 78-795,327. PUB. 9-19-2006, FILED 1-19-2006.

VICUS THERAPEUTICS

THE MARK CONSISTS OF STANDARD CHARACTERS WITHOUT CLAIM TO ANY PARTICULAR FONT, STYLE, SIZE, OR COLOR.

NO CLAIM IS MADE TO THE EXCLUSIVE RIGHT TO USE "THERAPEUTICS", APART FROM THE MARK AS SHOWN.

FOR DISCOVERY, DEVELOPMENT, RESEARCH AND TESTING OF PHARMACEUTICAL PREPARATIONS FOR OTHERS (U.S. CLS. 100 AND 101).

FIRST USE 3-13-2006; IN COMMERCE 3-13-2006.



3,399,789. ENCLARITY, INC., ALISO VIEJO, CA. SN 78-796,286. PUB. 9-5-2006, FILED 1-20-2006.

PHARMAPOINT

THE MARK CONSISTS OF STANDARD CHARACTERS WITHOUT CLAIM TO ANY PARTICULAR FONT, STYLE, SIZE, OR COLOR.

FOR APPLICATION SERVICE PROVIDER (ASP) FEATURING DATA INTEGRATION AND MARKET RESEARCH SOFTWARE IN THE HEALTHCARE, PHARMACEUTICAL AND INSURANCE RELATED FIELDS (U.S. CLS. 100 AND 101).

FIRST USE 1-31-2006; IN COMMERCE 1-31-2006.



3,399,790. ENCLARITY, INC., ALISO VIEJO, CA. SN 78-796,295. PUB. 9-5-2006, FILED 1-20-2006.

DEVICEPOINT

THE MARK CONSISTS OF STANDARD CHARACTERS WITHOUT CLAIM TO ANY PARTICULAR FONT, STYLE, SIZE, OR COLOR.

FOR APPLICATION SERVICE PROVIDER (ASP) FEATURING DATA INTEGRATION SOFTWARE IN THE HEALTHCARE FIELD (U.S. CLS. 100 AND 101).

FIRST USE 1-31-2006; IN COMMERCE 1-31-2006.

CLASS 42—(Continued).

3,399,799. PCI INSURANCE, INC., HARRISBURG, PA. SN 78-799,124. PUB. 9-26-2006, FILED 1-25-2006.

NERM

THE MARK CONSISTS OF STANDARD CHARACTERS WITHOUT CLAIM TO ANY PARTICULAR FONT, STYLE, SIZE, OR COLOR.

FOR PROVIDING TEMPORARY USE OF NON-DOWNLOADABLE COMPUTER SOFTWARE FOR EMPLOYEE BENEFIT MANAGEMENT, NAMELY, PREPARING CONSOLIDATED INVOICES (U.S. CLS. 100 AND 101).

FIRST USE 6-1-2004; IN COMMERCE 6-1-2004.



3,399,813. IDENTRUST, INC., SAN FRANCISCO, CA. SN 78-803,812. PUB. 5-1-2007, FILED 1-31-2006.

TRUST SOURCE

THE MARK CONSISTS OF STANDARD CHARACTERS WITHOUT CLAIM TO ANY PARTICULAR FONT, STYLE, SIZE, OR COLOR.

OWNER OF U.S. REG. NOS. 2,314,670 AND 2,319,404.

FOR DIGITAL CERTIFICATION AND SECURITY SERVICES, NAMELY, ISSUANCE AND VALIDATION OF DIGITAL CERTIFICATES PROVIDING AUTHENTICATION OF THE SOURCE OF A DIGITAL COMMUNICATION, AND AUTHENTICATION OF IDENTITY AND/OR OF A DIGITAL SIGNATURE IN AN ELECTRONIC TRANSACTION OR COMMUNICATION; COMPUTER CONSULTATION IN THE FIELD OF NETWORK SECURITY AND AUTHENTICATION OF DIGITAL SIGNATURES IN AN ELECTRONIC TRANSACTION OR COMMUNICATION; DESIGN OF COMPUTER HARDWARE, SOFTWARE, AND SPECIFICATIONS USED FOR NETWORK SECURITY AND AUTHENTICATION OF DIGITAL SIGNATURES AND IDENTITIES IN AN ELECTRONIC TRANSACTION OR COMMUNICATION; TECHNICAL SUPPORT SERVICES, NAMELY, TROUBLESHOOTING OF COMPUTER HARDWARE AND SOFTWARE PROBLEMS VIA TELEPHONE, EMAIL AND IN PERSON (U.S. CLS. 100 AND 101).

FIRST USE 10-1-2007; IN COMMERCE 10-1-2007.



3,399,814. IDENTRUST, INC., SAN FRANCISCO, CA. SN 78-803,821. PUB. 5-8-2007, FILED 1-31-2006.

TRUST INFRASTRUCTURE

CLASS 42—(Continued).

THE MARK CONSISTS OF STANDARD CHARACTERS WITHOUT CLAIM TO ANY PARTICULAR FONT, STYLE, SIZE, OR COLOR.

OWNER OF U.S. REG. NO. 2,359,508.

NO CLAIM IS MADE TO THE EXCLUSIVE RIGHT TO USE "INFRASTRUCTURE", APART FROM THE MARK AS SHOWN.

FOR DIGITAL CERTIFICATION AND SECURITY SERVICES, NAMELY, ISSUANCE AND VALIDATION OF DIGITAL CERTIFICATES PROVIDING AUTHENTICATION OF THE SOURCE OF A DIGITAL COMMUNICATION, AND AUTHENTICATION OF IDENTITY AND/OR OF A DIGITAL SIGNATURE IN AN ELECTRONIC TRANSACTION OR COMMUNICATION; COMPUTER CONSULTATION IN THE FIELD OF NETWORK SECURITY AND AUTHENTICATION OF DIGITAL SIGNATURES IN AN ELECTRONIC TRANSACTION OR COMMUNICATION; DESIGN OF COMPUTER HARDWARE, SOFTWARE, AND SPECIFICATIONS USED FOR NETWORK SECURITY AND AUTHENTICATION OF DIGITAL SIGNATURES AND IDENTITIES IN AN ELECTRONIC TRANSACTION OR COMMUNICATION; TECHNICAL SUPPORT SERVICES, NAMELY, TROUBLESHOOTING OF COMPUTER HARDWARE AND SOFTWARE PROBLEMS VIA TELEPHONE, EMAIL AND IN PERSON (U.S. CLS. 100 AND 101).

FIRST USE 10-1-2007; IN COMMERCE 10-1-2007.

3,399,854. CHARLESBERND AG, MÜNCHEN, FED REP GERMANY. SN 78-819,731. PUB. 9-12-2006, FILED 2-21-2006.

EDITSENSE

THE MARK CONSISTS OF STANDARD CHARACTERS WITHOUT CLAIM TO ANY PARTICULAR FONT, STYLE, SIZE, OR COLOR.

FOR PROVIDING CUSTOMIZED ON-LINE WEB PAGES FEATURING USER-DEFINED INFORMATION, WHICH INCLUDES SEARCH ENGINES AND ON-LINE WEB LINKS TO OTHER WEB SITES (U.S. CLS. 100 AND 101).

FIRST USE 2-21-2006; IN COMMERCE 7-15-2007.

3,399,856. HODGE, BRUCE, GREENFIELD, NY. SN 78-821,852. PUB. 10-17-2006, FILED 2-23-2006.

HODGEPODGE

THE MARK CONSISTS OF STANDARD CHARACTERS WITHOUT CLAIM TO ANY PARTICULAR FONT, STYLE, SIZE, OR COLOR.

FOR COMPUTER SERVICES, NAMELY, PROVIDING SEARCH ENGINES FOR OBTAINING DATA ON A GLOBAL COMPUTER NETWORK (U.S. CLS. 100 AND 101).

FIRST USE 7-31-2007; IN COMMERCE 7-31-2007.

CLASS 42—(Continued).

3,399,896. BALDWIN AVIATION, INC., HILTON HEAD ISLAND, SC. SN 78-841,894. PUB. 12-5-2006, FILED 3-21-2006.

JETDESK

THE MARK CONSISTS OF STANDARD CHARACTERS WITHOUT CLAIM TO ANY PARTICULAR FONT, STYLE, SIZE, OR COLOR.

FOR HELP DESK SERVICES TO SUPPORT AVIATION CONSULTING SERVICES AND RELATED PRODUCTS (U.S. CLS. 100 AND 101).

FIRST USE 2-1-2006; IN COMMERCE 3-7-2006.

3,399,950. 3TIER ENVIRONMENTAL FORECAST GROUP, INC. SEATTLE, WA. SN 78-865,800. PUB. 1-9-2007, FILED 4-20-2006.

Knowledge is Power

THE MARK CONSISTS OF STANDARD CHARACTERS WITHOUT CLAIM TO ANY PARTICULAR FONT, STYLE, SIZE, OR COLOR.

FOR WEATHER FORECASTING AND CONSULTING IN THE FIELD OF ASSESSMENT OF SOURCES OF RENEWABLE ENERGY (U.S. CLS. 100 AND 101).

FIRST USE 7-31-2006; IN COMMERCE 7-31-2006.

3,399,965. QAMHIYAH, ABIR, DBA ISEEK, AMES, IA. SN 78-875,052. PUB. 4-17-2007, FILED 5-3-2006.

ISEEK

THE MARK CONSISTS OF STANDARD CHARACTERS WITHOUT CLAIM TO ANY PARTICULAR FONT, STYLE, SIZE, OR COLOR.

FOR PROVIDING TEMPORARY USE OF NON-DOWNLOADABLE COMPUTER SEARCH ENGINE SHAPE BASED SOFTWARE FOR OBTAINING DATA IN THE FORM OF PICTURES, MODELS, IMAGES AND DIAGRAMS VIA A GLOBAL COMPUTER NETWORK AND COMPUTER SERVICES, NAMELY, PROVIDING TEMPORARY USE OF ONLINE NON-DOWNLOADABLE COMPUTER SEARCH ENGINE SHAPE BASED SOFTWARE FOR OBTAINING DATA IN THE FORM OF PICTURES, MODELS, IMAGES AND DIAGRAMS VIA A GLOBAL COMPUTER NETWORK (U.S. CLS. 100 AND 101).

FIRST USE 6-26-2006; IN COMMERCE 6-26-2006.

CLASS 42—(Continued).

3,399,967. DIGITAL TELEMEDIA INC., DBA LOGICWORKS, NEW YORK, NY. SN 78-876,257. PUB. 8-7-2007, FILED 5-4-2006.

FOUNDATION NETWORK SERVICES

THE MARK CONSISTS OF STANDARD CHARACTERS WITHOUT CLAIM TO ANY PARTICULAR FONT, STYLE, SIZE, OR COLOR.

NO CLAIM IS MADE TO THE EXCLUSIVE RIGHT TO USE "NETWORK SERVICES", APART FROM THE MARK AS SHOWN.

FOR MANAGED HOSTING SERVICES, NAMELY, HOSTING COMPUTER SOFTWARE APPLICATIONS OF OTHERS, HOSTING AND MANAGING THE WEB SITES OF OTHERS ON A COMPUTER SERVER, HOSTING OF DIGITAL CONTENT ON THE INTERNET, ADMINISTRATION AND MAINTENANCE OF DIGITAL CONTENT AND MEDIA FOR USE IN CONNECTION WITH DATA TRANSMISSION NETWORKS (U.S. CLS. 100 AND 101).

FIRST USE 11-0-2006; IN COMMERCE 11-0-2006.

3,400,000. NEOTOOL, LLC, PLANO, TX. SN 78-902,334. PUB. 1-23-2007, FILED 6-6-2006.



OWNER OF U.S. REG. NOS. 2,797,181, 2,800,022, AND 2,819,165.

THE COLOR(S) GREEN, YELLOW, RED, BLUE AND BLACK IS/ARE CLAIMED AS A FEATURE OF THE MARK. THE MARK CONSISTS OF FOUR ARROWS POINTING TO A MIDDLE POINT FORMING A SQUARE-LIKE FIGURE, THE ARROWS BEING THE COLORS, CLOCKWISE FROM THE UPPER LEFT, GREEN, YELLOW, BLUE AND RED; THE BLACK WORD NEOTOOL APPEARS TO THE RIGHT OF THE FIGURE.

FOR COMPUTER SOFTWARE DEVELOPMENT (U.S. CLS. 100 AND 101).

FIRST USE 5-0-2006; IN COMMERCE 5-0-2006.

3,400,004. NATIONAL INFRASTRUCTURE INSTITUTE, ALEXANDRIA, VA. SN 78-903,872. PUB. 1-16-2007, FILED 6-8-2006.

SMART School Tool

THE MARK CONSISTS OF STANDARD CHARACTERS WITHOUT CLAIM TO ANY PARTICULAR FONT, STYLE,

CLASS 42—(Continued).

SIZE, OR COLOR.

NO CLAIM IS MADE TO THE EXCLUSIVE RIGHT TO USE "SCHOOL TOOL", APART FROM THE MARK AS SHOWN.

FOR APPLICATION SERVICE PROVIDER (ASP) FEATURING SOFTWARE FOR ASSESSING SECURITY IN SCHOOLS (U.S. CLS. 100 AND 101).

FIRST USE 3-15-2005; IN COMMERCE 3-15-2005.

3,400,010. BARON SERVICES, INC., HUNTSVILLE, AL. SN 78-906,241. PUB. 2-27-2007, FILED 6-12-2006.

FORECASTING A BETTER FUTURE

THE MARK CONSISTS OF STANDARD CHARACTERS WITHOUT CLAIM TO ANY PARTICULAR FONT, STYLE, SIZE, OR COLOR.

FOR PROVIDING REAL-TIME AND HISTORICAL WEATHER INFORMATION TO STATIONARY AND MOBILE USERS, VIA SATELLITE, RADIO, AND CELLULAR PHONE TRANSMITTERS AND VIA LOCAL AND GLOBAL COMPUTERS; PROVIDING WEATHER-RELATED DATA AND INFORMATION AND WEATHER-RELATED IMAGES THROUGH A DISTRIBUTION NETWORK; PROVIDING REAL-TIME AND HISTORICAL WEATHER INFORMATION, NAMELY, PROVIDING WEATHER INFORMATION THAT FEATURES THE GRAPHICAL DISPLAY OF RADAR, LIGHTNING, THUNDERSTORMS, WIND VELOCITY, WIND SHEAR, WIND ROTATION, PRECIPITATION, STORM LOCATION, STORM TRACKING, AND OTHER WEATHER PHENOMENON AND WEATHER DATA; PROVIDING WEATHER INFORMATION SERVICES (U.S. CLS. 100 AND 101).

FIRST USE 1-31-2004; IN COMMERCE 1-31-2004.

3,400,086. CHARLES SCHWAB & CO., INC., SAN FRANCISCO, CA. SN 78-945,105. PUB. 4-3-2007, FILED 8-4-2006.

SCHWAB EQUIVIEW

THE MARK CONSISTS OF STANDARD CHARACTERS WITHOUT CLAIM TO ANY PARTICULAR FONT, STYLE, SIZE, OR COLOR.

FOR PROVIDING ONLINE NON-DOWNLOADABLE SOFTWARE FOR USE IN ADMINISTRATION OF EQUITY COMPENSATION PLANS (U.S. CLS. 100 AND 101).

FIRST USE 10-30-2006; IN COMMERCE 10-30-2006.

CLASS 42—(Continued).

3,400,151. CRANE PLASTICS SIDING LLC, COLUMBUS, OH. SN 78-963,061. PUB. 4-17-2007, FILED 8-29-2006.

CLASS 43—(Continued).

3,399,039. SODEXHO, INC., GAITHERSBURG, MD. SN 77-031,879. PUB. 6-5-2007, FILED 10-30-2006.

EXTERIOR PORTFOLIO

THE MARK CONSISTS OF STANDARD CHARACTERS WITHOUT CLAIM TO ANY PARTICULAR FONT, STYLE, SIZE, OR COLOR.

FOR PROVIDING TEMPORARY USE OF ON-LINE NON-DOWNLOADABLE SOFTWARE FOR HOME DESIGN (U.S. CLS. 100 AND 101).

FIRST USE 1-1-2007; IN COMMERCE 1-1-2007.

EXPERIENCE IT!

THE MARK CONSISTS OF STANDARD CHARACTERS WITHOUT CLAIM TO ANY PARTICULAR FONT, STYLE, SIZE, OR COLOR.

FOR PREPARING AND SERVING FOODS AND BEVERAGES; CONTRACT FOOD SERVICES (U.S. CLS. 100 AND 101).

FIRST USE 7-18-2006; IN COMMERCE 7-18-2006.

CLASS 43—HOTEL AND RESTAURANT SERVICES

3,399,006. LIVE! HOLDINGS, LLC, BALTIMORE, MD. SN 77-014,326. PUB. 5-22-2007, FILED 10-5-2006.

3,399,053. RITCHIE, SUSANNE, HIGLEY, AZ. SN 77-038,083. PUB. 9-25-2007, FILED 11-7-2006.

VININO

THE MARK CONSISTS OF STANDARD CHARACTERS WITHOUT CLAIM TO ANY PARTICULAR FONT, STYLE, SIZE, OR COLOR.

FOR RESTAURANT AND BAR SERVICES (U.S. CLS. 100 AND 101).

FIRST USE 11-16-2007; IN COMMERCE 11-16-2007.

THE SLICERY

THE MARK CONSISTS OF STANDARD CHARACTERS WITHOUT CLAIM TO ANY PARTICULAR FONT, STYLE, SIZE, OR COLOR.

FOR RESTAURANTS (U.S. CLS. 100 AND 101).

FIRST USE 2-1-2007; IN COMMERCE 7-1-2007.

3,399,038. SODEXHO, INC., GAITHERSBURG, MD. SN 77-031,876. PUB. 6-5-2007, FILED 10-30-2006.

3,399,068. GOLDEN GATE ANCILLARY LLC, FORT SMITH, AR. SN 77-044,637. PUB. 4-17-2007, FILED 11-15-2006.



OWNER OF U.S. REG. NO. 2,187,654.
THE MARK CONSISTS OF THE WORDS FRESH INSPIRATIONS, SHOWN WITH THE DESIGN OF A STYLIZED FRUIT OR VEGETABLE, A CURVED LINE AND THE WORDS EXPERIENCE IT!.

FOR PREPARING AND SERVING FOODS AND BEVERAGES; CONTRACT FOOD SERVICES (U.S. CLS. 100 AND 101).

FIRST USE 7-18-2006; IN COMMERCE 7-18-2006.

ESPECIALLY YOURS CATERING
AND EVENTS

THE MARK CONSISTS OF STANDARD CHARACTERS WITHOUT CLAIM TO ANY PARTICULAR FONT, STYLE, SIZE, OR COLOR.

NO CLAIM IS MADE TO THE EXCLUSIVE RIGHT TO USE "CATERING AND EVENTS", APART FROM THE MARK AS SHOWN.

FOR CATERING SERVICES (U.S. CLS. 100 AND 101).
FIRST USE 9-1-2006; IN COMMERCE 9-1-2006.

CLASS 43—(Continued).

3,399,072. THE BOWERY HOTEL, LLC, NEW YORK, NY. SN 77-047,727. PUB. 6-19-2007, FILED 11-20-2006.

GEMMA

THE MARK CONSISTS OF STANDARD CHARACTERS WITHOUT CLAIM TO ANY PARTICULAR FONT, STYLE, SIZE, OR COLOR.

FOR RESTAURANT, BAR, AND CATERING SERVICES; PROVIDING BANQUET AND SOCIAL FUNCTION FACILITIES (U.S. CLS. 100 AND 101).
FIRST USE 7-9-2007; IN COMMERCE 7-9-2007.

3,399,126. HRCA OF DEDHAM, INC., BOSTON, MA. SN 77-070,589. PUB. 7-24-2007, FILED 12-22-2006.

NEWBRIDGE ON THE CHARLES

THE MARK CONSISTS OF STANDARD CHARACTERS WITHOUT CLAIM TO ANY PARTICULAR FONT, STYLE, SIZE, OR COLOR.

NO CLAIM IS MADE TO THE EXCLUSIVE RIGHT TO USE "ON THE CHARLES", APART FROM THE MARK AS SHOWN.

FOR PROVIDING A RETIREMENT HOME COMMUNITY FOR SENIOR CITIZENS (U.S. CLS. 100 AND 101).
FIRST USE 6-30-2006; IN COMMERCE 6-30-2006.

3,399,207. OCEAN CHICKS, INC., ATHENS, GA. SN 77-111,408. PUB. 8-14-2007, FILED 2-20-2007.



NO CLAIM IS MADE TO THE EXCLUSIVE RIGHT TO USE "HOUSE", APART FROM THE MARK AS SHOWN.

THE COLOR(S) BLACK, WHITE, TWO SHADES OF BLUE AND TWO SHADES OF RED IS/ARE CLAIMED AS A FEATURE OF THE MARK.

THE MARK CONSISTS OF AN OVAL IN TWO SHADES OF BLUE OUTLINED IN BLACK; WITHIN THE TOP HALF

CLASS 43—(Continued).

OF THE OVAL IS THE WORD "THE" IN BLACK LETTERS AND IN THE LOWER HALF OF THE OVAL IS THE WORD "HOUSE" IN BLACK LETTERS, AND A BLACK BANNER STRETCHES HORIZONTALLY ACROSS THE CENTER OF THE OVAL WITH THE WORD "TARTAR" IN WHITE LETTERS ON THE BANNER; AND A SMILING SHRIMP IN TWO SHADES OF RED ALONG THE RIGHT SIDE OF THE OVAL. THE SHRIMP IS OUTLINED IN BLACK AND HAS A WHITE MOUTH. A SMALL PORTION OF THE BANNER IS WHITE.

FOR RESTAURANT SERVICES (U.S. CLS. 100 AND 101).
FIRST USE 5-23-2007; IN COMMERCE 5-23-2007.

3,399,256. CAL SOL CONCEPTS LLC, SAN FRANCISCO, CA. SN 77-135,332. PUB. 9-18-2007, FILED 3-20-2007.



NO CLAIM IS MADE TO THE EXCLUSIVE RIGHT TO USE "ROADSIDE BBQ", APART FROM THE MARK AS SHOWN.

FOR RESTAURANT SERVICES (U.S. CLS. 100 AND 101).
FIRST USE 10-1-2006; IN COMMERCE 10-1-2006.

3,399,271. SHARIPOVA, ELENA, WAHIWA, HI. SN 77-146,913. PUB. 10-2-2007, FILED 4-2-2007.

pizz.us

THE MARK CONSISTS OF STANDARD CHARACTERS WITHOUT CLAIM TO ANY PARTICULAR FONT, STYLE, SIZE, OR COLOR.

FOR CAFE-RESTAURANTS; CARRY-OUT RESTAURANTS; DELICATESSENS; FAST-FOOD RESTAURANTS; HOTEL, BAR AND RESTAURANT SERVICES; PROVIDING ON-LINE REVIEWS OF RESTAURANTS AND HOTELS; RESERVATION OF RESTAURANTS; RESTAURANT AND BAR SERVICES; RESTAURANTS; RESTAURANTS FEATURING HOME DELIVERY; SELF SERVICE RESTAURANTS; TAKE-OUT RESTAURANT SERVICES; TRAVEL AGENCY SERVICES, NAMELY, MAKING RESERVATIONS AND BOOKINGS FOR RESTAURANTS AND MEALS (U.S. CLS. 100 AND 101).
FIRST USE 8-8-2007; IN COMMERCE 8-8-2007.

CLASS 43—(Continued).

3,399,295. THE SHERATON LLC, WHITE PLAINS, NY. SN 77-167,065. PUB. 9-25-2007, FILED 4-26-2007.

CLASS 43—(Continued).

3,399,373. PACIFIC WEST PROPERTY SERVICES, INC., CAREFREE, AZ. SN 78-410,372. PUB. 10-25-2005, FILED 4-29-2004.

ASTOR COURT

THE MARK CONSISTS OF STANDARD CHARACTERS WITHOUT CLAIM TO ANY PARTICULAR FONT, STYLE, SIZE, OR COLOR.

FOR HOTEL SERVICES, NAMELY, PROVIDING FOOD AND BEVERAGE; RESTAURANT, BAR AND COCKTAIL LOUNGE SERVICES (U.S. CLS. 100 AND 101).

FIRST USE 9-0-1991; IN COMMERCE 9-0-1991.

La Bellasera

THE MARK CONSISTS OF STANDARD CHARACTERS WITHOUT CLAIM TO ANY PARTICULAR FONT, STYLE, SIZE, OR COLOR.

THE FOREIGN WORDING IN THE MARK TRANSLATES INTO ENGLISH AS "BEAUTIFUL EVENING".

FOR HOTEL SERVICES (U.S. CLS. 100 AND 101).
FIRST USE 7-27-2007; IN COMMERCE 7-27-2007.

3,399,343. VEGAS.COM LLC, LAS VEGAS, NV. SN 78-331,089. PUB. 9-6-2005, FILED 11-20-2003.

3,399,383. ROSENBERG, BRADLEY, SETH, HENDERSON, NV. SN 78-445,856. PUB. 6-14-2005, FILED 7-4-2004.

**FREQUENT LAS VEGAS
POINTS**

THE MARK CONSISTS OF STANDARD CHARACTERS WITHOUT CLAIM TO ANY PARTICULAR FONT, STYLE, SIZE, OR COLOR.

FOR TRAVEL SERVICES OFFERED TO CREDIT CARD HOLDERS, NAMELY, MAKING RESERVATIONS OR BOOKINGS FOR LODGING (U.S. CLS. 100 AND 101).
FIRST USE 10-10-2007; IN COMMERCE 10-10-2007.

**WHERE EATING
BETTER TASTES
BETTER**

THE MARK CONSISTS OF STANDARD CHARACTERS WITHOUT CLAIM TO ANY PARTICULAR FONT, STYLE, SIZE, OR COLOR.

FOR RESTAURANT SERVICES (U.S. CLS. 100 AND 101).

FIRST USE 9-13-2005; IN COMMERCE 9-13-2005.

CLASS 43—(Continued).

3,399,405. APPLE CORE HOTELS, INC., NEW YORK, NY. SN 78-493,337. PUB. 1-10-2006, FILED 10-1-2004.



OWNER OF U.S. REG. NOS. 2,115,441, 2,119,174, AND 2,233,681.

THE COLORS BLACK, WHITE, GREY, RED, YELLOW, GREEN ARE CLAIMED AS A FEATURE OF THE MARK.

THE COLOR BLACK APPEARS IN THE LETTERING OF THE MARK. THE COLORS RED, WHITE, GREY, YELLOW, GREEN AND BLACK APPEAR IN THE APPLE WHICH REPRESENTS THE "O" IN "CORE". THE BACKGROUND COLOR IS WHITE.

THE MARK CONSISTS IN PART OF THE WORD "CORE" IN STYLIZED FORM INCORPORATING THE IMAGE OF AN APPLE AS THE LETTER "O".

FOR HOTEL SERVICES (U.S. CLS. 100 AND 101).
FIRST USE 10-1-2004; IN COMMERCE 10-1-2004.

3,399,608. MA DURGA PARTNERSHIP INC., SCHAUMBURG, IL. SN 78-702,014. PUB. 5-30-2006, FILED 8-28-2005.

La Bonita Inn and Suites

THE MARK CONSISTS OF STANDARD CHARACTERS WITHOUT CLAIM TO ANY PARTICULAR FONT, STYLE, SIZE, OR COLOR.

NO CLAIM IS MADE TO THE EXCLUSIVE RIGHT TO USE "INN AND SUITES", APART FROM THE MARK AS SHOWN.

THE ENGLISH TRANSLATION OF THE WORDING "LA BONITA" IN THE MARK IS THE BEAUTIFUL.

FOR HOTELS (U.S. CLS. 100 AND 101).
FIRST USE 8-1-2005; IN COMMERCE 8-1-2005.

3,399,643. MARRIOTT INTERNATIONAL, INC., BETHESDA, MD. SN 78-732,691. PUB. 8-29-2006, FILED 10-13-2005.

PURE MAGIC

THE MARK CONSISTS OF STANDARD CHARACTERS WITHOUT CLAIM TO ANY PARTICULAR FONT, STYLE, SIZE, OR COLOR.

FOR HOTEL SERVICES; RESTAURANT, BAR AND COCKTAIL LOUNGE SERVICES; RESORT LODGING SERVICES; AND RESERVATION SERVICES FOR HOTEL ACCOMMODATIONS FOR OTHERS (U.S. CLS. 100 AND 101).

FIRST USE 10-0-2005; IN COMMERCE 10-0-2005.

CLASS 43—(Continued).

3,399,798. DD IP HOLDER LLC, CANTON, MA. SN 78-798,803. PUB. 9-26-2006, FILED 1-25-2006.

AMERICA RUNS ON DUNKIN'

THE MARK CONSISTS OF STANDARD CHARACTERS WITHOUT CLAIM TO ANY PARTICULAR FONT, STYLE, SIZE, OR COLOR.

OWNER OF U.S. REG. NOS. 748,901, 2,751,008, AND OTHERS.

FOR RESTAURANT SERVICES AND CARRY-OUT FOOD SERVICES (U.S. CLS. 100 AND 101).

FIRST USE 4-10-2006; IN COMMERCE 4-20-2006.

3,399,842. HAYMAN, DENISE, MIDVALE, UT. SN 78-816,947. PUB. 10-3-2006, FILED 2-16-2006.

SCOPOLOGY

THE MARK CONSISTS OF STANDARD CHARACTERS WITHOUT CLAIM TO ANY PARTICULAR FONT, STYLE, SIZE, OR COLOR.

FOR RESTAURANT SERVICES (U.S. CLS. 100 AND 101).

FIRST USE 8-10-2006; IN COMMERCE 8-10-2006.

3,399,859. KEEPYOU, COMPANY, LAS VEGAS, NV. SN 78-822,191. PUB. 4-17-2007, FILED 2-23-2006.

KEEYOU COMPANY

THE MARK CONSISTS OF STANDARD CHARACTERS WITHOUT CLAIM TO ANY PARTICULAR FONT, STYLE, SIZE, OR COLOR.

FOR PROVIDING NON-MEDICAL ASSISTED LIVING SERVICES IN THE NATURE OF MEAL PLANNING, DIET PLANNING, MEAL PREPARATION, MONITORING AND ASSISTING IN EATING, DRINKING AND DIET, AND PET DAY CARE (U.S. CLS. 100 AND 101).

FIRST USE 2-13-2006; IN COMMERCE 2-13-2006.

CLASS 43—(Continued).

3,399,869. THOMPSON HOTELS LLC, NEW YORK, NY. SN 78-827,487. PUB. 6-19-2007, FILED 3-2-2006.

6 COLUMBUS HOTEL

THE MARK CONSISTS OF STANDARD CHARACTERS WITHOUT CLAIM TO ANY PARTICULAR FONT, STYLE, SIZE, OR COLOR.

NO CLAIM IS MADE TO THE EXCLUSIVE RIGHT TO USE "HOTEL", APART FROM THE MARK AS SHOWN. FOR HOTEL SERVICES (U.S. CLS. 100 AND 101). FIRST USE 10-1-2007; IN COMMERCE 10-1-2007.

3,400,122. BURRITO BEACH, LLC, CHICAGO, IL. SN 78-956,591. PUB. 7-17-2007, FILED 8-21-2006.



NO CLAIM IS MADE TO THE EXCLUSIVE RIGHT TO USE "SMOOTHIES", APART FROM THE MARK AS SHOWN.

THE MARK CONSISTS OF A FANCIFUL DEPICTION OF THE WORDS "SMOOTHY'S SHACK" OVERLAYING A SURF BOARD ILLUSTRATION.

FOR RESTAURANT SERVICES FEATURING MEXICAN FOOD, SMOOTHIES, AND OTHER BEVERAGES (U.S. CLS. 100 AND 101). FIRST USE 8-18-2006; IN COMMERCE 8-18-2006.

CLASS 43—(Continued).

3,400,123. BASILE, RACHEL P., CHARLOTTE, NC. SN 78-956,713. PUB. 10-9-2007, FILED 8-21-2006.



THE COLOR(S) BROWN, ORANGE, YELLOW, GREY AND WHITE IS/ARE CLAIMED AS A FEATURE OF THE MARK.

THE MARK CONSISTS OF THE COLOR BROWN APPEARS IN THE WORDING "SWITCHIN KITCHENS" AND AS BACKGROUND TO THE WORDING "PREPARE DINNER IN OURS. ENJOY IT IN YOURS". THE COLOR ORANGE APPEARS AS AN OVAL BACKGROUND TO THE OVERALL MARK. THE COLOR YELLOW APPEARS AS AN OVAL BAND NEXT TO THE ORANGE OVAL BACKGROUND. THE COLOR GREY APPEARS AS LINING TO THE OVERALL DESIGN AND THE UTENSIL DESIGN. THE COLOR WHITE APPEARS IN THE LETTERING "PREPARE DINNER IN OURS. ENJOY IT IN YOURS" AND AS LINING TO THE OVERALL DESIGN AND TO THE WORDING "SWITCHIN KITCHENS".

FOR CATERING FOR THE PROVISION OF FOOD AND BEVERAGES; CATERING OF FOOD AND DRINKS; FOOD PREPARATION; PREPARATION OF FOOD AND BEVERAGES (U.S. CLS. 100 AND 101).

FIRST USE 9-14-2006; IN COMMERCE 9-14-2006.

3,400,182. LIFESTYLE HOLIDAYS VACATION CLUB, INC., MIAMI, FL. SN 78-968,676. PUB. 4-24-2007, FILED 9-7-2006.

VIP WORLD

THE MARK CONSISTS OF STANDARD CHARACTERS WITHOUT CLAIM TO ANY PARTICULAR FONT, STYLE, SIZE, OR COLOR.

FOR COCKTAIL LOUNGES; RESTAURANT AND BAR SERVICES; RESTAURANTS (U.S. CLS. 100 AND 101). FIRST USE 8-31-2006; IN COMMERCE 8-31-2006.

CLASS 43—(Continued).

3,400,183. LIFESTYLE HOLIDAYS VACATION CLUB, INC., MIAMI, FL. SN 78-968,685. PUB. 4-24-2007, FILED 9-7-2006.

CLASS 44—(Continued).

3,399,074. DELAWARE SLEEP DISORDER CENTERS, LLC, NEWARK, DE. SN 77-048,432. PUB. 7-17-2007, FILED 11-21-2006.

TELL IT ONLY TO YOUR BEST FRIENDS

THE MARK CONSISTS OF STANDARD CHARACTERS WITHOUT CLAIM TO ANY PARTICULAR FONT, STYLE, SIZE, OR COLOR.
FOR COCKTAIL LOUNGES; RESTAURANT AND BAR SERVICES; RESTAURANTS (U.S. CLS. 100 AND 101).
FIRST USE 8-31-2006; IN COMMERCE 8-31-2006.



Delaware Sleep Disorder Centers
"Partners For Sleep Health"

CLASS 44—MEDICAL, BEAUTY AND AGRICULTURAL SERVICES

3,398,897. M-R-ALPACAS RANCH, INC, WAKEMAN, OH. SN 76-636,019. PUB. 6-6-2006, FILED 4-14-2005.

NO CLAIM IS MADE TO THE EXCLUSIVE RIGHT TO USE "DELAWARE SLEEP DISORDER CENTERS", APART FROM THE MARK AS SHOWN.
THE COLOR(S) WHITE, LAVENDER AND NAVY BLUE IS/ARE CLAIMED AS A FEATURE OF THE MARK.
THE COLOR NAVY BLUE APPEARS IN THE WORDING "DELAWARE SLEEP DISORDER CENTERS" AND IN THE DESIGNS OF THE CRESCENT MOON AND THE STICK FIGURE IN THE MIDDLE; LAVENDER APPEARS IN THE WORDING "PARTNERS FOR SLEEP HEALTH" AND IN THE FIRST AND THIRD STICK FIGURES; WHITE APPEARS IN THE OUTLINING OF THE STICK FIGURES AGAINST THE CRESCENT AND IN THE CIRCLE WITHIN THE CRESCENT.

M-R ALPACAS RANCH, INC.

THE MARK CONSISTS OF STANDARD CHARACTERS WITHOUT CLAIM TO ANY PARTICULAR FONT, STYLE, SIZE, OR COLOR.
NO CLAIM IS MADE TO THE EXCLUSIVE RIGHT TO USE "ALPACAS RANCH, INC.", APART FROM THE MARK AS SHOWN.
FOR ALPACA BREEDING SERVICES (U.S. CLS. 100 AND 101).
FIRST USE 5-5-2006; IN COMMERCE 5-5-2006.

FOR HEALTH CARE (U.S. CLS. 100 AND 101).
FIRST USE 3-1-2007; IN COMMERCE 1-11-2008.

3,398,989. GOLDEN GATE ANCILLARY LLC, FORT SMITH, AR. SN 77-007,939. PUB. 4-10-2007, FILED 9-26-2006.

3,399,075. WEIGHT WATCHERS INTERNATIONAL, INC., NEW YORK, NY. SN 77-048,488. PUB. 9-18-2007, FILED 11-21-2006.



BE AN AFTER, STAY AN AFTER

THE COLOR(S) GOLD IS/ARE CLAIMED AS A FEATURE OF THE MARK.
THE MARK CONSISTS OF A HALF GOLDEN CIRCLE ON LEFT AND A HALF GOLDEN CIRCLE ON RIGHT BUT NOT JOINING.
FOR MANAGED HEALTH CARE SERVICES (U.S. CLS. 100 AND 101).
FIRST USE 9-1-2006; IN COMMERCE 9-1-2006.

THE MARK CONSISTS OF STANDARD CHARACTERS WITHOUT CLAIM TO ANY PARTICULAR FONT, STYLE, SIZE, OR COLOR.
FOR PROVIDING WEIGHT REDUCTION PLANNING, TREATMENT AND SUPERVISION THROUGH WEIGHT REDUCTION PROGRAMS FEATURING COUNSELING AND DIET PLANS; PROVIDING ADVICE, CONSULTATION AND INFORMATION IN THE FIELD OF WEIGHT CONTROL AND NUTRITION (U.S. CLS. 100 AND 101).
FIRST USE 12-24-2006; IN COMMERCE 12-24-2006.

CLASS 44—(Continued).

3,399,083. FRIEFELD & ASSOCIATES, LLC, WOBURN, MA.
SN 77-051,386. PUB. 6-19-2007, FILED 11-27-2006.

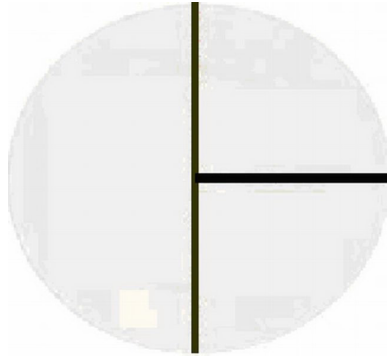

THE MARK CONSISTS OF A DINNER PLATE DIVIDED INTO THREE SECTIONS.

FOR FOOD NUTRITION CONSULTATION REGARDING FOOD SERVICE AND WELLNESS PROGRAMS FOR INSTITUTIONS AND INDIVIDUALS (U.S. CLS. 100 AND 101).

FIRST USE 6-30-2004; IN COMMERCE 6-30-2004.

3,399,114. ALLERGAN, INC., IRVINE, CA. SN 77-068,776.
PUB. 4-24-2007, FILED 12-20-2006.

TAME YOUR HUNGER

THE MARK CONSISTS OF STANDARD CHARACTERS WITHOUT CLAIM TO ANY PARTICULAR FONT, STYLE, SIZE, OR COLOR.

FOR PROVIDING INFORMATION DIRECTED TO CONSUMERS CONCERNING OBESITY TREATMENTS (U.S. CLS. 100 AND 101).

FIRST USE 8-30-2006; IN COMMERCE 7-27-2007.

3,399,390. MEDTRONIC NAVIGATION, INC., LOUISVILLE, CO. SN 78-466,974. PUB. 7-5-2005, FILED 8-13-2004.

STEALTHNAVIGATOR

THE MARK CONSISTS OF STANDARD CHARACTERS WITHOUT CLAIM TO ANY PARTICULAR FONT, STYLE, SIZE, OR COLOR.

OWNER OF U.S. REG. NOS. 2,191,709 AND 2,717,661.
FOR LEASING OF MEDICAL EQUIPMENT ON A FEE PER USE BASIS (U.S. CLS. 100 AND 101).

FIRST USE 8-16-2005; IN COMMERCE 8-16-2005.

CLASS 44—(Continued).

3,399,404. ESTEE LAUDER INC., NEW YORK, NY. SN 78-491,499. PUB. 9-20-2005, FILED 9-29-2004.

iMATCH

THE MARK CONSISTS OF STANDARD CHARACTERS WITHOUT CLAIM TO ANY PARTICULAR FONT, STYLE, SIZE, OR COLOR.

FOR BEAUTY CONSULTATION SERVICES (U.S. CLS. 100 AND 101).

FIRST USE 9-30-2005; IN COMMERCE 9-30-2005.

3,399,406. CATHOLIC HEALTHCARE WEST, SAN FRANCISCO, CA. SN 78-497,264. PUB. 9-13-2005, FILED 10-8-2004.

CHWHEALTH

THE MARK CONSISTS OF STANDARD CHARACTERS WITHOUT CLAIM TO ANY PARTICULAR FONT, STYLE, SIZE, OR COLOR.

OWNER OF U.S. REG. NOS. 1,560,221, 2,169,650, AND OTHERS.

FOR HEALTHCARE (U.S. CLS. 100 AND 101).
FIRST USE 11-10-2007; IN COMMERCE 12-6-2007.

CLASS 44—(Continued).

3,399,475. PRODUCT PARTNERS, LLC, BEVERLY HILLS, CA. SN 78-566,502. PUB. 12-13-2005, FILED 2-14-2005.

MILLION DOLLAR BODY

THE MARK CONSISTS OF STANDARD CHARACTERS WITHOUT CLAIM TO ANY PARTICULAR FONT, STYLE, SIZE, OR COLOR.

NO CLAIM IS MADE TO THE EXCLUSIVE RIGHT TO USE "BODY", APART FROM THE MARK AS SHOWN.

FOR WEIGHT REDUCTION AND DIET PLANNING (U.S. CLS. 100 AND 101).

FIRST USE 4-0-2007; IN COMMERCE 4-0-2007.

3,399,612. E-NATE INC., MONTREAL, QUEBEC, CANADA. SN 78-707,932. PUB. 4-10-2007, FILED 9-7-2005.

E-NATE

THE MARK CONSISTS OF STANDARD CHARACTERS WITHOUT CLAIM TO ANY PARTICULAR FONT, STYLE, SIZE, OR COLOR.

PRIORITY CLAIMED UNDER SEC. 44(D) ON CANADA APPLICATION NO. 1249803, FILED 3-8-2005, REG. NO. TMA668289, DATED 7-19-2006, EXPIRES 7-19-2021.

FOR WEBSITE SERVICES, NAMELY, PROVIDING A WEBSITE FOR USE BY CHIROPRACTORS AND OTHER PROFESSIONALS IN THE FIELD OF HEALTH CARE FOR ALL ASPECTS OF THEIR PRACTICE, NAMELY, MAINTAINING FILES AND RECORDS CONCERNING THE MEDICAL CONDITION OF PATIENTS, MAINTAINING PATIENT'S PERSONAL MEDICAL RECORDS AND FILES (U.S. CLS. 100 AND 101).

FIRST USE 1-0-2005; IN COMMERCE 4-10-2006.

3,399,639. PFIZER INC., NEW YORK, NY. SN 78-727,901. PUB. 3-20-2007, FILED 10-6-2005.



NO CLAIM IS MADE TO THE EXCLUSIVE RIGHT TO USE "DIABETIC NERVE PAIN", APART FROM THE MARK AS SHOWN.

CLASS 44—(Continued).

THE MARK CONSISTS OF TWO FOOT PRINTS IN THE MIDDLE OF THE PHRASE "STEP FORWARD FROM DIABETIC NERVE PAIN" IN A BOX.

FOR MEDICAL INFORMATION SERVICES, NAMELY, PROVIDING INFORMATION RELATING TO DIABETIC NERVE PAIN AND THE TREATMENT THEREOF; ON-LINE INFORMATION SERVICES, NAMELY, PROVIDING INFORMATION RELATING TO DIABETIC NERVE PAIN AND THE TREATMENT THEREOF VIA A GLOBAL COMPUTER NETWORK (U.S. CLS. 100 AND 101).

FIRST USE 11-5-2005; IN COMMERCE 11-5-2005.

3,399,680. UNIVERSITY OF MIAMI, CORAL GABLES, FL. SN 78-755,821. PUB. 7-18-2006, FILED 11-17-2005.

BASCOM PALMER SURGERY CENTER

THE MARK CONSISTS OF STANDARD CHARACTERS WITHOUT CLAIM TO ANY PARTICULAR FONT, STYLE, SIZE, OR COLOR.

OWNER OF U.S. REG. NO. 3,052,875.

NO CLAIM IS MADE TO THE EXCLUSIVE RIGHT TO USE "SURGERY CENTER", APART FROM THE MARK AS SHOWN.

FOR HEALTH CARE SERVICES, NAMELY, PROVIDING EYE TREATMENT FOR DISEASES OF THE EYE TO OUTPATIENTS (U.S. CLS. 100 AND 101).

FIRST USE 8-1-2006; IN COMMERCE 8-1-2006.

3,399,709. SAN ANTONIO COMMUNITY HOSPITAL, UPLAND, CA. SN 78-766,134. PUB. 8-22-2006, FILED 12-3-2005.

SACH

THE MARK CONSISTS OF STANDARD CHARACTERS WITHOUT CLAIM TO ANY PARTICULAR FONT, STYLE, SIZE, OR COLOR.

FOR HOSPITALS (U.S. CLS. 100 AND 101).

FIRST USE 7-30-2007; IN COMMERCE 7-30-2007.

CLASS 44—(Continued).

3,399,725. UHS OF DELAWARE, INC., KING OF PRUSSIA, PA. SN 78-773,420. PUB. 9-19-2006, FILED 12-14-2005.

THE WOMEN'S CENTER AT THE
GEORGE WASHINGTON
UNIVERSITY HOSPITAL

THE MARK CONSISTS OF STANDARD CHARACTERS WITHOUT CLAIM TO ANY PARTICULAR FONT, STYLE, SIZE, OR COLOR.

OWNER OF U.S. REG. NOS. 2,909,837 AND 2,909,838. NO CLAIM IS MADE TO THE EXCLUSIVE RIGHT TO USE "WOMEN'S CENTER" AND "UNIVERSITY HOSPITAL", APART FROM THE MARK AS SHOWN.

FOR MEDICAL, HEALTHCARE AND HOSPITAL SERVICES (U.S. CLS. 100 AND 101).

FIRST USE 5-4-2005; IN COMMERCE 5-4-2005.

3,399,729. PHOTO THERAPEUTICS LIMITED, ALTRINC-HAM, CHESHIRE, UNITED KINGDOM. SN 78-773,938. PUB. 4-24-2007, FILED 12-15-2005.

LUMIÈRE

THE MARK CONSISTS OF STANDARD CHARACTERS WITHOUT CLAIM TO ANY PARTICULAR FONT, STYLE, SIZE, OR COLOR.

THE ENGLISH TRANSLATION OF "LUMIÈRE" IS "LIGHT", "DAYLIGHT" OR "DAY".

FOR PROVIDING COSMETIC AND MEDICAL INFORMATION (U.S. CLS. 100 AND 101).

FIRST USE 8-2-2004; IN COMMERCE 8-2-2004.

3,399,823. THE GENERAL HOSPITAL CORPORATION, BOSTON, MA. SN 78-808,295. PUB. 3-20-2007, FILED 2-6-2006.



OWNER OF U.S. REG. NOS. 1,451,530 AND 2,384,444.

CLASS 44—(Continued).

NO CLAIM IS MADE TO THE EXCLUSIVE RIGHT TO USE "FIT" AND "1811", APART FROM THE MARK AS SHOWN.

THE MARK CONSISTS OF THE DESIGN OF A STYLIZED HUMAN FIGURE WITH RAISED ARMS HOLDING A BARBELL, WITH THE LETTERS "B" AND "E" SHOWN ON THE CIRCULAR ENDS OF THE BARBELL, WITH A SHIELD DESIGN ON THE CHEST OF THE HUMAN FIGURE CONTAINING THE INITIALS "MGH", THE NUMBER "1811" AND A STYLIZED REPRESENTATION OF THE DOME AND PEDIMENT OF A BUILDING, AND WITH THE WORD "FIT" SHOWN BENEATH THE HUMAN FIGURE, ALL SHOWN WITHIN A CIRCLE.

FOR COUNSELING IN THE FIELD OF HEALTH AND WELLNESS; HEALTH CARE SERVICES IN THE NATURE OF A PROGRAM IN WHICH PARTICIPANTS ARE ENCOURAGED TO ADOPT HEALTHY PRACTICES AND IMPROVE THEIR OVERALL FITNESS (U.S. CLS. 100 AND 101).

FIRST USE 1-21-2005; IN COMMERCE 1-21-2005.

3,399,906. PHYSICIANS IMMEDIATE CARE, LTD., MACHESNEY PARK, IL. SN 78-843,964. PUB. 5-1-2007, FILED 3-23-2006.

ZIP PASS

THE MARK CONSISTS OF STANDARD CHARACTERS WITHOUT CLAIM TO ANY PARTICULAR FONT, STYLE, SIZE, OR COLOR.

NO CLAIM IS MADE TO THE EXCLUSIVE RIGHT TO USE "PASS", APART FROM THE MARK AS SHOWN.

FOR MEDICAL SERVICES (U.S. CLS. 100 AND 101).

FIRST USE 3-24-2006; IN COMMERCE 3-24-2006.

3,399,922. LIFECLINIC INTERNATIONAL, INC., BURTONSVILLE, MD. SN 78-853,588. PUB. 11-14-2006, FILED 4-4-2006.

Group-Stat

THE MARK CONSISTS OF STANDARD CHARACTERS WITHOUT CLAIM TO ANY PARTICULAR FONT, STYLE, SIZE, OR COLOR.

FOR REMOTE MONITORING OF DATA INDICATIVE OF THE HEALTH OR CONDITION OF AN INDIVIDUAL OR GROUP OF INDIVIDUALS (U.S. CLS. 100 AND 101).

FIRST USE 11-30-2006; IN COMMERCE 11-30-2006.

CLASS 44—(Continued).

3,399,968. CYPRESS FAIRBANKS MEDICAL CENTER, INC., DALLAS, TX. SN 78-876,262. PUB. 12-12-2006, FILED 5-4-2006.

Putting the Hospitality
Back Into Hospital

THE MARK CONSISTS OF STANDARD CHARACTERS WITHOUT CLAIM TO ANY PARTICULAR FONT, STYLE, SIZE, OR COLOR.
FOR HEALTH CARE (U.S. CLS. 100 AND 101).
FIRST USE 7-6-2007; IN COMMERCE 7-6-2007.

CLASS 44—(Continued).

3,400,034. REESE, PAUL DAVID, WALTHAM, MA. SN 78-921,701. PUB. 9-4-2007, FILED 7-2-2006.



NO CLAIM IS MADE TO THE EXCLUSIVE RIGHT TO USE "THE CHILDREN'S STRABISMUS CENTER", APART FROM THE MARK AS SHOWN.
FOR MEDICAL SERVICES, NAMELY, OPHTHALMOLOGY (U.S. CLS. 100 AND 101).
FIRST USE 10-1-1993; IN COMMERCE 10-1-1993.

3,400,029. PEDIATRIX MEDICAL GROUP, INC., SUNRISE, FL. SN 78-918,904. PUB. 4-24-2007, FILED 6-28-2006.

3,400,060. THE VANDERBILT UNIVERSITY, NASHVILLE, TN. SN 78-935,356. PUB. 3-6-2007, FILED 7-22-2006.

PEOPLE WHO ASK, KNOW.



THE COLOR(S) DARK BLUE, GREEN AND LIGHT BLUE IS/ARE CLAIMED AS A FEATURE OF THE MARK.
THE TERM "SOUND" IS DARK BLUE. THE TERM "GENE" IS GREEN. THE SOUND WAVES ARE LIGHT BLUE.
FOR PROVIDING ANALYTICAL TESTING SERVICES FOR PRE-LINGUAL HEARING LOSS USING ANALYSIS OF DNA MUTATIONS ASSOCIATED WITH HEARING LOSS (U.S. CLS. 100 AND 101).
FIRST USE 1-0-2007; IN COMMERCE 1-0-2007.

THE MARK CONSISTS OF STANDARD CHARACTERS WITHOUT CLAIM TO ANY PARTICULAR FONT, STYLE, SIZE, OR COLOR.
FOR HEALTH CARE SERVICES; HOSPITAL SERVICES; MEDICAL CLINICS; MEDICAL COUNSELING; MEDICAL EVALUATION SERVICES, NAMELY, FUNCTIONAL ASSESSMENT PROGRAM FOR PATIENTS RECEIVING MEDICAL SERVICES FOR PURPOSES OF GUIDING TREATMENT AND ASSESSING PROGRAM EFFECTIVENESS; MEDICAL SERVICES; NUTRITION COUNSELING; PHYSICAL REHABILITATION SERVICES; PROVIDING INFORMATION IN THE FIELDS OF DISEASES, DISEASE PREVENTION, HEALTH CARE, MEDICINE AND MEDICAL SERVICES; AND PROVIDING INFORMATION VIA A GLOBAL COMMUNICATIONS NETWORK IN THE FIELDS OF DISEASES, DISEASE PREVENTION, HEALTH CARE, MEDICINE AND MEDICAL SERVICES (U.S. CLS. 100 AND 101).
FIRST USE 9-18-2006; IN COMMERCE 9-18-2006.

CLASS 44—(Continued).

3,400,097. INFUSCIENCE, INC., GURNEE, IL. SN 78-949,468.
PUB. 4-17-2007, FILED 8-10-2006.

INFUSCIENCE

THE MARK CONSISTS OF STANDARD CHARACTERS WITHOUT CLAIM TO ANY PARTICULAR FONT, STYLE, SIZE, OR COLOR.

FOR HOME INFUSION CARE THERAPY SERVICES; CATHETER CARE; PARENTERAL NUTRITION THERAPY, ENTERAL NUTRITION THERAPY, ANTIBIOTIC THERAPY, BONE MARROW AND SOLID ORGAN TRANSPLANT SUPPORT SERVICES; IMMUNE DEFICIENCY AND NEUROLOGICAL DISORDER TREATMENTS; INTRAVENOUS IMMUNE GLOBIN THERAPY; TREATMENT OF BLEEDING DISORDERS; AND PAIN MANAGEMENT SERVICES (U.S. CLS. 100 AND 101).
FIRST USE 2-0-2007; IN COMMERCE 2-0-2007.

3,400,124. GOLDEN GATE ANCILLARY LLC, FORT SMITH, AR. SN 78-956,842. PUB. 4-17-2007, FILED 8-21-2006.

GOLDEN CLINICAL SERVICES

THE MARK CONSISTS OF STANDARD CHARACTERS WITHOUT CLAIM TO ANY PARTICULAR FONT, STYLE, SIZE, OR COLOR.

NO CLAIM IS MADE TO THE EXCLUSIVE RIGHT TO USE "CLINICAL SERVICES", APART FROM THE MARK AS SHOWN.

FOR HEALTH CARE SERVICES (U.S. CLS. 100 AND 101).

FIRST USE 9-1-2006; IN COMMERCE 9-1-2006.

3,400,128. GOLDEN GATE ANCILLARY LLC, FORT SMITH, AR. SN 78-957,720. PUB. 5-15-2007, FILED 8-22-2006.

AEGIS THERAPIES

THE MARK CONSISTS OF STANDARD CHARACTERS WITHOUT CLAIM TO ANY PARTICULAR FONT, STYLE, SIZE, OR COLOR.

OWNER OF U.S. REG. NOS. 2,916,563 AND 3,049,860.

NO CLAIM IS MADE TO THE EXCLUSIVE RIGHT TO USE "THERAPIES", APART FROM THE MARK AS SHOWN.

FOR OCCUPATIONAL, PHYSICAL, AND SPEECH THERAPY SERVICES (U.S. CLS. 100 AND 101).

FIRST USE 4-22-2004; IN COMMERCE 4-22-2004.

CLASS 44—(Continued).

3,400,129. GOLDEN GATE ANCILLARY LLC, FORT SMITH, AR. SN 78-957,744. PUB. 6-5-2007, FILED 8-22-2006.



OWNER OF U.S. REG. NOS. 2,916,563 AND 3,049,860.
NO CLAIM IS MADE TO THE EXCLUSIVE RIGHT TO USE "THERAPIES", APART FROM THE MARK AS SHOWN.
THE MARK CONSISTS OF LITERAL ELEMENT "AEGIS" WITH AN ABSTRACT MAN DANCING WITH A RIBBON THEN THE LITERAL ELEMENT BELOW THE MAN IS "THERAPIES".

FOR OCCUPATIONAL, PHYSICAL, AND SPEECH THERAPY SERVICES (U.S. CLS. 100 AND 101).
FIRST USE 4-22-2004; IN COMMERCE 4-22-2004.

3,400,130. GOLDEN GATE ANCILLARY LLC, FORT SMITH, AR. SN 78-957,755. PUB. 5-15-2007, FILED 8-22-2006.

AEGIS ACUTE REHAB

THE MARK CONSISTS OF STANDARD CHARACTERS WITHOUT CLAIM TO ANY PARTICULAR FONT, STYLE, SIZE, OR COLOR.

OWNER OF U.S. REG. NOS. 2,916,563 AND 3,049,860.

NO CLAIM IS MADE TO THE EXCLUSIVE RIGHT TO USE "ACUTE REHAB", APART FROM THE MARK AS SHOWN.

FOR OCCUPATIONAL, PHYSICAL, AND SPEECH THERAPY SERVICES (U.S. CLS. 100 AND 101).

FIRST USE 2-17-2005; IN COMMERCE 2-17-2005.

CLASS 44—(Continued).

3,400,131. GOLDEN GATE ANCILLARY LLC, FORT SMITH, AR. SN 78-957,758. PUB. 6-5-2007, FILED 8-22-2006.



OWNER OF U.S. REG. NOS. 2,916,563 AND 3,049,860.
NO CLAIM IS MADE TO THE EXCLUSIVE RIGHT TO USE "ACUTE REHAB", APART FROM THE MARK AS SHOWN.

THE MARK CONSISTS OF LITERAL ELEMENT "AEGIS" WITH AN ABSTRACT MAN DANCING WITH A RIBBON THEN THE LITERAL ELEMENTS BELOW THE MAN ARE "ACUTE REHAB."

FOR OCCUPATIONAL, PHYSICAL, AND SPEECH THERAPY SERVICES (U.S. CLS. 100 AND 101).
FIRST USE 2-17-2005; IN COMMERCE 2-17-2005.

3,400,154. CALVIN N. TSAO, HOUSTON, TX. SN 78-963,398.
PUB. 4-24-2007, FILED 8-29-2006.



NO CLAIM IS MADE TO THE EXCLUSIVE RIGHT TO USE "LASER" AND "COSMETICS" AND "MEDSPA", APART FROM THE MARK AS SHOWN.

THE COLOR(S) LIGHT GREEN, WHITE, GREEN AND BLACK IS/ARE CLAIMED AS A FEATURE OF THE MARK.

THE COLOR LIGHT GREEN APPEARS IN THE CIRCLE. THE COLOR WHITE APPEARS IN THE LETTER "I" WITHIN THE CIRCLE. THE COLOR GREEN APPEARS IN THE WORDING "IMPRESSIONS" SUPERIMPOSED OVER THE CIRCLE AND LETTER "I". THE COLOR BLACK APPEARS IN THE WORDING "LASER", "COSMETICS", AND "MEDSPA" AND THE TWO VERTICAL LINES IN BETWEEN THE WORDING "LASER" AND "COSMETICS" AND "COSMETICS" AND "MEDSPA".

FOR MEDICAL CLINICS (U.S. CLS. 100 AND 101).
FIRST USE 11-3-2006; IN COMMERCE 11-3-2006.

CLASS 45—PERSONAL AND LEGAL SERVICES**CLASS 45—(Continued).**

3,398,916. LONG, ANNE, GREAT FALLS, VA. SN 76-653,281.
PUB. 3-13-2007, FILED 1-12-2006.



NO CLAIM IS MADE TO THE EXCLUSIVE RIGHT TO USE "PARKING & TRANSPORTATION, CONVENIENCE AND EXCELLENCE", APART FROM THE MARK AS SHOWN.

THE MARK CONSISTS, IN PART, OF A DESIGN OF A STYLIZED SUN WITHIN A SHADED CIRCLE.

FOR CONCIERGE SERVICES FOR OTHERS COMPRISING MAKING REQUESTED PERSONAL ARRANGEMENTS AND RESERVATIONS AND PROVIDING CUSTOMER-SPECIFIC INFORMATION TO MEET INDIVIDUAL NEEDS RENDERED TOGETHER IN AN APARTMENT COMPLEX, BUSINESS CONFERENCE, SHOPPING CENTER; HOTEL CONCIERGE SERVICES; CONTROL OF BUILDING ENVIRONMENTAL ACCESS AND SECURITY SYSTEMS; MONITORING BURGLAR AND SECURITY ALARMS; MONITORING OF COMPUTER SYSTEMS FOR SECURITY PURPOSES; MONITORING SECURITY SYSTEMS; SECURITY GUARD SERVICES; SECURITY GUARDING FOR FACILITIES; SECURITY INSPECTION SERVICES FOR OTHERS (U.S. CLS. 100 AND 101).
FIRST USE 4-1-2006; IN COMMERCE 4-1-2006.

3,398,978. INSTANT CREDIT CARD SECURITY SYSTEMS, INC., FREMONT, CA. SN 77-005,914. PUB. 9-18-2007, FILED 9-23-2006.

MYFRAUDDOG

THE MARK CONSISTS OF STANDARD CHARACTERS WITHOUT CLAIM TO ANY PARTICULAR FONT, STYLE, SIZE, OR COLOR.

FOR CREDIT CARD FRAUD PREVENTION SERVICES, NAMELY, PROVIDING AUTHENTICATION OF PERSONAL IDENTIFICATION INFORMATION; FRAUD DETECTION SERVICES IN THE FIELD OF CREDIT CARDS FOR ON-LINE PURCHASING; CONSULTATION IN THE FIELD OF DATA THEFT AND IDENTITY THEFT; FINANCIAL IDENTITY MONITORING SERVICE; REAL-TIME REPORTING OF FINANCIAL TRANSACTIONS IN CONJUNCTION WITH CREDIT CARD SECURITY AND IDENTITY THEFT (U.S. CLS. 100 AND 101).

FIRST USE 11-1-2006; IN COMMERCE 11-1-2006.

CLASS 45—(Continued).

3,398,995. MOORE SYNDICATION, INC., BIRMINGHAM, AL. SN 77-008,802. PUB. 5-22-2007, FILED 9-27-2006.

SAFEZONE

THE MARK CONSISTS OF STANDARD CHARACTERS WITHOUT CLAIM TO ANY PARTICULAR FONT, STYLE, SIZE, OR COLOR.

FOR PROVIDING INFORMATION ABOUT SAFETY ISSUES ASSOCIATED WITH NATURAL GAS LINES, ELECTRIC POWER LINES AND OTHER NATURAL GAS AND ELECTRIC POWER SITES, FOR CONTRACTORS AND OTHER BUSINESSES, CUSTOMERS, AND THE GENERAL PUBLIC (U.S. CLS. 100 AND 101).
FIRST USE 5-1-2007; IN COMMERCE 5-1-2007.

CLASS 45—(Continued).

3,399,377. REFLECTIONS LLC, ALBUQUERQUE, NM. SN 78-423,510. PUB. 12-13-2005, FILED 5-23-2004.

Reflection of Life

THE MARK CONSISTS OF STANDARD CHARACTERS WITHOUT CLAIM TO ANY PARTICULAR FONT, STYLE, SIZE, OR COLOR.

FOR FUNERAL HOME; FUNERAL SERVICE UNDERTAKING (U.S. CLS. 100 AND 101).
FIRST USE 6-1-2004; IN COMMERCE 6-1-2004.

3,399,029. KEEPCOMINGBACK.COM LLC, SAN DIEGO, CA. SN 77-028,127. PUB. 8-14-2007, FILED 10-24-2006.

KEEPCOMINGBACK.COM

THE MARK CONSISTS OF STANDARD CHARACTERS WITHOUT CLAIM TO ANY PARTICULAR FONT, STYLE, SIZE, OR COLOR.

FOR SOCIAL SERVICES, NAMELY, PROVIDING ONLINE SOCIAL NETWORKING FOR PEOPLE IN ADDICTION RECOVERY (U.S. CLS. 100 AND 101).
FIRST USE 7-9-2007; IN COMMERCE 7-9-2007.

3,399,653. DO SOMETHING!, INC., NEW YORK, NY. SN 78-740,352. PUB. 2-6-2007, FILED 10-25-2005.

TEENS FOR JEANS

THE MARK CONSISTS OF STANDARD CHARACTERS WITHOUT CLAIM TO ANY PARTICULAR FONT, STYLE, SIZE, OR COLOR.

FOR CHARITABLE SERVICES, NAMELY, ORGANIZING YOUTH GROUPS TO UNDERTAKE PROJECTS TO BENEFIT THE NEEDY AND THE COMMUNITY TO ENCOURAGE LEADERSHIP, CHARACTER, COMPASSION, AND GOOD CITIZENSHIP; CHARITABLE SERVICES, NAMELY, PROVIDING CLOTHING TO NEEDY PERSONS (U.S. CLS. 100 AND 101).
FIRST USE 1-7-2008; IN COMMERCE 1-7-2008.

3,399,215. CHALLENGER-NIBBS, KENDRA, BROOKLYN, NY. SN 77-115,440. PUB. 9-25-2007, FILED 2-24-2007.

PaperWitness

THE MARK CONSISTS OF STANDARD CHARACTERS WITHOUT CLAIM TO ANY PARTICULAR FONT, STYLE, SIZE, OR COLOR.

FOR LEGAL DOCUMENT PREPARATION SERVICES FOR INDIVIDUALS AND ATTORNEYS (U.S. CLS. 100 AND 101).
FIRST USE 12-28-2007; IN COMMERCE 12-28-2007.

3,400,224. FULLERTON, DONNA M., NEW YORK, NY. SN 78-979,668. PUB. 2-27-2007, FILED 12-28-2005.

FOOD FOR THE SOUL

THE MARK CONSISTS OF STANDARD CHARACTERS WITHOUT CLAIM TO ANY PARTICULAR FONT, STYLE, SIZE, OR COLOR.

FOR INFORMATION, ADVISORY AND CONSULTANCY SERVICES IN THE FIELD OF MOTIVATION AND PERSONAL DEVELOPMENT PROVIDED VIA A GLOBAL COMPUTER NETWORK (U.S. CLS. 100 AND 101).
FIRST USE 11-27-2005; IN COMMERCE 11-27-2005.

MARCH 18, 2008

U.S. PATENT AND TRADEMARK OFFICE

TM 1737

CLASS 45—(Continued).

CLASS 45—(Continued).

3,400,225. PREPARED RESPONSE, INC., SEATTLE, WA. SN
78-979,672. PUB. 3-6-2007, FILED 6-7-2006.

GUIDESAFE

THE MARK CONSISTS OF STANDARD CHARACTERS
WITHOUT CLAIM TO ANY PARTICULAR FONT, STYLE,
SIZE, OR COLOR.

FOR PROVIDING ON-LINE INFORMATION IN THE
FIELD OF EMERGENCY PROCEDURE (U.S. CLS. 100
AND 101).

FIRST USE 3-12-2007; IN COMMERCE 3-12-2007.

* * * * *

PRIOR UNITED STATES CLASSIFICATION

APPLICATION IN ONE CLASS

COLLECTIVE MEMBERSHIP MARKS

CLASS 200—COLLECTIVE MEMBERSHIP

3,399,222. BERKLEE COLLEGE OF MUSIC, INC., BOSTON, MA. SN 77-117,768. PUB. 7-24-2007, FILED 2-27-2007.

BERKLEE CITY MUSIC NETWORK

THE MARK CONSISTS OF STANDARD CHARACTERS WITHOUT CLAIM TO ANY PARTICULAR FONT, STYLE, SIZE, OR COLOR.

NO CLAIM IS MADE TO THE EXCLUSIVE RIGHT TO USE "MUSIC NETWORK", APART FROM THE MARK AS SHOWN.

FOR INDICATING MEMBERSHIP IN A(N) GROUP OF ENTITIES TEACHING MUSIC IN A PARTICULAR WAY TO UNDERSERVED COMMUNITIES AND UNDERPRIVILEGED CHILDREN (U.S. CL. 200).

FIRST USE 7-14-2007; IN COMMERCE 7-14-2007.

CERTIFICATION MARKS

CLASS A—GOODS

3,399,663. BOEHRINGER INGELHEIM VETMEDICA, INC., ST. JOSEPH, MO. SN 78-746,662. PUB. 12-19-2006, FILED 11-3-2005.

RANGE READY

THE MARK CONSISTS OF STANDARD CHARACTERS WITHOUT CLAIM TO ANY PARTICULAR FONT, STYLE, SIZE, OR COLOR.

THE CERTIFICATION MARK AS USED BY PERSONS AUTHORIZED BY THE CERTIFIER CERTIFIES THAT SUCH PERSONS ARE RAISING BULLS AND HEIFERS (CATTLE/LIVESTOCK) USING CERTIFIER'S VACCINES AND FOLLOWING CERTIFIER'S PROTOCOLS.

FOR LIVESTOCK, NAMELY CATTLE (U.S. CL. A). FIRST USE 1-31-2006; IN COMMERCE 1-31-2006.

3,400,215. TRANSFAIR USA, OAKLAND, CA. SN 78-979,621. PUB. 12-5-2006, FILED 9-6-2005.

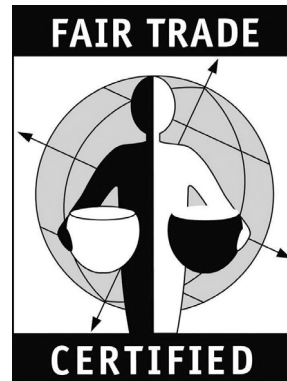

OWNER OF U.S. REG. NOS. 2,868,219 AND 2,989,872. NO CLAIM IS MADE TO THE EXCLUSIVE RIGHT TO USE "FAIR TRADE CERTIFIED", APART FROM THE MARK AS SHOWN.

THE CERTIFIER AUTHORIZES THIRD PARTIES WHO MEET THE CERTIFIER'S CERTIFICATION STANDARDS TO USE THE MARK IN COMMERCE TO DEMONSTRATE THE CERTIFIER'S CERTIFICATION OF GOODS LISTED IN THE APPLICATION. THE CERTIFIER IS EXERCISING LEGITIMATE CONTROL OVER THE USE OF THE MARK IN COMMERCE IN CONNECTION WITH CERTIFIER'S AUTHORIZATION OF THIRD PARTIES TO DISPLAY THE MARK AS A CERTIFICATION OF SUCH THIRD PARTIES' GOODS.

FOR ORANGES, FLOWERS AND VANILLA (U.S. CL. A).

FIRST USE 9-30-2006; IN COMMERCE 9-30-2006.

CERTIFICATION MARKS

CLASS B—SERVICES

3,398,976. ANGEL THERAPY, INC., LAGUNA BEACH, CA. SN 77-004,846. PUB. 9-11-2007, FILED 9-21-2006.

ANGEL THERAPIST

THE MARK CONSISTS OF STANDARD CHARACTERS WITHOUT CLAIM TO ANY PARTICULAR FONT, STYLE, SIZE, OR COLOR.

OWNER OF U.S. REG. NOS. 2,775,008, 2,883,867, AND 3,072,471.

NO CLAIM IS MADE TO THE EXCLUSIVE RIGHT TO USE "THERAPIST", APART FROM THE MARK AS SHOWN.

THE CERTIFICATION MARK, AS USED BY AUTHORIZED PERSONS, CERTIFIES COMPLETION OF TRAINING COURSES IN THE PRACTICE OF CERTIFIER'S METHOD OF SPIRITUAL HEALING.

FOR TRAINING SERVICES FOR PRACTITIONERS IN THE FIELD OF SPIRITUALITY AND PSYCHOLOGY UTILIZING CERTIFIER'S PROGRAM FOR SPIRITUAL AND EMOTIONAL WELL-BEING (U.S. CL. B).

FIRST USE 10-1-2007; IN COMMERCE 10-1-2007.



3,399,313. WATER QUALITY ASSOCIATION, LISLE, IL. SN 78-239,917. PUB. 10-4-2005, FILED 4-21-2003.



OWNER OF U.S. REG. NOS. 1,111,990, 1,574,057, AND OTHERS.

NO CLAIM IS MADE TO THE EXCLUSIVE RIGHT TO USE "WATER QUALITY ASSOCIATION" AND "CERTIFIED SALES REPRESENTATIVE", APART FROM THE MARK AS SHOWN.

THE CERTIFICATION MARK, AS USED BY PERSONS AUTHORIZED BY THE CERTIFIER, CERTIFIES THAT THE SERVICES ARE PERFORMED BY PERSONS WHO HAVE SATISFIED THE CERTIFIER'S REQUIREMENTS RELATING TO EXPERIENCE, KNOWLEDGE, EDUCATION AND PROFESSIONAL COMPETENCE AS EVIDENCED BY SUCCESSFUL COMPLETION OF AN EXAMINATION ADMINISTERED BY THE CERTIFIER.

FOR RETAIL SERVICES BY DIRECT SOLICITATION BY SALES AGENTS IN THE FIELD OF WATER QUALITY IMPROVEMENT EQUIPMENT, AND MAIL ORDER SERVICES FEATURING WATER QUALITY IMPROVEMENT EQUIPMENT (U.S. CL. B).

FIRST USE 7-23-2003; IN COMMERCE 7-23-2003.



3,400,143. HEARTLAND INSTITUTE OF FINANCIAL EDUCATION, AURORA, CO. SN 78-960,695. PUB. 4-10-2007, FILED 8-25-2006.

CRed

THE MARK CONSISTS OF STANDARD CHARACTERS WITHOUT CLAIM TO ANY PARTICULAR FONT, STYLE, SIZE, OR COLOR.

CERTIFICATION THAT INDIVIDUALS HAVE COMPLETED A SERIES OF PROFESSIONAL EDUCATIONAL ENDEAVORS AND HAVE MET A SET OF COMPETENCY AND QUALIFICATION STANDARDS, ESTABLISHED BY THE CERTIFIER, PERTAINING TO PROVIDING RETIREMENT EDUCATION.

FOR EDUCATION SERVICES IN THE FIELD OF RETIREMENT (U.S. CL. B).

FIRST USE 11-14-2007; IN COMMERCE 11-14-2007.

* * * * *

SUPPLEMENTAL REGISTER

These registrations are not subject to opposition.

SECTION 1.— INTERNATIONAL CLASSIFICATION

The short titles associated below with the international class numbers are terms designed merely for quick identification and are not an official part of the international classification. The full names of international classes are given in section 6.1 of the trademark rules of practice.

The designation "U.S. Cl." appearing in this section refers to the U.S. class in effect prior to Sep. 1, 1973 rather than the international class which applies to applications filed on or after that date. For adoption of international classification see notice in the OFFICIAL GAZETTE of Jun. 26, 1973 (911 O.G. TM 210).

Application in more than one class

3,400,240. AMERICAN PSYCHOLOGICAL ASSOCIATION, WASHINGTON, DC. SN 76-675,981. FILED P.R. 4-25-2007; AM. S.R. 1-3-2008.

3,400,243. LWBJ WEALTH RESOURCES, LLC, WEST DES MOINES, IA. SN 77-006,318. FILED P.R. 9-25-2006; AM. S.R. 8-16-2007.

COALITION FOR PSYCHOLOGY IN SCHOOLS AND EDUCATION

PREMIER PRIVATE WEALTH

THE MARK CONSISTS OF STANDARD CHARACTERS WITHOUT CLAIM TO ANY PARTICULAR FONT, STYLE, SIZE, OR COLOR.

CLASS 9—ELECTRICAL AND SCIENTIFIC APPARATUS

FOR DOWNLOADABLE ELECTRONIC PUBLICATIONS IN THE FIELD OF PSYCHOLOGY AND THE APPLICATION OF PSYCHOLOGY TO EDUCATION (U.S. CLS. 21, 23, 26, 36 AND 38).

FIRST USE 3-0-2003; IN COMMERCE 3-0-2003.

CLASS 35—ADVERTISING AND BUSINESS

FOR PROMOTING THE PUBLIC AWARENESS FOR THE IMPORTANCE OF HIGH QUALITY APPLICATION OF PSYCHOLOGY TO PROGRAMS AND POLICIES FOR SCHOOLS AND EDUCATION (U.S. CLS. 100, 101 AND 102).

FIRST USE 12-0-2002; IN COMMERCE 12-0-2002.

CLASS 41—EDUCATION AND ENTERTAINMENT

FOR EDUCATIONAL TRAINING AND WORKSHOPS IN THE FIELD OF PSYCHOLOGY AND THE APPLICATION OF PSYCHOLOGY TO EDUCATION; EDUCATIONAL RESEARCH IN THE FIELD OF PSYCHOLOGY, AND DEVELOPMENT AND DISSEMINATION OF EDUCATIONAL MATERIALS OF OTHERS IN THE FIELD OF PSYCHOLOGY (U.S. CLS. 100, 101 AND 107).

FIRST USE 12-0-2002; IN COMMERCE 12-0-2002.

THE MARK CONSISTS OF STANDARD CHARACTERS WITHOUT CLAIM TO ANY PARTICULAR FONT, STYLE, SIZE, OR COLOR.

NO CLAIM IS MADE TO THE EXCLUSIVE RIGHT TO USE "PRIVATE WEALTH", APART FROM THE MARK AS SHOWN.

CLASS 35—ADVERTISING AND BUSINESS

FOR TAX PLANNING SERVICES; BUSINESS DEVELOPMENT SERVICES, NAMELY, PROVIDING START-UP SUPPORT FOR BUSINESSES OF OTHERS (U.S. CLS. 100, 101 AND 102).

FIRST USE 9-1-2006; IN COMMERCE 9-1-2006.

CLASS 36—INSURANCE AND FINANCIAL

FOR FINANCIAL CONSULTATION PROVIDED TO HIGH NET WORTH INDIVIDUALS, NAMELY, FINANCIAL ADMINISTRATION AND ESTATE PLANNING (U.S. CLS. 100, 101 AND 102).

FIRST USE 9-1-2006; IN COMMERCE 9-1-2006.

3,400,244. COUNTRYWIDE ASSET & AUTO RECOVERY, L.P., MARYLAND HEIGHTS, MO. SN 77-010,971. FILED P.R. 9-29-2006; AM. S.R. 1-14-2008.

3,400,256. PROMETHEUS PAYMENT, INC., BOSTON, MA. SN 77-092,331. FILED P.R. 1-26-2007; AM. S.R. 11-19-2007.

**COUNTRYWIDE ASSET & AUTO
RECOVERY**

THE MARK CONSISTS OF STANDARD CHARACTERS WITHOUT CLAIM TO ANY PARTICULAR FONT, STYLE, SIZE, OR COLOR.

NO CLAIM IS MADE TO THE EXCLUSIVE RIGHT TO USE "ASSET & AUTO RECOVERY", APART FROM THE MARK AS SHOWN.

CLASS 36—INSURANCE AND FINANCIAL

FOR DEBT RECOVERY SERVICES AND REPOSSESSION OF ASSETS, NAMELY, AUTOMOBILES AND OTHER COLLATERAL (U.S. CLS. 100, 101 AND 102).
FIRST USE 5-2-2006; IN COMMERCE 5-2-2006.

CLASS 39—TRANSPORTATION AND STORAGE

FOR TRANSPORT AND STORAGE OF ASSETS, NAMELY, AUTOMOBILES AND OTHER COLLATERAL, RECOVERED THROUGH REPOSSESSION (U.S. CLS. 100 AND 105).
FIRST USE 5-2-2006; IN COMMERCE 5-2-2006.

3,400,246. THE NEW YORK CENTER FOR CHILDREN, NEW YORK, NY. SN 77-023,040. FILED P.R. 10-17-2006; AM. S.R. 12-13-2007.

**The New York Center for
Children**

THE MARK CONSISTS OF STANDARD CHARACTERS WITHOUT CLAIM TO ANY PARTICULAR FONT, STYLE, SIZE, OR COLOR.

NO CLAIM IS MADE TO THE EXCLUSIVE RIGHT TO USE "CENTER FOR CHILDREN", APART FROM THE MARK AS SHOWN.

CLASS 44—MEDICAL, BEAUTY AND AGRICULTURAL SERVICES

FOR MEDICAL SERVICES, NAMELY, EVALUATION AND TREATMENT SERVICES FOR ABUSED CHILDREN (U.S. CLS. 100 AND 101).
FIRST USE 1-0-2007; IN COMMERCE 1-0-2007.

CLASS 45—PERSONAL AND LEGAL SERVICES

FOR SOCIAL SERVICES, NAMELY, EVALUATION AND TREATMENT SERVICES FOR ABUSED CHILDREN (U.S. CLS. 100 AND 101).
FIRST USE 1-0-2007; IN COMMERCE 1-0-2007.

**EVIDENCE-INFORMED CASE
RATES**

THE MARK CONSISTS OF STANDARD CHARACTERS WITHOUT CLAIM TO ANY PARTICULAR FONT, STYLE, SIZE, OR COLOR.

CLASS 35—ADVERTISING AND BUSINESS

FOR PROMOTING PUBLIC AWARENESS OF THE NEED FOR IMPROVED HEALTH CARE BILLING, REIMBURSEMENT, AND PAYMENT MODELS AND FOR IMPROVED HEALTH CARE QUALITY AND EFFICIENCY; PROVIDING ONLINE INFORMATION IN THE FIELD OF HEALTH CARE BILLING; QUALITY IMPROVEMENT SERVICES IN THE FIELD OF HEALTH CARE PAYMENT, NAMELY, BUSINESS CONSULTATION IN THE FIELD OF BILLING AND PROVIDER REIMBURSEMENT; CONSULTING SERVICES IN THE COST AND PAYMENT MANAGEMENT OF HEALTH CARE; CONDUCTING INCENTIVE AWARD PROGRAMS TO PROMOTE THE QUALITY AND EFFICIENCY OF HEALTH CARE PROVIDERS; PROVIDING CONSUMER INFORMATION IN THE FIELD OF RATING OF THE QUALITY AND EFFICIENCY OF HEALTH CARE PROVIDERS (U.S. CLS. 100, 101 AND 102).
FIRST USE 11-30-2006; IN COMMERCE 11-30-2006.

CLASS 36—INSURANCE AND FINANCIAL

FOR PROVIDING ONLINE INFORMATION IN THE FIELD OF INSURANCE CLAIMS PAYMENT TO HEALTH CARE PROVIDERS (U.S. CLS. 100, 101 AND 102).

FIRST USE 11-30-2006; IN COMMERCE 11-30-2006.

3,400,260. THE CHAMBER OF COMMERCE OF THE UNITED STATES OF AMERICA, WASHINGTON, DC. SN 77-104,975. FILED P.R. 2-12-2007; AM. S.R. 12-3-2007.

LEGALNEWSLINE.COM

THE MARK CONSISTS OF STANDARD CHARACTERS WITHOUT CLAIM TO ANY PARTICULAR FONT, STYLE, SIZE, OR COLOR.

CLASS 41—EDUCATION AND ENTERTAINMENT

FOR NEWS AGENCIES, NAMELY, GATHERING AND DISSEMINATION OF NEWS; NEWS ANALYSIS AND FEATURES DISTRIBUTION; NEWS REPORTING SERVICES; NEWS SYNDICATION FOR THE BROADCASTING INDUSTRY; NEWS SYNDICATION REPORTING; PROVIDING NEWS IN THE NATURE OF CURRENT EVENT REPORTING; NEWS AGENCY SERVICES, NAMELY, THE GATHERING AND DISSEMINATION OF NEWS CONCERNING LEGAL REFORM ISSUES (U.S. CLS. 100, 101 AND 107).

FIRST USE 11-15-2006; IN COMMERCE 11-15-2006.

CLASS 42—SCIENTIFIC AND COMPUTER SERVICES

FOR PROVIDING ONLINE INFORMATION IN THE FIELD OF LEGAL REFORM ISSUES (U.S. CLS. 100 AND 101).

FIRST USE 11-15-2006; IN COMMERCE 11-15-2006.

3,400,265. CERES, INC., THOUSAND OAKS, CA. SN 77-108,216. FILED P.R. 2-15-2007; AM. S.R. 11-13-2007.

THE ENERGY CROP COMPANY

THE MARK CONSISTS OF STANDARD CHARACTERS WITHOUT CLAIM TO ANY PARTICULAR FONT, STYLE, SIZE, OR COLOR.

NO CLAIM IS MADE TO THE EXCLUSIVE RIGHT TO USE "COMPANY", APART FROM THE MARK AS SHOWN.

CLASS 31—NATURAL AGRICULTURAL PRODUCTS

FOR AGRICULTURAL SEEDS (U.S. CLS. 1 AND 46).
FIRST USE 10-29-2007; IN COMMERCE 10-29-2007.

CLASS 42—SCIENTIFIC AND COMPUTER SERVICES

FOR PROVIDING INFORMATION IN THE FIELD OF BIOFUEL RESEARCH; SCIENTIFIC RESEARCH SERVICES IN THE FIELD OF BIOFUELS (U.S. CLS. 100 AND 101).

FIRST USE 3-21-2007; IN COMMERCE 3-21-2007.
3,400,270. RYAN, DENNIS, CLIFTON PARK, NY. SN 77-114,846. FILED P.R. 2-23-2007; AM. S.R. 1-2-2008.

ADIRONDACK RADIO

THE MARK CONSISTS OF STANDARD CHARACTERS WITHOUT CLAIM TO ANY PARTICULAR FONT, STYLE, SIZE, OR COLOR.

CLASS 38—COMMUNICATION

FOR RADIO BROADCAST SERVICES, NAMELY, THE TRANSMISSION OF LIVE AND PRERECORDED AUDIO PROGRAMS OVER THE INTERNET (U.S. CLS. 100, 101 AND 104).

FIRST USE 11-28-2007; IN COMMERCE 11-28-2007.

CLASS 41—EDUCATION AND ENTERTAINMENT

FOR SPECIAL EVENT PLANNING; SPECIAL EVENT PLANNING CONSULTATION; EDUCATIONAL SERVICES, NAMELY, PRESENTATIONS AND SEMINARS IN THE FIELD OF ADVERTISING AND PUBLIC RELATIONS (U.S. CLS. 100, 101 AND 107).

FIRST USE 8-10-2007; IN COMMERCE 8-10-2007.

3,400,271. PROFESSIONAL DIAGNOSTICS & SAFETY, INC., NAPPANEE, IN. SN 77-115,815. FILED P.R. 2-26-2007; AM. S.R. 12-19-2007.

PROFESSIONAL DIAGNOSTICS & SAFETY

THE MARK CONSISTS OF STANDARD CHARACTERS WITHOUT CLAIM TO ANY PARTICULAR FONT, STYLE, SIZE, OR COLOR.

CLASS 41—EDUCATION AND ENTERTAINMENT

FOR PROMOTING A SAFE, SECURE, AND DRUG FREE WORK PLACE, NAMELY, PROVIDING TRAINING ON SAFETY IN THE WORKPLACE (U.S. CLS. 100, 101 AND 107).

FIRST USE 8-1-2006; IN COMMERCE 8-14-2006.

CLASS 44—MEDICAL, BEAUTY AND AGRICULTURAL SERVICES

FOR MEDICAL SERVICES THAT PROMOTE A SAFE, SECURE AND DRUG FREE WORK PLACE, NAMELY, PRE AND POST EMPLOYMENT DRUG SCREENING (U.S. CLS. 100 AND 101).

FIRST USE 8-1-2006; IN COMMERCE 8-14-2006.

CLASS 45—PERSONAL AND LEGAL SERVICES

FOR PROMOTING A SAFE, SECURE AND DRUG FREE WORK PLACE, NAMELY, PRE-EMPLOYMENT BACKGROUND SCREENING (U.S. CLS. 100 AND 101).

FIRST USE 8-1-2006; IN COMMERCE 8-14-2006.

3,400,274. PROBATE UNCOVERED, INC., PINELLAS PARK, FL. SN 77-121,796. FILED P.R. 3-4-2007; AM. S.R. 12-17-2007.

3,400,279. LONDON LUXURY LLC, NEW ROCHELLE, NY. SN 77-124,470. FILED P.R. 3-7-2007; AM. S.R. 12-18-2007.

Probate Liquidators

THE MARK CONSISTS OF STANDARD CHARACTERS WITHOUT CLAIM TO ANY PARTICULAR FONT, STYLE, SIZE, OR COLOR.

CLASS 35—ADVERTISING AND BUSINESS

FOR MATCHING CONSUMERS WITH REAL ESTATE PROFESSIONALS IN THE FIELD OF REAL ESTATE SERVICES VIA COMPUTER NETWORK; PROMOTING THE GOODS OF OTHERS BY MEANS OF ON-LINE REAL TIME PRESENTATION FOR INSPECTION, VIEWING OR SHOWING OF PROBATED PROPERTY; PROVIDING INTERACTIVE SALES ASSESSMENT SERVICES VIA THE TELEPHONE FOR MEASURING THE SKILLS AND KNOWLEDGE OF FIELD SALES FORCES IN REAL WORLD SELLING SITUATIONS; REAL ESTATE ADVERTISING SERVICES; REAL ESTATE AUCTIONS; REAL ESTATE MARKETING SERVICES IN THE FIELD OF PROBATE; REAL ESTATE MARKETING SERVICES, NAMELY, ON-LINE SERVICES FEATURING TOURS OF RESIDENTIAL AND COMMERCIAL REAL ESTATE; REAL ESTATE SALES MANAGEMENT (U.S. CLS. 100, 101 AND 102).

FIRST USE 12-31-2001; IN COMMERCE 12-31-2001.

CLASS 36—INSURANCE AND FINANCIAL

FOR ASSESSMENT AND MANAGEMENT OF REAL ESTATE; ESTATE PLANNING; ESTATE TRUST MANAGEMENT; EVALUATION OF REAL PROPERTY; FINANCIAL INVESTMENT IN THE FIELD OF PROBATE LIQUIDATION SERVICES; FINANCIAL SERVICES, NAMELY, ESTATE SETTLEMENT SERVICES; FINANCIAL VALUATION OF PERSONAL PROPERTY AND REAL ESTATE; HOUSING SERVICES, NAMELY, REAL PROPERTY ACQUISITION AND CONSUMER FINANCING TO FACILITATE HOME OWNERSHIP; LAND ACQUISITION, NAMELY, REAL ESTATE BROKERAGE; LEASING OF REAL ESTATE; LEASING OF REAL PROPERTY; PROVIDING INFORMATION IN THE FIELD OF REAL ESTATE BY MEANS OF LINKING THE WEB SITE TO OTHER WEB SITES FEATURING REAL ESTATE INFORMATION; PROVIDING INFORMATION IN THE FIELD OF REAL ESTATE VIA THE INTERNET; PROVIDING ONLINE INFORMATION IN THE FIELD CHARITABLE MONETARY GIVING THROUGH FINANCIAL AND ESTATE PLANNING; PROVIDING REAL ESTATE LISTINGS AND REAL ESTATE INFORMATION VIA THE INTERNET; REAL ESTATE ACQUISITION SERVICES; REAL ESTATE CONSULTANCY; REAL ESTATE CONSULTATION; REAL ESTATE EQUITY SHARING, NAMELY, MANAGING AND ARRANGING FOR CO-OWNERSHIP OF REAL ESTATE; REAL ESTATE INVESTMENT; REAL ESTATE LISTING; REAL ESTATE MANAGEMENT; REAL ESTATE MANAGEMENT CONSULTATION; REAL ESTATE PROCUREMENT FOR OTHERS; REAL ESTATE SERVICES, NAMELY, RENTAL OF VACATION HOMES, CONDOMINIUMS, CABINS, AND VILLAS USING PAY PER CLICK ADVERTISING ON A GLOBAL COMPUTER NETWORK; REAL ESTATE SYNDICATION; REAL ESTATE TRUSTEE SERVICES; REAL ESTATE VALUATION SERVICES; REAL ESTATE VALUATIONS (U.S. CLS. 100, 101 AND 102).

FIRST USE 12-31-2001; IN COMMERCE 12-31-2001.

PURE ORGANIC

THE MARK CONSISTS OF STANDARD CHARACTERS WITHOUT CLAIM TO ANY PARTICULAR FONT, STYLE, SIZE, OR COLOR.

CLASS 20—FURNITURE AND ARTICLES NOT OTHERWISE CLASSIFIED

FOR FILLED PILLOWS (U.S. CLS. 2, 13, 22, 25, 32 AND 50).

FIRST USE 2-0-2006; IN COMMERCE 2-0-2006.

CLASS 24—FABRICS

FOR BEDDING, NAMELY, PILLOW PROTECTORS IN THE NATURE OF PILLOW COVERS, MATTRESS PROTECTORS IN THE NATURE OF MATTRESS COVERS, COMFORTERS, COMFORTER COVERS, BED SHEETS, SHEET COVERS, DUVET COVERS AND MATTRESS PADS; TOWELS AND SHOWER CURTAINS (U.S. CLS. 42 AND 50).

FIRST USE 2-0-2006; IN COMMERCE 2-0-2006.

CLASS 25—CLOTHING

FOR BATH ROBES (U.S. CLS. 22 AND 39).

FIRST USE 2-0-2006; IN COMMERCE 2-0-2006.

CLASS 27—FLOOR COVERINGS

FOR BATH MATS AND BATH RUGS (U.S. CLS. 19, 20, 37, 42 AND 50).

FIRST USE 2-0-2006; IN COMMERCE 2-0-2006.

3,400,299. BOLCH, LLC, ATLANTA, GA. SN 77-140,058. FILED P.R. 3-26-2007; AM. S.R. 1-9-2008.

BOLCH

THE MARK CONSISTS OF STANDARD CHARACTERS WITHOUT CLAIM TO ANY PARTICULAR FONT, STYLE, SIZE, OR COLOR.

CLASS 36—INSURANCE AND FINANCIAL

FOR REAL ESTATE BROKERAGE (U.S. CLS. 100, 101 AND 102).

FIRST USE 11-1-2006; IN COMMERCE 11-1-2006.

CLASS 37—CONSTRUCTION AND REPAIR

FOR REAL ESTATE DEVELOPMENT (U.S. CLS. 100, 103 AND 106).
FIRST USE 11-1-2006; IN COMMERCE 11-1-2006.

3,400,326. NORTHSTAR TRAVEL MEDIA, LLC, SECAUCUS, NJ. SN 77-188,709. FILED P.R. 5-23-2007; AM. S.R. 12-27-2007.

ULTIMATE HOTEL GUIDE

THE MARK CONSISTS OF STANDARD CHARACTERS WITHOUT CLAIM TO ANY PARTICULAR FONT, STYLE, SIZE, OR COLOR.

CLASS 16—PAPER GOODS AND PRINTED MATTER

FOR MAGAZINES FEATURING TRAVEL AND INFORMATION CONCERNING HOTELS, CRUISES, TOUR OPERATORS, AIRLINES AND PRIVATE JETS (U.S. CLS. 2, 5, 22, 23, 29, 37, 38 AND 50).
FIRST USE 12-10-2007; IN COMMERCE 12-10-2007.

CLASS 41—EDUCATION AND ENTERTAINMENT

FOR ON-LINE PUBLICATION OF MAGAZINES FEATURING TRAVEL AND INFORMATION CONCERNING HOTELS, CRUISES, TOUR OPERATORS, AIRLINES AND PRIVATE JETS (U.S. CLS. 100, 101 AND 107).
FIRST USE 12-10-2007; IN COMMERCE 12-10-2007.

3,400,338. MOTORCYCLE USA, LLC, MEDFORD, OR. SN 77-231,973. FILED P.R. 7-17-2007; AM. S.R. 1-9-2008.

MOTORCYCLE USA

THE MARK CONSISTS OF STANDARD CHARACTERS WITHOUT CLAIM TO ANY PARTICULAR FONT, STYLE, SIZE, OR COLOR.

OWNER OF U.S. REG. NO. 2,794,846.

CLASS 38—COMMUNICATION

FOR PROVIDING ON-LINE FORUMS FOR TRANSMISSION OF MESSAGES AMONG COMPUTER USERS CONCERNING THE SUBJECT OF MOTORCYCLES (U.S. CLS. 100, 101 AND 104).
FIRST USE 9-1-1997; IN COMMERCE 9-1-1997.

CLASS 41—EDUCATION AND ENTERTAINMENT

FOR ENTERTAINMENT SERVICES, NAMELY, PROVIDING ON-LINE INFORMATION AND NEWS, GUIDES FOR DAY RIDES, TRAIL AND RACE TRACKS AND ELECTRONIC GAME SERVICES, ALL CONCERNING THE SUBJECT OF MOTORCYCLES IN THE NATURE OF MOTORCYCLING LIFESTYLES AND EVENTS (U.S. CLS. 100, 101 AND 107).

FIRST USE 9-1-1997; IN COMMERCE 9-1-1997.

3,400,354. RESORTS INTERNATIONAL HOLDINGS, LLC, NEW YORK, NY. SN 77-273,017. FILED P.R. 9-6-2007; AM. S.R. 1-11-2008.

ONE BUCK BUFFET

THE MARK CONSISTS OF STANDARD CHARACTERS WITHOUT CLAIM TO ANY PARTICULAR FONT, STYLE, SIZE, OR COLOR.

NO CLAIM IS MADE TO THE EXCLUSIVE RIGHT TO USE "BUFFET", APART FROM THE MARK AS SHOWN.

CLASS 35—ADVERTISING AND BUSINESS

FOR CUSTOMER LOYALTY PROGRAM, NAMELY A PROGRAM TO AWARD DINING DISCOUNTS TO PATRONS AND CUSTOMERS (U.S. CLS. 100, 101 AND 102).
FIRST USE 8-17-2007; IN COMMERCE 8-17-2007.

CLASS 43—HOTEL AND RESTAURANT SERVICES

FOR RESTAURANT AND HOTEL SERVICES (U.S. CLS. 100 AND 101).
FIRST USE 8-17-2007; IN COMMERCE 8-17-2007.

3,400,370. INDIANA NANOTECH, LLC, INDIANAPOLIS, IN. SN 77-975,097. FILED P.R. 3-8-2007; AM. S.R. 1-2-2008.

INDIANA NANOTECH

THE MARK CONSISTS OF STANDARD CHARACTERS WITHOUT CLAIM TO ANY PARTICULAR FONT, STYLE, SIZE, OR COLOR.

NO CLAIM IS MADE TO THE EXCLUSIVE RIGHT TO USE "NANOTECH", APART FROM THE MARK AS SHOWN.

CLASS 1—CHEMICALS

FOR CHEMICAL ADDITIVES FOR USE IN THE MANUFACTURE OF A WIDE VARIETY OF GOODS; CHEMICAL ADDITIVES FOR USE IN THE MANUFACTURE OF PHARMACEUTICALS, COSMETICS, FOOD, VITAMINS; CHEMICAL ADDITIVES FOR USE AS CLEANSING, DEODORIZING AND REFRESHING INGREDIENTS IN THE MANUFACTURE OF MOUTH SPRAYS, DENTAL CEMENTS AND MEDICINES FOR DENTAL PURPOSES; OXIDES; SYNTHETIC AND NATURAL OXIDES IN THE FORM OF POWDERS, LIQUIDS, PASTES AND GRANULES; SPECIALTY CHEMICALS, NAMELY, CHEMICAL ADDITIVES FOR GENERAL INDUSTRIAL USE IN THE MANUFACTURE OF A WIDE VARIETY OF GOODS (U.S. CLS. 1, 5, 6, 10, 26 AND 46).

FIRST USE 11-30-2007; IN COMMERCE 11-30-2007.

CLASS 10—MEDICAL APPARATUS

FOR COATINGS SOLD AS AN INTEGRAL COMPONENT OF MEDICAL STENTS AND OTHER IMPLANTABLE MEDICAL DEVICES (U.S. CLS. 26, 39 AND 44).

FIRST USE 11-30-2007; IN COMMERCE 11-30-2007.

3,400,382. CLUB MILANOMANHATTAN, MILAN, ITALY.
SN 78-756,442. FILED P.R. 11-17-2005; AM. S.R. 2-11-2008.



The logo for Milano Manhattan, featuring the word "Milano" in a stylized, lowercase font above the word "Manhattan" in a similar style.

PRIORITY CLAIMED UNDER SEC. 44(D) ON ERPN CMNTY TM OFC APPLICATION NO. 4713509, FILED 10-27-2005, REG. NO. 004713509, DATED 11-14-2006, EXPIRES 10-27-2015.

CLASS 37—CONSTRUCTION AND REPAIR

FOR VEHICLE REPAIR, NAMELY, VEHICLES MAINTENANCE AND REPAIR; AIRPLANES MAINTENANCE AND REPAIR; AIRPLANES CLEANING AND WASHING; CLEANING OF INTERIOR SURFACES OF BUILDINGS; LAUNDERING; PROVIDING INFORMATION WITH RELATION TO AIRCRAFT CONSTRUCTION, REPAIR AND MAINTENANCE; BUILDING CONSTRUCTION SUPERVISION; CLEANING OF EXTERIOR SURFACES OF BUILDINGS; WAREHOUSE CONSTRUCTION AND REPAIR; MAINTENANCE, REPAIR AND CLEANING OF LINEN; INSTALLATION, MAINTENANCE AND REPAIR OF COMPUTER HARDWARE; CONSTRUCTION OF AIRPORTS; CLEANING OF CLOTHING; MAINTENANCE, REPAIR AND CLEANING OF EARTHWARE (U.S. CLS. 100, 103 AND 106).

CLASS 39—TRANSPORTATION AND STORAGE

FOR TRANSPORT OF GOODS; PACKAGING AND STORAGE OF GOODS; TRANSPORTATION OF ANIMALS BY AIR; ARRANGING OF TRAVEL TOURS; TOUR ESCORTING OF TRAVELLERS; AIR TRANSPORT; AERONAUTICAL TRANSPORT; FREIGHT TRANSPORTATION BY AIRPLANE, BOAT, TRUCK AND TRAIN; TOURIST OFFICES, NAMELY, TOURIST AGENCY SERVICES, EXCLUDING HOTEL AND BOARDING HOUSES RESERVATIONS; VEHICLE TOWING; BUS TRANSPORT; CAR TRANSPORT; CAR RENTAL CHAUFFEUR SERVICES; PARCEL DELIVERY; PACKING OF GOODS FOR TRANSPORTATION; RENTAL OF STORAGE CONTAINERS; MESSAGE DELIVERY; FREIGHT-BROKERAGE; TRANSPORT-BROKERAGE; STORAGE OF FOOD STUFFS; DELIVERY OF NEWSPAPERS; DELIVERY OF GOODS AND WARES BY AIR; WRAPPING OF GOODS, NAMELY, WRAPPING SERVICES FOR BAGGAGE PROTECTION DURING TRAVEL; WAREHOUSING INFORMATION; RENTAL OF WAREHOUSE SPACE; ORGANIZATION OF EXCURSIONS; FREIGHT FORWARDING; FREIGHT, NAMELY, FREIGHT AIR TRANSPORT; GARAGE SPACE RENTAL; TRANSPORTATION INFORMATION, NAMELY, TRAVEL AND TOUR INFORMATION SERVICE; PROVIDING INFORMATION ABOUT TRANSPORTATION OF GOODS AND ANIMALS; RENTAL OF WHEELCHAIRS; PARKING SPACE RENTAL; RENTAL OF VEHICLES; COURIER SERVICES; CAR PARKING; PASSENGER TRANSPORT; PILOTING, NAMELY, AIRPLANE PILOTING; BOOKING OF SEATS FOR TRAVEL; SALVAGING, NAMELY, AIRCRAFT SALVAGE; RESCUE OPERATIONS, NAMELY, AMBULANCE TRANSPORT BY AIR; TAXI TRANSPORT; SIGHTSEEING, NAMELY, CONDUCTING SIGHTSEEING TOURS FOR OTHERS; FREIGHT FORWARDING; TRANSPORT RESERVATION, NAMELY, TRANSPORTATION RESERVATION SERVICES; TRANSPORTATION RESERVATION SERVICES FOR GOODS AND ANIMALS; ARMORED-CAR TRANSPORT; AIRPORT BAGGAGE CHECK-IN SERVICES; AIRPORT GOODS CHECK-IN SERVICES; AIRPORT PASSENGER CHECK-IN SERVICES; LOADING AND UNLOADING OF GOODS INTO AND FROM AIRPLANES; LOANING AND RENTAL OF AIRPLANES; PLACING OF AIRPLANES AT DISPOSAL, NAMELY, TOWING AND PARKING OF AIRPLANES (U.S. CLS. 100 AND 105).

CLASS 43—HOTEL AND RESTAURANT SERVICES

FOR RESTAURANTS; BAR SERVICES; BAR-RESTAURANTS SERVICES; CAFES; PROVIDING TEMPORARY ACCOMMODATION; CANTEN SERVICES; RENTAL OF TRANSPORTABLE BUILDINGS; CHILDREN'S CRECHES; HOTELS; RESERVATION OF HOTEL ROOMS FOR TRAVELLERS; SELF-SERVICE RESTAURANTS; RENTAL OF FOOD SERVICE AND BAR EQUIPMENT IN THE NATURE OF CHAIRS, TABLES, TABLE LINEN, GLASSWARE; RENTAL OF TEMPORARY ACCOMMODATION; RENTAL OF MEETING ROOMS; RENTAL OF TENTS; ACCOMMODATIONS, NAMELY, HOTELS AND BOARDING HOUSES; RESERVATION OF TEMPORARY ACCOMMODATION FOR TRAVELLERS; TOURIST HOMES; FAST-FOOD RESTAURANTS AND SNACK-BARS; MEALS, NAMELY, MAKING RESERVATIONS AND BOOKINGS FOR MEALS; PROVIDING IN-FLIGHT MEAL SERVICES IN AN AIRPLANE AND IN AIRPORTS; PROVIDING OF TEMPORARY ACCOMMODATION IN AIRPLANES AND IN AIRPORTS; PROVIDING FACILITIES FOR EXHIBITIONS; CATERING OF FOOD AND DRINK (U.S. CLS. 100 AND 101).

3,400,388. VOIP, INC., FORT LAUDERDALE, FL. SN 78-801,958. FILED P.R. 1-30-2006; AM. S.R. 7-11-2007.

3,400,390. NATIONAL BLACK MBA ASSOCIATION, INC., CHICAGO, IL. SN 78-829,443. FILED P.R. 3-5-2006; AM. S.R. 1-2-2007.

CARRIER DIRECT

THE MARK CONSISTS OF STANDARD CHARACTERS WITHOUT CLAIM TO ANY PARTICULAR FONT, STYLE, SIZE, OR COLOR.

NO CLAIM IS MADE TO THE EXCLUSIVE RIGHT TO USE "CARRIER", APART FROM THE MARK AS SHOWN.

CLASS 35—ADVERTISING AND BUSINESS

FOR ADMINISTRATION, BILLING AND RECONCILIATION OF ACCOUNTS ON BEHALF OF OTHERS (U.S. CLS. 100, 101 AND 102).

FIRST USE 8-31-2005; IN COMMERCE 8-31-2005.

CLASS 38—COMMUNICATION

FOR COMMUNICATIONS VIA FIBER-OPTIC NETWORKS, WIRELESS BROADBAND COMMUNICATION SERVICES, TELECOMMUNICATIONS GATEWAY SERVICES, ELECTRONIC VOICE MESSAGING, NAMELY, THE RECORDING AND SUBSEQUENT TRANSMISSION OF VOICE MESSAGES BY TELEPHONE, PROVIDING THIRD PARTY USERS WITH ACCESS TO TELECOMMUNICATION INFRASTRUCTURE IN THE NATURE OF PROVIDING ACCESS TO TOOLS THAT AUTOMATICALLY PROVISION NEW ACCOUNTS, DIRECT INWARD DIALING, AND 800 SERVICES, PROVIDING THE AFORESAID TELECOMMUNICATIONS SERVICES FOR IP ENABLING FACILITIES-BASED CARRIERS (U.S. CLS. 100, 101 AND 104).

FIRST USE 8-31-2005; IN COMMERCE 8-31-2005.

CLASS 42—SCIENTIFIC AND COMPUTER SERVICES

FOR TELECOMMUNICATIONS TECHNICAL SUPPORT SERVICES, NAMELY, DIAGNOSTICS IN THE NATURE OF TROUBLESHOOTING OF COMPUTER HARDWARE AND SOFTWARE PROBLEMS IN THE FIELD OF TELECOMMUNICATIONS, COMPUTER MONITORING SERVICE WHICH TRACKS TELECOMMUNICATIONS HARDWARE PERFORMANCE AND PROCESSES AND SENDS OUT HISTORICAL REPORTS AND ALERTS, COMPUTER DISASTER RECOVERY PLANNING, TECHNICAL SUPPORT, NAMELY, REAL-TIME MONITORING OF NETWORK SYSTEMS, COMPUTER PROGRAMMING FOR OTHERS, NAMELY, PROVIDING EXTENSIBLE MARKUP LANGUAGE BASED PROVISIONING AND MANAGEMENT IN THE TELECOMMUNICATIONS FIELD (U.S. CLS. 100 AND 101).

FIRST USE 8-31-2005; IN COMMERCE 8-31-2005.

NATIONAL BLACK MBA FOUNDATION

THE MARK CONSISTS OF STANDARD CHARACTERS WITHOUT CLAIM TO ANY PARTICULAR FONT, STYLE, SIZE, OR COLOR.

OWNER OF U.S. REG. NOS. 2,701,696 AND 2,828,815.

NO CLAIM IS MADE TO THE EXCLUSIVE RIGHT TO USE "FOUNDATION", APART FROM THE MARK AS SHOWN.

CLASS 36—INSURANCE AND FINANCIAL

FOR CHARITABLE FUND RAISING DEDICATED TO PROMOTING EDUCATION IN THE AFRICAN-AMERICAN COMMUNITY (U.S. CLS. 100, 101 AND 102).

FIRST USE 8-17-2005; IN COMMERCE 8-17-2005.

CLASS 41—EDUCATION AND ENTERTAINMENT

FOR EDUCATIONAL SERVICES, NAMELY, DEVELOPING, ARRANGING, AND CONDUCTING EDUCATIONAL CONFERENCES AND PROGRAMS AND PROVIDING COURSES OF INSTRUCTION IN THE FIELD OF PROMOTING ECONOMIC WEALTH IN THE AFRICAN-AMERICAN COMMUNITY; EDUCATIONAL SERVICES, NAMELY, CONDUCTING PROGRAMS, WORKSHOPS, SEMINARS FOCUSED ON INCREASING THE NUMBER OF AFRICAN AMERICANS IN BUSINESS EDUCATIONAL PROGRAMS THROUGHOUT THE WORLD; AND EDUCATIONAL SERVICES, NAMELY, CONDUCTING EDUCATIONAL PROGRAMS FOCUSED ON ENCOURAGING AND SUPPORTING YOUNG AFRICAN-AMERICANS INTERESTED IN PURSUING CAREERS IN MANAGEMENT (U.S. CLS. 100, 101 AND 107).

FIRST USE 8-17-2005; IN COMMERCE 8-17-2005.

3,400,400. INTELLISIST, INC., BELLEVUE, WA. SN 78-906,317. FILED P.R. 6-12-2006; AM. S.R. 12-24-2007.

SPOKEN COMMUNICATIONS

THE MARK CONSISTS OF STANDARD CHARACTERS WITHOUT CLAIM TO ANY PARTICULAR FONT, STYLE, SIZE, OR COLOR.

CLASS 9—ELECTRICAL AND SCIENTIFIC APPARATUS

FOR COMPUTER HARDWARE AND SOFTWARE, NAMELY, AUTOMATED AND HUMAN-GUIDED VOICE, TEXT MESSAGING, AND COMMUNICATIONS HARDWARE AND SOFTWARE FOR USE IN OPERATING AUTOMATED TELEPHONE CALL CENTERS (U.S. CLS. 21, 23, 26, 36 AND 38).

FIRST USE 3-5-2006; IN COMMERCE 3-5-2006.

CLASS 42—SCIENTIFIC AND COMPUTER SERVICES

FOR INFORMATION TECHNOLOGY ENGINEERING, CONSULTING, AND DEVELOPMENT FOR OTHERS OF AUTOMATED TELEPHONE CALL CENTERS (U.S. CLS. 100 AND 101).
FIRST USE 3-5-2006; IN COMMERCE 3-5-2006.



3,400,409. TKL MEDIA, LLC, DBA MEDIA IMAGERY, PENNSAUKEN, NJ. SN 78-968,618. FILED P.R. 9-6-2006; AM. S.R. 12-17-2007.

MEDIA IMAGERY

THE MARK CONSISTS OF STANDARD CHARACTERS WITHOUT CLAIM TO ANY PARTICULAR FONT, STYLE, SIZE, OR COLOR.
NO CLAIM IS MADE TO THE EXCLUSIVE RIGHT TO USE "MEDIA", APART FROM THE MARK AS SHOWN.

CLASS 35—ADVERTISING AND BUSINESS

FOR CREATING AND UPDATING ADVERTISING MATERIAL; PREPARING AND PLACING OF ADVERTISEMENTS, INCLUDING OUTDOOR ADVERTISEMENTS SUCH AS BILLBOARDS, FOR OTHERS; ADVERTISING AND PUBLICITY SERVICES; DIRECT MAIL ADVERTISING; AND ADVERTISING SERVICES, NAMELY, DEVELOPMENT OF ADVERTISING CAMPAIGNS FOR PRINT MEDIA (U.S. CLS. 100, 101 AND 102).
FIRST USE 10-17-2002; IN COMMERCE 11-6-2002.

CLASS 41—EDUCATION AND ENTERTAINMENT

FOR FILM EDITING; EDITING AND RECORDING OF SOUNDS AND VIDEO IMAGES; MOTION PICTURE FILM PRODUCTION; TELEVISION PRODUCTION; RADIO ENTERTAINMENT PRODUCTION; PRODUCTION OF CABLE TELEVISION PROGRAMS; PRODUCTION OF VIDEO AND CREATION OF VISUAL EFFECTS FOR OTHERS FOR USE IN DIGITAL VIDEO DISCS, TELEVISION PROGRAMS AND ON WEBSITES; PRODUCTION OF VIDEO DISCS FOR OTHERS; AND PHOTOGRAPHY SERVICES (U.S. CLS. 100, 101 AND 107).
FIRST USE 10-17-2002; IN COMMERCE 11-6-2002.

CLASS 42—SCIENTIFIC AND COMPUTER SERVICES

FOR DESIGNING WEBSITES FOR ADVERTISING PURPOSES (U.S. CLS. 100 AND 101).
FIRST USE 10-17-2002; IN COMMERCE 11-6-2002.

* * * * *

SECTION 2.— INTERNATIONAL CLASSIFICATION

The short titles associated below with the international class numbers are terms designed merely for quick identification and are not an official part of the international classification. The full names of international classes are given in section 6.1 of the trademark rules of practice.

The designation "U.S. Cl." appearing in this section refers to the U.S. class in effect prior to Sep. 1, 1973 rather than the international class which applies to applications filed on or after that date. For adoption of international classification see notice in the OFFICIAL GAZETTE of Jun. 26, 1973 (911 O.G. TM 210).

Application in one class

CLASS 1—CHEMICALS

3,400,379. BIOBASED CHEMICALS, LLC, FAYETTEVILLE, AR. SN 78-751,855. FILED P.R. 11-11-2005; AM. S.R. 6-27-2007.

BIOBASED TECHNOLOGIES

THE MARK CONSISTS OF STANDARD CHARACTERS WITHOUT CLAIM TO ANY PARTICULAR FONT, STYLE, SIZE, OR COLOR.

OWNER OF U.S. REG. NO. 3,220,894.

NO CLAIM IS MADE TO THE EXCLUSIVE RIGHT TO USE "TECHNOLOGIES", APART FROM THE MARK AS SHOWN.

FOR AGRICULTURALLY BASED POLYOLS FOR USE IN THE PRODUCTION OF POLYURETHANE (U.S. CLS. 1, 5, 6, 10, 26 AND 46).

FIRST USE 10-15-2005; IN COMMERCE 10-15-2005.

CLASS 3—(Continued).

3,400,312. HOUSE OF CHEATHAM, INC., STONE MOUNTAIN, GA. SN 77-150,664. FILED P.R. 4-6-2007; AM. S.R. 1-11-2008.

ULTIMATE ORGANICS

THE MARK CONSISTS OF STANDARD CHARACTERS WITHOUT CLAIM TO ANY PARTICULAR FONT, STYLE, SIZE, OR COLOR.

OWNER OF U.S. REG. NOS. 2,606,209 AND 2,708,162.

NO CLAIM IS MADE TO THE EXCLUSIVE RIGHT TO USE "ORGANICS", APART FROM THE MARK AS SHOWN. FOR BODY LOTION; BODY OIL; BODY CREAM (U.S. CLS. 1, 4, 6, 50, 51 AND 52).

FIRST USE 8-1-2004; IN COMMERCE 8-1-2004.

CLASS 3—COSMETICS AND CLEANING PREPARATIONS

3,400,286. SMITHKLINE BEECHAM CORPORATION, PHILADELPHIA, PA. SN 77-130,866. FILED P.R. 3-14-2007; AM. S.R. 12-19-2007.

WHITE TRAYS

THE MARK CONSISTS OF STANDARD CHARACTERS WITHOUT CLAIM TO ANY PARTICULAR FONT, STYLE, SIZE, OR COLOR.

FOR TOOTH WHITENING PREPARATIONS AND ACCELERATORS (U.S. CLS. 1, 4, 6, 50, 51 AND 52).

FIRST USE 1-19-2007; IN COMMERCE 1-19-2007.

3,400,313. HOUSE OF CHEATHAM, INC., STONE MOUNTAIN, GA. SN 77-150,672. FILED P.R. 4-6-2007; AM. S.R. 1-11-2008.

MEN'S ORGANICS

THE MARK CONSISTS OF STANDARD CHARACTERS WITHOUT CLAIM TO ANY PARTICULAR FONT, STYLE, SIZE, OR COLOR.

OWNER OF U.S. REG. NOS. 2,606,209 AND 2,708,162.

NO CLAIM IS MADE TO THE EXCLUSIVE RIGHT TO USE "ORGANICS", APART FROM THE MARK AS SHOWN. FOR HAIR CARE PREPARATIONS (U.S. CLS. 1, 4, 6, 50, 51 AND 52).

FIRST USE 8-1-2006; IN COMMERCE 8-1-2006.

CLASS 3—(Continued).

3,400,335. GARCEAU, ARTHUR H., HOLLYWOOD, FL. SN 77-225,347. FILED P.R. 7-9-2007; AM. S.R. 12-24-2007.

CARRINGTON

THE MARK CONSISTS OF STANDARD CHARACTERS WITHOUT CLAIM TO ANY PARTICULAR FONT, STYLE, SIZE, OR COLOR.

FOR EAU DE PERFUME; LIQUID PERFUMES; PERFUME; PERFUME OILS; COLOGNE; EAU DE COLOGNE; EAU DE TOILETTE (U.S. CLS. 1, 4, 6, 50, 51 AND 52).

FIRST USE 2-13-2007; IN COMMERCE 2-13-2007.

3,400,358. BOLIN, NGOZI E., SYLMAR, CA. SN 77-279,255. FILED P.R. 9-13-2007; AM. S.R. 1-7-2008.

Shinkafa

THE MARK CONSISTS OF STANDARD CHARACTERS WITHOUT CLAIM TO ANY PARTICULAR FONT, STYLE, SIZE, OR COLOR.

THE ENGLISH TRANSLATION OF THE WORD "SHINKAFA" IN THE MARK IS "RICE".

FOR BODY AND BEAUTY CARE COSMETICS; HAIR RELAXERS; HAIR CONDITIONERS; HAIR CREAMS; HAIR SHAMPOO; HAIR STRAIGHTENING PREPARATIONS; HAIR NOURISHERS; BODY CREAMS; BODY WASHES; FACE AND BODY CREAMS; FACIAL MASKS (U.S. CLS. 1, 4, 6, 50, 51 AND 52).

FIRST USE 1-11-2007; IN COMMERCE 1-19-2007.

3,400,385. STUART-CURTIS FAMILY TRUST, NEW YORK, NY. SN 78-769,640. FILED P.R. 12-8-2005; AM. S.R. 7-23-2007.

NIGHT BLOOMING LILY

THE MARK CONSISTS OF STANDARD CHARACTERS WITHOUT CLAIM TO ANY PARTICULAR FONT, STYLE, SIZE, OR COLOR.

FOR PERFUME (U.S. CLS. 1, 4, 6, 50, 51 AND 52).
FIRST USE 12-31-2006; IN COMMERCE 12-31-2006.

CLASS 5—PHARMACEUTICALS**CLASS 5—(Continued).**

3,400,258. WARNER CHILCOTT COMPANY, INC., FAJARDO, PUERTO RICO. SN 77-102,740. FILED P.R. 2-8-2007; AM. S.R. 2-9-2008.

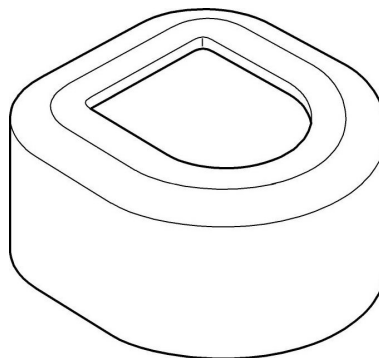

THE MARK CONSISTS OF D-SHAPED TABLET. FOR PHARMACEUTICAL PREPARATIONS, NAMELY HORMONE PREPARATIONS FOR MEDICAL USE (U.S. CLS. 6, 18, 44, 46, 51 AND 52).

FIRST USE 2-0-2000; IN COMMERCE 2-0-2000.

3,400,307. DR. ORGANICS, INC, SAVAGE, MN. SN 77-146,167. FILED 4-2-2007.

PURE PROTEIN

THE MARK CONSISTS OF STANDARD CHARACTERS WITHOUT CLAIM TO ANY PARTICULAR FONT, STYLE, SIZE, OR COLOR.

NO CLAIM IS MADE TO THE EXCLUSIVE RIGHT TO USE "PROTEIN", APART FROM THE MARK AS SHOWN.

FOR NUTRITIONAL SUPPLEMENT (U.S. CLS. 6, 18, 44, 46, 51 AND 52).

FIRST USE 3-1-2007; IN COMMERCE 3-1-2007.

CLASS 6—METAL GOODS

CLASS 6—(Continued).

3,400,366. CHICAGO CLAMP COMPANY, LLC, BROADVIEW, IL. SN 77-293,028. FILED 10-1-2007.

CHICAGO CLAMP SYSTEMS

THE MARK CONSISTS OF STANDARD CHARACTERS WITHOUT CLAIM TO ANY PARTICULAR FONT, STYLE, SIZE, OR COLOR.

NO CLAIM IS MADE TO THE EXCLUSIVE RIGHT TO USE "CLAMP SYSTEMS", APART FROM THE MARK AS SHOWN.

FOR METAL CLAMP (U.S. CLS. 2, 12, 13, 14, 23, 25 AND 50).

FIRST USE 6-1-2007; IN COMMERCE 6-1-2007.

CLASS 7—MACHINERY

3,400,387. EMERSON ELECTRIC CO., ST. LOUIS, MO. SN 78-782,545. FILED P.R. 12-29-2005; AM. S.R. 1-30-2008.

JAM-SENSOR

THE MARK CONSISTS OF STANDARD CHARACTERS WITHOUT CLAIM TO ANY PARTICULAR FONT, STYLE, SIZE, OR COLOR.

FOR ELECTRONIC INTEGRATED CIRCUIT SOLD AS A COMPONENT PART OF FOOD WASTE DISPOSERS AND GARBAGE DISPOSALS (U.S. CLS. 13, 19, 21, 23, 31, 34 AND 35).

FIRST USE 5-15-2006; IN COMMERCE 5-15-2006.

CLASS 8—HAND TOOLS

3,400,350. LIBERATORE-GRANA, SHARI, WHITTIER, CA. SN 77-263,833. FILED P.R. 8-24-2007; AM. S.R. 12-27-2007.

KLIPPER KAP

THE MARK CONSISTS OF STANDARD CHARACTERS WITHOUT CLAIM TO ANY PARTICULAR FONT, STYLE, SIZE, OR COLOR.

FOR FITTED PLASTIC COVERS AND FITTED VINYL COVERS USED TO COVER HAIR TRIMMERS AND CLIPPERS (U.S. CLS. 23, 28 AND 44).

FIRST USE 11-1-2006; IN COMMERCE 11-1-2006.

CLASS 9—ELECTRICAL AND SCIENTIFIC APPARATUS**CLASS 9—(Continued).**

3,400,245. IMMERSIVE MEDIA COMPANY, PORTLAND, OR. SN 77-015,638. FILED P.R. 10-6-2006; AM. S.R. 2-6-2008.

IMMERSIVE MEDIA

THE MARK CONSISTS OF STANDARD CHARACTERS WITHOUT CLAIM TO ANY PARTICULAR FONT, STYLE, SIZE, OR COLOR.

OWNER OF U.S. REG. NO. 2,493,953.

NO CLAIM IS MADE TO THE EXCLUSIVE RIGHT TO USE "MEDIA", APART FROM THE MARK AS SHOWN.

FOR SOFTWARE AND ELECTRONICS, NAMELY, PANORAMIC DIGITAL CAMERAS, AND IMAGE SOFTWARE FOR DISPLAYING AND PROCESSING STILL AND PANORAMIC MOTION PICTURES (U.S. CLS. 21, 23, 26, 36 AND 38).

FIRST USE 6-10-2004; IN COMMERCE 6-10-2004.

3,400,261. DAWG PRODUCTIONS LLC, DEXTER, MI. SN 77-106,278. FILED P.R. 2-13-2007; AM. S.R. 2-5-2008.



NO CLAIM IS MADE TO THE EXCLUSIVE RIGHT TO USE "DETROIT", APART FROM THE MARK AS SHOWN.

FOR MUSICAL SOUND RECORDINGS (U.S. CLS. 21, 23, 26, 36 AND 38).

FIRST USE 10-1-2006; IN COMMERCE 10-1-2006.

3,400,262. WILLOUGHBY, JASON, JUPITER, FL. SN 77-106,411. FILED P.R. 2-13-2007; AM. S.R. 1-3-2008.

CAB CASH

THE MARK CONSISTS OF STANDARD CHARACTERS WITHOUT CLAIM TO ANY PARTICULAR FONT, STYLE, SIZE, OR COLOR.

FOR MAGNETICALLY ENCODED PRE-PAID PAYMENT CARDS USED IN PROVIDING PAYMENT FOR CAB OR TAXI SERVICES (U.S. CLS. 21, 23, 26, 36 AND 38).

FIRST USE 1-0-2007; IN COMMERCE 1-0-2007.

CLASS 9—(Continued).

3,400,263. WILLOUGHBY, JASON, JUPITER, FL. SN 77-106,417. FILED P.R. 2-13-2007; AM. S.R. 1-3-2008.

UNIVERSITY CAB CASH

THE MARK CONSISTS OF STANDARD CHARACTERS WITHOUT CLAIM TO ANY PARTICULAR FONT, STYLE, SIZE, OR COLOR.
FOR MAGNETICALLY-ENCODED PRE-PAID PAYMENT CARDS USED IN PROVIDING PAYMENT FOR CAB OR TAXI SERVICES (U.S. CLS. 21, 23, 26, 36 AND 38).
FIRST USE 1-0-2007; IN COMMERCE 1-0-2007.

3,400,273. CODESTREET, LLC, NEW YORK, NY. SN 77-118,045. FILED P.R. 2-28-2007; AM. S.R. 1-10-2008.

REPLAYSERVICE

THE MARK CONSISTS OF STANDARD CHARACTERS WITHOUT CLAIM TO ANY PARTICULAR FONT, STYLE, SIZE, OR COLOR.
FOR COMPUTER SOFTWARE PROGRAM FOR CAPTURING, RECORDING, AND REPLAYING MARKET DATA AND FOR PROVIDING MESSAGING MIDDLEWARE PROTOCOLS (U.S. CLS. 21, 23, 26, 36 AND 38).
FIRST USE 8-1-2003; IN COMMERCE 8-1-2003.

3,400,275. POOLE, RUSSELL J., GREENSBORO, NC. SN 77-121,984. FILED P.R. 3-5-2007; AM. S.R. 12-6-2007.

GEAR GUARD

THE MARK CONSISTS OF STANDARD CHARACTERS WITHOUT CLAIM TO ANY PARTICULAR FONT, STYLE, SIZE, OR COLOR.
FOR PROTECTIVE CLOTHING (U.S. CLS. 21, 23, 26, 36 AND 38).
FIRST USE 9-1-2005; IN COMMERCE 9-1-2005.

CLASS 9—(Continued).

3,400,301. MIZUNO CORPORATION, OSAKA, JAPAN. SN 77-141,526. FILED P.R. 3-27-2007; AM. S.R. 1-1-2008.

PRECISION FIT

THE MARK CONSISTS OF STANDARD CHARACTERS WITHOUT CLAIM TO ANY PARTICULAR FONT, STYLE, SIZE, OR COLOR.
FOR INSTRUMENT FOR MEASURING FOOT PATTERNS AND SHAPES (U.S. CLS. 21, 23, 26, 36 AND 38).
FIRST USE 2-15-2007; IN COMMERCE 3-20-2007.

3,400,303. ADVENTNET, INC, PLEASANTON, CA. SN 77-143,381. FILED 3-29-2007.

AssetExplorer

THE MARK CONSISTS OF STANDARD CHARACTERS WITHOUT CLAIM TO ANY PARTICULAR FONT, STYLE, SIZE, OR COLOR.
FOR ASSET MANAGEMENT SOFTWARE FOR TRACKING AND MANAGING IT AND NON-IT ASSETS OF ENTERPRISES (U.S. CLS. 21, 23, 26, 36 AND 38).
FIRST USE 1-24-2007; IN COMMERCE 1-31-2007.

3,400,328. TERADICI CORPORATION, BURNABY, CANADA. SN 77-198,180. FILED P.R. 6-5-2007; AM. S.R. 12-19-2007.

PC-OVER-IP

THE MARK CONSISTS OF STANDARD CHARACTERS WITHOUT CLAIM TO ANY PARTICULAR FONT, STYLE, SIZE, OR COLOR.
FOR INTEGRATED CIRCUITS AND SOFTWARE FOR COMMUNICATION WITH AND REMOTE USE OF PERSONAL COMPUTER INTERFACES FOR COMMUNICATION OF GRAPHICS, VIDEO DISPLAYS, AUDIO, KEYBOARDS, PRINTERS, REMOVABLE MEDIA AND OTHER COMPUTER PERIPHERALS (U.S. CLS. 21, 23, 26, 36 AND 38).
FIRST USE 0-0-2006; IN COMMERCE 0-0-2006.

CLASS 9—(Continued).

3,400,334. MARTIN, PETER G, BELLEVUE, WA. SN 77-218,591. FILED P.R. 6-29-2007; AM. S.R. 11-28-2007.

JpegSizer

THE MARK CONSISTS OF STANDARD CHARACTERS WITHOUT CLAIM TO ANY PARTICULAR FONT, STYLE, SIZE, OR COLOR.

FOR COMPUTER GRAPHICS SOFTWARE (U.S. CLS. 21, 23, 26, 36 AND 38).
FIRST USE 12-11-2002; IN COMMERCE 9-1-2004.

3,400,383. INFOSTRUCTURE SOLUTIONS, L.L.C., HOUSTON, TX. SN 78-761,085. FILED P.R. 11-26-2005; AM. S.R. 11-12-2006.

PODCASTREADY

THE MARK CONSISTS OF STANDARD CHARACTERS WITHOUT CLAIM TO ANY PARTICULAR FONT, STYLE, SIZE, OR COLOR.

FOR PORTABLE LISTENING DEVICES, NAMELY, MP3 PLAYERS (U.S. CLS. 21, 23, 26, 36 AND 38).
FIRST USE 4-1-2005; IN COMMERCE 4-1-2005.

3,400,398. ELODRIVE GMBH, MINDEN, FED REP GERMANY. SN 78-893,829. FILED P.R. 5-26-2006; AM. S.R. 5-1-2007.

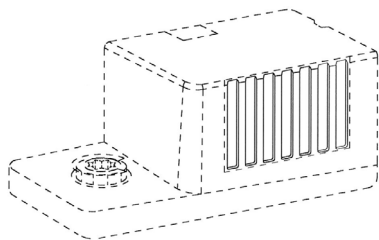

THE MARK CONSISTS OF A SERIES OF REPEATING PARALLEL GROOVES COVERING SUBSTANTIALLY ALL OF THE ENTIRE SURFACE OF THE TWO OPPOSITE SIDES OF THE GOODS. THE BROKEN LINES IN THE DRAWING SHOW PLACEMENT OF THE MARK AND DO NOT COMPRISE A PORTION OF THE MARK.

FOR ELECTRONIC ACTUATORS FOR AIR-HANDLING SYSTEMS (U.S. CLS. 21, 23, 26, 36 AND 38).
FIRST USE 1-31-2001; IN COMMERCE 1-31-2001.

CLASS 9—(Continued).

3,400,405. MIRABITO, JUDY, HUDSON, NH. SN 78-957,245. FILED P.R. 8-22-2006; AM. S.R. 1-10-2008.

DOGGIE CLASSICAL

THE MARK CONSISTS OF STANDARD CHARACTERS WITHOUT CLAIM TO ANY PARTICULAR FONT, STYLE, SIZE, OR COLOR.

NO CLAIM IS MADE TO THE EXCLUSIVE RIGHT TO USE "CLASSICAL", APART FROM THE MARK AS SHOWN. FOR COMPACT DISCS FEATURING MUSIC (U.S. CLS. 21, 23, 26, 36 AND 38).
FIRST USE 4-2-2006; IN COMMERCE 4-2-2006.

3,400,411. CMP MEDIA LLC, MANHASSET, NY. SN 78-978,191. FILED P.R. 2-2-2006; AM. S.R. 1-29-2007.

EETIMES

THE MARK CONSISTS OF STANDARD CHARACTERS WITHOUT CLAIM TO ANY PARTICULAR FONT, STYLE, SIZE, OR COLOR.

FOR DOWNLOADABLE ELECTRONIC MAGAZINES IN THE FIELDS OF ELECTRONICS, ENGINEERING, COMPUTERS, HIGH TECHNOLOGY AND OFFICE SYSTEMS MANAGEMENT (U.S. CLS. 21, 23, 26, 36 AND 38).
FIRST USE 3-1-2003; IN COMMERCE 3-1-2003.

CLASS 10—MEDICAL APPARATUS

3,400,233. VARTEC SOLUTIONS, INC., HUDSON, OH. SN 76-664,135. FILED P.R. 8-4-2006; AM. S.R. 12-20-2007.

Tube Tie

FOR SURGICAL, MEDICAL, DENTAL AND VETERINARY APPARATUS AND INSTRUMENTS, NAMELY, SECURING DEVICES FOR ENDOTRACHEAL TUBES (U.S. CLS. 26, 39 AND 44).

FIRST USE 5-18-2006; IN COMMERCE 5-18-2006.

CLASS 10—(Continued).

3,400,255. BEWELL HEALTH PRODUCTS, INC., COLUMBIA, MO. SN 77-086,236. FILED P.R. 1-19-2007; AM. S.R. 1-16-2008.

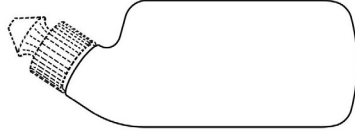

THE MARK CONSISTS OF A BOTTLE FOR AN ORGANIC NASAL WASH SOLUTION, THE BOTTLE HAVING CURVED EDGES AND AN ANGLED NECK SO THAT THE DIRECTION OF SPRAY IS OFFSET FROM THE LONGITUDINAL AXIS OF THE BOTTLE.

FOR BOTTLE FOR ORGANIC NASAL RINSING SOLUTION FOR NASAL WASHING FOR THE PURPOSE OF REFRESHING NASAL MEMBRANE LINE, MOISTURIZE AND WASH AWAY NASAL PARTICLES (U.S. CLS. 26, 39 AND 44).
FIRST USE 10-1-2004; IN COMMERCE 10-1-2004.

CLASS 11—(Continued).

3,400,252. CALIFORNIA FAUCETS, HUNTINGTON BEACH, CA. SN 77-065,617. FILED P.R. 12-15-2006; AM. S.R. 1-2-2008.

CUSTOM FAUCETRY

THE MARK CONSISTS OF STANDARD CHARACTERS WITHOUT CLAIM TO ANY PARTICULAR FONT, STYLE, SIZE, OR COLOR.

FOR FAUCETS; AND PLUMBING FITTINGS, NAMELY, DRAINS, SPOUTS, FAUCET FILTERS, FAUCET VALVES, DRAIN COVERS, CONNECTOR HOSES, TUB SPOUTS, SHOWER HEADS, AND HAND SHOWERS (U.S. CLS. 13, 21, 23, 31 AND 34).
FIRST USE 6-30-2007; IN COMMERCE 6-30-2007.

3,400,367. ALLIED PRECISION INDUSTRIES, INC., ELBURN, IL. SN 77-293,244. FILED P.R. 10-1-2007; AM. S.R. 1-10-2008.

3 in 1 De-icer

THE MARK CONSISTS OF STANDARD CHARACTERS WITHOUT CLAIM TO ANY PARTICULAR FONT, STYLE, SIZE, OR COLOR.

NO CLAIM IS MADE TO THE EXCLUSIVE RIGHT TO USE "DE-ICER", APART FROM THE MARK AS SHOWN.
FOR ELECTRIC DEICER (U.S. CLS. 13, 21, 23, 31 AND 34).
FIRST USE 4-3-2007; IN COMMERCE 4-3-2007.

3,400,295. SUTURA, INC., FOUNTAIN VALLEY, CA. SN 77-139,342. FILED P.R. 3-23-2007; AM. S.R. 1-4-2008.

HEARTSTITCH

THE MARK CONSISTS OF STANDARD CHARACTERS WITHOUT CLAIM TO ANY PARTICULAR FONT, STYLE, SIZE, OR COLOR.

FOR MEDICAL DEVICES, NAMELY, SUTURING DEVICES (U.S. CLS. 26, 39 AND 44).
FIRST USE 8-27-2007; IN COMMERCE 8-27-2007.

CLASS 13—FIREARMS

3,400,356. WORLEY, F. MICHAEL, PANAMA CITY BEACH, FL. SN 77-275,807. FILED P.R. 9-10-2007; AM. S.R. 1-8-2007.

Safety Bullet

THE MARK CONSISTS OF STANDARD CHARACTERS WITHOUT CLAIM TO ANY PARTICULAR FONT, STYLE, SIZE, OR COLOR.

NO CLAIM IS MADE TO THE EXCLUSIVE RIGHT TO USE "BULLET", APART FROM THE MARK AS SHOWN.
FOR FIREARM DISABLING DEVICES, NAMELY, GUN LOCKS IN THE NATURE OF ROUNDS OF AMMUNITION WHICH WHEN FIRED LOCKS THE FIREARM MAKING IT INOPERABLE (U.S. CLS. 2 AND 9).
FIRST USE 11-30-2007; IN COMMERCE 11-30-2007.

CLASS 11—ENVIRONMENTAL CONTROL APPARATUS

CLASS 13—(Continued).

3,400,393. THE TRUSTEES OF THE SALISH TRUST, A WASHINGTON TRUST, THE TRUSTEES COMPRISING MARVIN WILBUR, SR., JOAN WILBUR, LENORA WILBUR-COOK, C. MARVIN WILBUR, JR. AND MICHAEL WILBUR, ALL U.S. CITIZENS, ANACORTES, WA. SN 78-860,166. FILED P.R. 4-12-2006; AM. S.R. 3-26-2007.

BIG SMILEY

THE MARK CONSISTS OF STANDARD CHARACTERS WITHOUT CLAIM TO ANY PARTICULAR FONT, STYLE, SIZE, OR COLOR.

FOR FIREWORKS (U.S. CLS. 2 AND 9).
FIRST USE 6-13-2006; IN COMMERCE 6-13-2006.

3,400,395. THE TRUSTEES OF THE SALISH TRUST, A WASHINGTON TRUST, THE TRUSTEES COMPRISING OF C. MARVIN WILBUR, SR., JOAN WILBUR, LENORA WILBUR-COOK, C. MARVIN WILBUR, JR., MICHAEL WILBUR, ALL U.S. CITIZENS, ANACORTES, WA. SN 78-860,893. FILED P.R. 4-13-2006; AM. S.R. 3-26-2007.

BOWTIE WITH RING

THE MARK CONSISTS OF STANDARD CHARACTERS WITHOUT CLAIM TO ANY PARTICULAR FONT, STYLE, SIZE, OR COLOR.

FOR FIREWORKS (U.S. CLS. 2 AND 9).
FIRST USE 6-2-2006; IN COMMERCE 6-2-2006.

CLASS 14—JEWELRY

CLASS 14—(Continued).

3,400,231. RAMOS, LEONARDO, WESTON, FL. SN 76-653,117. FILED P.R. 1-9-2006; AM. S.R. 1-10-2008.



THE FOREIGN WORDING IN THE MARK TRANSLATES INTO ENGLISH AS "JESUS CHRIST OUR KING AND SAVIOR."

FOR JEWELRY (U.S. CLS. 2, 27, 28 AND 50).
FIRST USE 12-5-2007; IN COMMERCE 12-5-2007.

3,400,235. GOLDART INTERNATIONAL INC., GARDEN CITY, NY. SN 76-673,434. FILED P.R. 3-1-2007; AM. S.R. 1-17-2008.

GOLDS

THE MARK CONSISTS OF STANDARD CHARACTERS WITHOUT CLAIM TO ANY PARTICULAR FONT, STYLE, SIZE, OR COLOR.

FOR JEWELRY MADE IN WHOLE OR IN SUBSTANTIAL PART OF PART OF PRECIOUS METALS AND THEIR ALLOYS, NAMELY, GOLD; GOODS MADE AND COATED IN WHOLE OR SUBSTANTIAL PART OF GOLD, NAMELY, GOLD BARS, BADGES, BEADS FOR USE IN THE MANUFACTURE OF JEWELRY, BRACELETS, BROOCHES, BELT BUCKLES, WATCH WINDING BUTTONS, JEWELRY CHAINS, CHARMS, FAMILY CRESTS, CROSSES, CRUCIFIXES, CUFFLINKS, EARRINGS, LOCKETS, MONEY CLIPS, NECKLACES, PENDANTS, ORNAMENTAL PINS, RINGS, ST. CHRISTOPHER MEDALLIONS, STAR OF DAVID MEDALLIONS, TIE CLIPS, SLIDES FOR BOLO TIES, TIE PINS; PRECIOUS STONES AFFIXED IN PART TO GOLD; HOROLOGICAL AND CHRONOMETRIC INSTRUMENTS MADE IN WHOLE OR IN SUBSTANTIAL PART OF GOLD; CLOCKS, WATCHES AND WATCHBANDS MADE IN WHOLE OR IN SUBSTANTIAL PART OF GOLD (U.S. CLS. 2, 27, 28 AND 50).
FIRST USE 2-12-2003; IN COMMERCE 2-12-2003.

CLASS 14—(Continued).

3,400,283. I.DO. DIAMONDS, INC., LAS VEGAS, NV. SN 77-127,361. FILED P.R. 3-9-2007; AM. S.R. 1-28-2008.

THE PERFECT PRINCESS CUT

THE MARK CONSISTS OF STANDARD CHARACTERS WITHOUT CLAIM TO ANY PARTICULAR FONT, STYLE, SIZE, OR COLOR.

NO CLAIM IS MADE TO THE EXCLUSIVE RIGHT TO USE "PRINCESS CUT", APART FROM THE MARK AS SHOWN.

FOR CUT DIAMONDS (U.S. CLS. 2, 27, 28 AND 50).
FIRST USE 5-23-2007; IN COMMERCE 5-23-2007.

CLASS 15—(Continued).

3,400,250. GOLDFISH GUITARS LLC, LEAGUE CITY, TX. SN 77-060,799. FILED P.R. 12-9-2006; AM. S.R. 2-13-2008.

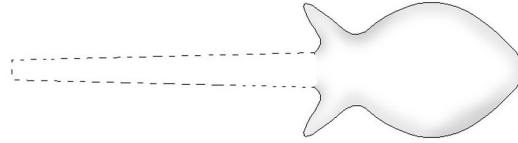

THE MARK CONSISTS OF THE CONFIGURATION OF THE BODY OF A GUITAR, IN THE SHAPE OF A FISH.

FOR CARRYING CASES FOR MUSICAL INSTRUMENTS; DRUMS; MUSIC PITCH PIPES; MUSICAL INSTRUMENT STANDS; MUSICAL INSTRUMENTS; MUSICAL INSTRUMENTS, NAMELY, BASS GUITARS; MUSICAL INSTRUMENTS, NAMELY, ELECTRIC GUITARS AND ACOUSTIC GUITARS; PICKS FOR STRINGED INSTRUMENTS; STANDS FOR MUSICAL INSTRUMENTS; STRING INSTRUMENTS, NAMELY, ACOUSTIC, ACOUSTIC/ELECTRIC AND ELECTRIC GUITARS AND ACOUSTIC, ACOUSTIC/ELECTRIC AND ELECTRIC BASSES AND REPLACEMENT PARTS, AND STRINGED INSTRUMENT ACCESSORIES, NAMELY, INSTRUMENT CASES, STANDS, PICKS, STRAPS AND STRINGS; TUNERS FOR MUSICAL INSTRUMENTS (U.S. CLS. 2, 21 AND 36).
FIRST USE 12-10-2000; IN COMMERCE 12-7-2002.

3,400,300. WRIGHT, MARCUS J., HIGASHI-OSAKA, JAPAN. SN 77-140,715. FILED P.R. 3-26-2007; AM. S.R. 1-7-2008.

STEINBACH

THE MARK CONSISTS OF STANDARD CHARACTERS WITHOUT CLAIM TO ANY PARTICULAR FONT, STYLE, SIZE, OR COLOR.

OWNER OF U.S. REG. NO. 3,003,106.
FOR MUSICAL INSTRUMENTS (U.S. CLS. 2, 21 AND 36).

FIRST USE 9-30-2004; IN COMMERCE 9-30-2004.

3,400,329. INTERNATIONAL BULLION AND METAL BROKERS (USA) INC., SUNRISE, FL. SN 77-203,007. FILED P.R. 6-11-2007; AM. S.R. 10-11-2007.

THE PRAYER BELL COLLECTION

THE MARK CONSISTS OF STANDARD CHARACTERS WITHOUT CLAIM TO ANY PARTICULAR FONT, STYLE, SIZE, OR COLOR.

FOR JEWELRY (U.S. CLS. 2, 27, 28 AND 50).
FIRST USE 11-1-2006; IN COMMERCE 11-1-2006.

CLASS 16—PAPER GOODS AND PRINTED MATTER

3,400,266. SUBURBAN PUBLISHING CORPORATION, PEABODY, MA. SN 77-110,772. FILED P.R. 2-19-2007; AM. S.R. 12-10-2007.

SUBURBAN REAL ESTATE NEWS.COM

THE MARK CONSISTS OF STANDARD CHARACTERS WITHOUT CLAIM TO ANY PARTICULAR FONT, STYLE,

CLASS 15—MUSICAL INSTRUMENTS

CLASS 16—(Continued).

SIZE, OR COLOR.

NO CLAIM IS MADE TO THE EXCLUSIVE RIGHT TO USE "REAL ESTATE NEWS.COM", APART FROM THE MARK AS SHOWN.

FOR PRINTED PUBLICATIONS CONTAINING ADVERTISING FOR OTHERS IN THE NATURE OF REAL ESTATE PROPERTIES AND INFORMATION RELATED TO THE REAL ESTATE INDUSTRY (U.S. CLS. 2, 5, 22, 23, 29, 37, 38 AND 50).

FIRST USE 2-0-2006; IN COMMERCE 2-0-2006.

3,400,285. CURTCO ROBB MEDIA, LLC, MALIBU, CA. SN 77-130,861. FILED P.R. 3-14-2007; AM. S.R. 12-21-2007.

WATCH COLLECTOR

THE MARK CONSISTS OF STANDARD CHARACTERS WITHOUT CLAIM TO ANY PARTICULAR FONT, STYLE, SIZE, OR COLOR.

FOR MAGAZINES FEATURING ARTICLES RELATED TO WATCHES, TIME PIECES, WATCH TECHNOLOGY, WATCHMAKING SKILLS, CRAFTSMEN, REGIONS, CENTERS AND CULTURES (U.S. CLS. 2, 5, 22, 23, 29, 37, 38 AND 50).

FIRST USE 9-12-2007; IN COMMERCE 9-12-2007.

3,400,292. WESTERN NATIONAL BANK, PHOENIX, CO. SN 77-136,369. FILED P.R. 3-21-2007; AM. S.R. 1-7-2008.

Cash Pads

THE MARK CONSISTS OF STANDARD CHARACTERS WITHOUT CLAIM TO ANY PARTICULAR FONT, STYLE, SIZE, OR COLOR.

FOR CARD STOCK SURROUNDING A STACK OF PAPER CURRENCY, BUNDLED TO PROVIDE ENHANCED ACCESSIBILITY (U.S. CLS. 2, 5, 22, 23, 29, 37, 38 AND 50).

FIRST USE 6-13-2005; IN COMMERCE 6-13-2005.

CLASS 16—(Continued).

3,400,293. HUNT-GOLLIDAY, PASHA S., CHICAGO, IL. SN 77-137,278. FILED 3-22-2007.

REDEEMABLE FOR

THE MARK CONSISTS OF STANDARD CHARACTERS WITHOUT CLAIM TO ANY PARTICULAR FONT, STYLE, SIZE, OR COLOR.

FOR ADHESIVE TAPES FOR STATIONERY OR HOUSEHOLD PURPOSES, NOTE PADS, NOTE PAPER, ANNOUNCEMENT CARDS, GREETING CARDS, AND STATIONERY (U.S. CLS. 2, 5, 22, 23, 29, 37, 38 AND 50).

FIRST USE 3-1-1994; IN COMMERCE 6-22-1994.

3,400,315. BLORE, NORMAN, GREENVILLE, SC. SN 77-156,368. FILED P.R. 4-13-2007; AM. S.R. 1-10-2008.

MOTORCYCLE LIFESTYLE

THE MARK CONSISTS OF STANDARD CHARACTERS WITHOUT CLAIM TO ANY PARTICULAR FONT, STYLE, SIZE, OR COLOR.

FOR MAGAZINES FEATURING MOTORCYCLES AND MOTORCYCLE RELATED EVENTS, ACCESSORIES, NEWS AND RELATED INFORMATION (U.S. CLS. 2, 5, 22, 23, 29, 37, 38 AND 50).

FIRST USE 7-1-2007; IN COMMERCE 7-1-2007.

3,400,320. CREATIONS BY YOU, ENGLEWOOD, CO. SN 77-168,922. FILED P.R. 4-30-2007; AM. S.R. 1-3-2008.

Baby Calendar

THE MARK CONSISTS OF STANDARD CHARACTERS WITHOUT CLAIM TO ANY PARTICULAR FONT, STYLE, SIZE, OR COLOR.

NO CLAIM IS MADE TO THE EXCLUSIVE RIGHT TO USE "CALENDAR", APART FROM THE MARK AS SHOWN.

FOR ARTS AND CRAFTS KITS COMPRISED OF DRAWING PAPER, STICKERS, ENVELOPES AND ADHESIVE TAPE DISPENSERS FOR HOUSEHOLD OR STATIONERY USE (U.S. CLS. 2, 5, 22, 23, 29, 37, 38 AND 50).

FIRST USE 6-13-2003; IN COMMERCE 6-13-2003.

CLASS 16—(Continued).

3,400,321. CREATIONS BY YOU, ENGLEWOOD, CO. SN 77-169,243. FILED P.R. 4-30-2007; AM. S.R. 1-3-2008.

CLASS 16—(Continued).

3,400,373. GREENSPRING MEDIA GROUP, INC, MINNEAPOLIS, MN. SN 78-556,856. FILED P.R. 1-31-2005; AM. S.R. 11-1-2007.

Kid Clock

THE MARK CONSISTS OF STANDARD CHARACTERS WITHOUT CLAIM TO ANY PARTICULAR FONT, STYLE, SIZE, OR COLOR.

NO CLAIM IS MADE TO THE EXCLUSIVE RIGHT TO USE "CLOCK", APART FROM THE MARK AS SHOWN.

FOR ARTS AND CRAFTS KITS COMPRISED OF DRAWING PAPER, MARKERS, ADHESIVE TAPE DISPENSERS FOR HOUSEHOLD OR STATIONERY USE AND ENVELOPES (U.S. CLS. 2, 5, 22, 23, 29, 37, 38 AND 50).

FIRST USE 2-29-2000; IN COMMERCE 2-29-2000.

REAL FOOD

THE MARK CONSISTS OF STANDARD CHARACTERS WITHOUT CLAIM TO ANY PARTICULAR FONT, STYLE, SIZE, OR COLOR.

FOR MAGAZINES FEATURING LIFESTYLES AND ORGANIC FOODS (U.S. CLS. 2, 5, 22, 23, 29, 37, 38 AND 50).

FIRST USE 11-1-2005; IN COMMERCE 11-1-2005.

3,400,330. WAINSCOT MEDIA LLC, MONTVALE, NJ. SN 77-203,551. FILED P.R. 6-12-2007; AM. S.R. 1-2-2008.

WESTCHESTER HEALTH & LIFE

THE MARK CONSISTS OF STANDARD CHARACTERS WITHOUT CLAIM TO ANY PARTICULAR FONT, STYLE, SIZE, OR COLOR.

OWNER OF U.S. REG. NOS. 2,855,371, 3,208,858, AND 3,278,194.

FOR MAGAZINES FEATURING ARTICLES ON GOOD HEALTH PRACTICES, MEDICAL THERAPIES AND PEOPLE OF INTEREST (U.S. CLS. 2, 5, 22, 23, 29, 37, 38 AND 50).

FIRST USE 9-25-2006; IN COMMERCE 9-25-2006.

3,400,380. WEEKLY READER CORPORATION, STAMFORD, CT. SN 78-752,304. FILED P.R. 11-11-2005; AM. S.R. 7-23-2007.

PUZZLE READERS

3,400,344. WAINSCOT MEDIA LLC, MONTVALE, NJ. SN 77-248,637. FILED P.R. 8-7-2007; AM. S.R. 1-2-2008.

MIDDLESEX HEALTH & LIFE

THE MARK CONSISTS OF STANDARD CHARACTERS WITHOUT CLAIM TO ANY PARTICULAR FONT, STYLE, SIZE, OR COLOR.

OWNER OF U.S. REG. NOS. 2,855,371, 3,208,858, AND 3,278,194.

FOR MAGAZINES FEATURING ARTICLES ON GOOD HEALTH PRACTICES, MEDICAL THERAPIES AND PEOPLE OF INTEREST (U.S. CLS. 2, 5, 22, 23, 29, 37, 38 AND 50).

FIRST USE 7-10-2007; IN COMMERCE 7-10-2007.

THE MARK CONSISTS OF STANDARD CHARACTERS WITHOUT CLAIM TO ANY PARTICULAR FONT, STYLE, SIZE, OR COLOR.

NO CLAIM IS MADE TO THE EXCLUSIVE RIGHT TO USE "READERS", APART FROM THE MARK AS SHOWN.

FOR BOOKS FOR TEACHING AND DEVELOPING LITERACY, VISUAL DISCRIMINATION AND FINE MOTOR SKILLS IN CHILDREN (U.S. CLS. 2, 5, 22, 23, 29, 37, 38 AND 50).

FIRST USE 1-1-2006; IN COMMERCE 1-1-2006.

CLASS 16—(Continued).

3,400,410. A-Z SOFTWARE SOLUTIONS AND SERVICES, SIMI VALLEY, CA. SN 78-972,902. FILED P.R. 9-12-2006; AM. S.R. 2-5-2008.

CHIP CUSTOMIZER

THE MARK CONSISTS OF STANDARD CHARACTERS WITHOUT CLAIM TO ANY PARTICULAR FONT, STYLE, SIZE, OR COLOR.

FOR STICKER KIT COMPRISED OF STICKERS AND COMPUTER SOFTWARE FOR THE PURPOSE OF CUSTOMIZING AND PERSONALIZING POKER CHIPS (U.S. CLS. 2, 5, 22, 23, 29, 37, 38 AND 50).

FIRST USE 3-1-2006; IN COMMERCE 3-1-2006.

CLASS 17—RUBBER GOODS

3,400,317. PLASTIC SPECIALTIES AND TECHNOLOGIES, INC., SOMERVILLE, NJ. SN 77-165,484. FILED P.R. 4-25-2007; AM. S.R. 12-18-2007.

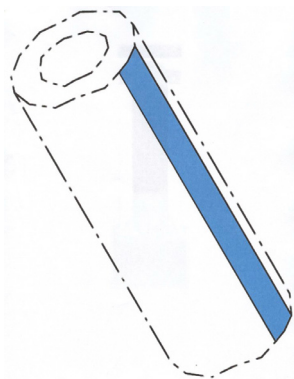

THE COLOR(S) BLUE IS/ARE CLAIMED AS A FEATURE OF THE MARK.

THE MARK CONSISTS OF THE COLOR BLUE APPLIED TO TUBING AS A SINGLE STRIPE ALONG ITS LENGTH. THE DOTTED OUTLINE OF THE GOODS IS INTENDED TO SHOW THE PORTION OF THE MARK ON THE GOODS AND IS NOT PART OF THE MARK.

FOR PLASTIC TUBES FOR USE IN AERATION TUBING (U.S. CLS. 1, 5, 12, 13, 35 AND 50).

FIRST USE 7-31-2006; IN COMMERCE 7-31-2006.

CLASS 19—NON-METALLIC BUILDING MATERIALS**CLASS 19—(Continued).**

3,400,249. CORAL CAST, LLC, PLAINVIEW, NY. SN 77-052,029. FILED P.R. 11-28-2006; AM. S.R. 9-27-2007.

Coral Cast

THE MARK CONSISTS OF STANDARD CHARACTERS WITHOUT CLAIM TO ANY PARTICULAR FONT, STYLE, SIZE, OR COLOR.

FOR BIRD BATHS MADE OF CONCRETE; BLOCKS OF CONCRETE; CONCRETE; CONCRETE BEAMS; CONCRETE BIRD BATHS; CONCRETE BLOCKS; CONCRETE BUILDING MATERIALS, NAMELY, CONCRETE; CONCRETE FLOORS; CONCRETE PANELS; CONCRETE RETAINING WALLS; CONCRETE SCULPTURES; CONCRETE WALLS; CONCRETE WALLS FOR BUILDING; DESKTOP STATUARY MADE OF CONCRETE; FIGURES OF CONCRETE; INDUSTRIAL CONCRETE FOR USE IN CIVIL ENGINEERING WORKS; MONUMENTS OF CONCRETE; NON-METAL CASTING FORMS FOR CONCRETE; SLABS OF CONCRETE; STATUES OF CONCRETE; STATUETTES OF CONCRETE (U.S. CLS. 1, 12, 33 AND 50).

FIRST USE 8-1-2006; IN COMMERCE 8-15-2006.

3,400,381. NORTH AMERICAN PIPE CORPORATION, HOUSTON, TX. SN 78-755,077. FILED P.R. 11-16-2005; AM. S.R. 1-14-2008.

NORTH AMERICAN PIPE

THE MARK CONSISTS OF STANDARD CHARACTERS WITHOUT CLAIM TO ANY PARTICULAR FONT, STYLE, SIZE, OR COLOR.

NO CLAIM IS MADE TO THE EXCLUSIVE RIGHT TO USE "PIPE", APART FROM THE MARK AS SHOWN.

FOR RIGID NON-METALLIC PIPE FOR CONVEYING LIQUID AND SEMI-LIQUID MATERIALS (U.S. CLS. 1, 12, 33 AND 50).

FIRST USE 6-14-2007; IN COMMERCE 6-14-2007.

CLASS 20—FURNITURE AND ARTICLES NOT OTHERWISE CLASSIFIED

CLASS 20—(Continued).

3,400,239. SUPERIOR FIBER MILLS, INC., BROOKLYN, NY.
SN 76-675,366. FILED P.R. 4-11-2007; AM. S.R. 1-17-2008.

INKJET PILLOWS

THE MARK CONSISTS OF STANDARD CHARACTERS WITHOUT CLAIM TO ANY PARTICULAR FONT, STYLE, SIZE, OR COLOR.

NO CLAIM IS MADE TO THE EXCLUSIVE RIGHT TO USE "PILLOWS", APART FROM THE MARK AS SHOWN.

FOR DECORATED THROW PILLOWS (U.S. CLS. 2, 13, 22, 25, 32 AND 50).

FIRST USE 3-20-2007; IN COMMERCE 3-20-2007.

3,400,333. RANDALL S. PORTER, YUCAIPA, CA. AND SHARON R. RICHARDSON, YUCAIPA, CA. SN 77-213,687. FILED P.R. 6-22-2007; AM. S.R. 12-19-2007.

Cartoon Furniture

THE MARK CONSISTS OF STANDARD CHARACTERS WITHOUT CLAIM TO ANY PARTICULAR FONT, STYLE, SIZE, OR COLOR.

NO CLAIM IS MADE TO THE EXCLUSIVE RIGHT TO USE "FURNITURE", APART FROM THE MARK AS SHOWN.

FOR BEDROOM FURNITURE; CABINETS; COMPUTER FURNITURE; DOORS FOR FURNITURE; ENTERTAINMENT CENTERS; FURNITURE; FURNITURE CHESTS; FURNITURE FOR DISPLAYING GOODS; FURNITURE FOR HOUSE, OFFICE AND GARDEN; FURNITURE FRAMES; LIVING ROOM FURNITURE; MIRRORS; OFFICE FURNITURE; OUTDOOR FURNITURE; SEATING FURNITURE; SEATS; TABLES; TOY BOXES (U.S. CLS. 2, 13, 22, 25, 32 AND 50).

FIRST USE 1-1-2006; IN COMMERCE 1-1-2006.

3,400,399. TRUCK ADS, LLC, MCLEAN, VA. SN 78-897,290. FILED P.R. 5-31-2006; AM. S.R. 1-2-2008.

THE INVISIBLE MEDIA FRAME SYSTEM

THE MARK CONSISTS OF STANDARD CHARACTERS WITHOUT CLAIM TO ANY PARTICULAR FONT, STYLE, SIZE, OR COLOR.

FOR PLASTIC FASTENERS FOR MOUNTING BANNERS (U.S. CLS. 2, 13, 22, 25, 32 AND 50).

FIRST USE 12-20-2005; IN COMMERCE 12-20-2005.

CLASS 21—HOUSEWARES AND GLASS**CLASS 21—(Continued).**

3,400,353. LAPOLLA, ANTHONY J., MARCY, NY. SN 77-272,480. FILED P.R. 9-5-2007; AM. S.R. 12-20-2007.



NO CLAIM IS MADE TO THE EXCLUSIVE RIGHT TO USE "BRUSH" AND "SCRUBBER", APART FROM THE MARK AS SHOWN.

THE MARK CONSISTS OF THE WORDS "DRILL" AND "BRUSH" SEPARATED BY A GRAPHIC OF A CORDLESS DRILL WITH THE PRODUCT BRUSH ATTACHED.

FOR SCRUBBING BRUSHES (U.S. CLS. 2, 13, 23, 29, 30, 33, 40 AND 50).

FIRST USE 2-14-2007; IN COMMERCE 3-31-2007.

3,400,402. ECO-HARVEST INC., LEESBURG, FL. SN 78-934,540. FILED P.R. 7-21-2006; AM. S.R. 12-20-2007.

Sustainable Food & Garden Solutions

THE MARK CONSISTS OF STANDARD CHARACTERS WITHOUT CLAIM TO ANY PARTICULAR FONT, STYLE, SIZE, OR COLOR.

FOR HYDROPONIC GARDEN KIT FOR HOME USE COMPRISING GROWING CONTAINERS AND ALSO INCLUDING HYDROPONIC FERTILIZERS, SEEDS, SUBSTRATE, DRAIN COMPONENTS, AND ELECTRONIC CONTROL PANEL FOR WATERING (U.S. CLS. 2, 13, 23, 29, 30, 33, 40 AND 50).

FIRST USE 12-20-2007; IN COMMERCE 12-20-2007.

CLASS 25—CLOTHING

3,400,257. KMITO, MICHAEL, HANOVER, MA. SN 77-101,909. FILED P.R. 2-7-2007; AM. S.R. 12-4-2007.

Lake Wear

THE MARK CONSISTS OF STANDARD CHARACTERS WITHOUT CLAIM TO ANY PARTICULAR FONT, STYLE, SIZE, OR COLOR.

NO CLAIM IS MADE TO THE EXCLUSIVE RIGHT TO USE "WEAR", APART FROM THE MARK AS SHOWN.

FOR BATHROBES; BEACH COVERUPS; GOLF SHIRTS; HATS; JACKETS; LOUNGEWEAR; T-SHIRTS; VISORS (U.S. CLS. 22 AND 39).

FIRST USE 11-15-2007; IN COMMERCE 11-20-2007.

CLASS 25—(Continued).

3,400,318. DC STANFA ENTERPRISES, LLC, CINCINNATI, OH. SN 77-165,992. FILED P.R. 4-26-2007; AM. S.R. 1-7-2008.

Will dance for MARGARITAS

THE MARK CONSISTS OF STANDARD CHARACTERS WITHOUT CLAIM TO ANY PARTICULAR FONT, STYLE, SIZE, OR COLOR.

FOR CLOTHING, NAMELY, BEACH WEAR, BEACH COVER-UPS, SHIRTS, TANK-TOPS, SKIRTS, SWEATSHIRTS, T-SHIRTS, JACKETS, PANTS, SHORTS; HEADGEAR, NAMELY, HEADWEAR AND SCARVES, HATS, CAPS, BASEBALL CAPS, AND VISORS (U.S. CLS. 22 AND 39).

FIRST USE 3-1-2006; IN COMMERCE 3-1-2006.

CLASS 25—(Continued).

3,400,371. JACQUELINE PODLASKI, HOLTSVILLE, NY. SN 78-313,664. FILED P.R. 10-15-2003; AM. S.R. 2-4-2008.



THE MARK CONSISTS OF A WOMAN WITH A BLOOMING BELLY AS THE "B" IN "BELLYLICIOUS".

FOR MATERNITY APPAREL, NAMELY, BRAS, SHIRTS, PANTS, SHORTS, AND DRESSES (U.S. CLS. 22 AND 39).

FIRST USE 6-12-2003; IN COMMERCE 7-24-2003.

3,400,369. SALOMON S.A., METZ-TESSY, FRANCE. SN 77-315,608. FILED 10-29-2007.

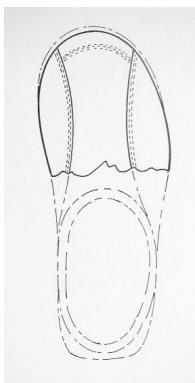

THE MARK CONSISTS OF THE FRONT PART OF A VAMP WITH A CENTRAL LONGITUDINAL STRIPE OVERLAID LATERALLY FROM BOTH SIDES BY ARCUATE LONGITUDINAL STRIPES WHICH SUGGEST STITCHING OF A SPORTS BALL.

FOR FOOTWEAR (U.S. CLS. 22 AND 39).
FIRST USE 12-22-1998; IN COMMERCE 12-22-1998.

3,400,378. GET LIT ENTERPRISES INC., CORAL GABLES, FL. SN 78-687,579. FILED P.R. 8-8-2005; AM. S.R. 12-21-2007.



FOR CLOTHING, NAMELY, SHIRTS, T-SHIRTS, POLO SHIRTS, TANK TOPS, SWEATSHIRTS, PANTS, SHORTS, RAINGEAR, JACKETS, WIND RESISTANT JACKETS, HATS AND VISORS (U.S. CLS. 22 AND 39).
FIRST USE 3-5-2007; IN COMMERCE 3-5-2007.

CLASS 25—(Continued).

3,400,389. HARRIS, HERB, AUSTIN, TX. SN 78-803,567.
FILED P.R. 1-31-2006; AM. S.R. 7-25-2006.

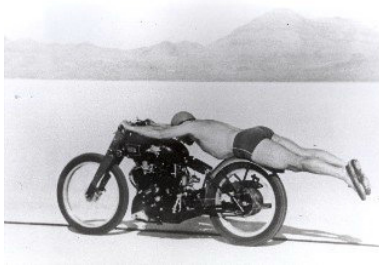

THE LIKENESS (OR, "PORTRAIT") IN THE MARK DOES NOT IDENTIFY A LIVING INDIVIDUAL.

THE COLOR(S) BLACK, WHITE AND GRAY IS/ARE CLAIMED AS A FEATURE OF THE MARK.

THE COLOR BLACK APPEARS WITHIN THE MOTORCYCLE, ITS WHEELS, THE MAN'S TRUNKS AND SHOES, AND THE SHADOW ON THE GROUND. THE COLOR GRAY APPEARS WITHIN THE MOTORCYCLE RIMS, THE MOUNTAIN RANGE, AND AS THE COLOR OF THE MAN'S SKIN. THE COLOR WITH APPEARS IN THE SAND IN THE DESERT

THE MARK CONSISTS OF A MAN LAYING DOWN ON A MOTORCYCLE WEARING SWIMMING TRUNKS AND TENNIS SHOES RACING TO SET SPEED RECORD. THE MAN IS IN THE DESERT WITH MOUNTAINS IN THE BACKGROUND.

FOR SHIRTS (U.S. CLS. 22 AND 39).

FIRST USE 9-12-1997; IN COMMERCE 12-27-1999.

CLASS 28—TOYS AND SPORTING GOODS

3,400,236. SATO, GARRY, SANTA MONICA, CA. SN 76-673,448. FILED P.R. 3-2-2007; AM. S.R. 12-26-2007.

SATO

THE MARK CONSISTS OF STANDARD CHARACTERS WITHOUT CLAIM TO ANY PARTICULAR FONT, STYLE, SIZE, OR COLOR.

FOR FISHING EQUIPMENT, NAMELY, FISHING TACKLE AND ACCESSORIES, FISHING LINE WINDERS AND FISHING KITS COMPRISING TOOLS AND SUPPLIES FOR MAKING FISHING LINE CONNECTIONS (U.S. CLS. 22, 23, 38 AND 50).

FIRST USE 1-0-2002; IN COMMERCE 1-0-2003.

CLASS 29—MEATS AND PROCESSED FOODS**CLASS 29—(Continued).**

3,400,294. KINGS COMMAND FOODS, INC., KENT, WA. SN 77-138,913. FILED P.R. 3-23-2007; AM. S.R. 1-7-2008.

Peel & Heat

THE MARK CONSISTS OF STANDARD CHARACTERS WITHOUT CLAIM TO ANY PARTICULAR FONT, STYLE, SIZE, OR COLOR.

FOR PROCESSED MEAT (U.S. CL. 46).

FIRST USE 1-2-2008; IN COMMERCE 1-2-2008.

3,400,308. JOYCE FOODS, INC., WINSTON SALEM, NC. SN 77-146,997. FILED P.R. 4-3-2007; AM. S.R. 1-7-2008.

POULET ROUGE FERMIER DU PIEDMONT

THE MARK CONSISTS OF STANDARD CHARACTERS WITHOUT CLAIM TO ANY PARTICULAR FONT, STYLE, SIZE, OR COLOR.

NO CLAIM IS MADE TO THE EXCLUSIVE RIGHT TO USE "POULET", APART FROM THE MARK AS SHOWN.

THE ENGLISH TRANSLATION OF "POULET ROUGE FERMIER DU PIEDMONT" IS "RED FARM CHICKENS FROM THE PIEDMONT".

FOR UNCOOKED POULTRY PARTS (U.S. CL. 46).

FIRST USE 8-0-2005; IN COMMERCE 8-0-2005.

3,400,340. HAINLINE, JEFFREY D., MISSOULA, MT. SN 77-237,515. FILED P.R. 7-24-2007; AM. S.R. 1-8-2008.

Rocky Mountain Gourmet Steaks

THE MARK CONSISTS OF STANDARD CHARACTERS WITHOUT CLAIM TO ANY PARTICULAR FONT, STYLE, SIZE, OR COLOR.

NO CLAIM IS MADE TO THE EXCLUSIVE RIGHT TO USE "STEAKS", APART FROM THE MARK AS SHOWN.

FOR MEAT (U.S. CL. 46).

FIRST USE 3-25-2004; IN COMMERCE 3-25-2004.

CLASS 29—(Continued).

3,400,363. WEISS, ALLAN C, DALLAS, TX. SN 77-289,043. FILED 9-26-2007.

Zesty Fried Queso Bites

THE MARK CONSISTS OF STANDARD CHARACTERS WITHOUT CLAIM TO ANY PARTICULAR FONT, STYLE, SIZE, OR COLOR.

NO CLAIM IS MADE TO THE EXCLUSIVE RIGHT TO USE "ZESTY " OR "FRIED", APART FROM THE MARK AS SHOWN.

FOR ZESTY FRIED QUESO BITES (U.S. CL. 46).
FIRST USE 8-1-2007; IN COMMERCE 8-1-2007.

CLASS 30—STAPLE FOODS

3,400,254. KENOVER MARKETING CORP., BROOKLYN, NY. SN 77-071,820. FILED P.R. 12-27-2006; AM. S.R. 11-14-2007.

MEDITERRANEAN CLASSICS

THE MARK CONSISTS OF STANDARD CHARACTERS WITHOUT CLAIM TO ANY PARTICULAR FONT, STYLE, SIZE, OR COLOR.

FOR COUSCOUS (U.S. CL. 46).
FIRST USE 11-7-2007; IN COMMERCE 11-7-2007.

3,400,311. CACKALACKY COFFEE ROASTERS INC., ROCKY MOUNT, NC. SN 77-149,207. FILED P.R. 4-5-2007; AM. S.R. 12-17-2007.

CACKALACKY COFFEE ROASTERS

THE MARK CONSISTS OF STANDARD CHARACTERS WITHOUT CLAIM TO ANY PARTICULAR FONT, STYLE, SIZE, OR COLOR.

NO CLAIM IS MADE TO THE EXCLUSIVE RIGHT TO USE "COFFEE", APART FROM THE MARK AS SHOWN.
FOR COFFEE AND TEA (U.S. CL. 46).
FIRST USE 11-1-2006; IN COMMERCE 11-1-2006.

CLASS 30—(Continued).

3,400,323. BOB EVANS RESTAURANTS OF MICHIGAN, INC., ANN ARBOR, MD. SN 77-174,536. FILED P.R. 5-7-2007; AM. S.R. 12-19-2007.

OATMEAL BOWLS

THE MARK CONSISTS OF STANDARD CHARACTERS WITHOUT CLAIM TO ANY PARTICULAR FONT, STYLE, SIZE, OR COLOR.

OWNER OF U.S. REG. NO. 2,733,559.
NO CLAIM IS MADE TO THE EXCLUSIVE RIGHT TO USE "OATMEAL", APART FROM THE MARK AS SHOWN.
FOR OATMEAL (U.S. CL. 46).
FIRST USE 7-5-2007; IN COMMERCE 7-5-2007.

3,400,360. DESIGN PAC, INC., MELROSE PARK, IL. SN 77-287,099. FILED P.R. 9-24-2007; AM. S.R. 1-11-2008.

PREMIUM SELECT

THE MARK CONSISTS OF STANDARD CHARACTERS WITHOUT CLAIM TO ANY PARTICULAR FONT, STYLE, SIZE, OR COLOR.

FOR COOKIES (U.S. CL. 46).
FIRST USE 9-1-2000; IN COMMERCE 10-1-2001.

3,400,376. PANDURATA ALIMENTOS LTDA., GUARULHOS, SAO PAULO, BRAZIL. SN 78-603,862. FILED P.R. 4-7-2005; AM. S.R. 1-30-2008.

GRAN NATALE

THE MARK CONSISTS OF STANDARD CHARACTERS WITHOUT CLAIM TO ANY PARTICULAR FONT, STYLE, SIZE, OR COLOR.

THE FOREIGN WORDING IN THE MARK TRANSLATES INTO ENGLISH AS GREAT CHRISTMAS.
FOR PANETTONES (U.S. CL. 46).
FIRST USE 0-0-1999; IN COMMERCE 10-19-2006.

CLASS 30—(Continued).

3,400,397. MCGREGOR AND MACALLAN, SANTA ROSA, CA. SN 78-875,268. FILED P.R. 5-3-2006; AM. S.R. 1-4-2008.

CLASS 32—(Continued).

3,400,386. SHIPYARD BREWING COMPANY, PORTLAND, ME. SN 78-780,869. FILED P.R. 12-27-2005; AM. S.R. 8-1-2007.

POPCORN CHIPS

THE MARK CONSISTS OF STANDARD CHARACTERS WITHOUT CLAIM TO ANY PARTICULAR FONT, STYLE, SIZE, OR COLOR.

NO CLAIM IS MADE TO THE EXCLUSIVE RIGHT TO USE "CHIPS", APART FROM THE MARK AS SHOWN.

FOR CHIPS MADE FROM POPPED CORN (U.S. CL. 46).

FIRST USE 3-22-2007; IN COMMERCE 3-22-2007.

EXCELLENCE IN BREWING

THE MARK CONSISTS OF STANDARD CHARACTERS WITHOUT CLAIM TO ANY PARTICULAR FONT, STYLE, SIZE, OR COLOR.

FOR BEER (U.S. CLS. 45, 46 AND 48).

FIRST USE 7-31-2007; IN COMMERCE 7-31-2007.

CLASS 31—NATURAL AGRICULTURAL PRODUCTS

3,400,325. LOVING PETS CORPORATION, CRANBERRY, NJ. SN 77-184,090. FILED P.R. 5-17-2007; AM. S.R. 1-7-2008.

GOURMET WRAPS

THE MARK CONSISTS OF STANDARD CHARACTERS WITHOUT CLAIM TO ANY PARTICULAR FONT, STYLE, SIZE, OR COLOR.

NO CLAIM IS MADE TO THE EXCLUSIVE RIGHT TO USE "WRAPS", APART FROM THE MARK AS SHOWN.

FOR PET TREATS (U.S. CLS. 1 AND 46).

FIRST USE 3-15-2007; IN COMMERCE 5-15-2007.

CLASS 33—WINES AND SPIRITS

3,400,287. MELLO TRADING AG, ZURICH, SWITZERLAND. SN 77-134,260. FILED P.R. 3-19-2007; AM. S.R. 12-5-2007.

CLASS 32—LIGHT BEVERAGES

3,400,251. TONY'S TAPS LLC D/B/A PAGOSA BREWING COMPANY, PAGOSA SPRINGS, CO. SN 77-065,609. FILED P.R. 12-15-2006; AM. S.R. 12-15-2006.

FUERST POTEMKIN

Pagosa Brewing Company

THE MARK CONSISTS OF STANDARD CHARACTERS WITHOUT CLAIM TO ANY PARTICULAR FONT, STYLE, SIZE, OR COLOR.

FOR BEVERAGES, NAMELY, BEER, BREWED MALT-BASED ALCOHOLIC BEVERAGE IN THE NATURE OF A BEER, PALE BEER, ALE, PORTER, STOUT, GINGER BEER, ROOT BEER, SOFT DRINKS (U.S. CLS. 45, 46 AND 48).

FIRST USE 11-29-2005; IN COMMERCE 6-19-2006.

THE MARK CONSISTS OF STANDARD CHARACTERS WITHOUT CLAIM TO ANY PARTICULAR FONT, STYLE, SIZE, OR COLOR.

OWNER OF ERPN CMNTY TM OFC REG. NO. 1000835, DATED 3-17-2000, EXPIRES 11-26-2008.

THE ENGLISH TRANSLATION OF THE WORD "FUERST" IN THE MARK IS "PRINCE".

FOR ALCOHOLIC BEVERAGES, NAMELY, VODKA, RUM AND GIN (U.S. CLS. 47 AND 49).

CLASS 33—(Continued).

3,400,374. ADEGA COOPERATIVA DE BORBA, CRL, BORBA 7150-999, PORTUGAL. SN 78-569,686. FILED P.R. 2-17-2005; AM. S.R. 2-6-2008.

adegaborba.pt

THE MARK CONSISTS OF STANDARD CHARACTERS WITHOUT CLAIM TO ANY PARTICULAR FONT, STYLE, SIZE, OR COLOR.

THE ENGLISH TRANSLATION OF MARK IS WINE PRODUCER OF BORBA.

FOR WINES (U.S. CLS. 47 AND 49).

FIRST USE 1-0-2005; IN COMMERCE 1-0-2005.

CLASS 34—SMOKERS' ARTICLES

3,400,247. HERNANDEZ DOMINGUEZ, BAUDELIO, MEXICO, MEXICO. SN 77-025,501. FILED P.R. 10-20-2006; AM. S.R. 11-26-2007.

ORNELAS

THE MARK CONSISTS OF STANDARD CHARACTERS WITHOUT CLAIM TO ANY PARTICULAR FONT, STYLE, SIZE, OR COLOR.

OWNER OF MEXICO REG. NO. 937733, DATED 5-31-2006, EXPIRES 5-17-2016.

FOR MATCHES; TOBACCO (U.S. CLS. 2, 8, 9 AND 17).

SERVICE MARKS**CLASS 35—ADVERTISING AND BUSINESS**

3,400,242. WHITE, TERRI, LAS VEGAS, NV. SN 76-681,777. FILED P.R. 9-12-2007; AM. S.R. 1-8-2008.

LAS VEGAS PROPERTIES

THE MARK CONSISTS OF STANDARD CHARACTERS WITHOUT CLAIM TO ANY PARTICULAR FONT, STYLE,

CLASS 35—(Continued).

SIZE, OR COLOR.

NO CLAIM IS MADE TO THE EXCLUSIVE RIGHT TO USE "PROPERTIES", APART FROM THE MARK AS SHOWN.

FOR BUSINESS RELOCATION, PERSONNEL RELOCATION, EMPLOYEE RELOCATION AND INFORMATION, REAL ESTATE MARKETING SERVICES, NAMELY, ON-LINE SERVICES FEATURING TOURS OF RESIDENTIAL HOMES (U.S. CLS. 100, 101 AND 102). FIRST USE 7-1-1996; IN COMMERCE 7-1-1996.

3,400,269. INTEGRATED SYSTEMS EVENTS LLC, FAIRFAX, VA. SN 77-114,434. FILED P.R. 2-23-2007; AM. S.R. 1-4-2008.

INTEGRATED SYSTEMS RUSSIA

THE MARK CONSISTS OF STANDARD CHARACTERS WITHOUT CLAIM TO ANY PARTICULAR FONT, STYLE, SIZE, OR COLOR.

OWNER OF U.S. REG. NOS. 2,956,011, 2,962,666, AND 3,003,039.

NO CLAIM IS MADE TO THE EXCLUSIVE RIGHT TO USE "RUSSIA", APART FROM THE MARK AS SHOWN.

FOR ORGANIZING, PROMOTING AND CONDUCTING CONFERENCES AND TRADE SHOWS CONCERNING THE PRODUCTS AND SERVICES OF AND TOPICS OF INTEREST TO THOSE IN THE AUDIO/VIDEO, PROJECTION, PRESENTATION AND AUDIOVISUAL COMMUNICATIONS INDUSTRIES (U.S. CLS. 100, 101 AND 102).

FIRST USE 11-8-2007; IN COMMERCE 11-8-2007.

3,400,284. LAYNE, CARRIE M, PLANO, TX. SN 77-130,695. FILED P.R. 3-14-2007; AM. S.R. 1-2-2008.

Best of the Caribbean

THE MARK CONSISTS OF STANDARD CHARACTERS WITHOUT CLAIM TO ANY PARTICULAR FONT, STYLE, SIZE, OR COLOR.

FOR ADVERTISING AGENCIES; ADVERTISING AGENCIES, NAMELY, PROMOTING THE GOODS AND SERVICES OF OTHERS; ADVERTISING AND ADVERTISEMENT SERVICES; ADVERTISING AND BUSINESS MANAGEMENT CONSULTANCY; ADVERTISING AND BUSINESS SERVICES, NAMELY, SECURING AIRTIME ON ALL FORMS OF MEDIA COMMUNICATIONS STATIONS, SYSTEMS, NETWORKS, AND SERVICES FOR THE PURPOSE OF PROMOTING THE GOODS AND SERVICES OF OTHERS; ADVERTISING AND COMMERCIAL INFORMATION SERVICES, VIA THE INTERNET; ADVERTISING AND MARKETING; ADVERTISING AND PROMOTION SERVICES AND RELATED CONSULTING; ADVERTISING AND PUBLICITY SERVICES; ADVERTISING AND PUBLICITY SERVICES, NAMELY, PROMOTING THE GOODS, SERVICES, BRAND IDENTITY AND COMMERCIAL INFORMATION AND NEWS OF THIRD PARTIES THROUGH PRINT, AUDIO, VIDEO, DIGITAL AND ON-LINE MEDIUM; ADVERTIS-

CLASS 35—(Continued).

ING CONSULTATION; ADVERTISING FLYER DISTRIBUTION; ADVERTISING PARTICULARLY SERVICES FOR THE PROMOTION OF GOODS; ADVERTISING SERVICES; ADVERTISING SERVICES OF A RADIO AND TELEVISION ADVERTISING AGENCY; ADVERTISING SERVICES, NAMELY, PROVIDING ADVERTISING SPACE IN A PERIODICAL; ADVERTISING SERVICES, NAMELY, CREATING CORPORATE AND BRAND IDENTITY FOR OTHERS; ADVERTISING SERVICES, NAMELY, CREATING CORPORATE LOGOS FOR OTHERS; ADVERTISING SERVICES, NAMELY, PROMOTING AND MARKETING THE GOODS AND SERVICES OF OTHERS THROUGH ALL PUBLIC COMMUNICATION MEANS; ADVERTISING SERVICES, NAMELY, PROMOTING THE FOOD AND WINE OF OTHERS; ADVERTISING SERVICES, NAMELY, PROMOTING THE GIFT CARDS OF OTHERS; ADVERTISING THROUGH ALL PUBLIC COMMUNICATION MEANS; ADVERTISING VIA ELECTRONIC MEDIA AND SPECIFICALLY THE INTERNET; ADVERTISING, INCLUDING PROMOTION RELATING TO THE SALE OF ARTICLES AND SERVICES FOR THIRD PARTIES BY THE TRANSMISSION OF ADVERTISING MATERIAL AND THE DISSEMINATION OF ADVERTISING MESSAGES ON COMPUTER NETWORKS; ADVERTISING, MARKETING AND PROMOTION SERVICES; COOPERATIVE ADVERTISING AND MARKETING SERVICES BY WAY OF SOLICITATION, CUSTOMER SERVICE AND PROVIDING MARKETING INFORMATION VIA WEBSITES ON A GLOBAL COMPUTER NETWORK; CREATING AND UPDATING ADVERTISING MATERIAL; CREATION OF MARKETING TOOLS DESIGNED TO INCREASE A CLIENT COMPANY'S KNOWLEDGE OF CUSTOMER NEEDS, AND ITS COMPETITORS' PRODUCTS AND SERVICES, PRICING, ADVERTISING STRATEGY AND SALES STRATEGY; DESIGN OF ADVERTISING MATERIALS FOR OTHERS; DIRECT MAIL ADVERTISING; DIRECT MARKETING ADVERTISING FOR OTHERS; DISPLAYING ADVERTISEMENTS FOR OTHERS; DISSEMINATION OF ADVERTISEMENTS AND OF ADVERTISING MATERIAL; DISSEMINATION OF ADVERTISING FOR OTHERS VIA AN ON-LINE COMMUNICATIONS NETWORK ON THE INTERNET; DISSEMINATION OF ADVERTISING FOR OTHERS VIA THE INTERNET; DISSEMINATION OF ADVERTISING MATERIAL; DISSEMINATION OF ADVERTISING MATTER; DISTRIBUTION AND DISSEMINATION OF ADVERTISING MATERIALS; DISTRIBUTION OF ADVERTISING MAIL AND OF ADVERTISING SUPPLEMENTS ATTACHED TO REGULAR EDITIONS; DISTRIBUTION OF PRODUCTS FOR ADVERTISING PURPOSES; ELECTRONIC BILLBOARD ADVERTISING; ELECTRONIC COMMERCE SERVICES, NAMELY, PROVIDING INFORMATION ABOUT PRODUCTS VIA TELECOMMUNICATION NETWORKS FOR ADVERTISING AND SALES PURPOSES; LAYOUT SERVICES FOR ADVERTISING PURPOSES; MEDIA BUYING ADVICE, NAMELY, ADVISING THE CLIENT HOW MUCH MEDIA TIME, AND AT WHAT TIMES THE CLIENT SHOULD BE PURCHASING ADVERTISING; MEDIA PLANNING, NAMELY, ADVISING THE CLIENT ON THE CORRECT TIMES AND STATIONS TO ADVERTISE BASED ON MEDIA ANALYSIS OF THE MARKET FOR THAT MEDIA; ON-LINE ADVERTISING AND MARKETING SERVICES; ON-LINE ADVERTISING ON COMPUTER COMMUNICATION NETWORKS; PLACING ADVERTISEMENTS FOR OTHERS; PLANNING AND CONDUCTING OF TRADE FAIRS, EXHIBITIONS AND PRESENTATIONS FOR ECONOMIC OR ADVERTISING PURPOSES; PREPARATION AND REALIZATION OF MEDIA AND ADVERTISING PLANS AND CONCEPTS; PREPARATION OF CUSTOM ADVERTISEMENTS FOR OTHERS; PREPARATION OF CUSTOM OR NON-CUSTOM ADVERTISING FOR BUSINESSES FOR DISSEMINATION VIA THE WEB, CD OR DVD FOR OPTIONAL UPLOAD OR DOWNLOAD TO A COMPUTER; PREPARING ADVERTISEMENTS FOR OTHERS; PREPARING AND PLACING ADVERTISEMENTS FOR OTHERS; PREPARING AND PLACING OF ADVERTISEMENTS; PREPARING AND PLACING OUTDOOR ADVERTISEMENTS FOR OTHERS; PROMOTING THE

CLASS 35—(Continued).

GOODS AND SERVICES OF OTHERS BY DISTRIBUTING ADVERTISING MATERIALS THROUGH A VARIETY OF METHODS; PROMOTING THE GOODS AND SERVICES OF OTHERS BY PREPARING AND PLACING ADVERTISEMENTS IN AN ELECTRONIC MAGAZINE ACCESSED THROUGH A GLOBAL COMPUTER NETWORK; PROMOTING, ADVERTISING AND MARKETING OF THE ON-LINE WEBSITES OF OTHERS; PROMOTION, ADVERTISING AND MARKETING OF ON-LINE WEBSITES; PROVIDING A SEARCHABLE ON-LINE ADVERTISING GUIDE FEATURING THE GOODS AND SERVICES OF OTHER ON-LINE VENDORS ON THE INTERNET; PROVIDING A WEB SITE THAT ENABLES USERS TO POST ITEMS FOR SALE THROUGH ON-LINE CLASSIFIED ADVERTISEMENTS; PROVIDING A WEB SITE WHICH FEATURES ADVERTISEMENTS FOR THE GOODS AND SERVICES OF OTHERS ON A GLOBAL COMPUTER NETWORK; PROVIDING SPACE AT A WEB SITE FOR THE ADVERTISEMENT OF THE GOODS AND SERVICES OF OTHERS; REAL ESTATE ADVERTISING SERVICES (U.S. CLS. 100, 101 AND 102).

FIRST USE 6-8-2007; IN COMMERCE 6-8-2007.

3,400,305. OUTSOURCE TELECOM, LLC, EL SEGUNDO, CA. SN 77-144,214. FILED P.R. 3-29-2007; AM. S.R. 1-8-2008.

OUTSOURCE TELECOM

THE MARK CONSISTS OF STANDARD CHARACTERS WITHOUT CLAIM TO ANY PARTICULAR FONT, STYLE, SIZE, OR COLOR.

NO CLAIM IS MADE TO THE EXCLUSIVE RIGHT TO USE "OUTSOURCE", APART FROM THE MARK AS SHOWN.

FOR HUMAN CAPITAL MANAGEMENT OUTSOURCING SERVICES; EMPLOYMENT HIRING, RECRUITING, PLACEMENT, STAFFING AND CAREER NETWORKING SERVICES; OUTSOURCING SERVICES; PERSONNEL PLACEMENT AND RECRUITMENT (U.S. CLS. 100, 101 AND 102).

FIRST USE 1-6-2004; IN COMMERCE 1-6-2004.

3,400,306. JPMORGAN CHASE & CO., NEW YORK, NY. SN 77-146,014. FILED P.R. 4-2-2007; AM. S.R. 1-9-2008.

2-FOR-1 FLIGHTS

THE MARK CONSISTS OF STANDARD CHARACTERS WITHOUT CLAIM TO ANY PARTICULAR FONT, STYLE, SIZE, OR COLOR.

FOR BANKING AND FINANCIAL SERVICES, NAMELY, PROMOTING THE SALE OF GOODS AND SERVICES OF OTHERS BY AWARDED PURCHASE POINTS FOR CREDIT CARD USE (U.S. CLS. 100, 101 AND 102).

FIRST USE 4-1-2007; IN COMMERCE 4-1-2007.

CLASS 35—(Continued).

3,400,316. SALON SHOWROOMS, INC., EAST SYRACUSE, NY. SN 77-157,264. FILED 4-16-2007.

Salon Showroom

THE MARK CONSISTS OF STANDARD CHARACTERS WITHOUT CLAIM TO ANY PARTICULAR FONT, STYLE, SIZE, OR COLOR.

FOR CATALOG ORDERING SERVICE FEATURING BARBER CHAIRS, HAIRDRESSER CHAIRS, AND MIRROR CABINETS (U.S. CLS. 100, 101 AND 102).

FIRST USE 3-1-2007; IN COMMERCE 4-1-2007.

3,400,319. DIRECT SELLING WOMEN'S ALLIANCE, INC., KAILUA, HI. SN 77-166,231. FILED P.R. 4-26-2007; AM. S.R. 8-30-2007.

DIRECT SELLING MEN'S ALLIANCE

THE MARK CONSISTS OF STANDARD CHARACTERS WITHOUT CLAIM TO ANY PARTICULAR FONT, STYLE, SIZE, OR COLOR.

NO CLAIM IS MADE TO THE EXCLUSIVE RIGHT TO USE "MEN'S ALLIANCE", APART FROM THE MARK AS SHOWN.

FOR ASSOCIATION SERVICES, NAMELY, PROMOTING THE INTERESTS OF INDEPENDENT DIRECT SELLERS THROUGH THE OFFERINGS OF INFORMATION, SUPPORT, AND BUSINESS BUILDING TOOLS (U.S. CLS. 100, 101 AND 102).

FIRST USE 8-1-2007; IN COMMERCE 8-1-2007.

3,400,322. WORLD WIDE PET INDUSTRY ASSOCIATION, MONROVIA, CA. SN 77-174,493. FILED P.R. 5-7-2007; AM. S.R. 1-29-2008.

THE NATIONAL SHOW FOR PET RETAILERS

THE MARK CONSISTS OF STANDARD CHARACTERS WITHOUT CLAIM TO ANY PARTICULAR FONT, STYLE, SIZE, OR COLOR.

NO CLAIM IS MADE TO THE EXCLUSIVE RIGHT TO USE "SHOW", APART FROM THE MARK AS SHOWN.

FOR ORGANIZING AND SPONSORING TRADE SHOW EXHIBITIONS IN THE FIELD OF DOMESTICATED ANIMALS AND RELATED PRODUCTS AND SERVICES, AND THE DISTRIBUTION OF PROGRAMS AND PRINTED ADVERTISING MATERIALS IN CONNECTION THEREWITH (U.S. CLS. 100, 101 AND 102).

FIRST USE 2-0-2007; IN COMMERCE 2-0-2007.

CLASS 35—(Continued).

3,400,337. MOTORCYCLE SUPERSTORE, INC., MEDFORD, OR. SN 77-231,969. FILED P.R. 7-17-2007; AM. S.R. 1-9-2008.

MOTORCYCLE SUPERSTORE

THE MARK CONSISTS OF STANDARD CHARACTERS WITHOUT CLAIM TO ANY PARTICULAR FONT, STYLE, SIZE, OR COLOR.

OWNER OF U.S. REG. NO. 2,794,846.

NO CLAIM IS MADE TO THE EXCLUSIVE RIGHT TO USE "SUPERSTORE", APART FROM THE MARK AS SHOWN.

FOR ON-LINE RETAIL STORE SERVICES FEATURING ITEMS RELATED TO THE MOTORCYCLING LIFESTYLE (U.S. CLS. 100, 101 AND 102).

FIRST USE 11-1-1998; IN COMMERCE 11-1-1998.

3,400,343. EMODA.COM CORPORATION, PHILADELPHIA, PA. SN 77-245,574. FILED P.R. 8-2-2007; AM. S.R. 1-8-2008.

ifashionmall

THE MARK CONSISTS OF STANDARD CHARACTERS WITHOUT CLAIM TO ANY PARTICULAR FONT, STYLE, SIZE, OR COLOR.

FOR ON-LINE RETAIL STORE SERVICES IN THE FIELD OF CLOTHING, CLOTHING ACCESSORIES, SHOES AND SLIPPERS, LEATHER GOODS AND BAGS (U.S. CLS. 100, 101 AND 102).

FIRST USE 12-15-2001; IN COMMERCE 12-15-2001.

3,400,355. SOULATI, SARA, INGLEWOOD, CA. SN 77-275,615. FILED 9-10-2007.

Global Cardio Care

THE MARK CONSISTS OF STANDARD CHARACTERS WITHOUT CLAIM TO ANY PARTICULAR FONT, STYLE, SIZE, OR COLOR.

NO CLAIM IS MADE TO THE EXCLUSIVE RIGHT TO USE "CARDIO CARE", APART FROM THE MARK AS SHOWN.

FOR MANAGEMENT OF HEALTH CARE CLINICS FOR OTHERS (U.S. CLS. 100, 101 AND 102).

FIRST USE 3-1-2002; IN COMMERCE 4-1-2002.

CLASS 35—(Continued).

3,400,359. INTERNATIONAL CITY/COUNTY MANAGEMENT ASSOCIATION (ICMA), WASHINGTON, DC. SN 77-284,381. FILED P.R. 9-20-2007; AM. S.R. 1-11-2008.

Center for Performance Measurement

THE MARK CONSISTS OF STANDARD CHARACTERS WITHOUT CLAIM TO ANY PARTICULAR FONT, STYLE, SIZE, OR COLOR.

FOR ASSOCIATION SERVICES, NAMELY, PROMOTING THE INTERESTS OF LOCAL AND INTERNATIONAL GOVERNMENTS (U.S. CLS. 100, 101 AND 102). FIRST USE 12-16-1997; IN COMMERCE 12-16-1997.

3,400,361. FRENCH, THOMAS, DUBLIN, CA. SN 77-288,978. FILED 9-26-2007.

Supply Chain Coach

THE MARK CONSISTS OF STANDARD CHARACTERS WITHOUT CLAIM TO ANY PARTICULAR FONT, STYLE, SIZE, OR COLOR.

FOR BUSINESS CONSULTING SERVICES RELATING TO PRODUCT DISTRIBUTION, OPERATIONS MANAGEMENT SERVICES, LOGISTICS, REVERSE LOGISTICS, SUPPLY CHAIN, AND PRODUCTION SYSTEMS AND DISTRIBUTION SOLUTIONS (U.S. CLS. 100, 101 AND 102).

FIRST USE 1-15-2005; IN COMMERCE 1-15-2005.

3,400,372. GREEK FINANCIAL MANAGEMENT, INC., BLOOMINGTON, IL. SN 78-555,699. FILED P.R. 1-28-2005; AM. S.R. 12-18-2006.

GREEK FINANCIAL MANAGEMENT

THE MARK CONSISTS OF STANDARD CHARACTERS WITHOUT CLAIM TO ANY PARTICULAR FONT, STYLE, SIZE, OR COLOR.

NO CLAIM IS MADE TO THE EXCLUSIVE RIGHT TO USE "FINANCIAL MANAGEMENT", APART FROM THE MARK AS SHOWN.

FOR BOOKKEEPING AND ACCOUNTING SERVICES, CONSULTING SERVICES IN BUSINESS ORGANIZATION AND MANAGEMENT (U.S. CLS. 100, 101 AND 102).

FIRST USE 3-0-2005; IN COMMERCE 3-0-2005.

CLASS 35—(Continued).

3,400,392. CREATIVE COMMERCE, LLC, NEW YORK, NY. SN 78-853,517. FILED P.R. 4-4-2006; AM. S.R. 12-3-2007.

INTERNATIONAL COMMERCE AGENCY

THE MARK CONSISTS OF STANDARD CHARACTERS WITHOUT CLAIM TO ANY PARTICULAR FONT, STYLE, SIZE, OR COLOR.

NO CLAIM IS MADE TO THE EXCLUSIVE RIGHT TO USE "AGENCY", APART FROM THE MARK AS SHOWN.

FOR ADVERTISING, MARKETING, AND PROMOTIONAL SERVICES; BUSINESS MARKETING CONSULTING SERVICES; PUBLIC RELATIONS; BUSINESS ADMINISTRATION; BUSINESS MANAGEMENT SERVICES; PROCURING OF CONTRACTS FOR THE PURCHASE AND SALE OF GOODS; ONLINE RETAIL STORES SERVICES FEATURING A WIDE VARIETY OF CONSUMER GOODS AND SERVICES OF OTHERS; PROVIDING HOME SHOPPING SERVICES FEATURING A WIDE VARIETY OF CONSUMER GOODS OF OTHERS BY MEANS OF TELEVISION AND THE INTERNET; IMPORT AND EXPORT AGENCY SERVICES; DIRECT RESPONSE RETAIL SERVICES BY MEANS OF INFORMATIONALS IN THE FIELD OF CONSUMER GOODS (U.S. CLS. 100, 101 AND 102).

FIRST USE 3-31-2006; IN COMMERCE 3-31-2006.

3,400,394. 1800DIAPERS, INC., NEPTUNE, NJ. SN 78-860,837. FILED 4-13-2006.

1800DIAPERS

THE MARK CONSISTS OF STANDARD CHARACTERS WITHOUT CLAIM TO ANY PARTICULAR FONT, STYLE, SIZE, OR COLOR.

FOR ON-LINE RETAIL STORE SERVICES FEATURING BABY-CARE PRODUCTS AND ACCESSORIES (U.S. CLS. 100, 101 AND 102).

FIRST USE 1-11-2005; IN COMMERCE 1-11-2005.

CLASS 35—(Continued).

3,400,404. MARKET AMERICA, INC., GREENSBORO, NC. SN 78-944,919. FILED P.R. 8-4-2006; AM. S.R. 1-28-2008.

marketamerica

OWNER OF U.S. REG. NOS. 1,847,850 AND 2,042,709. THE COLOR(S) BLACK AND BLUE IS/ARE CLAIMED AS A FEATURE OF THE MARK.

THE COLOR BLACK APPEARS IN THE WORD "MARKET". THE COLOR BLUE APPEARS IN THE WORD "AMERICA".

FOR WHOLESALE DISTRIBUTORSHIPS, ONLINE WHOLESALE DISTRIBUTORSHIPS, RETAIL STORE AND ONLINE RETAIL STORE SERVICES FEATURING DIETARY SUPPLEMENTS, NUTRITIONALLY FORTIFIED BEVERAGES, COSMETICS, FACE AND BODY CREAMS AND LOTIONS, SHAMPOOS, TOOTHPASTE, HOME AND AUTOMOTIVE CARE PRODUCTS, WATER FILTERS, WEIGHT MANAGEMENT FOOD AND BEVERAGE PRODUCTS, SPORTS DRINKS, COFFEE, CAPPUCCINO, HERBICIDES, INSECTICIDES, PESTICIDES AND FUNGICIDES FOR HOME, GARDEN AND LAWN USE AND FOR PROFESSIONAL USE; PROMOTING THE GOODS AND SERVICES OF OTHERS, NAMELY WEIGHT MANAGEMENT FOODS AND BEVERAGE PRODUCTS INCLUDING ON THE INTERNET; ADVERTISING AND MARKETING FOR OTHERS OF ON-LINE WEBSITES (U.S. CLS. 100, 101 AND 102).

FIRST USE 8-5-2006; IN COMMERCE 8-5-2006.

3,400,407. HANLEY-WOOD, LLC, WASHINGTON, DC. SN 78-959,722. FILED P.R. 8-24-2006; AM. S.R. 1-11-2008.

DECKEXPO

THE MARK CONSISTS OF STANDARD CHARACTERS WITHOUT CLAIM TO ANY PARTICULAR FONT, STYLE, SIZE, OR COLOR.

FOR ORGANIZING AND CONDUCTING TRADE SHOWS FEATURING PRODUCTS, MATERIALS, EQUIPMENT AND SERVICES RELATING TO THE DECK, DOCK AND RAILING INDUSTRY (U.S. CLS. 100, 101 AND 102).

FIRST USE 3-13-2003; IN COMMERCE 3-13-2003.

CLASS 35—(Continued).

3,400,408. INTERWORLD TELEVISION, INC, PLANO, TX. SN 78-966,741. FILED P.R. 9-4-2006; AM. S.R. 9-4-2006.

ARTWEENS

THE MARK CONSISTS OF STANDARD CHARACTERS WITHOUT CLAIM TO ANY PARTICULAR FONT, STYLE, SIZE, OR COLOR.

FOR PROMOTION USING AUDIOVISUAL MEDIA (U.S. CLS. 100, 101 AND 102).

FIRST USE 1-19-2006; IN COMMERCE 3-10-2006.

CLASS 36—INSURANCE AND FINANCIAL

3,400,278. INVESTMENT COUNSELORS OF REDLANDS LLC, REDLANDS, CA. SN 77-123,752. FILED P.R. 3-6-2007; AM. S.R. 12-19-2007.

**INVESTMENT COUNSELORS OF
REDLANDS**

THE MARK CONSISTS OF STANDARD CHARACTERS WITHOUT CLAIM TO ANY PARTICULAR FONT, STYLE, SIZE, OR COLOR.

NO CLAIM IS MADE TO THE EXCLUSIVE RIGHT TO USE "INVESTMENT COUNSELORS", APART FROM THE MARK AS SHOWN.

FOR INVESTMENT ADVISORY SERVICES (U.S. CLS. 100, 101 AND 102).

FIRST USE 7-1-2005; IN COMMERCE 1-10-2006.

3,400,282. MISSOURI PROFESSIONALS MUTUAL, ST. LOUIS, MO. SN 77-127,154. FILED P.R. 3-9-2007; AM. S.R. 12-20-2007.

**MISSOURI PROFESSIONALS
MUTUAL**

THE MARK CONSISTS OF STANDARD CHARACTERS WITHOUT CLAIM TO ANY PARTICULAR FONT, STYLE, SIZE, OR COLOR.

NO CLAIM IS MADE TO THE EXCLUSIVE RIGHT TO USE "MUTUAL", APART FROM THE MARK AS SHOWN.

FOR INSURANCE UNDERWRITING SERVICES IN THE FIELD OF MEDICAL MALPRACTICE (U.S. CLS. 100, 101 AND 102).

FIRST USE 1-31-2007; IN COMMERCE 1-31-2007.

CLASS 36—(Continued).

3,400,314. AMERICAN BANK & TRUST COMPANY, DBA AMBANK HOLDINGS, INC., DAVENPORT, IA. SN 77-150,856. FILED P.R. 4-6-2007; AM. S.R. 1-4-2008.

IMAGE CHECKING

THE MARK CONSISTS OF STANDARD CHARACTERS WITHOUT CLAIM TO ANY PARTICULAR FONT, STYLE, SIZE, OR COLOR.

NO CLAIM IS MADE TO THE EXCLUSIVE RIGHT TO USE "CHECKING", APART FROM THE MARK AS SHOWN. FOR BANKING SERVICES (U.S. CLS. 100, 101 AND 102).

FIRST USE 5-0-2007; IN COMMERCE 5-0-2007.

3,400,332. LEGACY MARKETING GROUP, PETALUMA, CA. SN 77-209,379. FILED P.R. 6-19-2007; AM. S.R. 12-10-2007.

Enhanced Care Rider

THE MARK CONSISTS OF STANDARD CHARACTERS WITHOUT CLAIM TO ANY PARTICULAR FONT, STYLE, SIZE, OR COLOR.

NO CLAIM IS MADE TO THE EXCLUSIVE RIGHT TO USE "RIDER", APART FROM THE MARK AS SHOWN.

FOR ANNUITY UNDERWRITING FEATURING AN OPTIONAL RIDER THAT GENERATES ADDITIONAL ANNUITY VALUE WHEN THE DESIGNATED ANNUITANT RECEIVES SPECIFIED CARE SERVICES (U.S. CLS. 100, 101 AND 102).

FIRST USE 4-22-2007; IN COMMERCE 4-22-2007.

3,400,339. SUSTAINABLE RESOURCE VENTURES, LLC, CONCORD, MA. SN 77-232,342. FILED P.R. 7-18-2007; AM. S.R. 1-3-2008.

SUSTAINABLE RESOURCE VENTURES

THE MARK CONSISTS OF STANDARD CHARACTERS WITHOUT CLAIM TO ANY PARTICULAR FONT, STYLE, SIZE, OR COLOR.

FOR FINANCIAL AND INVESTMENT SERVICES, NAMELY, THE MANAGEMENT OF PRIVATE EQUITY AND VENTURE CAPITAL INVESTMENT FUNDS (U.S. CLS. 100, 101 AND 102).

FIRST USE 5-22-2007; IN COMMERCE 5-22-2007.

CLASS 36—(Continued).

3,400,346. GARZA, RAYNALDO, MONARCH BEACH, CA. SN 77-252,911. FILED P.R. 8-10-2007; AM. S.R. 12-31-2007.

EL BANCO DE LAS VEGAS

THE MARK CONSISTS OF STANDARD CHARACTERS WITHOUT CLAIM TO ANY PARTICULAR FONT, STYLE, SIZE, OR COLOR.

NO CLAIM IS MADE TO THE EXCLUSIVE RIGHT TO USE "EL BANCO", APART FROM THE MARK AS SHOWN.

THE ENGLISH TRANSLATION OF THE WORD "EL BANCO DE" IN THE MARK IS THE BANK OF.

FOR BANKING SERVICES AND RELATED FINANCIAL SERVICES, NAMELY, PERSONAL AND BUSINESS SAVINGS, HOME LOANS, BUSINESS LOANS, INVESTMENT ADVISORY SERVICES AND PORTFOLIO ANALYSIS SERVICES (U.S. CLS. 100, 101 AND 102).

FIRST USE 9-17-2006; IN COMMERCE 5-5-2007.

3,400,401. JPMORGAN CHASE & CO., NEW YORK, NY. SN 78-924,835. FILED P.R. 7-7-2006; AM. S.R. 1-15-2008.

PROTECTED PORTFOLIO

THE MARK CONSISTS OF STANDARD CHARACTERS WITHOUT CLAIM TO ANY PARTICULAR FONT, STYLE, SIZE, OR COLOR.

FOR BANKING SERVICES; INVESTMENT BANKING SERVICES (U.S. CLS. 100, 101 AND 102).

FIRST USE 4-0-2006; IN COMMERCE 4-0-2006.

CLASS 39—TRANSPORTATION AND STORAGE

3,400,241. TRIPS2ITALY, LLC, HOUSTON, TX. SN 76-679,494. FILED P.R. 7-13-2007; AM. S.R. 1-4-2008.



FOR ARRANGING GUIDED, PACKAGED, AND PERSONALIZED TRAVEL TOURS; TRAVEL AGENCY, NAMELY, MAKING RESERVATIONS AND BOOKINGS FOR TRANSPORTATION; TRAVEL BOOKING AGENCIES (U.S. CLS. 100 AND 105).

FIRST USE 1-1-2003; IN COMMERCE 1-1-2003.

CLASS 40—MATERIAL TREATMENT

3,400,357. GERBER, RYAN D, CLEVELAND, OH. SN 77-276,626. FILED P.R. 9-11-2007; AM. S.R. 12-17-2007.

Gerber Fabrication

THE MARK CONSISTS OF STANDARD CHARACTERS WITHOUT CLAIM TO ANY PARTICULAR FONT, STYLE, SIZE, OR COLOR.

NO CLAIM IS MADE TO THE EXCLUSIVE RIGHT TO USE "FABRICATION", APART FROM THE MARK AS SHOWN.

FOR CUSTOM FABRICATION OF COUNTER TOPS; CABINET MAKING; CUSTOM CONSTRUCTION OF DISPLAY UNITS; PROVIDING WORKSHOP FACILITIES FOR BUILDING, WOODWORKING OR FRAMING PURPOSES; MILLWORKING (U.S. CLS. 100, 103 AND 106).
FIRST USE 1-1-2007; IN COMMERCE 1-1-2007.

CLASS 41—EDUCATION AND ENTERTAINMENT

3,400,229. HADDAD'S FINE ART INC., ANAHEIM, CA. SN 76-609,967. FILED P.R. 8-30-2004; AM. S.R. 12-22-2007.

GICLEE STUDIO

THE MARK CONSISTS OF STANDARD CHARACTERS WITHOUT CLAIM TO ANY PARTICULAR FONT, STYLE, SIZE, OR COLOR.

NO CLAIM IS MADE TO THE EXCLUSIVE RIGHT TO USE "GICLEE", APART FROM THE MARK AS SHOWN.

FOR FINE ART PUBLICATION SERVICES, NAMELY, SCANNING THE WORKS OF OTHERS WITH OPTIONAL COLOR CORRECTION AND IMAGE MANIPULATION; PREPARING DIGITAL FILES OF THE WORKS OF OTHERS FOR MAKING BOTH DIGITAL AND LITHOGRAPHIC REPRODUCTIONS; AND ARTISTIC SERVICES, NAMELY, HAND EMBELLISHING THE FINE ART WORKS OF OTHERS (U.S. CLS. 100, 101 AND 107).
FIRST USE 9-16-2004; IN COMMERCE 9-16-2004.

3,400,234. COLORADO SLEEP CENTER OF THE ROCKIES, LLC, LOVELAND, CO. SN 76-673,139. FILED P.R. 2-26-2007; AM. S.R. 12-17-2007.

COLORADO SLEEP SCHOOL OF THE ROCKIES

THE MARK CONSISTS OF STANDARD CHARACTERS WITHOUT CLAIM TO ANY PARTICULAR FONT, STYLE, SIZE, OR COLOR.

NO CLAIM IS MADE TO THE EXCLUSIVE RIGHT TO USE "SLEEP SCHOOL", APART FROM THE MARK AS SHOWN.

FOR EDUCATION SERVICES, NAMELY, PROVIDING CLASSES, SEMINARS, WORKSHOPS, TUTORING, AND MENTORING IN THE FIELD OF SLEEP MEDICINE (U.S. CLS. 100, 101 AND 107).
FIRST USE 12-15-2007; IN COMMERCE 12-15-2007.

CLASS 41—(Continued).

3,400,259. ONLINESEATS.COM INC., CHICAGO, IL. SN 77-103,288. FILED P.R. 2-9-2007; AM. S.R. 11-29-2007.

ONLINESEATS.COM

THE MARK CONSISTS OF STANDARD CHARACTERS WITHOUT CLAIM TO ANY PARTICULAR FONT, STYLE, SIZE, OR COLOR.

FOR ARRANGING FOR TICKET RESERVATIONS FOR SHOWS AND OTHER EVENTS (U.S. CLS. 100, 101 AND 107).

FIRST USE 8-15-2003; IN COMMERCE 8-15-2003.

3,400,267. RESSLER, MONIKA, NEW YORK, NY. SN 77-112,329. FILED P.R. 2-21-2007; AM. S.R. 1-8-2008.

SPIRITUAL CAPITALISM

THE MARK CONSISTS OF STANDARD CHARACTERS WITHOUT CLAIM TO ANY PARTICULAR FONT, STYLE, SIZE, OR COLOR.

FOR EDUCATION SERVICES, NAMELY, PROVIDING SEMINARS, LECTURES AND WORKSHOPS IN THE FIELD OF SELF HELP, AND EMPOWERMENT (U.S. CLS. 100, 101 AND 107).

FIRST USE 1-1-2003; IN COMMERCE 9-1-2004.

3,400,277. TELEVISION FOOD NETWORK, G.P., NEW YORK, NY. SN 77-123,063. FILED P.R. 3-6-2007; AM. S.R. 1-9-2008.

QUICK FIX MEALS

THE MARK CONSISTS OF STANDARD CHARACTERS WITHOUT CLAIM TO ANY PARTICULAR FONT, STYLE, SIZE, OR COLOR.

FOR ENTERTAINMENT SERVICES IN THE NATURE OF AN ON-GOING FOOD PROGRAM BROADCAST OVER TELEVISION, VIA SATELLITE, AND THROUGH OTHER AUDIOVISUAL MEDIA (U.S. CLS. 100, 101 AND 107).

FIRST USE 4-30-2006; IN COMMERCE 4-30-2006.

CLASS 41—(Continued).

3,400,280. SUNSTONE YOGA, L.L.C., DALLAS, TX. SN 77-124,509. FILED P.R. 3-7-2007; AM. S.R. 12-10-2007.

PAIN FREE YOGA

THE MARK CONSISTS OF STANDARD CHARACTERS WITHOUT CLAIM TO ANY PARTICULAR FONT, STYLE, SIZE, OR COLOR.

NO CLAIM IS MADE TO THE EXCLUSIVE RIGHT TO USE "YOGA", APART FROM THE MARK AS SHOWN.

FOR YOGA INSTRUCTION; EDUCATION SERVICES, NAMELY, PROVIDING CLASSES, SEMINARS, CONFERENCES AND WORKSHOPS IN THE FIELDS OF YOGA, FITNESS, HEALTH, AND MASSAGE THERAPY, AND DISTRIBUTING COURSE MATERIALS IN CONNECTION THEREWITH; YOGA INSTRUCTION, NAMELY, EDUCATIONAL TRAINING COURSES TO CERTIFY YOGA INSTRUCTORS (U.S. CLS. 100, 101 AND 107).

FIRST USE 8-1-2006; IN COMMERCE 8-1-2006.

3,400,281. SUNSTONE YOGA, L.L.C., DALLAS, TX. SN 77-124,534. FILED P.R. 3-7-2007; AM. S.R. 12-10-2007.

GET PAID TO DO YOGA

THE MARK CONSISTS OF STANDARD CHARACTERS WITHOUT CLAIM TO ANY PARTICULAR FONT, STYLE, SIZE, OR COLOR.

FOR YOGA INSTRUCTION, NAMELY, PROMOTING ATTENDANCE IN YOGA CLASSES BY MEANS OF A PREFERRED CUSTOMER PROGRAM FEATURING DISCOUNTS AND RELATED BENEFITS TO REWARD CUSTOMERS (U.S. CLS. 100, 101 AND 107).

FIRST USE 11-1-2005; IN COMMERCE 1-1-2006.

3,400,288. PADAMA, ARTURO, WALDORF, MD. AND PADAMA, TRINIDAD PANGALIMAN, WALDORF, MD. SN 77-134,557. FILED P.R. 3-19-2007; AM. S.R. 11-25-2007.

Miss Teenage Philippines

THE MARK CONSISTS OF STANDARD CHARACTERS WITHOUT CLAIM TO ANY PARTICULAR FONT, STYLE, SIZE, OR COLOR.

FOR ENTERTAINMENT IN THE NATURE OF BEAUTY PAGEANTS (U.S. CLS. 100, 101 AND 107).

FIRST USE 5-27-2007; IN COMMERCE 5-27-2007.

CLASS 41—(Continued).

3,400,296. AMERICAN STRING TEACHERS ASSOCIATION, FAIRFAX, VA. SN 77-139,665. FILED P.R. 3-25-2007; AM. S.R. 1-4-2008.

CERTIFICATE PROGRAM FOR STRINGS

THE MARK CONSISTS OF STANDARD CHARACTERS WITHOUT CLAIM TO ANY PARTICULAR FONT, STYLE, SIZE, OR COLOR.

NO CLAIM IS MADE TO THE EXCLUSIVE RIGHT TO USE "PROGRAM", APART FROM THE MARK AS SHOWN.

FOR EDUCATIONAL SERVICES, NAMELY, CONDUCTING PROGRAMS AND EDUCATIONAL ASSESSMENT OF STUDENTS' TECHNICAL AND MUSICAL PROGRESS IN THE FIELD OF STRING INSTRUMENTS, AND DISTRIBUTION, OF CURRICULUM GUIDE MATERIAL FOR SELECTION OF STUDY, THEREWITH (U.S. CLS. 100, 101 AND 107).

FIRST USE 12-31-1997; IN COMMERCE 12-31-1997.

3,400,297. DEMRAY, WILLIAM S., NORTHVILLE, MI. AND LEBLOCH, DENISE S., ST. CHARLES, IL. SN 77-139,850. FILED P.R. 3-26-2007; AM. S.R. 12-23-2007.

PRESERVATION DENTAL

THE MARK CONSISTS OF STANDARD CHARACTERS WITHOUT CLAIM TO ANY PARTICULAR FONT, STYLE, SIZE, OR COLOR.

FOR EDUCATIONAL SERVICES, NAMELY, CONDUCTING SEMINARS IN THE FIELD OF DENTISTRY (U.S. CLS. 100, 101 AND 107).

FIRST USE 7-0-2004; IN COMMERCE 7-0-2004.

3,400,302. QUATRAIN MEDIA, LLC, WOODBURY, NY. SN 77-142,239. FILED P.R. 3-28-2007; AM. S.R. 1-7-2008.

TOY COLLECTOR MAGAZINE

THE MARK CONSISTS OF STANDARD CHARACTERS WITHOUT CLAIM TO ANY PARTICULAR FONT, STYLE, SIZE, OR COLOR.

NO CLAIM IS MADE TO THE EXCLUSIVE RIGHT TO USE "MAGAZINE", APART FROM THE MARK AS SHOWN.

FOR ONLINE MAGAZINE IN THE FIELD OF TOYS (U.S. CLS. 100, 101 AND 107).

FIRST USE 6-1-2007; IN COMMERCE 6-1-2007.

CLASS 41—(Continued).

3,400,310. THE GILLETTE COMPANY, BOSTON, MA. SN 77-147,492. FILED P.R. 4-3-2007; AM. S.R. 12-27-2007.

FAST CARS & SUPERSTARS

THE MARK CONSISTS OF STANDARD CHARACTERS WITHOUT CLAIM TO ANY PARTICULAR FONT, STYLE, SIZE, OR COLOR.

FOR ENTERTAINMENT SERVICES IN THE NATURE OF AN ON-GOING REALITY BASED TELEVISION PROGRAM; PROVIDING INFORMATION IN THE FIELD OF ENTERTAINMENT FEATURING INFORMATION ON A REALITY BASED TELEVISION PROGRAM BY MEANS OF A GLOBAL COMPUTER NETWORK (U.S. CLS. 100, 101 AND 107).

FIRST USE 6-7-2007; IN COMMERCE 6-7-2007.

3,400,345. UNITED STATES POLO ASSOCIATION, LEXINGTON, KY. SN 77-251,136. FILED P.R. 8-9-2007; AM. S.R. 12-14-2007.

NATIONAL TWENTY GOAL

THE MARK CONSISTS OF STANDARD CHARACTERS WITHOUT CLAIM TO ANY PARTICULAR FONT, STYLE, SIZE, OR COLOR.

NO CLAIM IS MADE TO THE EXCLUSIVE RIGHT TO USE "TWENTY GOAL", APART FROM THE MARK AS SHOWN.

FOR ENTERTAINMENT SERVICES, NAMELY, ORGANIZING AND CONDUCTING POLO EVENTS AND TOURNAMENTS (U.S. CLS. 100, 101 AND 107).

FIRST USE 0-0-2006; IN COMMERCE 0-0-2006.

CLASS 41—(Continued).

3,400,347. GARZA, RAYNALDO, MONARCH CITY, CA. SN 77-253,135. FILED P.R. 8-12-2007; AM. S.R. 1-8-2008.

MEXICAN MOVIE CRITIC

THE MARK CONSISTS OF STANDARD CHARACTERS WITHOUT CLAIM TO ANY PARTICULAR FONT, STYLE, SIZE, OR COLOR.

NO CLAIM IS MADE TO THE EXCLUSIVE RIGHT TO USE "MOVIE CRITIC", APART FROM THE MARK AS SHOWN.

FOR ENTERTAINMENT SERVICES, NAMELY, LIVE STAGE PERFORMANCES BY A FICTIONAL CHARACTER; ENTERTAINMENT IN THE NATURE OF AN ONGOING TELEVISION PROGRAM FEATURING PERFORMANCES BY A FICTIONAL CHARACTER; ENTERTAINMENT SERVICES IN THE NATURE OF LIVE STAGE PERFORMANCES TRANSMITTED VIA SATELLITE OR GLOBAL COMPUTER NETWORKS AND PRESENTED BY WAY OF ON-GOING TELEVISION, RADIO AND INTERNET PROGRAMS FEATURING COMEDY AND MUSICAL PERFORMANCES AND DEMONSTRATIONS AND/OR DISCUSSIONS RELATING TO COOKING, POLITICS, CURRENT NEWS, FINANCE, SPORTS, MOTION PICTURES, BEAUTY PAGEANTS AND AWARD SHOWS; PRODUCTION AND DISTRIBUTION OF TELEVISION AND RADIO PROGRAMS; PRODUCTION AND DISTRIBUTION OF TELEVISION AND RADIO PROGRAMS VIA THE INTERNET FOR OTHERS; PRODUCTION OF AUDIO AND VIDEO RECORDINGS FOR OTHERS (U.S. CLS. 100, 101 AND 107).

FIRST USE 6-21-2007; IN COMMERCE 7-26-2007.

3,400,348. COLE, RICHARD M., FAIRFAX, VA. AND REAGLE, WILLIAM P., FAIRFAX, VA. AND REAGLE, JESSICA M., FAIRFAX, VA. AND TROCCOLI, FRANK, FAIRFAX, VA. AND KOVALCIK, JEROME, FAIRFAX, VA. AND FARTHING, JESSE L., FAIRFAX, VA. SN 77-256,393. FILED P.R. 8-15-2007; AM. S.R. 12-14-2007.

THE WASHINGTON AREA'S FAVORITE PARTY BAND!

THE MARK CONSISTS OF STANDARD CHARACTERS WITHOUT CLAIM TO ANY PARTICULAR FONT, STYLE, SIZE, OR COLOR.

FOR ENTERTAINMENT, NAMELY, LIVE PERFORMANCES BY A MUSICAL BAND (U.S. CLS. 100, 101 AND 107).

FIRST USE 2-1-2007; IN COMMERCE 2-1-2007.

CLASS 41—(Continued).

3,400,349. /RAYNALDO GARZA/, MONARCH BEACH, CA. SN 77-258,249. FILED P.R. 8-17-2007; AM. S.R. 1-2-2008.

CHINESE NEW YEAR LAS VEGAS

THE MARK CONSISTS OF STANDARD CHARACTERS WITHOUT CLAIM TO ANY PARTICULAR FONT, STYLE, SIZE, OR COLOR.

FOR ENTERTAINMENT SERVICES, NAMELY, CONDUCTING AN ANNUAL FESTIVAL FEATURING PARADES, MUSICAL CONCERTS, SHOWS, PAGEANTS, ARTS AND CRAFTS, DANCING, GAMES AND FOOD, RAFFLES, A STREET CARNIVAL, CULTURAL EVENTS, GOLF, MARATHON AND BICYCLE TOURNAMENTS, CASINO GAMING, MASQUERADE PARTIES, COSTUME, SINGING, DANCING AND COOKING CONTESTS; PROVIDING A HALL OF FAME MUSEUM FEATURING ITEMS FROM EVERY ASPECT OF THE ASIAN CULTURE; EDUCATIONAL SERVICES IN THE NATURE OF TOURNAMENTS AND CONTESTS, NAMELY, READING, WRITING, AND ARITHMETIC, SPELLING, SCIENCE, HISTORY, HEALTH AND FITNESS AND ARTS AND CRAFTS; ENTERTAINMENT SERVICES, IN THE NATURE OF TOURNAMENTS AND CONTESTS, NAMELY, RODEOS, BOXING, GAMING, SOCCER, FOOTBALL, RUGBY, GAMING, BASEBALL, GOLF, RUNNING, VOLLEYBALL, BASKETBALL, CAR RACING, SWIMMING, MARATHONS, TRIATHLONS, KARATE, CYCLING, BILLIARDS, STREET BASKETBALL, JOKES, MAGIC, SINGING, DANCING, ART, COOKING AND FASHION; ENTERTAINMENT SERVICES, NAMELY, LIVE STAGE PERFORMANCES FEATURING ASIAN MUSIC AND DANCE, AND ONGOING TELEVISION, SATELLITE, RADIO AND INTERNET PROGRAMS IN THE FIELDS OF COMEDY, MUSIC, AND ASIAN CULTURE; AND PRODUCTION AND DISTRIBUTION OF TELEVISION, RADIO AND INTERNET PROGRAMS FOR OTHERS (U.S. CLS. 100, 101 AND 107).

FIRST USE 5-6-2007; IN COMMERCE 6-20-2007.

3,400,352. THE INSTITUTE OF MEDICINE AND PUBLIC HEALTH OF NEW JERSEY, INC., LAWRENCEVILLE, NJ. SN 77-272,051. FILED P.R. 9-5-2007; AM. S.R. 1-9-2008.

INSTITUTE OF MEDICINE AND PUBLIC HEALTH

THE MARK CONSISTS OF STANDARD CHARACTERS WITHOUT CLAIM TO ANY PARTICULAR FONT, STYLE, SIZE, OR COLOR.

NO CLAIM IS MADE TO THE EXCLUSIVE RIGHT TO USE "INSTITUTE", APART FROM THE MARK AS SHOWN.

FOR MEDICAL TRAINING AND TEACHING; ORGANISATION OF CONFERENCES AND SYMPOSIA IN THE FIELD OF MEDICAL SCIENCE; PROVIDING CONTINUING MEDICAL EDUCATION COURSES (U.S. CLS. 100, 101 AND 107).

FIRST USE 12-1-2003; IN COMMERCE 12-1-2003.

CLASS 41—(Continued).

3,400,365. EXPERT ADMISSIONS, LLC, CORAL GABLES, FL. SN 77-291,152. FILED 9-28-2007.

EXPERT ADMISSIONS

THE MARK CONSISTS OF STANDARD CHARACTERS WITHOUT CLAIM TO ANY PARTICULAR FONT, STYLE, SIZE, OR COLOR.

FOR EDUCATIONAL COUNSELING SERVICES, NAMELY, ASSISTING STUDENTS IN PLANNING AND PREPARING FOR FURTHER EDUCATION, IN SELECTING AND APPLYING TO COLLEGES AND UNIVERSITIES AND IN APPLYING FOR SCHOLARSHIPS AND FINANCIAL AID (U.S. CLS. 100, 101 AND 107).

FIRST USE 9-14-2007; IN COMMERCE 9-14-2007.

3,400,384. PYRAMID PRODUCTIONS INC., CALGARY, CANADA. SN 78-764,428. FILED P.R. 12-1-2005; AM. S.R. 2-5-2008.

BOOKS INTO FILM

THE MARK CONSISTS OF STANDARD CHARACTERS WITHOUT CLAIM TO ANY PARTICULAR FONT, STYLE, SIZE, OR COLOR.

PRIORITY CLAIMED UNDER SEC. 44(D) ON CANADA APPLICATION NO. 1281416, FILED 9-30-2005, REG. NO. TMA702005, DATED 11-29-2007, EXPIRES 11-29-2022.

FOR ENTERTAINMENT IN THE NATURE OF ONGOING TELEVISION PROGRAMS IN THE FIELD OF POPULAR CULTURE; ENTERTAINMENT SERVICES, NAMELY, PROVIDING A TELEVISION PROGRAM IN THE FIELD OF POPULAR CULTURE VIA A GLOBAL COMPUTER NETWORK; PRODUCTION OF CABLE TELEVISION PROGRAMS; PRODUCTION OF TELEVISION PROGRAMS; TELEVISION PRODUCTION; TELEVISION SHOW PRODUCTION (U.S. CLS. 100, 101 AND 107).

CLASS 41—(Continued).

3,400,403. SOURCE MEDIA INC., NEW YORK, NY. SN 78-943,397. FILED P.R. 8-2-2006; AM. S.R. 6-11-2007.

INVESTMENT ADVISER COMPLIANCE CERTIFICATE PROGRAM

THE MARK CONSISTS OF STANDARD CHARACTERS WITHOUT CLAIM TO ANY PARTICULAR FONT, STYLE, SIZE, OR COLOR.

NO CLAIM IS MADE TO THE EXCLUSIVE RIGHT TO USE "CERTIFICATE PROGRAM", APART FROM THE MARK AS SHOWN.

FOR PROFESSIONAL EDUCATIONAL SERVICES, NAMELY, CLASSES, TRAINING SESSIONS, SEMINARS AND ONLINE SEMINARS IN THE FIELD OF FINANCIAL REGULATIONS FOR FINANCIAL AND COMPLIANCE PROFESSIONALS (U.S. CLS. 100, 101 AND 107).

FIRST USE 10-11-2004; IN COMMERCE 10-11-2004.

CLASS 42—SCIENTIFIC AND COMPUTER SERVICES

3,400,232. BERNETT RESEARCH SERVICES, INC., DBA BERNETT RESEARCH, BOSTON, MA. SN 76-659,222. FILED P.R. 4-27-2006; AM. S.R. 4-5-2007.

THE DELIBERATION CENTER

THE MARK CONSISTS OF STANDARD CHARACTERS WITHOUT CLAIM TO ANY PARTICULAR FONT, STYLE, SIZE, OR COLOR.

NO CLAIM IS MADE TO THE EXCLUSIVE RIGHT TO USE "CENTER", APART FROM THE MARK AS SHOWN.

FOR LEGAL SERVICES, NAMELY, MOCK JURY SURVEYING FOR MODELING TRIAL OUTCOMES BY MEANS OF DATA COLLECTED FROM POLLING, IN-PERSON AND ONLINE FOCUS GROUPS, SURVEYS AND QUESTIONNAIRES, AND TABULATION AND ANALYSIS OF SUCH DATA TO PROVIDE JURY PROFILING INFORMATION TO AID JURY SELECTION AND DEVELOPING TRIAL STRATAGEMS FOR LAW FIRMS AND THIRD PARTY AGENTS (U.S. CLS. 100 AND 101).

FIRST USE 4-2-2007; IN COMMERCE 4-2-2007.

3,400,237. SORENSON GENOMICS, L.L.C., SALT LAKE CITY, UT. SN 76-673,885. FILED P.R. 3-12-2007; AM. S.R. 12-27-2007.

SORENSON FORENSICS

THE MARK CONSISTS OF STANDARD CHARACTERS WITHOUT CLAIM TO ANY PARTICULAR FONT, STYLE, SIZE, OR COLOR.

NO CLAIM IS MADE TO THE EXCLUSIVE RIGHT TO USE FORENSICS, APART FROM THE MARK AS SHOWN.

FOR LABORATORY SERVICES, NAMELY, DNA-BASED HUMAN IDENTIFICATION TESTING FOR FORENSIC PURPOSES (U.S. CLS. 100 AND 101).

FIRST USE 10-3-2006; IN COMMERCE 10-3-2006.

CLASS 42—(Continued).

3,400,264. THE ACTIVE NETWORK, INC., SAN DIEGO, CA. SN 77-106,621. FILED P.R. 2-13-2007; AM. S.R. 1-7-2008.

Event Console

THE MARK CONSISTS OF STANDARD CHARACTERS WITHOUT CLAIM TO ANY PARTICULAR FONT, STYLE, SIZE, OR COLOR.

FOR PROVIDING WEB-BASED NON-DOWNLOADABLE CORPORATE EVENT MANAGEMENT AND PLANNING SOFTWARE (U.S. CLS. 100 AND 101).

FIRST USE 4-25-2006; IN COMMERCE 4-25-2006.

3,400,268. TONY C. BADALATO, THOUSAND OAKS, CA. SN 77-114,074. FILED P.R. 2-22-2007; AM. S.R. 12-11-2007.

L.A. Design Studio

THE MARK CONSISTS OF STANDARD CHARACTERS WITHOUT CLAIM TO ANY PARTICULAR FONT, STYLE, SIZE, OR COLOR.

NO CLAIM IS MADE TO THE EXCLUSIVE RIGHT TO USE "DESIGN", APART FROM THE MARK AS SHOWN.

FOR COMPUTER AIDED DESIGN FOR OTHERS; COMPUTER NETWORK DESIGN FOR OTHERS; COMPUTER SERVICES IN THE NATURE OF CUSTOMIZED WEB PAGES FEATURING USER-DEFINED INFORMATION, PERSONAL PROFILES AND INFORMATION; COMPUTER SERVICES, NAMELY, DESIGNING AND IMPLEMENTING NETWORK WEB PAGES FOR OTHERS; COMPUTER SERVICES, NAMELY, MANAGING WEB SITES FOR OTHERS; GRAPHIC DESIGN SERVICES; HOSTING THE WEB SITES OF OTHERS ON A COMPUTER SERVER FOR A GLOBAL COMPUTER NETWORK (U.S. CLS. 100 AND 101).

FIRST USE 11-16-2000; IN COMMERCE 11-16-2000.

CLASS 42—(Continued).

3,400,272. ENKI LLC, MOUNTAIN VIEW, CA. SN 77-116,152.
FILED P.R. 2-26-2007; AM. S.R. 1-16-2008.

Computing Utility

THE MARK CONSISTS OF STANDARD CHARACTERS WITHOUT CLAIM TO ANY PARTICULAR FONT, STYLE, SIZE, OR COLOR.

FOR APPLICATION SERVICE PROVIDER (ASP), NAMELY, HOSTING COMPUTER SOFTWARE APPLICATIONS OF OTHERS; COMPUTER COLOCATION SERVICES, NAMELY, PROVIDING FACILITIES FOR THE LOCATION OF COMPUTER SERVERS WITH THE EQUIPMENT OF OTHERS; COMPUTER CONSULTATION IN THE FIELD OF COMPUTER SECURITY; COMPUTER DIAGNOSTIC SERVICES; COMPUTER MONITORING SERVICE WHICH TRACKS HARDWARE PERFORMANCE AND PROCESSES AND SENDS OUT HISTORICAL REPORTS AND ALERTS; COMPUTER SECURITY SERVICE, NAMELY, RESTRICTING ACCESS TO AND BY COMPUTER NETWORKS TO AND OF UNDESIRE WEB SITES, MEDIA AND INDIVIDUALS AND FACILITIES; COMPUTER SERVICES, NAMELY, MONITORING AND REPORTING ON THE PERFORMANCE, AVAILABILITY, AND ERRORS OF WEBSITES OF OTHERS; COMPUTER SERVICES, NAMELY, MONITORING, TESTING, ANALYZING, AND REPORTING ON THE INTERNET TRAFFIC CONTROL AND CONTENT CONTROL OF THE WEBSITES OF OTHERS; COMPUTER SERVICES, NAMELY, DATA RECOVERY SERVICES; COMPUTER SERVICES, NAMELY, MONITORING THE WEBSITES OF OTHERS TO IMPROVE SCALABILITY AND PERFORMANCE OF WEBSITES OF OTHERS; COMPUTER TIME-SHARING SERVICES; HOSTING OF DIGITAL CONTENT ON THE INTERNET; HOSTING THE WEB SITES OF OTHERS ON A COMPUTER SERVER FOR A GLOBAL COMPUTER NETWORK; INSTALLATION OF COMPUTER SOFTWARE; LEASING COMPUTER FACILITIES; MONITORING THE COMPUTER SYSTEMS OF OTHERS FOR TECHNICAL PURPOSES AND PROVIDING BACK-UP COMPUTER PROGRAMS AND FACILITIES; PERIODIC UPGRADING OF COMPUTER SOFTWARE FOR OTHERS; RECOVERY OF COMPUTER DATA; REMOTE MONITORING SERVICES OF HEATING, VENTILATING AND AIR CONDITIONING APPARATUS; RENTAL OF A DATABASE SERVER (TO THIRD PARTIES); RENTAL OF WEB SERVERS; TECHNICAL SUPPORT, NAMELY, MONITORING OF NETWORK SYSTEMS; UPDATING OF COMPUTER SOFTWARE FOR OTHERS; WEB SITE HOSTING SERVICES (U.S. CLS. 100 AND 101).
FIRST USE 2-25-2007; IN COMMERCE 2-25-2007.

3,400,291. THE ACTIVE NETWORK, INC., SAN DIEGO, CA.
SN 77-135,432. FILED P.R. 3-20-2007; AM. S.R. 1-7-2008.

Speaker Resource Center

THE MARK CONSISTS OF STANDARD CHARACTERS WITHOUT CLAIM TO ANY PARTICULAR FONT, STYLE, SIZE, OR COLOR.

FOR PROVIDING WEB-BASED NON-DOWNLOADABLE CORPORATE EVENT MANAGEMENT AND PLANNING SOFTWARE USED BY SESSION SPEAKERS AND CONTENT MANAGERS (U.S. CLS. 100 AND 101).
FIRST USE 6-1-2003; IN COMMERCE 6-1-2003.

CLASS 42—(Continued).

3,400,304. THE ACTIVE NETWORK, INC., SAN DIEGO, CA.
SN 77-144,038. FILED P.R. 3-29-2007; AM. S.R. 1-7-2008.

Exhibitor Resource Center

THE MARK CONSISTS OF STANDARD CHARACTERS WITHOUT CLAIM TO ANY PARTICULAR FONT, STYLE, SIZE, OR COLOR.

FOR PROVIDING WEB-BASED NON-DOWNLOADABLE CORPORATE EVENT MANAGEMENT AND PLANNING SOFTWARE USED BY EVENT EXHIBITORS AND SUPPORT STAFF (U.S. CLS. 100 AND 101).
FIRST USE 9-1-2003; IN COMMERCE 9-1-2003.

3,400,309. IMT PARTNERS INC., NORTH CHELMSFORD, MA. SN 77-147,101. FILED P.R. 4-3-2007; AM. S.R. 1-7-2008.

ACTIVE STORAGE COST MANAGEMENT

THE MARK CONSISTS OF STANDARD CHARACTERS WITHOUT CLAIM TO ANY PARTICULAR FONT, STYLE, SIZE, OR COLOR.

FOR TECHNOLOGICAL CONSULTATION IN THE TECHNOLOGY FIELD OF DATA MANAGEMENT AND STORAGE (U.S. CLS. 100 AND 101).
FIRST USE 6-30-2006; IN COMMERCE 6-30-2006.

3,400,327. FIREPOND, INC., NEWTON, MA. SN 77-190,937.
FILED P.R. 5-25-2007; AM. S.R. 1-9-2008.

CONFIGURE-PRICE-QUOTE

THE MARK CONSISTS OF STANDARD CHARACTERS WITHOUT CLAIM TO ANY PARTICULAR FONT, STYLE, SIZE, OR COLOR.

FOR PROVIDING ONLINE NON-DOWNLOADABLE SOFTWARE, NAMELY, PROVIDING AN ONLINE NON-DOWNLOADABLE SUITE OF COMPUTER SOFTWARE THAT ENABLES A COMPANY'S SALES FORCE AND SUPPORTING ORGANIZATIONS TO CONFIGURE COMPLEX PRODUCTS AND SERVICES, ACCURATELY PRICE PRODUCTS AND SERVICES, DEVELOP PRICE QUOTES, GENERATE HIGH QUALITY PROPOSALS, AUTOMATE AND SIMPLIFY PRODUCT PRICING AND CONFIGURATION, IMPROVE ORDER ACCURACY AND REDUCE THE COST OF SALES, OPTIMIZE SALES PROCESSES, CREATE PRODUCT CATALOGS, AND PROVIDE AN INTERACTIVE SELLING SYSTEM (U.S. CLS. 100 AND 101).

FIRST USE 8-0-2005; IN COMMERCE 8-0-2005.

CLASS 42—(Continued).

3,400,336. IMPLIX SP. Z O.O., GDYNIA, POLAND. SN 77-230,257. FILED P.R. 7-16-2007; AM. S.R. 11-5-2007.

WEBSITEWIZARD

THE MARK CONSISTS OF STANDARD CHARACTERS WITHOUT CLAIM TO ANY PARTICULAR FONT, STYLE, SIZE, OR COLOR.

FOR COMPUTER HARDWARE AND SOFTWARE CONSULTING SERVICES; SUPPORT AND CONSULTATION SERVICES FOR MANAGING COMPUTER SYSTEMS, NAMELY, PROVIDING DATA MANAGEMENT, APPLICATION MANAGEMENT, AND PERFORMANCE OPTIMIZATION AND RECOVERY OF MAINFRAME AND DISTRIBUTED SYSTEMS COMPUTERS AND THE DATABASES AND BUSINESS APPLICATIONS, PROGRAMS, AND SYSTEMS THAT OPERATE THEREIN; INFORMATION RELATING TO COMPUTER HARDWARE OR SOFTWARE PROVIDED ON-LINE FROM A GLOBAL COMPUTER NETWORK OR THE INTERNET, NAMELY, INFORMATION RELATING TO WEB-SITES BUILDER SOFTWARE; GRAPHIC DESIGN FOR THE COMPILATION OF WEB PAGES ON THE INTERNET; PROVISION OF WEB PAGES TO AND FOR THIRD PARTIES; CREATING AND MAINTAINING WEB-SITES FOR OTHERS; HOSTING THE WEB-SITES OF OTHERS; COMPUTER SERVICES, NAMELY, DESIGN, CONSTRUCTION, MAINTENANCE AND HOSTING OF WEB SITES FOR OTHERS; HOSTING THE ONLINE AND MULTIMEDIA CONTENT OF OTHERS VIA A WEB SITE ON A GLOBAL COMPUTER NETWORK AND OTHER COMMUNICATION NETWORKS; TECHNICAL SUPPORT SERVICES, NAMELY, PROVIDING HELP DESK SERVICES AND ADVICE REGARDING WEB SITE DESIGN, CONSTRUCTION, MAINTENANCE, OPTIMIZATION, AND REGARDING THE CREATION OF ONLINE COMMUNITIES AND PERSONAL PORTALS; HOSTING OF DIGITAL CONTENT ON THE INTERNET, NAMELY, DIGITAL IMAGE HOSTING SERVICES; PROVIDING A WEBSITE FOR USE BY OTHERS TO DESIGN AND BUILD WEBSITES CONTAINING INSTANT MESSAGING, MESSAGE BOARDS, EMAIL, VIDEO EMAIL, WEBCAM, ECOMMERCE CAPABILITIES AND OTHER TECHNOLOGIES, NAMELY, E-PRODUCTS DISTRIBUTION AND PAYMENT SYSTEM (U.S. CLS. 100 AND 101). FIRST USE 10-1-2002; IN COMMERCE 1-1-2003.

CLASS 42—(Continued).

3,400,364. ENSAGA ENERGY GROUP LLC, TULSA, OK. SN 77-289,529. FILED 9-26-2007.

VIRTUAL DRILLING

THE MARK CONSISTS OF STANDARD CHARACTERS WITHOUT CLAIM TO ANY PARTICULAR FONT, STYLE, SIZE, OR COLOR.

NO CLAIM IS MADE TO THE EXCLUSIVE RIGHT TO USE "VIRTUAL", APART FROM THE MARK AS SHOWN.

FOR ANALYSIS AND TESTING FOR OIL WORKINGS; ANALYSIS FOR OIL RESEARCH; ANALYSIS OF OIL FIELDS; ANALYSIS SERVICES FOR OIL FIELD EXPLORATION; EXPLORATION AND SEARCHING OF OIL AND GAS; GAS EXPLORATION; GEOPHYSICAL EXPLORATION FOR THE OIL, GAS AND MINING INDUSTRIES; OIL EXPLORATION; OIL FIELD EXPLORATION; OIL FIELD SURVEYING; OIL PROSPECTING; OIL PROSPECTING, NAMELY, WELL LOGGING AND TESTING; PETROLEUM EXPLORATION; PROVIDING TECHNOLOGY INFORMATION IN THE OIL AND GAS INDUSTRY; SURVEYING OF OIL BEDS AND FIELDS (U.S. CLS. 100 AND 101).

FIRST USE 6-1-2005; IN COMMERCE 6-1-2005.

3,400,368. ZABA, INC., WOODLAND HILLS, CA. SN 77-297,812. FILED 10-5-2007.

PEOPLEDATA

THE MARK CONSISTS OF STANDARD CHARACTERS WITHOUT CLAIM TO ANY PARTICULAR FONT, STYLE, SIZE, OR COLOR.

FOR PROVIDING INFORMATION AT THE SPECIFIC REQUEST OF END-USERS BY MEANS OF TELEPHONE OR GLOBAL COMPUTER NETWORKS (U.S. CLS. 100 AND 101).

FIRST USE 2-22-2002; IN COMMERCE 5-7-2002.

3,400,391. ENGINEERSHOWWRITE, SANTA CLARA, CA. SN 78-843,928. FILED P.R. 3-23-2006; AM. S.R. 3-5-2007.

EngineersWhoWrite

THE MARK CONSISTS OF STANDARD CHARACTERS WITHOUT CLAIM TO ANY PARTICULAR FONT, STYLE, SIZE, OR COLOR.

FOR TECHNICAL WRITING FOR OTHERS (U.S. CLS. 100 AND 101).

FIRST USE 7-4-2005; IN COMMERCE 7-18-2005.

CLASS 42—(Continued).

3,400,396. CODEMANTRA, LLC, PLYMOUTH MEETING, PA. SN 78-863,324. FILED P.R. 4-18-2006; AM. S.R. 11-19-2007.

UNIVERSAL PDF

THE MARK CONSISTS OF STANDARD CHARACTERS WITHOUT CLAIM TO ANY PARTICULAR FONT, STYLE, SIZE, OR COLOR.

NO CLAIM IS MADE TO THE EXCLUSIVE RIGHT TO USE "PDF", APART FROM THE MARK AS SHOWN.

FOR COMPUTER SERVICES, NAMELY, CONVERSION OF ELECTRONIC DOCUMENTS FROM DIFFERENT FILE FORMATS INTO PORTABLE DOCUMENT FORMAT (PDF) (U.S. CLS. 100 AND 101).

FIRST USE 11-1-2004; IN COMMERCE 11-1-2004.

3,400,406. PROCESS DYNAMICS, INC., FAYETTEVILLE, AR. SN 78-957,315. FILED P.R. 8-22-2006; AM. S.R. 2-9-2008.

ISOTHERMING

THE MARK CONSISTS OF STANDARD CHARACTERS WITHOUT CLAIM TO ANY PARTICULAR FONT, STYLE, SIZE, OR COLOR.

FOR ENGINEERING, DESIGN AND TECHNOLOGICAL CONSULTATION AND ADVICE IN THE TECHNOLOGICAL FIELDS OF REFINING AND TREATMENT OF PETROLEUM AND HYDROCARBON PRODUCTS AND PETROLEUM AND HYDROCARBON PLANT AND REACTOR DESIGN (U.S. CLS. 100 AND 101).

FIRST USE 2-0-2005; IN COMMERCE 2-0-2005.

CLASS 43—HOTEL AND RESTAURANT SERVICES

3,400,230. NOODLES & COMPANY, BROOMFIELD, CO. SN 76-631,356. FILED P.R. 2-15-2005; AM. S.R. 11-1-2007.

Fresh Sauté & Grill

THE MARK CONSISTS OF STANDARD CHARACTERS WITHOUT CLAIM TO ANY PARTICULAR FONT, STYLE, SIZE, OR COLOR.

NO CLAIM IS MADE TO THE EXCLUSIVE RIGHT TO USE "GRILL", APART FROM THE MARK AS SHOWN.

FOR RESTAURANT SERVICES (U.S. CLS. 100 AND 101).

FIRST USE 3-1-2005; IN COMMERCE 3-1-2005.

CLASS 43—(Continued).

3,400,377. AGAKHANYAN, ARARAT, BURBANK, CA. SN 78-686,876. FILED P.R. 8-5-2005; AM. S.R. 1-9-2008.

GIANT SICILIAN

THE MARK CONSISTS OF STANDARD CHARACTERS WITHOUT CLAIM TO ANY PARTICULAR FONT, STYLE, SIZE, OR COLOR.

FOR RESTAURANT SERVICES, NAMELY, DINE IN, TAKE OUT AND HOME DELIVERY OF LARGE 36 INCH AND ABOVE PARTY PIZZAS (U.S. CLS. 100 AND 101).

FIRST USE 6-1-2001; IN COMMERCE 12-1-2005.

CLASS 44—MEDICAL, BEAUTY AND AGRICULTURAL SERVICES

3,400,238. COLORADO SLEEP CENTER OF THE ROCKIES, LLC, LOVELAND, CO. SN 76-674,010. FILED P.R. 3-13-2007; AM. S.R. 12-17-2007.

NEUROSCIENCE CENTER OF THE ROCKIES

THE MARK CONSISTS OF STANDARD CHARACTERS WITHOUT CLAIM TO ANY PARTICULAR FONT, STYLE, SIZE, OR COLOR.

NO CLAIM IS MADE TO THE EXCLUSIVE RIGHT TO USE "NEUROSCIENCE CENTER", APART FROM THE MARK AS SHOWN.

FOR MEDICAL SERVICES, NAMELY, CONSULTATION, DIAGNOSIS, AND TREATMENT OF SLEEP DISORDERS (U.S. CLS. 100 AND 101).

FIRST USE 12-14-2007; IN COMMERCE 12-14-2007.

3,400,248. THE PHYSICIAN'S RX, INC., PARKLAND, FL. SN 77-027,859. FILED P.R. 10-24-2006; AM. S.R. 12-14-2007.

THE PHYSICIAN'S RX

THE MARK CONSISTS OF STANDARD CHARACTERS WITHOUT CLAIM TO ANY PARTICULAR FONT, STYLE, SIZE, OR COLOR.

FOR SERVICES IN THE NATURE OF DISPENSING OF PHARMACEUTICALS (U.S. CLS. 100 AND 101).

FIRST USE 3-15-2006; IN COMMERCE 3-15-2006.

CLASS 44—(Continued).

3,400,290. MENCHE, DAVID S., BROOKLYN, NY. SN 77-134,668. FILED P.R. 3-19-2007; AM. S.R. 1-9-2008.

TherapyCare

THE MARK CONSISTS OF STANDARD CHARACTERS WITHOUT CLAIM TO ANY PARTICULAR FONT, STYLE, SIZE, OR COLOR.

FOR PHYSICAL THERAPY (U.S. CLS. 100 AND 101).
FIRST USE 5-1-2007; IN COMMERCE 5-1-2007.

3,400,298. DEMRAY, WILLIAM S., NORTHVILLE, MI. AND LEBLOCH, DENISE S., ST. CHARLES, IL. SN 77-139,851. FILED P.R. 3-26-2007; AM. S.R. 12-19-2007.

PRESERVATION DENTAL

THE MARK CONSISTS OF STANDARD CHARACTERS WITHOUT CLAIM TO ANY PARTICULAR FONT, STYLE, SIZE, OR COLOR.

NO CLAIM IS MADE TO THE EXCLUSIVE RIGHT TO USE "DENTAL", APART FROM THE MARK AS SHOWN.
FOR DENTIST SERVICES (U.S. CLS. 100 AND 101).
FIRST USE 10-18-2001; IN COMMERCE 1-7-2007.

3,400,324. KRAMER, STEVEN, FORT COLLINS, CO. AND KRAMER, MARK, FORT COLLINS, CO. AND KRAMER, JEFF, FORT COLLINS, CO. SN 77-181,185. FILED P.R. 5-15-2007; AM. S.R. 2-12-2008.

Dental Center of the Rockies

THE MARK CONSISTS OF STANDARD CHARACTERS WITHOUT CLAIM TO ANY PARTICULAR FONT, STYLE, SIZE, OR COLOR.

NO CLAIM IS MADE TO THE EXCLUSIVE RIGHT TO USE "DENTAL CENTER", APART FROM THE MARK AS SHOWN.
FOR DENTISTRY (U.S. CLS. 100 AND 101).
FIRST USE 1-15-2008; IN COMMERCE 1-15-2008.

CLASS 44—(Continued).

3,400,331. KIDNEYLIFE LLC, WEST ISLIP, NY. SN 77-204,388. FILED P.R. 6-12-2007; AM. S.R. 1-9-2008.

National Kidney Registry

THE MARK CONSISTS OF STANDARD CHARACTERS WITHOUT CLAIM TO ANY PARTICULAR FONT, STYLE, SIZE, OR COLOR.

FOR CONSULTING SERVICES CONCERNING KIDNEY EXCHANGES IN THE MEDICAL FIELD, NAMELY, TO HEALTH CARE PROVIDERS, HOSPITALS, CLINICS, KIDNEY DONORS AND KIDNEY RECIPIENTS (U.S. CLS. 100 AND 101).
FIRST USE 8-1-2007; IN COMMERCE 8-1-2007.

3,400,341. PASSPORTMD, INC, DELRAY BEACH, FL. SN 77-238,998. FILED P.R. 7-26-2007; AM. S.R. 1-8-2008.

Doctors Notes on Demand

THE MARK CONSISTS OF STANDARD CHARACTERS WITHOUT CLAIM TO ANY PARTICULAR FONT, STYLE, SIZE, OR COLOR.

FOR MAINTAINING PERSONAL MEDICAL HISTORY RECORDS AND FILES (U.S. CLS. 100 AND 101).
FIRST USE 7-15-2007; IN COMMERCE 7-15-2007.

3,400,342. HELP AT HOME INC, BOCA RATON, FL. SN 77-244,181. FILED P.R. 8-1-2007; AM. S.R. 1-8-2007.

Preferred Care At Home

THE MARK CONSISTS OF STANDARD CHARACTERS WITHOUT CLAIM TO ANY PARTICULAR FONT, STYLE, SIZE, OR COLOR.

FOR PROVIDING CARE AT HOME SERVICES, NAMELY, HOME HEALTH CARE SERVICES; NURSING HOME CARE SERVICES TO HOMEBOUND SENIORS, THE MENTALLY OR PHYSICALLY CHALLENGED, AND DISABLED; AT HOME COMPANION CARE TO THE ELDERLY, NEW MOTHERS, THOSE RECUPERATING FROM ILLNESS OR ACCIDENT, THE MENTALLY OR PHYSICALLY CHALLENGED, NAMELY, HOME HEALTH CARE SERVICES; MEDICAL CLINIC DAY CARE SERVICES FOR SICK CHILDREN FEATURING DROP-IN AND SICK CHILD CARE; NURSING CARE (U.S. CLS. 100 AND 101).
FIRST USE 7-15-2007; IN COMMERCE 7-15-2007.

CLASS 44—(Continued).

3,400,351. TENET HEALTHSYSTEM MEDICAL, INC., DALLAS, TX. SN 77-271,221. FILED P.R. 9-4-2007; AM. S.R. 1-7-2008.

CLASS 45—(Continued).

3,400,276. PUBLIC JUSTICE, P.C., WASHINGTON, DC. SN 77-122,516. FILED P.R. 3-5-2007; AM. S.R. 12-12-2007.

MAMMO-GRAM

THE MARK CONSISTS OF STANDARD CHARACTERS WITHOUT CLAIM TO ANY PARTICULAR FONT, STYLE, SIZE, OR COLOR.
FOR PROVIDING HEALTH INFORMATION (U.S. CLS. 100 AND 101).
FIRST USE 9-30-2007; IN COMMERCE 9-30-2007.

**The Nation's Public
Interest Law Firm**

3,400,362. DR. JOSE KATZ, CLOSTER, NJ. SN 77-288,996. FILED 9-26-2007.

THE MARK CONSISTS OF STANDARD CHARACTERS WITHOUT CLAIM TO ANY PARTICULAR FONT, STYLE, SIZE, OR COLOR.
NO CLAIM IS MADE TO THE EXCLUSIVE RIGHT TO USE "PUBLIC INTEREST LAW FIRM", APART FROM THE MARK AS SHOWN.
FOR LEGAL SERVICES (U.S. CLS. 100 AND 101).
FIRST USE 12-1-2007; IN COMMERCE 12-1-2007.

KATZ CARDIOSLEEP CENTERS

THE MARK CONSISTS OF STANDARD CHARACTERS WITHOUT CLAIM TO ANY PARTICULAR FONT, STYLE, SIZE, OR COLOR.
NO CLAIM IS MADE TO THE EXCLUSIVE RIGHT TO USE "CARDIOSLEEP CENTERS", APART FROM THE MARK AS SHOWN.
FOR MEDICAL CLINICS (U.S. CLS. 100 AND 101).
FIRST USE 6-1-2006; IN COMMERCE 6-1-2006.

3,400,289. ZIMMERMAN, MICHAEL, WACO, TX. SN 77-134,625. FILED P.R. 3-19-2007; AM. S.R. 10-25-2007.

CLASS 45—PERSONAL AND LEGAL SERVICES

3,400,253. LABOVICK, LABOVICK & WALD, P.A., JUPITER, FL. SN 77-068,184. FILED P.R. 12-20-2006; AM. S.R. 1-2-2008.

Legalizate**CIVIL JUSTICE PROSECUTORS**

THE MARK CONSISTS OF STANDARD CHARACTERS WITHOUT CLAIM TO ANY PARTICULAR FONT, STYLE, SIZE, OR COLOR.
FOR LEGAL SERVICES (U.S. CLS. 100 AND 101).
FIRST USE 1-15-2007; IN COMMERCE 1-15-2007.

THE MARK CONSISTS OF STANDARD CHARACTERS WITHOUT CLAIM TO ANY PARTICULAR FONT, STYLE, SIZE, OR COLOR.
THE FOREIGN WORDING IN THE MARK TRANSLATES INTO ENGLISH AS "LEGALIZE YOU".
FOR LEGAL SERVICES (U.S. CLS. 100 AND 101).
FIRST USE 3-19-2007; IN COMMERCE 3-19-2007.

CLASS 45—(Continued).

3,400,375. BERGER JACQUELINE M, REDHEAD, AUSTRALIA. SN 78-585,819. FILED P.R. 3-11-2005; AM. S.R. 7-27-2007.

CLASS 45—(Continued).

rateyourdate

THE MARK CONSISTS OF STANDARD CHARACTERS WITHOUT CLAIM TO ANY PARTICULAR FONT, STYLE, SIZE, OR COLOR.

FOR WEB SITE SERVICES FEATURING ON-LINE DATING CLUB (U.S. CLS. 100 AND 101).
FIRST USE 11-24-2004; IN COMMERCE 11-24-2004.

* * * * *

TRADEMARK REGISTRATIONS RENEWED

The designation "U.S. Cl." appearing in this section refers to the U.S. class in effect prior to Sep. 1, 1973 rather than the international class which applies to applications filed on or after that date. For adoption of international classification see notice in the OFFICIAL GAZETTE of Jun. 26, 1973 (911 O.G. TM 210).

68,150.	LEA & PERRINS AND DESIGN. U.S. CL. 46. (INT. CL. 30). REG. 3-10-1908.	837,819.	GUIDE TESTED FOR QUALITY AND PERFORMANCE AND DESIGN. U.S. CL. 19. (INT. CL. 12). REG. 10-31-1967.
243,976.	HEIDESTANDARD CHARACTER MARK U.S. CL. 46. (INT. CL. 30). REG. 7-3-1928.	842,268.	WEATHER GUARD (STYLIZED). U.S. CL. 2. (INT. CL. 1). REG. 1-16-1968.
348,905.	SUNSHINE LINE. U.S. CL. 38. (INT. CL. 16). REG. 8-17-1937.	842,307.	MOENFLO. U.S. CL. 13. (INT. CL. 6). REG. 1-16-1968.
355,451.	OLD HEAVEN HILL (STYLIZED). U.S. CL. 49. (INT. CL. 33). REG. 3-15-1938.	842,438.	MISCELLANEOUS DESIGN. U.S. CL. 34. (INT. CL. 11). REG. 1-16-1968.
362,601.	SIGNATURE. U.S. CL. 17. (INT. CL. 34). REG. 11-22-1938.	842,511.	JANTZEN. U.S. CL. 39. (INT. CL. 25). REG. 1-16-1968.
436,340.	PERSONNA (STYLIZED). U.S. CL. 23. (INT. CL. 8). REG. 2-3-1948.	842,850.	SUN-BAR. U.S. CL. 26. (INT. CL. 9). REG. 1-23-1968.
504,862.	SUPER BUBBLE (STYLIZED). U.S. CL. 46. (INT. CL. 30). REG. 12-14-1948.	842,961.	CODE. U.S. CL. 46. (INT. CL. 29). REG. 1-23-1968.
650,202.	CAPALASE (STYLIZED). U.S. CL. 46. (INT. CL. 1). REG. 8-13-1957.	843,369.	NESCAFE (STYLIZED). U.S. CL. 46. (INT. CL. 30). REG. 1-30-1968.
653,485.	FROSTIE (STYLIZED). U.S. CL. 45. (INT. CL. 32). REG. 10-22-1957.	843,373.	CAPE AND DESIGN. U.S. CL. 46. (INT. CL. 31). REG. 1-30-1968.
655,392.	SKYLINE. U.S. CL. 1. (INT. CL. 31). REG. 12-10-1957.	843,382.	TETRAMIN (STYLIZED). U.S. CL. 46. (INT. CL. 31). REG. 1-30-1968.
655,393.	IMPERIAL. U.S. CL. 1. (INT. CL. 31). REG. 12-10-1957.	843,477.	WEIGHT WATCHERS. U.S. CL. 3. (INT. CL. 18). REG. 2-6-1968.
656,451.	AXIA AND DESIGN. U.S. CL. 35. (INT. CL. 17). REG. 12-31-1957.	843,522.	RAINLOCK. U.S. CL. 12. (INT. CL. 19). REG. 2-6-1968.
657,107.	VARIAX. U.S. CL. 23. (INT. CL. 7). REG. 1-14-1958.	843,561.	A CARGO OF CONTENTMENT IN THE BOWL OF ANY PIPE AND DESIGN. U.S. CL. 17. (INT. CL. 34). REG. 2-6-1968.
657,279.	IGA AND DESIGN. U.S. CL. 200. REG. 1-14-1958.	843,620.	HICKORY & TWEED. U.S. CL. 22. (INT. CL. 28). REG. 2-6-1968.
657,386.	MERCEDES-BENZ. U.S. CL. 19. (INT. CL. 12). REG. 1-21-1958.	843,758.	BURETROL. U.S. CL. 44. (INT. CL. 10). REG. 2-6-1968.
657,387.	MISCELLANEOUS DESIGN. U.S. CL. 19. (INT. CL. 12). REG. 1-21-1958.	843,781.	HENRI'S. U.S. CL. 46. (INT. CL. 29). REG. 2-6-1968.
657,414.	MERCEDES-BENZ. U.S. CL. 23. (INT. CLS. 7, 8 AND 12). REG. 1-21-1958.	843,802.	FERMODYL. U.S. CL. 51. (INT. CL. 3). REG. 2-6-1968.
657,663.	BETADINE. U.S. CL. 18. (INT. CL. 5). REG. 1-28-1958.	843,944.	CHROMIX. U.S. CL. 6. (INT. CL. 1). REG. 2-13-1968.
657,927.	NATSYN (STYLIZED). U.S. CL. 1. (INT. CL. 17). REG. 2-4-1958.	844,209.	FROSH. U.S. CL. 45. (INT. CL. 32). REG. 2-13-1968.
659,290.	AIRETOOL. U.S. CL. 23. (INT. CL. 7). REG. 3-11-1958.	844,325.	TYRE MARQUE (STYLIZED). U.S. CL. 37. (INT. CL. 16). REG. 2-13-1968.
659,980.	FOLEX. U.S. CL. 6. (INT. CL. 1). REG. 4-1-1958.	844,443.	E-Z. U.S. CL. 21. (INT. CL. 9). REG. 2-20-1968.
660,264.	PAPI (STYLIZED). U.S. CL. 6. (INT. CL. 1). REG. 4-8-1958.	844,748.	FTD. U.S. CL. 101. (INT. CL. 35). REG. 2-20-1968.
662,511.	WIENERMOBILE. U.S. CL. 22. (INT. CL. 28). REG. 6-3-1958.	845,155.	PROTEGE. U.S. CL. 51. (INT. CL. 3). REG. 2-27-1968.
662,917.	SPRAYWAY. U.S. CL. 52. (INT. CL. 3). REG. 6-10-1958.	845,912.	MONO THANE. U.S. CL. 35. (INT. CL. 12). REG. 3-12-1968.
663,645.	NEVILLAC. U.S. CL. 6. (INT. CL. 1). REG. 7-1-1958.	845,979.	TOMAHAWK. U.S. CL. 46. (INT. CL. 31). REG. 3-12-1968.
669,805.	LIQUAMYCIN. U.S. CL. 18. (INT. CL. 5). REG. 11-18-1958.	846,367.	CHEF-MATE. U.S. CL. 46. (INT. CLS. 1, 5, 29, 30, 31 AND 32). REG. 3-19-1968.
780,824.	TEXATHERM. U.S. CL. 6. (INT. CL. 1). REG. 12-1-1964.	846,531.	RODEO. U.S. CL. 6. (INT. CL. 5). REG. 3-26-1968.
824,416.	AMLOC. INT. CL. 11. (U.S. CLS. 13, 21, 23, 31 AND 34). REG. 2-21-1967.	846,668.	NUPLA. U.S. CL. 23. (INT. CL. 8). REG. 3-26-1968.
833,385.	G GANT SHIRTMAKERS (STYLIZED). U.S. CL. 39. (INT. CL. 25). REG. 8-8-1967.	848,110.	ANIMA-STRATH. U.S. CL. 18. (INT. CL. 5). REG. 4-30-1968.
833,751.	MARK. U.S. CL. 44. (INT. CL. 10). REG. 8-15-1967.	850,448.	GARDOX. U.S. CL. 12. (INT. CL. 17). REG. 6-11-1968.
833,851.	FILAWOUND. INT. CL. 1. (U.S. CL. 1). REG. 8-22-1967.	851,740.	ONEIDA. U.S. CL. 13. (INT. CL. 21). REG. 7-2-1968.
833,852.	SPAULDING. U.S. CL. 1. (INT. CL. 17). REG. 8-22-1967.	853,890.	ULTRA BLUE. U.S. CL. 51. (INT. CL. 3). REG. 7-30-1968.
834,189.	MISCELLANEOUS DESIGN. U.S. CL. 2 ONLY. (INT. CLS. 6, 13, 14, 15, 16, 18, 20, 21, 22 AND 34). REG. 8-29-1967.	863,171.	I AM LOVED AND DESIGN. U.S. CL. 38. (INT. CL. 16). REG. 1-7-1969.
834,393.	LEUKOPOR. U.S. CL. 44. (INT. CL. 10). REG. 8-29-1967.	1,067,501.	ALTECO. INT. CL. 1. (U.S. CL. 5). REG. 6-14-1977.
836,491.	NOSCO. U.S. CL. 2 ONLY. (INT. CLS. 6, 13, 14, 15, 16, 18, 20, 21, 22 AND 34). REG. 10-10-1967.	1,070,863.	HARRISBURG AND DESIGN. INT. CLS. 7 AND 9 ONLY. (U.S. CLS. 23 AND 26). REG. 8-9-1977.
		1,071,250.	A ALBERTSONS AND DESIGN. INT. CLS. 3, 29 AND 30 ONLY. (U.S. CLS. 46 AND 52). REG. 8-16-1977.
		1,071,729.	ALO-SUN. INT. CL. 3. (U.S. CL. 51). REG. 8-23-1977.

- 1,072,816. COOKIN' GOOD (STYLIZED). INT. CL. 29. (U.S. CL. 46). REG. 9-6-1977.
- 1,074,398. MOBILGEAR. INT. CL. 4. (U.S. CL. 15). REG. 10-4-1977.
- 1,077,819. BRIGHT CAST AND DESIGN. INT. CL. 14. (U.S. CL. 14). REG. 11-22-1977.
- 1,079,101. VIRGINIA'S GIFT SHOP. INT. CL. 42. (U.S. CL. 101). REG. 12-6-1977.
- 1,082,341. DI-CAP. INT. CL. 9. (U.S. CL. 21). REG. 1-17-1978.
- 1,082,388. CURITY. INT. CL. 10. (U.S. CL. 44). REG. 1-17-1978.
- 1,082,475. QUICK CLAIM. INT. CL. 16. (U.S. CL. 38). REG. 1-17-1978.
- 1,082,522. CONGLAS AND DESIGN. INT. CLS. 17 AND 19. (U.S. CLS. 1, 5, 12, 13, 35 AND 50). REG. 1-17-1978.
- 1,082,527. THERMALBOND. INT. CL. 17. (U.S. CL. 12). REG. 1-17-1978.
- 1,082,603. DYNARIC. INT. CL. 22. (U.S. CL. 7). REG. 1-17-1978.
- 1,082,818. HH KG AND DESIGN. INT. CL. 31. (U.S. CL. 1). REG. 1-17-1978.
- 1,082,877. THE BIG BOARD. INT. CL. 36. (U.S. CL. 102). REG. 1-17-1978.
- 1,082,999. GASBADGE. INT. CL. 42. (U.S. CL. 100). REG. 1-17-1978.
- 1,083,160. MISCELLANEOUS DESIGN. INT. CL. 6. (U.S. CL. 13). REG. 1-24-1978.
- 1,083,161. TRIDON. INT. CL. 6. (U.S. CL. 13). REG. 1-24-1978.
- 1,083,168. LEGION. INT. CL. 6. (U.S. CL. 13). REG. 1-24-1978.
- 1,083,322. INTERVOX. INT. CL. 9. (U.S. CL. 21). REG. 1-24-1978.
- 1,083,334. FLAME-OUT. INT. CL. 10. (U.S. CL. 44). REG. 1-24-1978.
- 1,083,498. MEAN STREAK. INT. CL. 16. (U.S. CL. 37). REG. 1-24-1978.
- 1,083,519. VESPEL. INT. CL. 17. (U.S. CL. 35). REG. 1-24-1978.
- 1,083,591. PRETTY MAMA AND DESIGN. INT. CL. 25. (U.S. CL. 39). REG. 1-24-1978.
- 1,083,748. PENN-SAND. INT. CL. 1. (U.S. CL. 1). REG. 1-31-1978.
- 1,083,831. ALGAETRINE. INT. CL. 5. (U.S. CL. 6). REG. 1-31-1978.
- 1,084,139. TIGER. INT. CL. 29. (U.S. CL. 46). REG. 1-31-1978.
- 1,084,501. UNIMATIC. INT. CL. 6. (U.S. CL. 13). REG. 2-7-1978.
- 1,084,512. DYNAPOUR (STYLIZED). INT. CL. 7. (U.S. CL. 23). REG. 2-7-1978.
- 1,084,674. S-2-HD. INT. CL. 12. (U.S. CLS. 19, 21, 23, 31, 35 AND 44). REG. 2-7-1978.
- 1,084,974. COCO SUPREME. INT. CL. 30. (U.S. CL. 46). REG. 2-7-1978.
- 1,085,005. BUNNAHABHAIN. INT. CL. 33. (U.S. CL. 49). REG. 2-7-1978.
- 1,085,291. BARB-SERT. INT. CL. 6. (U.S. CL. 13). REG. 2-14-1978.
- 1,085,298. AQUAMET. INT. CL. 6. (U.S. CL. 13). REG. 2-14-1978.
- 1,085,719. DETROIT PISTONS AND DESIGN. INT. CL. 41. (U.S. CL. 107). REG. 2-14-1978.
- 1,085,815. QUALCO AND DESIGN. INT. CLS. 1 AND 21 ONLY. (U.S. CLS. 5, 6, 15 AND 42). REG. 2-21-1978.
- 1,086,148. MEMORY MASTER. INT. CL. 41. (U.S. CL. 107). REG. 2-21-1978.
- 1,086,169. KING SOOPERS AND DESIGN. INT. CL. 42. (U.S. CL. 101). REG. 2-21-1978.
- 1,086,233. BIKE AID. INT. CL. 4. (U.S. CL. 15). REG. 2-28-1978.
- 1,086,567. CARNATION. INT. CL. 30. (U.S. CL. 46). REG. 2-28-1978.
- 1,086,568. MISCELLANEOUS DESIGN. INT. CL. 30. (U.S. CL. 46). REG. 2-28-1978.
- 1,086,748. ROMAX. INT. CL. 1. (U.S. CL. 6). REG. 3-7-1978.
- 1,086,749. DURAPPOSIT. INT. CL. 1. (U.S. CL. 6). REG. 3-7-1978.
- 1,087,064. COASTAL VALLEY. INT. CL. 33. (U.S. CL. 47). REG. 3-7-1978.
- 1,087,285. EPRI JOURNAL. INT. CL. 16. (U.S. CL. 38). REG. 3-14-1978.
- 1,087,403. CHEF-MATE. INT. CL. 29. (U.S. CL. 46). REG. 3-14-1978.
- 1,089,900. KING SOOPERS. INT. CL. 42. (U.S. CL. 101). REG. 4-18-1978.
- 1,089,933. T. H. MANDY. INT. CL. 42. (U.S. CLS. 100 AND 101). REG. 4-18-1978.
- 1,089,999. MISCELLANEOUS DESIGN. INT. CL. 5. (U.S. CL. 18). REG. 4-25-1978.
- 1,090,628. FIDDLEBRITE. INT. CL. 3. (U.S. CL. 4). REG. 5-9-1978.
- 1,090,662. SURPASS. INT. CL. 5. (U.S. CL. 18). REG. 5-9-1978.
- 1,092,606. D (STYLIZED). INT. CLS. 3 AND 7. (U.S. CLS. 1 AND 23). REG. 6-6-1978.
- 1,093,671. SPA-PAK. INT. CL. 10. (U.S. CL. 34). REG. 6-20-1978.
- 1,096,391. DIRT FIGHTER. INT. CL. 2. (U.S. CL. 16). REG. 7-18-1978.
- 1,097,408. PSSI (STYLIZED). INT. CL. 16. (U.S. CL. 38). REG. 7-25-1978.
- 1,099,350. LIGHTGUARD. INT. CL. 9. (U.S. CL. 21). REG. 8-15-1978.
- 1,100,455. NEOXIL. INT. CL. 1. (U.S. CL. 1). REG. 8-29-1978.
- 1,101,373. CONSERVATION THROUGH ENGINEERING. INT. CL. 11. (U.S. CL. 13). REG. 9-5-1978.
- 1,102,941. TANK TRAIN. INT. CL. 12. (U.S. CL. 19). REG. 9-19-1978.
- 1,103,872. AMERICAN ENTERPRISE INSTITUTE. INT. CLS. 16, 35 AND 41. (U.S. CLS. 38, 101 AND 107). REG. 10-10-1978.
- 1,104,976. THE RUSTY DUCK RESTAURANTEST. 1873 REST. 1975 (STYLIZED). INT. CL. 42. (U.S. CL. 100). REG. 10-24-1978.
- 1,109,816. DAMP RID. INT. CL. 1. (U.S. CL. 6). REG. 12-26-1978.
- 1,110,596. LINDY. INT. CL. 28. (U.S. CL. 22). REG. 1-2-1979.
- 1,110,784. RE-SORB. INT. CL. 5. (U.S. CL. 18). REG. 1-9-1979.
- 1,274,754. PLEION. INT. CL. 11 ONLY. (U.S. CL. 21). REG. 4-24-1984.
- 1,399,192. QUADRO. INT. CL. 6. (U.S. CLS. 13 AND 32). REG. 7-1-1986.
- 1,419,134. APEX. INT. CLS. 14 AND 41 ONLY. (U.S. CLS. 2, 27, 28, 50 AND 107). REG. 12-2-1986.
- 1,422,908. MAT-FORM. INT. CL. 24. (U.S. CL. 42). REG. 12-30-1986.
- 1,424,705. VDR. INT. CL. 10. (U.S. CL. 44). REG. 1-13-1987.
- 1,438,652. CREAM WHITE. INT. CL. 29. (U.S. CL. 46). REG. 5-5-1987.
- 1,447,627. MISCELLANEOUS DESIGN. INT. CL. 25. (U.S. CL. 39). REG. 7-14-1987.
- 1,448,369. ROVER (STYLIZED). INT. CL. 12. (U.S. CL. 19). REG. 7-21-1987.
- 1,449,686. VACU-TITE!. INT. CL. 17. (U.S. CL. 19). REG. 7-28-1987.
- 1,451,090. THE CULTURED PEARL OF SHRIMP. INT. CL. 29. (U.S. CL. 46). REG. 8-4-1987.
- 1,451,455. AVANT. INT. CL. 42. (U.S. CL. 100). REG. 8-4-1987.
- 1,451,766. TRICON SUPER X. INT. CL. 6. (U.S. CL. 13). REG. 8-11-1987.
- 1,451,884. KELK (STYLIZED). INT. CL. 9. (U.S. CLS. 21 AND 26). REG. 8-11-1987.
- 1,452,047. DUAL PURPOSE SAFETY VENT. INT. CL. 12. (U.S. CL. 19). REG. 8-11-1987.
- 1,458,203. LEVEL 1. INT. CL. 10. (U.S. CL. 44). REG. 9-22-1987.
- 1,461,655. DRILLTEC AND DESIGN. INT. CL. 6. (U.S. CLS. 6 AND 13). REG. 10-20-1987.
- 1,462,142. TWELVE OAKS. INT. CL. 30. (U.S. CL. 46). REG. 10-20-1987.
- 1,466,836. VANDAR. INT. CL. 1. (U.S. CL. 1). REG. 12-1-1987.
- 1,467,335. PURCOAT. INT. CL. 17. (U.S. CLS. 18 AND 35). REG. 12-1-1987.
- 1,469,300. THE WATERS OF SAND SPRINGS. INT. CL. 32. (U.S. CL. 45). REG. 12-15-1987.
- 1,471,743. NAPA AUTO PARTS. INT. CL. 42. (U.S. CL. 101). REG. 1-5-1988.
- 1,471,858. SILVER-BRITE. INT. CL. 2. (U.S. CLS. 6, 11 AND 16). REG. 1-12-1988.
- 1,472,301. INSTA ARCH. INT. CL. 19. (U.S. CL. 12). REG. 1-12-1988.
- 1,472,619. KING AND DESIGN. INT. CL. 37. (U.S. CL. 103). REG. 1-12-1988.
- 1,472,758. XYLAR. INT. CL. 1. (U.S. CL. 6). REG. 1-19-1988.
- 1,473,016. TOTO (STYLIZED). INT. CL. 11. (U.S. CL. 13). REG. 1-19-1988.
- 1,473,157. BSA BEST. INT. CL. 18 ONLY. (U.S. CL. 3). REG. 1-19-1988.

- 1,473,158. BLACK BULL. INT. CL. 18 ONLY. (U.S. CL. 3). REG. 1-19-1988.
- 1,473,196. KAGE-ALL. INT. CL. 21. (U.S. CLS. 2, 13, 23, 29, 30, 33, 40 AND 50). REG. 1-19-1988.
- 1,473,270. GERBER AND DESIGN. INT. CL. 25. (U.S. CL. 39). REG. 1-19-1988.
- 1,473,341. WINMAU. INT. CL. 28. (U.S. CL. 22). REG. 1-19-1988.
- 1,473,417. KENTUCKY DELUXE. INT. CL. 33. (U.S. CL. 49). REG. 1-19-1988.
- 1,473,630. OVERTON'S. INT. CL. 42. (U.S. CLS. 100 AND 101). REG. 1-19-1988.
- 1,473,733. ULTRA. INT. CLS. 1 AND 2. (U.S. CLS. 6 AND 16). REG. 1-26-1988.
- 1,473,897. H AND DESIGN. INT. CL. 6. (U.S. CL. 13). REG. 1-26-1988.
- 1,474,339. ARCTIC STORM. INT. CL. 29. (U.S. CL. 46). REG. 1-26-1988.
- 1,474,523. MEDESCORT. INT. CLS. 39 AND 42. (U.S. CLS. 100 AND 105). REG. 1-26-1988.
- 1,474,550. A BETTER CHANCE. INT. CL. 41. (U.S. CL. 107). REG. 1-26-1988.
- 1,474,633. THE PERSONNEL DEPARTMENT AND DESIGN. INT. CL. 35. (U.S. CL. 101). REG. 1-26-1988.
- 1,474,719. OMNI. INT. CLS. 5 AND 10. (U.S. CLS. 18, 26, 39 AND 44). REG. 2-2-1988.
- 1,474,761. GRANEDA. INT. CL. 9. (U.S. CL. 38). REG. 2-2-1988.
- 1,474,762. NETRONIC AND DESIGN. INT. CL. 9. (U.S. CL. 38). REG. 2-2-1988.
- 1,474,852. KANGAROO. INT. CL. 10. (U.S. CL. 44). REG. 2-2-1988.
- 1,474,855. MISCELLANEOUS DESIGN. INT. CL. 11. (U.S. CLS. 13, 21 AND 34). REG. 2-2-1988.
- 1,474,876. SITESCAPE (STYLIZED). INT. CL. 11. (U.S. CL. 21). REG. 2-2-1988.
- 1,474,895. MISCELLANEOUS DESIGN. INT. CL. 12. (U.S. CL. 19). REG. 2-2-1988.
- 1,474,896. HUSKY. INT. CL. 12. (U.S. CL. 19). REG. 2-2-1988.
- 1,475,168. HALL'S. INT. CL. 29. (U.S. CL. 46). REG. 2-2-1988.
- 1,475,201. HILLTOWN FARMS AND DESIGN. INT. CL. 31. (U.S. CL. 46). REG. 2-2-1988.
- 1,475,315. PREFERRED INC. AND DESIGN. INT. CL. 37. (U.S. CL. 103). REG. 2-2-1988.
- 1,475,474. THE LIGHT MEASUREMENT PEOPLE. INT. CL. 42. (U.S. CL. 100). REG. 2-2-1988.
- 1,475,513. PRO. U.S. CL. 200. REG. 2-2-1988.
- 1,475,541. ULTROX. INT. CL. 1. (U.S. CL. 6). REG. 2-9-1988.
- 1,475,595. YOU CAN RELY ON CERTIFIED AND DESIGN. INT. CL. 4. (U.S. CL. 15). REG. 2-9-1988.
- 1,475,612. PEDIASURE. INT. CL. 5. (U.S. CL. 18). REG. 2-9-1988.
- 1,475,779. ROADNET. INT. CL. 9. (U.S. CLS. 26 AND 38). REG. 2-9-1988.
- 1,475,892. THE JOYFUL NOISELETTER. INT. CL. 16. (U.S. CL. 38). REG. 2-9-1988.
- 1,475,911. JACKSON THE JACKASS. INT. CL. 16. (U.S. CLS. 37 AND 38). REG. 2-9-1988.
- 1,475,930. STYRODECK. INT. CL. 17. (U.S. CL. 12). REG. 2-9-1988.
- 1,476,040. PROJECT. INT. CL. 25. (U.S. CL. 39). REG. 2-9-1988.
- 1,476,062. MECH. INT. CL. 28. (U.S. CL. 22). REG. 2-9-1988.
- 1,476,136. MISCELLANEOUS DESIGN. INT. CL. 33. (U.S. CL. 47). REG. 2-9-1988.
- 1,476,173. NAVISTAR (STYLIZED). INT. CL. 36. (U.S. CL. 102). REG. 2-9-1988.
- 1,476,220. GM AND DESIGN. INT. CL. 37. (U.S. CL. 103). REG. 2-9-1988.
- 1,476,402. US-LAWN AND DESIGN. INT. CL. 42. (U.S. CLS. 100 AND 103). REG. 2-9-1988.
- 1,476,450. FAST & EASY (STYLIZED). INT. CL. 3. (U.S. CL. 52). REG. 2-16-1988.
- 1,476,451. RTU HANDI SPRAYS. INT. CL. 3. (U.S. CL. 52). REG. 2-16-1988.
- 1,476,537. PRECEDENT. INT. CL. 5. (U.S. CL. 44). REG. 2-16-1988.
- 1,476,549. MMS. INT. CL. 6. (U.S. CL. 13). REG. 2-16-1988.
- 1,476,663. MICROSLEEVE. INT. CL. 9. (U.S. CLS. 23 AND 26). REG. 2-16-1988.
- 1,476,844. BEEF TODAY. INT. CL. 16. (U.S. CL. 38). REG. 2-16-1988.
- 1,477,039. ICE MOUNTAIN. INT. CL. 32. (U.S. CL. 45). REG. 2-16-1988.
- 1,477,098. STERIS. INT. CL. 37. (U.S. CL. 103). REG. 2-16-1988.
- 1,477,509. APREX. INT. CL. 9. (U.S. CL. 26). REG. 2-23-1988.
- 1,477,556. WASHLET (STYLIZED). INT. CL. 11. (U.S. CL. 13). REG. 2-23-1988.
- 1,477,587. H AND DESIGN. INT. CLS. 14 AND 25. (U.S. CLS. 28 AND 39). REG. 2-23-1988.
- 1,477,741. ELVSTROM SAILS AND DESIGN. INT. CL. 22. (U.S. CLS. 7, 19 AND 22). REG. 2-23-1988.
- 1,477,832. SML SPORT. INT. CL. 25. (U.S. CL. 39). REG. 2-23-1988.
- 1,477,950. OV. INT. CL. 32. (U.S. CL. 48). REG. 2-23-1988.
- 1,478,437. SILHOUETTE. INT. CL. 9. (U.S. CLS. 22, 26 AND 39). REG. 3-1-1988.
- 1,478,524. FLEXI-HOLDER AND DESIGN. INT. CL. 10. (U.S. CL. 44). REG. 3-1-1988.
- 1,478,920. AUDUBON. INT. CL. 31. (U.S. CL. 46). REG. 3-1-1988.
- 1,479,331. SINE PUMP AND DESIGN. INT. CL. 7. (U.S. CL. 23). REG. 3-8-1988.
- 1,479,338. TENSION-MASTER. INT. CL. 7. (U.S. CL. 23). REG. 3-8-1988.
- 1,479,504. ROTICULATOR. INT. CL. 10. (U.S. CL. 44). REG. 3-8-1988.
- 1,479,757. BATTLEMECH. INT. CL. 28. (U.S. CL. 22). REG. 3-8-1988.
- 1,480,345. MILDEX. INT. CL. 2. (U.S. CL. 6). REG. 3-15-1988.
- 1,480,510. DAVIDOFF AND DESIGN. INT. CL. 33 ONLY. (U.S. CLS. 47 AND 49). REG. 3-15-1988.
- 1,480,708. M+ AND DESIGN. INT. CL. 10. (U.S. CL. 44). REG. 3-15-1988.
- 1,481,179. THE GEORGIAN CLUB G AND DESIGN. INT. CL. 42. (U.S. CL. 100). REG. 3-15-1988.
- 1,481,362. JEVITY. INT. CL. 5. (U.S. CL. 18). REG. 3-22-1988.
- 1,481,363. SURVANTA. INT. CL. 5. (U.S. CL. 18). REG. 3-22-1988.
- 1,481,390. SAW BOSS. INT. CL. 7. (U.S. CL. 23). REG. 3-22-1988.
- 1,481,944. MISCELLANEOUS DESIGN. INT. CL. 41. (U.S. CL. 107). REG. 3-22-1988.
- 1,482,058. COMPACT. INT. CL. 9. (U.S. CL. 21). REG. 3-22-1988.
- 1,482,275. FRED. INT. CL. 14 ONLY. (U.S. CLS. 2, 27, 28 AND 50). REG. 3-29-1988.
- 1,482,816. MINI-TRACH. INT. CL. 10. (U.S. CL. 44). REG. 3-29-1988.
- 1,483,881. THE GOLDSMITH SHOP AND DESIGN. INT. CL. 42. (U.S. CL. 101). REG. 4-5-1988.
- 1,484,186. CURTIS. INT. CL. 12. (U.S. CLS. 19 AND 23). REG. 4-12-1988.
- 1,484,454. OCEAN MASTER. INT. CL. 29. (U.S. CL. 46). REG. 4-12-1988.
- 1,484,590. WASHINGTON EDITION. INT. CL. 36. (U.S. CL. 102). REG. 4-12-1988.
- 1,484,606. NEBRASKA EDITION. INT. CL. 36. (U.S. CL. 102). REG. 4-12-1988.
- 1,484,960. HANDY WICK. INT. CL. 4. (U.S. CL. 15). REG. 4-19-1988.
- 1,485,042. STYRO-FORMER (STYLIZED). INT. CL. 7. (U.S. CLS. 23 AND 44). REG. 4-19-1988.
- 1,485,100. COMMUNICATOR. INT. CL. 9. (U.S. CL. 21). REG. 4-19-1988.
- 1,485,501. MISCELLANEOUS DESIGN. INT. CL. 36. (U.S. CL. 102). REG. 4-19-1988.
- 1,485,605. MIAMI HEAT. INT. CL. 41. (U.S. CL. 107). REG. 4-19-1988.
- 1,487,357. CALIFORNIA TAN. INT. CL. 3. (U.S. CLS. 51 AND 52). REG. 5-10-1988.
- 1,487,965. DIGI-KEY. INT. CL. 42. (U.S. CL. 101). REG. 5-10-1988.
- 1,488,318. THE TRAPPER. INT. CL. 11. (U.S. CL. 31). REG. 5-17-1988.
- 1,489,842. REMEDY. INT. CL. 5. (U.S. CL. 6). REG. 5-31-1988.
- 1,491,180. STEP-SAVER. INT. CL. 22. (U.S. CL. 50). REG. 6-7-1988.
- 1,491,882. HOB-E-LUBE. INT. CL. 4. (U.S. CL. 15). REG. 6-14-1988.
- 1,491,904. OPTIVITE. INT. CL. 5. (U.S. CL. 18). REG. 6-14-1988.
- 1,491,961. AEROBELL. INT. CL. 7. (U.S. CL. 23). REG. 6-14-1988.

- 1,491,967. ATRA PLUS. INT. CL. 8. (U.S. CL. 23). REG. 6-14-1988.
- 1,491,986. MISCELLANEOUS DESIGN. INT. CLS. 9 AND 28 ONLY. (U.S. CLS. 21, 22, 23, 26, 36, 38 AND 50). REG. 6-14-1988.
- 1,492,063. CORCOM AND DESIGN. INT. CL. 9. (U.S. CL. 21). REG. 6-14-1988.
- 1,492,206. GREAT GRANDPA'S AND DESIGN. INT. CL. 16. (U.S. CL. 38). REG. 6-14-1988.
- 1,492,555. READING TERMINAL MARKET SINCE 1893 AND DESIGN. INT. CLS. 36 AND 42. (U.S. CLS. 100, 101 AND 102). REG. 6-14-1988.
- 1,492,556. READING TERMINAL MARKET. INT. CLS. 36 AND 42. (U.S. CLS. 100, 101 AND 102). REG. 6-14-1988.
- 1,492,770. CLEARBLUE. INT. CL. 1 ONLY. (U.S. CL. 6). REG. 6-21-1988.
- 1,493,758. DUST-BUSTER. INT. CL. 1. (U.S. CL. 6). REG. 6-28-1988.
- 1,494,162. MYSTI CRYSTALS AND DESIGN. INT. CL. 14. (U.S. CLS. 28 AND 50). REG. 6-28-1988.
- 1,494,214. 4 GRANDMA'S 3 AND DESIGN. INT. CL. 16. (U.S. CL. 38). REG. 6-28-1988.
- 1,495,169. SOUTHFORK. INT. CL. 25. (U.S. CLS. 22 AND 39). REG. 7-5-1988.
- 1,495,296. LEGEND. INT. CL. 34. (U.S. CL. 17). REG. 7-5-1988.
- 1,495,838. GRASS-FAST!. INT. CL. 22. (U.S. CLS. 1 AND 42). REG. 7-12-1988.
- 1,496,355. ARROW. INT. CLS. 1, 6 AND 8. (U.S. CLS. 5, 13 AND 23). REG. 7-19-1988.
- 1,496,417. BREAK-AWAY. INT. CL. 3. (U.S. CLS. 6 AND 52). REG. 7-19-1988.
- 1,496,702. THE GOLDSMITH SHOP AND DESIGN. INT. CL. 14. (U.S. CL. 28). REG. 7-19-1988.
- 1,496,931. MISCELLANEOUS DESIGN. INT. CL. 30. (U.S. CL. 46). REG. 7-19-1988.
- 1,497,578. P-K COMPACT. INT. CL. 11. (U.S. CL. 34). REG. 7-26-1988.
- 1,498,530. NAVISTAR. INT. CL. 12. (U.S. CL. 19). REG. 8-2-1988.
- 1,502,987. SHAKESPEARE. INT. CL. 16. (U.S. CL. 38). REG. 9-6-1988.
- 1,504,264. MISCELLANEOUS DESIGN. INT. CL. 36. (U.S. CL. 102). REG. 9-13-1988.
- 1,504,544. IMMUNECTAR. INT. CL. 5. (U.S. CL. 18). REG. 9-20-1988.
- 1,506,789. TRICON SUPER C. INT. CL. 6. (U.S. CL. 14). REG. 10-4-1988.
- 1,507,926. PRESS-TIGHT. INT. CL. 9. (U.S. CL. 26). REG. 10-11-1988.
- 1,509,807. ALRA. INT. CL. 3. (U.S. CL. 51). REG. 10-25-1988.
- 1,511,178. BEEF-PRO (STYLIZED). INT. CL. 31. (U.S. CL. 46). REG. 11-1-1988.
- 1,511,992. GARTH MERRICK'S BEEF'N MORE AND DESIGN. INT. CL. 31. (U.S. CL. 46). REG. 11-8-1988.
- 1,512,918. TABLE TALK. INT. CL. 30. (U.S. CL. 46). REG. 11-15-1988.
- 1,513,490. UNITED. INT. CL. 9. (U.S. CL. 21). REG. 11-22-1988.
- 1,517,173. POPSHOTS. INT. CL. 16. (U.S. CL. 38). REG. 12-20-1988.
- 1,517,566. COVENANT RETIREMENT COMMUNITIES. INT. CL. 42. (U.S. CL. 100). REG. 12-20-1988.
- 1,517,932. RF DESIGN. INT. CL. 16. (U.S. CL. 38). REG. 12-27-1988.
- 1,518,488. HOUSE OF HEARING. INT. CL. 42. (U.S. CL. 100). REG. 12-27-1988.
- 1,518,764. E-MON D-MON. INT. CL. 9. (U.S. CL. 26). REG. 1-3-1989.
- 1,519,293. THE FISHERMAN'S OUTLET AND DESIGN. INT. CL. 42. (U.S. CL. 101). REG. 1-3-1989.
- 1,520,224. ADVANTAGE AUTO STORES. INT. CL. 42. (U.S. CLS. 100 AND 101). REG. 1-10-1989.
- 1,520,295. AGRI SUPPLY. INT. CL. 42. (U.S. CL. 100). REG. 1-10-1989.
- 1,520,703. OUR BUSINESS IS EARNING YOUR TRUST. INT. CLS. 9 AND 12. (U.S. CLS. 19, 21 AND 35). REG. 1-17-1989.
- 1,521,645. INTERCARD (STYLIZED). INT. CL. 9. (U.S. CL. 26). REG. 1-24-1989.
- 1,522,033. CASA BLANCA. INT. CL. 34. (U.S. CL. 17). REG. 1-24-1989.
- 1,522,059. CAREERLAB (STYLIZED). INT. CL. 35. (U.S. CL. 101). REG. 1-24-1989.
- 1,888,352. SHARPSTAR. INT. CL. 10. (U.S. CL. 44). REG. 4-11-1995.
- 1,924,558. VIBE- AND DESIGN. INT. CL. 11. (U.S. CLS. 13, 21, 23, 31 AND 34). REG. 10-3-1995.
- 1,970,882. CTR SYSTEMS AND DESIGN. INT. CL. 9. (U.S. CLS. 21, 23, 26, 36 AND 38). REG. 4-30-1996.
- 1,993,663. MULE HEAD BRAND AND DESIGN. INT. CL. 3. (U.S. CLS. 1, 4, 6, 50, 51 AND 52). REG. 8-13-1996.
- 1,994,156. SALT WATER ASSASSIN. INT. CL. 28. (U.S. CLS. 22, 23, 38 AND 50). REG. 8-13-1996.
- 1,995,574. EDUPAGE. INT. CL. 42. (U.S. CLS. 100 AND 101). REG. 8-20-1996.
- 2,011,820. COLLEGETOWN. INT. CL. 42. (U.S. CLS. 100 AND 101). REG. 10-29-1996.
- 2,018,645. CHEQUEPOINT AND DESIGN. INT. CL. 36. (U.S. CLS. 100, 101 AND 102). REG. 11-26-1996.
- 2,037,825. SEALMASTER. INT. CL. 7. (U.S. CLS. 13, 19, 21, 23, 31, 34 AND 35). REG. 2-11-1997.
- 2,038,147. TOTAL MANAGEMENT SYSTEM (TMS). INT. CL. 35. (U.S. CLS. 100, 101 AND 102). REG. 2-18-1997.
- 2,039,217. BIOMEND. INT. CL. 5. (U.S. CLS. 6, 18, 44, 46, 51 AND 52). REG. 2-18-1997.
- 2,042,482. GIORDANO. INT. CL. 18. (U.S. CLS. 1, 2, 3, 22 AND 41). REG. 3-4-1997.
- 2,057,078. POWERGETIC. INT. CL. 32. (U.S. CLS. 45, 46 AND 48). REG. 4-29-1997.
- 2,059,153. AO PRO. INT. CL. 9. (U.S. CLS. 21, 23, 26, 36 AND 38). REG. 5-6-1997.
- 2,064,406. IBIS AND DESIGN. INT. CLS. 12 AND 25. (U.S. CLS. 19, 21, 22, 23, 31, 35, 39 AND 44). REG. 5-27-1997.
- 2,064,427. TENNESSEE ASSOCIATION OF RESCUE SQUADS AND DESIGN. INT. CL. 41. (U.S. CLS. 100, 101 AND 107). REG. 5-27-1997.
- 2,064,608. MILLIDISK. INT. CLS. 9 AND 11. (U.S. CLS. 13, 21, 23, 26, 31, 34, 36 AND 38). REG. 5-27-1997.
- 2,067,242. MISCELLANEOUS DESIGN. INT. CL. 30. (U.S. CL. 46). REG. 6-3-1997.
- 2,067,534. FIRST SENIORITY. INT. CL. 36. (U.S. CLS. 100, 101 AND 102). REG. 6-3-1997.
- 2,070,376. BEYOND THE CALL. INT. CLS. 38 AND 41. (U.S. CLS. 100, 101, 104 AND 107). REG. 6-10-1997.
- 2,076,337. TREASURED TIMES. INT. CL. 21. (U.S. CLS. 2, 13, 23, 29, 30, 33, 40 AND 50). REG. 7-1-1997.
- 2,076,862. ASHDENE. INT. CL. 21 ONLY. (U.S. CLS. 2, 13, 23, 29, 30, 33, 40 AND 50). REG. 7-8-1997.
- 2,077,856. SYNKDRIVE (STYLIZED). INT. CL. 7. (U.S. CLS. 13, 19, 21, 23, 31, 34 AND 35). REG. 7-8-1997.
- 2,078,587. ARS. INT. CL. 35. (U.S. CLS. 100, 101 AND 102). REG. 7-15-1997.
- 2,078,847. DURGO. INT. CL. 11. (U.S. CLS. 13, 21, 23, 31 AND 34). REG. 7-15-1997.
- 2,079,090. AUTOMATICALLY YOURS. INT. CL. 35. (U.S. CLS. 100, 101 AND 102). REG. 7-15-1997.
- 2,079,824. PYROMAX. INT. CL. 11. (U.S. CLS. 13, 21, 23, 31 AND 34). REG. 7-15-1997.
- 2,080,075. SERIOUSLY. INT. CL. 33. (U.S. CLS. 47 AND 49). REG. 7-15-1997.
- 2,081,097. FRIO-TEMP. INT. CL. 9. (U.S. CLS. 21, 23, 26, 36 AND 38). REG. 7-22-1997.
- 2,081,167. CALIDAD SUPERIOR GILBERTO OLIVA HECHO A MANO GO AND DESIGN. INT. CL. 34. (U.S. CLS. 2, 8, 9 AND 17). REG. 7-22-1997.
- 2,081,277. CEEK. INT. CL. 9. (U.S. CLS. 21, 23, 26, 36 AND 38). REG. 7-22-1997.
- 2,082,560. RACE READY. INT. CL. 12. (U.S. CLS. 19, 21, 23, 31, 35 AND 44). REG. 7-22-1997.
- 2,084,992. MINI DIAMOND GOLD SERIES. INT. CL. 10. (U.S. CLS. 26, 39 AND 44). REG. 7-29-1997.
- 2,085,767. S & S HINGE AND DESIGN. INT. CL. 6. (U.S. CLS. 2, 12, 13, 14, 23, 25 AND 50). REG. 8-5-1997.
- 2,086,186. TROPIC-FRESH AND DESIGN. INT. CL. 5. (U.S. CLS. 6, 18, 44, 46, 51 AND 52). REG. 8-5-1997.
- 2,086,524. THE NORM. INT. CL. 16. (U.S. CLS. 2, 5, 22, 23, 29, 37, 38 AND 50). REG. 8-5-1997.
- 2,086,750. RAZOR (STYLIZED). INT. CL. 16. (U.S. CLS. 2, 5, 22, 23, 29, 37, 38 AND 50). REG. 8-12-1997.
- 2,086,901. UNCLE JULIO'S RIO GRANDE CAFE. INT. CL. 42. (U.S. CLS. 100 AND 101). REG. 8-12-1997.
- 2,087,020. CRAFTSMAN. INT. CLS. 8, 9 AND 16. (U.S. CLS. 2, 5, 21, 22, 23, 26, 28, 29, 36, 37, 38, 44 AND 50). REG. 8-12-1997.
- 2,087,464. O FRAME. INT. CL. 9. (U.S. CLS. 21, 23, 26, 36 AND 38). REG. 8-12-1997.

- 2,087,465. PRO FRAME. INT. CL. 9. (U.S. CLS. 21, 23, 26, 36 AND 38). REG. 8-12-1997.
- 2,087,486. MISCELLANEOUS DESIGN. INT. CLS. 29 AND 31. (U.S. CLS. 1 AND 46). REG. 8-12-1997.
- 2,089,460. THE WINDOW REPLACEMENT ALTERNATIVE. INT. CL. 19. (U.S. CLS. 1, 12, 33 AND 50). REG. 8-19-1997.
- 2,090,478. MISCELLANEOUS DESIGN. INT. CL. 42. (U.S. CLS. 100 AND 101). REG. 8-26-1997.
- 2,091,157. AWAKE. INT. CL. 32. (U.S. CLS. 45, 46 AND 48). REG. 8-26-1997.
- 2,097,118. CORPORATE OFFICE. INT. CL. 9. (U.S. CLS. 21, 23, 26, 36 AND 38). REG. 9-16-1997.
- 2,099,249. 1/4 POUND BIG BITE. INT. CL. 30. (U.S. CL. 46). REG. 9-23-1997.
- 2,099,528. EXPECT THE WORLD. INT. CL. 16. (U.S. CLS. 2, 5, 22, 23, 29, 37, 38 AND 50). REG. 9-23-1997.
- 2,102,381. PERFECTPASS. INT. CL. 28. (U.S. CLS. 22, 23, 38 AND 50). REG. 9-30-1997.
- 2,102,641. FREESHOP. INT. CL. 35. (U.S. CLS. 100, 101 AND 102). REG. 10-7-1997.
- 2,103,240. ORION. INT. CL. 9. (U.S. CLS. 21, 23, 26, 36 AND 38). REG. 10-7-1997.
- 2,104,616. NORTHERN TRUST PRINCIPLES THAT ENDURE AND DESIGN. INT. CL. 36. (U.S. CLS. 100, 101 AND 102). REG. 10-14-1997.
- 2,105,962. OHANA. INT. CL. 32. (U.S. CLS. 45, 46 AND 48). REG. 10-14-1997.
- 2,106,167. SCRAM'WICH. INT. CL. 30. (U.S. CL. 46). REG. 10-21-1997.
- 2,106,614. SQUARE WIRE. INT. CL. 9. (U.S. CLS. 21, 23, 26, 36 AND 38). REG. 10-21-1997.
- 2,107,751. OPTIMIZE TECHNOLOGIES. INT. CL. 9. (U.S. CLS. 21, 23, 26, 36 AND 38). REG. 10-21-1997.
- 2,113,877. MISCELLANEOUS DESIGN. INT. CL. 6. (U.S. CLS. 2, 12, 13, 14, 23, 25 AND 50). REG. 11-18-1997.
- 2,114,228. CLOSE QUARTERS. INT. CL. 5. (U.S. CLS. 6, 18, 44, 46, 51 AND 52). REG. 11-18-1997.
- 2,114,761. CHASE CARS. INT. CL. 28. (U.S. CLS. 22, 23, 38 AND 50). REG. 11-18-1997.
- 2,115,040. 700% SOLUTION. INT. CL. 36. (U.S. CLS. 100, 101 AND 102). REG. 11-25-1997.
- 2,115,290. STRATEGIC LEADERSHIP ASSOCIATES, INC.. INT. CLS. 35 AND 41. (U.S. CLS. 100, 101, 102 AND 107). REG. 11-25-1997.
- 2,117,017. COLORMATION. INT. CL. 42. (U.S. CLS. 100 AND 101). REG. 11-25-1997.
- 2,117,375. MASA (STYLIZED). INT. CL. 7. (U.S. CLS. 13, 19, 21, 23, 31, 34 AND 35). REG. 12-2-1997.
- 2,117,537. ELLINGTON. INT. CL. 9. (U.S. CLS. 21, 23, 26, 36 AND 38). REG. 12-2-1997.
- 2,119,721. KEY WAY CURB COMPANY AND DESIGN. INT. CL. 37. (U.S. CLS. 100, 103 AND 106). REG. 12-9-1997.
- 2,120,163. PRO SERIES. INT. CL. 40. (U.S. CLS. 100, 103 AND 106). REG. 12-9-1997.
- 2,120,718. NORBEC. INT. CL. 6. (U.S. CLS. 2, 12, 13, 14, 23, 25 AND 50). REG. 12-16-1997.
- 2,121,171. BP'S PET ODOR ELIMINATOR. INT. CLS. 3 AND 5. (U.S. CLS. 1, 4, 6, 18, 44, 46, 50, 51 AND 52). REG. 12-16-1997.
- 2,121,349. MASTER. INT. CL. 8. (U.S. CLS. 23, 28 AND 44). REG. 12-16-1997.
- 2,122,405. AGR. INT. CL. 8. (U.S. CLS. 23, 28 AND 44). REG. 12-16-1997.
- 2,124,809. SEGRETA. INT. CLS. 10 AND 25. (U.S. CLS. 22, 26, 39 AND 44). REG. 12-30-1997.
- 2,124,926. JERGUSON. INT. CLS. 9 AND 11. (U.S. CLS. 13, 21, 23, 26, 31, 34, 36 AND 38). REG. 12-30-1997.
- 2,124,965. JUST IN TIME. INT. CL. 25. (U.S. CLS. 22 AND 39). REG. 12-30-1997.
- 2,125,126. K.C. PARKER. INT. CL. 25. (U.S. CLS. 22 AND 39). REG. 12-30-1997.
- 2,125,397. MALPASO. INT. CL. 9. (U.S. CLS. 21, 23, 26, 36 AND 38). REG. 12-30-1997.
- 2,125,398. MALPASO RECORDS. INT. CL. 9. (U.S. CLS. 21, 23, 26, 36 AND 38). REG. 12-30-1997.
- 2,126,810. THE WORLD ALMANAC FOR KIDS. INT. CL. 16. (U.S. CLS. 2, 5, 22, 23, 29, 37, 38 AND 50). REG. 1-6-1998.
- 2,126,880. BEST VANTAGE. INT. CLS. 35, 36, 41 AND 42. (U.S. CLS. 100, 101, 102 AND 107). REG. 1-6-1998.
- 2,126,897. MICROMASS. INT. CL. 9. (U.S. CLS. 21, 23, 26, 36 AND 38). REG. 1-6-1998.
- 2,126,929. PUROS INDIOS. INT. CL. 34. (U.S. CLS. 2, 8, 9 AND 17). REG. 1-6-1998.
- 2,126,990. HC HANCHANG (STYLIZED). INT. CL. 15. (U.S. CLS. 2, 21 AND 36). REG. 1-6-1998.
- 2,127,205. PICODOS. INT. CL. 9. (U.S. CLS. 21, 23, 26, 36 AND 38). REG. 1-6-1998.
- 2,127,218. HESSTON. INT. CL. 28. (U.S. CLS. 22, 23, 38 AND 50). REG. 1-6-1998.
- 2,127,395. CITYFARM. INT. CL. 29 ONLY. (U.S. CL. 46). REG. 1-6-1998.
- 2,127,432. CHROMOCULT. INT. CL. 5. (U.S. CLS. 6, 18, 44, 46, 51 AND 52). REG. 1-6-1998.
- 2,127,504. COMFORT CLUB. INT. CL. 20. (U.S. CLS. 2, 13, 22, 25, 32 AND 50). REG. 1-6-1998.
- 2,127,709. AMAX. INT. CL. 10. (U.S. CLS. 26, 39 AND 44). REG. 1-6-1998.
- 2,127,979. MOTOREX. INT. CLS. 1, 2, 3 AND 4 ONLY. (U.S. CLS. 1, 4, 5, 6, 10, 11, 15, 16, 26, 46, 50, 51 AND 52). REG. 1-13-1998.
- 2,128,004. GUYLIAN AND DESIGN. INT. CL. 30. (U.S. CL. 46). REG. 1-13-1998.
- 2,128,080. SIGNTECH. INT. CL. 17. (U.S. CLS. 1, 5, 12, 13, 35 AND 50). REG. 1-13-1998.
- 2,128,152. PADRON FABRICA DE TABACOS FUNDADA EN 1964 AND DESIGN. INT. CL. 34. (U.S. CLS. 2, 8, 9 AND 17). REG. 1-13-1998.
- 2,128,169. C AND DESIGN. INT. CLS. 16 AND 25. (U.S. CLS. 2, 5, 22, 23, 29, 37, 38, 39 AND 50). REG. 1-13-1998.
- 2,128,239. MODERN MARVELS. INT. CLS. 9 AND 41. (U.S. CLS. 21, 23, 26, 36, 38, 100, 101 AND 107). REG. 1-13-1998.
- 2,128,314. BOOKS ARE FUN. INT. CL. 35. (U.S. CLS. 100, 101 AND 102). REG. 1-13-1998.
- 2,128,330. IREX. INT. CL. 16. (U.S. CLS. 2, 5, 22, 23, 29, 37, 38 AND 50). REG. 1-13-1998.
- 2,128,337. MISCELLANEOUS DESIGN. INT. CLS. 1 AND 5. (U.S. CLS. 1, 5, 6, 10, 18, 26, 44, 46, 51 AND 52). REG. 1-13-1998.
- 2,128,434. INTELLECTUAL MULTIMEDIA. INT. CL. 9. (U.S. CLS. 21, 23, 26, 36 AND 38). REG. 1-13-1998.
- 2,128,441. VALU TIME. INT. CL. 29. (U.S. CL. 46). REG. 1-13-1998.
- 2,128,446. VALU TIME. INT. CL. 30. (U.S. CL. 46). REG. 1-13-1998.
- 2,128,504. INTUITECH AND DESIGN. INT. CL. 42. (U.S. CLS. 100 AND 101). REG. 1-13-1998.
- 2,128,635. ECO. INT. CL. 1. (U.S. CLS. 1, 5, 6, 10, 26 AND 46). REG. 1-13-1998.
- 2,128,735. TDT AIR SCAN. INT. CL. 42. (U.S. CLS. 100 AND 101). REG. 1-13-1998.
- 2,128,800. COACHMEN AND DESIGN. INT. CL. 12. (U.S. CLS. 19, 21, 23, 31, 35 AND 44). REG. 1-13-1998.
- 2,128,834. SIGNATURE DENTAL PLAN. INT. CL. 35. (U.S. CLS. 100, 101 AND 102). REG. 1-13-1998.
- 2,128,836. STARBIEN. INT. CL. 5. (U.S. CLS. 6, 18, 44, 46, 51 AND 52). REG. 1-13-1998.
- 2,128,934. HEART OF HOSPITALITY. INT. CL. 42. (U.S. CLS. 100 AND 101). REG. 1-13-1998.
- 2,129,018. MAXI-ZINC. INT. CL. 5. (U.S. CLS. 6, 18, 44, 46, 51 AND 52). REG. 1-13-1998.
- 2,129,072. PACCESS. INT. CL. 35. (U.S. CLS. 100, 101 AND 102). REG. 1-13-1998.
- 2,129,287. 7 AND DESIGN. INT. CL. 41. (U.S. CLS. 100, 101 AND 107). REG. 1-13-1998.
- 2,129,296. TWO CREEKS. INT. CLS. 41 AND 42 ONLY. (U.S. CLS. 100, 101 AND 107). REG. 1-13-1998.
- 2,129,318. BRIDGEFIELD CASUALTY INSURANCE COMPANY AND DESIGN. INT. CL. 36. (U.S. CLS. 100, 101 AND 102). REG. 1-13-1998.
- 2,129,362. SAVE EVERY MILE. INT. CLS. 16, 35, 36 AND 42. (U.S. CLS. 2, 5, 22, 23, 29, 37, 38, 50, 100, 101 AND 102). REG. 1-13-1998.
- 2,129,371. BRIDGEPOINT AND DESIGN. INT. CLS. 36 AND 42. (U.S. CLS. 100, 101 AND 102). REG. 1-13-1998.
- 2,129,395. OEHLBACH. INT. CL. 9. (U.S. CLS. 21, 23, 26, 36 AND 38). REG. 1-13-1998.
- 2,129,643. SPIRAC. INT. CLS. 7 AND 11. (U.S. CLS. 13, 19, 21, 23, 31, 34 AND 35). REG. 1-20-1998.
- 2,129,695. GREEN ICE. INT. CL. 3. (U.S. CLS. 1, 4, 6, 50, 51 AND 52). REG. 1-20-1998.
- 2,129,900. THE AMERICAN GIRLS CLUB. INT. CL. 16 ONLY. (U.S. CLS. 2, 5, 22, 23, 29, 37, 38 AND 50). REG. 1-20-1998.
- 2,129,964. IREX. INT. CLS. 35, 41 AND 42. (U.S. CLS. 100, 101, 102 AND 107). REG. 1-20-1998.

- 2,129,982. JUNGLE RED (STYLIZED). INT. CL. 3. (U.S. CLS. 1, 4, 6, 50, 51 AND 52). REG. 1-20-1998.
- 2,129,999. JOHN BEAN. INT. CL. 7. (U.S. CLS. 13, 19, 21, 23, 31, 34 AND 35). REG. 1-20-1998.
- 2,130,049. TAZ. INT. CL. 25. (U.S. CLS. 22 AND 39). REG. 1-20-1998.
- 2,130,107. PRODIGI. INT. CL. 2. (U.S. CLS. 6, 11 AND 16). REG. 1-20-1998.
- 2,130,138. COMP OPTIONS AND DESIGN. INT. CL. 36. (U.S. CLS. 100, 101 AND 102). REG. 1-20-1998.
- 2,130,152. TANGLE GUARD. INT. CLS. 16 AND 20. (U.S. CLS. 2, 5, 13, 22, 23, 25, 29, 32, 37, 38 AND 50). REG. 1-20-1998.
- 2,130,161. STOR-E-BUS. INT. CL. 20. (U.S. CLS. 2, 13, 22, 25, 32 AND 50). REG. 1-20-1998.
- 2,130,226. TRAVELDOR AND DESIGN. INT. CL. 34. (U.S. CLS. 2, 8, 9 AND 17). REG. 1-20-1998.
- 2,130,230. POCKET TRAVELDOR AND DESIGN. INT. CL. 34. (U.S. CLS. 2, 8, 9 AND 17). REG. 1-20-1998.
- 2,130,242. AMERICA'S MOST WANTED AMERICA FIGHTS BACK. INT. CL. 41. (U.S. CLS. 100, 101 AND 107). REG. 1-20-1998.
- 2,130,403. NEWGHURT. INT. CL. 29. (U.S. CL. 46). REG. 1-20-1998.
- 2,130,451. THE UNIVERSE IS YOURS.. INT. CL. 41. (U.S. CLS. 100, 101 AND 107). REG. 1-20-1998.
- 2,130,492. OXY-STEP. INT. CL. 5. (U.S. CLS. 6, 18, 44, 46, 51 AND 52). REG. 1-20-1998.
- 2,130,511. MAXI PRE-NATAL. INT. CL. 5. (U.S. CLS. 6, 18, 44, 46, 51 AND 52). REG. 1-20-1998.
- 2,130,531. SPACEMAKER PRESS. INT. CL. 16. (U.S. CLS. 2, 5, 22, 23, 29, 37, 38 AND 50). REG. 1-20-1998.
- 2,130,848. S BOULDER BUSTER (STYLIZED). INT. CL. 13. (U.S. CLS. 2 AND 9). REG. 1-20-1998.
- 2,130,971. MICRO-PLANER. INT. CL. 10. (U.S. CLS. 26, 39 AND 44). REG. 1-20-1998.
- 2,131,103. ALMOL. INT. CL. 5. (U.S. CLS. 6, 18, 44, 46, 51 AND 52). REG. 1-20-1998.
- 2,131,128. CIGAR AFICIONADO (STYLIZED). INT. CL. 42. (U.S. CLS. 100 AND 101). REG. 1-20-1998.
- 2,131,129. WINE SPECTATOR (STYLIZED). INT. CL. 42. (U.S. CLS. 100 AND 101). REG. 1-20-1998.
- 2,131,132. ANVIL EXPRESS. INT. CL. 41. (U.S. CLS. 100, 101 AND 107). REG. 1-20-1998.
- 2,131,135. ASCAFF. INT. CL. 5. (U.S. CLS. 6, 18, 44, 46, 51 AND 52). REG. 1-20-1998.
- 2,131,169. SUBPAR. INT. CLS. 25 AND 28. (U.S. CLS. 22, 23, 38, 39 AND 50). REG. 1-20-1998.
- 2,131,242. SLIMFITS. INT. CL. 5. (U.S. CLS. 6, 18, 44, 46, 51 AND 52). REG. 1-20-1998.
- 2,131,286. TEGREEN 97. INT. CL. 5. (U.S. CLS. 6, 18, 44, 46, 51 AND 52). REG. 1-20-1998.
- 2,131,658. GRINDSTED. INT. CL. 1 ONLY. (U.S. CLS. 1, 5, 6, 10, 26 AND 46). REG. 1-27-1998.
- 2,131,713. GIFT BRICKS AND DESIGN. INT. CL. 19. (U.S. CLS. 1, 12, 33 AND 50). REG. 1-27-1998.
- 2,131,729. CHEVRA HATZALAH. INT. CLS. 39, 41 AND 42. (U.S. CLS. 100, 101, 105 AND 107). REG. 1-27-1998.
- 2,131,826. ULTIMATE PROTEIN SYSTEM. INT. CL. 5. (U.S. CLS. 6, 18, 44, 46, 51 AND 52). REG. 1-27-1998.
- 2,132,228. CAMATTINI. INT. CL. 7. (U.S. CLS. 13, 19, 21, 23, 31, 34 AND 35). REG. 1-27-1998.
- 2,132,330. CVS GOLD EMBLEM AND DESIGN. INT. CL. 30. (U.S. CL. 46). REG. 1-27-1998.
- 2,132,386. POPTOP. INT. CL. 9. (U.S. CLS. 21, 23, 26, 36 AND 38). REG. 1-27-1998.
- 2,132,430. TRANSITE. INT. CL. 19. (U.S. CLS. 1, 12, 33 AND 50). REG. 1-27-1998.
- 2,132,447. OXYSONES. INT. CL. 3. (U.S. CLS. 1, 4, 6, 50, 51 AND 52). REG. 1-27-1998.
- 2,132,497. NUCLEPORE. INT. CL. 11. (U.S. CLS. 13, 21, 23, 31 AND 34). REG. 1-27-1998.
- 2,132,774. TALK 'N LEARN. INT. CL. 28. (U.S. CLS. 22, 23, 38 AND 50). REG. 1-27-1998.
- 2,132,826. THE WINNING COMBINATION. INT. CL. 36. (U.S. CLS. 100, 101 AND 102). REG. 1-27-1998.
- 2,132,872. PARENTS AS TEACHERS AND DESIGN. INT. CL. 41. (U.S. CLS. 100, 101 AND 107). REG. 1-27-1998.
- 2,132,897. GRANT AND DESIGN. INT. CLS. 25 AND 28. (U.S. CLS. 22, 23, 38, 39 AND 50). REG. 1-27-1998.
- 2,132,964. CDI. INT. CL. 11. (U.S. CLS. 13, 21, 23, 31 AND 34). REG. 1-27-1998.
- 2,133,086. NINE WEST. INT. CLS. 9 AND 25. (U.S. CLS. 21, 22, 23, 26, 36, 38 AND 39). REG. 1-27-1998.
- 2,133,100. SUPER BOWL CONCERT SERIES. INT. CL. 41. (U.S. CLS. 100, 101 AND 107). REG. 1-27-1998.
- 2,133,173. PROOF PERFECT. INT. CL. 30. (U.S. CL. 46). REG. 1-27-1998.
- 2,133,419. PROPINK. INT. CL. 17. (U.S. CLS. 1, 5, 12, 13, 35 AND 50). REG. 1-27-1998.
- 2,133,467. DRAIN PROTECTOR. INT. CL. 20. (U.S. CLS. 2, 13, 22, 25, 32 AND 50). REG. 1-27-1998.
- 2,133,479. MARKET ANALYST. INT. CL. 9. (U.S. CLS. 21, 23, 26, 36 AND 38). REG. 1-27-1998.
- 2,133,650. MVIO AND DESIGN. INT. CL. 25. (U.S. CLS. 22 AND 39). REG. 2-3-1998.
- 2,133,695. MISCELLANEOUS DESIGN. INT. CLS. 16, 18, 24, 25, 26 AND 28. (U.S. CLS. 1, 2, 3, 5, 22, 23, 29, 37, 38, 39, 40, 41, 42 AND 50). REG. 2-3-1998.
- 2,133,703. GALBANI AND DESIGN. INT. CL. 29. (U.S. CL. 46). REG. 2-3-1998.
- 2,133,730. VICHY. INT. CL. 9. (U.S. CLS. 21, 23, 26, 36 AND 38). REG. 2-3-1998.
- 2,133,785. MOM'S POMMES LIGHT AND DESIGN. INT. CLS. 11, 29 AND 30. (U.S. CLS. 13, 21, 23, 31, 34 AND 46). REG. 2-3-1998.
- 2,133,788. EOTR WEEKLY. INT. CL. 16. (U.S. CLS. 2, 5, 22, 23, 29, 37, 38 AND 50). REG. 2-3-1998.
- 2,133,793. CHSP. INT. CL. 41. (U.S. CLS. 100, 101 AND 107). REG. 2-3-1998.
- 2,133,799. GLOW KIDS. INT. CL. 16. (U.S. CLS. 2, 5, 22, 23, 29, 37, 38 AND 50). REG. 2-3-1998.
- 2,133,848. VOICENET AND DESIGN. INT. CL. 42 ONLY. (U.S. CLS. 100 AND 101). REG. 2-3-1998.
- 2,133,959. OREIS. INT. CL. 16. (U.S. CLS. 2, 5, 22, 23, 29, 37, 38 AND 50). REG. 2-3-1998.
- 2,133,992. POLYTRON. INT. CL. 17. (U.S. CLS. 1, 5, 12, 13, 35 AND 50). REG. 2-3-1998.
- 2,134,014. MOBIC. INT. CL. 5. (U.S. CLS. 6, 18, 44, 46, 51 AND 52). REG. 2-3-1998.
- 2,134,139. DIRTY HANDS. INT. CL. 41. (U.S. CLS. 100, 101 AND 107). REG. 2-3-1998.
- 2,134,207. FINANCIAL KNOWLEDGE NETWORK. INT. CL. 41. (U.S. CLS. 100, 101 AND 107). REG. 2-3-1998.
- 2,134,236. APPRAISAL NAVIGATOR. INT. CL. 9. (U.S. CLS. 21, 23, 26, 36 AND 38). REG. 2-3-1998.
- 2,134,240. BLUE GINGER. INT. CLS. 25 AND 35. (U.S. CLS. 22, 39, 100, 101 AND 102). REG. 2-3-1998.
- 2,134,252. SPRING VISTA. INT. CL. 21. (U.S. CLS. 2, 13, 23, 29, 30, 33, 40 AND 50). REG. 2-3-1998.
- 2,134,292. COOL BAY. INT. CL. 9. (U.S. CLS. 21, 23, 26, 36 AND 38). REG. 2-3-1998.
- 2,134,295. CALVERT NEW VISION SMALL CAP FUND. INT. CL. 36. (U.S. CLS. 100, 101 AND 102). REG. 2-3-1998.
- 2,134,340. AVENTAIL. INT. CL. 9. (U.S. CLS. 21, 23, 26, 36 AND 38). REG. 2-3-1998.
- 2,134,377. COLLINS GEM. INT. CL. 16. (U.S. CLS. 2, 5, 22, 23, 29, 37, 38 AND 50). REG. 2-3-1998.
- 2,134,399. ABRA HR. INT. CL. 9. (U.S. CLS. 21, 23, 26, 36 AND 38). REG. 2-3-1998.
- 2,134,426. SOIGNON. INT. CL. 29. (U.S. CL. 46). REG. 2-3-1998.
- 2,134,468. OREIS. INT. CL. 42. (U.S. CLS. 100 AND 101). REG. 2-3-1998.
- 2,134,469. OREIS. INT. CL. 41. (U.S. CLS. 100, 101 AND 107). REG. 2-3-1998.
- 2,134,481. THE DELI SOURCE. INT. CL. 29. (U.S. CL. 46). REG. 2-3-1998.
- 2,134,484. ASPENMOSS. INT. CL. 31. (U.S. CLS. 1 AND 46). REG. 2-3-1998.
- 2,134,595. FHM. INT. CL. 42. (U.S. CLS. 100 AND 101). REG. 2-3-1998.
- 2,134,596. FATHER'S HOUSE MINISTRIES. INT. CL. 42. (U.S. CLS. 100 AND 101). REG. 2-3-1998.
- 2,134,610. ICEBURGH. INT. CL. 41. (U.S. CLS. 100, 101 AND 107). REG. 2-3-1998.
- 2,134,626. HELIOETCH. INT. CL. 42. (U.S. CLS. 100 AND 101). REG. 2-3-1998.
- 2,134,628. HELIODOT. INT. CL. 42. (U.S. CLS. 100 AND 101). REG. 2-3-1998.
- 2,134,661. EATON VANCE. INT. CL. 36. (U.S. CLS. 100, 101 AND 102). REG. 2-3-1998.
- 2,134,711. WORKS ENTERPRISE. INT. CL. 41. (U.S. CLS. 100, 101 AND 107). REG. 2-3-1998.

- 2,134,713. FRAGMENTS. INT. CLS. 18 AND 20 ONLY. (U.S. CLS. 1, 2, 3, 13, 22, 25, 32, 41 AND 50). REG. 2-3-1998.
- 2,134,733. SWISS RE AND DESIGN. INT. CL. 36. (U.S. CLS. 100, 101 AND 102). REG. 2-3-1998.
- 2,134,746. CONTOUR. INT. CL. 9. (U.S. CLS. 21, 23, 26, 36 AND 38). REG. 2-3-1998.
- 2,134,790. GANT. INT. CL. 25. (U.S. CLS. 22 AND 39). REG. 2-3-1998.
- 2,134,817. MISCELLANEOUS DESIGN. INT. CL. 20. (U.S. CLS. 2, 13, 22, 25, 32 AND 50). REG. 2-3-1998.
- 2,134,893. FLIG. INT. CL. 9. (U.S. CLS. 21, 23, 26, 36 AND 38). REG. 2-3-1998.
- 2,135,053. MIX IT UP. INT. CL. 31. (U.S. CLS. 1 AND 46). REG. 2-3-1998.
- 2,135,055. BIRDS EYE. INT. CL. 29. (U.S. CL. 46). REG. 2-3-1998.
- 2,135,068. DAD'S KNOWS BEST. INT. CL. 31. (U.S. CLS. 1 AND 46). REG. 2-3-1998.
- 2,135,074. EARGRIPS. INT. CL. 25. (U.S. CLS. 22 AND 39). REG. 2-3-1998.
- 2,135,118. CATALOG AGE. INT. CL. 35. (U.S. CLS. 100, 101 AND 102). REG. 2-3-1998.
- 2,135,163. OPEN JOIST 2000 AND DESIGN. INT. CLS. 7 AND 19 ONLY. (U.S. CLS. 1, 12, 13, 19, 21, 23, 31, 33, 34, 35 AND 50). REG. 2-10-1998.
- 2,135,258. BIA CORDON BLEU INTERNATIONAL AND DESIGN. INT. CL. 21. (U.S. CLS. 2, 13, 23, 29, 30, 33, 40 AND 50). REG. 2-10-1998.
- 2,135,275. ETNIA (STYLIZED). INT. CL. 9. (U.S. CLS. 21, 23, 26, 36 AND 38). REG. 2-10-1998.
- 2,135,366. LEHIGH VALLEY DAIRY FARMS. INT. CLS. 29 AND 32 ONLY. (U.S. CLS. 45, 46 AND 48). REG. 2-10-1998.
- 2,135,418. OSMOSIS. INT. CL. 42 ONLY. (U.S. CLS. 100 AND 101). REG. 2-10-1998.
- 2,135,529. AMERICA'S MOST WANTED AMERICA FIGHTS BACK AND DESIGN. INT. CL. 41. (U.S. CLS. 100, 101 AND 107). REG. 2-10-1998.
- 2,135,536. STERN (STYLIZED). INT. CL. 12. (U.S. CLS. 19, 21, 23, 31, 35 AND 44). REG. 2-10-1998.
- 2,135,542. MAXSPEED AND DESIGN. INT. CL. 12. (U.S. CLS. 19, 21, 23, 31, 35 AND 44). REG. 2-10-1998.
- 2,135,635. HIGH SIERRA AND DESIGN. INT. CL. 18. (U.S. CLS. 1, 2, 3, 22 AND 41). REG. 2-10-1998.
- 2,135,638. TERM-PAK. INT. CL. 9. (U.S. CLS. 21, 23, 26, 36 AND 38). REG. 2-10-1998.
- 2,135,698. EVAY HAIR CARE PRODUCTS AND DESIGN. INT. CL. 3. (U.S. CLS. 1, 4, 6, 50, 51 AND 52). REG. 2-10-1998.
- 2,135,752. WROR. INT. CL. 38. (U.S. CLS. 100, 101 AND 104). REG. 2-10-1998.
- 2,135,793. TRIM SOL. INT. CL. 1. (U.S. CLS. 1, 5, 6, 10, 26 AND 46). REG. 2-10-1998.
- 2,135,807. STAY ON TOP OF IT. INT. CL. 42. (U.S. CLS. 100 AND 101). REG. 2-10-1998.
- 2,135,818. INHOLTRA. INT. CL. 5. (U.S. CLS. 6, 18, 44, 46, 51 AND 52). REG. 2-10-1998.
- 2,135,946. AGAINST ALL ODDS. INT. CL. 35. (U.S. CLS. 100, 101 AND 102). REG. 2-10-1998.
- 2,135,951. UNITED COTTON COMPANY. INT. CL. 25. (U.S. CLS. 22 AND 39). REG. 2-10-1998.
- 2,135,976. THE STINGERS BAND. INT. CL. 41. (U.S. CLS. 100, 101 AND 107). REG. 2-10-1998.
- 2,135,985. COWPOKES. INT. CL. 30. (U.S. CL. 46). REG. 2-10-1998.
- 2,136,001. ROYAL WORLD. INT. CL. 30. (U.S. CL. 46). REG. 2-10-1998.
- 2,136,006. MISCELLANEOUS DESIGN. INT. CL. 41. (U.S. CLS. 100, 101 AND 107). REG. 2-10-1998.
- 2,136,070. VANILLA MUSK BY COTY AND DESIGN. INT. CL. 3. (U.S. CLS. 1, 4, 6, 50, 51 AND 52). REG. 2-10-1998.
- 2,136,098. USA AND DESIGN. INT. CL. 25. (U.S. CLS. 22 AND 39). REG. 2-10-1998.
- 2,136,119. THE ACCESSORY CORP. INT. CL. 20. (U.S. CLS. 2, 13, 22, 25, 32 AND 50). REG. 2-10-1998.
- 2,136,264. VERAPURE. INT. CL. 5. (U.S. CLS. 6, 18, 44, 46, 51 AND 52). REG. 2-10-1998.
- 2,136,281. DOLPHIN. INT. CL. 9. (U.S. CLS. 21, 23, 26, 36 AND 38). REG. 2-10-1998.
- 2,136,308. OMNITRACE. INT. CL. 1. (U.S. CLS. 1, 5, 6, 10, 26 AND 46). REG. 2-10-1998.
- 2,136,309. OMNITRACE (STYLIZED). INT. CL. 1. (U.S. CLS. 1, 5, 6, 10, 26 AND 46). REG. 2-10-1998.
- 2,136,523. HOME DECORATORS COLLECTION. INT. CL. 35. (U.S. CLS. 100, 101 AND 102). REG. 2-17-1998.
- 2,136,547. PROVAL. INT. CL. 9. (U.S. CLS. 21, 23, 26, 36 AND 38). REG. 2-17-1998.
- 2,136,613. DUNE AND DESIGN. INT. CL. 19. (U.S. CLS. 1, 12, 33 AND 50). REG. 2-17-1998.
- 2,136,768. ADVANCE FOR MANAGERS OF RESPIRATORY CARE. INT. CL. 16. (U.S. CLS. 2, 5, 22, 23, 29, 37, 38 AND 50). REG. 2-17-1998.
- 2,136,772. ADVANCE FOR HEALTH INFORMATION PROFESSIONALS. INT. CL. 16. (U.S. CLS. 2, 5, 22, 23, 29, 37, 38 AND 50). REG. 2-17-1998.
- 2,136,773. ADVANCE FOR DIRECTORS IN REHABILITATION. INT. CL. 16. (U.S. CLS. 2, 5, 22, 23, 29, 37, 38 AND 50). REG. 2-17-1998.
- 2,136,775. ADVANCE FOR MEDICAL LABORATORY PROFESSIONALS. INT. CL. 16. (U.S. CLS. 2, 5, 22, 23, 29, 37, 38 AND 50). REG. 2-17-1998.
- 2,136,866. MOROSO. INT. CLS. 1, 4, 6, 7, 8, 9, 11, 12, 17, 20, 22 AND 25. (U.S. CLS. 1, 2, 5, 6, 7, 10, 12, 13, 14, 15, 19, 21, 22, 23, 25, 26, 28, 31, 32, 34, 35, 36, 38, 39, 42, 44, 46 AND 50). REG. 2-17-1998.
- 2,136,957. GRIZZLY. INT. CL. 7. (U.S. CLS. 13, 19, 21, 23, 31, 34 AND 35). REG. 2-17-1998.
- 2,137,156. REDEYE GRILL AND DESIGN. INT. CL. 42. (U.S. CLS. 100 AND 101). REG. 2-17-1998.
- 2,137,265. PARALLEL DIAMOND. INT. CL. 8. (U.S. CLS. 23, 28 AND 44). REG. 2-17-1998.
- 2,137,390. AL+CLEAR. INT. CL. 1. (U.S. CLS. 1, 5, 6, 10, 26 AND 46). REG. 2-17-1998.
- 2,137,397. MISCELLANEOUS DESIGN. INT. CL. 30. (U.S. CL. 46). REG. 2-17-1998.
- 2,137,411. BLOPENS. INT. CL. 28. (U.S. CLS. 22, 23, 38 AND 50). REG. 2-17-1998.
- 2,137,477. SULTAN. INT. CL. 29. (U.S. CL. 46). REG. 2-17-1998.
- 2,137,484. COUGAR. INT. CL. 12. (U.S. CLS. 19, 21, 23, 31, 35 AND 44). REG. 2-17-1998.
- 2,137,525. SAINT MICKAEL. INT. CL. 35. (U.S. CLS. 100, 101 AND 102). REG. 2-17-1998.
- 2,137,547. CANTINA. INT. CL. 21. (U.S. CLS. 2, 13, 23, 29, 30, 33, 40 AND 50). REG. 2-17-1998.
- 2,137,575. ECONOSCOPE. INT. CL. 16. (U.S. CLS. 2, 5, 22, 23, 29, 37, 38 AND 50). REG. 2-17-1998.
- 2,137,748. UNIONBANCAL CORPORATION. INT. CL. 36. (U.S. CLS. 100, 101 AND 102). REG. 2-17-1998.
- 2,137,942. NETIQ. INT. CL. 9. (U.S. CLS. 21, 23, 26, 36 AND 38). REG. 2-17-1998.
- 2,138,374. ADVANCE FOR ADMINISTRATORS OF THE LABORATORY. INT. CL. 16. (U.S. CLS. 2, 5, 22, 23, 29, 37, 38 AND 50). REG. 2-24-1998.
- 2,138,375. ADVANCE FOR SPEECH-LANGUAGE PATHOLOGISTS & AUDIOLOGISTS. INT. CL. 16. (U.S. CLS. 2, 5, 22, 23, 29, 37, 38 AND 50). REG. 2-24-1998.
- 2,138,489. HCG AND DESIGN. INT. CL. 11. (U.S. CLS. 13, 21, 23, 31 AND 34). REG. 2-24-1998.
- 2,138,721. IRREPLACEABLE ARTIFACTS AND DESIGN. INT. CL. 35. (U.S. CLS. 100, 101 AND 102). REG. 2-24-1998.
- 2,139,060. GOOD FOR YOU ROLLS!. INT. CL. 30. (U.S. CL. 46). REG. 2-24-1998.
- 2,139,061. GOOD FOR YOU BREAD!. INT. CL. 30. (U.S. CL. 46). REG. 2-24-1998.
- 2,139,404. SEASONS. INT. CL. 36. (U.S. CLS. 100, 101 AND 102). REG. 2-24-1998.
- 2,139,455. STARTLITE. INT. CL. 7. (U.S. CLS. 13, 19, 21, 23, 31, 34 AND 35). REG. 2-24-1998.
- 2,139,575. LMX LOW MOISTURE SOIL EXTRACTION SYSTEM (STYLIZED). INT. CL. 7. (U.S. CLS. 13, 19, 21, 23, 31, 34 AND 35). REG. 2-24-1998.
- 2,139,749. TURBO-LITT. INT. CL. 10. (U.S. CLS. 26, 39 AND 44). REG. 2-24-1998.
- 2,139,750. POWER-LITT. INT. CL. 10. (U.S. CLS. 26, 39 AND 44). REG. 2-24-1998.
- 2,139,940. OPEN JOIST 2000. INT. CLS. 7 AND 19 ONLY. (U.S. CLS. 1, 12, 13, 19, 21, 23, 31, 33, 34, 35 AND 50). REG. 3-3-1998.
- 2,140,053. DELIBERATIVE POLLING. INT. CL. 42. (U.S. CLS. 100 AND 101). REG. 3-3-1998.
- 2,140,068. LASERALIGN. INT. CL. 9. (U.S. CLS. 21, 23, 26, 36 AND 38). REG. 3-3-1998.
- 2,140,237. ADVANCE FOR RESPIRATORY CARE PRACTITIONERS. INT. CL. 16. (U.S. CLS. 2, 5, 22, 23, 29, 37, 38 AND 50). REG. 3-3-1998.

- 2,140,356. OLE AND DESIGN. INT. CL. 16. (U.S. CLS. 2, 5, 22, 23, 29, 37, 38 AND 50). REG. 3-3-1998.
- 2,140,390. OMAHA STEAKS. INT. CL. 30. (U.S. CL. 46). REG. 3-3-1998.
- 2,140,505. MISCELLANEOUS DESIGN. INT. CL. 36. (U.S. CLS. 100, 101 AND 102). REG. 3-3-1998.
- 2,140,590. JET G. INT. CLS. 9 AND 25. (U.S. CLS. 21, 22, 23, 26, 36, 38 AND 39). REG. 3-3-1998.
- 2,140,896. ACCURA. INT. CL. 9. (U.S. CLS. 21, 23, 26, 36 AND 38). REG. 3-3-1998.
- 2,140,952. MISCELLANEOUS DESIGN. INT. CL. 41. (U.S. CLS. 100, 101 AND 107). REG. 3-3-1998.
- 2,140,953. MISCELLANEOUS DESIGN. INT. CL. 35. (U.S. CLS. 100, 101 AND 102). REG. 3-3-1998.
- 2,141,005. 3M. INT. CL. 1. (U.S. CLS. 1, 5, 6, 10, 26 AND 46). REG. 3-3-1998.
- 2,141,006. 3M (STYLIZED). INT. CL. 1. (U.S. CLS. 1, 5, 6, 10, 26 AND 46). REG. 3-3-1998.
- 2,141,311. BANSI AND DESIGN. INT. CLS. 29 AND 30. (U.S. CL. 46). REG. 3-3-1998.
- 2,141,345. CROSSROADS CUISINES. INT. CL. 42. (U.S. CLS. 100 AND 101). REG. 3-3-1998.
- 2,141,594. CHIPHEADS. INT. CL. 37. (U.S. CLS. 100, 103 AND 106). REG. 3-3-1998.
- 2,141,907. VIN DE GLACIERE. INT. CL. 33. (U.S. CLS. 47 AND 49). REG. 3-10-1998.
- 2,141,999. OXY'LESS. INT. CL. 1. (U.S. CLS. 1, 5, 6, 10, 26 AND 46). REG. 3-10-1998.
- 2,142,101. RIGHT FROM THE FIELD. INT. CL. 29. (U.S. CL. 46). REG. 3-10-1998.
- 2,142,179. PROFILES. INT. CL. 16. (U.S. CLS. 2, 5, 22, 23, 29, 37, 38 AND 50). REG. 3-10-1998.
- 2,142,361. MEGA BLOKS AND DESIGN. INT. CL. 28. (U.S. CLS. 22, 23, 38 AND 50). REG. 3-10-1998.
- 2,142,583. FIDELITY DIRECT. INT. CL. 9. (U.S. CLS. 21, 23, 26, 36 AND 38). REG. 3-10-1998.
- 2,142,738. SPECWEB. INT. CL. 9. (U.S. CLS. 21, 23, 26, 36 AND 38). REG. 3-10-1998.
- 2,143,262. SILKAIR. INT. CL. 10. (U.S. CLS. 26, 39 AND 44). REG. 3-10-1998.
- 2,143,435. LIBERATOR. INT. CL. 7. (U.S. CLS. 13, 19, 21, 23, 31, 34 AND 35). REG. 3-10-1998.
- 2,143,502. COMMUNITY CD. INT. CL. 36. (U.S. CLS. 100, 101 AND 102). REG. 3-10-1998.
- 2,143,863. ZYDECO'S. INT. CL. 32. (U.S. CLS. 45, 46 AND 48). REG. 3-17-1998.
- 2,143,870. SUN BRAND. INT. CL. 30. (U.S. CL. 46). REG. 3-17-1998.
- 2,143,879. DIVEMASTER. INT. CLS. 18, 25 AND 28. (U.S. CLS. 1, 2, 3, 22, 23, 38, 39, 41 AND 50). REG. 3-17-1998.
- 2,144,208. BLUE LAGOON. INT. CL. 5. (U.S. CLS. 6, 18, 44, 46, 51 AND 52). REG. 3-17-1998.
- 2,144,397. L.O.E. STRIPPER. INT. CL. 3. (U.S. CLS. 1, 4, 6, 50, 51 AND 52). REG. 3-17-1998.
- 2,144,648. FLEXLOOP. INT. CL. 10. (U.S. CLS. 26, 39 AND 44). REG. 3-17-1998.
- 2,144,847. QUALITY CHOICE. INT. CLS. 3, 5, 8, 9, 10, 16, 21 AND 25 ONLY. (U.S. CLS. 1, 2, 4, 5, 6, 13, 18, 21, 22, 23, 26, 28, 29, 30, 33, 36, 37, 38, 39, 40, 44, 46, 50, 51 AND 52 ONLY). REG. 3-17-1998.
- 2,145,058. INSTANT TRAVEL. INT. CL. 39. (U.S. CLS. 100 AND 105). REG. 3-17-1998.
- 2,145,180. GLOBAL GOURMET. INT. CL. 42. (U.S. CLS. 100 AND 101). REG. 3-17-1998.
- 2,145,384. PRIVATE RESERVE. INT. CL. 29. (U.S. CL. 46). REG. 3-17-1998.
- 2,145,427. LOUIS RICH AND DESIGN. INT. CL. 29. (U.S. CL. 46). REG. 3-17-1998.
- 2,145,475. ENCORE. INT. CL. 24. (U.S. CLS. 42 AND 50). REG. 3-17-1998.
- 2,145,508. WHISPER SERIES. INT. CL. 7. (U.S. CLS. 13, 19, 21, 23, 31, 34 AND 35). REG. 3-17-1998.
- 2,145,649. LYONAECC AND DESIGN. INT. CL. 28. (U.S. CLS. 22, 23, 38 AND 50). REG. 3-24-1998.
- 2,145,849. SEA FOR YOURSELF. INT. CL. 39. (U.S. CLS. 100 AND 105). REG. 3-24-1998.
- 2,145,913. SY.MED SIMPLIFYING MANAGED CARE AND DESIGN. INT. CL. 9. (U.S. CLS. 21, 23, 26, 36 AND 38). REG. 3-24-1998.
- 2,146,225. IL POGGIO. INT. CL. 33. (U.S. CLS. 47 AND 49). REG. 3-24-1998.
- 2,146,227. ANZA-BORREGO DESERT STATE PARK. INT. CLS. 16 AND 41. (U.S. CLS. 2, 5, 22, 23, 29, 37, 38, 50, 100, 101 AND 107). REG. 3-24-1998.
- 2,146,299. SPEERT ADVERTISING SPECIALTIES. INT. CL. 35. (U.S. CLS. 100, 101 AND 102). REG. 3-24-1998.
- 2,146,350. INFANTS COOP. INT. CL. 10. (U.S. CLS. 26, 39 AND 44). REG. 3-24-1998.
- 2,146,998. SALSA DEL SOL. INT. CL. 30. (U.S. CL. 46). REG. 3-31-1998.
- 2,147,108. ESTRELLA. INT. CL. 30. (U.S. CL. 46). REG. 3-31-1998.
- 2,147,401. SILKWAY. INT. CLS. 39 AND 42. (U.S. CLS. 100, 101 AND 105). REG. 3-31-1998.
- 2,147,623. BIBBIANO. INT. CL. 33. (U.S. CLS. 47 AND 49). REG. 3-31-1998.
- 2,147,635. RADIO CITY ROCKETTES. INT. CL. 41. (U.S. CLS. 100, 101 AND 107). REG. 3-31-1998.
- 2,147,639. SPEAKING CIRCLES AND DESIGN. INT. CL. 41. (U.S. CLS. 100, 101 AND 107). REG. 3-31-1998.
- 2,147,696. ALPHAGRIP. INT. CL. 16. (U.S. CLS. 2, 5, 22, 23, 29, 37, 38 AND 50). REG. 3-31-1998.
- 2,147,969. ADSPAN. INT. CL. 19. (U.S. CLS. 1, 12, 33 AND 50). REG. 3-31-1998.
- 2,148,277. TRINGAS MUSICAL PRODUCTS. INT. CL. 42. (U.S. CLS. 100 AND 101). REG. 3-31-1998.
- 2,149,138. SCHOLASTIC SOLARES A LITERACY PROGRAM IN SPANISH AND DESIGN. INT. CL. 9. (U.S. CLS. 21, 23, 26, 36 AND 38). REG. 4-7-1998.
- 2,149,436. MOTORMAX. INT. CL. 28. (U.S. CLS. 22, 23, 38 AND 50). REG. 4-7-1998.
- 2,149,498. MISCELLANEOUS DESIGN. INT. CLS. 25 AND 41. (U.S. CLS. 22, 39, 100, 101 AND 107). REG. 4-7-1998.
- 2,149,751. EXTREME COLORS. INT. CL. 2. (U.S. CLS. 6, 11 AND 16). REG. 4-7-1998.
- 2,149,862. PROFESSIONAL INSTALLER SERIES. INT. CL. 7. (U.S. CLS. 13, 19, 21, 23, 31, 34 AND 35). REG. 4-7-1998.
- 2,149,897. NATIONAL INSURANCE SPECIALISTS. INT. CL. 36. (U.S. CLS. 100, 101 AND 102). REG. 4-7-1998.
- 2,149,946. COMMONHEALTH. INT. CLS. 35 AND 42. (U.S. CLS. 100, 101 AND 102). REG. 4-14-1998.
- 2,150,316. EANX WRECK NITROX TRIMIX EANX CAVE DEEP AIR INTERNATIONAL ASSOCIATION NITROX & TECHNICAL DIVERS N2 O2 AND DESIGN. INT. CLS. 14, 16, 25 AND 41. (U.S. CLS. 2, 5, 22, 23, 27, 28, 29, 37, 38, 39, 50, 100, 101 AND 107). REG. 4-14-1998.
- 2,150,387. ALSS. INT. CL. 9. (U.S. CLS. 21, 23, 26, 36 AND 38). REG. 4-14-1998.
- 2,150,397. HARD CANDY AND DESIGN. INT. CL. 3. (U.S. CLS. 1, 4, 6, 50, 51 AND 52). REG. 4-14-1998.
- 2,150,579. USA AND DESIGN. INT. CL. 30. (U.S. CL. 46). REG. 4-14-1998.
- 2,151,320. CLASSIC 50. INT. CL. 16. (U.S. CLS. 2, 5, 22, 23, 29, 37, 38 AND 50). REG. 4-14-1998.
- 2,151,904. SELECT-A-FUSE. INT. CL. 9. (U.S. CLS. 21, 23, 26, 36 AND 38). REG. 4-21-1998.
- 2,152,074. M MATURE 17+ CONTENT RATED BY ESRB AND DESIGN. U.S. CL. A. REG. 4-21-1998.
- 2,152,075. T TEEN CONTENT RATED BY ESRB AND DESIGN. U.S. CL. A. REG. 4-21-1998.
- 2,152,077. AO ADULTS ONLY CONTENT RATED BY ESRB AND DESIGN. U.S. CL. A. REG. 4-21-1998.
- 2,152,078. EC EARLY CHILDHOOD CONTENT RATED BY ESRB AND DESIGN. U.S. CL. A. REG. 4-21-1998.
- 2,152,806. HEARING IS BELIEVING. INT. CL. 9. (U.S. CLS. 21, 23, 26, 36 AND 38). REG. 4-21-1998.
- 2,152,992. NUTRA-PUFFS. INT. CL. 31. (U.S. CLS. 1 AND 46). REG. 4-21-1998.
- 2,153,093. HUNGWELL. INT. CL. 25. (U.S. CLS. 22 AND 39). REG. 4-21-1998.
- 2,153,193. BOOKEXPO AMERICA. INT. CLS. 35 AND 41. (U.S. CLS. 100, 101, 102 AND 107). REG. 4-21-1998.
- 2,153,234. MANAGED CARE DIGEST SERIES. INT. CL. 16. (U.S. CLS. 2, 5, 22, 23, 29, 37, 38 AND 50). REG. 4-21-1998.
- 2,153,246. TPS. INT. CL. 9. (U.S. CLS. 21, 23, 26, 36 AND 38). REG. 4-28-1998.
- 2,153,915. LAW & POLITICS. INT. CL. 16. (U.S. CLS. 2, 5, 22, 23, 29, 37, 38 AND 50). REG. 4-28-1998.
- 2,153,983. VERSASEAL. INT. CL. 10. (U.S. CLS. 26, 39 AND 44). REG. 4-28-1998.
- 2,154,056. SECURETOUCH. INT. CL. 9. (U.S. CLS. 21, 23, 26, 36 AND 38). REG. 4-28-1998.

- 2,154,147. INDIA'S EPIC MAHABHARATA GAME. INT. CL. 28. (U.S. CLS. 22, 23, 38 AND 50). REG. 4-28-1998.
- 2,154,242. ONE STEP. INT. CL. 10. (U.S. CLS. 26, 39 AND 44). REG. 4-28-1998.
- 2,154,378. PERSONAL AUTO CONSULTANTS. INT. CL. 35. (U.S. CLS. 100, 101 AND 102). REG. 4-28-1998.
- 2,154,754. JODY MARONI'S SAUSAGE KINGDOM AND DESIGN. INT. CL. 42. (U.S. CLS. 100 AND 101). REG. 5-5-1998.
- 2,155,026. FIGHTING COCK. INT. CL. 33. (U.S. CLS. 47 AND 49). REG. 5-5-1998.
- 2,155,053. FRATERNITE NOTRE DAME. INT. CL. 42. (U.S. CLS. 100 AND 101). REG. 5-5-1998.
- 2,155,443. BYTECAST. INT. CL. 9. (U.S. CLS. 21, 23, 26, 36 AND 38). REG. 5-5-1998.
- 2,155,456. SYNERGY. INT. CL. 28. (U.S. CLS. 22, 23, 38 AND 50). REG. 5-5-1998.
- 2,155,965. SCRATCH-ART. INT. CL. 16. (U.S. CLS. 2, 5, 22, 23, 29, 37, 38 AND 50). REG. 5-12-1998.
- 2,155,991. JET GLADIATOR. INT. CLS. 9, 22, 25 AND 28 ONLY. (U.S. CLS. 1, 2, 7, 19, 21, 22, 23, 26, 36, 38, 39, 42 AND 50). REG. 5-12-1998.
- 2,155,994. AMERICA'S FAVORITE SOFT PRETZEL. INT. CL. 30. (U.S. CL. 46). REG. 5-12-1998.
- 2,156,021. APPLIED INDUSTRIAL TECHNOLOGIES. INT. CL. 42. (U.S. CLS. 100 AND 101). REG. 5-12-1998.
- 2,156,325. EVERSWEET AND DESIGN. INT. CL. 31. (U.S. CLS. 1 AND 46). REG. 5-12-1998.
- 2,156,351. SIRIUS. INT. CL. 17. (U.S. CLS. 1, 5, 12, 13, 35 AND 50). REG. 5-12-1998.
- 2,157,428. PONDMASTER. INT. CL. 5. (U.S. CLS. 6, 18, 44, 46, 51 AND 52). REG. 5-12-1998.
- 2,157,554. AMBROTOSE. INT. CL. 5. (U.S. CLS. 6, 18, 44, 46, 51 AND 52). REG. 5-12-1998.
- 2,157,627. TROPIC-O'SSTANDARD CHARACTER MARK INT. CL. 30. (U.S. CL. 46). REG. 5-12-1998.
- 2,157,749. WATER CANVAS. INT. CL. 3. (U.S. CLS. 1, 4, 6, 50, 51 AND 52). REG. 5-12-1998.
- 2,158,350. HOT PACK SELF-HEATING NUTRITIOUS MEALS AND DESIGN. INT. CL. 29. (U.S. CL. 46). REG. 5-19-1998.
- 2,158,408. ITW. INT. CL. 42. (U.S. CLS. 100 AND 101). REG. 5-19-1998.
- 2,158,759. FRIEDMAN, BILLINGS, RAMSEY & CO. INC.. INT. CL. 36. (U.S. CLS. 100, 101 AND 102). REG. 5-19-1998.
- 2,158,760. MISCELLANEOUS DESIGN. INT. CL. 36. (U.S. CLS. 100, 101 AND 102). REG. 5-19-1998.
- 2,158,762. FBR. INT. CL. 36. (U.S. CLS. 100, 101 AND 102). REG. 5-19-1998.
- 2,159,384. COMMODORE AMERICUS. INT. CL. 36. (U.S. CLS. 100, 101 AND 102). REG. 5-19-1998.
- 2,159,517. BLUE CHIP. INT. CL. 41. (U.S. CLS. 100, 101 AND 107). REG. 5-19-1998.
- 2,159,679. PRISMVIEW. INT. CL. 9. (U.S. CLS. 21, 23, 26, 36 AND 38). REG. 5-19-1998.
- 2,159,704. CENTER OF EXCELLENCE FOR HERNIA REPAIR. INT. CL. 42. (U.S. CLS. 100 AND 101). REG. 5-19-1998.
- 2,159,986. CYBER. INT. CLS. 7 AND 9. (U.S. CLS. 13, 19, 21, 23, 26, 31, 34, 35, 36 AND 38). REG. 5-26-1998.
- 2,161,003. POWER PAIRS. INT. CL. 41. (U.S. CLS. 100, 101 AND 107). REG. 5-26-1998.
- 2,161,564. THE RIGHT WAY TO INVEST. INT. CL. 36. (U.S. CLS. 100, 101 AND 102). REG. 6-2-1998.
- 2,161,951. SMART AND DESIGN. INT. CL. 36. (U.S. CLS. 100, 101 AND 102). REG. 6-2-1998.
- 2,162,018. FST-GAGE. INT. CL. 42. (U.S. CLS. 100 AND 101). REG. 6-2-1998.
- 2,162,142. MISCELLANEOUS DESIGN. INT. CL. 29. (U.S. CL. 46). REG. 6-2-1998.
- 2,163,006. SORMA GROUP AND DESIGN. INT. CLS. 6, 7 AND 8. (U.S. CLS. 2, 12, 13, 14, 19, 21, 23, 25, 28, 31, 34, 35, 44 AND 50). REG. 6-9-1998.
- 2,163,196. RIDGID AND DESIGN. INT. CL. 6. (U.S. CLS. 2, 12, 13, 14, 23, 25 AND 50). REG. 6-9-1998.
- 2,163,587. PETERBILT SERVICENET. INT. CL. 9. (U.S. CLS. 21, 23, 26, 36 AND 38). REG. 6-9-1998.
- 2,163,612. DEARDEN'S. INT. CLS. 39 AND 42. (U.S. CLS. 100, 101 AND 105). REG. 6-9-1998.
- 2,163,613. DEARDEN'S. INT. CL. 35. (U.S. CLS. 100, 101 AND 102). REG. 6-9-1998.
- 2,163,691. PH UP (STYLIZED). INT. CL. 1. (U.S. CLS. 1, 5, 6, 10, 26 AND 46). REG. 6-9-1998.
- 2,163,692. PH DOWN (STYLIZED). INT. CL. 1. (U.S. CLS. 1, 5, 6, 10, 26 AND 46). REG. 6-9-1998.
- 2,164,547. BLUE CHIP. INT. CL. 35. (U.S. CLS. 100, 101 AND 102). REG. 6-9-1998.
- 2,164,948. DUTCH TWIST. INT. CL. 30. (U.S. CL. 46). REG. 6-16-1998.
- 2,166,092. ELITE LINE. INT. CLS. 8, 9 AND 21. (U.S. CLS. 2, 13, 21, 23, 26, 28, 29, 30, 33, 36, 38, 40, 44 AND 50). REG. 6-16-1998.
- 2,166,791. SPORT CLIP. INT. CL. 9. (U.S. CLS. 21, 23, 26, 36 AND 38). REG. 6-23-1998.
- 2,167,062. BIG ROCK BLUE MARLIN TOURNAMENT. INT. CL. 41. (U.S. CLS. 100, 101 AND 107). REG. 6-23-1998.
- 2,167,542. MTM. INT. CL. 1. (U.S. CLS. 1, 5, 6, 10, 26 AND 46). REG. 6-23-1998.
- 2,167,846. WONDERPOLE. INT. CL. 28. (U.S. CLS. 22, 23, 38 AND 50). REG. 6-23-1998.
- 2,167,884. CHAMPION AIR. INT. CL. 39. (U.S. CLS. 100 AND 105). REG. 6-23-1998.
- 2,169,523. ROYAL VAC AND DESIGN. INT. CL. 7. (U.S. CLS. 13, 19, 21, 23, 31, 34 AND 35). REG. 6-30-1998.
- 2,169,571. THE OIL DAILY. INT. CLS. 16 AND 42. (U.S. CLS. 2, 5, 22, 23, 29, 37, 38, 50, 100 AND 101). REG. 6-30-1998.
- 2,169,641. HEMOCOR. INT. CL. 10. (U.S. CLS. 26, 39 AND 44). REG. 6-30-1998.
- 2,169,978. ABRAKADABRA. INT. CL. 32. (U.S. CLS. 45, 46 AND 48). REG. 6-30-1998.
- 2,170,589. AERO DESIGN. INT. CL. 41. (U.S. CLS. 100, 101 AND 107). REG. 6-30-1998.
- 2,170,777. BECAUSE BASICALLY, PEOPLE JUST WANT GREAT STUFF. INT. CL. 35. (U.S. CLS. 100, 101 AND 102). REG. 7-7-1998.
- 2,171,412. KILCHURN ESTATE. INT. CL. 29. (U.S. CL. 46). REG. 7-7-1998.
- 2,172,431. MISCELLANEOUS DESIGN. INT. CL. 8. (U.S. CLS. 23, 28 AND 44). REG. 7-14-1998.
- 2,172,794. TIE-SAFE. INT. CL. 18. (U.S. CLS. 1, 2, 3, 22 AND 41). REG. 7-14-1998.
- 2,173,797. MISCELLANEOUS DESIGN. INT. CL. 9. (U.S. CLS. 21, 23, 26, 36 AND 38). REG. 7-14-1998.
- 2,174,655. ROYAL VAC. INT. CL. 7. (U.S. CLS. 13, 19, 21, 23, 31, 34 AND 35). REG. 7-21-1998.
- 2,174,995. SIXTH SENSE. INT. CL. 9. (U.S. CLS. 21, 23, 26, 36 AND 38). REG. 7-21-1998.
- 2,175,459. NATURE'S OWN. INT. CL. 29. (U.S. CL. 46). REG. 7-21-1998.
- 2,175,597. WORLD'S BEST SURPRISE BAG AND DESIGN. INT. CL. 30. (U.S. CL. 46). REG. 7-21-1998.
- 2,176,319. HITT. INT. CLS. 37 AND 42. (U.S. CLS. 100, 101, 103 AND 106). REG. 7-28-1998.
- 2,176,327. HITT CONTRACTING, INC.. INT. CLS. 37 AND 42. (U.S. CLS. 100, 101, 103 AND 106). REG. 7-28-1998.
- 2,176,498. PUREBRUSH AND DESIGN. INT. CL. 10. (U.S. CLS. 26, 39 AND 44). REG. 7-28-1998.
- 2,176,690. MASTER HIDE. INT. CL. 2. (U.S. CLS. 6, 11 AND 16). REG. 7-28-1998.
- 2,176,822. CORRY'S AND DESIGN. INT. CL. 5. (U.S. CLS. 6, 18, 44, 46, 51 AND 52). REG. 7-28-1998.
- 2,176,825. GRAHAM AND DESIGN. INT. CL. 5. (U.S. CLS. 6, 18, 44, 46, 51 AND 52). REG. 7-28-1998.
- 2,177,286. RESIDENT. INT. CL. 20. (U.S. CLS. 2, 13, 22, 25, 32 AND 50). REG. 7-28-1998.
- 2,177,349. MISCELLANEOUS DESIGN. INT. CL. 28. (U.S. CLS. 22, 23, 38 AND 50). REG. 7-28-1998.
- 2,177,351. ERKIE. INT. CL. 16. (U.S. CLS. 2, 5, 22, 23, 29, 37, 38 AND 50). REG. 7-28-1998.
- 2,178,019. EZ CAP AND DESIGN. INT. CL. 9. (U.S. CLS. 21, 23, 26, 36 AND 38). REG. 8-4-1998.
- 2,178,657. BLAZIN RED. INT. CL. 30. (U.S. CL. 46). REG. 8-4-1998.
- 2,179,344. QUIK CUT. INT. CL. 8. (U.S. CLS. 23, 28 AND 44). REG. 8-4-1998.
- 2,180,158. STRONGLITE. INT. CL. 10. (U.S. CLS. 26, 39 AND 44). REG. 8-11-1998.
- 2,180,812. PROBALL. INT. CL. 28. (U.S. CLS. 22, 23, 38 AND 50). REG. 8-11-1998.
- 2,180,823. UGLY STIK TIGER. INT. CL. 28. (U.S. CLS. 22, 23, 38 AND 50). REG. 8-11-1998.
- 2,182,103. HELIOLITE AND DESIGN. INT. CL. 11. (U.S. CLS. 13, 21, 23, 31 AND 34). REG. 8-18-1998.

- 2,182,137. JET CITY PIZZA CO. AND DESIGN. INT. CL. 42. (U.S. CLS. 100 AND 101). REG. 8-18-1998.
- 2,183,005. FRUSHEEZ. INT. CL. 30. (U.S. CL. 46). REG. 8-18-1998.
- 2,183,390. MISCELLANEOUS DESIGN. INT. CLS. 9, 10, 16, 41 AND 42. (U.S. CLS. 2, 5, 21, 22, 23, 26, 29, 36, 37, 38, 39, 44, 50, 100, 101 AND 107). REG. 8-25-1998.
- 2,183,817. MISCELLANEOUS DESIGN. INT. CL. 37. (U.S. CLS. 100, 103 AND 106). REG. 8-25-1998.
- 2,183,982. STROKEMASTER AND DESIGN. INT. CL. 9. (U.S. CLS. 21, 23, 26, 36 AND 38). REG. 8-25-1998.
- 2,184,058. FRIENDS FIRST "A HEALTHY CHOICE" AND DESIGN. INT. CL. 41. (U.S. CLS. 100, 101 AND 107). REG. 8-25-1998.
- 2,187,410. VEKTOR. INT. CL. 16. (U.S. CLS. 2, 5, 22, 23, 29, 37, 38 AND 50). REG. 9-8-1998.
- 2,187,545. CONGRUENT MUSIC CO. AND DESIGN. INT. CL. 9. (U.S. CLS. 21, 23, 26, 36 AND 38). REG. 9-8-1998.
- 2,187,619. COUNTRY CLUTTER AND DESIGN. INT. CL. 35. (U.S. CLS. 100, 101 AND 102). REG. 9-8-1998.
- 2,187,730. BANK OF TEXAS N.A. AND DESIGN. INT. CL. 36. (U.S. CLS. 100, 101 AND 102). REG. 9-8-1998.
- 2,187,843. BROADREACH. INT. CL. 39. (U.S. CLS. 100 AND 105). REG. 9-8-1998.
- 2,187,875. OHEKA. INT. CL. 42. (U.S. CLS. 100 AND 101). REG. 9-8-1998.
- 2,187,965. MISCELLANEOUS DESIGN. INT. CLS. 9, 16, 25 AND 28. (U.S. CLS. 2, 5, 21, 22, 23, 26, 29, 36, 37, 38, 39 AND 50). REG. 9-8-1998.
- 2,188,434. PRO GRID/IRON GRIDDLE. INT. CL. 21. (U.S. CLS. 2, 13, 23, 29, 30, 33, 40 AND 50). REG. 9-8-1998.
- 2,189,506. WAGS THE DOG. INT. CLS. 9, 16 AND 28. (U.S. CLS. 2, 5, 21, 22, 23, 26, 29, 36, 37, 38 AND 50). REG. 9-15-1998.
- 2,189,858. THE CLIFF CLUB. INT. CL. 36. (U.S. CLS. 100, 101 AND 102). REG. 9-15-1998.
- 2,190,571. VALUELINK. INT. CL. 36. (U.S. CLS. 100, 101 AND 102). REG. 9-22-1998.
- 2,190,686. CETROTIDE. INT. CL. 5. (U.S. CLS. 6, 18, 44, 46, 51 AND 52). REG. 9-22-1998.
- 2,191,468. PERMASORB. INT. CL. 11. (U.S. CLS. 13, 21, 23, 31 AND 34). REG. 9-22-1998.
- 2,192,033. BIOSYN. INT. CL. 10. (U.S. CLS. 26, 39 AND 44). REG. 9-29-1998.
- 2,192,225. GIFT OF BREATH. INT. CL. 36. (U.S. CLS. 100, 101 AND 102). REG. 9-29-1998.
- 2,193,630. ANDRE CHREKY. INT. CL. 42. (U.S. CLS. 100 AND 101). REG. 10-6-1998.
- 2,193,936. VULCAN (STYLIZED). INT. CL. 11. (U.S. CLS. 13, 21, 23, 31 AND 34). REG. 10-6-1998.
- 2,194,690. PORT OF TEXAS CITY. INT. CL. 39. (U.S. CLS. 100 AND 105). REG. 10-13-1998.
- 2,195,539. CITE. INT. CL. 41. (U.S. CLS. 100, 101 AND 107). REG. 10-13-1998.
- 2,195,568. MISCELLANEOUS DESIGN. INT. CL. 28. (U.S. CLS. 22, 23, 38 AND 50). REG. 10-13-1998.
- 2,196,107. DOROTHY THE DINOSAUR. INT. CLS. 9, 16, 25 AND 28. (U.S. CLS. 2, 5, 21, 22, 23, 26, 29, 36, 37, 38, 39 AND 50). REG. 10-13-1998.
- 2,196,676. BOBS SWEET STRIPES AND DESIGN. INT. CL. 30. (U.S. CL. 46). REG. 10-13-1998.
- 2,196,822. E M P R E S S (STYLIZED). INT. CL. 41. (U.S. CL. 107). REG. 10-20-1998.
- 2,196,836. DURA-BACK. INT. CL. 27. (U.S. CL. 42). REG. 10-20-1998.
- 2,199,626. CAPITAL LEGAL RESEARCH "INFORMATION IS USELESS UNLESS YOU KNOW WHERE TO FIND IT." AND DESIGN. INT. CL. 42. (U.S. CLS. 100 AND 101). REG. 10-27-1998.
- 2,200,256. RABAVERT. INT. CL. 5. (U.S. CLS. 6, 18, 44, 46, 51 AND 52). REG. 10-27-1998.
- 2,200,390. MPFP. INT. CL. 41. (U.S. CLS. 100, 101 AND 107). REG. 10-27-1998.
- 2,201,722. MATHMOS. INT. CL. 11. (U.S. CLS. 13, 21, 23, 31 AND 34). REG. 11-3-1998.
- 2,201,919. J.W. PET COMPANY. INT. CL. 28 ONLY. (U.S. CLS. 22, 23, 38 AND 50). REG. 11-3-1998.
- 2,202,081. B AND DESIGN. INT. CL. 36. (U.S. CLS. 100, 101 AND 102). REG. 11-3-1998.
- 2,202,162. BABY HANDS. INT. CL. 3. (U.S. CLS. 1, 4, 6, 50, 51 AND 52). REG. 11-3-1998.
- 2,202,281. DECUBITENE. INT. CL. 5. (U.S. CLS. 6, 18, 44, 46, 51 AND 52). REG. 11-3-1998.
- 2,202,681. HEART PATH. INT. CL. 42. (U.S. CLS. 100 AND 101). REG. 11-10-1998.
- 2,203,721. JIFFVSHARP AND DESIGN. INT. CL. 8. (U.S. CLS. 23, 28 AND 44). REG. 11-17-1998.
- 2,204,075. IF IT COMES FROM THE HEART, SHOULDN'T IT COME FROM HELZBERG DIAMONDS. INT. CL. 35. (U.S. CLS. 100, 101 AND 102). REG. 11-17-1998.
- 2,204,329. NAVISPHERE. INT. CL. 9. (U.S. CLS. 21, 23, 26, 36 AND 38). REG. 11-17-1998.
- 2,204,333. FOGO DE CHAO (STYLIZED). INT. CL. 25. (U.S. CLS. 22 AND 39). REG. 11-17-1998.
- 2,204,339. FOGO DE CHAO AND DESIGN. INT. CL. 25. (U.S. CLS. 22 AND 39). REG. 11-17-1998.
- 2,204,401. BURSAPLEX. INT. CL. 5. (U.S. CLS. 6, 18, 44, 46, 51 AND 52). REG. 11-17-1998.
- 2,204,487. MAGICHALK. INT. CL. 16. (U.S. CLS. 2, 5, 22, 23, 29, 37, 38 AND 50). REG. 11-17-1998.
- 2,205,161. F.I.R.S.T.. INT. CL. 42. (U.S. CLS. 100 AND 101). REG. 11-24-1998.
- 2,205,535. AIRPORT FAST PARK AND DESIGN. INT. CL. 39. (U.S. CLS. 100 AND 105). REG. 11-24-1998.
- 2,205,610. VISIPORT. INT. CL. 10. (U.S. CLS. 26, 39 AND 44). REG. 11-24-1998.
- 2,205,737. MOBISYL. INT. CL. 5. (U.S. CLS. 6, 18, 44, 46, 51 AND 52). REG. 11-24-1998.
- 2,206,242. HARVEST PREFERRED SEAFOODS. INT. CL. 29. (U.S. CL. 46). REG. 11-24-1998.
- 2,207,147. SOCIETY OF JESUS. INT. CLS. 16, 41 AND 42. (U.S. CLS. 2, 5, 22, 23, 29, 37, 38, 50, 100, 101 AND 107). REG. 12-1-1998.
- 2,208,176. NEW JERSEY LAW JOURNAL. INT. CL. 16. (U.S. CLS. 2, 5, 22, 23, 29, 37, 38 AND 50). REG. 12-8-1998.
- 2,208,270. USAFE AND DESIGN. INT. CL. 41. (U.S. CLS. 100, 101 AND 107). REG. 12-8-1998.
- 2,208,425. MILITARY ORDER OF THE PURPLE HEART SERVICE FOUNDATION AND DESIGN. INT. CLS. 36 AND 42. (U.S. CLS. 100, 101 AND 102). REG. 12-8-1998.
- 2,208,655. MTP AV. INT. CL. 9. (U.S. CLS. 21, 23, 26, 36 AND 38). REG. 12-8-1998.
- 2,208,838. JELLY ROYALE. INT. CL. 10. (U.S. CLS. 26, 39 AND 44). REG. 12-8-1998.
- 2,209,107. SILVER GOAT. INT. CL. 29. (U.S. CL. 46). REG. 12-8-1998.
- 2,209,148. SMOOTHIE'O AND DESIGN. INT. CL. 30. (U.S. CL. 46). REG. 12-8-1998.
- 2,210,289. VILLAGE GREEN. INT. CL. 36. (U.S. CLS. 100, 101 AND 102). REG. 12-15-1998.
- 2,210,752. SUPPORTWORKS. INT. CL. 35. (U.S. CLS. 100, 101 AND 102). REG. 12-15-1998.
- 2,211,489. BLUE CHIP. INT. CL. 6. (U.S. CLS. 2, 12, 13, 14, 23, 25 AND 50). REG. 12-15-1998.
- 2,212,570. E-POLL AND DESIGN. INT. CLS. 35 AND 42. (U.S. CLS. 100, 101 AND 102). REG. 12-22-1998.
- 2,212,694. PARACHUTES OVER AMERICA. INT. CL. 13. (U.S. CLS. 2 AND 9). REG. 12-22-1998.
- 2,213,836. BIO-DOPHILUS. INT. CL. 5. (U.S. CLS. 6, 18, 44, 46, 51 AND 52). REG. 12-29-1998.
- 2,213,896. BALLOON BOUTIQUE. INT. CL. 35. (U.S. CLS. 100, 101 AND 102). REG. 12-29-1998.
- 2,213,927. ARMS REACH. INT. CL. 20. (U.S. CLS. 2, 13, 22, 25, 32 AND 50). REG. 12-29-1998.
- 2,214,798. LEAPING LIZARD. INT. CL. 33. (U.S. CLS. 47 AND 49). REG. 12-29-1998.
- 2,215,417. FLXTITE. INT. CL. 16. (U.S. CLS. 2, 5, 22, 23, 29, 37, 38 AND 50). REG. 12-29-1998.
- 2,216,105. RAINWOOD. INT. CL. 19. (U.S. CLS. 1, 12, 33 AND 50). REG. 1-5-1999.
- 2,216,228. LORDS OF THE REALM. INT. CL. 9. (U.S. CLS. 21, 23, 26, 36 AND 38). REG. 1-5-1999.
- 2,216,460. BTC WHOLESALE DISTRIBUTORS AND DESIGN. INT. CL. 35. (U.S. CLS. 100, 101 AND 102). REG. 1-5-1999.
- 2,216,762. COMPROMISE IS UNACCEPTABLE. INT. CL. 33. (U.S. CLS. 47 AND 49). REG. 1-5-1999.
- 2,217,060. NATURE'S DIET CAPS + HERBS. INT. CL. 5. (U.S. CLS. 6, 18, 44, 46, 51 AND 52). REG. 1-12-1999.
- 2,217,154. LAUDATIO. INT. CL. 9. (U.S. CLS. 21, 23, 26, 36 AND 38). REG. 1-12-1999.

- 2,217,467. THE EXHAUST TECHNOLOGY COMPANY. INT. CL. 16. (U.S. CLS. 2, 5, 22, 23, 29, 37, 38 AND 50). REG. 1-12-1999.
- 2,217,505. AMCOT AND DESIGN. INT. CLS. 11, 37 AND 42. (U.S. CLS. 13, 21, 23, 31, 34, 100, 101, 103 AND 106). REG. 1-12-1999.
- 2,217,662. ACCOUNTLINK. INT. CL. 35. (U.S. CLS. 100, 101 AND 102). REG. 1-12-1999.
- 2,218,516. CANINE COMPANIONS FOR INDEPENDENCE AND DESIGN. INT. CL. 41. (U.S. CLS. 100, 101 AND 107). REG. 1-19-1999.
- 2,218,570. SUN DIEGO. INT. CL. 25. (U.S. CLS. 22 AND 39). REG. 1-19-1999.
- 2,219,439. QUICK CHANGE. INT. CL. 9. (U.S. CLS. 21, 23, 26, 36 AND 38). REG. 1-19-1999.
- 2,220,100. PRIVATE PORTFOLIOS, INC.. INT. CL. 36. (U.S. CLS. 100, 101 AND 102). REG. 1-26-1999.
- 2,220,267. NATUROSE. INT. CL. 1. (U.S. CLS. 1, 5, 6, 10, 26 AND 46). REG. 1-26-1999.
- 2,220,453. ¡TU MUSICA! (STYLIZED). INT. CL. 35. (U.S. CLS. 100, 101 AND 102). REG. 1-26-1999.
- 2,221,510. TECHNIKA. INT. CL. 35. (U.S. CLS. 100, 101 AND 102). REG. 2-2-1999.
- 2,221,868. MARY COHR. INT. CL. 3. (U.S. CLS. 1, 4, 6, 50, 51 AND 52). REG. 2-2-1999.

* * * * *

TRADEMARK REGISTRATIONS CANCELED

The designation "U.S. Cl." appearing in this section refers to the U.S. class in effect prior to Sep. 1, 1973 rather than the international class which applies to applications filed on or after that date. For adoption of international classification see notice in the OFFICIAL GAZETTE of Jun. 26, 1973 (911 O.G. TM 210).

SECTION 7(D)

- 2,114,222. UNITED STATES IDENTIFICATION CARD UNITED STATES * ID CARD SYSTEM * AND DESIGN. INT. CL. 16. REG. 11-18-1997.
- 2,505,746. PRICewaterHOUSECOOPERS TEAMMATE (STYLIZED). INT. CL. 9. REG. 11-13-2001.
- 2,817,971. WESTPORT AND DESIGN. INT. CL. 34. REG. 2-24-2004.
- 2,861,546. INSURECAT. INT. CL. 36. REG. 7-6-2004.
- 3,122,889. NBA RIVALRY WEEK AND DESIGN. INT. CL. 41. REG. 8-1-2006.
- 3,158,014. PRICewaterHOUSECOOPERS TEAMMATES-TANDARD CHARACTER MARK INT. CL. 9. REG. 10-17-2006.
- 3,162,997. ITS KOOL. INT. CL. 9. REG. 10-24-2006.
- 3,292,537. CASINO DE MONTE-CARLO. INT. CLS. 9, 16 AND 28. REG. 9-18-2007.
- 3,322,003. PIEZOSONSTANDARD CHARACTER MARK INT. CL. 10. REG. 10-23-2007.
- 3,351,939. SARESPASTANDARD CHARACTER MARK INT. CL. 5. REG. 12-11-2007.
- 1,438,504. SIXPAK. INT. CL. 9. REG. 5-5-1987.
- 1,438,506. ISLAND OPTICS AND DESIGN. INT. CL. 9. REG. 5-5-1987.
- 1,438,507. INFODESK. INT. CL. 9. REG. 5-5-1987.
- 1,438,508. EBONY EYES. INT. CL. 9. REG. 5-5-1987.
- 1,438,512. THE IDEA GENERATOR. INT. CL. 9. REG. 5-5-1987.
- 1,438,522. SEA-TRAC (STYLIZED). INT. CL. 9. REG. 5-5-1987.
- 1,438,526. Q/CARE. INT. CL. 9. REG. 5-5-1987.
- 1,438,533. PRECI-JET. INT. CL. 10. REG. 5-5-1987.
- 1,438,534. TICKLE TALKER. INT. CL. 10. REG. 5-5-1987.
- 1,438,538. MAG (STYLIZED). INT. CL. 11. REG. 5-5-1987.
- 1,438,540. COOL THRU. INT. CL. 11. REG. 5-5-1987.
- 1,438,541. DYNASTY CLASSICS AND DESIGN. INT. CL. 11. REG. 5-5-1987.
- 1,438,548. AUTO POWER AND DESIGN. INT. CL. 12. REG. 5-5-1987.
- 1,438,567. FUNIMALS. INT. CL. 16. REG. 5-5-1987.
- 1,438,576. CONTINUED SUCCESS (STYLIZED). INT. CL. 16. REG. 5-5-1987.
- 1,438,581. GOLDEN STEP AHEAD PLUS. INT. CL. 16. REG. 5-5-1987.
- 1,438,588. CRAYTUFF. INT. CL. 16. REG. 5-5-1987.
- 1,438,589. MICAFIL. INT. CL. 17. REG. 5-5-1987.
- 1,438,590. AURORA. INT. CL. 17. REG. 5-5-1987.
- 1,438,594. FIRECODE. INT. CL. 19. REG. 5-5-1987.
- 1,438,596. KAISER ISLAND CEMENT. INT. CL. 19. REG. 5-5-1987.
- 1,438,597. MINUTEMAN EASY-TO-STIR RUBBERIZED BLACKTOP SEALER & FILLER AND DESIGN. INT. CL. 19. REG. 5-5-1987.
- 1,438,603. TURBO. INT. CL. 21. REG. 5-5-1987.
- 1,438,621. DURA TRACT AND DESIGN. INT. CL. 27. REG. 5-5-1987.
- 1,438,622. KAWADA (STYLIZED). INT. CL. 28. REG. 5-5-1987.
- 1,438,638. SEVILLE. INT. CL. 28. REG. 5-5-1987.
- 1,438,649. LIGHT & LEAN AND DESIGN. INT. CL. 29. REG. 5-5-1987.
- 1,438,665. SHIMEREES. INT. CL. 30. REG. 5-5-1987.
- 1,438,674. CASA BRINA. INT. CL. 33. REG. 5-5-1987.
- 1,438,680. THINK STRAIGHT, TALK STRAIGHT. INT. CLS. 35 AND 36. REG. 5-5-1987.
- 1,438,686. U HELP, INC. ASHLAND ILLINOIS (STYLIZED). INT. CL. 36. REG. 5-5-1987.
- 1,438,688. EXHIBITGUARD. INT. CL. 36. REG. 5-5-1987.
- 1,438,691. THE JACKSONVILLE LANDING AND DESIGN. INT. CL. 36. REG. 5-5-1987.
- 1,438,695. "LOVE LIGHT". INT. CLS. 36 AND 42. REG. 5-5-1987.
- 1,438,700. MIRRORLITE GLASSLESS MIRRORS AND DESIGN. INT. CL. 37. REG. 5-5-1987.
- 1,438,703. CALL ON US. INT. CL. 38. REG. 5-5-1987.
- 1,438,706. INSTA-LEASE. INT. CL. 38. REG. 5-5-1987.
- 1,438,707. PLEASANT CALIFORNIA HOLIDAYS. INT. CL. 39. REG. 5-5-1987.
- 1,438,710. NATIONAL COURIER SYSTEMS AND DESIGN. INT. CL. 39. REG. 5-5-1987.
- 1,438,713. OSCO PHOTO EXPRESS AND DESIGN. INT. CL. 40. REG. 5-5-1987.
- 1,438,734. FIGLIO (STYLIZED). INT. CL. 42. REG. 5-5-1987.
- 1,438,736. CAMINO REAL. INT. CL. 42. REG. 5-5-1987.

SECTION 8

- 834,189. MISCELLANEOUS DESIGN. U.S. CLS. 8, 21, 23, 25, 32, 37 AND 50, ONLY. REG. 8-29-1967.
- 836,491. NOSCO. U.S. CLS. 23, 32 AND 37, ONLY. REG. 10-10-1967.
- 1,064,846. PACER-TRACER. INT. CL. 10. REG. 5-3-1977.
- 1,070,863. HARRISBURG AND DESIGN. INT. CLS. 4 AND 17 ONLY. REG. 8-9-1977.
- 1,085,815. QUALCO AND DESIGN. INT. CLS. 2 AND 17 ONLY. REG. 2-21-1978.
- 1,438,454. BIO-MEGA. INT. CL. 1. REG. 5-5-1987.
- 1,438,461. BABIFLORE. INT. CL. 3. REG. 5-5-1987.
- 1,438,464. PANAX. INT. CL. 5. REG. 5-5-1987.
- 1,438,468. DATA DIS-GUARD. INT. CL. 6. REG. 5-5-1987.
- 1,438,469. VIKING JOHNSON. INT. CL. 6. REG. 5-5-1987.
- 1,438,470. G-B (STYLIZED). INT. CL. 6. REG. 5-5-1987.
- 1,438,471. GB AND DESIGN. INT. CL. 6. REG. 5-5-1987.
- 1,438,475. TUFFY. INT. CL. 6. REG. 5-5-1987.
- 1,438,477. READY ACCESS (STYLIZED). INT. CL. 6. REG. 5-5-1987.
- 1,438,478. ASTRO AND DESIGN. INT. CL. 6. REG. 5-5-1987.
- 1,438,482. ELAN. INT. CL. 7. REG. 5-5-1987.
- 1,438,483. LFA (STYLIZED). INT. CLS. 7 AND 8. REG. 5-5-1987.
- 1,438,485. FE (STYLIZED). INT. CLS. 7 AND 11. REG. 5-5-1987.
- 1,438,491. COMMANDER. INT. CL. 7. REG. 5-5-1987.
- 1,438,492. JOHNSON. INT. CL. 7. REG. 5-5-1987.
- 1,438,495. KING GRABBER (STYLIZED). INT. CL. 7. REG. 5-5-1987.
- 1,438,496. CONFLO. INT. CL. 7. REG. 5-5-1987.
- 1,438,502. BRILLIANT IMAGE. INT. CLS. 9, 16 AND 42. REG. 5-5-1987.

- 1,438,738. OCEAN AND DESIGN. INT. CL. 42. REG. 5-5-1987.
- 1,438,740. COOKIN' WHAT AMERICA LOVES BEST. INT. CL. 42. REG. 5-5-1987.
- 1,438,743. RELAX, IN THE COMFORT OF THE COUNTRY. INT. CL. 42. REG. 5-5-1987.
- 1,438,745. MISCELLANEOUS DESIGN. INT. CL. 42. REG. 5-5-1987.
- 1,438,750. AFTER-CRASH. INT. CL. 42. REG. 5-5-1987.
- 1,438,754. SCIENTIFIC COMPUTING ASSOCIATES. INT. CLS. 9 AND 41. REG. 5-5-1987.
- 1,438,755. SPONGE & RINSE. INT. CL. 3. REG. 5-5-1987.
- 1,438,758. IMAGESCAN. INT. CL. 9. REG. 5-5-1987.
- 1,438,768. SUPERB. INT. CL. 20. REG. 5-5-1987.
- 1,438,781. LEGAL COPY SPECIALISTS. INT. CL. 35. REG. 5-5-1987.
- 1,438,784. MICRO LETTER OF CREDIT. INT. CL. 36. REG. 5-5-1987.
- 1,438,789. WINGFIELD'S (STYLIZED). INT. CL. 42. REG. 5-5-1987.
- 1,473,157. BSA BEST. INT. CL. 25 ONLY. REG. 1-19-1988.
- 1,473,158. BLACK BULL. INT. CL. 25 ONLY. REG. 1-19-1988.
- 1,480,510. DAVIDOFF AND DESIGN. INT. CLS. 9, 14, 16, 18 AND 25 ONLY. REG. 3-15-1988.
- 1,491,986. MISCELLANEOUS DESIGN. INT. CL. 25 ONLY. REG. 6-14-1988.
- 1,492,770. CLEARBLUE. INT. CL. 5 ONLY. REG. 6-21-1988.
- 1,839,188. 7 WONDERS. INT. CL. 3. REG. 6-14-1994.
- 1,973,282. HESTRA 1936 AND DESIGN. INT. CL. 28. REG. 5-7-1996.
- 2,058,511. FUKO AND DESIGN. INT. CL. 17. REG. 5-6-1997.
- 2,058,514. ZINC ALLOY AND DESIGN. INT. CLS. 6 AND 12. REG. 5-6-1997.
- 2,058,517. SIGNATURE LINE (STYLIZED). INT. CL. 25. REG. 5-6-1997.
- 2,058,521. INOXBRASS AND DESIGN. INT. CL. 6. REG. 5-6-1997.
- 2,058,533. HIT IT HARD SPORTSWEAR AND DESIGN. INT. CL. 25. REG. 5-6-1997.
- 2,058,536. VIRTUAL CAFE. INT. CL. 41. REG. 5-6-1997.
- 2,058,547. EL BUEN BIFE AND DESIGN. INT. CL. 42. REG. 5-6-1997.
- 2,058,551. BRANSON JAM. INT. CL. 41. REG. 5-6-1997.
- 2,058,556. DALISTICK. INT. CL. 9. REG. 5-6-1997.
- 2,058,557. MICRO GOLD AND DESIGN. INT. CL. 21. REG. 5-6-1997.
- 2,058,562. SECURITY ANALYST. INT. CL. 9. REG. 5-6-1997.
- 2,058,564. VIEWERNET (STYLIZED). INT. CLS. 41 AND 42. REG. 5-6-1997.
- 2,058,576. MISCELLANEOUS DESIGN. INT. CLS. 9, 16 AND 41. REG. 5-6-1997.
- 2,058,584. THE LIGHTWEIGHT HEAVYWEIGHT. INT. CL. 9. REG. 5-6-1997.
- 2,058,611. USE GENUINE MTD PARTS MADE IN U.S.A. AND DESIGN. INT. CL. 7. REG. 5-6-1997.
- 2,058,612. CLOTHING FOR THE RIVER OF LIFE. INT. CL. 25. REG. 5-6-1997.
- 2,058,624. SMALL ENTERPRISE ASSISTANCE FUNDS AND DESIGN. INT. CL. 42. REG. 5-6-1997.
- 2,058,639. CINE CANDY. INT. CL. 30. REG. 5-6-1997.
- 2,058,644. SLUMPEE & FRIEDA THE FITNESS FAIRY AND FRIENDS. INT. CL. 9. REG. 5-6-1997.
- 2,058,646. COMPUTER COMFORTS AND DESIGN. INT. CL. 40. REG. 5-6-1997.
- 2,058,654. 1-800-NU-BEST-5. INT. CL. 42. REG. 5-6-1997.
- 2,058,660. FOUNDATIONS IN SPEECH PERCEPTION. INT. CL. 9. REG. 5-6-1997.
- 2,058,664. MISCELLANEOUS DESIGN. INT. CL. 28. REG. 5-6-1997.
- 2,058,680. POWEROFFICE. INT. CL. 9. REG. 5-6-1997.
- 2,058,681. E (STYLIZED). INT. CL. 9. REG. 5-6-1997.
- 2,058,685. DATALYNX (STYLIZED). INT. CL. 9. REG. 5-6-1997.
- 2,058,695. INSPIRATIONS. INT. CL. 42. REG. 5-6-1997.
- 2,058,697. ARRAN FINE FOODS AND DESIGN. INT. CLS. 29 AND 30. REG. 5-6-1997.
- 2,058,703. THE LEARNING IMMUNE FUNCTION ENHANCEMENT PROGRAM AND DESIGN. INT. CL. 42. REG. 5-6-1997.
- 2,058,710. TRASAN. INT. CLS. 21, 24 AND 25. REG. 5-6-1997.
- 2,058,711. DOMAN. INT. CL. 19. REG. 5-6-1997.
- 2,058,712. LIPPINCOTT MARINE. INT. CL. 36. REG. 5-6-1997.
- 2,058,715. KI METHOD. INT. CL. 41. REG. 5-6-1997.
- 2,058,724. PHASE METRICS. INT. CL. 9. REG. 5-6-1997.
- 2,058,727. COLOR SEAL. INT. CL. 3. REG. 5-6-1997.
- 2,058,749. W AND DESIGN. INT. CL. 42. REG. 5-6-1997.
- 2,058,753. CC CARTIER AND DESIGN. INT. CL. 34. REG. 5-6-1997.
- 2,058,763. DON'T DRINK BEER FROM STRANGERS. INT. CL. 42. REG. 5-6-1997.
- 2,058,774. V-SEARCH. INT. CL. 9. REG. 5-6-1997.
- 2,058,782. ULTRA. INT. CL. 9. REG. 5-6-1997.
- 2,058,807. DARE. INT. CLS. 39 AND 42. REG. 5-6-1997.
- 2,058,816. SITE-BASED TESTING CENTERS. INT. CL. 16. REG. 5-6-1997.
- 2,058,824. AFC. INT. CL. 40. REG. 5-6-1997.
- 2,058,833. W WORLD WIDE MUSIC AND DESIGN. INT. CLS. 35 AND 42. REG. 5-6-1997.
- 2,058,855. BUCKINGHAM STENCILS. INT. CLS. 2 AND 16. REG. 5-6-1997.
- 2,058,861. THE DISMAL SCIENTIST. INT. CL. 42. REG. 5-6-1997.
- 2,058,871. AAS INTERNATIONAL ASSOCIATION OF ASSESSING OFFICERS ASSESSMENT ADMINISTRATION SPECIALIST AND DESIGN. U.S. CL. 200. REG. 5-6-1997.
- 2,058,878. EXPOSURE. INT. CL. 20. REG. 5-6-1997.
- 2,058,884. SCRIBBLES AND DESIGN. INT. CL. 25. REG. 5-6-1997.
- 2,058,891. FBD. INT. CL. 20. REG. 5-6-1997.
- 2,058,892. ALSAFLOOR. INT. CL. 19. REG. 5-6-1997.
- 2,058,894. USA STATS. INT. CL. 35. REG. 5-6-1997.
- 2,058,914. CAPITAL EXPRESS. INT. CL. 36. REG. 5-6-1997.
- 2,058,919. UCH ACADEMY. INT. CL. 41. REG. 5-6-1997.
- 2,058,939. THE POWER OF POWELL. INT. CLS. 40 AND 42. REG. 5-6-1997.
- 2,058,941. IT'S FAST. IT'S EASY. IT SAVES.. INT. CL. 38. REG. 5-6-1997.
- 2,058,948. SWIFTLINE. INT. CL. 9. REG. 5-6-1997.
- 2,058,949. BIS BAG. INT. CL. 18. REG. 5-6-1997.
- 2,058,951. MOVINET. INT. CL. 35. REG. 5-6-1997.
- 2,058,960. FORMULA MOTORSPORTS. INT. CL. 37. REG. 5-6-1997.
- 2,058,967. DESIGN AND DESIGN. INT. CL. 3. REG. 5-6-1997.
- 2,058,969. ELKHART TRAVELER. INT. CL. 12. REG. 5-6-1997.
- 2,058,973. LAWN PERFECT. INT. CL. 1. REG. 5-6-1997.
- 2,058,976. BIG POWER WS AND DESIGN. INT. CL. 9. REG. 5-6-1997.
- 2,058,982. WHITECUT. INT. CL. 4. REG. 5-6-1997.
- 2,058,998. CHEWYS RUGULACH. INT. CL. 30. REG. 5-6-1997.
- 2,058,999. MISCELLANEOUS DESIGN. INT. CL. 25. REG. 5-6-1997.
- 2,059,007. MONARCH. INT. CL. 42. REG. 5-6-1997.
- 2,059,008. HEARTBEAT. INT. CL. 41. REG. 5-6-1997.
- 2,059,009. VIATEK. INT. CL. 1. REG. 5-6-1997.
- 2,059,036. "MAKING TECHNOLOGY WORK FOR BUSINESS"...IS WHAT WE DO (STYLIZED). INT. CL. 42. REG. 5-6-1997.
- 2,059,039. IMPROV-IT!. INT. CL. 41. REG. 5-6-1997.
- 2,059,040. KD KIMAL DENSE DRY AND DESIGN. INT. CL. 19. REG. 5-6-1997.
- 2,059,052. SAFETY WORKS AND DESIGN. INT. CL. 36. REG. 5-6-1997.
- 2,059,062. O-KAY. INT. CL. 30. REG. 5-6-1997.
- 2,059,084. CUSTOM ACCENTS. INT. CL. 20. REG. 5-6-1997.
- 2,059,097. RANCHER'S SKILLET. INT. CL. 42. REG. 5-6-1997.
- 2,059,098. NITEBITE. INT. CL. 5. REG. 5-6-1997.
- 2,059,101. AUTRONICA. INT. CL. 9. REG. 5-6-1997.
- 2,059,108. ULTRITE. INT. CL. 3. REG. 5-6-1997.
- 2,059,109. BEADER'S TOUCH. INT. CL. 35. REG. 5-6-1997.

- 2,059,110. ATMOX. INT. CL. 11. REG. 5-6-1997.
2,059,121. THE ALOHA COLLECTION. INT. CL. 39. REG. 5-6-1997.
2,059,130. PROLINE AND DESIGN. INT. CL. 9. REG. 5-6-1997.
2,059,138. DIABLO. INT. CL. 28. REG. 5-6-1997.
2,059,139. OCD - ORGANIZATIONAL CAPITAL DEVELOPMENT. INT. CLS. 9, 35 AND 41. REG. 5-6-1997.
2,059,144. MESA. INT. CL. 9. REG. 5-6-1997.
2,059,147. BRIDGEWAY. INT. CL. 9. REG. 5-6-1997.
2,059,170. CHOICE REPAY. INT. CL. 36. REG. 5-6-1997.
2,059,171. CHOICE RATES. INT. CL. 36. REG. 5-6-1997.
2,059,175. PLAIN AND SIMPLE. INT. CL. 16. REG. 5-6-1997.
2,059,178. SPHERE CLOWN BAND AND DESIGN. INT. CL. 41. REG. 5-6-1997.
2,059,196. QMI GOLD. INT. CL. 13. REG. 5-6-1997.
2,059,210. EPNCONNECTOR. INT. CL. 9. REG. 5-6-1997.
2,059,213. UNIDET. INT. CL. 13. REG. 5-6-1997.
2,059,215. DECEMBER'S SPECIAL PLACE (STYLIZED). INT. CL. 42. REG. 5-6-1997.
2,059,218. INDRIVE. INT. CL. 7. REG. 5-6-1997.
2,059,220. LAZY LINER. INT. CL. 7. REG. 5-6-1997.
2,059,226. CHERUBINI. INT. CLS. 12 AND 37. REG. 5-6-1997.
2,059,232. HEAVY. INT. CL. 28. REG. 5-6-1997.
2,059,240. STERIYOLK (STYLIZED). INT. CL. 5. REG. 5-6-1997.
2,059,243. JJ AND DESIGN. INT. CL. 16. REG. 5-6-1997.
2,059,254. NEWSWORTHY. INT. CL. 7. REG. 5-6-1997.
2,059,258. QUIET MOUNT. INT. CL. 12. REG. 5-6-1997.
2,059,264. ROCKET AND DESIGN. INT. CL. 9. REG. 5-6-1997.
2,059,268. SAVER'S ACCESS. INT. CL. 36. REG. 5-6-1997.
2,059,273. KOOL KAMP LITE. INT. CL. 11. REG. 5-6-1997.
2,059,284. SHIELD TITLE AGENCY, INC. AND DESIGN. INT. CLS. 36 AND 42. REG. 5-6-1997.
2,059,285. MOHAIR AND DESIGN. INT. CL. 42. REG. 5-6-1997.
2,059,291. HEAT BUSTER. INT. CL. 11. REG. 5-6-1997.
2,059,303. MOOVIES (STYLIZED). INT. CL. 42. REG. 5-6-1997.
2,059,306. QUICK-TIE AND DESIGN. INT. CL. 16. REG. 5-6-1997.
2,059,327. GARGOYLES. INT. CL. 16. REG. 5-6-1997.
2,059,329. RIR AND DESIGN. INT. CL. 42. REG. 5-6-1997.
2,059,332. RIR AND DESIGN. INT. CL. 36. REG. 5-6-1997.
2,059,344. VILLAGE HEARTBEAT AND DESIGN. INT. CL. 41. REG. 5-6-1997.
2,059,346. BOTANICA. INT. CL. 21. REG. 5-6-1997.
2,059,350. KK AND DESIGN. INT. CL. 6. REG. 5-6-1997.
2,059,382. I AM IRREPLACEABLE. INT. CL. 42. REG. 5-6-1997.
2,059,392. BONE FORTE AND DESIGN. INT. CL. 5. REG. 5-6-1997.
2,059,409. MISCELLANEOUS DESIGN. INT. CL. 42. REG. 5-6-1997.
2,059,412. JERSEY JOE'S AUTHENTIC HOAGIES SINCE 1973 AND DESIGN. INT. CL. 42. REG. 5-6-1997.
2,059,414. MISCELLANEOUS DESIGN. INT. CL. 37. REG. 5-6-1997.
2,059,422. SOF BOOT. INT. CL. 25. REG. 5-6-1997.
2,059,442. THE ANSWER GUYS. INT. CL. 41. REG. 5-6-1997.
2,059,443. CLUB JERSEY. INT. CL. 25. REG. 5-6-1997.
2,059,447. JALAPENO KETCHUP AND DESIGN. INT. CL. 25. REG. 5-6-1997.
2,059,455. WHOA! FILMS INC AND DESIGN. INT. CL. 41. REG. 5-6-1997.
2,059,456. CLASSIC CHAMOMILE. INT. CLS. 5 AND 30. REG. 5-6-1997.
2,059,459. DURACLAY. INT. CL. 21. REG. 5-6-1997.
2,059,461. THE PINKERTON DIFFERENCE. INT. CLS. 36, 37 AND 42. REG. 5-6-1997.
2,059,476. OPENDOR. INT. CL. 19. REG. 5-6-1997.
2,059,477. CIGNATRADE. INT. CL. 36. REG. 5-6-1997.
2,059,479. GIRLS SPEAK OUT. INT. CL. 41. REG. 5-6-1997.
2,059,495. MISCELLANEOUS DESIGN. INT. CL. 42. REG. 5-6-1997.
2,059,498. WHOA! FILMS INC. AND DESIGN. INT. CL. 41. REG. 5-6-1997.
2,059,504. PR&E. INT. CLS. 37 AND 42. REG. 5-6-1997.
2,059,509. PRETTY COOL (STYLIZED). INT. CL. 14. REG. 5-6-1997.
2,059,512. WHEN YOU WISH YOU COULD BRUSH.... INT. CL. 21. REG. 5-6-1997.
2,059,520. MUSTANG. INT. CL. 5. REG. 5-6-1997.
2,059,522. GT90. INT. CL. 16. REG. 5-6-1997.
2,059,536. SPEAKEASY. INT. CL. 9. REG. 5-6-1997.
2,059,570. GOLF HAVEN. INT. CL. 25. REG. 5-6-1997.
2,059,587. SAFE SOUNDER. INT. CL. 9. REG. 5-6-1997.
2,059,605. LOUD RECORDS AND DESIGN. INT. CL. 25. REG. 5-6-1997.
2,059,613. STERI-KLEEN. INT. CL. 5. REG. 5-6-1997.
2,059,622. PASERBOARD. U.S. CL. A. REG. 5-6-1997.
2,059,627. HAPPY'S. INT. CLS. 29 AND 30. REG. 5-6-1997.
2,059,630. HUMMER. INT. CL. 10. REG. 5-6-1997.
2,059,654. RAL. INT. CL. 9. REG. 5-6-1997.
2,059,667. MIRAFLEX. INT. CL. 17. REG. 5-6-1997.
2,059,669. FUTURA. INT. CLS. 1 AND 10. REG. 5-6-1997.
2,059,679. MASS CUSTOMIZATION. INT. CL. 42. REG. 5-6-1997.
2,059,681. CHROMINANCE AND DESIGN. INT. CLS. 9 AND 41. REG. 5-6-1997.
2,059,688. PURIDEC. INT. CL. 1. REG. 5-6-1997.
2,059,709. CHECKER RECORD CO. (STYLIZED). INT. CL. 9. REG. 5-6-1997.
2,059,717. DUO LIFE. INT. CL. 6. REG. 5-6-1997.
2,059,723. JAMES RIVER STEAM BREWERY. INT. CL. 32. REG. 5-6-1997.
2,059,727. MARKET LOGIC. INT. CL. 35. REG. 5-6-1997.
2,059,730. T-5. INT. CL. 12. REG. 5-6-1997.
2,059,750. GLIT HOUSEHOLD PRODUCTS. INT. CL. 21. REG. 5-6-1997.
2,059,753. WOLF CREEK. INT. CL. 18. REG. 5-6-1997.
2,059,767. MEDALIA. INT. CL. 42. REG. 5-6-1997.
2,059,768. THE HEADACHE MEDICINE AND DESIGN. INT. CL. 5. REG. 5-6-1997.
2,059,790. YVES ROCHER PRO-BALANCE AND DESIGN. INT. CL. 3. REG. 5-6-1997.
2,059,791. BICEP LITE II. INT. CL. 5. REG. 5-6-1997.
2,059,797. LOTSA-STUFF. INT. CL. 28. REG. 5-6-1997.
2,059,799. BESTWAY. INT. CL. 30. REG. 5-6-1997.
2,059,808. EXCELSIOR. INT. CL. 34. REG. 5-6-1997.
2,059,813. OCEAN GEOGRAPHIC. INT. CL. 25. REG. 5-6-1997.
2,059,816. JANET G.. INT. CL. 24. REG. 5-6-1997.
2,059,820. PANAMINAS. INT. CLS. 7 AND 9. REG. 5-6-1997.
2,059,821. JOY ATHLETIC. INT. CL. 25. REG. 5-6-1997.
2,059,829. HOOYAH. INT. CL. 25. REG. 5-6-1997.
2,059,832. CYBERPAWN. INT. CL. 42. REG. 5-6-1997.
2,059,833. SHIATSU SHOWER MAT. INT. CL. 27. REG. 5-6-1997.
2,059,839. JEEPERS!. INT. CL. 21. REG. 5-6-1997.
2,059,843. SPORT FLIX. INT. CL. 16. REG. 5-6-1997.
2,059,844. CLICKSHARE AND DESIGN. INT. CL. 38. REG. 5-6-1997.
2,059,847. HOMELAND IRRIGATION CENTER. INT. CLS. 37 AND 42. REG. 5-6-1997.
2,059,849. Y'ALL. INT. CL. 42. REG. 5-6-1997.
2,059,859. SIXTH ESTATE. INT. CLS. 16 AND 42. REG. 5-6-1997.
2,059,865. E M A. INT. CL. 10. REG. 5-6-1997.
2,059,890. AWNMAX-LITE. INT. CL. 24. REG. 5-6-1997.
2,059,900. PAIS SELECT. INT. CL. 9. REG. 5-6-1997.
2,059,902. QUADRANET. INT. CL. 38. REG. 5-6-1997.
2,059,905. CASH DRAWER CARD. INT. CL. 16. REG. 5-6-1997.
2,059,906. VERSA-GUARD. INT. CL. 6. REG. 5-6-1997.
2,059,911. TO SURF AND PROTECT. INT. CL. 9. REG. 5-6-1997.
2,059,934. BIOFLEX. INT. CL. 5. REG. 5-6-1997.
2,059,938. O S B ONE STEP BEYOND. INT. CLS. 25 AND 28. REG. 5-6-1997.
2,059,952. SILKY KARE. INT. CL. 3. REG. 5-6-1997.
2,059,954. DEDICATED TO PATIENTS WITH UNCOMMON DISEASES. INT. CL. 42. REG. 5-6-1997.
2,059,960. WORLD UP PLAYER. INT. CL. 9. REG. 5-6-1997.

- 2,059,978. DEARFOAMS SIGNATURE COLLECTION. INT. CL. 25. REG. 5-6-1997.
- 2,059,980. RIGHT STEP. INT. CL. 36. REG. 5-6-1997.
- 2,059,983. MISCELLANEOUS DESIGN. INT. CLS. 6, 8, 9, 11, 14, 16, 18, 20, 21, 24, 25 AND 28. REG. 5-6-1997.
- 2,059,985. SPEEDSPOOL AND DESIGN. INT. CL. 7. REG. 5-6-1997.
- 2,060,006. PUTTING RELIEF IN YOUR HANDS. INT. CLS. 5 AND 9. REG. 5-6-1997.
- 2,060,008. POP POETRY. INT. CL. 28. REG. 5-6-1997.
- 2,060,009. MISCELLANEOUS DESIGN. INT. CL. 40. REG. 5-6-1997.
- 2,060,015. ENVIROLIFE AND DESIGN. INT. CL. 3. REG. 5-6-1997.
- 2,060,020. FITNESS TRIAGE AND DESIGN. INT. CL. 41. REG. 5-6-1997.
- 2,060,033. MEDICAL SENTINEL. INT. CL. 16. REG. 5-6-1997.
- 2,060,059. C2C. INT. CL. 38. REG. 5-6-1997.
- 2,060,060. VOICESTREAM. INT. CL. 9. REG. 5-6-1997.
- 2,060,062. ALLIE THE ANGEL. INT. CL. 16. REG. 5-6-1997.
- 2,060,066. CLEAN SWING. INT. CL. 28. REG. 5-6-1997.
- 2,060,076. ELECTROFLO (STYLIZED). INT. CL. 9. REG. 5-6-1997.
- 2,060,083. MASTERPIECE. INT. CL. 11. REG. 5-6-1997.
- 2,060,091. ROOKIE STALLIONS. INT. CL. 16. REG. 5-6-1997.
- 2,060,110. DYNAMO. INT. CL. 8. REG. 5-6-1997.
- 2,060,116. CLICK. INT. CL. 15. REG. 5-6-1997.
- 2,060,121. MISCELLANEOUS DESIGN. INT. CL. 12. REG. 5-6-1997.
- 2,060,126. LEADING GOLF COURSES OF AMERICA. INT. CLS. 25 AND 41. REG. 5-6-1997.
- 2,060,128. HAWAIIAN ISLAND BOTANICAL. INT. CL. 3. REG. 5-6-1997.
- 2,060,130. INTELLIGENT VENDING. INT. CL. 9. REG. 5-6-1997.
- 2,060,132. COLLECTIONS. INT. CL. 20. REG. 5-6-1997.
- 2,060,142. FIXAWRECK. INT. CL. 37. REG. 5-6-1997.
- 2,060,167. QUICK-MOUNT AND DESIGN. INT. CL. 11. REG. 5-6-1997.
- 2,060,170. A BETTER BUTTER ALTERNATIVE AND DESIGN. INT. CL. 29. REG. 5-6-1997.
- 2,081,198. DRIVING FORCE INC. AND DESIGN. INT. CL. 35. REG. 7-22-1997.
- 2,098,122. TSE. INT. CL. 14. REG. 9-16-1997.
- 2,127,395. CITYFARM. INT. CL. 30 ONLY. REG. 1-6-1998.
- 2,127,979. MOTOREX. INT. CLS. 8 AND 21 ONLY. REG. 1-13-1998.
- 2,129,296. TWO CREEKS. INT. CL. 25 ONLY. REG. 1-13-1998.
- 2,129,900. THE AMERICAN GIRLS CLUB. INT. CL. 14 ONLY. REG. 1-20-1998.
- 2,131,658. GRINDSTED. INT. CL. 30 ONLY. REG. 1-27-1998.
- 2,133,848. VOICENET AND DESIGN. INT. CL. 16 ONLY. REG. 2-3-1998.
- 2,135,163. OPEN JOIST 2000 AND DESIGN. INT. CLS. 9 AND 40 ONLY. REG. 2-10-1998.
- 2,139,940. OPEN JOIST 2000. INT. CL. 9 ONLY. REG. 3-3-1998.
- 2,146,323. ALTA ATLANTA LAWN TENNIS ASSOCIATION, INC. AND DESIGN. INT. CL. 16 ONLY. REG. 3-24-1998.
- 2,155,991. JET GLADIATOR. INT. CLS. 18 AND 20 ONLY. REG. 5-12-1998.
- 2,201,919. J.W. PET COMPANY. INT. CLS. 18, 19 AND 20 ONLY. REG. 11-3-1998.
- 2,281,032. SEVEN. INT. CL. 41. REG. 9-28-1999.
- 2,324,270. GRILLE WORKS AND DESIGN. INT. CL. 42. REG. 2-29-2000.
- 2,359,008. ACTIVCHEMISTRY AND DESIGN. INT. CL. 9. REG. 6-20-2000.
- 2,369,241. OPTIMAL. INT. CL. 10. REG. 7-18-2000.
- 2,439,955. INFOHIGHWAY. INT. CL. 35 ONLY. REG. 4-3-2001.
- 2,447,257. HOOPGEAR. INT. CL. 25. REG. 5-1-2001.
- 2,447,258. TONERJET AND DESIGN. INT. CL. 9. REG. 5-1-2001.
- 2,447,261. WOLF PACK. INT. CL. 32. REG. 5-1-2001.
- 2,447,262. LF LIQUID FORCE AND DESIGN. INT. CL. 28. REG. 5-1-2001.
- 2,447,263. ACCENTS & ELEMENTS. INT. CL. 25. REG. 5-1-2001.
- 2,447,264. GRANITE CREEK. INT. CL. 33. REG. 5-1-2001.
- 2,447,266. ACCESS... MEDPLUS (STYLIZED). INT. CL. 42. REG. 5-1-2001.
- 2,447,267. MICROEDGE AND DESIGN. INT. CL. 9. REG. 5-1-2001.
- 2,447,268. COMBESTRIL. INT. CL. 5. REG. 5-1-2001.
- 2,447,269. FACET. INT. CLS. 16 AND 17. REG. 5-1-2001.
- 2,447,272. PUDDLES. INT. CL. 16. REG. 5-1-2001.
- 2,447,273. SNEEZES. INT. CL. 42. REG. 5-1-2001.
- 2,447,274. SNIFFLES. INT. CL. 42. REG. 5-1-2001.
- 2,447,276. SHARP PERSONNEL. INT. CL. 35. REG. 5-1-2001.
- 2,447,277. ALICE. INT. CLS. 9, 35, 36 AND 42. REG. 5-1-2001.
- 2,447,279. PRSI. INT. CL. 36. REG. 5-1-2001.
- 2,447,285. INTERNATIONAL COMPUTER NETWORKS. INT. CLS. 35, 37, 41 AND 42. REG. 5-1-2001.
- 2,447,286. PURITY ITALIA. INT. CLS. 11 AND 21. REG. 5-1-2001.
- 2,447,287. HYDRODRY. INT. CL. 25. REG. 5-1-2001.
- 2,447,288. MISCELLANEOUS DESIGN. INT. CL. 28. REG. 5-1-2001.
- 2,447,290. SPICA AND DESIGN. INT. CLS. 7 AND 12. REG. 5-1-2001.
- 2,447,291. KICK BUTTS DAY YOW! AND DESIGN. INT. CL. 42. REG. 5-1-2001.
- 2,447,294. BLIPPO. INT. CL. 16. REG. 5-1-2001.
- 2,447,295. PERMAGEL. INT. CLS. 5 AND 42. REG. 5-1-2001.
- 2,447,297. WINDTEL. INT. CL. 38. REG. 5-1-2001.
- 2,447,300. STENOMASK. INT. CL. 9. REG. 5-1-2001.
- 2,447,301. OPUS. INT. CLS. 5, 9 AND 10. REG. 5-1-2001.
- 2,447,302. PARAGON CONSULTING GROUP AND DESIGN. INT. CLS. 35, 36, 41 AND 42. REG. 5-1-2001.
- 2,447,303. OLDE NEW ENGLAND CANDLE CO.. INT. CL. 4. REG. 5-1-2001.
- 2,447,305. DYNAMIC RUSSIAN RESOURCE FUND. INT. CL. 36. REG. 5-1-2001.
- 2,447,307. MMI. INT. CL. 35. REG. 5-1-2001.
- 2,447,308. THERMOVAC. INT. CLS. 7 AND 42. REG. 5-1-2001.
- 2,447,310. HOME DECOR. INT. CL. 16. REG. 5-1-2001.
- 2,447,314. LIFEWORKS EMPLOYEE RESOURCE AND DESIGN. INT. CLS. 35 AND 42. REG. 5-1-2001.
- 2,447,317. GUY. INT. CL. 3. REG. 5-1-2001.
- 2,447,324. PALM COURTT AND DESIGN. INT. CL. 36. REG. 5-1-2001.
- 2,447,325. BP AND DESIGN. INT. CL. 42. REG. 5-1-2001.
- 2,447,326. OLDWAY NETWAY. INT. CL. 42. REG. 5-1-2001.
- 2,447,330. DCC. INT. CL. 36. REG. 5-1-2001.
- 2,447,331. MISCELLANEOUS DESIGN. INT. CL. 42. REG. 5-1-2001.
- 2,447,334. THERMALITO. INT. CL. 11. REG. 5-1-2001.
- 2,447,335. OBIK AND DESIGN. INT. CLS. 16, 35 AND 42. REG. 5-1-2001.
- 2,447,336. FIRSTPLUS RACING #13 AND DESIGN. INT. CL. 34. REG. 5-1-2001.
- 2,447,337. HAEMOPROBE. INT. CLS. 5 AND 42. REG. 5-1-2001.
- 2,447,339. EYEBALLS. INT. CL. 41. REG. 5-1-2001.
- 2,447,340. S.O.S...SOUTH OF 7TH. INT. CL. 41. REG. 5-1-2001.
- 2,447,341. WEBSPIRS. INT. CLS. 9 AND 42. REG. 5-1-2001.
- 2,447,342. CATALINA MARKETING UNIVERSITY. INT. CL. 41. REG. 5-1-2001.
- 2,447,343. CAPITOLHILL. INT. CLS. 38 AND 42. REG. 5-1-2001.
- 2,447,345. PICK OUT. INT. CL. 5. REG. 5-1-2001.
- 2,447,346. MISCELLANEOUS DESIGN. INT. CL. 42. REG. 5-1-2001.
- 2,447,347. MISCELLANEOUS DESIGN. INT. CL. 41. REG. 5-1-2001.
- 2,447,348. DELTA TECH MOLD AND DESIGN. INT. CL. 40. REG. 5-1-2001.
- 2,447,352. OPPORTUNITY DOESN'T KNOCK ANYMORE. IT CLICKS.. INT. CL. 35. REG. 5-1-2001.

- 2,447,353. RESOURCEXCHANGE. INT. CL. 9. REG. 5-1-2001.
- 2,447,356. RADIO 20:20. INT. CL. 35. REG. 5-1-2001.
- 2,447,358. ACMECITY AND DESIGN. INT. CLS. 35, 41 AND 42. REG. 5-1-2001.
- 2,447,360. TECHNICAL STAFF CONNECTION. INT. CL. 35. REG. 5-1-2001.
- 2,447,372. FINGERBOARD. INT. CL. 25. REG. 5-1-2001.
- 2,447,378. SPIRAL MARKETING. INT. CL. 35. REG. 5-1-2001.
- 2,447,379. ITALK. INT. CL. 9. REG. 5-1-2001.
- 2,447,380. CLNG. INT. CL. 7. REG. 5-1-2001.
- 2,447,386. GREAT AUTOS OF YESTERYEAR AND DESIGN. INT. CL. 42. REG. 5-1-2001.
- 2,447,388. VMAX NETLINK/IS (STYLIZED). INT. CL. 10. REG. 5-1-2001.
- 2,447,396. RODALE'S SCUBA DIVING. INT. CL. 41. REG. 5-1-2001.
- 2,447,399. IE AND DESIGN. INT. CL. 42. REG. 5-1-2001.
- 2,447,402. CONSEJERO. COM AND DESIGN. INT. CL. 42. REG. 5-1-2001.
- 2,447,403. MIND-SHAPES AND DESIGN. INT. CL. 28. REG. 5-1-2001.
- 2,447,404. BRAIN TEETHER AND DESIGN. INT. CL. 28. REG. 5-1-2001.
- 2,447,405. WRIST WATCH-IT AND DESIGN. INT. CL. 28. REG. 5-1-2001.
- 2,447,407. CREW. INT. CLS. 35, 41 AND 42. REG. 5-1-2001.
- 2,447,411. KIOSKMAIL. INT. CLS. 38 AND 42. REG. 5-1-2001.
- 2,447,412. MT MR TERRY (STYLIZED). INT. CL. 3. REG. 5-1-2001.
- 2,447,413. MISCELLANEOUS DESIGN. INT. CL. 35. REG. 5-1-2001.
- 2,447,415. APPRECIATED SOFTWARE. INT. CL. 9. REG. 5-1-2001.
- 2,447,416. MISCELLANEOUS DESIGN. INT. CL. 42. REG. 5-1-2001.
- 2,447,421. A-ONE. INT. CL. 9. REG. 5-1-2001.
- 2,447,422. BENCHMARK CARBIDE AND DESIGN. INT. CL. 7. REG. 5-1-2001.
- 2,447,423. LABDEALS.COM. INT. CL. 35. REG. 5-1-2001.
- 2,447,424. GOT TO HAVE IT.COM. INT. CL. 8. REG. 5-1-2001.
- 2,447,429. SHOPPING1ST.COM. INT. CL. 35. REG. 5-1-2001.
- 2,447,430. COMMUNITIES IN CRISIS. INT. CL. 42. REG. 5-1-2001.
- 2,447,436. BAS. INT. CL. 37. REG. 5-1-2001.
- 2,447,437. TODAY'S KITCHEN. INT. CL. 35. REG. 5-1-2001.
- 2,447,438. OCTA-LITE. INT. CL. 19. REG. 5-1-2001.
- 2,447,439. DEALPOINT. INT. CLS. 35 AND 36. REG. 5-1-2001.
- 2,447,440. ISO 1400. INT. CL. 35. REG. 5-1-2001.
- 2,447,442. ISOTHERM AND DESIGN. INT. CL. 22. REG. 5-1-2001.
- 2,447,445. FIRSTLEGAL.COM. INT. CL. 42. REG. 5-1-2001.
- 2,447,447. CREATIVESTORE.COM (STYLIZED). INT. CL. 42. REG. 5-1-2001.
- 2,447,449. METROAMERICA MORTGAGE AND DESIGN. INT. CL. 36. REG. 5-1-2001.
- 2,447,450. RAGE (STYLIZED). INT. CL. 9. REG. 5-1-2001.
- 2,447,451. THEPROSHOP.COM AND DESIGN. INT. CL. 35. REG. 5-1-2001.
- 2,447,452. HEVEANE. INT. CLS. 20, 24 AND 25. REG. 5-1-2001.
- 2,447,456. IBALLS AND DESIGN. INT. CL. 35. REG. 5-1-2001.
- 2,447,457. IBALLS. INT. CL. 35. REG. 5-1-2001.
- 2,447,459. SMART WALKER. INT. CL. 10. REG. 5-1-2001.
- 2,447,463. HILLBILLY MALL. INT. CLS. 35 AND 36. REG. 5-1-2001.
- 2,447,466. STORYSTIK. INT. CL. 28. REG. 5-1-2001.
- 2,447,468. WARRANTY SUPERSTORE AND DESIGN. INT. CL. 36. REG. 5-1-2001.
- 2,447,469. CORPORATE CIRCLE. INT. CL. 41. REG. 5-1-2001.
- 2,447,470. ROYAL NUTRI-MASK FACE LIFT. INT. CL. 3. REG. 5-1-2001.
- 2,447,471. A ARKITA AND DESIGN. INT. CL. 6. REG. 5-1-2001.
- 2,447,475. HEARTBEATS LIFE CENTER. INT. CL. 42. REG. 5-1-2001.
- 2,447,476. PANALIGN PARTNERS. INT. CLS. 16, 35 AND 41. REG. 5-1-2001.
- 2,447,477. CONTRACTSTATION. INT. CL. 42. REG. 5-1-2001.
- 2,447,478. LEGAL SOLUTIONS. INT. CL. 35. REG. 5-1-2001.
- 2,447,481. PERSONAL INVESTMENT EDUCATION (P.I.E.) GUIDE. INT. CL. 16. REG. 5-1-2001.
- 2,447,482. STANLEY PAPEL DESIGNS (STYLIZED). INT. CL. 25. REG. 5-1-2001.
- 2,447,483. TELUX. INT. CL. 9. REG. 5-1-2001.
- 2,447,484. MEDWAY AND DESIGN. INT. CLS. 1 AND 9. REG. 5-1-2001.
- 2,447,485. NET PROFIT. INT. CLS. 35 AND 36. REG. 5-1-2001.
- 2,447,486. AUDIBLE HEAR. THERE. AND EVERYWHERE. AND DESIGN. INT. CLS. 35 AND 42. REG. 5-1-2001.
- 2,447,487. AMERICAN ADOPTIONS AMERICA'S ADOPTION AGENCY AND DESIGN. INT. CL. 42. REG. 5-1-2001.
- 2,447,488. MEGALAW.COM. INT. CL. 42. REG. 5-1-2001.
- 2,447,489. CAPITA. INT. CL. 42. REG. 5-1-2001.
- 2,447,490. CAPITA TECHNOLOGIES. INT. CL. 42. REG. 5-1-2001.
- 2,447,491. NO STEP-ONSITE. INT. CL. 10. REG. 5-1-2001.
- 2,447,493. JASPER WOOD PRODUCTS. INT. CLS. 15 AND 20. REG. 5-1-2001.
- 2,447,494. GET CARRIED AWAY. INT. CL. 38. REG. 5-1-2001.
- 2,447,495. BUSINESS KNOWLEDGE ARCHITECTS AND DESIGN. INT. CL. 42. REG. 5-1-2001.
- 2,447,496. PRIMOBAY. INT. CL. 5. REG. 5-1-2001.
- 2,447,497. THE EDGE. INT. CL. 35. REG. 5-1-2001.
- 2,447,498. CISM CRITICAL INCIDENT STRESS MANAGEMENT AND DESIGN. INT. CLS. 41 AND 42. REG. 5-1-2001.
- 2,447,500. MAGGY. INT. CL. 33. REG. 5-1-2001.
- 2,447,501. FIREFLY AND DESIGN. INT. CLS. 9, 18 AND 28. REG. 5-1-2001.
- 2,447,503. CONSUMER COMPANION. INT. CLS. 35 AND 36. REG. 5-1-2001.
- 2,447,508. VIVA! FIESTA AND DESIGN. INT. CL. 30. REG. 5-1-2001.
- 2,447,510. MISSION CONTROLS. INT. CLS. 9, 37 AND 42. REG. 5-1-2001.
- 2,447,512. DRIVER DIRECT AND DESIGN. INT. CL. 35. REG. 5-1-2001.
- 2,447,513. VENTEX. INT. CL. 20. REG. 5-1-2001.
- 2,447,515. EXPENSABLE.COM. INT. CL. 35. REG. 5-1-2001.
- 2,447,519. M MURPHY FAMILY FARMS AND DESIGN. INT. CL. 31. REG. 5-1-2001.
- 2,447,520. EMERALD FUNDING. INT. CL. 36. REG. 5-1-2001.
- 2,447,521. MICROCAST. INT. CL. 38. REG. 5-1-2001.
- 2,447,522. BEAD 'EM UP. INT. CL. 14. REG. 5-1-2001.
- 2,447,525. LETSEATOUT.COM YOUR PERSONAL GUIDE AND DESIGN. INT. CLS. 35 AND 42. REG. 5-1-2001.
- 2,447,526. I'M A CHEERIOS RACING KID! AND DESIGN. INT. CL. 25. REG. 5-1-2001.
- 2,447,528. POCKET DRAGON ADVENTURES. INT. CL. 28. REG. 5-1-2001.
- 2,447,531. HOSPITALROOM. INT. CL. 35. REG. 5-1-2001.
- 2,447,532. TUXEDOS FOR LESS AND DESIGN. INT. CL. 42. REG. 5-1-2001.
- 2,447,533. OPERATOR.COM. INT. CL. 42. REG. 5-1-2001.
- 2,447,534. ELITE SERVICE PROGRAM. INT. CL. 36. REG. 5-1-2001.
- 2,447,536. BETA-C ANTIOXIDANT CREME. INT. CL. 3. REG. 5-1-2001.
- 2,447,537. KALEIDO CARD. INT. CL. 16. REG. 5-1-2001.
- 2,447,538. EYEMAX. INT. CL. 9. REG. 5-1-2001.
- 2,447,542. WATCHNET. INT. CL. 42. REG. 5-1-2001.
- 2,447,543. PUZZLEKINS. INT. CL. 28. REG. 5-1-2001.
- 2,447,544. EDEFENSE. INT. CL. 35. REG. 5-1-2001.

- 2,447,546. THE WIZARD OF SALES (STYLIZED). INT. CLS. 9 AND 41. REG. 5-1-2001.
- 2,447,547. NEOSPACE. INT. CL. 12. REG. 5-1-2001.
- 2,447,548. NATIONAL MUSIC PUBLISHERS' ASSOCIATION. INT. CL. 41. REG. 5-1-2001.
- 2,447,549. CAROLINA ANTIQUE MALL. INT. CL. 35. REG. 5-1-2001.
- 2,447,550. MISCELLANEOUS DESIGN. INT. CL. 14. REG. 5-1-2001.
- 2,447,551. DOVELINE. INT. CL. 14. REG. 5-1-2001.
- 2,447,552. CYBERCORP.COM. INT. CL. 9. REG. 5-1-2001.
- 2,447,554. CHIPILETA. INT. CL. 30. REG. 5-1-2001.
- 2,447,555. ASIAPHILE. INT. CLS. 8, 20, 21 AND 24. REG. 5-1-2001.
- 2,447,556. IPMNET. INT. CL. 42. REG. 5-1-2001.
- 2,447,558. SHOP FOR PRICE... BUT DEMAND THE BEST. INT. CLS. 35 AND 39. REG. 5-1-2001.
- 2,447,559. CORY'S WORLD. INT. CL. 41. REG. 5-1-2001.
- 2,447,560. EVER-BRITE. INT. CL. 2. REG. 5-1-2001.
- 2,447,561. BONZIBUDDY. INT. CL. 9. REG. 5-1-2001.
- 2,447,562. METRIX MATRIX. INT. CL. 35. REG. 5-1-2001.
- 2,447,563. MISCELLANEOUS DESIGN. INT. CLS. 25 AND 41. REG. 5-1-2001.
- 2,447,569. MICROMOLD. INT. CL. 7. REG. 5-1-2001.
- 2,447,572. SNOW DOGS. INT. CL. 28. REG. 5-1-2001.
- 2,447,576. PROSESSION. INT. CL. 9. REG. 5-1-2001.
- 2,447,578. WASHINGTON WATCH. INT. CL. 16. REG. 5-1-2001.
- 2,447,580. OPEN ARMS CRISIS PREGNANCY CENTER. INT. CLS. 41 AND 42. REG. 5-1-2001.
- 2,447,581. COMMUNITIES MAGAZINE AND DESIGN. INT. CL. 16. REG. 5-1-2001.
- 2,447,582. KIDS LOVE IT. TEACHERS NEED IT. PARENTS TRUST IT.. INT. CLS. 38 AND 41. REG. 5-1-2001.
- 2,447,584. AUCTIONPRO. INT. CL. 35. REG. 5-1-2001.
- 2,447,587. TAKING RESPONSIBILITY PERSONALLY. INT. CL. 42. REG. 5-1-2001.
- 2,447,589. PEOPLES CHECK CARD. INT. CL. 36. REG. 5-1-2001.
- 2,447,591. PENNMEDIA.COM. INT. CL. 35. REG. 5-1-2001.
- 2,447,592. EPIX THE POWER OF MANY AND DESIGN. INT. CL. 35. REG. 5-1-2001.
- 2,447,593. SUPREME DOMINION. INT. CL. 28. REG. 5-1-2001.
- 2,447,594. SLICE OF LIFE PIZZA OF THE NORTH SHORE. INT. CL. 42. REG. 5-1-2001.
- 2,447,596. WWW. AMAZING VASE .COM AND DESIGN. INT. CL. 35. REG. 5-1-2001.
- 2,447,600. PANDORA'S BOX. INT. CL. 13. REG. 5-1-2001.
- 2,447,601. PROPIK (STYLIZED). INT. CL. 41. REG. 5-1-2001.
- 2,447,603. INSIDE E.D. A PENTON PUBLICATION AND DESIGN. INT. CL. 16. REG. 5-1-2001.
- 2,447,604. BUDDYADS.COM. INT. CL. 35. REG. 5-1-2001.
- 2,447,605. MARQUEE. INT. CL. 20. REG. 5-1-2001.
- 2,447,607. MEN IN ACTION. INT. CL. 16. REG. 5-1-2001.
- 2,447,608. I KID STORE AND DESIGN. INT. CL. 35. REG. 5-1-2001.
- 2,447,609. COLERTIF. INT. CL. 5. REG. 5-1-2001.
- 2,447,611. CITYBID. INT. CL. 35. REG. 5-1-2001.
- 2,447,615. SDSC SALES & DISTRIBUTION SOLUTIONS CORP. AND DESIGN. INT. CL. 35. REG. 5-1-2001.
- 2,447,617. HEALTHWIDE. INT. CLS. 35, 38 AND 42. REG. 5-1-2001.
- 2,447,618. MEDFOLIO. INT. CL. 42. REG. 5-1-2001.
- 2,447,619. BROOKER SALES. INT. CL. 35. REG. 5-1-2001.
- 2,447,623. THE CENTER FOR PROFESSIONAL DISTANCE LEARNING AND DESIGN. INT. CL. 41. REG. 5-1-2001.
- 2,447,625. TIVOLI MANAGE. ANYTHING. ANYWHERE.. INT. CLS. 16 AND 41. REG. 5-1-2001.
- 2,447,626. EZY. INT. CL. 10. REG. 5-1-2001.
- 2,447,627. SPECIALTY OIL SORBENTS. INT. CL. 35. REG. 5-1-2001.
- 2,447,630. PAULA LISHMAN SOFTWEAR. INT. CL. 25. REG. 5-1-2001.
- 2,447,631. NURESCCELL. INT. CL. 17. REG. 5-1-2001.
- 2,447,634. DORNIER ECOBLEACH AND DESIGN. INT. CL. 7. REG. 5-1-2001.
- 2,447,637. VALUTECH CARD SOLUTIONS AND DESIGN. INT. CL. 36. REG. 5-1-2001.
- 2,447,638. TWELVE DOZEN FISH (STYLIZED). INT. CL. 16. REG. 5-1-2001.
- 2,447,641. SALLIE MAE SOLUTIONS. INT. CL. 35. REG. 5-1-2001.
- 2,447,642. CLOWN BINGO. INT. CL. 9. REG. 5-1-2001.
- 2,447,643. SCIM. INT. CL. 9. REG. 5-1-2001.
- 2,447,644. TUSSIBID. INT. CL. 5. REG. 5-1-2001.
- 2,447,645. J C MILLENNIUM AND DESIGN. INT. CL. 14. REG. 5-1-2001.
- 2,447,646. LEGALARMY.COM. INT. CL. 42. REG. 5-1-2001.
- 2,447,647. IMAPGOLF. INT. CL. 42. REG. 5-1-2001.
- 2,447,648. HAWKEYE AND DESIGN. INT. CL. 9. REG. 5-1-2001.
- 2,447,649. ECONOMICSEARCH.COM AND DESIGN. INT. CL. 35. REG. 5-1-2001.
- 2,447,653. MISCELLANEOUS DESIGN. INT. CL. 25. REG. 5-1-2001.
- 2,447,655. EVEREST VIT AND DESIGN. INT. CLS. 9 AND 42. REG. 5-1-2001.
- 2,447,657. POLESTAR. INT. CL. 38. REG. 5-1-2001.
- 2,447,658. MEZZANOTTE. INT. CL. 25. REG. 5-1-2001.
- 2,447,665. MISCELLANEOUS DESIGN. INT. CL. 25. REG. 5-1-2001.
- 2,447,670. SPIRITED SALOON V.W. ISAACS CIRCA 1999 AND DESIGN. INT. CL. 42. REG. 5-1-2001.
- 2,447,672. OCEAN EXCHANGE. INT. CL. 39. REG. 5-1-2001.
- 2,447,673. PAYTIME. INT. CL. 35. REG. 5-1-2001.
- 2,447,674. SCUBART AND DESIGN. INT. CL. 9. REG. 5-1-2001.
- 2,447,675. ACCUSCAPE. INT. CL. 8. REG. 5-1-2001.
- 2,447,677. BIZWW. INT. CL. 35. REG. 5-1-2001.
- 2,447,678. BILLBOARD INTERNATIONAL TAPE/DISC DIRECTORY. INT. CL. 16. REG. 5-1-2001.
- 2,447,679. V2D (VOICE) VIDEO) DATA. INT. CL. 9. REG. 5-1-2001.
- 2,447,680. BUSINESSKOMBI. INT. CLS. 16, 35 AND 41. REG. 5-1-2001.
- 2,447,682. DISC GOLF ASSOCIATION. INT. CL. 28. REG. 5-1-2001.
- 2,447,684. SPORTEC. INT. CL. 21. REG. 5-1-2001.
- 2,447,686. FAMOUS LAMBERT'S. INT. CL. 30. REG. 5-1-2001.
- 2,447,687. COOLCOMPANIES. INT. CL. 42. REG. 5-1-2001.
- 2,447,688. WASHINGTON TECHWAY. INT. CLS. 16 AND 42. REG. 5-1-2001.
- 2,447,690. TOKALON. INT. CL. 3. REG. 5-1-2001.
- 2,447,692. CELOX. INT. CL. 9. REG. 5-1-2001.
- 2,447,693. KOVER-PLUS (STYLIZED). INT. CL. 19. REG. 5-1-2001.
- 2,447,694. HOTBEND. INT. CL. 9. REG. 5-1-2001.
- 2,447,695. HOUSE OF CHESS AND DESIGN. INT. CL. 28. REG. 5-1-2001.
- 2,447,697. ENERGIZER SOLUTIONS. INT. CL. 35. REG. 5-1-2001.
- 2,447,699. HBZACHRY.COM. INT. CL. 37. REG. 5-1-2001.
- 2,447,701. FLYINTHESOUP.COM. INT. CLS. 35, 41 AND 42. REG. 5-1-2001.
- 2,447,704. PROSNIP EXTRA CUT (STYLIZED). INT. CL. 8. REG. 5-1-2001.
- 2,447,707. LONDON PACIFIC LIFE & ANNUITY COMPANY. INT. CL. 36. REG. 5-1-2001.
- 2,447,710. THE GOLDEN HITCH. INT. CL. 41. REG. 5-1-2001.
- 2,447,712. MISCELLANEOUS DESIGN. INT. CL. 9. REG. 5-1-2001.
- 2,447,715. A AND DESIGN. INT. CL. 9. REG. 5-1-2001.
- 2,447,716. IMEAS AND DESIGN. INT. CL. 7. REG. 5-1-2001.
- 2,447,717. B DIAMOND B BEEF AND DESIGN. INT. CL. 29. REG. 5-1-2001.
- 2,447,721. SHARKTOOTHWORLD.COM. INT. CL. 35. REG. 5-1-2001.
- 2,447,724. THE NATIONAL CENTER FOR PARALEGAL TRAINING. INT. CL. 41. REG. 5-1-2001.

- 2,447,725. HILLSDALE ACADEMY. INT. CL. 41. REG. 5-1-2001.
- 2,447,727. LUXLITE (STYLIZED). INT. CL. 11. REG. 5-1-2001.
- 2,447,728. FAXSENSE. INT. CL. 9. REG. 5-1-2001.
- 2,447,733. LOANVISION. INT. CL. 9. REG. 5-1-2001.
- 2,447,734. OST ORGANIC SOIL TREATMENT. INT. CL. 1. REG. 5-1-2001.
- 2,447,736. NUOS CORPORATION. INT. CL. 42. REG. 5-1-2001.
- 2,447,737. PRINCESS. INT. CL. 41. REG. 5-1-2001.
- 2,447,738. INTERTEK. INT. CLS. 9, 12, 18 AND 21. REG. 5-1-2001.
- 2,447,742. CONSOLIDATED COMMERCE. INT. CL. 35. REG. 5-1-2001.
- 2,447,744. MISCELLANEOUS DESIGN. INT. CL. 37. REG. 5-1-2001.
- 2,447,745. 1800HOMESTUDY.COM CERTIFIED ADOPTION PROFESSIONALS GREAT ADOPTIONS BEGIN WITH A AND DESIGN. INT. CL. 35. REG. 5-1-2001.
- 2,447,748. CENTURYDIRECT. INT. CL. 35. REG. 5-1-2001.
- 2,447,753. E-FILL (STYLIZED). INT. CLS. 16 AND 42. REG. 5-1-2001.
- 2,447,754. ASSOCIATIONSAMERICA.COM. INT. CL. 35. REG. 5-1-2001.
- 2,447,756. THE LODGE AT ELK RIVER AND DESIGN. INT. CL. 42. REG. 5-1-2001.
- 2,447,757. 6TH BOROUGH STYLES AND DESIGN. INT. CL. 42. REG. 5-1-2001.
- 2,447,758. SPA ANALYTICS AND DESIGN. INT. CL. 3. REG. 5-1-2001.
- 2,447,759. WYNDHAM VACATIONS MEMORIES. LET US TAKE YOU THERE.. INT. CL. 42. REG. 5-1-2001.
- 2,447,762. YOUR PERSONAL HEALTH MANAGEMENT JOURNAL. INT. CL. 9. REG. 5-1-2001.
- 2,447,763. KEIKO-CHAN AND DESIGN. INT. CLS. 16 AND 28. REG. 5-1-2001.
- 2,447,766. RDO. INT. CL. 1. REG. 5-1-2001.
- 2,447,773. BLUE RICE AND DESIGN. INT. CL. 35. REG. 5-1-2001.
- 2,447,774. WORLD A BETTER PLACE. INT. CL. 42. REG. 5-1-2001.
- 2,447,775. SINGULARITY. INT. CL. 9. REG. 5-1-2001.
- 2,447,776. BIOVIEW. INT. CL. 9. REG. 5-1-2001.
- 2,447,777. ENTANGLED MINTS. INT. CL. 30. REG. 5-1-2001.
- 2,447,780. ADDZ. INT. CL. 35. REG. 5-1-2001.
- 2,447,781. JACK'S RECIPES THE WORD IS SPREADING AND DESIGN. INT. CL. 29. REG. 5-1-2001.
- 2,447,782. DENTALMART. INT. CL. 35. REG. 5-1-2001.
- 2,447,783. IM RECORDS (STYLIZED). INT. CL. 9. REG. 5-1-2001.
- 2,447,784. IM RECORDS. INT. CL. 9. REG. 5-1-2001.
- 2,447,785. FEDBUZZ. INT. CL. 42. REG. 5-1-2001.
- 2,447,786. MYCINNAMONTOAST. INT. CL. 42. REG. 5-1-2001.
- 2,447,790. SPEAKOUT.GOVSEEK. INT. CL. 35. REG. 5-1-2001.
- 2,447,793. CHAMPION EASY CLAIM. INT. CL. 36. REG. 5-1-2001.
- 2,447,795. MENGIBAR. INT. CL. 7. REG. 5-1-2001.
- 2,447,796. BABIDISC. INT. CL. 40. REG. 5-1-2001.
- 2,447,798. MARTHA REDBONE. INT. CL. 41. REG. 5-1-2001.
- 2,447,799. BLAST AND DESIGN. INT. CL. 4. REG. 5-1-2001.
- 2,447,800. MCKENICA. INT. CL. 7. REG. 5-1-2001.
- 2,447,801. AQUA MIST. INT. CL. 1. REG. 5-1-2001.
- 2,447,803. MISCELLANEOUS DESIGN. INT. CL. 42. REG. 5-1-2001.
- 2,447,805. SUBTABLE. INT. CL. 9. REG. 5-1-2001.
- 2,447,806. JDS AND DESIGN. INT. CL. 36. REG. 5-1-2001.
- 2,447,808. H.H. GREGG APPLIANCES ELECTRONICS COMPUTERS AND DESIGN. INT. CL. 35. REG. 5-1-2001.
- 2,447,809. ADEATECHED. INT. CL. 35. REG. 5-1-2001.
- 2,447,810. ADEAALUMNI. INT. CL. 35. REG. 5-1-2001.
- 2,447,811. BLAST AND DESIGN. INT. CL. 3. REG. 5-1-2001.
- 2,447,814. EXCLUSIVE FITNESS A PERSONAL TRAINING STUDIO AND DESIGN. INT. CL. 41. REG. 5-1-2001.
- 2,447,817. NERI AND DESIGN. INT. CL. 41. REG. 5-1-2001.
- 2,447,820. GOING UP?. INT. CL. 36. REG. 5-1-2001.
- 2,447,823. THESPORTSCOACH.COM WHERE THE DREAM BEGINS AND DESIGN. INT. CL. 41. REG. 5-1-2001.
- 2,447,824. PERSONALIZATION.COM. INT. CLS. 35, 38 AND 41. REG. 5-1-2001.
- 2,447,827. MADBALLS. INT. CL. 16. REG. 5-1-2001.
- 2,447,828. PJ'S CAROLINA CRITTER SAUCE. INT. CL. 30. REG. 5-1-2001.
- 2,447,829. MISCELLANEOUS DESIGN. INT. CL. 36. REG. 5-1-2001.
- 2,447,830. CORDIAGNOSTICS. INT. CL. 42. REG. 5-1-2001.
- 2,447,832. C CAPSIZED AND DESIGN. INT. CL. 35. REG. 5-1-2001.
- 2,447,833. CAPSIZED. INT. CL. 35. REG. 5-1-2001.
- 2,447,834. RITE-NOW. INT. CL. 5. REG. 5-1-2001.
- 2,447,837. BLUES LAB. INT. CL. 41. REG. 5-1-2001.
- 2,447,838. MINUTES IN SECONDS. INT. CL. 42. REG. 5-1-2001.
- 2,447,839. CRYOSIL. INT. CL. 10. REG. 5-1-2001.
- 2,447,840. POLAR-SKIRT. INT. CL. 6. REG. 5-1-2001.
- 2,447,841. SBR SOUTH BUFFALO RAILWAY AND DESIGN. INT. CL. 39. REG. 5-1-2001.
- 2,447,849. BEISLER AMERICA. INT. CL. 7. REG. 5-1-2001.
- 2,447,851. PRO DETOX. INT. CL. 5. REG. 5-1-2001.
- 2,447,852. GREYHAT. INT. CL. 42. REG. 5-1-2001.
- 2,447,853. INDISONIC. INT. CL. 35. REG. 5-1-2001.
- 2,447,854. GREAT NORTH. INT. CL. 41. REG. 5-1-2001.
- 2,447,858. WOODS-DUAL. INT. CL. 7. REG. 5-1-2001.
- 2,447,859. STAR BRIDGE SYSTEMS AND DESIGN. INT. CL. 42. REG. 5-1-2001.
- 2,447,861. ASIADERA. INT. CL. 38. REG. 5-1-2001.
- 2,447,862. VOICEPRINT. INT. CL. 9. REG. 5-1-2001.
- 2,447,863. GET 3DEEP OR GET FRAGGED. INT. CL. 9. REG. 5-1-2001.
- 2,447,865. A AND DESIGN. INT. CL. 36. REG. 5-1-2001.
- 2,447,866. IADMA. INT. CL. 35. REG. 5-1-2001.
- 2,447,871. CENETEC. INT. CL. 35. REG. 5-1-2001.
- 2,447,873. DAZZLER AND DESIGN. INT. CL. 15. REG. 5-1-2001.
- 2,447,876. WHERE GREAT IDEAS ARE SURFACING. INT. CL. 17. REG. 5-1-2001.
- 2,447,879. KRUNCH KIT. INT. CL. 16. REG. 5-1-2001.
- 2,447,880. IF BASKETBALL IS YOUR RELIGION THIS IS YOUR CHURCH. INT. CL. 41. REG. 5-1-2001.
- 2,447,882. INGEAR. INT. CL. 12. REG. 5-1-2001.
- 2,447,884. BATHMAX. INT. CL. 37. REG. 5-1-2001.
- 2,447,885. BRAIN NAVIGATOR. INT. CL. 9. REG. 5-1-2001.
- 2,447,886. ROTTEK. INT. CL. 42. REG. 5-1-2001.
- 2,447,888. BATHMAX AND DESIGN. INT. CL. 37. REG. 5-1-2001.
- 2,447,890. SIMPLIFY YOUR LIFE. INT. CL. 36. REG. 5-1-2001.
- 2,447,891. BLACK WIDOW. INT. CL. 12. REG. 5-1-2001.
- 2,447,892. GDC THE HOME DECORATING STORE. INT. CL. 35. REG. 5-1-2001.
- 2,447,895. EVERYTHING BUT THE GROOM. INT. CL. 42. REG. 5-1-2001.
- 2,447,897. STAY IN THE GAME!. INT. CL. 42. REG. 5-1-2001.
- 2,447,900. PANAMUL. INT. CL. 4. REG. 5-1-2001.
- 2,447,901. ENCAP. INT. CL. 1. REG. 5-1-2001.
- 2,447,902. PROSPERA FINANCIAL SERVICES AND DESIGN. INT. CL. 36. REG. 5-1-2001.
- 2,447,904. TAP GUARDIAN. INT. CL. 13. REG. 5-1-2001.
- 2,447,906. MISCELLANEOUS DESIGN. INT. CL. 8. REG. 5-1-2001.
- 2,447,907. IT PAYS TO PAY ATTENTION TO MARINE. INT. CL. 36. REG. 5-1-2001.
- 2,447,908. ADORNMENT THE NEWSLETTER OF JEWELRY & RELATED ARTS. INT. CL. 16. REG. 5-1-2001.
- 2,447,910. FAMILY DISCOUNT. INT. CL. 35. REG. 5-1-2001.
- 2,447,911. IF YOU'RE EMPLOYED YOU'RE APPROVED!. INT. CL. 35. REG. 5-1-2001.

- 2,447,912. HEART RESCUE. INT. CL. 41. REG. 5-1-2001.
 2,447,914. CARDWEAR. INT. CL. 35. REG. 5-1-2001.
 2,447,915. ROHN AND DESIGN. INT. CL. 19. REG. 5-1-2001.
 2,447,920. BRITSTOCK AND DESIGN. INT. CL. 42. REG. 5-1-2001.
 2,447,921. EDENHURST GALLERY AND DESIGN. INT. CL. 35. REG. 5-1-2001.
 2,447,922. TOOLS FOR SERIOUS LEADERS. INT. CL. 35. REG. 5-1-2001.
 2,447,923. REGARDS REWARD. INT. CL. 35. REG. 5-1-2001.
 2,447,928. MAID IN THE U.S.A.. INT. CL. 37. REG. 5-1-2001.
 2,447,930. POPTRONICS. INT. CL. 16. REG. 5-1-2001.
 2,447,932. BRINGING YOU MORE PLEASURE FROM THE MOST TRUSTED NAME IN EROTIC PRODUCTS. INT. CL. 28. REG. 5-1-2001.
 2,447,933. CA IMAGE. INT. CL. 16. REG. 5-1-2001.
 2,447,934. MERRYBRITE. INT. CLS. 20, 21, 22 AND 25. REG. 5-1-2001.
 2,447,935. SNODAZE (STYLIZED). INT. CL. 39. REG. 5-1-2001.
 2,447,936. EL NINO (STYLIZED). INT. CL. 39. REG. 5-1-2001.
 2,447,945. PSI55 MICR. INT. CL. 7. REG. 5-1-2001.
 2,447,948. THE PHILADELPHIA TOQUE AWARD. INT. CLS. 16 AND 35. REG. 5-1-2001.
 2,447,949. MISCELLANEOUS DESIGN. INT. CL. 35. REG. 5-1-2001.
 2,447,950. SHOWTIME HDTV AND DESIGN. INT. CL. 41. REG. 5-1-2001.
 2,447,952. SHOWTIME HDTV AND DESIGN. INT. CL. 38. REG. 5-1-2001.
 2,447,959. LOOKOUT. INT. CL. 9. REG. 5-1-2001.
 2,447,960. NHECB. INT. CL. 42. REG. 5-1-2001.
 2,447,963. SHAPES-UP!. INT. CL. 28. REG. 5-1-2001.
 2,447,965. TROPICAL WHISPERS. INT. CL. 16. REG. 5-1-2001.
 2,447,974. PROTECTION AT THE MICROBIAL LEVEL. INT. CL. 5. REG. 5-1-2001.
 2,447,975. THE PUDDIN' SWAMP SINGERS. INT. CL. 41. REG. 5-1-2001.
 2,447,976. CALYPSO. INT. CL. 16. REG. 5-1-2001.
 2,447,979. HOME ONE. INT. CL. 16. REG. 5-1-2001.
 2,447,980. PINHOLE. INT. CL. 9. REG. 5-1-2001.
 2,447,982. CASUAL KNOW-HOW. INT. CL. 35. REG. 5-1-2001.
 2,447,983. 99X. INT. CL. 38. REG. 5-1-2001.
 2,447,987. NEXTSTEP. INT. CL. 40. REG. 5-1-2001.
 2,447,988. IGNITING IDEAS. INT. CL. 36. REG. 5-1-2001.
 2,447,993. THE POWER EDGE. INT. CL. 16. REG. 5-1-2001.
 2,447,994. MACGREGOR. INT. CL. 20. REG. 5-1-2001.
 2,447,998. VISIONMARK. INT. CL. 36. REG. 5-1-2001.
 2,448,001. APPROVAL...STAT!. INT. CL. 36. REG. 5-1-2001.
 2,448,003. TOMBOLA. INT. CL. 30. REG. 5-1-2001.
 2,448,004. FLEXISOFT. INT. CL. 9. REG. 5-1-2001.
 2,448,006. REPLASCAPE. INT. CL. 26. REG. 5-1-2001.
 2,448,007. SURFDUK. INT. CL. 25. REG. 5-1-2001.
 2,448,011. CAFITESSE. INT. CL. 11. REG. 5-1-2001.
 2,448,013. RELIABILITY VALUE PERFORMANCE. INT. CL. 12. REG. 5-1-2001.
 2,448,014. AGAINST CRUELTY AND DESIGN. INT. CL. 3. REG. 5-1-2001.
 2,448,015. FOAMGRIP. INT. CL. 1. REG. 5-1-2001.
 2,448,016. ARACLEAR. INT. CL. 1. REG. 5-1-2001.
 2,448,018. ORIGINAL COORS. INT. CL. 42. REG. 5-1-2001.
 2,448,019. BACTICLEAN. INT. CL. 21. REG. 5-1-2001.
 2,448,020. SURFINSUITE. INT. CL. 9. REG. 5-1-2001.
 2,448,021. WHITE-WESTINGHOUSE. INT. CLS. 9 AND 11. REG. 5-1-2001.
 2,448,023. IMT INFORMATION MANAGEMENT TEAM INC. AND DESIGN. INT. CL. 35. REG. 5-1-2001.
 2,448,026. SOUTH BEACH. INT. CL. 24. REG. 5-1-2001.
 2,448,029. TRUSTSERVER. INT. CL. 9. REG. 5-1-2001.
 2,448,031. MISCELLANEOUS DESIGN. INT. CL. 16. REG. 5-1-2001.
 2,448,033. WARNER'S LACY NUDES. INT. CL. 25. REG. 5-1-2001.
 2,448,034. AMERICA THE BEAUTIFUL. INT. CL. 35. REG. 5-1-2001.
 2,448,038. ANTZ. INT. CLS. 9, 16 AND 28. REG. 5-1-2001.
 2,448,041. SPINPOINT. INT. CL. 9. REG. 5-1-2001.
 2,448,042. DESSERT-AVERT. INT. CL. 5. REG. 5-1-2001.
 2,448,043. SPORT SPOTS. INT. CLS. 16, 25 AND 42. REG. 5-1-2001.
 2,448,047. CALIFORNIA AND DESIGN. U.S. CL. A. REG. 5-1-2001.
 2,448,049. CYCLE SOX. INT. CL. 25. REG. 5-1-2001.
 2,448,050. DARKEDGE HAUNTED HOUSE AND DESIGN. INT. CL. 41. REG. 5-1-2001.
 2,448,051. MONSOON. INT. CL. 18. REG. 5-1-2001.
 2,448,052. CHERUBWERKS (STYLIZED). INT. CL. 42. REG. 5-1-2001.
 2,448,054. MORE THAN AN 800 NUMBER. INT. CL. 35. REG. 5-1-2001.
 2,448,056. WESTERN UNION PHONE PAY PLUS AND DESIGN. INT. CL. 36. REG. 5-1-2001.
 2,448,057. WESTERN UNION PHONE PAY PLUS. INT. CL. 36. REG. 5-1-2001.
 2,448,059. DIJIT AND DESIGN. INT. CL. 16. REG. 5-1-2001.
 2,448,060. VISIONPRIDE. INT. CL. 16. REG. 5-1-2001.
 2,448,061. FROLIC. INT. CL. 41. REG. 5-1-2001.
 2,448,062. SHIN CREST. INT. CL. 20. REG. 5-1-2001.
 2,448,066. HOMEPURE. INT. CLS. 11 AND 32. REG. 5-1-2001.
 2,448,068. MYSTIC KNIGHTS OF TIR NA NOG. INT. CL. 41. REG. 5-1-2001.
 2,448,071. SOLOJOSE AND DESIGN. INT. CL. 14. REG. 5-1-2001.
 2,448,072. RELIABLE MESSAGING MADE EASY. INT. CL. 38. REG. 5-1-2001.
 2,448,075. EXCITER. INT. CL. 28. REG. 5-1-2001.
 2,448,076. THE ULTIMATE CURE. INT. CL. 42. REG. 5-1-2001.
 2,448,077. RATEMUX. INT. CL. 9. REG. 5-1-2001.
 2,448,078. DYNAFLAT. INT. CL. 9. REG. 5-1-2001.
 2,448,082. U.S. REALTEL. INT. CL. 35. REG. 5-1-2001.
 2,448,083. ON ACCOUNT OF ME. INT. CLS. 16 AND 41. REG. 5-1-2001.
 2,448,085. ONENAME. INT. CL. 42. REG. 5-1-2001.
 2,448,086. LDTA-W. INT. CL. 1. REG. 5-1-2001.
 2,448,088. LDTA-A. INT. CL. 1. REG. 5-1-2001.
 2,448,089. BAJARITO'S. INT. CL. 42. REG. 5-1-2001.
 2,448,090. CHILDREN'S MOTRIN AND DESIGN. INT. CL. 5. REG. 5-1-2001.
 2,448,091. ECM DIRECTOR (STYLIZED). INT. CL. 9. REG. 5-1-2001.
 2,448,092. IMAGE ONE. INT. CL. 36. REG. 5-1-2001.
 2,448,093. EARTH MOBILE. INT. CLS. 12 AND 41. REG. 5-1-2001.
 2,448,094. IMPACT SHORTY. INT. CL. 9. REG. 5-1-2001.
 2,448,095. PEPPERPOT. INT. CL. 16. REG. 5-1-2001.
 2,448,097. OPTICOM. INT. CL. 35. REG. 5-1-2001.
 2,448,098. MISCELLANEOUS DESIGN. INT. CLS. 31 AND 35. REG. 5-1-2001.
 2,448,102. DURAPRESS SIDING. INT. CL. 19. REG. 5-1-2001.
 2,448,103. COOL MOUNTAIN CREAMERY & CAFE. INT. CLS. 30 AND 42. REG. 5-1-2001.
 2,448,104. CYGNUS. INT. CL. 10. REG. 5-1-2001.
 2,448,106. PROFOAM. INT. CL. 16. REG. 5-1-2001.
 2,448,107. CM.COMM. INT. CL. 9. REG. 5-1-2001.
 2,448,108. VXI PARROTT THE VOICE RECOGNITION HEADSET AND DESIGN. INT. CL. 9. REG. 5-1-2001.
 2,448,109. MISCELLANEOUS DESIGN. INT. CLS. 9 AND 10. REG. 5-1-2001.
 2,448,113. WYX. INT. CLS. 4 AND 21. REG. 5-1-2001.
 2,448,117. BIOSOMME (STYLIZED). INT. CLS. 3 AND 5. REG. 5-1-2001.
 2,448,118. PICONODE. INT. CLS. 9 AND 38. REG. 5-1-2001.
 2,448,120. CUDDLES. INT. CL. 31. REG. 5-1-2001.
 2,448,121. EYE TEMP AND DESIGN. INT. CL. 9. REG. 5-1-2001.
 2,448,125. DINOHIDE. INT. CL. 18. REG. 5-1-2001.
 2,448,126. BALLYHOO. INT. CL. 25. REG. 5-1-2001.
 2,448,127. WINTER FUN. INT. CL. 28. REG. 5-1-2001.
 2,448,133. JUNGLE CUTS. INT. CL. 42. REG. 5-1-2001.
 2,448,134. GIRL POWER. INT. CL. 28. REG. 5-1-2001.
 2,448,140. STORACTIVE. INT. CL. 9. REG. 5-1-2001.
 2,448,142. SOLAR CITY. INT. CL. 11. REG. 5-1-2001.

- 2,448,143. DIVOTI. INT. CL. 14. REG. 5-1-2001.
 2,448,144. FOREMOST ADVICE. INT. CL. 9. REG. 5-1-2001.
 2,448,146. WESTERN UNION SWIFTPAY AND DESIGN. INT. CL. 36. REG. 5-1-2001.
 2,448,149. CHAMELEON. INT. CL. 12. REG. 5-1-2001.
 2,448,151. THE PEAKS. INT. CL. 25. REG. 5-1-2001.
 2,448,152. UNIVERSAL STUDIOS ESCAPE AND DESIGN. INT. CL. 41. REG. 5-1-2001.
 2,448,153. UNIVERSAL STUDIOS ESCAPE AND DESIGN. INT. CL. 21. REG. 5-1-2001.
 2,448,154. SANTA CLOTH. INT. CL. 24. REG. 5-1-2001.
 2,448,155. GYNE-PRO. INT. CL. 10. REG. 5-1-2001.
 2,448,159. THE PEOPLE YOU TRUST WITH INFORMATION TECHNOLOGY. INT. CLS. 35 AND 42. REG. 5-1-2001.
 2,448,160. THE BUSINESS TIMES SINGAPORE (STYLIZED). INT. CLS. 38 AND 42. REG. 5-1-2001.
 2,448,161. THE BUSINESS TIMES SINGAPORE (STYLIZED). INT. CLS. 35, 36, 39, 41 AND 42. REG. 5-1-2001.
 2,448,163. SOLUS MAPMAKER. INT. CL. 42. REG. 5-1-2001.
 2,448,166. ORTHO BREEZE. INT. CL. 12. REG. 5-1-2001.
 2,448,167. MAGIC TORCH AND DESIGN. INT. CL. 34. REG. 5-1-2001.
 2,448,168. BE THERE - DO THAT. INT. CL. 16. REG. 5-1-2001.
 2,448,170. JAZZ HIGH FIVE (STYLIZED). INT. CL. 28. REG. 5-1-2001.
 2,448,171. WCA. INT. CL. 42. REG. 5-1-2001.
 2,448,172. PUTT O' GOLD (STYLIZED). INT. CL. 16. REG. 5-1-2001.
 2,448,173. DREAMTREK. INT. CLS. 9, 16 AND 41. REG. 5-1-2001.
 2,448,176. RANCHERS' LAMB OF TEXAS, INC. AND DESIGN. INT. CLS. 18 AND 29. REG. 5-1-2001.
 2,448,177. STUF. AND DESIGN. INT. CL. 3. REG. 5-1-2001.
 2,448,178. FLO PORE. INT. CL. 10. REG. 5-1-2001.
 2,448,182. GIGAGUIDE. INT. CL. 9. REG. 5-1-2001.
 2,448,186. MISCELLANEOUS DESIGN. INT. CL. 41. REG. 5-1-2001.
 2,448,187. ONLY THE MOST CARED FOR OLIVES MAKE IT TO THE LUCINI BOTTLE. INT. CL. 29. REG. 5-1-2001.
 2,448,188. COMFORT MESH. INT. CL. 10. REG. 5-1-2001.
 2,448,189. APNEXT. INT. CL. 9. REG. 5-1-2001.
 2,448,190. AGERE. INT. CL. 9. REG. 5-1-2001.
 2,448,191. ORLANDO MIRACLE AND DESIGN. INT. CL. 28. REG. 5-1-2001.
 2,448,193. MISCELLANEOUS DESIGN. INT. CLS. 3, 4, 5 AND 20. REG. 5-1-2001.
 2,448,194. PERGO FAMILY. INT. CLS. 19 AND 27. REG. 5-1-2001.
 2,448,195. WATER WEDGIE. INT. CL. 21. REG. 5-1-2001.
 2,448,196. NATIONS RENT "NO SWEAT." AND DESIGN. INT. CLS. 35 AND 37. REG. 5-1-2001.
 2,448,197. DRIVE ALERT. INT. CL. 5. REG. 5-1-2001.
 2,448,198. SONY MOBILE AND DESIGN. INT. CL. 9. REG. 5-1-2001.
 2,448,199. THE WOODLANDS AND DESIGN. INT. CL. 4. REG. 5-1-2001.
 2,448,200. TIME TOYS. INT. CL. 14. REG. 5-1-2001.
 2,448,201. USA AND DESIGN. INT. CL. 14. REG. 5-1-2001.
 2,448,202. BITCH. INT. CL. 32. REG. 5-1-2001.
 2,448,203. EQUIX. INT. CL. 36. REG. 5-1-2001.
 2,448,208. COMSTRUCT. INT. CL. 9. REG. 5-1-2001.
 2,448,209. ON-LINE VITAMINS AT BOTTOM LINE PRICES. INT. CL. 35. REG. 5-1-2001.
 2,448,210. STEWARD OF THE RIVER. INT. CL. 42. REG. 5-1-2001.
 2,448,215. TURNING POINT AND DESIGN. INT. CL. 16. REG. 5-1-2001.
 2,448,218. NAVIGATE GROUP. INT. CL. 42. REG. 5-1-2001.
 2,448,219. WITWORKS AND DESIGN. INT. CL. 9. REG. 5-1-2001.
 2,448,222. STAY-SOFT. INT. CL. 16. REG. 5-1-2001.
 2,448,223. NAVIGATE GROUP. INT. CL. 35. REG. 5-1-2001.
 2,448,227. MISCELLANEOUS DESIGN. INT. CL. 9. REG. 5-1-2001.
 2,448,228. MOTOHED AND DESIGN. INT. CL. 25. REG. 5-1-2001.
 2,448,230. MISCELLANEOUS DESIGN. INT. CL. 25. REG. 5-1-2001.
 2,448,234. MISCELLANEOUS DESIGN. INT. CL. 38. REG. 5-1-2001.
 2,448,236. PERFECT TIMING!. INT. CL. 28. REG. 5-1-2001.
 2,448,237. FUNLYTE. INT. CL. 11. REG. 5-1-2001.
 2,448,238. C-QUENCE. INT. CL. 5. REG. 5-1-2001.
 2,448,239. WHAT ARE YOU SAVING IT FOR?. INT. CL. 42. REG. 5-1-2001.
 2,448,240. WINE. WHAT ARE YOU SAVING IT FOR?. INT. CL. 42. REG. 5-1-2001.
 2,448,243. TOO MUCH. INT. CL. 5. REG. 5-1-2001.
 2,448,244. EPOCH-IMPACT. INT. CL. 25. REG. 5-1-2001.
 2,448,246. FLORA SOLUTIONS. INT. CL. 5. REG. 5-1-2001.
 2,448,249. POSITIVE WORK CHOICES. INT. CL. 41. REG. 5-1-2001.
 2,448,250. BELDING SPORTS BALANCE AND DESIGN. INT. CL. 28. REG. 5-1-2001.
 2,448,257. A TASTEFUL ALTERNATIVE IN WRITTEN GREETINGS. INT. CL. 16. REG. 5-1-2001.
 2,448,258. SIMPLE PARK. INT. CL. 20. REG. 5-1-2001.
 2,448,259. MY CIRCLE IS FOREVER UNBROKEN. INT. CL. 28. REG. 5-1-2001.
 2,448,261. PEACH KISS. INT. CL. 32. REG. 5-1-2001.
 2,448,263. IDEAFARM. INT. CLS. 16 AND 35. REG. 5-1-2001.
 2,448,264. WORKING THROUGH MENOPAUSE. INT. CL. 16. REG. 5-1-2001.
 2,448,265. MISCELLANEOUS DESIGN. INT. CL. 28. REG. 5-1-2001.
 2,448,267. TONY HANKINS. INT. CL. 25. REG. 5-1-2001.
 2,448,270. SHIP MUSEUM.COM. INT. CL. 35. REG. 5-1-2001.
 2,448,272. SFT. INT. CL. 9. REG. 5-1-2001.
 2,448,273. PIRATE PESOS AND CUTTHROAT CURRENCY. INT. CL. 35. REG. 5-1-2001.
 2,448,274. PAW GEAR IT'S DOG-ON TIME. INT. CL. 35. REG. 5-1-2001.
 2,448,275. FIELDS CHOICE. INT. CL. 1. REG. 5-1-2001.
 2,448,276. THE REPORTING SOLUTION. INT. CL. 9. REG. 5-1-2001.
 2,448,277. PROMETHYLATE. INT. CL. 5. REG. 5-1-2001.
 2,448,280. MISCELLANEOUS DESIGN. INT. CLS. 16 AND 36. REG. 5-1-2001.
 2,448,282. COLLATIE. INT. CL. 29. REG. 5-1-2001.
 2,448,283. THERE IS ANOTHER WAY. INT. CL. 42. REG. 5-1-2001.
 2,448,284. EVERGARD. INT. CL. 1. REG. 5-1-2001.
 2,448,286. SUN GOODNESS. INT. CL. 32. REG. 5-1-2001.
 2,448,287. THE WORLD IN SECONDS. INT. CL. 36. REG. 5-1-2001.
 2,448,290. REPAIRNOW.COM AND DESIGN. INT. CL. 37. REG. 5-1-2001.
 2,448,292. REPAIRNOW.COM AND DESIGN. INT. CL. 42. REG. 5-1-2001.
 2,448,293. REPAIRNOW.COM. INT. CL. 42. REG. 5-1-2001.
 2,448,295. JUMPIN' HOP RODS AND DESIGN. INT. CL. 28. REG. 5-1-2001.
 2,448,297. @NYTIME...EVERYWHERE AND DESIGN. INT. CL. 36. REG. 5-1-2001.
 2,448,298. FREEDOM (STYLIZED). INT. CL. 28. REG. 5-1-2001.
 2,448,299. THE VALUE OF YOU. INT. CLS. 16 AND 25. REG. 5-1-2001.
 2,448,300. EPIX. INT. CL. 35. REG. 5-1-2001.
 2,448,304. MISCELLANEOUS DESIGN. INT. CL. 35. REG. 5-1-2001.
 2,448,305. SKYBOX. INT. CL. 20. REG. 5-1-2001.
 2,448,306. AQUA STREAM. INT. CL. 16. REG. 5-1-2001.
 2,448,309. SKYLAR. INT. CLS. 17 AND 27. REG. 5-1-2001.
 2,448,310. LT BY LIZ THOMAS. INT. CL. 25. REG. 5-1-2001.
 2,448,311. ROOM BOOM. INT. CL. 20. REG. 5-1-2001.
 2,448,312. EAGLE EYE. INT. CL. 9. REG. 5-1-2001.
 2,448,316. ORI-CLEAN. INT. CL. 1. REG. 5-1-2001.
 2,448,318. CUDDLE PALS. INT. CL. 28. REG. 5-1-2001.
 2,448,321. MILK & MUNCHIES. INT. CL. 28. REG. 5-1-2001.
 2,448,325. WABITS. INT. CL. 42. REG. 5-1-2001.
 2,448,326. LEARNINGBUDDIES. INT. CL. 9. REG. 5-1-2001.

- 2,448,327. LA BELLE EPOQUE. INT. CL. 34. REG. 5-1-2001.
 2,448,329. JUSTSLEEP. INT. CL. 9. REG. 5-1-2001.
 2,448,331. CEDAR CANYON. INT. CL. 25. REG. 5-1-2001.
 2,448,332. MISCELLANEOUS DESIGN. INT. CL. 42. REG. 5-1-2001.
 2,448,333. MILLENNIUM. INT. CL. 28. REG. 5-1-2001.
 2,448,334. SILVER FEET. INT. CL. 35. REG. 5-1-2001.
 2,448,335. MISCELLANEOUS DESIGN. INT. CL. 3. REG. 5-1-2001.
 2,448,336. COUNTRY DISCOVERIES. INT. CL. 16. REG. 5-1-2001.
 2,448,339. NUTRI-KIDS SCHOOL AID. INT. CL. 32. REG. 5-1-2001.
 2,448,342. ERNEST & JULIO GALLO AND DESIGN. INT. CL. 33. REG. 5-1-2001.
 2,448,343. NETMACHINES. INT. CL. 9. REG. 5-1-2001.
 2,448,345. NAKI AND DESIGN. INT. CL. 9. REG. 5-1-2001.
 2,448,346. HARVEST CHOICE. INT. CL. 30. REG. 5-1-2001.
 2,448,347. QUICK HITS. INT. CL. 41. REG. 5-1-2001.
 2,448,348. 2K4 HEALTH. INT. CL. 42. REG. 5-1-2001.
 2,448,349. MISCELLANEOUS DESIGN. INT. CL. 25. REG. 5-1-2001.
 2,448,351. WE TALK DATA. INT. CL. 9. REG. 5-1-2001.
 2,448,357. QPC AND DESIGN. INT. CL. 9. REG. 5-1-2001.
 2,448,358. MISCELLANEOUS DESIGN. INT. CL. 25. REG. 5-1-2001.
 2,448,359. ATHLETICOM. INT. CLS. 38 AND 41. REG. 5-1-2001.
 2,448,362. LAVA. INT. CL. 33. REG. 5-1-2001.
 2,448,363. QUICKSEAL. INT. CL. 10. REG. 5-1-2001.
 2,448,364. MADE ESPECIALLY FOR YOU BY MONICA AND DESIGN. INT. CL. 18. REG. 5-1-2001.
 2,448,367. STRESS FREE. INT. CL. 36. REG. 5-1-2001.
 2,448,368. SAVE. INT. CL. 42. REG. 5-1-2001.
 2,448,369. INTELLIMORTGAGE. INT. CL. 36. REG. 5-1-2001.
 2,448,375. MURDER INC.. INT. CLS. 35 AND 42. REG. 5-1-2001.
 2,448,376. GENTRAN:CATALYST. INT. CL. 9. REG. 5-1-2001.
 2,448,378. FAMILY BIBLE STUDY VENTURES. INT. CL. 16. REG. 5-1-2001.
 2,448,379. DR. WALLY. INT. CL. 37. REG. 5-1-2001.
 2,448,382. MUSIC FOR THE DEVELOPING MIND. INT. CL. 9. REG. 5-1-2001.
 2,448,383. FLORAL PASSION. INT. CL. 25. REG. 5-1-2001.
 2,448,384. ISLANDER 2002. INT. CL. 11. REG. 5-1-2001.
 2,448,385. CLOUD NINE OF UTAH, INC.. INT. CL. 11. REG. 5-1-2001.
 2,448,386. PAINTED HILLS. INT. CL. 33. REG. 5-1-2001.
 2,448,387. ENRICH & THIN. INT. CL. 5. REG. 5-1-2001.
 2,448,388. DUB-C. INT. CL. 10. REG. 5-1-2001.
 2,448,389. DEMO. INT. CL. 7. REG. 5-1-2001.
 2,448,391. CHILLAPHANT. INT. CL. 28. REG. 5-1-2001.
 2,448,397. REINVENT YOURSELF. INT. CL. 35. REG. 5-1-2001.
 2,448,398. THINK DIRTY. INT. CL. 33. REG. 5-1-2001.
 2,448,399. I LIKE IT DIRTY. INT. CL. 33. REG. 5-1-2001.
 2,448,405. USALLIANZ. INT. CL. 36. REG. 5-1-2001.
 2,448,406. BIOASTIN. INT. CL. 5. REG. 5-1-2001.
 2,448,407. CLEAN SLATE. INT. CL. 3. REG. 5-1-2001.
 2,448,408. FLEXSELECT. INT. CL. 41. REG. 5-1-2001.
 2,448,411. SAY CHEESE. INT. CL. 28. REG. 5-1-2001.
 2,448,416. MISCELLANEOUS DESIGN. INT. CL. 42. REG. 5-1-2001.
 2,448,418. EVERY DAY IS PLAY DAY. INT. CL. 41. REG. 5-1-2001.
 2,448,423. ARTS AND QUILTS. INT. CL. 16. REG. 5-1-2001.
 2,448,425. EVAPR8. INT. CL. 25. REG. 5-1-2001.
 2,448,427. LIFEWORLD NETWORK. INT. CL. 42. REG. 5-1-2001.
 2,448,430. T-BEAR. INT. CL. 16. REG. 5-1-2001.
 2,448,433. WISEASK. INT. CL. 35. REG. 5-1-2001.
 2,448,434. GO GODDESS! AND DESIGN. INT. CL. 31. REG. 5-1-2001.
 2,448,439. CARDIO CALL INC. AND DESIGN. INT. CL. 42. REG. 5-1-2001.
 2,448,441. THE DANCE OF BIRTH. INT. CL. 41. REG. 5-1-2001.
 2,448,442. ULLICARE AND DESIGN. INT. CL. 42. REG. 5-1-2001.
 2,448,444. STRAYZ. INT. CL. 28. REG. 5-1-2001.
 2,448,447. TECHNET TRADING AND DESIGN. INT. CL. 36. REG. 5-1-2001.
 2,448,451. VINTAGE PROVIDENCE. INT. CL. 14. REG. 5-1-2001.
 2,448,452. UNLOCKING POTENTIAL OF YOUTH & FAMILIES. INT. CL. 42. REG. 5-1-2001.
 2,448,453. TRIM CHIPS. INT. CL. 20. REG. 5-1-2001.
 2,448,454. KIDS CORNER AND DESIGN. INT. CL. 41. REG. 5-1-2001.
 2,448,455. RATESTALKER. INT. CL. 36. REG. 5-1-2001.
 2,448,458. TRUCCROSSING. INT. CL. 36. REG. 5-1-2001.
 2,448,459. THE WAY YOU INVEST NOW. ONLY BETTER.. INT. CL. 36. REG. 5-1-2001.
 2,448,460. SPONGE-BLAST. INT. CL. 1. REG. 5-1-2001.
 2,448,462. ENZO FERRETTI. INT. CL. 25. REG. 5-1-2001.
 2,448,463. HELPUISOFT (STYLIZED). INT. CLS. 9 AND 42. REG. 5-1-2001.
 2,448,464. SIGNASEAL. INT. CL. 16. REG. 5-1-2001.
 2,448,465. SKIP THE SINK. INT. CL. 3. REG. 5-1-2001.
 2,448,466. MEDICAL EXPRESS. INT. CL. 36. REG. 5-1-2001.
 2,448,467. PAMPERS PREMIUM CUSTOM FIT. INT. CL. 16. REG. 5-1-2001.
 2,448,468. THE MASTERS' CLASSROOM!. INT. CL. 9. REG. 5-1-2001.
 2,448,470. PULP ADDICTION. INT. CL. 30. REG. 5-1-2001.
 2,448,471. STUDIO BLUE. INT. CL. 18. REG. 5-1-2001.
 2,448,474. #1 IN MUZZLELOADING. INT. CL. 13. REG. 5-1-2001.
 2,448,475. REAL-TIME PROCESSING MANAGER. INT. CL. 9. REG. 5-1-2001.
 2,448,477. BEST VALUE. INT. CLS. 3, 29 AND 30. REG. 5-1-2001.
 2,448,481. SMART TCU. INT. CL. 9. REG. 5-1-2001.
 2,448,482. ENOTECA. INT. CL. 33. REG. 5-1-2001.
 2,448,483. CARTILAGE CARE. INT. CL. 5. REG. 5-1-2001.
 2,448,484. CAYMAN EXCHANGE. INT. CLS. 9, 35, 36 AND 41. REG. 5-1-2001.
 2,448,486. BUYSITE. INT. CL. 9. REG. 5-1-2001.
 2,448,487. EPERSONNEL.COM. INT. CL. 35. REG. 5-1-2001.
 2,448,489. WHOLE HEALTH. INT. CL. 41. REG. 5-1-2001.
 2,448,492. EMBOSSGEAR. INT. CL. 18. REG. 5-1-2001.
 2,448,493. MULTI-LINGUAL/400. INT. CL. 9. REG. 5-1-2001.
 2,448,495. AMERICA'S GOLF TRAINER. INT. CL. 42. REG. 5-1-2001.
 2,448,496. CLEARCONFERENCE. INT. CL. 38. REG. 5-1-2001.
 2,448,498. EAST COAST CHALLENGE. INT. CL. 28. REG. 5-1-2001.
 2,448,499. EASYLIFT. INT. CL. 7. REG. 5-1-2001.
 2,448,500. FOREMOST ADHESIVES FORMULATOR. INT. CL. 42. REG. 5-1-2001.
 2,448,501. THE E-SERVICES LEADER. INT. CL. 42. REG. 5-1-2001.
 2,448,502. CRISIS COMMUNICATIONS. INT. CL. 42. REG. 5-1-2001.
 2,448,503. HOW TO GUARANTEE A PROFIT WITH A HOME BASED BUSINESS. INT. CL. 9. REG. 5-1-2001.
 2,448,505. CASH CENTERS OF AMERICA. INT. CL. 36. REG. 5-1-2001.
 2,448,508. CASINO ARIZONA AT SALT RIVER AND DESIGN. INT. CL. 25. REG. 5-1-2001.
 2,448,512. BIFOCAL CENTERS OF AMERICA. INT. CL. 35. REG. 5-1-2001.
 2,448,514. FOWL PLAY. INT. CL. 25. REG. 5-1-2001.
 2,448,515. JEANOLOGY PERFORMANCE. INT. CL. 16. REG. 5-1-2001.
 2,448,519. CAPITAL PERFORMANCE ADVISORS. INT. CL. 42. REG. 5-1-2001.
 2,448,520. EBONDTRADE. INT. CL. 36. REG. 5-1-2001.
 2,448,521. PERSONAL HEALTH MANAGER. INT. CL. 42. REG. 5-1-2001.
 2,448,522. MINI MEASURE. INT. CL. 9. REG. 5-1-2001.
 2,448,523. AMERICA'S MISSION. INT. CL. 36. REG. 5-1-2001.

- 2,448,524. SOUTH JERSEY WEDDINGS. INT. CL. 16. REG. 5-1-2001.
- 2,448,525. BENEFITSLAWYERS.COM. INT. CL. 42. REG. 5-1-2001.
- 2,448,527. WALL STREET EUROPE. INT. CL. 36. REG. 5-1-2001.
- 2,448,528. ASSOCIATION FOR FINISHING PROCESSES OF THE SOCIETY OF MANUFACTURING ENGINEERS. U.S. CL. 200. REG. 5-1-2001.
- 2,448,529. ROBOTICS INTERNATIONAL OF THE SOCIETY OF MANUFACTURING ENGINEERS. U.S. CL. 200. REG. 5-1-2001.
- 2,448,530. RUB-A-WAY. INT. CL. 16. REG. 5-1-2001.
- 2,448,532. SCENT OF A FLOWER. INT. CL. 5. REG. 5-1-2001.
- 2,448,533. AVIAN PAC. INT. CL. 31. REG. 5-1-2001.
- 2,448,534. A WEDDING STORY. INT. CL. 41. REG. 5-1-2001.
- 2,448,535. A DATING STORY. INT. CL. 41. REG. 5-1-2001.
- 2,448,539. BUILDING ONLINE BUSINESS MAGAZINE. INT. CL. 16. REG. 5-1-2001.
- 2,448,540. HOLLYWOOD ACTRESS OF THE YEAR AWARD. INT. CL. 41. REG. 5-1-2001.
- 2,448,541. MISCELLANEOUS DESIGN. INT. CL. 16. REG. 5-1-2001.
- 2,448,542. USALEGAL. INT. CL. 35. REG. 5-1-2001.
- 2,448,543. GERMAN NUTRITION SERIES. INT. CL. 5. REG. 5-1-2001.
- 2,448,549. BIG TUNA. INT. CL. 30. REG. 5-1-2001.
- 2,448,550. SPIRALIGHT. INT. CL. 11. REG. 5-1-2001.
- 2,448,551. FABULOUS EGG. INT. CL. 20. REG. 5-1-2001.
- 2,448,552. EXPERIENCE BASED TRAINING. INT. CL. 41. REG. 5-1-2001.
- 2,448,555. I-AM-I POETRY IN MOTION AND DESIGN. INT. CL. 25. REG. 5-1-2001.
- 2,448,556. SMART TOOLS. INT. CL. 35. REG. 5-1-2001.
- 2,448,557. BUSINESS BUILDER. INT. CL. 35. REG. 5-1-2001.
- 2,448,558. THE COLLECTION. INT. CL. 16. REG. 5-1-2001.
- 2,448,559. INVESTMENT ECONOMICS. INT. CL. 36. REG. 5-1-2001.
- 2,448,560. FLOAT U.S.. INT. CL. 42. REG. 5-1-2001.
- 2,448,561. BOKA. INT. CL. 9. REG. 5-1-2001.
- 2,448,563. QUAD SHELL. INT. CL. 28. REG. 5-1-2001.
- 2,448,564. FOR PEOPLE WITH A PASSION FOR SKIING AND BOARDING. INT. CL. 41. REG. 5-1-2001.
- 2,448,565. ULTRA DEEP ENGINEERING. INT. CL. 16. REG. 5-1-2001.
- 2,448,566. REEFER UTILITY PALLET. INT. CL. 16. REG. 5-1-2001.
- 2,448,569. NATURAL BIRTH HYPNOSIS. INT. CL. 42. REG. 5-1-2001.
- 2,498,593. BRAILLIANT TOUCH. INT. CLS. 37 AND 42 ONLY. REG. 10-16-2001.
- 2,501,468. CCI AND DESIGN. INT. CL. 2 ONLY. REG. 10-30-2001.
- 2,506,137. AEP INDUSTRIES INC.. INT. CL. 17 ONLY. REG. 11-13-2001.
- 2,511,342. SPECTROCOLOR. INT. CLS. 3 AND 42 ONLY. REG. 11-27-2001.
- 2,516,656. MENARDO STREAM. INT. CLS. 5, 8, 16 AND 21 ONLY. REG. 12-11-2001.
- 2,523,919. FORUM GRIMALDI. INT. CLS. 20, 38 AND 42 ONLY. REG. 1-1-2002.
- 2,530,868. TOYTESTER. INT. CL. 35 ONLY. REG. 1-15-2002.
- 2,531,271. H4H. INT. CL. 36 ONLY. REG. 1-22-2002.
- 2,533,198. CONCENTRIX. INT. CL. 40 ONLY. REG. 1-29-2002.
- 2,536,624. 17TH STREET PRODUCTIONS (STYLIZED). INT. CL. 41 ONLY. REG. 2-5-2002.
- 2,537,692. DEVILNET. INT. CL. 38 ONLY. REG. 2-12-2002.
- 2,541,948. RAPIDTRIALS. INT. CL. 36 ONLY. REG. 2-19-2002.
- 2,548,257. ESPECIALLY FOR BABY. INT. CL. 18 ONLY. REG. 3-12-2002.
- 2,562,389. AMERICAST AND DESIGN. INT. CL. 41 ONLY. REG. 4-16-2002.
- 2,606,793. SIC. INT. CL. 37 ONLY. REG. 8-13-2002.
- 2,618,569. ECHALK. INT. CL. 9 ONLY. REG. 9-10-2002.
- 2,627,460. DRIVE SOBER AND DESIGN. INT. CL. 20 ONLY. REG. 10-1-2002.
- 2,630,470. CUSTOMIZER. INT. CL. 16 ONLY. REG. 10-8-2002.
- 2,634,066. UNIGLOBE 7*24 RESCUE LINE. INT. CL. 42 ONLY. REG. 10-15-2002.
- 2,640,270. TAKE HEART. INT. CL. 32 ONLY. REG. 10-22-2002.
- 2,647,808. TEC4 AND DESIGN. INT. CL. 42 ONLY. REG. 11-12-2002.
- 2,665,865. MSDSONLINE AND DESIGN. INT. CL. 9 ONLY. REG. 12-24-2002.
- 2,665,866. MSDSADVANTAGE. INT. CL. 9 ONLY. REG. 12-24-2002.

SECTION 18

- 1,196,869. GOLDDIGGERS. INT. CL. 25. REG. 6-1-1982.
- 1,510,528. PEEL & SEAL. INT. CL. 16. REG. 10-25-1988.
- 2,899,647. LET'S GO RVING. INT. CL. 16. REG. 11-2-2004.
- 2,980,248. CASTROSTANDARD CHARACTER MARK INT. CL. 34. REG. 7-26-2005.
- 3,018,398. BSN. INT. CL. 35. REG. 11-22-2005.
- 3,214,514. LEMONVATESTANDARD CHARACTER MARK INT. CL. 5. REG. 3-6-2007.
- 3,238,754. CORDLESS AND DESIGN. INT. CL. 7. REG. 5-8-2007.
- 3,266,560. MISCELLANEOUS DESIGN. INT. CL. 25. REG. 7-17-2007.
- 3,266,561. MISCELLANEOUS DESIGN. INT. CL. 25. REG. 7-17-2007.

* * * * *

TRADEMARK REGISTRATIONS AMENDED, CORRECTED, ETC.

The designation "U.S. Cl." appearing in this section refers to the U.S. class in effect prior to Sep. 1, 1973 rather than the international class which applies to applications filed on or after that date. For adoption of international classification see notice in the OFFICIAL GAZETTE of Jun. 26, 1973 (911 O.G. TM 210).

Any change to the registration will be indicated at the bottom of each entry under ELEMENTS AMENDED, CORRECTED OR RESTRICTED. With the exception of changes to the goods and services, additions to the registration will appear in asterisks and deletions of the registration will appear in brackets. Elements which are only changed will be listed with no punctuation. As to the goods/services statement, amendments to the goods/services will appear in asterisks and deletions will appear in brackets. In addition if any change to the goods/services occurs, the element "Goods/Services" will be listed under ELEMENTS AMENDED, CORRECTED OR RESTRICTED.

644,959. REG. 5-7-1957. OMYA AG (SWITZERLAND CORPORATION) BASLERSTRASSE 42, OFTRINGEN, CH-4665, SWITZERLAND., SN 72-004,834. FILED 3-19-1956. PRINCIPAL REGISTER.



INT. CL. 1/U.S. CLS. 1
FOR WHITING.
FIRST USE 6-0-1948; IN COMMERCE 6-0-1948.

ELEMENTS CORRECTED
INTERNATIONAL CLASS(ES)

2,070,376. REG. 6-10-1997. WORLD RADIO MISSIONARY FELLOWSHIP, INC. (FLORIDA CORPORATION) 1065 GARDEN OF THE GODS ROAD, COLORADO SPRINGS, CO, 80907. SN 74-660,460. FILED 4-13-1995. PRINCIPAL REGISTER.

BEYOND THE CALL

INT. CL. 38/U.S. CLS. 100, 101 AND 104
FOR RADIO BROADCASTING SERVICES, NAMELY BROADCASTING RADIO PROGRAMS FEATURING CHRISTIAN RELIGIOUS CONTENT OR CONTENT BASED ON CHRISTIAN RELIGIOUS VALUES.
FIRST USE 4-1-1996; IN COMMERCE 4-1-1996.

INT. CL. 41/U.S. CLS. 100, 101 AND 107
FOR BROCHURES LISTING RADIO STATIONS FOR WHICH APPLICANT PRODUCES THE BEYOND THE CALL SERIES OF RADIO PROGRAMS; ALSO, AT THE END OF EACH PROGRAM, THE BROADCASTER ACKNOWLEDGES THAT APPLICANT IS THE PRODUCER OF THE SERIES OF RADIO PROGRAMS.
FIRST USE 4-1-1996; IN COMMERCE 4-1-1996.

ELEMENTS CORRECTED
GOODS/SERVICES

2,075,388. REG. 7-1-1997. PORTAGE WORLD WIDE, INC. (NEW YORK CORPORATION) 110 GREENE STREET - SUITE 407, NEW YORK, NY, 10012, SN 75-089,263. FILED 4-16-1996. PRINCIPAL REGISTER.



NO CLAIM IS MADE TO THE EXCLUSIVE RIGHT TO USE "MADE IN", "MANHATTAN" AND "NEW YORK, NEW YORK USA LTD", APART FROM THE MARK AS SHOWN.
INT. CL. 18/U.S. CLS. 1, 2, 3, 22 AND 41
FOR SOFT LUGGAGE, SHOULDER BAGS, BACKPACKS, ALL PURPOSE SPORT BAGS, [BICYCLE WAIST PACKS] .
FIRST USE 4-25-1983; IN COMMERCE 4-25-1983.
INT. CL. 22/U.S. CLS. 1, 2, 7, 19, 22, 42 AND 50
FOR CANVAS MESSENGER BAGS.
FIRST USE 4-25-1983; IN COMMERCE 4-25-1983.

ELEMENTS AMENDED
MARK

2,128,735. REG. 1-13-1998. PRISM ANALYTICAL TECHNOLOGIES, INC. (MICHIGAN CORPORATION), DBA PRISM ANALYTICAL, INC., 1200 N. FANCHER, MT. PLEASANT, MI, 48858, SN 75-214,555. FILED 12-17-1996. PRINCIPAL REGISTER.

TDT AIR SCAN

NO CLAIM IS MADE TO THE EXCLUSIVE RIGHT TO USE "AIR SCAN", APART FROM THE MARK AS SHOWN.
INT. CL. 42/U.S. CLS. 100 AND 101

FOR CHEMICAL AND PHYSICAL ANALYSIS OF THE MATERIAL TRAPPED ON A TUBE CONTAINING A SORPTION MATERIAL(S) WHICH IS (ARE) USED TO TRAP CHEMICAL VAPORS AND PARTICULATES FROM THE AIR BY FLOWING THE AIR THROUGH THE TUBE.

FIRST USE 12-10-1996; IN COMMERCE 12-10-1996.

ELEMENTS CORRECTED

DBA/AKA
OWNER NAME



2,273,448. REG. 8-31-1999. DFS GROUP L.P. (DELAWARE LIMITED PARTNERSHIP) 525 MARKET STREET, 33RD FLOOR, SAN FRANCISCO, CA. 941052708, SN 75-357,412. FILED 9-15-1997. PRINCIPAL REGISTER.



GALLERIA

OWNER OF U.S. REG. NOS. 1,596,947 AND 1,689,466. NO CLAIM IS MADE TO THE EXCLUSIVE RIGHT TO USE "GALLERIA", APART FROM THE MARK AS SHOWN. INT. CL. 35/U.S. CLS. 100, 101 AND 102 FOR RETAIL DEPARTMENT STORE SERVICES. FIRST USE 1-31-1997; IN COMMERCE 1-31-1997.

ELEMENTS AMENDED
MARK



2,459,398. REG. 6-12-2001. IOWA MOLD TOOLING CO., INC. (IOWA CORPORATION) 500 HIGHWAY 18 WEST, P.O. BOX 189, GARNER, IA, 50438, SN 75-886,418. FILED 1-4-2000. PRINCIPAL REGISTER.

PREDATOR

INT. CL. 12/U.S. CLS. 19, 21, 23, 31, 35 AND 44 FOR TIRE-SERVICE TRUCK BODIES FOR INSTALLATION ON TRUCK CHASSIS TO FACILITATE SERVING OF VEHICLE TIRES IN THE FIELD. FIRST USE 12-1-1999; IN COMMERCE 12-1-1999.

ELEMENTS CORRECTED
OWNER NAME



2,465,621. REG. 7-3-2001. PALOMAR MEDICAL TECHNOLOGIES, INC. (DELAWARE CORPORATION) 82 CAMBRIDGE STREET, BURLINGTON, MA, 01803, SN 76-058,179. FILED 5-26-2000. PRINCIPAL REGISTER.

PALOMAR

INT. CL. 10/U.S. CLS. 26, 39 AND 44

FOR APPARATUS FOR PERFORMING DERMATOLOGICAL PROCEDURES.
FIRST USE 3-0-1998; IN COMMERCE 3-0-1998.

ELEMENTS CORRECTED
CITIZENSHIP



2,508,796. REG. 11-20-2001. CHRISTOPHER REEVE FOUNDATION, THE (NEW JERSEY NON-PROFIT CORPORATION) 636 MORRIS TURNPIKE, SUITE 3A, SHORT HILLS, NJ, 07078, SN 75-876,288. FILED 12-20-1999. PRINCIPAL REGISTER.



CHRISTOPHER REEVE
PARALYSIS FOUNDATION

NO CLAIM IS MADE TO THE EXCLUSIVE RIGHT TO USE "PARALYSIS FOUNDATION", APART FROM THE MARK AS SHOWN.

THE NAME SHOWN IN THE MARK IS OF A PARTICULAR LIVING INDIVIDUAL. MR. CHRISTOPHER ACCOMPANYING THIS APPLICATION IS A DOCUMENT SIGNED BY MR. REEVE CONFIRMING HIS CONSENT TO THE APPLICANT'S USE AND REGISTRATION OF THE NAME. INT. CL. 36/U.S. CLS. 100, 101 AND 102

FOR CHARITABLE FUNDRAISING, AND PHILANTHROPIC SERVICES CONCERNING MONETARY DONATIONS, NAMELY GRANT MAKING.

FIRST USE 4-22-1999; IN COMMERCE 4-22-1999. INT. CL. 42/U.S. CLS. 100 AND 101 FOR ASSOCIATION SERVICES, NAMELY, PROMOTING THE INTERESTS OF THE PHYSICALLY CHALLENGED BY PROMOTING RESEARCH TO FIND A CURE FOR PARALYSIS.

FIRST USE 4-22-1999; IN COMMERCE 4-22-1999.

ELEMENTS CORRECTED
OWNER NAME



2,511,714. REG. 11-27-2001. IOWA MOLD TOOLING CO., INC. (IOWA CORPORATION) 500 HIGHWAY 18 WEST, PO BOX 189, GARNER, IA, 50438, SN 75-886,447. FILED 1-4-2000. PRINCIPAL REGISTER.



OWNER OF U.S. REG. NOS. 896,784 AND 1,194,203. INT. CL. 7/U.S. CLS. 13, 19, 21, 23, 31, 34 AND 35

FOR CRANES; AIR COMPRESSORS AND LUBRICATING OIL FOR AIR COMPRESSORS; TIRE SERVICE TOOLS AND TIRE HANDLING EQUIPMENT, NAMELY, BEAD BREAKERS, SPLIT RIM REMOVERS, RIM HANDLING TOOLS AND POWERED TIRE CLAMPING MECHANISMS FOR ATTACHMENT TO LIFTING DEVICES.

FIRST USE 0-0-1993; IN COMMERCE 0-0-1993. INT. CL. 12/U.S. CLS. 19, 21, 23, 31, 35 AND 44 FOR MECHANICS, LUBRICATION, SPECIALTY AND TIRE SERVICE BODIES FOR VEHICLES. FIRST USE 0-0-1993; IN COMMERCE 0-0-1993.

ELEMENTS CORRECTED
OWNER NAME

2,538,958. REG. 2-19-2002. ALPHA CALCIT FULLSTOFF GESELLSCHAFT (FED REP GERMANY CORPORATION) OTTO-HAHN-STRAUBE 9-11, KOLN, FED REP GERMANY, D50997, SN 75-778,658. FILED 8-18-1999. PRINCIPAL REGISTER.

ALPHA

INT. CL. 9/U.S. CLS. 21, 23, 26, 36 AND 38
 FOR INDUSTRIAL CHEMICALS FOR USE AS FILERS IN THE MANUFACTURE OF COSMETICS, FOODSTUFFS INSULATION, PAINTS, COATINGS, ADHESIVES, RUBBER, SEALERS, GLASS, FIBERGLASS, LIQUID ABRASIVES, PLASTER, PAPER, CARDBOARD AND PLASTICS.
 FIRST USE 0-0-1973; IN COMMERCE 0-0-1993.

ELEMENTS CORRECTED
 OWNER NAME

2,572,036. REG. 5-21-2002. GEODIGM CORPORATION (MINNESOTA CORPORATION) 1630 LAKE DRIVE WEST, CHANHASSEN, MN, 55317, SN 75-981,862. FILED 3-11-1997. PRINCIPAL REGISTER.

EMODEL

THE MARK CONSISTS OF STANDARD CHARACTERS WITHOUT CLAIM TO ANY PARTICULAR FONT, STYLE, SIZE, OR COLOR.
 INT. CL. 9/U.S. CLS. 21, 23, 26, 36 AND 38
 FOR COMPUTER SOFTWARE FOR USE IN CONJUNCTION WITH ELECTRONIC SCANNING DEVICES FOR MANIPULATING, STORING AND TRANSMITTING IMAGES AND IMAGE DATA; ALL FOR USE IN THE MEDICAL, BIOMEDICAL AND DENTAL FIELDS.
 FIRST USE 1-29-2001; IN COMMERCE 4-1-2001.

ELEMENTS AMENDED
 ASSIGNMENT/NAME CHANGE
 MARK

2,626,101. REG. 9-24-2002. GUTZEES, LLC (NEW JERSEY LTD LIAB CO) 20 W. PALISADE AVENUE, SUITE 5229, ENGLEWOOD, NJ, 07631, SN 76-101,399. FILED 8-1-2000. PRINCIPAL REGISTER.



THE STIPPLING IN THE DRAWING IS FOR SHADING PURPOSES ONLY.
 INT. CL. 21/U.S. CLS. 2, 13, 23, 29, 30, 33, 40 AND 50
 FOR SHOE TREES.
 FIRST USE 9-24-2000; IN COMMERCE 12-5-2000.

ELEMENTS AMENDED
 OWNER ADDRESS
 MARK

2,639,381. REG. 10-22-2002. ROCK AND ROLL HALL OF FAME FOUNDATION, INC. (NEW YORK CORPORATION) 1290 AVENUE OF THE AMERICAS, NEW YORK, NY, 10104, SN 76-356,470. FILED 1-8-2002. PRINCIPAL REGISTER.

ROCK HALL

NO CLAIM IS MADE TO THE EXCLUSIVE RIGHT TO USE "ROCK" FOR CLASS 9 ONLY, APART FROM THE MARK AS SHOWN.
 INT. CL. 9/U.S. CLS. 21, 23, 26, 36 AND 38
 FOR EAR PLUGS NOT FOR MEDICAL PURPOSES.
 FIRST USE 7-1-2001; IN COMMERCE 7-1-2001.
 INT. CL. 21/U.S. CLS. 2, 13, 23, 29, 30, 33, 40 AND 50
 FOR MUGS AND BEVERAGE GLASSWARE.
 FIRST USE 7-1-2001; IN COMMERCE 7-1-2001.

ELEMENTS CORRECTED
 OWNER NAME

2,662,542. REG. 12-17-2002. COFFEECOL, INC. (FLORIDA CORPORATION) 1201 PLACETAS AVENUE, CORAL GABLES, FL, 33146, SN 76-326,733. FILED 10-18-2001. PRINCIPAL REGISTER.

COFFEECOL, INC.

THE MARK CONSISTS OF STANDARD CHARACTERS WITHOUT CLAIM TO ANY PARTICULAR FONT, STYLE, SIZE, OR COLOR.
 NO CLAIM IS MADE TO THE EXCLUSIVE RIGHT TO USE "INC.", APART FROM THE MARK AS SHOWN.
 INT. CL. 35/U.S. CLS. 100, 101 AND 102
 FOR WHOLESALE DISTRIBUTORSHIP FEATURING COFFEE GROWN BY OTHERS.
 FIRST USE 0-0-1988; IN COMMERCE 0-0-1988.

ELEMENTS AMENDED
 MARK

2,701,185. REG. 3-25-2003. SWEET LIFE ENTERPRISES, INC., THE (CALIFORNIA CORPORATION) 2350 PULLMAN STREET, SANTA ANA, CA, 92614, SN 76-256,632. FILED 5-14-2001. PRINCIPAL REGISTER.



NO CLAIM IS MADE TO THE EXCLUSIVE RIGHT TO USE "COOKIES", APART FROM THE MARK AS SHOWN.
 INT. CL. 30/U.S. CL. 46

FOR FOOD PRODUCTS, NAMELY BAKERY GOODS; COOKIES; ROLLS; MUFFINS; BAKERY DESSERTS; CEREAL BASED SNACK FOODS; RICE BASED SNACK FOODS; WHEAT BASED SNACK FOODS; GRANOLA BASED SNACK BARS.

FIRST USE 2-23-2001; IN COMMERCE 2-23-2001.
INT. CL. 35/U.S. CLS. 100, 101 AND 102

FOR BAKERY SERVICES, NAMELY RETAIL AND WHOLESALE STORE FEATURING FRESH AND FROZEN BAKERY GOODS, SNACK FOODS AND DESSERTS AND ON LINE SERVICES FEATURING FRESH AND FROZEN BAKERY GOODS, SNACK FOODS.

FIRST USE 2-23-2001; IN COMMERCE 2-23-2001.

ELEMENTS CORRECTED
OWNER NAME
OWNER ADDRESS
MARK TYPE

2,747,967. REG. 8-5-2003. SWEET LIFE ENTERPRISE, INC., THE (CALIFORNIA CORPORATION) 2350 PULLMAN STREET, SANTA ANA, CA, 92705, SN 76-192,794. FILED 1-10-2001. PRINCIPAL REGISTER.

CHIPPY

INT. CL. 28/U.S. CLS. 22, 23, 38 AND 50
FOR DOLLS.
FIRST USE 4-19-1999; IN COMMERCE 4-19-1999.

ELEMENTS CORRECTED
OWNER NAME
OWNER ADDRESS

2,762,309. REG. 9-9-2003. SWEET LIFE ENTERPRISES, INC., THE (CALIFORNIA CORPORATION) 2350 PULLMAN STREET, SANTA ANA, CA, 92705, SN 76-192,795. FILED 1-10-2001. PRINCIPAL REGISTER.

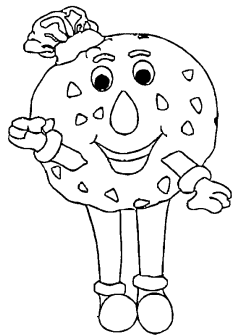

THE MARK CONSISTS OF A STYLIZED COOKIE WITH ARMS, LEGS, AND A CHEF'S HAT.
INT. CL. 28/U.S. CLS. 22, 23, 38 AND 50
FOR DOLLS.
FIRST USE 4-29-1999; IN COMMERCE 4-29-1999.

ELEMENTS CORRECTED
OWNER NAME
OWNER ADDRESS

2,816,996. REG. 2-24-2004. SWEET LIFE ENTERPRISES, INC., THE (CALIFORNIA CORPORATION) 2350 PULLMAN STREET, SANTA ANA, CA, 92705, SN 78-106,221. FILED 2-1-2002. PRINCIPAL REGISTER.

SWEET LIFE

INT. CL. 30/U.S. CL. 46
FOR FOOD PRODUCTS, NAMELY BAKERY GOODS; COOKIES; ROLLS; MUFFINS; BAKERY DESSERTS; CEREAL BASED SNACK FOODS; RICE BASED SNACK FOODS; WHEAT BASED SNACK FOODS; GRANOLA BASED SNACK BARS.

FIRST USE 8-14-1991; IN COMMERCE 8-14-1991.
INT. CL. 35/U.S. CLS. 100, 101 AND 102
FOR BAKERY SERVICES, NAMELY RETAIL AND WHOLESALE STORE FEATURING FRESH AND FROZEN BAKERY GOODS, SNACK FOODS AND DESSERTS AND ON-LINE RETAIL AND WHOLESALE STORE SERVICES FEATURING FRESH AND FROZEN BAKERY GOODS, SNACK FOODS AND ON-LINE SALE OF FRESH AND FROZEN BAKERY GOODS AND SNACK FOODS.

FIRST USE 8-14-1991; IN COMMERCE 8-14-1991.

ELEMENTS CORRECTED
OWNER NAME
OWNER ADDRESS

2,893,198. REG. 10-12-2004. RETAIL BRAND ALLIANCE, INC. (DELAWARE CORPORATION) 100 PHOENIX AVENUE, ENFIELD, CT, 06082, SN 78-229,743. FILED 3-25-2003. PRINCIPAL REGISTER.

BROOKS BUYS

THE MARK CONSISTS OF STANDARD CHARACTERS WITHOUT CLAIM TO ANY PARTICULAR FONT, STYLE, SIZE, OR COLOR.

OWNER OF U.S. REG. NOS. 667,458, 1,835,798 AND 2,523,247.

INT. CL. 35/U.S. CLS. 100, 101 AND 102
FOR RETAIL STORES SERVICES AND COMPUTERIZED ONLINE ORDERING AND RETAIL SERVICES VIA A COMPUTER NETWORK IN THE FIELD OF CONSUMER GOODS, NAMELY, SHIRTS, TOPS, SWEATERS, JACKETS, PANTS, SUITS, BOTTOMS, SOCKS, HATS AND CAPS, SHOES, SHORTS, COATS, NECKTIES, UNDERWEAR, VESTS, ROBES, HOSIERY, SKIRTS, DRESSES, LOUNGEWEAR, SCARVES, RAINWEAR, TROUSERS, ASCOTS, TIES, OUTER SHIRTS INCLUDING EVENING, DRESS, POLO, AND SPORTS SHIRTS, COLLARS, PAJAMAS, ROBES, SMOKING JACKETS, DRESSING GOWNS, MUFFLERS, GLOVES, HANDKERCHIEFS, HOSE, BELTS, SUSPENDERS, GARTERS, BOOTS, SLIPPERS, SHOES, OVERSHOES, BEACH WEAR, SWIMWEAR, FORMAL WEAR, HANDBAGS, TOTE BAGS, BACKPACKS, LUGGAGE, WALLETS, PURSES, KEY CASES, BRIEF CASES, DUFFLE BAGS, ALL-PURPOSE SPORT BAGS, BUSINESS CARD CASES, CREDIT CARD CASES, BRIEFCASE-TYPE PORTFOLIOS, BILLFOLDS, ATTACHE CASES, KEY CASES, PASSPORT CASES, SUIT BAGS, WAIST AND FANNY PACKS, TRUNKS, TRAVEL BAGS, HAT BOXES FOR TRAVEL, KEY FOBS, LUGGAGE TAGS, OVERNIGHT BAGS AND CASES, COSMETIC, TOILETRY AND VANITY CASES SOLD EMPTY, UMBRELLAS, CANES, AND WALKING STICKS, COSMETICS AND JEWELRY, GOLF ACCESSORIES NAMELY GOLF EQUIPMENT INCLUDING GOLF BALLS, GOLF CLUBS, GOLF BAGS, GOLF SHOES, GOLF BALL WASHERS, GOLF CARTS, GOLF TEES, AND GOLF CLUB COVERS.
FIRST USE 9-0-2001; IN COMMERCE 9-0-2001.

ELEMENTS AMENDED
MARK

3,066,192. REG. 3-7-2006. BARDELLE NICOLA (ITALY INDIVIDUAL) FLAT 3, 40 BRAMHAM GARDENS, LONDON SW5 0HG, UNITED KINGDOM., SN 79-009,389. FILED 8-13-2004. PRINCIPAL REGISTER.

3,069,706. REG. 3-21-2006. GERHARD D. WEMPE (FED REP GERMANY K.G. GERMAN LIMITED PARTNERSHIP) STEINSTRASSE 23, 20095 HAMBURG, FED REP GERMANY., SN 76-558,179. FILED 10-23-2003. PRINCIPAL REGISTER.

Show your true feelings



PRIORITY DATE OF 5-14-2004 IS CLAIMED.
OWNER OF INTERNATIONAL REGISTRATION 0844885
DATED 8-13-2004, EXPIRES 8-13-2014.
"JACOB COHEN" DOES NOT IDENTIFY A LIVING INDIVIDUAL.

INT. CL. 3/U.S. CLS. 1, 4, 6, 50, 51 AND 52

FOR PERFUMES, TOILET WATER, PERSONAL DEODORANTS, ESSENTIAL OILS FOR PERSONAL USE, BODY LOTIONS, SHOWER GEL, BUBBLE BATH, BATH OILS, BATH PEARLS, NON-MEDICATED BATH SALTS, SKIN SOAPS, SHAVING BALMS, SHAVING CREAM, AFTERSHAVE LOTIONS, EYE SHADOWS, COSMETIC PENCILS, FOUNDATION MAKE-UP, FACE POWDERS, TALCUM POWDER, ROUGES, LIPSTICKS, MASCARAS, SKIN CLEANSING CREAMS, SKIN CLEANSING LOTIONS, SUN SCREEN PREPARATIONS, NAIL POLISH, BEAUTY MASKS, FACIAL SCRUBS, FACE CREAMS, BODY CREAMS; COSMETIC CREAMS, LOTIONS AND GELS ALL FOR WEIGHT REDUCTION OR SLIMMING PURPOSES; COSMETIC CREAMS, LOTIONS AND GELS ALL FOR THE PREVENTION, REDUCTION AND ELIMINATION OF CELLULITE; HAIR SHAMPOOS, HAIR SPRAYS, HAIR LOTIONS, HAIR COLOR REMOVERS, HAIR COLOR, HAIR DYE, HAIR RINSES, HAIR LIGHTENERS, HAIR CONDITIONERS, HAIR MOISTURIZERS, PERMANENT WAVE PREPARATIONS, HAIR STYLING FOAM AND GELS, DENTIFRICES.

INT. CL. 9/U.S. CLS. 21, 23, 26, 36 AND 38

FOR EYEGLASSES, SUNGLASSES, CASES FOR GLASSES, SPORT GLASSES, CHAINS FOR GLASSES, FRAMES FOR GLASSES, LENSES FOR GLASSES, PINCE-NEZ, PROTECTIVE HELMETS, CD PLAYER CASES, SPECTACLE CHAINS.

FIRST USE ; IN COMMERCE .

INT. CL. 25/U.S. CLS. 22 AND 39

FOR [BRASSIERES, CORSETS, SINGLETTS, PETTICOATS, NIGHTGOWNS, PYJAMAS, DRESSING GOWNS, PULLOVERS, BATH ROBES, BATHING SUITS, GLOVES, CARDIGANS, JERSEYS, NECKTIES, NECKERCHIEFS, SCARVES, SWEATERS, SOCKS, STOCKINGS, TIGHTS, TROUSERS, LEGGINGS, SKIRTS, JACKETS, JERKINS, SHIRTS, VESTS, WAISTCOATS, JUMPERS, TRACK SUITS, BLOUSES, JEANS, PANTIES, UNDERPANTS, BERMUDA SHORTS, T-SHIRTS, SWEAT-SHIRTS, SUITS AND DRESSES, OVERCOATS, ANORAKS, COATS, RAINCOATS, BELTS, SUSPENDERS, PAREUS, SHOES, BOOTS, SLIPPERS, HATS, CAPS].

FIRST USE ; IN COMMERCE .

ELEMENTS CORRECTED
CITIZENSHIP
ENTITY

PRIORITY CLAIMED UNDER SEC. 44(D) ON ERPN CMNTY TM OFC APPLICATION NO. 003281912, FILED 7-23-2003, REG. NO. 003281912, DATED 7-23-2003, EXPIRES 7-23-2013.

INT. CL. 14/U.S. CLS. 2, 27, 28 AND 50

FOR PRECIOUS METALS AND THEIR ALLOYS; HANDCRAFTED ITEMS MADE OF, OR PLATED WITH; PRECIOUS METALS AND/OR THEIR ALLOYS, NAMELY, JEWELRY, NECKLACES, BRACELETS, BANGLES, EAR CLIPS, EARRINGS, RINGS, PENDANTS FOR NECKLACES, LAPEL PINS; BROOCHES, PINS, WRIST AND POCKET WATCHES, CIGAR AND CIGARETTE CASES AND HOLDERS, MONEY CLIPS, TIE PINS AND TACKS, CUFF LINKS, KEY CHAINS AND TAGS, PILL BOXES, PICTURE FRAMES; ITEMS MADE OF, OR PLATED WITH, PRECIOUS METALS AND/OR THEIR ALLOYS, NAMELY, JEWELRY, NECKLACES, BRACELETS, BANGLES, EAR CLIPS, EARRINGS, RINGS, PENDANTS FOR NECKLACES, LAPEL PINS, BROOCHES, PINS, WRIST AND POCKET WATCHES, CIGAR AND CIGARETTE CASES AND HOLDERS, MONEY CLIPS, TIE PINS [AID LACKS] * AND TACKS * , CUFF LINKS, KEY CHAINS AND TAGS, PILL BOXES, PICTURE FRAMES; PRECIOUS STONES; CLOCKS, NAMELY TABLE, WALL AND NAUTICAL CLOCKS; CHRONOMETERS.

FIRST USE ; IN COMMERCE .

ELEMENTS CORRECTED
FOREIGN COUNTRY OF ORIGIN

3,103,863. REG. 6-13-2006. CHEVRON INTELLECTUAL PROPERTY LLC (DELAWARE LTD LIAB CO) 6001 BOLLINGER CANYON ROAD, SAN RAMON, CA, 94583, SN 78-658,788. FILED 6-27-2005. PRINCIPAL REGISTER.

HYDRAZONE

THE MARK CONSISTS OF STANDARD CHARACTERS WITHOUT CLAIM TO ANY PARTICULAR FONT, STYLE, SIZE, OR COLOR.

INT. CL. 35/U.S. CLS. 100, 101 AND 102

FOR RETAIL OUTLET SERVICES, NAMELY CONVENIENCE STORES.

FIRST USE 5-7-2005; IN COMMERCE 5-7-2005.

ELEMENTS AMENDED
MARK

3,109,619. REG. 6-27-2006. DAIMLER AG (FED REP GERMANY CORPORATION) MERCEDESSTRASSE 137, STUTTGART, FED REP GERMANY, 70327, SN 76-330,032. FILED 10-26-2001. PRINCIPAL REGISTER.

FASTruck

INT. CL. 36/U.S. CLS. 100, 101 AND 102
FOR FINANCING OF TRUCKS.
FIRST USE 4-2-2001; IN COMMERCE 4-2-2001.

ELEMENTS CORRECTED
MARK

3,161,266. REG. 10-24-2006. BEDE SCIENTIFIC INSTRUMENTS LIMITED (UNITED KINGDOM CORPORATION) BELMONT BUSINESS PARK, DURHAM DH1 1TW, UNITED KINGDOM., SN 76-538,395. FILED 8-18-2003. PRINCIPAL REGISTER.

BEDEMETRIX

PRIORITY CLAIMED UNDER SEC. 44(D) ON ERP N CMNTY TM OFC APPLICATION NO. 003260569, FILED 7-8-2003, REG. NO. 003260569, DATED 12-7-2004, EXPIRES 7-8-2013.

OWNER OF U.S. REG. NO. 2,755,299.
INT. CL. 9/U.S. CLS. 21, 23, 26, 36 AND 38

FOR MEASURING AND ANALYTICAL APPARATUS AND INSTRUMENTS AND MATERIALS CHARACTERIZATION AND MATERIALS TESTING APPARATUS AND INSTRUMENTS, NAMELY, APPARATUS AND INSTRUMENTS FOR ANALYZING AND TESTING THIN FILMS, METALLIC THIN FILMS, MULTI LAYERS, CERAMICS, SUPER CONDUCTORS AND SEMI-CONDUCTORS; POWDER, SINGLE CRYSTAL AND HIGH RESOLUTION DIFFRACTION MEASURING TOOLS; X-RAY APPARATUS AND INSTRUMENTS, NAMELY, X-RAY TUBES, X-RAY CAMERAS, X-RAY DETECTORS, DIFFRACTOMETERS, REFLECTOMETERS, AND X-RAY TOPOGRAPHY APPARATUS AND INSTRUMENTS FOR USE IN THE FIELD OF MATERIALS CHARACTERIZATION AND MATERIALS TESTING; COMPUTER HARDWARE ADAPTED FOR USE WITH THE AFORESAID; COMPUTER OPERATING SYSTEM SOFTWARE ADAPTED FOR USE WITH THE AFORESAID.

FIRST USE ; IN COMMERCE .

ELEMENTS CORRECTED
FOREIGN COUNTRY OF ORIGIN
FOREIGN APPLICATION FILING DATE
FOREIGN REG. DATE
FOREIGN REG. EXPIRATION DATE

3,246,330. REG. 5-29-2007. 167081 CANADA INC. (CANADA CORPORATION), DBA DIZARO, 1625 CHABANEL STREET WEST, SUITE 600 MONTREAL, QUEBEC, CANADA, H4N 2S7, SN 78-718,558. FILED 9-22-2005. PRINCIPAL REGISTER.



THE COLOR(S) WHITE AND RED IS/ARE CLAIMED AS A FEATURE OF THE MARK.

THE MARK CONSISTS OF A DESIGN OF A WHITE FLOWER AND THE WORDS BEBA LOVE IN WHITE LETTERING ALL ON A RED BACKGROUND.

INT. CL. 25/U.S. CLS. 22 AND 39

FOR WEARING APPAREL, NAMELY SKIRTS, PANTS, SHORTS, SHIRTS, BLOUSES, T-SHIRTS, TANK TOPS, SWEATSHIRTS, SWEATPANTS, SWEATSUITS, SUITS, SWEATERS, JUMPERS, OVERALLS, ROMPERS, DRESSES, SLACKS, JACKETS, JEANS, VESTS AND COATS.

FIRST USE 9-1-2004; IN COMMERCE 9-1-2004.

ELEMENTS CORRECTED
[TRANSLATION OF MARK]

3,252,857. REG. 6-19-2007. UCB, S.A. (BELGIUM CORPORATION) ALLEE DE LA RECHERCHE, 60, B1070 BRUSSELS, BELGIUM., SN 78-229,750. FILED 3-25-2003. PRINCIPAL REGISTER.

ZAQUEST

OWNER OF ERP N CMNTY TM OFC REG. NO. 003093804, DATED 10-29-2004, EXPIRES 3-13-2013.

INT. CL. 5/U.S. CLS. 6, 18, 44, 46, 51 AND 52

FOR PHARMACEUTICAL PREPARATIONS, NAMELY PREPARATIONS FOR THE TREATMENT OF INFECTIOUS DISEASES, CANCER, OPHTHALMOLOGIC CONDITIONS AND DISEASES, CENTRAL NERVOUS SYSTEMS DISEASES AND DISORDERS, PARKINSON'S DISEASE, CARDIOVASCULAR DISEASES AND CONDITIONS, MIGRAINES, ARTHRITIS, PHARMACEUTICAL PREPARATIONS FOR THE TREATMENT OF GASTROINTESTINAL DISEASES, CROHNS DISEASE, PHARMACEUTICAL PREPARATIONS FOR THE TREATMENT AND SYMPTOMS OF DIABETES, PHARMACEUTICAL PREPARATIONS FOR UROLOGICAL USE, PHARMACEUTICAL PREPARATIONS FOR THE TREATMENT OF URINARY TRACT AND BLADDER INFECTIONS, GYNECOLOGICAL PREPARATIONS FOR THE TREATMENT OF BIRTH CONTROL, AND FOR THE TREATMENT FOR ENDOMETRIOSIS, HORMONAL PREPARATIONS, NAMELY HORMONE REPLACEMENT THERAPY; ANALGESICS; ANTI-INFLAMMATORY PHARMACEUTICAL PREPARATIONS.

ELEMENTS CORRECTED
FOREIGN COUNTRY OF ORIGIN

3,257,522. REG. 7-3-2007. DOLPHIN MEASUREMENT SYSTEMS, LLC (RHODE ISLAND CORPORATION) 303 ALLENS AVENUE, PROVIDENCE, RI, 02905, SN 76-665,120. FILED 8-25-2006. PRINCIPAL REGISTER.

3,272,134. REG. 7-31-2007. WESTERN VETERINARY CONFERENCE (NEVADA NON-PROFIT CORPORATION) 2425 EAST OQUENDO ROAD, LAS VEGAS, NV, 891202406, SN 78-861,005. FILED 4-13-2006. PRINCIPAL REGISTER.

DOLPHIN

WVC-ENCORE

THE MARK CONSISTS OF STANDARD CHARACTERS WITHOUT CLAIM TO ANY PARTICULAR FONT, STYLE, SIZE, OR COLOR.

INT. CL. 9/U.S. CLS. 21, 23, 26, 36 AND 38

FOR ELECTROMAGNETIC PRECISION GAUGE USED TO MEASURE THE THICKNESS OF A MATERIAL SUCH AS A METAL SHEET.

FIRST USE 12-8-2003; IN COMMERCE 12-8-2003.

THE MARK CONSISTS OF STANDARD CHARACTERS WITHOUT CLAIM TO ANY PARTICULAR FONT, STYLE, SIZE, OR COLOR.

INT. CL. 9/U.S. CLS. 21, 23, 26, 36 AND 38

FOR DVD'S AND DOWNLOADABLE EDUCATIONAL SOFTWARE FEATURING ANNUAL CONFERENCE MATERIALS, NAMELY, AUDIO AND COMPUTER SOFTWARE PRESENTATIONS FEATURING CLASSES, SEMINARS, CONFERENCES, AND WORKSHOPS IN THE FIELD OF VETERINARY MEDICINE.

FIRST USE 10-1-2005; IN COMMERCE 10-1-2005.

ELEMENTS CORRECTED
OWNER NAME

ELEMENTS AMENDED
MARK

3,262,562. REG. 7-10-2007. B.A.S.S. (IP), LLC (DELAWARE LTD LIAB CO) ESPN PLAZA, BRISTOL, CT, 06010, SN 78-654,939. FILED 6-21-2005. PRINCIPAL REGISTER.

WOMEN'S BASSMASTER TOUR

3,289,138. REG. 9-4-2007. GREATER BAY INC. (CALIFORNIA CORPORATION) 3156 HIGHLANDER RD., FULLERTON, CA, 92833, SN 78-978,697. FILED 3-8-2006. PRINCIPAL REGISTER.

THE MARK CONSISTS OF STANDARD CHARACTERS WITHOUT CLAIM TO ANY PARTICULAR FONT, STYLE, SIZE, OR COLOR.

OWNER OF U.S. REG. NO. 1,913,301.

NO CLAIM IS MADE TO THE EXCLUSIVE RIGHT TO USE "WOMEN'S" OR "TOUR" FOR SERVICES IN CLASS 41, APART FROM THE MARK AS SHOWN.

INT. CL. 25/U.S. CLS. 22 AND 39

FOR T-SHIRTS, SWEATSHIRTS, SWEATPANTS, HOODED SWEATSHIRTS, FLEECE VESTS AND COATS, SWEATERS, NYLON PULLOVER JACKETS, ZIP-UP JACKETS, LEATHER JACKETS, COATS, PARKAS, PONCHOS, POLO SHIRTS, BUTTON-UP DRESS SHIRTS, DENIM SHIRTS, PANTS, SHORTS, EAR WARMERS, WRIST WARMERS, HAND WARMERS, VESTS, TANK TOPS, COVERALLS, OVERALLS, SWIMSUITS, WARM-UP SUITS, PONCHOS, RAIN WEAR, SWIMWEAR, SUSPENDERS, BELTS, CAPS, HATS, HEADBANDS, SWEATBANDS, BANDANAS, VISORS, SUN VISORS [RUBBER HIP WADERS].

FIRST USE 4-30-2006; IN COMMERCE 4-30-2006.

INT. CL. 41/U.S. CLS. 100, 101 AND 107

FOR PROVISION OF INFORMATION CONCERNING FISHING OVER THE INTERNET; ORGANIZING, SPONSORING AND CONDUCTING FISHING TOURNAMENTS; PROVIDING FISHING INFORMATION VIA WIRELESS AND MOBILE DEVICES.

FIRST USE 7-31-2005; IN COMMERCE 7-31-2005.

ELEMENTS AMENDED
GOODS/SERVICES

GB GREATER BAY

THE MARK CONSISTS OF STANDARD CHARACTERS WITHOUT CLAIM TO ANY PARTICULAR FONT, STYLE, SIZE, OR COLOR.

INT. CL. 25/U.S. CLS. 22 AND 39

FOR CAP VISORS; FOOTWEAR FOR MEN AND WOMEN; HATS; JOGGING PANTS; MEN AND WOMEN JACKETS, COATS, TROUSERS, VESTS; SWEAT PANTS; SWEAT SHIRTS; SWEATERS; SWIM WEAR; T-SHIRTS; TANK TOPS; TOPS.

FIRST USE 3-9-2007; IN COMMERCE 3-9-2007.

ELEMENTS CORRECTED
OWNER NAME

3,302,421. REG. 10-2-2007. NEWARK FRATERNAL ORDER OF POLICE LODGE #12 (NEW JERSEY INCORPORATED ASSOCIATION) 51 RECTOR STREET, NEWARK, NJ, 07102, SN 78-923,802. FILED 7-6-2006. PRINCIPAL REGISTER.

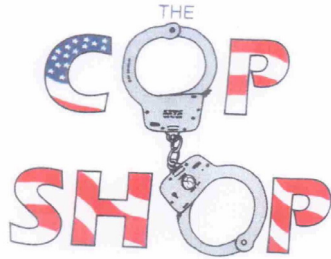

THE COLOR(S) RED, WHITE, BLUE, GRAY AND BLACK IS/ARE CLAIMED AS A FEATURE OF THE MARK.

THE LETTER 'O' IN THE WORD "COP" AND IN THE WORD "SHOP" ARE REPRESENTED BY A PAIR OF HANDCUFFS, WHICH IS IN COLOR GRAY. THE CONSONANTS IN THE WORDS "COP" AND "SHOP" ARE COLORED IN AMERICAN FLAG PATTERN OF STARS AND STRIPES IN THE COLORS RED, WHITE AND BLUE. THE COLOR GRAY APPEARS IN THE WORD "THE" AND THE OUTLINING OF THE HANDCUFFS AND THE WORDING "COP SHOP" IS IN THE COLOR BLACK.

SEC. 2(F).
INT. CL. 35/U.S. CLS. 100, 101 AND 102
FOR RETAIL SALES STORE FEATURING POLICE AND SECURITY UNIFORMS AND OTHER RELATED MERCHANDISE.

FIRST USE 1-1-1993; IN COMMERCE 1-1-1993.

ELEMENTS CORRECTED
LINING/STIPPLING STATEMENT

3,308,983. REG. 10-9-2007. MEDTRONIC, INC. (MINNESOTA CORPORATION) 710 MEDTRONIC PARKWAY, MINNEAPOLIS, MN, 554325604, SN 78-736,242. FILED 10-19-2005. PRINCIPAL REGISTER.

EOPA

THE MARK CONSISTS OF STANDARD CHARACTERS WITHOUT CLAIM TO ANY PARTICULAR FONT, STYLE, SIZE, OR COLOR.

OWNER OF U.S. REG. NO. 2,872,461.
INT. CL. 10/U.S. CLS. 26, 39 AND 44
FOR CANNULAE.
FIRST USE 6-2-2006; IN COMMERCE 6-2-2006.

ELEMENTS CORRECTED
GOODS/SERVICES

3,317,508. REG. 10-23-2007. INLAND VALLEYS ASSOCIATION OF REALTORS (CALIFORNIA CORPORATION) 31594-C RAILROAD CANYON RD., CANYON LAKE, CA, 92587, SN 78-841,233. FILED 3-20-2006. PRINCIPAL REGISTER.



THE COLOR(S) BLUE IS/ARE CLAIMED AS A FEATURE OF THE MARK.

THE COLOR BLUE APPEARS IN THE LETTERING AND THE DESIGN.

INT. CL. 35/U.S. CLS. 100, 101 AND 102
FOR ASSOCIATION SERVICES, NAMELY, PROMOTING THE FINANCIAL AND CAREER INTERESTS OF CALIFORNIA REALTY PROFESSIONALS.

FIRST USE 1-1-1958; IN COMMERCE 1-1-1958.

ELEMENTS CORRECTED
OWNER NAME

3,329,142. REG. 11-6-2007. COOPERATIVE HOUSING FOUNDATION (NEW JERSEY CORPORATION) SUITE 800, 8601 GEORGIA AVE, SILVER SPRING, MD, 20910, SN 78-715,392. FILED 9-19-2005. PRINCIPAL REGISTER.



NO CLAIM IS MADE TO THE EXCLUSIVE RIGHT TO USE INTERNATIONAL, APART FROM THE MARK AS SHOWN.

THE MARK CONSISTS OF THE LETTERS CHF INTERNATIONAL WITH THE LOWER PART OF THE H FORMING A HOUSE WITH TREES THEREUNDER.

INT. CL. 35/U.S. CLS. 100, 101 AND 102

FOR INTERNATIONAL DEVELOPMENT AND HUMANITARIAN RELIEF SERVICES THROUGH GRASSROOTS ASSISTANCE, NAMELY DEVELOPING, COORDINATING, ORGANIZING AND CONDUCTING VOLUNTEER PROJECTS IN THE NATURE OF WORKING WITH COMMUNITY GROUPS TO ENSURE THEY ARE KEY STAKEHOLDERS THROUGHOUT THE DEVELOPMENT PROCESS AND INFRASTRUCTURE PROJECTS, WORKING WITH COMMUNITIES SO THAT THEY SELECT THE PROJECTS THEY MOST WANT TO WORK ON, GETTING THEIR BUY-IN THROUGHOUT ALL STAGES OF THE PROJECT, WORKING WITH LOCAL COMMUNITY GROUPS TO ENSURE INFRASTRUCTURE PROJECTS GENERATE EMPLOYMENT, AND VOCATIONAL TRAINING, COMMUNITY MOBILIZATION OR DEMOCRATIZATION PROGRAMS, WORKING TO HELP INFORM COMMUNITY MEMBERS ABOUT THEIR RIGHTS/RESPONSIBILITIES, CREATING LINKAGES WITH THEIR LOCAL GOVERNMENTS SO THAT THEY CAN BE BETTER ADVOCATES, INFORMING THEM OF AVAILABLE SERVICES, COOPERATIVE DEVELOPMENT SERVICES, ASSOCIATION BUILDING SERVICES, CREATION AND STRENGTHENING OF NGO'S, WORKING TO DEVELOP COMMUNITY MEMBER'S SKILL SETS SO AS TO HELP THEM THROUGH THE PROCESS OF ESTABLISHING THEMSELVES INSTITUTIONALLY, AS NEEDED, TO CONTINUE LOCAL DEVELOPMENT EFFORTS.

FIRST USE 12-1-2000; IN COMMERCE 12-1-2000.

INT. CL. 36/U.S. CLS. 100, 101 AND 102

FOR INTERNATIONAL DEVELOPMENT AND HUMANITARIAN RELIEF SERVICES, NAMELY PROVIDING A WIDE RANGE OF FINANCIAL ASSISTANCE TO LOW-INCOME AND OTHER DISTRESSED COMMUNITIES IN VARIOUS AREAS, NAMELY, PROVIDING MICRO CREDIT TO EXPAND OR START BUSINESSES, FUND EDUCATION, FUND HOME IMPROVEMENT, FUND AGRICULTURAL PRODUCTION AND MARKETING; WHOLESALE COMMERCIAL LENDING TO INSTITUTIONS.

FIRST USE 12-1-2000; IN COMMERCE 12-1-2000.

INT. CL. 37/U.S. CLS. 100, 103 AND 106

FOR INTERNATIONAL DEVELOPMENT AND HUMANITARIAN RELIEF SERVICES, NAMELY PROVIDING A WIDE RANGE OF INFRASTRUCTURAL ASSISTANCE TO LOW-INCOME AND OTHER DISTRESSED COMMUNITIES, NAMELY, CONSTRUCTION OF TRANSITIONAL SHELTERS, CONSTRUCTION OF PERMANENT HOMES, CONSTRUCTION OF DEVELOPED WASTE MANAGEMENT AND WATER TREATMENT/PURIFICATION SYSTEMS, CONSTRUCTION OF ROADS, BRIDGES, ELECTRICAL SYSTEMS, SCHOOLS, CLINICS AND OTHER MUNICIPAL SYSTEMS.

FIRST USE 12-1-2000; IN COMMERCE 12-1-2000.

INT. CL. 42/U.S. CLS. 100 AND 101

FOR INTERNATIONAL DEVELOPMENT AND HUMANITARIAN RELIEF SERVICES, NAMELY PROVIDING A WIDE RANGE OF INFRASTRUCTURAL ASSISTANCE TO LOW-INCOME AND OTHER DISTRESSED COMMUNITIES, NAMELY, DESIGN OF TRANSITIONAL SHELTERS, DESIGN OF PERMANENT HOMES, ENGINEERING IN THE FIELD OF DEVELOPED WASTE MANAGEMENT AND WATER TREATMENT/PURIFICATION SYSTEMS, ENGINEERING IN THE FIELD OF REHABILITATION OF ROADS, BRIDGES, ELECTRICAL SYSTEMS, SCHOOLS, CLINICS AND OTHER MUNICIPAL SYSTEMS.

FIRST USE 12-1-2000; IN COMMERCE 12-1-2000.

INT. CL. 43/U.S. CLS. 100 AND 101

FOR INTERNATIONAL DEVELOPMENT AND HUMANITARIAN RELIEF SERVICES, NAMELY PROVIDING A WIDE RANGE OF INFRASTRUCTURAL ASSISTANCE TO LOW-INCOME AND OTHER DISTRESSED COMMUNITIES, NAMELY, PROVISION OF TRANSITIONAL SHELTERS MADE OUT OF MATERIALS SUCH AS BAMBOO, BRICK, METAL, CONCRETE AND CINDER BLOCKS AND SANITATION SYSTEMS IN DISASTER SETTINGS.

FIRST USE 12-1-2000; IN COMMERCE 12-1-2000.

ELEMENTS CORRECTED
[OWNER NAME]

3,340,862. REG. 11-20-2007. DS WATERS OF AMERICA, INC. (DELAWARE CORPORATION) 5660 NEW NORTHSIDE DRIVE, SUITE 500, ATLANTA, GA, 30328, SN 78-386,156. FILED 3-17-2004. PRINCIPAL REGISTER.

CRYSTAL SPRINGS

THE MARK CONSISTS OF STANDARD CHARACTERS WITHOUT CLAIM TO ANY PARTICULAR FONT, STYLE, SIZE, OR COLOR.

OWNER OF U.S. REG. NOS. 1,750,905, 2,662,265 AND OTHERS.

INT. CL. 11/U.S. CLS. 13, 21, 23, 31 AND 34

FOR DRINKING WATER DISPENSERS.

FIRST USE 7-0-2000; IN COMMERCE 7-0-2000.

INT. CL. 32/U.S. CLS. 45, 46 AND 48

FOR DRINKING WATER.

FIRST USE 1-0-1990; IN COMMERCE 1-0-1990.

INT. CL. 39/U.S. CLS. 100 AND 105

FOR DELIVERY SERVICES FOR BOTTLED DRINKING WATER.

FIRST USE 7-0-2000; IN COMMERCE 7-0-2000.

ELEMENTS CORRECTED

OWNER ADDRESS

CITIZENSHIP

OWNER NAME

ENTITY

3,349,682. REG. 12-4-2007. REELCRAFT INDUSTRIES, INC. (INDIANA CORPORATION) 2842 EAST BUSINESS 30, COLUMBIA CITY, IN, 46725, SN 78-704,971. FILED 9-1-2005. PRINCIPAL REGISTER.

INDURION

THE MARK CONSISTS OF STANDARD CHARACTERS WITHOUT CLAIM TO ANY PARTICULAR FONT, STYLE, SIZE, OR COLOR.

INT. CL. 6/U.S. CLS. 2, 12, 13, 14, 23, 25 AND 50

FOR MANUAL AND SPRING REFRACTED REELS MADE PRIMARILY OF METAL, FOR ELECTRICAL CABLE, HOSE AND CORD.

FIRST USE 11-0-2005; IN COMMERCE 5-0-2006.

ELEMENTS CORRECTED
GOODS/SERVICES

3,359,538. REG. 12-25-2007. PEREGO, MARIA (ITALY INDIVIDUAL) 39, AVENUE DES PAPALINS, MONACO, MONACO, MC 98000, SN 78-569,413. FILED 2-17-2005. PRINCIPAL REGISTER.

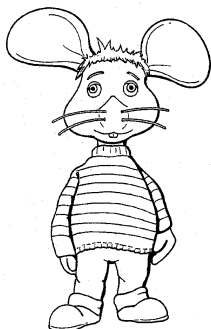

OWNER OF ITALY REG. NO. 678139, DATED 5-14-1996, RENEWED AS REG. NO. 1046702, DATED 5-4-2007, EXPIRES 1-3-2014.

THE MARK CONSISTS OF THE DESIGN OF A MOUSE.
INT. CL. 9/U.S. CLS. 21, 23, 26, 36 AND 38

FOR SPECTACLES, SPECTACLE CASES, SPECTACLE FRAMES, GOGGLES FOR SPORTS; COMPUTER PROGRAMS FOR PRE-RECORDED GAMES, COMPUTER GAME PROGRAMS, DISK DRIVES FOR COMPUTERS, PRE-RECORDED MAGNETIC DISKS FEATURING MUSIC, FLOPPY DISCS DRIVES FOR COMPUTERS, FLOPPY DISCS FEATURING COMPUTER GAME PROGRAMS, CALCULATORS, POCKET-SIZED ELECTRONIC CALCULATORS, DIRECTIONAL COMPASSES, COMPUTER PERIPHERALS, NAMELY, ELECTRONIC PENS WITH VISUAL DISPLAY UNITS; CASSETTE PLAYERS, COMPACT DISC PLAYERS, TAPE RECORDERS, VIDEO TAPE RECORDERS, RADIOS; PRE-RECORDED VIDEO CASSETTES, PRE-RECORDED AUDIO CASSETTES, AUDIO-VIDEO COMPACT DISCS AND READ-ONLY-MEMORY COMPACT DISCS FEATURING MUSIC, STORIES, GAMES, LEARNING ACTIVITIES AND ANIMATED ENTERTAINMENT; VIDEO GAME CARTRIDGES, VIDEOTAPES AND VIDEO DISKS RECORDED WITH ANIMATION, WALKIE-TALKIES; CAMERAS, CINEMATOGRAPHIC CAMERAS, MOVIE PROJECTORS, PICTURE PROJECTORS, PROJECTORS PARTICULARLY PROJECTORS FOR THE ENTERTAINMENT INDUSTRY, CINEMATOGRAPHIC FILMS, EXPOSED CINEMATOGRAPHIC FILMS; PROTECTIVE HELMETS; DOWNLOADABLE ELECTRONIC PUBLICATIONS IN THE NATURE OF BOOKS, MANUALS, MAGAZINES AND NEWSPAPERS IN THE FIELD OF MUSIC, STORIES, GAMES, LEARNING ACTIVITIES AND ANIMATED ENTERTAINMENT; VIDEO DISKS AND VIDEO TAPES WITH RECORDED ANIMATED CARTOONS; MOUSE PADS, BEING COMPUTER PERIPHERAL; VIDEOGAME MACHINES FOR USE WITH TELEVISIONS; SWIMMING ACCESSORIES, NAMELY, SWIMMING GOGGLES.

FIRST USE : IN COMMERCE .

INT. CL. 16/U.S. CLS. 2, 5, 22, 23, 29, 37, 38 AND 50

FOR DIARIES, MAGAZINES FEATURING STORIES, GAMES AND LEARNING ACTIVITIES, NEWSPAPERS, NEWSPAPER COMIC STRIPS, CHILDREN'S BOOKS, BOOKS FEATURING STORIES, GAMES AND LEARNING ACTIVITIES, EXERCISE BOOKS, COLORING BOOKS, SCHOOL WRITING BOOKS, PAMPHLETS FEATURING STORIES, GAME AND LEARNING ACTIVITIES, PHOTOGRAPHS, PLASTIC AND PAPER BAGS FOR PACKAGING, DECALCOMANIAS, ADHESIVE LABELS, BLANK OR PARTIALLY PRINTED PAPER LABELS; PUNCHES, BEING OFFICE REQUISITES; DOCUMENT HOLDERS, STATIONERY-TYPE PORTFOLIOS, GIFT CARDS, GREETING CARDS, OCCASION CARDS, POSTCARDS, BLANK CARDS, NOTE PADS, SCRATCH PADS; BOND PAPER, ILLUSTRATION PAPER, GIFT WRAPPING PAPER, WRITING PAPER; WRITING PADS, ENVELOPES; PAPER BOXES, CARD-BOARD BOXES; WRITING PAPER PADS, PAPER BOARDS, POSTERS, PICTURES, TELEPHONE NUMBER BOOKS, PHOTOGRAPH MOUNTS, ERASERS, MAG-

NETIC BOARDS, PENCIL SHARPENERS, PENS, PENCILS, PENCIL CASES AND HOLDERS, PEN CASES AND HOLDERS, GLUE FOR STATIONERY USE, ARTISTS' PASTELS, PAPER CUTTERS, PAPERWEIGHTS, PAPER FASTENERS, FILE FOLDERS, DESK SETS, DESK TOP ORGANIZERS; TABLE LINENS OF PAPER, TABLE CLOTHS OF PAPER, PAPER RIBBONS, PAPER BOWS FOR GIFT WRAP, PAPER CAKE DECORATIONS, DECORATIVE PAPER CENTERPIECES, PAPER HANDKERCHIEFS, PAPER NAPKINS, PAPER MATS, PAPER TOWELS, CALENDARS, PHOTOGRAPH ALBUMS, PERSONAL ORGANIZERS, ADHESIVE BANDS AND TAPES FOR STATIONERY OR HOUSEHOLD PURPOSES; COMPASSES FOR DRAWING.

FIRST USE ; IN COMMERCE .

INT. CL. 17/U.S. CLS. 1, 5, 12, 13, 35 AND 50

FOR PLASTICS IN EXTRUDED FORM FOR GENERAL INDUSTRIAL USE; PLASTICS IN THE FORM OF BLOCKS, PELLETS, RODS, BARS, SHEETS, FILMS AND TUBES FOR USE IN MANUFACTURING; PLASTIC IN POWDERED FORM; RUBBER AND PLASTICS FOR USE IN THE MANUFACTURE OF PUPPETS, DOLLS AND TOYS IN GENERAL, RAW AND SEMI WORKED RUBBER; SYNTHETIC RUBBER, STUFFING OF RUBBER OR PLASTIC.

FIRST USE ; IN COMMERCE .

INT. CL. 18/U.S. CLS. 1, 2, 3, 22 AND 41

FOR SPECIAL TOTE BAGS FOR SWIMWEAR.
FIRST USE ; IN COMMERCE .

INT. CL. 25/U.S. CLS. 22 AND 39

FOR PULLOVERS, CARDIGANS, JERSEYS, SWEATERS, SOCKS, STOCKINGS, TIGHTS, TROUSERS, LEGGINGS, SKIRTS, JACKETS, JERKINS, SHIRTS, VESTS, WAISTCOATS, JUMPERS, TRACK SUITS, BLOUSES, BLOUSONS, JEANS, SWEAT PANTS, GYM SUITS, KNICKERS, PANTS, SHORTS, T-SHIRTS, SWEAT-SHIRTS, SUITS AND DRESSES, OVERCOATS, COATS, ANORAKS, RAINCOATS, GLOVES; BIBS, NOT OF PAPER, BELTS, BEING CLOTHING; SUSPENDERS, LOUNGEWEAR, UNDERWEAR, BEACHWEAR, SLEEPWEAR, NECKWEAR, FOOTWEAR, HATS, CAPS; SWIMMING ACCESSORIES, NAMELY, SWIMMING CAPS.

FIRST USE ; IN COMMERCE .

INT. CL. 28/U.S. CLS. 22, 23, 38 AND 50

FOR RUBBER CHARACTER TOYS, CONSTRUCTION TOYS, ANIMATED AND NON ANIMATED TOY FIGURES, STUFFED TOYS AND UNSTUFFED TOYS, IN THE NATURE OF PLASTIC CHARACTER TOYS, PLAYING CARDS, BALLOONS, SPORT BALLS, RUBBER BALLS, ELECTRONIC TOYS IN THE NATURE OF ARCADE-TYPE ELECTRONIC EDUCATION VIDEO GAMES, ELECTRONIC ACTION TOYS, ELECTRONIC TOY TRAIN TRANSFORMERS, ELECTRONIC DART GAMES, ELECTRONIC EDUCATIONAL GAME MACHINES FOR CHILDREN, ELECTRONIC TOY BUILDING BLOCKS, ELECTRONICALLY OPERATED TOY MOTOR VEHICLES, ELECTRONIC CHESS GAMES, ELECTRONIC CHECKER GAMES, ELECTRONIC PUZZLES, ELECTRONIC PUPPETS, ELECTRONIC BOARD GAMES; ELECTRONIC TOY BUILDING BLOCKS, FACE MASKS, COSTUME MASKS, PUPPETS, MARIONETTE PUPPETS, PUPPETS HAVING ANIMAL CONFIGURATIONS, THEATERS FOR PUPPETS, PUZZLES, JIGSAW PUZZLES, MANIPULATIVE PUZZLES, CUBE-TYPE PUZZLES, BOXED BOARD GAMES, BOARD GAMES, RUBBER ACTION BALLS, ACTION SKILL GAMES, MECHANICAL ACTION TOYS, ACTION TYPE TARGET GAMES, TARGETS, TOY VEHICLES, ROCKING HORSES, SKATEBOARDS; WALKABLE TWO-WAY RADIO SETS, BEING TOYS; PORTABLE TELEPHONES, BEING TOYS; WRISTWATCHES, BEING TOYS, COIN OR NON-COIN OPERATED PINBALL MACHINES; GOLF BAGS, SWIMMING ACCESSORIES, NAMELY, WATER WING SWIM AIDS FOR RECREATIONAL USE, SWIM FINS, SWIM BOARDS FOR RECREATIONAL USE, SWIM FLOATS FOR RECREATIONAL USE, POOL RINGS AS SWIMMING AIDS, INFLATABLE MATTRESSES FOR AQUATIC RECREATIONAL USE, INFLATABLE INNER TUBES FOR AQUATIC RECREATIONAL USE; BOWLING BAGS, CRAFT SETS FOR DECORATING BALLOONS, DOLLS, DOLL CASES,

DOLL CLOTHING, DOLL HOUSE FURNISHINGS, DOLL ACCESSORIES, INFLATABLE FLOAT MATTRESSES OR PADS FOR RECREATIONAL USE, INFLATABLE FLOAT TUBES FOR FISHING, FLOATING RECREATIONAL LOUNGE CHAIRS; RING BUOYS FOR RECREATIONAL USE; ARM FLOATS AND SWIM FLOAT, FOR RECREATIONAL USE; INFLATABLE RIDE-ON TOYS, INFLATABLE BATH TOYS, INFLATABLE SWIMMING POOLS, BEING PLAY ARTICLES; VIDEOGAME MACHINES OTHER THAN THOSE FOR USE WITH TELEVISIONS, NAMELY, STAND-ALONE VIDEOGAME MACHINES.

FIRST USE ; IN COMMERCE .
INT. CL. 38/U.S. CLS. 100, 101 AND 104
FOR RADIO AND TELEVISION BROADCASTING;
CABLE TELEVISION BROADCASTING.

FIRST USE ; IN COMMERCE .
INT. CL. 41/U.S. CLS. 100, 101 AND 107
FOR PROVIDING CINEMA FACILITIES, NAMELY CINEMA STUDIOS AND CINEMA THEATERS; EDUCATIONAL SERVICES, NAMELY ARRANGING AND CONDUCTING EDUCATIONAL CONFERENCES, ORGANIZING EXHIBITIONS FOR EDUCATIONAL PURPOSES, PROVIDING FACILITIES FOR MOVIES, SHOWS, PLAYS, MUSIC OR EDUCATIONAL TRAINING; ENTERTAINMENT SERVICES, NAMELY PRODUCTION OF TELEVISION SHOWS, CONDUCTING ENTERTAINMENT EXHIBITIONS IN THE NATURE OF PUPPET THEATERS, ENTERTAINMENT IN THE NATURE OF THEATER SHOWS FOR CHILDREN, ENTERTAINMENT IN THE NATURE OF PUPPET THEATER SHOWS, ONGOING TELEVISION PROGRAMS IN THE FIELD OF VARIETY AND OF CHILDREN'S ENTERTAINMENT, ENTERTAINMENT IN THE NATURE OF THEATER PRODUCTIONS AND OF VISUAL AND AUDIO, MUSICAL AND VARIETY PERFORMANCES; MOTION PICTURE FILM PRODUCTION, PRESENTATION OF LIVE SHOW PERFORMANCES, MOVIE STUDIOS; ENTERTAINMENT SERVICES, NAMELY ORGANIZATION AND PRODUCTION OF RADIO SHOWS AND TELEVISION SHOWS; PHOTOGRAPHIC REPORTING, PHOTOGRAPHY SERVICES, PRODUCTION OF RADIO AND TELEVISION PROGRAMS; VIDEOTAPE FILM PRODUCTION, RECORDING STUDIOS; RENTAL OF CINEMA FILMS, RENTAL OF MOTION PICTURES.

FIRST USE ; IN COMMERCE .

ELEMENTS CORRECTED
FOREIGN REG. EXPIRATION DATE
FOREIGN RENEWAL REG. NO.

3,363,256. REG. 1-1-2008. KANSAS CITY ROYALS BASEBALL CORPORATION (MISSOURI CORPORATION) HARRY S. TRUMAN SPORTS COMPLEX, 1 ROYAL WAY, KANSAS CITY, MO, 64129, SN 78-642,375. FILED 6-2-2005. PRINCIPAL REGISTER.



OWNER OF U.S. REG. NOS. 1,538,005, 1,607,457 AND OTHERS.

INT. CL. 28/U.S. CLS. 22, 23, 38 AND 50
FOR TOYS AND SPORTING GOODS, NAMELY, STUFFED TOYS, PLUSH TOYS, SOFT SCULPTURE FOAM TOYS; FOAM NOVELTY ITEMS, NAMELY, FOAM FINGERS; BALLOONS, BOARD GAMES, CARD GAMES, PLAYING CARDS, DART BOARDS AND DART BOARD ACCESSORIES, NAMELY, DARTS, DART SHAFTS AND DART FLIGHTS, TOY VEHICLES, TOY MOBILES, JIGSAW AND MANIPULATIVE PUZZLES, TOY BANKS, TOY FIGURES, TOY VEHICLES, DOLLS AND DOLL ACCESSORIES, BOBBING HEAD DOLLS; DECORATIVE WIND SOCKS, MINIATURE BASEBALL BATS, TOY NECKLACES, MINIATURE TOY BASEBALLS, BASEBALLS, HOLDERS FOR BASEBALLS, AUTOGRAPHED BASEBALLS, PLAYGROUND BALLS, RUBBER ACTION BALLS, GOLF BALLS, GOLF CLUB HEAD COVERS, GOLF PUTTERS; BILLIARD ACCESSORIES, NAMELY, CUES, BILLIARD BALLS AND CUE CASES; BASEBALL BASES, BASEBALL BATS, BASEBALL GLOVES; COSTUME MASKS; CHRISTMAS TREE ORNAMENTS, EXCLUDING CONFECTIONERY AND ILLUMINATION ARTICLES, AND CHRISTMAS STOCKINGS.

FIRST USE 5-0-1985; IN COMMERCE 5-0-1985.

ELEMENTS CORRECTED
GOODS/SERVICES

* * * * *

TRADEMARK REGISTRATIONS—NEW CERTIFICATES

New Certificates issued under section 7(d) of the Trademark Act of 1946 for the unexpired term of the original registrations.

3,390,480. FAIRYDOWN. INT. CLS. 20 AND 24. ARTHUR ELLIS LIMITED, CHRISTCHURCH, NEW ZEALAND. REG. 3-9-2004. NEW CERT. SEC. 7(D) TO REGISTRANT.	3,390,481. ASSOULINE. INT. CLS. 16, 35 AND 41. TRILOGIE ASSOULINE S.A.R.L., 75001 PARIS, FRANCE. REG. 6-12- 2001. NEW CERT. SEC. 7(D) TO REGISTRANT.
---	--

* * * * *

INDEX OF REGISTRANTS

MARCH 18, 2008

(Registered; Renewed; Canceled; Amended, Corrected, etc.; New Certificates; 12c Publications.)

The designation "U.S. Cl." appearing in this section refers to the U.S. class in effect prior to Sep. 1, 1973 rather than the international class which applies to applications filed on or after that date. For adoption of international classification see notice in the OFFICIAL GAZETTE of Jun. 26, 1973 (911 O.G. TM 210).

/RAYNALDO GARZA/, MONARCH BEACH, CA:
3,400,349, INT. CL. 41.
"WHITE GOLD", LLC, MOSCOW, RUSSIAN FED.:
3,399,843, INT. CL. 33.
3,399,844, INT. CL. 33.
A B SEA, LLC, NEW YORK, NY:
3,399,278, INT. CL. 25.
A BETTER CHANCE, INC., NEW YORK, NY:
1,474,550, REN. 2-13-08, INT. CL. 41.
A WHITE ORCHID WEDDING, INC., WAILUKU, HI:
3,398,165, PUB. 1-1-2008, INT. CL. 41.
A. M. TODD COMPANY, KALAMAZOO, MI:
3,400,106, INT. CL. 5.
A.L.E.G., INC., PARKER, TX:
3,397,476, PUB. 1-1-2008, INT. CL. 1.
A.M. MACHINERY INC., SAINT-EUGENE DE L'ISLE, CANADA:
3,398,170, PUB. 1-1-2008, INT. CL. 7.
A.P. MØLLER A/S - MÆRSK A/S, DENMARK:
3,398,717, PUB. 1-1-2008, MULTIPLE CLASS, INT. CLS. 9, 16, 35, 38, 39 AND 42.
A&E TELEVISION NETWORKS, NEW YORK, NY:
2,128,239, REN. 2-13-08, MULTIPLE CLASS, INT. CLS. 9 AND 41.
A-Z SOFTWARE SOLUTIONS AND SERVICES, SIMI VALLEY, CA:
3,400,410, INT. CL. 16.
AADLAND, CHIP, SCOTTSDALE, AZ:
3,396,887, PUB. 1-1-2008, INT. CL. 25.
AAXION SOFTWARE CORPORATION, MARLBOROUGH, MA:
2,447,959, CANC. INT. CL. 9.
ABBOTT LABORATORIES, ABBOTT PARK, IL, TA ROSS LABORATORIES:
1,475,612, REN. 2-12-08, INT. CL. 5.
ABBOTT LABORATORIES, ABBOTT PARK, IL:
1,481,362, REN. 2-12-08, INT. CL. 5.
1,481,363, REN. 2-12-08, INT. CL. 5.
3,397,337, PUB. 1-1-2008, INT. CL. 9.
ABBOTT SPECIALTY STAFFING, INC., TUSTIN, CA:
2,447,360, CANC. INT. CL. 35.
ABC BAIL BONDS, INC., MORRISVILLE, PA:
3,397,529, PUB. 1-1-2008, INT. CL. 36.
ABDO, EICK & MEYERS LLP, EDINA, MN:
3,397,802, PUB. 1-1-2008, INT. CL. 35.
ABILITY MOUNTAIN INSTITUTE, SANTA CLARA, CA:
3,396,904, PUB. 1-1-2008, INT. CL. 41.
ABLENET, INC., MINNEAPOLIS, MN:
2,059,536, CANC. INT. CL. 9.
ABOUNDI, INC., NASHUA, NH:
3,399,098, INT. CL. 9.
ABOVENET, INC., WHITE PLAINS, NY:
3,399,181, INT. CL. 38.
ABREU, CARLOS, BEVERLY HILLS, CA:
2,448,540, CANC. INT. CL. 41.
ABRUZZESE, ANTHONY P., AUBURN, MA:
2,447,607, CANC. INT. CL. 16.
ABSTRACTA DESIGNS, INC., NORTH HOLLYWOOD, CA:
2,058,878, CANC. INT. CL. 20.
ACCELERATED CARE PLUS CORP., RENO, NV:
3,399,777, INT. CL. 10.
ACCELLER, INC., MIAMI, FL, DBA BUYTELCO:
3,399,762, INT. CL. 35.
ACCESS INTERNATIONAL, INC., BETHLEHEM, PA, DBA ACCESS-ABILITY, INC.:
3,398,351, PUB. 1-1-2008, INT. CL. 7.
ACCESSORY CORP., THE, NEW YORK, NY:
2,134,817, REN. 2-11-08, INT. CL. 20.
2,136,119, REN. 2-11-08, INT. CL. 20.
ACCIONA, S.A., ALCOBENDAS (MADRID), SPAIN:
3,398,585, PUB. 1-1-2008, INT. CL. 40.
ACCOR, EVRY, FRANCE:
3,399,429, MULTIPLE CLASS, INT. CLS. 9, 35, 36 AND 42.
ACCORDENCE, INC., BURLINGAME, CA:
3,399,744, MULTIPLE CLASS, INT. CLS. 35, 41 AND 42.
ACCOUNTNOW, INC., SAN RAMON, CA:
3,398,347, PUB. 1-1-2008, MULTIPLE CLASS, INT. CLS. 35, 36 AND 45.
ACCURATE AUTOMATION CORPORATION, CHATTANOOGA, TN:
2,059,495, CANC. INT. CL. 42.
ACE TECH INCORPORATED, TROY, MI:
3,397,045, PUB. 1-1-2008, MULTIPLE CLASS, INT. CLS. 9, 35 AND 36.
ACH FOOD COMPANIES, INC., CORDOVA, TN:
843,781, REN. 2-14-08, U.S. CL. 46 (INT. CL. 29).
3,399,931, MULTIPLE CLASS, INT. CLS. 1 AND 30.
ACK VENTURES HOLDINGS, LLC, DELRAY BEACH, FL:
3,399,754, MULTIPLE CLASS, INT. CLS. 9, 35, 38 AND 41.
ACORN CONCEPTS LLC, BROOKLYN, NY:
3,397,391, PUB. 1-1-2008, INT. CL. 25.
ACORN KITCHENS, KITCHENER, ONTARIO, CANADA:
3,398,510, PUB. 1-1-2008, INT. CL. 20.
ACS TECHNOLOGIES GROUP, INC., FLORENCE, SC:
3,397,018, PUB. 1-1-2008, INT. CL. 9.
ACT OF COMMUNICATION, CULVER CITY, CA:
3,399,170, INT. CL. 25.
ACTION LLC, VIRGINIA BEACH, VA:
3,399,382, INT. CL. 3.
ACTION ONLINE, LLC, MARGATE, FL:
3,397,202, PUB. 1-1-2008, INT. CL. 42.
ACTION TRAILER DEPOT, ALBUQUERQUE, NM:
3,397,573, PUB. 1-1-2008, INT. CL. 35.
ACTIVE CREATIONS, GALLATIN, TN:
3,396,894, PUB. 1-1-2008, INT. CL. 25.
3,396,895, PUB. 1-1-2008, INT. CL. 25.
ACTIVISION PUBLISHING, INC., SANTA MONICA, CA:
3,398,311, PUB. 1-1-2008, MULTIPLE CLASS, INT. CLS. 9, 16 AND 25.
ACTUANT CORPORATION, BUTLER, WI:
3,397,657, PUB. 11-27-2007, INT. CL. 9.
ADAMI S.R.L., ITALY:
3,398,773, PUB. 1-1-2008, INT. CL. 33.
ADAMS, JOHN, RICHARDSON, TX, DBA CONGRUENT MUSIC COMPANY:
2,187,545, REN. 2-11-08, INT. CL. 9.
ADAMS, SHAWN MAURICE, YONKERS, NY:
3,399,001, INT. CL. 25.
ADE CORPORATION, WESTWOOD, MA:
3,398,593, PUB. 1-1-2008, INT. CL. 9.
ADEA SOLUTIONS, INC., IRVING, TX:
2,447,809, CANC. INT. CL. 35.
2,447,810, CANC. INT. CL. 35.

- ADEGA COOPERATIVA DE BORBA, CRL, BORBA 7150-999, PORTUGAL:
3,400,374, INT. CL. 33.
- ADELARD AND EDWARDS, INC, MILWAUKEE, WI:
3,399,239, INT. CL. 25.
- ADITON LIMITED, UNITED KINGDOM:
3,398,813, PUB. 1-1-2008. MULTIPLE CLASS, INT. CLS. 9,
35 AND 38.
- ADJUNGA, LLC, CUPERTINO, CA:
2,447,715, CANC. INT. CL. 9.
- ADLER FELS WINERY, LLC, THOUSAND OAKS, CA:
2,214,798, REN. 2-11-08. INT. CL. 33.
- ADP, INC., HOFFMAN ESTATES, IL:
3,399,427, INT. CL. 35.
- ADRENALIN GAMING, LLC., LADERA RANCH, CA:
3,399,025, INT. CL. 9.
- ADVANCE CONCRETE PRODUCTS CO., HIGHLAND, MI:
2,147,969, REN. 2-11-08. INT. CL. 19.
- ADVANCE MERCHANDISING COMPANY, INC., ROANOKE, VA:
3,399,245, INT. CL. 3.
- ADVANCED BIOLOGICAL MARKETING, VAN WERT, OH:
3,398,312, PUB. 1-1-2008. INT. CL. 1.
3,398,313, PUB. 1-1-2008. INT. CL. 1.
- ADVANCED BIOMETRIC SOLUTIONS, INC., NEW YORK, NY:
3,400,166, INT. CL. 9.
- ADVANCED MEASUREMENT TECHNOLOGIES, INC., OAK RIDGE, TN:
2,132,386, REN. 2-13-08. INT. CL. 9.
- ADVANCED MEDICAL NUTRITION, INC., PITTSBURGH, PA:
2,213,836, REN. 2-11-08. INT. CL. 5.
- ADVANCED ORTHOTIC DESIGN, INC., MISSISSAUGA, ONTARIO, CANADA:
2,447,459, CANC. INT. CL. 10.
- ADVANCED SLEEP CONCEPTS, INC., ROME, GA:
3,398,928, INT. CL. 20.
- ADVANSTAR COMMUNICATIONS INC., CLEVELAND, OH:
2,447,497, CANC. INT. CL. 35.
- ADVANSYS, INC., KING OF PRUSSIA, PA:
2,447,576, CANC. INT. CL. 9.
- ADVANTIS TECHNOLOGIES, INC., ALPHARETTA, GA,
APPLIED BIOCHEMISTS, INC., MEQUON, WI:
1,083,831, REN. 2-13-08. INT. CL. 5.
- ADVENTNET, INC, PLEASANTON, CA:
3,400,303, INT. CL. 9.
- AELERA CONSULTING CORPORATION, ALPHARETTA, GA:
3,398,924, INT. CL. 35.
- AEP INDUSTRIES INC., SOUTH HACKENSACK, NJ:
2,506,137, CANC. INT. CL. 17.
- AEP INDUSTRIES, INC., SOUTH HACKENSACK, NJ:
2,215,417, REN. 2-13-08. INT. CL. 16.
- AEP MEMCO LLC, CHESTERFIELD, MO:
3,397,236, PUB. 1-1-2008. INT. CL. 16.
- AERO INDUSTRIES, INC., INDIANAPOLIS, IN:
2,059,730, CANC. INT. CL. 12.
- AEROBICS AND FITNESS ASSOCIATION OF AMERICA, SHERMAN OAKS, CA:
1,419,134, REN. 2-12-08. MULTIPLE CLASS, INT. CLS. 14
AND 41.
2,060,020, CANC. INT. CL. 41.
3,398,864, INT. CL. 41.
- AETERNA ZENTARIS GMBH, FRANKFURT AM MAIN, FED REP GERMANY:
2,190,686, REN. 2-12-08. INT. CL. 5.
- AFFIRMED ENTERPRISES, LLC, BAL HARBOUR, FL:
3,400,223, INT. CL. 25.
- AFI INTERNATIONAL GROUP INC., MILTON, ONTARIO, CANADA:
3,399,527, INT. CL. 42.
- AFTER-CRASH, INC., BATON ROUGE, LA:
1,438,750, CANC. INT. CL. 42.
- AGA KHAN FOUNDATION CANADA, ONTARIO OTTAWA, CANADA:
3,398,391, PUB. 7-3-2007. INT. CL. 36.
- AGAINST ALL ODDS INC., MOONACHIE, NJ:
2,135,946, REN. 2-13-08. INT. CL. 35.
- AGAKHANYAN, ARARAT, BURBANK, CA:
3,400,377, INT. CL. 43.
- AGARWAL, NIRANKAR SARAN, TWIN LAKES, WI:
2,154,147, REN. 2-14-08. INT. CL. 28.
- AGCO CORPORATION, DULUTH, GA:
2,127,218, REN. 2-13-08. INT. CL. 28.
- AGERE, INC., AUSTIN, TX:
2,448,190, CANC. INT. CL. 9.
- AGING AT HOME, LTD., MINEOLA, NY:
3,397,798, PUB. 1-1-2008. INT. CL. 45.
- AGRI-SUPPLY COMPANY, INC., GARNER, NC:
1,520,295, REN. 2-13-08. INT. CL. 42.
- AGRILOGIC, INC., COLLEGE STATION, TX:
2,447,733, CANC. INT. CL. 9.
- AGROS HOLDING S.A., 15-950 BIALYSTOK, POLAND:
3,396,813, PUB. 1-1-2008. INT. CL. 33.
- AGS ADVANCED INSTRUMENTS DIVISION, LAS VEGAS, NV:
3,397,715, PUB. 1-1-2008. MULTIPLE CLASS, INT. CLS. 9
AND 35.
- AHURAMAZDA, INC., SAN DIEGO, CA:
2,058,998, CANC. INT. CL. 30.
- AIDS PROJECT LOS ANGELES, LOS ANGELES, CA:
3,397,378, PUB. 1-1-2008. INT. CL. 16.
3,397,379, PUB. 1-1-2008. INT. CL. 41.
3,397,380, PUB. 1-1-2008. INT. CL. 36.
- AIGNER-CLARK LLC, LONE TREE, CO:
3,399,336, INT. CL. 18.
- AIR AMBULANCE SPECIALISTS, INC., ENGLEWOOD, CO:
3,398,434, PUB. 1-1-2008. INT. CL. 39.
- AIR COURIER DISPATCH, INC., MARIETTA, GA:
3,399,758, INT. CL. 39.
- AIR MOVEMENT AND CONTROL ASSOCIATION, INC., ARLINGTON HEIGHTS, IL:
3,397,627, PUB. 1-1-2008. INT. CL. 42.
- AIR RITE SERVICE SUPPLY INC., CLEVELAND, OH:
2,183,817, REN. 2-11-08. INT. CL. 37.
- AIRE-MASTER OF AMERICA, INC., NIXA, MO:
2,144,208, REN. 2-13-08. INT. CL. 5.
- AIRS HUMAN CAPITAL SOLUTIONS, INC., WHITE RIVER JUNCTION, VT:
3,399,105, INT. CL. 41.
- AIRSTRUCTURES WORLDWIDE, LTD., ST. LOUIS, MO:
3,399,616, INT. CL. 19.
- AJAX TOCCO MAGNETHERMIC CORPORATION, WARREN, OH:
1,084,512, REN. 2-11-08. INT. CL. 7.
- AJAY EQUIPMENT CORPORATION, PLACENTIA, CA:
3,398,360, PUB. 1-1-2008. MULTIPLE CLASS, INT. CLS. 7
AND 37.
- AK STEEL CORPORATION, WEST CHESTER, OH, ARMCO STEEL CORPORATION, MIDDLETOWN, OH:
1,085,298, REN. 2-12-08. INT. CL. 6.
- AKTIEBOLAGET DURGO, 169 03 SOLNA, SWEDEN:
2,078,847, REN. 2-14-08. INT. CL. 11.
- ALANOD; ALUMINIUM-VEREDLUNG GMBH & CO. KG, 58256 ENNEPETAL, FED REP GERMANY:
3,398,706, PUB. 1-1-2008. MULTIPLE CLASS, INT. CLS. 6,
11 AND 17.
- ALASKA AIRLINES, INC., SEATTLE, WA:
2,145,058, REN. 2-11-08. INT. CL. 39.
- ALASKAN BUSHWHEEL INC., JOSEPH, OR:
3,397,192, PUB. 1-1-2008. INT. CL. 12.
- ALBANO, EDMOND P., NORTH SALEM, NY, DBA SCUBART LLC:
2,447,674, CANC. INT. CL. 9.
- ALBERT C. PIERRE COMMUNITY SERVICE CENTER, INC., MIAMI, FL:
3,396,936, PUB. 1-1-2008. INT. CL. 41.
- ALCHEMY TRADING TECHNOLOGIES, INC., BOULDER, CO:
3,397,456, PUB. 1-1-2008. INT. CL. 9.
- ALCHEMY WORLDWIDE, LLC, SHERMAN OAKS, CA:
3,399,176, INT. CL. 3.
3,400,012, INT. CL. 3.

ALCOA INC., PITTSBURGH, PA:
843,522. REN. 2-13-08. U.S. CL. 12 (INT. CL. 19).

ALEXIAN BROTHERS OF AMERICA, INC., ELK GROVE VILLAGE, IL:
3,396,837, PUB. 1-1-2008. INT. CL. 44.

ALFESCA HF., ICELAND:
3,398,752, PUB. 1-1-2008. MULTIPLE CLASS, INT. CLS. 29, 30 AND 35.

ALL CITIES REALTY, INC., COSTA MESA, CA:
3,398,559, PUB. 1-1-2008. INT. CL. 36.

ALL TALK CORPORATION, WESTBORO, MA:
3,397,338, PUB. 1-1-2008. INT. CL. 16.

ALL WAYS MOVING & STORAGE, WASHINGTON, PA:
3,397,687, PUB. 1-1-2008. INT. CL. 39.

ALL 4 KIDS, LLC, KINGWOOD, TX:
3,399,289, INT. CL. 41.

ALLAIRE, ROSS, UPLAND, CA:
3,396,879, PUB. 1-1-2008. INT. CL. 40.

ALLEN EDWIN COMPANY, INC., PORTAGE, MI:
3,396,892, PUB. 1-1-2008. INT. CL. 37.

ALLEN, CHARLOTTE ELAINE, SAN JOSE, CA:
3,018,398, CANC. INT. CL. 35.

ALLERGAN, INC., IRVINE, CA:
3,399,114, INT. CL. 44.
3,399,478, INT. CL. 5.

ALLIANZ SE, MUNCHEN, FED REP GERMANY:
2,448,405, CANC. INT. CL. 36.

ALLIANZ SE, FED REP GERMANY:
3,398,790, PUB. 1-1-2008. MULTIPLE CLASS, INT. CLS. 36, 42 AND 45.

ALLIED DOMEQ SPIRITS & WINE LIMITED, BEDMINSTER DOWN, BRISTOL BS13 8AR, ENGLAND:
2,448,362, CANC. INT. CL. 33.

ALLIED MANAGEMENT, INC., LIVINGSTON, NJ:
3,399,511, INT. CL. 33.

ALLIED PRECISION INDUSTRIES, INC., ELBURN, IL:
3,400,367, INT. CL. 11.

ALLIED RESINOUS PRODUCTS, INC., CONNEAUT, OH:
2,448,019, CANC. INT. CL. 21.

ALLIED TUBE AND CONDUIT CORPORATION, HARVEY, IL:
3,397,277, PUB. 1-1-2008. INT. CL. 6.

ALLOY MEDIA, NEW YORK, NY, DBA ALLOY ENTERTAINMENT:
2,536,624, CANC. INT. CL. 41.

ALLSET RV SYSTEMS, LLC, PAYSON, AZ:
3,398,017, PUB. 1-1-2008. INT. CL. 12.

ALLSTAR SUPPLY, INC., COLLINSVILLE, CT:
3,397,693, PUB. 1-1-2008. INT. CL. 35.

ALLSTAR WATER SYSTEMS, INC., SAN DIEGO, CA:
3,397,084, PUB. 1-1-2008. INT. CL. 40.

ALM PROPERTIES, INC., NEW YORK, NY, ALM IP, LLC, NEW YORK, NY:
2,208,176. REN. 2-12-08. INT. CL. 16.

ALNET TRANSPORTATION, INC., WINTER PARK, FL:
3,397,533, PUB. 1-1-2008. MULTIPLE CLASS, INT. CLS. 35 AND 41.

ALO SCIENCE, INC., NORTH BRANCH, NJ, ALOE CREME LABORATORIES, INC., FORT LAUDERDALE, FL:
1,071,729. REN. 2-12-08. INT. CL. 3.

ALOISI, MICHAEL, LANCASTER, PA:
1,438,567, CANC. INT. CL. 16.

ALOPECIL CORPORATION, C. X A., SANTO DOMINGO, DOMINICAN REP:
3,398,194, PUB. 1-1-2008. INT. CL. 3.

ALP NETWORKS LLC, KING OF PRUSSIA, PA:
3,399,183, INT. CL. 35.

ALP SPORTS LIMITED, CHRISTCHURCH, NEW ZEALAND:
3,390,480 NEW CERT. 3-18-2008. MULTIPLE CLASS, INT. CLS. 20 AND 24.

ALPHA CALCIT FULLSTOFF GESELLSCHAFT, 50997 KOLN, FED REP GERMANY:
2,538,958, COR. INT. CL. 9.

ALPHAPOINTE ASSOCIATION FOR THE BLIND, KANSAS CITY, MO:
2,147,696. REN. 2-12-08. INT. CL. 16.

ALS OF MICHIGAN, INC., SOUTHFIELD, MI:
3,397,157, PUB. 1-1-2008. INT. CL. 36.

ALSAPAN, 67190 DINSHEIM, FRANCE:
2,058,892, CANC. INT. CL. 19.

ALSIP & COMPANY, SEATTLE, WA:
3,399,197, INT. CL. 28.

ALSTON, BRUCE, CHARLOTTE, NC:
3,399,915, INT. CL. 25.

ALTAIR ENGINEERING, INC., TROY, MI:
3,399,656, INT. CL. 42.

ALTANA PHARMA AG, KONSTANZ, FED REP GERMANY:
3,399,473, MULTIPLE CLASS, INT. CLS. 5, 9, 16, 35, 41 AND 44.

ALTECO INC., OSAKA, JAPAN:
1,067,501. REN. 2-8-08. INT. CL. 1.

ALTERNATIVA 3, SOCIEDAD COOPERATIVA CATALANA LIMITADA, TERRASSA, BARCELONA, SPAIN:
3,398,544, PUB. 1-1-2008. MULTIPLE CLASS, INT. CLS. 30 AND 35.

ALTICOR INC., ADA, MI:
3,399,569, MULTIPLE CLASS, INT. CLS. 16, 18, 21, 25 AND 32.

ALTINEX, INC., BREA, CA:
3,397,386, PUB. 1-1-2008. INT. CL. 9.

ALVAREZ, VERONICA M., LOS ANGELES, CA:
3,400,069, INT. CL. 38.

ALZA CORPORATION, PALO ALTO, CA:
2,448,215, CANC. INT. CL. 16.

ALZHEIMER'S DISEASE AND RELATED DISORDERS ASSOCIATION, INC., CHICAGO, IL:
2,059,329, CANC. INT. CL. 42.
2,059,332, CANC. INT. CL. 36.

AMADEVS NORTH AMERICA, INC, MIAMI, FL:
2,447,469, CANC. INT. CL. 41.

AMAZONEN-WERKE H. DREYER GMBH & CO. KG, FED REP GERMANY:
3,398,763, PUB. 1-1-2008. MULTIPLE CLASS, INT. CLS. 7 AND 42.

AMBROSE, STEPHEN D, RICHMOND, VA:
3,399,216, INT. CL. 35.

AMC, INC., ATLANTA, GA:
3,396,852, PUB. 1-1-2008. INT. CL. 35.

AMERICA YA MEI LI CHEMICAL ENGINEERING LIMITED, GUANGZHOU, CHINA:
3,400,117, INT. CL. 4.

AMERICAN ADOPTIONS, OVERLAND PARK, KS:
2,447,487, CANC. INT. CL. 42.

AMERICAN ALDES VENTILATION CORPORATION, SARASOTA, FL:
3,398,535, PUB. 1-1-2008. MULTIPLE CLASS, INT. CLS. 9 AND 11.

AMERICAN ANTHROPOLOGICAL ASSOCIATION, ARLINGTON, VA:
3,396,889, PUB. 1-1-2008. INT. CL. 16.

AMERICAN BALLROOM THEATER COMPANY, INC., NEW YORK, NY:
3,398,101, PUB. 1-1-2008. INT. CL. 41.

AMERICAN BANK & TRUST COMPANY, DAVENPORT, IA, DBA AMBANK HOLDINGS, INC.:
3,400,314, INT. CL. 36.

AMERICAN CHEMICAL SOCIETY, WASHINGTON, DC:
3,398,265, PUB. 1-1-2008. INT. CL. 9.

AMERICAN COIN VAULT, INC, VALLEY STREAM, NY:
3,399,168, INT. CL. 35.
3,399,169, INT. CL. 35.

AMERICAN COMPUTER GROUP, TEMPE, AZ:
2,447,533, CANC. INT. CL. 42.

AMERICAN CULINARY CHEFSBEST, INC., SAN FRANCISCO, CA:
3,398,092, PUB. 1-1-2008. INT. CL. 35.

AMERICAN DRUG STORES, INC., OAKBROOK, IL:
1,438,713, CANC. INT. CL. 40.

AMERICAN ELECTRIC POWER COMPANY, INC., COLUMBUS, OH:
3,399,408, INT. CL. 41.

AMERICAN ENTERPRISE INSTITUTE FOR PUBLIC POLICY RESEARCH, WASHINGTON, DC:
1,103,872. REN. 2-8-08. MULTIPLE CLASS, INT. CLS. 16,

- 35 AND 41.
 AMERICAN GIRL, LLC, EL SEGUNDO, CA:
 2,129,900. REN. 2-14-08. INT. CL. 16.
 2,129,900, CANC. INT. CL. 14.
 3,398,872, INT. CL. 28.
- AMERICAN HOMESTAR CORPORATION, LEAGUE CITY, TX:
 3,396,913, PUB. 1-1-2008. MULTIPLE CLASS, INT. CLS. 35 AND 40.
- AMERICAN HOTEL & LODGING EDUCATIONAL INSTITUTE, ORLANDO, FL, EDUCATIONAL INSTITUTE OF THE AMERICAN HOTEL & MOTEL ASSOCIATION, THE, EAST LANSING, MI:
 2,133,793. REN. 2-14-08. INT. CL. 41.
- AMERICAN HOUSE LICENSING LLC, BLOOMFIELD HILLS, MI:
 3,397,833, PUB. 1-1-2008. INT. CL. 43.
 3,397,843, PUB. 1-1-2008. MULTIPLE CLASS, INT. CLS. 16 AND 43.
 3,397,846, PUB. 1-1-2008. INT. CL. 16.
- AMERICAN INSTITUTE OF AERONAUTICS AND ASTRONAUTICS, INC., RESTON, VA:
 3,397,285, PUB. 1-1-2008. INT. CL. 41.
- AMERICAN INTERNATIONAL GROUP, INC., NEW YORK, NY:
 2,139,404. REN. 2-13-08. INT. CL. 36.
 3,399,275, INT. CL. 36.
- AMERICAN LEBANESE SYRIAN ASSOCIATED CHARITIES, INC., MEMPHIS, TN:
 3,399,055, MULTIPLE CLASS, INT. CLS. 25 AND 36.
- AMERICAN LIFELINE, INC. BARABOO, WI:
 3,398,045, PUB. 1-1-2008. INT. CL. 5.
 3,398,046, PUB. 1-1-2008. INT. CL. 5.
- AMERICAN MULTI-CINEMA, INC., KANSAS CITY, MO:
 2,058,639, CANC. INT. CL. 30.
- AMERICAN OPTICAL IP CORPORATION, SAN DIEGO, CA, AMERICAN OPTICAL CORPORATION, SOUTHBRIDGE, MA:
 2,059,153. REN. 2-12-08. INT. CL. 9.
- AMERICAN PERFORMANCE PARTS WAREHOUSE, INC., ATLANTA, GA:
 3,397,519, PUB. 1-1-2008. INT. CL. 35.
- AMERICAN POLARIZERS, INC., READING, PA:
 842,850. REN. 2-13-08. U.S. CL. 26 (INT. CL. 9).
- AMERICAN PSYCHOLOGICAL ASSOCIATION, WASHINGTON, DC:
 3,396,922, PUB. 1-1-2008. MULTIPLE CLASS, INT. CLS. 35, 41 AND 44.
 3,400,240, MULTIPLE CLASS, INT. CLS. 9, 35 AND 41.
- AMERICAN RACING EQUIPMENT, INC., RANCHO DOMINGUEZ, CA:
 2,060,121, CANC. INT. CL. 12.
- AMERICAN READING COMPANY, KING OF PRUSSIA, PA:
 3,399,969, INT. CL. 41.
- AMERICAN RECREATION PRODUCTS, INC., ST. LOUIS, MO:
 2,059,273, CANC. INT. CL. 11.
- AMERICAN SAFETY RAZOR COMPANY, CEDAR KNOLLS, NJ, PERSONNA BLADE CO., INC., NEW YORK 22, NY:
 436,340. REN. 2-11-08. U.S. CL. 23 (INT. CL. 8).
- AMERICAN SOCCER TENNIS ORGANIZATION, LLC, LAGUNA NIGUEL, CA:
 3,397,226, PUB. 1-1-2008. INT. CL. 41.
- AMERICAN STANDARD INTERNATIONAL INC., NEW YORK, NY:
 3,399,676, INT. CL. 20.
- AMERICAN STRING TEACHERS ASSOCIATION, FAIRFAX, VA:
 3,400,296, INT. CL. 41.
- AMERICAN TAEKWONDO ASSOCIATION, INC., LITTLE ROCK, AR, DBA AMERICAN TAEKWONDO ASSOCIATION:
 3,396,873, PUB. 1-1-2008. INT. CL. 41.
- AMERICAN TECHNOLOGY CORPORATION, SAN DIEGO, CA:
 2,448,272, CANC. INT. CL. 9.
- AMERICAN TOOL COMPANIES, INC., HOFFMAN ESTATES, IL:
 2,447,704, CANC. INT. CL. 8.
- AMERICAN WOODMARK CORPORATION, WINCHESTER, VA:
 2,447,994, CANC. INT. CL. 20.
- AMERICANA TELEVISION PRODUCTS LLC, ENGLEWOOD, CO TO INSPIRATIONAL MEDIA PROPERTIES, INC, CHARLOTTE, NC:
 2,058,551, CANC. INT. CL. 41.
- AMERICANS FOR FAIR TAXATION, HOUSTON, TX:
 3,398,558, PUB. 1-1-2008. INT. CL. 35.
- AMERICAP FINANCIAL, INC., CHERRY HILL, NJ:
 3,397,295, PUB. 1-1-2008. INT. CL. 36.
- AMERICORPS ANNIVERSARY COMMITTEE, WASHINGTON, DC:
 2,447,587, CANC. INT. CL. 42.
- AMERIPRISE FINANCIAL, INC., MINNEAPOLIS, MN:
 2,447,481, CANC. INT. CL. 16.
- AMERISEARCH, INC., ST. LOUIS, MO:
 3,398,581, PUB. 1-1-2008. INT. CL. 41.
- AMERITYRE, BOULDER CITY, NV:
 3,400,176, INT. CL. 1.
- AMES RESEARCH LABORATORIES, INC., JEFFERSON, OR:
 3,397,083, PUB. 1-1-2008. INT. CL. 2.
- AMF BOWLING WORLDWIDE, INC., MECHANICSVILLE, VA:
 3,399,150, INT. CL. 41.
- AMGEN INC., THOUSAND OAKS, CA:
 3,399,445, INT. CL. 10.
- AMI CORPORATION, DENVER, CO:
 2,059,130, CANC. INT. CL. 9.
- AMIR, INC., EAGAN, MN:
 3,399,836, INT. CL. 3.
- AMOREPACIFIC CORPORATION, SEOUL, REPUBLIC OF KOREA:
 3,400,146, INT. CL. 3.
- AMPC, INC., AMES, IA:
 3,399,085, MULTIPLE CLASS, INT. CLS. 29 AND 30.
- AMRION, INC., BOULDER, CO:
 2,448,483, CANC. INT. CL. 5.
- AMTROL INC., WEST WARWICK, RI:
 3,398,848, INT. CL. 11.
- AMVAC CHEMICAL CORPORATION, NEWPORT BEACH, CA, VIRGINIA-CAROLINA CHEMICAL CORPORATION, RICHMOND, VA:
 659,980. REN. 2-12-08. U.S. CL. 6 (INT. CL. 1).
- AN EXTRA PAIR OF HANDS, LLC, OWINGS MILLS, MD:
 3,397,730, PUB. 1-1-2008. INT. CL. 45.
- ANCHIN, BLOCK & ANCHIN LLP, NEW YORK, NY:
 3,398,152, PUB. 1-1-2008. MULTIPLE CLASS, INT. CLS. 35 AND 36.
- ANDELI GROUP CO., LTD., CHINA:
 3,398,787, PUB. 1-1-2008. INT. CL. 9.
- ANDERSON, DOUGLAS, SAN DIEGO, CA:
 3,399,204, INT. CL. 3.
- ANDERSON, MARK L., SPRING VALLEY, WI:
 2,142,179. REN. 2-14-08. INT. CL. 16.
- ANDIN INTERNATIONAL INC., NEW YORK, NY:
 3,400,218, INT. CL. 35.
- ANDIS COMPANY, STURTEVANT, WI:
 2,121,349. REN. 2-14-08. INT. CL. 8.
 2,122,405. REN. 2-14-08. INT. CL. 8.
- ANDRE CHREKY, INC., WASHINGTON, DC:
 2,193,630. REN. 2-14-08. INT. CL. 42.
- ANDRX PHARMACEUTICALS, INC., DAVIE, FL, DBA WATSON LABORATORIES - FLORIDA:
 3,397,863, PUB. 1-1-2008. INT. CL. 5.
- ANGEL THERAPY, INC., LAGUNA BEACH, CA:
 3,398,976, U.S. CL. B.
- ANHEUSER-BUSCH, INCORPORATED, ST. LOUIS, MO:
 2,447,261, CANC. INT. CL. 32.
 3,399,307, INT. CL. 35.
- ANHUI JIANGHUAI AUTOMOBILE GROUP CO., LTD., HEFEI CITY, CHINA:
 3,398,112, PUB. 1-1-2008. INT. CL. 12.

ANIMALATIONS LLC, LAS VEGAS, NV:
3,399,966, INT. CL. 16.

ANIMALS B' GONE, INC., BETHLEHEM, GA:
3,399,240, INT. CL. 37.

ANIMAS TECHNOLOGIES LLC, WEST CHESTER, PA:
2,448,104, CANC. INT. CL. 10.

ANNCO, INC., MILFORD, CT:
3,399,970, INT. CL. 35.

ANNUITY INVESTORS LIFE INSURANCE COMPANY,
CINCINNATI, OH:
2,159,384, REN. 2-13-08, INT. CL. 36.

ANTEC CORPORATION, DULUTH, GA:
2,447,679, CANC. INT. CL. 9.

ANTHONY, ALICE, EAST PEORIA, IL, DBA ANTHONY'S
HOME OF ALEECE'S PITA CHIPS:
3,399,529, MULTIPLE CLASS, INT. CLS. 29 AND 30.

ANTOGNOLLI, ANTONIO S., MENDOZA, ARGENTINA:
3,398,406, PUB. 1-1-2008, INT. CL. 33.

ANTON PUBLISHING INC., RANCHO MIRAGE, CA:
3,396,929, PUB. 1-1-2008, INT. CL. 35.
3,396,930, PUB. 1-1-2008, INT. CL. 35.

AO TECHNOLOGY AG, CHUR, SWITZERLAND:
2,183,390, REN. 2-8-08, MULTIPLE CLASS, INT. CLS. 9,
10, 16, 41 AND 42.

AOL LLC, DULLES, VA:
2,447,653, CANC. INT. CL. 25.
3,398,566, PUB. 1-1-2008, MULTIPLE CLASS, INT. CLS. 41
AND 42.
3,398,578, PUB. 1-1-2008, INT. CL. 41.
3,399,057, INT. CL. 9.

APEX ENGINEERING PRODUCTS CORPORATION,
PLAINFIELD, IL:
2,447,766, CANC. INT. CL. 1.

APEX, LLC, PAWTUCKET, RI:
3,397,814, PUB. 1-1-2008, INT. CL. 35.
3,397,822, PUB. 1-1-2008, INT. CL. 35.

APLICARE, INC., MERIDEN, CT:
3,397,049, PUB. 1-1-2008, MULTIPLE CLASS, INT. CLS. 1,
3, 5 AND 21.

APOS - SPORTS AND MEDICAL TECHNOLOGIES LTD.,
DIMONA, ISRAEL:
3,398,412, PUB. 1-1-2008, INT. CL. 28.

APPASSURE SOFTWARE, INC., RESTON, VA:
3,399,127, INT. CL. 9.

APPLE CORE HOTELS, INC., NEW YORK, NY:
3,399,405, INT. CL. 43.

APPLE INC., CUPERTINO, CA:
3,398,242, PUB. 1-1-2008, INT. CL. 9.

APPLIED DATA TRENDS, INC., MADISON, AL:
2,448,357, CANC. INT. CL. 9.

APPLIED GENETICS INCORPORATED DERMATICS,
FREEPORT, NY, APPLIED GENETICS INC., FREEPORT,
NY:
2,132,447, REN. 2-11-08, INT. CL. 3.

APPLIED GENETICS INCORPORATED DERMATICS,
FREEPORT, NY:
3,399,870, INT. CL. 3.

APPLIED INDUSTRIAL TECHNOLOGIES, INC., CLEVELAND,
OH, APPLIED INDUSTRIAL TECHNOLOGIES,
INC., CLEVELAND, OH:
2,156,021, REN. 2-9-08, INT. CL. 42.

APREX CORPORATION, UNION CITY, CA:
1,477,509, REN. 2-12-08, INT. CL. 9.

AQUILA DISTRIBUTORS, INC., NEW YORK, NY:
1,485,501, REN. 2-12-08, INT. CL. 36.
1,504,264, REN. 2-12-08, INT. CL. 36.

AR NEW YORK LIMITED CORP., UNION, NJ:
3,399,116, INT. CL. 18.

ARAMARK CORPORATION, PHILADELPHIA, PA:
2,324,270, CANC. INT. CL. 42.
2,448,016, CANC. INT. CL. 1.

ARAMCO IMPORTS INC., COMMERCE, CALIFORNIA
90040 USA, CA:
3,399,741, INT. CL. 11.

ARBITRAGE GROUP, LLC, THE, ATLANTA, GA:
2,448,089, CANC. INT. CL. 42.

ARBOR AND VINE, PORT ORANGE, FL:
3,399,272, INT. CL. 35.

ARBOR BREWING COMPANY, LLC, ANN ARBOR, MI:
3,398,081, PUB. 1-1-2008, INT. CL. 32.
3,398,180, PUB. 1-1-2008, INT. CL. 32.
3,398,192, PUB. 1-1-2008, INT. CL. 32.

ARBOR PACKAGING INC., HOLLIS, NY:
2,448,026, CANC. INT. CL. 24.

ARCH CAPITAL GROUP (U.S.) INC., NEW YORK, NY:
3,397,790, PUB. 1-1-2008, INT. CL. 36.
3,398,253, PUB. 1-1-2008, INT. CL. 36.

ARCHITECTURAL POLYMERS, INC., PALMERTON, PA:
3,397,771, PUB. 1-1-2008, MULTIPLE CLASS, INT. CLS. 19
AND 40.

ARCHON PAINTBALL, INC., GREENVILLE, SC:
2,180,812, REN. 2-14-08, INT. CL. 28.

ARCTIC STORM, INC., SEATTLE, WA:
1,474,339, REN. 2-11-08, INT. CL. 29.

ARCURI, ANTHONY, HILTON HEAD ISLAND, SC, DBA
HILTON HEAD BREWING COMPANY:
2,058,763, CANC. INT. CL. 42.

ARES TRADING S.A., AUBONNE, SWITZERLAND:
3,397,381, PUB. 1-1-2008, MULTIPLE CLASS, INT. CLS. 5
AND 44.

ARGONAUT GROUP, INC., SAN ANTONIO, TX:
3,397,507, PUB. 1-1-2008, INT. CL. 36.

ARGOSY GAMING CORPORATION, ALTON, IL:
2,196,822, REN. 2-14-08, INT. CL. 41.

ARISTOCRAT LEISURE INDUSTRIES PTY LTD, NEW
SOUTH WALES, AUSTRALIA:
2,447,642, CANC. INT. CL. 9.

ARISTOCRAT TECHNOLOGIES AUSTRALIA PTY LTD,
LANE COVE, NSW, AUSTRALIA:
3,397,251, PUB. 1-1-2008, INT. CL. 9.
3,397,332, PUB. 1-1-2008, INT. CL. 9.
3,397,336, PUB. 1-1-2008, INT. CL. 9.
3,397,387, PUB. 1-1-2008, INT. CL. 9.

ARISTOCRAT TECHNOLOGIES AUSTRALIA PTY LTD,
LANE COVE, NEW SOUTH WALES, AUSTRALIA:
3,399,841, INT. CL. 9.

ARITECH CORP., HICKORY, MA:
1,438,504, CANC. INT. CL. 9.

ARIZONA CHAPTER AMERICAN PARKINSON DISEASE
ASSOCIATION, TUCSON, AZ:
3,399,173, INT. CL. 41.

ARIZONA CHAPTER NATIONAL SAFETY COUNCIL,
PHOENIX, AZ:
2,208,270, REN. 2-13-08, INT. CL. 41.

ARKANSAS FACE VENEER COMPANY, INC., BENTON,
AR:
3,399,811, MULTIPLE CLASS, INT. CLS. 3, 5, 19 AND 20.

ARLEN CORPORATION, PROVIDENCE, RI:
3,398,182, PUB. 1-1-2008, INT. CL. 36.

ARMCHAIR SAILOR, INC., SEATTLE, WA:
3,399,378, MULTIPLE CLASS, INT. CLS. 25 AND 35.

ARMS REACH CONCEPTS, INC., MALIBU, CA:
2,213,927, REN. 2-14-08, INT. CL. 20.

AROFF, PATRICK, SANTA MONICA, CA:
3,399,480, INT. CL. 25.

ARORA GULSHAN, MIAMI, FL AND ARORA RAJINDER,
MIAMI, FL:
3,398,281, PUB. 1-1-2008, INT. CL. 25.

ARRAY PRINTERS AB, 431 33 MOLNDAL, SWEDEN:
2,447,258, CANC. INT. CL. 9.

ARROW FASTENER CO., INC., SADDLE BROOK, NJ:
1,496,355, REN. 2-8-08, MULTIPLE CLASS, INT. CLS. 1, 6
AND 8.

AROWEYE SOLUTIONS, INC., CHICAGO, IL:
3,397,570, PUB. 1-1-2008, INT. CL. 45.

ART DREAMS HOME, INC., VENTURA, CA:
3,398,318, PUB. 1-1-2008, INT. CL. 20.

ART JURIS GALLERIES, FT. LAUDERDALE, FL:
3,396,928, PUB. 1-1-2008, INT. CL. 35.

ARTE GRAFICO EDITORIAL ARGENTINO S.A., CP.1140,
BUENOS AIRES, ARGENTINA:
2,140,356, REN. 2-8-08, INT. CL. 16.

ARTHREX, INC., NAPLES, FL:
3,399,849, INT. CL. 10.

ARTHUR ANDERSEN & CO., CHICAGO, IL:
1,438,680, CANC. MULTIPLE CLASS, INT. CLS. 35 AND

36.
 ARTHUR L. GRUEN, MD, INC., RANCHO SANTA FE, CA:
 3,399,193, INT. CL. 35.
- ARVID NORDQUIST HAB, SOLNA, SWEDEN:
 3,398,366, PUB. 1-1-2008. INT. CL. 30.
- ARXCEL, INC., WILLIAMSVILLE, NY:
 3,400,156, INT. CL. 35.
- ASA HANDBAGS, INC. LOS ANGELES, CA:
 3,399,044, INT. CL. 18.
- ASAHI KASEI FIBERS CORPORATION, OSAKA, JAPAN:
 3,399,614, INT. CL. 22.
- ASCENT MEDIA GROUP, LLC, SANTA MONICA, CA:
 3,399,692, MULTIPLE CLASS, INT. CLS. 40 AND 41.
- ASCOTT INTERNATIONAL MANAGEMENT PTE LTD,
 SINGAPORE 238874, SINGAPORE:
 2,447,324, CANC. INT. CL. 36.
- ASD SPECIALTY HEALTHCARE, INC., FRISCO, TX, DBA
 AMERISOURCEBERGEN SPECIALTY GROUP:
 3,399,822, INT. CL. 35.
- ASHDENE MANUFACTURING PTY LTD, BAYSWATER,
 VICTORIA, 3153, AUSTRALIA:
 2,076,862, REN. 2-11-08. INT. CL. 21.
- ASHLAND LICENSING AND INTELLECTUAL PROPERTY
 LLC, DUBLIN, OH:
 2,448,015, CANC. INT. CL. 1.
- ASHLAND, IL. U-HELP, INC., ASHLAND, IL:
 1,438,686, CANC. INT. CL. 36.
- ASHTON INDUSTRIES, INC., BOXFORD, MA:
 3,399,370, INT. CL. 10.
- ASIADERA, INC., FREMONT, CA:
 2,447,861, CANC. INT. CL. 38.
- ASIAPHILE, INC., GLENDALE, CA:
 2,447,555, CANC. MULTIPLE CLASS, INT. CLS. 8, 20, 21
 AND 24.
- ASICS CORPORATION, CHUO-KU, KOBE, JAPAN:
 3,399,160, INT. CL. 25.
- ASPEN SKIING COMPANY, ASPEN, CO:
 2,129,296, REN. 2-11-08. MULTIPLE CLASS, INT. CLS. 41
 AND 42.
 2,129,296, CANC. INT. CL. 25.
- ASSAY DESIGNS, INC., ANN ARBOR, MI:
 3,398,379, PUB. 1-1-2008. INT. CL. 42.
- ASSOULINE, PROSPER, PARIS, FRANCE:
 3,390,481 NEW CERT. 3-18-2008. MULTIPLE CLASS, INT.
 CLS. 16, 35 AND 41.
- ASTENJOHNSON, INC., CHARLESTON, SC:
 3,397,095, PUB. 1-1-2008. INT. CL. 7.
- ASTRAZENECA AB, SWEDEN:
 3,398,740, PUB. 1-1-2008. INT. CL. 5.
 3,398,741, PUB. 1-1-2008. INT. CL. 5.
 3,398,742, PUB. 1-1-2008. INT. CL. 5.
 3,398,743, PUB. 1-1-2008. INT. CL. 5.
- ASTRO METALLURGICAL, INC.:
 1,438,478, CANC. INT. CL. 6.
- ASTRO STUDIOS, INC., SAN FRANCISCO, CA:
 2,131,169, REN. 2-13-08. MULTIPLE CLASS, INT. CLS. 25
 AND 28.
- AT CONCEPTS, INC., HOMER GLEN, IL:
 3,398,949, INT. CL. 12.
- ATHLEISURE, INC., CALSBAD, CA:
 2,218,570, REN. 2-11-08. INT. CL. 25.
- ATHLETICOM, LLC, CHARLOTTE, NC:
 2,448,359, CANC. MULTIPLE CLASS, INT. CLS. 38 AND
 41.
- ATLANTA KITCHEN & BATH CABINET OUTLET, INC.,
 EAST POINT, GA:
 3,397,676, PUB. 1-1-2008. MULTIPLE CLASS, INT. CLS.
 35, 37 AND 42.
- ATLANTA LAWN TENNIS ASSOCIATION, INC., ATLAN-
 TA, GA:
 2,146,323, CANC. INT. CL. 16.
- ATLANTIC NATIONAL BANK, BRUNSWICK, GA:
 3,396,868, PUB. 9-25-2007. INT. CL. 36.
- ATLAS OIL COMPANY AB, S-131 04 NACKA, SWEDEN:
 2,058,982, CANC. INT. CL. 4.
- ATLAS VAN LINES, INC., EVANSVILLE, IN:
 1,438,688, CANC. INT. CL. 36.
- ATMEL CORPORATION, SAN JOSE, CA:
 2,219,439, REN. 2-12-08. INT. CL. 9.
- ATRONIC INTERNATIONAL GMBH, 32312 LÜBBECKE,
 FED REP GERMANY:
 3,398,389, PUB. 11-7-2006. MULTIPLE CLASS, INT. CLS. 9
 AND 28.
 3,398,397, PUB. 11-21-2006. MULTIPLE CLASS, INT. CLS.
 9 AND 28.
- ATSI COMMUNICATIONS, INC., SAN ANTONIO, TX:
 3,397,237, PUB. 1-1-2008. INT. CL. 38.
- ATTACK, INDÚSTRIA COMÉRCIO E REPRESENTAÇÕES
 LTDA., GASPAS, SANTA CATARINA, BRAZIL:
 3,400,053, INT. CL. 29.
- ATTINGER, BILLY J., CHULA VISTA, CA:
 2,058,884, CANC. INT. CL. 25.
- ATWORK!, ISSAQUAH, WA:
 3,397,795, PUB. 1-1-2008. INT. CL. 41.
- ATZEMOGLOU, GEORGIOS FILIPPOS, NEO IRAKLIO,
 GREECE, DBA ATZEMOGLOU, GEORGE PHILIP:
 3,397,986, PUB. 1-1-2008. MULTIPLE CLASS, INT. CLS. 38
 AND 42.
- AUCTION INN CORPORATION, LANCASTER, PA:
 3,397,888, PUB. 1-1-2008. INT. CL. 41.
- AUCTIONPRO, INC., NORMAN, OK:
 2,447,584, CANC. INT. CL. 35.
- AUDIBLE, INC., WAYNE, NJ:
 2,447,486, CANC. MULTIPLE CLASS, INT. CLS. 35 AND
 42.
- AUDIOSCROBBLER LIMITED, UNITED KINGDOM:
 3,398,822, PUB. 1-1-2008. MULTIPLE CLASS, INT. CLS. 9,
 35, 38 AND 41.
- AUER MORTGAGE CO., INC., COLORADO SPRINGS, CO:
 2,448,001, CANC. INT. CL. 36.
- AUGUST HOME PUBLISHING COMPANY, DES MOINES,
 IA:
 3,399,161, MULTIPLE CLASS, INT. CLS. 9, 38 AND 41.
- AUSSIE FRANCHISING LLC, WILMINGTON, DE:
 3,399,546, INT. CL. 30.
- AUSTHINK SOFTWARE PTY LTD, CARLTON, VICTORIA,
 AUSTRALIA:
 3,400,042, INT. CL. 9.
- AUSTIN GEOMODELING, INC., AUSTIN, TX:
 3,397,537, PUB. 1-1-2008. MULTIPLE CLASS, INT. CLS. 9,
 40 AND 42.
- AUSTIN POWDER COMPANY, CLEVELAND, OH:
 3,399,661, INT. CL. 13.
- AUSTIN, DALLAS, ATLANTA, GA:
 3,399,376, INT. CL. 9.
- AUSTRALIAN WOOL INNOVATION LIMITED, SYDNEY
 NEW SOUTH WALES, AUSTRALIA:
 3,397,265, PUB. 1-1-2008. MULTIPLE CLASS, INT. CLS.
 23, 24 AND 25.
- AUTHENTIC MARTIAL ARTS INTERNATIONAL, INC.,
 LARGO, FL:
 3,396,983, PUB. 1-1-2008. INT. CL. 41.
- AUTHENTIDATE HOLDING CORP., BERKELEY HEIGHTS,
 NJ:
 3,399,593, INT. CL. 9.
- AUTHORCONNECT, BERKELEY, CA:
 3,399,548, INT. CL. 35.
- AUTODESK, INC., SAN RAFAEL, CA:
 3,398,275, PUB. 1-1-2008. INT. CL. 42.
- AUTOMATED FLEXIBLE CONVEYOR, INC., CLIFTON, NJ:
 3,398,545, PUB. 1-1-2008. INT. CL. 9.
- AUTOMATED SOLUTIONS CORPORATION, RICHFIELD,
 OH:
 3,398,459, PUB. 1-1-2008. INT. CL. 9.
- AUTOMOTIVE RENTALS, INC., MT. LAUREL, NJ:
 2,038,147, REN. 2-13-08. INT. CL. 35.
- AUTOMOTIVE RENTALS, INC., MOUNT LAUREL, NJ:
 3,398,069, PUB. 1-1-2008. INT. CL. 35.
 3,398,070, PUB. 1-1-2008. MULTIPLE CLASS, INT. CLS. 35
 AND 39.
- AUTOMOTIVE RESOURCES DEVELOPMENT GROUP,
 LLC, HAMPTON, VA:
 3,397,523, PUB. 10-9-2007. MULTIPLE CLASS, INT. CLS.
 35, 36, 37 AND 39.

AUTRONICA MARINE, U.S.A., INC., NORTHVALE, NJ TO KONGSBERG MARITIME SHIP SYSTEMS AS, TRONDHIM, NORWAY:
2,059,101, CANC. INT. CL. 9.

AVANT, INCORPORATED, MINNEAPOLIS, MN:
1,451,455. REN. 2-13-08. INT. CL. 42.

AVENGED SEVENFOLD PARTNERSHIP, LOS ANGELES, CA:
3,397,561, PUB. 1-1-2008. MULTIPLE CLASS, INT. CLS. 9, 25 AND 41.

AVENTAIL LLC, SUNNYVALE, CA:
2,134,340. REN. 2-11-08. INT. CL. 9.

AVENTIS HOLDINGS, INC., GREENVILLE, DE:
2,153,234. REN. 2-13-08. INT. CL. 16.

AVENTURINE INC., CORAL SPRINGS, FL:
3,397,684, PUB. 1-1-2008. INT. CL. 9.

AVENUE A, INC., SEATTLE, WA:
2,447,456, CANC. INT. CL. 35.
2,447,457, CANC. INT. CL. 35.

AVEPOINT, INC., JERSEY CITY, NJ:
3,397,534, PUB. 1-1-2008. MULTIPLE CLASS, INT. CLS. 9, 41 AND 42.

EVERY MEDICAL FASHIONS INC., NORWALK, CT, DBA BALLYHOO:
2,448,126, CANC. INT. CL. 25.

AWI LICENSING COMPANY, WILMINGTON, DE:
3,396,822, PUB. 1-1-2008. MULTIPLE CLASS, INT. CLS. 3, 6, 19 AND 27.
3,398,953, INT. CL. 19.

AYLMER, HONEE C, KANSAS CITY, MO:
3,399,263, INT. CL. 35.

AZAR NUT COMPANY, LLC, EL PASO, TX:
3,398,562, PUB. 7-31-2007. INT. CL. 29.

AZEK BUILDING PRODUCTS, INC., SCRANTON, PA:
3,397,777, PUB. 1-1-2008. INT. CL. 19.

AZTEC SYSTEMS, INC., CARROLLTON, TX:
3,397,743, PUB. 1-1-2008. INT. CL. 9.

B. BRAUN MEDICAL INC., BETHLEHEM, PA:
3,398,179, PUB. 1-1-2008. INT. CL. 10.

B. F. ASCHER & COMPANY, INC., LENEXA, KS:
2,205,737. REN. 2-13-08. INT. CL. 5.

B.A.S.S. (IP), LLC, BRISTOL, CT:
3,262,562, AM. MULTIPLE CLASS, INT. CLS. 25 AND 41.

B.BETTER SUCCESS COACHING AND CONSULTING, LLC, WAYZATA, MN:
3,397,712, PUB. 1-1-2008. INT. CL. 41.

B.H.D. INC, LOS ANGELES, CA:
3,397,664, PUB. 1-1-2008. INT. CL. 14.

B.I.A. CORDON BLEU, INCORPORATED, SOUTH SAN FRANCISCO, CA:
2,135,258. REN. 2-14-08. INT. CL. 21.

B&G CREPE LLC, SAN ANTONIO, TX:
3,397,741, PUB. 1-1-2008. MULTIPLE CLASS, INT. CLS. 30 AND 43.

B-T TRADING COMPANY, GARLAND, TX:
2,059,447, CANC. INT. CL. 25.

BABCOCK & WILCOX COMPANY, THE, BARBERTON, OH:
2,162,018. REN. 2-13-08. INT. CL. 42.

BABYSHOWERDEPOT.COM LLC, EDISON, NJ:
3,397,852, PUB. 1-1-2008. INT. CL. 35.

BACK TEE TRADITION A/S, DENMARK:
3,398,658, PUB. 1-1-2008. MULTIPLE CLASS, INT. CLS. 18, 25 AND 28.

BACKYARD ADVENTURES OF COLORADO, ENGLEWOOD, CO:
3,397,370, PUB. 1-1-2008. INT. CL. 20.

BAHA MAR RESORTS LTD, NEW PROVIDENCE, BAHAMAS:
3,400,222, INT. CL. 25.

BAIRNCO CORPORATION, LAKE MARY, FL AND ARLON, INC., LAKE MARY, FL AND KASCO, LAKE MARY, FL AND ARLON SIGNTech, LTD., LAKE MARY, FL AND SOUTHERN SAW ACQUISITION CORPORATION, LAKE MARY, FL:
2,128,080. REN. 2-8-08. INT. CL. 17.

BAKER & TAYLOR, INC., CHARLOTTE, NC:
2,079,090. REN. 2-9-08. INT. CL. 35.

BAKER, DONELSON, BEARMAN, CALDWELL & BERKOWITZ, PC, MEMPHIS, TN:
3,397,620, PUB. 1-1-2008. INT. CL. 41.

BALANCE, SAN FRANCISCO, CA:
3,399,259, INT. CL. 41.

BALDWIN AVIATION, INC., HILTON HEAD ISLAND, SC:
3,399,896, INT. CL. 42.

BALLANTINE & COMPANY, INC., CARLISLE, MA:
2,448,556, CANC. INT. CL. 35.
2,448,557, CANC. INT. CL. 35.

BALLS-N-STRIKES GROUP, INC., CHESTERFIELD, MO:
3,397,714, PUB. 1-1-2008. INT. CL. 41.

BALLUFF, INC., FLORENCE, KY:
2,183,982. REN. 2-14-08. INT. CL. 9.

BALTIMORE BIOMEDICAL INC., BALTIMORE, MD:
2,448,329, CANC. INT. CL. 9.

BANACHEK, INC., HOUSTON, TX:
3,397,200, PUB. 1-1-2008. INT. CL. 41.

BANK OF NEW YORK MELLON CORPORATION, THE, PITTSBURGH, PA:
3,396,830, PUB. 1-1-2008. INT. CL. 36.

BANK OF OKLAHOMA, NATIONAL ASSOCIATION, TULSA, OK:
2,187,730. REN. 2-13-08. INT. CL. 36.

BANKERS LIFE INSURANCE COMPANY, SAINT PETERSBURG, FL:
2,447,890, CANC. INT. CL. 36.

BANKVERTISING COMPANY, THE, CHAMPAIGN, IL:
1,438,576, CANC. INT. CL. 16.

BANNER MANAGEMENT INC., ADDISON, TX:
3,397,298, PUB. 1-1-2008. INT. CL. 43.

BARCLAYS GLOBAL INVESTORS, N.A., SAN FRANCISCO, CA:
2,448,459, CANC. INT. CL. 36.

BARDELLE NICOLA, ITALY:
3,066,192, COR. MULTIPLE CLASS, INT. CLS. 3 AND 9.

BARGAIN NETWORK, INC., GOLETA, CA:
2,447,748, CANC. INT. CL. 35.

BARMATE LIMITED, WHETSTONE, LONDON, UNITED KINGDOM:
3,399,982, INT. CL. 9.

BARNES & NOBLE COLLEGE BOOKSELLERS, INC., BASKING RIDGE, NJ:
3,398,491, PUB. 1-1-2008. INT. CL. 35.

BARNETT, CYNTHIA, NORWALK, CT:
3,396,937, PUB. 1-1-2008. INT. CL. 16.

BARON SERVICES, INC., HUNTSVILLE, AL:
3,400,010, INT. CL. 42.

BARRY, PATRICIA GORMAN, DENVER, CO:
2,448,249, CANC. INT. CL. 41.

BARTLE, CHERYL, BROWNSVILLE, TX:
3,397,694, PUB. 1-1-2008. INT. CL. 42.

BARTOLOMEH INCORPORATED, NEW YORK, NY:
2,448,398, CANC. INT. CL. 33.
2,448,399, CANC. INT. CL. 33.

BARTOLOMEI, ALBERTO S., GURABO, PUERTO RICO, DBA AJ BART:
2,447,644, CANC. INT. CL. 5.

BARTON BRANDS, LTD., CHICAGO, IL:
3,398,357, PUB. 6-6-2006. INT. CL. 33.

BASE2STAY LIMITED, LONDON, UNITED KINGDOM:
3,397,600, PUB. 1-1-2008. INT. CL. 43.

BASF AKTIENGESELLSCHAFT, FED REP GERMANY:
3,398,757, PUB. 1-1-2008. MULTIPLE CLASS, INT. CLS. 1 AND 4.

BASF CORPORATION, FLORHAM PARK, NJ:
2,149,751. REN. 2-14-08. INT. CL. 2.

BASF CORPORATION, MOUNT OLIVE, NJ:
2,447,879, CANC. INT. CL. 16.

BASIC AMERICAN, INC., SAN FRANCISCO, CA:
2,175,459. REN. 2-8-08. INT. CL. 29.

BASILE, RACHEL P., CHARLOTTE, NC:
3,400,123, INT. CL. 43.

BASKETBALL NETWORK, INC., THE, PAOLI, PA, DBA HOOPSTV.COM:
2,447,880, CANC. INT. CL. 41.

BASS ASSASSIN LURES, INC., MAYO, FL:
1,994,156. REN. 2-13-08. INT. CL. 28.

- BASS PRO TRADEMARKS, L.L.C., SPRINGFIELD, MO:
2,448,075, CANC. INT. CL. 28.
3,397,625, PUB. 1-1-2008. MULTIPLE CLASS, INT. CLS. 25
AND 28.
- BATH & BODY WORKS, INC., REYNOLDSBURG, OH:
3,399,878, INT. CL. 3.
- BATTAT INCORPORATED, PLATTSBURGH, NY:
3,399,708, INT. CL. 28.
- BAUDTEC CORPORATION, TAIPEI COUNTY, TAIWAN:
3,399,134, INT. CL. 9.
- BAXTER INTERNATIONAL INC., DEERFIELD, IL, BAX-
TER LABORATORIES, INC., MORTON GROVE, IL:
843,758. REN. 2-14-08. U.S. CL. 44 (INT. CL. 10).
- BAY RIDGE AUTOMOTIVE MANAGEMENT CORP.,
BROOKLYN, NY:
3,397,526, PUB. 1-1-2008. INT. CL. 35.
- BAYER AKTIENGESELLSCHAFT, LEVERKUSEN-BAYER-
WERK, FED REP GERMANY:
3,399,462, INT. CL. 1.
- BAYERISCHE MOTOREN WERKE AKTIENGE-
SELLSCHAFT, MUNICH, FED REP GERMANY:
3,398,330, PUB. 1-1-2008. MULTIPLE CLASS, INT. CLS.
12, 35, 36, 37, 39 AND 42.
- BBI, INC., WILMINGTON, DE:
3,398,985, INT. CL. 29.
3,398,986, INT. CL. 29.
3,399,853, INT. CL. 29.
- BBZ BETONBAU-ZUBEHOR HANDELSGESELLSCHAFT
MBH, 4156 WILLICH, FED REP GERMANY TO TRICO-
SAL GMBH, FED REP GERMANY:
2,058,511, CANC. INT. CL. 17.
- BDH TWO, INC., WILMINGTON, DE:
1,510,528, CANC. INT. CL. 16.
- BE AEROSPACE, INC., WELLINGTON, FL:
3,399,576, INT. CL. 11.
- BE INCORPORATED, MENLO PARK, CA:
2,448,332, CANC. INT. CL. 42.
- BEACON LAW ADVISORS, PLLC, SEATTLE, WA:
3,397,611, PUB. 1-1-2008. INT. CL. 45.
- BEAD EM UP, CARROLLTON, TX:
2,447,522, CANC. INT. CL. 14.
- BEAGLE, DONALD LAMARR JR., METAIRIE, LA:
2,448,560, CANC. INT. CL. 42.
- BEATTIE, ROGER L., BOUNTIFUL, UT:
3,396,901, PUB. 1-1-2008. MULTIPLE CLASS, INT. CLS. 9
AND 41.
3,399,506, MULTIPLE CLASS, INT. CLS. 16 AND 41.
- BEAULIEU GROUP, LLC, DALTON, GA:
3,398,565, PUB. 1-1-2008. INT. CL. 27.
- BEAUMONT PRODUCTS, INC., KENNESAW, GA:
2,121,171. REN. 2-13-08. MULTIPLE CLASS, INT. CLS. 3
AND 5.
- BEAUTIFUL BRANDS INTERNATIONAL, INC., TULSA,
OK:
3,399,118, INT. CL. 35.
- BEAUTY BY MARY SCHOOK, LLC., NEW YORK, NY:
3,398,044, PUB. 1-1-2008. INT. CL. 44.
- BECK'S HYBRIDS, ATLANTA, IN:
3,397,196, PUB. 1-1-2008. INT. CL. 44.
- BECTON, DICKINSON AND COMPANY, FRANKLIN
LAKES, NJ:
3,398,431, PUB. 1-1-2008. INT. CL. 10.
- BEDE SCIENTIFIC INSTRUMENTS LIMITED, DURHAM
DH1 1TW, UNITED KINGDOM:
3,161,266, COR. INT. CL. 9.
- BEDROC CONTRACTING, LLC, LYNDHURST, NJ:
3,396,898, PUB. 1-1-2008. INT. CL. 37.
- BEDWAY, DAVID, FRANKLIN, TN:
2,448,333, CANC. INT. CL. 28.
- BEE HIVE HEAD PRODUCTIONS, LLC, HOUSTON, TX:
3,397,229, PUB. 1-1-2008. INT. CL. 41.
- BEEF 'N MORE, LTD., HEREFORD, TX:
1,511,992. REN. 2-14-08. INT. CL. 31.
- BEHAVIORAL TECHNOLOGY, INC., MEMPHIS, TN:
2,447,712, CANC. INT. CL. 9.
- BEISLER AMERICA INC., SOMERVILLE, NJ:
2,447,849, CANC. INT. CL. 7.
- BEJANI, FADI JOSEPH, ESSEX FALLS, NJ:
2,448,348, CANC. INT. CL. 42.
- BELDING SPORTS, INC., OXNARD, CA:
2,448,250, CANC. INT. CL. 28.
- BELL'O INTERNATIONAL CORP., MORGANVILLE, NJ:
3,397,530, PUB. 1-1-2008. INT. CL. 6.
- BELLO, ANDREW, JR., NEW YORK, NY:
3,396,991, PUB. 1-1-2008. INT. CL. 3.
- BELLSOUTH CORPORATION, ATLANTA, GA:
1,438,703, CANC. INT. CL. 38.
- BELOGORTSEFF, ANDREI, ROCKVILLE, UT, DBA WIN-
ABILITY:
2,447,775, CANC. INT. CL. 9.
- BEN & JERRY'S HOMEMADE, INC., BURLINGTON, VT:
2,447,777, CANC. INT. CL. 30.
2,448,470, CANC. INT. CL. 30.
- BENECCI CORPORATION, ANAHEIM, CA:
3,397,734, PUB. 1-1-2008. INT. CL. 25.
- BENEFICIAL DESIGNS, INC., MINDEN, NV:
3,399,575, INT. CL. 12.
- BENEFICIAL SAVINGS BANK, PHILADELPHIA, PA:
2,202,081. REN. 2-13-08. INT. CL. 36.
- BENJAMIN MOORE & CO., MONTVALE, NJ:
2,448,453, CANC. INT. CL. 20.
- BENNET, CARESSA D., BETHESDA, MD AND POKONOS-
KY, JEFF, SAN DIEGO, CA:
3,399,610, INT. CL. 41.
- BENTLEY COLLEGE, WALTHAM, MA:
2,200,390. REN. 2-11-08. INT. CL. 41.
- BENTLEY LINGERIE, INC., JERSEY CITY, NJ:
2,448,311, CANC. INT. CL. 20.
- BERGER JACQUELINE M, REDHEAD, AUSTRALIA:
3,400,375, INT. CL. 45.
- BERGERON, ANTHONY, SAINT PAUL, MN:
3,397,826, PUB. 1-1-2008. INT. CL. 9.
- BERIOZKASHOP.COM, INC., NEW YORK, NY:
3,397,520, PUB. 1-1-2008. INT. CL. 35.
3,397,595, PUB. 1-1-2008. INT. CL. 35.
- BERKLEE COLLEGE OF MUSIC, INC., BOSTON, MA:
3,399,222, U.S. CL. 200.
- BERKSON, HOWARD C., SAN DIEGO, CA:
3,400,125, MULTIPLE CLASS, INT. CLS. 41 AND 43.
- BERMAN INVESTMENT GROUP, NEWPORT BEACH, CA:
3,400,140, INT. CL. 41.
- BERNATELLO'S PIZZA, INC., MAPLE LAKE, MN:
2,067,242. REN. 2-8-08. INT. CL. 30.
- BERNETT RESEARCH SERVICES, INC., BOSTON, MA, DBA
BERNETT RESEARCH:
3,400,232, INT. CL. 42.
- BERNSTEIN, WILLIAM N., NEW YORK, NY:
2,447,677, CANC. INT. CL. 35.
- BERRY PLASTICS HOLDING CORPORATION, EVANS-
VILLE, IN:
3,400,015, MULTIPLE CLASS, INT. CLS. 16 AND 17.
- BERTHOLD TYPES LIMITED, CHICAGO, IL:
2,217,154. REN. 2-12-08. INT. CL. 9.
- BERTHOLON-ROWLAND CORP., NEW YORK, NY:
3,396,826, PUB. 1-1-2008. INT. CL. 36.
- BESSETTE, MATTHEW J., TAMPA, FL, DBA INTERLU-
TION:
3,396,958, PUB. 1-1-2008. INT. CL. 36.
- BEST AMERICAN ARTISTS AND ARTISANS, INC., CO-
LUMBUS, OH:
3,399,301, INT. CL. 35.
- BEST VANTAGE, INC., NORTHBROOK, IL:
2,126,880. REN. 2-11-08. MULTIPLE CLASS, INT. CLS. 35,
36, 41 AND 42.
- BEST WESTERN INTERNATIONAL, INC., PHOENIX, AZ:
3,399,078, INT. CL. 35.
- BETHLEHEM STEEL SUBSIDIARY RAILROAD COMPA-
NIES, BETHLEHEM, PA:
2,447,841, CANC. INT. CL. 39.
- BETTY MITCHELL, SACRAMENTO, DC:
3,397,609, PUB. 1-1-2008. INT. CL. 5.
- BEWELL HEALTH PRODUCTS, INC., COLUMBIA, MO:
3,400,255, INT. CL. 10.
- BEYOND MASK, INC., WASHINGTON, DC:
3,398,935, INT. CL. 16.

BHP PETROLEUM PTY LIMITED, MELBOURNE, VICTORIA, AUSTRALIA:
2,447,380, CANC. INT. CL. 7.

BI-LO, LLC, GREENVILLE, SC:
2,448,346, CANC. INT. CL. 30.

BIG M, INC., TOTOWA, NJ, SPORTIQUE, INC., ROCKVILLE, MD:
1,089,933, REN. 2-13-08. INT. CL. 42.

BILCO COMPANY, THE, WEST HAVEN, CT:
3,398,948, INT. CL. 19.

BILLINGS, ROGER E., INDEPENDENCE, MO:
3,397,461, PUB. 1-1-2008. INT. CL. 42.

BILLY AZBELL ELECTRONICS, INC., FT. HOOD, TX:
3,397,938, PUB. 1-1-2008. INT. CL. 9.

BIO STRATH AG, ZURICH, SWITZERLAND, STRATH LABOR AG, ZURICH, SWITZERLAND:
848,110, REN. 2-13-08. U.S. CL. 18 (INT. CL. 5).

BIO-LAB, INC., LAWRENCEVILLE, GA:
1,438,755, CANC. INT. CL. 3.

BIO-LOGIC AQUA TECHNOLOGIES, INC., GRANTS PASS, OR:
3,399,765, INT. CL. 3.
3,399,766, INT. CL. 5.

BIO-MEGA/BOEHRINGER INGELHEIM RECHERCHE, INC.- BIO-MEGA/BOEHRINGER INGELHEIM RESEARCH, INC., LAVAL, QUEBEC, CANADA:
1,438,454, CANC. INT. CL. 1.

BIO-PURE PRODUCTS, INC., AUBURN, CA:
3,398,098, PUB. 1-1-2008. INT. CL. 1.

BIOADVANTEX PHARMA INC., MISSISSAUGA, ONTARIO, CANADA:
3,398,088, PUB. 1-1-2008. INT. CL. 5.
3,398,090, PUB. 1-1-2008. INT. CL. 5.

BIOBASED CHEMICALS, LLC, FAYETTEVILLE, AR:
3,400,379, INT. CL. 1.

BIOCATALYTIC ENTERPRISES, INC., SPRINGFIELD, MA:
2,058,973, CANC. INT. CL. 1.

BIOCELL TECHNOLOGY, LLC, NEWPORT BEACH, CA:
3,397,375, PUB. 1-1-2008. INT. CL. 1.

BIOCROWN, INC., PLACENTIA, CA:
3,399,441, INT. CL. 5.

BIOCURY MEDICAL INSTRUMENTS, INC., CANTON, OH:
3,399,305, INT. CL. 10.

BIOFARMA, NEUILLY-SUR-SEINE, FRANCE:
3,397,260, PUB. 1-1-2008. INT. CL. 5.

BIOGAIA AB, SWEDEN:
3,398,673, PUB. 1-1-2008. MULTIPLE CLASS, INT. CLS. 5 AND 29.

BIOHIT OYJ, FINLAND:
3,398,694, PUB. 1-1-2008. MULTIPLE CLASS, INT. CLS. 5 AND 30.

BIOLITEC, INC., EAST LONGMEADOW, MA:
2,139,749, REN. 2-13-08. INT. CL. 10.

BIOLITEC, INC., E LONGMEADOW, MA:
2,139,750, REN. 2-13-08. INT. CL. 10.

BIOMNI LIMITED, LONDON, UNITED KINGDOM:
3,398,354, PUB. 11-14-2006. MULTIPLE CLASS, INT. CLS. 9, 35, 38 AND 42.

BIONIX DEVELOPMENT CORPORATION, TOLEDO, OH:
2,144,648, REN. 2-14-08. INT. CL. 10.
2,146,350, REN. 2-14-08. INT. CL. 10.

BIOPROTON PTY LTD, SUNNYBANK QLD 4109, AUSTRALIA:
3,396,915, PUB. 1-1-2008. INT. CL. 5.
3,396,916, PUB. 1-1-2008. INT. CL. 5.

BIOTRIAL, F-35000 RENNES, FRANCE:
3,398,765, PUB. 1-1-2008. MULTIPLE CLASS, INT. CLS. 35 AND 42.

BIOVERIS CORPORATION, GAITHERSBURG, MD:
2,448,316, CANC. INT. CL. 1.

BIOXESS CORPORATION, ALISO VIEJO, CA:
3,398,484, PUB. 1-1-2008. INT. CL. 36.

BIRD PRODUCTS CORPORATION, PALM SPRINGS, CA, BIRD SPACE TECHNOLOGY, INC., PALM SPRINGS, CA:
833,751, REN. 2-13-08. U.S. CL. 44 (INT. CL. 10).

BIRTHDAY SCENES, INC., NAPERVILLE, IL:
3,398,137, PUB. 1-1-2008. INT. CL. 35.

BISS PRODUCT DEVELOPMENT LLC, MOORESVILLE, NC:
3,397,916, PUB. 1-1-2008. INT. CL. 12.

BLACK & DECKER CORPORATION, THE, TOWSON, MD:
3,238,754, CANC. INT. CL. 7.

BLACKBOARD INC., WASHINGTON, DC, REZUN INTERACTIVE CONCEPTS, INC., VIENNA, VA:
2,011,820, REN. 2-8-08. INT. CL. 42.

BLAIR CORPORATION, WARREN, PA:
2,447,437, CANC. INT. CL. 35.

BLESSING, RON, DALLAS, OR:
3,399,010, INT. CL. 19.

BLIND INDUSTRIES AND SERVICES OF MARYLAND, BALTIMORE, MD:
2,058,949, CANC. INT. CL. 18.

BLISS WORLD LLC, NEW YORK, NY:
3,398,106, PUB. 1-1-2008. INT. CL. 3.

BLOOMBERG L.P., NEW YORK, NY:
3,397,348, PUB. 1-1-2008. MULTIPLE CLASS, INT. CLS. 16, 41 AND 42.

BLOOMWORKS SOAP COMPANY, LC, YORKTOWN, VA:
3,398,256, PUB. 1-1-2008. INT. CL. 3.
3,398,269, PUB. 1-1-2008. INT. CL. 3.
3,398,270, PUB. 1-1-2008. INT. CL. 3.

BLOOMWORKS SOAP COMPANY, LC, YORKTOWN, VA, DBA BLOOMWORKS SOAP COMPANY, LC:
3,398,332, PUB. 1-1-2008. INT. CL. 3.

BLOOMWORKS SOAP COMPANY, LC, YORKTOWN, VA:
3,398,342, PUB. 1-1-2008. INT. CL. 3.
3,398,346, PUB. 1-1-2008. INT. CL. 3.

BLORE, NORMAN, GREENVILLE, SC:
3,400,315, INT. CL. 16.

BLS, INC., WILMINGTON, DE:
3,396,967, PUB. 1-1-2008. INT. CL. 9.

BLUE GINGER DESIGNS, LTD., KAHULUI, HI:
2,134,240, REN. 2-11-08. MULTIPLE CLASS, INT. CLS. 25 AND 35.

BLUE LINE MEDIA, INC., ARLINGTON, VA:
3,396,990, PUB. 1-1-2008. INT. CL. 35.

BLUE NILE, INC., SEATTLE, WA:
3,398,442, PUB. 1-1-2008. INT. CL. 35.

BLUE RICE LLC, FRESNO, CA:
2,447,773, CANC. INT. CL. 35.

BLUE SUN FILM COMPANY, NEW YORK, NY:
3,398,576, PUB. 1-1-2008. INT. CL. 9.

BLUE WAVE SYSTEMS INC., CARROLLTON, TX:
2,448,208, CANC. INT. CL. 9.

BLUEGRASS UNLIMITED, INC., WARRENTON, VA:
3,397,629, PUB. 1-1-2008. INT. CL. 9.

BLUEGREEN CORPORATION, BOCA RATON, FL:
3,398,440, PUB. 1-1-2008. MULTIPLE CLASS, INT. CLS. 36 AND 37.

BLÜCHER GMBH, FED REP GERMANY:
3,398,699, PUB. 1-1-2008. MULTIPLE CLASS, INT. CLS. 9, 11 AND 24.

BM DIRECT, ROCHESTER, MN:
3,399,929, MULTIPLE CLASS, INT. CLS. 25 AND 41.

BMC MORTGAGE SERVICES, INC., FORT WORTH, TX:
2,448,369, CANC. INT. CL. 36.

BNY CONVERGEX GROUP, LLC, NEW YORK, NY:
3,397,048, PUB. 1-1-2008. INT. CL. 42.

BNZ MATERIALS, INC., LITTLETON, CO:
2,132,430, REN. 2-11-08. INT. CL. 19.

BOAT MARKETING CORPORATION, WESTPORT, CT:
3,400,009, INT. CL. 25.

BOB EVANS RESTAURANTS OF MICHIGAN, INC., ANN ARBOR, MD:
3,400,323, INT. CL. 30.

BOBO WEAR, INC., PHILADELPHIA, PA:
3,399,820, INT. CL. 25.

BOC ASSET MANAGEMENT GMBH, AUSTRIA:
3,398,618, PUB. 1-1-2008. INT. CL. 42.

BOCA RATON, FOSTER CITY, CA:
2,447,774, CANC. INT. CL. 42.

BOCK, DAVID, GLENDALE, CA:
3,398,219, PUB. 1-1-2008. INT. CL. 9.

BODEGAS LUIS ALEGRE, S.A., SPAIN:
3,398,726, PUB. 1-1-2008. INT. CL. 33.

- BODEGAS SAN VALERO, S. COOP., E-50400 CARIÑENA (ZARAGOZA), SPAIN:
3,398,725, PUB. 1-1-2008. INT. CL. 33.
- BODY IMAGE SOLUTIONS, LLC, BATON ROUGE, LA:
3,397,051, PUB. 1-1-2008. MULTIPLE CLASS, INT. CLS. 5, 41 AND 44.
- BOEHRINGER INGELHEIM PHARMA GMBH & CO. KG, 55216 INGELHEIM AM RHEIN, FED REP GERMANY:
2,128,337. REN. 2-11-08. MULTIPLE CLASS, INT. CLS. 1 AND 5.
- BOEHRINGER INGELHEIM PHARMA GMBH & CO. KG, INGELHEIM, FED REP GERMANY:
2,134,014. REN. 2-11-08. INT. CL. 5.
- BOEHRINGER INGELHEIM VETMEDICA, INC., ST. JOSEPH, MO:
2,448,408, CANC. INT. CL. 41.
3,399,663, U.S. CL. A.
- BOLCH, LLC, ATLANTA, GA:
3,400,299, MULTIPLE CLASS, INT. CLS. 36 AND 37.
- BOLIN, NGOZI E., SYLMAR, CA:
3,400,358, INT. CL. 3.
- BOMBARDIER RECREATIONAL PRODUCTS INC., VAL-COURT, CANADA:
1,438,492, CANC. INT. CL. 7.
- BONGIOVI, JOHN, LOS ANGELES, CA:
3,398,869, INT. CL. 21.
3,398,870, INT. CL. 24.
3,398,871, INT. CL. 25.
- BONNY DOON WINERY, INC., SANTA CRUZ, CA:
3,398,116, PUB. 1-1-2008. INT. CL. 33.
- BONZI SOFTWARE, SAN LUIS OBISPO, CA:
2,447,561, CANC. INT. CL. 9.
- BOOKS ARE FUN, LTD., FAIRFIELD, IA:
2,128,314. REN. 2-11-08. INT. CL. 35.
- BOOT ROYALTY COMPANY, L.P., FORT WORTH, TX:
3,398,852, INT. CL. 25.
- BOOTHE, WILLIAM A., MD, PLANO, TX:
3,398,568, PUB. 1-1-2008. INT. CL. 44.
- BOOTIQUE TRENDS, INC., LOS ANGELES, CA:
2,448,334, CANC. INT. CL. 35.
- BORDEN CHEMICAL INVESTMENTS, INC, WILMINGTON, DE:
2,448,500, CANC. INT. CL. 42.
- BORDER HOLDINGS (UK) LIMITED, SHROPSHIRE, UNITED KINGDOM:
3,398,677, PUB. 1-1-2008. INT. CL. 12.
- BORG UNLIMITED INC., MONTEREY PARK, CA:
3,400,049, INT. CL. 16.
- BORGERT PRODUCTS, INC., ST. JOSEPH, MN:
3,397,576, PUB. 1-1-2008. INT. CL. 19.
- BORGIA, WILLIAM, BENSALEM, PA:
3,397,454, PUB. 1-1-2008. MULTIPLE CLASS, INT. CLS. 42 AND 45.
- BOSA DEVELOPMENT CALIFORNIA II INC., SAN DIEGO, CA:
3,398,297, PUB. 1-1-2008. INT. CL. 35.
- BOSSDEV INC., ST. CLAIR SHORES, MI:
3,399,696, MULTIPLE CLASS, INT. CLS. 9, 37 AND 42.
- BOSSMATE, LLC, CHATTANOOGA, TN:
3,400,174, INT. CL. 20.
- BOSTON PARTY TOURS, INC., LOWELL, MA:
3,396,954, PUB. 1-1-2008. INT. CL. 39.
- BOSTON RED SOX BASEBALL CLUB LIMITED PARTNERSHIP, BOSTON, MA:
3,397,948, PUB. 1-1-2008. INT. CL. 35.
- BOSTON SCIENTIFIC SCIMED, INC., MAPLE GROVE, MN:
3,399,538, INT. CL. 10.
- BOSTON SYMPHONY ORCHESTRA, INC., BOSTON, MA:
3,397,555, PUB. 1-1-2008. INT. CL. 41.
- BOTICA COMERCIAL FARMACEUTICA LTDA, SÃO JOSE DOS PINAIS - PARANÁ, BRAZIL:
3,399,440, INT. CL. 3.
- BOTKIN, SANFORD C., GERMANTOWN, MD:
2,448,503, CANC. INT. CL. 9.
- BOULDER CREEK PROPERTIES LLC, MELVILLE, NY:
3,397,556, PUB. 1-1-2008. INT. CL. 43.
- BOWLERAMA, INC., NEW CASTLE, DE:
2,448,498, CANC. INT. CL. 28.
- BOX-O-BOX, LLC, FREEHOLD, NJ:
3,397,973, PUB. 1-1-2008. INT. CL. 35.
- BOY SCOUTS OF AMERICA, IRVING, TX:
1,473,157, REN. 2-14-08. INT. CL. 18.
1,473,157, CANC. INT. CL. 25.
1,473,158, REN. 2-14-08. INT. CL. 18.
1,473,158, CANC. INT. CL. 25.
- BOYD GAMING CORPORATION, LAS VEGAS, NV, BLUE CHIP CASINO, INC., MICHIGAN CITY, IN:
2,159,517, REN. 2-14-08. INT. CL. 41.
- BOYD GAMING CORPORATION, LAS VEGAS, NV, BLUE CHIP CASINO, INC., MICHIGAN, IN:
2,164,547, REN. 2-13-08. INT. CL. 35.
- BOYD GAMING CORPORATION, LAS VEGAS, NV, BLUE CHIP CASINO, INC., MICHIGAN CITY, IN:
2,211,489, REN. 2-13-08. INT. CL. 6.
- BOYS & GIRLS CLUBS OF AMERICA, ATLANTA, GA:
3,397,578, PUB. 1-1-2008. INT. CL. 41.
- BPI COMMUNICATIONS INC., NEW YORK, NY:
2,447,678, CANC. INT. CL. 16.
- BR CONSULTING, INC., SEDONA, AZ:
3,397,171, PUB. 1-1-2008. INT. CL. 41.
3,399,934, MULTIPLE CLASS, INT. CLS. 41 AND 44.
- BRA*TENDERS, INC., NEW YORK, NY:
3,397,619, PUB. 1-1-2008. INT. CL. 25.
- BRADLEY-MORRIS, INC., KENNESAW, GA:
3,398,126, PUB. 1-1-2008. INT. CL. 35.
3,398,128, PUB. 1-1-2008. INT. CL. 35.
- BRAINTCH CANADA, INC., NORTH VANCOUVER, BRITISH COLUMBIA, CANADA:
3,398,356, PUB. 5-18-2004. MULTIPLE CLASS, INT. CLS. 9 AND 42.
- BRANCH PROPERTIES, INC., OCALA, FL, DBA SEMINOLE STORES:
3,398,198, PUB. 1-1-2008. INT. CL. 31.
- BRANDED LLC, DALLAS, TX:
2,448,310, CANC. INT. CL. 25.
- BRAUN GMBH, FED REP GERMANY:
3,398,638, PUB. 1-1-2008. MULTIPLE CLASS, INT. CLS. 3 AND 8.
- BRAVO, PABLO SOTO, MADRID, SPAIN:
3,396,953, PUB. 1-1-2008. INT. CL. 9.
- BRAZILIAN SPECIALTY FOODS, INC., NORTH BERGEN, NJ:
3,397,466, PUB. 1-1-2008. INT. CL. 29.
- BREGER MUELLER WELT CORPORATION, CHICAGO, IL:
2,447,980, CANC. INT. CL. 9.
- BREVIS MUSIC, INC., NEW YORK, NY:
2,135,976, REN. 2-13-08. INT. CL. 41.
- BRIAN TRACY INTERNATIONAL, INC., SOLANA BEACH, CA:
3,396,886, PUB. 1-1-2008. INT. CL. 35.
- BRICE, MERI, VISTA, CA AND BRICE, DAVID, VISTA, CA:
3,397,866, PUB. 1-1-2008. MULTIPLE CLASS, INT. CLS. 25 AND 35.
3,398,133, PUB. 1-1-2008. INT. CL. 25.
- BRICKARMS LLC, REDMOND, WA:
3,397,903, PUB. 1-1-2008. INT. CL. 28.
- BRIDGE ENTERTAINMENT, INC., ENCINO, CA:
2,212,570, REN. 2-11-08. MULTIPLE CLASS, INT. CLS. 35 AND 42.
- BRIDGEBAY FINANCIAL, INC., SAN RAMON, CA:
3,397,765, PUB. 1-1-2008. INT. CL. 36.
- BRIDGEPOINT SYSTEMS, INC., SAN RAMON, CA:
2,129,371, REN. 2-11-08. MULTIPLE CLASS, INT. CLS. 36 AND 42.
- BRIDGESTONE SPORTS CO., LTD., TOKYO, JAPAN:
3,399,463, INT. CL. 28.
- BRIDGEWAY CORPORATION, BELLEVUE, WA:
2,059,147, CANC. INT. CL. 9.
- BRIGHT HORIZONS LIMITED PARTNERSHIP, WATERTOWN, MA:
3,398,239, PUB. 1-1-2008. INT. CL. 43.
- BRILLIANT IMAGE INCORPORATED, NEW YORK, NY:
1,438,502, CANC. MULTIPLE CLASS, INT. CLS. 9, 16 AND 42.
- BRINSON, CYNTHIA L., DOYLESTOWN, PA:
3,397,328, PUB. 1-1-2008. INT. CL. 25.

BRIOT INTERNATIONAL, 27340 PONT DE L'ARCHE, FRANCE:
 2,140,896. REN. 2-8-08. INT. CL. 9.
 BRISTOL-MYERS SQUIBB COMPANY, NEW YORK, NY:
 3,399,330, MULTIPLE CLASS, INT. CLS. 16, 36 AND 41.
 3,399,369, INT. CL. 5.
 BRISTOW GROUP INC., HOUSTON, TX:
 3,396,881, PUB. 1-1-2008. MULTIPLE CLASS, INT. CLS. 35, 37, 39, 41, 42, 44 AND 45.
 BRITISH AIRWAYS PLC, UNITED KINGDOM:
 3,398,693, PUB. 1-1-2008. MULTIPLE CLASS, INT. CLS. 39 AND 43.
 BRITT, DONALD C., BRADENTON, FL:
 3,397,680, PUB. 1-1-2008. INT. CL. 40.
 BRITT, ROBIN, ANNAPOLIS, MD, DBA BRITT'S INDUSTRIES:
 1,492,206. REN. 2-12-08. INT. CL. 16.
 1,494,214. REN. 2-12-08. INT. CL. 16.
 BROADREACH INC., RALEIGH, NC:
 2,187,843. REN. 2-13-08. INT. CL. 39.
 BROCK WELD, CERRITOS, CA:
 3,400,041, INT. CL. 12.
 BRODY, RONALD F., BREWER, ME:
 3,397,571, PUB. 1-1-2008. INT. CL. 36.
 BROMLEY PRINTING, INC., MINNEAPOLIS, MN:
 2,447,325, CANC. INT. CL. 42.
 BROOKE CORPORATION, OVERLAND PARK, KS:
 2,447,865, CANC. INT. CL. 36.
 BROOKLINE, INC., CHARLOTTE, NC:
 2,448,425, CANC. INT. CL. 25.
 BROQUEVILLE, PAULETTE RENEE, COSTA MESA, CA:
 3,398,169, PUB. 1-1-2008. INT. CL. 28.
 BROTHERHOOD MUTUAL INSURANCE COMPANY, FORT WAYNE, IN:
 3,399,137, INT. CL. 36.
 BROUK COMPANY, ST. LOUIS, MO:
 1,438,589, CANC. INT. CL. 17.
 BROWN BAG NATURALS, MALIBU, CA:
 3,397,959, PUB. 1-1-2008. INT. CL. 39.
 BROWN, ERIC M. BOYLSTON, MA:
 3,397,326, PUB. 1-1-2008. INT. CL. 14.
 BROWN, GEORGE WAYNE, WEATHERFORD, TX:
 2,081,198, CANC. INT. CL. 35.
 BROWN, JEFF, OXNARD, CA:
 3,399,700, INT. CL. 40.
 BROWN, JOHNNIE W., COMANCHE, OK:
 3,398,534, PUB. 1-1-2008. INT. CL. 7.
 BROWN, NEIL, WOODSTOCK, GA:
 3,398,215, PUB. 1-1-2008. INT. CL. 41.
 BRUKER AXS MICROANALYSIS GMBH, 12489 BERLIN, FED REP GERMANY:
 3,398,651, PUB. 1-1-2008. INT. CL. 9.
 BRUNSWICK BOWLING & BILLIARDS CORPORATION, LAKE FOREST, IL:
 3,398,408, PUB. 1-1-2008. INT. CL. 28.
 BRUNSWICK ET FILS SA, FRANCE:
 3,398,798, PUB. 1-1-2008. INT. CL. 24.
 BRÜEL & KJÆR SOUND & VIBRATION; MEASUREMENT A/S, DENMARK:
 3,398,653, PUB. 1-1-2008. MULTIPLE CLASS, INT. CLS. 9, 37 AND 42.
 BSE HOLDINGS CO., LTD., REPUBLIC OF KOREA:
 3,398,775, PUB. 1-1-2008. MULTIPLE CLASS, INT. CLS. 9, 10, 35 AND 36.
 BSN MEDICAL GMBH, HAMBURG, FED REP GERMANY:
 834,393. REN. 2-9-08. U.S. CL. 44 (INT. CL. 10).
 3,399,992, INT. CL. 10.
 BTC WHOLESALE DISTRIBUTORS, INC., ALABASTER, AL:
 2,216,460. REN. 2-8-08. INT. CL. 35.
 BUCCHI S.R.L., ITALY:
 3,398,800, PUB. 1-1-2008. MULTIPLE CLASS, INT. CLS. 7, 17 AND 20.
 BUCHER AG LANGENTHAL, CH-4900 LANGENTHAL, SWITZERLAND:
 2,127,979. REN. 2-13-08. MULTIPLE CLASS, INT. CLS. 1, 2, 3 AND 4.
 2,127,979, CANC. MULTIPLE CLASS, INT. CLS. 8 AND 21.
 BUCKINGHAM STENCILS INC., NANOOSE BAY, CANADA:
 2,058,855, CANC. MULTIPLE CLASS, INT. CLS. 2 AND 16.
 BUDDIES BBQ & SOUTHERN FOOD COMPANY, LLC, LAKELEND, FL:
 3,396,883, PUB. 1-1-2008. INT. CL. 43.
 BUDGE, CRISTIAN VIAL, RANCAGUA, CHILE:
 3,398,445, PUB. 5-15-2007. INT. CL. 29.
 BUEHLER FOOD MARKETS, INCORPORATED, WOOSTER, OH:
 3,399,649, INT. CL. 30.
 BUI, CATHERINE T., ALAMEDA, CA:
 3,399,221, INT. CL. 25.
 BUILD-A-BEAR RETAIL MANAGEMENT, INC., ST. LOUIS, MO:
 3,399,145, INT. CL. 9.
 BULLSEYE TELECOM, INC., SOUTHFIELD, MI FROM ENTERPRISE NETWORK SOLUTIONS, L.L.C., SOUTHFIELD, MI:
 3,398,839, INT. CL. 9.
 BUMBLE BEE FOODS, LLC, SAN DIEGO, CA:
 3,398,877, INT. CL. 29.
 BUNCHBALL INC., REDWOOD CITY, CA:
 3,399,198, INT. CL. 42.
 BUNGE OILS, INC., ST. LOUIS, MO:
 3,399,779, INT. CL. 1.
 BURDEN, BILLY, AMORY, MS:
 1,086,148. REN. 2-9-08. INT. CL. 41.
 BURGOS, MARGARET ANN, NEW YORK, NY:
 3,399,702, INT. CL. 16.
 BURLYMAN ENTERTAINMENT, INC., LOS ANGELES, CA:
 3,397,118, PUB. 1-1-2008. INT. CL. 16.
 BURN STEWART DISTILLERS LIMITED, EAST KILBRIDE, UNITED KINGDOM, HIGHLAND DISTILLERIES COMPANY LIMITED, THE, GLASGOW G1 2QY, SCOTLAND:
 1,085,005. REN. 2-13-08. INT. CL. 33.
 BURRITO BEACH, LLC, CHICAGO, IL:
 3,400,122, INT. CL. 43.
 BUSINESS ACQUISITIONS, LTD., DENVER, CO:
 3,398,228, PUB. 1-1-2008. INT. CL. 36.
 BUSINESS KNOWLEDGE ARCHITECTS, INC., FINCASTLE, VA:
 2,447,495, CANC. INT. CL. 42.
 BUTTERY MOON MEDIA LLC, WOODBRIDGE, NJ:
 3,397,778, PUB. 1-1-2008. INT. CL. 41.
 BUYONEERS, LLC, CHANDLER, AZ:
 3,399,141, INT. CL. 9.
 BWS HOLDING COMPANY, MIAMI, FL:
 3,397,153, PUB. 1-1-2008. INT. CL. 9.
 BYERS PRODUCTS, INC., OKLAHOMA CITY, OK:
 2,448,550, CANC. INT. CL. 11.
 C & M PEACE ENTERPRISES, INC., HOLLYWOOD, FL:
 3,396,849, PUB. 1-1-2008. INT. CL. 43.
 C. R. BARD, INC., MURRAY HILL, NJ:
 2,448,155, CANC. INT. CL. 10.
 C.M.I. ENTERPRISES, INC., MIAMI, FL:
 3,399,719, INT. CL. 24.
 3,399,940, INT. CL. 24.
 C-NETMEDIA INC., MOBILE, AL:
 3,397,077, PUB. 1-1-2008. INT. CL. 9.
 C/HCA, INC., NASHVILLE, TN:
 3,400,193, INT. CL. 41.
 CABELA'S INC., SIDNEY, NE:
 3,397,443, PUB. 1-1-2008. INT. CL. 35.
 CABIN CREEK, LLC, PLEASANT GROVE, UT:
 3,397,764, PUB. 1-1-2008. INT. CL. 16.
 CABOT SAFETY INTERMEDIATE CORPORATION, NEWARK, DE:
 3,399,567, INT. CL. 9.
 CACERES, AUGUSTO B., TORRANCE, CA, DBA ABC BEAUTY WHOLESALE:
 3,397,911, PUB. 1-1-2008. INT. CL. 5.
 CACKALACKY COFFEE ROASTERS INC., ROCKY MOUNT, NC:
 3,400,311, INT. CL. 30.
 CADILLAC JACK, INC., DULUTH, GA:
 3,399,048, INT. CL. 9.

- CADILLAC PLASTIC GROUP, INC., TROY, MI:
2,447,438, CANC. INT. CL. 19.
- CAFOLLA, MARK, BURBANK, CA:
3,397,551, PUB. 1-1-2008. MULTIPLE CLASS, INT. CLS. 35 AND 41.
- CAGAN, LEIGH DAVID, SAN JOSE, CA:
3,399,236, INT. CL. 15.
- CAL MALIBU, INC., BUENA PARK, CA:
2,447,288, CANC. INT. CL. 28.
- CAL SOL CONCEPTS LLC, SAN FRANCISCO, CA:
3,399,256, INT. CL. 43.
- CAL TAN, LLC, LOS ANGELES, CA:
1,487,357, REN. 2-8-08. INT. CL. 3.
- CAL/WEST SEEDS, WOODLAND, CA:
3,397,865, PUB. 1-1-2008. INT. CL. 31.
3,397,874, PUB. 1-1-2008. INT. CL. 31.
- CALE ACCESS AB, 171 25 SOLNA, SWEDEN:
3,399,483, MULTIPLE CLASS, INT. CLS. 9 AND 37.
- CALIBER POINT BUSINESS SOLUTIONS LIMITED, MAHAPE, NAVI MUMBAI, INDIA:
3,399,437, INT. CL. 35.
- CALIFORNIA CLASSIC PROPERTIES CORP., ANAHEIM, CA:
3,397,007, PUB. 1-1-2008. INT. CL. 36.
- CALIFORNIA CUSTOM FRUITS AND FLAVORS, INC., IRWINDALE, CA:
3,398,955, INT. CL. 40.
- CALIFORNIA EXOTIC NOVELTIES, INC., CHINO, CA:
2,208,838, REN. 2-13-08. INT. CL. 10.
- CALIFORNIA FAUCETS, HUNTINGTON BEACH, CA:
3,400,252, INT. CL. 11.
- CALIFORNIA STATE AUTOMOBILE ASSOCIATION, SAN FRANCISCO, CA:
3,398,381, PUB. 9-12-2006. MULTIPLE CLASS, INT. CLS. 35, 36, 37, 39, 42 AND 43.
- CALIFORNIA STRAWBERRY COMMISSION, WATSONVILLE, CA:
2,448,047, CANC. U.S. CL. A.
- CALLAHAN CONSTRUCTION, INC., MUSTANG, OK:
3,397,934, PUB. 1-1-2008. INT. CL. 37.
- CALLAHAN REALTY COMPANY, NEW LONDON, CT:
3,397,278, PUB. 1-1-2008. MULTIPLE CLASS, INT. CLS. 25, 35 AND 43.
3,397,279, PUB. 1-1-2008. MULTIPLE CLASS, INT. CLS. 25, 35 AND 43.
- CALMEYN, ALICE A., WHEELING, IL:
2,060,062, CANC. INT. CL. 16.
- CALP CORPORATION, TOKYO, JAPAN:
3,400,160, MULTIPLE CLASS, INT. CLS. 1 AND 17.
- CALVERT GROUP LTD., BETHESDA, MD:
2,134,295, REN. 2-14-08. INT. CL. 36.
- CALVIN N. TSAO, HOUSTON, TX:
3,400,154, INT. CL. 44.
- CAMPAGNOLO S.R.L., VICENZA, ITALY:
3,399,707, INT. CL. 12.
- CAMPBELL MITHUN LLC, MINNEAPOLIS, MN:
3,397,259, PUB. 1-1-2008. INT. CL. 35.
- CAMPOS DISTRIBUTORS, INC., OAK LAWN, IL:
2,162,142, REN. 2-11-08. INT. CL. 29.
- CAMPSIX (DE) INC., SAN FRANCISCO, CA:
2,447,820, CANC. INT. CL. 36.
- CANDLE CORPORATION OF AMERICA, DES PLAINES, IL:
1,484,960, REN. 2-14-08. INT. CL. 4.
- CANEPA, VICKIE P., WESTLAKE VILLAGE, CA:
3,399,323, INT. CL. 28.
- CANFIELD, JOHN T., COSTA MESA, CA AND HANSEN & HANSEN LLC, COSTA MESA, CA:
3,397,836, PUB. 1-1-2008. INT. CL. 31.
- CANFIELD, JOHN T., COSTA MESA, CA AND HANSEN & HANSEN, LLC, COSTA MESA, CA:
3,397,839, PUB. 1-1-2008. INT. CL. 31.
3,397,841, PUB. 1-1-2008. INT. CL. 31.
3,397,845, PUB. 1-1-2008. INT. CL. 31.
- CANINE COMPANIONS FOR INDEPENDENCE, SANTA ROSA, CA:
2,218,516, REN. 2-9-08. INT. CL. 41.
- CANLAND UK (HOT PACK) LTD., LONGWICK, BUCKS, UNITED KINGDOM:
2,158,350, REN. 2-14-08. INT. CL. 29.
- CANNUFLOW, INC., SAN JOSE, CA:
3,396,972, PUB. 1-1-2008. INT. CL. 10.
- CAO GROUP, INC., WEST JORDAN, UT:
3,397,928, PUB. 1-1-2008. INT. CL. 9.
3,397,933, PUB. 1-1-2008. INT. CL. 9.
3,397,936, PUB. 1-1-2008. INT. CL. 9.
3,397,962, PUB. 1-1-2008. INT. CL. 11.
- CAP VISTALBA SOCIEDAD ANONIMA, MENDOZA, ARGENTINA:
3,399,996, INT. CL. 33.
- CAPARO REAL ESTATE, CONSHOHOCKEN, PA, DBA COLDWELL BANKER PREFERRED:
3,398,527, PUB. 1-1-2008. MULTIPLE CLASS, INT. CLS. 35 AND 36.
- CAPITA TECHNOLOGIES CALIFORNIA, INC., IRVINE, CA:
2,447,489, CANC. INT. CL. 42.
2,447,490, CANC. INT. CL. 42.
- CAPITAL AUTOMOTIVE LLC, MCLEAN, VA:
3,398,473, PUB. 1-1-2008. INT. CL. 36.
- CAPITAL BLUECROSS, HARRISBURG, PA:
3,397,541, PUB. 1-1-2008. INT. CL. 44.
- CAPITAL EXPRESS, L.L.C., LYNDHURST, NJ:
2,058,914, CANC. INT. CL. 36.
- CAPITAL PERFORMANCE ADVISORS, LLC, WALNUT CREEK, CA:
2,448,519, CANC. INT. CL. 42.
- CAPITALSOURCE FINANCE LLC, AS COLLATERAL AGENT, CHEVY CHASE, MD:
3,397,176, PUB. 1-1-2008. INT. CL. 36.
- CAPITOL WHOLESALE MEATS CORPORATION, CHICAGO, IL:
3,398,906, INT. CL. 29.
- CAPS GROUP ACQUISITION, LLC, CHICAGO, IL:
2,090,478, REN. 2-13-08. INT. CL. 42.
- CAPSIZED, INC., WALTHAM, MA:
2,447,832, CANC. INT. CL. 35.
2,447,833, CANC. INT. CL. 35.
- CAPTAIN OUTRAGEOUS OF KEY WEST, CORP., JACKSONVILLE, FL:
3,396,884, PUB. 1-1-2008. INT. CL. 16.
- CAPTARIS, INC., BELLEVUE, WA:
3,399,746, INT. CL. 9.
- CAPTIVE CHANNEL CORPORATION, MARKHAM, ONTARIO, CANADA:
3,396,965, PUB. 1-1-2008. MULTIPLE CLASS, INT. CLS. 35 AND 37.
- CARDGUARD U.S.A., INC., STILLWATER, MN:
2,447,830, CANC. INT. CL. 42.
- CARDIAC SCIENCE CORPORATION, BOTHELL, WA:
3,399,493, INT. CL. 10.
3,399,494, INT. CL. 28.
- CARDIAC WELLNESS SUPPLEMENTS LLC, WRIGHTSVILLE BEACH, NC:
3,400,137, MULTIPLE CLASS, INT. CLS. 5 AND 44.
- CARDIO CALL, INC., CENTRAL ISLIP, NY:
2,448,439, CANC. INT. CL. 42.
- CAREERLAB, INC., LONE TREE, CO, FRANK, WILLIAM S., ENGLEWOOD, CO:
1,522,059, REN. 2-14-08. INT. CL. 35.
- CAREMORE HEALTH PLAN, CERRITOS, CA:
3,398,557, PUB. 1-1-2008. MULTIPLE CLASS, INT. CLS. 35, 36, 41 AND 44.
- CAREERLAB, INC., LONE TREE, CO, FRANK, WILLIAM S., ENGLEWOOD, CO:
3,398,595, PUB. 1-1-2008. MULTIPLE CLASS, INT. CLS. 35, 36, 41 AND 44.
- CAREY, ROY EUGENE, EL CAJON, CA, DBA CAREY'S WINDERS:
2,058,664, CANC. INT. CL. 28.
- CARGILL FOOD INGREDIENTS US, LLC, WAYZATA, MN:
650,202, REN. 2-14-08. U.S. CL. 46 (INT. CL. 1).
- CARGILL, INCORPORATED, WAYZATA, MN:
3,399,327, INT. CL. 30.
3,399,344, INT. CL. 30.
3,399,508, INT. CL. 30.
- CARKHUFF THINKING SYSTEMS, INC., MCLEAN, VA:
2,059,139, CANC. MULTIPLE CLASS, INT. CLS. 9, 35

- AND 41.
- CARLSON TRAVEL GROUP, INC., MINNEAPOLIS, MN:
3,397,268, PUB. 1-1-2008. INT. CL. 39.
- CARPENE' MALVOLTI S.P.A., ITALY:
3,398,766, PUB. 1-1-2008. INT. CL. 33.
- CARPENTER CO., RICHMOND, VA:
1,475,930. REN. 2-13-08. INT. CL. 17.
- CART-RITE, LLC, CLINTON, CT:
3,397,560, PUB. 1-1-2008. INT. CL. 12.
- CARTE BLANCHE GREETINGS LIMITED, CHICHESTER,
UNITED KINGDOM:
3,398,380, PUB. 9-25-2007. MULTIPLE CLASS, INT. CLS.
16 AND 21.
- CARTIER INTERNATIONAL B.V., 3980 AMSTERDAM,
NETHERLANDS:
2,058,753, CANC. INT. CL. 34.
- CARTRIDGE WORLD NORTH AMERICA, EMERYVILLE,
CA:
3,399,341, INT. CL. 35.
- CASCADES CANADA INC., MONTREAL, QUEBEC, CANA-
DA:
3,398,549, PUB. 10-23-2007. INT. CL. 16.
- CASELLA, DAVID ADAM, SAN FRANCISCO, CA:
3,398,401, PUB. 1-1-2008. INT. CL. 14.
- CASH AMERICA, INC. OF NEVADA, FORT WORTH, TX:
2,059,832, CANC. INT. CL. 42.
- CASH ASSET MANAGEMENT, LLC, SPARKS, NV:
3,397,274, PUB. 1-1-2008. INT. CL. 45.
- CASH CENTERS OF AMERICA, INC., CLEVELAND, TN:
2,448,505, CANC. INT. CL. 36.
- CASHMERE HOUSE, INC., SANTA ANA, CA:
2,098,122, CANC. INT. CL. 14.
- CASHWELL III, JOHNNY J, MURFREESBORO, TN:
3,399,156, INT. CL. 30.
- CASTALINE, JEFFREY, SAN MATEO, CA:
3,397,559, PUB. 1-1-2008. INT. CL. 14.
- CASTANEDA, ERMINIA, HAWTHORNE, CA:
3,397,942, PUB. 1-1-2008. INT. CL. 3.
- CATALINA MARKETING CORPORATION, ST. PETERS-
BURG, FL:
2,447,342, CANC. INT. CL. 41.
- CATALYST INTERNATIONAL, INC., FOLCROFT, PA:
3,399,786, MULTIPLE CLASS, INT. CLS. 17 AND 24.
- CATAPHORA, INC., REDWOOD CITY, CA:
3,399,308, INT. CL. 9.
- CATAPHOTE, INC., JACKSON, MS:
2,447,560, CANC. INT. CL. 2.
- CATENA, ERNESTO, BUENOS AIRES, ARGENTINA:
3,399,310, INT. CL. 33.
- CATERPILLAR INC., PEORIA, IL:
3,399,496, INT. CL. 9.
- CATHEDRAL HERITAGE FOUNDATION, INC., LOUIS-
VILLE, KY:
2,058,695, CANC. INT. CL. 42.
- CATHERINES OF CALIFORNIA, INC., LOS ANGELES, CA:
3,399,167, MULTIPLE CLASS, INT. CLS. 25 AND 35.
- CATHOLIC HEALTHCARE WEST, SAN FRANCISCO, CA:
3,399,406, INT. CL. 44.
- CAVANAGH GROUP INTERNATIONAL, INC., DULUTH,
GA:
3,399,426, MULTIPLE CLASS, INT. CLS. 11, 15 AND 28.
- CAYMAN ISLANDS STOCK EXCHANGE, GEORGE TOWN,
GRAND CAYMAN, CAYMAN ISLANDS:
2,448,484, CANC. MULTIPLE CLASS, INT. CLS. 9, 35, 36
AND 41.
- CDM TECHNOLOGIES, INC., SAN LUIS OBISPO, CA:
3,398,025, PUB. 1-1-2008. INT. CL. 9.
3,398,040, PUB. 1-1-2008. INT. CL. 9.
- CEDAR AUDIO, LTD., PORTLAND, ME:
3,398,314, PUB. 1-1-2008. INT. CL. 9.
- CELEBREE HOLDINGS, INC., BEL AIR, MD:
3,398,254, PUB. 1-1-2008. INT. CL. 43.
- CELEBRITY JET CHARTER, LLC, MALVERN, PA:
3,396,997, PUB. 1-1-2008. INT. CL. 39.
- CELLCO PARTNERSHIP, BASKING RIDGE, NJ, DBA
VERIZON WIRELESS:
3,399,631, INT. CL. 38.
- CELLULAR EXPRESS, INC., BOSTON, MA TO NEW WIRE-
LESS SERVICES, INC., BEDFORD, MA:
2,060,059, CANC. INT. CL. 38.
- CELOX COMMUNICATIONS CORPORATION, ST. LOUIS,
MO:
2,447,692, CANC. INT. CL. 9.
- CELPLAST METALLIZED PRODUCTS LTD., TORONTO,
CANADA:
3,399,270, INT. CL. 17.
- CEMDAG MAKINA; SANAYI VE TICARET LIMITED
SIRKETI, TURKEY:
3,398,734, PUB. 1-1-2008. MULTIPLE CLASS, INT. CLS. 7
AND 37.
- CENETEC, LLC, BOCA RATON, FL:
2,447,871, CANC. INT. CL. 35.
- CENTER CITY PROPRIETOR'S FOUNDATION, PHILA-
DELPHIA, PA:
2,447,948, CANC. MULTIPLE CLASS, INT. CLS. 16 AND
35.
- CENTER FOR ADAPTIVE MANAGEMENT, THE, CINCIN-
NATI, OH:
2,448,186, CANC. INT. CL. 41.
- CENTER FOR VALUE-BASED MEDICINE, LLC, FLOUR-
TOWN, PA:
3,398,493, PUB. 1-1-2008. INT. CL. 42.
- CENTEX CORPORATION, DALLAS, TX:
3,398,168, PUB. 1-1-2008. INT. CL. 37.
3,398,344, PUB. 1-1-2008. INT. CL. 37.
3,398,345, PUB. 1-1-2008. INT. CL. 37.
- CENTEX/TAYLOR, LLC, CHANTILLY, VA:
3,399,316, MULTIPLE CLASS, INT. CLS. 25 AND 28.
- CENTRAL RESERVATION ASSOCIATION OF DESTINA-
TION RESORTS, INC., DENVER, CO:
3,399,630, MULTIPLE CLASS, INT. CLS. 35, 39 AND 43.
- CENTURION SYSTEMS USA INC., EDISON, NJ:
3,396,978, PUB. 1-1-2008. INT. CL. 5.
- CENTURY SYSTEMS INC., ATLANTA, GA:
1,839,188, CANC. INT. CL. 3.
- CEQUENT TOWING PRODUCTS, INC., PLYMOUTH, MI:
2,059,258, CANC. INT. CL. 12.
- CERES, INC., THOUSAND OAKS, CA:
3,400,265, MULTIPLE CLASS, INT. CLS. 31 AND 42.
- CERTAINTEED CORPORATION, VALLEY FORGE, PA:
2,448,102, CANC. INT. CL. 19.
- CERTESS S.A., FRANCE:
3,398,657, PUB. 1-1-2008. MULTIPLE CLASS, INT. CLS. 9,
16 AND 42.
- CESARI, UMBERTO, 40050 CASTEL SAN PIETRO (BO),
ITALY:
2,146,225. REN. 2-14-08. INT. CL. 33.
- CETALUS LLC, BURLINGTON, MA:
3,398,012, PUB. 1-1-2008. INT. CL. 36.
- CEULEMANS, JAN, B-2610 WILRIJK, BELGIUM:
2,447,645, CANC. INT. CL. 14.
- CFS GERMANY GMBH, FED REP GERMANY:
3,398,619, PUB. 1-1-2008. MULTIPLE CLASS, INT. CLS. 7,
16 AND 39.
- CGE ENTERPRISES, LLC, MANCHESTER CENTER, VT:
3,399,359, INT. CL. 3.
- CHAIN DRUG MARKETING ASSOCIATION, INC., NOVI,
MI:
2,144,847. REN. 2-11-08. MULTIPLE CLASS, INT. CLS. 3,
5, 8, 9, 10, 16, 21 AND 25.
- CHALFONT, BYRON E., SAN CARLOS, CA:
2,059,412, CANC. INT. CL. 42.
- CHALLENGER-NIBBS, KENDRA, BROOKLYN, NY:
3,399,215, INT. CL. 45.
- CHAMPION INTERNATIONAL CORPORATION, STAM-
FORD, CT:
2,447,793, CANC. INT. CL. 36.
- CHAN, DAVID M., SOUTH EL MONTE, CA:
2,447,372, CANC. INT. CL. 25.
- CHARCOAL COMPANION, INC., OAKLAND, CA:
2,448,113, CANC. MULTIPLE CLASS, INT. CLS. 4 AND
21.
- CHARLES SCHWAB & CO., INC., SAN FRANCISCO, CA:
3,400,086, INT. CL. 42.

- CHARLES TUNE, EL PASO, TX:
3,397,113, PUB. 1-1-2008. INT. CL. 35.
- CHARLESBERND AG, MÜNCHEN, FED REP GERMANY:
3,399,180, INT. CL. 42.
3,399,854, INT. CL. 42.
- CHARMED ATTITUDES, COSTA MESA, CA:
3,398,553, PUB. 1-1-2008. INT. CL. 14.
- CHATEAU D'ESCLANS; DOMAINES SACHA LICHINE, FRANCE:
3,398,797, PUB. 1-1-2008. INT. CL. 33.
- CHATEAU LAROSE TRINTAUDON, FRANCE:
3,398,689, PUB. 1-1-2008. INT. CL. 33.
- CHATTERELLI, SHELLY, MASSILLON, OH AND PARKER, ANGELA, MASSILLON, OH:
3,397,502, PUB. 1-1-2008. INT. CL. 41.
- CHAUVET & SONS, INC., HOLLYWOOD, FL:
3,399,588, INT. CL. 11.
- CHAVEZ, EDUARDO, MENDOTA HEIGHTS, MN:
3,399,961, INT. CL. 25.
- CHECK TECHNOLOGY CORPORATION, MINNETONKA, MN:
2,447,945, CANC. INT. CL. 7.
- CHECKMATE GEOSYNTHETICS INC., CHILLIWACK, BRITISH COLUMBIA, CANADA:
3,398,489, PUB. 11-27-2007. INT. CL. 19.
- CHECKPOINT SYSTEMS, INC., THOROFARE, NJ:
3,400,073, INT. CL. 9.
- CHEER APPAREL, LLC, CHARLOTTE, NC:
3,399,697, INT. CL. 9.
- CHEER-BLING, LLC, SHEPHERDSVILLE, KY:
3,397,740, PUB. 1-1-2008. INT. CL. 41.
- CHEIL INDUSTRIES INC., GUMI, KYONGSANGBUK-DO, REPUBLIC OF KOREA:
2,133,650, REN. 2-14-08. INT. CL. 25.
- CHEMICAL LIGHT, INC., VERNON HILLS, IL:
3,399,017, INT. CL. 35.
- CHEN JIAN QING, CHINA:
3,398,702, PUB. 1-1-2008. INT. CL. 9.
- CHENG SHIN RUBBER USA, INC., SUWANEE, GA:
3,400,066, INT. CL. 12.
- CHENG, JOHNNY T., ARTESIA, CA:
3,397,173, PUB. 1-1-2008. INT. CL. 16.
- CHENONE STORES LIMITED, LAHORE, PAKISTAN:
3,399,400, MULTIPLE CLASS, INT. CLS. 24 AND 25.
- CHEQUEPOINT FRANCHISE CORPORATION, PANAMA, PANAMA:
2,018,645, REN. 2-8-08. INT. CL. 36.
- CHERISE, LLC, STAMFORD, CT:
3,398,962, INT. CL. 25.
- CHERRYSTONEIT, INC., HUNTINGTON BEACH, CA:
3,397,806, PUB. 1-1-2008. MULTIPLE CLASS, INT. CLS. 35 AND 42.
- CHEVRA HATZALAH, BROOKLYN, NY:
2,131,729, REN. 2-11-08. MULTIPLE CLASS, INT. CLS. 39, 41 AND 42.
- CHEVRON INTELLECTUAL PROPERTY LLC, SAN RAMON, CA:
780,824, REN. 2-12-08. U.S. CL. 6 (INT. CL. 1).
3,103,863, AM. INT. CL. 35.
- CHICAGO CLAMP COMPANY, LLC, BROADVIEW, IL:
3,400,366, INT. CL. 6.
- CHICAGO CLIMATE EXCHANGE, INC., CHICAGO, IL:
3,399,471, INT. CL. 36.
- CHICKASAW NATION, ADA, OK:
3,399,284, INT. CL. 41.
- CHIEN ET. CHAT, INC., CENTENNIAL, CO:
3,398,032, PUB. 1-1-2008. INT. CL. 35.
- CHIESI FARMACEUTICI S.P.A., ITALY:
3,398,834, PUB. 1-1-2008. INT. CL. 5.
- CHILD CARE EDUCATION INSTITUTE, LLC, DULUTH, GA:
3,396,860, PUB. 1-1-2008. INT. CL. 41.
- CHILDREN INTERNATIONAL:
1,438,695, CANC. MULTIPLE CLASS, INT. CLS. 36 AND 42.
- CHILDREN'S HEALTH CARE SYSTEM, SEATTLE, WA:
2,135,807, REN. 2-11-08. INT. CL. 42.
- CHILDREN'S HOSPITAL, NEW ORLEANS, LA:
1,438,745, CANC. INT. CL. 42.
- CHILDS, MARGERIE, SUWANEE, GA:
2,133,799, REN. 2-11-08. INT. CL. 16.
- CHIMNEY SWEEPING LOG, LLC, LAS VEGAS, NV:
3,399,549, INT. CL. 4.
- CHINA JIANYIN INVESTMENT LIMITED, CHINA:
3,398,778, PUB. 1-1-2008. MULTIPLE CLASS, INT. CLS. 35 AND 36.
- CHINA NATIONAL AERO-TECHNOLOGY IMP. & EXP. GUANGZHOU CORPORATION, DONGSHAN, GUANGZHOU, CHINA:
3,399,776, INT. CL. 12.
- CHINA NATIONAL SAMKWONG FIREWORKS CO., LTD., CAUSEWAY BAY, HONG KONG:
2,447,600, CANC. INT. CL. 13.
- CHINA UNION (CASHMERE) INTERNATIONAL GROUP LIIMITED, KWAI CHUNG, N.T., HONG KONG:
3,399,532, INT. CL. 25.
- CHINNICI DIRECT, INC., NEW YORK, NY:
3,397,130, PUB. 1-1-2008. INT. CL. 35.
- CHIPHEADS, INC., RICHFIELD, MN:
2,141,594, REN. 2-10-08. INT. CL. 37.
- CHLN, INC., HOUSTON, TX:
3,397,586, PUB. 1-1-2008. INT. CL. 43.
- CHLOE S.A.S., 75008 PARIS, FRANCE:
3,398,517, PUB. 1-1-2008. INT. CL. 18.
- CHOCOLADEFABRIKEN LINDT & SPRÜNGLI AG, CH-8802 KILCHBERG, SWITZERLAND:
3,396,899, PUB. 1-1-2008. INT. CL. 30.
- CHOCOLADEFABRIKEN LINDT & SPRÜNGLI AG, KILCHBERG, SWITZERLAND:
3,399,674, INT. CL. 30.
- CHOCOLADEFABRIKEN; LINDT & SPRÜNGLI AG, SWITZERLAND:
3,398,667, PUB. 1-1-2008. INT. CL. 30.
- CHOCOLATE PRINTING COMPANY, INC., INWOOD, NY:
3,399,319, INT. CL. 30.
- CHOCOLATERIE GUYLIAN N.V., 9100 SINT-NIKLAAS, BELGIUM:
2,128,004, REN. 2-11-08. INT. CL. 30.
- CHR. HANSEN INC., MILWAUKEE, WI:
3,399,123, INT. CL. 30.
- CHRISTINA ZELJEZNIK, KANSAS CITY, KS:
3,397,238, PUB. 8-21-2007. INT. CL. 25.
- CHRISTLIKE ENTERPRISES, LLC, LEXINGTON, KY:
3,399,041, INT. CL. 25.
- CHRISTMAS TREE SHOPS, INC., SOUTH YARMOUTH, MA:
2,166,092, REN. 2-11-08. MULTIPLE CLASS, INT. CLS. 8, 9 AND 21.
- CHRISTOPHER REEVE PARALYSIS FOUNDATION, THE, SPRINGFIELD, NJ:
2,508,796, COR. MULTIPLE CLASS, INT. CLS. 36 AND 42.
- CHRISTOPHER TECHNOLOGIES, LLC, WEST CHESTER, OH:
3,397,815, PUB. 1-1-2008. INT. CL. 42.
- CHROME HEARTS LLC, HOLLYWOOD, CA:
3,399,056, INT. CL. 6.
- CHROMINANCE, SIMI VALLEY, CA:
2,059,681, CANC. MULTIPLE CLASS, INT. CLS. 9 AND 41.
- CHRONOMITE LABORATORIES, INC., CITY OF INDUSTRY, CA, OMNI PRODUCTS, YUCCA VALLEY, CA:
1,101,373, REN. 2-13-08. INT. CL. 11.
- CHUDINA JR, GEORGE J, KODAK, TN:
3,397,385, PUB. 1-1-2008. INT. CL. 40.
- CHUNG, JOO HYUN, LOS ANGELES, CA:
3,399,465, INT. CL. 25.
- CHUNGHWA TELECOM CO., LTD., TAIPEI, TAIWAN:
3,399,721, INT. CL. 38.
- CIARROCCA, LUCA, NEW YORK, NY:
2,448,527, CANC. INT. CL. 36.
- CIBA SPECIALTY CHEMICALS CORPORATION, TARRY-TOWN, NY:
3,399,604, MULTIPLE CLASS, INT. CLS. 1 AND 3.

- CIBA-GEIGY CORPORATION, TARRYTOWN, NY TO SYNGENTA INVESTMENT CORPORATION, GREENSBORO, NC:
2,059,791, CANC. INT. CL. 5.
- CICERON, INC., MINNEAPOLIS, MN:
2,447,853, CANC. INT. CL. 35.
- CIGNA CORPORATION, PHILADELPHIA, PA TO CIGNA INTELLECTUAL PROPERTY, INC., CLAYMONT, DE:
2,059,477, CANC. INT. CL. 36.
- CIMARRON FIREARMS COMPANY, INC., FREDERICKSBURG, TX:
3,398,586, PUB. 1-1-2008. INT. CL. 13.
- CINNABON, INC., ATLANTA, GA:
3,397,317, PUB. 1-1-2008. INT. CL. 30.
- CINTEX INTERNATIONAL (CANADA) LIMITED, MISSISSAUGA, ONTARIO, CANADA:
3,399,764, MULTIPLE CLASS, INT. CLS. 18, 25 AND 28.
- CIRCLE MEDIA, INC., THORNWOOD, NY:
3,397,193, PUB. 1-1-2008. INT. CL. 16.
3,397,201, PUB. 1-1-2008. INT. CL. 16.
- CISCO SYSTEMS, INC., SAN JOSE, CA:
2,448,077, CANC. INT. CL. 9.
- CISCO'S, INC., CHARLESTON, SC:
3,397,315, PUB. 1-1-2008. INT. CL. 43.
- CITIGROUP GLOBAL MARKETS INC., NEW YORK, NY:
3,399,609, INT. CL. 36.
- CITIZEN CBM KABUSHIKI KAISHA, ALSO TRADING AS JAPAN CBM CORPORATION, NAKANO-KU, TOKYO, JAPAN:
3,397,120, PUB. 1-1-2008. INT. CL. 14.
- CITY CLUB/ATLANTA GALLERIA, INC., ATLANTA, GA:
1,481,179, REN. 2-11-08. INT. CL. 42.
- CITY OF ALISO VIEJO, ALISO VIEJO, CA:
3,397,383, PUB. 1-1-2008. MULTIPLE CLASS, INT. CLS. 35, 41 AND 44.
- CITY OF DALLAS, DALLAS, TX:
3,397,267, PUB. 1-1-2008. INT. CL. 16.
- CITY OF MIAMI BEACH, MIAMI BEACH, FL:
3,397,626, PUB. 11-27-2007. INT. CL. 41.
- CITY OF NORTH KANSAS CITY, NORTH KANSAS CITY, MO:
3,399,865, INT. CL. 38.
3,399,866, INT. CL. 38.
- CJ APPAREL GROUP, LLC, NORTHBROOK, IL:
3,399,348, MULTIPLE CLASS, INT. CLS. 9, 18 AND 25.
- CLACK CORPORATION, WINDSOR, WI:
2,167,542, REN. 2-11-08. INT. CL. 1.
- CLAIR CO., LTD., OSAKA-SHI, OSAKA PREF., JAPAN:
2,058,967, CANC. INT. CL. 3.
- CLAIRE-SPRAYWAY, INC., ADDISON, IL:
662,917, REN. 2-14-08. U.S. CL. 52 (INT. CL. 3).
- CLARDY, GLINDA, HUNTSVILLE, AL:
3,399,495, INT. CL. 25.
- CLARK-RELIANCE CORPORATION, STRONGSVILLE, OH:
2,124,926, REN. 2-13-08. MULTIPLE CLASS, INT. CLS. 9 AND 11.
- CLARKE MOSQUITO EQUIPMENT, INC., ROSELLE, IL:
2,136,957, REN. 2-11-08. INT. CL. 7.
2,137,484, REN. 2-11-08. INT. CL. 12.
- CLASSMATE, L.L.C., HOUSTON, TX:
3,397,239, PUB. 1-1-2008. INT. CL. 41.
- CLAYTON SERVICES, INC., SHELTON, CT:
3,397,926, PUB. 1-1-2008. INT. CL. 36.
- CLAYTON/NATIONAL COURIER SYSTEMS, INC.:
1,438,710, CANC. INT. CL. 39.
- CLD CONSULTANTS, INC., LAGUNA BEACH, CA:
3,397,433, PUB. 1-1-2008. INT. CL. 35.
- CLEAN COMMANDO, LLC, AUSTIN, TX:
3,398,956, INT. CL. 37.
- CLEAR PHOENIX MEDIA, FAIRFIELD, NJ:
3,396,863, PUB. 1-1-2008. INT. CL. 41.
- CLEARSTATE (PTE.) LTD., SINGAPORE, SINGAPORE:
3,397,262, PUB. 1-1-2008. INT. CL. 35.
- CLEO INC, MEMPHIS, TN:
2,448,558, CANC. INT. CL. 16.
- CLICKEATS, INC., BELLEVUE, WA:
3,399,636, MULTIPLE CLASS, INT. CLS. 35 AND 42.
- CLICKSHARE CORP., WILLIAMSTOWN, MA TO CLICKSHARE SERVICE CORP., WILLIAMSTOWN, MA:
2,059,844, CANC. INT. CL. 38.
- CLINFOSOURCE, DANVILLE, CA:
3,397,250, PUB. 1-1-2008. INT. CL. 41.
- CLINQS, LLC, BROOKLYN, NY:
3,399,095, INT. CL. 20.
- CLOPAY BUILDING PRODUCTS R&D COMPANY, INC., MASON, OH, DBA CLOPAY BUILDING PRODUCTS COMPANY, INC.:
3,399,628, INT. CL. 19.
- CLOUD NINE OF UTAH, INC., RIVERDALE, UT:
2,448,384, CANC. INT. CL. 11.
2,448,385, CANC. INT. CL. 11.
- CLOUD 9 GAMES, INC, AUSTIN, TX:
3,399,191, INT. CL. 9.
- CLUB MILANOMANHATTAN, MILAN, ITALY:
3,400,382, MULTIPLE CLASS, INT. CLS. 37, 39 AND 43.
- CMI ENTERPRISES, LLC, SANTA MONICA, CA:
3,396,870, PUB. 9-25-2007. INT. CL. 25.
- CMK, INC., PORTLAND, OR:
1,438,495, CANC. INT. CL. 7.
- CMP MEDIA LLC, MANHASSET, NY:
3,400,411, INT. CL. 9.
- CNA HOLDINGS, INC., SUMMIT, NJ:
1,466,836, REN. 2-14-08. INT. CL. 1.
- CNI USA CORP, INC., LAS VEGAS, NV:
3,400,172, INT. CL. 21.
- COACHMEN RECREATIONAL VEHICLE COMPANY, LLC, MIDDLEBURY, TN:
2,128,800, REN. 2-13-08. INT. CL. 12.
- COAST DISTRIBUTION SYSTEM, INC., THE, MORGAN HILL, CA:
1,474,895, REN. 2-11-08. INT. CL. 12.
1,474,896, REN. 2-11-08. INT. CL. 12.
- COASTAL PROMOTIONS, INC., WEST PALM BEACH, FL:
3,399,561, INT. CL. 32.
- COATING SCIENCES INC., WINDSOR, CT TO SCAPA TAPES NORTH AMERICA, INC., WINDSOR, CT:
2,059,934, CANC. INT. CL. 5.
- COBRA GOLF INCORPORATED, CARLSBAD, CA:
3,399,648, MULTIPLE CLASS, INT. CLS. 28 AND 41.
- COCHRAN, R. KEITH, IRVING, TX:
3,399,233, INT. CL. 35.
- COCONUT GROVE BANK, MIAMI, FL:
3,397,669, PUB. 1-1-2008. INT. CL. 36.
- CODEMANTRA, LLC, PLYMOUTH MEETING, PA:
3,400,396, INT. CL. 42.
- CODESTREET, LLC, NEW YORK, NY:
3,400,273, INT. CL. 9.
- COFE CO., LTD, BANGKOK, THAILAND:
3,397,501, PUB. 1-1-2008. INT. CL. 32.
- COFFEECOL, INC., CORAL GABLES, FL:
2,662,542, AM. INT. CL. 35.
- COHEN, DOUGLAS A., ORANGE, CA:
3,398,451, PUB. 10-17-2006. INT. CL. 36.
- COHERA MEDICAL, INC., PITTSBURGH, PA:
3,400,026, INT. CL. 10.
- COLAS, FRANCE:
3,398,723, PUB. 1-1-2008. MULTIPLE CLASS, INT. CLS. 19 AND 37.
- COLBERT, MONIQUE, CORAL SPRINGS, FL:
3,398,452, PUB. 1-1-2008. INT. CL. 3.
- COLDSTREAMS GROUP, SPOKANE, WA:
3,398,522, PUB. 1-1-2008. INT. CL. 41.
- COLE, RICHARD M., FAIRFAX, VA AND REAGLE, WILLIAM P., FAIRFAX, VA AND REAGLE, JESSICA M., FAIRFAX, VA AND TROCCOLI, FRANK, FAIRFAX, VA AND KOVALCIK, JEROME, FAIRFAX, VA AND FARTHING, JESSE L., FAIRFAX, VA:
3,400,348, INT. CL. 41.
- COLEMAN CABLE, INC., WAUKEGAN, IL:
3,398,337, PUB. 1-1-2008. INT. CL. 9.
3,398,340, PUB. 1-1-2008. INT. CL. 9.
- COLEMAN NATURAL PRODUCTS, INC., GOLDEN, CO:
3,398,372, PUB. 9-20-2005. INT. CL. 29.
- COLLEEN QUIGLEY, ORMOND BEACH, FL, DBA ISCUBA:
3,398,014, PUB. 1-1-2008. INT. CL. 25.

- COLLIER RESEARCH & DEVELOPMENT CORP., HAMP-
TON, VA:
3,398,233, PUB. 1-1-2008. INT. CL. 9.
- COLORADO COALITION FOR ABSTINENCE EDUCATION,
INC., LITTLETON, CO:
2,184,058. REN. 2-14-08. INT. CL. 41.
- COLORADO SLEEP CENTER OF THE ROCKIES, LLC,
LOVELAND, CO:
3,400,234, INT. CL. 41.
3,400,238, INT. CL. 44.
- COLORADO STATE PATROL, DENVER, CO:
3,398,271, PUB. 1-1-2008. INT. CL. 45.
- COLUMBIA INSURANCE COMPANY, OMAHA, NE:
863,171. REN. 2-13-08. U.S. CL. 38 (INT. CL. 16).
2,204,075. REN. 2-14-08. INT. CL. 35.
3,399,393, INT. CL. 25.
- COLUMBIAN CHEMICALS COMPANY, ATLANTA, GA:
1,473,733. REN. 2-13-08. MULTIPLE CLASS, INT. CLS. 1
AND 2.
- COLUMBUS BASEBALL TEAM, INC., COLUMBUS, OH:
2,128,169. REN. 2-13-08. MULTIPLE CLASS, INT. CLS. 16
AND 25.
- COLWELL INDUSTRIES, INC., MINNEAPOLIS, MN:
3,399,022, MULTIPLE CLASS, INT. CLS. 35 AND 40.
- COM DEV LTD., CAMBRIDGE, ONTARIO, CANADA:
3,397,152, PUB. 1-1-2008. INT. CL. 9.
- COMBAT FIGHTING CHAMPIONSHIPS, LLC, OCALA, FL:
3,397,189, PUB. 1-1-2008. INT. CL. 41.
3,397,190, PUB. 1-1-2008. INT. CL. 41.
- COMC LLC, OMAHA, NE:
3,399,845, INT. CL. 19.
- COMCAST SPORTS MANAGEMENT SERVICES LLC, PHI-
LADELPHIA, PA:
3,400,032, INT. CL. 41.
- COMCAST SPORTSNET PHILADELPHIA, L.P., PHILADEL-
PHIA, PA:
3,398,998, MULTIPLE CLASS, INT. CLS. 38 AND 41.
- COMFORT WINDOW CO., INC., SYRACUSE, NY:
3,397,766, PUB. 1-1-2008. INT. CL. 37.
3,397,982, PUB. 1-1-2008. INT. CL. 37.
- COMMERCE ONE, INC., WALNUT CREEK, CA:
2,448,486, CANC. INT. CL. 9.
- COMMERCIAL & INDUSTRIAL DESIGN CO, INC., IRVINE,
CA:
2,134,292. REN. 2-12-08. INT. CL. 9.
- COMMISSION ON GRADUATES OF FOREIGN NURSING
SCHOOLS, PHILADELPHIA, PA:
3,397,398, PUB. 1-1-2008. MULTIPLE CLASS, INT. CLS. 35
AND 41.
- COMMON GROUND ALLIANCE, CHANTILLY, VA:
3,399,889, MULTIPLE CLASS, INT. CLS. 35 AND 41.
- COMMONHEALTH LLC, PARSIPPANY, NJ:
2,149,946. REN. 2-13-08. MULTIPLE CLASS, INT. CLS. 35
AND 42.
- COMMONWEALTH EDISON COMPANY, CHICAGO, IL:
3,400,021, INT. CL. 9.
- COMMUNICAID GROUP LIMITED, LONDON EC3A 5AW,
UNITED KINGDOM:
3,398,605, PUB. 1-1-2008. MULTIPLE CLASS, INT. CLS. 9,
16, 35 AND 41.
- COMMUNITY WEST FOUNDATION, CLEVELAND, OH:
3,399,122, INT. CL. 36.
- COMO, CHARLES T., SANTA MONICA, CA:
3,397,980, PUB. 1-1-2008. INT. CL. 41.
- COMP OPTIONS INSURANCE COMPANY, INC., JACKSON-
VILLE, FL:
2,130,138. REN. 2-13-08. INT. CL. 36.
- COMPANY "KARAVAN" LTD., RUSSIAN FED.:
3,398,801, PUB. 1-1-2008. INT. CL. 30.
- COMPART FAMILY FARMS, INC., NICOLLET, MN:
3,399,861, INT. CL. 29.
- COMPLETECAMPAIGNS.COM, LLC, SAN DIEGO, CA:
3,397,064, PUB. 1-1-2008. INT. CL. 9.
- COMPS.COM, INC., SAN DIEGO, CA:
2,447,439, CANC. MULTIPLE CLASS, INT. CLS. 35 AND
36.
- COMPTON, PATRICIA, J, KAILUA, HI:
3,399,328, MULTIPLE CLASS, INT. CLS. 25, 35 AND 41.
- COMPUTER ASSOCIATES THINK, INC., ISLANDIA, NY:
3,399,671, MULTIPLE CLASS, INT. CLS. 9 AND 42.
- COMPUTER COMFORTS, INC., HOUSTON, TX:
2,058,646, CANC. INT. CL. 40.
- COMRENT INTERNATIONAL, LLC, OWINGS, MD:
3,399,265, INT. CL. 9.
- CONAIR CORPORATION, STAMFORD, CT:
3,399,530, INT. CL. 20.
- CONCENTRIX CORPORATION, PITTSFORD, NY TO SYN-
NEX CORPORATION, FREMONT, CA:
2,533,198, CANC. INT. CL. 40.
- CONCEPT DESIGN MANUFACTURING AND ELECTRO-
NICS, INC., GRAHAM, NC:
2,447,796, CANC. INT. CL. 40.
- CONDIMENTMAN, LLC, SKILLMAN, NJ:
3,398,302, PUB. 1-1-2008. MULTIPLE CLASS, INT. CLS. 25
AND 30.
- CONFIDENCE INC., PORT WASHINGTON, NY:
3,398,362, PUB. 1-1-2008. INT. CL. 5.
- CONKIN COMPANY, INC., SHAKOPEE, MN:
3,399,941, MULTIPLE CLASS, INT. CLS. 2 AND 19.
- CONKLIN COMPANY, INC., SHAKOPEE, MN:
3,399,679, INT. CL. 19.
- CONN-SELMER, INC., ELKHART, IN:
2,447,873, CANC. INT. CL. 15.
- CONNECTAMERICA.COM, LLC, BROOMALL, PA:
3,397,744, PUB. 1-1-2008. INT. CL. 45.
- CONNECTING TOUCH THERAPY & WELLNESS CENTER,
INC., CUYAHOGA FALLS, OH:
3,397,362, PUB. 1-1-2008. INT. CL. 44.
- CONNECTIONS ACADEMY, LLC, BALTIMORE, MD:
3,398,893, INT. CL. 41.
- CONNELLA, STEPHEN J., KAPAA, HI:
2,060,128, CANC. INT. CL. 3.
- CONNOR, ROBERT, A., MINNEAPOLIS, MN:
3,399,757, INT. CL. 35.
- CONQUEST INTERNATIONAL CORPORATION, PLAIN-
VILLE, KS:
2,447,538, CANC. INT. CL. 9.
- CONSEIL EUROPEEN DE LA CONSTRUCTION; D'APPAR-
EILS DOMESTIQUES; AISBL EN ABRÉGÉ CECED, B-1030
BRUXELLES, BELGIUM:
3,398,684, PUB. 1-1-2008. MULTIPLE CLASS, INT. CLS. 7,
9, 11, 35, 37 AND 42.
- CONSOLIDATED CIGAR CORPORATION, FORT LAUDER-
DALE, FL TO MAX ROHR, INC., WILMINGTON, DE:
2,059,808, CANC. INT. CL. 34.
- CONSOLIDATED COMMERCE, INC., DES PLAINES, IL:
2,447,742, CANC. INT. CL. 35.
- CONSOLIDATED FIBERGLASS PRODUCTS COMPANY,
BAKERSFIELD, CA:
1,082,522. REN. 2-11-08. MULTIPLE CLASS, INT. CLS. 17
AND 19.
- CONSORTIUM FOR INTERNATIONAL CROP PROTEC-
TION, CORVALLIS, OR:
2,447,556, CANC. INT. CL. 42.
- CONSORZIO TUTELA PECORINO TOSCANO D.O.P.,
GROSSETO, ITALY:
3,396,956, PUB. 1-1-2008. U.S. CL. A.
- CONSTANT CONTACT, INC., WALTHAM, MA:
3,399,937, INT. CL. 38.
- CONSUMERS UNION OF UNITED STATES, INC., YON-
KERS, NY:
3,396,985, PUB. 1-1-2008. INT. CL. 35.
- CONTAINER YACHTS LLC, BUFFALO, NY:
3,399,804, INT. CL. 12.
3,399,805, INT. CL. 12.
- CONTECH CONSTRUCTION PRODUCTS INC., MIDDLE-
TOWN, OH:
3,398,383, PUB. 1-1-2008. MULTIPLE CLASS, INT. CLS. 37
AND 40.
- CONTESSA PREMIUM FOODS, INC., SAN PEDRO, CA:
1,451,090. REN. 2-11-08. INT. CL. 29.
- CONTINENTAL AMERICAN INDUSTRIES INC., SAN
FRANCISCO, CA:
2,447,932, CANC. INT. CL. 28.

CONTINENTAL AUTOMOTIVE LICENSING CORP., AUBURN HILLS, MI:
3,399,785, INT. CL. 12.

CONTINENTAL COMMERCIAL PRODUCTS, LLC, BRIDGETON, MO:
2,134,746, REN. 2-13-08, INT. CL. 9.

CONTINENTAL ELECTRONICS CORPORATION, DALLAS, TX:
2,155,443, REN. 2-11-08, INT. CL. 9.

CONTINUSERVE, LLC, CAMBRIDGE, MA:
3,396,829, PUB. 1-1-2008, INT. CL. 35.

CONVERGENCE MEDIA INC., TERRA COTTA, ONTARIO, CANADA:
2,447,754, CANC. INT. CL. 35.

CONVERGYS CMG UTAH INC., SOUTH JORDAN, UT:
2,448,475, CANC. INT. CL. 9.

COOL AIR INTERNATIONAL, INC., BLOOMINGTON, MN:
3,397,947, PUB. 1-1-2008, INT. CL. 11.

COOL MOUNTAIN CREAMERY & CAFE LLC, CARY, NC:
2,448,103, CANC. MULTIPLE CLASS, INT. CLS. 30 AND 42.

COOLFIRE MEDIA, LLC, ST. LOUIS, MO:
3,398,083, PUB. 1-1-2008, INT. CL. 41.

COOMER, MICHAEL LEE, MONROEVILLE, IN:
3,397,042, PUB. 1-1-2008, INT. CL. 31.

COOPER COSMETICS S.A., GENEVA, SWITZERLAND:
2,447,690, CANC. INT. CL. 3.

COOPER TECHNOLOGIES COMPANY, HOUSTON, TX, AIRETOOL MANUFACTURING COMPANY, THE, SPRINGFIELD, OH:
659,290, REN. 2-14-08, U.S. CL. 23 (INT. CL. 7).

COOPER, DEBORRAH LYNNE, OAKLAND, CA:
2,059,008, CANC. INT. CL. 41.

COOPERATIVE HOUSING FOUNDATION LIMITED, SILVER SPRING, MD:
3,329,142, COR. MULTIPLE CLASS, INT. CLS. 35, 36, 37, 42 AND 43.

COORS GLOBAL PROPERTIES, INC., LAKEWOOD, CO:
2,448,018, CANC. INT. CL. 42.

COORS GLOBAL PROPERTIES, INC., GOLDEN, CO:
2,627,460, CANC. INT. CL. 20.

COPERNICUS EDUCATIONAL PRODUCTS INC., ARTHUR, CANADA:
3,397,499, PUB. 1-1-2008, INT. CL. 16.

COR.MAR S.A.S; DI CORVARI MARINO & C., ITALY:
3,398,809, PUB. 1-1-2008, MULTIPLE CLASS, INT. CLS. 18 AND 25.

CORAL CAST, LLC, PLAINVIEW, NY:
3,400,249, INT. CL. 19.

CORD, BARRY STEVEN, NEW YORK, NY:
3,399,978, INT. CL. 14.

CORDIS CORPORATION, MIAMI LAKES, FL:
3,398,898, INT. CL. 10.

CORINNE DAMAS-SANDIFORD, FRANCE:
3,398,784, PUB. 1-1-2008, MULTIPLE CLASS, INT. CLS. 9, 35 AND 41.

CORNERSPEED INC., CHARLOTTE, NC:
3,397,492, PUB. 1-1-2008, MULTIPLE CLASS, INT. CLS. 25 AND 41.

CORNICHE GROUP, INC., EULESS, TX:
2,447,468, CANC. INT. CL. 36.

CORONADO RUNABOUTS INC., EUREKA SPRINGS, AR:
3,398,447, PUB. 1-1-2008, INT. CL. 12.

CORPORACION ITALCAMBIO, C.A., CARACAS, VENEZUELA:
3,400,018, INT. CL. 36.

CORPORATE MEDIA PARTNERS, LOS ANGELES, CA, DBA AMERICAST:
2,562,389, CANC. INT. CL. 41.

CORPORATE PROPERTY DISPOSITIONS, ATLANTA, GA:
3,397,516, PUB. 1-1-2008, INT. CL. 36.

CORPORATION FOR AMERICAN BANKING, WASHINGTON, DC:
3,397,104, PUB. 1-1-2008, INT. CL. 36.

CORRPRO COMPANIES, INC., MEDINA, OH:
2,501,468, CANC. INT. CL. 2.

CORSICA ENTERPRISES, LTD., PERKASIE, PA:
3,397,601, PUB. 1-1-2008, INT. CL. 35.
3,397,602, PUB. 1-1-2008, INT. CL. 35.

CORVIDEA, LLC, ALPHARETTA, GA:
3,397,372, PUB. 1-1-2008, MULTIPLE CLASS, INT. CLS. 35 AND 42.

COSBY, BRIAN K, REX, GA:
3,399,964, INT. CL. 41.

COSMETIC CREATIV SERVICE GMBH, KARLSFELD, FED REP GERMANY:
3,399,318, INT. CL. 3.

COSMETIC SPECIALTY LABS, INC., LAWTON, OK:
3,399,035, INT. CL. 3.

COSMOAGRO, S.A., PALMIRA VALLE, COLOMBIA:
3,399,733, INT. CL. 1.

COTMER PRODUCTIONS, INC., MCNEIL, TX:
2,448,236, CANC. INT. CL. 28.

COTY US LLC, NEW YORK, NY:
2,136,070, REN. 2-8-08, INT. CL. 3.

COUNCIL FOR INTERNATIONAL TAX EDUCATION, INC., WHITE PLAINS, NY:
2,195,539, REN. 2-12-08, INT. CL. 41.

COUNTRY HEARTH INN, INC., ATLANTA, GA:
1,438,743, CANC. INT. CL. 42.

COUNTRY LIFE, LLC, HAUPPAUGE, NY:
2,129,018, REN. 2-11-08, INT. CL. 5.
2,130,511, REN. 2-11-08, INT. CL. 5.
2,131,826, REN. 2-11-08, INT. CL. 5.

COUNTRY VISIONS, INC., VACAVILLE, CA:
2,187,619, REN. 2-12-08, INT. CL. 35.

COUNTRYWIDE ASSET & AUTO RECOVERY, L.P., MARYLAND HEIGHTS, MO:
3,400,244, MULTIPLE CLASS, INT. CLS. 36 AND 39.

COUNTY OF CHESTERFIELD, VIRGINIA, CHESTERFIELD, VA:
3,398,157, PUB. 1-1-2008, INT. CL. 35.

COUPONS, INC., MOUNTAIN VIEW, CA:
3,398,474, PUB. 1-1-2008, INT. CL. 42.

COUSIN CORPORATION OF AMERICA, LARGO, FL:
3,397,860, PUB. 1-1-2008, INT. CL. 3.

COVENANT RELIANCE PRODUCERS, LLC, NASHVILLE, TN:
3,398,317, PUB. 1-1-2008, INT. CL. 41.

COVER-POOLS INCORPORATED, SALT LAKE CITY, UT:
1,491,180, REN. 2-11-08, INT. CL. 22.

COVIDIEN AG, NEUHAUSEN AM RHEINFALL, SWITZERLAND:
1,474,852, REN. 2-13-08, INT. CL. 10.
1,888,352, REN. 2-13-08, INT. CL. 10.
3,398,203, PUB. 1-1-2008, INT. CL. 41.

CRAFTMADE INTERNATIONAL, INC., COPPELL, TX:
3,397,943, PUB. 1-1-2008, INT. CL. 11.

CRAFTS, ETC!, LTD., OKLAHOMA CITY, OK:
3,398,013, PUB. 1-1-2008, INT. CL. 35.

CRAIG ANTHONY POLSTON, FREDERICKSBURG, VA:
3,400,168, INT. CL. 16.

CRANE PLASTICS SIDING LLC, COLUMBUS, OH:
3,400,151, INT. CL. 42.
3,400,152, INT. CL. 19.

CRB INC., CHULA VISTA, CA, DBA AMERICAN BIOLOGICS:
3,396,871, PUB. 1-1-2008, INT. CL. 5.

CREATION TECHNOLOGIES, BURNABY, CANADA:
3,397,633, PUB. 1-1-2008, INT. CL. 35.
3,397,634, PUB. 1-1-2008, INT. CL. 39.
3,397,635, PUB. 1-1-2008, INT. CL. 40.
3,397,636, PUB. 1-1-2008, INT. CL. 42.

CREATIONS BY ALAN STUART, INC., NEW YORK, NY:
2,448,532, CANC. INT. CL. 5.

CREATIONS BY YOU, ENGLEWOOD, CO:
3,400,320, INT. CL. 16.
3,400,321, INT. CL. 16.

CREATIVE ADVANTAGE, INC., SAN RAFAEL, CA:
2,059,039, CANC. INT. CL. 41.

CREATIVE COMMERCE, LLC, NEW YORK, NY:
3,400,392, INT. CL. 35.

CREATIVE DESIGN GROUP, DEERFIELD, FL:
3,400,177, INT. CL. 6.

- CREDIT GENIE FRANCHISING, LLC, DAPHNE, AL, DBA CREDIT GENIE:
3,398,181, PUB. 1-1-2008. INT. CL. 36.
3,398,185, PUB. 1-1-2008. INT. CL. 36.
- CREDO TECHNOLOGY CORPORATION, BROADVIEW, IL:
3,398,028, PUB. 1-1-2008. INT. CL. 7.
- CREOMED, INC., NAPLES, FL:
3,398,518, PUB. 1-1-2008. MULTIPLE CLASS, INT. CLS. 5 AND 35.
- CRI SYSTEMS, INC., ELKRIDGE, MD:
3,398,492, PUB. 1-1-2008. INT. CL. 9.
- CRIA TECHNOLOGIES INC., LOS ALTOS, CA:
2,447,477, CANC. INT. CL. 42.
- CRICKET COMMUNICATIONS, INC., SAN DIEGO, CA:
3,397,319, PUB. 1-1-2008. INT. CL. 38.
- CRICKET PRODUCTIONS INC, MARLBORO, MA:
3,399,217, INT. CL. 21.
- CRISIS CARE NETWORK, INC., DORR, MI:
2,447,498, CANC. MULTIPLE CLASS, INT. CLS. 41 AND 42.
- CRISTALL U.S.A., INC., BOCA RATON, FL:
2,216,762, REN. 2-11-08. INT. CL. 33.
3,396,938, PUB. 1-1-2008. INT. CL. 33.
- CRITERIA CORPORATION, LOS ANGELES, CA:
3,400,081, INT. CL. 35.
- CRITICAL PURSUITS, FULLERTON, CA:
3,397,252, PUB. 1-1-2008. INT. CL. 35.
- CRITICAL SIGNAL TECHNOLOGIES, FARMINGTON HILLS, MI:
3,397,231, PUB. 1-1-2008. INT. CL. 44.
3,397,232, PUB. 1-1-2008. INT. CL. 44.
- CRODA, INC., EDISON, NJ:
3,399,293, INT. CL. 1.
- CROSBY SERVICES, INC., PROVO, UT:
3,400,187, INT. CL. 5.
- CROSSTEX INTERNATIONAL, INC., HAUPPAUGE, NY:
2,369,241, CANC. INT. CL. 10.
- CROWLEY DEBORAH E. EUREKA, CA:
3,397,510, PUB. 1-1-2008. INT. CL. 16.
- CROWN CENTRAL LLC, BALTIMORE, MD:
2,129,362, REN. 2-13-08. MULTIPLE CLASS, INT. CLS. 16, 35, 36 AND 42.
- CRYSTAL COAST TOURNAMENT, INC., MOREHEAD CITY, NC:
2,167,062, REN. 2-14-08. INT. CL. 41.
- CRYSTAL SPRINGS RANCH, INC., WILSON, WY:
3,399,350, INT. CL. 25.
- CRYSTALIER, LIMITED, EVERGREEN, CO:
3,399,047, MULTIPLE CLASS, INT. CLS. 21 AND 35.
- CSS TEST INC., VOORHEES, NJ:
3,397,065, PUB. 1-1-2008. MULTIPLE CLASS, INT. CLS. 44 AND 45.
- CSSN, INC., LOS ANGELES, CA, DBA CARD SCANNING SOLUTIONS:
3,397,544, PUB. 1-1-2008. INT. CL. 9.
- CTR SYSTEMS, INC., WARRENDALE, PA:
1,970,882, REN. 2-14-08. INT. CL. 9.
- CU SERVICE NETWORK, INC., LAKEWOOD, CO:
3,397,681, PUB. 1-1-2008. INT. CL. 36.
- CUBIS FINANCIAL, LTD., LAS VEGAS, NV:
3,399,504, INT. CL. 36.
- CULINARY STANDARDS CORPORATION, LOUISVILLE, KY:
1,475,168, REN. 2-11-08. INT. CL. 29.
- CULVER ENTERPRISES, INC., PRAIRIE DU SAC, WI:
2,106,167, REN. 2-14-08. INT. CL. 30.
- CUPCAFE NY, LLC, NEW YORK, NY, DBA MOCCA LOUNGE:
3,398,144, PUB. 1-1-2008. INT. CL. 43.
- CURRAN MANUFACTURING CORPORATION, HAUPPAUGE, NY:
3,399,287, INT. CL. 7.
- CURRAN, EDWARD J., GLENVIEW, IL:
2,530,868, CANC. INT. CL. 35.
- CURRENT MEDICINE GROUP, LLC, PHILADELPHIA, PA:
3,397,242, PUB. 1-1-2008. INT. CL. 9.
3,397,243, PUB. 1-1-2008. INT. CL. 9.
- CURRY, MARCUS, SAN DIEGO, CA:
2,448,495, CANC. INT. CL. 42.
- CURTSCO ROBB MEDIA, LLC, MALIBU, CA:
3,400,285, INT. CL. 16.
- CURTIS SUPERIOR VALVE COMPANY, INC., CHANDLER, AZ:
1,484,186, REN. 2-11-08. INT. CL. 12.
- CURWOOD INC., OSHKOSH, WI, ARVEY CORPORATION, CHICAGO, IL:
1,480,708, REN. 2-13-08. INT. CL. 10.
- CURWOOD, INC., OSHKOSH, WI:
1,479,338, REN. 2-13-08. INT. CL. 7.
2,169,523, REN. 2-13-08. INT. CL. 7.
2,174,655, REN. 2-11-08. INT. CL. 7.
- CUSHING, EDWIN A., RIDGEFIELD, WA:
3,397,864, PUB. 1-1-2008. INT. CL. 37.
- CUSTOM BUILDING PRODUCTS, INC., SEAL BEACH, CA:
3,400,210, MULTIPLE CLASS, INT. CLS. 2 AND 19.
- CUSTOM CARBRIDE CORPORATION, SPRINGFIELD, MA:
2,447,422, CANC. INT. CL. 7.
- CUSTOM METALCRAFT, INC., SPRINGFIELD, MO:
3,400,142, INT. CL. 6.
- CUSTOM PLASTECH LTD., NEWBURY, OH:
2,447,605, CANC. INT. CL. 20.
- CUSTOM PLASTICS, INC., ELK GROVE VILLAGE, IL:
2,059,084, CANC. INT. CL. 20.
- CUSTOM PROTECT EAR INC., SURREY, B.C., CANADA:
3,397,310, PUB. 1-1-2008. INT. CL. 9.
3,397,399, PUB. 1-1-2008. INT. CL. 9.
- CUSTOM SYNTHESIS, LLC, ANDERSON, SC:
3,399,851, INT. CL. 4.
- CUSTOMER POTENTIAL MANAGEMENT CORPORATION, EAST PEORIA, IL:
2,133,479, REN. 2-14-08. INT. CL. 9.
- CUSTOMERS FOREVER, INC., MEQUON, WI:
2,448,203, CANC. INT. CL. 36.
- CUTLERY SHOPPE, INC., MERIDIAN, ID:
2,447,906, CANC. INT. CL. 8.
- CUTLIP, CHERYL HEBERT, NEW YORK, NY:
3,397,599, PUB. 1-1-2008. INT. CL. 41.
- CUTSFORTH PRODUCTS, INC., COHASSET, MN:
3,397,170, PUB. 1-1-2008. INT. CL. 7.
- CVS PHARMACY, INC., WOONSOCKET, RI:
2,132,330, REN. 2-12-08. INT. CL. 30.
2,447,934, CANC. MULTIPLE CLASS, INT. CLS. 20, 21, 22 AND 25.
- CW AUTOMOTIVE, INC., SYOSSET, NY:
3,396,850, PUB. 1-1-2008. INT. CL. 7.
- CYANOTECH CORPORATION, KAILUA-KONA, HI:
2,220,267, REN. 2-14-08. INT. CL. 1.
2,448,406, CANC. INT. CL. 5.
- CYBER ANGEL SECURITY SOLUTIONS, INC., NASHVILLE, TN:
3,397,658, PUB. 1-1-2008. INT. CL. 9.
- CYBERCORP, INC., AUSTIN, TX:
2,447,552, CANC. INT. CL. 9.
- CYBERLINK CORPORATION, TAIPEI, TAIWAN:
3,398,403, PUB. 1-1-2008. INT. CL. 9.
- CYBERNET ENTERTAINMENT, LLC, SAN FRANCISCO, CA:
3,396,959, PUB. 9-25-2007. INT. CL. 41.
- CYBEROPTICS CORPORATION, MINNEAPOLIS, MN:
2,140,068, REN. 2-9-08. INT. CL. 9.
- CYBERSET, LLC, SAN FRANCISCO, CA:
3,399,424, INT. CL. 9.
- CYNTHIA ERB, ALAMO, CA:
3,397,606, PUB. 1-1-2008. INT. CL. 42.
- CYNTHIA S FERRARO, SPRINGBORO, OH:
3,397,825, PUB. 1-1-2008. INT. CL. 3.
- CYPRESS FAIRBANKS MEDICAL CENTER, INC., DALLAS, TX:
3,399,968, INT. CL. 44.
- CYPRESS PERFORMING ARTS ASSOCIATION, SAN FRANCISCO, CA:
3,398,022, PUB. 1-1-2008. INT. CL. 41.
- CYTOSPORT, INC., BENICIA, CA:
3,397,203, PUB. 1-1-2008. MULTIPLE CLASS, INT. CLS. 5 AND 32.

D & S FARMS, PITTSBURGH, NJ:
3,399,559, INT. CL. 1.

D. COLUCCIO & SONS, INC., BROOKLYN, NY:
3,397,027, PUB. 1-1-2008. INT. CL. 29.

D. G. YUENGLING & SON, INC., POTTSVILLE, PA:
2,059,723, CANC. INT. CL. 32.

D.T.R. SERVICES, INC., MODESTO, CA:
2,448,121, CANC. INT. CL. 9.

D'AMATO MALONEY & LONBORG, ATTORYS AT LAW,
HONOLULU, HI:
2,448,525, CANC. INT. CL. 42.

D'ANDREA BROTHERS LLC, LOS ANGELES, CA:
2,059,829, CANC. INT. CL. 25.

D'ARCY, JAN T., EDMONDS, WA:
3,397,588, PUB. 1-1-2008. INT. CL. 41.

D'ARRIGO BROTHERS COMPANY OF CALIFORNIA, SAL-
INAS, CA:
2,156,325, REN. 2-12-08. INT. CL. 31.

DAD'S PET CARE, MEADVILLE, PA:
2,135,068, REN. 2-11-08. INT. CL. 31.

DAD'S PRODUCTS CO., INC., MEADVILLE, PA, DBA
DAD'S PET CARE:
3,399,742, INT. CL. 31.

DADE BEHRING INC., DEERFIELD, IL:
2,447,301, CANC. MULTIPLE CLASS, INT. CLS. 5, 9 AND
10.

DAEDAL VENTURES, LLC, REDMOND, WA:
3,400,074, INT. CL. 25.

DAEMO ENGINEERING CO., LTD., SEOUL, REPUBLIC OF
KOREA:
2,448,389, CANC. INT. CL. 7.

DAIMLER AG, STUTTGART, FED REP GERMANY:
657,386, REN. 2-14-08. U.S. CL. 19 (INT. CL. 12).
657,387, REN. 2-14-08. U.S. CL. 19 (INT. CL. 12).
657,414, REN. 2-14-08. U.S. CL. 23 (INT. CLS. 7, 8 AND 12).
842,438, REN. 2-10-08. U.S. CL. 34 (INT. CL. 11).

DAIMLERCHRYSLER AG, 70567 STUTTGART, FED REP
GERMANY:
3,109,619, COR. INT. CL. 36.

DAIMLERCHRYSLER AG, D-70567 STUTTGART, FED REP
GERMANY:
3,397,182, PUB. 1-1-2008. INT. CL. 12.

DAKOTA VIDEO & POST PRODUCTIONS, L.L.C., SIOUX
FALLS, SD:
3,397,698, PUB. 1-1-2008. INT. CL. 35.

DALEN PRODUCTS, INC., KNOXVILLE, TN:
1,495,838, REN. 2-11-08. INT. CL. 22.

DALEY, DAHLIA C, BOWIE, MD:
3,399,375, MULTIPLE CLASS, INT. CLS. 35 AND 36.

DALIC, S.A., RUE DES EAUX, 35500 VITRE, FRANCE:
2,058,556, CANC. INT. CL. 9.

DALLA BETTA, RALPH A., MOUNTAIN VIEW, CA:
3,397,034, PUB. 1-1-2008. INT. CL. 42.

DALLEK GARY M, MINNEAPOLIS, MN:
2,448,569, CANC. INT. CL. 42.

DAN RIVER INC., DANVILLE, VA:
3,399,749, INT. CL. 18.
3,399,750, INT. CL. 25.

DANGLER, PAUL J., SARASOTA, FL:
3,399,831, INT. CL. 14.

DANIELS WHOLESALE SIGN & PLASTICS, INC., DELAND,
FL:
3,398,196, PUB. 1-1-2008. INT. CL. 35.

DANISCO A/S, DK-1001 KOBENHAVN K, DENMARK:
2,131,658, REN. 2-11-08. INT. CL. 1.
2,131,658, CANC. INT. CL. 30.

DANISCO A/S, DK-1001 COPENHAGEN K, DENMARK:
3,398,712, PUB. 1-1-2008. INT. CL. 1.
3,398,713, PUB. 1-1-2008. INT. CL. 1.

DANZIGER - DAN FLOWER FARM, BEIT DAGAN, IS-
RAEL:
3,397,345, PUB. 1-1-2008. INT. CL. 31.

DART MANUFACTURING COMPANY, DALLAS, TX:
2,117,017, REN. 2-13-08. INT. CL. 42.

DARWIN PROFESSIONAL UNDERWRITERS, INC., FARM-
INGTON, CT:
3,398,420, PUB. 1-1-2008. INT. CL. 36.

DASHAMERICA, INC., BROOMFIELD, CO:
2,059,443, CANC. INT. CL. 25.

DATACOLOR HOLDING AG., LUZERN, SWITZERLAND:
3,399,442, INT. CL. 9.

DATAFLOW/ALASKA, INC., ANCHORAGE, AK:
3,399,539, INT. CL. 42.

DAVES, JADA L., OOLTEWAH, TN:
2,448,299, CANC. MULTIPLE CLASS, INT. CLS. 16 AND
25.

DAVID & YOUNG CO, NEW YORK, NY:
3,397,308, PUB. 1-1-2008. INT. CL. 25.

DAVID DEVIN, STAMFORD, CT:
3,397,036, PUB. 1-1-2008. INT. CL. 35.

DAVID FEELEY, WATERFORD, IRELAND:
3,398,621, PUB. 1-1-2008. MULTIPLE CLASS, INT. CLS. 9,
16 AND 38.

DAVID M GRASMICK, UPLAND, CA:
3,399,395, INT. CL. 41.

DAVIS, SR. ANTONIO M., LYNCHBURG, VA:
3,397,235, PUB. 1-1-2008. INT. CL. 28.

DAWG PRODUCTIONS LLC, DEXTER, MI:
3,400,261, INT. CL. 9.

DAYS HEALTHCARE U.K. LIMITED, BRIDGEND, MID
GLAMORGAN, UNITED KINGDOM:
3,398,359, PUB. 9-25-2007. MULTIPLE CLASS, INT. CLS.
10 AND 12.

DAYSRING CARDS, INC., SILOAM SPRINGS, AR, GOS-
PEL TRUMPET COMPANY, ANDERSON, IN:
348,905, REN. 2-11-08. U.S. CL. 38 (INT. CL. 16).

DC STANFA ENTERPRISES, LLC, CINCINNATI, OH:
3,400,318, INT. CL. 25.

DCM ALLIANCE, LLC, RANDOLPH, NJ:
3,398,117, PUB. 1-1-2008. INT. CL. 35.

DCS DAYLIGHT CLEANING SYSTEMS INC., CALGARY,
ALBERTA:
3,396,834, PUB. 1-1-2008. INT. CL. 16.

DC3 ENTERTAINMENT, LLC, SEATTLE, WA:
3,398,077, PUB. 1-1-2008. INT. CL. 30.
3,398,080, PUB. 1-1-2008. INT. CL. 30.

DD IP HOLDER LLC, CANTON, MA:
3,399,798, INT. CL. 43.

DEALERS WHOLESALE, INC., CHICAGO, IL:
2,448,284, CANC. INT. CL. 1.

DEAN INTELLECTUAL PROPERTY SERVICES, L.P., DAL-
LAS, TX, LEHIGH VALLEY DAIRIES, INC., LANSDALE,
PA:
2,135,366, REN. 2-12-08. MULTIPLE CLASS, INT. CLS. 29
AND 32.

DEARDEN'S, LOS ANGELES, CA:
2,163,612, REN. 2-11-08. MULTIPLE CLASS, INT. CLS. 39
AND 42.
2,163,613, REN. 2-11-08. INT. CL. 35.

DECIPHER, INC., NORFOLK, VA:
2,448,134, CANC. INT. CL. 28.

DECISION NEWS MEDIA SAS, FRANCE:
3,398,659, PUB. 1-1-2008. MULTIPLE CLASS, INT. CLS. 9,
35, 38, 41 AND 42.
3,398,660, PUB. 1-1-2008. MULTIPLE CLASS, INT. CLS. 9,
35, 38, 41 AND 42.

DEEP FOODS, INC., UNION, NJ:
2,141,311, REN. 2-14-08. MULTIPLE CLASS, INT. CLS. 29
AND 30.

DEERE & COMPANY, MOLINE, IL:
3,398,748, PUB. 1-1-2008. MULTIPLE CLASS, INT. CLS. 7,
9, 12 AND 41.

DEFENSE PROCUREMENT MANUFACTURING SER-
VICES, INC., ST. CLOUD, MN:
3,397,174, PUB. 1-1-2008. INT. CL. 13.

DEGNAN, JOHN (JACK) PATRICK, TROY, NY:
2,447,347, CANC. INT. CL. 41.

DEGRAFF, ADAM J., LEWISBURG, WV:
3,397,858, PUB. 1-1-2008. INT. CL. 41.

DEHART, GREGORY M., JAMUL, CA:
3,399,564, INT. CL. 30.

DEHCO, INC., ELKHART, IN:
3,397,405, PUB. 1-1-2008. INT. CL. 39.

- DEL FRESCO PRODUCE LTD., KINGSVILLE, ONTARIO, CANADA:
3,399,108, INT. CL. 31.
- DEL LABORATORIES, INC., UNIONDALE, NY:
3,399,731, INT. CL. 3.
- DEL MONTE CORPORATION, SAN FRANCISCO, CA:
3,399,045, INT. CL. 31.
- DELAWARE CAPITAL FORMATION, INC., WILMINGTON, DE:
1,082,341, REN. 2-11-08. INT. CL. 9.
3,397,132, PUB. 1-1-2008. INT. CL. 7.
- DELAWARE RIVER MARITIME ENTERPRISE COUNCIL, TREVOSE, PA:
3,398,425, PUB. 1-1-2008. MULTIPLE CLASS, INT. CLS. 35 AND 45.
- DELAWARE SLEEP DISORDER CENTERS, LLC, NEWARK, DE:
3,399,074, INT. CL. 44.
- DELI SOURCE, INC., THE, ANTIOCH, IL:
2,134,481, REN. 2-13-08. INT. CL. 29.
- DELL INC., ROUND ROCK, TX:
3,399,117, INT. CL. 9.
- DELORME PUBLISHING COMPANY, INC., YARMOUTH, ME:
2,448,163, CANC. INT. CL. 42.
- DELTA GOLF CO., CHICAGO, IL:
1,438,638, CANC. INT. CL. 28.
- DELTA TECH MOLD, INC., ARLINGTON HEIGHTS, IL:
2,447,348, CANC. INT. CL. 40.
- DEMAIN TECHNOLOGY PTY LTD, BRAESIDE VIC 3195, AUSTRALIA:
3,398,730, PUB. 1-1-2008. INT. CL. 7.
- DEMATTEIS, BOB, GRASS VALLEY, CA:
2,448,541, CANC. INT. CL. 16.
- DEMRAY, WILLIAM S., NORTHVILLE, MI AND LEBLOCH, DENISE S., ST. CHARLES, IL:
3,400,297, INT. CL. 41.
3,400,298, INT. CL. 44.
- DENEL (PTY) LIMITED, CAPE PROVINCE, SOUTH AFRICA:
2,130,848, REN. 2-14-08. INT. CL. 13.
- DENISE N. BOOTHMAN AND GEORGE J. BOOTHMAN, IV PARTNERSHIP, THE, PHILADELPHIA, PA, DBA EVERY DAY'S A WIN:
3,399,587, INT. CL. 9.
- DENNY HECKER'S AUTOMOTIVE GROUP, INC., MINNEAPOLIS, MN:
3,396,842, PUB. 1-1-2008. MULTIPLE CLASS, INT. CLS. 35, 36, 37 AND 39.
- DENVER NUGGETS LIMITED PARTNERSHIP, THE, DENVER, CO:
3,399,570, INT. CL. 16.
- DEO L.L.C., SAN ANSELMO, CA:
2,448,043, CANC. MULTIPLE CLASS, INT. CLS. 16, 25 AND 42.
- DERMATOLOGICAL SCIENCES CORPORATION, NEW YORK, NY:
2,448,117, CANC. MULTIPLE CLASS, INT. CLS. 3 AND 5.
- DERMFX, P.C., ROSWELL, GA:
3,398,072, PUB. 1-1-2008. INT. CL. 35.
- DERRYBERRY, DOUGLAS, CARLSBAD, CA:
3,397,003, PUB. 1-1-2008. INT. CL. 39.
- DESERT DREAMS PRODUCTIONS, LLC, PHOENIX, AZ:
3,399,094, INT. CL. 9.
- DESIGN PAC, INC., MELROSE PARK, IL:
3,400,360, INT. CL. 30.
- DESIGN WITHIN REACH, INC., SAN FRANCISCO, CA:
3,398,550, PUB. 1-1-2008. INT. CL. 41.
- DESIGNER SKIN, L.L.C., PHOENIX, AZ:
3,399,374, INT. CL. 3.
- DESROSIER, LAURIE M., ACTON, MA:
3,398,876, INT. CL. 28.
- DETROIT PISTONS BASKETBALL COMPANY, AUBURN HILLS, MI:
1,085,719, REN. 2-14-08. INT. CL. 41.
3,399,421, INT. CL. 28.
- DEUTSCHE BANK AG, LONDON, UNITED KINGDOM:
3,397,227, PUB. 1-1-2008. MULTIPLE CLASS, INT. CLS. 16, 35 AND 36.
3,397,228, PUB. 1-1-2008. MULTIPLE CLASS, INT. CLS. 16, 35 AND 36.
- DEUTSCHE TELEKOM AG, BONN, FED REP GERMANY:
3,397,439, PUB. 1-1-2008. INT. CL. 38.
3,398,416, PUB. 1-1-2008. INT. CL. 39.
3,398,577, PUB. 1-1-2008. INT. CL. 43.
- DEVELOPMENT CAPITAL COMPANY, L.L.C., ALEXANDRIA, VA:
2,447,330, CANC. INT. CL. 36.
- DEVON GLENN, SHERMAN OAKS, CA:
3,397,297, PUB. 1-1-2008. INT. CL. 39.
- DEVONE LAWSON, INCORPORATED, MARINA DEL REY, CA:
3,398,266, PUB. 1-1-2008. INT. CL. 31.
- DEVRO PLC, CHRYSTON, SCOTLAND:
2,448,282, CANC. INT. CL. 29.
- DEWEES, PAUL J., GRANDVIEW, MO:
2,134,236, REN. 2-11-08. INT. CL. 9.
- DEWIED INTERNATIONAL, INC., SAN ANTONIO, TX:
3,397,044, PUB. 1-1-2008. INT. CL. 18.
- DFS GROUP L.P., SAN FRANCISCO, CA:
2,273,448, AM. INT. CL. 35.
- DG PERFORMANCE SPECIALTIES, INC, ANAHEIM, CA:
3,398,902, INT. CL. 7.
- DGDAWG REELS, ELK GROVE, CA:
3,399,566, MULTIPLE CLASS, INT. CLS. 41 AND 42.
- DIABLOSPORT, LLC, BOCA RATON, FL:
3,398,912, INT. CL. 9.
- DIAGEO BRANDS B.V., AMSTERDAM 1014 BG, NETHERLANDS:
3,397,721, PUB. 1-1-2008. INT. CL. 33.
3,397,723, PUB. 1-1-2008. INT. CL. 33.
- DIAGEO NORTH AMERICA, INC., NORWALK, CT:
3,397,286, PUB. 1-1-2008. INT. CL. 33.
- DIAL CORP, THE, PHOENIX, AZ TO DIAL BRANDS, INC., SCOTTSDALE, AZ:
2,058,727, CANC. INT. CL. 3.
- DIAMOND AND JEWELRY GALLERY, INC., WOODLAND HILLS, CA:
3,400,019, INT. CL. 35.
- DIAMOND B BEEF, L.L.C., PALMER, NE:
2,447,717, CANC. INT. CL. 29.
- DIANE THOMAS, QUEENSVILLE, CANADA:
3,397,115, PUB. 1-1-2008. INT. CL. 16.
- DIAZ, LOU, SANTA PAULA, CA:
2,447,782, CANC. INT. CL. 35.
- DICKERSON, KIMBERLY, NEW YORK, NY:
3,399,396, INT. CL. 16.
- DIDIER, ANTHONY G, FORT WAYNE, IN:
3,398,059, PUB. 1-1-2008. INT. CL. 41.
- DIELECTRIC SOLUTIONS, LLC, KITTANNING, PA:
3,397,340, PUB. 1-1-2008. INT. CL. 21.
- DIGI-KEY CORPORATION, THIEF RIVER FALLS, MN:
1,487,965, REN. 2-11-08. INT. CL. 42.
- DIGITAL INFO SECURITY CO, INC, WESTMINSTER, CO:
3,397,409, PUB. 1-1-2008. INT. CL. 9.
- DIGITAL PAYMENT TECHNOLOGIES CORP., BURNABY, BRITISH COLUMBIA, CANADA:
3,400,204, INT. CL. 9.
- DIGITAL TELEMEDIA INC., NEW YORK, NY, DBA LOGICWORKS:
3,399,967, INT. CL. 42.
- DILIGENT ENVIRONMENTAL SERVICES, INC., BOCA RATON, FL:
3,398,910, INT. CL. 37.
- DILLON COMPANIES, INC., HUTCHINSON, KS:
1,086,169, REN. 2-14-08. INT. CL. 42.
1,089,900, REN. 2-14-08. INT. CL. 42.
- DIMCOGRAY CORPORATION, CENTERVILLE, OH:
3,397,786, PUB. 1-1-2008. INT. CL. 20.
- DININGFEVER LLC, JERSEY CITY, NJ:
3,399,682, INT. CL. 35.
- DIRECT SELLING WOMEN'S ALLIANCE, INC., KAILUA, HI:
3,400,319, INT. CL. 35.
- DIRECT SUPPLY, INC., MILWAUKEE, WI:
3,398,470, PUB. 1-1-2008. INT. CL. 35.

DIRSCHERL, DANIEL D., EAGLE RIVER, AK:
3,397,508, PUB. 1-1-2008. INT. CL. 37.

DIRTY ROYALTY, LLC, MIRAMAR, FL:
3,397,424, PUB. 1-1-2008. INT. CL. 25.

DISC GOLF ASSOCIATION, INC., WATSONVILLE, CA:
2,447,682, CANC. INT. CL. 28.

DISCOVER RE MANAGERS, INC., FARMINGTON, CT:
3,400,054, INT. CL. 36.

DISCOVER RESTAURANTS, LTD., SAN ANTONIO, TX:
3,397,460, PUB. 1-1-2008. MULTIPLE CLASS, INT. CLS. 25 AND 43.

DISCOVERY COMMUNICATIONS, INC., BETHESDA, MD:
2,448,489, CANC. INT. CL. 41.
2,448,534, CANC. INT. CL. 41.
2,448,535, CANC. INT. CL. 41.

DISGUISE, INC., POWAY, CA:
3,399,059, INT. CL. 25.
3,399,064, INT. CL. 25.
3,400,184, INT. CL. 25.

DISH, LLC, BOULDER, CO:
3,398,610, PUB. 1-1-2008. INT. CL. 43.

DISNEY ENTERPRISES, INC., BURBANK, CA:
3,397,256, PUB. 1-1-2008. INT. CL. 41.
3,399,326, INT. CL. 36.
3,399,385, INT. CL. 9.
3,399,724, INT. CL. 41.

DISTINCT INDULGENCE, INC., GLENDALE, CA:
3,397,879, PUB. 1-1-2008. INT. CL. 30.
3,397,881, PUB. 1-1-2008. INT. CL. 30.

DISTRIBUIDORA DE ALIMENTOS NATURALES Y NUTRICIONALES, S.A. DE C.V., MEXICO, MEXICO:
3,399,242, INT. CL. 5.
3,399,243, INT. CL. 5.

DISTRIBUIDORA DE ALIMENTOS NATURALES Y NUTRICIONALES, S.A. DE C.V., MEXICO, DISTRITO FEDERAL, MEXICO:
3,399,886, INT. CL. 5.

DIVAS UNCORKED, INC., MILTON, MA:
3,400,082, INT. CL. 33.

DIVERSIFIED ADVANTAGE GROUP, INC., NEWPORT BEACH, CA:
3,399,219, INT. CL. 5.

DIVERSIFIED CONTROL, INC., ORCHARD PARK, NY:
3,397,351, PUB. 1-1-2008. INT. CL. 9.

DIVINE VODKA, LLC, BARODA, MI:
3,399,627, INT. CL. 33.

DIXON, MARK A. HUNTINGTON BEACH, CA:
3,398,363, PUB. 1-1-2008. INT. CL. 3.

DMS ELECTRIC APPARATUS SERVICE, INC., KALAMAZOO, MI:
3,399,723, INT. CL. 7.

DNA ENTERPRISES, GOSHEN, IN:
2,058,969, CANC. INT. CL. 12.

DO SOMETHING!, INC., NEW YORK, NY:
3,399,653, INT. CL. 45.

DOBLIN INC., CHICAGO, IL:
3,398,184, PUB. 1-1-2008. INT. CL. 35.

DOGWATCH INC., NATICK, MA:
3,399,447, INT. CL. 9.

DOLE FOOD COMPANY, INC., WESTLAKE VILLAGE, CA:
3,398,308, PUB. 1-1-2008. INT. CL. 28.
3,398,309, PUB. 1-1-2008. INT. CL. 28.
3,398,310, PUB. 1-1-2008. INT. CL. 28.

DOLORES FONT CORTES, VILLA REAL, SPAIN:
3,397,191, PUB. 1-1-2008. INT. CL. 25.

DOLPHIN MEASUREMENT SYSTEMS, LLC, PROVIDENCE, RI:
3,257,522, COR. INT. CL. 9.

DOMINO PRINTING SCIENCES PLC, CAMBRIDGE, ENGLAND:
1,438,482, CANC. INT. CL. 7.

DON MECHANICS ENTERPRISES, LTD., ADDISON, TX:
3,400,189, INT. CL. 20.

DONG SUH FOODS CORPORATION, BUPYUNG-KU, REPUBLIC OF KOREA:
3,396,846, PUB. 11-14-2006. INT. CL. 30.

DONNELLY, ROBERT B., BOSTON, MA, DBA LEGAL COPY SPECIALISTS:
1,438,781, CANC. INT. CL. 35.

DONRUSS PLAYOFF, L.P., ARLINGTON, TX:
2,059,843, CANC. INT. CL. 16.

DORCHESTER CAPITAL MANAGEMENT COMPANY, HOUSTON, TX:
3,396,833, PUB. 1-1-2008. INT. CL. 36.

DOSTAL, JAMES A., JACKSON, MN:
2,448,275, CANC. INT. CL. 1.

DOTSTER, INC., VANCOUVER, WA:
3,399,028, INT. CL. 38.

DOUBLE BASS PRODUCTIONS, VAN NUYS, CA:
3,398,499, PUB. 1-1-2008. MULTIPLE CLASS, INT. CLS. 9 AND 41.

DOUBLE BLACK IMAGING CORPORATION, WESTMINSTER, CO:
3,397,442, PUB. 1-1-2008. INT. CL. 9.

DOW AGROSCIENCE LLC, INDIANAPOLIS, IN, DOW CHEMICAL COMPANY, THE, MIDLAND, MI:
1,489,842, REN. 2-14-08. INT. CL. 5.

DOW AGROSCIENCES LLC, INDIANAPOLIS, IN:
846,531, REN. 2-14-08. U.S. CL. 6 (INT. CL. 5).

DOW AGROSCIENCES LLC, INDIANAPOLIS, IN, STAUFFER CHEMICAL COMPANY, WESTPORT, CT:
1,090,662, REN. 2-14-08. INT. CL. 5.

DOW CHEMICAL COMPANY, THE, MIDLAND, MI, CARWIN COMPANY, THE, NORTH HAVEN, CT:
660,264, REN. 2-14-08. U.S. CL. 6 (INT. CL. 1).

DOWN EAST ENTERPRISE, INC., CAMDEN, ME:
3,398,251, PUB. 1-1-2008. INT. CL. 16.
3,398,288, PUB. 1-1-2008. INT. CL. 41.
3,398,305, PUB. 1-1-2008. INT. CL. 35.

DR. JIMMY, INC., CLEARWATER, FL:
3,397,946, PUB. 1-1-2008. INT. CL. 44.

DR. JOSE KATZ, CLOSTER, NJ:
3,400,362, INT. CL. 44.

DR. ORGANICS, INC, SAVAGE, MN:
3,400,307, INT. CL. 5.

DRAPER-O'CROTTY, HEATHER D., DES MOINES, WA:
3,397,585, PUB. 1-1-2008. INT. CL. 44.

DREAMWORKS ANIMATION L.L.C., GLENDALE, CA:
2,448,038, CANC. MULTIPLE CLASS, INT. CLS. 9, 16 AND 28.

DRI MANAGEMENT SYSTEMS, INC., NEWPORT BEACH, CA:
3,397,667, PUB. 1-1-2008. INT. CL. 42.

DRILLTEC PATENTS & TECHNOLOGIES CORPORATION, HOUSTON, TX, DRILLTEC REMP UND DREYFUSS, G.M.B.H., UELZEN, FED REP GERMANY, DBA DRILLTEC:
1,461,655, REN. 2-13-08. INT. CL. 6.

DRUG FREE WORKPLACE ADMINISTRATORS, INC., LAS VEGAS, NV:
2,447,491, CANC. INT. CL. 10.

DS WATERS OF AMERICA, INC., ATLANTA, GA:
3,340,862, COR. MULTIPLE CLASS, INT. CLS. 11, 32 AND 39.

DSM IP ASSETS B.V., HEERLEN, NETHERLANDS, SAVID S.P.A., COMO-TAVERNOLA, ITALY:
1,100,455, REN. 2-13-08. INT. CL. 1.

DUALFLEX COMPANY, LTD., WINDSOR, ONTARIO, CANADA:
1,092,606, REN. 2-11-08. MULTIPLE CLASS, INT. CLS. 3 AND 7.

DUBC, INC., CHINA SPRING, TX:
2,448,388, CANC. INT. CL. 10.

DUCKHORN WINE COMPANY, ST. HELENA, CA:
3,397,835, PUB. 1-1-2008. INT. CL. 33.

DUKE UNIVERSITY, DURHAM, NC:
2,537,692, CANC. INT. CL. 38.

DULCES ANAHUAC, S.A. DE C.V., PUE, MEXICO:
2,447,554, CANC. INT. CL. 30.

DUMANOGULLARI, SEMIH, LYNDHURST, NJ:
3,397,878, PUB. 1-1-2008. MULTIPLE CLASS, INT. CLS. 9 AND 45.

DUMONT, STEFANIE, CARLSBAD, CA:
3,399,521, MULTIPLE CLASS, INT. CLS. 16 AND 28.

- DUMPMATCH, LLC, PLANT CITY, FL:
3,398,067, PUB. 1-1-2008. INT. CL. 39.
- DUNDEE CORPORATION, TORONTO, ONTARIO, CANADA:
2,447,305, CANC. INT. CL. 36.
- DUNE CERAMICA, S.L., SAN JUAN DE MORO, CASTELLON, SPAIN:
2,136,613. REN. 2-11-08. INT. CL. 19.
- DUPUIS, MICHAEL J., SACRAMENTO, CA:
3,398,858, INT. CL. 25.
- DURACOTE CORPORATION, RAVENNA, OH:
1,438,590, CANC. INT. CL. 17.
2,448,309, CANC. MULTIPLE CLASS, INT. CLS. 17 AND 27.
- DURAMAX, INC., MIDDLEFIELD, OH:
1,438,491, CANC. INT. CL. 7.
- DURAY, JANET M, FARGO, ND:
3,399,528, INT. CL. 25.
- DVI COMMUNICATIONS, INC., NEW YORK, NY:
2,448,368, CANC. INT. CL. 42.
- DWECK INDUSTRIES, INC., NEW YORK, NY:
3,396,896, PUB. 1-1-2008. INT. CL. 14.
- DWYER INSTRUMENTS, INC., MICHIGAN CITY, IN:
3,397,050, PUB. 1-1-2008. INT. CL. 9.
- DYCOM IDENTITY, LLC, PALM BEACH GARDENS, FL:
3,398,413, PUB. 11-27-2007. INT. CL. 37.
3,398,414, PUB. 11-27-2007. INT. CL. 37.
3,398,415, PUB. 11-27-2007. INT. CL. 37.
- DYMAX CORPORATION, TORRINGTON, CT:
2,448,076, CANC. INT. CL. 42.
- DYNARIC, INC., VIRGINIA BEACH, VA:
1,082,603. REN. 2-14-08. INT. CL. 22.
- DYNASTY CLASSICS, REDONDO BEACH, CA:
1,438,541, CANC. INT. CL. 11.
- DYNASTY FOOTWEAR, LTD., EL SEGUNDO, CA:
3,266,560, CANC. INT. CL. 25.
3,266,561, CANC. INT. CL. 25.
- DYNIC USA CORP., HILLSBORO, OR:
2,156,351. REN. 2-8-08. INT. CL. 17.
- DYNO NOBEL INC., SALT LAKE CITY, UT:
2,059,213, CANC. INT. CL. 13.
- DYWIDAG-SYSTEMS INTERNATIONAL GMBH, D-85609 ASCHHEIM, FED REP GERMANY:
3,399,455, MULTIPLE CLASS, INT. CLS. 2, 6, 7, 8, 9, 19, 35, 36, 37 AND 42.
- D4D TECHNOLOGIES, LLC, RICHARDSON, TX:
3,399,669, INT. CL. 10.
- E J ACQUISITION LLC, NEW YORK, NY:
3,398,842, MULTIPLE CLASS, INT. CLS. 25 AND 26.
- E. & J. GALLO WINERY, MODESTO, CA:
2,448,342, CANC. INT. CL. 33.
- E. EXCEL INTERNATIONAL, INC., SANDY, UT:
3,399,138, INT. CL. 5.
- E. I. DU PONT DE NEMOURS AND COMPANY, WILMINGTON, DE:
1,083,519. REN. 2-13-08. INT. CL. 17.
3,399,451, INT. CL. 5.
- E-COLOR, INC., SAN FRANCISCO, CA:
2,447,863, CANC. INT. CL. 9.
- E-MON, LLC, LANGHORNE, PA:
1,518,764. REN. 2-13-08. INT. CL. 9.
- E-NATE INC., MONTREAL, QUEBEC, CANADA:
3,399,612, INT. CL. 44.
- E-VENTUS CORPORATION, CLEVELAND, OH:
3,397,478, PUB. 1-1-2008. INT. CL. 35.
- EAGLE MATERIALS IP LLC, DALLAS, TX:
3,399,358, MULTIPLE CLASS, INT. CLS. 16 AND 19.
- EAGLE TAX SERVICES GROUP, INC., PHILADELPHIA, PA:
3,398,319, PUB. 1-1-2008. INT. CL. 35.
3,398,320, PUB. 1-1-2008. INT. CL. 35.
- EAR-TRONICS, INC., FORT MYERS, FL:
3,398,482, PUB. 1-1-2008. MULTIPLE CLASS, INT. CLS. 10 AND 44.
- EARNHARDT, TERESA H, MOORESVILLE, NC FROM EARNHARDT, RALPH DALE, MOORESVILLE, NC:
3,398,840, INT. CL. 25.
- EARTH FRIENDLY CHEMICALS, INC., VIRGINIA BEACH, VA:
3,397,932, PUB. 1-1-2008. INT. CL. 3.
- EASCO HAND TOOLS, INC., SIMSBURY, CT:
3,399,218, INT. CL. 8.
- EASTERN BROADCASTING CO., LTD., TAIPEI, TAIWAN:
3,399,524, INT. CL. 38.
- EASTMAN KODAK COMPANY, ROCHESTER, NY:
2,060,009, CANC. INT. CL. 40.
- EASTMAN, JOHN B., LISLE, IL:
2,448,455, CANC. INT. CL. 36.
- EASTWOOD, CLINT, LOS ANGELES, CA:
2,125,397. REN. 2-9-08. INT. CL. 9.
2,125,398. REN. 2-9-08. INT. CL. 9.
- EASY CHOICES, INC., MADEIRA BEACH, FL:
3,399,877, INT. CL. 25.
- EASYSYN, SOUTH BEND, IN:
3,397,396, PUB. 1-1-2008. INT. CL. 9.
- EAT'N PARK HOSPITALITY GROUP, INC., HOMESTEAD, PA:
2,128,934. REN. 2-13-08. INT. CL. 42.
- EATON AEROQUIP INC., CLEVELAND, OH:
2,139,455. REN. 2-8-08. INT. CL. 7.
- EATON VANCE MANAGEMENT, BOSTON, MA:
2,134,661. REN. 2-13-08. INT. CL. 36.
- EBAY INC., SAN JOSE, CA:
3,399,871, INT. CL. 35.
3,399,872, INT. CL. 38.
- EBNER, WALTER P., BOULDER, CO:
1,438,508, CANC. INT. CL. 9.
- EBONDTRADE.COM INC., WALNUT CREEK, CA:
2,448,520, CANC. INT. CL. 36.
- EBSCO INDUSTRIES, INC., BIRMINGHAM, AL:
2,448,474, CANC. INT. CL. 13.
- ECASH4.NET CORP, NEWARK, DE:
3,399,011, INT. CL. 36.
- ECCO SKO A/S, DENMARK:
3,398,682, PUB. 1-1-2008. INT. CL. 25.
- ECHALK, LLC, NEW YORK, NY:
2,618,569, CANC. INT. CL. 9.
- ECO-HARVEST INC., LEESBURG, FL:
3,400,402, INT. CL. 21.
- ECO-SOLUTION, FRANCE:
3,398,648, PUB. 1-1-2008. MULTIPLE CLASS, INT. CLS. 9 AND 42.
- ECOLAB INC., ST. PAUL, MN:
2,130,492. REN. 2-10-08. INT. CL. 5.
- ECONOMICSEARCH.COM, INC., AUSTIN, TX:
2,447,649, CANC. INT. CL. 35.
- ECOQUEST INTERNATIONAL, INC., KNOXVILLE, TN:
3,398,569, PUB. 9-25-2007. U.S. CL. B.
- EDDIE BAUER, INC., BELLEVUE, WA:
3,398,853, INT. CL. 25.
- EDENHURST GALLERY, BEVERLY HILLS, CA:
2,447,921, CANC. INT. CL. 35.
- EDIBLE FOOD GROUP, LLC., CRANSTON, RI:
3,397,617, PUB. 1-1-2008. INT. CL. 29.
- EDIFICE, INC., CHARLOTTE, NC:
3,397,797, PUB. 1-1-2008. INT. CL. 37.
- EDISON GROUP, INC., DALLAS, TX TO AVERVAKH DEVELOPMENT GROUP, L.P., DALLAS, TX:
2,059,036, CANC. INT. CL. 42.
- EDIZIONE HOLDING S.P.A., I-31100 TREVISO, ITALY:
3,398,736, PUB. 1-1-2008. INT. CL. 36.
- EDUCATION MANAGEMENT LLC, PITTSBURGH, PA:
2,447,724, CANC. INT. CL. 41.
3,399,418, INT. CL. 41.
- EDUCATION UNLIMITED, INC., BERKELEY, CA:
3,398,475, PUB. 10-17-2006. INT. CL. 41.
- EDUCATIONAL ADVANTAGE, INC., PARK CITY, UT:
3,397,823, PUB. 1-1-2008. INT. CL. 41.
- EDUCAUSE, BOULDER, CO, INTERUNIVERSITY COMMUNICATIONS COUNCIL, INC., WASHINGTON, DC, DBA EDUCOM:
1,995,574. REN. 2-14-08. INT. CL. 42.
- EDWARD L. PAXTON AND LLOYD M. PAXTON PARTNERSHIP, THE, SALEM, UT:
3,398,865, INT. CL. 12.

EGS ELECTRICAL GROUP LLC, CHICAGO, IL:
2,448,107, CANC. INT. CL. 9.

EHLERS, JOHN F., MONTECITO, CA, DBA MESA:
2,059,144, CANC. INT. CL. 9.

EHOB INCORPORATION, INDIANAPOLIS, IN:
2,448,178, CANC. INT. CL. 10.

EILEEN FISHER, INC., IRVINGTON, NY:
2,448,349, CANC. INT. CL. 25.

EISAI INC., WOODCLIFF LAKE, NJ:
3,399,050, MULTIPLE CLASS, INT. CLS. 16 AND 44.

EKAF INDUSTRIA NAZIONALE; DEL CAFFÈ SPA, ITALY:
3,398,823, PUB. 1-1-2008. INT. CL. 30.

EKIOSK.COM CORPORATION, NEW LENOX, IL:
2,447,411, CANC. MULTIPLE CLASS, INT. CLS. 38 AND 42.

EL BUEN BIFE RESTAURANT, S.A. DE C.V., MEXICO CITY, MEXICO TO JUAN MIGUEL COLIN PRAT, HOUSTON, TX:
2,058,547, CANC. INT. CL. 42.

EL CHICO RESTAURANTS, INC., DALLAS, TX:
3,398,400, PUB. 1-1-2008. INT. CL. 33.

ELANTAS CAMATTINI S.P.A., 43044 COLLECCHIO (PR), ITALY:
2,132,228. REN. 2-8-08. INT. CL. 7.

ELECTRIC POWER RESEARCH INSTITUTE, INC., PALO ALTO, CA:
1,087,285. REN. 2-13-08. INT. CL. 16.

ELECTRO SOURCE, LLC, SHERMAN OAKS, CA:
3,399,331, INT. CL. 9.

ELECTRONIC CREATIONS CORP., SANTA ROSA, CA:
3,399,565, INT. CL. 35.

ELECTRONICS FOR IMAGING, INC., FOSTER CITY, CA:
3,399,657, MULTIPLE CLASS, INT. CLS. 2, 3, 9, 37, 40, 41 AND 42.

ELEMENTAGE, LLC, NEW YORK, NY:
3,399,177, INT. CL. 3.

ELGATO SYSTEMS GMBH, MÜNCHEN, FED REP GERMANY:
3,397,316, PUB. 1-1-2008. MULTIPLE CLASS, INT. CLS. 9, 16 AND 42.

ELIF LEATHER GOODS, LLC, RUTHERFORD, NJ:
3,399,104, MULTIPLE CLASS, INT. CLS. 9 AND 18.

ELLA BLUE INC., ELK GROVE, CA:
3,400,078, INT. CL. 3.

ELMER'S PRODUCTS, INC., COLUMBUS, OH:
3,399,106, MULTIPLE CLASS, INT. CLS. 8 AND 16.

ELODRIVE GMBH, MINDEN, FED REP GERMANY:
3,400,398, INT. CL. 9.

ELVSTROM, PAUL, MR., HELLERUP, DENMARK:
1,477,741. REN. 2-8-08. INT. CL. 22.

ELWOOD PACKAGING, INC., CHICAGO, IL:
3,396,885, PUB. 1-1-2008. INT. CL. 16.

ELY CHAMBER OF COMMERCE, ELY, MN:
3,398,477, PUB. 1-1-2008. INT. CL. 35.

EMARITRADE.COM, INC., ATLANTA, GA, DBA OCEAN EXCHANGE:
2,447,672, CANC. INT. CL. 39.

EMBARQ HOLDINGS COMPANY LLC, OVERLAND PARK, KS:
3,399,800, MULTIPLE CLASS, INT. CLS. 9, 16, 35, 36, 37, 38 AND 42.

EMBREX, INC., RESEARCH TRIANGLE PARK, NC:
2,204,401. REN. 2-8-08. INT. CL. 5.

EMC CORPORATION, HOPKINTON, MA:
2,204,329. REN. 2-14-08. INT. CL. 9.

EMD CHEMICALS INC., GIBBSTOWN, NJ, EM INDUSTRIES, INCORPORATED, HAWTHORNE, NY:
2,136,308. REN. 2-13-08. INT. CL. 1.
2,136,309. REN. 2-13-08. INT. CL. 1.

EMERALD HILL CAPITAL PARTNERS, LLC, DOVER, DE:
3,399,537, INT. CL. 36.

EMERALD TEXAS, INC., HOUSTON, TX:
2,447,520, CANC. INT. CL. 36.

EMERGENCY SERVICES RESTORATION, INC., REDONDO BEACH, CA:
3,397,388, PUB. 1-1-2008. INT. CL. 37.

EMERSON ELECTRIC CO., ST. LOUIS, MO:
3,399,503, INT. CL. 7.
3,400,387, INT. CL. 7.

EMERSON POWER TRANSMISSION MANUFACTURING, MAYSVILLE, KY:
2,037,825. REN. 2-14-08. INT. CL. 7.

EMERSON, MELINDA F., PHILADELPHIA, PA:
3,398,102, PUB. 1-1-2008. MULTIPLE CLASS, INT. CLS. 35 AND 41.

EMIGRANT BANK, NEW YORK, NY:
3,397,155, PUB. 1-1-2008. INT. CL. 36.

EMILY'S EDIBLES, LLC, GREAT NECK, NY:
3,398,047, PUB. 1-1-2008. INT. CL. 30.

EMMI FONDUE AG (EMMI FONDUE SA) (EMMI FONDUE LTD.), CH-3550 LANGNAU, SWITZERLAND:
1,084,139. REN. 2-14-08. INT. CL. 29.

EMODA.COM CORPORATION, PHILADELPHIA, PA:
3,400,343, INT. CL. 35.

EMPIRE WINERIES, LLC, NEW PORT RICHEY, FL, DBA EMPIRE WINERY AND DISTILLERY:
3,397,211, PUB. 1-1-2008. INT. CL. 33.

EMPLOYEE & FAMILY RESOURCES, DES MOINES, IA:
3,399,232, INT. CL. 41.

EMSCO INC., GIRARD, PA, DBA EMSCO GROUP:
2,447,572, CANC. INT. CL. 28.

EMSLAND-STÄRKE GMBH, FED REP GERMANY:
3,398,799, PUB. 1-1-2008. INT. CL. 1.

EMSLAND-STÄRKE GMBH, 49824 EMLICHHEIM, FED REP GERMANY:
3,398,814, PUB. 1-1-2008. MULTIPLE CLASS, INT. CLS. 1, 2, 5 AND 30.
3,398,815, PUB. 1-1-2008. MULTIPLE CLASS, INT. CLS. 1, 2, 5 AND 30.

EMULSION TECHNOLOGY, INC., WILMINGTON, DE:
2,447,900, CANC. INT. CL. 4.
2,447,901, CANC. INT. CL. 1.

ENCLARITY, INC., ALISO VIEJO, CA:
3,399,789, INT. CL. 42.
3,399,790, INT. CL. 42.

ENDOWMENT CAPITAL GROUP, L.P., PHILADELPHIA, PA:
3,398,467, PUB. 1-1-2008. INT. CL. 9.

ENERGY INTELLIGENCE GROUP, INC., NEW YORK, NY:
2,169,571. REN. 2-9-08. MULTIPLE CLASS, INT. CLS. 16 AND 42.

ENFORMA NATURAL PRODUCTS, INC., ENCINO, CA:
2,448,042, CANC. INT. CL. 5.

ENGINEERING FITNESS INTERNATIONAL CORP., SAN DIEGO, CA, DBA TOTAL GYM, DBA EFI AND DBA EFI MEDICAL SYSTEMS:
3,398,857, INT. CL. 41.

ENGINEERING SERVICES NETWORK, INC., ARLINGTON, VA:
3,397,141, PUB. 1-1-2008. INT. CL. 42.
3,397,142, PUB. 1-1-2008. INT. CL. 42.

ENGINEERSHOWWRITE, SANTA CLARA, CA:
3,400,391, INT. CL. 42.

ENKI LLC, MOUNTAIN VIEW, CA:
3,400,272, INT. CL. 42.

ENOR CORPORATION, NORTHVALE, NJ:
3,397,733, PUB. 1-1-2008. INT. CL. 28.

ENPAPER MFG. CO., LTD., GYEONGGI-DO, REPUBLIC OF KOREA:
3,396,989, PUB. 1-1-2008. INT. CL. 16.

ENRICH CORPORATION, THE, OREM, UT:
2,448,387, CANC. INT. CL. 5.

ENSAGA ENERGY GROUP LLC, TULSA, OK:
3,400,364, INT. CL. 42.

ENTEPI HAMUI, ALFONSO, MÉXICO, MÉXICO, D.F., MEXICO:
3,399,832, INT. CL. 25.

ENTERTAINMENT PROPERTIES HOLDINGS, LTD., OCEAN RIDGE, FL:
3,398,899, INT. CL. 9.

- ENTERTAINMENT SOFTWARE ASSOCIATION, WASHINGTON, DC:
2,152,074. REN. 2-13-08. U.S. CL. A.
2,152,075. REN. 2-13-08. U.S. CL. A.
2,152,077. REN. 2-13-08. U.S. CL. A.
2,152,078. REN. 2-13-08. U.S. CL. A.
- ENTRAVISION COMMUNICATIONS CORPORATION, SANTA MONICA, CA:
3,398,142, PUB. 1-1-2008. INT. CL. 41.
- ENVIN, LLC, EXTON, PA:
3,399,497, INT. CL. 36.
- ENVIRONMENT ONE CORPORATION, NISKAYUNA, NY:
3,399,732, INT. CL. 9.
- ENVIRONMENTAL RESOURCE SERVICES, INC., ATLANTA, GA:
3,398,290, PUB. 1-1-2008. INT. CL. 35.
- ENVIRONMENTAL RESOURCES MANAGEMENT, INC., EXTON, PA TO PMC TECHNOLOGIES, INC., EXTON, PA:
2,058,824, CANC. INT. CL. 40.
- EPCON COMMUNITIES FRANCHISING, INC., DUBLIN, OH:
2,059,414, CANC. INT. CL. 37.
- EPIC MEDIA GROUP LLC, EL SEGUNDO, CA:
3,398,513, PUB. 1-1-2008. INT. CL. 41.
- EPISCOPAL RELIEF AND DEVELOPMENT, NEW YORK, NY:
3,398,154, PUB. 1-1-2008. INT. CL. 36.
- EPIX HOLDINGS CORPORATION, TAMPA, FL:
2,447,592, CANC. INT. CL. 35.
2,448,300, CANC. INT. CL. 35.
- EQUINOX PRODUCTS L.L.C., TROY, MI:
3,398,399, PUB. 1-1-2008. INT. CL. 11.
- EQUINOX PRODUCTS, L.L.C., TROY, MI:
3,398,398, PUB. 1-1-2008. INT. CL. 11.
- EQUISTAR CHEMICALS, LP, HOUSTON, TX:
3,399,585, INT. CL. 1.
- EQUITEXX, INC., SAN FRANCISCO, CA:
3,399,706, INT. CL. 25.
- EQUUSTYLE, INC., GOLDEN, CO:
3,398,900, MULTIPLE CLASS, INT. CLS. 20, 25 AND 35.
- ERA ECOSYSTEM RESTORATION ASSOCIATES INC, NORTH VANCOUVER, CANADA:
3,397,335, PUB. 1-1-2008. INT. CL. 44.
- ERAL BRAVO S.A., MENDOZA, ARGENTINA:
3,398,991, INT. CL. 33.
- ERGODYNE CORPORATION, ST. PAUL, MN:
3,399,868, INT. CL. 9.
- ERIKA LYNN DESIGNS INC., NEW YORK, NY:
3,397,485, PUB. 1-1-2008. INT. CL. 25.
- ERKIE INC, WOODLAND HILLS, CA, ERKIE, INC., WOODLAND HILLS, CA:
2,177,351. REN. 2-13-08. INT. CL. 16.
- ERNEST COMMUNICATIONS, INC., NORCROSS, GA:
3,397,760, PUB. 1-1-2008. INT. CL. 38.
- ERNST & YOUNG U.S. LLP, NEW YORK, NY:
2,447,544, CANC. INT. CL. 35.
- ERNST MÜHLBAUER GMBH & CO. KG, FED REP GERMANY:
3,398,650, PUB. 1-1-2008. INT. CL. 5.
- ERWIN JUNKER.; BROUSÍČI TECHNIKA MELNÍK A.S., CZECH REPUBLIC:
3,398,750, PUB. 1-1-2008. INT. CL. 7.
- ESAB GROUP, INC., FLORENCE, SC:
3,399,509, MULTIPLE CLASS, INT. CLS. 7 AND 9.
- ESAKI MEDICAL INSTRUMENT CO., LTD., NAGAOKA-KYO-SHI, JAPAN:
3,399,512, INT. CL. 5.
- ESAPARMA S.R.L., MILANO, ITALY:
3,214,514, CANC. INT. CL. 5.
- ESCALANTE, THOMAS ANTHONY, CAMARILLO, CA:
3,398,395, PUB. 1-1-2008. INT. CL. 35.
- ESCH, ARTHUR G., STUART, FL:
3,397,154, PUB. 1-1-2008. INT. CL. 35.
- ESCUELA DE DECORACION VERACRUZ AC., ZAPOPAN, MEXICO:
3,399,523, INT. CL. 41.
- ESPN, INC., BRISTOL, CT:
3,399,340, MULTIPLE CLASS, INT. CLS. 38 AND 41.
- ESSE TRADING, INC., BOCA RATON, FL:
3,397,350, PUB. 1-1-2008. MULTIPLE CLASS, INT. CLS. 6 AND 19.
- ESTEE LAUDER INC., NEW YORK, NY:
3,399,404, INT. CL. 44.
- ESTYLE, INC., LOS ANGELES, CA:
3,397,039, PUB. 1-1-2008. INT. CL. 35.
- ETABLISSEMENTS AMYOT, PONTARLIER, FRANCE:
1,438,483, CANC. MULTIPLE CLASS, INT. CLS. 7 AND 8.
- ETERLINK INTERNATIONAL CORPORATION, SACRAMENTO, CA:
3,399,042, INT. CL. 9.
- ETHNIC COMMUNICATIONS, INC., LOS ANGELES, CA:
3,397,536, PUB. 1-1-2008. INT. CL. 35.
- ETHNICITEE, TUSTIN, CA:
3,397,539, PUB. 1-1-2008. INT. CL. 25.
- ETRIAL COMMUNICATIONS, INC., DENVER, CO:
3,399,981, INT. CL. 9.
- EURIAL-POITOURAINE, 44327 NANTES CEDEX 3, FRANCE:
2,134,426. REN. 2-11-08. INT. CL. 29.
- EURO SKATE, INC., TACOMA, WA TO GEN-X SPORTS SARL, CHATEL ST. DENIS, SWITZERLAND:
2,059,232, CANC. INT. CL. 28.
- EUROPEAN COMMODITY CLEARING AG, FED REP GERMANY:
3,398,698, PUB. 1-1-2008. MULTIPLE CLASS, INT. CLS. 35, 36 AND 39.
- EVANGELICAL COVENANT CHURCH, THE, CHICAGO, IL, DBA COVENANT RETIREMENT COMMUNITIES:
1,517,566. REN. 2-11-08. INT. CL. 42.
- EVAY COSMETICS LAB, INC., HARTFORD, CT:
2,135,698. REN. 2-14-08. INT. CL. 3.
- EVENFLO COMPANY, INC., VANDALIA, OH:
2,448,188, CANC. INT. CL. 10.
- EVENTPRO STRATEGIES, INC., TEMPE, AZ:
3,398,041, PUB. 1-1-2008. INT. CL. 35.
3,398,091, PUB. 1-1-2008. INT. CL. 35.
- EVEREADY BATTERY COMPANY, INC., ST. LOUIS, MO:
2,447,697, CANC. INT. CL. 35.
- EVEREST COLD STORAGE LIMITED, TORONTO, CANADA:
3,398,554, PUB. 1-1-2008. INT. CL. 35.
- EVEREST VIT, INC., FLANDERS, NJ:
2,447,655, CANC. MULTIPLE CLASS, INT. CLS. 9 AND 42.
- EVERFINE PHOTO-E-INFO CO., LTD., HANGZHOU, CHINA:
3,397,283, PUB. 1-1-2008. INT. CL. 9.
- EVERGREEN ENERGY INC., DENVER, CO:
3,397,666, PUB. 1-1-2008. MULTIPLE CLASS, INT. CLS. 37 AND 42.
- EVERITT, THOMAS J., LITTLE RIVER, SC:
3,397,650, PUB. 1-1-2008. INT. CL. 19.
- EVOLUTIONARY IT, WEST ROXBURY, MA:
3,396,926, PUB. 1-1-2008. MULTIPLE CLASS, INT. CLS. 35, 41 AND 42.
- EXCALIBUR ELECTRONICS, INC., MIAMI, FL:
3,400,045, INT. CL. 11.
- EXCELLENT, LESLIE F., PORT-AU-PRINCE, HAITI AND EXCELLENT, ROBERT, PORT-AU-PRINCE, HAITI:
3,398,457, PUB. 5-15-2007. MULTIPLE CLASS, INT. CLS. 29 AND 30.
- EXECUTIVE TURF MANAGEMENT, INC., SUWANEE, GA:
3,397,897, PUB. 1-1-2008. INT. CL. 44.
- EXELOGY INCORPORATED, SUNNYVALE, CA:
3,399,792, MULTIPLE CLASS, INT. CLS. 9 AND 42.
- EXPERIENCE BASED LEARNING, INC., ROCKFORD, IL:
2,448,552, CANC. INT. CL. 41.
- EXPERIENCE HENDRIX, L.L.C., SEATTLE, WA:
3,399,951, INT. CL. 20.
- EXPERT ADMISSIONS, LLC, CORAL GABLES, FL:
3,400,365, INT. CL. 41.
- EXPERT COMPUTER INTERNATIONAL INC., GARDENA, CA:
2,173,797. REN. 2-13-08. INT. CL. 9.
- EXPERT TRAVEL SERVICES, LLC, PATCHOGUE, NY:
3,399,262, INT. CL. 39.

- EXPONATION, L.L.C., ROSWELL, GA:
3,397,403, PUB. 9-25-2007. INT. CL. 35.
- EXPRESSWAY USA FREIGHTLINES, INC., PORT CARTER-
ET, NJ:
2,447,558, CANC. MULTIPLE CLASS, INT. CLS. 35 AND
39.
- EXTRA INNINGS, INC., MIDDLETON, MA:
3,397,393, PUB. 1-1-2008. MULTIPLE CLASS, INT. CLS. 35
AND 41.
- EXTREME MEDIA AND ENTERTAINMENT LLC, SCOTTS-
DALE, AZ:
3,399,325, INT. CL. 35.
- EXXCEL INTERNATIONAL, INC., ALEXANDRIA, VA:
2,447,643, CANC. INT. CL. 9.
- EXXONMOBIL OIL CORPORATION, IRVING, TX:
1,074,398, REN. 2-13-08. INT. CL. 4.
- EYE CATCH SIGNS, LTD., HALIFAX, N.S., CANADA:
2,498,593, CANC. MULTIPLE CLASS, INT. CLS. 37 AND
42.
- EYE CORP PTY LIMITED, PYRMONT, NSW, AUSTRALIA:
3,399,397, MULTIPLE CLASS, INT. CLS. 35 AND 42.
- EZPOWER SYSTEMS, INC., PHILADELPHIA, PA TO DOC-
UCORP INTERNATIONAL, INC., DALLAS, TX:
2,058,680, CANC. INT. CL. 9.
- E3 FINANCIAL, INC., NEWPORT BEACH, CA:
3,398,037, PUB. 1-1-2008. INT. CL. 36.
- F.TECH INCORPORATION, SAITAMA, JAPAN:
3,398,901, INT. CL. 12.
- F+W PUBLICATIONS, INC., CINCINNATI, OH:
2,447,396, CANC. INT. CL. 41.
- F&W ASSOCIATES, INC., MILWAUKIE, OR:
3,398,873, MULTIPLE CLASS, INT. CLS. 35 AND 44.
- FAB-IND LIMITED, TORONTO, ONTARIO, CANADA:
2,447,658, CANC. INT. CL. 25.
- FABRIC EDITIONS LLC, GREENVILLE, SC, AKA FE
ACQUISITION LLC:
3,399,552, INT. CL. 24.
- FABRICA DE ESPECIAS Y PRODUCTOS EL REY S.A.,
7700500 BOGOTA, COLOMBIA:
3,398,515, PUB. 1-1-2008. INT. CL. 30.
- FACILE & CO AB, STOCKHOLM, SWEDEN:
2,080,075, REN. 2-14-08. INT. CL. 33.
- FACTOR SYSTEMS, INC., JAMESBURG, NJ:
3,397,408, PUB. 1-1-2008. MULTIPLE CLASS, INT. CLS. 35
AND 36.
- FAITH HOLISTIC HEALTHCARE, FOUNTAIN HILLS, AZ:
3,397,985, PUB. 1-1-2008. INT. CL. 44.
- FAMILY PURSUIT, LC, PROVO, UT:
3,397,435, PUB. 1-1-2008. INT. CL. 42.
- FAMOUS LEGENDS AND SPORTS HEROES, INC., WEST
BERLIN, NJ:
2,448,298, CANC. INT. CL. 28.
- FAMOUS SMOKE SHOP-PA, INC., EASTON, PA:
3,399,368, INT. CL. 34.
- FANARO, MARY, SHERMAN OAKS, CA:
3,399,894, INT. CL. 10.
- FAR EAST CABLE FACTORY, CHINA:
3,398,679, PUB. 1-1-2008. INT. CL. 9.
- FAR EAST CABLE FACTORY, JIANGSU, CHINA:
3,398,690, PUB. 1-1-2008. INT. CL. 9.
- FARLEY'S & SATHERS CANDY COMPANY, INC., ROUND
LAKE, MN, THOMAS-WIENER COMPANY, MEMPHIS,
TN:
504,862, REN. 2-9-08. U.S. CL. 46 (INT. CL. 30).
- FARLEY'S & SATHERS CANDY COMPANY, INC., ROUND
LAKE, MN:
2,196,676, REN. 2-8-08. INT. CL. 30.
- FARLEY'S AND SATHERS CANDY COMPANY, INC.,
ROUND LAKE, MN:
3,398,129, PUB. 1-1-2008. INT. CL. 30.
- FARLEYS & SATHERS CANDY COMPANY, INC., ROUND
LAKE, MN:
2,157,627, REN. 2-8-08. INT. CL. 30.
- FARM CONNECTION, MIAMI, FL:
2,448,098, CANC. MULTIPLE CLASS, INT. CLS. 31 AND
35.
- FARM JOURNAL, INC., PHILADELPHIA, PA:
1,476,844, REN. 2-14-08. INT. CL. 16.
- FARMHOUSE YARNS, LLC, EAST HADDAM, CT:
3,396,945, PUB. 1-1-2008. INT. CL. 23.
- FARMS AND FAMILIES OF NORTH AMERICA INCORPO-
RATED, SASKATOON, SASKATCHEWAN, CANADA:
3,397,092, PUB. 1-1-2008. INT. CL. 35.
- FARMS FOR CITY KIDS FOUNDATION, INC., PORT
WASHINGTON, NY:
3,397,430, PUB. 1-1-2008. INT. CL. 41.
- FARRINGTON PRODUCTIONS, INC., LAS VEGAS, NV:
3,398,469, PUB. 1-1-2008. INT. CL. 41.
- FARUQ, SALA, MITCHELLVILLE, MD AND WALKER,
WILLIAM, MITCHELLVILLE, MD, DBA CAPITAL LE-
GAL RESEARCH:
2,199,626, REN. 2-14-08. INT. CL. 42.
- FASHION SEAL CORP., LAS VEGAS, NV:
1,083,334, REN. 2-14-08. INT. CL. 10.
- FAST FORWARD BRANDS, LLC, DENVER, CO:
3,398,084, PUB. 1-1-2008. INT. CL. 33.
- FAT BOY POSSE ENTERPRISES, DALLAS, TX:
2,448,202, CANC. INT. CL. 32.
- FATHER FLANAGAN'S BOYS' HOME, BOYS TOWN, NE:
3,396,981, PUB. 1-1-2008. MULTIPLE CLASS, INT. CLS.
16, 41, 42, 43, 44 AND 45.
- FAYGO BEVERAGES, INC., DETROIT, MI, FEIGENSON,
INCORPORATED, DETROIT, MI, DBA FAYGO BEVER-
AGE COMPANY:
844,209, REN. 2-11-08. U.S. CL. 45 (INT. CL. 32).
- FAYGO BEVERAGES, INC., DETROIT, MI:
2,105,962, REN. 2-11-08. INT. CL. 32.
- FAZI BATTAGLIA S.P.A. O CON SIGLA; "F & B S.P.A.",
ITALY:
3,398,826, PUB. 1-1-2008. INT. CL. 33.
- FEDER. LAUREN S., BEVERLY HILLS, CA:
2,448,243, CANC. INT. CL. 5.
- FEDERATED GROUP, INC., THE, ARLINGTON HEIGHTS,
IL:
2,060,170, CANC. INT. CL. 29.
- FELLOWSHIP OF MERRY CHRISTIANS, INC., PORTAGE,
MI, ROSEJOY PUBLICATIONS, KALAMAZOO, MI:
1,475,892, REN. 2-13-08. INT. CL. 16.
- FENDER MUSICAL INSTRUMENTS CORPORATION,
SCOTTSDALE, AZ:
3,396,823, PUB. 3-16-2004. INT. CL. 15.
3,396,824, PUB. 3-16-2004. INT. CL. 15.
3,396,825, PUB. 3-16-2004. INT. CL. 15.
- FERDINAND RICHTER GMBH, A-4061 PASCHING, AUS-
TRIA:
3,398,640, PUB. 1-1-2008. INT. CL. 18.
- FERDINANDO BUCCI S.R.L., ITALY:
3,398,789, PUB. 1-1-2008. MULTIPLE CLASS, INT. CLS. 3
AND 14.
- FERENTINO'S PIZZERIA EAST, INC., LAKE FOREST, IL:
2,447,594, CANC. INT. CL. 42.
- FERNDALE IP, INC., FERNDALE, MI:
2,202,281, REN. 2-13-08. INT. CL. 5.
- FERRAZ SHAWMUT S.A., VILLEURBANNE, FRANCE:
2,151,904, REN. 2-11-08. INT. CL. 9.
- FETHERSTON DESIGN GROUP, GLENBROOK, NV:
3,398,104, PUB. 1-1-2008. INT. CL. 25.
- FIAT AUTO S.P.A., 200 TURIN, ITALY:
2,447,290, CANC. MULTIPLE CLASS, INT. CLS. 7 AND
12.
- FIBER CABLES DIRECT, LLC, SANTA MARGUERITA, CA:
3,397,364, PUB. 1-1-2008. INT. CL. 9.
- FIBREWORKS CORPORATION, LOUISVILLE, KY:
3,398,015, PUB. 1-1-2008. INT. CL. 27.
- FICKETT, GLENN A., TEMPE, AZ:
3,400,067, INT. CL. 28.
- FILIPPO, ELIZABETH GAIL, LIBERTYVILLE, IL:
2,448,423, CANC. INT. CL. 16.
- FILO AMERICA, VERNON, CA:
3,397,983, PUB. 1-1-2008. INT. CL. 8.
3,397,984, PUB. 1-1-2008. INT. CL. 5.
- FILTER TECH, INC., HUNTINGTON, WV:
2,447,801, CANC. INT. CL. 1.
- FINAL DRAFT, INC., CALABASAS, CA:
3,400,162, INT. CL. 41.

- FINANCIAL INDEPENDENCE GROUP, INC., CORNELIUS, NC:
3,397,357, PUB. 1-1-2008. INT. CL. 35.
- FINE LINE PLASTICS, INC., GREENVILLE, IN:
2,059,220, CANC. INT. CL. 7.
- FINEST FOOD DISTRIBUTING CO. N.Y. INC., WOODHAVEN, NY:
2,057,078, REN. 2-11-08. INT. CL. 32.
- FINGERHUT DIRECT MARKETING, INC., EDEN PRAIRIE, MN:
3,399,460, INT. CL. 21.
- FINISHING EQUIPMENT, INC., ST. PAUL, MN:
1,438,485, CANC. MULTIPLE CLASS, INT. CLS. 7 AND 11.
- FINJAN SOFTWARE LTD., NETANYA SOUTH 42504, ISRAEL:
2,448,020, CANC. INT. CL. 9.
- FINMAR PTY LTD, LANDSDALE, WESTERN AUSTRALIA, AUSTRALIA:
2,447,513, CANC. INT. CL. 20.
- FINNEY, BRYAN D., CLEVELAND, OH:
2,447,611, CANC. INT. CL. 35.
- FIOCCHI MUNIZIONI S.P.A., ITALY:
3,398,835, PUB. 1-1-2008. INT. CL. 13.
- FIREPOND, INC., NEWTON, MA:
3,400,327, INT. CL. 42.
- FIRST BRANDS PROPERTIES INC., WILMINGTON, DE TO THE GLAD PRODUCTS COMPANY, OAKLAND, CA:
2,059,306, CANC. INT. CL. 16.
- FIRST CHILDREN'S FINANCE, MINNEAPOLIS, MN:
3,396,890, PUB. 1-1-2008. INT. CL. 36.
3,396,891, PUB. 1-1-2008. INT. CL. 41.
- FIRST CHOICE MORTGAGE, INC., WAUKESHA, WI:
3,399,577, INT. CL. 36.
- FIRST CITIZENS BANCSHARES, INC., RALEIGH, NC:
3,398,286, PUB. 1-1-2008. INT. CL. 36.
- FIRST CLASS SERVICES, INC., LOS ANGELES, CA:
2,447,445, CANC. INT. CL. 42.
- FIRST FINANCIAL MANAGEMENT CORPORATION, ATLANTA, GA:
2,448,056, CANC. INT. CL. 36.
2,448,057, CANC. INT. CL. 36.
2,448,146, CANC. INT. CL. 36.
- FIRST FISHERY DEVELOPMENT SERVICES INC., SAN DIEGO, CA:
3,397,754, PUB. 1-1-2008. INT. CL. 5.
- FIRST FORENSIC, INCORPORATED, CENTERVILLE, OH:
3,397,309, PUB. 1-1-2008. INT. CL. 44.
- FIRST INSURANCE FUNDING CORP., NORTHBROOK, IL:
3,397,768, PUB. 1-1-2008. INT. CL. 36.
3,397,769, PUB. 1-1-2008. INT. CL. 36.
- FIRST NATIONAL BANK OF OMAHA, OMAHA, NE:
1,484,590, REN. 2-11-08. INT. CL. 36.
1,484,606, REN. 2-11-08. INT. CL. 36.
3,399,147, INT. CL. 35.
3,399,984, INT. CL. 36.
- FIRST SCIENTIFIC CORPORATION, OGDEN, UT:
2,447,974, CANC. INT. CL. 5.
- FIRST TRUST CORPORATION, DENVER, CO:
2,058,685, CANC. INT. CL. 9.
- FIRSTMERIT CORPORATION, AKRON, OH:
3,399,157, INT. CL. 16.
- FIRSTPLUS FINANCIAL GROUP, INC., DALLAS, TX:
2,447,336, CANC. INT. CL. 34.
- FISCHER CONNECTORS HOLDING S.A., CH-1143 APPLES, SWITZERLAND:
3,398,647, PUB. 1-1-2008. INT. CL. 9.
3,398,652, PUB. 1-1-2008. INT. CL. 9.
- FISHKIN, JAMES STEVEN, STANFORD, CA:
2,140,053, REN. 2-9-08. INT. CL. 42.
- FITNESS MAXX, MIAMI, FL:
3,397,662, PUB. 1-1-2008. INT. CL. 41.
- FITNESS, INC., WEST BLOOMFIELD, MI, DBA EXCLUSIVE FITNESS:
2,447,814, CANC. INT. CL. 41.
- FLAGSHIP STUDIOS, INC., SAN FRANCISCO, CA:
3,399,332, MULTIPLE CLASS, INT. CLS. 9 AND 41.
- FLAGSHIP VENTURES MANAGEMENT, INC., CAMBRIDGE, MA:
3,398,845, MULTIPLE CLASS, INT. CLS. 35 AND 36.
- FLAIR CORPORATION, OCALA, FL:
824,416, REN. 2-14-08. U.S. CL. 11 (INT. CL. 11).
- FLEETWOOD ENTERPRISES, INC., RIVERSIDE, CA:
3,399,413, INT. CL. 36.
- FLOORAGE PRODUCTS CORP., MIAMI, FL:
3,397,101, PUB. 1-1-2008. INT. CL. 19.
- FLORES, DAVID LOUIS, ALAMOGORDO, NM:
2,448,228, CANC. INT. CL. 25.
- FLORIDA LEISURE, INC, KISSIMMEE, FL:
3,398,922, INT. CL. 36.
- FLORISTS' TRANSWORLD DELIVERY ASSOCIATION, DOWNERS GROVE, IL:
844,748, REN. 2-11-08. U.S. CL. 101 (INT. CL. 35).
- FLOWING CONTENT, S.A., BRIDEL, LUXEMBOURG:
3,396,966, PUB. 1-1-2008. MULTIPLE CLASS, INT. CLS. 9, 35 AND 38.
- FLOWMASTER, INC., SANTA ROSA, CA:
2,149,862, REN. 2-11-08. INT. CL. 7.
2,217,467, REN. 2-11-08. INT. CL. 16.
- FLYING FINGERS, INC., TARRYTOWN, NY:
3,398,435, PUB. 1-1-2008. MULTIPLE CLASS, INT. CLS. 16, 35 AND 41.
- FMR LLC, BOSTON, MA:
2,142,583, REN. 2-11-08. INT. CL. 9.
- FOGO DE CHAO CHURRASCARIA (HOLDINGS) LLC, DALLAS, TX:
2,204,333, REN. 2-13-08. INT. CL. 25.
2,204,339, REN. 2-13-08. INT. CL. 25.
- FOOTBALL ASSOCIATION LIMITED, THE, LONDON, W1D 4FA, ENGLAND:
2,133,695, REN. 2-11-08. MULTIPLE CLASS, INT. CLS. 16, 18, 24, 25, 26 AND 28.
- FORD MOTOR COMPANY, DEARBORN, MI:
2,059,520, CANC. INT. CL. 5.
2,059,522, CANC. INT. CL. 16.
3,399,361, INT. CL. 12.
- FOREFIELD, INC., WORCESTER, MA:
2,448,144, CANC. INT. CL. 9.
- FOREIGN CANDY COMPANY, INC., THE, HULL, IA:
2,175,597, REN. 2-11-08. INT. CL. 30.
- FOREMOST DENTAL LLC, ENGLEWOOD, NJ:
3,398,984, MULTIPLE CLASS, INT. CLS. 3 AND 5.
3,400,014, MULTIPLE CLASS, INT. CLS. 3 AND 5.
- FORERUNNERS TECHNOLOGY, INC., LOS ANGELES, CA:
3,397,855, PUB. 1-1-2008. INT. CL. 10.
- FOREVER NEW INTERNATIONAL, INC., SIOUX FALLS, SD:
3,397,882, PUB. 1-1-2008. INT. CL. 3.
- FORKMEDIA LLC, WIMBERLEY, TX, ELECTRONIC GOURMET GUIDE, INC., CHERRY VALLEY, CA:
2,145,180, REN. 2-11-08. INT. CL. 42.
- FORMED FIBER TECHNOLOGIES, INC., AUBURN, ME:
1,422,908, REN. 2-11-08. INT. CL. 24.
- FORMOSA SAINT JOSE CORP., TAIPEI, TAIWAN:
3,399,536, MULTIPLE CLASS, INT. CLS. 12 AND 27.
- FORMULA GARAGE INC., LONG ISLAND CITY, NY, DBA FORMULA MOTORSPORTS:
2,058,960, CANC. INT. CL. 37.
- FORREST GENERAL HOSPITAL, HATTIESBURG, MS:
3,397,024, PUB. 1-1-2008. MULTIPLE CLASS, INT. CLS. 41, 44 AND 45.
3,397,025, PUB. 1-1-2008. MULTIPLE CLASS, INT. CLS. 41, 44 AND 45.
3,397,032, PUB. 1-1-2008. MULTIPLE CLASS, INT. CLS. 41, 44 AND 45.
- FOX RIDGE INVESTMENTS, LLC, LEHI, UT:
3,400,227, INT. CL. 37.
- FOX, SANDY, STUDIO CITY, CA AND LANG, LEX, STUDIO CITY, CA:
3,400,003, INT. CL. 32.
- FOXFIRE ENTERPRISES, INC., WEST, TX:
3,397,674, PUB. 1-1-2008. INT. CL. 40.
- FPT HOLDING S.A., LUXEMBOURG, LUXEMBOURG:
3,398,193, PUB. 1-1-2008. INT. CL. 7.

- FRAGMENTS, INC., NEW YORK, NY:
2,134,713. REN. 2-14-08. MULTIPLE CLASS, INT. CLS. 18 AND 20.
- FRANCHISE SERVICES, INC., MISSION VIEJO, CA:
3,397,071, PUB. 1-1-2008. INT. CL. 35.
- FRANCIS S. MILLIER, MURPHYS, CA AND ELIZABETH J. MILLIER, MURPHYS, CA:
3,397,366, PUB. 1-1-2008. INT. CL. 33.
- FRANK D. FAKINOS, GARDEN GROVE, CA:
3,397,410, PUB. 9-25-2007. INT. CL. 41.
- FRANK J. SEPE, INC., VALLEY STREAM, NY:
3,397,673, PUB. 1-1-2008. INT. CL. 16.
- FRANK'S INTERNATIONAL, INC., HOUSTON, TX:
3,398,881, INT. CL. 7.
- FRANKENSTEIN, GRETCHEN E. SEATTLE, WA AND KESSNER, THOMAS D. SEATTLE, WA:
3,398,189, PUB. 1-1-2008. INT. CL. 20.
- FRANQUET, JOSE PELLICER, BARCELONA, SPAIN:
2,135,275. REN. 2-12-08. INT. CL. 9.
- FRANTZ, DON E., HOUSTON, TX:
2,059,865, CANC. INT. CL. 10.
- FRASCIO GIACINTO S.R.L., AGNOSINE (BRESCIA), ITALY TO FRASCIO S.P.A., LAVENONE (BS), ITALY:
2,058,521, CANC. INT. CL. 6.
- FRASER PAPERS LIMITED, MADAWASKA, ME:
3,397,885, PUB. 1-1-2008. INT. CL. 16.
- FRATERNITE NOTRE DAME, INC., CHICAGO, IL:
2,137,525. REN. 2-8-08. INT. CL. 35.
2,155,053. REN. 2-14-08. INT. CL. 42.
- FRAUDHALT LTD, DUBLIN 3, IRELAND:
3,399,490, INT. CL. 9.
- FRED PARIS, 75001 PARIS, FRANCE:
1,482,275. REN. 2-13-08. INT. CL. 14.
- FREIGHT SALES CARPET AND TILE OF POLK COUNTY, L.L.C., LAKE LAND, FL:
3,396,923, PUB. 1-1-2008. INT. CL. 35.
- FRENCH, THOMAS, DUBLIN, CA:
3,400,361, INT. CL. 35.
- FREUD, ALIZA, MAPLEWOOD, NJ:
3,399,051, INT. CL. 35.
- FRIEDMAN, BILLINGS, RAMSEY GROUP, INC., ARLINGTON, VA:
2,158,759. REN. 2-11-08. INT. CL. 36.
2,158,760. REN. 2-11-08. INT. CL. 36.
2,158,762. REN. 2-14-08. INT. CL. 36.
- FRIEFELD & ASSOCIATES, LLC, WOBURN, MA:
3,399,083, INT. CL. 44.
- FRIENDLY FRUIT, INC., NEW BEDFORD, MA, DBA SID WAINER & SON:
2,171,412. REN. 2-14-08. INT. CL. 29.
- FRIENDS, INC., CINCINNATI, OH:
2,447,532, CANC. INT. CL. 42.
- FRIGINOX, FRANCE:
3,398,739, PUB. 1-1-2008. INT. CL. 11.
- FRUIT OF THE LOOM, INC., BOWLING GREEN, KY:
3,399,372, INT. CL. 25.
- FRUITFEET, INC., NEW YORK, NY:
3,399,993, INT. CL. 25.
- FRYMASTER LLC, SHREVEPORT, LA:
3,397,186, PUB. 1-1-2008. INT. CL. 11.
- FUJIAN HUIKANG FOODS; INDUSTRY CO., LTD, CHINA:
3,398,683, PUB. 1-1-2008. INT. CL. 30.
- FUJIFILM CORPORATION, TOKYO, JAPAN:
3,398,911, INT. CL. 10.
- FULL FLAME GMBH, FED REP GERMANY:
3,398,751, PUB. 1-1-2008. MULTIPLE CLASS, INT. CLS. 9, 16, 41 AND 45.
- FULL SPECTRUM SOLUTIONS, INC., JACKSON, MI:
3,397,434, PUB. 9-25-2007. INT. CL. 11.
- FULLER, CHEVON, ELLISVILLE, MO:
3,397,910, PUB. 1-1-2008. INT. CL. 42.
- FULLERTON, DONNA M., NEW YORK, NY:
3,400,224, INT. CL. 45.
- FULMORE, DIANE, BROOKLYN, NY:
2,447,798, CANC. INT. CL. 41.
- FULTON-MORALES, JULIA A, CORPUS CHRISTI, TX:
3,397,017, PUB. 1-1-2008. INT. CL. 21.
- FUNDACIÓ UBUNTU, BARCELONA, SPAIN:
3,399,930, INT. CL. 41.
- FUNK FOODS, INC., TIFTON, GA:
3,397,773, PUB. 1-1-2008. INT. CL. 30.
- FUNKY DARLIN', LLC, ANDALUSIA, AL:
3,399,030, INT. CL. 16.
- FURUKAWA ELECTRIC NORTH AMERICA, INC., NORCROSS, GA:
2,448,182, CANC. INT. CL. 9.
- FUTURE FORTUNES, INC., OAK HILL, OH:
3,398,909, INT. CL. 41.
- FUTUREMATRIX INTERVENTIONAL, INC., ATHENS, TX:
3,399,392, INT. CL. 10.
- FUYI INTERNATIONAL TRADING LIMITED, HONG KONG, CHINA:
3,399,164, INT. CL. 25.
- G.H. MUMM & CIE, SOCIÉTÉ VINICOLE; DE CHAMPAGNE, SUCCESSEUR.; SOCIÉTÉ ANONYME, FRANCE:
3,398,805, PUB. 1-1-2008. INT. CL. 33.
- G.H. SMART & COMPANY INC., CHICAGO, IL:
3,397,099, PUB. 1-1-2008. INT. CL. 35.
- GA MODEFINE S.A., CH-6850 MENDRISIO, SWITZERLAND:
3,398,631, PUB. 1-1-2008. MULTIPLE CLASS, INT. CLS. 12 AND 26.
- GABRIELLE STUDIO, INC., NEW YORK, NY:
3,398,130, PUB. 1-1-2008. INT. CL. 3.
- GACITUA, MAXIMILIANO, NEW YORK, NY:
3,399,600, INT. CL. 25.
- GADHVI, REKHA, NEW YORK, NY:
2,059,109, CANC. INT. CL. 35.
- GAGE ROADS BREWING CO. LTD, PALMYRA, WA, AUSTRALIA:
3,398,325, PUB. 1-1-2008. INT. CL. 32.
- GAGGOHAAS GMBH, SWITZERLAND:
3,398,714, PUB. 1-1-2008. MULTIPLE CLASS, INT. CLS. 25, 30 AND 43.
- GAHANNA-CREEKSIDE INVESTMENTS LLC, GAHANNA, OH:
3,397,596, PUB. 1-1-2008. INT. CL. 37.
- GALILEO PRESS GMBH, 53227 BONN, FED REP GERMANY:
3,396,921, PUB. 1-1-2008. INT. CL. 16.
- GALLERY OF THE MASTERS, INC., ST. LOUIS, MO:
3,400,203, INT. CL. 41.
- GALLO, MARC N., BAYSIDE, NY, DBA GALLO ENGINEERING, PLLC:
3,397,981, PUB. 1-1-2008. INT. CL. 9.
- GALT WESTERN PERSONNEL LTD., VANCOUVER, BRITISH COLUMBIA, CANADA:
1,474,633. REN. 2-13-08. INT. CL. 35.
- GAMBER-JOHNSON LLC, STEVENS POINT, WI:
3,397,054, PUB. 1-1-2008. MULTIPLE CLASS, INT. CLS. 9 AND 12.
- GAMBILL, SHANNON, LOUISVILLE, KY:
3,400,207, INT. CL. 14.
- GAMETECH INTERNATIONAL, INC., RENO, NV:
3,399,985, INT. CL. 9.
- GANT AB, NACKA STRAND, SWEDEN, GANT OF NEW HAVEN, INC., NEW HAVEN, CT:
833,385. REN. 2-11-08. U.S. CL. 39 (INT. CL. 25).
- GANT AB, NACKA STRAND, SWEDEN:
2,134,790. REN. 2-11-08. INT. CL. 25.
- GANZHOU RARE EARTH METALS CO., LTD., JIANGXI PROVINCE, CHINA:
3,399,887, INT. CL. 1.
- GAP GÜNEYDOĞU TEKSTİL; SANAYİ VE TİCARET ANONİM ŞİRKETİ, TURKEY:
3,398,831, PUB. 1-1-2008. INT. CL. 24.
- GARCEAU, ARTHUR H., HOLLYWOOD, FL:
3,400,335, INT. CL. 3.
- GAREB SHAMUS ENTERPRISES, INC., CONGERS, NY:
3,399,315, INT. CL. 16.
3,399,717, INT. CL. 41.
- GARMIN LTD., GEORGE TOWN, CAYMAN ISLANDS:
3,399,900, INT. CL. 9.
- GARRETT, NORMAN, AUSTIN, TX:
2,060,142, CANC. INT. CL. 37.

- GARRITANO, FRANCO, SAN DIEGO, CA AND ALAVI, MATT, SAN DIEGO, CA AND ELLIOTT, KIRK, SAN DIEGO, CA:
3,399,491, INT. CL. 30.
- GARTMORE INVESTMENT MANAGEMENT PLC, LONDON, ENGLAND, UNITED KINGDOM:
3,398,350, PUB. 9-14-2004. INT. CL. 36.
- GARY S. STEVENS FOUNDATION, BLOOMINGTON, MN:
3,397,331, PUB. 1-1-2008. INT. CL. 41.
3,397,333, PUB. 1-1-2008. INT. CL. 41.
- GARY W. MALLOW, M.D., P.A., PLANTATION, FL:
3,397,811, PUB. 1-1-2008. INT. CL. 44.
- GARZA, RAYNALDO, MONARCH BEACH, CA:
3,399,586, INT. CL. 25.
3,400,346, INT. CL. 36.
- GARZA, RAYNALDO, MONARCH CITY, CA:
3,400,347, INT. CL. 41.
- GATEWAY DOG TRAINING, INC., DRIPPING SPRINGS, TX:
3,397,923, PUB. 1-1-2008. INT. CL. 41.
- GATEWAY HEALTH PLAN L.P., PITTSBURGH, PA:
3,397,304, PUB. 1-1-2008. INT. CL. 44.
- GATEWAY, INC., IRVINE, CA:
3,399,065, INT. CL. 9.
- GATX CORPORATION, CHICAGO, IL:
1,102,941, REN. 2-9-08. INT. CL. 12.
- GB LICENSING LLC, NEW YORK, NY:
2,132,897, REN. 2-11-08. MULTIPLE CLASS, INT. CLS. 25 AND 28.
- GE HEALTHCARE BIOSCIENCE BIOPROCESS CORP., PISCATAWAY, NJ:
3,399,913, INT. CL. 9.
- GEAR WASH LLC, MILWAUKEE, WI:
3,397,989, PUB. 1-1-2008. INT. CL. 37.
- GEARHART, HENRY, EAST STROUDSBURG, PA:
3,399,439, INT. CL. 35.
- GEBBIA, JOSEPH N., SAN FRANCISCO, CA AND GRIGSBY, MATT, PROVIDENCE, RI:
3,397,584, PUB. 1-1-2008. INT. CL. 42.
- GEBRUDER LODIGE MASCHINENBAU-GESELLSCHAFT MIT BESCHRANKTER HAFTUNG, D-33102 PADERBORN, FED REP GERMANY:
2,447,308, CANC. MULTIPLE CLASS, INT. CLS. 7 AND 42.
- GECCO IMPORT-EXPORT; HANDELSGESELLSCHAFT MBH, A-1060 WIEN, AUSTRIA:
3,398,718, PUB. 1-1-2008. MULTIPLE CLASS, INT. CLS. 3, 5, 29, 30 AND 31.
- GEERPRES, INC., MUSKEGON, MI:
3,397,483, PUB. 1-1-2008. MULTIPLE CLASS, INT. CLS. 6, 20 AND 21.
- GEMENY, STEVEN E., MONTGOMERY VILLAGE, MD:
3,397,801, PUB. 1-1-2008. INT. CL. 41.
- GEMINI SOUND PRODUCTS CORP., CARTERET, NJ:
2,448,237, CANC. INT. CL. 11.
- GENCOR PACIFIC, INC., AUSTIN, TX:
3,399,903, INT. CL. 5.
- GENDEX CORPORATION, DES PLAINES, IL:
3,399,919, INT. CL. 10.
3,399,920, INT. CL. 10.
- GENEON ENTERTAINMENT (USA) INC., LONG BEACH, CA AND VICTOR ENTERTAINMENT, INC., MINATOKU, TOKYO, JAPAN AND TOKUMA SHOTEN PUBLISHING CO., LTD., MINATO-KU, TOKYO, JAPAN:
3,399,384, MULTIPLE CLASS, INT. CLS. 9, 16, 25 AND 28.
- GENERAL CHEMICAL PERFORMANCE PRODUCTS LLC, PARSIPPANY, NJ:
2,137,390, REN. 2-13-08. INT. CL. 1.
- GENERAL DYNAMICS LAND SYSTEMS CUSTOMER SERVICE & SUPPORT COMPANY, STERLING HEIGHTS, MI:
2,150,387, REN. 2-11-08. INT. CL. 9.
- GENERAL ELECTRIC COMPANY, SCHENECTADY, NY:
3,399,353, MULTIPLE CLASS, INT. CLS. 7, 11, 37 AND 42.
- GENERAL MEDVENTURES INTERNATIONAL, LLC, EARTH CITY, MO:
3,399,018, INT. CL. 10.
- GENERAL MILLS IP HOLDINGS II, LLC, MINNEAPOLIS, MN:
3,398,419, PUB. 1-1-2008. INT. CL. 30.
- GENERAL MILLS, INC., MINNEAPOLIS, MN:
2,447,526, CANC. INT. CL. 25.
- GENERAL MOTORS CORPORATION, DETROIT, MI:
1,476,220, REN. 2-14-08. INT. CL. 37.
- GENERAL SCIENCES, INC., SOUDERTON, PA:
3,398,010, PUB. 1-1-2008. INT. CL. 1.
- GENESIS TODAY, INC., AUSTIN, TX:
3,398,227, PUB. 1-1-2008. INT. CL. 5.
- GENLYTE THOMAS GROUP LLC, LOUISVILLE, KY, ESB INCORPORATED, PHILADELPHIA, PA:
1,099,350, REN. 2-8-08. INT. CL. 9.
- GENUINE HEALTH INC., TORONTO, CANADA:
3,397,002, PUB. 1-1-2008. INT. CL. 5.
- GEO. A. HORMEL & COMPANY, AUSTIN, MN:
1,438,649, CANC. INT. CL. 29.
- GEOCITIES, SANTA CLARA, CA:
2,447,343, CANC. MULTIPLE CLASS, INT. CLS. 38 AND 42.
- GEODIGM CORPORATION, CHANHASSEN, MN TO GEODIGM CORPORATION, CHANHASSEN, MN:
2,572,036, AM. INT. CL. 9.
- GEOFFREY, INC., WAYNE, NJ:
2,548,257, CANC. INT. CL. 18.
- GEOPLASMA, LLC, ATLANTA, GA:
3,398,002, PUB. 1-1-2008. INT. CL. 40.
- GEORGE KELK CORPORATION, TORONTO, ONTARIO, CANADA, GEORGE KELK LIMITED, TORONTO, ONTARIO, CANADA:
1,451,884, REN. 2-11-08. INT. CL. 9.
- GEORGE ZIMMER 1988 LIVING TRUST, COMPRISING JAMES ZIMMER, LAURIE ECKSTEIN, DAVID EDWAB AND CHARLES BRESLER ALL U.S. CITIZEN., FREMONT, CA:
3,398,879, MULTIPLE CLASS, INT. CLS. 37 AND 40.
- GEORGIA EDUCATIONAL TECHNOLOGY CONSORTIUM, INC., ATHENS, GA:
3,397,097, PUB. 1-1-2008. INT. CL. 41.
- GERBER PRODUCTS COMPANY, FREMONT, MI:
1,473,270, REN. 2-11-08. INT. CL. 25.
- GERBER, RYAN D, CLEVELAND, OH:
3,400,357, INT. CL. 40.
- GERHARD D. WEMPE, 20095 HAMBURG, FED REP GERMANY:
3,069,706, COR. INT. CL. 14.
- GERLACH, PAUL H., SAN JOSE, CA:
3,399,914, MULTIPLE CLASS, INT. CLS. 16 AND 41.
- GERMITEC, F-75008 PARIS, FRANCE:
3,398,715, PUB. 1-1-2008. MULTIPLE CLASS, INT. CLS. 10, 11 AND 37.
3,398,719, PUB. 1-1-2008. MULTIPLE CLASS, INT. CLS. 10, 11 AND 37.
- GERNER, MICHAEL, NEW YORK, NY AND GRUBB, JOSH, NEW YORK, NY AND FOSS, MICHAEL, NEW YORK, NY AND BERKO, IVAN, NEW YORK, NY:
3,397,440, PUB. 1-1-2008. INT. CL. 9.
- GERNSBACK PUBLICATIONS, INC., HAUPPAUGE, NY:
2,447,930, CANC. INT. CL. 16.
- GERSHI, YEHUDA, BNEI BRAK, ISRAEL:
3,398,463, PUB. 1-1-2008. INT. CL. 14.
- GET LIT ENTERPRISES INC., CORAL GABLES, FL:
3,400,378, INT. CL. 25.
- GETQUIK, INC., LOS GATOS, CA:
3,397,080, PUB. 1-1-2008. INT. CL. 35.
- GFX INTERNATIONAL, INC., GRAYSLAKE, IL:
3,397,059, PUB. 1-1-2008. INT. CL. 42.
- GHISALLO HOLDINGS, LLC, CHESTERFIELD, MO:
3,398,132, PUB. 1-1-2008. MULTIPLE CLASS, INT. CLS. 35 AND 41.
- GIBRALTAR CONSTRUCTION CO., OMAHA, NE:
3,397,314, PUB. 1-1-2008. INT. CL. 37.
- GIDDINGS & LEWIS MACHINE TOOLS, LLC, FOND DU LAC, WI, GIDDINGS & LEWIS MACHINE TOOL COMPANY, FOND DU LAC, WI:
657,107, REN. 2-13-08. U.S. CL. 23 (INT. CL. 7).

GIGATOR LLC, KANEOHE, HI:
3,399,745, INT. CL. 42.

GILLETTE COMPANY, THE, BOSTON, MA:
1,491,967, REN. 2-13-08, INT. CL. 8.

GIMMEGRUB, FULLERTON, CA:
3,397,005, PUB. 1-1-2008, INT. CL. 35.

GINN REAL ESTATE COMPANY, LLC, CELEBRATION, FL:
3,397,444, PUB. 1-1-2008, MULTIPLE CLASS, INT. CLS.
35, 36 AND 37.
3,397,458, PUB. 1-1-2008, MULTIPLE CLASS, INT. CLS. 35
AND 37.

GIOVANNI JEWELRY COMPANY, PROVIDENCE, RI:
2,448,451, CANC. INT. CL. 14.

GLANCE NETWORKS, INC., ARLINGTON, MA:
3,398,505, PUB. 1-1-2008, INT. CL. 42.

GLASS, PATRICK, D, SAN DIEGO, CA:
3,400,002, INT. CL. 38.

GLAXO GROUP LIMITED, GREENFORD, MIDDLESEX
UB6 ONN, UNITED KINGDOM:
3,351,939, CANC. INT. CL. 5.

GLAXO GROUP LIMITED, GREENFORD, MIDDLESEX,
UNITED KINGDOM:
3,397,394, PUB. 1-1-2008, INT. CL. 5.

GLICKSTEIN, LEE, WOODACRE, CA:
2,147,639, REN. 2-13-08, INT. CL. 41.

GLIT, INC., WRENS, GA TO HALLMARK HOLDINGS, INC.,
WREN, GA:
2,059,750, CANC. INT. CL. 21.

GLOBAL ENVIRONMENT & TECHNOLOGY FOUNDA-
TION, ANNANDALE, VA:
2,447,687, CANC. INT. CL. 42.

GLOBAL GIG, INC., PALM BEACH, FL:
3,397,988, PUB. 1-1-2008, INT. CL. 35.

GLOBAL HARVEST OF COLORADO LLC, SEATTLE, WA:
1,478,920, REN. 2-13-08, INT. CL. 31.

GLOBAL LANGUAGE SOLUTIONS, INC., NEWPORT
BEACH, CA:
3,398,521, PUB. 1-1-2008, MULTIPLE CLASS, INT. CLS. 9
AND 41.

GLOBAL LEAD, LLC, CINCINNATI, OH:
2,161,003, REN. 2-14-08, INT. CL. 41.

GLOBAL NAVIGATION INC., LA VERNE, CA:
3,399,713, INT. CL. 9.

GLOBAL ORGANICS, LLC, GOODYEAR, AZ:
3,397,828, PUB. 1-1-2008, INT. CL. 1.
3,397,830, PUB. 1-1-2008, INT. CL. 1.
3,397,831, PUB. 1-1-2008, INT. CL. 1.
3,397,834, PUB. 1-1-2008, INT. CL. 1.
3,397,837, PUB. 1-1-2008, INT. CL. 1.
3,397,840, PUB. 1-1-2008, INT. CL. 1.
3,397,842, PUB. 1-1-2008, INT. CL. 1.
3,397,844, PUB. 1-1-2008, INT. CL. 1.

GLOBECHARGE PTY LTD, VICTORIA, AUSTRALIA:
3,397,349, PUB. 1-1-2008, MULTIPLE CLASS, INT. CLS. 35
AND 36.

GMB, INC., KING, NC, LARUS & BROTHER COMPANY,
RICHMOND, VA:
362,601, REN. 2-13-08, U.S. CL. 17 (INT. CL. 34).

GMB, INC., KING, NC:
1,495,296, REN. 2-13-08, INT. CL. 34.

GO GODDESS, INC., MIAMI, FL:
2,448,434, CANC. INT. CL. 31.

GOALSGUY LEARNING SYSTEMS, INC., PALM HARBOR,
FL:
3,399,487, INT. CL. 16.

GODLEY, JOHN H., MARSTONS MILLS, MA:
2,127,205, REN. 2-11-08, INT. CL. 9.

GOGO TOURS, INC., RAMSEY, NJ:
2,205,161, REN. 2-11-08, INT. CL. 42.

GOLD MEDAL PRODUCTS CO., CINCINNATI, OH:
2,183,005, REN. 2-8-08, INT. CL. 30.

GOLD MEDAL PRODUCTS COMPANY, CINCINNATI, OH:
2,209,148, REN. 2-8-08, INT. CL. 30.

GOLD STAR BRANDS LLC DBA HONGAR FARMS GOUR-
MET FOODS, TUCKER, GA:
3,397,382, PUB. 1-1-2008, INT. CL. 29.

GOLDART INTERNATIONAL INC., GARDEN CITY, NY:
3,400,235, INT. CL. 14.

GOLDEN APPLE (CA) CORPORATION, HAYWARD, CA:
2,135,536, REN. 2-13-08, INT. CL. 12.
2,135,542, REN. 2-13-08, INT. CL. 12.

GOLDEN APPELXX CO., INC., INDUSTRY, CA:
3,397,902, PUB. 1-1-2008, INT. CL. 40.

GOLDEN GATE ANCILLARY LLC, FORT SMITH, AR:
3,398,989, INT. CL. 44.
3,399,068, INT. CL. 43.
3,400,118, INT. CL. 35.
3,400,124, INT. CL. 44.
3,400,128, INT. CL. 44.
3,400,129, INT. CL. 44.

GOLDEN GATE ANCILLARY LLC, FORST SMITH, AR:
3,400,130, INT. CL. 44.

GOLDEN GATE ANCILLARY LLC, FORT SMITH, AR:
3,400,131, INT. CL. 44.

GOLDEN STATE SCHOLARSHARE TRUST, SACRAMEN-
TO, CA:
2,447,829, CANC. INT. CL. 36.

GOLDFISH GUITARS LLC, LEAGUE CITY, TX:
3,400,250, INT. CL. 15.

GOLDMAN, SUSAN, BERKELEY, CA AND DANA, RI-
CHARD, BERKELEY, CA AND SEGALL, LEWIS, BERKE-
LEY, CA:
3,397,643, PUB. 1-1-2008, INT. CL. 41.

GOLDRIDGEPINOT.COM LLC, SEBASTOPOL, CA:
3,399,963, INT. CL. 33.

GOLDSMITH SHOP, INC., THE, HILTON HEAD ISLAND,
SC:
1,483,881, REN. 2-12-08, INT. CL. 42.
1,496,702, REN. 2-12-08, INT. CL. 14.

GOLDSMITH, IVAN, LAS VEGAS, NV:
3,397,162, PUB. 1-1-2008, INT. CL. 5.

GOLF LAB, LLC, SALT LAKE CITY, UT:
3,397,732, PUB. 1-1-2008, INT. CL. 41.

GOLF, L.L.C, OMAHA, NE:
2,447,647, CANC. INT. CL. 42.

GOLFNOW INC., SCOTTSDALE, AZ:
3,397,119, PUB. 1-1-2008, INT. CL. 41.

GOLFSMITH INTERNATIONAL, INC., AUSTIN, TX:
3,398,038, PUB. 1-1-2008, INT. CL. 28.
3,398,339, PUB. 1-1-2008, INT. CL. 35.

GONTOWSKI, RENEE A., CHERRY HILL, NJ:
3,398,033, PUB. 1-1-2008, INT. CL. 44.

GOOD KARMA FOOD TECHNOLOGIES, INC., GLEN-
DALE, CA:
3,399,007, INT. CL. 30.

GOOD PET PRODUCTS, LTD., HEREFORD, TX:
1,511,178, REN. 2-10-08, INT. CL. 31.

GOODMAN, NANCY S, TURBEVILLE, SC:
2,447,975, CANC. INT. CL. 41.

GOODYEAR TIRE & RUBBER COMPANY, THE, AKRON,
OH:
657,927, REN. 2-11-08, U.S. CL. 1 (INT. CL. 17).

GORDON PAPE ENTERPRISES LTD., TORONTO, ONTAR-
IO, CANADA:
3,398,361, PUB. 5-29-2007, MULTIPLE CLASS, INT. CLS. 9
AND 16.

GORDON, DWAYNE, HACKENSACK, NJ:
3,397,637, PUB. 1-1-2008, INT. CL. 41.

GORS, DON, CHICAGO, IL:
3,398,208, PUB. 1-1-2008, INT. CL. 3.

GOSERUD, J. THOMAS, LANDISVILLE, PA:
2,448,172, CANC. INT. CL. 16.

GOUVERNEMENT DE LA PRINCIPAUTE DE MONACO,
PALAIS DU GOUVERNEMENT MC 98000, MONACO:
2,523,919, CANC. MULTIPLE CLASS, INT. CLS. 20, 38
AND 42.

GOVERNMENT DEVELOPMENT BANK FOR PUERTO
RICO, SAN JUAN, PUERTO RICO:
2,447,279, CANC. INT. CL. 36.

GOVERNMENT EMPLOYEES INSURANCE COMPANY,
WASHINGTON, DC:
3,398,021, PUB. 1-1-2008, INT. CL. 36.

GRAHAM GROUP INTERNATIONAL, INC., LACHINE,
QUEBEC, CANADA:
3,397,750, PUB. 1-1-2008, MULTIPLE CLASS, INT. CLS. 9,
40 AND 42.

- GRAND HOLDINGS, INC., BLOOMINGTON, MN:
2,167,884. REN. 2-13-08. INT. CL. 39.
- GRANT PRIDECO, L.P., HOUSTON, TX:
3,399,840. INT. CL. 6.
- GRANT, ANGELA, SACRAMENTO, CA:
3,398,975. INT. CL. 25.
- GRANT, STEPHEN, TOORAK, VIC. 3142, AUSTRALIA:
3,397,369. PUB. 1-1-2008. INT. CL. 9.
- GRAPHIC SCIENCES, INC., ROYAL OAK, MI:
2,447,838. CANC. INT. CL. 42.
- GRAPHIC SERVICES IMAGING, INC., STERLING HEIGHTS, MI:
3,400,095. INT. CL. 40.
- GRAPHICS 2000, INC., NORWALK, CT:
3,398,454. PUB. 1-1-2008. MULTIPLE CLASS, INT. CLS. 16 AND 19.
- GRAPHILUX INTERNATIONAL S.A., LUXEMBOURG, LUXEMBOURG:
3,399,939. INT. CL. 14.
- GRASS-TELEFACTOR CORPORATION, WEST WARWICK, RI:
2,447,885. CANC. INT. CL. 9.
- GRASSROOTS OUTDOOR ALLIANCE, INC., ASHEVILLE, NC:
3,397,361. PUB. 1-1-2008. INT. CL. 35.
- GRAY MANUFACTURING COMPANY, INC., ST. JOSEPH, MO:
3,399,158. INT. CL. 35.
- GRAY MATTER HOLDINGS, LLC, BALTIMORE, MD,
GORGONZ GROUP, INC., THE, CHICAGO, IL:
2,135,074. REN. 2-13-08. INT. CL. 25.
- GRAY TEK, INC., NEWARK, DE:
3,398,861. INT. CL. 10.
- GREAT AMERICAN INSURANCE COMPANY, CINCINNATI, OH:
2,059,052. CANC. INT. CL. 36.
- GREAT AMERICAN PRODUCTS, INC., DESTIN, FL:
3,396,900. PUB. 1-1-2008. INT. CL. 5.
- GREAT AUTOS OF YESTERYEAR, SANTA ANA, CA:
2,447,386. CANC. INT. CL. 42.
- GREAT NORTH COMMUNICATIONS LTD., EDMONTON, ALBERTA:
2,447,854. CANC. INT. CL. 41.
- GREAT SOUTHERN WOOD PRESERVING, INC., ABBEVILLE, AL:
2,216,105. REN. 2-13-08. INT. CL. 19.
- GREAT WHITE SHARK ENTERPRISES, INC., JUPITER, FL:
2,177,349. REN. 2-11-08. INT. CL. 28.
- GREAT-WEST LIFE & ANNUITY INSURANCE COMPANY, GREENWOOD VILLAGE, CA:
3,398,240. PUB. 1-1-2008. INT. CL. 36.
- GREAT-WEST LIFE & ANNUITY INSURANCE COMPANY, GREENWOOD VILLAGE, CO:
3,398,241. PUB. 1-1-2008. INT. CL. 36.
- GREATER BAY INC., FULLERTON, CA:
3,289,138. COR. INT. CL. 25.
- GREATER BOSTON RADIO, INC., BRAINTREE, MA:
2,135,752. REN. 2-13-08. INT. CL. 38.
- GREATWIDE LOGISTICS SERVICES, INC., DALLAS, TX:
3,399,737. MULTIPLE CLASS, INT. CLS. 35 AND 39.
- GREEK FINANCIAL MANAGEMENT, INC., BLOOMINGTON, IL:
3,400,372. INT. CL. 35.
- GREEN ISLAND ASSOCIATES, PHILADELPHIA, PA:
3,398,024. PUB. 1-1-2008. INT. CL. 43.
- GREEN, LEWIS A, AVENTURA, FL:
3,397,904. PUB. 1-1-2008. INT. CL. 9.
- GREENBRIER & RUSSEL, INC., SCHAUMBURG, IL:
2,448,159. CANC. MULTIPLE CLASS, INT. CLS. 35 AND 42.
- GREENE STREET CAPITAL CORP., NEW YORK, NY:
2,447,340. CANC. INT. CL. 41.
- GREENHECK FAN CORPORATION, SCHOFIELD, WI:
3,400,080. INT. CL. 11.
- GREENSPRING MEDIA GROUP, INC, MINNEAPOLIS, MN:
3,400,373. INT. CL. 16.
- GREENWOOD FINANCE, INC., WILMINGTON, DE:
3,397,124. PUB. 1-1-2008. INT. CL. 41.
- GREGG APPLIANCES, INC., INDIANAPOLIS, IN:
2,447,808. CANC. INT. CL. 35.
- GREGORIE, DOUGLAS & COMPANY, CHARLESTON, SC:
2,447,892. CANC. INT. CL. 35.
- GREGORY ENTERPRISES, INC., GARLAND, TX:
3,400,064. INT. CL. 9.
- GREYHAT, LLC, LAWRENCEVILLE, GA:
2,447,852. CANC. INT. CL. 42.
- GRIDWAVE RECORDS, INC., SANDWICH, IL:
3,399,060. INT. CL. 9.
- GRIFFIN, MARK A., LANCASTER, PA:
3,397,614. PUB. 1-1-2008. INT. CL. 18.
- GRILL VENTURES, INC., ATLANTA, GA:
3,399,251. INT. CL. 30.
3,399,252. INT. CL. 30.
- GROOV-PIN CORPORATION, SMITHFIELD, RI:
1,085,291. REN. 2-11-08. INT. CL. 6.
- GROSBERG MIKE THOMAS, CHICO, CA:
3,398,584. PUB. 1-1-2008. INT. CL. 8.
- GROUND DESIGNS 2000, ALHAMBRA, CA:
2,447,891. CANC. INT. CL. 12.
- GROUND ZERO SERVICES, LLC, COURTLAND, MN:
3,398,060. PUB. 1-1-2008. INT. CL. 37.
- GROUNDWORK EQUITY, LLC, CAMARILLO, CA:
3,397,342. PUB. 1-1-2008. MULTIPLE CLASS, INT. CLS. 35 AND 36.
- GROVE FARM COMPANY, INCORPORATED, LIHUE, HI:
3,399,654. MULTIPLE CLASS, INT. CLS. 35 AND 36.
- GRUBBS, ROGER STEVEN, VAN BUREN, AR:
3,396,878. PUB. 1-1-2008. INT. CL. 32.
- GRUNDFOS MANAGEMENT A/S, DENMARK:
3,398,806. PUB. 1-1-2008. INT. CL. 7.
3,398,816. PUB. 1-1-2008. INT. CL. 7.
- GRUPO OMNILIFE S.A. DE C.V., ZAPOPAN, JALISCO 45129, MEXICO:
2,128,836. REN. 2-11-08. INT. CL. 5.
2,130,403. REN. 2-11-08. INT. CL. 29.
- GSH HOLDINGS, INC, SANTA CRUZ, CA:
3,396,903. PUB. 1-1-2008. INT. CL. 30.
- GSN GLOBAL SERVICES NETWORK (USA), INC., PORTLAND, OR:
2,447,657. CANC. INT. CL. 38.
- GTE HEALTH SYSTEM INCORPORATED:
1,438,526. CANC. INT. CL. 9.
- GUANGDONG MEIWEIXIAN FLAVORING; FOODS CO., LTD., CHINA:
3,398,802. PUB. 1-1-2008. INT. CL. 30.
- GUARDAIR CORPORATION, CHICOPEE, MA:
3,397,037. PUB. 1-1-2008. INT. CL. 7.
- GUARDIAN POOL FENCE SYSTEMS, INC., VAN NUYS, CA:
3,399,678. INT. CL. 6.
- GUARDID SYSTEMS, INC., SAN MATEO, CA:
3,399,618. INT. CL. 9.
- GUARINO, JERRY C, BAY SHORE, NY:
3,397,726. PUB. 1-1-2008. MULTIPLE CLASS, INT. CLS. 25 AND 41.
- GUERLAIN S.A., 75008 PARIS, FRANCE:
3,398,483. PUB. 1-1-2008. INT. CL. 3.
- GUERRA, JOSEFINA R., SYLMAR, CA AND GUERRA, RAUL, SYLMAR, CA:
3,399,446. INT. CL. 25.
- GUIDE PROGRAM, INC., LAUREL, MD:
3,397,249. PUB. 1-1-2008. MULTIPLE CLASS, INT. CLS. 43, 44 AND 45.
- GUIDEPOINT GLOBAL, LLC, NEW YORK, NY:
3,400,157. INT. CL. 35.
- GURU DENIM INC., VERNON, CA:
3,397,067. PUB. 1-1-2008. INT. CL. 25.
- GUTTENPLAN'S FROZEN DOUGH, INC., MIDDLETOWN, NJ:
2,137,397. REN. 2-12-08. INT. CL. 30.
2,139,060. REN. 2-12-08. INT. CL. 30.
2,139,061. REN. 2-12-08. INT. CL. 30.
- GUTZEES, LLC, ENGLEWOOD, NJ:
2,626,101. AM. INT. CL. 21.

GW NORTH MANUFACTURING, INC., ETOBICOKE, ONTARIO, M9C 2A8, CANADA:
2,448,120, CANC. INT. CL. 31.

GYRUS MEDICAL GMBH, FED REP GERMANY:
3,398,700, PUB. 1-1-2008. INT. CL. 10.

H DE V, LLC, HOOD RIVER, OR:
3,398,884, INT. CL. 33.

H.B. ZACHRY COMPANY, SAN ANTONIO, TX:
2,447,699, CANC. INT. CL. 37.

H.C. BRILL COMPANY, INC., TUCKER, GA:
3,399,046, INT. CL. 30.

H&N HERBS, ARCADIA, CA:
3,397,432, PUB. 9-25-2007. INT. CL. 5.

H-B INSTRUMENT COMPANY, COLLEGEVILLE-TRAPPE, PA:
2,081,097, REN. 2-13-08. INT. CL. 9.

H-CARD, LLC, OMAHA, NE:
3,397,144, PUB. 1-1-2008. INT. CL. 36.
3,397,145, PUB. 1-1-2008. INT. CL. 36.

HACIENDA PUBLISHING, INC., MACON, GA:
2,060,033, CANC. INT. CL. 16.

HADALA, ANTHONY J., BRECKSVILLE, OH:
3,399,911, INT. CL. 9.

HADASH, EDWARD, BURNSVILLE, MN:
3,399,266, INT. CL. 28.

HADDAD'S FINE ART INC., ANAHEIM, CA:
3,400,229, INT. CL. 41.

HAGENSBOG CHOCOLATES LTD., MAPLE RIDGE, CANADA:
3,397,404, PUB. 1-1-2008. INT. CL. 30.

HAGER DESIGN, INC., FRAMINGHAM, MA:
3,399,120, INT. CL. 25.

HAGUE, GREGORY D., PARADISE VALLEY, AZ:
3,398,936, INT. CL. 35.

HAHN AUTOMOTIVE WAREHOUSE, INC., ROCHESTER, NY:
1,520,224, REN. 2-14-08. INT. CL. 42.

HAHN BAROSSA VINEYARDS (SA) PTY LTD, AUSTRALIA:
3,398,722, PUB. 1-1-2008. INT. CL. 33.

HAINLINE, JEFFREY D., MISSOULA, MT:
3,400,340, INT. CL. 29.

HAIRXTEND INC., VIENNA, VA:
3,398,377, PUB. 1-1-2008. INT. CL. 26.

HALL, SARAH K., ROCKLIN, CA AND KAGETA, MARIA L., ROCKLIN, CA:
3,398,079, PUB. 1-1-2008. INT. CL. 45.

HALLBERG, HOLLY, MALIBU, CA:
3,399,229, INT. CL. 35.

HALLER, REESE R., BAY CITY, MI:
3,399,599, MULTIPLE CLASS, INT. CLS. 9 AND 16.

HALLMARK, DAVID A., PORTSMOUTH, NH:
3,399,677, MULTIPLE CLASS, INT. CLS. 16 AND 25.

HALLOWEEN LTD. FAMILY PARTNERSHIP, SAN ANTONIO, TX:
2,448,050, CANC. INT. CL. 41.

HAMBRECHT WINE GROUP, LP, HEALDSBURG, CA:
3,398,113, PUB. 1-1-2008. INT. CL. 33.

HAMMESFAHR, WILLIAM, CLEARWATER, FL:
2,059,859, CANC. MULTIPLE CLASS, INT. CLS. 16 AND 42.

HAMPTON BAKE CO. INC., SOUTHAMPTON, NY:
3,397,953, PUB. 1-1-2008. INT. CL. 30.

HAMWORTHY COMBUSTION ENGINEERING; LIMITED, UNITED KINGDOM:
3,398,664, PUB. 1-1-2008. MULTIPLE CLASS, INT. CLS. 9 AND 11.

HANCHANG CO., LTD., KYONGGI-DO, REPUBLIC OF KOREA:
2,126,990, REN. 2-11-08. INT. CL. 15.

HAND HELD PRODUCTS, INC., SKANEATELES FALLS, NY:
2,136,281, REN. 2-12-08. INT. CL. 9.

HANDTECH.COM, INC., AUSTIN, TX:
2,447,413, CANC. INT. CL. 35.

HANGZHOU SHI TONGLU YILIAO; GUANGXUEYIQI ZONGCHANG, ZHEJIANG, CHINA:
3,398,671, PUB. 1-1-2008. INT. CL. 10.

HANLEY-WOOD, LLC, WASHINGTON, DC:
3,400,407, INT. CL. 35.

HANNA-BARBERA PRODUCTIONS, INC., BURBANK, CA:
3,399,935, INT. CL. 41.

HANNECKE DISPLAY SYSTEMS, INC., BOONTON, NJ:
3,397,100, PUB. 1-1-2008. INT. CL. 20.

HANNUM, SANDRA RAE, SACRAMENTO, CA:
3,397,679, PUB. 1-1-2008. INT. CL. 16.

HANOVER LANTERN, INC., HANOVER, PA:
1,474,876, REN. 2-11-08. INT. CL. 11.

HAPPY'S POTATO CHIP CO., MINNEAPOLIS, MN:
2,059,627, CANC. MULTIPLE CLASS, INT. CLS. 29 AND 30.

HARBORVIEW MEDICAL CENTER, SEATTLE, WA:
3,398,418, PUB. 1-1-2008. MULTIPLE CLASS, INT. CLS. 42 AND 44.

HARDWOOD PLYWOOD & VENEER ASSOCIATION, RESTON, VA:
3,396,912, PUB. 1-1-2008. U.S. CL. A.

HARE, KENNETH E., CHICAGO, IL:
3,397,871, PUB. 1-1-2008. INT. CL. 37.

HARGER, WILLIAM, COLORADO SPRINGS, CO, DBA KEY WAY CURB COMPANY:
2,119,721, REN. 2-9-08. INT. CL. 37.

HARMAN INTERNATIONAL INDUSTRIES, INCORPORATED, NORTHRIDGE, CA:
3,397,212, PUB. 9-25-2007. INT. CL. 9.

HARNISCHFEGER TECHNOLOGIES, INC., WILMINGTON, DE:
3,397,213, PUB. 1-1-2008. INT. CL. 9.

HARPERCOLLINS PUBLISHERS LTD., GLASGOW, ENGLAND:
2,134,377, REN. 2-12-08. INT. CL. 16.

HARRIS CORPORATION, MELBOURNE, FL:
3,399,987, INT. CL. 9.

HARRIS, BERNADETTE M., SUGARLAND, TX:
3,397,257, PUB. 1-1-2008. INT. CL. 14.

HARRIS, HERB, AUSTIN, TX:
3,400,389, INT. CL. 25.

HARRIS, JEFFREY P., HEALDSBURG, CA:
3,400,169, INT. CL. 33.

HARRIS, LAWRENCE J., POMPANO BEACH, FL:
3,396,911, PUB. 1-1-2008. INT. CL. 45.

HARRIS, PAUL, MINNEAPOLIS, MN, DBA PIRATE TREASURE:
2,448,273, CANC. INT. CL. 35.

HARRIS, WAYNE, AUSTIN, TX:
2,135,638, REN. 2-14-08. INT. CL. 9.

HARRISBURG, INC., HOUSTON, TX TO NATIONAL OILWELL VARCO, L.P., HOUSTON, TX:
1,070,863, CANC. MULTIPLE CLASS, INT. CLS. 4 AND 17.

HARSCO TECHNOLOGIES CORPORATION, FAIRMOUNT, MN:
1,497,578, REN. 2-14-08. INT. CL. 11.

HART, BEVERLY, SUWANEE, GA:
3,398,111, PUB. 1-1-2008. INT. CL. 36.

HARTFORD FIRE INSURANCE COMPANY, HARTFORD, CT:
2,447,907, CANC. INT. CL. 36.

HARTSTRINGS, LLC, STRAFFORD, PA:
2,125,126, REN. 2-13-08. INT. CL. 25.

HARTZ CAPITAL, INC., SECAUCUS, NJ:
3,396,877, PUB. 1-1-2008. INT. CL. 36.

HARVARD PILGRIM HEALTH CARE, INC., WELLESLEY, MA:
2,067,534, REN. 2-13-08. INT. CL. 36.

HASBRO, INC., PAWTUCKET, RI:
3,398,951, INT. CL. 28.

HAVEY, MICHAEL, CASTAIC, CA:
2,447,550, CANC. INT. CL. 14.
2,447,551, CANC. INT. CL. 14.

HAYMAN, DENISE, MIDVALE, UT:
3,399,842, INT. CL. 43.

HBP ACQUISITION LLC, WAYNE, NJ:
3,398,409, PUB. 1-1-2008. INT. CL. 19.

HD NUTRITION, INC., COSTA MESA, CA:
3,399,791, INT. CL. 3.

- HDNET LLC, DALLAS, TX:
3,399,109, INT. CL. 41.
- HE, WAN RONG, SAN DIEGO, CA:
2,448,143, CANC. INT. CL. 14.
- HEALING POWER INC., WOODLAND HLS, CA:
3,398,231, PUB. 1-1-2008. INT. CL. 5.
- HEALTH AND WELLNESS AWARENESS INTERNATIONAL, INC., OLDSMAR, FL:
2,448,259, CANC. INT. CL. 28.
- HEALTH CARE LOGISTICS, INC., CIRCLEVILLE, OH:
3,397,089, PUB. 1-1-2008. INT. CL. 16.
- HEALTH SOLUTIONS OF MORTON, LLC, BLOOMINGTON, IL:
3,398,355, PUB. 9-27-2005. INT. CL. 44.
- HEALTHCARE FACILITIES SOLUTIONS, INC., NEWPORT, DE:
3,397,857, PUB. 1-1-2008. INT. CL. 42.
- HEALTHCORPS, NEW YORK, NY:
3,397,995, PUB. 1-1-2008. INT. CL. 41.
3,398,020, PUB. 1-1-2008. INT. CL. 41.
3,398,023, PUB. 1-1-2008. INT. CL. 41.
- HEALTHWAYS, INC., NASHVILLE, TN:
3,396,974, PUB. 1-1-2008. INT. CL. 44.
- HEALTHWIDE.COM CORPORATION, MILBRAE, CA:
2,447,617, CANC. MULTIPLE CLASS, INT. CLS. 35, 38 AND 42.
2,447,618, CANC. INT. CL. 42.
- HEALTHY DIRECTIONS, LLC, POTOMAC, MD:
3,399,416, MULTIPLE CLASS, INT. CLS. 16, 35, 36, 39, 41, 42, 43, 44 AND 45.
- HEART TO HEART INTERNATIONAL, INC., OLATHE, KS:
3,399,500, MULTIPLE CLASS, INT. CLS. 35, 36, 41 AND 44.
- HEART'S DELIGHT BAKERY, INC., LEXINGTON, MA:
3,398,448, PUB. 1-1-2008. INT. CL. 30.
- HEARTLAND INSTITUTE OF FINANCIAL EDUCATION, AURORA, CO:
3,400,143, U.S. CL. B.
- HEARTLAND, LLC, MADISON, AL:
3,397,819, PUB. 1-1-2008. INT. CL. 41.
- HEATER CRAFT MARINE PRODUCTS, RATHDRUM, ID:
3,400,025, INT. CL. 11.
- HEAVEN HILL DISTILLERIES, INC., BARDSTOWN, KY, OLD HEAVEN HILL SPRINGS DISTILLERY, INCOOPERATED, BARDSTOWN, KY:
355,451, REN. 2-13-08. U.S. CL. 49 (INT. CL. 33).
- HEAVEN HILL DISTILLERIES, INC., BARDSTOWN, KY:
1,473,417, REN. 2-11-08. INT. CL. 33.
2,155,026, REN. 2-12-08. INT. CL. 33.
- HEAVENLY BIRTHDAY, L.L.C., BIRMINGHAM, AL:
3,397,975, PUB. 1-1-2008. INT. CL. 42.
- HEAVENLY COUTURE, DIAMOND BAR, CA:
3,397,725, PUB. 1-1-2008. INT. CL. 35.
- HEB GROCERY COMPANY, L.P., SAN ANTONIO, TX:
3,399,391, MULTIPLE CLASS, INT. CLS. 1, 3, 5, 16 AND 32.
- HEIM, HANS, APTOS, CA:
2,064,406, REN. 2-9-08. MULTIPLE CLASS, INT. CLS. 12 AND 25.
- HEINRICH AMELUNG GMBH HERSTELLUNG VON MEDIZINISCHEN LABORGERATEN, 32657 LEMGO, FED REP GERMANY:
2,127,709, REN. 2-11-08, INT. CL. 10.
- HEINZ WEYERMANN: RÖSTMALZBIERBRAUEREI BAMBERG GMBH, FED REP GERMANY:
3,398,692, PUB. 1-1-2008. INT. CL. 32.
- HELENA HOLDING COMPANY, WILMINGTON, DE:
3,399,352, INT. CL. 5.
- HELIO LLC, LOS ANGELES, CA:
3,399,208, INT. CL. 9.
- HELIO MEDICAL SUPPLIES, INC., SANTA CLARA, CA:
2,447,626, CANC. INT. CL. 10.
- HELIOGRAMME AMERICA, INC., MEMPHIS, TN:
2,134,626, REN. 2-11-08. INT. CL. 42.
2,134,628, REN. 2-11-08. INT. CL. 42.
- HELLER, GARY LYNN, GOLDEN, CO AND DECAMP, BOB J., GOLDEN, CO:
2,059,833, CANC. INT. CL. 27.
- HELMET HOUSE, INC., CALABASAS, CA:
3,397,649, PUB. 1-1-2008. INT. CL. 18.
- HELP AT HOME INC, BOCA RATON, FL:
3,400,342, INT. CL. 44.
- HELPUOSOFT CORPORATION, CONCORD, CA:
2,448,463, CANC. MULTIPLE CLASS, INT. CLS. 9 AND 42.
- HELTON, ANNETTE, DETROIT, MI AND HOLMES, ROSALIND, DETROIT, MI:
3,399,927, INT. CL. 41.
- HENKEL CAPITAL, S.A. DE C.V., HUIXQUILUCAN, MEXICO:
3,397,624, PUB. 11-27-2007. INT. CL. 3.
- HENKEL KOMMANDITGESELLSCHAFT AUF AKTIEN (HENKEL KGAA), D-40191 DUESSELDORF, FED REP GERMANY:
2,511,342, CANC. MULTIPLE CLASS, INT. CLS. 3 AND 42.
- HENRY HEIDE, INCORPORATED, NEW BRUNSWICK, NJ:
243,976, REN. 2-8-08. U.S. CL. 46 (INT. CL. 30).
- HERALD MEDIA INC., SEOUL, REPUBLIC OF KOREA:
3,399,581, INT. CL. 16.
- HERBA ENTERPRISE, INC., SAN FRANCISCO, CA:
3,399,916, MULTIPLE CLASS, INT. CLS. 5 AND 30.
- HERBALIFE INTERNATIONAL, INC., LOS ANGELES, CA:
3,399,409, MULTIPLE CLASS, INT. CLS. 35 AND 44.
- HERBORIUM, INC., TEANECK, NJ:
3,399,454, INT. CL. 5.
- HEREFORD BI-PRODUCTS, INC., HEREFORD, TX:
3,398,838, INT. CL. 18.
- HERITAGE NEW YORK IPA, INC., GARDEN CITY, NY:
3,397,159, PUB. 1-1-2008. INT. CL. 44.
- HERITAGE NEW YORK, IPA INC., GARDEN CITY, NY:
3,397,158, PUB. 1-1-2008. INT. CL. 44.
- HERITAGE PRESERVATION CORPORATION, SPARTANBURG, SC:
3,399,650, INT. CL. 42.
- HERNANDEZ DOMINGUEZ, BAUDELIO, MEXICO, MEXICO:
3,400,247, INT. CL. 34.
- HERSHEY CHOCOLATE & CONFECTIONERY CORPORATION, WHEAT RIDGE, CO:
3,399,139, INT. CL. 30.
3,399,163, INT. CL. 30.
- HESS, GLORIA, STURTEVANT, WI, DBA CREATIVE BRICK AND CONCRETE:
2,131,713, REN. 2-11-08. INT. CL. 19.
- HESTRA-HANDSKEN AB, 330 27 HESTRA, SWEDEN:
1,973,282, CANC. INT. CL. 28.
- HETTICH MARKETING UND VERTRIEBS GMBH & CO. KG, 32269 KIRCHLENGERN, FED REP GERMANY, HETTICH AMERICA CORPORATION, CHARLOTTE, NC:
1,399,192, REN. 2-13-08. INT. CL. 6.
- HEWITT ASSOCIATES LLC, LINCOLNSHIRE, IL:
2,448,276, CANC. INT. CL. 9.
- HI-QUALITY PACKING, INC., DELTA, CO:
845,979, REN. 2-12-08. U.S. CL. 46 (INT. CL. 31).
- HI-TECH ELECTRONIC DISPLAYS, INC., CLEARWATER, FL:
3,398,966, INT. CL. 9.
- HI-VIDOMIN LABORATORIES, INC., PITTSBURGH, PA:
2,217,060, REN. 2-13-08. INT. CL. 5.
- HICKORY & TWEED, INC., ARMONK, NY:
843,620, REN. 2-14-08. U.S. CL. 22 (INT. CL. 28).
- HIDE 'N SEEK CHILDREN'S FOUNDATION, SALINAS, CA:
3,398,195, PUB. 1-1-2008. INT. CL. 20.
- HIGH ENERGY DECISIONS, LLC, OLIVETTE, MO:
3,397,543, PUB. 1-1-2008. INT. CL. 41.
- HIGH SIERRA SPORT COMPANY, VERNON HILLS, CA:
2,135,635, REN. 2-13-08. INT. CL. 18.
- HIGH SPEED PRODUCTIONS, INC., SAN FRANCISCO, CA:
3,398,507, PUB. 1-1-2008. INT. CL. 25.
- HIGH TECH BLOCKS LLC, REDLANDS, CA:
3,398,118, PUB. 1-1-2008. INT. CL. 35.
- HIGH WIND PRODUCTIONS, INC., RUTHERSVILLE, VA:
1,447,627, REN. 2-11-08. INT. CL. 25.
- HIGHER CALL INC, LANCASTER, PA:
3,399,178, INT. CL. 36.

HILL-ROM SERVICES, INC., BATESVILLE, IN:
2,143,262. REN. 2-12-08. INT. CL. 10.
2,177,286. REN. 2-13-08. INT. CL. 20.

HILLBILLY MALL, INC., TOPTON, NC:
2,447,463. CANC. MULTIPLE CLASS, INT. CLS. 35 AND 36.

HILLERICH & BRADSBY CO., LOUISVILLE, KY:
3,399,553. INT. CL. 28.

HILLIOS, SONIA R., SOUTHAMPTON, MA AND HILLIOS, CHRISTOPHER H., SOUTHAMPTON, MA:
3,399,172. INT. CL. 10.

HILLSDALE COLLEGE, HILLSDALE, MI:
2,447,725. CANC. INT. CL. 41.

HIRAOKA SHOKUSEN KABUSHIKI KAISHA (HIRAOKA & CO., LTD.), ARAKAWA-KU, TOKYO, JAPAN:
2,059,890. CANC. INT. CL. 24.

HIRE DISABILITY SOLUTIONS, LLC, BROOKLYN, NY:
3,399,468. INT. CL. 35.

HIS COMPANY, INC., HOUSTON, TX:
3,398,520. PUB. 1-1-2008. MULTIPLE CLASS, INT. CLS. 35 AND 40.

HITT CONTRACTING, INC., FAIRFAX, VA:
2,176,319. REN. 2-14-08. MULTIPLE CLASS, INT. CLS. 37 AND 42.
2,176,327. REN. 2-14-08. MULTIPLE CLASS, INT. CLS. 37 AND 42.

HM ELECTRONICS, INC., POWAY, CA:
1,485,100. REN. 2-13-08. INT. CL. 9.

HMSHOST CORPORATION, BETHESDA, MD:
3,399,146. INT. CL. 35.

HOBART CORPORATION, TROY, OH:
2,193,936. REN. 2-13-08. INT. CL. 11.

HOBBY LOBBY STORES, INC., OKLAHOMA CITY, OK:
3,400,104. INT. CL. 26.

HOCHENG CORPORATION, SEC. 3, TAIPEI, TAIWAN:
2,138,489. REN. 2-13-08. INT. CL. 11.

HODGE, BRUCE, GREENFIELD, NY:
3,399,856. INT. CL. 42.
3,399,857. INT. CL. 35.

HOFFMAN, ANDREA, HAMBURG, NJ:
3,396,906. PUB. 1-1-2008. INT. CL. 35.

HOGUE, CHERYL, SALINE, MI:
2,447,920. CANC. INT. CL. 42.

HOLCOMBE, DAVID L., ORINDA, CA:
2,447,415. CANC. INT. CL. 9.

HOLLANDER, TAMEIRA L., LITTLETON, CO:
3,399,474. INT. CL. 16.

HOLLEY, JAMES M., DALLAS, TX:
3,397,632. PUB. 1-1-2008. INT. CL. 37.

HOLLIDAY II, DAVID, SCOTTSDALE, AZ:
3,398,026. PUB. 1-1-2008. INT. CL. 41.

HOLLYWOOD ENTERTAINMENT CORPORATION, WILSONVILLE, OR:
3,399,430. INT. CL. 35.

HOLLYWOOD.COM, INC., BOCA RATON, FL:
2,447,710. CANC. INT. CL. 41.

HOLSCHEN, RICHARD, KAKTOVIK, AK:
3,398,402. PUB. 10-10-2006. INT. CL. 3.

HOLT HOSIERY MILLS, INC., BURLINGTON, NC:
3,398,929. INT. CL. 25.

HOME BASE YOUTH SERVICES, INC., PHOENIX, AZ:
3,397,796. PUB. 1-1-2008. MULTIPLE CLASS, INT. CLS. 41, 43 AND 44.

HOMEFRONTS L.L.C., GRAND RAPIDS, MI:
3,399,917. INT. CL. 37.

HOMER TLC, INC., CLAYMONT, DE, HOME DECORATORS COLLECTION, INC., ST. LOUIS, MO:
2,136,523. REN. 2-13-08. INT. CL. 35.

HOMS, LLC, CLAYTON, NC:
3,397,177. PUB. 1-1-2008. INT. CL. 5.

HONEYWELL FEDERAL CREDIT UNION, MINNEAPOLIS, MN:
3,399,020. INT. CL. 36.

HONEYWELL INTERNATIONAL INC., MORRISTOWN, NJ:
3,399,110. INT. CL. 1.

HOODLIFT LTD, WEST SACRAMENTO, CA:
3,397,568. PUB. 1-1-2008. INT. CL. 12.

HOONVED S.R.L., MILAN, ITALY:
3,397,528. PUB. 1-1-2008. INT. CL. 7.

HOOPS FOR HOPE, INC., EAST HAMPTON, NY:
2,531,271. CANC. INT. CL. 36.

HOPE AESTHETICS COSMECEUTICAL, INC., ESCONDI-DO, CA:
3,397,038. PUB. 1-1-2008. INT. CL. 3.

HOPE FOR THE HEART, INC., DALLAS, TX:
3,396,918. PUB. 1-1-2008. MULTIPLE CLASS, INT. CLS. 9 AND 16.

HOPE FOR YOU! CORPORATION, COLORADO SPRINGS, CO:
3,397,742. PUB. 1-1-2008. INT. CL. 25.

HORIZON CHRISTIAN FELLOWSHIP, SAN DIEGO, CA:
3,400,205. INT. CL. 16.

HORIZON REAL-TIME SYSTEMS, INC, NEW YORK, NY:
2,059,210. CANC. INT. CL. 9.

HORMEL FOODS, LLC, AUSTIN, MN, KRAFT, INC., GLENVIEW, IL:
1,438,652. REN. 2-8-08. INT. CL. 29.

HORNADY MANUFACTURING COMPANY, GRAND ISLAND, NE:
2,447,904. CANC. INT. CL. 13.

HORTILUX SCHRÉDER B.V., NETHERLANDS:
3,398,758. PUB. 1-1-2008. MULTIPLE CLASS, INT. CLS. 11, 35, 42 AND 44.
3,398,759. PUB. 1-1-2008. MULTIPLE CLASS, INT. CLS. 11, 35, 42 AND 44.

HOSKET, GARY W., TROY, MT:
3,398,214. PUB. 1-1-2008. INT. CL. 45.

HOSPIRA, INC., LAKE FOREST, IL:
3,398,201. PUB. 1-1-2008. INT. CL. 10.
3,399,021. INT. CL. 9.

HOSPITALROOM.COM, INC., BELLEVUE, WA:
2,447,531. CANC. INT. CL. 35.

HOTBEND CORPORATION, ARLINGTON, TX:
2,447,694. CANC. INT. CL. 9.

HOTELES CAMINO REAL, S.A. DE C.V., 11590 MEXICO, D.F., MEXICO:
1,438,736. CANC. INT. CL. 42.

HOURLY-ZERO CRISIS CONSULTING LTD., EDMONTON, CANADA:
3,398,123. PUB. 1-1-2008. MULTIPLE CLASS, INT. CLS. 41 AND 45.

HOUSE OF CHEATHAM, INC., STONE MOUNTAIN, GA:
3,400,312. INT. CL. 3.
3,400,313. INT. CL. 3.

HOUSE OF HEARING, INC., LANCASTER, OH:
1,518,488. REN. 2-11-08. INT. CL. 42.

HOUSE OF SILK FLOWERS, INC., HAVELOCK, NC:
3,397,590. PUB. 1-1-2008. INT. CL. 35.

HOUSTON LIVESTOCK SHOW & RODEO, INC., HOUSTON, TX:
1,477,587. REN. 2-13-08. MULTIPLE CLASS, INT. CLS. 14 AND 25.

HOWARD PRECISION, INC., FANWOOD, NJ, DBA QUALCO PRODUCTS CO. TO ILLINOIS TOOL WORKS INC., GLENVIEW, IL:
1,085,815. CANC. MULTIPLE CLASS, INT. CLS. 2 AND 17.

HOWSTUFFWORKS, INC., ATLANTA, GA:
3,398,322. PUB. 1-1-2008. INT. CL. 42.

HR CAPITAL MANAGEMENT, ROCKVILLE, MD:
3,400,058. MULTIPLE CLASS, INT. CLS. 35 AND 36.

HR CAPITAL MANAGEMENT, INC., ROCKVILLE, MD:
3,400,059. INT. CL. 35.

HRCA OF DEDHAM, INC., BOSTON, MA:
3,399,126. INT. CL. 43.

HRONCICH, BRIAN M., CRANBERRY TOWNSHIP, PA:
3,399,469. INT. CL. 35.

HRS ENTERPRISES, INC., SCOTTSDALE, AZ:
2,059,476. CANC. INT. CL. 19.

HSH NORDBANK AG, HAMBURG, FED REP GERMANY:
3,399,314. INT. CL. 35.

HTC HOLDING CO., WATERLOO, IL:
3,397,011. PUB. 1-1-2008. INT. CL. 38.

- HUBEI AVIATION PRECISION MACHINERY TECHNOLOGY CO., LTD., HUBEI, CHINA:
3,397,807, PUB. 1-1-2008. INT. CL. 12.
- HUBERT COMPANY, HARRISON, OH:
2,058,891, CANC. INT. CL. 20.
- HUCK INTERNATIONAL INC., TUCSON, AZ, HUCK MANUFACTURING COMPANY, IRVINE, CA:
1,473,897. REN. 2-13-08. INT. CL. 6.
- HUCK INTERNATIONAL, INC., TUCSON, AZ, HUCK MANUFACTURING COMPANY, DETROIT, MI:
1,084,501. REN. 2-14-08. INT. CL. 6.
- HUDSON, ALBION, BEVERLY HILLS, CA:
3,397,367, PUB. 1-1-2008. INT. CL. 25.
- HUESTIS MACHINE CORPORATION, BRISTOL, RI:
1,478,524. REN. 2-9-08. INT. CL. 10.
1,485,042. REN. 2-9-08. INT. CL. 7.
- HUGHESWARE COMPUTER SERVICES, L.L.C., HARPER WOODS, MI:
3,397,540, PUB. 1-1-2008. INT. CL. 36.
- HUGO BENZING GMBH & CO. KG, 70825 KORNTAL-MÜNCHINGEN, FED REP GERMANY:
3,398,630, PUB. 1-1-2008. MULTIPLE CLASS, INT. CLS. 6, 7 AND 8.
- HUHTAMAKI CONSUMER PACKAGING, INC., DESOTO, KS:
2,187,410. REN. 2-11-08. INT. CL. 16.
- HUMPHREYS & PARTNERS ARCHITECTS, L.P., DALLAS, TX:
3,397,511, PUB. 1-1-2008. INT. CL. 42.
- HUNT-GOLLIDAY, PASHA S., CHICAGO, IL:
3,400,293, INT. CL. 16.
- HUNTER DOUGLAS INC., UPPER SADDLE RIVER, NJ:
3,399,366, INT. CL. 20.
- HUNTER'S SPECIALTIES, INC., CEDAR RAPIDS, IA:
3,399,099, INT. CL. 8.
- HUNTING ENERGY SERVICES, INC., HOUSTON, TX:
1,476,549. REN. 2-10-08. INT. CL. 6.
- HURRICANE JUICE COMPANY, LLC, SARASOTA, FL:
3,398,967, INT. CL. 32.
- HY-KO PRODUCTS COMPANY, NORTHFIELD, OH:
3,400,040, INT. CL. 7.
- HY-SECURITY GATE, INC., KENT, WA:
3,397,849, PUB. 1-1-2008. MULTIPLE CLASS, INT. CLS. 7 AND 9.
- HY-TECH WORLDWIDE, INC., LAS VEGAS, NV:
3,399,712, INT. CL. 7.
- HYALURON, INC., BURLINGTON, MA:
3,397,075, PUB. 1-1-2008. INT. CL. 40.
- HYBRID AIRCRAFT CONSULTANTS INC., EDGEWOOD, NM:
3,399,472, INT. CL. 42.
- HYDRONIKA, INC. SHELBYVILLE, CA:
3,397,613, PUB. 1-1-2008. INT. CL. 11.
- HYDROPOOL INDUSTRIES INC., TORONTO, ONTARIO:
3,397,293, PUB. 1-1-2008. MULTIPLE CLASS, INT. CLS. 11 AND 19.
- HYLANT SPECIALTY PROGRAMS, LTD., TOLEDO, OH:
2,149,897. REN. 2-13-08. INT. CL. 36.
- HYMAN, HERBERT B., CAMARILLO, CA:
3,398,882, INT. CL. 28.
- HYNIX SEMICONDUCTOR INC., KYOUNGKI-DO, REPUBLIC OF KOREA:
3,399,983, INT. CL. 9.
- HYOGUARD AMERICA LIMITED, EDINA, MN:
3,399,864, INT. CL. 10.
- HYUNDAI CORPORATION, SEOUL, REPUBLIC OF KOREA:
3,399,477, INT. CL. 3.
- H2O INTERNATIONAL, INC., DEERFIELD BEACH, FL:
3,397,695, PUB. 1-1-2008. INT. CL. 11.
- I.DO. DIAMONDS, INC., LAS VEGAS, NV:
3,400,283, INT. CL. 14.
- I.E.P.C. CORP, HUNTINGTON BEACH, CA:
3,399,434, INT. CL. 9.
- I.M. RECORDS, INC., LOS ANGELES, CA:
2,447,783, CANC. INT. CL. 9.
2,447,784, CANC. INT. CL. 9.
- I'LL BEE THERE ANIMAL AND BEE REMOVAL, INC., MIAMI, FL:
3,397,685, PUB. 1-1-2008. INT. CL. 37.
- IADMA LLC, ENGLEWOOD, CO:
2,447,866, CANC. INT. CL. 35.
- IAN DESIGN, INC., TOMS RIVER, NJ:
3,398,365, PUB. 12-7-2004. INT. CL. 35.
- IAN GRIGGS, AUSTRALIA:
3,398,811, PUB. 1-1-2008. INT. CL. 10.
- IBAA FINANCIAL SERVICES CORPORATION, MEMPHIS, TN:
2,059,268, CANC. INT. CL. 36.
- ICS TRIPLEX TECHNOLOGY LTD., MALDON, UNITED KINGDOM:
3,398,560, PUB. 9-4-2007. MULTIPLE CLASS, INT. CLS. 9 AND 37.
- ID INTERACTIVE LLC, DELRAY BEACH, OH:
3,399,936, INT. CL. 9.
- IDAHO-EASTERN OREGON ONION COMMITTEE, PARMA, ID:
3,397,028, PUB. 1-1-2008. U.S. CL. A.
- IDEA AMERICA LLC, HELENA, MT:
3,399,479, MULTIPLE CLASS, INT. CLS. 25 AND 28.
- IDEAL CONCRETE BLOCK COMPANY, INC., WESTFORD, MA:
3,399,334, INT. CL. 19.
- IDEALOGISTS LLC, AVON, CT:
2,448,411, CANC. INT. CL. 28.
- IDEMITSU KOSAN CO., LTD., JAPAN:
3,398,724, PUB. 1-1-2008. INT. CL. 1.
- IDENTISPHERE INC, BLOOMINGTON, MN:
3,399,014, INT. CL. 42.
- IDENTRUST, INC., SAN FRANCISCO, CA:
3,399,813, INT. CL. 42.
3,399,814, INT. CL. 42.
- IDEUM INC., CORRALES, NM:
3,398,058, PUB. 1-1-2008. INT. CL. 42.
- IGA, INC., CHICAGO, IL, INDEPENDENT GROCERS' ALLIANCE DISTRIBUTING CO., CHICAGO, IL:
657,279. REN. 2-11-08. U.S. CL. 200.
- IGNITE USA, LLC, CHICAGO, IL:
3,400,093, INT. CL. 20.
- IGT, RENO, NV:
3,400,149, INT. CL. 41.
- IKAN TECHNOLOGIES INC., RIVERSIDE, CT:
3,399,531, INT. CL. 35.
- IL ANNUITY AND INSURANCE COMPANY, INDIANAPOLIS, IN:
2,447,998, CANC. INT. CL. 36.
- ILANI, DORIT SUSAN, DESERT HOT SPRINGS, CA:
3,399,740, INT. CL. 41.
- ILLINOIS INSTITUTE OF TECHNOLOGY, CHICAGO, IL:
3,397,737, PUB. 1-1-2008. INT. CL. 25.
- ILLINOIS TOOL WORKS INC., GLENVIEW, IL, HOWARD PRECISION, INC., FANWOOD, NJ, DBA QUALCO PRODUCTS CO.:
1,085,815. REN. 2-13-08. MULTIPLE CLASS, INT. CLS. 1 AND 21.
- ILLINOIS TOOL WORKS INC., GLENVIEW, IL:
2,158,408. REN. 2-14-08. INT. CL. 42.
- ILLINOIS TOOL WORKS, INC., CHICAGO, IL, CHAMPION SPARK PLUG COMPANY, TOLEDO, OH:
1,491,961. REN. 2-13-08. INT. CL. 7.
- ILLUMINATING CONCEPTS, LTD., FARMINGTON HILLS, MI:
3,399,681, MULTIPLE CLASS, INT. CLS. 9, 37 AND 42.
- IMAGES APPLIED LLC, PLEASANT HILL, CA:
3,397,755, PUB. 1-1-2008. INT. CL. 14.
- IMAGINE COMMUNICATIONS, INC., CARDIFF-BY-THE-SEA, CA:
3,399,190, INT. CL. 9.
- IMARKET SERVICES, LLC, SANTA MONICA, CA:
3,399,928, INT. CL. 9.
- IMEAS S.P.A. OF VILLA CORTESE, ITALY, VIA PACINOTTI, 36, ITALY:
2,447,716, CANC. INT. CL. 7.
- IMG WORLDWIDE, INC., CLEVELAND, OH:
3,399,867, MULTIPLE CLASS, INT. CLS. 35, 38, 41 AND

42.
IMMERSIVE MEDIA COMPANY, PORTLAND, OR:
3,400,245, INT. CL. 9.
IMPLIX SP. Z O.O., GDYNIA, POLAND:
3,400,336, INT. CL. 42.
IMPLUS CORPORATION, DURHAM, NC TO IMPLUS
FOOTCARE LLC, MORRISVILLE, NC:
2,059,422, CANC. INT. CL. 25.
IMS INFORMATION MANAGEMENT SERVICES, INC., ST
JOHNSBURY, VT:
2,447,353, CANC. INT. CL. 9.
IMT PARTNERS INC., NORTH CHELMSFORD, MA:
3,400,309, INT. CL. 42.
IMWELL HEALTH, LLC, FORT SMITH, AR:
3,397,672, PUB. 1-1-2008. INT. CL. 44.
IN THE ARENA, INC., CAMBRIDGE, MA:
3,399,223, INT. CL. 36.
3,399,224, INT. CL. 36.
INDEPENDENCE CHERUBINI COMPANY, INC., DELVAN,
NJ:
2,059,226, CANC. MULTIPLE CLASS, INT. CLS. 12 AND
37.
INDEPENDENT DISTRIBUTORS COOPERATIVE - USA,
INDIANAPOLIS, IN:
3,396,925, PUB. 1-1-2008. INT. CL. 7.
INDEPENDENT PACKAGING, L.P., DALLAS, TX:
2,448,060, CANC. INT. CL. 16.
INDERA MILLS COMPANY, YADKINVILLE, NC:
3,398,143, PUB. 1-1-2008. INT. CL. 25.
3,398,249, PUB. 1-1-2008. INT. CL. 25.
INDIANA NANOTECH, LLC, INDIANAPOLIS, IN:
3,400,370, MULTIPLE CLASS, INT. CLS. 1 AND 10.
INDIEPENCEMUSIC.NET, INC., LAKE OSWEGO, OR:
3,396,940, PUB. 1-1-2008. INT. CL. 35.
INDIE911, LLC, WEST HOLLYWOOD, CA:
3,397,280, PUB. 1-1-2008. MULTIPLE CLASS, INT. CLS.
35, 41 AND 42.
INDUSTRIAL SCIENTIFIC CORPORATION, OAKDALE,
PA:
1,082,999, REN. 2-8-08. INT. CL. 42.
INDUSTRIAL TOWER AND WIRELESS, LLC, MARSH-
FIELD, MA:
3,398,458, PUB. 1-1-2008. MULTIPLE CLASS, INT. CLS.
35, 37, 38 AND 42.
INDUSTRIOUS KID, INC., OAKLAND, CA:
3,399,962, INT. CL. 41.
INFANGER INVESTMENT TECHNOLOGY, LLC, MOUN-
TAIN VIEW, CA:
3,398,599, PUB. 1-1-2008. INT. CL. 9.
INFINITY INSURANCE COMPANY, BIRMINGHAM, AL:
3,399,802, INT. CL. 36.
INFOHIGHWAY COMMUNICATIONS CORPORATION,
NEW YORK, NY:
2,439,955, CANC. INT. CL. 35.
INFORMATION MANAGEMENT TEAM, INC., SAINT
JOHN, WA:
2,448,023, CANC. INT. CL. 35.
INFORMATIVE SOLUTIONS, GARDEN GROVE, CA:
3,397,969, PUB. 1-1-2008. INT. CL. 45.
INFOSTRUCTURE SOLUTIONS, L.L.C., HOUSTON, TX:
3,400,383, INT. CL. 9.
INFRARED FIBER SYSTEMS, INC., SILVER SPRING, MD:
3,398,504, PUB. 7-31-2007. INT. CL. 9.
INFUSCIENCE, INC., GURNEE, IL:
3,400,097, INT. CL. 44.
INGEAR, BUFFALO GROVE, IL:
2,447,882, CANC. INT. CL. 12.
INGRAM ENTERPRISES, INC., SPRINGFIELD, MO:
2,212,694, REN. 2-14-08. INT. CL. 13.
INLAND VACUUM INDUSTRIES, INC., CHURCHVILLE,
NY:
3,396,914, PUB. 1-1-2008. INT. CL. 1.
INLAND VALLEYS ASSOCIATION OF REALTORS, CAN-
YON LAKE, CA:
3,317,508, COR. INT. CL. 35.
INNER CIRCLE TECHNOLOGIES, INC., SHREWSBURY,
MA:
2,058,536, CANC. INT. CL. 41.
INNER-CITY MUSLIM ACTION NETWORK, CHICAGO, IL:
3,397,214, PUB. 1-1-2008. MULTIPLE CLASS, INT. CLS.
41, 43 AND 44.
INNERDYNE, INC., NORTH HAVEN, CT:
2,154,242, REN. 2-12-08. INT. CL. 10.
INNIVATION, LLC, CINCINNATI, OH:
3,397,422, PUB. 9-25-2007. INT. CL. 3.
INNOVATI, INC., HSINCHU, TAIWAN:
3,399,957, INT. CL. 9.
INNOVATIS AG, FED REP GERMANY:
3,398,780, PUB. 1-1-2008. MULTIPLE CLASS, INT. CLS. 9
AND 10.
INNOVATIVE AUDIO CORPORATION, LAGUNA BEACH,
CA:
2,447,805, CANC. INT. CL. 9.
INNOVATIVE FASHION GROUP CORP., NEW YORK, NY:
3,399,461, INT. CL. 25.
INRESCO PORTFOLIOS LTD., ETNA, NH:
2,447,503, CANC. MULTIPLE CLASS, INT. CLS. 35 AND
36.
INSEL, RACHEL LAUREN, LOS ANGELES, CA:
3,399,606, INT. CL. 41.
INSIGHT EQUITY A.P.X., LP, SOUTHLAKE, TX, DBA
VISION-EASE LENS:
3,399,551, INT. CL. 9.
3,399,573, INT. CL. 9.
INSOUND LLC, NEW YORK, NY:
3,398,057, PUB. 1-1-2008. INT. CL. 35.
INSTA-ARCH CORPORATION, HAMDEN, CT:
1,472,301, REN. 2-11-08. INT. CL. 19.
INSTANT CREDIT CARD SECURITY SYSTEMS, INC.,
FREMONT, CA:
3,398,978, INT. CL. 45.
INSTANT HAIR REMOVAL CLINIC PTY LTD; ACN 095 241
884, AUSTRALIA:
3,398,705, PUB. 1-1-2008. MULTIPLE CLASS, INT. CLS. 3,
5, 35 AND 44.
INSTINET CORPORATION, NEW YORK, NY:
2,448,304, CANC. INT. CL. 35.
INSTITUTE FOR INTERNATIONAL RESEARCH, NEW
YORK, NY:
2,447,817, CANC. INT. CL. 41.
INSTITUTE OF ELECTRICAL AND ELECTRONICS ENGI-
NEERS, THE, PISCATAWAY, NJ:
2,447,578, CANC. INT. CL. 16.
INSTROMEDIX, INC., HILLSBORO, OR:
1,064,846, CANC. INT. CL. 10.
INSTRUMENTATION LABORATORY, S.P.A., MILAN 20128,
ITALY:
2,059,669, CANC. MULTIPLE CLASS, INT. CLS. 1 AND
10.
INTEC INC., MIAMI, FL:
3,399,294, INT. CL. 9.
INTEGRATED BEVERAGE GROUP, LTD, FARMINGDALE,
NY:
3,399,052, INT. CL. 30.
INTEGRATED OFFICE SOLUTIONS, INC., ELLENWOOD,
GA:
2,448,416, CANC. INT. CL. 42.
INTEGRATED SYSTEMS EVENTS LLC, FAIRFAX, VA:
3,400,269, INT. CL. 35.
INTEGRITY PARTNERS, INC., LOS ANGELES, CA:
3,399,699, INT. CL. 16.
INTELLECTUAL PROPERTY INT'L, INC., LAS VEGAS, NV:
2,447,839, CANC. INT. CL. 10.
INTELLIDYN CORP., HINGHAM, MA:
3,398,061, PUB. 1-1-2008. INT. CL. 35.
INTELLIGENT LIFE CORPORATION, NORTH PALM
BEACH, FL:
2,447,402, CANC. INT. CL. 42.
INTELLIGENTZ CORPORATION, AUSTIN, TX:
3,397,346, PUB. 9-25-2007. MULTIPLE CLASS, INT. CLS.
35 AND 42.
INTELLISCENTS, LLC, SAN FRANCISCO, CA:
3,398,229, PUB. 1-1-2008. INT. CL. 3.
3,398,230, PUB. 1-1-2008. INT. CL. 3.
INTELLISIST, INC., BELLEVUE, WA:
3,400,400, MULTIPLE CLASS, INT. CLS. 9 AND 42.

- INTERACTIVE VIEWS INCORPORATED, ASHBURN, VA:
3,397,645, PUB. 1-1-2008. INT. CL. 42.
- INTERCARD, INC., ST. LOUIS, MO, INTERFACE CONTROL SYSTEMS, INC., ST. LOUIS, MO:
1,521,645. REN. 2-13-08. INT. CL. 9.
- INTEREP NATIONAL RADIO SALES, INC., NEW YORK, NY:
2,447,356, CANC. INT. CL. 35.
- INTERNATIONAL ASSOCIATION OF ASSESSING OFFICERS, CHICAGO, IL:
2,058,871, CANC. U.S. CL. 200.
- INTERNATIONAL ASSOCIATION OF NITROX DIVERS, INC., MIAMI SHORES, FL, DBA IANTD, INC.:
2,150,316. REN. 2-11-08. MULTIPLE CLASS, INT. CLS. 14, 16, 25 AND 41.
- INTERNATIONAL BULLION AND METAL BROKERS (USA) INC., SUNRISE, FL:
3,400,329, INT. CL. 14.
- INTERNATIONAL BUSINESS MACHINES CORPORATION, ARMONK, NY:
2,447,625, CANC. MULTIPLE CLASS, INT. CLS. 16 AND 41.
3,399,438, MULTIPLE CLASS, INT. CLS. 16, 35, 41 AND 42.
- INTERNATIONAL CATALYST TECHNOLOGY, INC., AUBURN HILLS, MI:
3,399,464, INT. CL. 7.
- INTERNATIONAL CITY/COUNTY MANAGEMENT ASSOCIATION (ICMA), WASHINGTON, DC:
3,400,359, INT. CL. 35.
- INTERNATIONAL COFFEE & TEA, LLC, LOS ANGELES, CA, DBA THE COFFEE BEAN AND TEA LEAF:
3,399,767, INT. CL. 30.
- INTERNATIONAL COMPONENTS CORPORATION, HAUPPAUGE, NY:
1,083,322. REN. 2-13-08. INT. CL. 9.
- INTERNATIONAL COURIER NETWORK, INC., NEW YORK, NY:
3,399,485, MULTIPLE CLASS, INT. CLS. 35 AND 39.
- INTERNATIONAL DATA GROUP, INC., FRAMINGHAM, MA:
2,448,501, CANC. INT. CL. 42.
- INTERNATIONAL DIABETES FEDERATION; OU FÉDÉRATION INTERNATIONALE DU DIABÈTE; ÉGALEMENT DÉNOMMÉE IDF OU FID.; ASSOCIATION INTERNATIONALE SANS BUT LUCRATIF, B-1000 BRUXELLES, BELGIUM:
3,398,791, PUB. 1-1-2008. MULTIPLE CLASS, INT. CLS. 16, 35 AND 45.
- INTERNATIONAL ENGINEERING & MANUFACTURING INC., HOPE, MI, DBA INTERNATIONAL ENGINEERING AND INTERNATIONAL ENGINEERING CO.:
3,396,880, PUB. 1-1-2008. MULTIPLE CLASS, INT. CLS. 9, 16, 20, 24 AND 26.
- INTERNATIONAL FELLOWSHIP OF CHRISTIANS AND JEWS, INC., CHICAGO, IL:
3,398,540, PUB. 1-1-2008. INT. CL. 41.
- INTERNATIONAL GLOBAL OPPORTUNITY NETWORK LLC, PORT CHARLOTTE, FL:
3,399,516, INT. CL. 35.
- INTERNATIONAL GREETINGS PLC, HERTS, ENGLAND:
2,448,095, CANC. INT. CL. 16.
- INTERNATIONAL GROUP, INC., THE, WAYNE, PA:
2,130,107. REN. 2-8-08. INT. CL. 2.
- INTERNATIONAL GROWER'S SUPPLY INCORPORATED, CULVER CITY, CA:
3,400,228, INT. CL. 11.
- INTERNATIONAL MARKET BRANDS, INC., ERIE, PA:
2,178,657. REN. 2-11-08. INT. CL. 30.
- INTERNATIONAL PAPER COMPANY, PURCHASE, NY TO EASTMAN KODAK COMPANY, ROCHESTER, NY:
2,059,254, CANC. INT. CL. 7.
- INTERNATIONAL PLANT BREEDING A.G., CH-3006 BERN, SWITZERLAND, HERMANN HOLTKAMP KG, ISSELBURG, FED REP GERMANY:
1,082,818. REN. 2-11-08. INT. CL. 31.
- INTERNATIONAL RESEARCH & EXCHANGES BOARD, WASHINGTON, DC:
2,128,330. REN. 2-12-08. INT. CL. 16.
2,129,964. REN. 2-12-08. MULTIPLE CLASS, INT. CLS. 35, 41 AND 42.
- INTERNATIONAL SPECIALTY TREATMENTS, LLC, OAKVILLE, CT:
3,399,714, INT. CL. 3.
- INTERSPORT INTERNATIONAL CORPORATION GMBH, 3072 OSTERMUNDIGEN, SWITZERLAND:
2,447,501, CANC. MULTIPLE CLASS, INT. CLS. 9, 18 AND 28.
- INTERSTATE BAKERIES CORPORATION, KANSAS CITY, MO:
3,398,276, PUB. 1-1-2008. INT. CL. 30.
3,398,278, PUB. 1-1-2008. INT. CL. 30.
- INTERTEK INTERNATIONAL CORPORATION, FORT LAUDERDALE, FL:
2,447,738, CANC. MULTIPLE CLASS, INT. CLS. 9, 12, 18 AND 21.
- INTERTRUST TECHNOLOGIES CORPORATION, SANTA CLARA, CA:
2,448,029, CANC. INT. CL. 9.
- INTERWORLD TELEVISION, INC, PLANO, TX:
3,400,408, INT. CL. 35.
- INTLINE.COM, INC., ATLANTA, GA:
2,447,429, CANC. INT. CL. 35.
- INTOUCH GROUP, INC., BERKELEY, CA:
2,058,833, CANC. MULTIPLE CLASS, INT. CLS. 35 AND 42.
- INTRO-TECH AUTOMOTIVE, INC., CHINO, CA:
3,398,204, PUB. 1-1-2008. INT. CL. 27.
3,398,206, PUB. 1-1-2008. INT. CL. 27.
- INTUITECH, INC., SALT LAKE CITY, UT:
2,128,504. REN. 2-11-08. INT. CL. 42.
- INVENTAL LABORATORY, INC., MORRO BAY, CA:
3,399,290, INT. CL. 21.
- INVESTIGATIVE CONSULTANTS, INC., WASHINGTON, DC:
3,397,521, PUB. 1-1-2008. INT. CL. 45.
- INVESTMENT COUNSELORS OF REDLANDS LLC, REDLANDS, CA:
3,400,278, INT. CL. 36.
- INVICTA WATCH COMPANY OF AMERICA, INC., HOLLYWOOD, FL:
3,398,997, INT. CL. 14.
- INVISIBLE IMAGES, INC., CINCINNATI, OH:
2,448,464, CANC. INT. CL. 16.
- IONA APPLIANCES INC., WELLAND, ONTARIO, CANADA TO EURO-PRO CORPORATION, SAINT-LAURENT, QUEBEC:
2,058,584, CANC. INT. CL. 9.
- IONATRON INC., TUSCON, AZ:
3,399,394, INT. CL. 42.
- IONIC OASIS, LLC, LINCOLN, NE:
3,398,036, PUB. 1-1-2008. INT. CL. 35.
- IONOPTIKA LIMITED, CHANDLEER'S FORD, HANTS, UNITED KINGDOM:
2,134,893. REN. 2-12-08. INT. CL. 9.
- IOWA MOLD TOOLING CO., INC., GARNER, IA:
2,459,398, COR. INT. CL. 12.
2,511,714, COR. MULTIPLE CLASS, INT. CLS. 7 AND 12.
- IP UNITY GLENAYRE, INC., DULUTH, GA:
3,399,312, INT. CL. 9.
- IRPINIA, RICHMOND HILL, CANADA:
3,397,194, PUB. 1-1-2008. MULTIPLE CLASS, INT. CLS. 20 AND 42.
- IRRIGATION CONSULTANTS UNLIMITED, INC., VERO BEACH, FL:
2,059,847, CANC. MULTIPLE CLASS, INT. CLS. 37 AND 42.
- ISCIENCE INTERVENTIONAL CORPORATION, MENLO PARK, CA:
3,398,878, INT. CL. 10.
- ISNARD, ARNAUD, LONDON, UNITED KINGDOM:
3,398,056, PUB. 1-1-2008. INT. CL. 36.
- ISOTECH LABORATORIES, INC., CHAMPAIGN, IL:
3,400,158, INT. CL. 6.

ISTEC, INC., ALBUQUERQUE, NM:
3,397,079, PUB. 1-1-2008. MULTIPLE CLASS, INT. CLS. 41 AND 42.

ISTITUTO DEL VINO ITALIANO; DI QUALITA' - GRANDI MARCHI S.R.L.; CONSORTILE, I-37124 VERONA, ITALY:
3,398,756, PUB. 1-1-2008. INT. CL. 33.

IT'S ALL GOOD-HEALTH, INC., MOORESVILLE, NC:
3,398,315, PUB. 1-1-2008. INT. CL. 44.

IT'SUGAR LLC, GREENWICH, CT:
3,399,718, INT. CL. 35.

ITALEE OPTICS, INC., LOS ANGELES, CA:
3,398,468, PUB. 1-1-2008. INT. CL. 35.

ITS KOOL, LLC, BOULDER, CO:
3,162,997, CANC. INT. CL. 9.

ITV MARKETING GROUP, INC., BEVERLY, MA:
3,397,275, PUB. 1-1-2008. INT. CL. 35.

IVB, INC., VAN NUYS, CA:
3,400,202, INT. CL. 9.

IVX ANIMAL HEALTH, INC., ST. JOSEPH, MO:
3,398,086, PUB. 1-1-2008. INT. CL. 5.

IXIA, CALABASAS, CA:
3,397,021, PUB. 1-1-2008. INT. CL. 9.

IZZE BEVERAGE CO., BOULDER, CO:
3,399,136, INT. CL. 32.

1360TECHNOLOGIES, INC., RESTON, VA:
3,397,356, PUB. 1-1-2008. MULTIPLE CLASS, INT. CLS. 35 AND 42.

J & D BRUSH CO., INC., HAUPPAUGE, NY:
3,399,693, INT. CL. 21.

J D SERVICES, INCORPORATED, SALT LAKE CITY, UT:
2,447,806, CANC. INT. CL. 36.

J. A. KING & COMPANY, INC., GREENSBORO, NC:
1,472,619, REN. 2-12-08. INT. CL. 37.

J. CRAIG VENTER INSTITUTE, INC., ROCKVILLE, MD:
3,399,230, INT. CL. 42.

J. J. KELLER & ASSOCIATES, INC., NEENAH, WI:
2,630,470, CANC. INT. CL. 16.

J. LLOYD INTERNATIONAL, INC., CEDAR RAPIDS, IA:
3,399,371, INT. CL. 28.

J. MITTON & ASSOCIATES, INC., NEW HOLLAND, PA:
2,172,794, REN. 2-14-08. INT. CL. 18.

J. P. DURGA, L.L.C., PORT LUDLOW, WA:
3,400,071, INT. CL. 3.

J.R. SIMPLOT COMPANY, BOISE, ID:
3,397,751, PUB. 1-1-2008. INT. CL. 1.

J.S. ENGLISH CO., CHAGRIN FALLS, OH:
3,398,860, INT. CL. 16.

J&B WHOLESALE DISTRIBUTING, INC., ST. MICHAEL, MN:
3,398,597, PUB. 9-25-2007. INT. CL. 29.
3,399,277, INT. CL. 29.

J&J SNACK FOODS CORP., PENNSAUKEN, NJ:
2,155,994, REN. 2-14-08. INT. CL. 30.

J&J SNACK FOODS CORP., PENNSAUKEN, NJ, J&J SNACK FOODS CORP., PENNSAUKEN, NJ:
2,164,948, REN. 2-14-08. INT. CL. 30.

JABIL CIRCUIT, INC., ST. PETERSBURG, FL:
3,397,918, PUB. 1-1-2008. MULTIPLE CLASS, INT. CLS. 40 AND 42.

JACK AND JILL OF AMERICA INCORPORATED, WASHINGTON, DC:
3,397,125, PUB. 1-1-2008. MULTIPLE CLASS, INT. CLS. 35 AND 41.

JACK DANIEL'S PROPERTIES, INC., SAN RAFAEL, CA:
3,399,727, INT. CL. 15.
3,400,062, INT. CL. 15.

JACK ORETSKY HOLDINGS, LLC, WEST PALM BEACH, FL:
3,399,254, INT. CL. 5.

JACKSON NATIONAL LIFE, CHICAGO, IL:
2,447,262, CANC. INT. CL. 28.

JACKSON WINE ESTATES INTERNATIONAL LIMITED, COUNTY DUBLIN, IRELAND:
3,400,065, INT. CL. 33.

JACQUELINE PODLASKI, HOLTSVILLE, NY:
3,400,371, INT. CL. 25.

JAFER LIMITED, HAMILTON, HM, BERMUDA:
3,399,026, INT. CL. 3.
3,399,154, INT. CL. 3.

JAGELS, DANIEL, LA CANADA, CA:
3,397,747, PUB. 1-1-2008. INT. CL. 41.

JAGO USA, INC., WILMINGTON, DE:
3,397,090, PUB. 1-1-2008. INT. CL. 33.

JAKKS PACIFIC, INC., MALIBU, CA:
2,137,411, REN. 2-11-08. INT. CL. 28.

JAMES ROGER NELSON BLUE, LOS ANGELES, CA, DBA JIMMY BLUE:
3,397,979, PUB. 1-1-2008. INT. CL. 41.

JAMNICA D.D., CROATIA:
3,398,824, PUB. 1-1-2008. INT. CL. 32.

JANET G., INC., PACIFIC PALISADES, CA:
2,059,816, CANC. INT. CL. 24.

JANICE WALKER, CARINGBAH NSW 1495, AUSTRALIA:
3,398,617, PUB. 1-1-2008. INT. CL. 16.

JANIS E WHITE, HOLLYWOOD, FL:
3,397,731, PUB. 1-1-2008. INT. CL. 16.

JANSPORT APPAREL CORP., WILMINGTON, DE:
2,059,753, CANC. INT. CL. 18.

JANTZE, MICHAEL, SAN ANSELMO, CA:
2,086,524, REN. 2-11-08. INT. CL. 16.

JANTZEN APPAREL, LLC, MIAMI, FL:
842,511, REN. 2-10-08. U.S. CL. 39 (INT. CL. 25).

JAPAN TOBACCO INC., JAPAN:
3,398,639, PUB. 1-1-2008. INT. CL. 34.

JARROW FORMULAS, INC., LOS ANGELES, CA:
3,397,965, PUB. 1-1-2008. INT. CL. 5.
3,397,968, PUB. 1-1-2008. INT. CL. 5.

JASON BAILEY, CEDAR RAPIDS, IA:
3,397,892, PUB. 1-1-2008. INT. CL. 37.

JASON ENTERPRISES, INC., DALLAS, TX:
3,398,490, PUB. 1-1-2008. INT. CL. 44.

JASPAL COMPANY LIMITED, BANGKOK 10260, THAILAND:
3,399,402, MULTIPLE CLASS, INT. CLS. 18 AND 25.

JASPER WOOD PRODUCTS CO., INC., JASPER, IN:
2,447,493, CANC. MULTIPLE CLASS, INT. CLS. 15 AND 20.

JASSO, BERNARDO CUEVA, GUADALAJARA, MEXICO:
3,399,910, INT. CL. 25.

JAZZ GOLF EQUIPMENT INC., WINNIPEG, MANITOBA:
2,448,170, CANC. INT. CL. 28.

JBF HOLDING LLC, MIAMI GARDENS, FL:
3,399,070, INT. CL. 25.

JEFFREY R. TINO, LAS VEGAS, NV:
3,399,489, INT. CL. 40.

JELD-WEN, INC., KLAMATH FALLS, OR:
3,397,306, PUB. 1-1-2008. INT. CL. 41.
3,397,307, PUB. 1-1-2008. INT. CL. 41.

JENNY PRODUCTS, INCORPORATED, SOMERSET, PA:
3,396,874, PUB. 1-1-2008. INT. CL. 7.

JENSEN, JAY L., FORNEY, TX:
3,398,122, PUB. 1-1-2008. INT. CL. 41.

JESUIT CONFERENCE, WASHINGTON, DC:
2,207,147, REN. 2-9-08. MULTIPLE CLASS, INT. CLS. 16, 41 AND 42.

JET CITY PIZZA CO., INC., WOODINVILLE, WA:
2,182,137, REN. 2-11-08. INT. CL. 42.

JIALE GLASSWARE MANUFACTORY CO., LTD., DONG-GUAN CITY, GUANG DONG, CHINA:
3,396,864, PUB. 1-1-2008. INT. CL. 11.

JIMMY JOHN ENTERPRISES, LLC, CHAMPAIGN, IL:
3,397,952, PUB. 1-1-2008. INT. CL. 9.

JIMONG CHOE, SUWANEE, GA:
3,397,246, PUB. 1-1-2008. INT. CL. 41.

JO, EUN JU, LOS ANGELES, CA:
3,396,947, PUB. 1-1-2008. INT. CL. 25.

JOAN FLEISCHMAN MD PC, BROOKLYN, NY:
3,398,187, PUB. 1-1-2008. INT. CL. 44.

JOCK, SHIRLEY, CUDAHY, WI:
2,447,928, CANC. INT. CL. 37.

JODA ENTERPRISES, INC., CHICAGO, IL:
2,060,110, CANC. INT. CL. 8.

- JODY MARONI'S ITALIAN SAUSAGE KINGDOM, INC., LOS ANGELES, CA:
2,154,754. REN. 2-14-08. INT. CL. 42.
- JOH. VAILLANT GMBH U. CO., REMSCHEID, FED REP GERMANY:
1,438,538, CANC. INT. CL. 11.
- JOHN B. SANFILIPPO & SON, INC., ELGIN, IL:
3,400,088, INT. CL. 29.
- JOHN C. JEPPESEN, DMD, INC., VENTURA, CA:
3,400,192, INT. CL. 35.
- JOHN DI LEMME, WEST PALM BEACH, FL:
3,397,488, PUB. 1-1-2008. MULTIPLE CLASS, INT. CLS. 9 AND 16.
- JOHN L. WELCH, BOSTON, MA:
3,398,417, PUB. 1-1-2008. INT. CL. 41.
- JOHN TRACY CLINIC, LOS ANGELES, CA:
3,398,232, PUB. 1-1-2008. INT. CL. 44.
- JOHNNY'S SPORTSWEAR, INC., MOCKSVILLE, NC:
3,397,013, PUB. 1-1-2008. INT. CL. 25.
3,397,014, PUB. 1-1-2008. INT. CL. 25.
- JOHNS MANVILLE, DENVER, CO:
3,399,320, MULTIPLE CLASS, INT. CLS. 35 AND 41.
- JOHNSON & JOHNSON, NEW BRUNSWICK, NJ:
2,448,090, CANC. INT. CL. 5.
- JOHNSON & SHADLE LLC, LOS ANGELES, CA:
3,398,500, PUB. 7-31-2007. INT. CL. 41.
- JOHNSON FRANCHISE CONSULTING, INC., LINCOLN, NE:
3,398,529, PUB. 1-1-2008. U.S. CL. B.
- JOHNSTON, ANDREA, SAN FRANCISCO, CA:
2,059,479, CANC. INT. CL. 41.
- JOINER ASSOCIATES INCORPORATED, MADISON, WI TO TALISAM, LLC, EDISON, NJ:
2,059,175, CANC. INT. CL. 16.
- JOLIBEE FOODS CORPORATION, PASIG CITY 1600, PHILIPPINES:
3,399,726, INT. CL. 30.
- JOLLY JACK FOOD PRODUCTS, LLC., ST. CLOUD, MN:
2,447,781, CANC. INT. CL. 29.
- JOMAX INTERNATIONAL, CORP., PEMBROKE PINES, FL:
3,397,671, PUB. 1-1-2008. INT. CL. 2.
- JONES MANAGEMENT SERVICES, LLC, CLEVELAND, TN:
3,398,064, PUB. 1-1-2008. INT. CL. 44.
- JOSEPH A. ZAMBITO, DOVE CANYON, CA:
3,396,961, PUB. 1-1-2008. INT. CL. 5.
- JOSEPH CAMPBELL FOUNDATION, SAN ANSELMO, CA:
2,140,952. REN. 2-11-08. INT. CL. 41.
2,140,953. REN. 2-11-08. INT. CL. 35.
3,398,868, MULTIPLE CLASS, INT. CLS. 9, 16 AND 25.
- JOURNAL OF BONE AND JOINT SURGERY, INC., THE, NEEDHAM, MA:
2,059,243, CANC. INT. CL. 16.
- JOY ATHLETIC, INC., HIALEAH, FL:
2,059,821, CANC. INT. CL. 25.
- JOY LIMITED, HERTFORDSHIRE, UNITED KINGDOM:
3,396,836, PUB. 1-1-2008. INT. CL. 3.
- JOYCE FOODS, INC., WINSTON SALEM, NC:
3,400,308, INT. CL. 29.
- JPMORGAN CHASE & CO., NEW YORK, NY:
1,438,784, CANC. INT. CL. 36.
2,447,979, CANC. INT. CL. 16.
3,397,515, PUB. 1-1-2008. INT. CL. 36.
3,400,306, INT. CL. 35.
3,400,401, INT. CL. 36.
- JSONG INTERNATIONAL INC., NEW YORK, NY:
3,397,542, PUB. 1-1-2008. MULTIPLE CLASS, INT. CLS. 16 AND 25.
- JUDY'S CANDY COMPANY, BERKELEY, CA:
3,400,138, INT. CL. 30.
- JUERGENS, PETER, PHOENIX, AZ:
2,447,638, CANC. INT. CL. 16.
- JUIENG, DANIEL, ATLANTA, GA:
2,448,433, CANC. INT. CL. 35.
- JULIA STOOPS, PORTLAND, OR:
3,397,583, PUB. 1-1-2008. INT. CL. 42.
- JULIA TODOROW, FED REP GERMANY:
3,398,622, PUB. 1-1-2008. MULTIPLE CLASS, INT. CLS. 35 AND 41.
- JULIE QUIGLEY, WEED, CA:
3,397,271, PUB. 9-25-2007. INT. CL. 35.
- JUMP START MANIFOLDS, LLC, WINGDALE, NY:
3,397,569, PUB. 1-1-2008. INT. CL. 11.
- JUNELAB, LLC, CHEVY CHASE, MD:
3,399,212, INT. CL. 3.
- JUNGLE CUTS, INC., SANFORD, FL:
2,448,133, CANC. INT. CL. 42.
- JUNGLE JIM'S PLAYLANDS, INC., WALTHAM, MA TO JEEPERS! INC., WALTHAM, MA:
2,059,839, CANC. INT. CL. 21.
- JURGEN TOBYS, KENMORE, WA, DBA J. TOBYS & ASSOCIATES:
2,448,427, CANC. INT. CL. 42.
- JUST A MOM MARKETING (JAMM), LLC, WARSON WOODS, MO:
3,399,069, INT. CL. 9.
- JUSTSYSTEMS CORPORATION, TOKUSHIMA, JAPAN:
3,400,212, INT. CL. 9.
- JUTRZENKA S.A., PL-85-079 BYDGOSZCZ, POLAND:
3,398,669, PUB. 1-1-2008. INT. CL. 30.
- JVWEB, INC., HOUSTON, TX:
2,448,502, CANC. INT. CL. 42.
- JW PET COMPANY, INC., TETERBORO, NJ:
2,201,919. REN. 2-14-08. INT. CL. 28.
2,201,919, CANC. MULTIPLE CLASS, INT. CLS. 18, 19 AND 20.
- J7 RECORDS, INC., BATON ROUGE, LA:
3,397,292, PUB. 1-1-2008. INT. CL. 41.
- K & S ENTERPRISES, NASHUA, NH:
3,398,156, PUB. 1-1-2008. INT. CL. 43.
- K. HANSOTIA & CO., INC., MIAMI, FL:
3,399,412, INT. CL. 34.
- KABUNGA INC, HOUSTON, TX:
3,400,008, INT. CL. 35.
- KABUSHIKI KAISHA BANDAI, TAITO-KU, JAPAN, AKA BANDAI CO., LTD.:
3,399,659, INT. CL. 9.
- KABUSHIKI KAISHA BANPRESTO (BANPRESTO CO., LTD.), SHINAGAWA-KU, TOKYO, JAPAN:
3,400,001, INT. CL. 9.
3,400,135, INT. CL. 9.
- KABUSHIKI KAISHA FAST RETAILING, JAPAN:
3,398,749, PUB. 1-1-2008. MULTIPLE CLASS, INT. CLS. 3, 9, 18, 24 AND 25.
- KABUSHIKI KAISHA G-MODE, TOKYO, JAPAN, DBA G-MODE CO., LTD.:
3,399,448, MULTIPLE CLASS, INT. CLS. 9 AND 41.
- KABUSHIKI KAISHA SATO, SHIBUYA-KU, TOKYO 150-0013, JAPAN:
3,396,845, PUB. 1-1-2008. INT. CL. 9.
- KABUSHIKI KAISHA SQUARE ENIX, TOKYO, JAPAN, AKA SQUARE ENIX CO., LTD.:
3,399,024, INT. CL. 28.
- KABUSHIKI KAISHA SQUARE ENIX (ALSO TRADING AS SQUARE ENIX CO., LTD.), TOKYO, JAPAN:
3,397,215, PUB. 1-1-2008. INT. CL. 9.
- KABUSHIKI KAISHA TOSHIBA, MINATO-KU, TOKYO, JAPAN:
3,396,876, PUB. 1-1-2008. INT. CL. 9.
- KACO GMBH. + CO., HEILBRONN (NECKAR), FED REP GERMANY, KUPFER-ASBEST-CO. GUSTAV BACH, HEILBRONN (NECKAR), FED REP GERMANY:
656,451. REN. 2-12-08. U.S. CL. 35 (INT. CL. 17).
- KAISER CEMENT CORPORATION, WALNUT CREEK, CA:
1,438,596, CANC. INT. CL. 19.
- KALESERAMIK ÇANAKKALE KALEBODUR SERAMIK SANAYI ANONIM SIRKETI, BINASI LEVENT; ISTANBUL, TURKEY:
3,398,624, PUB. 1-1-2008. INT. CL. 9.
- KAMAR PRODUCTS INCORPORATED, IRVINGTON, NY:
1,438,700, CANC. INT. CL. 37.
- KAMSUT, INC., THOUSAND OAKS, CA:
3,398,987, INT. CL. 3.
- KANSAS CITY LIFE INSURANCE COMPANY, KANSAS CITY, MO:
2,448,297, CANC. INT. CL. 36.

KANSAS CITY POWER & LIGHT COMPANY, KANSAS CITY, MO:
2,217,662. REN. 2-13-08. INT. CL. 35.

KANSAS CITY ROYALS BASEBALL CORPORATION, KANSAS CITY, MO:
3,363,256. COR. INT. CL. 28.

KANZAKI SPECIALTY PAPERS, INC., WARE, MA:
2,447,976. CANC. INT. CL. 16.

KAPLAN, INC., NEW YORK, NY:
3,399,054. MULTIPLE CLASS, INT. CLS. 16 AND 41.

KARLIN, ELYSE, NEW ROCHELLE, NY, DBA ADORNMENT:
2,447,908. CANC. INT. CL. 16.

KAROTTKI, SALVADOR K., CHICAGO, IL, DBA S.B. RECORDING COMPANY:
3,399,946. INT. CL. 41.

KASPER, CATHERINE M., CEDARBURG, WI:
3,397,431. PUB. 1-1-2008. MULTIPLE CLASS, INT. CLS. 9 AND 41.

KATAI, NOELLE C., ENCINITAS, CA:
3,397,691. PUB. 1-1-2008. INT. CL. 3.

KATE ASPEN, INC., NORCROSS, GA:
3,397,612. PUB. 1-1-2008. INT. CL. 8.

KATHLEEN HANSEN, KUNA, ID:
3,398,512. PUB. 1-1-2008. INT. CL. 43.

KATUN CORPORATION, MINNEAPOLIS, MN:
1,476,663. REN. 2-8-08. INT. CL. 9.

KAUTZ VINEYARDS, INC, MURPHYS, CA, DBA IRONSTONE VINEYARDS:
3,399,292. INT. CL. 33.

KAWADA CO., LTD., SHINJUKU-KU TOKYO, JAPAN:
1,438,622. CANC. INT. CL. 28.

KAYTEE PRODUCTS INCORPORATED, CHILTON, WI:
2,152,992. REN. 2-12-08. INT. CL. 31.

KAZ, INCORPORATED, NEW YORK, NY:
3,397,622. PUB. 1-1-2008. INT. CL. 11.

KAZI, ANWAR, HONOLULU, HI:
3,397,467. PUB. 1-1-2008. INT. CL. 35.

KCD IP, LLC, HOFFMAN ESTATES, IL, SEARS, ROEBUCK AND CO., HOFFMAN ESTATES, IL:
2,087,020. REN. 2-14-08. MULTIPLE CLASS, INT. CLS. 8, 9 AND 16.

KEALOPIKO LLC, HONOLULU, HI:
3,399,162. INT. CL. 25.

KEEP ROCKIN', LLC, AUBURN, WA:
3,398,220. PUB. 1-1-2008. INT. CL. 32.
3,398,221. PUB. 1-1-2008. INT. CL. 32.

KEEPCOMINGBACK.COM LLC, SAN DIEGO, CA:
3,399,029. INT. CL. 45.

KEEPYOU, COMPANY, LAS VEGAS, NV:
3,399,858. INT. CL. 35.
3,399,859. INT. CL. 43.

KEITH C. FERDINAND, M.D., F.A.C.C. & DAPHNE FERDINAND, R.N., M.N. PARTNERSHIP, THE, NEW ORLEANS, LA:
2,447,475. CANC. INT. CL. 42.

KEITH STEWART, UNITED KINGDOM:
3,398,788. PUB. 1-1-2008. INT. CL. 10.

KELLER COLLEGE SERVICES, LLC, COLUMBIA, MD:
3,397,276. PUB. 9-25-2007. MULTIPLE CLASS, INT. CLS. 36 AND 41.

KELLEY ORNAMENTAL IRON, LLC, PEORIA, IL, DBA PEORIA AWNING:
3,398,940. INT. CL. 22.

KELLOGG NORTH AMERICA COMPANY, BATTLE CREEK, MI:
3,398,335. PUB. 1-1-2008. INT. CL. 30.

KEMIN INDUSTRIES, INC., DES MOINES, IA:
3,399,159. INT. CL. 5.

KENAN, WAFAA, NORTHRIDGE, CA:
3,397,074. PUB. 1-1-2008. INT. CL. 16.

KENG'S FIREARMS SPECIALTY, INC., ATLANTA, GA:
3,398,428. PUB. 1-1-2008. INT. CL. 13.

KENNELLY, KIM, OLDSMAR, FL:
3,397,273. PUB. 1-1-2008. INT. CL. 16.

KENNETH JAMES PEDERSEN, TUCSON, AZ:
3,397,504. PUB. 1-1-2008. INT. CL. 37.

KENOVER MARKETING CORP., BROOKLYN, NY:
3,400,254. INT. CL. 30.

KENT COUNTY, GRAND RAPIDS, MI:
3,396,857. PUB. 1-1-2008. INT. CL. 41.

KENZO S.A., 75001 PARIS, FRANCE:
3,397,035. PUB. 1-1-2008. INT. CL. 3.

KEOLIS, PARIS, FRANCE:
3,398,785. PUB. 1-1-2008. INT. CL. 39.

KERRY GROUP SERVICES INTERNATIONAL, LTD., TRALEE, COUNTY KERRY, IRELAND:
3,398,556. PUB. 1-1-2008. INT. CL. 30.

KERSEN, ISABEL, SECAUCUS, NJ:
2,447,993. CANC. INT. CL. 16.

KEVIN ALSOP, MURRIETA, CA, DBA AMRYL ENTERTAINMENT:
2,086,750. REN. 2-13-08. INT. CL. 16.

KEY PROFESSIONAL MEDIA, INC., MINNEAPOLIS, MN:
2,153,915. REN. 2-13-08. INT. CL. 16.

KEY PROGRAM, INC., THE, FRAMINGHAM, MA:
2,448,452. CANC. INT. CL. 42.

KEYCORP, CLEVELAND, OH:
2,161,951. REN. 2-12-08. INT. CL. 36.

KEYSTONE FOOD PRODUCTS, INC., EASTON, PA:
2,059,062. CANC. INT. CL. 30.

KEYSTONE RETAINING WALL SYSTEMS, INC., MINNEAPOLIS, MN:
3,400,096. INT. CL. 19.

KFD TRAINING & CONSULTATION, LLC, WETHERSFIELD, CT:
3,397,800. PUB. 1-1-2008. INT. CL. 41.

KI KORPO - COMERCIO DE CONFECÇÕES LTDA, RJ CEP 23.059-150, BRAZIL:
3,396,840. PUB. 1-1-2008. INT. CL. 25.

KI MEMORIES, INC., ADDISON, TX:
3,398,462. PUB. 1-1-2008. INT. CL. 16.

KIDNEYLIFE LLC, WEST ISLIP, NY:
3,400,331. INT. CL. 44.

KIDS II, INC., ALPHARETTA, GA:
3,398,598. PUB. 1-1-2008. MULTIPLE CLASS, INT. CLS. 10, 20, 21 AND 28.

KIDTHING, INC., DEL MAR, CA:
3,400,100. INT. CL. 9.

KIKO FOODS, INC., KENNER, LA:
2,143,863. REN. 2-10-08. INT. CL. 32.
2,169,978. REN. 2-11-08. INT. CL. 32.

KIKUCHI, YOICHI, SHIBUYA-KU; TOKYO, JAPAN:
3,398,728. PUB. 1-1-2008. MULTIPLE CLASS, INT. CLS. 14, 18, 25 AND 26.

KIM, EUNJUNG, DIAMOND BAR, CA:
3,397,547. PUB. 1-1-2008. INT. CL. 9.

KIM, JANET L., HARTSDALE, NY:
3,399,244. INT. CL. 25.

KIMAL LUMBER COMPANY, NOKOMIS, FL:
2,059,040. CANC. INT. CL. 19.

KING KOIL LICENSING COMPANY, INC., ST. PAUL, MN:
1,438,768. CANC. INT. CL. 20.

KING MIDAS ENTERPRISE INC., AZUSA, CA:
2,059,350. CANC. INT. CL. 6.

KING STAFFING INC, PALM BEACH GARDENS, FL:
2,447,276. CANC. INT. CL. 35.

KING TECHNOLOGY OF MISSOURI, INC., O'FALLON, MO:
3,398,958. INT. CL. 9.

KING, GLENN THOMAS, CARROLLTON, TX:
2,058,715. CANC. INT. CL. 41.

KING'S DAUGHTERS' MEDICAL CENTER, ASHLAND, KY:
3,397,339. PUB. 1-1-2008. INT. CL. 44.

KING'S MATERIAL, INC., CEDAR RAPIDS, IA:
3,397,384. PUB. 1-1-2008. INT. CL. 19.

KINGS COMMAND FOODS, INC., KENT, WA:
3,400,294. INT. CL. 29.

KINGSBRIDGE INTERNATIONAL INC., CHATSWORTH, CA:
2,448,551. CANC. INT. CL. 20.

KIOSK INFORMATION SYSTEMS, INC., LOUISVILLE, CO:
3,399,739. MULTIPLE CLASS, INT. CLS. 9, 37, 40 AND 42.
3,400,043. INT. CL. 9.
3,400,161. INT. CL. 9.

- KIPLING APPAREL CORP., WILMINGTON, DE:
3,397,799, PUB. 1-1-2008. INT. CL. 35.
- KIRKPATRICK, CHRISTOPHER, GLENDALE, CA:
3,399,986, INT. CL. 41.
- KIRSCH, MICHAEL I., SYOSSET, NY:
3,399,248, INT. CL. 41.
- KITTRIDGE & FREDRICKSON, LTD., TIGARD, OR:
3,397,861, PUB. 1-1-2008. INT. CL. 30.
3,397,862, PUB. 1-1-2008. INT. CL. 30.
- KLEAR-VU CORPORATION, FALL RIVER, MA:
3,399,933, INT. CL. 20.
- KLECK, JONATHAN, SAN ANTONIO, TX:
2,448,049, CANC. INT. CL. 25.
- KLEIN, ELLIOT, NEW YORK, NY:
3,399,298, INT. CL. 9.
- KMC TELECOM INC, BEDMINSTER, NJ:
2,448,496, CANC. INT. CL. 38.
- KMITO, MICHAEL, HANOVER, MA:
3,400,257, INT. CL. 25.
- KNAACK LLC, CRYSTAL LAKE, IL:
842,268, REN. 2-9-08. U.S. CL. 2 (INT. CL. 1).
- KNESS MFG. CO., INC., ALBIA, IA:
1,473,196, REN. 2-14-08. INT. CL. 21.
- KNOTT'S BERRY FARM, BUENA PARK, CA:
1,079,101, REN. 2-12-08. INT. CL. 42.
- KNOWLEDGE ESSENTIALS, LLC, OKLAHOMA CITY, OK:
3,399,414, INT. CL. 16.
- KOBACKER, SOPHIA T., LAGUNA BEACH, CA:
3,399,782, MULTIPLE CLASS, INT. CLS. 9, 16, 41 AND 45.
- KOHLER CO., KOHLER, WI:
3,397,451, PUB. 1-1-2008. INT. CL. 11.
3,399,067, INT. CL. 11.
3,400,133, INT. CL. 11.
- KOKUA HAWAII FOUNDATION, SAN FRANCISCO, CA:
3,397,165, PUB. 1-1-2008. INT. CL. 41.
3,397,166, PUB. 1-1-2008. INT. CL. 9.
- KOKUYO KABUSHIKI KAISHA, HIGASHINARI-KU, OSAKA-SHI, OSAKA-FU, JAPAN, TA KOKUYO CO., LTD.:
2,448,306, CANC. INT. CL. 16.
- KOLALOKA INDUSTRIES, LP, DALLAS, TX:
3,400,107, MULTIPLE CLASS, INT. CLS. 1 AND 16.
3,400,108, MULTIPLE CLASS, INT. CLS. 1 AND 16.
- KOLLER ENTERPRISES, INC., FENTON, MO:
3,399,563, INT. CL. 8.
- KOLON GLOTECH, INC., KWACHEON-CITY, KYUNGGI-DO, REPUBLIC OF KOREA:
3,399,556, INT. CL. 25.
3,399,557, INT. CL. 24.
- KONAMI DIGITAL ENTERTAINMENT CO. LTD., TOKYO 107-8324, JAPAN:
3,399,423, INT. CL. 41.
- KONAMI GAMING, INC., LAS VEGAS, NV:
3,398,981, INT. CL. 9.
3,398,982, INT. CL. 9.
3,398,983, INT. CL. 9.
- KONGSBERG AUTOMOTIVE AB, 565 28 MULLSJO, SWEDEN:
2,448,481, CANC. INT. CL. 9.
- KONINKLIJKE PHILIPS ELECTRONICS N.V., NETHERLANDS:
3,398,747, PUB. 1-1-2008. INT. CL. 9.
- KOOMZAAL CO., LTD., MAPO-GU, SEOUL, REPUBLIC OF KOREA:
3,397,070, PUB. 1-1-2008. MULTIPLE CLASS, INT. CLS. 9, 16 AND 41.
- KOOPERATIEWE WYNBOUERSVERENIGING VAN SUID-AFRIKA BEPERK, PAARL, SOUTH AFRICA:
2,447,264, CANC. INT. CL. 33.
- KOOTENAY GROWER'S SUPPLY LTD., NELSON, BRITISH COLUMBIA, CANADA:
3,398,388, PUB. 1-1-2008. INT. CL. 11.
- KOR REALTY GROUP, L.L.C., LOS ANGELES, CA:
3,397,390, PUB. 1-1-2008. INT. CL. 43.
- KORN/FERRY INTERNATIONAL FUTURESTEP, INC., LOS ANGELES, CA:
2,447,352, CANC. INT. CL. 35.
- KOSS CORPORATION, MILWAUKEE, WI:
2,152,806, REN. 2-13-08. INT. CL. 9.
2,166,791, REN. 2-13-08. INT. CL. 9.
- KOTOBUKI & CO., LTD., SAITAMA-KEN, JAPAN:
3,398,919, INT. CL. 16.
- KOVACH, BARBARA, J, FRANKLIN, MI AND DARWISH, TIMOTHY, A, FRANKLIN, MI:
3,399,797, INT. CL. 3.
- KOVARCIK, THOMAS J., NEW YORK, NY:
3,399,760, INT. CL. 16.
- KR U.S.A., INC., SACRAMENTO, CA:
3,397,400, PUB. 1-1-2008. INT. CL. 16.
- KRAFT FOODS HOLDINGS INC, NORTHFIELD, IL, KRAFT FOODS, INC., NORTHFIELD, IL:
2,145,427, REN. 2-8-08. INT. CL. 29.
- KRAFT FOODS HOLDINGS, INC., NORTHFIELD, IL, OSCAR MAYER & CO., INC., CHICAGO, IL:
662,511, REN. 2-8-08. U.S. CL. 22 (INT. CL. 28).
- KRAFT FOODS HOLDINGS, INC., NORTHFIELD, IL:
2,195,568, REN. 2-8-08. INT. CL. 28.
3,399,846, INT. CL. 29.
- KRALIK, JONATHAN, C, SALT LAKE CITY, UT:
3,399,625, INT. CL. 35.
- KRAMER, STEVEN, FORT COLLINS, CO AND KRAMER, MARK, FORT COLLINS, CO AND KRAMER, JEFF, FORT COLLINS, CO:
3,400,324, INT. CL. 44.
- KREPAK, WENDY, WINTER SPRINGS, FL:
3,399,264, INT. CL. 18.
- KRISTAL, HILLEL, NEW YORK, NY:
3,397,804, PUB. 1-1-2008. INT. CL. 43.
- KRISTYNIK, KRIS, DALLAS, TX:
3,399,835, INT. CL. 36.
- KRONIK LLC, FLORISSANT, MO:
3,397,631, PUB. 1-1-2008. INT. CL. 21.
- KRUEGER INTERNATIONAL, INC., GREEN BAY, WI:
3,399,195, INT. CL. 20.
- KRYPTONICS, INC., LOUISVILLE, CO TO BRAVO SPORTS, CYPRESS, CA:
2,059,138, CANC. INT. CL. 28.
- KRYPTYX ENTERTAINMENT PTY LTD, BRONTE, AUSTRALIA:
3,398,635, PUB. 1-1-2008. MULTIPLE CLASS, INT. CLS. 16, 28 AND 30.
- KSR KUEBLER NIVEAU-MESSTECHNIK AKTIENGESELLSCHAFT, FED REP GERMANY:
3,398,628, PUB. 1-1-2008. INT. CL. 9.
- KTM-SPORTMOTORCYCLE AG, A-5230 MATTIGHOFEN, AUSTRIA:
3,398,627, PUB. 1-1-2008. INT. CL. 12.
- KUDEVIZ, LARRY, GREENVILLE, SC:
3,399,905, INT. CL. 35.
- KURIHARA CORPORATION, OSAKA-FU, JAPAN:
3,399,806, INT. CL. 25.
- KURIYAMA OF AMERICA, INC., SCHAUMBURG, IL:
3,398,171, PUB. 1-1-2008. INT. CL. 17.
- KURTZ, MITCHELL A., NEW YORK, NY:
3,399,655, MULTIPLE CLASS, INT. CLS. 35 AND 36.
- K2M, INC., LEESBURG, VA:
3,399,124, INT. CL. 10.
- L & D, S.A., ALMERIA, SPAIN:
2,086,186, REN. 2-11-08. INT. CL. 5.
- L. C. LICENSING, INC., NEW YORK, NY:
3,400,198, INT. CL. 3.
- L. M. SCOFIELD COMPANY, LOS ANGELES, CA:
843,944, REN. 2-11-08. U.S. CL. 6 (INT. CL. 1).
- L&P PROPERTY MANAGEMENT COMPANY, SOUTH GATE, CA:
3,398,942, INT. CL. 20.
3,398,943, INT. CL. 20.
- L-DOT DESIGNS, LLC, LAKEVILLE, MN:
3,397,472, PUB. 1-1-2008. INT. CL. 28.
- L'OREAL, 75008 PARIS, FRANCE:
2,447,345, CANC. INT. CL. 5.
- L'OREAL, PARIS, FRANCE:
3,400,196, INT. CL. 3.
- L'OREAL USA CREATIVE, INC., NEW YORK, NY:
3,399,540, INT. CL. 3.

- LA BELLE TIME, MIAMI, FL:
3,396,951, PUB. 1-1-2008. INT. CL. 40.
- LA COMMUNICATIONS INC., CINNAMINSON, NJ:
2,447,785, CANC. INT. CL. 42.
- LA HIGUERA S.A., SAN FELIPE, CHILE:
3,400,167, INT. CL. 31.
- LA RIOJANA COOPERATIVA VITIVINIFRUTICOLA DE LA RIOJA LIMITADA, CHILECITO, LA RIOJA, ARGENTINA:
3,399,683, INT. CL. 33.
- LA SPIROTECHNIQUE INDUSTRIELLE ET COMMERCIALE, CARROS, FRANCE:
3,396,859, PUB. 1-1-2008. MULTIPLE CLASS, INT. CLS. 9, 18, 25, 28 AND 41.
- LA TORTILLA FACTORY INC., SANTA ROSA, CA:
3,400,110, INT. CL. 30.
3,400,111, INT. CL. 30.
- LA TOURAINE, INC., SAN DIEGO, CA:
3,397,875, PUB. 1-1-2008. INT. CL. 41.
3,397,880, PUB. 1-1-2008. INT. CL. 41.
3,397,883, PUB. 1-1-2008. INT. CL. 41.
3,397,884, PUB. 1-1-2008. INT. CL. 41.
- LA WEIGHT LOSS FRANCHISE COMPANY, HORSHAM, PA:
3,397,270, PUB. 1-1-2008. INT. CL. 5.
- LA-CO INDUSTRIES, INC., ELK GROVE VILLAGE, IL,
LAKE CHEMICAL CO., CHICAGO, IL:
844,325, REN. 2-13-08. U.S. CL. 37 (INT. CL. 16).
- LABORATOIRE COSMEPRO INC., LONGUEUIL, CANADA:
3,399,572, INT. CL. 3.
- LABORATOIRE MOUTIERS MARINE, S.A.R.L., F-44760 LES MOUTIERS-EN-RETZ, FRANCE:
3,398,720, PUB. 1-1-2008. INT. CL. 5.
- LABORATOIRES DE BIOLOGIE VEGETALE YVES ROCHER, 56200 LA GACILLY, FRANCE:
2,059,790, CANC. INT. CL. 3.
- LABORATOIRES DE BIOLOGIE VEGETALE YVES ROCHER, LA GACILLY, FRANCE:
1,438,461, CANC. INT. CL. 3.
- LABOVICK, LABOVICK & WALD, P.A., JUPITER, FL:
3,400,253, INT. CL. 45.
- LACE LASTICS COMPANY, INC., OXFORD, NC:
3,400,216, INT. CL. 24.
- LAGASSE, INC., DEERFIELD, IL:
3,397,269, PUB. 1-1-2008. MULTIPLE CLASS, INT. CLS. 6, 8, 16 AND 21.
- LAKE NORMAN CONVENTION & VISITORS BUREAU, CORNELIUS, NC:
3,397,241, PUB. 1-1-2008. MULTIPLE CLASS, INT. CLS. 35, 39 AND 43.
- LAMANS, KRIS, STUDIO CITY, CA:
3,400,147, INT. CL. 41.
- LAMBERT'S FAMOUS PRODUCTS, INC., LITTLE ROCK, AR:
2,447,686, CANC. INT. CL. 30.
- LAMPESE, RICHARD, SETAUKET, NY AND CARPENTER, FRED, SETAUKET, NY:
3,399,255, INT. CL. 41.
- LANAFORM LANA ALLPEAK S.A., EN ABRÉGÉ LANA S.A., BELGIUM:
3,398,819, PUB. 1-1-2008. INT. CL. 10.
- LAND O'LAKES, INC., ARDEN HILLS, MN:
3,398,223, PUB. 1-1-2008. INT. CL. 16.
- LANDER CO., INC., ENGLEWOOD, NJ:
2,448,014, CANC. INT. CL. 3.
- LANDERS, KEVIN, INTERLAKEN, NJ:
3,398,063, PUB. 1-1-2008. INT. CL. 41.
- LANDIES CANDIES CO., INC., BUFFALO, NY:
3,397,941, PUB. 1-1-2008. INT. CL. 30.
- LANDRY'S TRADEMARK, INC., HOUSTON, TX:
1,104,976, REN. 2-8-08. INT. CL. 42.
- LANGER, ALEXANDER G., BOSTON, MA:
3,398,880, MULTIPLE CLASS, INT. CLS. 28 AND 35.
- LANHAM, CORP., ASHLAND, KY:
3,397,497, PUB. 1-1-2008. INT. CL. 44.
- LANIFICIO ERMENEGILDO ZEGNA & FIGLI S.P.A., TRIVERO, BIELLA, ITALY:
3,400,087, INT. CL. 25.
- LANWORTH, INC., ITASCA, IL:
3,398,099, PUB. 1-1-2008. INT. CL. 16.
- LANZA ENTERTAINMENT COMPANY, LLC, LOS ANGELES, CA:
3,397,073, PUB. 1-1-2008. INT. CL. 41.
- LANZO, CHARLES P., ACWORTH, GA:
3,397,272, PUB. 1-1-2008. INT. CL. 43.
- LAPOLLA, ANTHONY J., MARCY, NY:
3,400,353, INT. CL. 21.
- LARocca, JAMES C., METAIRIE, LA:
3,397,706, PUB. 1-1-2008. MULTIPLE CLASS, INT. CLS. 9 AND 41.
- LASER TECHNOLOGY, INC., ENGLEWOOD, CO AND KAMA-TECH, HK LTD., TSIM SHA TSUI, HONG KONG:
3,400,023, INT. CL. 9.
- LASERCARE THERAPEUTICS INC., LANGLEY, CANADA:
3,398,603, PUB. 1-1-2008. INT. CL. 44.
- LASERTEC CORPORATION, JAPAN:
3,398,654, PUB. 1-1-2008. INT. CL. 9.
- LATIN AMERICAN ONLINE SERVICES, INC., PANAMA, PANAMA:
3,398,608, PUB. 1-1-2008. MULTIPLE CLASS, INT. CLS. 39, 42 AND 43.
- LAUNCH MATH LLC, NEW YORK, NY:
3,397,654, PUB. 1-1-2008. INT. CL. 41.
- LAYNE, CARRIE M, PLANO, TX:
3,400,284, INT. CL. 35.
- LE, VIET N., SAN JOSE, CA, DBA SALSAMORE:
3,398,301, PUB. 1-1-2008. INT. CL. 41.
- LEACHCO, INC., ADA, OK:
3,399,826, INT. CL. 28.
- LEADING EDGE FLAVORS, INC., TEMPLE, TX, FROSTIE COMPANY, THE, BALTIMORE, MD:
653,485, REN. 2-14-08. U.S. CL. 45 (INT. CL. 32).
- LEADING GOLF COURSES OF AMERICA L.L.C., THE, WHEELING, IL:
2,060,126, CANC. MULTIPLE CLASS, INT. CLS. 25 AND 41.
- LEAPFROG ENTERPRISES, INC., EMERYVILLE, CA:
3,399,999, INT. CL. 9.
- LEARJET INC., WICHITA, KS:
2,447,436, CANC. INT. CL. 37.
- LEARNING HORIZONS, INC., CLEVELAND, OH:
2,447,963, CANC. INT. CL. 28.
- LEASECOMM CORPORATION, WALTHAM, MA:
1,438,706, CANC. INT. CL. 38.
- LEBANON SEABOARD CORPORATION, LEBANON, PA:
3,396,934, PUB. 1-1-2008. MULTIPLE CLASS, INT. CLS. 1, 5 AND 31.
- LEE EQUITY PARTNERS, LLC, NEW YORK, NY:
3,397,184, PUB. 1-1-2008. INT. CL. 36.
- LEE SNIJDERS DESIGNS, PORTER RANCH, CA:
3,398,938, INT. CL. 20.
3,398,939, INT. CL. 20.
- LEE, DAVID P., APO, NJ:
3,398,846, INT. CL. 35.
- LEE, SACHIHO, TORRANCE, CA:
3,399,555, INT. CL. 25.
- LEFEVRE, HOLLY CHRISTINE, EL SEGUNDO, CA:
2,447,895, CANC. INT. CL. 42.
- LEGACY MARKETING GROUP, PETALUMA, CA:
3,400,332, INT. CL. 36.
- LEGAL RESOURCES, INC., ROSWELL, GA:
2,447,478, CANC. INT. CL. 35.
- LEGALARMY.COM, NEWPORT BEACH, CA:
2,447,646, CANC. INT. CL. 42.
- LEHMANN MANAGEMENT CORP., CINCINNATI, OH:
3,399,036, INT. CL. 35.
- LEIGHTON, JOHN T, DERRY, NH:
3,397,593, PUB. 1-1-2008. INT. CL. 9.
- LEIPHART, JEFFREY M., SAN DIEGO, CA TO SHANTI PROJECT, SAN FRANCISCO, CA:
2,058,703, CANC. INT. CL. 42.
- LEISURE BOY, LLC, OCONOMOWOC, WI:
3,399,476, MULTIPLE CLASS, INT. CLS. 25 AND 41.
- LEISUREMORE CORPORATION, NEWPORT BEACH, CA:
2,448,195, CANC. INT. CL. 21.

- LENBRIDGE FORGE PTY. LTD., COLDSTREAM, AUSTRALIA:
3,400,070, INT. CL. 33.
- LENOX, INCORPORATED, BRISTOL, PA:
2,134,252, REN. 2-11-08. INT. CL. 21.
- LENOX, INCORPORATED, LAWRENCEVILLE, NJ:
2,137,265, REN. 2-11-08. INT. CL. 8.
- LEONCINI S.R.L., COLA'LAZISE (VERONA), ITALY:
3,397,659, PUB. 1-1-2008. INT. CL. 29.
- LERNER, JAIME K. DBA THE GEEK GODDESS, SOUTH ELGIN, IL:
3,397,591, PUB. 1-1-2008. INT. CL. 42.
- LES SCHWAB WAREHOUSE CENTER, INC., PRINEVILLE, OR:
1,520,703, REN. 2-11-08. MULTIPLE CLASS, INT. CLS. 9 AND 12.
- LES VIGNERONS DU SIEUR D'ARQUES SOCIETE COOPERATIVE AGRICOLE, LIMOUX, FRANCE:
3,398,591, PUB. 6-26-2007. INT. CL. 33.
- LETHERT, ANDREW J., FORT MYERS, FL, DBA DECCO BATH & SHOWER WORKS, CORP.:
3,399,892, INT. CL. 11.
- LETSEATOUT.COM, LLC, WESTPORT, CT:
2,447,525, CANC. MULTIPLE CLASS, INT. CLS. 35 AND 42.
- LEVEL FOUR GROUP, LLC, PLANO, TX:
3,396,888, PUB. 1-1-2008. INT. CL. 36.
- LEVEL ONE PERSONNEL, INC., COLUMBIA, MD:
3,397,709, PUB. 1-1-2008. INT. CL. 35.
- LEVINGER COMPANY, DELRAY BEACH, FL:
2,447,922, CANC. INT. CL. 35.
- LEVINE, SUZANNE BRAUN, NEW YORK, NY:
3,399,501, INT. CL. 41.
- LEVITON MANUFACTURING CO., INC., LITTLE NECK, NY:
3,399,884, INT. CL. 9.
- LF, LLC, WILMINGTON, DE:
3,397,498, PUB. 1-1-2008. MULTIPLE CLASS, INT. CLS. 2 AND 37.
- LFP IP, LLC, BEVERLY HILLS, CA:
3,397,553, PUB. 1-1-2008. INT. CL. 41.
- LGE PERFORMANCE SYSTEMS, INC. DBA HUMAN PERFORMANCE INSTITUTE, ORLANDO, FL:
3,397,876, PUB. 1-1-2008. INT. CL. 41.
- LI, LI, RICHMOND HILL, ONTARIO, CANADA AND DING, BEI, RICHMOND HILL, ONTARIO, CANADA:
3,399,071, INT. CL. 11.
- LIANG CHI (U.S.A.) CORP., ONTARIO, CA, DBA AMCOT COOLING TOWER CORP.:
2,217,505, REN. 2-13-08. MULTIPLE CLASS, INT. CLS. 11, 37 AND 42.
- LIBELTEX BESLOTEN VENNOOTSCHAP MET BEPERKTE AANSPRAKELIJKHEID, 8760 MEULEBEKE, BELGIUM:
2,447,442, CANC. INT. CL. 22.
- LIBERATION MANAGEMENT LLC, SAN DIEGO, CA:
3,399,720, INT. CL. 38.
- LIBERATORE-GRANA, SHARI, WHITTIER, CA:
3,400,350, INT. CL. 8.
- LIBERTECH, DURHAM, NC TO EGGER, LOUIS DANIEL, DURHAM, NC:
2,058,774, CANC. INT. CL. 9.
- LIBERTY ASSURANCE GROUP, BENTONIA, MS, DBA LIBERTY ASSURANCE GROUP:
3,398,062, PUB. 1-1-2008. INT. CL. 36.
- LIBERTY MUTUAL INSURANCE COMPANY, BOSTON, MA:
2,129,318, REN. 2-11-08. INT. CL. 36.
- LICHTMAN, JOAN, PHILADELPHIA, PA:
2,447,407, CANC. MULTIPLE CLASS, INT. CLS. 35, 41 AND 42.
- LIFECLINIC INTERNATIONAL, INC., BURTONSVILLE, MD:
3,399,922, INT. CL. 44.
- LIFEHEALTHY LTD, LLC, COLUMBUS, OH:
2,447,762, CANC. INT. CL. 9.
- LIFESTAR NETWORK, LLC, MURRAY, UT:
3,398,018, PUB. 1-1-2008. INT. CL. 44.
- LIFESTYLE HOLIDAYS VACATION CLUB, INC., MIAMI, FL:
3,400,182, INT. CL. 43.
3,400,183, INT. CL. 43.
- LIFESTYLES INTERNATIONAL HOLDINGS CORPORATION, GIBRALTAR, GIBRALTAR:
2,060,015, CANC. INT. CL. 3.
- LIFEWAY CHRISTIAN RESOURCES OF THE SOUTHERN BAPTIST CONVENTION, NASHVILLE, TN:
2,448,378, CANC. INT. CL. 16.
- LIGHT DIMENSIONS, INC., PALO ALTO, CA:
3,400,199, MULTIPLE CLASS, INT. CLS. 10 AND 21.
- LIGHT ENGINEERING, INDIANAPOLIS, IN:
3,397,029, PUB. 1-1-2008. INT. CL. 7.
3,397,030, PUB. 1-1-2008. INT. CL. 7.
- LIMELIFE, INC., MENLO PARK, CA:
3,397,956, PUB. 1-1-2008. INT. CL. 38.
- LIN, GUANG, GREER, SC:
3,399,130, INT. CL. 9.
- LIN, GUNAG, GREER, SC:
3,399,101, INT. CL. 9.
- LINCOLN LOGS, LTD., CHESTERTOWN, NY:
3,396,844, PUB. 1-1-2008. MULTIPLE CLASS, INT. CLS. 19 AND 42.
- LINDAUER DORNIER GESELLSCHAFT MBH, D- 88129 LINDAU, FED REP GERMANY:
2,447,634, CANC. INT. CL. 7.
- LINDAUER DORNIER GESELLSCHAFT; MIT BESCHRÄNKTER HAFTUNG., FED REP GERMANY:
3,398,733, PUB. 1-1-2008. MULTIPLE CLASS, INT. CLS. 7, 17, 24 AND 25.
- LINDEN OAKS CORPORATION, WILMINGTON, DE:
2,135,055, REN. 2-12-08. INT. CL. 29.
- LINDY-LITTLE JOE, INC., BRAINERD, MN:
1,110,596, REN. 2-9-08. INT. CL. 28.
- LINERS DIRECT, INC., WOOD DALE, IL:
2,447,884, CANC. INT. CL. 37.
2,447,888, CANC. INT. CL. 37.
- LINGOLYNX, LLC, BUENA VISTA, CO:
3,398,213, PUB. 1-1-2008. MULTIPLE CLASS, INT. CLS. 9, 16 AND 41.
- LION COPOLYMER, LLC, BATON ROUGE, LA:
3,399,949, INT. CL. 17.
- LIPPINCOTT SAILING YACHTS, INC., GRASONVILLE, MD:
2,058,712, CANC. INT. CL. 36.
- LIQUID MILITIA, LLC, SANTA BARBARA, CA:
3,398,226, PUB. 1-1-2008. INT. CL. 25.
- LIQUID SOLID SURFACE FRANCHISING, LTD., MASSILLON, OH:
3,398,131, PUB. 1-1-2008. INT. CL. 37.
3,398,149, PUB. 1-1-2008. INT. CL. 37.
- LITE-FORM TECHNOLOGIES LLC, SOUTH SIOUX CITY, NE:
3,396,917, PUB. 1-1-2008. INT. CL. 19.
- LITEL INSTRUMENTS, SAN DIEGO, CA:
3,398,944, INT. CL. 9.
- LITTLE CITY KIDS FRANCHISE SERVICES, LLC, WAUNAKEE, WI:
3,397,395, PUB. 1-1-2008. MULTIPLE CLASS, INT. CLS. 35 AND 43.
- LITTLE RACQUETS, LLC, SOLON, OH:
3,397,794, PUB. 1-1-2008. INT. CL. 41.
- LIVE NETWORKING, INC., FAIR OAKS, CA:
2,447,542, CANC. INT. CL. 42.
- LIVE! HOLDINGS, LLC, BALTIMORE, MD:
3,399,006, INT. CL. 43.
- LOBNEK WEALTH MANAGEMENT SA; C/O SERCOFIN, SOCIÉTÉ DE SERVICES; COMPTABLES ET FINANCIERS SA, GENÈVE, SWITZERLAND:
3,398,767, PUB. 1-1-2008. INT. CL. 36.
- LOCAL CHOICE MARKETING, LLC, BLACK EARTH, WI:
3,397,998, PUB. 1-1-2008. INT. CL. 29.
- LODGE MANUFACTURING COMPANY, SOUTH PITTSBURG, TN:
2,188,434, REN. 2-13-08. INT. CL. 21.
- LOGGERHEAD TOOLS LLC, PALOS PARK, IL:
3,399,450, INT. CL. 8.

- LOGICAL PERCEPTIONS, INC., GARDEN GROVE, CA:
3,397,893, PUB. 1-1-2008. INT. CL. 35.
- LONDON GROUP, LLC, OLD WESTBURY, NY:
3,399,269, INT. CL. 33.
- LONDON LUXURY LLC, NEW ROCHELLE, NY:
3,400,279, MULTIPLE CLASS, INT. CLS. 20, 24, 25 AND 27.
- LONDON PACIFIC LIFE & ANNUITY COMPANY, RALEIGH, NC:
2,447,707, CANC. INT. CL. 36.
- LONG, ANNE, GREAT FALLS, VA:
3,398,914, INT. CL. 39.
3,398,915, INT. CL. 35.
3,398,916, INT. CL. 45.
- LONGHORN CABINETS, CORDES LAKES, AZ:
3,397,646, PUB. 1-1-2008. INT. CL. 35.
- LONGO, VINCENT, NEW YORK, NY:
2,157,749, REN. 2-12-08. INT. CL. 3.
- LONGS DRUG STORES CALIFORNIA, INC., WALNUT CREEK, CA:
2,448,034, CANC. INT. CL. 35.
- LOOK! MARKETING INC., OCALA, FL:
3,397,531, PUB. 1-1-2008. INT. CL. 18.
- LOPATIN, JEREMY, ANN ARBOR, MI AND LOPATIN, AUBREY, ANN ARBOR, MI:
3,399,297, INT. CL. 30.
- LOS TOROS MEXICAN RESTAURANT, INC., CHATSWORTH, CA:
3,397,468, PUB. 1-1-2008. INT. CL. 43.
3,397,469, PUB. 1-1-2008. INT. CL. 43.
- LOUD TRADEMARK HOLDINGS, LLC, WOODLAND HILLS, CA:
2,059,605, CANC. INT. CL. 25.
- LOUIS GLUNZ WINES, INC., WHEELING, IL, LOUIS GLUNZ, INC., LINCOLNWOOD, IL:
1,087,064, REN. 2-13-08. INT. CL. 33.
- LOUISVILLE DEVELOPMENT BANCORP, INC., LOUISVILLE, KY:
2,143,502, REN. 2-13-08. INT. CL. 36.
- LOVE A CHILD, INC., NAPLES, FL:
3,396,861, PUB. 1-1-2008. MULTIPLE CLASS, INT. CLS. 37, 43 AND 44.
- LOVELACE RESPIRATORY RESEARCH INSTITUTE, ALBUQUERQUE, NM:
2,192,225, REN. 2-11-08. INT. CL. 36.
- LOVELAND INDUSTRIES, INC, GREELEY, CO:
2,448,533, CANC. INT. CL. 31.
- LOVELAND PRODUCTS, INC., GREELEY, CO:
3,399,153, INT. CL. 5.
3,399,228, INT. CL. 1.
- LOVEMYPETS, LLC, TAYLORS, SC:
3,399,715, INT. CL. 9.
- LOVING PETS CORPORATION, CRANBERRY, NJ:
3,400,325, INT. CL. 31.
- LOWRANCE ELECTRONICS, INC., TULSA, OK:
2,058,782, CANC. INT. CL. 9.
- LOWTWAIT, STEVE, BOULDER, CO:
3,397,423, PUB. 1-1-2008. INT. CL. 42.
- LOYAL WROUGHT IRON CO., LTD., PANYU, GUANGZHOU, CHINA:
3,397,121, PUB. 1-1-2008. INT. CL. 6.
- LPD MUSIC INTERNATIONAL, MADISON HEIGHTS, MI:
3,397,341, PUB. 1-1-2008. INT. CL. 15.
- LRF SLATER COMPANIES, INC., LIVINGSTON, NJ:
2,448,379, CANC. INT. CL. 37.
- LTV ENERGY PRODUCTS COMPANY, DALLAS, TX:
1,438,475, CANC. INT. CL. 6.
- LUCASFILM LTD., SAN FRANCISCO, CA:
3,399,560, INT. CL. 41.
- LUCCELLO, INC., NEW YORK, NY:
3,398,497, PUB. 1-1-2008. INT. CL. 14.
- LUCINI ITALIA COMPANY, MIAMI, FL:
2,448,187, CANC. INT. CL. 29.
- LUCIO SANTORO AND MEERA SANTORO PARTNERSHIP, THE, LONDON, UNITED KINGDOM:
3,399,354, INT. CL. 3.
- LUCZAK JERZY; PRZEDSIEBIORSTWO; PRODUKCYJNO-HANDLOWO-USLUGOWE; LORIN, POLAND:
3,398,727, PUB. 1-1-2008. MULTIPLE CLASS, INT. CLS. 24 AND 25.
- LUDINGTON TECHNOLOGIES, INC., ESCANABA, MI:
3,399,443, INT. CL. 9.
- LUIS G. BONOMI Y CÍA. S.A., MONTEVIDEO, URUGUAY:
3,398,303, PUB. 1-1-2008. INT. CL. 29.
- LULU'S, LLC, NEW YORK, NY:
3,398,472, PUB. 1-1-2008. MULTIPLE CLASS, INT. CLS. 41 AND 43.
- LUMIKO USA INC., JAMESBURG, NJ:
2,182,103, REN. 2-11-08. INT. CL. 11.
- LUND BOAT COMPANY, NEW YORK MILLS, MN:
837,819, REN. 2-11-08. U.S. CL. 19 (INT. CL. 12).
- LUPATECH S/A, CAXIAS DO SUL, BRAZIL:
3,397,546, PUB. 1-1-2008. INT. CL. 6.
- LUSY'S LEGACY, INC., MANTEO, NC, DBA PJ'S CREATIONS:
2,447,828, CANC. INT. CL. 30.
- LUTHERAN SOCIAL SERVICE OF MINNESOTA, DULUTH, MN:
2,447,314, CANC. MULTIPLE CLASS, INT. CLS. 35 AND 42.
- LUXLITE USA, CORPORATION, JERSEY CITY, NJ:
2,447,727, CANC. INT. CL. 11.
- LUXPRO CORPORATION, NEIHU DISTRICT, TAIPEI CITY, TAIWAN:
3,398,888, INT. CL. 9.
- LWBJ WEALTH RESOURCES, LLC, WEST DES MOINES, IA:
3,400,243, MULTIPLE CLASS, INT. CLS. 35 AND 36.
- LYMABEAN, LLC, HUNTINGTON BEACH, CA:
3,398,287, PUB. 1-1-2008. INT. CL. 45.
- LYMAN PRODUCTS CORPORATION, MIDDLEFIELD, CT:
1,438,603, CANC. INT. CL. 21.
- LYON AVIATION ENGINEERING EQUIPMENT CO., LTD, HONG KONG, HONG KONG:
2,145,649, REN. 2-13-08. INT. CL. 28.
- LYONDELL CHEMICAL COMPANY, HOUSTON, TX:
3,400,194, INT. CL. 1.
- LYONS, ROBERT, MADISON, WI:
655,392, REN. 2-9-08. U.S. CL. 1 (INT. CL. 31).
- LYONS, ROBERT, MADISON, OH, COLE NURSERY COMPANY, THE, PAINESVILLE, OH:
655,393, REN. 2-9-08. U.S. CL. 1 (INT. CL. 31).
- LYONS, ROBERT L., III, MIDLOTHIAN, IL:
3,398,896, INT. CL. 12.
- LYTIX LLC, NEW YORK, NY:
3,400,226, MULTIPLE CLASS, INT. CLS. 35 AND 36.
- LYTLE STATE BANK, LYTLE, TX:
3,396,927, PUB. 1-1-2008. INT. CL. 36.
- M & G BRANDS, LIMITED, GRAND CAYMAN, CAYMAN ISLANDS:
3,398,199, PUB. 1-1-2008. INT. CL. 33.
- M. A. MORTENSON COMPANY, MINNEAPOLIS, MN:
3,397,603, PUB. 1-1-2008. MULTIPLE CLASS, INT. CLS. 37 AND 45.
- M. ROGERS DESIGN, INC., NORTHBROOK, IL:
3,398,590, PUB. 1-1-2008. MULTIPLE CLASS, INT. CLS. 35, 37 AND 42.
- M. SHANKEN COMMUNICATIONS, INC., NEW YORK, NY:
2,131,128, REN. 2-13-08. INT. CL. 42.
2,131,129, REN. 2-13-08. INT. CL. 42.
- M-R-ALPACAS RANCH, INC, WAKEMAN, OH:
3,398,897, INT. CL. 44.
- MA DURGA PARTNERSHIP INC., SCHAUMBURG, IL:
3,399,608, INT. CL. 43.
- MACATAWA BANK CORPORATION, HOLLAND, MI:
3,399,888, INT. CL. 41.
- MACCAFERRI, INC., WILLIAMSPORT, MD:
3,397,887, PUB. 1-1-2008. INT. CL. 19.
3,397,907, PUB. 1-1-2008. INT. CL. 19.
- MACDERMID, INCORPORATED, WATERBURY, CT:
2,059,009, CANC. INT. CL. 1.
- MACHAT, MICHAEL, BEVERLY HILLS, CA:
3,398,160, PUB. 1-1-2008. INT. CL. 33.
- MACK DADDY CO., LTD., JAPAN:
3,398,703, PUB. 1-1-2008. MULTIPLE CLASS, INT. CLS. 3,

- 14, 18, 25 AND 26.
MACK, NICHOLAS, ORANGE, CA:
3,397,763, PUB. 1-1-2008. INT. CL. 39.
MACKMYRA SVENSK WHISKY AB, SE-81832 VALBO,
SWEDEN:
3,398,851, INT. CL. 33.
MADDOX, EDDIE, LUBBOCK, TX:
3,397,697, PUB. 1-1-2008. INT. CL. 36.
MADE IN MONTESINOS, S.L., SPAIN:
3,398,731, PUB. 1-1-2008. INT. CL. 25.
MAGIC SEASONING BLENDS, INC., HARAHAN, LA:
3,400,217, INT. CL. 41.
MAGNETO LLC, SAN FRANCISCO, CA:
3,399,775, INT. CL. 25.
MAHLE TECHNOLOGY, INC., FARMINGHILLS, MI, AE
CLEVITE INC., ANN ARBOR, MI:
2,081,277. REN. 2-12-08. INT. CL. 9.
MAHONEY JR., MICHAEL, ODESSA, FL:
3,398,109, PUB. 1-1-2008. INT. CL. 41.
MAIER-KAHAN ASSOCIATES, LTD., BELLEROSE, NY:
2,448,305, CANC. INT. CL. 20.
MAIJERS, CORNELIS A., 9747 AN GRONINGEN, NETHER-
LANDS, DBA PRO CONSULT:
2,447,337, CANC. MULTIPLE CLASS, INT. CLS. 5 AND
42.
MAIL FOR YOU INC., LAS VEGAS, NV:
3,397,651, PUB. 1-1-2008. INT. CL. 39.
MAIN STREET INGREDIENTS LLC, LA CROSSE, WI:
3,400,006, INT. CL. 29.
MAINLINE, INC., TORRANCE, CA:
3,397,209, PUB. 1-1-2008. INT. CL. 9.
MAINTENANCE SUPPLY HEADQUARTERS, LP, STAF-
FORD, TX:
3,400,153, INT. CL. 35.
MAJOR LEAGUE BASEBALL PROPERTIES, INC., NEW
YORK, NY:
3,399,695, INT. CL. 25.
MAKE UP STORE AB, STOCKHOLM, SWEDEN:
3,397,411, PUB. 1-1-2008. MULTIPLE CLASS, INT. CLS. 3
AND 44.
MAKIT PRODUCTS, INC., DALLAS, TX:
3,397,787, PUB. 1-1-2008. INT. CL. 16.
3,397,788, PUB. 1-1-2008. INT. CL. 16.
MALEY, MICHAEL, PHILADELPHIA, PA:
3,397,188, PUB. 1-1-2008. MULTIPLE CLASS, INT. CLS. 9
AND 41.
MALNIK, SHAREEF, MIAMI BEACH, FL:
3,398,478, PUB. 1-1-2008. MULTIPLE CLASS, INT. CLS. 9,
41 AND 43.
MALT-O-MEAL COMPANY, MINNEAPOLIS, MN:
3,397,597, PUB. 1-1-2008. INT. CL. 30.
MAMIYE BROTHERS, INC., NEW YORK, NY:
1,196,869, CANC. INT. CL. 25.
MANA INTERNET SOLUTIONS, SAN JOSE, COSTA RICA:
3,397,647, PUB. 1-1-2008. INT. CL. 45.
MANAGEMARK, INC., SUNNYVALE, CA:
2,447,515, CANC. INT. CL. 35.
MANELIS, RICHARD E., FRAMINGHAM, MA:
2,448,168, CANC. INT. CL. 16.
MANHATTAN GROUP, LLC, MINNEAPOLIS, MN:
2,447,294, CANC. INT. CL. 16.
2,447,403, CANC. INT. CL. 28.
2,447,404, CANC. INT. CL. 28.
2,447,405, CANC. INT. CL. 28.
MANHEIM AUCTIONS, INC., ATLANTA, GA:
3,397,218, PUB. 1-1-2008. INT. CL. 37.
MANLEY, MARLEEN R., ACWORTH, GA AND MANLEY,
BYRON J., ACWORTH, GA:
3,400,102, INT. CL. 9.
MANNA MARKETING & DEVELOPMENT GROUP, INC.,
DALLAS, TX:
3,397,305, PUB. 1-1-2008. INT. CL. 20.
MANNATECH, INC., COPPELL, TX:
2,157,554. REN. 2-8-08. INT. CL. 5.
MANPOWER INC., MILWAUKEE, WI:
3,399,743, MULTIPLE CLASS, INT. CLS. 16, 35 AND 41.
MANSFIELD OIL COMPANY OF GAINESVILLE, INC.,
GAINESVILLE, GA:
3,397,641, PUB. 1-1-2008. MULTIPLE CLASS, INT. CLS. 4,
35, 39 AND 42.
3,397,642, PUB. 1-1-2008. INT. CL. 37.
MANUFACTURING AND CONSULTING SERVICES, INC.,
PAYSON, AZ:
2,131,132. REN. 2-13-08. INT. CL. 41.
MAPLES INDUSTRIES, INC., NEW YORK, NY:
2,196,836. REN. 2-12-08. INT. CL. 27.
MARCELLUS, ALVIN, A., ANAHEIM, CA:
3,399,825, MULTIPLE CLASS, INT. CLS. 25 AND 28.
MARCOS, PEDRO, EAST ELMHURST, NY:
3,396,856, PUB. 1-1-2008. INT. CL. 25.
MARGAUX SINGLETON, CALISTOGA, CA:
2,448,482, CANC. INT. CL. 33.
MARIA LO BIANCO, ASHBURN, VA:
3,397,425, PUB. 1-1-2008. INT. CL. 36.
MARICOPA COUNTY COMMUNITY COLLEGE DISTRICT,
TEMPE, AZ:
3,397,557, PUB. 1-1-2008. INT. CL. 41.
MARINI, GIUSEPPE, POUGHQUAG, NY:
3,398,373, PUB. 1-1-2008. INT. CL. 29.
MARK ADAMS, CAMBRIDGE, CANADA:
3,397,992, PUB. 1-1-2008. INT. CL. 3.
MARK ANTHONY INTERNATIONAL SRL, ROCKLEY,
CHRIST CHURCH, BARBADOS:
3,399,734, MULTIPLE CLASS, INT. CLS. 18, 25, 32 AND
33.
MARK MCKENZIE, AUSTRALIA:
3,398,769, PUB. 1-1-2008. INT. CL. 41.
MARK OF THE UNICORN, INC., CAMBRIDGE, MA:
2,208,655. REN. 2-12-08. INT. CL. 9.
MARK-10 CORPORATION, COPIAGUE, NY:
3,399,140, INT. CL. 9.
MARKET AMERICA, INC., GREENSBORO, NC:
3,400,404, INT. CL. 35.
MARKET LOGIC, INC., COSTA MESA, CA TO CATALINA
MARKETING INTERNATIONAL, INC., ST. PETERS-
BURG, FL:
2,059,727, CANC. INT. CL. 35.
MARKETCOUNSEL, LLC, ENGLEWOOD, NJ:
3,397,752, PUB. 1-1-2008. INT. CL. 35.
MARKETING MANAGEMENT, INC., FORT WORTH, TX:
2,059,799, CANC. INT. CL. 30.
2,447,307, CANC. INT. CL. 35.
MARKINETICS, INC., MARIETTA, OH:
2,447,512, CANC. INT. CL. 35.
MARKMONITOR INC., BOISE, ID:
3,399,398, INT. CL. 35.
MARQUEZ BROTHERS INTERNATIONAL, INC., SAN
JOSE, CA:
3,399,752, INT. CL. 29.
MARR, JEAN A., KERNERSVILLE, NC AND BONEBREAK,
KEVIN J., KERNERSVILLE, NC:
1,494,162. REN. 2-11-08. INT. CL. 14.
MARRIOTT INTERNATIONAL, INC., BETHESDA, MD:
3,399,643, INT. CL. 43.
MARS FISHCARE NORTH AMERICA, INC., CHALFONT,
PA:
2,163,691. REN. 2-13-08. INT. CL. 1.
2,163,692. REN. 2-13-08. INT. CL. 1.
MARSHALL BANKFIRST CORP., MINNEAPOLIS, MN:
3,399,452, INT. CL. 36.
MARSHALL, MARGUERITE, BAKERSFIELD, CA:
2,447,466, CANC. INT. CL. 28.
MARTELLO, KEN, SPOKANE, WA:
3,398,065, PUB. 1-1-2008. INT. CL. 41.
MARTHE SANSREGRET ET ASSOCIES, CONSULTANTS
INC., QUTREMONT, QUEBEC, CANADA:
2,058,576, CANC. MULTIPLE CLASS, INT. CLS. 9, 16
AND 41.
MARTIN STUART, LTD., NEW YORK, NY:
2,135,951. REN. 2-12-08. INT. CL. 25.
MARTIN, PETER G, BELLEVUE, WA:
3,400,334, INT. CL. 9.

- MARUKOME KABUSHIKI KAISHA, NAGANO PREFECTURE, JAPAN:
3,398,849, INT. CL. 30.
- MARVEL MANUFACTURING COMPANY, INC., OSHKOSH, WI:
3,399,873, INT. CL. 7.
- MARY COHR S.A., 75002 PARIS, FRANCE:
2,221,868, REN. 2-11-08. INT. CL. 3.
- MARYLAND PUBLIC SECONDARY SCHOOLS ATHLETIC ASSOCIATION (MPSSAA), BALTIMORE, MD:
3,397,552, PUB. 1-1-2008. INT. CL. 41.
- MASA AG, D-56625 ANDERNACH, FED REP GERMANY:
2,117,375, REN. 2-12-08. INT. CL. 7.
- MASSACHUSETTS HIGHER EDUCATION ASSISTANCE CORPORATION, BOSTON, MA, DBA AMERICAN STUDENT ASSISTANCE:
3,396,866, PUB. 1-1-2008. INT. CL. 41.
3,396,867, PUB. 1-1-2008. INT. CL. 35.
- MASSIVE ENTERTAINMENT AB, MALMO, SWEDEN:
3,400,011, MULTIPLE CLASS, INT. CLS. 9 AND 41.
- MASTER CHEMICAL CORPORATION, PERRYSBURG, OH:
2,135,793, REN. 2-8-08. INT. CL. 1.
- MASTERBUILDER FELLOWSHIP FOR THE BUILT ENVIRONMENT, INCORPORATED, MATTHEWS, NC:
3,397,022, PUB. 1-1-2008. MULTIPLE CLASS, INT. CLS. 37 AND 42.
- MASTERCRAFT INDUSTRIES, INC., RICE LAKE, WI:
3,399,268, INT. CL. 6.
- MATA AMRITANANDAMAYI CENTER, CASTRO VALLEY, CA:
3,398,600, PUB. 9-25-2007. MULTIPLE CLASS, INT. CLS. 3, 9, 14, 16, 20, 25, 35, 36, 37, 43 AND 45.
- MATA, ARIEL ALEJANDRO, TLAJOMULCO DE ZUNIGA, JALISCO, MEXICO:
3,398,980, INT. CL. 30.
- MATHMOS LTD., POOLE, DORSET, UNITED KINGDOM, MATHMOS LTD., POOLE, DORSET, UNITED KINGDOM:
2,201,722, REN. 2-11-08. INT. CL. 11.
- MATIAS, JONATHAN R., HOLLIS, NY:
3,398,159, PUB. 1-1-2008. INT. CL. 3.
- MATRIX TECHNOLOGIES CORP., LOWELL, MA:
2,448,094, CANC. INT. CL. 9.
- MATSKIV, VICTOR M., WALNUT CREEK, CA:
3,399,086, INT. CL. 9.
- MATSON, LLC, NORTH BEND, WA:
2,176,822, REN. 2-13-08. INT. CL. 5.
- MATSUSHITA ELECTRIC INDUSTRIAL CO., LTD., OSAKA PREFECTURE, JAPAN:
2,059,820, CANC. MULTIPLE CLASS, INT. CLS. 7 AND 9.
- MATSUSHITA ELECTRIC INDUSTRIAL CO., LTD., KADOMA-SHI OSAKA, JAPAN:
3,397,299, PUB. 1-1-2008. INT. CL. 2.
3,397,300, PUB. 1-1-2008. MULTIPLE CLASS, INT. CLS. 7, 9 AND 11.
3,397,301, PUB. 1-1-2008. INT. CL. 20.
3,397,302, PUB. 1-1-2008. INT. CL. 21.
3,397,303, PUB. 1-1-2008. INT. CL. 37.
3,397,323, PUB. 1-1-2008. MULTIPLE CLASS, INT. CLS. 3, 17, 28 AND 36.
- MATSUSHITA ELECTRIC WORKS, LTD., OSAKA, JAPAN:
3,400,150, INT. CL. 7.
- MATTEL, INC., EL SEGUNDO, CA:
2,448,127, CANC. INT. CL. 28.
2,448,321, CANC. INT. CL. 28.
2,448,326, CANC. INT. CL. 9.
3,397,325, PUB. 1-1-2008. INT. CL. 28.
3,397,406, PUB. 1-1-2008. INT. CL. 28.
3,397,480, PUB. 1-1-2008. INT. CL. 28.
3,397,512, PUB. 1-1-2008. INT. CL. 28.
3,397,525, PUB. 1-1-2008. INT. CL. 28.
3,398,150, PUB. 1-1-2008. INT. CL. 28.
3,399,562, INT. CL. 28.
3,399,954, INT. CL. 28.
3,400,031, INT. CL. 28.
3,400,101, INT. CL. 28.
3,400,134, INT. CL. 28.
- MATTHEY-JOHNSON, PHYLLIS A., DILLSBURG, PA:
3,399,685, MULTIPLE CLASS, INT. CLS. 16 AND 41.
- MATTRESS FIRM, INC., HOUSTON, TX, DBA MATTRESS FIRM:
3,399,550, INT. CL. 35.
3,399,574, INT. CL. 35.
3,399,584, INT. CL. 35.
- MAVCO, INC., HANOVER, MN:
3,397,076, PUB. 1-1-2008. INT. CL. 37.
- MAX AND SEATTLE CO INC. DBA BUBBLE ISLAND, SEATTLE, WA:
3,397,696, PUB. 1-1-2008. MULTIPLE CLASS, INT. CLS. 35 AND 43.
- MAX RAVE, LLC, VERNON, CA:
3,399,602, INT. CL. 25.
- MAXAL INTERNATIONAL, INC., TRAVERSE CITY, MI:
3,399,235, INT. CL. 6.
- MAXIMUM QUALITY FOODS INC., LINDEN, NJ:
3,399,227, INT. CL. 30.
- MAY CHEONG TOY PRODUCTS FACTORY LTD., KWUN TONG, KOWLOON, HONG KONG:
2,448,295, CANC. INT. CL. 28.
- MAYBARD COMPANY, LLC, POWDER SPRINGS, GA:
3,399,210, INT. CL. 35.
- MAYER, CRAIG R., AUSTIN, TX:
3,399,257, MULTIPLE CLASS, INT. CLS. 35 AND 42.
- MAYERS, JUSTIS, HENDERSON, NV, DBA MAYERS LABORATORIES:
1,438,464, CANC. INT. CL. 5.
- MAZDA MOTOR CORPORATION, AKI-GUN, HIROSHIMA, JAPAN:
2,447,547, CANC. INT. CL. 12.
- MCA RECORDS, INC., UNIVERSAL CITY, CA TO UMG RECORDINGS, INC., SANTA MONICA, CA:
2,059,709, CANC. INT. CL. 9.
- MCARTHUR/GLEN EUROPE HOLDINGS LIMITED, LLC, WILMINGTON, DE:
3,398,385, PUB. 1-2-2007. MULTIPLE CLASS, INT. CLS. 18, 21, 25, 36, 43, 44 AND 45.
3,398,386, PUB. 1-2-2007. MULTIPLE CLASS, INT. CLS. 18, 21, 25, 36, 43, 44 AND 45.
- MCCLATCHY U.S.A., INC., SACRAMENTO, CA:
3,398,300, PUB. 1-1-2008. INT. CL. 41.
- MCCUE, MATT, J, WESTWOOD, MA, DBA MCCUE TRAINING:
3,397,978, PUB. 1-1-2008. INT. CL. 41.
- MCCULLOCH, JOANNE, GLEN ALLEN, VA:
2,448,265, CANC. INT. CL. 28.
- MCDOWELL, CHARLES W., III, ALPHARETTA, VA:
3,396,992, PUB. 1-1-2008. MULTIPLE CLASS, INT. CLS. 9, 36 AND 41.
- MCFERSON, CASSANDRA, WASHINGTON, DC:
3,400,098, MULTIPLE CLASS, INT. CLS. 35 AND 41.
- MCGRATH NORTH MULLIN & KRATZ, PC LLO, OMAHA, NE:
3,398,202, PUB. 1-1-2008. INT. CL. 45.
- MCGRATH, CATHERINE E., NORTH ANDOVER, MA:
3,397,762, PUB. 1-1-2008. INT. CL. 10.
- MCGRAW-HILL COMPANIES, INC., THE, NEW YORK, NY:
2,058,660, CANC. INT. CL. 9.
- MCGRAW, THOMAS L., POMPANO BEACH, FL:
3,397,772, PUB. 1-1-2008. INT. CL. 5.
- MCGREGOR AND MACALLAN, SANTA ROSA, CA:
3,400,397, INT. CL. 30.
- MCI COMMUNICATIONS CORPORATION, WASHINGTON, DC:
2,058,941, CANC. INT. CL. 38.
- MCINNIS, GARY M., BATON ROUGE, LA:
2,448,522, CANC. INT. CL. 9.
- MCR TECHNOLOGIES GROUP, INC., STERLING, IL:
3,398,009, PUB. 1-1-2008. INT. CL. 9.
- MDC SERVICES, INC., DALLAS, TX:
2,059,007, CANC. INT. CL. 42.
- MDR FITNESS CORP., SUNRISE, FL:
2,114,228, REN. 2-12-08. INT. CL. 5.
- MEADWESTVACO CORPORATION, GLEN ALLEN, VA:
3,399,595, INT. CL. 16.
3,399,641, INT. CL. 9.
3,399,642, INT. CL. 16.

- MECHANIC ENTERPRISES, INC., ADDISON, TX:
2,076,337. REN. 2-8-08. INT. CL. 21.
- MEDALIA HEALTHCARE L.L.C., SEATTLE, WA TO PROVIDENCE HEALTH SYSTEM, AVENUE, WA:
2,059,767. CANC. INT. CL. 42.
- MEDED RESOURCES, LLC, ELLICOTT CITY, MD:
3,400,185. INT. CL. 41.
- MEDESCORT INTERNATIONAL, INC., ALLENTOWN, PA:
1,474,523. REN. 2-11-08. MULTIPLE CLASS, INT. CLS. 39 AND 42.
- MEDIAMOBILES, INC., WESTON, CT:
2,448,093. CANC. MULTIPLE CLASS, INT. CLS. 12 AND 41.
- MEDICAL ACADEMIC AND SCIENTIFIC COMMUNITY ORGANIZATION, INC., BOSTON, MA:
3,396,998. PUB. 1-1-2008. MULTIPLE CLASS, INT. CLS. 35 AND 45.
- MEDICAL FOODS, INC., CAMBRIDGE, MA:
2,059,098. CANC. INT. CL. 5.
- MEDICAL QUANT USA, INC., SOLON, OH:
3,397,421. PUB. 1-1-2008. INT. CL. 10.
- MEDINICHE, INC., CHESTERFIELD, MO:
3,399,355. INT. CL. 5.
- MEDTRONIC NAVIGATION, INC., LOUISVILLE, CO:
3,399,390. INT. CL. 44.
- MEDTRONIC XOMED, INC., JACKSONVILLE, FL, XOMED SURGICAL PRODUCTS, INC., JACKSONVILLE, FL:
2,130,971. REN. 2-12-08. INT. CL. 10.
- MEDTRONIC, INC., MINNEAPOLIS, MN:
3,308,983. COR. INT. CL. 10.
3,398,358. PUB. 1-1-2008. INT. CL. 10.
- MEDWAY SA, 6805 MEZZOVICO, SWITZERLAND:
2,447,484. CANC. MULTIPLE CLASS, INT. CLS. 1 AND 9.
- MEERA SANTORO AND LUCIO SANTORO PARTNERSHIP, THE, LONDON, UNITED KINGDOM, DBA SANTORO LICENSING:
3,399,000. INT. CL. 42.
- MEGA BRANDS INC., MONTREAL, QUEBEC, CANADA, RITVIK HOLDINGS INC., MONTREAL, QUEBEC, CANADA:
2,142,361. REN. 2-11-08. INT. CL. 28.
- MEGA BRANDS INTERNATIONAL, LUXEMBOURG, ZUG BRANCH, ZUG, SWITZERLAND:
1,438,588. CANC. INT. CL. 16.
2,059,797. CANC. INT. CL. 28.
2,448,222. CANC. INT. CL. 16.
- MEGALAW.COM, LLC, SAN FRANCISCO, CA:
2,447,488. CANC. INT. CL. 42.
- MEGATRAN, INC., DORAL, FL:
3,400,005. INT. CL. 37.
- MEIJER, INC., GRAND RAPIDS, MI:
3,400,165. INT. CL. 32.
- MELLO TRADING AG, ZURICH, SWITZERLAND:
3,400,287. INT. CL. 33.
- MENCHE, DAVID S., BROOKLYN, NY:
3,400,290. INT. CL. 44.
- MENGIBAR AUTOMATION, INC., IVYLAND, PA:
2,447,795. CANC. INT. CL. 7.
- MERCK KGAA, 64293 DARMSTADT, FED REP GERMANY:
2,127,432. REN. 2-11-08. INT. CL. 5.
- MERCURY ENTERPRISES, INC., CLEARWATER, FL:
3,399,246. INT. CL. 9.
- MEREDITH CORPORATION, DES MOINES, IA:
3,399,132. INT. CL. 41.
3,399,282. INT. CL. 41.
- MEREDITH GARRETT, LOS ANGELES, CA:
3,397,898. PUB. 1-1-2008. INT. CL. 25.
- MERION PUBLICATIONS, INC., KING OF PRUSSIA, PA:
2,136,768. REN. 2-9-08. INT. CL. 16.
2,136,772. REN. 2-9-08. INT. CL. 16.
2,136,773. REN. 2-9-08. INT. CL. 16.
2,136,775. REN. 2-9-08. INT. CL. 16.
2,138,374. REN. 2-9-08. INT. CL. 16.
2,138,375. REN. 2-9-08. INT. CL. 16.
2,140,237. REN. 2-9-08. INT. CL. 16.
- MERIT INDUSTRIES, INC., BENSALEM, PA:
3,399,748. INT. CL. 9.
- MERRILL LYNCH & CO., INC., NEW YORK, NY:
3,398,918. INT. CL. 36.
- MERRITT, LORI FAITH, TUCSON, AZ:
3,399,995. INT. CL. 41.
- MERWANJEE POONJAJEE & SONS PRIVATE LIMITED, MUMBAI, INDIA:
2,143,870. REN. 2-8-08. INT. CL. 30.
- MESG LLC, BALTIMORE, MD:
3,397,019. PUB. 1-1-2008. INT. CL. 16.
- METAGENICS, INC., SAN CLEMENTE, CA:
3,396,827. PUB. 1-1-2008. INT. CL. 5.
- METAL FORM MANUFACTURING COMPANY, PHOENIX, AZ:
3,399,583. INT. CL. 11.
- METALS USA BUILDING PRODUCTS, L.P., HOUSTON, TX:
3,399,300. INT. CL. 6.
- METEO FRANCE, FRANCE:
3,398,701. PUB. 1-1-2008. MULTIPLE CLASS, INT. CLS. 9, 35, 38 AND 42.
- METRA ELECTRONICS CORPORATION, HOLLY HILL, FL:
2,447,450. CANC. INT. CL. 9.
- METRIX MATRIX, INC., ROCHESTER, NY:
2,447,562. CANC. INT. CL. 35.
- METRO ENTERPRISES, INC., BEVERLY HILLS, CA, DBA DOMYSTUFF.COM:
3,398,176. PUB. 1-1-2008. INT. CL. 35.
- METROCALL, INC., ALEXANDRIA, VA:
2,448,072. CANC. INT. CL. 38.
- METROCITIES MORTGAGE, LLC, SHERMAN OAKS, CA:
2,447,449. CANC. INT. CL. 36.
- METROMEDIA STEAKHOUSES COMPANY, L.P., PLANO, TX:
2,059,097. CANC. INT. CL. 42.
- METROPOLITAN LIFE INSURANCE COMPANY, LONG ISLAND CITY, NY:
3,398,543. PUB. 1-1-2008. INT. CL. 36.
- MEYER, KATHLEEN SUE, APPLETON, WI, DBA ON ACCOUNT OF ME:
2,448,083. CANC. MULTIPLE CLASS, INT. CLS. 16 AND 41.
- MHI CORRUGATING MACHINERY COMPANY, HUNT VALLEY, MD TO MITSUBISHI HEAVY INDUSTRIES AMERICA, INC., HUNT VALLEY, MD:
2,059,622. CANC. U.S. CL. A.
- MIAMI HEAT LIMITED PARTNERSHIP, THE, MIAMI, FL, BASKETBALL, INC., COCONUT GROVE, FL:
1,485,605. REN. 2-11-08. INT. CL. 41.
- MICHAEL DAVID WARD PRODUCTIONS, INC., SANTA ROSA, CA:
3,399,481. MULTIPLE CLASS, INT. CLS. 16 AND 25.
3,399,664. MULTIPLE CLASS, INT. CLS. 16 AND 25.
- MICHAEL F. HEALY, PEACHTREE CITY, GA:
3,397,023. PUB. 1-1-2008. INT. CL. 43.
- MICHAEL SEILER, LOS ANGELES, CA:
3,397,608. PUB. 1-1-2008. INT. CL. 25.
- MICHAELS, MELISSA, BOULDER, CO:
2,448,441. CANC. INT. CL. 41.
- MICHAELS, MELISSA, PORTLAND, OR, DBA THE INSPIRED ROOM:
3,398,035. PUB. 1-1-2008. INT. CL. 42.
- MICHELLE BUONFIGLIO, BLOOMINGTON, MN:
3,397,402. PUB. 1-1-2008. INT. CL. 41.
- MICHIGAN HIGH SCHOOL ATHLETIC ASSOCIATION, EAST LANSING, MI:
3,397,134. PUB. 4-17-2007. INT. CL. 36.
- MICHIGAN INDUSTRIAL TOOLS, GRAND RAPIDS, MI:
3,400,221. INT. CL. 8.
- MICHIGAN TUBE SWAGERS & FABRICATORS, INC., TEMPERANCE, MI:
3,399,250. INT. CL. 20.
- MICROCAST INC., WESTPORT, CT:
2,447,521. CANC. INT. CL. 38.
- MICROEDGE, INC., NEW YORK, NY:
2,447,267. CANC. INT. CL. 9.
- MICROLYTICS, INC.:
1,438,507. CANC. INT. CL. 9.

MICROMASS LIMITED, WYTHENSHAWE MANCHESTER, UNITED KINGDOM:
2,126,897. REN. 2-11-08. INT. CL. 9.

MICROMOLD PRODUCTS, INC., YONKERS, NY:
2,447,569. CANC. INT. CL. 7.

MICRONTEL S.P.A., ITALY:
3,398,626. PUB. 1-1-2008. INT. CL. 9.

MICROSAIC SYSTEMS LIMITED, WOKING, SURREY, UNITED KINGDOM:
3,399,399. MULTIPLE CLASS, INT. CLS. 9 AND 42.

MICROSEMI CORPORATION, BEND, OR:
3,398,209. PUB. 1-1-2008. INT. CL. 9.

MICROSOFT CORPORATION, REDMOND, WA:
3,399,885. INT. CL. 9.

MICROSYSTEMS SOFTWARE INC., FRAMINGHAM, MA TO SURFCONTROL PLC, CONGLETON, CHESHIRE, UNITED KINGDOM:
2,059,911. CANC. INT. CL. 9.

MID-CONTINENT RESEARCH FOR EDUCATION AND LEARNING, DENVER, CO:
3,400,214. MULTIPLE CLASS, INT. CLS. 16 AND 41.

MID-WEST METAL PRODUCTS, INC., MUNCIE, IN:
3,399,759. INT. CL. 21.

MIDAS INTERNATIONAL CORPORATION, ITASCA, IL:
3,397,493. PUB. 1-1-2008. INT. CL. 37.
3,397,494. PUB. 1-1-2008. INT. CL. 37.

MIDDLEBY MARSHALL, INC., ELGIN, IL:
2,079,824. REN. 2-14-08. INT. CL. 11.

MIDWEST FILTRATION COMPANY, CINCINNATI, OH:
3,397,131. PUB. 1-1-2008. INT. CL. 11.

MIDWEST INDUSTRIAL SUPPLY, INC. CANTON, OH:
1,493,758. REN. 2-14-08. INT. CL. 1.

MIELE, PATRICK A., OLD WESTBURY, NY:
3,397,179. PUB. 1-1-2008. INT. CL. 43.
3,397,180. PUB. 1-1-2008. INT. CL. 43.

MILCOR LIMITED PARTNERSHIP, HOLLAND, OH TO H&C MILCOR, INC. FKA AQUATICO OF TEXAS, INC., LIMA, OH:
2,060,083. CANC. INT. CL. 11.

MILES SR, RAY, BUCHANAN, VA:
3,398,043. PUB. 1-1-2008. INT. CL. 41.

MILITARY ORDER OF THE PURPLE HEART SERVICE FOUNDATION, INC., ANNANDALE, VA:
2,208,425. REN. 2-13-08. MULTIPLE CLASS, INT. CLS. 36 AND 42.

MILL MASTERS, INC., JACKSON, TN:
2,447,800. CANC. INT. CL. 7.

MILLAR, DUNCAN JAMES BEN, LONDON, UNITED KINGDOM:
2,447,421. CANC. INT. CL. 9.

MILLENNIUM TENNIS & FITNESS CLUB, L.L. C., WEBB CITY, MO:
2,447,563. CANC. MULTIPLE CLASS, INT. CLS. 25 AND 41.

MILLER BROTHERS FURNITURE, FALLSCREEK, PA:
3,400,068. INT. CL. 35.

MILLER PRODUCTS COMPANY, MILWAUKEE, WI:
3,397,704. PUB. 1-1-2008. INT. CL. 35.

MILLER, ANGELES A., PROVO, UT:
3,398,390. PUB. 12-12-2006. INT. CL. 28.

MILLER, JANE E., LA JOLLA, CA:
3,397,873. PUB. 1-1-2008. INT. CL. 41.

MILLER, TERRY LEE, STOCK BRIDGE, GA:
2,447,412. CANC. INT. CL. 3.

MILLIKEN & COMPANY, NEW YORK, NY:
2,145,475. REN. 2-13-08. INT. CL. 24.

MILLIPORE CORPORATION, BILLERICA, MA:
2,064,608. REN. 2-14-08. MULTIPLE CLASS, INT. CLS. 9 AND 11.

MILLS- DEBOER, LYNDISAY J., CUPERTINO, CA:
2,134,207. REN. 2-11-08. INT. CL. 41.

MILWAUKEE COUNTY DEPARTMENT OF AGING, MILWAUKEE, WI:
3,398,502. PUB. 1-1-2008. INT. CL. 41.
3,398,503. PUB. 1-1-2008. INT. CL. 41.

MIND MEDIA, INC., SANTA CRUZ, CA:
3,398,376. PUB. 1-1-2008. INT. CL. 25.

MINIMAL ART, GIBSONIA, PA:
3,398,225. PUB. 1-1-2008. INT. CL. 41.

MINITUBE OF AMERICA, INC., VERONA, WI:
2,059,240. CANC. INT. CL. 5.

MINNESOTA AIDS PROJECT, MINNEAPOLIS, MN:
2,058,999. CANC. INT. CL. 25.

MINNESOTA STATE LOTTERY AGENCY, ROSEVILLE, MN:
2,448,418. CANC. INT. CL. 41.

MINNESOTA TWINS, LLC, MINNEAPOLIS, MN:
3,399,541. INT. CL. 18.

MINNTECH CORPORATION, MINNEAPOLIS, MN:
2,169,641. REN. 2-13-08. INT. CL. 10.

MINSKY, RICHARD P., HUDSON, NY:
3,399,258. INT. CL. 41.

MIRABITO, JUDY, HUDSON, NH:
3,400,405. INT. CL. 9.

MIRACLE WORLD CORPORATION, SANTA CLARA, CA:
3,399,288. INT. CL. 3.

MIRAMONTES, ERIK, W. LOS ANGELES, CA AND RAMIREZ, JUAN, LA, CA AND MICHAELSEN, GLEN, LA, CA:
2,448,230. CANC. INT. CL. 25.

MISSION CITY PRESS, INC., SAN ANTONIO, TX:
3,399,973. INT. CL. 28.

MISSION CONTROLS AUTOMATION, INC., IRVINE, CA, DBA MISSION CONTROLS:
2,447,510. CANC. MULTIPLE CLASS, INT. CLS. 9, 37 AND 42.

MISSION HOSPITALS, INC., ASHEVILLE, NC:
2,202,681. REN. 2-14-08. INT. CL. 42.

MISSION MARKETING CORPORATION, PHOENIX, AZ:
1,924,558. REN. 2-13-08. INT. CL. 11.

MISSION PHARMACAL COMPANY, SAN ANTONIO, TX:
3,399,449. INT. CL. 5.

MISSOURI PROFESSIONALS MUTUAL, ST. LOUIS, MO:
3,400,282. INT. CL. 36.

MITSUBISHI ELECTRIC CORPORATION, TOKYO, JAPAN:
3,399,329. INT. CL. 7.

MITSUBISHI KAGAKU IMAGING CORP., CHESAPEAKE, VA:
3,399,796. MULTIPLE CLASS, INT. CLS. 2 AND 9.

MIZRAHI DESIGN GROUP, INC., LOS ANGELES, CA:
3,397,052. PUB. 1-1-2008. INT. CL. 25.

MIZUNO CORPORATION, OSAKA, JAPAN:
3,400,301. INT. CL. 9.

MÉTHODE L'AUDACE, LLC, TULSA, OK:
3,399,097. MULTIPLE CLASS, INT. CLS. 16 AND 41.

MOBILE CONCEPTS BY SCOTTY, MT. PLEASANT, PA:
3,397,363. PUB. 1-1-2008. INT. CL. 12.

MOBILE HYDRAULICS EQUIPMENT COMPANY, LLC, NORTH KANSAS CITY, MO:
3,397,135. PUB. 1-1-2008. INT. CL. 7.

MOBILI MALERBA SNC DI MALERBA NUNZIO & C., ITALY:
3,398,625. PUB. 1-1-2008. INT. CL. 20.

MOBILITY BUSINESS SOLUTIONS, INC., PLANO, TX:
3,398,530. PUB. 1-1-2008. INT. CL. 9.

MOCHA MOMS, INC., BOWIE, MD:
3,397,463. PUB. 1-1-2008. INT. CL. 45.

MODAGO SHOWROOMS, CHICAGO, IL:
3,397,261. PUB. 1-1-2008. INT. CL. 35.

MODERN OPTICAL INTERNATIONAL, LTD., ROSELLE, IL:
3,397,792. PUB. 1-1-2008. INT. CL. 9.

MODY, MIHIR, HOUSTON, TX:
3,397,847. PUB. 1-1-2008. INT. CL. 35.

MOEN INCORPORATED, NORTH OLMSTED, OH, STANDARD SCREW COMPANY, HARTFORD, CT:
842,307. REN. 2-11-08. U.S. CL. 13 (INT. CL. 6).

MOEN INCORPORATED, NORTH OLMSTED, OH:
3,399,780. INT. CL. 11.

MOG, INC., KENSINGTON, CA:
3,399,687. INT. CL. 38.
3,399,688. INT. CL. 42.

MOLECA, LLC, CORAL GABLES, FL:
3,398,172. PUB. 1-1-2008. INT. CL. 33.

- MOLEON, GARY, RIDGEWOOD, NJ:
3,399,975, MULTIPLE CLASS, INT. CLS. 25 AND 30.
3,399,976, MULTIPLE CLASS, INT. CLS. 25 AND 30.
- MOLSON CANADA 2005, TORONTO, ONTARIO:
1,477,950, REN. 2-11-08. INT. CL. 32.
- MOMAC B.V., NETHERLANDS:
3,398,783, PUB. 1-1-2008. INT. CL. 38.
- MOMMA GOLDBERG'S DELI, INC., AUBURN, AL:
3,397,429, PUB. 1-1-2008. INT. CL. 43.
- MONAHAN PRODUCTS, LLC, ROCKLAND, MA:
3,400,027, INT. CL. 12.
- MONDA (U.S.A.) LLC, CHINO HILLS, CA:
2,447,693, CANC. INT. CL. 19.
- MONEY SAVVY GENERATION, LLC, LAKE BLUFF, IL:
3,397,289, PUB. 1-1-2008. INT. CL. 16.
- MONITOR COMPANY GROUP LIMITED PARTNERSHIP,
CAMBRIDGE, MA:
3,399,543, MULTIPLE CLASS, INT. CLS. 9 AND 35.
- MONOTYPE CORPORATION, THE, REDMOND, WA:
2,117,537, REN. 2-12-08. INT. CL. 9.
- MONSANTO TECHNOLOGY LLC, SAINT LOUIS, MO:
3,398,334, PUB. 1-1-2008. INT. CL. 16.
- MONSEY PRODUCTS CO., KIMBERTON, PA:
1,438,597, CANC. INT. CL. 19.
- MONTEREY GOURMET FOODS, INC., SALINAS, CA:
3,397,665, PUB. 11-27-2007. INT. CL. 30.
- MOOG AUTOMOTIVE, INC., ST. LOUIS, MO:
1,438,548, CANC. INT. CL. 12.
- MOORE NORTH AMERICA, INC., STAMFORD, CT:
2,059,905, CANC. INT. CL. 16.
- MOORE SYNDICATION, INC., BIRMINGHAM, AL:
3,398,995, INT. CL. 45.
- MOORE, JOHN, SILVER SPRING, MD:
3,397,057, PUB. 1-1-2008. INT. CL. 43.
- MOOVIES, INC., GREENVILLE, SC:
2,059,303, CANC. INT. CL. 42.
- MORAN FOODS, INC., ST. LOUIS, MO TO SAVE-A-LOT
FOOD STORES, LTD., EARTH CITY, MO:
2,059,952, CANC. INT. CL. 3.
- MORGAN MOTOR COMPANY LIMITED, WORCESTER-
SHIRE, UNITED KINGDOM:
3,399,815, INT. CL. 18.
- MORGAN RANCH BEEF, INC., BURWELL, NE:
3,396,931, PUB. 1-1-2008. INT. CL. 29.
- MORGAN, THOMAS H., LANCASTER, PA:
2,447,416, CANC. INT. CL. 42.
- MORLEY, RICHARD A., NIWOT, CO:
2,448,125, CANC. INT. CL. 18.
- MOROSO PERFORMANCE PRODUCTS, INC., GUILFORD,
CT:
2,136,866, REN. 2-13-08. MULTIPLE CLASS, INT. CLS. 1,
4, 6, 7, 8, 9, 11, 12, 17, 20, 22 AND 25.
- MORQUEST, LLC, WINTER PARK, FL:
3,397,699, PUB. 1-1-2008. INT. CL. 36.
- MORRIS VISITOR PUBLICATIONS, LLC, AUGUSTA, GA:
3,398,449, PUB. 1-1-2008. INT. CL. 16.
- MORSE, WILLIAM N., ELLICOTT CITY, MD:
3,398,979, INT. CL. 6.
- MORTGAGE U, INC., BINGHAM FARMS, MI:
3,397,457, PUB. 1-1-2008. MULTIPLE CLASS, INT. CLS.
16, 36 AND 41.
- MOTHER'S CAKE & COOKIE CO., OAKLAND, CA:
3,396,964, PUB. 1-1-2008. INT. CL. 30.
- MOTHERS AGAINST DRUNK DRIVING, IRVING, TX:
3,397,106, PUB. 1-1-2008. INT. CL. 35.
- MOTHERS POLISHES WAXES CLEANERS, HUNTINGTON
BEACH, CA:
3,399,090, INT. CL. 3.
- MOTHERTALK, INC, PHILADELPHIA, PA:
3,398,607, PUB. 1-1-2008. INT. CL. 35.
- MOTOR OIL, INC., ELK GROVE VILLAGE, IL:
3,397,291, PUB. 1-1-2008. MULTIPLE CLASS, INT. CLS. 1,
2, 4 AND 17.
- MOTORCYCLE SUPERSTORE, INC., MEDFORD, OR:
3,400,337, INT. CL. 35.
- MOTORCYCLE USA, LLC, MEDFORD, OR:
3,400,338, MULTIPLE CLASS, INT. CLS. 38 AND 41.
- MOTOROLA, INC., LIBERTYVILLE, IL:
3,399,324, INT. CL. 9.
- MOUNT SNOW, LTD., WEST DOVER, VT:
3,397,668, PUB. 1-1-2008. INT. CL. 41.
- MOUTAHIR, MEHDI, PROVIDENCE, RI:
3,399,897, INT. CL. 25.
- MOVADO CORPORATION, WILMINGTON, DE:
2,448,200, CANC. INT. CL. 14.
- MOVADO LLC, WILMINGTON, DE:
3,400,052, INT. CL. 14.
- MOYERSON, JEAN-FRANCOIS, MC, MONACO:
2,133,730, REN. 2-13-08. INT. CL. 9.
- MPG BASS GUITARS, COLORADO SPRINGS, CO:
3,399,260, INT. CL. 15.
- MR & MRS CLEAN, VALENCIA, PA:
2,447,744, CANC. INT. CL. 37.
- MRU HOLDINGS, INC., NEW YORK, NY:
3,399,974, INT. CL. 36.
- MSC.SOFTWARE CORPORATION, SANTA ANA, CA:
3,400,173, INT. CL. 9.
- MSDSOONLINE INC., CHICAGO, IL:
2,665,865, CANC. INT. CL. 9.
2,665,866, CANC. INT. CL. 9.
- MSI GUARANTEEDWEATHER, LLC, OVERLAND PARK,
KS:
3,398,141, PUB. 1-1-2008. INT. CL. 36.
- MTD PRODUCTS INC, CLEVELAND, OH:
2,448,499, CANC. INT. CL. 7.
- MTD PRODUCTS INC., CLEVELAND, OH:
2,058,611, CANC. INT. CL. 7.
- MTS MEDICATION TECHNOLOGIES, INC., ST. PETERS-
BURG, FL:
3,399,834, INT. CL. 9.
- MTS PRODUCTS, SUN VALLEY, CA:
3,399,133, INT. CL. 9.
- MTT MEDIAWORKS, SANTA MONICA, CA:
3,398,443, PUB. 9-25-2007. MULTIPLE CLASS, INT. CLS.
35, 38, 39 AND 41.
- MUELLER SPORTS MEDICINE, INC., PRAIRIE DU SAC,
WI:
3,398,476, PUB. 1-1-2008. MULTIPLE CLASS, INT. CLS. 10
AND 28.
- MUELLER, DITTMAR, BERGISCH GLADBACH, FED REP
GERMANY:
3,398,582, PUB. 1-1-2008. MULTIPLE CLASS, INT. CLS.
35, 37, 40 AND 42.
- MUGGERUD, LAWRENCE, NEW YORK, NY:
3,399,338, MULTIPLE CLASS, INT. CLS. 9 AND 41.
- MUIA, TONY, BROOKLYN, NY:
3,399,525, MULTIPLE CLASS, INT. CLS. 25 AND 39.
3,399,526, MULTIPLE CLASS, INT. CLS. 25 AND 39.
- MULICA, F. JAMES, MESA, AZ:
2,448,173, CANC. MULTIPLE CLASS, INT. CLS. 9, 16
AND 41.
- MULLIN, GREGORY, ATLANTA, GA:
3,397,353, PUB. 1-1-2008. INT. CL. 9.
- MULTIMEDIA GAMES, INC., AUSTIN, TX:
3,399,952, INT. CL. 9.
- MULTIPARTNER S.P.A., ROME, ITALY:
3,396,994, PUB. 10-30-2007. INT. CL. 35.
- MUNRO CONCRETE PRODUCTS LTD., BARRIE, ONTAR-
IO, CANADA:
3,396,816, PUB. 9-14-2004. INT. CL. 11.
- MURDOCK LABORATORIES, INC., BURLINGAME, CA:
2,176,498, REN. 2-14-08. INT. CL. 10.
- MUREX S.A.S., PARIS, FRANCE:
3,399,419, MULTIPLE CLASS, INT. CLS. 9 AND 42.
- MURPHY FARMS, INC., ROSE HILL, NC:
2,447,519, CANC. INT. CL. 31.
- MURPHY, ROLAND, MOUNT JOY, PA:
3,397,856, PUB. 1-1-2008. INT. CL. 14.
- MUSE IMAGERY, LLC, LAS VEGAS, NV:
3,398,859, INT. CL. 16.
- MUSEUM OF CONTEMPORARY ART JACKSONVILLE,
INC., JACKSONVILLE, FL:
3,398,075, PUB. 1-1-2008. INT. CL. 41.
- MUSGRAVE, REAL, FLOWER MOUND, TX:
2,447,528, CANC. INT. CL. 28.

- MUSHEGAIN, DAVID EDWARD, PASADENA, CA:
3,399,756, INT. CL. 25.
- MUSIC STAR PRODUCTIONS, CONCORD, CA:
3,398,066, PUB. 1-1-2008. INT. CL. 9.
- MUSICAL INNOVATIONS CORPORATION, ORELAND, PA:
2,060,116, CANC. INT. CL. 15.
- MVBH, INC., TITUSVILLE, FL:
2,447,447, CANC. INT. CL. 42.
- MWM CREATIONS, INC., SAFETY HARBOR, FL:
3,398,461, PUB. 1-1-2008. INT. CL. 25.
- MWR HOLDINGS, LLC, PARSIPPANY, NJ:
3,400,047, INT. CL. 41.
- MY FAVORITE COMPANY, INC., LOS ANGELES, CA:
3,397,977, PUB. 1-1-2008. INT. CL. 30.
- MY LITTLE PRINTS, INC., FORT LAUDERDALE, FL:
2,448,530, CANC. INT. CL. 16.
- MYSPEACE, INC., BEVERLY HILLS, CA:
3,399,651, INT. CL. 9.
- MYSQL AB, UPPSALA, SWEDEN:
3,397,122, PUB. 1-1-2008. MULTIPLE CLASS, INT. CLS. 9,
16, 41 AND 42.
- MYSTERY SHOPPING PROVIDERS ASSOCIATION, DAL-
LAS, TX:
3,397,509, PUB. 1-1-2008. INT. CL. 35.
- MZI HEALTHCARE LLC, VALENCIA, CA:
2,178,019, REN. 2-11-08. INT. CL. 9.
- N.V. BEKAERT S.A., BELGIUM:
3,398,678, PUB. 1-1-2008. INT. CL. 11.
3,398,753, PUB. 1-1-2008. MULTIPLE CLASS, INT. CLS. 1,
6, 17 AND 40.
- N.V. SUMATRA TOBACCO TRADING COMPANY, SUMA-
TERA UTARA, INDONESIA:
3,398,547, PUB. 1-1-2008. INT. CL. 34.
- NADILO, CORY, NORWALK, CT:
2,447,559, CANC. INT. CL. 41.
- NAKI INTERNATIONAL, INC., SUN VALLEY, CA:
2,448,345, CANC. INT. CL. 9.
- NALLEY, MARK, MURRIETA, CA:
3,398,895, INT. CL. 28.
- NAMCO BANDAI GAMES AMERICA INC., SANTA CLARA,
CA:
3,399,281, INT. CL. 9.
- NAMCO BANDAI GAMES INC., TOKYO, JAPAN:
3,398,903, MULTIPLE CLASS, INT. CLS. 9 AND 28.
- NANODYNAMICS, INC., NEW YORK, NY:
3,398,411, PUB. 1-1-2008. MULTIPLE CLASS, INT. CLS. 10
AND 42.
- NANTUCKET BRAND, LLC, NAPLES, FL:
3,397,736, PUB. 1-1-2008. INT. CL. 25.
- NAPA WINE COMPANY, LLC, OAKVILLE, CA:
3,396,963, PUB. 1-1-2008. INT. CL. 33.
- NAPO, INC. D/B/A NATIONAL ASSOCIATION OF PROFES-
SIONAL ORGANIZERS, MOUNT LAUREL, NJ:
3,397,352, PUB. 1-1-2008. INT. CL. 42.
- NARS COSMETICS, INC., NEW YORK, NY:
2,129,982, REN. 2-11-08. INT. CL. 3.
- NASHVILLE CONVENTION & VISITORS BUREAU, NASH-
VILLE, TN:
3,397,103, PUB. 1-1-2008. INT. CL. 41.
- NASHVILLE SOUNDS BASEBALL CLUB LIMITED PART-
NERSHIP, NASHVILLE, TN:
3,397,376, PUB. 1-1-2008. INT. CL. 25.
- NATIONAL AMBULATORY HERNIA INSTITUTE, INC.,
FULLERTON, CA:
2,159,704, REN. 2-12-08. INT. CL. 42.
- NATIONAL ARBITRATION AND MEDIATION, INC., GAR-
DEN CITY, NY:
3,397,921, PUB. 1-1-2008. INT. CL. 45.
- NATIONAL ASSOCIATION OF ANOREXIA NERVOSA AND
ASSOCIATED DISORDERS, HIHGLAND PARK, IL:
3,397,781, PUB. 1-1-2008. INT. CL. 44.
- NATIONAL AUTOMOTIVE PARTS ASSOCIATION, ATLAN-
TA, GA:
1,471,743, REN. 2-13-08. INT. CL. 42.
3,399,979, INT. CL. 7.
- NATIONAL BLACK MBA ASSOCIATION, INC., CHICAGO,
IL:
3,400,390, MULTIPLE CLASS, INT. CLS. 36 AND 41.
- NATIONAL CENTER FOR TOBACCO-FREE KIDS, WA-
SHINGTON, DC:
2,447,291, CANC. INT. CL. 42.
- NATIONAL EDUCATIONAL FINANCIAL SERVICES COR-
PORATION, PONTE VERDRA, FL:
2,132,826, REN. 2-12-08. INT. CL. 36.
- NATIONAL ELECTRONICS WARRANTY CORPORATION,
STERLING, VA:
2,448,293, CANC. INT. CL. 42.
- NATIONAL FEDERATION OF PARALEGAL ASSOCIA-
TIONS, INC., EDMONDS, WA:
3,397,592, PUB. 1-1-2008. INT. CL. 35.
- NATIONAL FOOTBALL LEAGUE, NEW YORK, NY:
2,133,100, REN. 2-11-08. INT. CL. 41.
- NATIONAL FRANCHISE CENTER, INC., MESA, AZ:
3,397,401, PUB. 1-1-2008. INT. CL. 35.
- NATIONAL FRUIT PRODUCT COMPANY, INCORPO-
RATED, WINCHESTER, VA:
1,462,142, REN. 2-12-08. INT. CL. 30.
- NATIONAL GYM SUPPLY, INC., CULVER CITY, CA:
2,447,799, CANC. INT. CL. 4.
2,447,811, CANC. INT. CL. 3.
- NATIONAL HOLISTIC INSTITUTE, EMERYVILLE, CA:
3,398,539, PUB. 1-1-2008. INT. CL. 41.
- NATIONAL INFRASTRUCTURE INSTITUTE, ALEXAN-
DRIA, VA:
3,400,004, INT. CL. 42.
- NATIONAL INSTITUTE FOR LEARNING DISABILITIES,
INC., NORFOLK, VA:
3,399,592, INT. CL. 41.
- NATIONAL MUSIC PUBLISHERS' ASSOCIATION, INC.,
NEW YORK, NY:
2,447,548, CANC. INT. CL. 41.
- NATIONAL OILWELL VARCO, L.P., HOUSTON, TX, HAR-
RISBURG, INC., HOUSTON, TX:
1,070,863, REN. 2-11-08. MULTIPLE CLASS, INT. CLS. 7
AND 9.
- NATIONAL PROBATE RESCUE, INC., ORLANDO, FL:
3,397,914, PUB. 1-1-2008. INT. CL. 36.
3,397,915, PUB. 1-1-2008. INT. CL. 36.
- NATIONAL SERVICE INDUSTRIES, INC., ATLANTA, GA
TO ACUITY BRANDS, INC., ATLANTA, GA:
2,060,167, CANC. INT. CL. 11.
- NATIONS CORP. LIMITED, ROAD TOWN TORTOLA,
BR.VIRGIN ISLANDS:
2,447,734, CANC. INT. CL. 1.
- NATURAL DIAMOND COMPANY LIMITED, ST. HELIER,
JERSEY:
3,398,384, PUB. 10-30-2007. MULTIPLE CLASS, INT. CLS.
14, 35, 37, 40 AND 42.
- NATURAL HEALTH EXAMINATION AND CERTIFICA-
TION BOARD, INC., WASHINGTON, DC:
2,447,960, CANC. INT. CL. 42.
- NATURAL HORIZONS WELLNESS CENTER, FAIRFOX,
VA:
3,397,245, PUB. 1-1-2008. INT. CL. 44.
- NATURAL ORGANICS, INC., MELVILLE, NY:
1,504,544, REN. 2-11-08. INT. CL. 5.
- NATURE FRIEND, INC., HACIENDA HEIGHTS, CA:
3,398,889, INT. CL. 5.
- NATURE INSPIRES MANUFACTURE, INC., NEW YORK,
NY:
3,397,894, PUB. 1-1-2008. INT. CL. 20.
- NATUREX S.A., CEDEX 9, FRANCE:
2,141,999, REN. 2-11-08. INT. CL. 1.
- NATURIBE BERRY GROWERS, INC., SALINAS, CA:
2,087,486, REN. 2-11-08. MULTIPLE CLASS, INT. CLS. 29
AND 31.
- NAUI SERVICES GROUP, INC., TAMPA, FL:
3,397,329, PUB. 1-1-2008. INT. CL. 16.
- NAUTEC INDUSTRIA METALURGICA LTDA, CAXIAS DO
SUL, BRAZIL:
3,399,200, MULTIPLE CLASS, INT. CLS. 6 AND 12.
- NAVIGATE GROUP, THE, INDIANAPOLIS, IN:
2,448,218, CANC. INT. CL. 42.
2,448,223, CANC. INT. CL. 35.

- NAVISTAR INTERNATIONAL CORPORATION, WARRENVILLE, IL, NAVISTAR INTERNATIONAL TRANSPORTATION CORP., CHICAGO, IL:
1,476,173. REN. 2-13-08. INT. CL. 36.
- NAVISTAR INTERNATIONAL CORPORATION, WINFIELD, IL, NAVISTAR INTERNATIONAL CORPORATION, WINFIELD, IL:
1,498,530. REN. 2-8-08. INT. CL. 12.
- NBA PROPERTIES, INC., NEW YORK, NY:
3,122,889. CANC. INT. CL. 41.
- NBTY, INC., BOHEMIA, NY:
2,448,339. CANC. INT. CL. 32.
- NCH CORPORATION, IRVING, TX:
1,475,595. REN. 2-14-08. INT. CL. 4.
- NCORE LIMITED, WORCESTERSHIRE, ENGLAND:
3,397,490. PUB. 1-1-2008. INT. CL. 5.
- NEC ELECTRONICS CORPORATION, KANAGAWA, JAPAN:
3,399,817. INT. CL. 9.
- NECODO, LLC, SEATTLE, WA:
3,399,019. INT. CL. 35.
- NEESE INDUSTRIES, INC., GONZALES, LA:
2,058,517. CANC. INT. CL. 25.
- NELLCOR PURITAN BENNETT INCORPORATED, BOULDER, CO:
3,399,646. INT. CL. 10.
- NEMO EQUIPMENT, INC., NASHUA, NH:
3,399,862. INT. CL. 22.
- NEOPSY SYSTEMS LLC, DENVER, CO:
3,400,017. INT. CL. 35.
- NEOTOOL, LLC, PLANO, TX:
3,400,000. INT. CL. 42.
- NERAC, INC., TOLLAND, CT:
2,059,382. CANC. INT. CL. 42.
- NESTLE WATERS NORTH AMERICA INC., GREENWICH, CT, GREAT SPRING WATERS OF AMERICA, INC., RUMFORD, ME:
1,477,039. REN. 2-13-08. INT. CL. 32.
- NET PERCEPTIONS, INC., EDEN PRAIRIE, MN:
2,447,824. CANC. MULTIPLE CLASS, INT. CLS. 35, 38 AND 41.
- NET PROFIT, GREENVILLE, SC:
2,447,485. CANC. MULTIPLE CLASS, INT. CLS. 35 AND 36.
- NETBORED INC., OAKVILLE, ONTARIO, CANADA:
3,396,831. PUB. 1-1-2008. INT. CL. 35.
- NETCHOICETV INC., PETALUMA, CA:
3,400,181. INT. CL. 38.
- NETIQ CORPORATION, HOUSTON, TX:
2,137,942. REN. 2-13-08. INT. CL. 9.
- NETMACHINES, INC., PLEASANTON, CA:
2,448,343. CANC. INT. CL. 9.
- NETRONIC SOFTWARE GMBH, 52076 AACHEN, FED REP GERMANY, NETRONIC STANDARD SOFTWARE SCHMITZ GMBH, AACHEN, FED REP GERMANY:
1,474,761. REN. 2-11-08. INT. CL. 9.
- NETRONIC SOFTWARE GMBH, D-5100 AACHEN, FED REP GERMANY, NETRONIC STANDARD SOFTWARE SCHMITZ GMBH, AACHEN, FED REP GERMANY:
1,474,762. REN. 2-11-08. INT. CL. 9.
- NETWORK APPLIANCE, INC., SUNNYVALE, CA:
3,397,589. PUB. 1-1-2008. MULTIPLE CLASS, INT. CLS. 36, 37 AND 42.
- NETWORK ENTERPRISES, INC., NEW YORK, NY:
3,399,637. INT. CL. 41.
- NEUE COSMETIC COMPANY, INC., ROLLING HILLS ESTATES, CA:
1,509,807. REN. 2-11-08. INT. CL. 3.
- NEULAND & PARTNER BERATENDE; DIPLOM-KAUF-FRAU DIPLOM-DESIGNER; MODERATOREN UND SEMINARTRAINER, FED REP GERMANY:
3,398,670. PUB. 1-1-2008. MULTIPLE CLASS, INT. CLS. 35 AND 41.
- NEUSPORT FOOTBALL CLUB, LAS VEGAS, NV:
3,398,162. PUB. 1-1-2008. INT. CL. 41.
3,398,263. PUB. 1-1-2008. INT. CL. 41.
- NEVADA COUNTY PUBLISHING CO., RENO, NV:
3,397,330. PUB. 1-1-2008. MULTIPLE CLASS, INT. CLS. 16 AND 41.
- NEVILLE CHEMICAL COMPANY, PITTSBURGH, PA:
663,645. REN. 2-13-08. U.S. CL. 6 (INT. CL. 1).
- NEW AGE SYSTEMS, INC., PRINCETON, IN:
3,397,924. PUB. 1-1-2008. INT. CL. 9.
- NEW ALBERTSON'S, INC., BOISE, ID:
1,071,250. REN. 2-11-08. MULTIPLE CLASS, INT. CLS. 3, 29 AND 30.
- NEW CARBON COMPANY, INC., SOUTH BEND, IN:
1,496,931. REN. 2-10-08. INT. CL. 30.
- NEW COOPERATIVE, INC., FORT DODGE, IA:
3,397,056. PUB. 1-1-2008. INT. CL. 42.
- NEW VENTURE ENT. LTD., HUNTINGTON BEACH, CA:
2,447,424. CANC. INT. CL. 8.
- NEW VISION INTERNATIONAL, INC., TEMPE, AZ:
2,447,536. CANC. INT. CL. 3.
- NEW YORK CENTER FOR COACHING, INC., THE, NEW YORK, NY:
3,399,716. INT. CL. 9.
- NEW YORK FOOTBALL GIANTS, INC., EAST RUTHERFORD, NJ:
3,397,365. PUB. 1-1-2008. INT. CL. 14.
- NEW YORK HOSPITAL MEDICAL CENTER OF QUEENS, FLUSHING, NY:
2,447,912. CANC. INT. CL. 41.
- NEW YORK LIFE INSURANCE COMPANY, NEW YORK, NY:
3,399,938. INT. CL. 36.
- NEW YORK TIMES COMPANY, THE, NEW YORK, NY:
2,099,528. REN. 2-13-08. INT. CL. 16.
- NEWARK FRATERNAL ORDER OF POLICE LODGE #12, NEWARK, NJ:
3,302,421. COR. INT. CL. 35.
- NEWBRIDGE PARTNERS LLC, NEW YORK, NY:
2,448,458. CANC. INT. CL. 36.
- NEWCOME KARTARIK, MARY JO, SHOREVIEW, MN:
3,399,457. INT. CL. 16.
- NEWPORT CORPORATION, IRVINE, CA:
2,103,240. REN. 2-12-08. INT. CL. 9.
- NEWPORT EXCHANGE HOLDINGS, INC., IRVINE, CA:
3,397,464. PUB. 1-1-2008. INT. CL. 41.
- NEWPORT NEWS HOLDINGS CORPORATION, NEW YORK, NY:
2,448,515. CANC. INT. CL. 16.
- NEWTON, DONALD E., SPRINGFIELD, MO, DBA MISSOURI MOTOR COMPANY:
2,447,911. CANC. INT. CL. 35.
- NEWTON, STEVEN J., CLEVER, MO:
3,399,948. INT. CL. 24.
- NEXANS, FRANCE:
3,398,828. PUB. 1-1-2008. INT. CL. 9.
3,398,829. PUB. 1-1-2008. INT. CL. 9.
- NEXANTIS CORPORATION, TOKYO, JAPAN:
3,399,360. MULTIPLE CLASS, INT. CLS. 9 AND 42.
- NEXGEN SOFTWARE SERVICES, INC., THE WOODLANDS, TX:
3,397,495. PUB. 1-1-2008. INT. CL. 9.
- NEXTCAT, INC., QUINCY, MA:
3,397,167. PUB. 1-1-2008. MULTIPLE CLASS, INT. CLS. 35, 38 AND 42.
- NGUYEN, JULIE MONG, TUSTIN, CA:
3,398,613. PUB. 1-1-2008. MULTIPLE CLASS, INT. CLS. 3, 35 AND 41.
- NICE GUY STRATEGIES, LLC, NEWBURYPORT, MA:
3,399,818. INT. CL. 41.
- NICE SHOT INC., ALBION, PA:
3,397,420. PUB. 1-1-2008. INT. CL. 13.
- NICHOLSON, HAL L, HAVERSTRAW, NY, AKA KING PAPS AND NICHOLSON, STEVIE O., HAVERSTRAW, NY, AKA STEVIE PRIEST:
3,398,298. PUB. 1-1-2008. INT. CL. 9.
- NICNAK, LLC, CHATSWORTH, CA:
3,396,944. PUB. 1-1-2008. INT. CL. 25.
- NIERENBERG, GERARD I., NEW YORK, NY:
1,438,512. CANC. INT. CL. 9.
- NIGHT TERRORZ INC., BELLEROSE, NY:
3,399,545. MULTIPLE CLASS, INT. CLS. 25 AND 26.

- NIHC, INC., PORTLAND, OR:
2,448,397, CANC. INT. CL. 35.
- NIHON UNISYS, LTD., TOKYO, JAPAN:
3,398,471, PUB. 10-9-2007. MULTIPLE CLASS, INT. CLS. 9, 35 AND 42.
- NIKE, INC., BEAVERTON, OR:
3,398,343, PUB. 1-1-2008. INT. CL. 28.
- NIKON CORPORATION, TOKYO, JAPAN:
3,398,612, PUB. 9-18-2007. INT. CL. 9.
- NIM, INC., RALEIGH, NC, DBA CAROLINA ANTIQUE MALL:
2,447,549, CANC. INT. CL. 35.
- NIMCO DIVERSIFIED PRODUCTS, INC., NEWARK, DE:
2,447,537, CANC. INT. CL. 16.
- NINA CUSANELLI LLC, DAYTON, MD:
3,398,950, MULTIPLE CLASS, INT. CLS. 14 AND 20.
- NINE WEST DEVELOPMENT CORPORATION, WILMINGTON, DE, NINE WEST DEVELOPMENT CORPORATION, WILMINGTON, DE:
2,133,086, REN. 2-13-08. MULTIPLE CLASS, INT. CLS. 9 AND 25.
- NINGBO BIG WINDMILL; EDUCATIONAL MATERIALS CO., LTD., YUYAO, ZHEJIANG, CHINA:
3,398,680, PUB. 1-1-2008. INT. CL. 16.
- NINGBO ZHENHAI XINGYI; FASTENERS CO., LTD; (NINGBOSHI ZHENHAI XINGYI JINGUJIAN; ZHIZAO YOUXIAN GONGSI), CHINA:
3,398,644, PUB. 1-1-2008. INT. CL. 6.
- NIPPON CHEMI-CON CORPORATION, JAPAN:
3,398,642, PUB. 1-1-2008. INT. CL. 9.
- NIPPON MENARD COSMETIC CO., LTD., AICHI-KEN, JAPAN:
2,516,656, CANC. MULTIPLE CLASS, INT. CLS. 5, 8, 16 AND 21.
- NISSAN JIDOSHA KABUSHIKI KAISHA, YOKOHAMA-SHI, KANAGAWA-KEN, JAPAN, TA NISSAN MOTOR CO., LTD.:
3,398,867, INT. CL. 9.
- NMW, INC., NOWATA, OK:
1,488,318, REN. 2-9-08. INT. CL. 11.
- NO-MUV CORPORATION, INC., JACKSONVILLE, FL:
1,438,621, CANC. INT. CL. 27.
- NOAH'S NATURALS, LLC, LOS ANGELES, CA:
3,398,920, MULTIPLE CLASS, INT. CLS. 3 AND 5.
- NOBODYSMILING INC, BROOKLYN, NY:
3,397,824, PUB. 1-1-2008. INT. CL. 41.
- NOCONA LEATHER GOODS COMPANY, LTD., NOCONA, TX:
3,399,049, INT. CL. 28.
- NOMACO, INC., ZEBULON, NC:
3,398,992, INT. CL. 28.
3,398,993, INT. CL. 28.
3,398,994, INT. CL. 28.
- NOODLES & COMPANY, BROOMFIELD, CO:
3,400,230, INT. CL. 43.
- NOPEC, INC., PASADENA, CA:
3,400,178, INT. CL. 9.
- NORCO DELIVERY SERVICE, INC., ANAHEIM, CA:
3,397,102, PUB. 1-1-2008. INT. CL. 18.
- NORD-PLAN A/S, DENMARK:
3,398,645, PUB. 1-1-2008. MULTIPLE CLASS, INT. CLS. 6 AND 20.
- NORDOST CORPORATION, ASHLAND, MA:
2,128,635, REN. 2-13-08. INT. CL. 1.
- NORMENT SECURITY GROUP, INC., MONTGOMERY, AL:
3,398,421, PUB. 1-1-2008. MULTIPLE CLASS, INT. CLS. 37 AND 42.
- NORSTAN, INC., MINNETONKA, MN:
2,447,346, CANC. INT. CL. 42.
- NORTEL NETWORKS LIMITED, MONTREAL, QUEBEC H2Y 3Y4, CANADA:
2,448,118, CANC. MULTIPLE CLASS, INT. CLS. 9 AND 38.
- NORTH AMERICAN PIPE CORPORATION, HOUSTON, TX:
3,400,381, INT. CL. 19.
- NORTH AMERICAN SAFETY PRODUCTS, INC., FRANKFORT, IL TO NORTH AMERICAN SAFETY PRODUCTS, INC., FRANKFORT, IL:
2,059,906, CANC. INT. CL. 6.
- NORTH AMERICAN SERVICE GROUP, LLC, LIVONIA, MI:
3,398,952, INT. CL. 37.
- NORTH COUNTY FIGHT CLUB, LLC, CARLSBAD, CA:
3,397,412, PUB. 1-1-2008. MULTIPLE CLASS, INT. CLS. 9, 25 AND 41.
- NORTH DAKOTA STATE UNIVERSITY OF AGRICULTURE AND APPLIED SCIENCE, FARGO, ND:
3,398,927, MULTIPLE CLASS, INT. CLS. 16 AND 25.
- NORTHERN TRUST CORPORATION, CHICAGO, IL:
2,104,616, REN. 2-13-08. INT. CL. 36.
- NORTHSTAR TRAVEL MEDIA, LLC, SECAUCUS, NJ:
3,400,326, MULTIPLE CLASS, INT. CLS. 16 AND 41.
- NORTHWEST NOTARY NETWORK, LLC, PORTLAND, OR:
3,399,080, INT. CL. 42.
- NORI UPGRADE, CUPERTINO, CA:
3,399,623, INT. CL. 35.
- NORI, INC., CUPERTINO, CA:
3,399,611, INT. CL. 35.
3,399,622, INT. CL. 35.
3,399,624, INT. CL. 35.
- NOSCO, INC., GURNEE, IL:
834,189, REN. 2-8-08. U.S. CL. 2 (INT. CLS. 6, 13, 14, 15, 16, 18, 20, 21, 22 AND 34).
834,189, CANC. MULTIPLE CLASS, U.S. CLS. 8, 21, 23, 25, 32, 37 AND 50.
836,491, REN. 2-8-08. U.S. CL. 2 (INT. CLS. 6, 13, 14, 15, 16, 18, 20, 21, 22 AND 34).
836,491, CANC. MULTIPLE CLASS, U.S. CLS. 23, 32 AND 37.
- NOVA GAMING, LLC, GREENVILLE, SC:
3,399,043, INT. CL. 9.
- NOVARTIS AG, BASEL, SWITZERLAND:
2,059,768, CANC. INT. CL. 5.
- NOVARTIS AG, SWITZERLAND:
3,398,623, PUB. 1-1-2008. INT. CL. 5.
- NOVARTIS AG, CH-4002 BASEL, SWITZERLAND:
3,398,668, PUB. 1-1-2008. INT. CL. 5.
3,398,681, PUB. 1-1-2008. INT. CL. 5.
- NOVARTIS VACCINES AND DIAGNOSTICS GMBH & CO. KG, 35041 MARBURG, FED REP GERMANY:
2,200,256, REN. 2-13-08. INT. CL. 5.
- NOVATEL INC., CALGARY, CANADA:
3,398,524, PUB. 1-1-2008. INT. CL. 9.
- NOVOCOL PHARMACEUTICAL OF CANADA, INC., CAMBRIDGE, ONTARIO, CANADA:
2,176,825, REN. 2-13-08. INT. CL. 5.
- NOWAK PIPE REAMING, INC., GODDARD, KS:
3,397,820, PUB. 1-1-2008. INT. CL. 37.
- NSB ASSOCIATES, INC., BEVERLY HILLS, CA:
3,399,425, INT. CL. 37.
- NSE PRODUCTS, INC., PROVO, UT, PHARMANEX, INC., SIMI VALLEY, CA:
2,131,286, REN. 2-14-08. INT. CL. 5.
- NU-AIR VENTILATION SYSTEMS INC., WINDSOR, CANADA:
3,398,594, PUB. 1-1-2008. INT. CL. 11.
- NU-BEST DIAGNOSTIC LABS, INC., PALM HARBOR, FL:
2,058,654, CANC. INT. CL. 42.
- NUAIR MANUFACTURING COMPANY, TAMPA, FL:
3,398,890, INT. CL. 6.
- NUFARM AMERICAS INC., BURR RIDGE, IL:
3,399,773, INT. CL. 5.
- NUMBTHUMB.COM LLC, YELM, WA:
3,397,156, PUB. 1-1-2008. INT. CL. 41.
- NUOS CORPORATION, LOS ANGELES, CA:
2,447,736, CANC. INT. CL. 42.
- NUPLA CORPORATION, SUN VALLEY, CA, NEW PLASTIC CORPORATION, LOS ANGELES, CA:
846,668, REN. 2-13-08. U.S. CL. 23 (INT. CL. 8).
- NURESCCELL INC., NEWPORT BEACH, CA:
2,447,631, CANC. INT. CL. 17.
- NUVASIVE, INC., SAN DIEGO, CA:
3,399,364, INT. CL. 10.

- NYLON PUNK, LTD., PALISADES PARK, NJ:
 3,397,447, PUB. 1-1-2008. INT. CL. 25.
- NYSE GROUP, INC., NEW YORK, NY:
 1,082,877. REN. 2-8-08. INT. CL. 36.
- O.S.B. MANUFACTURING INC., VIRGINIA BEACH, VA:
 2,059,938, CANC. MULTIPLE CLASS, INT. CLS. 25 AND 28.
- OAKLEY, INC., FOOTHILL RANCH, CA:
 2,087,464. REN. 2-11-08. INT. CL. 9.
 2,087,465. REN. 2-11-08. INT. CL. 9.
 2,106,614. REN. 2-11-08. INT. CL. 9.
- OBIK, L.L.C., PRINCETON, NJ:
 2,447,335, CANC. MULTIPLE CLASS, INT. CLS. 16, 35 AND 42.
- OBJECTIVE INTEGRITY, INC., PAOLI, PA:
 3,397,473, PUB. 1-1-2008. INT. CL. 42.
 3,397,474, PUB. 1-1-2008. INT. CL. 42.
- OBJECTWORLD COMMUNICATIONS CORP., KANATA, CANADA:
 3,398,592, PUB. 1-1-2008. INT. CL. 9.
- OCCUPATIONAL PERFORMANCE CENTER, INC., SALINA, KS:
 3,397,937, PUB. 1-1-2008. INT. CL. 44.
- OCEAN CHICKS, INC., ATHENS, GA:
 3,399,207, INT. CL. 43.
- OCEAN PETROLEUM, INC., STONY BROOK, NY:
 1,438,738, CANC. INT. CL. 42.
- OCEANIC BEVERAGES CO., INC., SAN-CHUNG CITY, TAIPEI HSIEN, TAIWAN:
 3,396,817, PUB. 8-27-2002. INT. CL. 32.
- OCEANIC BEVERAGES CO., LTD., TAIPEI HSIEN, TAIWAN:
 3,398,352, PUB. 6-17-2003. INT. CL. 29.
 3,398,353, PUB. 7-29-2003. INT. CL. 32.
- OCUSAFE, SAINT MARYS, KS:
 3,397,660, PUB. 1-1-2008. INT. CL. 9.
- ODEGARD, INC., NEW YORK, NY:
 3,398,519, PUB. 1-1-2008. MULTIPLE CLASS, INT. CLS. 8, 11, 19, 20, 21, 24 AND 27.
- OEHLBACH KABEL GMBH, D-76297 STUTENSEE, FED REP GERMANY:
 2,129,395. REN. 2-11-08. INT. CL. 9.
- OERLIKON CONTRAVES AG, SWITZERLAND:
 3,398,738, PUB. 1-1-2008. INT. CL. 9.
 3,398,762, PUB. 1-1-2008. INT. CL. 13.
- OFS SALES CORP., HUNTINGBURG, IN:
 3,399,635, INT. CL. 20.
- OHEKA MANAGEMENT CORP., COLD SPRING HILLS, NY:
 2,187,875. REN. 2-13-08. INT. CL. 42.
- OLD MEETING HOUSE HOMEMADE ICE CREAM LLC, TAMPA, FL:
 3,399,751, INT. CL. 30.
- OLDE NEW ENGLAND CANDLE CO., INC., BENTON, ME:
 2,447,303, CANC. INT. CL. 4.
- OLIVA COGAR COMPANY, MIAMI LAKES, FL:
 2,081,167. REN. 2-13-08. INT. CL. 34.
- OLIVERMCMILLAN, LLC, SAN DIEGO, CA:
 3,397,927, PUB. 1-1-2008. MULTIPLE CLASS, INT. CLS. 36 AND 37.
 3,397,958, PUB. 1-1-2008. MULTIPLE CLASS, INT. CLS. 36 AND 37.
 3,397,960, PUB. 1-1-2008. MULTIPLE CLASS, INT. CLS. 36 AND 37.
- OLYMPUS CORPORATION, TOKYO, JAPAN:
 3,399,763, INT. CL. 10.
- OMAHA STEAKS INTERNATIONAL, OMAHA, NE:
 2,140,390. REN. 2-12-08. INT. CL. 30.
- OMAHA STEAKS INTERNATIONAL, INC., OMAHA, NE:
 2,145,384. REN. 2-12-08. INT. CL. 29.
- OMAHA THEATER COMPANY, OMAHA, NE:
 3,397,234, PUB. 1-1-2008. INT. CL. 41.
- OMD, INC., EDEN PRAIRIE, MN:
 2,060,066, CANC. INT. CL. 28.
- OMEGA PSI PHI FRATERNITY, INC., DECATUR, GA:
 3,396,832, PUB. 1-1-2008. INT. CL. 25.
- ON SITE CONCRETE INC., SACRAMENTO, CA:
 3,399,144, INT. CL. 12.
- ONE SIMPLE MOVE, LLC, SANTA BARBARA, CA:
 3,396,975, PUB. 1-1-2008. MULTIPLE CLASS, INT. CLS. 9, 35 AND 42.
- ONE STOP WEDDING SHOP, L.L.C., LOVES PARK, IL:
 3,398,508, PUB. 1-1-2008. MULTIPLE CLASS, INT. CLS. 35 AND 41.
- ONE TRUE VINE, LLC, ST. HELENA, CA:
 3,399,875, INT. CL. 33.
- ONEIDA LTD., ONEIDA, NY:
 851,740. REN. 2-14-08. U.S. CL. 13 (INT. CL. 21).
- ONENAME CORPORATION, SEATTLE, WA:
 2,448,085, CANC. INT. CL. 42.
- ONEPIN, INC., WESTBOROUGH, MA:
 3,396,935, PUB. 1-1-2008. INT. CL. 35.
- ONGKO, PETER, HUNTINGTON BEACH, CA:
 3,396,814, PUB. 1-1-2008. INT. CL. 42.
- ONLINESEATS.COM INC., CHICAGO, IL:
 3,400,259, INT. CL. 41.
- ONSET MEDICAL CORPORATION, IRVINE, CA:
 3,399,335, INT. CL. 10.
- ONTHANK, CHRISTOPHER, WILTON, CT:
 3,399,613, MULTIPLE CLASS, INT. CLS. 9, 12, 18, 20, 35, 41, 43 AND 44.
- OPEN ARMS CRISIS PREGNANCY CENTER, COLUMBIA, MT:
 2,447,580, CANC. MULTIPLE CLASS, INT. CLS. 41 AND 42.
- OPEN BANK SANTANDER CONSUMER, S.A., MADRID, SPAIN:
 3,397,518, PUB. 1-1-2008. MULTIPLE CLASS, INT. CLS. 16, 35, 36 AND 38.
- OPEN JOIST 2000 INC., TROIS-RIVIERES, QUEBEC, CANADA:
 2,135,163. REN. 2-13-08. MULTIPLE CLASS, INT. CLS. 7 AND 19.
 2,135,163, CANC. MULTIPLE CLASS, INT. CLS. 9 AND 40.
 2,139,940. REN. 2-13-08. MULTIPLE CLASS, INT. CLS. 7 AND 19.
 2,139,940, CANC. INT. CL. 9.
- OPEN LABS, INC., AUSTIN, TX:
 3,397,506, PUB. 1-1-2008. INT. CL. 15.
- OPENVIEW FORUM, CHICAGO, IL:
 3,397,564, PUB. 1-1-2008. MULTIPLE CLASS, INT. CLS. 35, 38 AND 42.
- OPERATION RESPOND INSTITUTE, INC., WASHINGTON, DC:
 2,133,959. REN. 2-14-08. INT. CL. 16.
 2,134,468. REN. 2-14-08. INT. CL. 42.
 2,134,469. REN. 2-14-08. INT. CL. 41.
- OPPENHEIMERFUNDS, INC., NEW YORK, NY:
 2,140,505. REN. 2-11-08. INT. CL. 36.
 2,161,564. REN. 2-11-08. INT. CL. 36.
- OPTILED HOLDINGS COMPANY LIMITED, SHATIN, HONG KONG:
 3,397,675, PUB. 1-1-2008. INT. CL. 11.
- OPTIMIZE TECHNOLOGIES, INC., OREGON CITY, OR:
 2,107,751. REN. 2-13-08. INT. CL. 9.
- OPTIMOX CORPORATION, TORRANCE, CA:
 1,491,904. REN. 2-13-08. INT. CL. 5.
- OPTIMUM SYNERGY ENTERPRISES, TOLUCA LAKE, CA:
 3,397,753, PUB. 1-1-2008. INT. CL. 36.
- OPTIMUS INTERNATIONAL, INC., MURPHY, TX:
 3,399,597, MULTIPLE CLASS, INT. CLS. 8, 9, 14 AND 25.
- ORANGE COUNTY PARKS AND RECREATION DIVISION, ORLANDO, FL:
 3,400,079, INT. CL. 35.
- ORCAS INTERNATIONAL, INC., FLANDERS, NJ:
 3,396,919, PUB. 1-1-2008. INT. CL. 5.
- ORE-CAL CORPORATION, LOS ANGELES, CA:
 1,519,293. REN. 2-11-08. INT. CL. 42.
 2,206,242. REN. 2-11-08. INT. CL. 29.
- ORFEVRERIE CHRISTOFLE, 75008 PARIS, FRANCE:
 2,058,557, CANC. INT. CL. 21.
- ORGANIC DIVERSIONS, INC., RIVERDALE, MD:
 2,447,851, CANC. INT. CL. 5.
- ORGANIC LAWN, FORT MILL, SC:
 3,398,284, PUB. 1-1-2008. INT. CL. 44.

ORIBE LLC, NEW YORK, NY:
3,398,567, PUB. 1-1-2008. INT. CL. 3.

ORIGINIZE IP AG; C/O INCO CONSULTING AG, CH-6300 ZUG, SWITZERLAND:
3,398,649, PUB. 1-1-2008. MULTIPLE CLASS, INT. CLS. 9, 16 AND 35.

ORMCO CORPORATION, ORANGE, CA:
2,084,992. REN. 2-14-08. INT. CL. 10.

ORPHAN MEDICAL, INC., MINNETONKA, MN:
2,059,954, CANC. INT. CL. 42.

ORTEGA, ROLANDO, HEMSTEAD, NY:
3,400,132, INT. CL. 32.

ORTHOLUTION CO., LTD., SEOUL, REPUBLIC OF KOREA:
3,399,819, INT. CL. 10.

ORTHOMED, FRANCE:
3,398,737, PUB. 1-1-2008. INT. CL. 10.

OSAM DOCUMENT SOLUTIONS INC, PHOENIX, AZ:
3,398,488, PUB. 1-1-2008. MULTIPLE CLASS, INT. CLS. 37 AND 42.

OSHKOSH TRUCK CORPORATION, OSHKOSH, WI:
3,399,852, INT. CL. 12.

OSI RESTAURANT PARTNERS, LLC, TAMPA, FL:
3,397,392, PUB. 1-1-2008. MULTIPLE CLASS, INT. CLS. 35 AND 43.

OSMENT MODELS INC., LINN CREEK, MO:
1,491,882. REN. 2-11-08. INT. CL. 4.

OSMOSIS DEVELOPMENT CORPORATION, GARDEN CITY PARK, NY:
2,135,418. REN. 2-11-08. INT. CL. 42.

OSTEOMETER MEDITECH A/S, DK-2970 HORSHOLM, DENMARK:
2,448,109, CANC. MULTIPLE CLASS, INT. CLS. 9 AND 10.

OTKRYTOE AKTSIONERNOE OBCHTCHESTVO; "NEFTYANAYA KOMPANIYA "LUKOIL", RUSSIAN FED.:
3,398,764, PUB. 1-1-2008. MULTIPLE CLASS, INT. CLS. 4, 6, 12, 14, 16, 20, 24, 25, 28, 34, 35, 37 AND 39.

OTKRYTOYE AKTSIONERNOYE OBCHTCHESTVO; "SYNERGIYA KAPITAL", RUSSIAN FED.:
3,398,807, PUB. 1-1-2008. MULTIPLE CLASS, INT. CLS. 32 AND 33.

OTTO BOCK HEALTHCARE GMBH, FED REP GERMANY:
3,398,770, PUB. 1-1-2008. MULTIPLE CLASS, INT. CLS. 9 AND 10.
3,398,771, PUB. 1-1-2008. MULTIPLE CLASS, INT. CLS. 9 AND 10.
3,398,772, PUB. 1-1-2008. MULTIPLE CLASS, INT. CLS. 9 AND 10.

OTTO LESQUE LLC, NEW YORK, NY:
3,397,686, PUB. 1-1-2008. MULTIPLE CLASS, INT. CLS. 24 AND 25.

OUT OF THE WOODWORK PRODUCTIONS, INC., WOODBRIDGE, VA:
3,397,817, PUB. 1-1-2008. INT. CL. 41.

OUTBACK GOLF, INC., MILTON, MA:
2,448,444, CANC. INT. CL. 28.

OUTOTEC OYJ, FINLAND:
3,398,696, PUB. 1-1-2008. MULTIPLE CLASS, INT. CLS. 7, 40 AND 42.
3,398,833, PUB. 1-1-2008. INT. CL. 7.

OUTSOURCE TELECOM, LLC, EL SEGUNDO, CA:
3,400,305, INT. CL. 35.

OUTSYSTEMS, SOFTWARE EM REDE, S.A., LINDA-AVELHA, PORTUGAL:
3,398,407, PUB. 1-1-2008. MULTIPLE CLASS, INT. CLS. 9, 35, 41 AND 42.

OVED & OVED LLP, NEW YORK, NY:
3,397,920, PUB. 1-1-2008. INT. CL. 45.

OVERSEAS MEDIA INC, NEW YORK, NY:
3,398,306, PUB. 1-1-2008. INT. CL. 41.

OVERTON'S INC., GREENVILLE, NC:
1,473,630. REN. 2-13-08. INT. CL. 42.

OVERTON'S INCORPORATED, GREENVILLE, NC:
2,140,590. REN. 2-13-08. MULTIPLE CLASS, INT. CLS. 9 AND 25.
2,143,879. REN. 2-13-08. MULTIPLE CLASS, INT. CLS. 18, 25 AND 28.
2,155,991. REN. 2-13-08. MULTIPLE CLASS, INT. CLS. 9, 22, 25 AND 28.
2,155,991, CANC. MULTIPLE CLASS, INT. CLS. 18 AND 20.

OWEN BIOSCIENCES, INC., BATON ROUGE, LA:
3,397,689, PUB. 1-1-2008. INT. CL. 40.

OWENS CORNING INTELLECTUAL CAPITAL, LLC, TOLEDO, OH:
2,133,419. REN. 2-13-08. INT. CL. 17.
3,399,893, INT. CL. 19.

OWENS-CORNING FIBERGLAS TECHNOLOGY INC., SUMMIT, IL:
2,059,667, CANC. INT. CL. 17.

OWNP INTERACTIVE, LLC, SAN FRANCISCO, CA:
2,448,375, CANC. MULTIPLE CLASS, INT. CLS. 35 AND 42.

OXFORD HEALTH PLANS LLC, TRUMBULL, CT:
2,448,283, CANC. INT. CL. 42.

OXFORD INDUSTRIES, INC., ATLANTA, GA:
3,399,710, INT. CL. 25.

OXONIA INSURANCE GROUP, INC., PLANTATION, FL:
3,399,079, INT. CL. 36.

OXONICA MATERIALS LIMITED, KIDLINGTON, OXFORDSHIRE, UNITED KINGDOM:
3,398,768, PUB. 1-1-2008. INT. CL. 1.

OZONE DESIGN INC., NEW YORK, NY:
3,399,944, INT. CL. 25.

O2 INNOVATIONS LLC, WEST PITTSSTON, PA:
3,399,505, INT. CL. 10.

PACCAR INC, BELLEVUE, WA, DBA PETERBILT MOTORS CO.:
2,163,587. REN. 2-14-08. INT. CL. 9.

PACCARD FONDERIE, FRANCE:
3,398,688, PUB. 1-1-2008. MULTIPLE CLASS, INT. CLS. 6 AND 15.

PACCESS LLC, PORTLAND, OR:
2,129,072. REN. 2-12-08. INT. CL. 35.

PACIFIC CLUB IMPACT FOUNDATION, NEWPORT BEACH, CA:
3,399,890, INT. CL. 41.

PACIFIC COAST BUILDING PRODUCTS, INC., RANCHO CORDOVA, CA:
3,399,100, INT. CL. 19.

PACIFIC LOCK COMPANY, CHATSWORTH, CA:
3,398,523, PUB. 1-1-2008. INT. CL. 6.

PACIFIC PENSION INSTITUTE, A PUBLIC BENEFIT CORPORATION, SAN FRANCISCO, CA:
3,397,016, PUB. 1-1-2008. INT. CL. 41.

PACIFIC PLANT FARM, INC., SNOHOMISH, WA, DBA HENRY'S PLANT FARM:
2,135,053. REN. 2-13-08. INT. CL. 31.

PACIFIC RATE MORTGAGE, INC., TRABUCO CANYON, CA:
3,397,940, PUB. 1-1-2008. INT. CL. 36.

PACIFIC RESEARCH & ENGINEERING CORPORATION, CARLSBAD, CA TO HARRIS CORPORATION, MELBOURNE, FL:
2,059,504, CANC. MULTIPLE CLASS, INT. CLS. 37 AND 42.

PACIFIC RIM WINEMAKERS, INC., PORTLAND, OR:
2,141,907. REN. 2-12-08. INT. CL. 33.

PACIFIC SUN, L.A., SHERMAN OAKS, CA:
3,398,404, PUB. 1-1-2008. INT. CL. 44.

PACIFIC WEST PROPERTY SERVICES, INC., CAREFREE, AZ:
3,399,373, INT. CL. 43.

PADAMA, ARTURO, WALDORF, MD AND PADAMA, TRINIDAD PANGALIMAN, WALDORF, MD:
3,400,288, INT. CL. 41.

PADRES, L.P., SAN DIEGO, CA:
2,448,031, CANC. INT. CL. 16.

PAINE, RAGNHILD H., LAFAYETTE, CA:
2,058,710, CANC. MULTIPLE CLASS, INT. CLS. 21, 24 AND 25.

PAIVA, INC., INDIANAPOLIS, IN:
3,399,703, INT. CL. 25.

PALLET-CRAFT, INC., LONG BEACH, NY:
2,448,566, CANC. INT. CL. 16.

- PALM BAY IMPORTS, INC., PORT WASHINGTON, NY:
3,399,580, INT. CL. 33.
- PALMROTH INTERNATIONAL B.V., NETHERLANDS:
3,398,754, PUB. 1-1-2008. MULTIPLE CLASS, INT. CLS.
18, 25 AND 35.
- PALOMAR MEDICAL TECHNOLOGIES, INC., BURLING-
TON, MA:
2,465,621, COR. INT. CL. 10.
- PAMELA DRAKE IMPORTS, INC., BERKELEY, CA, DBA
PAMELA DRAKE INC.:
2,447,543, CANC. INT. CL. 28.
- PANALIGN PARTNERS, INCORPORATED, SAN FRANCIS-
CO, CA:
2,447,476, CANC. MULTIPLE CLASS, INT. CLS. 16, 35
AND 41.
- PANAMA JACK INTERNATIONAL, INC., ORLANDO, FL:
2,129,695, REN. 2-11-08. INT. CL. 3.
- PANASAS, INC., FREMONT, CA:
3,399,499, INT. CL. 9.
- PANDURATA ALIMENTOS LTDA., GUARULHOS, SAO
PAULO, BRAZIL:
3,400,376, INT. CL. 30.
- PANNELL KERR FORSTER OF TEXAS, P.C., HOUSTON,
TX:
3,400,116, INT. CL. 35.
- PANOLAM INDUSTRIES INTERNATIONAL, INC., SHEL-
TON, CT:
3,399,850, INT. CL. 40.
- PANOZ AUTOMOTIVE DEVELOPMENT CORPORATION,
HOSCHTON, GA:
2,448,013, CANC. INT. CL. 12.
- PANTHERS FOOTBALL LLC, CHARLOTTE, NC:
2,129,287, REN. 2-11-08. INT. CL. 41.
- PAPEL, STANLEY, LOS ANGELES, CA:
2,447,482, CANC. INT. CL. 25.
- PARACEL INC., PASADENA, CA:
2,447,776, CANC. INT. CL. 9.
- PARADE COMPANY, THE, DETROIT, MI:
2,149,498, REN. 2-13-08. MULTIPLE CLASS, INT. CLS. 25
AND 41.
- PARAGON CONSULTING GROUP, THE, ENCINO, CA:
2,447,302, CANC. MULTIPLE CLASS, INT. CLS. 35, 36, 41
AND 42.
- PARALLELS SOFTWARE INTERNATIONAL, INC., ROAD
TOWN, TORTOLA, BR. VIRGIN ISLANDS:
3,397,263, PUB. 1-1-2008. INT. CL. 9.
- PARAMOUNT AUTOMOTIVE GROUP, LLC, LONGWOOD,
FL, DBA TRUCK HEAVEN USA:
3,398,917, INT. CL. 35.
- PARAMOUNT EDUCATIONAL SEMINARS, LLC, OMAHA,
NE:
3,397,757, PUB. 1-1-2008. INT. CL. 41.
- PARASOLE RESTAURANTS HOLDINGS, INC., MINNEA-
POLIS, MN:
1,438,734, CANC. INT. CL. 42.
- PARENTS AS TEACHERS NATIONAL CENTER, INC., ST.
LOUIS, MO:
2,132,872, REN. 2-14-08. INT. CL. 41.
- PARFUMS CARLO CORINTO PARIS S.A.R.L., PARIS,
FRANCE:
3,399,522, INT. CL. 3.
- PARIS, MARTY E., LINCOLN, NC:
3,400,094, INT. CL. 41.
- PARK, JOHN, DIAMOND BAR, CA:
2,134,595, REN. 2-12-08. INT. CL. 42.
2,134,596, REN. 2-11-08. INT. CL. 42.
- PARK, KENNY J., LOS ANGELES, CA:
3,400,197, INT. CL. 25.
- PARK, SUNOOK, LOS ANGELES, CA:
3,398,186, PUB. 1-1-2008. INT. CL. 41.
- PARKER, ALAN, LOS ANGELES, CA:
2,134,139, REN. 2-11-08. INT. CL. 41.
- PARKING COMPANY OF AMERICA, INC., CINCINNATI,
OH:
2,205,535, REN. 2-11-08. INT. CL. 39.
- PARMELEE-HILL WINES, SONOMA, CA:
3,397,139, PUB. 1-1-2008. INT. CL. 33.
- PARTICLE MEASURING SYSTEMS, INC., BOULDER, CO:
3,397,110, PUB. 1-1-2008. MULTIPLE CLASS, INT. CLS. 9,
37, 41 AND 42.
- PARTNERS IN HUMAN RESOURCES INTERNATIONAL,
INC., NEW YORK CITY, NY:
3,398,183, PUB. 1-1-2008. MULTIPLE CLASS, INT. CLS. 35
AND 41.
- PARTNERSHIP OF ROBERT JONES AND SAMUEL WISE,
THE, MORRIS, IL:
2,448,258, CANC. INT. CL. 20.
- PASSPORTMD, INC, DELRAY BEACH, FL:
3,400,341, INT. CL. 44.
- PATCH PRODUCTS, INC., BELOIT, WI:
3,399,211, INT. CL. 28.
- PATENTHEALTH, LLC, CANTON, OH:
3,399,261, INT. CL. 5.
- PATERSON ARRAN LIMITED, LIVINGSTON, WEST
LOTHIAN EH54 5DN, SCOTLAND:
2,058,697, CANC. MULTIPLE CLASS, INT. CLS. 29 AND
30.
- PATIENT POWER, MERCER ISLAND, WA:
3,400,089, MULTIPLE CLASS, INT. CLS. 38 AND 41.
- PATIO ENCLOSURES, INC., MACEDONIA, OH:
3,398,147, PUB. 1-1-2008. INT. CL. 20.
3,398,153, PUB. 1-1-2008. INT. CL. 37.
- PATRICK DUDERSTADT, FED REP GERMANY:
3,398,832, PUB. 1-1-2008. MULTIPLE CLASS, INT. CLS. 20
AND 37.
- PATRICK, RICHARD V., LITTLE SILVER, NJ:
3,397,138, PUB. 1-1-2008. MULTIPLE CLASS, INT. CLS. 38
AND 41.
- PATTEN SEED COMPANY, LAKELAND, GA:
3,397,886, PUB. 1-1-2008. MULTIPLE CLASS, INT. CLS. 31
AND 35.
- PATTERSON MEDICAL HOLDINGS, INC., BOLING-
BROOK, IL:
1,448,369, REN. 2-11-08. INT. CL. 12.
- PATTON ENTERPRISES, INC., TULSA, OK:
2,059,218, CANC. INT. CL. 7.
- PATTON, VALENE, PUYALLUP, WA:
3,398,925, INT. CL. 25.
- PAUL BROOKER SALES, L.L.C., WICHITA, KS:
2,447,619, CANC. INT. CL. 35.
- PAUL TRANSPORTATION, INC., ENID, OK:
3,398,166, PUB. 1-1-2008. INT. CL. 39.
- PAULA LISHMAN LIMITED, BLACKSTOCK, ONTARIO
LOB 1B0, CANADA:
2,447,630, CANC. INT. CL. 25.
- PAVEMENT DEPOT OF MARYLAND, LLC, FREDERICK,
MD:
3,397,869, PUB. 1-1-2008. INT. CL. 35.
- PAW GEAR, L.L.C., CASPER, WY:
2,448,274, CANC. INT. CL. 35.
- PAXIOM, INC., MONTREAL, CANADA:
3,400,044, INT. CL. 9.
- PAYCE, INC., TOWSON, MD:
2,447,673, CANC. INT. CL. 35.
- PAYES, AARON T, WOODSTOCK, GA:
3,397,900, PUB. 1-1-2008. INT. CL. 9.
- PAYES, AARON T, WOODSTOCK, GA, DBA LIVE WIRE
EMPIRE AND MONICA, STEPHEN M, WOODSTOCK,
GA, DBA LIVE WIRE EMPIRE:
3,398,267, PUB. 1-1-2008. INT. CL. 9.
- PAYMENT SOLUTIONS, SAN DIEGO, CA:
3,396,819, PUB. 1-1-2008. INT. CL. 36.
- PAYMENT SYSTEMS GROUP, INC., ST. CHARLES, MO:
3,397,853, PUB. 1-1-2008. INT. CL. 42.
3,397,854, PUB. 1-1-2008. INT. CL. 42.
- PAYNE, LARRY J., LOS ANGELES, CA:
3,400,072, MULTIPLE CLASS, INT. CLS. 9 AND 41.
- PBI/GORDON CORPORATION, KANSAS CITY, MO:
2,157,428, REN. 2-11-08. INT. CL. 5.
- PC PLUS, INC., HERNDON, VA:
2,447,285, CANC. MULTIPLE CLASS, INT. CLS. 35, 37, 41
AND 42.
- PCI INSURANCE, INC., HARRISBURG, PA:
3,399,799, INT. CL. 42.

PCRS, INC., WAYNE, PA:
2,541,948, CANC. INT. CL. 36.

PEACH STATE MFG., INC., COLLEGE PARK, GA:
3,399,205, INT. CL. 19.
3,399,206, INT. CL. 19.
3,399,213, INT. CL. 19.

PEARCE PHARMACEUTICALS PTY LTD., VICTORIA, AUSTRALIA:
2,448,177, CANC. INT. CL. 3.

PEARSON EDUCATION, INC., UPPER SADDLE RIVER, NJ:
2,359,008, CANC. INT. CL. 9.
3,398,456, PUB. 1-1-2008. INT. CL. 9.

PEAVEY ELECTRONICS CORPORATION, MERIDIAN, MS:
3,399,241, INT. CL. 9.

PEBLE CORP., TORRANCE, CA:
3,396,924, PUB. 1-1-2008. INT. CL. 5.

PEDIATRIX MEDICAL GROUP, INC., SUNRISE, FL:
3,400,029, INT. CL. 44.

PEDIGREE DOLLS & TOYS LIMITED, EXETER, DEVON, UNITED KINGDOM:
3,399,303, INT. CL. 28.

PEELER, LLC, LOS ANGELES, CA:
3,398,589, PUB. 1-1-2008. INT. CL. 25.

PEERLESS COFFEE & TEA, OAKLAND, CA, DBA PEERLESS COFFEE COMPANY:
3,398,138, PUB. 1-1-2008. INT. CL. 30.

PEERLESS NETWORK, LLC, CHICAGO, IL:
3,399,296, INT. CL. 38.

PEET'S TRADEMARK COMPANY, EMERYVILLE, CA:
3,397,496, PUB. 1-1-2008. INT. CL. 35.

PEI LICENSING, INC., MIAMI, FL:
2,448,358, CANC. INT. CL. 25.

PELEGRINI, MARCO, BELLEVUE, WA AND PELLEGRINI, SUSAN, BELLEVUE, WA:
2,447,596, CANC. INT. CL. 35.

PELLETRON CORPORATION, LANCASTER, PA:
3,397,514, PUB. 1-1-2008. INT. CL. 7.

PEMBROKE POINT PHASE I LLC, RALEIGH, NC:
3,397,783, PUB. 1-1-2008. INT. CL. 36.

PENDERGRASS, TORRY, WEST HOLLYWOOD, CA:
3,400,206, INT. CL. 25.

PENFORD PRODUCTS CO., CEDAR RAPIDS, IA:
2,448,054, CANC. INT. CL. 35.

PENGUIN GROUP (USA) INC., NEW YORK, NY, PRICE/STERN/SLOAN PUBLISHERS, INC., LOS ANGELES, CA:
1,097,408. REN. 2-11-08. INT. CL. 16.

PENGUIN GROUP (USA) INC., NEW YORK, NY FROM PENGUIN PUTNAM INC., NEW YORK, NY:
3,398,843, MULTIPLE CLASS, INT. CLS. 16, 25 AND 28.

PENN L.L.C., TINLEY PARK, IL:
2,447,591, CANC. INT. CL. 35.

PENNEL INDUSTRIES S.A., 59100 ROUBAIX, FRANCE:
2,447,452, CANC. MULTIPLE CLASS, INT. CLS. 20, 24 AND 25.

PENNWELL CORPORATION, TULSA, OK:
2,448,565, CANC. INT. CL. 16.
3,397,775, PUB. 1-1-2008. INT. CL. 35.

PENTAIR PUMP GROUP, INC., GOLDEN VALLEY, MN:
3,399,444, INT. CL. 7.

PENTON BUSINESS MEDIA, INC., NEW YORK, NY:
1,517,932. REN. 2-14-08. INT. CL. 16.
2,135,118. REN. 2-12-08. INT. CL. 35.

PENTON MEDIA, INC., OVERLAND PARK, KS:
2,447,603, CANC. INT. CL. 16.

PEOPLES SAVINGS BANK, THE, HOLYOKE, MA, DBA PEOPLES BANK:
2,447,589, CANC. INT. CL. 36.

PEPPERMINTS SALON, INC., BEECHURST, NY:
3,399,898, INT. CL. 3.
3,399,899, INT. CL. 3.
3,399,901, INT. CL. 3.
3,399,902, INT. CL. 3.

PERCUSSIONAIRE CORPORATION, SANDPOINT, ID:
1,424,705. REN. 2-11-08. INT. CL. 10.

PERDUE HOLDINGS, INC., WILMINGTON, DE, SHOWELL FARMS, INC., SHOWELL, MD:
1,072,816. REN. 2-13-08. INT. CL. 29.

PEREGO, MARIA, MONACO, MONACO:
3,359,538, COR. MULTIPLE CLASS, INT. CLS. 9, 16, 17, 18, 25, 28, 38 AND 41.

PEREZ, JORGE, CHULA VISTA, CA:
3,398,068, PUB. 1-1-2008. INT. CL. 42.

PERFECT PERCEPTIONS, LLC, FLOURTOWN, PA:
3,399,768, INT. CL. 3.

PERFECTA PRODUCTS, INC., NORTH LIMA, OH:
3,398,001, PUB. 1-1-2008. INT. CL. 3.

PERFORMANCE FRICTION CORPORATION, CLOVER, SC:
2,082,560. REN. 2-11-08. INT. CL. 12.

PERFORMANCE PET PRODUCTS, LLC, FAIRMONT, MN:
3,399,166, INT. CL. 31.

PERFORMIX INC., HOUSTON, TX:
3,398,596, PUB. 1-1-2008. INT. CL. 9.

PERGO (EUROPE) AB, TRELLEBORG, SWEDEN:
2,448,194, CANC. MULTIPLE CLASS, INT. CLS. 19 AND 27.

PERMAFIL, INC., MAGNOLIA, TX:
2,191,468. REN. 2-9-08. INT. CL. 11.

PERMATEC TECHNOLOGIE AG, 6301 ZUG, SWITZERLAND:
2,447,295, CANC. MULTIPLE CLASS, INT. CLS. 5 AND 42.

PERSONAL AUTO CONSULTANTS, INC., FLORISSANT, MO:
2,154,378. REN. 2-11-08. INT. CL. 35.

PERSONAL HEALTEMANAGER, JENKINTOWN, PA:
2,448,521, CANC. INT. CL. 42.

PERSONNEL DATA SYSTEMS, INC., BLUE BELL, PA, DBA PDS:
3,398,947, INT. CL. 9.

PERSYST DEVELOPMENT CORPORATION, INC., PRESCOTT, AZ:
3,397,225, PUB. 7-31-2007. INT. CL. 9.

PES INC., VIRGINIA BEACH, VA:
3,397,729, PUB. 1-1-2008. INT. CL. 20.

PETAHOLICS LLC, NEW YORK, NY:
3,398,042, PUB. 1-1-2008. INT. CL. 44.

PETER TROSKA, FED REP GERMANY:
3,398,755, PUB. 1-1-2008. MULTIPLE CLASS, INT. CLS. 3, 35 AND 44.

PETRA INDUSTRIES, INC., EDMOND, OK:
3,397,377, PUB. 1-1-2008. INT. CL. 9.

PETROPURE, INC., CLIFTON, NJ:
2,447,987, CANC. INT. CL. 40.

PFIZER INC., NEW YORK, NY, CHAS. PFIZER & CO., INC., BROOKLYN, NY:
669,805. REN. 2-8-08. U.S. CL. 18 (INT. CL. 5).

PFIZER INC., NEW YORK, NY, BEECHAM INC., CLIFTON, NJ:
1,110,784. REN. 2-8-08. INT. CL. 5.

PFIZER INC., NEW YORK, NY:
3,399,433, INT. CL. 5.
3,399,639, INT. CL. 44.
3,399,955, MULTIPLE CLASS, INT. CLS. 16 AND 44.

PGMS, INC., TARRYTOWN, NY:
3,397,140, PUB. 1-1-2008. INT. CL. 42.

PH DPI, LLC, POTOMAC, MD:
2,448,246, CANC. INT. CL. 5.

PHAETON AVIATION, INC., CHAPEL HILL, NC:
3,399,634, INT. CL. 39.

PHARMETRICS, INC., WATERTOWN, MA:
3,399,339, INT. CL. 35.

PHASE METRICS, INC., SAN DIEGO, CA TO KLA-TENCOR TECHNOLOGIES CORPORATION, MILPITAS, CA:
2,058,724, CANC. INT. CL. 9.

PHILIP MORRIS USA INC., RICHMOND, VA:
3,399,591, MULTIPLE CLASS, INT. CLS. 16, 35 AND 44.

PHILIP, CHRISTINE, ATLANTA, GA:
3,396,902, PUB. 1-1-2008. MULTIPLE CLASS, INT. CLS. 14 AND 25.

PHILIPS, DANIEL, OXNARD, CA:
3,399,909, INT. CL. 33.

PHOENIX BUILDING SOLUTIONS, INC., BROOKVILLE, OH:
3,397,535, PUB. 1-1-2008. INT. CL. 37.

- PHOENIX INTANGIBLES HOLDING COMPANY, GREENVILLE, DE, KONICA PHOTO SERVICE U.S.A., INC., EAST HARTFORD, CT:
2,120,163. REN. 2-11-08. INT. CL. 40.
- PHOTO RESEARCH, INC., CHATSWORTH, CA:
1,475,474. REN. 2-11-08. INT. CL. 42.
- PHOTO THERAPEUTICS LIMITED, ALTRINCHAM, CHESHIRE, UNITED KINGDOM:
3,399,729. INT. CL. 44.
- PHOTODEX CORPORATION, AUSTIN, TX:
3,399,102. INT. CL. 9.
- PHOTOGRAPIC RESEARCH ORGANIZATION, INC., FAIRFIELD, CT:
1,475,513. REN. 2-13-08. U.S. CL. 200.
- PHY-CON INC., OAK LAWN, IL:
3,399,769. INT. CL. 12.
- PHYSICAL ENTERPRISES INC., VANCOUVER, CANADA:
3,397,728. PUB. 1-1-2008. INT. CL. 44.
- PHYSICIAN'S CARE ALLIANCE, LLC, SCOTTSDALE, AZ:
3,397,373. PUB. 1-1-2008. INT. CL. 3.
- PHYSICIANS IMMEDIATE CARE, LTD., MACHESNEY PARK, IL:
3,399,906. INT. CL. 44.
- PHYSICIANS MUTUAL INSURANCE COMPANY, OMAHA, NE:
2,447,534. CANC. INT. CL. 36.
- PIAGGIO & C. S.P.A., ITALY:
3,398,721. PUB. 1-1-2008. INT. CL. 28.
- PIATT, BRETT T., OXNARD, CA:
3,399,087. INT. CL. 40.
- PIDILITE USA, INC., JUPITER, FL, DBA CYCLO INDUSTRIES, INC.:
1,496,417. REN. 2-9-08. INT. CL. 3.
- PIEDMONT DISTILLERS, INC., MADISON, NC:
3,399,128. INT. CL. 33.
- PIFA ENTERPRISES CORP., WATERLOO, ONTARIO, CANADA:
3,397,623. PUB. 1-1-2008. INT. CL. 43.
- PILOTO CIGARS, INC., MIAMI, FL:
2,128,152. REN. 2-11-08. INT. CL. 34.
- PINCUS, ALLAN D. WARREN, NJ:
3,397,088. PUB. 1-1-2008. INT. CL. 37.
- PINEDA, MANUEL, SAN JOSE, CA:
3,397,867. PUB. 1-1-2008. INT. CL. 11.
- PINK RIBBON ROUND-UP, INC., CRANBERRY TOWNSHIP, PA:
3,397,446. PUB. 1-1-2008. INT. CL. 36.
- PINKERTON SERVICE CORPORATION, WESTLAKE VILLAGE, CA:
2,059,461. CANC. MULTIPLE CLASS, INT. CLS. 36, 37 AND 42.
- PINNACLE RESTAURANT GROUP, INC., BOULDER, CO:
3,397,334. PUB. 9-25-2007. INT. CL. 30.
- PIRATES MUTINY, LLC, MAGALUF, MALLORCA, SPAIN:
3,399,998. MULTIPLE CLASS, INT. CLS. 9, 16, 25, 28 AND 41.
- PIRELLI & C. S.P.A., I-20123 MILANO, ITALY:
3,398,636. PUB. 1-1-2008. MULTIPLE CLASS, INT. CLS. 9, 16 AND 35.
- PITT COUNTY MEMORIAL HOSPITAL, INCORPORATED, GREENVILLE, NC AND EAST CAROLINA UNIVERSITY, GREENVILLE, NC:
3,398,509. PUB. 1-1-2008. INT. CL. 44.
- PITTSBURGH PENGUINS LP, PITTSBURGH, PA:
2,134,610. REN. 2-8-08. INT. CL. 41.
2,136,006. REN. 2-14-08. INT. CL. 41.
- PIXART IMAGING INC., HSIN-CHU, TAIWAN:
3,399,980. INT. CL. 28.
- PIZ GRANITE INC., GASTONIA, NC:
2,059,110. CANC. INT. CL. 11.
- PIZZA DI ROMA INTERNATIONAL, INC., INDIANAPOLIS, IN:
3,398,268. PUB. 1-1-2008. INT. CL. 43.
- PLACEVISION, INC., CHICAGO, IL:
3,397,419. PUB. 1-1-2008. INT. CL. 9.
- PLAINVILLE FARMS, LLC, PLAINVILLE, NY:
3,397,031. PUB. 1-1-2008. INT. CL. 29.
- PLANET GRAPE LLC, SAN FRANCISCO, CA:
3,397,219. PUB. 1-1-2008. MULTIPLE CLASS, INT. CLS. 16, 41 AND 43.
- PLANET HOLLYWOOD (REGION IV), INC., ORLANDO, FL:
3,398,027. PUB. 1-1-2008. INT. CL. 36.
3,400,112. MULTIPLE CLASS, INT. CLS. 25, 41 AND 43.
- PLANET SMOOTHIE FRANCHISES, L.L.C., ATLANTA, GA:
2,448,549. CANC. INT. CL. 30.
- PLASTIC SPECIALTIES AND TECHNOLOGIES, INC., SOMERVILLE, NJ:
3,400,317. INT. CL. 17.
- PLAYER'S WORLD, INC., ROSWELL, GA:
2,059,409. CANC. INT. CL. 42.
- PLAYFIRST, INC., SAN FRANCISCO, CA:
3,399,273. INT. CL. 9.
- PLAYOFF CORPORATION, ARLINGTON, TX:
2,060,091. CANC. INT. CL. 16.
- PLAYTEX PRODUCTS, INC., WESTPORT, CT:
2,131,242. REN. 2-14-08. INT. CL. 5.
- PLEASANT TIME INDUSTRIES, AMRITSAR-143 001, INDIA:
2,447,695. CANC. INT. CL. 28.
- PLEASANT TRAVEL SERVICE, WESTLAKE VILLAGE, CA, DBA PLEASANT HAWAIIAN HOLIDAYS:
1,438,707. CANC. INT. CL. 39.
- PLEION CORPORATION, SANTA ANA, CA:
1,274,754. REN. 2-13-08. INT. CL. 11.
- PLEXTEK LIMITED, UNITED KINGDOM:
3,398,709. PUB. 1-1-2008. MULTIPLE CLASS, INT. CLS. 9, 38 AND 45.
- PLF INTERNATIONAL A/S, DK-5700 SVENDBORG, DENMARK:
2,133,785. REN. 2-12-08. MULTIPLE CLASS, INT. CLS. 11, 29 AND 30.
- PLUCK CORPORATION, AUSTIN, TX:
3,397,178. PUB. 1-1-2008. INT. CL. 42.
- PLUESS-STAUFER (NORTH AMERICAN) INC., NEW YORK, NY:
644,959. COR. U.S. CL. 1.
- PLUGG LTD, LONDON, UNITED KINGDOM:
3,398,367. PUB. 10-16-2007. INT. CL. 11.
- PLUM ENTERPRISES, INC., VALLEY FORGE, PA:
3,397,195. PUB. 1-1-2008. INT. CL. 9.
- PLUSH PIPPIN COMPANY, LLC, BROWNSBURG, IN:
3,397,181. PUB. 1-1-2008. INT. CL. 30.
- PLYMKRAFT, INC., NEWPORT NEWS, VA:
3,398,511. PUB. 1-1-2008. INT. CL. 22.
- POET & DIDN'T KNOW IT CO., CHICAGO, IL:
2,060,008. CANC. INT. CL. 28.
- POET, LLC, SIOUX FALLS, SD:
3,397,963. PUB. 1-1-2008. INT. CL. 31.
- POOF, LLC, LOS ANGELES, CA:
3,398,173. PUB. 1-1-2008. INT. CL. 3.
- POOLE, RUSSELL J., GREENSBORO, NC:
3,400,275. INT. CL. 9.
- POOLPARTY.COM, LLC, CHICAGO, IL:
3,399,003. INT. CL. 35.
- POPE INVESTMENT ECONOMICS, INC., EDINA, MN:
2,448,559. CANC. INT. CL. 36.
- POPNOGGINS, LLC, ORLANDO, FL:
3,397,168. PUB. 1-1-2008. MULTIPLE CLASS, INT. CLS. 35, 42 AND 45.
- PORTAGE WORLD WIDE, INC., NEW YORK, NY:
2,075,388. AM. MULTIPLE CLASS, INT. CLS. 18 AND 22.
- PORTALS LIMITED, LONDON WC2N 4DE, ENGLAND:
2,447,269. CANC. MULTIPLE CLASS, INT. CLS. 16 AND 17.
- PORTER AVIATION HOLDINGS INC., TORONTO, CANADA:
3,398,564. PUB. 1-1-2008. INT. CL. 39.
- PORTER AVIATION HOLDINGS INC., TORONTO, ONTARIO, CANADA:
3,398,609. PUB. 1-1-2008. INT. CL. 16.
- PORTILLO, EDMUNDO, EL PASO, TX:
3,396,828. PUB. 6-14-2005. INT. CL. 41.
- POTEC CO., LTD., DAEJEON-CITY, REPUBLIC OF KOREA:
3,396,970. PUB. 1-1-2008. INT. CL. 10.

POULTON, CRAIG K. SALT LAKE, UT:
2,861,546, CANC. INT. CL. 36.

POWELL INDUSTRIES, INC., HOUSTON, TX:
2,058,939, CANC. MULTIPLE CLASS, INT. CLS. 40 AND 42.

POWER DISTRIBUTING LLC, ELMHURST, IL:
2,448,261, CANC. INT. CL. 32.

POWERSHACK HEALTH AND FITNESS PRODUCTS, L.L.C., SHAWNEE, KS:
2,448,543, CANC. INT. CL. 5.

POWERSHOP GYM, INC., BROOKINGS, SD:
3,398,326, PUB. 1-1-2008. INT. CL. 41.

PPC MARKETING, LTD., PITTSBURG, TX:
3,398,237, PUB. 1-1-2008. INT. CL. 29.

PRACTICE LIFECYCLE, LLC, BOSTON, MA:
3,399,617, INT. CL. 35.

PRAIRIE FOODS, INC., PLEASANT PLAINS, IL:
3,396,858, PUB. 1-1-2008. INT. CL. 30.

PRANA EVOLUTIONS, PENSACOLA, FL:
3,396,847, PUB. 1-1-2008. INT. CL. 3.

PRAXAIR TECHNOLOGY, INC., DANBURY, CT:
3,397,208, PUB. 1-1-2008. MULTIPLE CLASS, INT. CLS. 1 AND 6.

PRAXLIENT, INC., NEENAH, WI:
3,399,876, INT. CL. 35.

PRECISION TOOL, DIE AND MACHINE CO., INC., LOUISVILLE, KY:
3,399,837, MULTIPLE CLASS, INT. CLS. 40 AND 42.

PRECO MANUFACTURING, INC., LIVERPOOL, NY:
2,059,509, CANC. INT. CL. 14.

PREFERRED, INC. - FORT WAYNE, FORT WAYNE, IN:
1,475,315. REN. 2-11-08. INT. CL. 37.

PREMARK RWP HOLDINGS, INC., WILMINGTON, DE:
2,447,876, CANC. INT. CL. 17.

PREMEIUM COMPONENTS, LLC, ALOHA, OR:
2,059,196, CANC. INT. CL. 13.

PREMIUM IMPORTS, INC., CORAL GABLES, FL:
2,448,327, CANC. INT. CL. 34.

PRENGLER LIGHTING, INC., PLANO, TX:
2,448,142, CANC. INT. CL. 11.

PREPARED RESPONSE, INC., SEATTLE, WA:
3,400,225, INT. CL. 45.

PRESBY ENVIRONMENTAL, INC., SUGAR HILL, NH:
3,396,905, PUB. 1-1-2008. MULTIPLE CLASS, INT. CLS. 11, 17 AND 19.

PRESERVED TREESCAPES, INTERNATIONAL, OCEANSIDE, CA:
2,448,006, CANC. INT. CL. 26.

PRETTY MAMA, INC., CAPITOLA, CA:
1,083,591. REN. 2-8-08. INT. CL. 25.

PREVALENCE HEALTH, LLC, JACKSON, MS:
3,399,991, INT. CL. 35.

PREVENT LOSS, LTD., PLANO, TX:
3,397,690, PUB. 1-1-2008. INT. CL. 35.

PRICE POINT ACCESSORIES LLC, ASBURY PARK, NJ:
3,397,793, PUB. 1-1-2008. INT. CL. 9.

PRICELINE.COM INCORPORATED, NORWALK, CT:
3,399,722, INT. CL. 39.

PRICEWATERHOUSECOOPERS LLP, NEW YORK, NY:
2,505,746, CANC. INT. CL. 9.

PRIMA DENTAL GROUP, GLOUCESTER, UNITED KINGDOM:
3,399,225, INT. CL. 10.
3,399,226, INT. CL. 10.

PRIMARY INVESTMENTS GROUP LIMITED, ROAD TOWN, TORTOLA, BR. VIRGIN ISLANDS:
2,135,818. REN. 2-11-08. INT. CL. 5.

PRIME WIRE & CABLE, INC., LOS ANGELES, CA:
3,400,077, INT. CL. 9.

PRIMEDIA MAGAZINES INC., NEW YORK, NY:
2,448,524, CANC. INT. CL. 16.

PRIMOBAY, LLC, RUSTON, LA:
2,447,496, CANC. INT. CL. 5.

PRINCE LIONHEART, INC., SANTA MARIA, CA:
3,399,638, INT. CL. 20.

PRINTMARK INDUSTRIES, INC., HAZLETON, PA:
3,398,841, INT. CL. 25.

PRISM ANALYTICAL TECHNOLOGIES, INC., MT. PLEASANT, MI, DBA PRISM ANALYTICAL, INC.:
2,128,735. REN. 2-14-08. INT. CL. 42.
2,128,735, COR. INT. CL. 42.

PRITEST, INC., REDMOND, WA:
3,398,847, MULTIPLE CLASS, INT. CLS. 1, 5 AND 10.

PRIVATE PORTFOLIOS, INC., SAN MATEO, CA:
2,220,100. REN. 2-12-08. INT. CL. 36.

PRL USA HOLDINGS, INC., WILMINGTON, DE:
3,397,416, PUB. 1-1-2008. INT. CL. 25.

PRO LOTIONS, LLC, RED BANK, NJ:
3,398,426, PUB. 1-1-2008. INT. CL. 3.

PRO ONCALL TECHNOLOGIES, LLC, CINCINNATI, OH:
3,396,952, PUB. 1-1-2008. MULTIPLE CLASS, INT. CLS. 37 AND 42.

PRO PIK, LLC, WEST ORANGE, NJ:
2,447,601, CANC. INT. CL. 41.

PRO-FRUIT MARKETING, INC., PARAMUS, NJ:
3,397,705, PUB. 1-1-2008. INT. CL. 35.

PROBAT-WERKE VON GIMBORN MASCHINENFABRIK GMBH, D-46446 EMMERICH, FED REP GERMANY:
2,447,334, CANC. INT. CL. 11.

PROBATE UNCOVERED, INC., PINELLAS PARK, FL:
3,400,274, MULTIPLE CLASS, INT. CLS. 35 AND 36.

PROBITY, LLC, TRUMBULL, CT:
3,397,487, PUB. 1-1-2008. INT. CL. 37.

PROCAPS L.P., VILLE ST. LAURENT, QUEBEC, CANADA:
3,399,304, INT. CL. 25.
3,400,213, INT. CL. 28.

PROCESADORA CAMPOFRESCO, INC., SANTA ISABEL, PUERTO RICO, FOODPRO, INC., SANTURCE, PUERTO RICO:
2,091,157. REN. 2-11-08. INT. CL. 32.

PROCESS DYNAMICS, INC., FAYETTEVILLE, AR:
3,400,406, INT. CL. 42.

PROCON INC., KNOXVILLE, TN:
3,397,688, PUB. 1-1-2008. INT. CL. 42.

PROCTER & GAMBLE COMPANY, THE, CINCINNATI, OH:
853,890. REN. 2-13-08. U.S. CL. 51 (INT. CL. 3).
2,448,335, CANC. INT. CL. 3.
2,448,465, CANC. INT. CL. 3.
2,448,467, CANC. INT. CL. 16.

PRODISO, LLC, MIAMI, FL:
3,397,890, PUB. 1-1-2008. INT. CL. 35.

PRODUCT PARTNERS, LLC, BEVERLY HILLS, CA:
3,399,475, INT. CL. 44.

PROFESSIONAL BULL RIDERS, INC., COLORADO SPRINGS, CO:
3,398,960, MULTIPLE CLASS, INT. CLS. 16 AND 25.

PROFESSIONAL DIAGNOSTICS & SAFETY, INC., NAPPANEE, IN:
3,400,271, MULTIPLE CLASS, INT. CLS. 41, 44 AND 45.

PROFESSIONAL LAW ENFORCEMENT ASSOCIATION, INC., TROY, MI:
3,398,222, PUB. 1-1-2008. INT. CL. 36.

PROFITNESS PHYSICAL THERAPY, P.C., NEW YORK, NY:
3,397,123, PUB. 1-1-2008. INT. CL. 44.

PROJECT QUALITY ASSURANCE, LLC, BLUE ISLAND, IL:
3,397,185, PUB. 1-1-2008. MULTIPLE CLASS, INT. CLS. 35, 36 AND 37.
3,397,187, PUB. 1-1-2008. MULTIPLE CLASS, INT. CLS. 35, 36 AND 37.

PROJECT R.I.S.E., INC., BRAINTREE, MA:
3,397,060, PUB. 1-1-2008. MULTIPLE CLASS, INT. CLS. 39 AND 41.

PROJECTGROUND, INC., RESTON, VA:
3,397,899, PUB. 1-1-2008. INT. CL. 35.

PROJECTS IN KNOWLEDGE, INC., LITTLE FALLS, NJ:
3,398,004, PUB. 1-1-2008. INT. CL. 9.
3,398,255, PUB. 1-1-2008. INT. CL. 9.
3,398,282, PUB. 1-1-2008. INT. CL. 9.

PROJETCLUB, VILLENEUVE D'ASCQ, FRANCE:
3,396,996, PUB. 1-1-2008. MULTIPLE CLASS, INT. CLS. 9 AND 18.

PROMARK BRANDS INC., MERIDIAN, ID, LEA & PERINS, WORCESTER, WORCESTERSHIRE, UNITED KINGDOM:
68,150. REN. 2-14-08. U.S. CL. 46 (INT. CL. 30).

- PROMETHEUS PAYMENT, INC., BOSTON, MA:
3,400,256, MULTIPLE CLASS, INT. CLS. 35 AND 36.
- PROMOFILM US LLC, HIALEAH, FL:
3,399,925, INT. CL. 41.
- PROPAY USA, INC., OREM, UT:
3,397,677, PUB. 1-1-2008. INT. CL. 36.
- PROSIEBENSAT.1 MEDIA AG, FED REP GERMANY:
3,398,637, PUB. 1-1-2008. MULTIPLE CLASS, INT. CLS. 9,
16, 35, 38, 41 AND 42.
- PROSKAUER ROSE LLP, NEW YORK, NY:
3,397,931, PUB. 1-1-2008. INT. CL. 45.
- PROSOURCE MORTGAGE MARKETING, INC., LAKE
OSWEGO, OR:
3,397,944, PUB. 1-1-2008. INT. CL. 35.
- PROSPERA FINANCIAL SERVICES, INC., DALLAS, TX:
2,447,902, CANC. INT. CL. 36.
- PROSTRONG, INC., OAKVILLE, CT:
3,398,003, PUB. 1-1-2008. INT. CL. 3.
3,398,071, PUB. 1-1-2008. INT. CL. 3.
3,398,073, PUB. 1-1-2008. INT. CL. 3.
- PROTEGE CORPORATION, SKOKIE, IL:
845,155. REN. 2-13-08. U.S. CL. 51 (INT. CL. 3).
- PROVINA, INCORPORATED, SAN JOSE, CA:
3,399,711, INT. CL. 33.
- PROVISION THEATER COMPANY, CHICAGO, IL:
3,397,489, PUB. 1-1-2008. INT. CL. 41.
- PROXYMED, INC., NORCROSS, GA:
3,399,747, MULTIPLE CLASS, INT. CLS. 35, 38 AND 42.
- PRUFROCK LLC, NEW YORK, NY:
2,448,364, CANC. INT. CL. 18.
- PS HERE LLC, DALLAS, TX:
3,400,208, MULTIPLE CLASS, INT. CLS. 9, 38 AND 41.
3,400,211, MULTIPLE CLASS, INT. CLS. 9 AND 41.
- PSI URETHANES, INC., AUSTIN, TX:
2,133,467. REN. 2-14-08. INT. CL. 20.
- PSION TEKLOGIX INC., MISSISSAUGA, CANADA:
3,398,615, PUB. 1-1-2008. INT. CL. 9.
- PSP CORPORATION, TORONTO, ONTARIO, CANADA:
3,397,198, PUB. 1-1-2008. INT. CL. 16.
- PSS WORLD MEDICAL, INC., JACKSONVILLE, FL:
3,398,243, PUB. 1-1-2008. INT. CL. 16.
- PSYCHOLOGICAL CORPORATION, SAN ANTONIO, TX:
2,058,816, CANC. INT. CL. 16.
- PUBLIC ACCESS CORPORATION OF THE DISTRICT OF
COLUMBIA, WASHINGTON, DC:
3,397,663, PUB. 1-1-2008. INT. CL. 38.
- PUBLIC AFFAIRS INFORMATION SERVICE, INC., NEW
YORK, NY TO PROQUEST-CSA, BETHESDA, MD:
2,059,900, CANC. INT. CL. 9.
- PUBLIC BROADCASTING SERVICE, ARLINGTON, VA:
3,399,507, INT. CL. 36.
- PUBLIC JUSTICE, P.C., WASHINGTON, DC:
3,400,276, INT. CL. 45.
- PUERINI, RUSSELL ANTHONY, MIDDLETOWN, RI:
3,400,121, INT. CL. 16.
- PUNKY MOMS, BUTLER, PA:
3,397,041, PUB. 1-1-2008. INT. CL. 38.
- PURDUE PRODUCTS L.P., STAMFORD, CT, INTERNA-
TIONAL LATEX CORPORATION, DOVER, DE:
657,663. REN. 2-14-08. U.S. CL. 18 (INT. CL. 5).
- PURE ESSENCE LABS, LAS VEGAS, NV:
3,396,986, PUB. 1-1-2008. INT. CL. 5.
- PURE N.R.G. PRODUCTS, INC., MANALAPAN, NJ:
3,398,934, INT. CL. 5.
- PUREWORLD BOTANICALS, INC., SOUTH HACKEN-
SACK, NJ:
2,136,264. REN. 2-11-08. INT. CL. 5.
- PURITAN'S PRIDE, INC., BOHEMIA, NY:
2,448,209, CANC. INT. CL. 35.
- PURITY ITALIA S.R.L., NOVI LIGURE, PROVINCE OF A-
LESSANDRIA, ITALY:
2,447,286, CANC. MULTIPLE CLASS, INT. CLS. 11 AND
21.
- PUROS INDIOS CIGARS, INC., MIAMI, FL:
2,126,929. REN. 2-11-08. INT. CL. 34.
- PUSH PULL OPEN CLOSE INCORPORATED, AUSTIN, TX:
3,397,407, PUB. 1-1-2008. INT. CL. 6.
- PYN, S.A. DE C.V., NAUCALPAN, MEXICO:
3,398,537, PUB. 1-1-2008. INT. CL. 17.
- PYRAMID PRODUCTIONS INC., CALGARY, CANADA:
3,400,384, INT. CL. 41.
- PYRAMYD AIR, BEDFORD HTS, OH:
3,397,782, PUB. 1-1-2008. INT. CL. 28.
- Q IMPORT EXPORT COMPANY, INC., FORT LAUDER-
DALE, FL, DBA Q INTERNATIONAL:
2,817,971, CANC. INT. CL. 34.
- QAMHIYAH, ABIR, AMES, IA, DBA ISEEK:
3,399,965, INT. CL. 42.
- QCHARM, LLC, BETHESDA, MD:
3,397,813, PUB. 1-1-2008. INT. CL. 14.
- QINGBANG, LLC, LOUISVILLE, CO:
3,399,209, INT. CL. 25.
- QINGDAO HUATIAN HAND TRUCK LTD., LLC, QING-
DAO, CHINA:
3,398,926, INT. CL. 12.
- QOMO HITEVISION, TROY, MI:
3,397,922, PUB. 1-1-2008. INT. CL. 9.
- QSTRAT INC., TORONTO, ONTARIO, CANADA:
3,398,396, PUB. 4-10-2007. MULTIPLE CLASS, INT. CLS.
9, 35, 41 AND 42.
- QUADRATEC, INC., WESTCHESTER, PA:
3,397,210, PUB. 1-1-2008. INT. CL. 35.
- QUADSYSTEMS, SUSSEX, WI:
3,399,781, INT. CL. 9.
- QUAKER OATS COMPANY, THE, CHICAGO, IL:
2,640,270, CANC. INT. CL. 32.
- QUALITY FOOD BRANDS, INC., SYOSSET, NY:
3,399,956, INT. CL. 30.
- QUALITY PROGRAMMING CORPORATION, PARKLAND,
FL:
3,397,812, PUB. 1-1-2008. MULTIPLE CLASS, INT. CLS. 9
AND 38.
- QUALITY TONNES, LLC, WASHINGTON, DC, DC:
3,398,370, PUB. 1-1-2008. INT. CL. 35.
- QUANTUM CORPORATION, SAN JOSE, CA:
3,399,422, INT. CL. 9.
- QUANTUM OPTICS, INC., SMITHFIELD, RI:
2,059,327, CANC. INT. CL. 16.
- QUATRIN MEDIA, LLC, WOODBURY, NY:
3,400,302, INT. CL. 41.
- QUEST MANUFACTURING CORP, MEDLEY, FL:
3,398,526, PUB. 1-1-2008. MULTIPLE CLASS, INT. CLS. 6,
9 AND 20.
- QUEUES ENFORTH DEVELOPMENT, INC., CAMBRIDGE,
MA TO STRUCTURED DECISIONS CORP., WEST NEW-
TON, MA:
2,058,948, CANC. INT. CL. 9.
- QUICK HITS GOLF, LLC, SCOTTSDALE, AZ:
2,448,347, CANC. INT. CL. 41.
- QUIDEL CORPORATION, SAN DIEGO, CA:
3,397,700, PUB. 1-1-2008. INT. CL. 5.
- QUIKSILVER, INC., HUNTINGTON BEACH, CA:
3,399,346, INT. CL. 18.
- QUINN, MICHAEL P., TRAVERSE CITY, MI:
2,448,514, CANC. INT. CL. 25.
- QVC, INC., WEST CHESTER, PA:
2,448,331, CANC. INT. CL. 25.
3,399,945, INT. CL. 25.
- QWEST COMMUNICATIONS INTERNATIONAL INC.,
DENVER, CO:
3,398,280, PUB. 1-1-2008. INT. CL. 6.
3,399,107, INT. CL. 38.
- R AND J CORPORATION, WESTLAKE, OH, DBA HAYNES
MANUFACTURING COMPANY:
3,398,506, PUB. 1-1-2008. INT. CL. 40.
- R. EXPO, FEDERAL WAY, WA:
3,398,148, PUB. 1-1-2008. INT. CL. 3.
3,398,158, PUB. 1-1-2008. INT. CL. 3.
- R. EXPO (USA) LTD., INC., FEDERAL WAY, WA:
3,398,272, PUB. 1-1-2008. INT. CL. 3.
- R.G. APPLGATE STEEL COMPANY, INC., SARATOGA,
IN:
3,398,016, PUB. 1-1-2008. INT. CL. 6.
3,398,019, PUB. 1-1-2008. INT. CL. 6.

- R.G. BARRY CORPORATION, PICKERINGTON, OH TO
R.G. BARRY CORPORATION, PICKERINGTON, OH:
2,059,978, CANC. INT. CL. 25.
- R&R HEALTHCARE COMMUNICATIONS, INC., OLD-
SMAR, FL:
3,398,583, PUB. 11-27-2007. INT. CL. 41.
- RA BRANDS, L.L.C., MADISON, NC:
3,397,579, PUB. 1-1-2008. INT. CL. 13.
3,397,580, PUB. 1-1-2008. INT. CL. 13.
- RACINE INDUSTRIES, INC., RACINE, WI:
2,143,435. REN. 2-14-08. INT. CL. 7.
- RACING AGAINST DIABETES FOUNDATION, INC., LA
JOLLA, CA:
3,397,727, PUB. 1-1-2008. INT. CL. 35.
- RACING GREEN LIMITED, UNITED KINGDOM:
3,398,629, PUB. 1-1-2008. INT. CL. 25.
- RADIAN COMMUNICATION SERVICES, INC., RICHRD-
SON, TX:
2,447,915, CANC. INT. CL. 19.
- RADIO CITY TRADEMARKS, LLC, NEW YORK, NY,
RADIO CITY TRADEMARKS, LLC, NEW YORK, NY:
2,147,635. REN. 2-13-08. INT. CL. 41.
- RADIO SYSTEMS CORPORATION, KNOXVILLE, TN:
3,399,633, INT. CL. 9.
- RADON-EASE, INC., MOSELEY, VA:
3,396,946, PUB. 1-1-2008. INT. CL. 42.
- RAFFA, ANTHONY, ORLANDO, FL:
3,400,013, INT. CL. 20.
- RAGAN, RAYMOND K, PHOENIX, AZ:
3,399,459, INT. CL. 42.
- RAINTREE ESSIX INC., WILMINGTON, DE:
3,397,453, PUB. 1-1-2008. INT. CL. 5.
- RALPH GLENN, SAN LEANDRO, CA:
3,399,179, INT. CL. 25.
- RAMONE MOYA LIMITED, DALLAS, TX:
2,448,267, CANC. INT. CL. 25.
- RAMOS, LEONARDO, WESTON, FL:
3,400,231, INT. CL. 14.
- RAMSEY MEDIAPRIVACY LLC, JOPLIN, MO:
3,397,183, PUB. 1-1-2008. INT. CL. 25.
- RANCHERS' LAMB OF TEXAS, INC., SAN ANGELO, TX:
2,448,176, CANC. MULTIPLE CLASS, INT. CLS. 18 AND
29.
- RANCHO MIRAGE GOLF, INC., RANCHO MIRAGE, CA:
3,396,854, PUB. 1-1-2008. MULTIPLE CLASS, INT. CLS.
25, 28 AND 35.
- RANDALL S. PORTER, YUCAIPA, CA AND SHARON R.
RICHARDSON, YUCAIPA, CA:
3,400,333, INT. CL. 20.
- RANG, ULLA CAMILLA, DEL MAR, CA:
3,397,462, PUB. 11-27-2007. INT. CL. 25.
- RANSOM INDUSTRIES, LP, BIRMINGHAM, AL:
1,438,470, CANC. INT. CL. 6.
1,438,471, CANC. INT. CL. 6.
- RAPID PRODUCT DEVELOPMENT GROUP, INC., ESCON-
DIDO, CA:
3,398,364, PUB. 1-1-2008. INT. CL. 40.
- RARE VALLEY RESOURCES, INC, PRAIRIE GROVE, AR:
3,397,085, PUB. 1-1-2008. INT. CL. 5.
- RATCHET, INC., MINNEAPOLIS, MN:
3,400,037, MULTIPLE CLASS, INT. CLS. 9 AND 42.
3,400,038, MULTIPLE CLASS, INT. CLS. 9 AND 42.
3,400,039, MULTIPLE CLASS, INT. CLS. 9 AND 42.
- RAWL, JON, OXFORD, MS:
2,059,849, CANC. INT. CL. 42.
- RAYMOND A. NUZZO, EAST HAVEN, CT:
3,399,091, INT. CL. 35.
- RAYPAK, INC., OXNARD, CA:
1,093,671. REN. 2-13-08. INT. CL. 10.
- RAZORPAGES, INC., SAN FRANCISCO, CA:
3,398,570, PUB. 1-1-2008. INT. CL. 35.
- RBMARK, INC., WILMINGTON, DE:
1,449,686. REN. 2-14-08. INT. CL. 17.
- RC GENERAL ENTERPRISES, INC., BRONX, NY:
3,397,971, PUB. 1-1-2008. INT. CL. 39.
- RCN TELECOM SERVICES, INC., PRINCETON, NJ:
3,400,083, INT. CL. 38.
- RC2 CORPORATION, DYERSVILLE, IA:
2,114,761. REN. 2-12-08. INT. CL. 28.
- RE-MENT INTERNATIONAL, INC., IRVINE, CA:
3,399,907, INT. CL. 28.
3,399,908, INT. CL. 28.
- REACTIVE SYSTEMS, INC., ORADELL, NJ:
2,447,623, CANC. INT. CL. 41.
- READING TERMINAL MARKET CORPORATION, PHILA-
DELPHIA, PA:
1,492,555. REN. 2-13-08. MULTIPLE CLASS, INT. CLS. 36
AND 42.
1,492,556. REN. 2-13-08. MULTIPLE CLASS, INT. CLS. 36
AND 42.
- READY METAL MANUFACTURING COMPANY, CHICA-
GO, IL:
1,438,477, CANC. INT. CL. 6.
- READYCHEM INC., SANFORD, FL:
3,398,536, PUB. 1-1-2008. INT. CL. 5.
- REALTY RESCUE, INC., LOS ANGELES, CA:
3,399,895, INT. CL. 39.
3,399,904, INT. CL. 39.
- REAS' OLIVE RANCH INC., TEMPE, AZ:
3,400,180, INT. CL. 30.
- REBEKAH GRACE FOOD & SUPPLEMENTS FOR LIFE,
LLC, HAZARD, KY:
3,397,517, PUB. 1-1-2008. MULTIPLE CLASS, INT. CLS.
29, 30 AND 31.
- RECIVA LIMITED, UNITED KINGDOM:
3,398,663, PUB. 1-1-2008. MULTIPLE CLASS, INT. CLS. 9
AND 42.
- RECKITT BENCKISER INC., PARSIPPANY, NJ:
3,398,245, PUB. 1-1-2008. INT. CL. 3.
- RECOULES S.A., 77330 OZOIR-LA-FERRIER, FRANCE:
2,448,004, CANC. INT. CL. 9.
- RED BOX TOY FACTORY LTD., TSIMSHATSUI EAST,
KOWLOON, HONG KONG:
2,149,436. REN. 2-11-08. INT. CL. 28.
- REDMOND, ELAINE, CAROLINA BEACH, NC AND ROWL-
INGS, SCOTT, CAROLINA BEACH, NC:
3,397,707, PUB. 1-1-2008. INT. CL. 41.
- REDUCE MY FEE, LLC, GREAT NECK, NY:
3,399,148, INT. CL. 35.
- REEBOK INTERNATIONAL LTD., CANTON, MA:
2,447,257, CANC. INT. CL. 25.
- REED ELSEVIER PROPERTIES INC., WILMINGTON, DE:
2,153,193. REN. 2-14-08. MULTIPLE CLASS, INT. CLS. 35
AND 41.
- REELCRAFT INDUSTRIES, INC., COLUMBIA CITY, IN:
3,349,682, COR. INT. CL. 6.
- REESE, PAUL DAVID, WALTHAM, MA:
3,400,034, INT. CL. 44.
- REFLECTIONS LLC, ALBUQUERQUE, NM:
3,399,377, INT. CL. 45.
- REGAL CINEMEDIA CORPORATION, ENGLEWOOD, CO:
3,398,392, PUB. 1-1-2008. INT. CL. 41.
- REGAN, JR., ROLAND J., MARBLEHEAD, MA AND
MULLALY, ROBERT W., MARBLEHEAD, MA:
3,397,628, PUB. 1-1-2008. INT. CL. 41.
- REGENCY INTERNATIONAL MARKETING, LLC, LAS
VEGAS, NV:
3,398,963, INT. CL. 10.
3,398,964, INT. CL. 10.
- REGIONAL FINANCIAL ASSOCIATES, WEST CHESTER,
PA TO MIS QUALITY MANAGEMENT CORP., WIL-
MINGTON, DE:
2,058,861, CANC. INT. CL. 42.
- REGIONS ASSET COMPANY, WILMINGTON, DE:
3,397,322, PUB. 6-5-2007. INT. CL. 41.
- REGIS TECHNOLOGIES, INC., MORTON GROVE, IL:
3,397,581, PUB. 1-1-2008. INT. CL. 9.
3,397,582, PUB. 1-1-2008. INT. CL. 42.
- REGULATOR RECORDS, INC., CLIFTON, NJ:
3,396,882, PUB. 1-1-2008. INT. CL. 9.
- REID, RALPH, HENDERSON, NV AND FALLON, ZACH,
HENDERSON, NV:
3,399,417, INT. CL. 25.
- REID, SUSAN LEE, MCGAHEYSVILLE, VA:
3,398,134, PUB. 1-1-2008. INT. CL. 35.

- REID'S MILKY-WAY DAIRY STORES INC., BELLEVILLE, ONTARIO, CANADA:
3,397,500, PUB. 1-1-2008. MULTIPLE CLASS, INT. CLS. 29, 30 AND 35.
- REIMAN PUBLICATIONS, LLC, GREENDALE, WI:
2,448,336, CANC. INT. CL. 16.
- REINDL, GERHARD., 54329 KONZ, FED REP GERMANY:
3,398,643, PUB. 1-1-2008. INT. CL. 34.
- REINOSO RODRIGUEZ, CESAR TULIO, BOGOTÁ, COLOMBIA:
3,400,191, INT. CL. 12.
- REINOSO-RODRIGUEZ, CESAR TULIO, BOGOTÁ DC, COLOMBIA:
3,398,965, INT. CL. 17.
- REINWALD, JILL L., WARRENTON, MO:
2,058,644, CANC. INT. CL. 9.
- REIS, NICHOLAS, LONG ISLAND CITY, NY:
3,399,960, INT. CL. 41.
- REITMANS (CANADA) LIMITED, MONTREAL, CANADA:
3,397,164, PUB. 1-1-2008. MULTIPLE CLASS, INT. CLS. 3, 9, 18 AND 25.
- REKON TECHNOLOGIES, PASADENA, CA:
3,397,821, PUB. 1-1-2008. MULTIPLE CLASS, INT. CLS. 9 AND 42.
- RELATIONSHIP MANAGEMENT PROGRAMS, INC., DALLAS, TX:
2,059,121, CANC. INT. CL. 39.
- RELAXATION & RETREAT MASSAGES OF YORK, LLC, YORK, PA:
3,397,078, PUB. 1-1-2008. INT. CL. 44.
- RELIANCE ORTHODONTIC PRODUCTS, INC., ITASCA, IL:
1,476,537, REN. 2-8-08. INT. CL. 5.
- RELIGHTNY, NEW YORK, NY:
3,398,082, PUB. 1-1-2008. INT. CL. 35.
3,398,094, PUB. 1-1-2008. INT. CL. 35.
- RELIGIOUS TECHNOLOGY CENTER, LOS ANGELES, CA:
1,481,944, REN. 2-14-08. INT. CL. 41.
- REMWES MEDICAL, LLC, SPRINGFIELD, IL:
3,397,770, PUB. 1-1-2008. INT. CL. 35.
- RENEWAL FOR LIFE, LLC, SCOTTSDALE, AZ:
3,396,942, PUB. 1-1-2008. INT. CL. 5.
3,396,943, PUB. 1-1-2008. INT. CL. 5.
- RENO SCHUHCENTRUM GMBH, FED REP GERMANY:
3,398,685, PUB. 1-1-2008. INT. CL. 25.
- REPAIRNOW.COM, INC., STERLING, VA:
2,448,290, CANC. INT. CL. 37.
- REPAIRNOW.COM, INC., STERLING, VA:
2,448,292, CANC. INT. CL. 42.
- REPUTATIONDEFENDER, INC., MENLO PARK, CA:
3,397,072, PUB. 1-1-2008. INT. CL. 42.
3,397,371, PUB. 1-1-2008. INT. CL. 42.
- RESEARCHTRAIL LTD., MODI'IN, ISRAEL:
3,397,951, PUB. 1-1-2008. INT. CL. 42.
- RESORTS INTERNATIONAL HOLDINGS, LLC, NEW YORK, NY:
3,400,354, MULTIPLE CLASS, INT. CLS. 35 AND 43.
- RESOURCEFUL PRODUCTS, INC. (THE RPI GROUP), SOLON, OH:
3,398,913, INT. CL. 21.
- RESSLER, MONIKA, NEW YORK, NY:
3,400,267, INT. CL. 41.
- REST MY CASE INCORPORATED, VALENCIA, CA:
3,397,810, PUB. 1-1-2008. INT. CL. 24.
- RESTAR ASSOCIATES, LLC, VALLEY FORGE, PA:
3,397,266, PUB. 1-1-2008. INT. CL. 35.
- RESTEK CORPORATION, BELLEFONTE, PA:
1,507,926, REN. 2-14-08. INT. CL. 9.
- RESTORATION WINDOWS, NEW YORK, NY:
3,397,532, PUB. 1-1-2008. INT. CL. 37.
- RETAIL BRAND ALLIANCE, INC., ENFIELD, CT:
2,893,198, AM. INT. CL. 35.
- RETAIL STORE NETWORKS, INC., RICHMOND, VA, DBA WHOLESALPET.COM:
3,398,135, PUB. 1-1-2008. INT. CL. 35.
- RETROBELT USA, LLC, CHINO, CA:
3,399,129, INT. CL. 12.
- REV. KEMPF, JOSEPH G., O'FALLON, MO:
3,399,793, INT. CL. 41.
- REVISS SERVICES LIMITED, NICOSIA, CYPRUS:
2,059,688, CANC. INT. CL. 1.
- REVOLUTION TEA, LLC, PHOENIX, AZ:
3,399,833, INT. CL. 30.
- REX'S OUTRAGEOUS, LLC, JERICHO, VT:
3,398,049, PUB. 1-1-2008. INT. CL. 30.
- RHOADES, DEAN L., BEVERLY HILLS, CA:
3,400,061, INT. CL. 3.
- RHODES DESIGN AND DEVELOPMENT CORPORATION, LAS VEGAS, NV:
3,400,126, INT. CL. 37.
3,400,127, INT. CL. 37.
- RHONE-POULENC RORER PHARMACEUTICALS INC., COLLEGEVILLE, PA:
2,448,264, CANC. INT. CL. 16.
- RI-WAL CERAMICHE S.P.A., ITALY:
3,398,687, PUB. 1-1-2008. INT. CL. 19.
- RICHARD WOLF GMBH, KNITTLINGEN, FED REP GERMANY:
3,322,003, CANC. INT. CL. 10.
- RICHARD, RACHELLE, PHOENIX, AZ:
3,397,974, PUB. 1-1-2008. INT. CL. 35.
- RICHARDS, CONRAD R, FRESH MEADOWS, NY:
3,399,182, INT. CL. 16.
- RICHLAND ANIMAL HOSPITAL, RICHLAND, MI:
3,398,601, PUB. 1-1-2008. INT. CL. 44.
- RICK GOODWIN ENTERPRISES, INC., BRISTOL, TN:
3,396,815, PUB. 12-26-2000. INT. CL. 28.
- RIDGID, INC., NEWARK, DE:
2,163,196, REN. 2-14-08. INT. CL. 6.
- RIDLEY BLOCK OPERATIONS, INC., MANKATO, MN:
3,399,143, INT. CL. 5.
3,399,186, INT. CL. 5.
- RIFAST SYSTEMS LLC, LINCOLNWOOD, IL:
3,399,918, INT. CL. 6.
- RIGBERG, HOWARD EVAN, NY, NY AND KIM, JULIANE HEEJEAN, NY, NY AND GUTIERREZ, MIGUEL, BROOKLYN, NY:
2,447,737, CANC. INT. CL. 41.
- RIO VISTA WINE & SPIRITS, LLC, FAIRFIELD, CA:
3,396,988, PUB. 1-1-2008. INT. CL. 33.
- RISK DATA CORPORATION, MINNEAPOLIS, MN:
2,448,091, CANC. INT. CL. 9.
- RISLEYCORUM, LEYEA R. SOUTH PORTLAND, ME AND CORUM, BENJAMIN M, SOUTH PORTLAND, ME:
3,397,445, PUB. 1-1-2008. INT. CL. 3.
- RITCHIE, SUSANNE, HIGLEY, AZ:
3,399,053, INT. CL. 43.
- RITZ CAMERA CENTERS, INC., BELTSVILLE, MD:
3,397,919, PUB. 1-1-2008. INT. CL. 35.
- RIVAS, JULIO CESAR, LOS ANGELES, CA, CA:
3,397,343, PUB. 1-1-2008. INT. CL. 41.
- RIVERA, RONNIE, BRANDON, FL:
3,397,426, PUB. 1-1-2008. INT. CL. 41.
- RIVERDEEP INTERACTIVE LEARNING LIMITED, DUBLIN, IRELAND:
2,448,059, CANC. INT. CL. 16.
- RMI TITANIUM COMPANY, NILES, OH:
3,397,720, PUB. 1-1-2008. INT. CL. 6.
- RMLL INC. COMMERCE TOWNSHIP, MI:
3,398,528, PUB. 1-1-2008. MULTIPLE CLASS, INT. CLS. 39 AND 43.
- ROARING SPRING BLANK BOOK CO., ROARING SPRING, PA:
3,399,002, INT. CL. 16.
- ROBERT A. TOIGO FOUNDATION, OAKLAND, CA:
3,398,460, PUB. 1-1-2008. INT. CL. 41.
- ROBERT E. HOVEY JR., CHICAGO, IL AND JAMES F. DAVIS II, CHICAGO, IL:
3,399,015, INT. CL. 35.
- ROBERT J. REINA, WESTON, FL:
3,397,976, PUB. 1-1-2008. INT. CL. 9.
- ROBERTSON, ALAN SCOTT, SANTEE, CA:
3,399,828, INT. CL. 25.
- ROBERTSON, ANN K., COS COB, CT:
3,397,248, PUB. 1-1-2008. INT. CL. 31.

ROBINS, PAUL, GRANITE BAY, CA AND COWAN, PHIL, FOLSOM, CA:
2,059,442, CANC. INT. CL. 41.

ROBINSON & MARSHALL TRADING CO, LLC, CONYERS, GA:
3,399,778, INT. CL. 25.

ROBOTOOLZ LIMITED, KWUN TONG, KOWLOON, HONG KONG:
3,399,673, INT. CL. 9.

ROCCO ALTABELLI, INC., BURNSVILLE, MN:
3,396,932, PUB. 1-1-2008. INT. CL. 3.
3,396,933, PUB. 1-1-2008. INT. CL. 3.

ROCHESTER MIDLAND CORPORATION, ROCHESTER, NY:
2,448,430, CANC. INT. CL. 16.

ROCHESTER, ALTON D., LAKELAND, FL:
3,399,234, INT. CL. 11.

ROCK AND ROLL HALL OF FAME FOUNDATION, INC., NEW YORK, NY:
2,639,381, COR. MULTIPLE CLASS, INT. CLS. 9 AND 21.

ROCK HARDWEAR, LITTLETON, CO:
3,399,194, MULTIPLE CLASS, INT. CLS. 18, 20, 21 AND 25.

ROCKET FOODS, LLC, BELLEVUE, WA:
3,397,253, PUB. 1-1-2008. MULTIPLE CLASS, INT. CLS. 30 AND 43.
3,397,254, PUB. 1-1-2008. MULTIPLE CLASS, INT. CLS. 30 AND 43.

ROCKET GAMING SYSTEMS, LLC, LAS VEGAS, NV:
3,399,839, INT. CL. 9.

ROCKET SOFTWARE, INC, NEWTON, MA:
2,059,264, CANC. INT. CL. 9.

ROCKFORD CORPORATION, TEMPE, AZ:
3,399,794, INT. CL. 9.
3,399,795, INT. CL. 9.

ROCKY PEANUT CO., INC., FERNDALE, MI:
2,127,395, REN. 2-11-08. INT. CL. 29.
2,127,395, CANC. INT. CL. 30.

RODAS-PAIS, VILMA ROXANA, MEMPHIS, TN:
2,447,581, CANC. INT. CL. 16.

ROGER L. ZAPATA, FAIR OAKS RANCH, CA:
3,397,598, PUB. 1-1-2008. INT. CL. 41.

ROHM AND HAAS COMPANY, PHILADELPHIA, PA:
1,086,748, REN. 2-13-08. INT. CL. 1.

ROHM AND HAAS COMPANY, PHILADELPHIA, PA, SHIPLEY COMPANY INC., NEWTON, MA:
1,086,749, REN. 2-13-08. INT. CL. 1.

ROJAS, CESAR MAURICIO ROJAS, BOGOTA, COLOMBIA:
3,399,728, INT. CL. 3.

ROMUALDO LAMBERTI, CHERRY HILL, NJ:
3,397,020, PUB. 1-1-2008. INT. CL. 43.

ROOFLINK, IRVING, TX, DBA NATIONAL ROOFING PARTNERS:
3,396,897, PUB. 1-1-2008. INT. CL. 35.

ROR COMPANY, LLC, NEWTOWN, CT:
3,398,299, PUB. 1-1-2008. INT. CL. 30.

ROSA MARIA BOLIVAR GARCIA, BOYNTON BEACH, FL:
3,397,870, PUB. 1-1-2008. INT. CL. 42.

ROSA MEXICANO BRANDS, INC., NEW YORK, NY:
3,397,605, PUB. 1-1-2008. INT. CL. 43.

ROSENBERG, BRADLEY, SETH, HENDERSON, NV:
3,399,383, INT. CL. 43.

ROSETTA STONE LTD., HARRISONBURG, VA:
3,398,548, PUB. 1-1-2008. INT. CL. 9.

ROSS, REBECCA, SHORELINE, WA:
3,397,701, PUB. 1-1-2008. INT. CL. 45.

ROSSI, BARBARA, HIGHLAND PARK, NJ:
2,448,468, CANC. INT. CL. 9.

ROTEK SYSTEMS INC., BURNSVILLE, MN:
2,447,886, CANC. INT. CL. 42.

ROTHER HUNGARY LIMITED, HUNGARY:
3,398,716, PUB. 1-1-2008. MULTIPLE CLASS, INT. CLS. 7, 12 AND 35.

ROTOTYPE S.P.A., ITALY:
3,398,732, PUB. 1-1-2008. MULTIPLE CLASS, INT. CLS. 7, 9 AND 16.

ROTTAPHARM LTD., DUBLIN 15, IRELAND:
2,447,268, CANC. INT. CL. 5.

ROUSE-JACKSONVILLE, INC., COLUMBIA, MD:
1,438,691, CANC. INT. CL. 36.

ROUX LABORATORIES, INC., JACKSONVILLE, FL, FERMODYL LABORATORIES, INC., LOS ANGELES, CA:
843,802, REN. 2-12-08. U.S. CL. 51 (INT. CL. 3).

ROVER RETREAT FRANCHISING, LLC, BROOMFIELD, CO:
3,398,108, PUB. 1-1-2008. INT. CL. 43.

ROWLAND COFFEE ROASTERS, INC., MIAMI, FL:
2,147,108, REN. 2-13-08. INT. CL. 30.

ROYAL BANK OF CANADA, MONTREAL, QUEBEC, CANADA:
2,137,575, REN. 2-11-08. INT. CL. 16.

ROYAL SOUNDS ANCA PRODUCTIONS, TACOMA, WA:
3,397,004, PUB. 1-1-2008. INT. CL. 9.

ROZIN OPTICAL INTERNATIONAL LLC, MIAMI, FL:
3,399,202, INT. CL. 9.

RR Y ASOCIADOS,S.A., SANTO DOMINGO, DOMINICAN REP:
3,397,327, PUB. 1-1-2008. INT. CL. 3.

RSC THE QUALITY MEASUREMENT COMPANY, EVANSVILLE, IN, RESEARCH SYSTEMS CORPORATION, EVANSVILLE, IN:
2,078,587, REN. 2-11-08. INT. CL. 35.

RSI HOME PRODUCTS MANAGEMENT, INC., NEWPORT BEACH, CA:
3,399,808, INT. CL. 20.

RTS REALTIME SYSTEMS, INC., CHICAGO, IL:
3,397,053, PUB. 1-1-2008. INT. CL. 9.

RTW, INC., BLOOMINGTON, MN:
3,397,086, PUB. 1-1-2008. INT. CL. 36.
3,397,087, PUB. 1-1-2008. INT. CL. 36.

RUBIN, STEPHAN R., NEW YORK, NY:
3,399,660, INT. CL. 14.
3,399,662, INT. CL. 14.

RUDE MANEUVERS INDUSTRIES, L.L.C., TUCSON, AZ:
3,397,945, PUB. 1-1-2008. INT. CL. 25.

RUDELL, ELLIOT, TORRANCE, CA, DBA RUDELL DESIGN:
2,102,381, REN. 2-8-08. INT. CL. 28.

RUDY GREEN VENTURES, LLC, LOUISVILLE, KY:
3,399,279, INT. CL. 31.
3,399,283, INT. CL. 31.

RUHE, RODNEY CHARLES, SCOTTSDALE, AZ:
2,448,238, CANC. INT. CL. 5.
2,448,277, CANC. INT. CL. 5.

RUIZ ROSILES, ALBERTO Q., GUADALAJARA JALISCO, MEXICO:
2,447,508, CANC. INT. CL. 30.

RUMBLEFISH, INC., PORTLAND, OR:
3,398,039, PUB. 1-1-2008. INT. CL. 35.

RUNNYC.COM LLC, BROOKLYN, NY:
3,399,534, MULTIPLE CLASS, INT. CLS. 25, 35 AND 41.

RUSH ASSOCIATED LABELS, INC., NEW YORK, NY:
2,059,654, CANC. INT. CL. 9.

RUTH, SHEILA S., BALTIMORE, MD:
2,447,786, CANC. INT. CL. 42.

RYAN BASICS LLC, NEW YORK, NY:
3,400,220, INT. CL. 25.

RYAN, DENNIS, CLIFTON PARK, NY:
3,400,270, MULTIPLE CLASS, INT. CLS. 38 AND 41.

RYOBI AMERICA CORPORATION, ANDERSON, SC TO MTD PRODUCTS INC., CLEVELAND, OH:
2,059,985, CANC. INT. CL. 7.

S & S HINGE COMPANY, BLOOMINGDALE, IL:
2,085,767, REN. 2-12-08. INT. CL. 6.

S. C. JOHNSON & SON, INC., RACINE, WI:
3,399,420, INT. CL. 5.
3,399,431, INT. CL. 5.

S.D. WARREN COMPANY, BOSTON, MA, DBA SAPPI FINE PAPER NORTH AMERICA:
3,399,365, INT. CL. 16.

S.P.A EGIDIO GALBANI, MELZO (MILAN), ITALY:
2,133,703, REN. 2-13-08. INT. CL. 29.

S.S. TARIS ZEYTIN VE ZEYTINYAGI TARIM SATIS KOOPERATIFLERI BIRLIGI, ALSANCAK-IZMIR, TURKEY:
3,399,322, MULTIPLE CLASS, INT. CLS. 1, 2, 3, 29 AND

30.
 SAAMAN DEVELOPMENT LLC, CLAYTON, MO:
 3,397,759, PUB. 1-1-2008. MULTIPLE CLASS, INT. CLS. 36 AND 37.
- SABAN ENTERTAINMENT, INC., LOS ANGELES, CA:
 2,448,068, CANC. INT. CL. 41.
- SABRE VISION PTY LTD, CHARLESTOWN, AUSTRALIA:
 3,398,606, PUB. 8-7-2007. MULTIPLE CLASS, INT. CLS. 9, 16 AND 25.
- SADDLEMAN, INC., LOGAN, UT:
 2,448,166, CANC. INT. CL. 12.
- SAE INTERNATIONAL, WARRENDALE, PA:
 2,170,589, REN. 2-11-08. INT. CL. 41.
- SAFCO TECHNOLOGIES, INC., CHICAGO, IL:
 2,447,862, CANC. INT. CL. 9.
- SAFEGUARD BUSINESS SYSTEMS, INC., DALLAS, TX:
 1,082,475, REN. 2-14-08. INT. CL. 16.
- SAFFRON TECHNOLOGY, INC., MORRISVILLE, NC:
 3,397,774, PUB. 1-1-2008. INT. CL. 9.
- SAFILIAN, STEVEN, BOCA RATON, FL:
 2,447,721, CANC. INT. CL. 35.
- SAGE RETAIL, INC., GLENCOE, IL:
 3,399,821, MULTIPLE CLASS, INT. CLS. 35 AND 36.
- SAGE SOFTWARE, INC., IRVINE, CA:
 2,134,399, REN. 2-12-08. INT. CL. 9.
- SAGMEL, INC., LIBERTYVILLE, IL:
 2,131,103, REN. 2-12-08. INT. CL. 5.
 2,131,135, REN. 2-12-08. INT. CL. 5.
- SAINI, KIRPAL, RANCHO CORDOVA, CA:
 3,398,321, PUB. 1-1-2008. INT. CL. 25.
- SAINT-GOBAIN ABRASIVES, INC., WORCESTER, MA:
 1,082,527, REN. 2-8-08. INT. CL. 17.
- SALAAM REMI MUSIC, LLC, MIAMI, FL:
 3,398,885, MULTIPLE CLASS, INT. CLS. 9, 25 AND 41.
 3,398,886, MULTIPLE CLASS, INT. CLS. 9, 25 AND 41.
- SALEM COMMUNICATIONS HOLDING CORPORATION, CAMARILLO, CA:
 3,396,955, PUB. 1-1-2008. INT. CL. 38.
 3,396,982, PUB. 1-1-2008. INT. CL. 38.
 3,396,984, PUB. 1-1-2008. INT. CL. 38.
 3,396,987, PUB. 1-1-2008. INT. CL. 38.
 3,396,999, PUB. 1-1-2008. INT. CL. 38.
 3,397,001, PUB. 1-1-2008. INT. CL. 38.
 3,397,015, PUB. 1-1-2008. INT. CL. 38.
 3,397,026, PUB. 1-1-2008. INT. CL. 38.
- SALES & DISTRIBUTION SOLUTIONS CORP., NEW FRANKEN, WI:
 2,447,615, CANC. INT. CL. 35.
- SALLIE MAE, INC., RESTON, VA:
 2,447,641, CANC. INT. CL. 35.
- SALLS, ALAN, RIO RANCHO, NM:
 3,397,929, PUB. 1-1-2008. INT. CL. 36.
- SALOMON S.A., METZ-TESSY, FRANCE:
 3,400,369, INT. CL. 25.
- SALON SHOWROOMS, INC., EAST SYRACUSE, NY:
 3,400,316, INT. CL. 35.
- SALONTEC, INC., TREASURE ISLAND, FL:
 3,397,724, PUB. 1-1-2008. INT. CL. 9.
- SALT RIVER PIMA MARICOPA INDIAN COMMUNITY, THE, SCOTTSDALE, AZ:
 2,448,508, CANC. INT. CL. 25.
- SALVATORE FERRAGAMO ITALIA S.P.A., ITALY:
 3,398,817, PUB. 1-1-2008. INT. CL. 3.
- SAMARA, JAWAD N., MUNSTER, IN:
 3,397,063, PUB. 1-1-2008. INT. CL. 43.
- SAMSUNG DISPLAY DEVICE CO., LTD., SUWON-CITY, KYUNGKI-DO, REPUBLIC OF KOREA:
 2,448,078, CANC. INT. CL. 9.
- SAMSUNG ELECTRONICS CO., LTD., SUWON CITY, KYUNGKI-DO, REPUBLIC OF KOREA:
 2,448,041, CANC. INT. CL. 9.
- SAMSUNG ELECTRONICS CO., LTD., GYEONGGI-DO, REPUBLIC OF KOREA:
 3,398,465, PUB. 1-1-2008. INT. CL. 11.
- SAMSUNG ELECTRONICS CO., LTD., SUWON-SI, GYEONGGI-DO, REPUBLIC OF KOREA:
 3,399,151, INT. CL. 9.
- SAMSUNG NETWORKS, INC., SEOUL, REPUBLIC OF KOREA:
 3,397,109, PUB. 1-1-2008. INT. CL. 9.
- SAN ANTONIO COMMUNITY HOSPITAL, UPLAND, CA:
 3,399,709, INT. CL. 44.
- SAN FRANCISCO BAY BOAT CRUISES, LLC, SAN FRANCISCO, CA:
 3,398,217, PUB. 1-1-2008. INT. CL. 39.
- SAN FRANCISCO LESBIAN GAY BISEXUAL TRANSGENDER PRIDE CELEBRATION COMMITTEE, INC., SAN FRANCISCO, CA:
 3,397,354, PUB. 1-1-2008. INT. CL. 41.
- SAN PEDRO, PATRICIA, CORAL GABLES, FL:
 3,397,482, PUB. 1-1-2008. INT. CL. 41.
- SANCHEZ, MARIA TRESA, TROUTVILLE, VA:
 3,397,558, PUB. 1-1-2008. INT. CL. 16.
- SAND SPRINGS SPRINGWATER COMPANY, WILLIAMSTOWN, MA:
 1,469,300, REN. 2-11-08. INT. CL. 32.
- SANDRIDGE FOOD CORPORATION, MEDINA, OH:
 3,397,719, PUB. 1-1-2008. INT. CL. 29.
- SANFORD, L.P., OAK BROOK, IL, SANFORD CORPORATION, BELLWOOD, IL:
 1,083,498, REN. 2-14-08. INT. CL. 16.
- SANGAMENT, INC., WESTBURY, NY:
 3,399,997, INT. CL. 9.
- SANSAY, INC., SAN DIEGO, CA:
 3,399,670, INT. CL. 9.
- SANTA CLARA, INC., WHIPPANY, NJ, J & R TOBACCO CORP., FAIRFIELD, NJ:
 1,522,033, REN. 2-14-08. INT. CL. 34.
- SAPOREITALIANO IMPORTING CO., INC., FORT LEE, NJ:
 3,398,316, PUB. 1-1-2008. INT. CL. 32.
- SARA ELIZABETH WALTHER, SAN FRANCISCO, CA:
 3,397,848, PUB. 1-1-2008. INT. CL. 3.
- SARA LEE D.E./NV, 3532 AD UTRECHT, NETHERLANDS:
 2,448,011, CANC. INT. CL. 11.
- SARA LEE FOODS, LLC, BLUE ASH, OH:
 3,398,252, PUB. 1-1-2008. INT. CL. 29.
- SARAH SALIM SORATHIA INC, TAMPA, FL:
 3,398,496, PUB. 1-1-2008. INT. CL. 43.
- SARALEX, INC., ISELIN, NJ, DBA WORLD IMPORT DISTRIBUTORS:
 2,209,107, REN. 2-11-08. INT. CL. 29.
- SARGENTO FOODS, INC., PLYMOUTH, WI:
 3,399,926, MULTIPLE CLASS, INT. CLS. 29 AND 30.
- SAROYAN LUMBER CO., HUNTINGTON PARK, CA:
 3,398,498, PUB. 1-1-2008. INT. CL. 19.
- SATA GMBH & CO. KG, 70806 KORNWESTHEIM, FED REP GERMANY:
 3,398,827, PUB. 1-1-2008. INT. CL. 7.
- SATHERS, INC., ROUND LAKE, MN:
 1,438,665, CANC. INT. CL. 30.
- SATO, GARRY, SANTA MONICA, CA:
 3,400,236, INT. CL. 28.
- SAVE YOUR WORLD, LLC, SHORT HILLS, NJ:
 3,399,847, INT. CL. 3.
- SAVINO, DAVID A., VIRGINIA BEACH, VA:
 3,397,415, PUB. 1-1-2008. INT. CL. 25.
- SAWYER INDUSTRIAL PLASTICS, INC., WEST MONROE, LA:
 2,133,992, REN. 2-12-08. INT. CL. 17.
- SAZERAC COMPANY, INC., NEW ORLEANS, LA:
 3,400,190, INT. CL. 33.
- SB PRODUCTS, INC., VENICE, FL:
 2,059,512, CANC. INT. CL. 21.
- SBC INTERACTIVE, PASADENA, CA:
 2,448,234, CANC. INT. CL. 38.
- SCAMSAFE, INC., SANTA BARBARA, CA:
 3,397,220, PUB. 1-1-2008. INT. CL. 36.
 3,397,221, PUB. 1-1-2008. INT. CL. 36.
 3,397,222, PUB. 1-1-2008. INT. CL. 36.
 3,397,223, PUB. 1-1-2008. INT. CL. 36.
- SCHALLERT, JON, LONGMONT, CO AND SCHALLERT, MARGARET, LONGMONT, CO:
 3,397,996, PUB. 1-1-2008. INT. CL. 35.
- SCHAUB, ELISA R., SUNRISE BEACH, MO:
 3,399,470, MULTIPLE CLASS, INT. CLS. 18 AND 25.

- SCHENCK ROTEC GMBH, DARMSTADT, FED REP GERMANY:
3,396,976, PUB. 1-1-2008. MULTIPLE CLASS, INT. CLS. 7, 9 AND 37.
3,396,977, PUB. 1-1-2008. MULTIPLE CLASS, INT. CLS. 7, 9 AND 37.
- SCHERER LABORATORIES, INC., LAKE FOREST, IL:
3,398,224, PUB. 1-1-2008. INT. CL. 5.
- SCHERRER, FRED C., A CITIZEN OF THE UNITED STATES, SEBASTOPOL, CA, DBA SCHERRER WINERY:
3,398,188, PUB. 1-1-2008. INT. CL. 33.
- SCHIRALDI, DAVID ANTHONY, SHAKER HEIGHTS, OH:
3,399,645, INT. CL. 1.
- SCHLEGEL, PETE EUGENE, DEFIANCE, OH AND BARTLEY, MARK ALLEN, CONTINENTAL, OH:
2,447,670, CANC. INT. CL. 42.
- SCHLUTER-SYSTEMS KG, ISERLOHN, FED REP GERMANY:
3,399,578, MULTIPLE CLASS, INT. CLS. 1, 17 AND 19.
- SCHMID, ROBERT CHRISTOPHER, RICHMOND, VA:
2,447,758, CANC. INT. CL. 3.
- SCHNEIDER ELECTRIC INDUSTRIES SAS, RUEIL-MALMAISON, FRANCE:
1,482,058, REN. 2-12-08. INT. CL. 9.
- SCHOLASTIC INC., NEW YORK, NY:
2,149,138, REN. 2-11-08. INT. CL. 9.
3,399,135, INT. CL. 41.
3,399,171, INT. CL. 16.
3,399,923, INT. CL. 9.
3,399,924, INT. CL. 9.
- SCHOLTEN, INGO, KONSTANZ, FED REP GERMANY:
3,399,119, INT. CL. 5.
- SCHOOLBUDDIES INC., CORAL SPRINGS, FL:
2,447,604, CANC. INT. CL. 35.
- SCHWAN'S IP, LLC, MARSHALL, MN, SSE FOODS, INC., MARSHALL, MN:
2,133,173, REN. 2-11-08. INT. CL. 30.
- SCHWAN'S IP, LLC, MARSHALL, MN:
3,399,276, INT. CL. 30.
- SCHWARTZ, JEREMY S., NEW YORK, NY AND RUBY, ETHAN, NEW YORK, NY:
3,397,827, PUB. 1-1-2008. MULTIPLE CLASS, INT. CLS. 36 AND 41.
- SCHWEITZZ DIST. INC., FLUSHING, NY:
2,059,392, CANC. INT. CL. 5.
- SCHWEIZ. SERUM- & IMPFINSTITUT BERN, CH-3018 BERN, SWITZERLAND:
2,447,609, CANC. INT. CL. 5.
- SCHWINN ACQUISITION, LLC, MADISON, WI:
3,400,103, INT. CL. 12.
- SCI MANAGEMENT CORPORATION, HOUSTON, TX:
2,447,430, CANC. INT. CL. 42.
- SCIENTIFIC COMPUTING ASSOCIATES CORP., CHICAGO, IL:
1,438,754, CANC. MULTIPLE CLASS, INT. CLS. 9 AND 41.
- SCIENTIFIC TOYS, LTD., KOWLOON, HONG KONG:
2,132,774, REN. 2-14-08. INT. CL. 28.
- SCIQUEST.COM, INC., MORRISVILLE, NC:
2,447,423, CANC. INT. CL. 35.
- SCONEHENGE, BERKELEY, CA:
3,397,311, PUB. 1-1-2008. INT. CL. 30.
- SCORE ACQUISITIONS CORP., BLAUVELT, NY, DBA CODY-KRAMER IMPORTS:
3,399,185, INT. CL. 30.
- SCORPION PERFORMANCE, INC., FORT LAUDERDALE, FL:
3,397,455, PUB. 1-1-2008. INT. CL. 7.
- SCOTT P. GIBSON, NEW PALTZ, NY:
3,397,128, PUB. 1-1-2008. INT. CL. 18.
- SCOTT, DOUGLAS BRYCE, SAN DIEGO, CA AND BALTIC, BENJAMIN FRANKLIN, SAN DIEGO, CA:
3,397,224, PUB. 1-1-2008. INT. CL. 43.
- SCOTT, FRED M., DES MOINES, IA:
3,397,360, PUB. 1-1-2008. INT. CL. 25.
- SCOTT, SYLVIA, CHARLESTON, SC:
3,400,035, INT. CL. 25.
- SCRATCH MEDIA PRODUCTIONS, LLC, NEW YORK, NY:
3,398,855, INT. CL. 18.
- SCRATCH-ART COMPANY, INC., AVON, MA:
2,155,965, REN. 2-11-08. INT. CL. 16.
- SCREEN IMAGING TECHNOLOGY, INC., HOUSTON, TX:
3,397,000, PUB. 1-1-2008. INT. CL. 42.
- SCREENLIFE, LLC, SEATTLE, WA:
3,399,351, INT. CL. 41.
- SCRIPPS TREASURE COAST PUBLISHING COMPANY, STUART, FL:
3,397,216, PUB. 1-1-2008. INT. CL. 35.
- SDI TECHNOLOGIES, INC., RAHWAY, NJ:
3,399,005, INT. CL. 9.
- SEA WORLD, INC., ST. LOUIS, MO:
3,397,859, PUB. 1-1-2008. INT. CL. 41.
- SEA-LAND SERVICE, INC., EDISON, NJ:
1,438,522, CANC. INT. CL. 9.
- SEACROSS GLOBAL ADVISORS LLC, BOSTON, MA:
3,399,089, INT. CL. 36.
- SEAREAL PRODUCTIONS, LLC, SEATTLE, WA:
3,397,040, PUB. 1-1-2008. MULTIPLE CLASS, INT. CLS. 9 AND 41.
- SEARS BRANDS, LLC, HOFFMAN ESTATES, IL:
3,397,294, PUB. 1-1-2008. MULTIPLE CLASS, INT. CLS. 7 AND 11.
- SEC INSIGHT, INC., PLYMOUTH, MN:
3,400,050, MULTIPLE CLASS, INT. CLS. 35 AND 36.
- SECURE VANTAGE TECHNOLOGIES, INC., BERTHOUD, CO:
3,396,869, PUB. 1-1-2008. INT. CL. 9.
- SECURITY BENEFIT LIFE INSURANCE COMPANY, TOPEKA, KS:
2,058,562, CANC. INT. CL. 9.
- SECURITY BOSS MANUFACTURING, LLC, PLYMOUTH, WI:
3,399,214, INT. CL. 6.
- SECURITY ENGINEERED MACHINERY CO., INC., WESTBORO, MA:
1,438,468, CANC. INT. CL. 6.
- SEJINIGB CO., LTD., KYUNGGI-DO, REPUBLIC OF KOREA:
3,400,155, INT. CL. 7.
- SELECT HOTELS GROUP, L.L.C., CHICAGO, IL:
2,447,803, CANC. INT. CL. 42.
- SELECTPRO SALES, INC., LOS ANGELES, CA:
3,397,061, PUB. 1-1-2008. MULTIPLE CLASS, INT. CLS. 29, 31 AND 32.
3,397,062, PUB. 1-1-2008. MULTIPLE CLASS, INT. CLS. 29, 31 AND 32.
- SELLARS ABSORBENT MATERIALS, INC., MILWAUKEE, WI:
3,399,367, INT. CL. 16.
- SELLION, INC., NORTH KINGSTOWN, RI:
3,399,199, INT. CL. 5.
- SELMER COMPANY, INC., THE, ELKHART, IN:
1,090,628, REN. 2-14-08. INT. CL. 3.
- SEMICONDUCTOR ENERGY LABORATORY CO., LTD., KANAGAWA-KEN, JAPAN:
3,398,494, PUB. 1-1-2008. INT. CL. 9.
- SENNHEISER ELECTRONIC GMBH & CO. KG, FED REP GERMANY:
3,398,633, PUB. 1-1-2008. INT. CL. 9.
- SENSE8 CORPORATION, MILL VALLEY, CA TO BMA/SENSE8, INC., SAN RAFAEL, CA:
2,059,960, CANC. INT. CL. 9.
- SENSIUM NV, B-3001 LEUVEN, BELGIUM:
3,398,697, PUB. 1-1-2008. MULTIPLE CLASS, INT. CLS. 9, 35 AND 42.
- SENSOR SWITCH, INC., WALLINGFORD, CT:
3,398,996, INT. CL. 9.
- SENSORMEDICS, YORBA LINDA, CA:
2,447,388, CANC. INT. CL. 10.
- SENSORY ANALYTICS, LLC, GREENSBORO, NC:
3,400,136, INT. CL. 9.
- SENTRY MEDICAL PRODUCTS, INC., GREEN BAY, WI:
3,398,096, PUB. 1-1-2008. INT. CL. 10.
3,398,100, PUB. 1-1-2008. INT. CL. 10.

- SEOUL BROS. GROUP, INC., GLENDALE, CA:
3,398,110, PUB. 1-1-2008. INT. CL. 43.
3,398,115, PUB. 1-1-2008. INT. CL. 43.
- SEPHORA USA, INC., SAN FRANCISCO, CA:
3,397,838, PUB. 1-1-2008. INT. CL. 41.
- SERAPH COSMETICS, INC., HOLLYWOOD, CA:
3,399,115, INT. CL. 3.
3,399,860, INT. CL. 3.
- SERBIN, GLEN, SANTA BARBARA, CA:
2,447,933, CANC. INT. CL. 16.
- SERENUS JOHNSON PORTABLES, LLC, BAY CITY, MI:
3,397,244, PUB. 1-1-2008. INT. CL. 6.
- SERVA CORPORATION, WICHITA FALLS, TX:
3,397,999, PUB. 1-1-2008. INT. CL. 7.
3,398,005, PUB. 1-1-2008. INT. CL. 6.
- SERVICE EVALUATION CONCEPTS, INC., WOODBURY, NY:
3,398,441, PUB. 1-1-2008. INT. CL. 35.
- SERVINGSCHOOLS.COM, PORTLAND, ME:
3,400,175, INT. CL. 35.
- SETCOM MEDIA, INC., MT. PLEASANT, SC:
3,400,007, MULTIPLE CLASS, INT. CLS. 16 AND 35.
3,400,091, MULTIPLE CLASS, INT. CLS. 16 AND 35.
3,400,092, MULTIPLE CLASS, INT. CLS. 16 AND 35.
- SEVEN, INC., BATON ROUGE, LA:
2,281,032, CANC. INT. CL. 41.
- SEVERE, EMANUEL J., LAUDERHILL, FL:
3,398,561, PUB. 1-1-2008. INT. CL. 25.
- SEWERTUFF, LLC, FRANKLIN PARK, IL:
3,399,142, INT. CL. 2.
- SHABEAR INC., TROY, MT:
3,398,136, PUB. 1-1-2008. INT. CL. 45.
- SHADI.COM DIVISION OF AMPAK BILLING CORP., HOPEWELL JUNCTION, NY:
3,396,843, PUB. 1-1-2008. INT. CL. 45.
- SHAE CORPORATION, ANAHEIM, CA, DBA PREMIER FLOORING SOLUTIONS:
3,399,155, INT. CL. 19.
- SHAH, MITAL MAHESH, WESTFORD, MA:
3,398,990, INT. CL. 16.
- SHAKESPEARE COMPANY, LLC, COLUMBIA, SC:
1,502,987, REN. 2-13-08. INT. CL. 16.
- SHAKESPEARE COMPANY, LLC, COLUMBIA, SC, SHAKE-SPEARE COMPANY, COLUMBIA, SC:
2,155,456, REN. 2-8-08. INT. CL. 28.
2,167,846, REN. 2-13-08. INT. CL. 28.
- SHAKESPEARE COMPANY, LLC, COLUMBIA, SC:
2,180,823, REN. 2-13-08. INT. CL. 28.
- SHALOM ZANZURI, STUDIO CITY, CA:
3,396,968, PUB. 1-1-2008. INT. CL. 11.
- SHANGHAI PEIDI BRAND INT'L TRADE CO., LTD, SHANGHAI, CHINA:
3,400,075, INT. CL. 31.
- SHANGHAI PEIDI BRAND INT'L TRADE CO., LTD., SHANGHAI, CHINA:
3,400,076, INT. CL. 31.
- SHAPEFIT, LLC, SAINT PETERSBURG, FL:
3,397,789, PUB. 1-1-2008. INT. CL. 44.
- SHARIPOVA, ELENA, WAHIAWA, HI:
3,399,271, INT. CL. 43.
- SHARP ROCK TECHNOLOGIES LLC, LEWES, DE:
3,397,006, PUB. 1-1-2008. INT. CL. 9.
- SHASTA UNION HIGH SCHOOL DISTRICT, REDDING, CA:
3,397,718, PUB. 1-1-2008. INT. CL. 30.
- SHAW, RALPH, MISSION VIEJO, CA:
2,447,317, CANC. INT. CL. 3.
- SHEPHERD MEDICAL SOLUTIONS LLC, CANTON, NC:
3,397,146, PUB. 1-1-2008. INT. CL. 9.
- SHERMAN, MICHAEL D, NORTHRIDGE, CA:
3,398,119, PUB. 1-1-2008. INT. CL. 41.
- SHERWOOD BRANDS, LLC, ROCKVILLE, MD:
2,135,985, REN. 2-13-08. INT. CL. 30.
- SHERWOOD SCUBA, LLC, SANTA ANA, CA:
1,478,437, REN. 2-13-08. INT. CL. 9.
- SHIELD TITLE AGENCY, INC., SOUTHFIELD, MI:
2,059,284, CANC. MULTIPLE CLASS, INT. CLS. 36 AND 42.
- SHIMADZU CORPORATION, KYOTO, JAPAN:
3,397,358, PUB. 1-1-2008. INT. CL. 10.
- SHIMANO INC., SAKAI CITY, JAPAN:
3,400,188, INT. CL. 28.
- SHIN NIPPON MACHINERY CO., LTD., TOKYO, JAPAN:
3,398,436, PUB. 10-31-2006. INT. CL. 7.
- SHIPYARD BREWING COMPANY, PORTLAND, ME:
3,400,386, INT. CL. 32.
- SHIZUKA MATSUMORI, OKAYAMA-SHI, JAPAN:
3,396,980, PUB. 5-15-2007. INT. CL. 25.
- SHOE MAGNATE, INC., CITY OF INDUSTRY, CA:
3,399,809, INT. CL. 25.
- SHOLAR, WILLIAM, FRISCO, TX:
3,398,114, PUB. 1-1-2008. INT. CL. 42.
- SHOME, DEBASHISH, WASHINGTON, DC:
2,448,542, CANC. INT. CL. 35.
- SHOOK, HARDY & BACON L.L.P., KANSAS CITY, MO:
3,397,791, PUB. 1-1-2008. INT. CL. 45.
- SHOP.COM, MONTEREY, CA, ONLINE INTERACTIVE, INC., SEATTLE, WA:
2,102,641, REN. 2-11-08. INT. CL. 35.
- SHOP.COM, MONTEREY, CA:
3,396,995, PUB. 1-1-2008. INT. CL. 35.
- SHOPKO STORES OPERATING CO., LLC, GREEN BAY, WI:
2,447,263, CANC. INT. CL. 25.
- SHOPPERS VILLAGE LIQUORS, LLC, LEXINGTON, KY:
3,399,658, INT. CL. 33.
- SHOWTIME NETWORKS INC., NEW YORK, NY:
2,447,950, CANC. INT. CL. 41.
2,447,952, CANC. INT. CL. 38.
- SHUTTERFLY, INC., REDWOOD CITY, CA:
3,397,397, PUB. 1-1-2008. MULTIPLE CLASS, INT. CLS. 16 AND 40.
- SIC MARKING, 69380 LISSIEU, FRANCE:
2,606,793, CANC. INT. CL. 37.
- SICHUAN GUOQUANG; AGROCHEMICAL CO., LTD, CHINA:
3,398,792, PUB. 1-1-2008. INT. CL. 1.
- SIDIGU, ANNAH O., DAYTON, OH:
3,397,889, PUB. 1-1-2008. INT. CL. 41.
- SIEMENS AKTIENGESELLSCHAFT, MUNICH, FED REP GERMANY:
2,647,808, CANC. INT. CL. 42.
- SIEMENS MEDICAL SOLUTIONS USA, INC., MALVERN, PA:
3,397,816, PUB. 1-1-2008. INT. CL. 9.
3,399,510, INT. CL. 10.
- SIEMENS WATER TECHNOLOGIES HOLDING CORP., WARRENDALE, PA:
2,132,964, REN. 2-13-08. INT. CL. 11.
- SIERRA ENTERTAINMENT, INC., LOS ANGELES, CA:
2,216,228, REN. 2-14-08. INT. CL. 9.
- SIERRA NEVADA CORPORATION, SPARKS, NV:
3,399,971, INT. CL. 9.
3,399,972, INT. CL. 9.
- SIGMA CHI CORPORATION, EVANSTON, IL:
3,398,093, PUB. 1-1-2008. INT. CL. 25.
3,398,125, PUB. 1-1-2008. INT. CL. 25.
3,398,151, PUB. 1-1-2008. INT. CL. 14.
- SIGMA CORPORATION, TOKYO 201, JAPAN:
2,058,681, CANC. INT. CL. 9.
- SIGNATURE BRANDS LLC, OCALA, FL:
3,400,164, INT. CL. 30.
- SIGNATURE CELEBRITIES, INC., YAKIMA, WA:
3,398,572, PUB. 1-1-2008. INT. CL. 35.
- SIGNATURE FINANCIAL/MARKETING, INC., WILMINGTON, DE:
2,128,834, REN. 2-13-08. INT. CL. 35.
- SIGNWAREHOUSE, INC., DENISON, TX:
3,397,566, PUB. 1-1-2008. INT. CL. 16.
3,397,574, PUB. 1-1-2008. INT. CL. 20.
- SIKA AG, CH-6341 BAAR, SWITZERLAND:
3,398,803, PUB. 1-1-2008. INT. CL. 17.
- SILICON VALLEY GROUP, THERMAL SYSTEMS LLC, SCOTT VALLEY, CA:
2,448,189, CANC. INT. CL. 9.
- SILKWAY INTERNATIONAL LIMITED, HONG KONG:
2,147,401, REN. 2-14-08. MULTIPLE CLASS, INT. CLS. 39

- AND 42.
 SILLY ME. INC., NEW YORK, NY:
 3,397,163, PUB. 1-1-2008. INT. CL. 25.
 SILVA, CHRISTINE LEONORA, PLYMOUTH, MA:
 3,397,749, PUB. 1-1-2008. INT. CL. 25.
 SILVER CINEMAS ACQUISITION CO., LOS ANGELES, CA:
 2,058,951, CANC. INT. CL. 35.
 SILVER SPUR PARTNERS, INC., MARYSVILLE, WA:
 3,397,197, PUB. 1-1-2008. INT. CL. 33.
 SILVER STAR INTERNATIONAL, INC., ST. PETERSBURG,
 FL:
 2,448,492, CANC. INT. CL. 18.
 SILVER, PATRICIA, TORONTO, ONTARIO, CANADA:
 2,059,178, CANC. INT. CL. 41.
 SILVERADE LLC, EAST BRUNSWICK, NJ:
 3,398,945, INT. CL. 5.
 3,398,946, INT. CL. 5.
 SILVERPLATTER INTERNATIONAL, N.V., CURACAO,
 NETHERLD ANTILLES:
 2,447,341, CANC. MULTIPLE CLASS, INT. CLS. 9 AND
 42.
 SILVIO MESSANA, ITALY:
 3,398,794, PUB. 11-27-2007. INT. CL. 33.
 SIMMS FISHING PRODUCTS LLC, BOZEMAN, MT:
 3,398,453, PUB. 1-1-2008. MULTIPLE CLASS, INT. CLS.
 14, 18, 21, 24, 25 AND 28.
 SIMON, JOEL, MENLO PARK, CA, DBA JOEL SIMON
 IMAGES:
 2,145,849, REN. 2-13-08. INT. CL. 39.
 SIMPLE BUSINESS SYSTEMS, INC., SCOTTS VALLEY, CA:
 3,398,163, PUB. 1-1-2008. INT. CL. 42.
 SIMUCAD DESIGN AUTOMATION, INC., SANTA CLARA,
 CA:
 3,397,012, PUB. 1-1-2008. INT. CL. 9.
 SINELLI, JEFFREY, DALLAS, TX:
 3,397,756, PUB. 1-1-2008. INT. CL. 43.
 3,397,758, PUB. 1-1-2008. INT. CL. 43.
 SINGAPORE PRESS HOLDINGS LTD., NEWS CENTRE,
 SINGAPORE:
 2,448,160, CANC. MULTIPLE CLASS, INT. CLS. 38 AND
 42.
 2,448,161, CANC. MULTIPLE CLASS, INT. CLS. 35, 36, 39,
 41 AND 42.
 SINO GEOPHYSICAL CO., LTD., BEIJING, CHINA:
 3,397,149, PUB. 1-1-2008. INT. CL. 42.
 SINOCHEM CORPORATION, CHINA:
 3,398,704, PUB. 1-1-2008. INT. CL. 1.
 3,398,710, PUB. 1-1-2008. INT. CL. 1.
 3,398,729, PUB. 1-1-2008. INT. CL. 1.
 SIONEX CORPORATION, BEDFORD, MA:
 3,397,877, PUB. 1-1-2008. INT. CL. 9.
 SIR CHARLES BLUES LAB, THE, LOS ANGELES, CA:
 2,447,837, CANC. INT. CL. 41.
 SIR GROOVY INC., MAMARONECK, NY:
 3,397,491, PUB. 1-1-2008. MULTIPLE CLASS, INT. CLS. 36
 AND 45.
 SIR, RICHARD HYUN, LOS ANGELES, CA:
 2,124,965, REN. 2-11-08. INT. CL. 25.
 SK&A, INC., LEOLA, PA:
 2,448,263, CANC. MULTIPLE CLASS, INT. CLS. 16 AND
 35.
 SKECHERS U.S.A., INC. II, MANHATTAN BEACH, CA:
 3,399,073, INT. CL. 25.
 3,399,196, INT. CL. 26.
 SKWORTSOW KOSTER MEDIA GROEP (SKMG) B.V.,
 NETHERLANDS:
 3,398,804, PUB. 1-1-2008. MULTIPLE CLASS, INT. CLS.
 35, 40, 41 AND 42.
 SLEEPSONIC, LLC, YELM, WA:
 3,397,832, PUB. 1-1-2008. INT. CL. 9.
 SLUTSKY, JEFF, GAHANNA, OH:
 2,447,546, CANC. MULTIPLE CLASS, INT. CLS. 9 AND
 41.
 SMALL ENTERPRISE ASSISTANCE FUNDS, WASHING-
 TON, DC:
 2,058,624, CANC. INT. CL. 42.
 SMART PAPERS HOLDINGS LLC, HAMILTON, OH:
 3,398,427, PUB. 1-1-2008. INT. CL. 16.
 SMARTPAK EQUINE, LLC., PLYMOUTH, MA:
 3,398,277, PUB. 1-1-2008. INT. CL. 5.
 SMARTPOOL INCORPORATED, LAKEWOOD, NJ:
 3,400,016, INT. CL. 1.
 SMITH ABRASIVES, INC., HOT SPRINGS, AR:
 2,203,721, REN. 2-9-08. INT. CL. 8.
 SMITH ENGINEERING CONSULTANTS, INC., MCHENRY,
 IL:
 3,398,422, PUB. 1-1-2008. INT. CL. 42.
 SMITH NEWS COMPANY, INC., SAN FRANCISCO, CA:
 3,399,520, INT. CL. 25.
 SMITHKLINE BEECHAM CORPORATION, PHILADEL-
 PHIA, PA:
 3,400,286, INT. CL. 3.
 SMITHKLINE BEECHAM PLC, BRENTFORD, MIDDLE-
 SEX, UNITED KINGDOM:
 3,399,357, INT. CL. 5.
 SMITHS MEDICAL ASD, INC., KEENE, NH:
 1,458,203, REN. 2-14-08. INT. CL. 10.
 SMITHS MEDICAL ASD, INC., KEANE, NH:
 1,482,816, REN. 2-8-08. INT. CL. 10.
 SMJ GROUP, INC., NEW YORK, NY:
 2,137,156, REN. 2-9-08. INT. CL. 42.
 SML SPORT, LTD., NEW YORK, NY:
 1,476,040, REN. 2-11-08. INT. CL. 25.
 1,477,832, REN. 2-11-08. INT. CL. 25.
 SMYTH, STUART KJ, SHELBURNE, VT:
 3,399,467, INT. CL. 10.
 SN EVENTS INC., BEVERLY HILLS, CA:
 3,397,151, PUB. 1-1-2008. INT. CL. 41.
 SNAP-ON INCORPORATED, KENOSHA, WI:
 2,129,999, REN. 2-11-08. INT. CL. 7.
 SNBT DIAMONDS & JEWELRY, LTD., HOUSTON, TX:
 3,396,855, PUB. 1-1-2008. INT. CL. 35.
 SNOWBIRD CORPORATION, SNOWBIRD, UT:
 2,189,858, REN. 2-12-08. INT. CL. 36.
 2,448,564, CANC. INT. CL. 41.
 SNYDER, STEPHEN B., FISHERS, IN:
 3,399,388, MULTIPLE CLASS, INT. CLS. 16 AND 41.
 SOCIAL SAUCE, NEW YORK, NY:
 3,399,012, INT. CL. 42.
 3,399,013, INT. CL. 42.
 SOCIETE ANONYME DES BAINS DE MER ET DU CERCLE
 DES ETRANGERS A MONACO, MONACO:
 3,292,537, CANC. MULTIPLE CLASS, INT. CLS. 9, 16
 AND 28.
 SOCIETE CIVILE DU CHATEAU RAYNE VIGNEAU,
 BOMMES, FRANCE:
 3,397,683, PUB. 1-1-2008. INT. CL. 33.
 SOCIETE DES PRODUITS NESTLE S.A., VEVEY, SWITZER-
 LAND:
 843,369, REN. 2-14-08. U.S. CL. 46 (INT. CL. 30).
 SOCIETE DES PRODUITS NESTLE S.A., VEVEY, SWITZER-
 LAND, CARNATION COMPANY, LOS ANGELES, CA:
 846,367, REN. 2-13-08. U.S. CL. 46 (INT. CLS. 1, 5, 29, 30, 31
 AND 32).
 SOCIETE DES PRODUITS NESTLE S.A., 1800 VEVEY,
 SWITZERLAND:
 1,084,974, REN. 2-14-08. INT. CL. 30.
 SOCIETE DES PRODUITS NESTLE S.A., 1800 VEVEY,
 SWITZERLAND, CARNATION COMPANY, LOS AN-
 GELES, CA:
 1,086,567, REN. 2-13-08. INT. CL. 30.
 1,086,568, REN. 2-13-08. INT. CL. 30.
 1,087,403, REN. 2-13-08. INT. CL. 29.
 SOCIETE DES PRODUITS NESTLE S.A., VEVEY, SWITZER-
 LAND:
 1,089,999, REN. 2-12-08. INT. CL. 5.
 SOCIETY FOR MAINTENANCE AND RELIABILITY PRO-
 FESSIONALS, MCLEAN, VA:
 3,397,961, PUB. 1-1-2008. INT. CL. 35.
 SOCIETY FOR THE ARTS IN HEALTHCARE, WASHING-
 TON, DC:
 3,397,682, PUB. 1-1-2008. INT. CL. 41.
 SOCIETY OF COMPETITIVE INTELLIGENCE PROFES-
 SIONALS, ALEXANDRIA, VA:
 3,398,574, PUB. 1-1-2008. INT. CL. 16.

- SOCIETY OF MANUFACTURING ENGINEERS, DEARBORN, MI:
2,448,528, CANC. U.S. CL. 200.
2,448,529, CANC. U.S. CL. 200.
- SODEXHO, INC., GAITHERSBURG, MD:
2,141,345, REN. 2-11-08. INT. CL. 42.
3,399,038, INT. CL. 43.
3,399,039, INT. CL. 43.
- SOFT PLAY, L.L.C., CHARLOTTE, NC:
2,448,454, CANC. INT. CL. 41.
- SOFT-LITE L.L.C., STREETSBORO, OH:
3,400,030, INT. CL. 19.
- SOFTSPIKES, LLC, GAITHERSBURG, MD:
3,396,821, PUB. 8-31-2004. INT. CL. 25.
- SOKOL, BRENT D., LOS ANGELES, CA AND CHIANG, CHIA C., LOS ANGELES, CA:
3,399,302, INT. CL. 21.
- SOL STIX, LLC, MARBLE HILL, GA:
3,398,894, INT. CL. 29.
- SOLARI GOLF, INC., MARINA DEL REY, CA:
3,398,970, INT. CL. 28.
- SOLARNIX INTERNATIONAL INC., VANCOUVER, BRITISH COLUMBIA, CANADA:
2,448,007, CANC. INT. CL. 25.
- SOLEL SOFTWARE CORPORATION, SAN DIEGO, CA:
3,397,615, PUB. 1-1-2008. INT. CL. 9.
- SOLID AXLE INDUSTRIES LLC, NORTH JACKSON, OH:
3,397,081, PUB. 1-1-2008. INT. CL. 12.
- SOLO JOSE INTERNATIONAL CORPORATION, ROAD TOWN, TORTOLA, BR. VIRGIN ISLANDS:
2,448,071, CANC. INT. CL. 14.
- SOLORIO, ANTHONY, RIVERSIDE, CA AND CUMMINGS, JARED, RIVERSIDE, CA:
3,397,233, PUB. 1-1-2008. INT. CL. 25.
- SOLSTICE MARKETING CORPORATION, PARSIPPANY, NJ:
3,396,949, PUB. 1-1-2008. INT. CL. 35.
- SOMERSET PHARMACEUTICALS, INC., TAMPA, FL:
3,399,830, MULTIPLE CLASS, INT. CLS. 5, 16 AND 42.
- SOMFY SAS, FRANCE:
3,398,821, PUB. 1-1-2008. INT. CL. 9.
- SOMO, INC., MELBOURNE, FL:
3,398,212, PUB. 1-1-2008. INT. CL. 33.
- SON, JAMES, PALMDALE, CA AND SON, CINTHIA HYUN-MI, PALMDALE, CA:
2,448,244, CANC. INT. CL. 25.
- SONOMAX HEARING HEALTHCARE INC., MONTREAL, QUEBEC H4P 2E2, CANADA:
3,396,841, PUB. 1-1-2008. MULTIPLE CLASS, INT. CLS. 9, 10, 42 AND 44.
- SONY KABUSHIKI KAISHA, TOKYO, JAPAN, TA SONY CORPORATION:
2,448,198, CANC. INT. CL. 9.
- SONY NEC OPTIARC INC., JAPAN:
3,398,666, PUB. 1-1-2008. INT. CL. 9.
- SOREMARTEC S.A., 6700 SCHOPPACH-ARLON, BELGIUM:
2,448,003, CANC. INT. CL. 30.
- SORENSEN GENOMICS, L.L.C., SALT LAKE CITY, UT:
3,400,237, INT. CL. 42.
- SORGENTE VALCIMOLIANA S.R.L., I-33080 CIMOLAIS (PN), ITALY:
3,398,745, PUB. 1-1-2008. INT. CL. 32.
- SORMA S.P.A., 47023 CESENA, ITALY:
2,163,006, REN. 2-13-08. MULTIPLE CLASS, INT. CLS. 6, 7 AND 8.
- SOULATI, SARA, INGLEWOOD, CA:
3,400,355, INT. CL. 35.
- SOURCE MEDIA INC., NEW YORK, NY:
3,400,403, INT. CL. 41.
- SOURCECODE TECHNOLOGY HOLDINGS, INC., REDMOND, WA:
3,398,387, PUB. 1-1-2008. MULTIPLE CLASS, INT. CLS. 9 AND 42.
- SOURCENTERPRISES, INC., ANAHEIM, CA:
3,399,016, INT. CL. 28.
3,399,093, INT. CL. 28.
- SOUTH AFRICAN RUGBY UNION, NEWLANDS, SOUTH AFRICA:
3,396,820, PUB. 1-1-2008. INT. CL. 25.
- SOUTH SHORE CONSERVATORY OF MUSIC, INC., HINGHAM, MA:
3,398,207, PUB. 1-1-2008. INT. CL. 41.
- SOUTHGATE ENTERPRISES, INC., SOUTHGATE, MI TO BYCOR, INC., SOUTHGATE, MI:
2,059,215, CANC. INT. CL. 42.
- SPACE EXPLORERS, INC., DE PERE, WI:
3,397,987, PUB. 1-1-2008. INT. CL. 41.
- SPACE RADIO PRODUCTIONS LLC, ROSLINDALE, MA:
3,399,783, INT. CL. 41.
- SPACEMAKER PRESS, LLC, WASHINGTON, DC:
2,130,531, REN. 2-14-08. INT. CL. 16.
- SPAM CUBE, INC, NEW YORK, NY, DBA SPAM CUBE:
3,398,368, PUB. 11-15-2005. INT. CL. 9.
- SPAMFIGHTER APS, COPENHAGEN N, DENMARK:
3,398,423, PUB. 5-2-2006. INT. CL. 9.
- SPANGLER CANDY COMPANY, BRYAN, OH:
3,397,436, PUB. 1-1-2008. INT. CL. 30.
- SPANJAARD GROUP LIMITED, WYNBERG, SANDTON 2196, GAUTENG, SOUTH AFRICA:
3,399,502, INT. CL. 4.
- SPARTAN CHEMICAL CO., INC., MAUMEE, OH:
1,476,450, REN. 2-8-08. INT. CL. 3.
1,476,451, REN. 2-8-08. INT. CL. 3.
- SPARTAN CHEMICAL COMPANY, INC., MAUMEE, OH:
2,144,397, REN. 2-8-08. INT. CL. 3.
- SPAULDING COMPOSITES, INC., ROCHESTER, NH:
833,851, REN. 2-14-08. U.S. CL. 1 (INT. CL. 1).
833,852, REN. 2-9-08. U.S. CL. 1 (INT. CL. 17).
- SPC RESOURCES, INC., HARTSVILLE, SC:
3,398,053, PUB. 1-1-2008. INT. CL. 40.
- SPD SWISS PRECISION DIAGNOSTICS GMBH, GENEVA, SWITZERLAND, UNIPATH LIMITED, BEDFORD, ENGLAND:
1,492,770, REN. 2-9-08. INT. CL. 1.
- SPEAKOUT.COM, INC., WASHINGTON, DC:
2,447,790, CANC. INT. CL. 35.
- SPECIALTY MANUFACTURING, INC., PINEVILLE, NC:
1,452,047, REN. 2-8-08. INT. CL. 12.
- SPECIALTY SPINE PRODUCTS, LLC, REDLANDS, CA:
3,397,452, PUB. 1-1-2008. INT. CL. 10.
- SPEERT ADVERTISING SPECIALTIES, INC., REISTERTOWN, MD:
2,146,299, REN. 2-9-08. INT. CL. 35.
- SPER SCIENTIFIC, LTD., SCOTTSDALE, AZ:
2,221,510, REN. 2-11-08. INT. CL. 35.
- SPIELO MANUFACTURING ULC, MONCTON, NEW BRUNSWICK, CANADA:
3,399,891, INT. CL. 9.
3,399,994, INT. CL. 9.
- SPINAL RESTORATION, INC., AUSTIN, TX:
3,399,111, INT. CL. 5.
- SPINWAVE SYSTEMS, INC., WESTFORD, MA:
3,399,801, INT. CL. 9.
- SPIRAC ENGINEERING AB, SE-216 08 MALMO, SWEDEN:
2,129,643, REN. 2-13-08. MULTIPLE CLASS, INT. CLS. 7 AND 11.
- SPIRAL-UP INTERACTIVE, INC., ORLANDO, FL:
2,447,378, CANC. INT. CL. 35.
- SPLAT*R KATCH*R, INC., TAMPA, FL:
3,399,081, INT. CL. 16.
3,399,082, INT. CL. 16.
- SPOILED ROTTEN U.S.A., BRONX, NY:
3,398,862, INT. CL. 25.
- SPONSORDIRECT, LLC, TARRYTOWN, NY:
3,399,345, INT. CL. 9.
- SPORTCRAFT, LTD., MT. OLIVE, NJ:
1,491,986, REN. 2-14-08. MULTIPLE CLASS, INT. CLS. 9 AND 28.
1,491,986, CANC. INT. CL. 25.
- SPORTEC PRODUCTS COMPANY, DUBLIN, OH:
2,447,684, CANC. INT. CL. 21.
- SPORTSCOACH.COM, INC., THE, MOORPARK, CA:
2,447,823, CANC. INT. CL. 41.

SPORTSPOWER, LTD., HUNGHOM KOWLOON, HONG KONG:
3,399,152, INT. CL. 10.

SPOT-ON NETWORKS, LLC, NEW HAVEN, CT:
3,396,971, PUB. 1-1-2008. INT. CL. 38.

SPRAYING SYSTEMS CO., WHEATON, IL:
3,400,200, INT. CL. 9.

SPRAYWAY LIMITED, MANCHESTER M1 5GE, UNITED KINGDOM:
2,447,287, CANC. INT. CL. 25.

SRQ PROPERTY GROUP, LLC, SARASOTA, FL:
3,399,238, INT. CL. 36.

SSP FINANCING UK LIMITED, UNITED KINGDOM:
3,398,646, PUB. 1-1-2008. MULTIPLE CLASS, INT. CLS. 16, 35 AND 43.

ST. CLAIR ENTERTAINMENT GROUP INC., THE, ST. LAURENT, QUEBEC:
2,448,382, CANC. INT. CL. 9.

ST. JAMES, CHARLES, MILFORD, CT:
3,397,716, PUB. 1-1-2008. INT. CL. 41.

ST. JUDE MEDICAL ATRIAL FIBRILLATION DIVISION, INC., MINNETONKA, MN:
3,397,949, PUB. 1-1-2008. INT. CL. 10.
3,397,950, PUB. 1-1-2008. INT. CL. 10.

STAG-PARKWAY, INC., ATLANTA, GA:
2,899,647, CANC. INT. CL. 16.

STAGL, JOHN, BRADENTON, FL:
3,397,653, PUB. 1-1-2008. INT. CL. 9.

STAKEHOLDER, INC, WHEATON, MD:
3,397,126, PUB. 1-1-2008. INT. CL. 35.

STAMPINGTON & COMPANY, LLC, LAGUNA HILLS, CA:
3,397,481, PUB. 1-1-2008. INT. CL. 16.

STANDARD CAR TRUCK COMPANY, PARK RIDGE, IL:
1,084,674, REN. 2-14-08. INT. CL. 12.

STANDARD PERFORMANCE EVALUATION CORPORATION, WARRENTON, VA:
2,142,738, REN. 2-13-08. INT. CL. 9.

STANFORD FINANCIAL GROUP COMPANY, HOUSTON, TX:
3,396,962, PUB. 1-1-2008. INT. CL. 36.

STANLEY LOGISTICS, INC., NEW BRITAIN, CT:
2,447,675, CANC. INT. CL. 8.

STAPLE DESIGN STUDIO INC., NEW YORK, NY:
3,398,216, PUB. 1-1-2008. INT. CL. 25.
3,398,218, PUB. 1-1-2008. INT. CL. 42.

STAPLES THE OFFICE SUPERSTORE, LLC, FRAMINGHAM, MA:
3,399,403, INT. CL. 35.

STAR BRIDGE SYSTEMS, INC., DRAPER, UT:
2,447,859, CANC. INT. CL. 42.

STARBRIDGE LLC, SAN DIEGO, CA:
3,399,977, MULTIPLE CLASS, INT. CLS. 35 AND 36.

STARDIAL COMMUNICATIONS CORPORATION, NEW YORK, NY:
2,138,721, REN. 2-13-08. INT. CL. 35.

STARSAT, LLC, LOUISVILLE, KY:
3,398,850, MULTIPLE CLASS, INT. CLS. 9, 35, 38 AND 45.

STARTER FLUID MANAGEMENT, LLC, SAN FRANCISCO, CA:
2,447,988, CANC. INT. CL. 36.

STARZ ENTERTAINMENT, LLC, ENGLEWOOD, CO:
2,447,582, CANC. MULTIPLE CLASS, INT. CLS. 38 AND 41.

STATE OF CALIFORNIA DEPARTMENT OF PARKS AND RECREATION, SACRAMENTO, CA:
2,146,227, REN. 2-14-08. MULTIPLE CLASS, INT. CLS. 16 AND 41.

STATICOFF, LLC, SOUTH PORTLAND, ME:
3,400,028, INT. CL. 9.

STEAK N SHAKE LLC, INDIANAPOLIS, IN:
3,399,855, INT. CL. 30.

STEC, INC., SANTA ANA, CA:
3,398,236, PUB. 1-1-2008. INT. CL. 9.

STEEL CITY CORPORATION, THE, YOUNGSTOWN, OH:
3,396,875, PUB. 11-27-2007. INT. CL. 20.

STEFAN GERLEMAN, SWEDEN:
3,398,672, PUB. 1-1-2008. INT. CL. 11.

STEINBECK COUNTRY MARKETING, INC., SALINAS, CA, HILLTOWN PACKING COMPANY, SALINAS, CA:
1,475,201, REN. 2-11-08. INT. CL. 31.

STEINMEYER, NANCY L., BULL VALLEY, IL:
3,399,088, INT. CL. 16.

STELLAR MANUFACTURING, INC., BEND, OR:
3,399,989, INT. CL. 21.

STEM/LEACH COMPANY, ATTLEBORO, MA:
1,077,819, REN. 2-12-08. INT. CL. 14.

STEP 13, INC., DENVER, CO:
3,397,136, PUB. 1-1-2008. MULTIPLE CLASS, INT. CLS. 36 AND 37.

STEPHENS & COMPANY, ST. HELENA, CA, DBA D.R. STEPHENS ESTATE:
3,397,908, PUB. 1-1-2008. INT. CL. 33.

STERILEX CORPORATION, HAVERFORD, PA TO VENUS LABORATORIES, INC., WOOD DALE, IL:
2,059,613, CANC. INT. CL. 5.

STERIS CORPORATION, MENTOR, OH:
1,477,098, REN. 2-14-08. INT. CL. 37.

STERLING COMMERCE, INC., DALLAS, TX:
2,448,376, CANC. INT. CL. 9.

STERLING LIFE INSURANCE COMPANY, GLENVIEW, IL:
3,397,217, PUB. 1-1-2008. INT. CL. 36.

STERLING PUBLISHING CO., INC., NEW YORK, NY:
3,399,231, INT. CL. 16.

STERLING STARS, INC., SCARSDALE, NY:
3,399,027, MULTIPLE CLASS, INT. CLS. 41 AND 44.

STEVE CHANDLER, GERMANTOWN, TN:
3,397,374, PUB. 9-25-2007. INT. CL. 7.

STEVE ELLIS DESIGN, INC., VIRGINIA CITY, NV:
2,448,257, CANC. INT. CL. 16.

STEWART STEEL INC., WEYBURN, SASKATCHEWAN, CANADA:
3,399,389, INT. CL. 7.

STEWART, RICK, ARDEN, NC, DBA VENGEANCE GUITARS AND GRAPHIX:
3,397,972, PUB. 1-1-2008. INT. CL. 15.

STEWART, ANNE C, MEMPHIS, TN:
3,399,810, INT. CL. 25.

STEWART, GREGORY J., NEW YORK, NY:
3,400,144, INT. CL. 25.

STF PRODUCTIONS, INC., LOS ANGELES, CA:
2,130,242, REN. 2-9-08. INT. CL. 41.
2,135,529, REN. 2-8-08. INT. CL. 41.

STILLWELL, MELINDA, SPARKS, NV:
1,475,911, REN. 2-13-08. INT. CL. 16.

STONYFIELD FARM, INC., LONDONDERRY, NH:
3,399,084, INT. CL. 35.

STORACTIVE, INC., MARINA DEL REY, CA:
2,448,140, CANC. INT. CL. 9.

STOWE WOODWARD COMPANY LLC, YOUNGSVILLE, NC:
3,399,558, INT. CL. 7.

STOWE WOODWARD LLC, WESTBOROUGH, MA:
3,399,879, INT. CL. 7.
3,399,880, INT. CL. 7.
3,399,881, INT. CL. 7.
3,399,882, INT. CL. 7.

STRAIGHT LINE INSULATION I, LP, SOUTH HOUSTON, TX:
3,400,141, INT. CL. 17.

STRATEGIC LEADERSHIP ASSOCIATES, INC., DAYTON, OH:
2,115,290, REN. 2-13-08. MULTIPLE CLASS, INT. CLS. 35 AND 41.

STRATEGY COMPANION TAIWAN CORPORATION, TAIPEI, TAIWAN:
3,399,492, MULTIPLE CLASS, INT. CLS. 9 AND 42.

STRATSTAFF, LLC, DENVER, CO:
3,397,964, PUB. 1-1-2008. INT. CL. 35.

STREAM INTERNATIONAL INC., CANTON, MA:
2,447,399, CANC. INT. CL. 42.

STREET INK CORPORATION, APOPKA, FL:
3,397,670, PUB. 1-1-2008. MULTIPLE CLASS, INT. CLS. 41 AND 45.

STRICKLAND, KAREN, WEST CHESTER, OH:
3,397,785, PUB. 1-1-2008. INT. CL. 41.

- STRIKEMASTER CORPORATION, BIG LAKE, MN:
3,398,954, INT. CL. 25.
- STRONGLITE, LLC, SALT LAKE CITY, UT:
2,180,158, REN. 2-14-08, INT. CL. 10.
- STRYKER CORPORATION, KALAMAZOO, MI:
2,059,630, CANC. INT. CL. 10.
- STUART-CURTIS FAMILY TRUST, NEW YORK, NY:
3,400,385, INT. CL. 3.
- STUDENT LOAN XPRESS, INC., SAN DIEGO, CA:
2,448,466, CANC. INT. CL. 36.
- STUDOR, INC., DUNEDIN, FL:
3,398,874, INT. CL. 11.
- STUDYGLOBAL M&A SL, BARCELONA, SPAIN:
3,399,253, INT. CL. 35.
- STURGIS BANK & TRUST COMPANY, STURGIS, MI:
3,398,055, PUB. 1-1-2008, INT. CL. 36.
- STYLE EYES, INC., COSTA MESA, CA:
3,396,920, PUB. 1-1-2008, INT. CL. 9.
- SU-KAM COMMUNICATION SYSTEMS LTD., NEW DELHI 110046, INDIA:
3,398,378, PUB. 1-1-2008, INT. CL. 9.
- SUB-Q, INC., SAN CLEMENTE, CA:
2,448,363, CANC. INT. CL. 10.
- SUBURBAN PUBLISHING CORPORATION, PEABODY, MA:
3,400,266, INT. CL. 16.
- SUCCESSFULMATCH.COM, INC., SAN FRANCISCO, CA:
3,398,531, PUB. 1-1-2008, INT. CL. 45.
- SUCCESSFULMATCH.COM, INC., MOUNTAIN VIEW, CA:
3,398,532, PUB. 1-1-2008, INT. CL. 45.
3,398,533, PUB. 1-1-2008, INT. CL. 45.
- SUIGIYAMA SAW MFG. CO., LTD., JAPAN:
3,398,818, PUB. 1-1-2008, INT. CL. 7.
- SUKI, INC., NORTHAMPTON, MA:
3,398,178, PUB. 1-1-2008, INT. CL. 3.
- SUMMER PRODUCTIONS, INC., ALEXANDRIA, VA:
2,447,339, CANC. INT. CL. 41.
- SUMMER WINTER ACTION TOURS, LLC, REDONDO BEACH, CA:
2,447,935, CANC. INT. CL. 39.
2,447,936, CANC. INT. CL. 39.
- SUMMIT LABORATORIES, INC., HARVEY, IL:
3,399,672, MULTIPLE CLASS, INT. CLS. 3 AND 5.
- SUMMIT STONE, INC., NORTH LAWRENCE, OH:
3,399,735, INT. CL. 19.
- SUN LIFE ASSURANCE COMPANY OF CANADA, TORONTO, ONTARIO, CANADA:
3,400,109, INT. CL. 36.
- SUNBELT RENTALS, INC., FORT MILL, SC:
2,448,196, CANC. MULTIPLE CLASS, INT. CLS. 35 AND 37.
- SUNDANCE CHANNEL, LLC, NEW YORK, NY:
3,398,969, INT. CL. 41.
- SUNDS DEFIBRATOR AKTIEBOLAG, SUNSVALL, SWEDEN:
1,438,496, CANC. INT. CL. 7.
- SUNDYNE CORPORATION, ARVADA, CO, KONTRON COMPANY, INC., THE, ORANGE, MA:
1,479,331, REN. 2-13-08, INT. CL. 7.
- SUNPLUS TECHNOLOGY CO., LTD., HSIN-CHU, TAIWAN:
3,398,495, PUB. 1-1-2008, INT. CL. 9.
- SUNPORT HOMES, LLC, BRANDON, FL:
3,399,066, INT. CL. 37.
- SUNRISE SYSTEMS LIMITED, WATERBEACH, CAMBRIDGE, ENGLAND:
3,398,211, PUB. 1-1-2008, INT. CL. 9.
- SUNS LEGACY PARTNERS, LLC, PHOENIX, AZ:
3,399,317, INT. CL. 25.
- SUNSHINE MILLS, INC., RED BAY, AL:
3,399,149, INT. CL. 31.
- SUNSTONE YOGA, L.L.C., DALLAS, TX:
3,400,280, INT. CL. 41.
3,400,281, INT. CL. 41.
- SUNSTREET MORTGAGE, LLC, TUCSON, AZ:
3,397,114, PUB. 1-1-2008, MULTIPLE CLASS, INT. CLS. 35 AND 36.
- SUNTRUST BANKS, INC., ORLANDO, FL:
3,399,220, INT. CL. 36.
- SUNVIEW SOFTWARE, INC., TAMPA, FL:
3,397,917, PUB. 1-1-2008, INT. CL. 9.
- SUOMINEN KUITUKANKAAT OY, FI-29250 NAKKILA, FINLAND:
3,398,776, PUB. 1-1-2008, INT. CL. 24.
3,398,777, PUB. 1-1-2008, INT. CL. 24.
- SUPERIOR BRANDS, INC., NORTH HOLLYWOOD, CA:
3,397,954, PUB. 1-1-2008, INT. CL. 32.
- SUPERIOR ESSEX COMMUNICATIONS LP, ATLANTA, GA:
3,399,518, INT. CL. 9.
- SUPERIOR FIBER MILLS, INC., BROOKLYN, NY:
3,400,239, INT. CL. 20.
- SUPERIOR INTERNATIONAL TRADING, L. C., MIAMI BEACH, FL:
2,448,477, CANC. MULTIPLE CLASS, INT. CLS. 3, 29 AND 30.
- SUPERIOR SEWING MACHINE AND SUPPLY LLC, NEW YORK, NY:
844,443, REN. 2-13-08, U.S. CL. 21 (INT. CL. 9).
- SUPERMED HEALTH INC., POMONA, CA:
3,397,471, PUB. 1-1-2008, INT. CL. 5.
- SUPPORTWORKS: THE SELF-HELP CLEARINGHOUSE, INC., CHARLOTTE, NC:
2,210,752, REN. 2-12-08, INT. CL. 35.
- SUPREME CORPORATION, CONOVER, NC:
3,397,066, PUB. 1-1-2008, INT. CL. 17.
- SUPREME DOMINION, INC., WEST PATERSON, NJ:
2,447,593, CANC. INT. CL. 28.
- SUREFIRE, LLC, FOUNTAIN VALLEY, CA:
3,397,776, PUB. 1-1-2008, INT. CL. 11.
- SURFCONTROL PLC, CONGLETON, UNITED KINGDOM:
3,398,438, PUB. 1-1-2008, MULTIPLE CLASS, INT. CLS. 9 AND 42.
- SURGEON'S MANAGEMENT, INC., HOUSTON, TX:
3,397,572, PUB. 1-1-2008, INT. CL. 44.
3,397,577, PUB. 1-1-2008, INT. CL. 44.
- SURVIVAL ARMOR, INC., FORT MYERS, FL:
3,400,084, INT. CL. 9.
3,400,085, INT. CL. 9.
- SUSAN DELL, INC., NEW YORK, NY:
3,398,875, INT. CL. 18.
- SUSANNE BOJESEN ROSENQVIST, DK-1811 FREDERIKSBERG C, DENMARK:
3,398,675, PUB. 1-1-2008, MULTIPLE CLASS, INT. CLS. 8, 14, 20, 21, 28 AND 35.
- SUSQUEHANNA RADIO CORP., YORK, PA:
2,447,983, CANC. INT. CL. 38.
- SUSTAINABLE AGRICO, L.L.C., SANTE FE, NM:
3,399,912, INT. CL. 30.
3,399,921, INT. CL. 30.
- SUSTAINABLE RESOURCE VENTURES, LLC, CONCORD, MA:
3,400,339, INT. CL. 36.
- SUSTAINABLE SOURCING, LLC, GREAT BARRINGTON, MA:
3,397,503, PUB. 1-1-2008, INT. CL. 30.
- SUSY DORN PRODUCTIONS, LLC, SAN JOSE, CA:
3,397,459, PUB. 1-1-2008, INT. CL. 41.
- SUTHERLAND, STEVE S., MANASSA, CO AND SUTHERLAND, CHRISTINA, MANASSA, CO:
3,398,588, PUB. 6-5-2007, INT. CL. 14.
- SUTTON GREEN, LLC, CASTLE ROCK, CO:
3,398,333, PUB. 1-1-2008, INT. CL. 36.
- SUTTON, ADAM, KANEOHE, HI:
3,399,466, INT. CL. 6.
- SUTURA, INC., FOUNTAIN VALLEY, CA:
3,400,295, INT. CL. 10.
- SW CREATIONS, NOCONA, TX:
3,398,439, PUB. 1-1-2008, INT. CL. 12.
- SWANSON, JOHN WESTWOOD, PORTLAND, OR:
3,399,772, INT. CL. 16.
- SWANSON, SCOTT, W. HOLLYWOOD, CA:
2,448,052, CANC. INT. CL. 42.
- SWAROVSKI AKTIENGESELLSCHAFT, LIECHTENSTEIN:
3,398,641, PUB. 1-1-2008, MULTIPLE CLASS, INT. CLS. 35 AND 41.

SWAT.FAME, INC., CITY OF INDUSTRY, CA:
3,400,219, INT. CL. 25.

SWEDISH MATCH UNITED BRANDS AB, STOCKHOLM, SWEDEN, AMERICAN TOBACCO COMPANY, THE, NEW YORK, NY:
843,561, REN. 2-9-08. U.S. CL. 17 (INT. CL. 34).

SWEET LIFE ENTERPRISE, INC., THE, IRVINE, CA:
2,747,967, COR. INT. CL. 28.

SWEET LIFE ENTERPRISES, INC., THE, IRVINE, CA:
2,701,185, COR. MULTIPLE CLASS, INT. CLS. 30 AND 35.
2,762,309, COR. INT. CL. 28.
2,816,996, COR. MULTIPLE CLASS, INT. CLS. 30 AND 35.

SWEETMAN CONST. CO., SIOUX FALLS, SD:
3,397,148, PUB. 1-1-2008. INT. CL. 19.

SWIFT-LITE CHARCOAL COMPANY LTD., BATTLE EAST SUSSEX, UNITED KINGDOM:
3,398,375, PUB. 1-1-2008. MULTIPLE CLASS, INT. CLS. 4 AND 34.

SWIMC, INC., WILMINGTON, DE:
1,096,391, REN. 2-9-08. INT. CL. 2.

SWIMC, INC., WILMINGTON, DE, SHERWIN-WILLIAMS COMPANY, THE, CLEVELAND, OH:
1,471,858, REN. 2-13-08. INT. CL. 2.

SWIMC, INC., WILMINGTON, DE:
2,172,431, REN. 2-14-08. INT. CL. 8.

SWIMC, INC., WILMINGTON, DE, SHERWIN-WILLIAMS COMPANY, THE, CLEVELAND, OH:
2,176,690, REN. 2-12-08. INT. CL. 2.

SWIMC, INC., WILMINGTON, DE:
2,447,310, CANC. INT. CL. 16.

SWING SCIENCE, LLC, INDIANAPOLIS, IN:
3,400,057, INT. CL. 28.

SWISS REINSURANCE COMPANY, 8022 ZURICH, SWITZERLAND:
2,134,733, REN. 2-11-08. INT. CL. 36.

SWISSCLINICAL S.A., 1800 VEVEY, SWITZERLAND:
3,397,610, PUB. 1-1-2008. INT. CL. 3.

SWYCHCO INFRASTRUCTURE SERVICES PTY LTD, VICTORIA 3000, AUSTRALIA:
2,447,277, CANC. MULTIPLE CLASS, INT. CLS. 9, 35, 36 AND 42.

SY.MED DEVELOPMENT, INC., BRENTWOOD, TN:
2,145,913, REN. 2-11-08. INT. CL. 9.

SYLMARK HOLDINGS LIMITED, DUBLIN 2, IRELAND:
3,399,347, INT. CL. 28.

SYMANTEC CORPORATION, CUPERTINO, CA:
3,399,306, INT. CL. 9.

SYMRISE GMBH & CO. KG, HOLZMINDEN, FED REP GERMANY:
3,398,338, PUB. 1-1-2008. INT. CL. 3.

SYNCHROPLEX IMAGING SYSTEMS, INC., OVERLAND PARK, KS:
3,399,321, INT. CL. 9.

SYNKINETICS, INC., LOWELL, MA:
2,077,856, REN. 2-11-08. INT. CL. 7.

SYRACUSE CHINA COMPANY, TOLEDO, OH:
2,137,547, REN. 2-9-08. INT. CL. 21.

SYSCO CORPORATION, HOUSTON, TX:
3,399,689, INT. CL. 36.
3,399,690, INT. CL. 35.
3,399,691, INT. CL. 41.

SYSTEMES NORBEC INC., BOUCHERVILLE, QUEBEC, CANADA:
2,120,718, REN. 2-13-08. INT. CL. 6.

T PRO INC., NEW YORK, NY:
2,058,807, CANC. MULTIPLE CLASS, INT. CLS. 39 AND 42.

T.W. PELTON & CO., PINE BLUFF, AR:
1,993,663, REN. 2-13-08. INT. CL. 3.

T-MOBILE USA, INC., BELLEVUE, WA:
3,398,289, PUB. 1-1-2008. INT. CL. 5.
3,398,292, PUB. 1-1-2008. INT. CL. 28.
3,398,293, PUB. 1-1-2008. INT. CL. 30.
3,398,294, PUB. 1-1-2008. INT. CL. 11.
3,398,295, PUB. 1-1-2008. INT. CL. 25.
3,398,296, PUB. 1-1-2008. INT. CL. 6.

T-TOWN, L.L.C., TUCSON, AZ:
3,399,943, INT. CL. 25.

TABLE TALK REALTY COMPANY LIMITED PARTNERSHIP, WORCESTER, MA:
1,512,918, REN. 2-12-08. INT. CL. 30.

TACODA, INC., NEW YORK, NY:
3,398,264, PUB. 1-1-2008. INT. CL. 35.

TAIWAN SHIN YEH ENTERPRISE CO., LTD., CHIA YI HSIEN, TAIWAN:
2,448,062, CANC. INT. CL. 20.

TAKEDA PHARMACEUTICAL COMPANY LIMITED, CHUO-KU, OSAKA, JAPAN:
3,397,437, PUB. 11-27-2007. INT. CL. 5.

TALK, INCORPORATED, ROSWELL, GA:
2,447,300, CANC. INT. CL. 9.

TALMADGE, CANDACE L., LANCASTER, TX:
3,399,544, INT. CL. 16.

TAMOLLY'S MEXICAN RESTAURANT OF AMERICA, LTD., TEXARKANA, TX:
3,397,913, PUB. 1-1-2008. INT. CL. 30.

TANGLEFOOT COMPANY, THE, GRAND RAPIDS, MI:
2,130,152, REN. 2-11-08. MULTIPLE CLASS, INT. CLS. 16 AND 20.

TAO LONGEVITY LLC, RENO, NV:
2,447,470, CANC. INT. CL. 3.

TAPUZ PEOPLE LTD., RAMAT GAN, ISRAEL:
3,399,953, MULTIPLE CLASS, INT. CLS. 9, 38 AND 41.

TARA GRINNA, INC., CONWAY, SC:
3,398,959, INT. CL. 25.

TARGA RESOURCES, INC., HOUSTON, TX:
3,398,455, PUB. 1-1-2008. INT. CL. 39.

TAX ANALYSTS, FALLS CHURCH, VA:
2,133,788, REN. 2-11-08. INT. CL. 16.

TAXI TECHNOLOGY CORPORATION, ENGLEWOOD, NJ:
3,397,010, PUB. 1-1-2008. INT. CL. 42.

TAYLOR MADE GOLF COMPANY, INC., CARLSBAD, CA:
3,399,174, INT. CL. 28.
3,399,175, INT. CL. 28.

TCO FRANQUIA LTDA., RIO DE JANEIRO, BRAZIL:
3,396,818, PUB. 1-1-2008. INT. CL. 25.

TEACHERS' CURRICULUM INSTITUTE, INC., PALO ALTO, CA:
3,398,587, PUB. 1-1-2008. INT. CL. 41.

TEAM QUALITY SERVICES, INC., AUBURN, IN:
3,398,074, PUB. 1-1-2008. INT. CL. 42.

TEAVANA CORPORATION, ATLANTA, GA:
3,398,050, PUB. 1-1-2008. INT. CL. 30.
3,398,051, PUB. 1-1-2008. INT. CL. 30.
3,398,052, PUB. 1-1-2008. INT. CL. 30.
3,398,054, PUB. 1-1-2008. INT. CL. 30.
3,398,124, PUB. 1-1-2008. INT. CL. 30.
3,398,177, PUB. 1-1-2008. INT. CL. 30.

TECH NET TRADING, INC., FT. LAUDERDALE, FL:
2,448,447, CANC. INT. CL. 36.

TECHGUARD SECURITY L.L.C., CHESTERFIELD, MO:
3,399,629, INT. CL. 9.

TECHNICAL ADVANTAGE, INC., BOONTON, NJ:
2,059,587, CANC. INT. CL. 9.

TECHNICAL AID CORPORATION, DEDHAM, MA:
3,399,112, INT. CL. 35.

TECHNIKU CORPORATION, DENVER, CO:
2,448,312, CANC. INT. CL. 9.

TECHNO SOURCE, KOWLOON, HONG KONG:
3,397,281, PUB. 1-1-2008. INT. CL. 28.
3,397,284, PUB. 1-1-2008. INT. CL. 28.

TECNICAS DE ELECTRONICA; Y AUTOMATISMOS, S.A., SPAIN:
3,398,781, PUB. 1-1-2008. INT. CL. 9.

TED GIBSON & COMPANY, INC., NEW YORK, NY:
3,399,031, INT. CL. 3.

TEKELEC, MORRISVILLE, NC:
2,448,351, CANC. INT. CL. 9.

TELEVISION DE LAS AMERICAS, LLC, VISALIA, CA:
3,397,722, PUB. 1-1-2008. MULTIPLE CLASS, INT. CLS. 38 AND 41.

TELEVISION FOOD NETWORK, G.P., NEW YORK, NY:
3,400,277, INT. CL. 41.

- TELLSOFT TECHNOLOGIES, INC., COLORADO SPRINGS, CO:
2,447,379, CANC. INT. CL. 9.
- TELLURIDE RESORT AND SPA L.L.C., TELLURIDE, CO:
2,448,151, CANC. INT. CL. 25.
- TEMENOS HEADQUARTERS SA, 1205 GENEVA, SWITZERLAND:
3,398,844, MULTIPLE CLASS, INT. CLS. 9 AND 16.
- TEMO, INC., CLINTON TOWNSHIP, MI:
3,397,033, PUB. 1-1-2008. MULTIPLE CLASS, INT. CLS. 19 AND 37.
- TEN CATE ADVANCED TEXTILES B.V., NIJVERDAL, NETHERLANDS:
3,398,620, PUB. 10-31-2006. MULTIPLE CLASS, INT. CLS. 9, 10, 22, 24 AND 25.
- TENET HEALTHSYSTEM MEDICAL, INC., DALLAS, TX:
3,400,351, INT. CL. 44.
- TENNESSEE ASSOCIATION OF RESCUE SQUADS, KNOXVILLE, TN:
2,064,427, REN. 2-12-08. INT. CL. 41.
- TENNESSEE MANAGED CARE NETWORK, NASHVILLE, TN:
2,447,266, CANC. INT. CL. 42.
- TENUTA DI BIBBIANO S.R.L., SIENA, ITALY:
2,147,623, REN. 2-13-08. INT. CL. 33.
- TEQUILA DON JULIO, S.A. DE C.V., ATOTONILCO EL ALTO, JALISCO, MEXICO:
3,398,866, INT. CL. 33.
- TERADICI CORPORATION, BURNABY, CANADA:
3,400,328, INT. CL. 9.
- TERCERO RODRIGUEZ, ALDO ERNESTO, XALAPA, MEXICO:
3,397,428, PUB. 1-1-2008. INT. CL. 41.
- TERMINAL DATA CORPORATION, MOORPARK, CA:
1,438,758, CANC. INT. CL. 9.
- TERRA PROPERTY MANAGEMENT, TETON VILLAGE, WY:
3,397,008, PUB. 1-1-2008. INT. CL. 43.
- TERRY STEVENS, INC., FORT WORTH, TX:
3,397,717, PUB. 1-1-2008. INT. CL. 41.
- TESKY, STEPHEN V., RIO RANCHO, NM:
3,399,061, INT. CL. 16.
- TEST-UM, INC., CAMARILLO, CA:
3,399,589, INT. CL. 9.
- TESTING CORP., YONKERS, NY:
3,397,161, PUB. 1-1-2008. INT. CL. 42.
- TETRA GMBH, MELLE, FED REP GERMANY:
843,382, REN. 2-13-08. U.S. CL. 46 (INT. CL. 31).
- TEXAS ANGORA GOAT RAISERS' ASSOCIATION, BERTRAM, TX:
2,059,285, CANC. INT. CL. 42.
- TEXAS CITY TERMINAL RAILWAY COMPANY, TEXAS CITY, TX, DBA PORT OF TEXAS CITY:
2,194,690, REN. 2-12-08. INT. CL. 39.
- TEXAS SURGICAL ASSOCIATES, L.L.P., HOUSTON, TX:
3,397,479, PUB. 1-1-2008. INT. CL. 44.
- TEXTILE INC., TORTOLA BRITISH, BR. VIRGIN ISLANDS:
2,059,570, CANC. INT. CL. 25.
- TEXTILE MANAGEMENT ASSOCIATES, INC., DALTON, GA:
3,398,323, PUB. 1-1-2008. INT. CL. 27.
3,398,324, PUB. 1-1-2008. INT. CL. 27.
- TEXTILE RUBBER & CHEMICAL COMPANY, INC., DALTON, GA:
3,398,892, INT. CL. 27.
- THANG LONG GARMENTS COMPANY LIMITED, VUNG TAU CITY, BA RIA - VUNG TAU PROVINCE, VIETNAM:
3,399,684, MULTIPLE CLASS, INT. CLS. 18, 20, 24 AND 25.
- THANG LONG GARMENTS COMPANY LIMITED, VUNG TAU CITY, BA RIA-VUNG TAU PROVINCE, VIETNAM:
3,399,694, MULTIPLE CLASS, INT. CLS. 18, 20, 24 AND 25.
- THATCHER, MARK, FLAGSTAFF, AZ:
2,058,612, CANC. INT. CL. 25.
- THE ACTIVE NETWORK, INC., SAN DIEGO, CA:
3,400,264, INT. CL. 42.
3,400,291, INT. CL. 42.
3,400,304, INT. CL. 42.
- THE ARC GROUP, LLC., AUSTIN, TX:
3,398,078, PUB. 1-1-2008. INT. CL. 42.
- THE ART & CREATIVE MATERIALS INSTITUTE, INC., HANSON, MA:
3,397,175, PUB. 1-1-2008. U.S. CL. A.
- THE ASHTON-DRAKE GALLERIES, LTD., NILES, IL:
3,399,488, INT. CL. 20.
- THE BANK OF NOVA SCOTIA, TORONTO, ONTARIO, CANADA:
3,399,988, INT. CL. 36.
- THE BAY STATE, MIDDLETOWN, RI:
3,397,901, PUB. 1-1-2008. INT. CL. 41.
- THE BICYCLE GARAGE, LLC, COLCHESTER, CT:
3,399,040, INT. CL. 37.
- THE BLACK & DECKER CORPORATION, TOWSON, MD:
1,481,390, REN. 2-14-08. INT. CL. 7.
2,145,508, REN. 2-14-08. INT. CL. 7.
- THE BLOOD AND TISSUE CENTER OF CENTRAL TEXAS,, AUSTIN, TX:
3,397,169, PUB. 1-1-2008. MULTIPLE CLASS, INT. CLS. 35 AND 44.
- THE BOARD OF REGENTS OF THE UNIVERSITY OF TEXAS SYSTEM, AUSTIN, TX:
3,397,296, PUB. 1-1-2008. INT. CL. 25.
- THE BOWERY HOTEL, LLC, NEW YORK, NY:
3,399,072, INT. CL. 43.
- THE BRAUN CORPORATION, WINAMAC, IN:
3,399,237, INT. CL. 12.
- THE CHAMBER OF COMMERCE OF THE UNITED STATES OF AMERICA, WASHINGTON, DC:
3,400,260, MULTIPLE CLASS, INT. CLS. 41 AND 42.
- THE CHILDREN'S MUSEUM OF INDIANAPOLIS, INC., INDIANAPOLIS, IN:
3,399,062, INT. CL. 41.
3,399,063, INT. CL. 41.
- THE CHRIS DRAFT FAMILY FOUNDATION, ATLANTA, GA:
3,398,246, PUB. 1-1-2008. INT. CL. 35.
- THE COCA-COLA COMPANY, ATLANTA, GA:
3,399,381, INT. CL. 32.
- THE COMMON PURPOSE CHARITABLE TRUST, LONDON, UNITED KINGDOM:
3,398,662, PUB. 1-1-2008. MULTIPLE CLASS, INT. CLS. 16 AND 41.
- THE CONNECTICUT AUDUBON SOCIETY, INC., FAIRFIELD, CT:
3,398,450, PUB. 1-2-2007. INT. CL. 41.
- THE DATAMAX SOFTWARE GROUP, INC., EL DORADO HILLS, CA:
3,398,048, PUB. 1-1-2008. INT. CL. 9.
- THE DIAGNOSTIC GROUP, INC., NEENAH, WI:
3,398,907, INT. CL. 11.
- THE DOWN TO EARTH DAD, LLC, COEUR D'ALENE, ID:
3,396,973, PUB. 1-1-2008. INT. CL. 45.
- THE EPISCOPAL CHURCH, NEW YORK, NY:
3,397,068, PUB. 1-1-2008. INT. CL. 45.
3,397,082, PUB. 1-1-2008. INT. CL. 41.
- THE FARM, INC., MIAMI, FL:
3,398,200, PUB. 1-1-2008. MULTIPLE CLASS, INT. CLS. 31 AND 44.
- THE FRESH MARKET, INC., GREENSBORO, NC:
3,400,179, INT. CL. 35.
- THE GATES CORPORATION, UNITED STATES:
3,398,812, PUB. 1-1-2008. MULTIPLE CLASS, INT. CLS. 6, 7 AND 12.
- THE GENERAL HOSPITAL CORPORATION, BOSTON, MA:
3,399,823, INT. CL. 44.
- THE GILLETTE COMPANY, BOSTON, MA:
3,400,310, INT. CL. 41.
- THE GORMAN-RUPP COMPANY, MANSFIELD, OH:
3,398,891, INT. CL. 7.
- THE GREAT GAME TRAVEL COMPANY LIMITED, BELFAST, UNITED KINGDOM:
3,398,464, PUB. 1-1-2008. MULTIPLE CLASS, INT. CLS.

- 16, 39 AND 43.
 THE GYM WMD, INC., MONTVALE, NJ:
 3,398,887, MULTIPLE CLASS, INT. CLS. 5 AND 44.
 THE HERFF JONES COMPANY OF INDIANA, INC.,
 INDIANAPOLIS, IN:
 3,399,738, INT. CL. 14.
 THE INCREDIBEDS CORPORATION, BELLE ISLE, FL:
 3,398,175, PUB. 1-1-2008. INT. CL. 20.
 THE INSTITUTE OF ELECTRICAL AND ELECTRONICS
 ENGINEERS, INC., PISCATAWAY, NJ:
 3,399,582, MULTIPLE CLASS, INT. CLS. 9 AND 16.
 THE INSTITUTE OF MEDICINE AND PUBLIC HEALTH OF
 NEW JERSEY, INC., LAWRENCEVILLE, NJ:
 3,400,352, INT. CL. 41.
 THE J. JILL GROUP, INC., HINGHAM, MA:
 3,399,428, INT. CL. 35.
 THE KRAFTMARK COMPANY, SPRING CITY, PA:
 3,397,147, PUB. 1-1-2008. INT. CL. 16.
 THE KROGER CO. OF MICHIGAN, LIVONIA, MI:
 3,399,932, INT. CL. 29.
 THE LEUKEMIA & LYMPHOMA SOCIETY, INC., WHITE
 PLAINS, NY:
 3,396,909, PUB. 1-1-2008. INT. CL. 36.
 3,396,910, PUB. 1-1-2008. INT. CL. 36.
 THE LIFE VESSEL CORPORATION, COTTONWOOD, AZ:
 3,398,973, INT. CL. 5.
 THE LITTLE POTATO COMPANY LTD, EDMONTON,
 ALBERTA, CANADA:
 3,398,487, PUB. 1-1-2008. INT. CL. 31.
 THE MATWORKS COMPANY, LLC, BELTSVILLE, MD:
 3,398,164, PUB. 1-1-2008. INT. CL. 37.
 THE MAY DEPARTMENT STORES COMPANY, ST. LOUIS,
 MO:
 2,447,923, CANC. INT. CL. 35.
 THE MCGRAW-HILL COMPANIES, INC., NEW YORK, NY:
 3,397,448, PUB. 1-1-2008. INT. CL. 36.
 3,397,449, PUB. 1-1-2008. INT. CL. 36.
 THE MEREDITH GROUP, INC., SAVANNAH, GA:
 3,398,552, PUB. 1-1-2008. INT. CL. 35.
 THE MIGRAINE AND PAIN FUND, INC., NEW YORK,
 UNITED STATES:
 3,397,486, PUB. 1-1-2008. INT. CL. 36.
 THE MOST VENERABLE ORDER OF THE HOSPITAL OF
 ST. JOHN OF JERUSALEM, LONDON, UNITED KING-
 DOM:
 3,397,058, PUB. 1-1-2008. INT. CL. 36.
 THE MYTA CORPORATION, ROCKVILLE, MD:
 3,397,661, PUB. 1-1-2008. INT. CL. 42.
 THE NEW YORK CENTER FOR CHILDREN, NEW YORK,
 NY:
 3,400,246, MULTIPLE CLASS, INT. CLS. 44 AND 45.
 THE ORVIS COMPANY, INC., MANCHESTER, VT:
 3,399,299, INT. CL. 25.
 THE OUTDOOR CHANNEL, INC., TEMECULA, CA:
 3,398,087, PUB. 1-1-2008. MULTIPLE CLASS, INT. CLS. 38
 AND 41.
 THE PHYSICIAN'S RX, INC., PARKLAND, FL:
 3,400,248, INT. CL. 44.
 THE PILLSBURY COMPANY, MINNEAPOLIS, MN:
 3,398,250, PUB. 1-1-2008. INT. CL. 30.
 THE PREMIUM CONNECTION, INC., LAS VEGAS, NV:
 3,399,675, INT. CL. 8.
 THE PROCTER & GAMBLE COMPANY, CINCINNATI, OH:
 3,399,286, INT. CL. 5.
 3,400,033, INT. CL. 3.
 THE RED FLAG GROUP LIMITED, HONG KONG, HONG
 KONG:
 3,399,058, MULTIPLE CLASS, INT. CLS. 35, 41 AND 42.
 THE RED RIBBON FOUNDATION, INC, GREENWICH, CT:
 3,399,032, INT. CL. 14.
 THE REHMANN GROUP, SAGINAW, MI:
 3,398,155, PUB. 1-1-2008. INT. CL. 35.
 THE SAMUEL WAXMAN CANCER RESEARCH FOUNDA-
 TION, NEW YORK, NY:
 3,397,204, PUB. 1-1-2008. MULTIPLE CLASS, INT. CLS.
 35, 36 AND 42.
 3,397,205, PUB. 1-1-2008. MULTIPLE CLASS, INT. CLS.
 35, 36 AND 42.
 3,397,206, PUB. 1-1-2008. MULTIPLE CLASS, INT. CLS.
 35, 36 AND 42.
 3,397,207, PUB. 1-1-2008. MULTIPLE CLASS, INT. CLS.
 35, 36 AND 42.
 THE SCHALLERT GROUP, INC., LONGMONT, CO:
 3,398,000, PUB. 1-1-2008. INT. CL. 41.
 3,398,006, PUB. 1-1-2008. INT. CL. 41.
 3,398,007, PUB. 1-1-2008. INT. CL. 35.
 THE SCOTT FETZER COMPANY, WESTLAKE, OH:
 3,396,851, PUB. 1-1-2008. INT. CL. 7.
 THE SEABERG COMPANY, INC., NEWPORT, OR:
 3,399,380, INT. CL. 10.
 THE SHERATON LLC, WHITE PLAINS, NY:
 3,399,295, INT. CL. 43.
 THE SPARK AGENCY, INC., ST. LOUIS, MO:
 3,397,550, PUB. 1-1-2008. INT. CL. 35.
 THE STATE LIFE INSURANCE COMPANY, INDIANAPO-
 LIS, IN:
 3,398,097, PUB. 1-1-2008. INT. CL. 36.
 THE SUFFOLK POINTE SHOE CO.LTD, EARL SHILTON,-
 LEICESTER, ENGLAND:
 3,397,199, PUB. 1-1-2008. INT. CL. 25.
 THE SUSAN G. KOMEN BREAST CANCER FOUNDATION,
 INC., DALLAS, TX:
 3,399,816, INT. CL. 36.
 THE TECHNOLOGY GUIDE, LLC, CENTENNIAL, CO:
 3,399,103, INT. CL. 42.
 THE TICKET RESERVE, INC., CHICAGO, IL:
 3,397,710, PUB. 1-1-2008. INT. CL. 36.
 THE TJX COMPANIES, INC., FRAMINGHAM, MA:
 3,399,554, INT. CL. 21.
 THE TRACY FOULKES AND PAUL RAPHAELY PART-
 NERSHIP, CAPE TOWN, SOUTH AFRICA:
 3,397,105, PUB. 1-1-2008. MULTIPLE CLASS, INT. CLS. 29
 AND 30.
 THE TRAVELERS INDEMNITY COMPANY, HARTFORD,
 CT:
 3,398,327, PUB. 1-1-2008. INT. CL. 36.
 THE TRUSTEES OF INDIANA UNIVERSITY, BLOOMING-
 TON, IN:
 3,398,085, PUB. 1-1-2008. INT. CL. 41.
 THE TRUSTEES OF THE PWC BUSINESS TRUST, NEW
 YORK, NY:
 3,158,014, CANC. INT. CL. 9.
 THE TRUSTEES OF THE RODNEY A. HAMILTON LIVING
 TRUST A CALIFORNIA TRUST, COMPRISING RODNEY
 A. HAMILTON, A UNITED STATES C, LOS ANGELES,
 CA:
 3,398,937, INT. CL. 35.
 THE TRUSTEES OF THE SALISH TRUST, A WASHINGTON
 TRUST, THE TRUSTEES COMPRISING MARVIN WIL-
 BUR, SR., JOAN WILBUR, LENORA WILBUR-COOK, C.
 MARVIN WILBUR, JR. AND MICHAEL WILBUR, ALL
 U.S. CITIZENS, ANACORTES, WA:
 3,400,393, INT. CL. 13.
 THE TRUSTEES OF THE SALISH TRUST, A WASHINGTON
 TRUST, THE TRUSTEES COMPRISING OF C. MARVIN
 WILBUR, SR., JOAN WILBUR, LENORA WILBUR-COOK,
 C. MARVIN WILBUR, JR., MICHAEL WILBUR, ALL U.S.
 CITIZENS, ANACORTES, WA:
 3,400,395, INT. CL. 13.
 THE UNIVERSITY OF SOUTH DAKOTA, VERMILLION,
 SD:
 3,397,318, PUB. 1-1-2008. INT. CL. 41.
 THE VALSPAR CORPORATION, MINNEAPOLIS, MN:
 3,400,051, INT. CL. 2.
 THE VANDERBILT UNIVERSITY, NASHVILLE, TN:
 3,400,060, INT. CL. 44.
 THE VOLLRATH COMPANY, L.L.C., SHEBOYGAN, WI:
 3,398,563, PUB. 1-1-2008. INT. CL. 21.
 3,400,105, INT. CL. 11.
 THE WALSH GROUP LTD., CHICAGO, IL:
 3,397,093, PUB. 1-1-2008. INT. CL. 37.
 THE WEDDING BUREAU, INC., PORTLAND, OR:
 3,398,029, PUB. 1-1-2008. INT. CL. 41.
 3,398,031, PUB. 1-1-2008. INT. CL. 41.

- THE WESTERN AND SOUTHERN LIFE INSURANCE COMPANY, CINCINNATI, OH:
3,397,055, PUB. 1-1-2008. INT. CL. 36.
- THE YARD, INC., CHILMARK, MA:
3,397,895, PUB. 1-1-2008. INT. CL. 41.
- THE 67 GROUP, LLC, LAS VEGAS, NV, DBA ANGEL MUSIC GROUP:
3,398,095, PUB. 1-1-2008. INT. CL. 41.
- THELMA AND LOUISE CLUB LIMITED, LONDON, UNITED KINGDOM:
3,398,571, PUB. 1-1-2008. MULTIPLE CLASS, INT. CLS. 35 AND 43.
- THEPROSHOP.COM, INC., FORT MYERS, FL:
2,447,451, CANC. INT. CL. 35.
- THERAPYZONE, INC., DENVER, CO:
3,399,456, MULTIPLE CLASS, INT. CLS. 10 AND 28.
- THERM-O-LITE, INC., SOUTH BEND, IN:
2,089,460. REN. 2-14-08. INT. CL. 19.
- THERMO CIDTEC, LIVERPOOL, NY:
3,397,818, PUB. 1-1-2008. INT. CL. 9.
- THERMO FISHER SCIENTIFIC (MILWAUKEE) LLC, MILWAUKEE, WI:
3,398,579, PUB. 8-7-2007. INT. CL. 40.
3,398,580, PUB. 8-7-2007. INT. CL. 40.
- THERMO-TEK MFG. INC., THIEF RIVER FALLS, MN:
2,447,840, CANC. INT. CL. 6.
- THERMOGENESIS CORPORATION, RANCHO CORDOVA, CA:
3,399,533, INT. CL. 10.
- THERMOS L.L.C., ROLLING MEADOWS, IL:
3,398,988, INT. CL. 18.
3,399,848, INT. CL. 21.
- THESAUCE.COM, INC., CHICAGO, IL:
2,447,701, CANC. MULTIPLE CLASS, INT. CLS. 35, 41 AND 42.
- THF EQUITIES, LP, WESTCHESTER, IL:
3,400,163, INT. CL. 29.
- THINK HOLDINGS LLC, CORAL SPRINGS, FL:
3,397,655, PUB. 1-1-2008. INT. CL. 9.
- THIS MUSIC, LLC, NASHVILLE, TN:
3,398,541, PUB. 1-1-2008. INT. CL. 41.
- THOMAS PUBLISHING COMPANY, NEW YORK, NY:
3,396,839, PUB. 1-1-2008. MULTIPLE CLASS, INT. CLS. 35 AND 38.
- THOMAS WALSH, IDAHO SPRINGS, CO:
3,397,652, PUB. 1-1-2008. INT. CL. 45.
- THOMPSON & CO. OF TAMPA, INC., TAMPA, FL:
3,399,201, INT. CL. 35.
- THOMPSON HOTELS LLC, NEW YORK, NY:
3,399,869, INT. CL. 43.
- THOMSON, BOULOGNE-BILLAN COURT, FRANCE:
3,398,466, PUB. 10-9-2007. MULTIPLE CLASS, INT. CLS. 9, 38 AND 41.
- THOR SYSTEMS, INC., LARKSVILLE, PA:
2,204,487. REN. 2-13-08. INT. CL. 16.
- THOSE CHARACTERS FROM CLEVELAND, INC., CLEVELAND, OH:
2,447,827, CANC. INT. CL. 16.
- THREE DEUCE BRANDING, LLC, CINCINNATI, OH:
3,397,930, PUB. 1-1-2008. INT. CL. 35.
3,397,935, PUB. 1-1-2008. INT. CL. 35.
- THREESIXTY SOURCING LTD., TORTOLA, BR. VIRGIN ISLANDS:
3,397,912, PUB. 1-1-2008. INT. CL. 35.
- THRIVENT FINANCIAL LIFELONG RESOURCES INC., APPLETON, WI:
3,399,958, INT. CL. 20.
3,399,959, INT. CL. 20.
- THULE, INC., SEYMOUR, CT:
2,448,051, CANC. INT. CL. 18.
- TICINO FINANZIARIA S.P.A., 20149 MILANO, ITALY:
2,124,809. REN. 2-13-08. MULTIPLE CLASS, INT. CLS. 10 AND 25.
- TICKETMASTER CORPORATION, WEST HOLLYWOOD, CA:
3,397,745, PUB. 1-1-2008. INT. CL. 42.
3,397,746, PUB. 1-1-2008. INT. CL. 42.
- TIGER CORPORATION, OSAKA, JAPAN, TIGER VACUUM BOTTLE CO., LTD., OSAKA, JAPAN:
1,474,855. REN. 2-13-08. INT. CL. 11.
- TIM & ANDY LLC, MANHEIM, PA:
3,398,923, MULTIPLE CLASS, INT. CLS. 29 AND 32.
- TIME INC., NEW YORK, NY:
3,397,563, PUB. 1-1-2008. INT. CL. 16.
3,398,244, PUB. 1-1-2008. INT. CL. 16.
- TIME WARNER ENTERTAINMENT COMPANY, L.P., NEW YORK, NY:
2,447,358, CANC. MULTIPLE CLASS, INT. CLS. 35, 41 AND 42.
2,448,325, CANC. INT. CL. 42.
- TIMEWATCH PLC, LONDON, UNITED KINGDOM:
3,399,453, MULTIPLE CLASS, INT. CLS. 9, 35, 41 AND 42.
- TIMOTHY D. HUDDLESTON, LLC., HIGH SPRINGS, FL:
3,399,189, INT. CL. 25.
- TIONG LIONG INDUSTRIAL CO., LTD., TAICHUNG HSIEN, TAIWAN:
3,399,410, INT. CL. 24.
- TITAN SAFETY PRODUCTS, INC., SANTA ANA, CA, DBA TAG INOVENTIONS, INC.:
3,398,235, PUB. 1-1-2008. INT. CL. 9.
- TIVO BRANDS LLC, ALVISO, CA:
3,398,479, PUB. 1-1-2008. INT. CL. 41.
3,398,480, PUB. 1-1-2008. INT. CL. 41.
3,398,481, PUB. 1-1-2008. INT. CL. 41.
- TJ SEVEN INCORPORATION, PINOLE, CA:
3,399,701, INT. CL. 29.
- TKJ CORPORATION, TOKYO, JAPAN:
3,399,568, INT. CL. 17.
- TKL MEDIA, LLC, PENNSAUKEN, NJ, DBA MEDIA IMAGERY:
3,400,409, MULTIPLE CLASS, INT. CLS. 35, 41 AND 42.
- TLC COMPANY INC., ALBUQUERQUE, NM:
3,398,161, PUB. 1-1-2008. INT. CL. 37.
- TMW MARKETING COMPANY, INC., FREMONT, CA:
2,447,982, CANC. INT. CL. 35.
- TN MEDIA, INC., NEW YORK, NY:
2,448,097, CANC. INT. CL. 35.
- TOBIAS RÜCKERT, 73650 WINTERBACH, FED REP GERMANY:
3,398,746, PUB. 1-1-2008. INT. CL. 9.
- TOBIN, KATHLEEN, SAN FRANCISCO, CA:
2,447,608, CANC. INT. CL. 35.
- TODAYS WOMENCARE COMPANY, MEDIA, PA:
3,398,167, PUB. 1-1-2008. INT. CL. 5.
- TODD, JOHN PAUL, ANCHORAGE, AR:
2,058,533, CANC. INT. CL. 25.
- TODINNO S.A.C., LIMA 15, PERU:
3,398,904, INT. CL. 30.
- TOFIXIT!, INC., PHOENIX, AZ:
3,396,948, PUB. 1-1-2008. INT. CL. 35.
3,396,950, PUB. 1-1-2008. INT. CL. 35.
- TOLIX STEEL DESIGN, FRANCE:
3,398,830, PUB. 1-1-2008. INT. CL. 20.
- TOM KURTHY AND ROBERT MADDEN PARTNERSHIP, THE, NEW YORK, NY:
2,448,061, CANC. INT. CL. 41.
- TOMORROW'S SOFTWARE LLC, CHICAGO, IL, GRAPHIC M*I*S, LLC, CHICAGO, IL:
2,128,434. REN. 2-8-08. INT. CL. 9.
- TOMPkins ASSOCIATES, RALEIGH, NC:
2,447,753, CANC. MULTIPLE CLASS, INT. CLS. 16 AND 42.
- TOMTOM INTERNATIONAL B.V., NETHERLANDS:
3,398,686, PUB. 1-1-2008. MULTIPLE CLASS, INT. CLS. 9, 38, 39, 41, 42 AND 45.
- TONE PRODUCTS, INC., MELROSE PARK, IL:
3,397,230, PUB. 1-1-2008. INT. CL. 30.
- TONY C. BADALATO, THOUSAND OAKS, CA:
3,400,268, INT. CL. 42.
- TONY FORT SERVICES, LLC, PADUCAH, KY:
3,397,735, PUB. 1-1-2008. INT. CL. 37.
- TONY HAWK, INC., VISTA, CA:
3,398,614, PUB. 1-1-2008. MULTIPLE CLASS, INT. CLS. 9, 35, 38, 41 AND 42.

TONY MARGERIE & ASSOCIATES, SAUSALITO, CA:
 2,448,471, CANC. INT. CL. 18.
 TONY'S TAPS LLC D/B/A PAGOSA BREWING COMPANY,
 PAGOSA SPRINGS, CO:
 3,400,251, INT. CL. 32.
 TOOLINGHOUSE.COM, FOWLERVILLE, MI:
 3,400,145, INT. CL. 7.
 TOOTSA'S, LLC, HOLLAND, OH:
 3,397,150, PUB. 1-1-2008. INT. CL. 43.
 TOP SECRET RECIPES, INC., LAS VEGAS, NV:
 3,397,160, PUB. 1-1-2008. INT. CL. 30.
 TOPCO HOLDINGS, INC., SKOKIE, IL:
 2,128,441. REN. 2-8-08. INT. CL. 29.
 2,128,446. REN. 2-8-08. INT. CL. 30.
 TOPOTARGET A/S, COPENHAGEN, DENMARK:
 3,399,644, INT. CL. 5.
 TOPPER'S PIZZA, INC., WHITEWATER, WI:
 3,400,159, MULTIPLE CLASS, INT. CLS. 39 AND 43.
 TOPSYSTEM SYSTEMHAUS GMBH, FED REP GERMANY:
 3,398,695, PUB. 1-1-2008. INT. CL. 9.
 TORAY KABUSHIKI KAISHA (TORAY INDUSTRIES, INC.),
 CHUO-KU, TOKYO, JAPAN:
 3,397,438, PUB. 1-1-2008. MULTIPLE CLASS, INT. CLS. 24
 AND 25.
 TOTAL SUCCESS TECHNOLOGIES, INC., PORTLAND, OR:
 3,398,146, PUB. 1-1-2008. INT. CL. 36.
 TOTAL TEMPERATURE INSTRUMENTATION, INC.,
 WILLISTON, VT:
 2,174,995. REN. 2-14-08. INT. CL. 9.
 TOTANI CORPORATION, MINAMI-KU, KYOTO, JAPAN:
 3,399,863, INT. CL. 16.
 TOTO, LTD., KOKURAKITA-KU, KITAKYUSHU-SHI, JA-
 PAN:
 1,473,016. REN. 2-11-08. INT. CL. 11.
 1,477,556. REN. 2-12-08. INT. CL. 11.
 TOTSBOTS LIMITED, GLASGOW, UNITED KINGDOM:
 3,397,172, PUB. 1-1-2008. INT. CL. 25.
 TOWBIN DODGE, HENDERSON, NV:
 3,399,458, INT. CL. 35.
 TOY CONCEPTS, FREEHOLD, NJ:
 2,448,318, CANC. INT. CL. 28.
 TOYOTA JIDOSHA KABUSHIKI KAISHA, T/A TOYOTA
 MOTOR CORPORATION, AICHI-KEN, JAPAN:
 3,397,850, PUB. 10-30-2007. INT. CL. 12.
 TPG IT CONSULTING - THE PILOT GROUP, LLC, KATY,
 TX:
 3,399,291, INT. CL. 42.
 TPI CORPORATION, JOHNSON CITY, TN:
 3,398,089, PUB. 1-1-2008. MULTIPLE CLASS, INT. CLS. 9
 AND 11.
 TPS SYSTEMS, INC., SAN ANTONIO, TX:
 2,153,246. REN. 2-11-08. INT. CL. 9.
 TRACER RESEARCH CORPORATION, TUCSON, AZ:
 2,448,086, CANC. INT. CL. 1.
 2,448,088, CANC. INT. CL. 1.
 TRACEY MAYER, INC., MT. PROSPECT, IL:
 3,396,907, PUB. 1-1-2008. INT. CL. 14.
 TRADE GUYS INTERNATIONAL PTY LTD, QUEENS-
 LAND, AUSTRALIA:
 3,396,979, PUB. 9-25-2007. INT. CL. 20.
 TRADEMARK MANAGEMENT COMPANY, MERIDIAN,
 ID, PORTION PAC, INC., MASON, OH:
 2,146,998. REN. 2-12-08. INT. CL. 30.
 TRADEMARK MANAGEMENT COMPANY, MERIDIAN,
 ID:
 3,398,961, MULTIPLE CLASS, INT. CLS. 29 AND 30.
 3,399,125, INT. CL. 30.
 TRADITIONAL MEDICINALS, INC., SEBASTOPOL, CA:
 2,059,456, CANC. MULTIPLE CLASS, INT. CLS. 5 AND
 30.
 TRAINING & DEVELOPMENT CORPORATION, BUCK-
 SPORT, ME:
 2,134,711. REN. 2-14-08. INT. CL. 41.
 TRAN, ANH HAO, ALHAMBRA, CA:
 3,397,258, PUB. 1-1-2008. INT. CL. 36.
 TRANS WORLD NEW YORK, LLC, ALBANY, NY:
 2,220,453. REN. 2-14-08. INT. CL. 35.
 TRANSFAIR USA, OAKLAND, CA:
 3,400,215, U.S. CL. A.
 TRANSFORM REAL ESTATE, LAS VEGAS, NV:
 3,397,264, PUB. 1-1-2008. INT. CL. 36.
 TRANSONIX CORPORATION, LOWELL, MA:
 1,438,540, CANC. INT. CL. 11.
 TRANSPHOTON CORP., MIAMI, FL:
 3,399,280, INT. CL. 10.
 TRAVEL GROUP ADVENTURES, INC., ANAHEIM, CA:
 3,400,090, MULTIPLE CLASS, INT. CLS. 39 AND 43.
 TRAVELDOR, LLC, MAYFIELD, KY, TRAVELDOR, LLC,
 MAYFIELD, KY:
 2,130,226. REN. 2-8-08. INT. CL. 34.
 2,130,230. REN. 2-8-08. INT. CL. 34.
 TREBOL U.S.A., LLC, ANDREWS, SC, M&T CHEMICALS
 INC., WOODBRIDGE, NJ:
 1,475,541. REN. 2-13-08. INT. CL. 1.
 TREE OF LIFE, INC., ST. AUGUSTINE, FL:
 3,397,829, PUB. 1-1-2008. INT. CL. 35.
 TREFIMETAUX S.A., F-92400 COURBEVOIE, FRANCE:
 2,447,471, CANC. INT. CL. 6.
 TREK BICYCLE CORPORATION, WATERLOO, WI:
 3,397,739, PUB. 1-1-2008. INT. CL. 35.
 TREL RESTAURANT INC., NEW YORK, NY:
 3,398,394, PUB. 1-1-2008. INT. CL. 43.
 TRELISE COOPER LIMITED, AUCKLAND, NEW ZEAL-
 AND:
 3,398,602, PUB. 1-1-2008. INT. CL. 25.
 TRELLEBORG INDUSTRI AB., TRELLEBORG, SWEDEN,
 MONARCH RUBBER COMPANY, THE, HARTVILLE, OH:
 845,912. REN. 2-10-08. U.S. CL. 35 (INT. CL. 12).
 TRENDMASTERS, INC., ST. LOUIS, MO:
 2,448,391, CANC. INT. CL. 28.
 TRI ALL 3 SPORTS, SAN CLEMENTE, CA:
 3,397,621, PUB. 1-1-2008. INT. CL. 18.
 TRI RIVERS SURGICAL ASSOCIATES, INC., PITTSBURGH,
 PA:
 2,447,897, CANC. INT. CL. 42.
 TRI-POWER GROUP, INC., SAN JOSE, CA:
 3,399,838, INT. CL. 37.
 TRIAD OF NORTH ATLANTA, LLC, MARIETTA, GA:
 3,397,247, PUB. 1-1-2008. INT. CL. 25.
 TRIANGLE ENGINEERING OF ARKANSAS, INC., JACK-
 SONVILLE, AR:
 2,059,291, CANC. INT. CL. 11.
 TRICON METALS & SERVICES, INC., BIRMINGHAM, AL:
 1,451,766. REN. 2-13-08. INT. CL. 6.
 1,506,789. REN. 2-11-08. INT. CL. 6.
 TRIDENT SEAFOODS CORPORATION, SEATTLE, WA,
 OSCAR MAYER FOODS CORPORATION, MADISON,
 WI, DBA KEMP'S FOODS:
 1,484,454. REN. 2-11-08. INT. CL. 29.
 TRIDON INCORPORATED, BRANTFORD, CANADA:
 1,083,160. REN. 2-14-08. INT. CL. 6.
 TRIDON INCORPORATED, BRANTFORD, ONTARIO, CA-
 NADA, TRIDON LIMITED, BURLINGTON, ONTARIO,
 CANADA:
 1,083,161. REN. 2-9-08. INT. CL. 6.
 1,083,168. REN. 2-9-08. INT. CL. 6.
 TRINGAS, GREG, PENSACOLA, FL:
 2,148,277. REN. 2-9-08. INT. CL. 42.
 TRINITY CHRISTIAN CENTER OF SANTA ANA, INC.,
 SANTA ANA, CA:
 3,398,410, PUB. 1-1-2008. MULTIPLE CLASS, INT. CLS. 38
 AND 41.
 TRINITY MANAGEMENT SERVICES, SAN FRANCISCO,
 CA:
 3,399,309, MULTIPLE CLASS, INT. CLS. 36 AND 37.
 TRIP DOGS TRAVEL SERVICES, LLC, PLYMOUTH, MN:
 3,397,522, PUB. 1-1-2008. INT. CL. 39.
 TRIPADVISOR LLC, NEEDHAM, MA:
 3,397,368, PUB. 1-1-2008. MULTIPLE CLASS, INT. CLS.
 38, 39, 41, 42 AND 43.
 TRIPS2ITALY, LLC, HOUSTON, TX:
 3,400,241, INT. CL. 39.
 TRISH MCEVOY LTD., NEW YORK, NY:
 3,399,333, MULTIPLE CLASS, INT. CLS. 3 AND 21.

- TRIVENTO BODEGAS Y VINEDOS S.A., MAIPU MENDOZA, ARGENTINA:
3,399,004, INT. CL. 33.
- TRIVENTO BODEGAS Y VINEDOS S.A., MENDOZA, ARGENTINA:
3,400,024, INT. CL. 33.
- TROPIC OPTICS, LAHAINA, HI:
1,438,506, CANC. INT. CL. 9.
- TROPICAL SERVICES, L.L.C., GULF SHORES, AL:
2,447,965, CANC. INT. CL. 16.
- TROVAO, FRANK TEIXIERA, ARTESIA, CA:
2,447,665, CANC. INT. CL. 25.
- TROXLER ELECTRONIC LABORATORIES, INC., RESEARCH TRIANGLE PARK, NC:
3,398,930, INT. CL. 9.
- TRU VUE, INC., MCCOOK, IL:
3,399,033, INT. CL. 21.
- TRUCK ADS, LLC, MCLEAN, VA:
3,400,399, INT. CL. 20.
- TRUDY DUJARDIN LLC, EAST NORWALK, CT:
3,396,939, PUB. 1-1-2008. INT. CL. 42.
- TRUE FITNESS TECHNOLOGY, INC., O'FALLON, MO:
3,399,579, INT. CL. 28.
- TRUE NORTH, LLC, NASHVILLE, TN:
3,397,779, PUB. 1-1-2008. INT. CL. 35.
- TRUE TEMPER SPORTS, INC., MEMPHIS, TN:
3,399,761, INT. CL. 28.
- TRUE VALUE COMPANY, CHICAGO, IL:
3,399,598, INT. CL. 2.
3,399,824, MULTIPLE CLASS, INT. CLS. 6, 11 AND 21.
- TRUEBLOOD, SAMUEL E., DALLAS, TX:
3,398,238, PUB. 1-1-2008. INT. CL. 25.
- TRUSTEE OF MGLOBAL TRUST, PORT LOUIS, MAURITIUS:
3,398,307, PUB. 1-1-2008. MULTIPLE CLASS, INT. CLS. 35 AND 41.
- TRUSTIN TECHNOLOGY, LLC, IRVINE, CA:
3,396,908, PUB. 9-25-2007. INT. CL. 35.
- TSAI, LEE & CHEN PATENT ATTORNEYS COMPANY, TAIPEI 104, TAIWAN:
3,399,498, MULTIPLE CLASS, INT. CLS. 35 AND 42.
- TUBE-FAB LTD., STREETSVILLE, ONTARIO L5M 2C1, CANADA:
1,438,533, CANC. INT. CL. 10.
- TUBOS DE ACERO DE MEXICO S.A., VERACRUZ, MEXICO:
3,400,148, INT. CL. 6.
- TUBULAR USA, INC., WELDON SPRING, MO:
3,398,486, PUB. 1-1-2008. INT. CL. 6.
- TUCKER, RICHARD B., MANCHESTER, NH, DBA THE TUCKER COMPANY:
2,130,161, REN. 2-13-08. INT. CL. 20.
- TUGGY PRODUCTS INC., CENTRAL POINT, OR:
3,398,034, PUB. 1-1-2008. INT. CL. 22.
- TULLY'S COFFEE CORPORATION, SEATTLE, WA:
3,399,874, INT. CL. 29.
- TUNG THIH ENTERPRISE CO., LTD., LUCHU TOWNSHIP, TAOYUA, TAIWAN:
3,397,107, PUB. 1-1-2008. INT. CL. 9.
- TUNG THIH ENTERPRISE CO., LTD., TAOYUAN COUNTY, TAIWAN:
3,397,111, PUB. 1-1-2008. INT. CL. 9.
- TURBINE TECHNOLOGY SERVICES CORPORATION, CLIFTON PARK, NY TO TELEFLEX INCORPORATED, PLYMOUTH MEETING, PA:
2,060,076, CANC. INT. CL. 9.
- TURNBULL ENTERPRISES, INC., SAN CARLOS, CA:
3,400,139, INT. CL. 20.
- TURNER EVENTS AND MARKETING, LLC, OMAHA, NE:
3,397,288, PUB. 1-1-2008. INT. CL. 35.
- TUTOR TIME LEARNING CENTERS, LLC, NOVI, MI:
2,447,272, CANC. INT. CL. 16.
2,447,273, CANC. INT. CL. 42.
2,447,274, CANC. INT. CL. 42.
- TV GUIDE MAGAZINE GROUP, INC., LOS ANGELES, CA:
3,398,883, MULTIPLE CLASS, INT. CLS. 38 AND 41.
- TWEEL HOME FURNISHINGS, INC., HARRISON, NJ:
2,448,154, CANC. INT. CL. 24.
- TWEEN BRANDS INVESTMENT, LLC, NEW ALBANY, OH:
3,399,647, MULTIPLE CLASS, INT. CLS. 3 AND 41.
- TWEEZERMAN INTERNATIONAL, INC., PORT WASHINGTON, NY:
2,179,344, REN. 2-13-08. INT. CL. 8.
- TWENTIETH CENTURY FOX FILM CORPORATION, LOS ANGELES, CA:
3,397,347, PUB. 1-1-2008. INT. CL. 41.
3,399,535, INT. CL. 16.
- TWIN HENS, INC., PRINCETON, NJ:
3,398,933, INT. CL. 30.
- TWINS ENTERPRISE, INC., DEDHAM, MA:
3,397,324, PUB. 1-1-2008. INT. CL. 25.
- TWISTHINK, LLC, HOLLAND, MI:
3,398,341, PUB. 1-1-2008. INT. CL. 42.
- TWO CELLS CO. LTD., JAPAN:
3,398,774, PUB. 1-1-2008. MULTIPLE CLASS, INT. CLS. 5 AND 9.
- TXTBUZZ INC., CINCINNATI, OH:
3,396,872, PUB. 1-1-2008. MULTIPLE CLASS, INT. CLS. 35 AND 45.
- TY INC., WESTMONT, IL:
3,400,115, INT. CL. 28.
- TYCO ELECTRONICS CORPORATION, MIDDLETOWN, PA:
1,492,063, REN. 2-13-08. INT. CL. 9.
2,154,056, REN. 2-13-08. INT. CL. 9.
3,399,807, INT. CL. 9.
- TYCO HEALTHCARE GROUP LP, MANSFIELD, MA, KENDALL COMPANY, THE, WALPOLE, MA:
1,082,388, REN. 2-14-08. INT. CL. 10.
- TYCO HEALTHCARE GROUP LP, NORTH HAVEN, CT, UNITED STATES SURGICAL CORPORATION, NORWALK, CT:
2,153,983, REN. 2-13-08. INT. CL. 10.
- TYCOON DYNASTY, INC., NEW YORK, NY:
3,398,030, PUB. 1-1-2008. INT. CL. 41.
- TYLER, JAMES, VAN NUYS, CA:
3,398,011, PUB. 1-1-2008. INT. CL. 15.
3,398,348, PUB. 1-1-2008. INT. CL. 9.
- U.S. BALLOON MFG. CO., BROOKLYN, NY:
2,059,679, CANC. INT. CL. 42.
- U.S. BRICK & BLOCK SYSTEMS, INC., FORT LAUDERDALE, FL:
3,396,853, PUB. 1-1-2008. INT. CL. 37.
- U.S. CHINA TRADING CORP., WILLOWBROOK, IL:
3,397,970, PUB. 1-1-2008. INT. CL. 28.
- U.S. HIGHWAY PRODUCTS, INC., BRIDGEPORT, CT:
3,397,955, PUB. 1-1-2008. INT. CL. 17.
- U.S. LAWNS, INC., ORLANDO, FL:
1,476,402, REN. 2-12-08. INT. CL. 42.
- U.S. NONWOVENS CORPORATION, BRENTWOOD, NY:
3,397,094, PUB. 1-1-2008. INT. CL. 3.
- U.S. REALTEL, INC., CHICAGO, IL:
2,448,082, CANC. INT. CL. 35.
- U.S. SILICA COMPANY, BERKELEY SPRINGS, WV:
1,083,748, REN. 2-14-08. INT. CL. 1.
- U.S. TECHNOLOGY CORP., CANTON, OH:
2,448,460, CANC. INT. CL. 1.
- U.S. TECHNOLOGY CORPORATION, CANTON, OH:
3,397,117, PUB. 1-1-2008. INT. CL. 3.
- U-S-S. MEDICAL CORP., GUAYNABO, PUERTO RICO:
3,397,524, PUB. 1-1-2008. INT. CL. 41.
- UAP DISTRIBUTION, INC., GREELEY, CO:
3,397,809, PUB. 1-1-2008. MULTIPLE CLASS, INT. CLS. 39 AND 40.
- UBIQUITY BANK OF CANADA, ABBOTSFORD, BRITISH COLUMBIA, CANADA:
3,396,835, PUB. 5-16-2006. MULTIPLE CLASS, INT. CLS. 9, 35, 36 AND 42.
- UBISOFT INC., SAN FRANCISCO, CA:
3,398,611, PUB. 11-27-2007. INT. CL. 41.
- UBROADCAST, INC., SAN DIEGO, CA:
3,400,055, MULTIPLE CLASS, INT. CLS. 9, 38, 41 AND 42.
3,400,056, MULTIPLE CLASS, INT. CLS. 9, 38, 41 AND 42.
- UBS AG, CH-8001 ZÜRICH, SWITZERLAND:
3,398,810, PUB. 1-1-2008. MULTIPLE CLASS, INT. CLS. 9, 35 AND 36.

UBS FINANCIAL SERVICES INC., WEEHAWKEN, NJ:
3,399,607, INT. CL. 36.

UCB, S.A., B1070 BRUSSELS, BELGIUM:
3,252,857, COR. INT. CL. 5.

UCB, SOCIÉTÉ ANONYME, BELGIUM:
3,398,786, PUB. 1-1-2008. INT. CL. 5.

UCN, INC., BLUFFDALE, UT:
2,059,902, CANC. INT. CL. 38.

UDV NORTH AMERICA, INC., NORWALK, CT:
2,448,386, CANC. INT. CL. 33.

UEMORI SABURO, JAPAN:
3,398,676, PUB. 1-1-2008. INT. CL. 25.

UHS OF DELAWARE, INC., KING OF PRUSSIA, PA:
3,399,725, INT. CL. 44.

ULLICO INC., WASHINGTON, DC:
2,448,442, CANC. INT. CL. 42.

ULTEM, INC., BEVERLY HILLS, CA, DBA ENZO FERRETTI:
2,448,462, CANC. INT. CL. 25.

ULTIMA FITNESS SUPPLEMENTS, LLC, PLANO, TX:
3,399,165, INT. CL. 32.

ULTIMATE WIREFORMS, INC., BRISTOL, CT:
3,396,941, PUB. 1-1-2008. INT. CL. 10.

ULTRA RAYZ, INC., JOPLIN, MO:
3,397,427, PUB. 1-1-2008. INT. CL. 39.

ULTRA-DEX TOOLING SYSTEMS, FLUSHING, MI:
3,397,359, PUB. 1-1-2008. INT. CL. 7.

ULTRA-OPTIX, INC., EAST HAVEN, CT:
3,398,076, PUB. 1-1-2008. INT. CL. 9.

ULTRAMATIC SLEEP OF CANADA INC., BURLINGTON,
ONTARIO L7L 5V1, CANADA:
2,127,504, REN. 2-11-08. INT. CL. 20.

UNCLE JULIO'S CORPORATION, IRVING, TX, DBA UN-
CLE JULIO'S:
2,086,901, REN. 2-11-08. INT. CL. 42.

UNIBOX EXPRESS SYSTEMS CORP., MIAMI, FL:
3,397,616, PUB. 1-1-2008. INT. CL. 35.

UNIFLAME, INC., ZION, IL TO BLUE RHINO GLOBAL
SOURCING LLC, WINSTON-SALEM, NC:
2,059,459, CANC. INT. CL. 21.

UNIFRUCO LIMITED, WESTERN CAPE, SOUTH AFRICA:
843,373, REN. 2-10-08. U.S. CL. 46 (INT. CL. 31).

UNIGLOBE TRAVEL INTERNATIONAL LIMITED PART-
NERSHIP, VANCOUVER, CANADA:
2,634,066, CANC. INT. CL. 42.

UNILEVER SUPPLY CHAIN, INC., CLINTON, CT:
2,448,407, CANC. INT. CL. 3.

UNIMIN CORPORATION, NEW CANAAN, CT:
3,398,555, PUB. 1-1-2008. MULTIPLE CLASS, INT. CLS.
35, 37, 40 AND 42.

UNION BANK OF CALIFORNIA, N.A., SAN FRANCISCO,
CA, UNION BANK OF CALIFORNIA, N.A., SAN FRAN-
CISCO, CA:
2,137,748, REN. 2-11-08. INT. CL. 36.

UNION PACIFIC RAILROAD COMPANY, OMAHA, NE:
3,398,854, MULTIPLE CLASS, INT. CLS. 8, 9, 11, 12, 14, 16,
18, 20, 21, 22, 24, 25, 26 AND 28.
3,400,209, INT. CL. 39.

UNION RESCUE MISSION, LOS ANGELES, CA:
2,448,523, CANC. INT. CL. 36.

UNIPATH LIMITED, BEDFORD, ENGLAND TO SPD SWISS
PRECISION DIAGNOSTICS GMBH, GENEVA, SWITZER-
LAND:
1,492,770, CANC. INT. CL. 5.

UNIPRO FOODSERVICE, INC., ATLANTA, GA:
842,961, REN. 2-13-08. U.S. CL. 46 (INT. CL. 29).

UNIROPE LIMITED, MISSISSAUGA, ONTARIO, CANADA:
3,397,656, PUB. 1-1-2008. INT. CL. 6.

UNITED BISCUITS (UK) LIMITED, HAYES, MIDDLESEX,
UNITED KINGDOM:
3,400,036, INT. CL. 30.

UNITED CALIFORNIA RETURNS, LOS ANGELES, CA:
3,397,638, PUB. 1-1-2008. INT. CL. 40.
3,397,639, PUB. 1-1-2008. INT. CL. 40.
3,397,640, PUB. 1-1-2008. INT. CL. 40.

UNITED CASH REGISTER & COMPUTER COMPANY, FOX
LAKE, IL, UNITED CASH REGISTER, INC., CICERO, IL:
1,513,490, REN. 2-13-08. INT. CL. 9.

UNITED COLOR GEMS, INC., NEW YORK, NY:
3,399,285, INT. CL. 14.

UNITED CYCLING, LLC, NEWPORT BEACH, CA:
3,399,615, MULTIPLE CLASS, INT. CLS. 25 AND 41.

UNITED DEVELOPMENT SYTEMS, INC., CLEARWATER,
FL:
3,399,486, INT. CL. 42.

UNITED FOOD IMPORT, DAYTON, NJ:
3,398,369, PUB. 7-18-2006. INT. CL. 29.

UNITED IMPACT MEDIA, FT MYERS, FL:
3,397,320, PUB. 1-1-2008. MULTIPLE CLASS, INT. CLS. 38
AND 42.

UNITED INDUSTRIES CORPORATION, ST. LOUIS, MO:
3,397,604, PUB. 1-1-2008. INT. CL. 5.

UNITED INFOXCHANGE, LLC, BYFIELD, MA:
3,399,640, INT. CL. 16.

UNITED PARCEL SERVICE OF AMERICA, INC., ATLAN-
TA, GA, ROADNET TECHNOLOGIES, INC., WILMING-
TON, DE:
1,475,779, REN. 2-13-08. INT. CL. 9.

UNITED STAFFING SYSTEMS, INC, NEW YORK, NY:
2,448,487, CANC. INT. CL. 35.

UNITED STATES GYPSUM COMPANY, CHICAGO, IL:
1,438,594, CANC. INT. CL. 19.

UNITED STATES IDENTIFICATION CARD, INC., INGLE-
WOOD, CA:
2,114,222, CANC. INT. CL. 16.

UNITED STATES MARINE CORPS, A COMPONENT OF
THE DEPARTMENT OF THE NAVY, ARLINGTON, VA:
3,399,387, INT. CL. 35.

UNITED STATES MARKETING COPRORATION, HUN-
TINGTON STATION, NY:
2,448,270, CANC. INT. CL. 35.

UNITED STATES MASTERS SWIMMING, INC., LONDON-
DERRY, NH:
3,397,137, PUB. 1-1-2008. INT. CL. 35.

UNITED STATES OLYMPIC COMMITTEE, COLORADO
SPRINGS, CO:
2,150,579, REN. 2-12-08. INT. CL. 30.
2,448,201, CANC. INT. CL. 14.

UNITED STATES POLO ASSOCIATION, LEXINGTON, KY:
3,400,345, INT. CL. 41.

UNITED STATES SURGICAL CORPORATION, NORTH
HAVEN, CT:
1,479,504, REN. 2-8-08. INT. CL. 10.
2,192,033, REN. 2-12-08. INT. CL. 10.
2,205,610, REN. 2-9-08. INT. CL. 10.

UNITED SUNTECH CRAFT, INC., DUARTE, CA:
2,448,561, CANC. INT. CL. 9.

UNITED TECHNOLOGIES CORPORATION, HARTFORD,
CT:
3,397,240, PUB. 1-1-2008. INT. CL. 44.

UNITED WAY OF MINNEAPOLIS AREA, MINNEAPOLIS,
MN:
2,448,227, CANC. INT. CL. 9.

UNITELLER FINANCIAL SERVICES, INC., ROCHELLE
PARK, NJ:
2,448,287, CANC. INT. CL. 36.

UNIVERSAL CITY STUDIOS, INC., UNIVERSAL CITY, CA:
2,448,152, CANC. INT. CL. 41.
2,448,153, CANC. INT. CL. 21.

UNIVERSAL CREATIVITY UNLIMITED, INC., STUDIO
CITY, CA:
3,399,249, INT. CL. 35.

UNIVERSAL DATA CORPORATION, STUDIO CITY, CA:
3,398,139, PUB. 1-1-2008. INT. CL. 35.

UNIVERSAL EQUITIES CORPORATION, WESTLAKE, OH,
DBA UNIVERSAL EQUITIES, INC.:
2,448,066, CANC. MULTIPLE CLASS, INT. CLS. 11 AND
32.

UNIVERSAL WOODS, INCORPORATED, LOUISVILLE, KY:
3,398,127, PUB. 1-1-2008. INT. CL. 20.

UNIVERSITY OF CHICAGO HOSPITALS, THE, CHICAGO,
IL:
2,058,919, CANC. INT. CL. 41.

UNIVERSITY OF LOUISVILLE, LOUISVILLE, KY:
2,447,914, CANC. INT. CL. 35.

- UNIVERSITY OF MARKETING, LA, INC., AGOURA HILLS, CA:
3,398,140, PUB. 1-1-2008. INT. CL. 41.
- UNIVERSITY OF MELBOURNE, THE, VICTORIA, AUSTRALIA:
1,438,534, CANC. INT. CL. 10.
- UNIVERSITY OF MIAMI, CORAL GABLES, FL:
3,399,680, INT. CL. 44.
- UNIVERSITY OF NORTH CAROLINA AT GREENSBORO, THE, GREENSBORO, NC:
3,399,594, INT. CL. 41.
- UNIVERSITY OF PITTSBURGH - OF THE COMMONWEALTH SYSTEM OF HIGHER EDUCATION, PITTSBURGH, PA:
3,396,838, PUB. 1-1-2008. INT. CL. 36.
- UNIVERSITY OF THE INCARNATE WORD, SAN ANTONIO, TX:
2,130,451, REN. 2-13-08. INT. CL. 41.
- UNIVEX CORPORATION, SALEM, NH:
3,398,429, PUB. 1-1-2008. MULTIPLE CLASS, INT. CLS. 7 AND 9.
- UP WITH PAPER, LLC, MASON, OH:
1,517,173, REN. 2-8-08. INT. CL. 16.
- UPLIFT NUTRITION, INC., ROY, UT:
3,398,977, INT. CL. 32.
- URBAN DECAY COSMETICS, LLC, HOLLYWOOD, FL:
2,150,397, REN. 2-14-08. INT. CL. 3.
- URBAN FARMING, INC., SOUTHFIELD, MI:
3,397,112, PUB. 1-1-2008. INT. CL. 43.
- URBAN OUTFITTERS (DELAWARE), INC., PHILADELPHIA, PA:
3,399,770, INT. CL. 20.
- URBAN SOLE, LAGRANGE, IL:
3,397,484, PUB. 1-1-2008. INT. CL. 35.
- URBANIMAL, LLC, CHICAGO, IL:
3,398,105, PUB. 1-1-2008. INT. CL. 35.
- US CABLE OF COASTAL TEXAS, MONTVALE, NJ:
3,397,091, PUB. 1-1-2008. INT. CL. 38.
- US DREAM INC., ELIZABETH, NJ:
2,447,910, CANC. INT. CL. 35.
- US GREENFIBER, LLC, CHARLOTTE, NC:
3,400,022, INT. CL. 17.
- US JESCO INTERNATIONAL LTD. INC., CARROLLTON, TX:
2,448,167, CANC. INT. CL. 34.
- USA BASKETBALL, COLORADO SPRINGS, CO:
2,136,098, REN. 2-14-08. INT. CL. 25.
- USA FRANCHISING LLC, SCHAUMBURG, IL:
3,396,957, PUB. 1-1-2008. INT. CL. 37.
- USA GROUP SECONDARY MARKET SERVICES, INC., INDIANAPOLIS, IN:
2,059,170, CANC. INT. CL. 36.
2,059,171, CANC. INT. CL. 36.
- USA STATS, INC., BALTIMORE, MD:
2,058,894, CANC. INT. CL. 35.
- USA TECHNOLOGIES, INC., MALVERN, PA:
2,060,130, CANC. INT. CL. 9.
- USADATA.COM, INC., NEW YORK, NY:
2,447,949, CANC. INT. CL. 35.
- USCALIBRATION INCORPORATED, IRVINE, CA:
3,397,046, PUB. 1-1-2008. INT. CL. 42.
- USHORSE.BIZ, INC., GLENDALE, CA:
3,398,291, PUB. 1-1-2008. INT. CL. 35.
- USI, INC., MADISON, CT:
2,448,106, CANC. INT. CL. 16.
- USM HOLDING AG, SWITZERLAND:
3,398,808, PUB. 1-1-2008. INT. CL. 20.
- UTILX CORPORATION, KENT, WA:
3,398,205, PUB. 1-1-2008. INT. CL. 42.
- UVIEW ULTRAVIOLET SYSTEMS, INC., MISSISSAUGA, ONTARIO L4Y 1M5, CANADA:
2,447,648, CANC. INT. CL. 9.
- UWE ZIRBES, 67346 SPEYER, FED REP GERMANY:
3,398,661, PUB. 1-1-2008. INT. CL. 35.
- VACONO ALUMINIUM COVERS GMBH, FED REP GERMANY:
3,398,674, PUB. 1-1-2008. MULTIPLE CLASS, INT. CLS. 6, 11, 17, 19 AND 42.
- VALBEX SA, SWITZERLAND:
3,398,793, PUB. 1-1-2008. INT. CL. 14.
- VALDIVIA'S SALSA, LLC, NORTH PLATTE, NE:
3,397,630, PUB. 1-1-2008. INT. CL. 30.
- VALIANT GROUP, INC., SANTA BARBARA, CA:
3,397,957, PUB. 1-1-2008. INT. CL. 25.
3,398,285, PUB. 1-1-2008. INT. CL. 43.
- VALLE DE OLIVOS S.A., SANTIAGO, CHILE:
3,398,546, PUB. 1-1-2008. INT. CL. 29.
- VALLEJO, BORIS, ALLENTOWN, PA AND BELL, JULIE, ALLENTOWN, PA:
2,448,280, CANC. MULTIPLE CLASS, INT. CLS. 16 AND 36.
- VALLEY FEED AND SUPPLY, INC., EL PASO, TX:
3,396,862, PUB. 1-1-2008. INT. CL. 45.
- VALLEY FIBERS CORPORATION, NORTHAMPTON, MA, DBA WEBS:
3,397,344, PUB. 1-1-2008. INT. CL. 35.
- VALSPAR SOSURCING, INC., MINNEAPOLIS, MN, OWENS, RICHARD L., LITHONIA, GA:
1,480,345, REN. 2-13-08. INT. CL. 2.
- VALSPAR SOURCING, INC., MINNEAPOLIS, MN, DRISLIDE, INC., FREMONT, MI:
1,086,233, REN. 2-13-08. INT. CL. 4.
- VALUE CITY OF MICHIGAN, INC., WESTLAND, MI:
3,397,133, PUB. 9-25-2007. INT. CL. 25.
- VALUELINK, LLC, GREENWOOD VILLAGE, CO:
2,190,571, REN. 2-14-08. INT. CL. 36.
- VALUTEC CARD SOLUTIONS, LLC, PORTSMOUTH, NH:
2,447,637, CANC. INT. CL. 36.
- VAN KAMPEN INVESTMENTS INC., NEW YORK, NY:
3,399,096, INT. CL. 36.
- VAN WERT, ZIMMER & CONLIN, P.C., WALTHAM, MA:
3,397,545, PUB. 1-1-2008. INT. CL. 45.
- VAN ZANTEN, DAN, ENCINITAS, CA:
2,059,813, CANC. INT. CL. 25.
- VANCE FROST, SAN ANSELMO, CA:
3,399,603, INT. CL. 35.
- VANDERKAM, JACOB, PHELAN, CA:
3,399,947, INT. CL. 25.
- VANG, TONG BRUCE, GRAND RAPIDS, MI:
3,398,542, PUB. 1-1-2008. INT. CL. 5.
- VANGUARD GROUP, INC., THE, MALVERN, PA:
2,059,980, CANC. INT. CL. 36.
- VANILLA GORILLA, L.P., LONG BEACH, CA:
3,399,542, INT. CL. 16.
- VANTAGE CONTROLS, INC., OREM, UT:
3,399,415, INT. CL. 9.
- VARCO PRUDEN BUILDINGS, INC., MEMPHIS, TN:
3,400,113, INT. CL. 6.
- VARELA HERMANOS, S.A., CUIDAD DE PANAMA, PANAMA:
3,398,837, INT. CL. 33.
- VARTEC SOLUTIONS, INC., HUDSON, OH:
3,400,233, INT. CL. 10.
- VASKE, ALPHONSE J., AURORA, CO:
2,448,512, CANC. INT. CL. 35.
- VASQUEZ, CARLOS, LOS ANGELES, CA:
3,397,413, PUB. 1-1-2008. INT. CL. 5.
- VCFO HOLDINGS, INC, AUSTIN, TX:
3,400,195, INT. CL. 35.
- VCFO HOLDINGS, INC., AUSTIN, TX:
3,399,121, INT. CL. 35.
- VECTOR PRODUCTS, INC., FT. LAUDERDALE, FL:
3,398,856, INT. CL. 9.
- VECTOR PRODUCTS, INC., PLANTATION, FL:
3,399,827, MULTIPLE CLASS, INT. CLS. 9 AND 11.
- VECTOR PRODUCTS, INC., FT. LAUDERDALE, FL:
3,399,942, MULTIPLE CLASS, INT. CLS. 9 AND 11.
- VECTRON SYSTEMS AG, FED REP GERMANY:
3,398,760, PUB. 1-1-2008. MULTIPLE CLASS, INT. CLS. 9, 37 AND 42.
- VEEV SPIRITS, LLC, BEVERLY HILLS, CA:
3,399,188, INT. CL. 33.
- VEGAS.COM LLC, HENDERSON, NV:
3,399,342, INT. CL. 35.
- VEGAS.COM LLC, LAS VEGAS, NV:
3,399,343, INT. CL. 43.

- VELEZ, BEN, BROOKLYN, NY:
3,397,644, PUB. 1-1-2008. INT. CL. 35.
- VENTANA VINTNERS, LLC, MONTEREY, CA:
3,398,008, PUB. 1-1-2008. INT. CL. 33.
- VERACITY PAYMENT SOLUTIONS, INC., ATLANTA, GA:
3,397,538, PUB. 1-1-2008. INT. CL. 36.
- VERASUN AURORA CORPORATION, BROOKINGS, SD:
3,399,514, INT. CL. 4.
3,399,515, INT. CL. 4.
- VERICAL, INCORPORATED, ALEXANDRIA, VA:
3,399,590, MULTIPLE CLASS, INT. CLS. 35 AND 42.
- VERLAGSGRUPPE HANDELSBLATT GMBH, 40213 DUSSELDORF, FED REP GERMANY:
2,447,680, CANC. MULTIPLE CLASS, INT. CLS. 16, 35 AND 41.
- VERMILLION CONSULTING, INC., GRAYSLAKE, IL:
3,397,780, PUB. 1-1-2008. INT. CL. 9.
- VERMONT BUTTER AND CHEESE COMPANY, INC., WEBSTERVILLE, VT:
3,398,328, PUB. 1-1-2008. INT. CL. 29.
- VERNIER SOFTWARE & TECHNOLOGY LLC, BEAVERTON, OR:
3,398,921, INT. CL. 9.
- VERO SYSTEMS INC., ATLANTA, GA:
3,397,767, PUB. 1-1-2008. INT. CL. 9.
- VEROS SOFTWARE INC., SANTA ANA, CA:
3,398,501, PUB. 1-1-2008. INT. CL. 35.
- VERPOORTEN GMBH & CO. KG, FED REP GERMANY:
3,398,691, PUB. 1-1-2008. INT. CL. 33.
- VERTASOURCE, LLC, BUFFALO, NY:
3,398,931, INT. CL. 35.
3,398,932, INT. CL. 35.
- VERTICAL COMMUNICATIONS, INC., CAMBRIDGE, MA:
2,097,118, REN. 2-11-08. INT. CL. 9.
- VERTIFLEX, INC., SAN CLEMENTE, CA:
3,399,753, INT. CL. 10.
- VESTA CREDIT SOLUTIONS, LLC, PORTLAND, WA:
3,399,787, INT. CL. 36.
3,399,788, INT. CL. 36.
- VETERINARY ENCAPSULATION BIOSCIENCES PTY LTD, TARINGA QLD, AUSTRALIA:
3,398,616, PUB. 1-1-2008. MULTIPLE CLASS, INT. CLS. 5 AND 13.
- VIACOM INTERNATIONAL INC., NEW YORK, NY:
3,398,257, PUB. 1-1-2008. INT. CL. 16.
3,398,258, PUB. 1-1-2008. INT. CL. 18.
3,398,259, PUB. 1-1-2008. INT. CL. 25.
3,398,260, PUB. 1-1-2008. INT. CL. 28.
3,398,261, PUB. 1-1-2008. INT. CL. 41.
- VIATOR, INC., SAN FRANCISCO, CA:
3,398,573, PUB. 10-2-2007. MULTIPLE CLASS, INT. CLS. 39, 41, 43 AND 44.
- VIBIA, INC., EDISON, NJ:
3,397,761, PUB. 1-1-2008. MULTIPLE CLASS, INT. CLS. 11 AND 20.
- VICKY FORM, S.A. DE C.V., TLALNEPNTLA, MEXICO:
3,399,362, INT. CL. 25.
- VICTAULIC PUBLIC LIMITED COMPANY, HITCHIN, HERTFORDSHIRE, ENGLAND:
1,438,469, CANC. INT. CL. 6.
- VICTORIA PRINCIPAL PRODUCTIONS, INC., LOS ANGELES, CA:
2,202,162, REN. 2-13-08. INT. CL. 3.
- VICTORIA QUADE, CHICAGO, IL:
3,399,274, INT. CL. 41.
- VICTORY BOLT & SPECIALTY, INC., INDIAN TRAIL, NC:
3,398,197, PUB. 1-1-2008. INT. CL. 6.
- VICUS THERAPEUTICS, LLC, MORRISTOWN, NJ:
3,399,784, INT. CL. 42.
- VIDEO PROFESSOR, INC., LAKEWOOD, CO:
3,399,704, MULTIPLE CLASS, INT. CLS. 9 AND 35.
- VIEWTECH INCORPORATED, OCEANSIDE, CA:
3,397,803, PUB. 1-1-2008. INT. CL. 9.
- VIKING FENCE COMPANY, INC., AUSTIN, TX:
3,397,108, PUB. 1-1-2008. INT. CL. 37.
- VILEX, INC., PITTSBURGH, PA:
3,399,652, MULTIPLE CLASS, INT. CLS. 10, 35 AND 44.
- VILLAGE GREEN MANAGEMENT COMPANY, FARMINGTON HILLS, MI:
2,210,289, REN. 2-11-08. INT. CL. 36.
- VILLASANA, CARLOS, ATLANTA, GA:
3,396,893, PUB. 1-1-2008. MULTIPLE CLASS, INT. CLS. 30 AND 32.
- VILLEROY & BOCH S.A.R.L., LUXEMBOURG, GRAND DUCHY OF LUXEMBOURG, LUXEMBOURG:
2,059,346, CANC. INT. CL. 21.
- VINEYARD, INC., THE, BARBOURSVILLE, WV TO POST, CONNIE B., BARBOURSVILLE, WV:
2,060,132, CANC. INT. CL. 20.
- VINTWOOD INTERNATIONAL, LTD., HUNTINGTON, NY:
3,399,401, INT. CL. 33.
- VIRGIN ENTERPRISES LIMITED, LONDON, UNITED KINGDOM:
3,398,247, PUB. 1-1-2008. INT. CL. 36.
3,398,248, PUB. 1-1-2008. INT. CL. 36.
- VIRGO PUBLISHING, INC., PHOENIX, AZ:
2,448,539, CANC. INT. CL. 16.
- VIRSUN, INC., SEATTLE, WA:
1,438,674, CANC. INT. CL. 33.
- VIRTUAL HOMES INCORPORATED, AMHERST, NH:
3,397,470, PUB. 1-1-2008. MULTIPLE CLASS, INT. CLS. 35 AND 42.
- VIRTUTRIX, INC., NORTH ST. PAUL, MN:
3,397,713, PUB. 1-1-2008. MULTIPLE CLASS, INT. CLS. 35 AND 42.
- VISHAY SEMICONDUCTOR GMBH, 74072 HEILBRONN, FED REP GERMANY:
2,447,483, CANC. INT. CL. 9.
- VISION CO., LLC, GREENWOOD VILLAGE, CO:
3,399,092, INT. CL. 1.
- VISION TECH AMERICA, INC., MOUNTAIN VIEW, CA:
3,399,755, INT. CL. 9.
- VISION 4 MUSIC, INC., HOCKESSIN, DE:
3,396,848, PUB. 1-1-2008. MULTIPLE CLASS, INT. CLS. 9, 35 AND 41.
- VISUAL CHANGES SKIN CARE INTERNATIONAL, INC., FRESNO, CA:
3,399,311, INT. CL. 9.
- VITA BELLA TRADING COMPANY SAS, ITALY:
3,398,632, PUB. 1-1-2008. MULTIPLE CLASS, INT. CLS. 14, 18 AND 25.
- VITALPAINTBALL, LLC., LEXINGTON, NC:
3,397,618, PUB. 1-1-2008. MULTIPLE CLASS, INT. CLS. 35 AND 41.
- VITAQUEST INTERNATIONAL, INC., WEST CALDWELL, NJ:
2,448,197, CANC. INT. CL. 5.
- VIVA VISION, INC., SAN DIEGO, CA:
3,397,043, PUB. 1-1-2008. INT. CL. 9.
3,400,171, INT. CL. 9.
- VIVIO, LAVERN W., SPRINGFIELD, TN:
3,399,571, INT. CL. 28.
- VODRA, RICHARD E., FALLS CHURCH, VA:
2,115,040, REN. 2-8-08. INT. CL. 36.
- VOGELZANG INTERNATIONAL CORPORATION, HOLLAND, MI:
3,400,048, INT. CL. 11.
- VOICENET COMMUNICATIONS, INC., PHILADELPHIA, PA:
2,133,848, REN. 2-11-08. INT. CL. 42.
2,133,848, CANC. INT. CL. 16.
- VOICESTAR, INC., PHILADELPHIA, PA:
3,397,872, PUB. 1-1-2008. INT. CL. 35.
- VOIKEX, INC., MANHATTAN BEACH, CA:
3,399,519, INT. CL. 10.
- VOIP, INC., FORT LAUDERDALE, FL:
3,400,388, MULTIPLE CLASS, INT. CLS. 35, 38 AND 42.
- VOLK OPTICAL INC., MENTOR, OH:
3,400,020, INT. CL. 9.
- VON SCHRADER COMPANY, RACINE, WI:
2,139,575, REN. 2-13-08. INT. CL. 7.
- VONAGE MARKETING INC., HOLMDEL, NJ:
3,399,990, INT. CL. 9.
- VONDELL, THOMAS, RED HOOK, NY:
2,447,780, CANC. INT. CL. 35.

- VSA PARTNERS, INC., CHICAGO, IL:
3,397,417, PUB. 1-1-2008. MULTIPLE CLASS, INT. CLS. 35 AND 42.
3,397,418, PUB. 1-1-2008. MULTIPLE CLASS, INT. CLS. 35 AND 42.
- VXI CORPORATION, ROLLINSFORD, NH:
2,448,108, CANC. INT. CL. 9.
- W & F MANUFACTURING INC., GLENDALE, CA:
2,059,717, CANC. INT. CL. 6.
- W LAB ACQUISITION CORP., BOSTON, MA:
3,399,601, INT. CL. 3.
- W. R. MEADOWS, INC., HAMPSHIRE, IL:
850,448, REN. 2-14-08. U.S. CL. 12 (INT. CL. 17).
- W. R. RAYSON CO., INC., BURGAW, NC:
3,399,023, MULTIPLE CLASS, INT. CLS. 8, 16 AND 21.
- W.F. YOUNG, INCORPORATED, EAST LONGMEADOW, MA:
3,399,626, INT. CL. 5.
- W.H. PAIGE AND CO., INC., INDIANAPOLIS, IN:
3,397,891, PUB. 1-1-2008. MULTIPLE CLASS, INT. CLS. 37 AND 41.
- W.M. BARR & COMPANY, INC., MEMPHIS, TN:
1,109,816, REN. 2-9-08. INT. CL. 1.
- W.R. MEADOWS, INC., HAMPSHIRE, IL:
2,059,108, CANC. INT. CL. 3.
- W.S. SPA, 31010 FONTE, TREVISO, ITALY:
2,058,976, CANC. INT. CL. 9.
- WACHOVIA CORPORATION, WINSTON-SALEM, NC:
2,448,367, CANC. INT. CL. 36.
- WADING RIVER HOLDINGS, LLC, NEW GRETN, NJ:
3,397,116, PUB. 1-1-2008. INT. CL. 9.
- WAGNER, STEVE, SAN CLEMENTE, CA:
3,397,805, PUB. 1-1-2008. INT. CL. 42.
- WAHL CLIPPER CORPORATION, STERLING, IL:
3,397,355, PUB. 1-1-2008. INT. CL. 8.
3,398,273, PUB. 1-1-2008. INT. CL. 8.
- WAHL CLIPPER CORPORATION, STERLING, IL:
3,398,274, PUB. 1-1-2008. INT. CL. 8.
- WAHL CLIPPER CORPORATION, STERLING, IL:
3,398,283, PUB. 1-1-2008. INT. CL. 8.
- WAINSCOT MEDIA LLC, MONTVALE, NJ:
3,400,330, INT. CL. 16.
3,400,344, INT. CL. 16.
- WAKE UP AMERICA GROUP, WESTON, FL:
3,397,925, PUB. 1-1-2008. INT. CL. 30.
- WAL-MART STORES, INC., BENTONVILLE, AR:
2,448,286, CANC. INT. CL. 32.
- WALGREEN CO., DEERFIELD, IL:
3,398,957, INT. CL. 14.
- WALTON INTERNATIONAL LTD., GEORGE TOWN, GRAND CAYMAN, CAYMAN ISLANDS:
2,042,482, REN. 2-11-08. INT. CL. 18.
- WANDRIAN, INC., WHITE PLAINS, NY:
3,396,960, PUB. 1-1-2008. MULTIPLE CLASS, INT. CLS. 35, 39 AND 42.
- WARD, JOHN, MR., GREENWICH, CT:
3,399,517, INT. CL. 25.
- WARDEN, CHRISTOPHER STEPHEN, NEW YORK, NY:
3,397,607, PUB. 1-1-2008. INT. CL. 41.
- WARMUP PLC, LONDON, UNITED KINGDOM:
3,398,405, PUB. 1-1-2008. MULTIPLE CLASS, INT. CLS. 9, 11 AND 17.
3,398,444, PUB. 1-1-2008. MULTIPLE CLASS, INT. CLS. 9, 11 AND 17.
- WARNACO U.S., INC., BRIDGEPORT, CT:
2,448,033, CANC. INT. CL. 25.
- WARNACO U.S., INC., MILFORD, CT:
2,448,383, CANC. INT. CL. 25.
- WARNER BROS. ENTERTAINMENT INC., BURBANK, CA, LORIMAR PRODUCTIONS, INC., CULVER CITY, CA:
1,495,169, REN. 2-13-08. INT. CL. 25.
- WARNER BROS. ENTERTAINMENT INC., BURBANK, CA:
2,130,049, REN. 2-13-08. INT. CL. 25.
3,399,349, MULTIPLE CLASS, INT. CLS. 9 AND 41.
3,399,620, INT. CL. 41.
- WARNER BROS. RECORDS INC., BURBANK, CA:
3,399,356, MULTIPLE CLASS, INT. CLS. 6, 18, 21 AND 25.
- WARNER CHILCOTT COMPANY, INC., FAJARDO, PUERTO RICO:
3,400,258, INT. CL. 5.
- WASHINGTON COUNTY VISITORS ASSOCIATION, BEAVERTON, OR:
3,397,678, PUB. 1-1-2008. INT. CL. 39.
- WASHINGTON MILLS COMPANY, TONAWANDA, NY:
3,397,313, PUB. 1-1-2008. INT. CL. 3.
- WASHINGTON NATIONALS BASEBALL CLUB, LLC, WASHINGTON, DC:
3,399,435, INT. CL. 28.
- WASHINGTON NATIONALS BASEBALL CLUB, LLC, WASHINGTON, DISTRICT OF COLUMBIA, DC:
3,399,436, INT. CL. 25.
- WASHTEC HOLDING GMBH, AUGSBURG, FED REP GERMANY:
3,398,968, INT. CL. 7.
- WATCH WINDER STORE, CHINO HILLS, CA:
3,398,145, PUB. 1-1-2008. INT. CL. 14.
- WATER QUALITY ASSOCIATION, LISLE, IL:
3,399,313, U.S. CL. B.
- WATER-JEL TECHNOLOGIES, INC., CARLSTADT, NJ TO WATER-JEL TECHNOLOGIES, LLC, CARLSTADT, NJ:
2,060,006, CANC. MULTIPLE CLASS, INT. CLS. 5 AND 9.
- WATSON ROAD HOLDING CORPORATION, FENTON, MO, DBA STUART B. MILLNER & ASSOCIATES:
3,397,129, PUB. 1-1-2008. INT. CL. 35.
- WATSON ROAD HOLDING CORPORATION, DBA STUART B. MILLNER & ASSOCIATES, FENTON, MO:
3,397,127, PUB. 1-1-2008. INT. CL. 35.
- WAUSAU FINANCIAL SYSTEMS, INC., MOSINEE, WI:
2,448,092, CANC. INT. CL. 36.
- WAYNE C. HENDERSON, DOYLESTOWN, PA:
3,397,738, PUB. 1-1-2008. INT. CL. 39.
- WAYSHAK, CORINNE, LOS ALTOS, CA:
3,398,424, PUB. 6-27-2006. INT. CL. 25.
- WEBMETHODS, INC., FAIRFAX, VA:
3,399,407, MULTIPLE CLASS, INT. CLS. 9, 41 AND 42.
- WEBROOT SOFTWARE, INC., BOULDER, CO:
3,398,974, INT. CL. 9.
- WEC COMPANY, OREGON, IL:
2,447,858, CANC. INT. CL. 7.
- WECAM FOUNDATION, INC., ORLANDO, FL:
3,399,009, INT. CL. 30.
- WEDNESDAY MANAGEMENT LLC, VIENNA, VA:
3,397,096, PUB. 1-1-2008. MULTIPLE CLASS, INT. CLS. 35 AND 36.
- WEEKEND WARRIOR PRODUCTIONS L.L.C., DENHAM SPRINGS, LA:
3,398,908, INT. CL. 9.
- WEEKLY READER CORPORATION, STAMFORD, CT:
3,400,380, INT. CL. 16.
- WEIGHT WATCHERS INTERNATIONAL, INC., NEW YORK, NY:
843,477, REN. 2-13-08. U.S. CL. 3 (INT. CL. 18).
3,399,075, INT. CL. 44.
- WEINER, RUSSELL G., LAS VEGAS, NV:
3,398,516, PUB. 1-1-2008. INT. CL. 32.
- WEISS INSTRUMENTS, INC., HOLTSVILLE, NY:
3,399,771, INT. CL. 9.
- WEISS, ALLAN C, DALLAS, TX:
3,400,363, INT. CL. 29.
- WEJOYSING, INC., GROVE CITY, OH:
3,397,575, PUB. 11-27-2007. INT. CL. 41.
- WELCH, CEDRIC, CAMDEN, NJ:
3,397,143, PUB. 1-1-2008. INT. CL. 38.
- WELLPOINT, INC., INDIANAPOLIS, IN:
3,398,120, PUB. 1-1-2008. INT. CL. 36.
3,398,121, PUB. 1-1-2008. INT. CL. 36.
3,399,883, INT. CL. 36.
- WELLS FARGO & COMPANY, MINNEAPOLIS, MN:
3,397,851, PUB. 1-1-2008. INT. CL. 9.
3,400,201, INT. CL. 41.
- WENGER CORPORATION, OWATONNA, MN:
2,151,320, REN. 2-13-08. INT. CL. 16.
3,399,203, INT. CL. 20.
- WENGO, FRANCE:
3,398,761, PUB. 1-1-2008. MULTIPLE CLASS, INT. CLS.

- 35, 36 AND 38.
WENTE BROS., LIVERMORE, CA:
3,397,990, PUB. 1-1-2008. INT. CL. 33.
3,397,991, PUB. 1-1-2008. INT. CL. 33.
3,397,993, PUB. 1-1-2008. INT. CL. 33.
3,397,994, PUB. 1-1-2008. INT. CL. 33.
WENZHOULIXINLONG IMPORT AND EXPORT COMPANY LTD, XINQIAO, WENZHOUL, CHINA:
3,399,076, INT. CL. 25.
WENZHOULIXINLONG IMPORT AND EXPORT COMPANY LTD, WENZHOUL, ZHEJIANG, CHINA:
3,399,077, INT. CL. 25.
WEST COAST ATHLETIC CLUBS, INC., SANTA BARBARA, CA:
3,396,993, PUB. 1-1-2008. INT. CL. 41.
WEST COAST BANCORP, LAKE OSWEGO, OR:
3,397,997, PUB. 1-1-2008. INT. CL. 36.
WEST CORPORATION, OMAHA, NE:
3,399,513, INT. CL. 35.
WEST IMPORT & EXPORT, LLC, KENAI, AK:
2,447,500, CANC. INT. CL. 33.
WEST MICHIGAN TROUT UNLIMITED, INC., GRAND RAPIDS, MI:
2,448,210, CANC. INT. CL. 42.
WEST PHARMACEUTICAL SERVICES, INC., LIONVILLE, PA:
1,467,335, REN. 2-13-08. INT. CL. 17.
WEST PUBLISHING CORPORATION, EAGAN, MN:
3,399,596, INT. CL. 42.
WESTBRAE NATURAL FOODS INC, MELVILLE, NY:
2,142,101, REN. 2-13-08. INT. CL. 29.
WESTERN FOREST PRODUCTS INC., VANCOUVER, CANADA:
2,058,711, CANC. INT. CL. 19.
WESTERN NATIONAL BANK, PHOENIX, CO:
3,400,292, INT. CL. 16.
WESTERN PUBLISHING COMPANY, INC., RACINE, WI:
1,438,581, CANC. INT. CL. 16.
WESTERN SIZZLIN, INC., DALLAS, TX:
1,438,740, CANC. INT. CL. 42.
WESTERN VETERINARY CONFERENCE, LAS VEGAS, NV:
3,272,134, AM. INT. CL. 9.
WESTERN WIRELESS CORPORATION, BELLEVUE, WA TO VOICESTREAM WIRELESS CORPORATION, BELLEVUE, WA:
2,060,060, CANC. INT. CL. 9.
WESTGATE EFI LIMITED, CHELTENHAM, GLOUCESTERSHIRE, UNITED KINGDOM:
3,398,374, PUB. 6-5-2007. MULTIPLE CLASS, INT. CLS. 9, 18, 25 AND 28.
WESTINGHOUSE ELECTRIC CORPORATION, PITTSBURGH, PA:
2,448,021, CANC. MULTIPLE CLASS, INT. CLS. 9 AND 11.
WESTINGHOUSE LIGHTING CORPORATION, PHILADELPHIA, PA:
3,398,336, PUB. 1-1-2008. INT. CL. 24.
WESTMOOR MFG. CO., FT. WORT, TX:
3,398,971, INT. CL. 25.
3,398,972, INT. CL. 25.
WESTRIM, INC., VAN NUYS, CA:
3,398,538, PUB. 1-1-2008. INT. CL. 20.
WET EDGE TECHNOLOGIES, MESA, AZ:
3,397,527, PUB. 1-1-2008. INT. CL. 19.
WHAM-O, INC., EMERYVILLE, CA:
3,399,008, MULTIPLE CLASS, INT. CLS. 17, 25 AND 28.
3,400,186, INT. CL. 28.
WHATMAN INC., CLIFTON, NJ:
2,132,497, REN. 2-14-08. INT. CL. 11.
WHEELER, BRUCE, BRENTWOOD, TN, DBA WHEELER MARKETING:
2,134,484, REN. 2-12-08. INT. CL. 31.
WHIRLED MUSIC PUBLISHING, INC., PHOENIX, AZ:
3,399,829, INT. CL. 35.
WHISPER TECH LTD., CHRISTCHURCH, NEW ZEALAND:
3,398,382, PUB. 5-8-2007. INT. CL. 7.
WHITAKER, GREG R., FRIENDSWOOD, TX:
2,153,093, REN. 2-13-08. INT. CL. 25.
WHITE DRIVE PRODUCTS, INC., HOPKINSVILLE, KY:
3,398,525, PUB. 1-1-2008. MULTIPLE CLASS, INT. CLS. 7, 9 AND 12.
WHITE, JEFFEORY H. MD/PC, DALTON, GA:
3,397,414, PUB. 9-25-2007. INT. CL. 44.
WHITE, TERRI, LAS VEGAS, NV:
3,400,242, INT. CL. 35.
WHITEPAGES.COM, INC., SEATTLE, WA:
3,397,808, PUB. 1-1-2008. INT. CL. 35.
WHITESSELL INTERNATIONAL CORPORATION, MUSCLE SHOALS, AL:
2,113,877, REN. 2-13-08. INT. CL. 6.
WHITESMOKE, INC., WILMINGTON, DE:
3,400,114, INT. CL. 9.
WHITFORD CORPORATION, WEST CHESTER, PA:
1,472,758, REN. 2-14-08. INT. CL. 1.
WHO! FILMS INC., DECATUR, GA:
2,059,498, CANC. INT. CL. 41.
WHO! FILMS, INC., ST DECATUR, GA:
2,059,455, CANC. INT. CL. 41.
WICKED FASHIONS, INC., FORT LEE, NJ:
3,399,812, INT. CL. 25.
WICKED JOE, LLC, BRUNSWICK, ME:
3,397,513, PUB. 1-1-2008. INT. CL. 30.
WIEDEMANN & LOMASNEY, LLC, LOMBARD, IL:
3,397,711, PUB. 1-1-2008. INT. CL. 35.
WIELAND DENTAL + TECHNIK GMBH & CO. KG, PFORZHEIM, FED REP GERMANY:
3,398,430, PUB. 11-14-2006. MULTIPLE CLASS, INT. CLS. 5 AND 10.
WIENER, ALLISON LEIGH, CHAPPAQUA, NY:
3,399,686, INT. CL. 16.
WIGGLES PTY LIMITED, THE, BONDI, JUNCTION, AUSTRALIA:
2,187,965, REN. 2-14-08. MULTIPLE CLASS, INT. CLS. 9, 16, 25 AND 28.
WIGGLES PTY LIMITED, THE, BONDI JUNCTION, NSW 2022, AUSTRALIA:
2,189,506, REN. 2-14-08. MULTIPLE CLASS, INT. CLS. 9, 16 AND 28.
2,196,107, REN. 2-14-08. MULTIPLE CLASS, INT. CLS. 9, 16, 25 AND 28.
WILDERNESS LODGES, INC., ST. LOUIS, MO:
2,447,756, CANC. INT. CL. 42.
WILLI KUSSBERGER, FED REP GERMANY:
3,398,795, PUB. 1-1-2008. MULTIPLE CLASS, INT. CLS. 12, 37 AND 39.
WILLIAM E. PHILLIPS, INC., WEST CHICAGO, IL:
2,447,627, CANC. INT. CL. 35.
WILLIAM H. HATCHER, LANDSCAPE, DESIGN AND CONSTRUCTION, MANCHESTER, MA:
2,447,331, CANC. INT. CL. 42.
WILLIAMS COMMUNICATIONS, INC., TULSA, OK:
2,447,494, CANC. INT. CL. 38.
WILLIAMS-SONOMA, INC., SAN FRANCISCO, CA:
3,397,441, PUB. 1-1-2008. INT. CL. 25.
WILLIAMS, DEBRA JEAN, BAYTOWN, TX:
3,397,896, PUB. 1-1-2008. INT. CL. 36.
WILLIAMS, FREIDA SCLAFANI, LAKE LAND, FL:
3,397,648, PUB. 1-1-2008. MULTIPLE CLASS, INT. CLS. 38, 41 AND 42.
WILLIAMS, GARY, SANTA CLARA, CA:
3,398,863, INT. CL. 4.
WILLOUGHBY, JASON, JUPITER, FL:
3,400,262, INT. CL. 9.
3,400,263, INT. CL. 9.
WILLOWBROOK, LLC, SPARTANBURG, SC:
2,448,193, CANC. MULTIPLE CLASS, INT. CLS. 3, 4, 5 AND 20.
WIN SOON, INC., SOUTH GATE, CA, DBA EPOCA:
3,397,098, PUB. 1-1-2008. INT. CL. 29.
WIN SUN JEWELLERY COMPANY LIMITED, TSIMSHAT-SUI EAST, KOWLOON, HONG KONG:
3,399,482, INT. CL. 14.
WINDTEL CORP, NEW YORK, NY:
2,447,297, CANC. INT. CL. 38.

- WINE MARKET COUNCIL, GREENBRAE, CA:
2,448,239, CANC. INT. CL. 42.
2,448,240, CANC. INT. CL. 42.
- WINE SCOUT INTERNATIONAL, NAPA, CA:
2,170,777, REN. 2-9-08. INT. CL. 35.
- WINE.A.RITA LLC, TEXARKANA, TX:
3,398,446, PUB. 1-1-2008. INT. CL. 30.
- WING HING LUNG LTD., TORONTO, CANADA:
3,398,432, PUB. 1-1-2008. INT. CL. 30.
3,398,433, PUB. 1-1-2008. INT. CL. 30.
- WINGATE HEALTHCARE, INC., NEEDHAM, MA:
3,399,665, MULTIPLE CLASS, INT. CLS. 36 AND 44.
- WINGFIELD'S INC., CHESTERTON, IN:
1,438,789, CANC. INT. CL. 42.
- WINKLEVOSS CONSULTANTS, INC., GREENWICH, CT:
2,136,547, REN. 2-11-08. INT. CL. 9.
- WINMAU DARTBOARD COMPANY LIMITED, HAVERHILL, SUFFOLK, ENGLAND:
1,473,341, REN. 2-10-08. INT. CL. 28.
- WINSTON STUART ASSOCIATES, LTD., MORGANVILLE, NJ:
3,397,009, PUB. 1-1-2008. INT. CL. 14.
- WINTERLAB LIMITED, NEW YORK, NY:
3,397,548, PUB. 1-1-2008. INT. CL. 29.
- WISCONSIN ARBORIST ASSOCIATION, INC., GREEN BAY, WI:
3,398,234, PUB. 1-1-2008. INT. CL. 35.
- WISE COMPONENTS, INC., STAMFORD, CT:
3,397,549, PUB. 1-1-2008. INT. CL. 35.
- WISEKEY SA, SWITZERLAND:
3,398,711, PUB. 1-1-2008. MULTIPLE CLASS, INT. CLS. 9, 35, 36, 38, 42 AND 45.
- WISSEL CORPORATION, MINATO-KU, TOKYO 105, JAPAN:
2,058,749, CANC. INT. CL. 42.
- WITTENSTEIN, MANFRED, D-97980 BAD MERGENTHEIM, FED REP GERMANY:
2,159,986, REN. 2-13-08. MULTIPLE CLASS, INT. CLS. 7 AND 9.
- WITWORKS, INC., COEUR D'ALENE, ID:
2,448,219, CANC. INT. CL. 9.
- WIV WEIN INTERNATIONAL AG, DE-55452 BURG LAYEN, FED REP GERMANY, AURA PROMOTIONS, LTD., LINCOLNSHIRE, IL:
1,476,136, REN. 2-11-08. INT. CL. 33.
- WIZKIDS, INC., BELLEVUE, WA:
1,476,062, REN. 2-12-08. INT. CL. 28.
1,479,757, REN. 2-12-08. INT. CL. 28.
- WLF | THE WILLIAMS LAW FIRM, PC, NEWPORT BEACH, CA:
3,397,069, PUB. 1-1-2008. MULTIPLE CLASS, INT. CLS. 38 AND 41.
- WMS GAMING INC., WAUKEGAN, IL:
3,399,131, INT. CL. 9.
3,399,432, INT. CL. 9.
3,399,605, INT. CL. 9.
3,400,119, INT. CL. 9.
3,400,120, INT. CL. 9.
- WNBA ENTERPRISES, LLC, SECAUCUS, NJ:
2,448,191, CANC. INT. CL. 28.
3,399,621, INT. CL. 41.
- WOLF-WORTHMAN, B. ZORINA, PALO ALTO, CA:
2,059,344, CANC. INT. CL. 41.
- WOLF, MARSHALL JON, SANTA MONICA, CA:
3,397,966, PUB. 1-1-2008. INT. CL. 28.
- WOLFFE, K. MIURA, PHILADELPHIA, PA:
2,447,763, CANC. MULTIPLE CLASS, INT. CLS. 16 AND 28.
- WOLFFKRAN GMBH, FED REP GERMANY:
3,398,735, PUB. 1-1-2008. MULTIPLE CLASS, INT. CLS. 7, 36, 37, 38 AND 42.
- WOLVERINE PROCTOR & SCHWARTZ LTD, GLASGOW G75 OYG, UNITED KINGDOM:
3,398,655, PUB. 1-1-2008. MULTIPLE CLASS, INT. CLS. 7 AND 11.
- WOLVERINE PROCTOR & SCHWARTZ LTD, UNITED KINGDOM:
3,398,656, PUB. 1-1-2008. MULTIPLE CLASS, INT. CLS. 7 AND 11.
- WOMEN IN CONSULTING, SAN JOSE, CA:
3,398,485, PUB. 1-1-2008. MULTIPLE CLASS, INT. CLS. 35, 38 AND 41.
- WOODESSEN, INC., HUNTINGTON BEACH, CA:
3,398,905, INT. CL. 16.
- WOODFOREST NATIONAL BANK, THE WOODLANDS, TX:
3,398,393, PUB. 7-18-2006. INT. CL. 36.
- WOODLANDS LAND DEVELOPMENT COMPANY, L.P., THE, THE WOODLANDS, TX:
2,448,199, CANC. INT. CL. 4.
- WOODWARD, JOHN R., DALLAS, TX:
3,399,184, INT. CL. 5.
- WOOT, INC., CARROLLTON, TX:
3,397,587, PUB. 1-1-2008. MULTIPLE CLASS, INT. CLS. 28, 35 AND 38.
3,397,594, PUB. 1-1-2008. INT. CL. 35.
- WORKPLACE MEDIA, INC., MENTOR, OH:
3,399,267, INT. CL. 35.
- WORLD ALMANAC EDUCATION GROUP, INC., PLEASANTVILLE, NY:
2,126,810, REN. 2-11-08. INT. CL. 16.
- WORLD CLASS INFORMATION SYSTEMS, INC., THE, CINCINNATI, OH:
2,448,493, CANC. INT. CL. 9.
- WORLD RADIO MISSIONARY FELLOWSHIP, INC., COLORADO SPRINGS, CO:
2,070,376, REN. 2-14-08. MULTIPLE CLASS, INT. CLS. 38 AND 41.
2,070,376, COR. MULTIPLE CLASS, INT. CLS. 38 AND 41.
- WORLD WIDE IMPORTS, INC., KENT, WA:
3,397,389, PUB. 1-1-2008. INT. CL. 14.
- WORLD WIDE PET INDUSTRY ASSOCIATION, MONROVIA, CA:
3,400,322, INT. CL. 35.
- WORLD WRESTLING ENTERTAINMENT, INC., STAMFORD, CT:
3,399,803, INT. CL. 28.
- WORLEY, F. MICHAEL, PANAMA CITY BEACH, FL:
3,400,356, INT. CL. 13.
- WORTH, LLC, TULLAHOVA, TN:
2,448,563, CANC. INT. CL. 28.
- WOUND CARE AMERICA, INC., MANDEVILLE, LA:
2,448,171, CANC. INT. CL. 42.
- WOVI, INC., DALLAS, TX:
3,398,514, PUB. 1-1-2008. MULTIPLE CLASS, INT. CLS. 35 AND 41.
- WRANGLER APPAREL CORP., WILMINGTON, DE:
3,397,465, PUB. 1-1-2008. INT. CL. 35.
3,399,247, INT. CL. 25.
3,399,386, MULTIPLE CLASS, INT. CLS. 9, 21 AND 25.
- WRIGHT BROTHERS SALES & MARKETING, INC., KENT, WA:
3,399,337, INT. CL. 30.
- WRIGHT, JAMES P DDS, LAS VEGAS, NV:
3,398,174, PUB. 1-1-2008. INT. CL. 44.
- WRIGHT, MARCUS J., HIGASHI-OSAKA, JAPAN:
3,400,300, INT. CL. 15.
- WU, BOJIAN, SHANGHAI, CHINA AND LIU, YANLING, PIZHOU, CHINA:
3,398,551, PUB. 1-1-2008. INT. CL. 25.
- WUHAN IRON AND STEEL (GROUP) CO., CHINA:
3,398,779, PUB. 1-1-2008. INT. CL. 6.
- WUXI NATURAL TEXTILE INDUSTRIAL; COMPANY LTD., CHINA:
3,398,707, PUB. 1-1-2008. INT. CL. 25.
3,398,708, PUB. 1-1-2008. INT. CL. 25.
- WYATT, AUSTIN & ASSOCIATES, P.C., ADA, OK:
3,397,047, PUB. 1-1-2008. INT. CL. 42.
- WYATT, EDDIE JR., MADISON, GA:
2,448,555, CANC. INT. CL. 25.
- WYETH HOLDINGS CORPORATION, MADISON, NJ:
3,399,034, INT. CL. 5.
- WYNDHAM TM CORP., WILMINGTON, DE:
2,447,759, CANC. INT. CL. 42.

W3 PARTNERS, LLC, ROGERS, AR:
 3,397,702, PUB. 1-1-2008. INT. CL. 29.
 3,397,703, PUB. 1-1-2008. INT. CL. 29.
 X-OUT PEST SERVICES, LLC, MURPHY, TX:
 3,398,190, PUB. 1-1-2008. INT. CL. 37.
 3,398,191, PUB. 1-1-2008. INT. CL. 37.
 X/NET ASSOCIATES, INC., FAIRPORT, NY:
 2,447,728, CANC. INT. CL. 9.
 X, INC., CANOGA PARK, CA, DBA ONE STOP SHOP:
 3,399,113, INT. CL. 35.
 XL ACADEMICS, INC., DEKALB, IL:
 3,397,748, PUB. 1-1-2008. INT. CL. 42.
 XTREME TOOLS INTERNATIONAL, INC., HIALEAH, FL:
 3,398,604, PUB. 9-18-2007. MULTIPLE CLASS, INT. CLS.
 8, 9 AND 11.
 YACABUCCI, ANTHONY, HOPEWELL JUNCTION, NY:
 3,398,304, PUB. 1-1-2008. INT. CL. 25.
 YAFRIRO INTERNATIONAL PTE LTD, #01-29 PARAGON,
 SINGAPORE:
 3,398,371, PUB. 12-5-2006. MULTIPLE CLASS, INT. CLS.
 14, 35, 36 AND 37.
 YAGODA, M.D., MICHELLE R., NEW YORK, NY AND
 GANS, PH.D., EUGENE H., WESTPORT, CT:
 3,397,505, PUB. 1-1-2008. INT. CL. 5.
 YAHOO! INC., SUNNYVALE, CA:
 3,398,836, MULTIPLE CLASS, INT. CLS. 3, 16 AND 24.
 YALCIN, RABIA, CHICAGO, IL:
 3,397,287, PUB. 1-1-2008. INT. CL. 25.
 YALE UNIVERSITY, NEW HAVEN, CT:
 3,397,282, PUB. 1-1-2008. INT. CL. 41.
 YAMAGUCHI ELECTRIC INDUSTRY CO., LTD., TOKYO,
 154, JAPAN:
 3,400,046, MULTIPLE CLASS, INT. CLS. 7, 9 AND 12.
 YAMASAN, PLANO, TX:
 3,399,379, INT. CL. 35.
 YANG, XIAOYONG, SICHUAN PROVINCE, CHINA:
 3,400,099, INT. CL. 30.
 YAROS COMMUNICATIONS, INC., MADISON, WI:
 2,058,564, CANC. MULTIPLE CLASS, INT. CLS. 41 AND
 42.
 YEE, BENJAMIN, NEW YORK, NY:
 3,397,554, PUB. 1-1-2008. INT. CL. 41.
 YELL STEEL ENTERPRISE CO. INC., SANTA ANA, CA:
 3,400,063, INT. CL. 25.
 YELLOW FEVER #1, LLC, MANAGING MEMBER, JAMI-
 SON ERNEST REVOCABLE TRUST, NEW YORK, NY:
 3,399,619, INT. CL. 28.
 YESBERGER, THOMAS, EDMONDS, WA:
 3,397,321, PUB. 1-1-2008. INT. CL. 18.
 YONG I. KIM, SEATTLE, WA:
 3,397,450, PUB. 1-1-2008. INT. CL. 37.
 YONKERS RACING CORPORATION, YONKERS, NY:
 3,397,868, PUB. 1-1-2008. INT. CL. 41.
 YORK INTERNATIONAL CORPORATION, YORK, PA:
 2,059,983, CANC. MULTIPLE CLASS, INT. CLS. 6, 8, 9, 11,
 14, 16, 18, 20, 21, 24, 25 AND 28.
 YOU NEVER KNOW, INC., NEWNAN, GA:
 3,399,632, INT. CL. 25.
 YOUNG CHANG AKKI CO, LTD., INCHEON, REPUBLIC
 OF KOREA:
 3,399,484, INT. CL. 15.
 YOUNG ELECTRIC SIGN COMPANY, SALT LAKE CITY,
 UT:
 2,159,679, REN. 2-13-08. INT. CL. 9.
 YOUNG, RUSSELL, AUSTIN, TX:
 3,397,708, PUB. 1-1-2008. INT. CL. 41.
 YOUTHNET OF GREATER KANSAS CITY, KANSAS CITY,
 MO:
 3,399,698, INT. CL. 41.
 YU, BRYAN, VERNON, CA:
 3,399,547, INT. CL. 25.
 YUND, JENNIFER L., DELRAY BEACH, FL:
 3,399,192, INT. CL. 39.
 Z & U SPIRITUOSEN MARKETING GMBH, A-1190 VIEN-
 NA, AUSTRIA:
 3,399,774, INT. CL. 33.
 Z INTERNATIONAL, C.A., CARACAS, VENEZUELA:
 3,399,363, INT. CL. 30.
 Z SPOKE, LLC, NEW YORK, NY:
 3,397,477, PUB. 1-1-2008. INT. CL. 18.
 ZABA, INC., WOODLAND HILLS, CA:
 3,400,368, INT. CL. 42.
 ZAPDOT INTERACTIVE, LLC, NORTH SMITHFIELD, RI:
 3,397,905, PUB. 1-1-2008. INT. CL. 42.
 3,397,906, PUB. 1-1-2008. INT. CL. 42.
 3,397,909, PUB. 1-1-2008. INT. CL. 42.
 ZARNEKEE, JERRY, CORONA, CA:
 3,398,331, PUB. 1-1-2008. INT. CL. 32.
 ZB IMPORTING, INC., CICERO, IL:
 2,136,001, REN. 2-8-08. INT. CL. 30.
 2,137,477, REN. 2-13-08. INT. CL. 29.
 ZEACOM GROUP LIMITED, IRVINE, CA:
 3,398,999, INT. CL. 38.
 ZEFTRON, INC., MONTGOMERY, IL:
 2,448,149, CANC. INT. CL. 12.
 ZELKOVA, LITHONIA, GA:
 3,399,705, INT. CL. 9.
 ZELKY, INC., FOSTER CITY, CA:
 3,397,784, PUB. 1-1-2008. MULTIPLE CLASS, INT. CLS.
 35, 42 AND 45.
 ZENTECH, INC., HOUSTON, TX:
 3,397,475, PUB. 1-1-2008. INT. CL. 9.
 ZHANG ZHOU SHI HENG LI DIAN; ZI YOU XIAN GONG
 SI, CHINA:
 3,398,796, PUB. 1-1-2008. INT. CL. 14.
 ZHAO, JIAN FENG, MONROVIA, CA:
 2,980,248, CANC. INT. CL. 34.
 ZHEJIANG BAOKANG; HOUSEHOLD APPLIANCE., LTD.,
 QUANXI TOWN, WUYI, ZHEJIANG 321200, CHINA:
 3,398,665, PUB. 1-1-2008. INT. CL. 21.
 ZHEJIANG GEMSY; SEWING MACHINE CO., LTD., CHI-
 NA:
 3,398,782, PUB. 1-1-2008. INT. CL. 7.
 ZHEJIANG HEART & HEART; ELECTRIC CO., LTD,
 CHINA:
 3,398,825, PUB. 1-1-2008. INT. CL. 11.
 ZHEJIANG JINDA NEW MATERIALS CO., LTD., 314419, P.
 R., CHINA, DBA HAINING JINDA COATING CO., LTD.:
 3,396,865, PUB. 1-1-2008. INT. CL. 24.
 ZHEJIANG PUJIANG PLUM-BLOSSOM; LOCK INDUSTRY
 GROUP CO., LTD, CHINA:
 3,398,820, PUB. 1-1-2008. INT. CL. 6.
 ZHEJIANG TIANMA BEARING CO., LTD, CHINA:
 3,398,744, PUB. 1-1-2008. INT. CL. 7.
 ZIFF DAVIS PUBLISHING HOLDINGS INC., NEW YORK,
 NY:
 2,447,326, CANC. INT. CL. 42.
 ZIMMER DENTAL, INC., CARLSBAD, CA, COLLA-TEC,
 INC., PLAINSBORO, NJ:
 2,039,217, REN. 2-14-08. INT. CL. 5.
 ZIMMERMAN, MICHAEL, WACO, TX:
 3,400,289, INT. CL. 45.
 ZINCALOY INC., MISSISSAUGA, ONTARIO, CANADA:
 2,058,514, CANC. MULTIPLE CLASS, INT. CLS. 6 AND
 12.
 ZINK, JASON W., LOWELL, IN:
 3,397,967, PUB. 1-1-2008. INT. CL. 41.
 ZINO DAVIDOFF SA, 1700 FRIBOURG, SWITZERLAND:
 1,480,510, REN. 2-13-08. INT. CL. 33.
 1,480,510, CANC. MULTIPLE CLASS, INT. CLS. 9, 14, 16,
 18 AND 25.
 ZITO, DEBORAH J., TAMPA, FL:
 3,398,210, PUB. 1-1-2008. INT. CL. 36.
 ZS PUBLISHING, INC., TORONTO, ONTARIO, CANADA:
 3,399,411, INT. CL. 16.
 ZULUWORKS, LLC, SAN FRANCISCO, CA:
 3,398,437, PUB. 12-26-2006. MULTIPLE CLASS, INT. CLS.
 16 AND 35.
 ZUTIS, CERENA WEST, SAN MATEO, CA:
 3,399,730, INT. CL. 18.
 ZYCAL BIOCEUTICALS, INC., SOUTHBOROUGH, MA:
 3,399,187, INT. CL. 5.
 1 SPORT LLC, MIAMI BEACH, FL:
 3,398,279, PUB. 1-1-2008. INT. CL. 35.
 1-800-FLOWERS.COM, INC., CARLE PLACE, NY:
 2,213,896, REN. 2-14-08. INT. CL. 35.

- 100 HOMES, INC., SAN MARINO, CA:
3,397,290, PUB. 1-1-2008. MULTIPLE CLASS, INT. CLS. 36 AND 41.
- 100MC, LLC, LARKSPUR, CA:
3,399,037, INT. CL. 25.
3,399,736, INT. CL. 25.
- 1105 MEDIA, INC., CHATSWORTH, CA:
2,447,688, CANC. MULTIPLE CLASS, INT. CLS. 16 AND 42.
- 14 X 48 DESIGN, INC., EVANSTON, IL:
3,398,575, PUB. 1-1-2008. INT. CL. 18.
- 1400 WORDS, INC., DALLAS, TX:
2,447,440, CANC. INT. CL. 35.
- 1514890 ONTARIO INC., PAKENHAM, ONTARIO, CANADA, DBA GONGSHOW GEAR:
3,400,170, MULTIPLE CLASS, INT. CLS. 25 AND 26.
- 167081 CANADA INC., QUEBEC, CANADA, DBA DIZARO:
3,246,330, COR. INT. CL. 25.
- 1800DIAPERS, INC., NEPTUNE, NJ:
3,400,394, INT. CL. 35.
- 1800HOMESTUDY.COM, INC., OVERLAND PARK, KS:
2,447,745, CANC. INT. CL. 35.
- 2CAST, INC., SAN JOSE, CA:
3,397,312, PUB. 1-1-2008. MULTIPLE CLASS, INT. CLS. 35 AND 42.
- 206 MACOPIN CORP, BLOOMINGDALE, NJ:
3,397,939, PUB. 1-1-2008. INT. CL. 32.
- 23 BOTTLES OF BEER LLC, SANTA ROSA, CA:
3,397,562, PUB. 1-1-2008. INT. CL. 32.
3,397,565, PUB. 1-1-2008. INT. CL. 32.
3,397,567, PUB. 1-1-2008. INT. CL. 32.
- 24/7 REAL MEDIA, INC., NEW YORK, NY:
3,396,969, PUB. 1-1-2008. MULTIPLE CLASS, INT. CLS. 35 AND 42.
- 2608961 CANADA INC., MONTREAL, QUEBEC, CANADA:
3,397,692, PUB. 1-1-2008. INT. CL. 24.
- 3-PLUS HF., REYKJAVIK, ICELAND:
3,398,349, PUB. 7-15-2003. MULTIPLE CLASS, INT. CLS. 9, 35, 38, 41 AND 42.
- 3DH COMMUNICATIONS, INC., NORCROSS, GA:
3,399,666, INT. CL. 9.
3,399,667, INT. CL. 9.
3,399,668, MULTIPLE CLASS, INT. CLS. 40 AND 41.
- 3IVX TECHNOLOGIES PTY LTD, AUSTRALIA:
3,398,634, PUB. 1-1-2008. INT. CL. 9.
- 3M COMPANY, ST. PAUL, MN:
1,474,719, REN. 2-11-08. MULTIPLE CLASS, INT. CLS. 5 AND 10.
- 3M COMPANY, ST. PAUL, MN, MINNESOTA MINING AND MANUFACTURING COMPANY, SAINT PAUL, MN, AKA 3M:
2,141,005, REN. 2-12-08. INT. CL. 1.
2,141,006, REN. 2-12-08. INT. CL. 1.
- 3M COMPANY, ST. PAUL, MN:
3,398,103, PUB. 1-1-2008. INT. CL. 16.
3,398,262, PUB. 1-1-2008. INT. CL. 3.
3,398,329, PUB. 1-1-2008. MULTIPLE CLASS, INT. CLS. 9 AND 10.
- 3TIER ENVIRONMENTAL FORECAST GROUP, INC, SEATTLE, WA:
3,399,950, INT. CL. 42.
- 310 GLOBAL BRANDS, INC., MANHATTAN BEACH, CA:
3,398,107, PUB. 1-1-2008. INT. CL. 18.
- 4LIFE TRADEMARKS, LLC, SANDY, UT:
2,447,834, CANC. INT. CL. 5.
- 417394 ALBERTA LTD., COCHRANE, CANADA:
3,397,255, PUB. 1-1-2008. MULTIPLE CLASS, INT. CLS. 11 AND 37.
- 6TH BOROUGH STYLES, INC., MIAMI BEACH, FL:
2,447,757, CANC. INT. CL. 42.
- 7-ELEVEN, INC., DALLAS, TX:
2,099,249, REN. 2-12-08. INT. CL. 30.
- 735 AVENUE OF THE AMERICAS LLC, BERWYN, PA:
3,398,941, INT. CL. 36.

* * * * *